

# **USER'S MANUAL**

# **SYSDRIVE 3G3HV**

**High-capacity General-purpose Inverter**

---

Thank you for choosing this SYSDRIVE 3G3HV-series product. Proper use and handling of the product will ensure proper product performance, will lengthen product life, and may prevent possible accidents.

Please read this manual thoroughly and handle and operate the product with care.

---

## **NOTICE**

1. This manual describes the functions of the product and relations with other products. You should assume that anything not described in this manual is not possible.
2. Although care has been given in documenting the product, please contact your OMRON representative if you have any suggestions on improving this manual.
3. The product contains potentially dangerous parts under the cover. Do not attempt to open the cover under any circumstances. Doing so may result in injury or death and may damage the product. Never attempt to repair or disassemble the product.
4. We recommend that you add the following precautions to any instruction manuals you prepare for the system into which the product is being installed.
  - Precautions on the dangers of high-voltage equipment.
  - Precautions on touching the terminals of the product even after power has been turned off. (These terminals are live even with the power turned off.)
5. Specifications and functions may be changed without notice in order to improve product performance.

## **Items to Check Before Unpacking**

1. Check the following items before removing the product from the package:
  - Has the correct product been delivered (i.e., the correct model number and specifications)?
  - Has the product been damaged in shipping?
  - Are any screws or bolts loose?

## **Notice:**

OMRON products are manufactured for use according to proper procedures by a qualified operator and only for the purposes described in this manual.

The following conventions are used to indicate and classify precautions in this manual. Always heed the information provided with them. Failure to heed precautions can result in injury to people or damage to property.

 **DANGER** Indicates an imminently hazardous situation which, if not avoided, will result in death or serious injury.

 **WARNING** Indicates a potentially hazardous situation which, if not avoided, could result in death or serious injury.

 **Caution** Indicates a potentially hazardous situation which, if not avoided, may result in minor or moderate injury, or property damage.

## **OMRON Product References**

All OMRON products are capitalized in this manual. The word “Unit” is also capitalized when it refers to an OMRON product, regardless of whether or not it appears in the proper name of the product.

The abbreviation “Ch,” which appears in some displays and on some OMRON products, often means “word” and is abbreviated “Wd” in documentation in this sense.

The abbreviation “PC” means Programmable Controller and is not used as an abbreviation for anything else.

## **Visual Aids**

The following headings appear in the left column of the manual to help you locate different types of information.

**Note** Indicates information of particular interest for efficient and convenient operation of the product.

## **© OMRON, 1996**

All rights reserved. No part of this publication may be reproduced, stored in a retrieval system, or transmitted, in any form, or by any means, mechanical, electronic, photocopying, recording, or otherwise, without the prior written permission of OMRON.









No patent liability is assumed with respect to the use of the information contained herein. Moreover, because OMRON is constantly striving to improve its high-quality products, the information contained in this manual is subject to change without notice. Every precaution has been taken in the preparation of this manual. Nevertheless, OMRON assumes no responsibility for errors or omissions. Neither is any liability assumed for damages resulting from the use of the information contained in this publication.

## General Precautions



Observe the following precautions when using the SYSDRIVE Inverters and peripheral devices.

This manual may include illustrations of the product with protective covers removed in order to describe the components of the product in detail. Make sure that these protective covers are on the product before use.





Consult your OMRON representative when using the product after a long period of storage.

-  **WARNING** Do not touch the inside of the Inverter. Doing so may result in electrical shock.
-  **WARNING** Operation, maintenance, or inspection must be performed after turning OFF the power supply, confirming that the CHARGE indicator (or status indicators) are OFF, and after waiting for the time specified on the front cover. Not doing so may result in electrical shock.
-  **WARNING** Do not damage, pull on, apply stress to, place heavy objects on, or pinch the cables. Doing so may result in electrical shock.
-  **WARNING** Do not touch the rotating parts of the motor under operation. Doing so may result in injury.
-  **WARNING** Do not modify the product. Doing so may result in injury or damage to the product.
-  **Caution** Do not store, install, or operate the product in the following places. Doing so may result in electrical shock, fire or damage to the product.
  - Locations subject to direct sunlight.
  - Locations subject to temperatures or humidity outside the range specified in the specifications.
  - Locations subject to condensation as the result of severe changes in temperature.
  - Locations subject to corrosive or flammable gases.
  - Locations subject to exposure to combustibles.
  - Locations subject to dust (especially iron dust) or salts.
  - Locations subject to exposure to water, oil, or chemicals.
  - Locations subject to shock or vibration.
-  **Caution** Do not touch the Inverter radiator, regenerative resistor, or Servomotor while the power is being supplied or soon after the power is turned OFF. Doing so may result in a skin burn due to the hot surface.
-  **Caution** Do not conduct a dielectric strength test on any part of the Inverter. Doing so may result in damage to the product or malfunction.
-  **Caution** Take appropriate and sufficient countermeasures when installing systems in the following locations. Not doing so may result in equipment damage.
  - Locations subject to static electricity or other forms of noise.
  - Locations subject to strong electromagnetic fields and magnetic fields.
  - Locations subject to possible exposure to radioactivity.
  - Locations close to power supplies.





## ***Transportation Precautions***







-  **Caution** Do not hold by front cover or panel, instead, hold by the radiation fin (heat sink) while transporting the product. Doing so may result in injury.
-  **Caution** Do not pull on the cables. Doing so may result in damage to the product or malfunction.
-  **Caution** Use the eye-bolts only for transporting the Inverter. Using them for transporting the machinery may result in injury or malfunction.

## ***Installation Precautions***







-  **WARNING** Provide an appropriate stopping device on the machine side to secure safety. (A holding brake is not a stopping device for securing safety.) Not doing so may result in injury.
-  **WARNING** Provide an external emergency stopping device that allows an instantaneous stop of operation and power interruption. Not doing so may result in injury.
-  **Caution** Be sure to install the product in the correct direction and provide specified clearances between the Inverter and control panel or with other devices. Not doing so may result in fire or malfunction.
-  **Caution** Do not allow foreign objects to enter inside the product. Doing so may result in fire or malfunction.
-  **Caution** Do not apply any strong impact. Doing so may result in damage to the product or malfunction.





## ***Wiring Precautions***

-  **WARNING** Wiring must be performed only after confirming that the power supply has been turned OFF. Not doing so may result in electrical shock.
-  **WARNING** Wiring must be performed by authorized personnel. Not doing so may result in electrical shock or fire.
-  **WARNING** Be sure to confirm operation only after wiring the emergency stop circuit. Not doing so may result in injury.
-  **WARNING** Always connect the ground terminals to a ground of 100  $\Omega$  or less for the 200-V AC class, or 10  $\Omega$  or less for the 400-V AC class. Not connecting to a proper ground may result in electrical shock.







-  **Caution** Install external breakers and take other safety measures against short-circuiting in external wiring. Not doing so may result in fire.
-  **Caution** Confirm that the rated input voltage of the Inverter is the same as the AC power supply voltage. An incorrect power supply may result in fire, injury, or malfunction.
-  **Caution** Connect the Braking Resistor and Braking Resistor Unit as specified in the manual. Not doing so may result in fire.
-  **Caution** Be sure to wire correctly and securely. Not doing so may result in injury or damage to the product.
-  **Caution** Be sure to firmly tighten the screws on the terminal block. Not doing so may result in fire, injury, or damage to the product.
-  **Caution** Do not connect an AC power to the U, V, or W output. Doing so may result in damage to the product or malfunction.

## ***Operation and Adjustment Precautions***

-  **WARNING** Turn ON the input power supply only after mounting the front cover, terminal covers, bottom cover, Operator, and optional items. Not doing so may result in electrical shock.
-  **WARNING** Do not remove the front cover, terminal covers, bottom cover, Operator, or optional items while the power is being supplied. Not doing so may result in electrical shock or damage to the product.
-  **WARNING** Do not operate the Operator or switches with wet hands. Doing so may result in electrical shock.
-  **WARNING** Do not touch the inside of the Inverter. Doing so may result in electrical shock.
-  **WARNING** Do not come close to the machine when using the error retry function because the machine may abruptly start when stopped by an alarm. Doing so may result in injury.
-  **WARNING** Do not come close to the machine immediately after resetting momentary power interruption to avoid an unexpected restart (if operation is set to be continued in the processing selection function after momentary power interruption is reset). Doing so may result in injury.
-  **WARNING** Provide a separate emergency stop switch because the STOP Key on the Operator is valid only when function settings are performed. Not doing so may result in injury.

-  **WARNING** Be sure confirm that the RUN signal is turned OFF before turning ON the power supply, resetting the alarm, or switching the LOCAL/REMOTE selector. Doing so while the RUN signal is turned ON may result in injury.
-  **Caution** Be sure to confirm permissible ranges of motors and machines before operation because the Inverter speed can be easily changed from low to high. Not doing so may result in damage to the product.
-  **Caution** Provide a separate holding brake when necessary. Not doing so may result in injury.
-  **Caution** Do not perform a signal check during operation. Doing so may result in injury or damage to the product.
-  **Caution** Do not carelessly change settings. Doing so may result in injury or damage to the product.

## ***Maintenance and Inspection Precautions***

-  **WARNING** Do not touch the Inverter terminals while the power is being supplied.
-  **WARNING** Maintenance or inspection must be performed only after turning OFF the power supply, confirming that the CHARGE indicator (or status indicators) is turned OFF, and after waiting for the time specified on the front cover. Not doing so may result in electrical shock.
-  **WARNING** Maintenance, inspection, or parts replacement must be performed by authorized personnel. Not doing so may result in electrical shock or injury.
-  **WARNING** Do not attempt to take the Unit apart or repair. Doing either of these may result in electrical shock or injury.
-  **Caution** Carefully handle the Inverter because it uses semiconductor elements. Careless handling may result in malfunction.
-  **Caution** Do not change wiring, disconnect connectors, the Operator, or optional items, or replace fans while power is being supplied. Doing so may result in injury, damage to the product, or malfunction.



# Warning Labels

Warning labels are pasted on the product as shown in the following illustration. Be sure to follow the instructions given there.

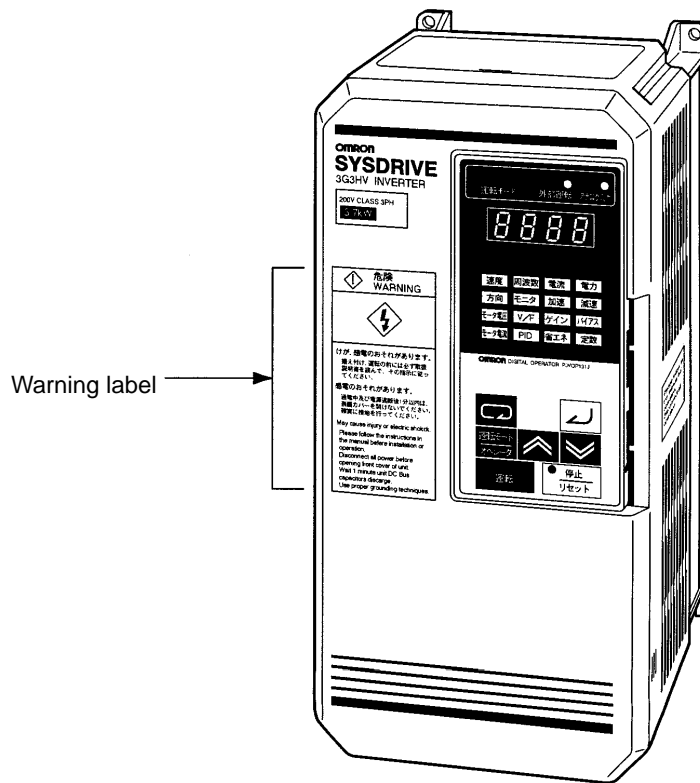
## ■ Warning Labels



## ■ Contents of Warning

 <b>危険</b> <b>WARNING</b>

<p>けが、感電のおそれがあります。          据え付け、運転の前には必ず取扱説明書を読んで、その指示に従ってください。</p> <p>感電のおそれがあります。          通電中及び電源遮断後1分以内は、表面カバーを開けないでください。確実に接地を行ってください。</p> <p>May cause injury of electric shock.          Please follow the instructions in the manual before installation or operation.          Disconnect all power before opening front cover of unit.          Wait 1 minute until DC Bus capacitors discharge.          Use proper grounding techniques.</p>





## Maximum Applicable Motor Capacity

037	3.7 kW
055	5.5 kW
075	7.5 kW
110	11 kW
150	15 kW
185	18.5 kW
220	22 kW
300	30 kW
370	37 kW
450	45 kW
550	55 kW
750	75 kW
11K	110 kW
16K	160 kW
18K	185 kW
22K	220 kW
30K	300 kW

## Voltage Class

2	Three-phase 200-V AC input (200-V class)
4	Three-phase 400-V AC input (400-V class)

## Enclosure Rating

A	Panel-mounting (IP10 min.) or closed wall-mounting model
B	Panel-mounting (IP00)

### ● Checking for Damage

Check the overall appearance and check for damage or scratches resulting from transportation. Check that parts connected by screws are securely fastened.

### ■ Checking the Accessories

Note that this manual is the only accessory provided with the 3G3HV. Set screws and other necessary parts must be provided by the user.

## About this Manual

This manual is divided into the chapters described in the following table. Information is organized by application area to enable you to use the manual more efficiently.

Chapter	Contents
Chapter 1 Introduction	Describes functions and nomenclature.
Chapter 2 Installation	Provides dimensions, installation methods, and wiring methods.
Chapter 3 Preparing for Operation	<p>Describes procedures required for preparing the Inverter and Digital Operator for operation. It is divided into the following areas:</p> <p><u>Preparation Procedure</u> Outlines the procedures required to use the Inverter from purchase right up to actual operation.</p> <p><u>Using the Digital Operator</u> Describes the nomenclature, operating methods, such as Digital Operator key operations, and monitor functions.</p> <p><u>Test Run</u> Describes how to perform a test run using the Digital Operator to confirm operation for the Inverter and the system in which it is to be used.</p> <p><u>Basic Operation</u> Describes the functions used for the basic control. The functions described here are the minimum required for running a motor with an Inverter.</p> <p><u>Applied Operation</u> Describes all the applied functions that are available with the Inverter. This includes explanations for functions that can be used to improve the responsiveness (torque characteristic) and the speed accuracy, as well as additional functions such as PID control and overtorque detection.</p>
Chapter 4 Operation	Provides information related to Inverter maintenance. This includes possible causes and countermeasures for errors, as well as inspection procedures.
Chapter 5 Specifications	Provides Inverter specifications, as well as the specifications and dimensions of peripheral devices.
Chapter 6 Appendix	Provides notes on using the Inverter on a motor and gives a list of standard models. It also provides ordered lists of parameters for easy reference. The parameter lists include page references.

# Table of Contents

---

<b>Chapter 1. Introduction</b> .....	<b>1-1</b>
1-1 Function .....	1-2
1-2 Nomenclature .....	1-5
1-3 Additional Functions .....	1-7
<b>Chapter 2. Installation</b> .....	<b>2-1</b>
2-1 Mounting .....	2-2
2-1-1 Dimensions .....	2-2
2-1-2 Installation Conditions .....	2-7
2-2 Wiring .....	2-10
2-2-1 Removing and Mounting the Front Cover .....	2-11
2-2-2 Terminals .....	2-13
2-2-3 Standard Connection Diagram .....	2-16
2-2-4 Wiring Around the Main Circuit .....	2-18
2-2-5 Wiring Control Circuit Terminals .....	2-34
<b>Chapter 3. Preparing for Operation</b> .....	<b>3-1</b>
3-1 Preparation Procedure .....	3-3
3-2 Using the Digital Operator .....	3-4
3-2-1 Nomenclature .....	3-4
3-2-2 Summary .....	3-5
3-3 Test Run .....	3-10
3-4 Basic Operation .....	3-13
3-5 Applied Operation .....	3-25
3-5-1 Energy-saving Mode .....	3-25
3-5-2 PID Control .....	3-31
3-5-3 List of Parameters .....	3-40
3-5-4 Parameters in Detail .....	3-54
<b>Chapter 4. Operation</b> .....	<b>4-1</b>
4-1 Protective and Diagnostic Functions .....	4-2
4-2 Troubleshooting .....	4-8
4-3 Maintenance and Inspection .....	4-14
<b>Chapter 5. Specifications</b> .....	<b>5-1</b>
5-1 Specifications of Inverters .....	5-2
5-2 Specifications of Peripheral Devices .....	5-5
5-2-1 Peripheral Devices .....	5-5
5-2-2 3G3HV-PCMA2 Voltage/Current Conversion Card .....	5-6
5-2-3 K3TJ-V11□ Scaling Meter .....	5-7
5-2-4 3G3IV-PJVOP96□ Analog Operator (Standard Model with Steel Casing) .....	5-8
5-2-5 3G3IV-PJVOP95□ Analog Operator (Miniature Model with Plastic Casing) .....	5-9
5-2-6 3G3IV-PCDBR□B Braking Unit (Yaskawa Electric) .....	5-10
5-2-7 3G3IV-PLKEB□ Braking Resistor Unit .....	5-10
5-2-8 3G3HV-PUZDAB□A□MH DC Reactor .....	5-12
5-2-9 3G3IV-PUZBAB□A□MH AC Reactor .....	5-14
5-2-10 Simple Input Noise Filter and Input Noise Filter .....	5-17
5-2-11 3G3IV-PLF□ Output Noise Filter (Tokin Corp.) .....	5-21

# Table of Contents

---

**Chapter 6. Appendix . . . . . 6-1**

6-1 Notes on Using the Inverter for a Motor . . . . . 6-2

6-2 List of Parameters . . . . . 6-5

**Revision History . . . . . R-1**

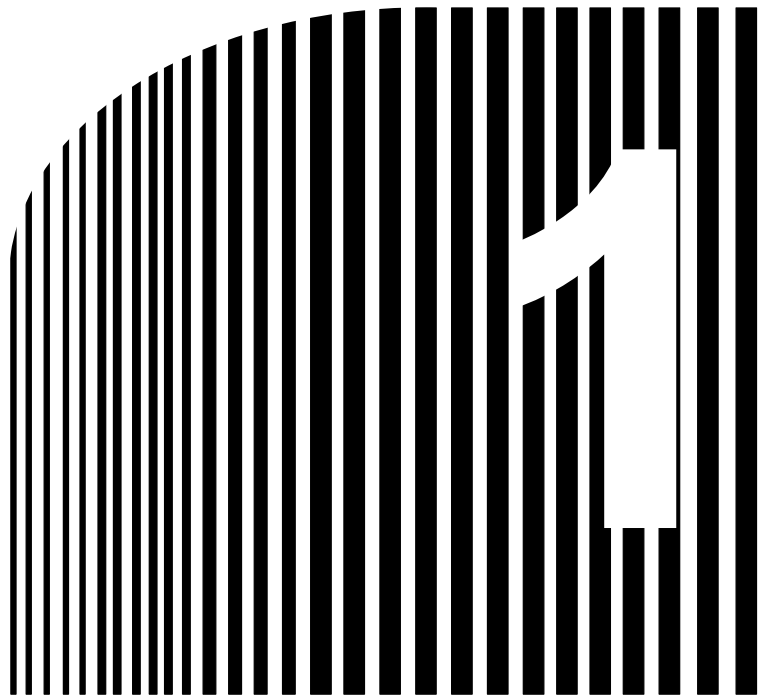

# Chapter 1

## • Introduction •

- 1-1 Function
- 1-2 Nomenclature
- 1-3 Additional Functions

## 1-1 Function

The 3G3HV High-capacity General-purpose Inverter is an easy-to-use inverter that has advanced features, such as PID control and energy-saving operations.

### ■ SYSDRIVE 3G3HV Inverter Models

- The following 200- and 400-V class 3G3HV Inverter models are available.
- A total of 21 types of Inverter are available for maximum applicable motor capacities of 0.4 to 300 kW.

Voltage class	Protective structure	Maximum applied motor capacity	Model		
200-V Class (3-phase)	NEMA1 type	3.7 kW	3G3HV-A2037-E		
		5.5 kW	3G3HV-A2055-E		
		7.5 kW	3G3HV-A2075-E		
		11 kW	3G3HV-A2110-E		
		15 kW	3G3HV-A2150-E		
	Open chassis type	18.5 kW	3G3HV-B2185-E		
		22 kW	3G3HV-B2220-E		
		30 kW	3G3HV-B2300-E		
		37 kW	3G3HV-B2370-E		
		45 kW	3G3HV-B2450-E		
		55 kW	3G3HV-B2550-E		
		75 kW	3G3HV-B2750-E		
		400-V Class (3-phase)	NEMA1 type	3.7 kW	3G3HV-A4037-E
				5.5 kW	3G3HV-A4055-E
7.5 kW	3G3HV-A4075-E				
11 kW	3G3HV-A4110-E				
15 kW	3G3HV-A4150-E				
Open chassis type	18.5 kW		3G3HV-B4185-E		
	22 kW		3G3HV-B4220-E		
	30 kW		3G3HV-B4300-E		
	37 kW		3G3HV-B4370-E		
	45 kW		3G3HV-B4450-E		
	55 kW		3G3HV-B4550-E		
	75 kW	3G3HV-B4750-E			
	110 kW	3G3HV-B411K-E			
	160 kW	3G3HV-B416K-E			
	185 kW	3G3HV-B418K-E			
	220 kW	3G3HV-B422K-E			
	300 kW	3G3HV-B430K-E			

## ■ Energy-saving Operation

- The rotation speed of a three-phase induction motor does not decrease when the supply voltage drops if the motor has a light load. The 3G3HV Inverter in energy-saving operation automatically detects the current consumption of the motor connected to the Inverter, estimates its load, and drops the output voltage, thus saving the power consumption of the motor efficiently.
- Use the auto-tuning function of the Inverter in energy-saving mode to reduce the power consumption of the motor most efficiently if the ratings of the motor are unknown.
- The Inverter in energy-saving mode is ideal for the following applications.
  - Rotation control of fans and blowers
  - Flow control of pumps
  - Control of machines with variable loads, such as metal-working machines, wood-working machines, and food-processing machines
  - Control of machines that mainly operate with light loads

## ■ PID Control

- The Inverter has a PID control function, thus performing follow-up control with ease.
- Follow-up control is a control method in which the Inverter uses a sensor and senses the rotation speed of the motor and changes the output frequency to control the rotation speed of the motor.
- Follow-up control can be applied to a variety of control operations.
- PID control is ideal for the following applications.
  - Speed control: With a speed sensor, such as a tachometric generator, the Inverter regulates the rotation speed of the motor regardless of the load of the motor or synchronizes the rotation speed of the motor with that of another motor.
  - Pressure control: With a pressure sensor, the Inverter performs constant pressure control.
  - Current control: With a current sensor, the Inverter performs precise current control.
  - Temperature control: With a temperature sensor and fan, the Inverter performs temperature control.

## ■ Frequency Reference

- The following three types of frequency references are possible to control the output frequency of the Inverter.
  - Numeric input from the Digital Operator of the Inverter
  - Voltage input within a range from 0 to 10 V
  - Current input within a range from 4 to 20 mA

The Inverter can use one of the above if it is designated with parameters.

- A maximum of four frequency references can be registered with the Inverter. With remote multi-step input, the Inverter can be in multi-step speed operation with a maximum of four speed steps.

## ■ Frequency Jump

- The frequency jump function prevents the Inverter from generating any frequency that causes the machine to resonate.



**■ Acceleration/Deceleration Time Settings**

- The acceleration time and deceleration time of the Inverter can be set independently within a range of 0.0 to 3,600 s.
- Two acceleration times and two deceleration times can be set with the Inverter, any of which can be selected with remote output.

**■ V/f Settings**

- Select a V/f pattern out of the 15 V/f patterns preset with the Inverter according to the application.
- An optional V/f pattern can be set with the Inverter.

**■ Monitor Function**

- The following items can be monitored with the Digital Operator.
  - Frequency reference, output frequency, output current, output voltage, DC voltage, output power, status of input terminals, inverter status, power interruption error, PROM number, total operating time, and PID feedback value

**■ Low Noise (3.7- to 160-kW Models)**

- The output transistor of the Inverter is an IGBT (insulated gate bipolar transistor). Using a sine-wave PWM method with a high-frequency carrier, the motor does not generate metallic noise.

**■ High Torque at Low Output Frequency Range**

- A torque rate of 150% can be achieved even in a low speed range where output frequency is only 3 Hz.

**■ Automatic Torque Boost**

- The Inverter automatically adjusts the output according to the required torque of the motor that is rotating at constant or accelerative speed, thus ensuring the powerful rotation of the motor.

**■ Harmonic Countermeasures (3.7- to 160-kW Models)**

- DC reactors (optional) can be connected to 3.7- to 15-kW models.
- Models of 18.5- to 160-kW have a built-in DC reactor and also employ 12-pulse rectification, which suppresses harmonics better than a reactor.

## 1-2 Nomenclature

### ■ Panel

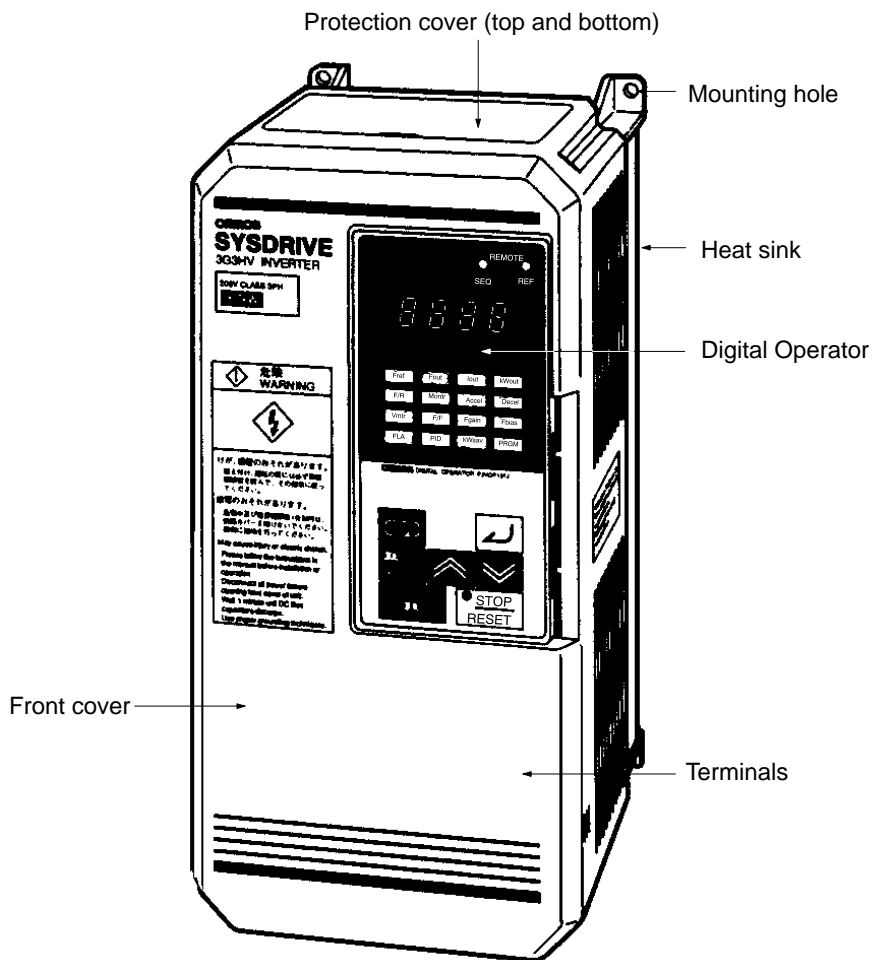

• Terminals (with Front Cover Removed)

Example: 200-V Class Inverter with 3.7-kW Output

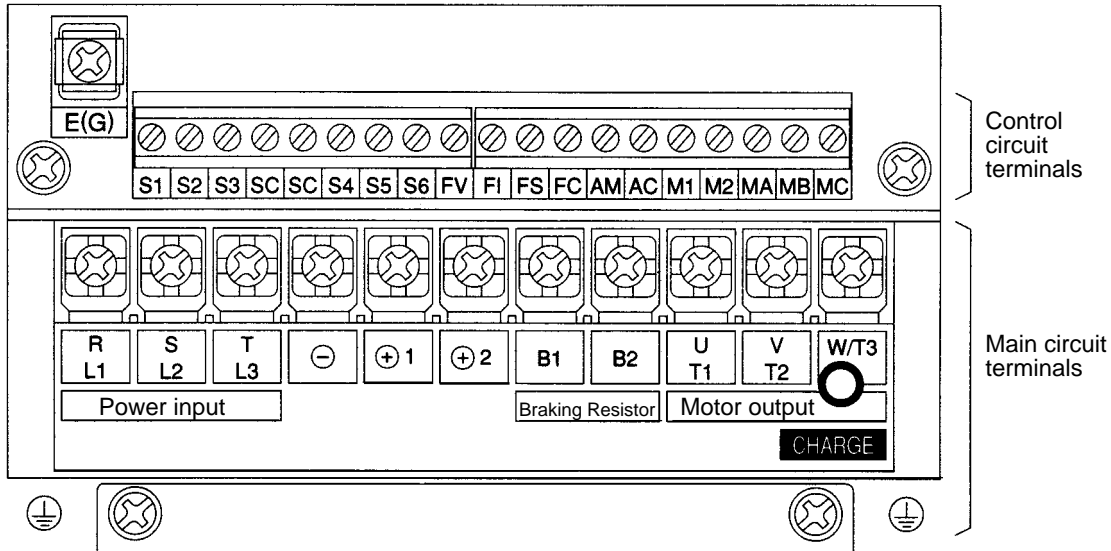

■ Digital Operator

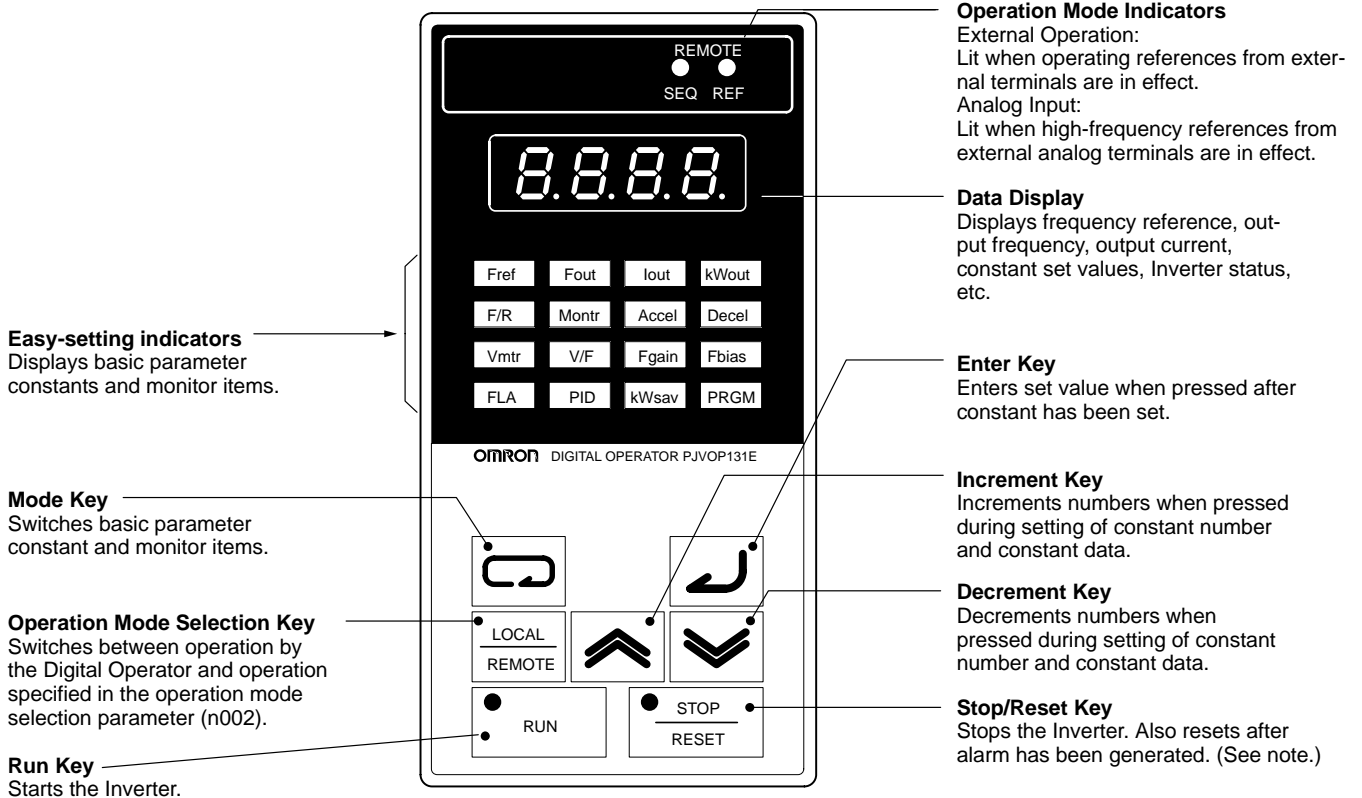

**Note** For safety reasons, the reset function cannot be used while the run command (forward/reverse) is being input. Turn the run command OFF before using the reset function.

## 1-3 Additional Functions

New functions have been added to the following versions, for which production was started in April 1997.

3.7 to 15-kW models: Software version S2011 (VSP102011) or later

18.5 to 55-kW models: Software version S3012 (VSP103012) or later

Note: The software version can be confirmed by viewing the 4-digit PROM number with the monitor function. This number is set to the number of the software version.

The functions that have been added with these versions and outlines of these functions are given below. For details of the functions, refer to *Section 4 Operation*.

### ■ Independent Initialization for Motor Rotation Direction

Although the functionality of the forward/reverse rotation selection parameter (n005) itself has not been changed, with new models it will not be initialized when the parameter write prohibit selection/parameter initialization parameter (n001) is set to 6 or 7.

### ■ V/f Default Settings Changed (Inverters of 55 kW or More)

The default settings for V/f patterns have been changed for the Inverters of 55 kW or more as shown below.

Model	Intermediate output frequency voltage (n016)	Minimum output frequency voltage (n018)
3G3HV-A2550	12.0 V	6.0 V
3G3HV-A4550	24.0 V	12.0 V

### ■ Output Frequency Upper Limit Changed

The upper limit of the setting range for the output frequency upper limit parameter (n030) has been changed. The addition of a slip compensation function means that frequencies greater than the maximum frequency (n012) may occur (because the frequency reference is added to the compensation value). For this reason, the upper limit of the setting range of the output frequency upper limit parameter (n030) has been increased from 100% to 109%.

### ■ PID Input Characteristic Selection Function (n039)

A PID input characteristic selection input (set value: 27) function has been added to the multi-function input 5 parameter (n039) that determines the function of terminal S6.

### ■ Carrier Frequency Settings Increased (n050)

The setting 7.0 Hz (set value: 10) has been added to the available carrier frequency settings.

### ■ Minimum Baseblock Time Setting Range Increased (n053)

The setting range for the minimum baseblock time has been increased from the range 0.5 to 5.0 s to the range 0.5 to 10.0 s for increased motor responsiveness.

### ■ Slip Compensation Function (n109 to n111)

A function that compensates for motor slip, a characteristic of induction motors, has been added. Using this function, the amount of slip is estimated from the output current of the Inverter, and the output frequency is compensated accordingly. By using the slip compensation function, speed fluctuations of the load can be reduced more effectively than with previous models.

### ■ Changing Parameters while Inverter is Running

It is now possible to change some parameters and, related to this, monitor and set the items in the bottom two lines of easy-setting indicators while the Inverter is running. Using this feature, set values for some parameters can be adjusted while monitoring operation. For details of which parameters can be changed while the Inverter is running, refer to the parameter lists.

### ■ Operation Selection at Digital Operator Interruption Function (n112)

A function that detects communications errors between the Digital Operator and the Inverter itself, and interrupts Inverter outputs has been added.

### ■ Settable Detection Width (n113)

The detection width of the optional frequency agreement and the optical frequency detection can be set with parameters. With previous models this setting was fixed.

### ■ Operation Selection at Operation Mode Switching (Local/Remote Switching) (n114)

Using the Operation Mode Selection Key on the Digital Operator or operation mode selection input set using the multi-function input parameters (set value: 5), it is possible to switch between operation from the Digital Operator and operation according to the setting of the operation mode selection parameter (n002). A function that selects whether run signals input while the operation mode is switching are enabled or disabled after the mode has changed, has been added.

**Note** If this setting is set to enable run commands, when the operation mode changes the Inverter will start running immediately. Take steps to ensure safety for such operation.

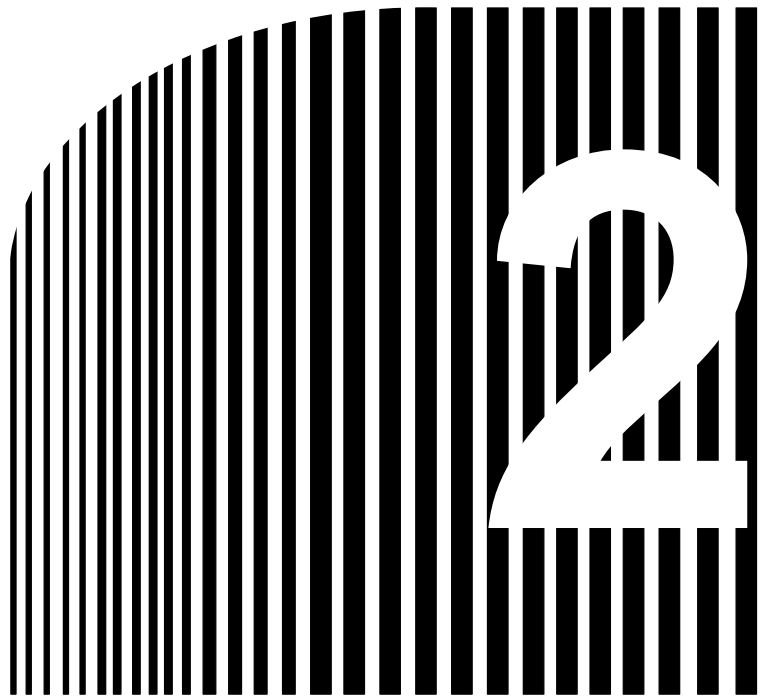

## Chapter 2

### • Installation •

2-1 Mounting

2-2 Wiring

## 2-1 Mounting

### 2-1-1 Dimensions

#### ■ 3G3HV-A2037/-A4037

##### ● External Dimensions

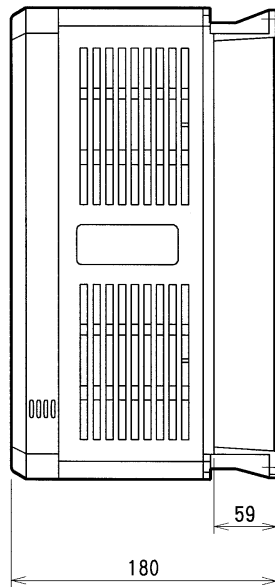
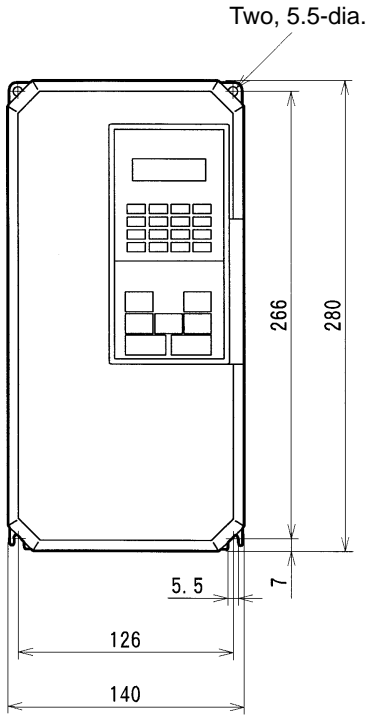

##### ● Mounting Dimensions

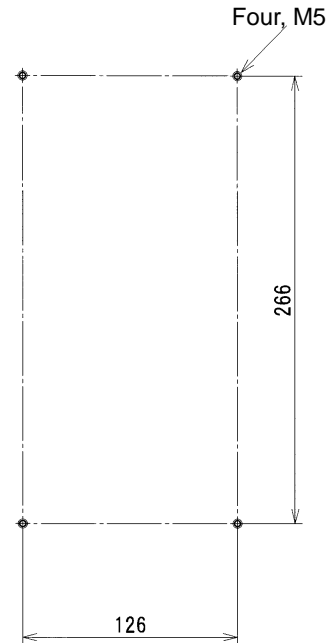

#### ■ 3G3HV-A2055/-A2075/-A4055/-A4075

##### ● External Dimensions

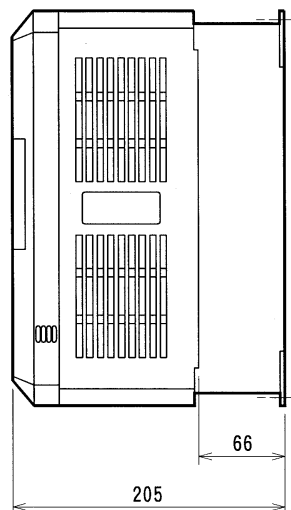
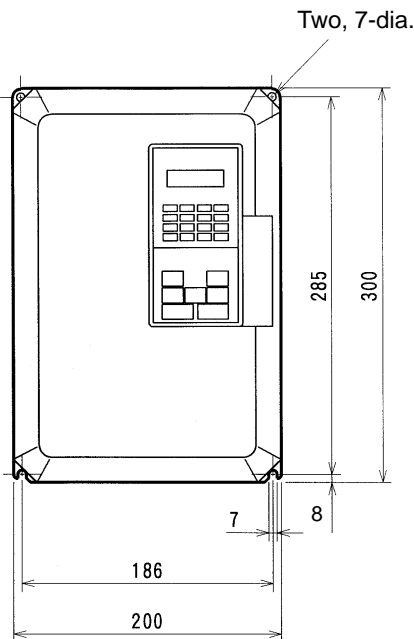

##### ● Mounting Dimensions

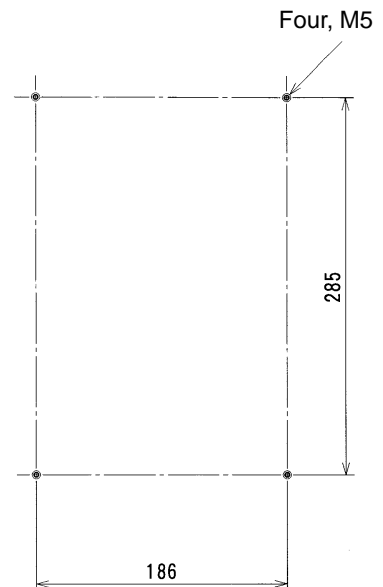

■ 3G3HV-A2110/-A2150/-A4110/-A4150

● External Dimensions

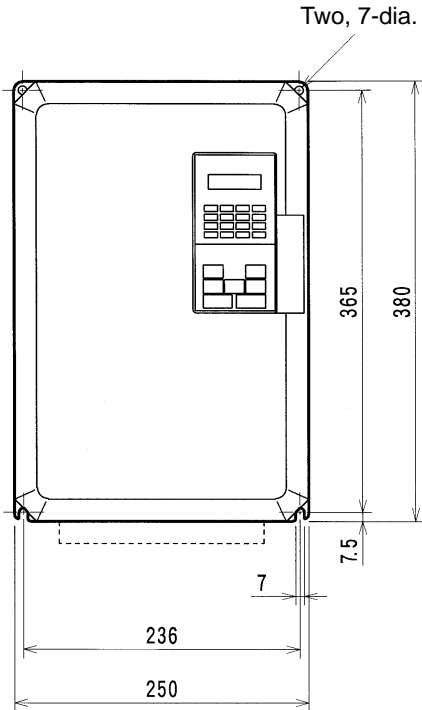

● Mounting Dimensions

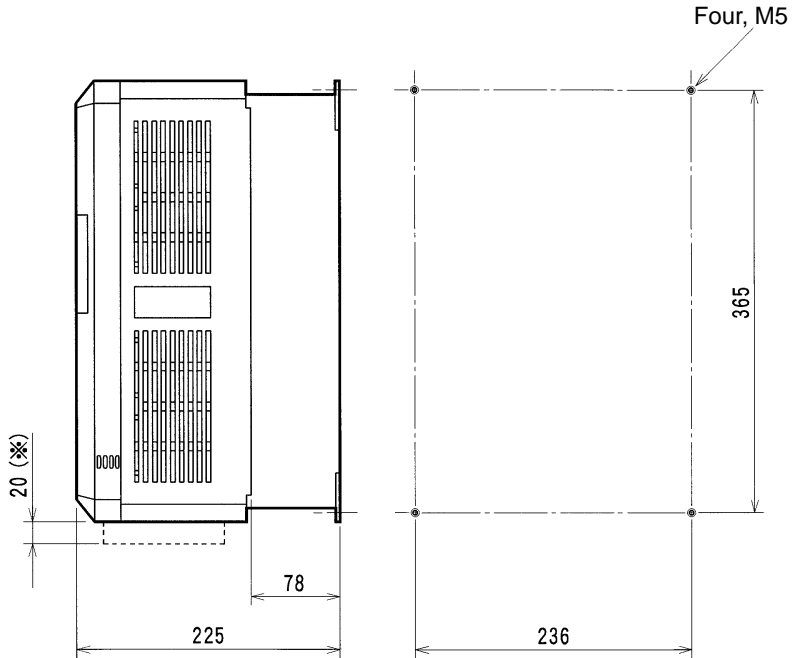

Note \*The dashed lines apply only to the A2150.

■ 3G3HV-B2185/-B2220/-B4185/-B4220/-B4300/-B4450

● External Dimensions

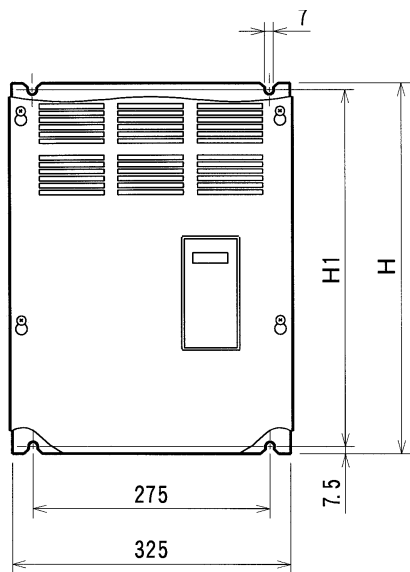

● Mounting Dimensions

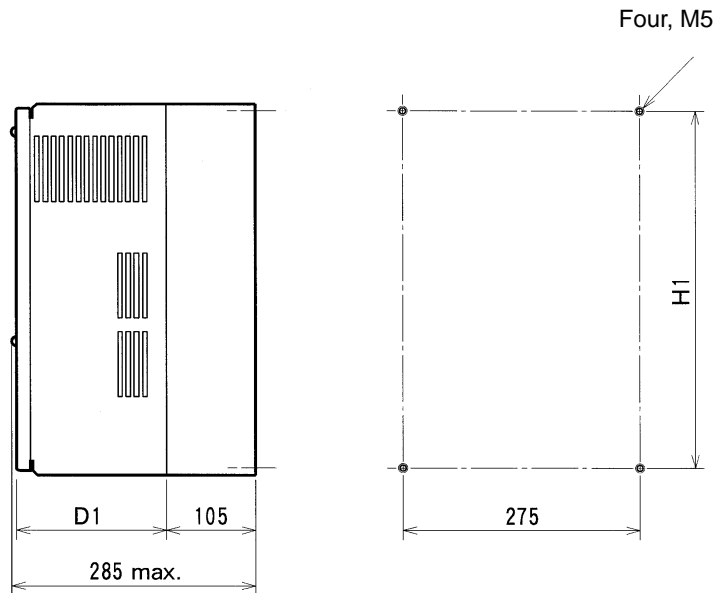

Voltage class	Model 3G3HV-	Dimensions (mm)		
		H	H1	D1
200-V	B2185/B2220	450	435	174.5
400-V	B4185/B4220	450	435	174.5
	B4300/B4370/B4450	526	610	175



■ 3G3HV-B2300/-B2370/-B2450/-B2550/-B4550/-B4750

● External Dimensions

● Mounting Dimensions

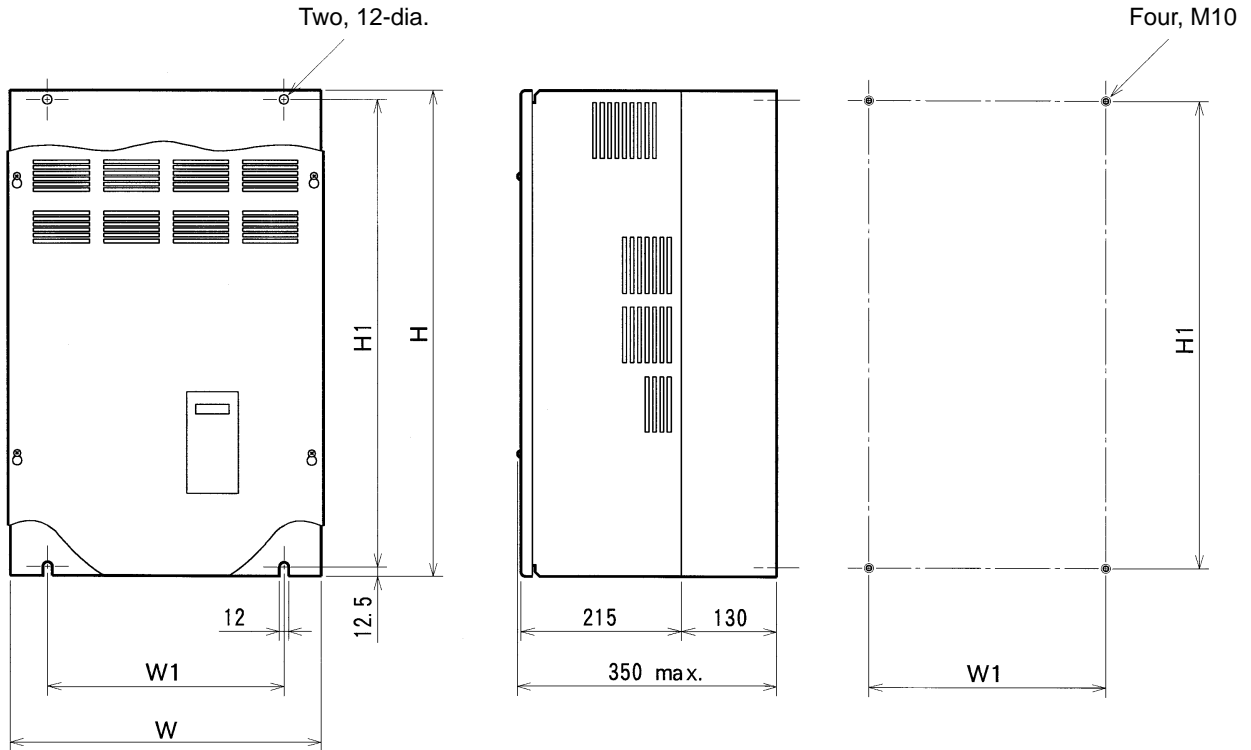

Voltage class	Model 3G3HV-	Dimensions (mm)			
		W	H	W1	H1
200-V	B2300/B2370	425	675	320	650
	B2450/B2550	475	800	370	775
400-V	B4550/B4750	455	820	350	795

■ 3G3HV-B2750/-B411K/-B416K

● External Dimensions

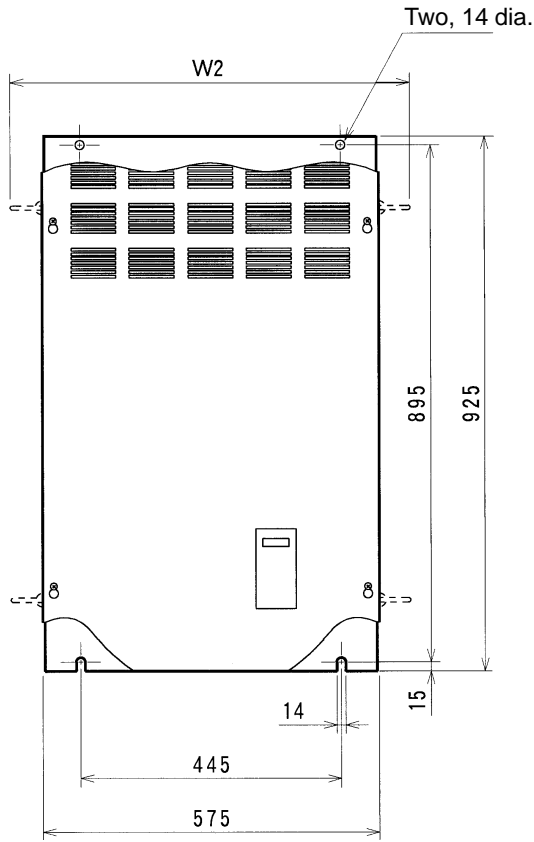

● Mounting Dimensions

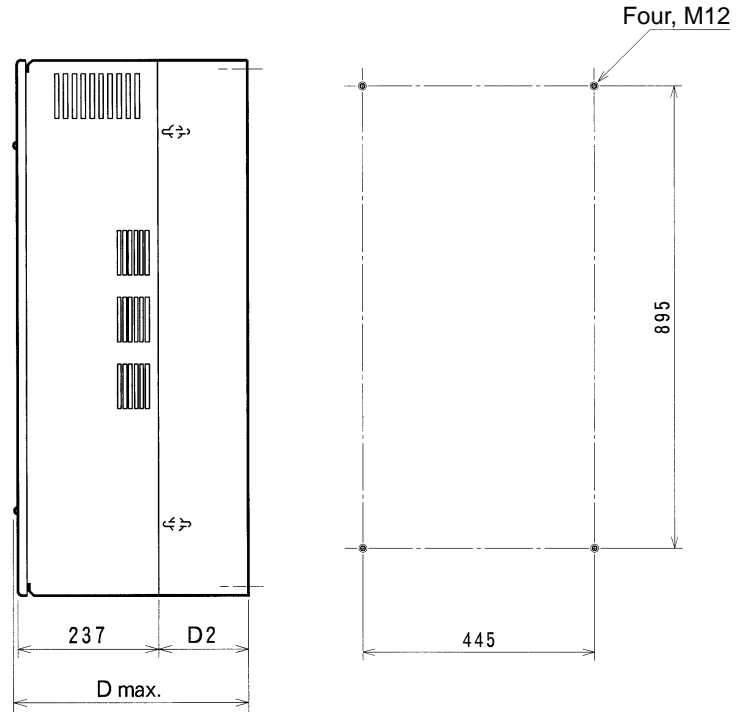

Voltage class	Model 3G3HV-	Dimensions (mm)		
		D	D2	W2
200-V	B2750	400 max.	158	695
400-V	B411K	375 max.	130	695
	B416K	400 max.	158	695

■ 3G3HV-B418K/-B422K

● External Dimensions

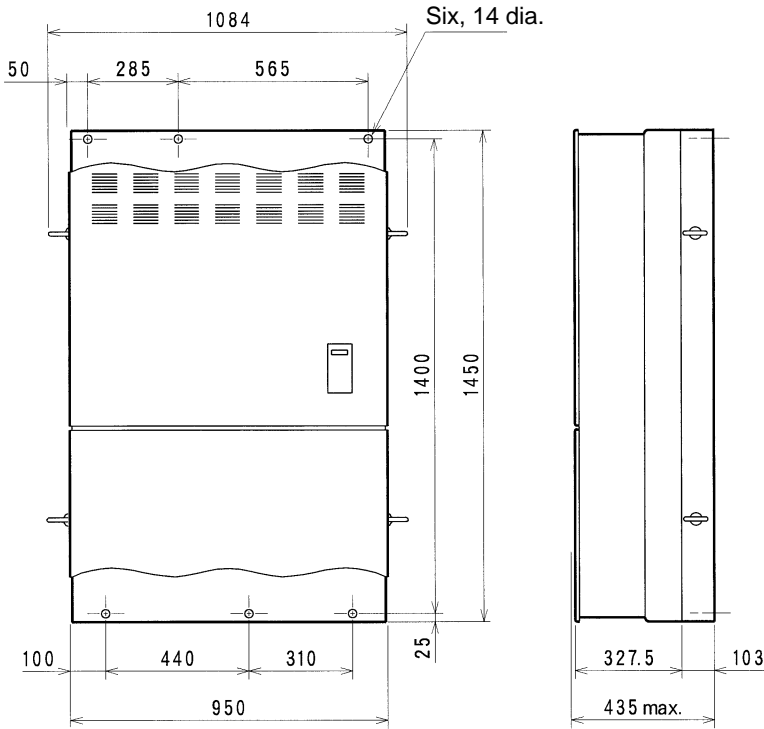

● Mounting Dimensions

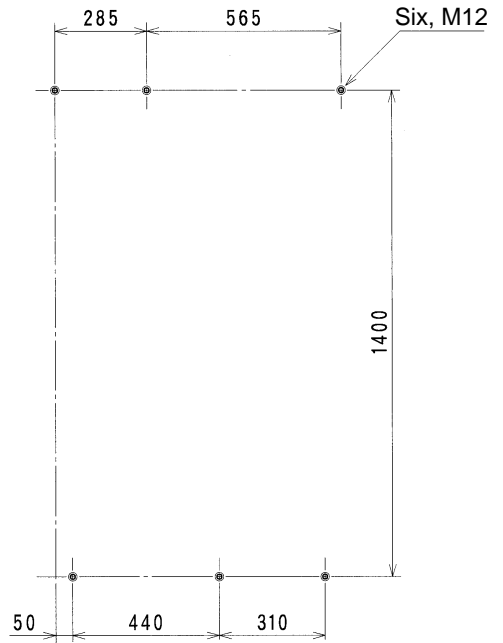

■ 3G3HV-B430K

● External Dimensions

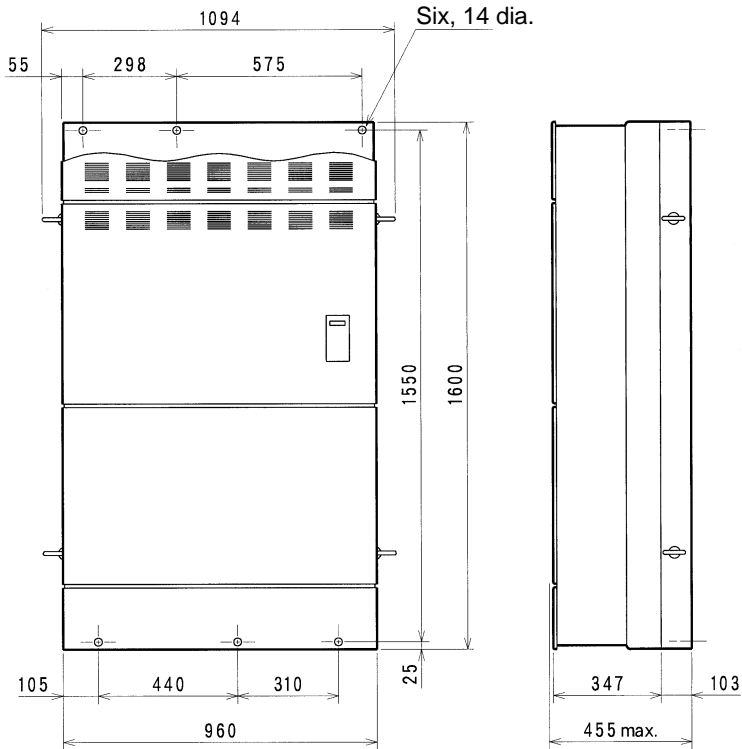

● Mounting Dimensions

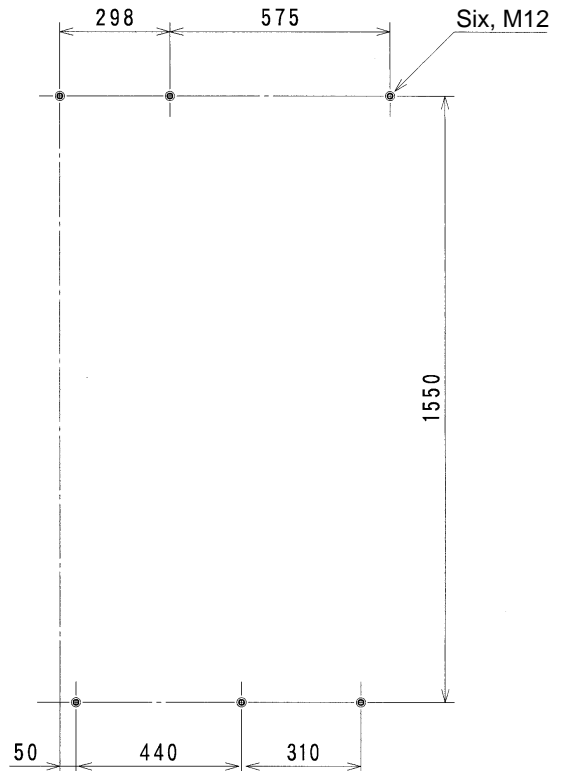

● Digital Operator Installation

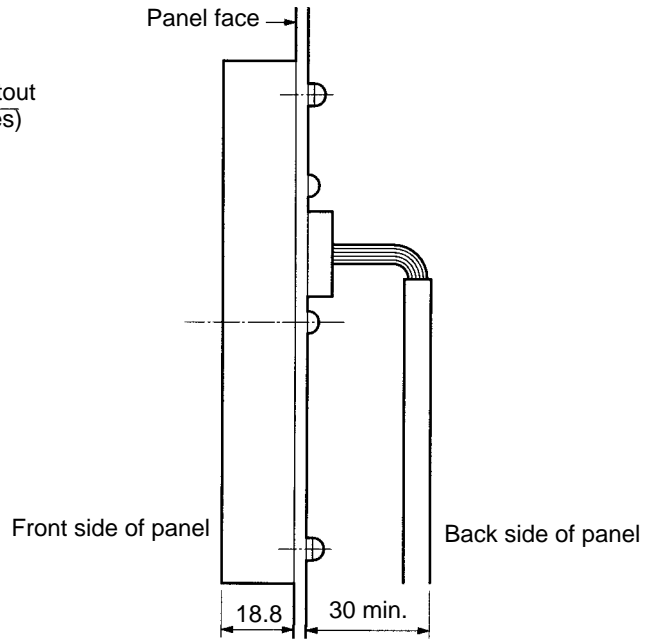
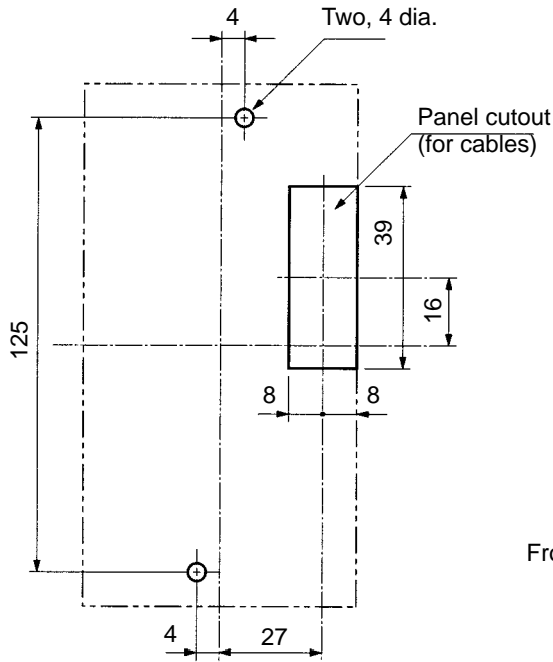

2-1-2 Installation Conditions

■ Cautions and Warnings

**! WARNING** Provide an appropriate stopping device on the machine side to secure safety. (A holding brake is not a stopping device for securing safety.) Not doing so may result in injury.

**! WARNING** Provide an external emergency stopping device that allows an instantaneous stop of operation and power interruption. Not doing so may result in injury.

**! Caution** Be sure to install the product in the correct direction and provide specified clearances between the Inverter and control panel or with other devices. Not doing so may result in fire or malfunction.

**! Caution** Do not allow foreign objects to enter inside the product. Doing so may result in fire or malfunction.

**! Caution** Do not apply any strong impact. Doing so may result in damage to the product or malfunction.

**■ Direction and Space**

- Install the Inverter on a vertical surface so that the characters on the nameplate are oriented upward.
- When installing the Inverter, always provide the following installation space to allow normal heat dissipation from the Inverter.

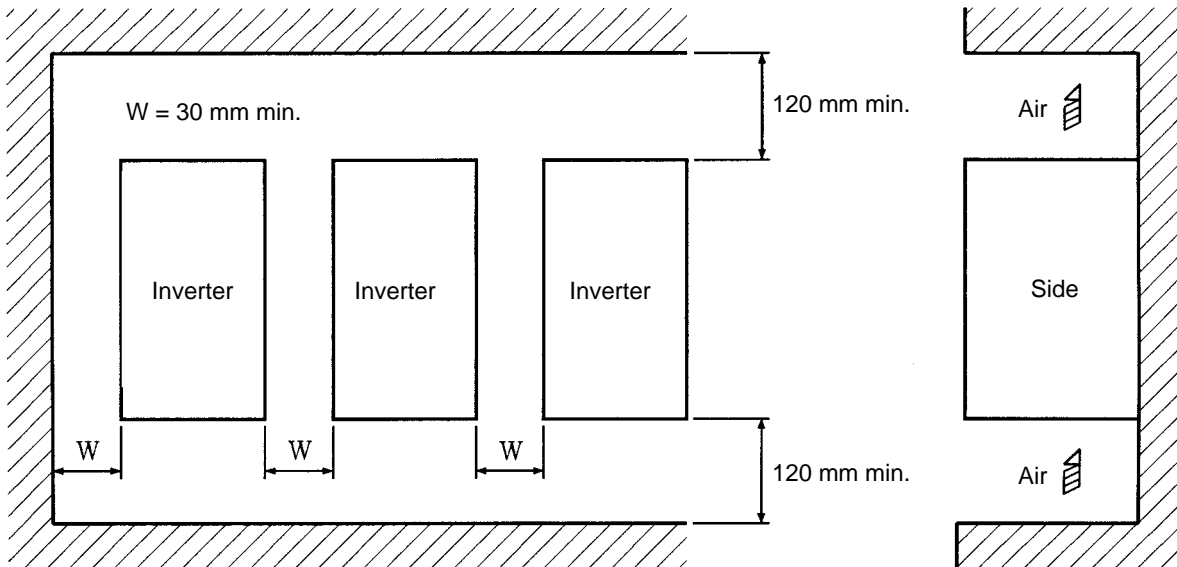

**■ Installation Site**

- Install the Inverter under the following conditions.

**NEMA1 Type**

Ambient temperature for operation:  $-10$  to  $40^{\circ}\text{C}$   
 Humidity: 90% RH or less (no condensation)

**Open Chassis Type**

Ambient temperature for operation:  $-10$  to  $45^{\circ}\text{C}$   
 Humidity: 90% RH or less (no condensation)

**Note** A protection cover is attached to the top and bottom of the Inverter. Be sure to remove the protection covers before installing the 200- or 400-V Class Inverter that has an output of 15 kW or less to a panel.

- Install the Inverter in a clean location free from oil mist and dust. Alternatively, install it in a totally enclosed panel that is completely shielded from floating dust.
- When installing or operating the Inverter, always take special care so that metal powder, oil, water, or other foreign matter does not get into the Inverter.
- Do not install the Inverter on inflammable material such as wood.

**■ Ambient Temperature Control**

- To enhance operation reliability, the Inverter should be installed in an environment free from extreme temperature rises.
- If the Inverter is installed in an enclosed environment such as a box, use a cooling fan or air conditioner to maintain the internal air temperature below  $45^{\circ}\text{C}$ .











**■ Protecting Inverter from Foreign Matter during Installation**

- Place a cover over the Inverter during installation to shield it from metal power produced by drilling.
- Upon completion of installation, always remove the cover from the Inverter. Otherwise, ventilation will be affected, causing the Inverter to overheat.

---

## 2-2 Wiring

---

-  **WARNING** Wiring must be performed only after confirming that the power supply has been turned OFF. Not doing so may result in electrical shock.
-  **WARNING** Wiring must be performed by authorized personnel. Not doing so may result in electrical shock or fire.
-  **WARNING** Be sure to confirm operation only after wiring the emergency stop circuit. Not doing so may result in injury.
-  **WARNING** Always connect the ground terminals to a ground of 100  $\Omega$  or less for the 200-V AC class, or 10  $\Omega$  or less for the 400-V AC class. Not connecting to a proper ground may result in electrical shock.
-  **Caution** Install external breakers and take other safety measures against short-circuiting in external wiring. Not doing so may result in fire.
-  **Caution** Confirm that the rated input voltage of the Inverter is the same as the AC power supply voltage. An incorrect power supply may result in fire, injury, or malfunction.
-  **Caution** Connect the Braking Resistor and Braking Resistor Unit as specified in the manual. Not doing so may result in fire.
-  **Caution** Be sure to wire correctly and securely. Not doing so may result in injury or damage to the product.
-  **Caution** Be sure to firmly tighten the screws on the terminal block. Not doing so may result in fire, injury, or damage to the product.
-  **Caution** Do not connect an AC power to the U, V, or W output. Doing so may result in damage to the product or malfunction.

## 2-2-1 Removing and Mounting the Front Cover

---

Remove the front cover to wire the terminals. Remove the Digital Operator from the front cover before removing the front cover. Do not remove or mount the front cover without first removing the Digital Operator, otherwise Digital Operator may malfunction due to imperfect contact.

---

### ■ Removing the Digital Operator

- Press the lever on the side of the Digital Operator in the arrow ① direction to unlock the Digital Operator and lift the Digital Operator in the arrow ② direction to remove the Digital Operator as shown in the following illustration.

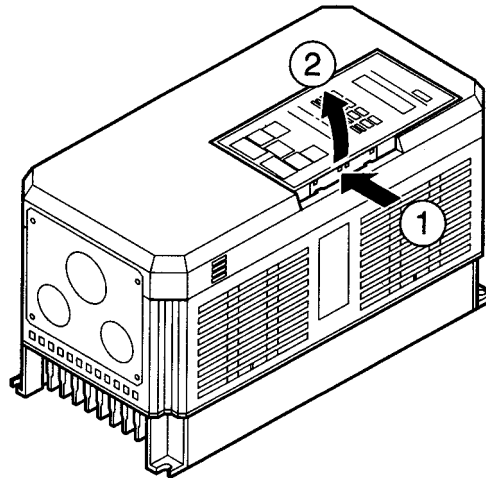

### ■ Removing the Front Cover

- Press the left and right sides of the front cover in the arrow ① directions and lift the bottom of the cover in the arrow ② direction to remove the front cover as shown in the following illustration.

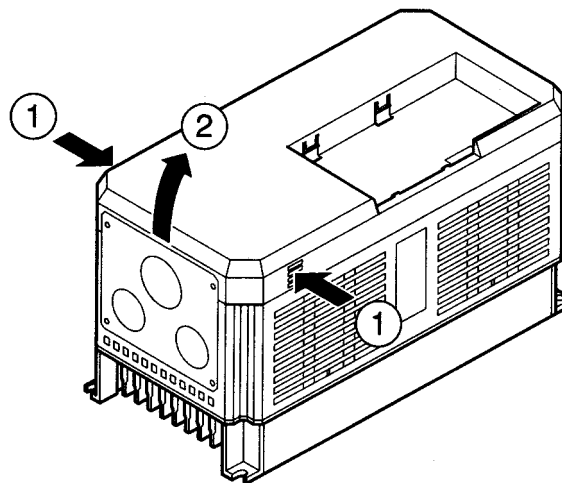



### ■ Mounting the Front Cover

- Mount the front cover to the Inverter by taking in reverse order to the steps to remove the front cover after wiring the terminals.
- Do not mount the front cover with the Digital Operator attached to the front cover, otherwise Digital Operator may malfunction due to imperfect contact.
- Insert the tab of the upper part of the front cover into the groove of the Inverter and press the lower part of the front cover onto the Inverter until the front cover snaps shut.

### ■ Attaching the Digital Operator

- Hook the Digital Operator on clicks A of the front cover in the arrow ① direction as shown in the following illustration.
- Press the Digital Operator in the arrow ② direction until it snaps shut with clicks B.

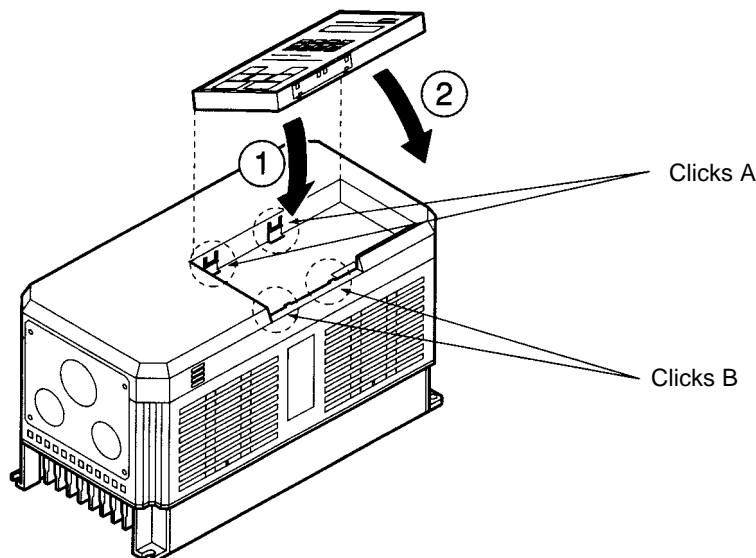

**Note** Do not remove or attach the Digital Operator or mount or remove the front cover using methods other than those mentioned above, otherwise the Inverter may malfunction due to imperfect contact or break.

### ■ Removing the Front Cover of the Inverter with 18.5-kW Output or More

- The front cover can be removed without removing the Digital Operator from the Inverter provided that the Inverter is a model with an output of 18.5 kW or more.
- Loosen the four screws of the front cover and move the front cover slightly upwards to remove the front cover.

## 2-2-2 Terminals

### ■ Terminal Block Configuration (200-V Class with 3.7-kW Output)

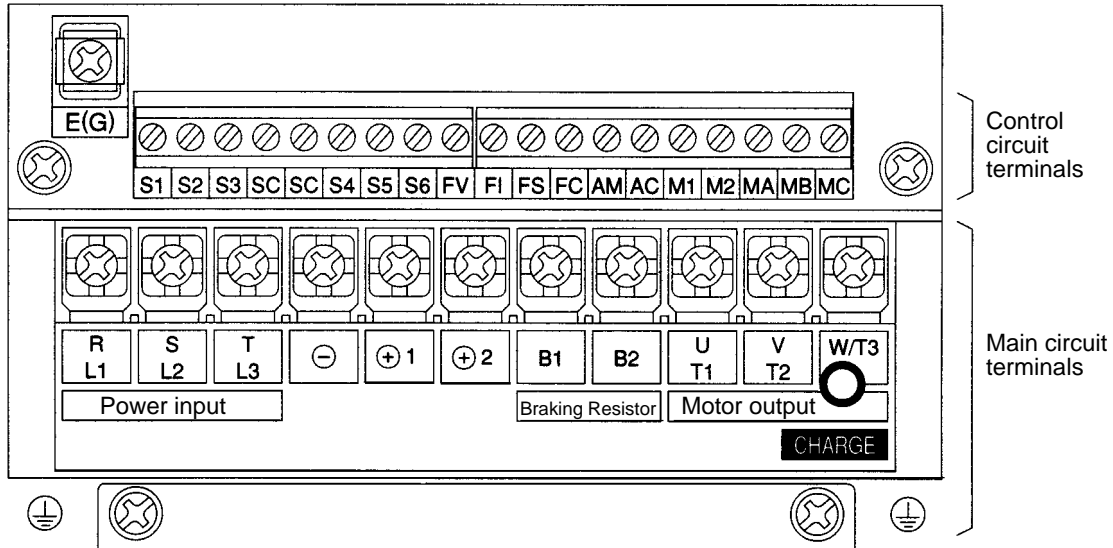

### ■ Main Circuit Terminals

#### ● 200-V Class

Model 3G3HV-	A2037 to A2075	A2110 to A2150	B2185 to B2750
Maximum applied motor capacity	3.7 to 7.5 kW	11 to 15 kW	18.5 to 75 kW
L1 (R)	Power supply input terminals, 3-phase, 200 to 230 VAC, 50/60 Hz		Power supply input terminals, 3-phase, 200 to 230 VAC, 50/60 Hz
L2 (S)			
L3 (T)			
L11 (R1)	---		
L21 (S1)			
L31 (T1)			
T1 (U)	Motor output terminals, 3-phase, 200 to 230 VAC (correspond to input voltage)		
T2 (V)			
T3 (W)			
B1	Braking Resistor Unit connection terminals	---	
B2			
+ 1	DC reactor connection terminal (+ 1-(+ 2)	DC reactor connection terminal (+ 1-(+ 2)	---
+ 2	DC power supply input terminal (+ 1-(+ 2)	DC power supply input terminal (+ 1-(+ 2)	
-		Braking Unit connection terminal (+ 3-(+ 2)	
+ 3	---		
⊥	Ground the terminal at a resistance of less than 100 Ω.		

● 400-V Class

Model 3G3HV-	A4037 to A4150	B4185 to B416K	B418K to B430K	
Maximum applied motor capacity	3.7 to 15 kW	18.5 to 160 kW	185 to 300 kW	
L1 (R)	Power supply input terminals, 3-phase, 380 to 460 VAC, 50/60 Hz	Power supply input terminals, 3-phase, 380 to 460 VAC, 50/60 Hz	Power supply input terminals, 3-phase, 380 to 460 VAC, 50/60 Hz	
L2 (S)				
L3 (T)				
L11 (R1)				---
L21 (S1)				---
L31 (T1)				---
T1 (U)	Motor output terminals, 3-phase, 380 to 460 VAC (correspond to input voltage)			
T2 (V)				
T3 (W)				
B1	Braking Resistor Unit connection terminals	---		
B2				
⊕ 1	DC reactor connection terminal (⊕ 1-⊕ 2) DC power supply input terminal (⊕ 1-⊖)	---	DC power supply input terminal (⊕ 1-⊖)	
⊕ 2			---	
⊖			Braking Unit connection terminal (⊕ 3-⊖)	
⊕ 3			---	
⊕	Ground the terminal at a resistance of less than 10 Ω.			

■ Control Circuit Terminals for All 3G3HV Models

Symbol	Name	Function	Signal level		
Input	S1	Forward run/Stop	Stops at OFF.	Photocoupler 24 VDC, 8 mA	
	S2	Multi-function input 1 (S2)	Set by constant n035 (reverse run/stop).		
	S3	Multi-function input 2 (S3)	Set by constant n036 (external error a).		
	S4	Multi-function input 3 (S4)	Set by constant n037 (error reset).		
	S5	Multi-function input 4 (S5)	Set by constant n038 (multi-step speed reference 1).		
	S6	Multi-function input 5 (S6)	Set by constant n039 (multi-step speed reference 2).		
	SC	Sequence input common	Common for S1 to S6.		
	FS	Frequency reference power supply	DC power supply for frequency reference.	15 VDC, 20 mA	
	FV	Frequency reference input (voltage)	Voltage input terminal for frequency reference.	0 to 10 VDC (Input impedance: 20 kΩ)	
	FI	Frequency reference input (current)	Current input terminal for frequency reference.	4 to 20 mA (Input impedance: 250 kΩ)	
	FC	Frequency reference input common	Common for FV, F1.	---	
	E (G)	Shielded wire connection ground	Shielded terminal for sequence and frequency reference inputs. (see note 2)	---	
Output	MA	Multi-function contact output 1 (normally open)	Set by constant n040 (error)	Contact output 30 VDC, 1 A max. 250 VAC, 1 A max.	
	MB	Multi-function contact output 1 (normally closed)			
	MC	Multi-function contact output 1 common			Common for MA, MB
	M1	Multi-function contact output 2 (normally open)	Set by constant n041 (running)		
	M2	Multi-function contact output 2 common	Common for M1		
	AM	Multi-function analog output	Set by constant n048 (output frequency)		0 to 10 VDC, 2 mA
	AC	Multi-function analog output common	Common for AM		

- Note 1.** Parameter settings can be used to select various functions for multi-function inputs 1 to 5 and the multi-function contact output.  
The functions in parentheses are the default settings.
- Note 2.** Do not connect a grounding wire to the E (G) terminal. Connect the grounding wire to the ground terminal of the main circuit terminals.

### 2-2-3 Standard Connection Diagram

- For Inverter Models of 200- to 400-V Class with 3.7- to 15-kW Output

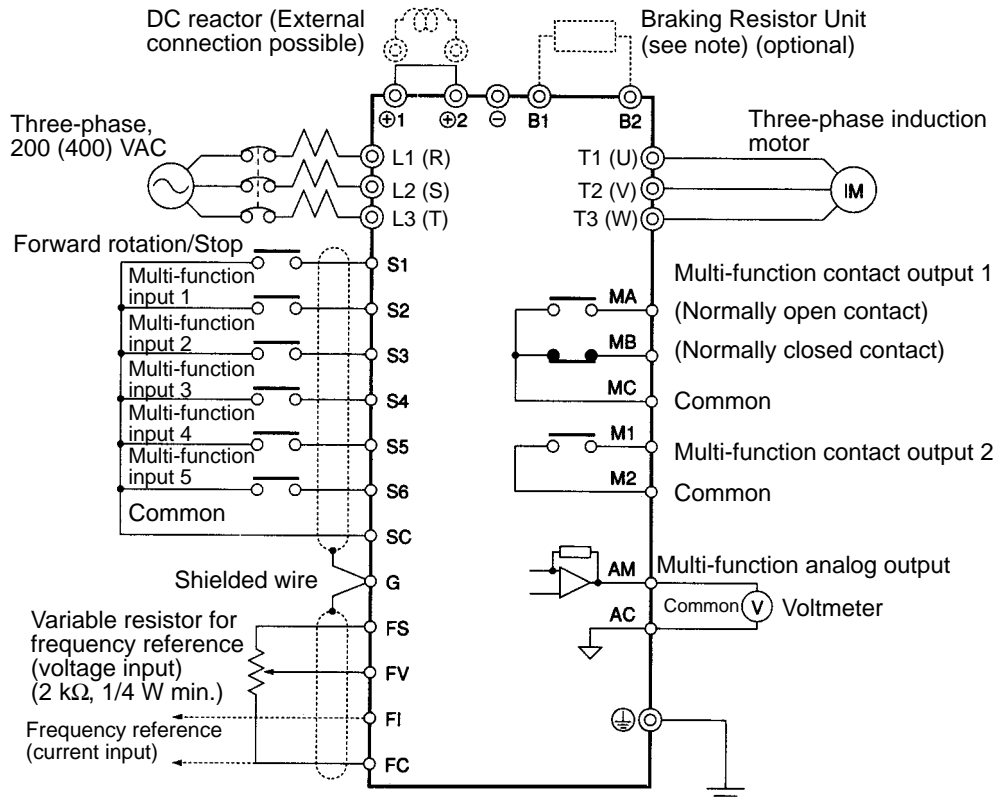

**Note:** These terminals of the 3G3HV-A2110 and 3G3HV-A2150 connect to the Braking Unit and Braking Resistor Unit.

- Example of Wiring for 3-wire Sequential Operation

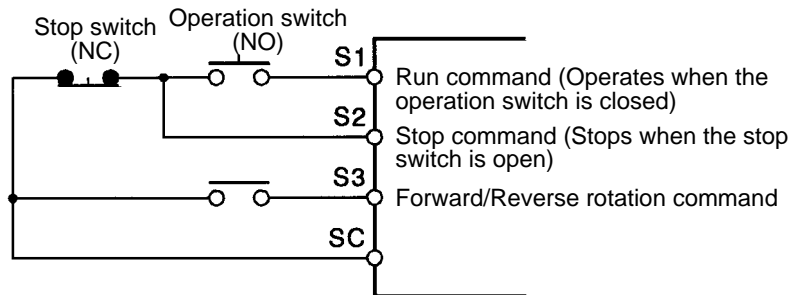

• For Inverter Models of 200- to 400-V Class with 18.5- to 300-kW Output

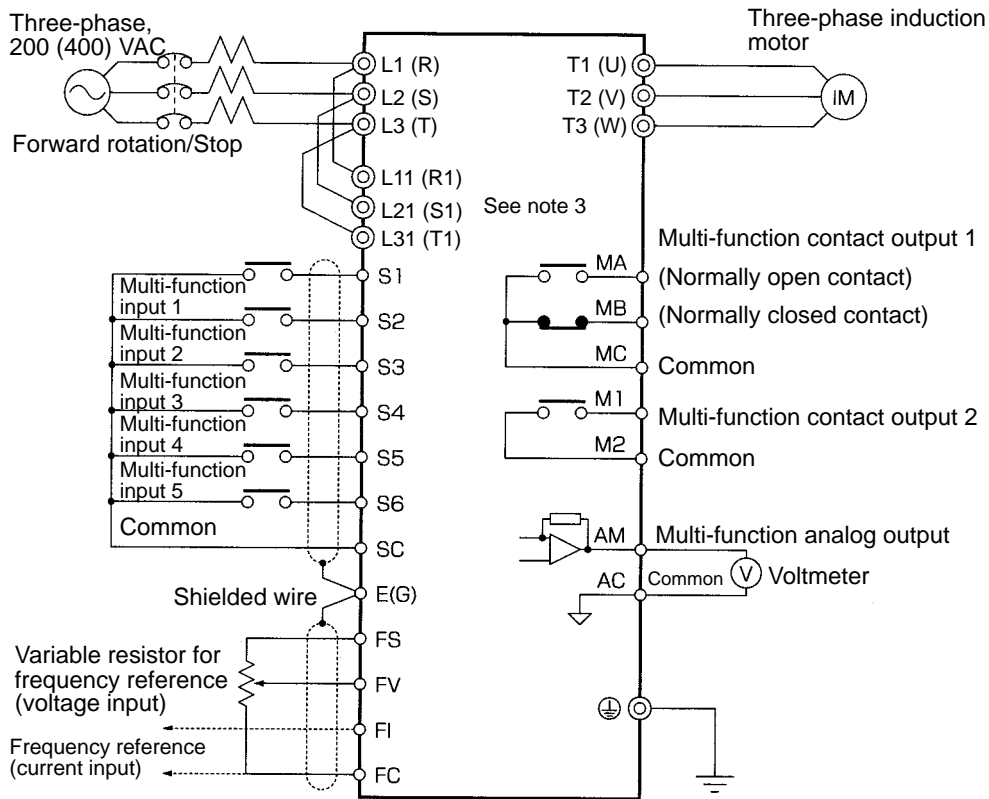

- Note 1.** The Braking Unit or Braking Resistor Unit cannot be connected to the Inverter (18.5 kW to 160 kW). However, 185-kW to 300-kW models can be connected.
- Note 2.** Make sure that terminals R and R1, S and S1, and T and T1 are short-circuited. These terminals are short-circuited with short bars before shipping. Be sure to remove the short bars, however, when using 12-pulse rectification.
- Note 3.** Terminals L11 (R1), L21 (S1), and L31 (T1) are not available on the 185- to 300-kW Inverters.
- Note 4.** The 185- to 300-kW Inverters do not have built-in DC reactors, nor can DC reactors be externally connected.

• Example of Wiring for 3-wire Sequential Operation

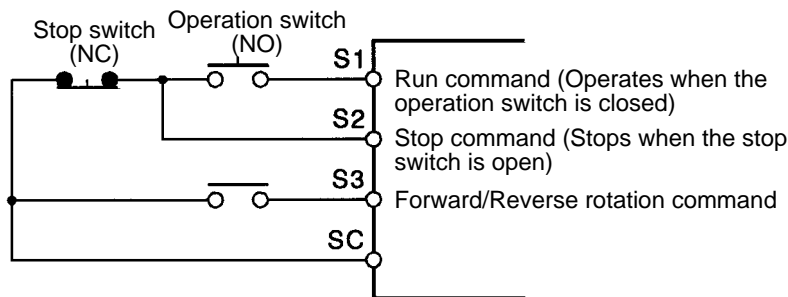













## 2-2-4 Wiring Around the Main Circuit

















System reliability and noise resistance are affected by the wiring method used. Therefore, always follow the instructions given below when connecting the Inverter to peripheral devices and other parts.

### ■ Wire Size and Round Solderless Terminal

For the main circuit and ground, always use 600-V polyvinyl chloride (PVC) cables. If the cable is long and may cause voltage drops, increase the wire size according to the cable length.

#### ● Wire Sizes

Voltage class	Model	Terminal	Terminal screw	Wire thickness (mm <sup>2</sup> )
200-V Class	3G3HV-A2037	L1, L2, L3, (-), (+)1, (+)2, B1, B2, T1, T2, T3	M4	5.5
				
	3G3HV-A2055	L1, L2, L3, (-), (+)1, (+)2, B1, B2, T1, T2, T3	M5	8
				5.5 to 8
	3G3HV-A2075	L1, L2, L3, (-), (+)1, (+)2, B1, B2, T1, T2, T3	M5	8
				5.5 to 8
	3G3HV-A2110	L1, L2, L3, (-), (+)1, (+)2, (+)3, T1, T2, T3	M6	22
				8
	3G3HV-A2150	L1, L2, L3, (-), (+)1, (+)2, (+)3, T1, T2, T3	M8	30
			M6	8
	3G3HV-B2185	L1, L2, L3, L11, L21, L31, T1, T2, T3	M8	30
				14
	3G3HV-B2220	L1, L2, L3, L11, L21, L31, T1, T2, T3	M8	38
				14
	3G3HV-B2300	L1, L2, L3, L11, L21, L31, T1, T2, T3	M10	100
			M8	22
	3G3HV-B2370	L1, L2, L3, L11, L21, L31, T1, T2, T3	M10	60 x 2P
			M8	22
	3G3HV-B2450	L1, L2, L3, L11, L21, L31, T1, T2, T3	M10	60 x 2P
			M8	22
3G3HV-B2550	L1, L2, L3, L11, L21, L31, T1, T2, T3	M10	60 x 2P	
		M8	30	
3G3HV-B2750	L1, L2, L3, L11, L21, L31, T1, T2, T3	M12	100 x 2P	
		M8	50	

Voltage class	Model	Terminal	Terminal screw	Wire thickness (mm <sup>2</sup> )
400-V Class	3G3HV-A4037	L1, L2, L3, (-), (+)1, (+)2, B1, B2, T1, T2, T3	M4	2 to 5.5
				3.5 to 5.5
	3G3HV-A4055	L1, L2, L3, (-), (+)1, (+)2, B1, B2, T1, T2, T3	M4	3.5 to 5.5
				
	3G3HV-A4075	L1, L2, L3, (-), (+)1, (+)2, B1, B2, T1, T2, T3	M4	5.5
				
	3G3HV-A4110	L1, L2, L3, (-), (+)1, (+)2, B1, B2, T1, T2, T3	M5	8 to 14
			M6	8
	3G3HV-A4150	L1, L2, L3, (-), (+)1, (+)2, B1, B2, T1, T2, T3	M5	8 to 14
			M6	8
	3G3HV-B4185	L1, L2, L3, L11, L21, L31, T1, T2, T3	M6	14
			M8	8
400-V Class	3G3HV-B4220	L1, L2, L3, L11, L21, L31, T1, T2, T3	M6	22
			M8	8
	3G3HV-B4300	L1, L2, L3, L11, L21, L31, T1, T2, T3	M8	22
				8
	3G3HV-B4370	L1, L2, L3, L11, L21, L31, T1, T2, T3	M8	30
				14
	3G3HV-B4450	L1, L2, L3, L11, L21, L31, T1, T2, T3	M8	50
				14
	3G3HV-B4550	L1, L2, L3, L11, L21, L31, T1, T2, T3	M10	100
			M8	22
	3G3HV-B4750	L1, L2, L3, L11, L21, L31, T1, T2, T3	M10	60 x 2P
			M8	22
	3G3HV-B411K	L1, L2, L3, L11, L21, L31, T1, T2, T3	M10	60 x 2P
			M8	30
	3G3HV-B416K	L1, L2, L3, L11, L21, L31, T1, T2, T3	M12	100 x 2P
			M8	50
	3G3HV-B418K	L1, L2, L3, (-), (+)1, (+)3, T1, T2, T3	M16	325 x 2P
			M8	50
	3G3HV-B422K	L1, L2, L3, (-), (+)1, (+)3, T1, T2, T3	M16	325 x 2P
			M8	60
3G3HV-B430K	L1, L2, L3, (-), (+)1, (+)3, T1, T2, T3	M16	325 x 2P	
		M8	60	

**Note** The wire thickness is set for copper wires at 75°C.



● Round Solderless Terminals and Tightening Torque

Wire thickness (mm <sup>2</sup> )	Terminal screw	Size	Tightening torque (N•m)
0.5	M4	1.25 – 4	1.2
0.75	M4	1.25 – 4	1.2
1.25	M4	1.25 – 4	1.2
2	M4	2 – 4	1.2
	M5	2 – 5	2.0
	M6	2 – 6	2.5
	M8	2 – 8	6.0
3.5/5.5	M4	5.5 – 4	1.2
	M5	5.5 – 5	2.0
	M6	5.5 – 6	2.5
	M8	5.5 – 8	6.0
8	M5	8 – 5	2.0
	M6	8 – 6	2.5
	M8	8 – 8	6.0
14	M6	14 – 6	2.5
	M8	14 – 8	6.0
22	M6	22 – 6	2.5
	M8	22 – 8	6.0
30/38	M8	38 – 8	6.0
50/60	M8	60 – 8	6.0
	M10	60 – 10	10.0
80	M10	80 – 10	10.0
100		100 – 10	10.0
100	M12	100 – 12	14.0
150		150 – 12	14.0
200		200 – 12	14.0
325	M12 x 2	325 – 12	14.0
	M16	325 – 16	25.0

**Note Determining Wire Size**

Determine the wire size for the main circuit so that line voltage drop is within 2% of the rated voltage.

Line voltage drop is calculated as follows:

$$\text{Line voltage drop (V)} = \sqrt{3} \times \text{wire resistance } (\Omega/\text{km}) \times \text{wire length (m)} \times \text{current (A)} \times 10^{-3}$$

■ Wiring on the Input Side of the Main Circuit

● Installing a Molded-case Circuit Breaker

Always connect the power input terminals (R/L1, S/L2, and T/L3) and power supply via a molded case circuit breaker (MCCB) suitable to the Inverter.

- Install one wiring circuit breaker per Inverter.
- Choose an MCCB with a capacity of 1.5 to 2 times the Inverter’s rated current.
- For the MCCB’s time characteristics, be sure to consider the Inverter’s overload protection (one minute at 150% of the rated output current).
- If the MCCB is to be used in common among multiple Inverters, or other devices, set up a sequence such that the power supply will be turned OFF by a fault output, as shown in the following diagram.

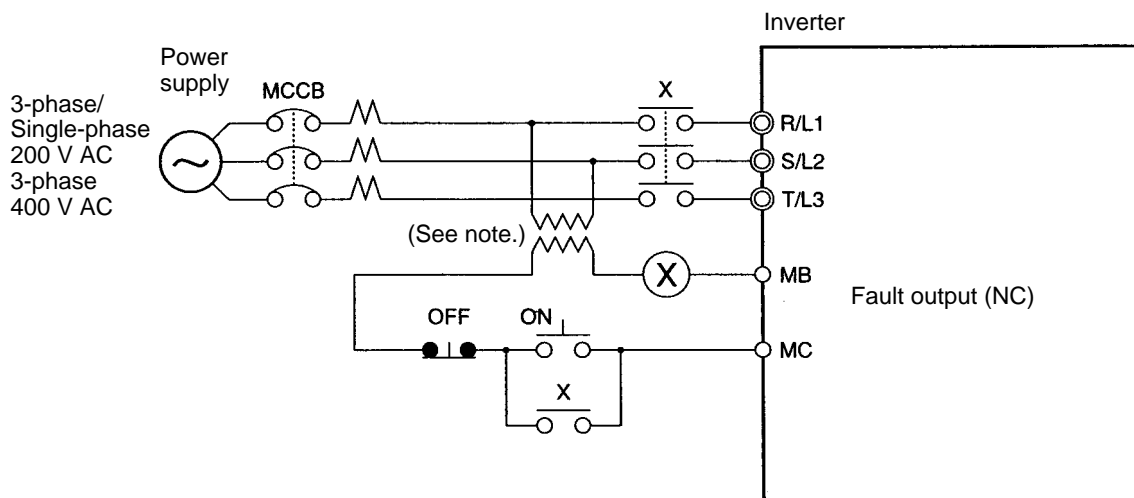

**Note** Use a 400/200 V transformer for a 400-V model.

● Installing a Ground Fault Interrupter

Inverter outputs use high-speed switching, so high-frequency leakage current is generated.

In general, a leakage current of approximately 100 mA will occur for each Inverter (when the power cable is 1 m) and approximately 5 mA for each additional meter of power cable.

Therefore, at the power supply input area, use a special-purpose breaker for Inverters, which detects only the leakage current in the frequency range that is hazardous to humans and excludes high-frequency leakage current.

- For the special-purpose breaker for Inverters, choose a ground fault interrupter with a sensitivity amperage of at least 10 mA per Inverter.
- When using a general leakage breaker, choose a ground fault interrupter with a sensitivity amperage of 200 mA or more per Inverter and with an operating time of 0.1 s or more.

**● Installing a Magnetic Contactor**

If the power supply of the main circuit is to be shut off because of the sequence, a magnetic contactor can be used instead of a molded-case circuit breaker.

When a magnetic contactor is installed on the primary side of the main circuit to stop a load forcibly, however, the regenerative braking does not work and the load coasts to a stop.

- A load can be started and stopped by opening and closing the magnetic contactor on the primary side. Frequently opening and closing the magnetic contactor, however, may cause the Inverter to break down. To maintain the service life of the Inverter's internal relays and electrolytic capacitors, it is recommended that this operation be performed no more than once every 30 minutes.
- When the Inverter is operated with the Digital Operator, automatic operation cannot be performed after recovery from a power interruption.
- When using the Braking Resistor Unit, be sure to arrange a sequence in which the thermal relay of the Unit turns the magnetic contactor OFF.

**● Connecting Input Power Supply to the Terminal Block**

Input power supply can be connected to any terminal on the terminal block because the phase sequence of input power supply is irrelevant to the phase sequence (R/L1, S/L2, and T/L3).

**● Installing an AC Reactor**

If the Inverter is connected to a large-capacity power transformer (660 kW or more) or the phase advance capacitor is switched, an excessive peak current may flow through the input power circuit, causing the converter unit to break down.

To prevent this, install an optional AC reactor on the input side of the Inverter.

This also improves the power factor on the power supply side.

**● Installing a Surge Absorber**

Always use a surge absorber or diode for the inductive loads near the Inverter. These inductive loads include magnetic contactors, electromagnetic relays, solenoid valves, solenoid, and magnetic brakes.

● **Installing a Noise Filter on the Power Supply Side**

The Inverter’s outputs utilize high-speed switching, so noise may be transmitted from the Inverter to the power line and adversely affect other devices in the vicinity. It is recommended that a Noise Filter be installed at the Power Supply to minimize this noise transmission. Conversely, noise can also be reduced from the power line to the Inverter.

**Wiring Example 1**

**Input Noise Filters**

Simple Input Noise Filter: 3G3EV-PLNFD□

Input Noise Filter: 3G3IV-PFN□

EMC-conforming Input Noise Filter: 3G3FV-PFS□

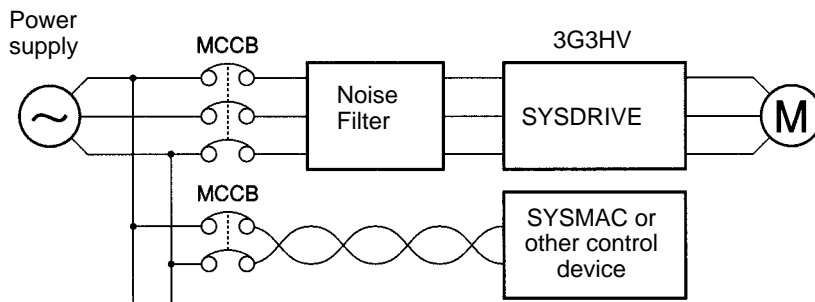

**Note** Use a noise filter designed for Inverters. A general-purpose noise filter will be less effective and may not reduce noise.

● **Calculating the Inverter’s Input Power Supply Capacity**

The power supply capacity for the Inverter can be calculated in the way shown below. The value obtained should only be as a reference; allow for some degree of variation.

Input power supply capacity (kVA) = Motor output (kW)/(Motor efficiency × Inverter efficiency × Inverter input power factor)

Motor efficiency = 0.8 (typ.)

Inverter efficiency = 0.9 (typ.)

Inverter input power factor = 0.65 to 0.9

**Note** The Inverter’s input power factor varies with the impedance. If an AC reactor is used, take the value to be 0.9, and if an AC reactor is not used, take the value to be 0.65.

To calculate the input current, divide the input power supply capacity obtained above by the input voltage. The Inverter has an overload capacity of 150%, and so set to a value 1.5 times the result of this calculation.

Example: 3-phase 200-V:  $1.5 \times \text{Input power supply capacity} / (\sqrt{3} \times 200 \text{ V})$

Single-phase 200-V:  $1.5 \times \text{Input power supply capacity} / 200 \text{ V}$

● **Setting the Power Supply Voltage Short Pin (400-V Class Inverters of 18.5 kW or More)**

Set the power supply voltage short pin for 400-V Class Inverters with a capacity of 18.5 kW or more.

**Short Pin Setting Procedure**

1. Turn OFF the power supply and wait for at least one minute (three minutes for Inverters of 30 kW or more) before removing the front panel.

2. Insert the short pin mounted on the board into the voltage connector nearest to the actual power supply voltage. The default setting is 440 V.

The following example shows board of a 400-V Class Inverter of 18.5 to 45 kW.

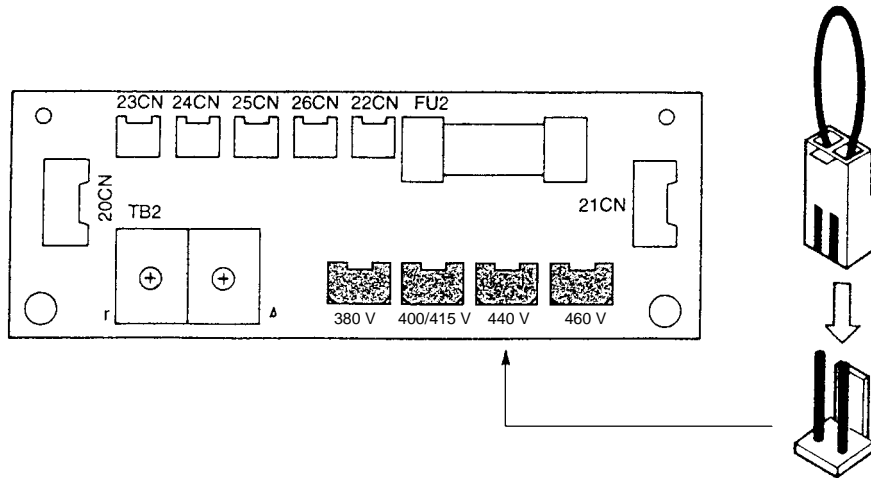

3. Put the front panel to its original position.

## ■ Wiring on the Output Side of Main Circuit

### ● Connecting the Terminal Block to the Load

Connect output terminals T1 (U), T2 (V), and T3 (W) to motor lead wires T1 (U), T2 (V), and T3 (W), respectively. Check that the motor rotates forward with the forward command. Switch over any two of the output terminals to each other and reconnect if the motor rotates in reverse with the forward command.

### ● Never Connect a Power Supply to Output Terminals

Never connect a power supply to output terminals T1 (U), T2 (V), and T3 (W). If voltage is applied to the output terminals, the internal circuit of the Inverter will be damaged.

### ● Never Short or Ground Output Terminals

If the output terminals are touched with bare hands or the output wires come into contact with the Inverter casing, an electric shock or grounding will occur. This is extremely hazardous. Also, be careful not to short the output wires.

### ● Do Not Use a Phase Advancing Capacitor or Noise Filter

Never to connect a phase advance capacitor or LC/RC noise filter to the output circuit. Doing so may result in damage to the Inverter or cause other parts to burn.

### ● Do Not Use an Electromagnetic Switch or Magnetic Contactor

Do not connect an electromagnetic switch or magnetic contactor to the output circuit. If a load is connected to the Inverter during running, an inrush current will actuate the overcurrent protective circuit in the Inverter.

● **Installing a Thermal Relay**

This Inverter has an electronic thermal protection function to protect the motor from overheating. If, however, more than one motor is operated with one Inverter or multi-polar motor is used, always install a thermal relay (THR) between the Inverter and the motor and set n033 to 0 (no thermal protection). In this case, program the sequence so that the magnetic contactor on the input side of the main circuit is turned off by the contact of the thermal relay.

● **Installing a Noise Filter on Output Side**

Connect a noise filter to the output side of the Inverter to reduce radio noise and induction noise.

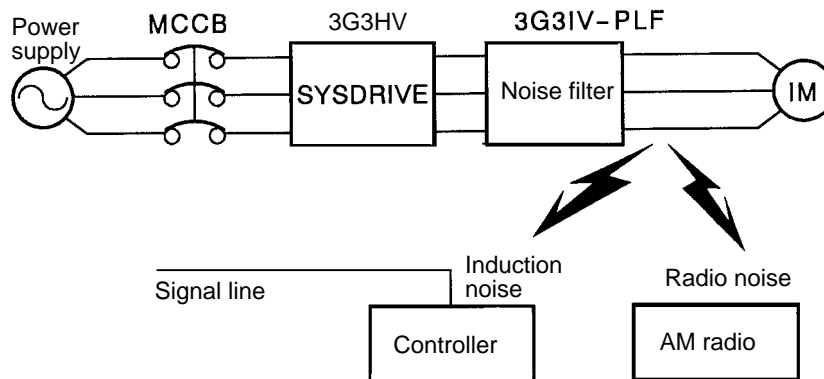

Induction Noise: Electromagnetic induction generates noise on the signal line, causing the controller to malfunction.  
 Radio Noise: Electromagnetic waves from the Inverter and cables cause the broadcasting radio receiver to make noise.

● **Countermeasures Against Induction Noise**

As described previously, a noise filter can be used to prevent induction noise from being generated on the output side. Alternatively, cables can be routed through a grounded metal pipe to prevent induction noise. Keeping the metal pipe at least 30 cm away from the signal line considerably reduces induction noise.

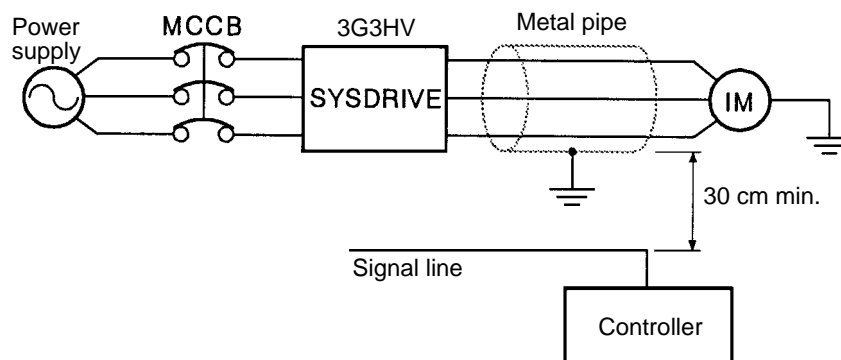

● Countermeasures Against Radio Interference

Radio noise is generated from the Inverter as well as the input and output lines. To reduce radio noise, install noise filters on both input and output sides, and also install the Inverter in a totally enclosed steel box. The cable between the Inverter and the motor should be as short as possible.

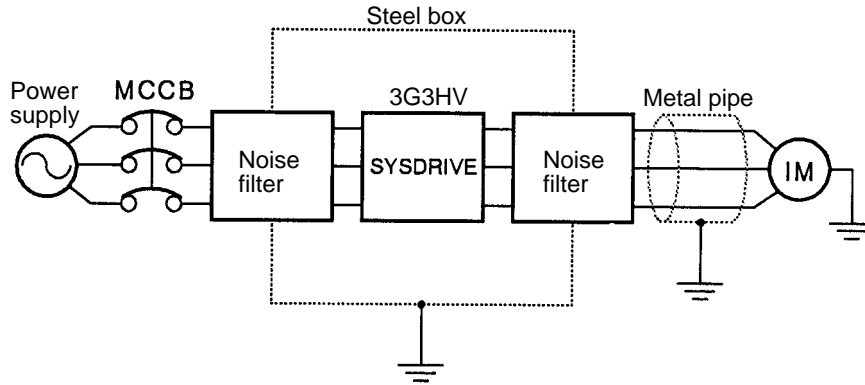

● Cable Length between Inverter and Motor

As the cable length between the Inverter and the motor is increased, the floating capacity between the Inverter outputs and the ground is increased proportionally. The increase in floating capacity at the Inverter outputs causes the high-frequency leakage current to increase, and this may adversely affect peripheral devices and the current detector in the Inverter’s output section. To prevent this from occurring, use a cable of no more than 100 meters between the Inverter and the motor. If the cable must be longer than 100 meters, take measures to reduce the floating capacity by not wiring in metallic ducts, by using a separate cable for each phase, and so on.

Also adjust the carrier frequency according to the cable length between the Inverter and the motor, as shown in the table below.

Cable length	50 m max.	100 m max.	More than 100 m
Carrier frequency (n050)	15 kHz max. (6 max.)	10 kHz max. (4 max.)	5 kHz max. (2 max.)

**Note** The carrier frequency setting range varies depending on the Inverter capacity.

200-V class, 22 kW max.; 400-V class, 22 kW max.: 0.4 to 15.0 kHz

200-V class, 30 to 75 kW; 400-V class, 30 to 160 kW: 0.4 to 10.0 kHz

400-V class, 185 to 300 kW: 0.4 to 2.5 kHz

● Single-phase Motors Cannot Be Used

The Inverter is not suited for the variable speed control of single-phase motors.

Single-phase motors are either capacitor start motors or split-phase start motors. (The method for determining rotation direction at startup is different.) If a capacitor start motor is used, the capacitor may be damaged by a sudden electric discharge caused by Inverter output. If a split-phase start motor is used, the starting coil may burn because the centrifugal switch does not operate.

■ Ground Wiring

- Always use the ground terminal of the 200-V Inverter with a ground resistance of less than 100 Ω and that of the 400-V Inverter with a ground resistance of less than 10 Ω.
- Do not share the ground wire with other devices such as welding machines or power tools.
- Always use a ground wire that complies with technical standards on electrical equipment and minimize the length of the ground wire.  
Leakage current flows through the Inverter. Therefore, if the distance between the ground electrode and the ground terminal is too long, potential on the ground terminal of the Inverter will become unstable.
- When using more than one Inverter, be careful not to loop the ground wire.

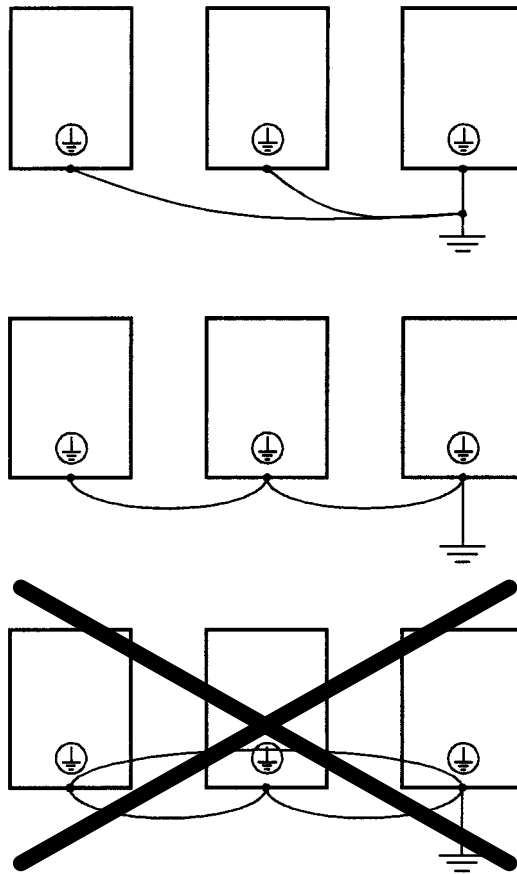



■ Countermeasures against Harmonics

With the continuing development of electronics, the generation of harmonics from industrial machines has been causing problems recently. Refer to the following for the definition of harmonics (i.e., harmonic currents with voltages) and countermeasures against the generation of harmonics from the Inverter.

● Harmonics (Harmonic Currents with Voltages)

● Definition

Harmonics consist of electric power produced from AC power and alternating at frequencies that are integral multiples of the frequency of the AC power.

The following are the harmonic frequencies of a 60- or 50-Hz commercial power supply.

Second harmonic: 120 (100) Hz

Third harmonic: 180 (150) Hz

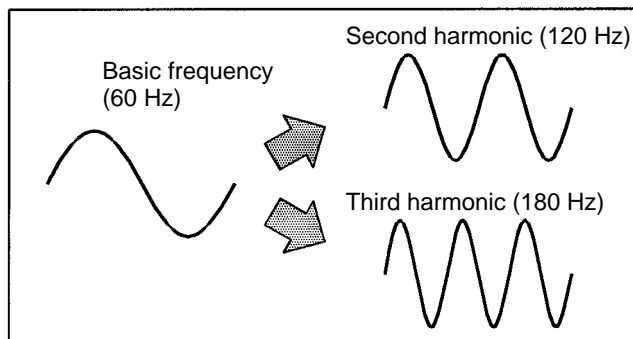

● Problems Caused by the Harmonics Generation

The waveform of commercial power supply will be distorted if the commercial power supply contains excessive harmonic currents.

Machines with such a commercial power supply will malfunction or generate excessive heat.

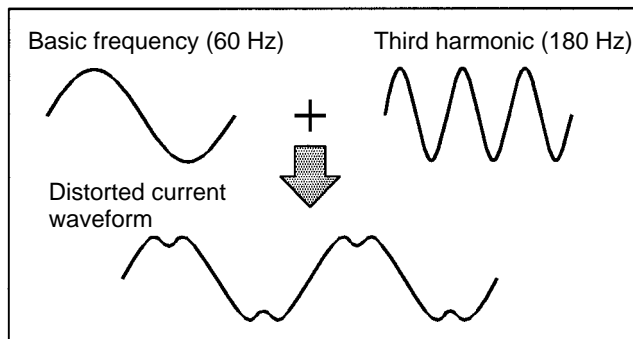

● Causes of Harmonics Generation

Usually, electric machines have built-in circuitry that converts commercial AC power supply into DC power. Such AC power, however, contains harmonics due to the difference in current flow between AC and DC.

● Obtaining DC from AC using Rectifiers and Capacitors

DC voltage is obtained by converting AC voltage into a pulsating one-side voltage with rectifiers and smoothing the pulsating one-side voltage with capacitors. Such AC, however, contains harmonics.

• **Inverter**

The Inverter as well as normal electric machines has an output current containing harmonics because the Inverter converts AC into DC.

The output current of the Inverter is comparatively high. Therefore, the ratio of harmonics in the output current of the Inverter is higher than that of any other electric machine.

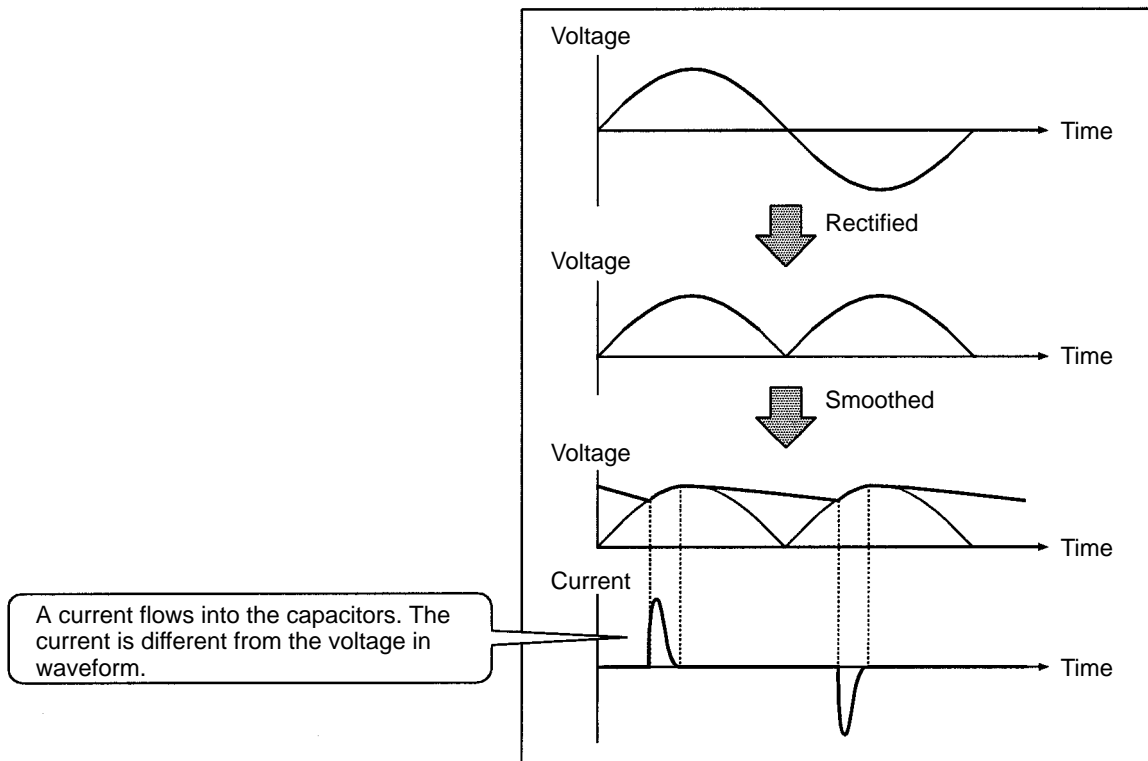

• **Countermeasures with Reactors against Harmonics Generation**

• **DC/AC Reactors**

The DC reactor and AC reactor suppress harmonics and currents that change suddenly and greatly. The DC reactor suppresses harmonics better than the AC reactor. The DC reactor used with the AC reactor suppresses harmonics more effectively.

The input power factor of the Inverter is improved by suppressing the harmonics in the input current of the Inverter.

**Note** 18.5- to 160-kW Inverters have a built-in DC reactor.

185- to 300-kW Inverters cannot use a DC reactor.

• **Connection**

Connect the DC reactor to the internal DC power supply of the Inverter after shutting off the power supply to the Inverter and making sure that the charge indicator of the Inverter turns off.

**! WARNING** Do not touch the internal circuitry of the Inverter in operation, otherwise an electric shock or a burn injury may occur.

• **Wiring Method**  
**With DC Reactor**

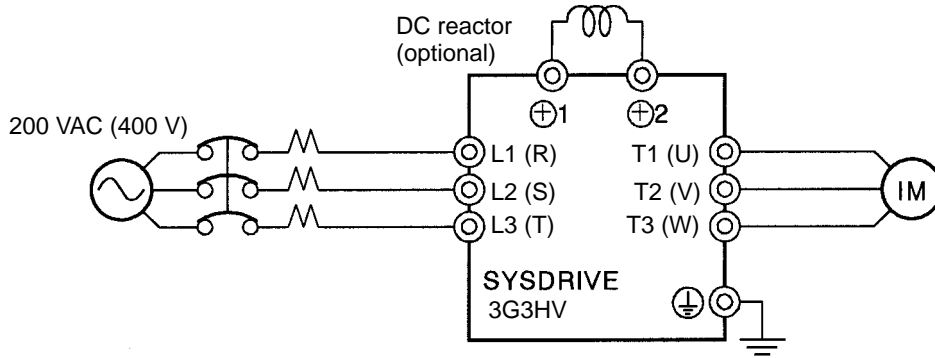

**Note** Be sure to remove the short bar on terminals +1 and +2 before connecting the DC reactor.

**With DC and AC Reactors**

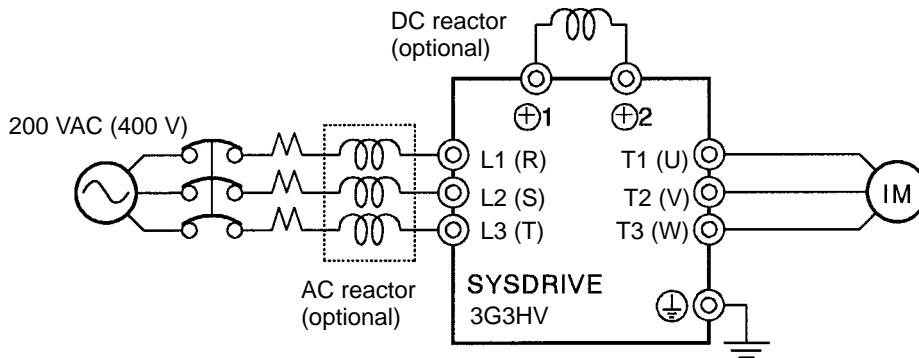

**Note** Be sure to remove the short bar on terminals +1 and +2 before connecting the DC reactor.

• **Reactor Effects**

Harmonics are effectively suppressed when the DC reactor is used with the AC reactor as shown in the following table.

Harmonic suppression method	Harmonic generation rate (%)							
	5th harmonic	7th harmonic	11th harmonic	13th harmonic	17th harmonic	19th harmonic	23th harmonic	25th harmonic
No reactor	65	41	8.5	7.7	4.3	3.1	2.6	1.8
AC reactor	38	14.5	7.4	3.4	3.2	1.9	1.7	1.3
DC reactor	30	13	8.4	5	4.7	3.2	3.0	2.2
DC and AC reactors	28	9.1	7.2	4.1	3.2	2.4	1.6	1.4

● Countermeasures with 12-pulse Rectification against Harmonics Generation

● 12-pulse Rectification

The 3G3HV-series Inverter with an output of 18.5 to 160 kW can employ 12-pulse rectification, which suppresses harmonics better than reactors. The 3G3HV-series Inverter with an output of 15 kW or less and 185 kW or more cannot employ 12-pulse rectification.

● Wiring Method

1. Terminals L1 (R) and L11 (R1), L2 (S) and L21 (S1), and L3 (T) and L31 (T1) are short-circuited with short bars before shipping. Be sure to remove the short bars when employing 12-pulse rectification, otherwise the Inverter will break down.
2. Do not ground the secondary winding side of the transformer, otherwise the Inverter may break down.

With Input Transformer for 12-pulse Rectification

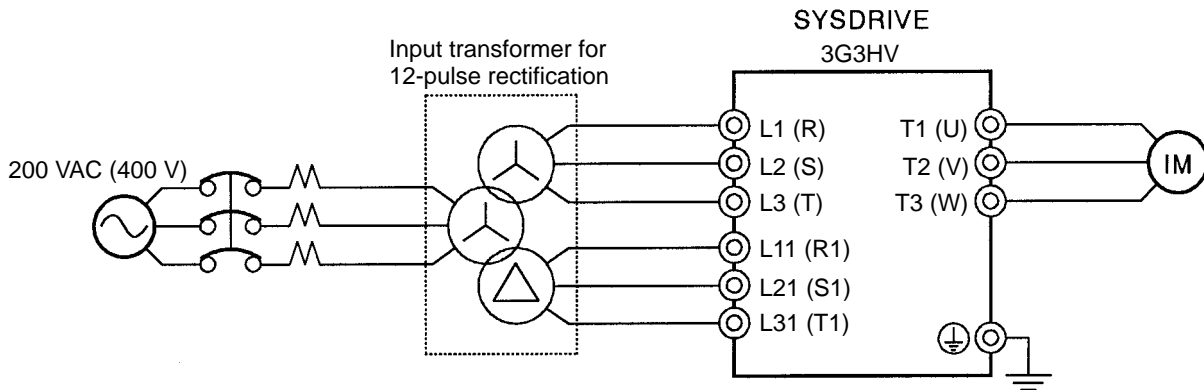

With Standard Transformers for 12-pulse Rectification

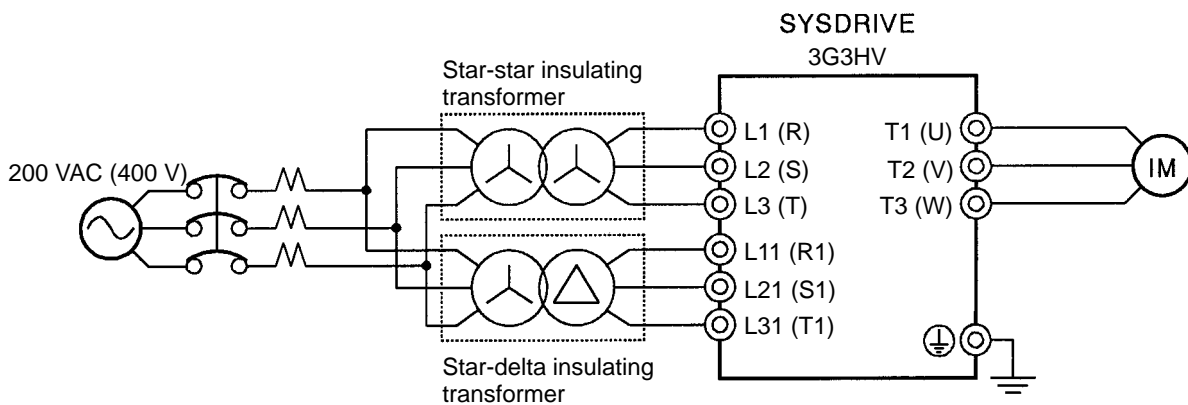

**Note** Use insulating transformers.

• **Input Transformers for 12-pulse Rectification**

Refer to the following table to select the input transformer for 12-pulse rectification. Refer to the minimum currents on the secondary winding side in the table when selecting two standard transformers used in combination for 12-pulse rectification.

Inverter model 3G3HV-	Input voltage (V)	Minimum current on the primary winding side (A)	Minimum current on the secondary winding side (A)
B2185	I/O voltage ratio: 1:1 200 to 230 V ±10%/ 200 to 230 V ±10% at 50/60 Hz	100	50
B2220		120	60
B2300		164	82
B2370		200	100
B2450		230	115
B2550		280	140
B2750		380	190
B4185		I/O voltage ratio: 1:1 380 to 460 V ±10%/ 380 to 460 V ±10% at 50/60 Hz	52
B4220	66		33
B4300	82		41
B4370	100		50
B4450	120		60
B4550	180		80
B4750	206		103
B411K	280		140
B416K	380		190

• **12-pulse Rectification Effect**

Harmonics are suppressed effectively with 12-pulse rectification as shown in the following table.

Harmonic suppression method	Harmonic generation rate (%)							
	5th harmonic	7th harmonic	11th harmonic	13th harmonic	17th harmonic	19th harmonic	23th harmonic	25th harmonic
No reactor	65	41	8.5	7.7	4.3	3.1	2.6	1.8
12-pulse rectification	5.43	5.28	5.40	5.96	0.69	0.19	1.49	1.18

■ **Braking Resistor Unit and Braking Unit**

- Connect the Braking Resistor Unit and Braking Unit to the Inverter as shown in the following.
- Set n079 to 0 (i.e., no overheating protection of the Braking Resistor Unit) and n070 to 0 (i.e., no decelerating stall prevention) before using the Inverter with the Braking Resistor Unit connected.

**Note 1.** Set n079 to 0 before operating the Inverter with the Braking Resistor Unit without thermal relay trip contacts.

**Note 2.** The Braking Resistor Unit cannot be used and the deceleration time cannot be shortened by the Inverter if n070 is set to 1 (i.e., decelerating stall prevention).

- To prevent the Unit from overheating, make a power supply sequence as shown below or connect the thermal relay trip output of the Unit to the remote error input terminal of the Inverter to interrupt the operation of the Inverter.
- The Braking Resistor Unit or Braking Unit cannot be connected to the Inverter with an output of 18.5 kW to 160 kW.

• 200-V Class with 3.7- to 7.5-kW Output and 400-V Class with 3.7- to 15-kW Output

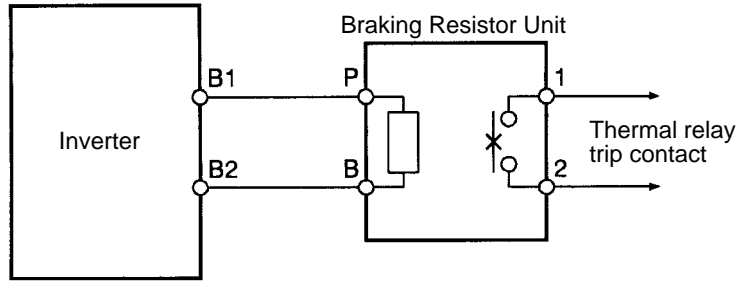

• 200-V Class with 11- to 15-kW Output and 400-V Class with 185- to 300-kW Output

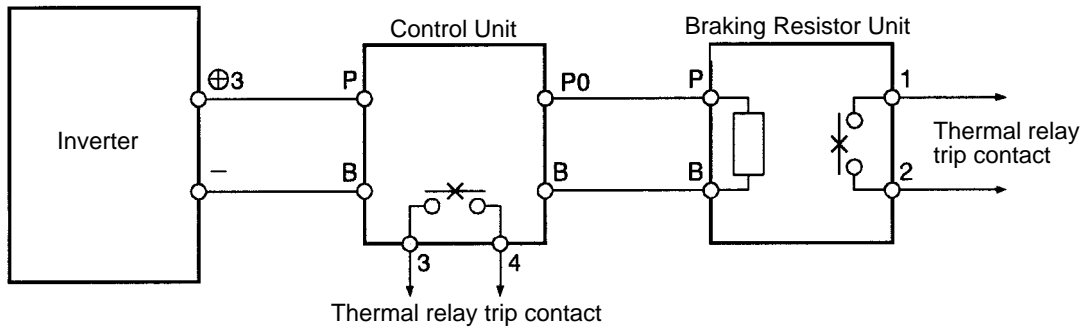

• Connecting Braking Units in Parallel

When connecting two or more Braking Units in parallel, use the wiring and connectors shown in the following diagram. There are connectors for selecting whether each Braking Unit is to be a Master or Slave. Select “Master” for the first Braking Unit only; select “Slave” for all other Braking Units (i.e., from the second Unit onwards).

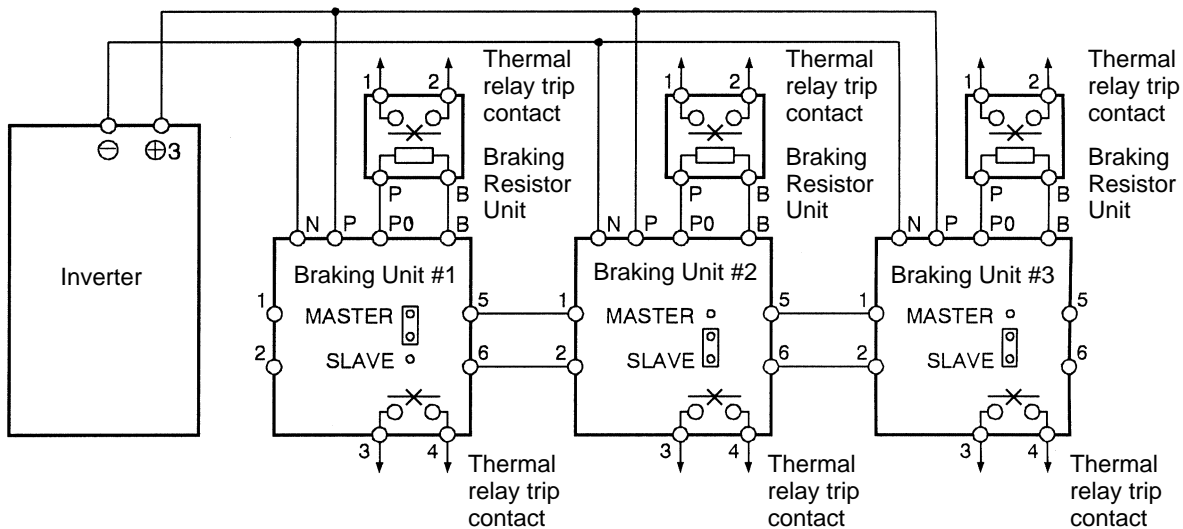

● Power Supply Sequence

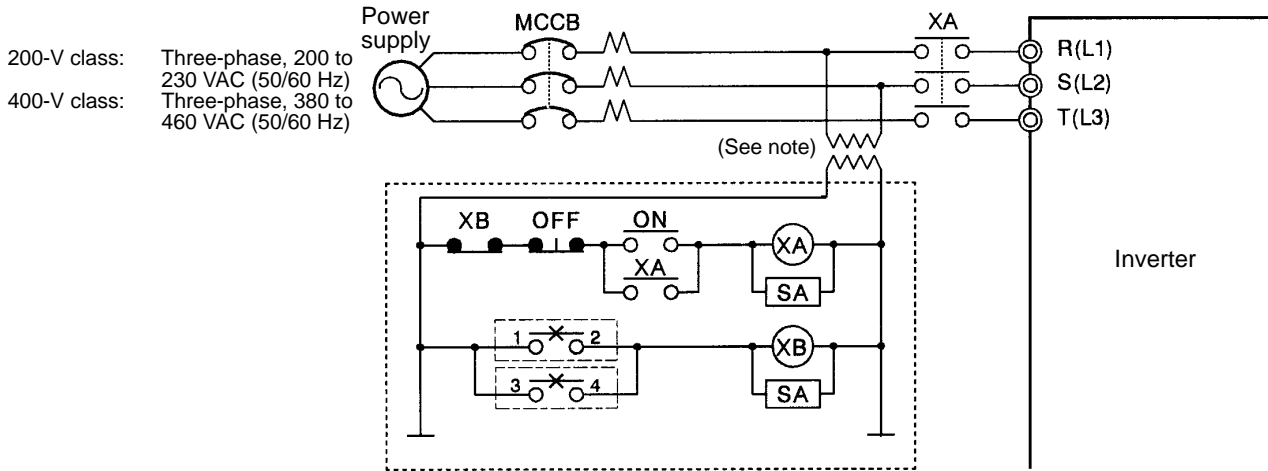

**Note** Use a transformer with 200- and 400-V outputs for the power supply of the 400-V Inverter.

### 2-2-5 Wiring Control Circuit Terminals

A control signal line must be 50 m maximum and separated from power lines. The frequency reference must be input to the Inverter through twisted-pair wires.

■ Wire Size and Solderless Terminals

Use thick wires to prevent voltage drops if the wires are long.

● Wires for All Inverter Models

Terminal	Terminal screw	Wire thickness (mm <sup>2</sup> )	Type
S1, S2, S3, S4, S5, S6, SC, FV, FI, FS, FC, AM, AC, M1, M2, MA, MB, MC	---	Stranded wire: 0.5 to 1.25 Single wire: 0.5 to 1.25	Shielded, twisted-pair wire Shielded, polyethylene-covered, vinyl sheath cable
E (G)	M3.5	0.5 to 2	

● Solderless Terminals for Control Circuit Terminals

The use of solderless terminals for the control circuit terminals is recommended because solderless terminals are easy to connect securely.

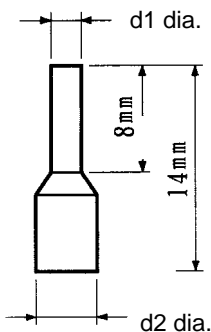

Wire thickness	Model	d1	d2	Manufacturer
0.5 mm <sup>2</sup>	A1 0.5-8WH	1.00	2.60	Phoenix Contact
0.75 mm <sup>2</sup>	A1 0.75-8GY	1.20	2.80	
1 mm <sup>2</sup>	A1 1-8RD	1.40	3.00	
1.5 mm <sup>2</sup>	A1 1.5-8BK	1.70	3.50	

**Note** Do not solder wires with the control circuit terminals if wires are used instead of solderless terminals. Wires may not contact well with the control circuit terminals or the wires may be disconnected from the control circuit terminals due to vibration if the wires are soldered.

● **Round Solderless Terminals for Ground Terminal**

Wire thickness (mm <sup>2</sup> )	Terminal screw	Size
0.5	M3.5	1.25 to 3.5
0.75		1.25 to 3.5
1.25		1.25 to 3.5
2		2 to 3.5

■ **Wiring Control Circuit Terminals**

● **Wiring Method**

1. Loosen the terminal screws with a thin-slotted screwdriver.
2. Insert the wires from underneath the terminal block.
3. Tighten the terminal screws firmly.

**Note 1.** Always separate the control signal line from the main circuit cables and other power cables.

**Note 2.** Do not solder the wires to the control circuit terminals. The wires may not contact well with the control circuit terminals if the wires are soldered.

**Note 3.** The end of each wire connected to the control circuit terminals must be stripped for approximately 7 mm.

**Note 4.** Use a shielded wire for the ground terminal.

**Note 5.** Insulate the shield with tape so that the shield will not touch any signal line or device.

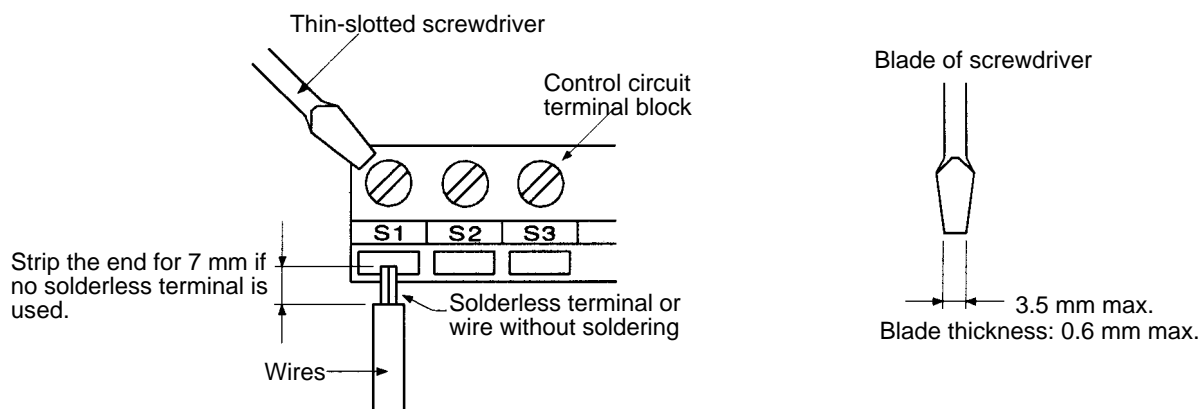

**Note** Tighten screws to a torque between 0.5 and 0.6 N•m. Tightening to a torque greater than this may cause the terminal block to be damaged. Tightening to a torque less than this may result in malfunction or short-circuiting.



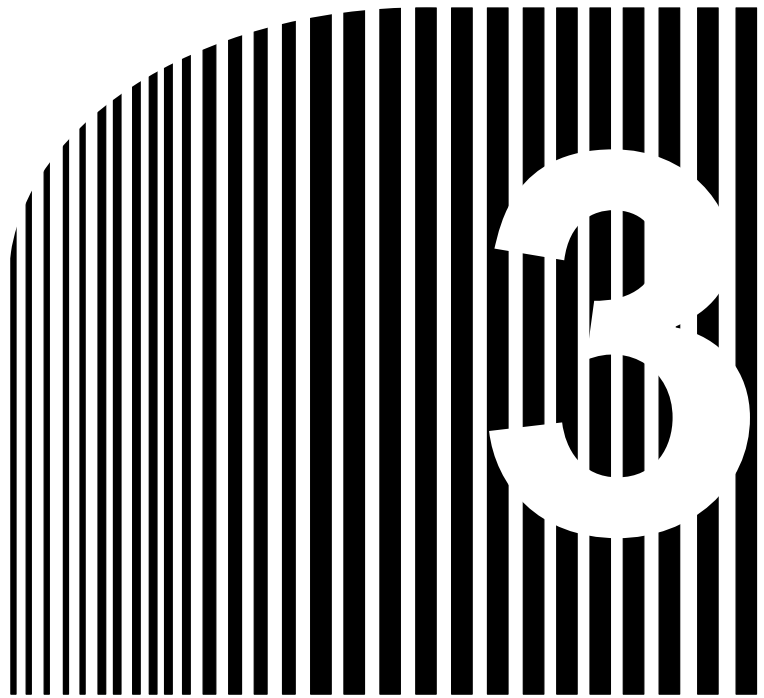













## Chapter 3

### • Preparing for Operation •

- 3-1 Preparation Procedure
- 3-2 Using the Digital Operator
- 3-3 Test Run
- 3-4 Basic Operation
- 3-5 Applied Operation

■ Cautions and Warnings

-  **WARNING** Turn ON the input power supply only after mounting the front cover, terminal covers, bottom cover, Operator, and optional items. Not doing so may result in electrical shock.
-  **WARNING** Do not remove the front cover, terminal covers, bottom cover, Operator, or optional items while the power is being supplied. Not doing so may result in electrical shock or damage to the product.
-  **WARNING** Do not operate the Operator or switches with wet hands. Doing so may result in electrical shock.
-  **WARNING** Do not touch the inside of the Inverter. Doing so may result in electrical shock.
-  **WARNING** Do not come close to the machine when using the error retry function because the machine may abruptly start when stopped by an alarm. Doing so may result in injury.
-  **WARNING** Do not come close to the machine immediately after resetting momentary power interruption to avoid an unexpected restart (if operation is set to be continued in the processing selection function after momentary power interruption is reset). Doing so may result in injury.
-  **WARNING** Provide a separate emergency stop switch because the STOP Key on the Operator is valid only when function settings are performed. Not doing so may result in injury.
-  **WARNING** Be sure confirm that the RUN signal is turned OFF before turning ON the power supply, resetting the alarm, or switching the LOCAL/REMOTE selector. Doing so while the RUN signal is turned ON may result in injury.
-  **Caution** Be sure to confirm permissible ranges of motors and machines before operation because the Inverter speed can be easily changed from low to high. Not doing so may result in damage to the product.
-  **Caution** Provide a separate holding brake when necessary. Not doing so may result in injury.
-  **Caution** Do not perform a signal check during operation. Doing so may result in injury or damage to the product.
-  **Caution** Do not carelessly change settings. Doing so may result in injury or damage to the product.

---

## **3-1 Preparation Procedure**

---

### 1. Installation

Install the Inverter according to installation conditions. Refer to *page 2-7*.

- Check that all the installation conditions are met.

### 2. Wiring

Connect the power supply and peripheral devices. Refer to *page 2-10*.

- Select peripheral devices that meet the specifications, and wire them correctly.

### 3. Turning the Power ON

Check the necessary items, then turn the power ON.

- Check that the power voltage is correct and the power input terminals (L1 (R), L2 (S), and L3 (T)) are wired correctly. Supply three-phase, 200 to 230 VAC (50/60 Hz) to the 200-V Inverter and three-phase 380 to 460 VAC (50/60 Hz) to the 400-V Inverter.
- Check that the motor output terminals (T1 (U), T2 (V), and T3 (W)) and motor are connected correctly.
- Check that the control circuit terminals and controller are connected correctly.

### 4. Checking the Display Status

Check the Inverter for errors.

- If everything is normal, the data display will show the data selected with a monitor item indicator.
- If the Inverter is error, the data display will show data indicating that the Inverter is error. Refer to *Section 4 Operation* for details.

### 5. Setting the Parameters

Use the Digital Operator to set parameters required for operation. Refer to *page 3-4*.

- Set each parameter as described in this manual.

### 6. Test RUN

Use the Digital Operator to rotate the motor. Refer to *page 3-10*.

- Check that the motor is rotating normally.

### 7. Operation

Basic operation (The Inverter operates with basic settings). Refer to *page 3-13*.

Applied operation (The Inverter performs energy-saving control, PID control, or other applied control). Refer to *page 3-25*.

- Refer to *3-4 Basic Operation* for operation with basic parameters only.
- Refer to *3-4 Basic Operation* and *3-5 Applied Operation* for energy-saving control, PID control, frequency jumping, error retrying, or S-shaped acceleration and deceleration.
- Refer to *3-5 Applied Operation* for parameters in detail.

## 3-2 Using the Digital Operator

### 3-2-1 Nomenclature

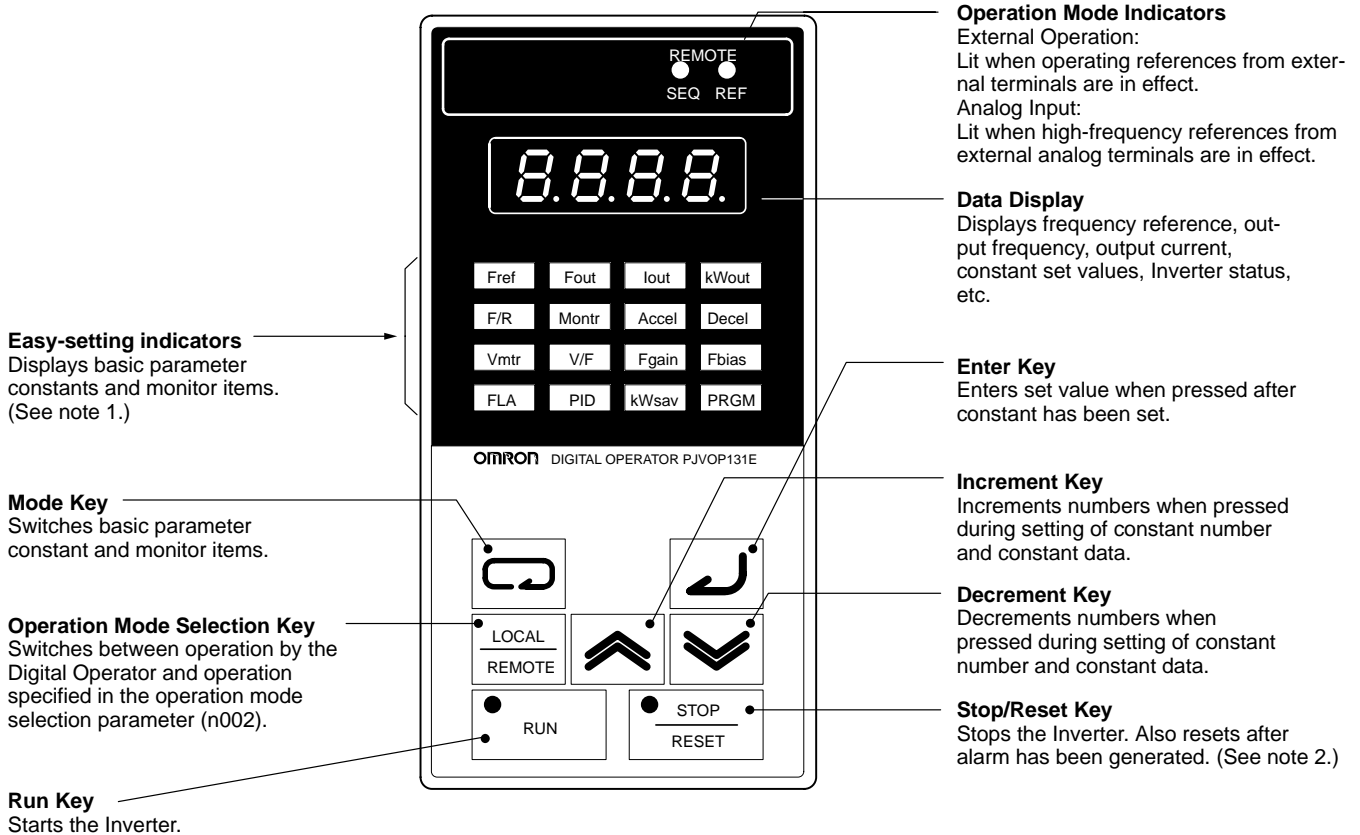

**Note 1.** The Inverter does not start while any indicator on the bottom two lines is lit. To start the Inverter, press the Mode Key to light up an indicator on the top two lines and press the RUN Key.

**Note 2.** For safety reasons, the reset function cannot be used while the run command (forward/reverse) is being input. Turn the run command OFF before using the reset function.

### 3-2-2 Summary

#### ■ Data Display

Press the Mode Key to select the item displayed on the data display.  
 The items on the first two lines of the monitor item indicators can be set or monitored while the Inverter is running.  
 All the items of the monitor item indicators can be set or monitored while the Inverter is not running.

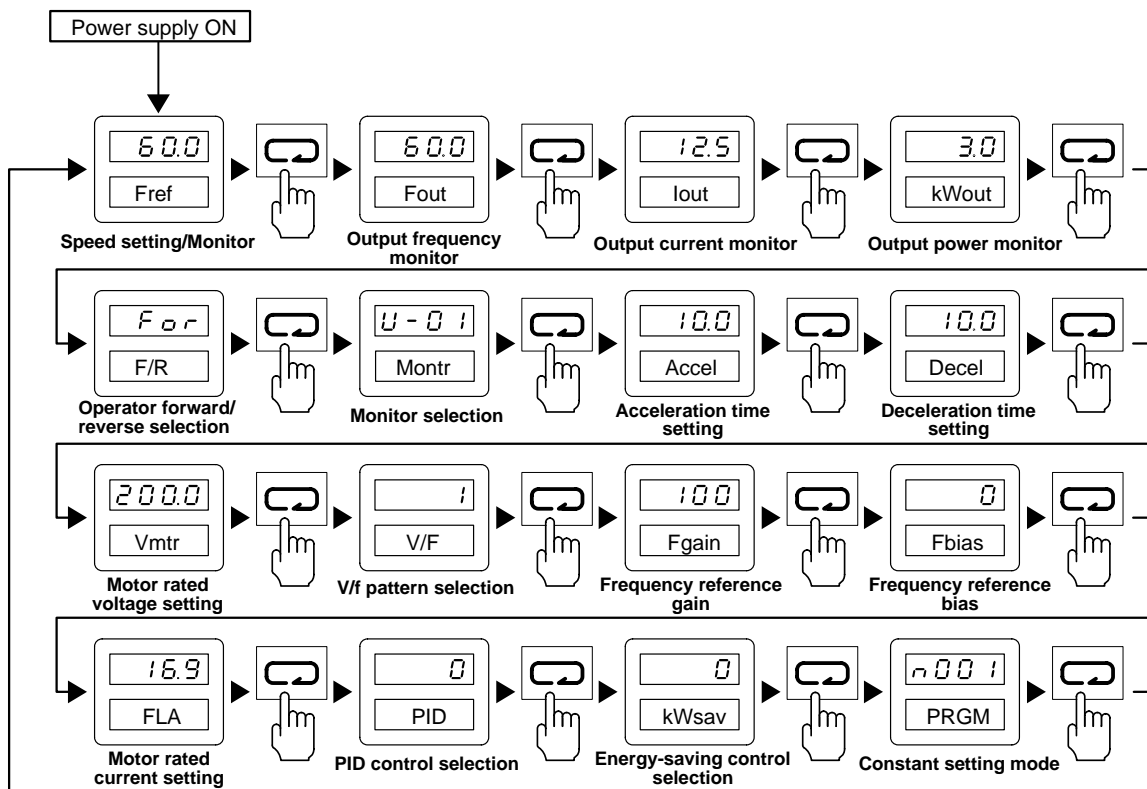

**Note** The following items can be set or monitored with the monitor item indicators.

<b>Indicator</b>	<b>Item</b>	<b>Function</b>
Fref	Speed setting/Monitor	The frequency reference can be set or monitored. The unit to be used can be set with n024.
Fout	Output frequency monitor	The output frequency can be monitored. The setting unit can be set with n024.
Iout	Output current monitor	The output current can be monitored in 0.1-A units.
kWout	Output power monitor	The output power can be monitored in 0.1-kW units.
F/R	Operator forward/reverse selection	The forward or reverse rotation of the motor can be set or checked. This item can be set with the Digital Operator only.
Montr	Monitor selection	Thirteen items can be monitored.
Accel	Acceleration time setting	Acceleration time 1 can be set or checked with n019 in 1-s units if acceleration time 1 is set to 1,000 or a larger value and 0.1-s units if acceleration time 1 is set to a value less than 1,000.
Decel	Deceleration time setting	Deceleration time 1 can be set or checked with n020 in 1-s units if the deceleration time is set to 1,000 or a larger value and 0.1-s units if the deceleration time is set to a value less than 1,000.
Vmtr	Motor rated voltage setting	The rated input voltage of the motor can be set with n011 while the Inverter is not running.
V/F	V/f pattern selection	The V/f pattern can be set with n010 while the Inverter is not running.
Fgain	Frequency reference gain	The frequency reference gain can be set with n046 while the Inverter is not running.
Fbias	Frequency reference bias	The frequency reference bias can be set with n047 while the Inverter is not running.
FLA	Motor rated current setting	The rated input current of the motor can be set with n032 while the Inverter is not running.
PID	PID control selection	The PID control function can be selected with n084 while the Inverter is not running.
kWsav	Energy-saving control selection	The energy-saving control function can be selected with n095 while the Inverter is not running.
PRGM	Constant setting mode	All parameters can be set or checked.

■ Parameters

Parameters can be set with the monitor item indicators or by designating the corresponding parameter numbers. Basic parameters can be set with the monitor item indicators. Parameter settings with the monitor item indicators are different in method from parameter settings by designating the corresponding parameter constants.

● Setting Parameter Constants with the Indicators

Example: Changing Acceleration Time From 10 s to 50 s

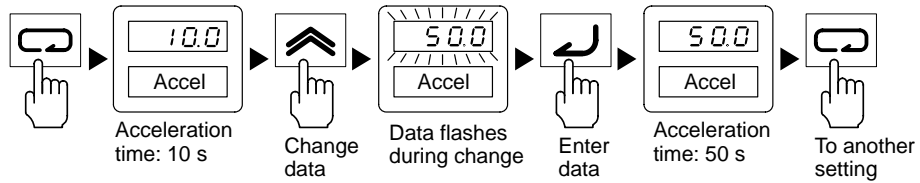

● Setting Parameter Constants by Specifying Parameter Constant Number

Example: Setting Constant No. 025 (Frequency Reference 1)

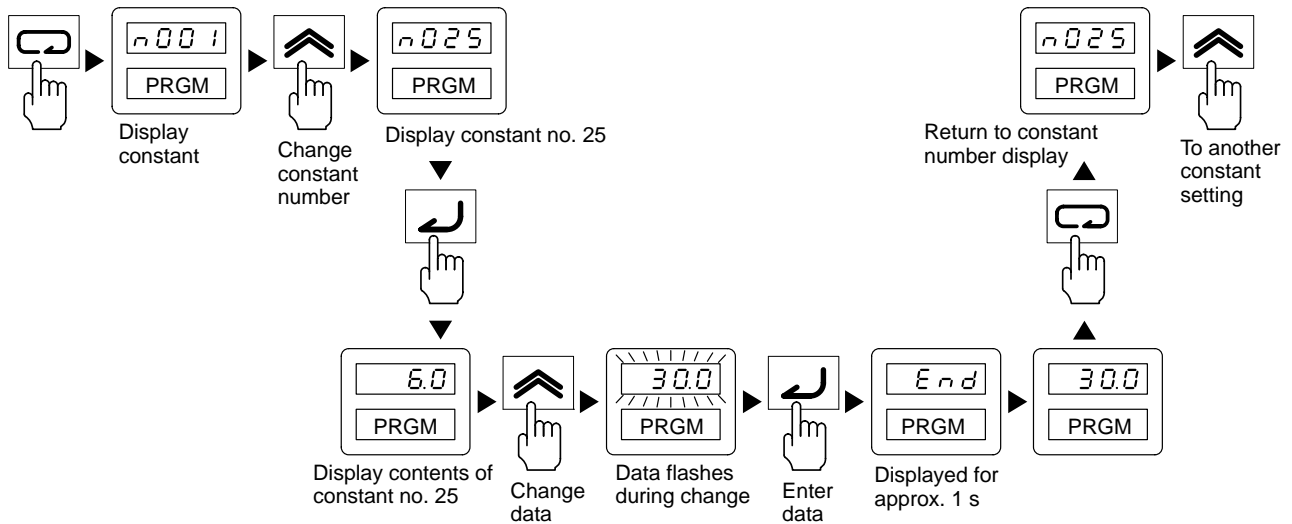

**Note** There are some parameters that cannot be changed while the Inverter is running. To change these parameter, stop the Inverter first.

■ Checking Monitor Contents

Example: Checking Output Voltage (Monitor Item No. U-04)

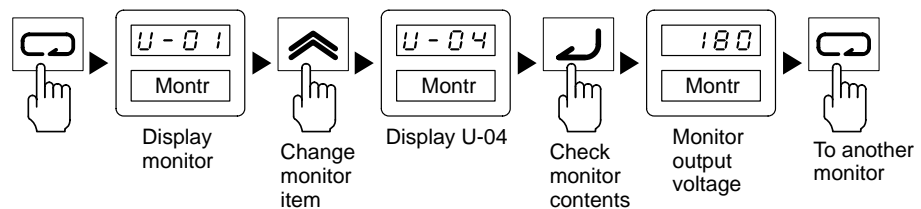

● Monitor Display Table

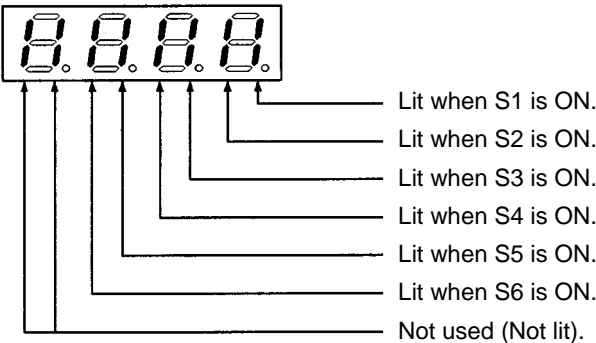
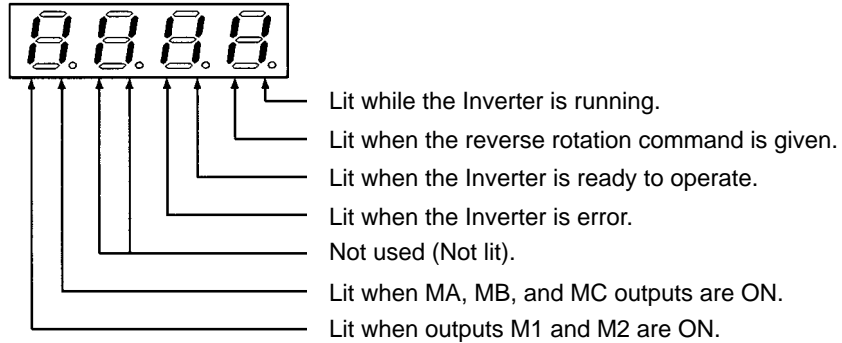
Monitor No.	Monitor item	Description
U-01	Frequency reference	The frequency reference can be monitored. The display unit can be set with n024. The frequency reference can be monitored with the FREF indicator as well.
U-02	Output frequency	The output frequency can be monitored. The display unit can be set with n024. The output frequency can be monitored with the FREQUENCY indicator as well.
U-03	Output current	The output current can be monitored in 0.1-A units. The output current can be monitored with 0.1-A units with the IOUT indicator as well.
U-04	Output voltage	The output voltage can be monitored in 1-V units.
U-05	DC voltage	The DC voltage can be monitored in 1-V units.
U-06	Output power	The output power can be monitored in 0.1-kW units. The output power can be monitored in 0.1-kW units with the POWER indicator as well.
U-07	Input terminal status	<p>The statuses of input terminals S1 to S6 can be monitored.</p> 
U-08	Inverter status	<p>The status of the Inverter can be monitored.</p> 
U-09	Error before power interruption	The four most-recent errors before the power supplied to the Inverter is turned OFF can be checked.
U-10	PROM number	For the manufacturer's use.
U-11	Total operating time (rightmost 4 digits)	<p>The accumulated operating time can be monitored with 1-h units. The maximum value is 279,620 h.                      Accumulated operating time (h) = U-12 value x 10,000 + U-11 value</p>
U-12	Total operating time (leftmost 2 digits)	
U-13	PID feedback value	The PID feedback can be monitored in 0.1-Hz units.

■ Operation Mode Selection Key/Operation Mode Selection Input

The operation mode of the Inverter can be changed using the Operation Mode Selection Key on the Digital Operator. Using this key, it is possible to switch between the two operation modes shown below.



The same kind of switching is also possible with control circuit terminals set using the multi-function input parameters 1 to 5 (set value: 5).

Operation mode	Description	Contents
Remote	Inverter operates according to control signals from a higher level control system.	Run commands and frequency references determined by the setting of the operation mode selection parameter (n002).
Local	Inverter operates alone in order to check operation directly related to the Inverter.	Run commands: RUN and STOP/RESET Keys. Frequency reference: Value set with the Digital Operator. <b>Note</b> Performs operation for a operation mode selection parameter value (n002) of 0.

**Note 1.** The operation mode will always be Remote mode when power is supplied. Therefore, to start operation immediately after power is supplied, set n002 to the required settings in advance.

**Note 2.** If n002 is set to 0, there is no difference in the two modes.

**Note 3.** Frequencies set from the Digital Operator using the speed setting will be entered in frequency reference parameters 1 to 4 (n025 to n028) or the inching frequency reference parameter (n029) regardless of whether the mode is Remote mode or Local mode.

**Note 4.** Multi-function inputs 1 to 5 will be enabled regardless of whether the mode is Remote mode or Local mode. The following settings, however, will be disabled in Local mode.

- Reverse rotation/stop (2-wire sequence selection); Set value: 0
- Stop command (3-wire sequence selection); Set value: 1

**Note 5.** For safety reasons, run signals input while changing from Local mode to Remote mode are usually ignored. Input the run signal again after the mode has changed. It is possible, however, to stop such run signals being ignored by setting the Operation Selection at Operation Mode switching (Local/Remote switching) parameter (n114) to 1. If this setting is made, when the mode changes from Local mode to Remote mode, the Inverter will start running immediately. Take steps to ensure the safety of the system for such operation.

### 3-3 Test Run

After wiring is complete, perform a test run of the Inverter. First, start the motor through the Digital Operator without connecting the motor to the mechanical system. Next, connect the motor to the mechanical system and perform a test run. Finally, operate the controller to make sure that the sequence of operations is correct. Refer to the following to perform a test run of the Inverter.

#### 1. Wiring

- Check that power is connected to power input terminals L1 (R), L2 (S), and L3 (T).  
Supply three-phase, 200 to 230 VAC (50/60 Hz) to the 200-V Inverter and three-phase 380 to 460 VAC (50/50 Hz) to the 400-V Inverter.
- Check that terminals T1 (U), T2 (V), and T3 (W) are correctly connected to the motor power cables.
- Do not load the motor with a mechanical system. Check that the motor has no load.
- Check that the forward/stop and reverse/stop inputs are OFF before connecting signal lines to the control circuit terminals.

#### 2. Turning Power ON and Checking Indicator Display

- Supply power to the Inverter.
- Check that the data display is not showing any error.

#### 3. Parameter Initialization

- Set n001 to 6 to initialize all parameters.

Key	Indicator	Data example	Explanation
Mode Key	PRGM	n001	Press the Mode Key until the PRGM indicator is lit.
Enter Key	PRGM	1	Check that “n001” is displayed and press the Enter Key so that the data of n001 will be displayed. If “n001” is not displayed, press the Increment Key or Decrement Key so that “n001” will be displayed. Then press the Enter Key.
Up/Down Key	PRGM	6 (Flashing)	Press the Increment Key or Decrement Key so that “6” will be displayed, in which case the data display will flash.
Enter Key	PRGM	End	Press the Enter Key. “End” will appear for approximately 1 s.
	PRGM	1	After “End” appears, n001 will be initialized and “1” will be displayed.
Mode Key	PRGM	n001	Press the Mode Key so that “n001” will be displayed.

#### 4. Rated Input Voltage of Motor

- Set the rated input voltage of the motor with the Digital Operator.
- The 200-V Inverter is set to 200.0 V and the 400-V Inverter is set to 400.0 V as rated input voltages of motors before shipping.

- Check the rated input voltage of the motor and set the rated input voltage of the motor.

Example: Motor with Rated Input Voltage of 180 V

Key	Indicator	Data example	Explanation
Mode Key	Vmtr	200.0	Press the Mode Key until the MOTOR VOLTAGE indicator is lit.
Down Key	Vmtr	180.0 (Flashing)	Press the Increment Key so that "180.0" will be displayed, in which case the data display will flash.
Enter Key	Vmtr	180.0	Press the Enter Key.

5. Rated Input Current of Motor

- Set the rated input current of the motor with the Digital Operator.
- The default-set value varies with the Inverter model.
- Check the rated input current of the motor and set the rated input current.

Example: Motor with Rated Input Current of 8.5 A

Key	Indicator	Data example	Explanation
Mode Key	FLA	14.1	Press the Mode Key until the MOTOR CURRENT indicator is lit.
Down Key	FLA	8.5 (Flashing)	Press the Increment Key so that "8.5" will be displayed, in which case the data display will flash.
Enter Key	FLA	8.5	Press the Enter Key.

6. Frequency Reference

- Set the frequency according to the rotation speed of the motor.
- Press the Mode Key until the FREF indicator is lit, press the Increment Key or Decrement Key to set the frequency, and press the Enter Key.

7. Operation With No Load

- Press the Operation Mode Selection Key.
- Check that the operation mode indicators (i.e., the remote RUN indicator and analog input indicator) are not lit.
- Press the RUN Key to start the motor.
- To change the rotation direction of the motor, press the Mode Key until the F/R indicator is lit, press the Increment Key or Decrement Key to set the rotation direction, and press the Enter Key.

Indicator	Data example	Explanation
F/R	$F_{OR}$	Forward rotation command
	$rE_U$	Reverse rotation command

- Check that the motor is rotating without error vibration or noise after the frequency reference or rotation direction is changed.
- To stop the motor, press the STOP/RESET Key.

8. Mechanical System

- Load the motor with the mechanical system after making sure that the motor rotates normally.
- Before loading the motor with the mechanical system, check that the output of the Inverter is interrupted and the motor stops by pressing the STOP/RESET Key.

9. V/f Pattern

- Set the V/f pattern according to the characteristics of the mechanical system.

- Press the Mode Key until the V/F indicator is lit.
- The following two methods are available to set the V/f pattern.
  - Select one of the fixed 15 V/f patterns preset with the Inverter, in which case set the V/f pattern to 0, 1, 2, 3, 4, 5, 6, 7, 8, 9, A, b, C, d, or E.
  - Set the V/f pattern to F for an optional V/f pattern.
- The following are the fixed V/f patterns preset with the Inverter. Refer to 3-4 Basic Operation for details.

Characteristic	Use	Set value	Specification
General purpose	These V/f patterns are mainly used for general purposes, such as the control of straight conveyor lines. Apply these V/f patterns to the motor if the rotation speed of the motor must change in almost direct proportion to the load factor of the motor.	0	50 Hz
		1	60 Hz
		2	60 Hz. Voltage saturation at 50 Hz.
		3	72 Hz. Voltage saturation at 60 Hz.
Reduced torque	These V/f patterns are mainly used for fan pumps. Apply these V/f patterns to the motor if the rotation speed of the motor must change in square or cube proportion to the load factor of the motor.	4	50 Hz with cube reduction.
		5	50 Hz with square reduction.
		6	60 Hz with cube reduction.
		7	60 Hz with square reduction.
High starting torque	These V/f patterns are usually unnecessary because the Inverter has a full automatic torque boost function to supply enough power to meet the starting torque of the motor.	8	50 Hz with low starting torque.
		9	50 Hz with high starting torque.
		A	60 Hz with low starting torque.
		B	60 Hz with high starting torque.
Constant power operation	These V/f patterns are used to rotate the motor with an output at 60 Hz or more. Apply these V/f patterns to the motor to impose a constant voltage at 60 Hz min. on the motor.	C	90 Hz. Voltage saturation at 60 Hz.
		D	120 Hz. Voltage saturation at 60 Hz.
		E	180 Hz. Voltage saturation at 60 Hz.

- Select a V/f pattern suited to the mechanical system from the above V/f patterns.
- Set the V/f pattern to F for an optional V/f pattern to be determined with n012 to n018. The optional V/f pattern set with the Inverter before shipping is the same as the V/f pattern obtained with the set value 1.

10. Operation with Actual Load

- Be ready to press the STOP/RESET Key for any error operation of the Inverter or the load.
- Use the Digital Operator to operate the Inverter in the same way as the operation of the Inverter with no load.
- Set the frequency reference so that the motor will rotate at an approximately 10% of the rotation speed of the motor in actual operation.
- Set the frequency reference according to the actual rotation speed of the motor after making sure that the mechanical system operates correctly and smoothly.
- Change the frequency reference and the rotation direction of the motor and check that the mechanical system operates without error vibration or noise.

### 3-4 Basic Operation

Refer to the following for the basic settings required to start and stop operating the Inverter. Only these settings are required for the Inverter in basic operation. These settings as well as other settings are required by the Inverter for any applied operation, such as energy-saving control or PID control.

#### ■ Parameter Write Prohibit Selection (n001)

- The parameters used by the Inverter are classified into the following three groups.
  - Group 1: n001 to n034
  - Group 2: n035 to n049
  - Group 3: n050 to n108 (Up to n102 can be used.)
- The Inverter is default-set so that only parameters of group 1 can be set and checked and the parameters of groups 2 and 3 can only be checked.
- The Inverter in basic operation uses the parameters of groups 1 and 2. Therefore, set n001 to 2 or 3 so that these parameters can be checked and set.

n001 Parameter Write Prohibit Selection/Parameter Initialization					
Setting range	0, 1, 2, 3, 6, and 7	Unit	---	Default setting	1

#### Set Values

Set value	Description
0	The parameters n001 can be set and checked and the parameters n002 to n108 can be only checked.
1	The parameters of group 1 (i.e., n001 to n034) can be set and checked and the parameters of groups 2 and 3 (i.e., n035 to n049 and n050 to n108) can be only checked.
2	The parameters of groups 1 and 2 can be set and checked and the parameters of group 3 can only be checked.
3	The parameters of groups 1, 2, and 3 can be set and checked.
6	All parameters will be set to default-set values.
7	All parameters will be initialized with a three-wire sequence.

**Note** Do not set n001 to any value other than the above.

#### ■ Operation Mode Selection (n002)

- The Inverter has four operation modes. Select one of the modes with n002.

n002 Operation Mode Selection					
Setting range	0 to 3	Unit	---	Default setting	3

#### Set Values

Set value	Run command	Frequency reference
0	Digital Operator (RUN/STOP Key)	Digital Operator (Frequency reference 1)
1	Control circuit terminals (Forward/reverse/stop input)	Digital Operator (Frequency reference 1)
2	Digital Operator (RUN/STOP Key)	Control circuit terminals (Analog input)
3	Control circuit terminals (Forward/reverse/stop input)	Control circuit terminals (Analog input)

- Note 1.** Do not set n002 to any value other than the above.
- Note 2.** The frequency reference input according to the operation mode selection setting will be used as frequency reference 1 in multi-step speed operation. If the frequency reference is determined by control circuit terminals, the frequency reference input using the control circuit terminals' analog input will be enabled and the frequency reference 1 parameter setting (n025) will be ignored. (If, however, the mode is changed to Local mode using the Digital Operator, then the value set in n025 will be enabled.)
- Note 3.** Frequency references 2 to 4 (n026 to n028) and the inching frequency reference (n029) used in multi-step speed operation will be determined by the parameter settings, regardless of the operation mode selection setting.

■ **Frequency Reference Type Selection (n042, n046, and n047) through Control Circuit Terminal**

- Select the FV terminal to input the frequency reference within a voltage range from 0 to 10 VDC or the FI terminal to input the frequency reference within a current range from 4 to 20 mA with n042.

<i>n042</i> <b>Analog Frequency Reference Voltage/Current Selection</b>					
<b>Setting range</b>	0, 1	<b>Unit</b>	---	<b>Default setting</b>	0

**Set Values**

Set value	Description
0	The FV terminal can be used for the analog frequency reference within a voltage range from 0 to 10 VDC.
1	The FI terminal can be used for the analog frequency reference. Set the input level with n043.

- Note 1.** The FI terminal is a current input terminal for 4 to 20 mA. The FI terminal can be a voltage input terminal by changing the FI input level with n043 and cutting jumper wire of the PCB. Do not, however, change the FI terminal to a voltage input terminal unless the Inverter is used for PID control.

- Note 2.** Set n042 according to the type of frequency reference.

- Set the frequency reference gain with n046 and the frequency reference bias with n047.

<i>n046</i> <b>Frequency Reference Gain</b>					
<b>Setting range</b>	0 to 200	<b>Unit</b>	%	<b>Default setting</b>	100

<i>n047</i> <b>Frequency Reference Bias</b>					
<b>Setting range</b>	-100 to 100	<b>Unit</b>	%	<b>Default setting</b>	0

**Set Values**

- n046: The frequency for 10-V or 20-mA input can be set in 1% units based on the maximum frequency set with n012 as 100%.

- n047: The frequency for 0-V or 4-mA input can be set in 1% units based on the maximum frequency set with n012 as 100%.

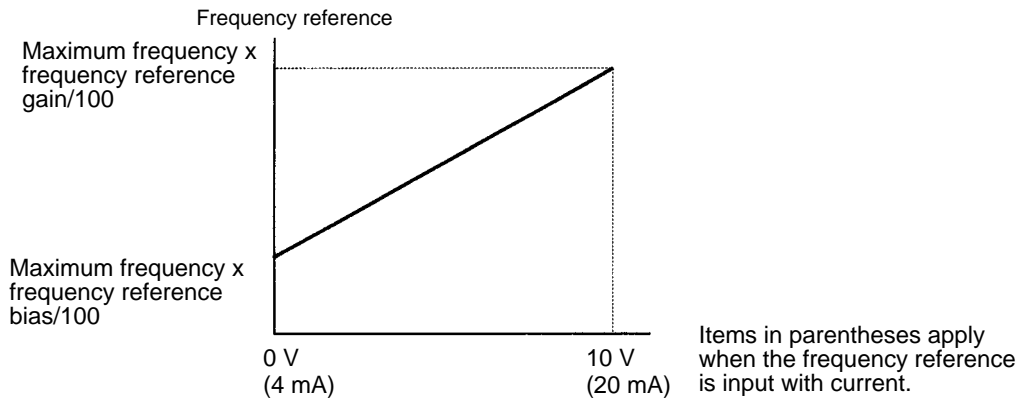

**Note** The frequency reference gain and frequency reference bias can be set with the GAIN indicator and BIAS indicator.

### ■ Frequency Reference Selection (n024 to n029) through Digital Operator

- Frequency references can be input through the Digital Operator by setting the unit of the frequency references with n024 and the values of the frequency references with n025 to n028. The inching frequency reference must be set with n029 if an inching frequency is required.

n024	<b>Unit of Frequency Reference</b>				
<b>Setting range</b>	0 to 3,999	<b>Unit</b>	---	<b>Default setting</b>	0

#### Set Values

Set value	Description
0	0.1-Hz units
1	0.1% units based on the maximum frequency as 100%.
2 to 39	r/min (r/min = 120 x frequency/n024) Set n024 to the number of poles of the motor.
40 to 3,999	Determine the display method of the maximum frequency set with n012. A frequency less than the maximum frequency will be displayed proportionally. Example: Set n024 to 1100 so that "10.0" will be displayed at the maximum frequency. 10.0 → 1100 └─┬─┘ └─┘ Value with no decimal point. Decimal point position

- Set frequency references 1 to 4 with n025 to n028. The multi-step speed command must be selected to use frequency references 2 to 4. Refer to page 3-17, *Multi-function Input Selection (n035 to n039)* for details.

n025	<b>Frequency Reference 1</b>				
<b>Setting range</b>	0 to maximum frequency	<b>Unit</b>	Set with n024	<b>Default setting</b>	6.0

n026	<b>Frequency Reference 2</b>				
<b>Setting range</b>	0 to maximum frequency	<b>Unit</b>	Set with n024	<b>Default setting</b>	0.0

n027	<b>Frequency Reference 3</b>				
<b>Setting range</b>	0 to maximum frequency	<b>Unit</b>	Set with n024	<b>Default setting</b>	0.0

n028	<b>Frequency Reference 4</b>				
<b>Setting range</b>	0 to maximum frequency	<b>Unit</b>	Set with n024	<b>Default setting</b>	0.0

- The inching frequency reference must be set with n029 if an inching frequency is required. The inching command must be selected to use the inching frequency reference. Refer to *page 3-17, Multi-function Input Selection (n035 to n039)* for details.

n029	<b>Inching Frequency Reference</b>				
<b>Setting range</b>	0 to maximum frequency	<b>Unit</b>	Set with n024	<b>Default setting</b>	6.0

■ **Acceleration/Deceleration Time Selection (n019 to n022)**

- Acceleration time and deceleration time can be set with n019 to n022.
- The acceleration/deceleration time switching command must be selected to use acceleration time 2 and deceleration time 2. Refer to *page 3-17, Multi-function Input Selection (n035 to n039)* for details.

n019	<b>Acceleration Time 1</b>				
<b>Setting range</b>	0.0 to 3,600	<b>Unit</b>	s	<b>Default setting</b>	10.0

n020	<b>Deceleration Time 1</b>				
<b>Setting range</b>	0.0 to 3,600	<b>Unit</b>	s	<b>Default setting</b>	10.0

n021	<b>Acceleration Time 2</b>				
<b>Setting range</b>	0.0 to 3,600	<b>Unit</b>	s	<b>Default setting</b>	10.0

n022	<b>Deceleration Time 2</b>				
<b>Setting range</b>	0.0 to 3,600	<b>Unit</b>	s	<b>Default setting</b>	10.0

**Set Values**

- Acceleration time: The time required for the output frequency to be 100% from 0% of the maximum frequency.
- Deceleration time: The time required for the output frequency to be 0% from 100% of the maximum frequency.
- Acceleration time 2 and deceleration time 2 is available if the acceleration/deceleration time switching command is set.

■ **Motor Rotation Direction Selection (n005 and n006)**

- Set the rotation direction of the motor with n005 so that the motor will rotate in the set direction when the forward rotation command is input.



- Set the rotation direction of the motor with n006 so that the motor will rotate in the set direction when the reverse rotation command is input or set n006 so that the reverse rotation command will be ignored.

n005	<b>Forward/Reverse Rotation Selection</b>				
<b>Setting range</b>	0, 1	<b>Unit</b>	---	<b>Default setting</b>	0

**Set Values**

Set value	Description
0	The motor seen from the load side rotates counterclockwise.
1	The motor seen from the load side rotates clockwise.

**Note** The forward/reverse rotation selection setting (n005) is not initialized when the parameter initialization is performed by setting the parameter write prohibit selection/parameter initialization parameter (n001) to 6 or 7. To change this setting, change the value of the parameter directly.

n006	<b>Reverse Rotation-inhibit Selection</b>				
<b>Setting range</b>	0, 1	<b>Unit</b>	---	<b>Default setting</b>	0

**Set Values**

Set value	Description
0	The motor can rotate reversely.
1	The motor cannot rotate reversely.

■ **Multi-function Input Selection (n035 to n039)**

- Set n035 to n039 so that the Inverter can use multi-function input terminals 2 to 6 to perform the following.
  - Three-wire sequential operation
  - Multi-step operation
  - Inching operation
  - Operation using acceleration time 2 and deceleration time 2
- Refer to 3-5-3 List of Parameters for details.

n035	<b>Multi-function Input 1 (S2)</b>				
<b>Setting range</b>	0 to 24	<b>Unit</b>	---	<b>Default setting</b>	0

n036	<b>Multi-function Input 2 (S3)</b>				
<b>Setting range</b>	2 to 24	<b>Unit</b>	---	<b>Default setting</b>	2

n037	<b>Multi-function Input 3 (S4)</b>				
<b>Setting range</b>	2 to 24	<b>Unit</b>	---	<b>Default setting</b>	4

n038	<b>Multi-function Input 4 (S5)</b>				
<b>Setting range</b>	2 to 24	<b>Unit</b>	---	<b>Default setting</b>	9

n039	<b>Multi-function Input 5 (S6)</b>				
<b>Setting range</b>	2 to 25	<b>Unit</b>	---	<b>Default setting</b>	10

**Set Values**

Set value	Description
0	Reverse rotation/Stop (2-wire sequence)
1	Stop command (3-wire sequence). S3 will be used for the forward/reverse rotation command and the value set with n036 will be ignored.
9	Multi-step speed command 1
10	Multi-step speed command 2
11	Inching command
12	Acceleration/Deceleration time switching command

● **Example of Wiring for 2-wire Sequential Operation (Set Value: 0)**

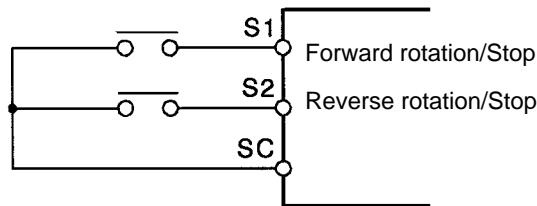

● **Example of Wiring for 3-wire Sequential Operation (Set Value: 1)**

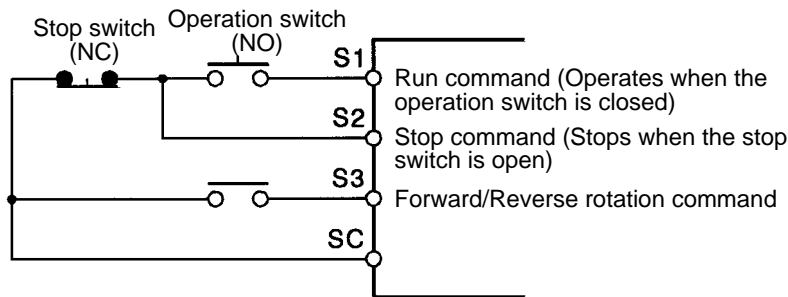

● **Example of Multi-step Operation (Set Values: 9 and 10)**

Select multi-step speed command 1 for the Inverter in two-step speed operation and multi-step speed commands 1 and 2 for the Inverter in four-step speed operation.

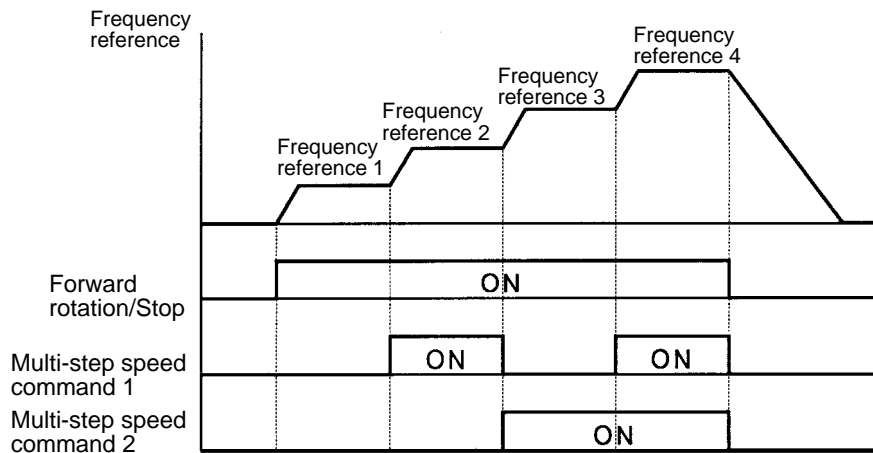

● Example of Inching Operation (Set Value: 11)

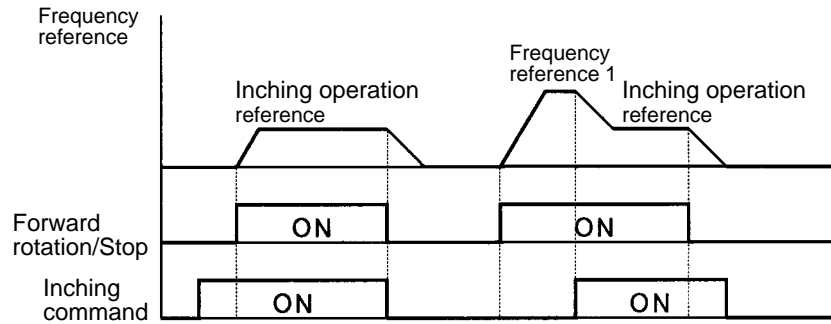

● Example of Acceleration/Deceleration Time Switching (Set Value 12)

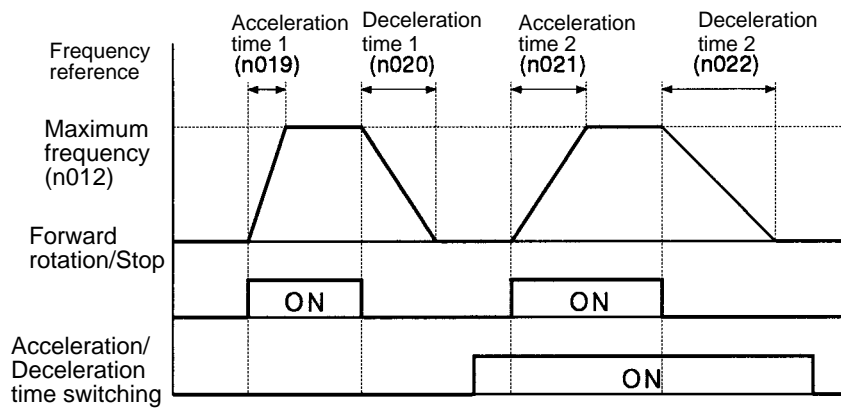

**Note** The acceleration time and deceleration time of the Inverter will be switched the moment the acceleration/deceleration time switching command is input while the Inverter is accelerating or decelerating the motor.

■ V/f Pattern Selection (n010 to n018)

- Set the V/f pattern according to the characteristics of the mechanical system.
- Set the rated input voltage of the motor with n011 according to the rated input voltage of the motor before setting the V/f pattern. This set value will be used to calculate the voltage axis of the V/f pattern.

n011	<b>Motor Rated Voltage</b>				
<b>Setting range</b>	150.0 to 255.0 (510.0)	<b>Unit</b>	V	<b>Default setting</b>	200.0 (400.0)

**Note** The figures in the parentheses apply to the 400-V Inverter.

- Set the V/f pattern.

n010	<b>V/f Pattern Selection</b>				
<b>Setting range</b>	0 to F	<b>Unit</b>	---	<b>Default setting</b>	1

**Set Values**

- The following two methods are available to set the V/f pattern.

- Select one of the 15 V/f patterns preset with the Inverter, in which case set n010 to 0, 1, 2, 3, 4, 5, 6, 7, 8, 9, A, b, C, d, or E.
- Set n010 to F for an optional V/f pattern.
- The following are the V/f patterns preset with the Inverter.

Characteristic	Use	Set value	Specification
General purpose	These V/f patterns are mainly used for general purposes, such as the control of straight conveyor lines. Apply these V/f patterns to the motor if the rotation speed of the motor must change in almost direct proportion to the load factor of the motor.	0	50 Hz
		1	60 Hz
		2	60 Hz. Voltage saturation at 50 Hz.
		3	72 Hz. Voltage saturation at 60 Hz.
Reduced torque	These V/f patterns are mainly used for fan pumps. Apply these V/f patterns to the motor if the rotation speed of the motor must change in square or cube proportion to the load factor of the motor.	4	50 Hz with cube reduction.
		5	50 Hz with square reduction.
		6	60 Hz with cube reduction.
		7	60 Hz with square reduction.
High starting torque	These V/f patterns are usually unnecessary because the Inverter has a full automatic torque boost function to supply enough power to meet the starting torque of the motor.	8	50 Hz with low starting torque.
		9	50 Hz with high starting torque.
		A	60 Hz with low starting torque.
		B	60 Hz with high starting torque.
Constant power operation	These V/f patterns are used to rotate the motor with output at 60 Hz or more. Apply these V/f patterns to the motor to impose a constant voltage at 60 Hz minimum on the motor.	C	90 Hz. Voltage saturation at 60 Hz.
		D	120 Hz. Voltage saturation at 60 Hz.
		E	180 Hz. Voltage saturation at 60 Hz.

- Note 1.** Set n010 so that the Inverter will produce high starting torque only in the following cases.
- The wiring distance between the Inverter and the motor is approximately 150 m or more.
  - The motor requires high starting torque. The motor requires high starting torque if the motor is connected a vertical-axis load.
  - Power is input to or output from the Inverter through an AC or DC reactor.
- Note 2.** The set values of n012 to n018 will change automatically if any of the patterns listed in the above table is selected.
- Note 3.** Refer to the following graphs for the characteristics of the V/f patterns. The maximum voltage shown in each of the graphs is 200 V. The actual voltage, however, corresponds to the set value of n011 (i.e., the rated input voltage of the motor). All voltage values will change in proportion to the set value of n011. For example, the default-set value of n011 of the 400-V Inverter is 400 (V). Therefore, double all the voltage values when using the 400-V Inverter.

Characteristics of V/f Patterns

• General Characteristics (Set Value: 0 to 3)

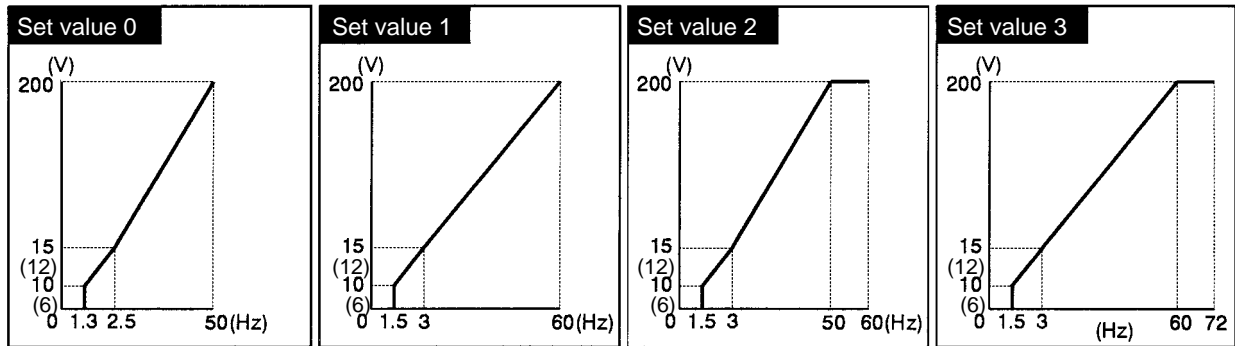

• Reduced Torque Characteristics (Set Value: 4 to 7)

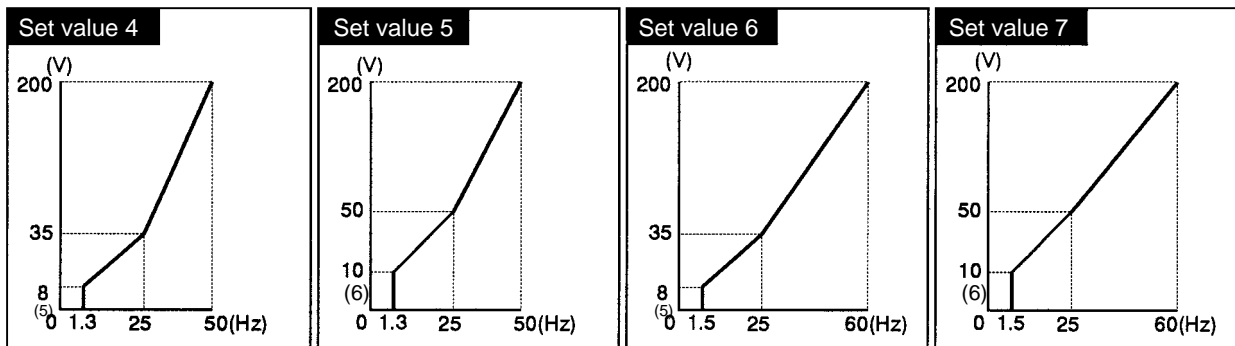

• High Starting Torque Characteristics (Set Value: 8 to b)

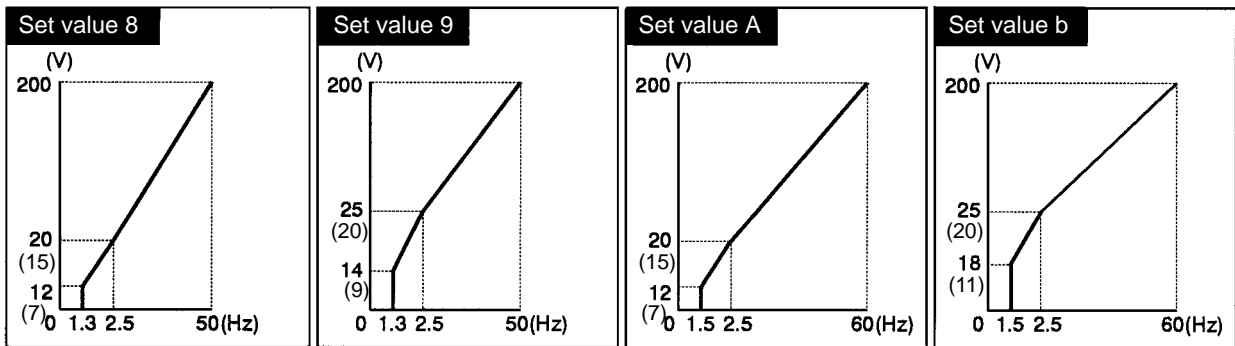

• Constant Power Operation Characteristics (Set Value: C to E)

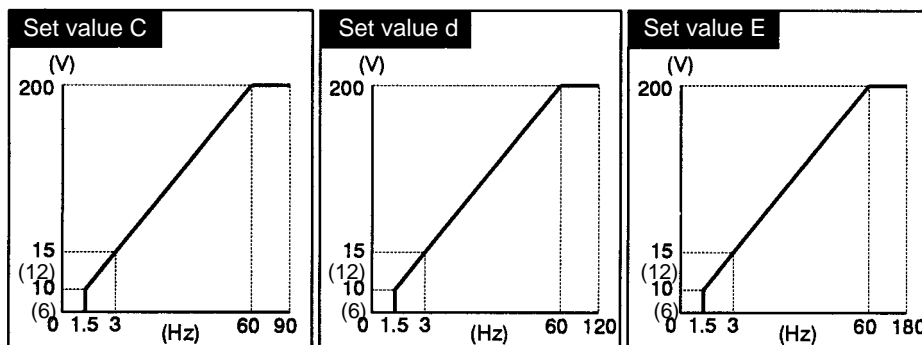

Note Figures in parentheses apply to 55-kW or higher Inverters.

- An optional V/f pattern is available and n012 to n018 can be set if the V/f pattern is set to F.

n012	<b>Maximum Frequency (FMAX)</b>				
<b>Setting range</b>	50.0 to 400.0	<b>Unit</b>	Hz	<b>Default setting</b>	60.0

n013	<b>Maximum Voltage (VMAX)</b>				
<b>Setting range</b>	0.1 to 255.0 (510.0)	<b>Unit</b>	V	<b>Default setting</b>	200.0 (400.0)

n014	<b>Maximum Voltage Frequency (FA)</b>				
<b>Setting range</b>	0.2 to 400.0	<b>Unit</b>	Hz	<b>Default setting</b>	60.0

n015	<b>Intermediate Output Frequency (FB)</b>				
<b>Setting range</b>	0.1 to 399.9	<b>Unit</b>	Hz	<b>Default setting</b>	3.0

n016	<b>Intermediate Output Frequency Voltage (VC)</b>				
<b>Setting range</b>	0.1 to 255.0 (510.0)	<b>Unit</b>	V	<b>Default setting</b>	15.0 (30.0) (See note 2.)

n017	<b>Minimum Output Frequency (FMIN)</b>				
<b>Setting range</b>	0.1 to 10.0	<b>Unit</b>	Hz	<b>Default setting</b>	1.5

n018	<b>Minimum Output Frequency Voltage (VMIN)</b>				
<b>Setting range</b>	0.1 to 50.0 (100.0)	<b>Unit</b>	V	<b>Default setting</b>	10.0 (20.0) (See note 2.)

**Note 1.** Figures in parentheses apply to the 400-V Inverter.

**Note 2.** The default settings for 55-kW or higher Inverters are as follows:

200-V 55-kW or higher Inverters: n016 = 12.0 V, n018 = 6.0 V

400-V 55-kW or higher Inverters: n016 = 24.0 V, n018 = 12.0 V

**Optional V/f Pattern in Detail**

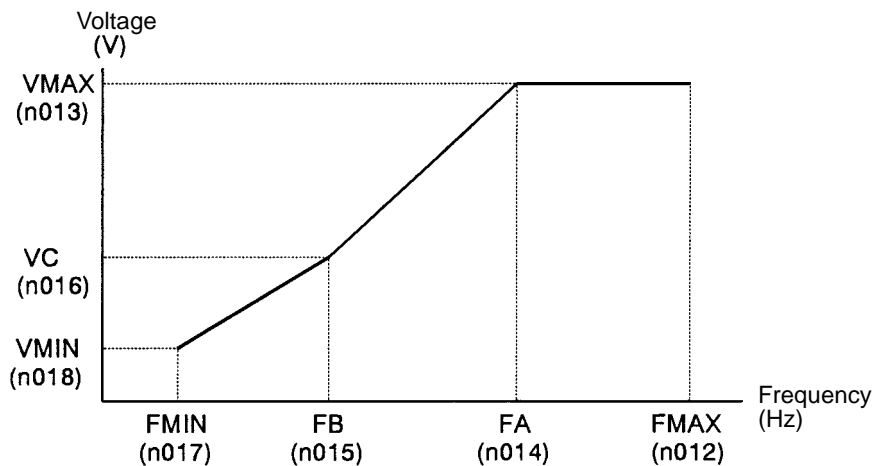

**Note** The V/f pattern is a straight line if there is no difference between n015 and n017 in set value, in which case the set value of n016 will be ignored.

■ **Interruption Mode and Protective Function Selection (n003, n004, n008, n032, and n033)**

- Set the input voltage of the Inverter to determine the voltage protective level of the Inverter.

n003	<b>Input Voltage Selection</b>				
<b>Setting range</b>	150.0 to 255.0 (510.0)	<b>Unit</b>	V	<b>Default setting</b>	200.0 (400.0)

- Set the stop mode of the Inverter with n004.

n004	<b>Interruption Mode Selection</b>				
<b>Setting range</b>	0 to 3	<b>Unit</b>	---	<b>Default setting</b>	0

**Set Values**

Set value	Description
0	Deceleration stop (See notes 1 and 2.)
1	Free running stop (See note 3.)
2	Free running stop 1 with timer. The run command during acceleration time 1 or 2 will be ignored.
3	Free running stop 2 with timer. The constant run command is valid. The motor will start running after deceleration time 1 or 2 passes.

**Note 1.** If multi-function inputs 1 to 5 (n035 to n039) are not set to acceleration/deceleration time switching command (set value: 12), the motor will decelerate to a stop according to the setting of deceleration time 1 (n020). If any one of the multi-function inputs is set to acceleration/deceleration time switching command, then the motor will decelerate according to the deceleration time selected at the time the stop signal is input.

**Note 2.** If a run signal is input while the motor is decelerating, deceleration will stop and the motor will accelerate at the same rate.

**Note 3.** During free running stop, do not input the run signal if the speed at which the motor is rotating has not dropped sufficiently. If the run signal is input in this state, the motor will be decelerated to a low frequency very rapidly, and an overvoltage and overcurrent will be detected. In this case, use free running stop (1 or 2) with timer, and set deceleration times that will ensure that the speed of the motor has reduced sufficiently. (In either case, the motor will not start running before the deceleration time has passed.)

To start running during free running stop, turn ON speed search for one of the multi-function inputs 1 to 5 (n035 to n039). Speed search will detect when the motor has reached an appropriate speed to start running.

- Set n008 so that the STOP/RESET Key will function properly.

n008	<b>Stop Key Function Selection</b>				
<b>Setting range</b>	0, 1	<b>Unit</b>	---	<b>Default setting</b>	1

**Set Values**

Set value	Description
0	The STOP/RESET Key will function only when the Inverter is running with the run command through the Digital Operator.
1	The STOP/RESET Key will be available anytime.

- Set the rated input current of the motor with n032 and the electronic thermal protective function with n033 to determine the motor protective characteristics.

<i>n032</i>	<b>Motor Rated Current</b>				
<b>Setting range</b>	See note 1	<b>Unit</b>	---	<b>Default setting</b>	1

**Note 1.** The set value range is from 10% to 200% of the rated output current.

**Note 2.** The default-set value varies with the Inverter model.

**Note 3.** Be sure to set n032 after checking the rated input current of the motor.

<i>n033</i>	<b>Electronic Thermal Protection Function Selection</b>				
<b>Setting range</b>	0 to 4	<b>Unit</b>	---	<b>Default setting</b>	1

**Set Values**

<b>Set value</b>	<b>Description</b>
0	No protection.
1	For standard motors with standard ratings (with a time constant of 8 min).
2	For standard motors with short-time ratings (with a time constant of 5 min).
3	For dedicated motors with standard ratings (with a time constant of 8 min).
4	For dedicated motors with short-time ratings (with a time constant of 5 min).



---

## 3-5 Applied Operation

---

### 3-5-1 Energy-saving Mode

---

---

The Inverter in energy-saving mode will automatically save unnecessary power supply to the motor if the load is light and the motor is a standard motor or dedicated motor for inverters.

The Inverter in energy-saving mode will estimate the load factor of the motor from the current consumption of the motor and controls the output voltage to supply only necessary power if the load is light. Energy-saving mode is appropriate for loads with little fluctuation. It is not appropriate for control that requires a response time of less than 50 ms. The longer the energy-saving time of the Inverter is, the more effectively the power supplied to the load is saved. The power supplied to the load will be hardly saved if the load exceeds 70% of the rated output torque of the motor.

The Inverter in energy-saving mode cannot save unnecessary power supply to special motors, such as spindle motors and submersible motor.

Refer to the following for the settings of the Inverter enabling it to perform energy-saving control.

---

---

#### ■ Energy-saving Control

The following are the energy-saving control steps of the Inverter.

1. The Inverter starts accelerating the motor normally. The Inverter does not perform energy-saving control while the Inverter is accelerating the motor.
2. The Inverter will perform energy-saving control when the output frequency corresponds to the frequency specified by the frequency reference.
3. The Inverter calculates the ideal output voltage from the running condition of the Inverter and the energy-saving coefficient K2 set with n096.
4. The output voltage is changed to the ideal output voltage.
5. The Inverter uses the auto-tuning function (search operation) to find the minimum output power that the Inverter supplies to the motor.

Auto-tuning function (search operation):

Finds the minimum output power that the Inverter supplies to the motor by changing the output voltage with the auto-tuning voltage steps set with n101 and n102.

6. The Inverter starts decelerating the motor normally. The Inverter does not perform energy-saving control while the Inverter is decelerating the motor.

The most efficient input voltage imposed on the motor varies with the load factor of the motor. The Inverter in energy-saving mode calculates the ideal output voltage and adjusts the ideal output voltage so that the actual power supplied to the motor can be minimized.

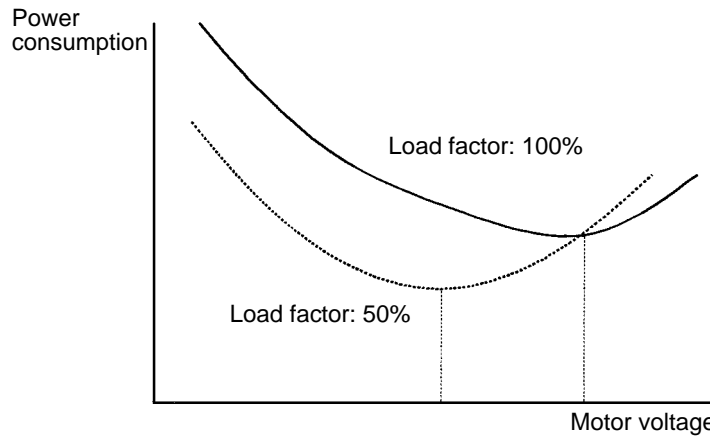

■ Energy-saving Control Settings

n095	<b>Energy-saving Control Selection</b>				
<b>Setting range</b>	0, 1	<b>Unit</b>	---	<b>Default setting</b>	0

**Set Values**

Set value	Description
0	Inhibits the Inverter from performing energy-saving control.
1	Permits the Inverter to perform energy-saving control.

**Note** Set n095 to 1 so that the Inverter will perform energy-saving control.

n096	<b>Energy-saving Coefficient K2</b>				
<b>Setting range</b>	0.00 to 655.0	<b>Unit</b>	---	<b>Default setting</b>	See note

**Note** The default-set value of n096 varies with the Inverter model.

**Set Values**

- Set the K2 value according to the capacity of the motor.
- The K2 value of each Inverter model is set to the following before shipping according to the maximum capacity of the motor that can be connected to the Inverter model.

200-V class		400-V class	
Capacity of motor (kW)	Energy-saving coefficient K2 (n096)	Capacity of motor (kW)	Energy-saving coefficient K2 (n096)
0.4	288.2	0.4	576.4
0.75	223.7	0.75	447.4
1.5	169.4	1.5	338.8
2.2	156.8	2.2	313.6
3.7	122.9	3.7	245.8
5.5	94.75	5.5	189.5
7.5	72.69	7.5	145.4
11	70.44	11	140.9
15	63.13	15	126.3
18	57.87	18	115.7
22	51.79	22	103.6
30	46.27	30	92.54
37	38.16	37	76.32
45	35.78	45	71.56
55	31.35	55	67.20
75	23.10	75	46.20
---	---	110	36.23
		160	30.13
		185	30.57
		220	27.13
		300	21.76

**Note 1.** The above K2 values are for standard motors and dedicated motors for inverters. The Inverter in energy-saving mode cannot save unnecessary power supply to high-speed motors (e.g., spindle motors) or any other motor that has an efficiency curve with more than one peak (e.g., any double squirrel-cage motor).

**Note 2.** The Inverter performs energy-saving control at 15 to 120 Hz. The Inverter does not perform energy-saving control at a frequency exceeding 120 Hz.

n100	Search Control Voltage Limit				
<b>Setting range</b>	0 to 100	<b>Unit</b>	% (Rated input voltage ratio of motor)	<b>Default setting</b>	0

**Set Values**

- Set the range of the variable voltage of the Inverter in search operation mode with 1% units based on the rated input voltage of the motor set with n011 as 100%.
- The value of n100 is usually set to a range from 0 to 20%. Usually n100 is set to 10%.
- The search operation will not be available if n100 is set to 0.

n097	Energy-saving Voltage Lower Limit for 60 Hz				
<b>Setting range</b>	0 to 120	<b>Unit</b>	% (Rated input voltage ratio of motor)	<b>Default setting</b>	50

<i>n098</i>	<b>Energy-saving Voltage Lower Limit for 6 Hz</b>				
<b>Setting range</b>	0 to 25	<b>Unit</b>	% (Rated input voltage ratio of motor)	<b>Default setting</b>	12

**Set Values**

- Set the lower output voltage limits of the Inverter in energy-saving mode.
- It is usually unnecessary to change the default-set values of n097 and n098.
- The parameters n097 and n098 set the lower output voltage limits of the Inverter to prevent the motor from stalling.
- Set n097 and n098 to values 5% to 10% larger than the default-set values if the motor stalls.

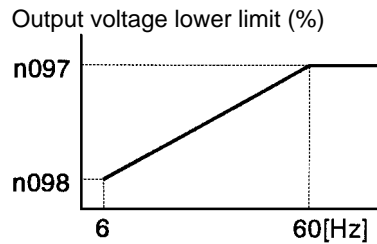

<i>n099</i>	<b>Mean Power Time</b>				
<b>Setting range</b>	1 to 200	<b>Unit</b>	x 25 ms	<b>Default setting</b>	1

**Set Values**

- Set time to calculate the mean output power of the Inverter in energy-saving mode.
- It is usually not necessary to change the default-set value of n099.
- The Inverter calculates its mean output power during the time set with n099 for the energy-saving control of the motor.
- The time set with n099 is used as a search operation period, in which the output voltage of the Inverter in search operation mode changes.
- Set n099 to a value larger than the default-set value if the load factor of the motor changes greatly or the friction factor of the load is large and the motor vibrates.

<i>n101</i>	<b>Search Operation Control Voltage Step when 100%</b>				
<b>Setting range</b>	0.1 to 10.0	<b>Unit</b>	% (Rated input voltage ratio of motor)	<b>Default setting</b>	0.5

<i>n102</i>	<b>Search Operation Control Voltage Step when 5%</b>				
<b>Setting range</b>	0.1 to 10.0	<b>Unit</b>	% (Rated input voltage ratio of motor)	<b>Default setting</b>	0.2

**Set Values**

- The values set with n101 and n102 are used as voltage change rates, at which the output voltage of the Inverter in search operation mode changes.
- It is usually not necessary to change the default-set values of n101 and n102.

- A voltage change rate can be set according to the output voltage of the Inverter.
- Set n101 and n102 to values smaller than the default-set values if it is necessary to minimize the speed ripples of the motor.

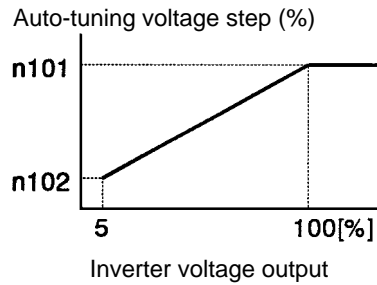

**■ Effective Energy-saving Control**

Take the following steps to check whether the Inverter in energy-saving mode is saving unnecessary power supply to the motor.

**1. Output Power**

Press the ENERGY SAVE Key and POWER Key to check whether the output power of the Inverter in energy-saving mode is lower than that of the Inverter not in energy-saving mode.

**2. Motor**

Check that the motor does not stall or vibrate error when the Inverter performs energy-saving control.

**■ Troubleshooting of Energy-saving Control Problems**

If the Inverter in energy-saving mode stalls the motor, vibrates the motor, or does not save unnecessary power supply to the motor, refer to the following table to check the probable cause of the trouble and take countermeasures against the trouble. Running conditions of the motor may inhibit the Inverter from performing effective energy-saving control.

Problem	Probable cause	Remarks
Output power does not change	Inverter is running at a frequency exceeding 120 Hz	The Inverter does not save unnecessary power supply to the motor while the Inverter is running at a frequency exceeding 120 Hz.

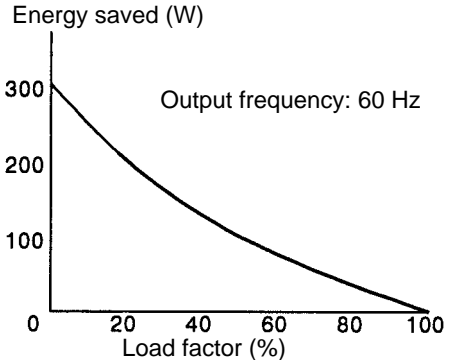
Problem	Probable cause	Remarks
<p>Inverter does not perform effective energy-saving control</p>	<p>Load factor of the motor is too large</p>	<p>The Inverter does not perform effective energy-saving control if the load factor of the motor is too large.</p> <p>Reference: Energy-saving control of motor with 7.5-kW output</p> 
<p>Constantly rotating motor drops its rotation speed for a moment</p>	<p>Value of the energy-saving coefficient K2 is too small and the ideal output voltage calculated by the Inverter is low</p>	<p>Set K2 with n096 according to the capacity of the motor.</p> <p>Reset K2 to the value for the capacity of a motor one rank lower than the motor in use if the same trouble occurs after K2 is set according to the capacity of the motor.</p>
<p>Motor vibrates or does not rotate smoothly when the load is light</p>	<p>Mechanical system is resonating with the Inverter</p>	<p>Set the mean power time with n099 to a larger value.</p>
<p>Motor stalls</p>	<p>Output voltage is too small</p>	<p>Set the lower output voltage limits with n097 and n098 to larger values.</p> <p>Set the energy-saving coefficient K2 with n096 to a larger value.</p> <p>Reset K2 to the value for the capacity of a motor one rank lower than the motor in use if the same trouble occurs after K2 is set according to the capacity of the motor.</p>
<p>Motor changes its rotation speed periodically in synchronization with the mean power time</p>	<p>Speed ripples are generated by the search operation voltage change rates</p>	<p>Set the values of n101 and n102 to smaller values.</p> <p>Set the search operation voltage limit with n100 to 0 so that the search operation function will not work.</p>
<p>Motor is overloaded only when the Inverter performs energy-saving control although the weight of the load is the same as or less than the rated output torque of the motor</p>	<p>Search operation function is not working and the output voltage is high</p>	<p>Set the search operation voltage limit with n100 to a smaller value.</p> <p>Set the search operation voltage limit with n100 to 0 so that the search operation function will not work.</p>

### 3-5-2 PID Control

PID (proportional, integral, and derivative) control is a method to control a mechanical system by making the feedback values obtained from the mechanical system agree with the set point that has been preset.

This method makes it possible to control a mechanical system that has dead time.

The Inverter is not suitable for PID control that requires a response time of 50 ms or less. Refer to the following for examples of PID control that can be performed by the Inverter as well as the operation of PID control in detail and the settings and adjustments of the parameters.

#### ■ Examples of PID Control

Refer to the following for examples of PID control that can be performed by the Inverter.

Application	Control	Required sensor
Speed control	The Inverter uses the feedback of speed data of the mechanical system and makes the operation speed of the mechanical system agree with the set point.  The Inverter controls the mechanical system in synchronization with another mechanical system that inputs its speed data as the set point to the Inverter.	Tachometric generator
Pressure control	The Inverter performs constant pressure control with the feedback of pressure data.	Pressure sensor
Flow control	The Inverter performs flow control with the feedback of flow data.	Flow sensor
Temperature control	The Inverter performs temperature control using fans with the feedback of temperature data.	Thermocouple Thermistor

#### ■ PID Control Operation

The following graph shows control output (output frequency) changes with a constant deviation (i.e., the difference between the set point and feedback is constant).

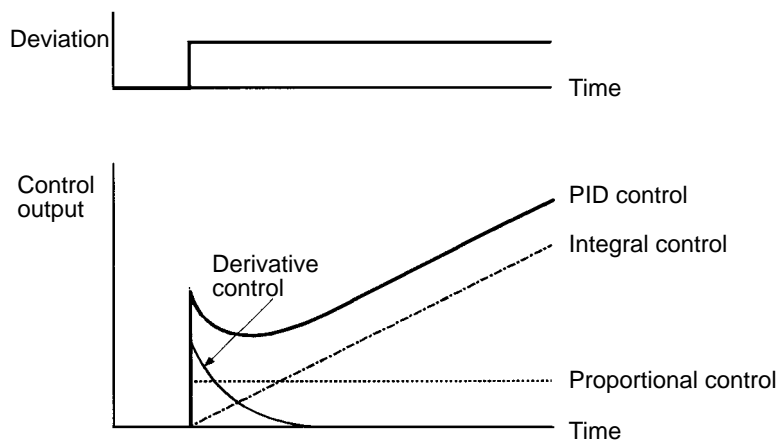

#### ● Proportional Control

Control output in proportion to the deviation is obtained through proportional control. Proportional control alone cannot make the deviation zero.

● **Integral Control**

The integrated deviation is obtained as control output from integral control. Integral control makes the feedback agree with the set point effectively. Integral control, however, cannot keep up with rapid feedback changes.

● **Derivative Control**

The differentiated deviation is obtained as control output from derivative control. Derivative control can keep up with rapid feedback changes.

● **PID Control**

PID control makes use of the merits of proportional control, integral control, and derivative control to perform ideal control.

■ **Types of PID Control**

The Inverter performs two types of PID control (i.e., derivative data PID control and basic PID control). The Inverter usually performs derivative data PID control.

● **Derivative Data PID Control**

Derivative data PID control is a type of PID control which differentiates the feedback of values and keeps up with set point changes and control object changes.

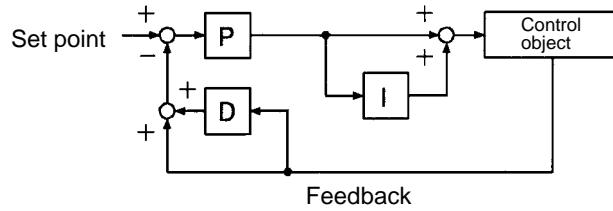

● **Basic PID Control**

Basic PID control may cause overshooting or undershooting when the set point changes if the response of derivative control is adjusted to keep up with object changes.

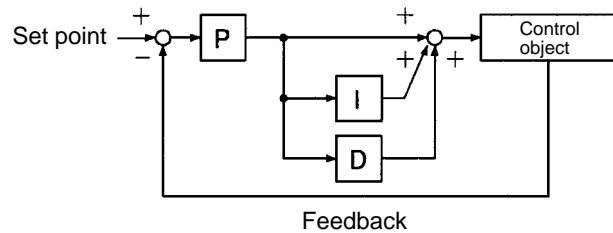



■ PID Control Function

Refer to the following block diagram for the PID control performed by the Inverter.

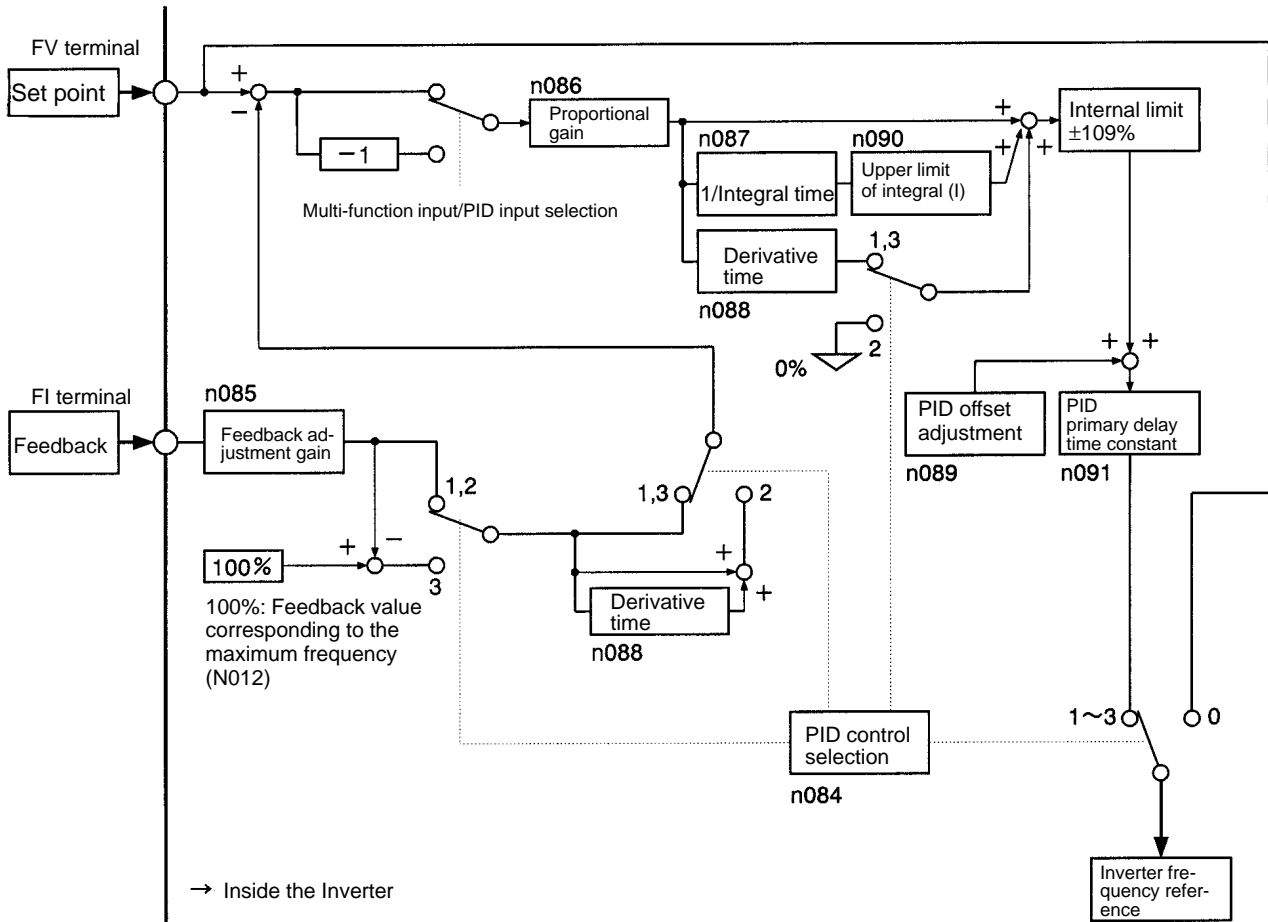

■ PID Control Settings

<i>n084</i>	<b>PID Control Function Selection</b>				
<b>Setting range</b>	0, 1, and 2	<b>Unit</b>	---	<b>Default setting</b>	0

Set Values

Set value	Description
0	No PID control.
1	PID control with deviation derivative control.
2	PID control with feedback derivative control.
3	PID control with negative feedback characteristic control.

**Note 1.** Set n084 to 1, 2, or 3 to permit the Inverter to perform PID control.

**Note 2.** Usually set n084 to 2 to change set points.

**Note 3.** Set n084 to 3 to perform PID control using the negative characteristic of the characteristic of the feedback value input from the sensor. Using the negative characteristic means that [100% – feedback value] is used as the PID feedback value. This is effective for negative characteristic control (control where the feedback value drops when the Inverter’s output frequency rises).

- If n084 is set to 1 or 2, the method to input the set point will be determined by the operation mode set with n002 and the FI terminal will be used for feedback input. Set the FI input level with n043 to select current feedback input or voltage feedback input to the Inverter.

Input terminal	Operation mode selection (n002)	
	0 or 1 (Frequency reference: Digital Operator)	2 or 3 (Frequency reference: Control circuit terminals)
Set point input	Frequency reference: n025 to n029	FV terminal: Voltage frequency reference input
Feedback input	FI terminal: Frequency reference input (default-set to current frequency reference input)	

n043 FI Input Level Selection					
Setting range	0, 1	Unit	---	Default setting	1

Set Values

Set value	Description
0	Voltage input within a range from 0 to 10 V. Be sure to cut jumper wire J1.
1	Current input within a range from 4 to 20 mA.

**Note** Do not impose voltage on the Inverter without cutting jumper wire J1 if n043 is set to 0, otherwise the input resistor of the Inverter will burn out.

- 200 V, 3.7 kW

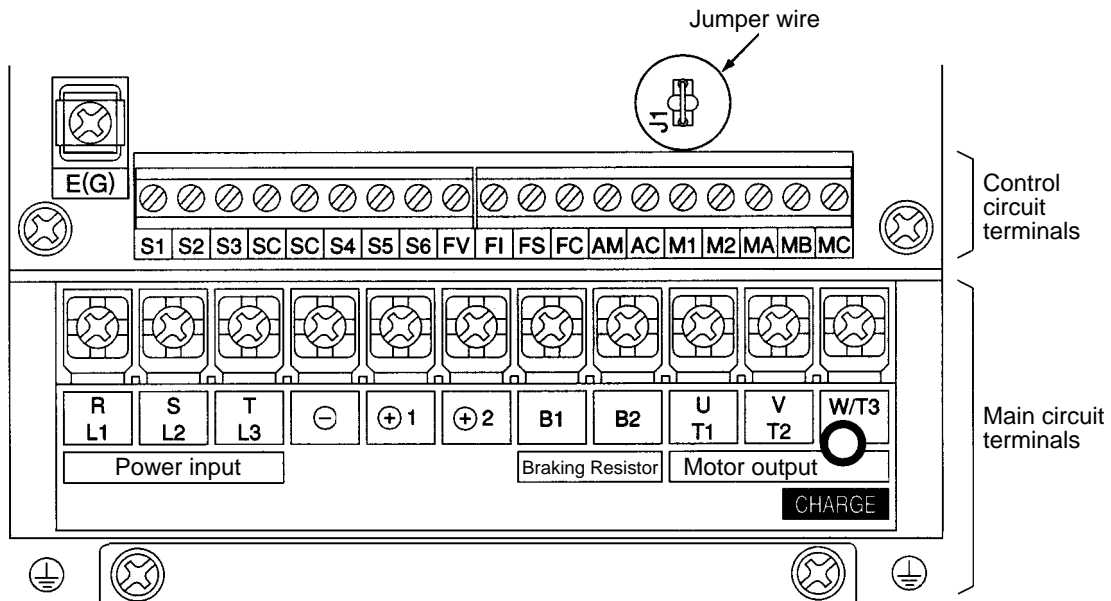

n085 Feedback Adjustment Gain					
Setting range	0.00 to 10.00	Unit	Times	Default setting	1.00

**Set Values**

- Set the feedback adjustment gain with n085.
- The feedback of the FI terminal multiplied by the feedback adjustment gain will be the feedback adjustment gain data of the Inverter.

n086	<b>Proportional Gain (P)</b>				
<b>Setting range</b>	0.0 to 10.0	<b>Unit</b>	Times	<b>Default setting</b>	1.0

n087	<b>Integral Time (I)</b>				
<b>Setting range</b>	0.0 to 100.0	<b>Unit</b>	s	<b>Default setting</b>	10.0

n088	<b>Derivative Time (D)</b>				
<b>Setting range</b>	0.00 to 1.00	<b>Unit</b>	s	<b>Default setting</b>	0.00

**Set Values**

- The parameters n086, n087, n088 adjust PID control response.
- Set n086, n087, and n088 to optimum values by operating the mechanical system. Refer to *page 3-36, PID Adjustments* for details.
- Proportional control or integral control will not be performed if n086 or n087 is set to 0.0 and derivative control will not be performed if n088 is set to 0.00.

n089	<b>PID Offset Adjustment</b>				
<b>Setting range</b>	-109 to 109	<b>Unit</b>	% (Maximum frequency ratio)	<b>Default setting</b>	100

**Set Values**

- The parameter n089 adjusts the PID control offset of the Inverter.
- The Inverter adjusts the offset of the voltage used to determine the set point and the offset of analog input to the FI terminal according to the value set with n089.
- Set n089 so that the output frequency of the Inverter will be 0 Hz when the set point and feedback are both zero.

n090	<b>Integral Upper Limit</b>				
<b>Setting range</b>	0 to 109	<b>Unit</b>	% (Maximum frequency ratio)	<b>Default setting</b>	100

**Set Values**

- The upper limit of integral control quotients is set with n090.
- It is usually unnecessary to change the default-set value of n090.
- Set n090 to a small value if the response of the Inverter may damage the load or allow the motor to go out of control when the load factor of the motor varies greatly.
- The feedback will not agree with set point if n090 is set to a value that is too small.

n091	<b>PID Primary Delay Constant</b>				
<b>Setting range</b>	0.0 to 2.5	<b>Unit</b>	s	<b>Default setting</b>	0.0

**Set Values**

- The parameter n091 works as a low-pass filter for the PID control output.
- It is usually not necessary to change the default-set value of n091.
- If the friction factor of the mechanical system is large and the mechanical system resonates, set n091 to a value larger than the resonance frequency, in which case, however, the PID response of the Inverter will be low.

n092	<b>Feedback Loss Detection Selection</b>				
<b>Setting range</b>	0, 1	<b>Unit</b>	---	<b>Default setting</b>	0

**Set Values**

Set value	Description
0	Feedback loss is detected.
1	Feedback loss is not detected.

- By setting n092 to 1, the Inverter determines that the feedback line is disconnected if the Inverter receives a feedback value that is too low.
- The Inverter will have PID feedback loss output as multi-function output if the Inverter detects feedback loss. Therefore, program a sequence to interrupt the operation of the Inverter.

n093	<b>Feedback Loss Detection Level</b>				
<b>Setting range</b>	0 to 100	<b>Unit</b>	% (Maximum frequency ratio)	<b>Default setting</b>	0

n094	<b>Feedback Loss Detection Time</b>				
<b>Setting range</b>	0.0 to 25.5	<b>Unit</b>	s	<b>Default setting</b>	1.0

**Set Values**

- Set feedback loss detection conditions with n093 and n094.
- Feedback loss will be detected if the Inverter receives feedback values lower than the feedback loss detection level set with n093 for the time set with n094.
- Set n093 to a value based on the maximum frequency set with n012 as 100%.

■ **PID Adjustments**

● **Step Response**

The parameter values used by the Inverter to perform PID control can be adjusted according to the step response of the control object.

1. **Step Response Waveform**

Take the following steps to measure the step response waveform of the control object.

- a) Connect the load in the same way as the connection of the load to the Inverter in normal operation.
- b) Set n084 to 0 so that the Inverter will not perform PID control.
- c) Minimize the acceleration time and input step frequency reference.
- d) Measure the response waveform of the feedback.

**Note** Measure the response waveform so that the timing of the step input will be known.

**2. Calculation of PID Parameters**

- Draw a tangent line contacting with the steepest inclining point of the response waveform.
- **Measurement of R**  
Measure the gradient of the tangent line provided that the set point is 1.
- **Measurement of L**  
Measure the required time (seconds) between the origin and the point of intersection of the tangent line and time axis.
- **Measurement of T**  
Measure the required time (seconds) between the point of intersection of the tangent line and time axis and the point of intersection of the tangent line and set point line.
- **PID Parameters**  
The following can be calculated from the R, L, and T values as “rules of thumb.”

Control	Proportional gain (P) (n086)	Integral time (I) (n087)	Derivative time (D) (n088)
Proportional control	0.3/RL	---	---
Proportional/Integral control	0.35/RL	1.2T	---
PID control	0.6/RL	T	0.5L

- Note 1.** Obtain PID parameter values from the above method, set the PID parameters, and tune in the PID parameter values exactly.
- Note 2.** PID parameter values obtained from the above method may not be optimum values if the friction factor of the mechanical system is large.

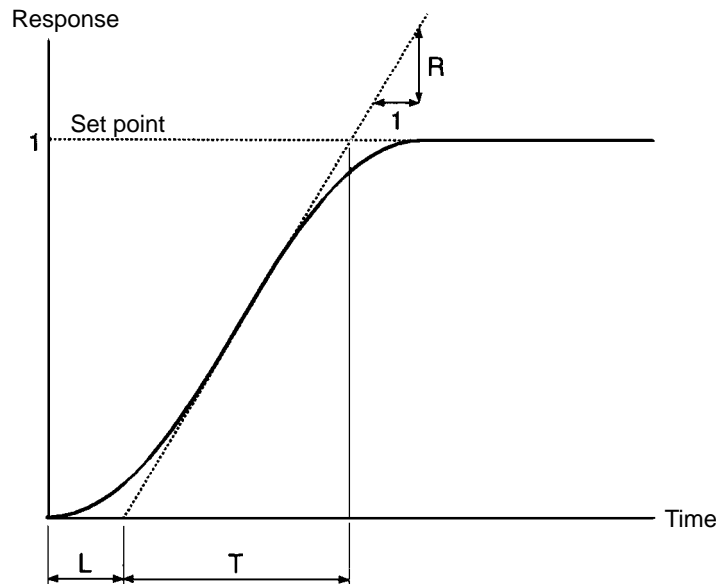

**• Manual Adjustments**

Take the following steps to adjust the PID parameter values of the Inverter performing PID control by measuring the response waveform.

1. Set n084 to 2 or 1 so that the Inverter will perform PID control.

- 2. Increase the proportional gain with n086 within a range causing no vibration.
- 3. Increase the integral time with n087 within a range causing no vibration.
- 4. Increase the derivative time with n088 within a range causing no vibration.

■ **PID Fine Tuning**

Refer to the following to tune in PID parameters exactly.

● **Suppression of Overshooting**

Set the derivative time to a smaller value and the integral time to a larger value if overshooting results.

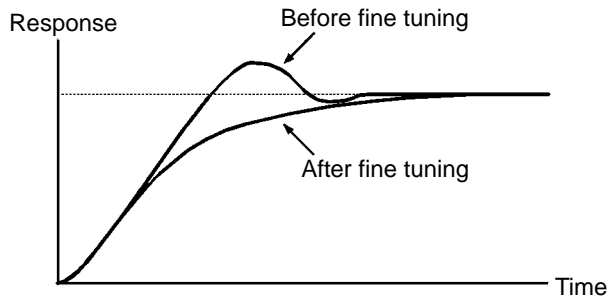

● **Prompt Control**

Set the integral time to a smaller value and the derivative time to a large value for the prompt control of overshooting.

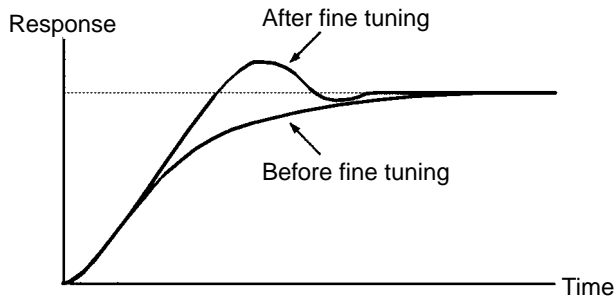

● **Suppression of Long-cycle Vibration**

Vibration with a wavelength longer than the integral time results from excessive integral control. The vibration can be suppressed by setting the integral time to a larger value.

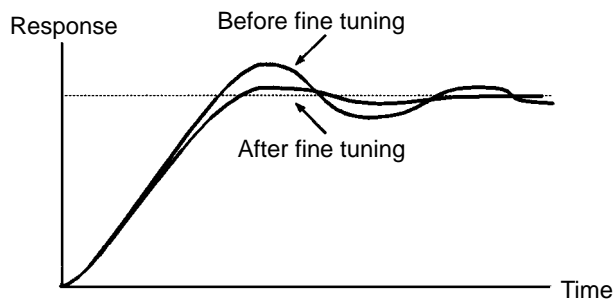

● **Suppression of Short-cycle Vibration**

Vibration with a wavelength almost as long as the derivative time results from excessive derivative control. The vibration can be suppressed by setting the derivative time to a smaller value. Set the proportional gain to a smaller value or the PID primary delay constant to a larger value if the vibration cannot be suppressed after the derivative time is set to 0.00.

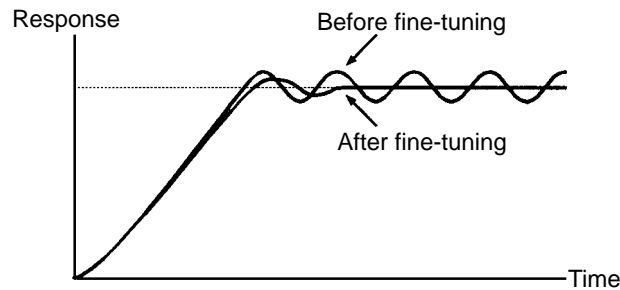

### 3-5-3 List of Parameters

Values in brackets [ ] are default-set values.

**Note** Parameters that can be changed while the Inverter is running are indicated in bold type.

■ **Group 1: n001 to n034**

Function	No.	Name	Description	Setting range	Reference page										
Parameter group selection	n001	Parameter write prohibit selection/Parameter initialization	0: The parameters n001 can be set and checked and the parameters n002 to n108 can be only checked. The speed and direction of the Digital Operator can be set.) 1: The parameters of group 1 (i.e., n001 to n034) can be set and checked and the parameters of groups 2 and 3 (i.e., n035 to n049 and n050 to n108) can be only checked. 2: The parameters of groups 1 and 2 can be set and checked and the parameters of group 3 can only be checked. 3: The parameters of groups 1, 2, and 3 can be set and checked. 6: All parameters will be set to default-set values. 7: All parameters will be initialized with a three-wire sequence. <b>Note</b> When parameter initialization is performed by setting to 6 or 7, the Forward/Reverse rotation selection (n005) is not initialized. (It is only initialized when a CPF4 error is detected.)	0 to 7 [1]	3-13										
Parameter initialization															
Operation mode selection	n002	Operation mode selection	Selects method to input run command and frequency reference. <table style="width: 100%; border: none;"> <tr> <td style="text-align: center;"><u>Run command</u></td> <td style="text-align: center;"><u>Frequency reference</u></td> </tr> <tr> <td>0: Digital Operator</td> <td>Digital Operator</td> </tr> <tr> <td>1: Control circuit terminals</td> <td>Digital Operator</td> </tr> <tr> <td>2: Digital Operator</td> <td>Control circuit terminals</td> </tr> <tr> <td>3: Control circuit terminals</td> <td>Control circuit terminals</td> </tr> </table>	<u>Run command</u>	<u>Frequency reference</u>	0: Digital Operator	Digital Operator	1: Control circuit terminals	Digital Operator	2: Digital Operator	Control circuit terminals	3: Control circuit terminals	Control circuit terminals	0 to 3 [3]	3-13
<u>Run command</u>	<u>Frequency reference</u>														
0: Digital Operator	Digital Operator														
1: Control circuit terminals	Digital Operator														
2: Digital Operator	Control circuit terminals														
3: Control circuit terminals	Control circuit terminals														
Input voltage selection	n003	Input voltage selection (see note)	Set Inverter input voltage in 1-V units.	150.0 to 255.0 [200.0]	3-23										
Interruption mode selection	n004	Interruption mode selection	0: Deceleration stop 1: Free running stop 2: Free running stop 1 with timer. The run command during deceleration time 1 or 2 will be ignored. 3: Free running stop 2 with timer. The constant run command is valid. The motor will start running after deceleration time 1 or 2 passes.	0 to 3 [0]	3-23										

**Note** With 400-V Inverters, the setting range upper limits and default settings are double those shown in the table.

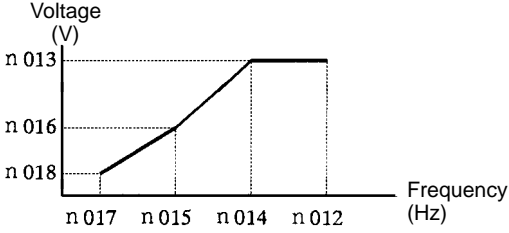

Function	No.	Name	Description	Setting range	Reference page
Motor rotation direction selection	n005	Forward/Reverse rotation selection	0: When the forward rotation command is input, the motor seen from the load side rotates counterclockwise. 1: When the forward rotation command is input, the motor seen from the load side rotates clockwise. <b>Note</b> This parameter is not initialized when parameter initialization is performed by setting n001 to 6 or 7. (It is only initialized when a CPF4 error is detected.)	0, 1 [0]	3-17
	n006	Reverse rotation-inhibit selection	0: The motor can rotate in reverse. 1: The motor cannot rotate in reverse.	0, 1 [0]	3-17

Function	No.	Name	Description	Setting range	Reference page
Digital Operator function selection	n007	Operation direction selection key permit/inhibit	0: Inhibits Operation Mode Selection Key from functioning. 1: Permits Operation Mode Selection Key to function.	0, 1 [1]	3-57
	n008	Stop Key function selection	0: The STOP/RESET Key will function only when the Inverter is running with the run command through the Digital Operator. 1: The STOP/RESET Key will function anytime.	0, 1 [1]	3-58
	n009	Frequency reference setting selection	0: Permits frequency reference set with the Digital Operator to be valid without Enter Key input. 1: Permits frequency reference set with the Digital Operator to be valid with Enter Key input.	0, 1 [1]	3-58
V/f pattern selection	n010	V/f pattern selection	0 to E: Selects from 15 fixed V/f patterns. F: Selects optional V/f pattern with n012 to n018 settings.	0 to F [1]	3-58
	n011	Rated input voltage of motor (see note)	Set rated input voltage of motor with 1 V units.	150.0 to 255.0 [200.0]	3-60
V/f pattern selection	n012	Maximum frequency (FMAX)	 <p>The V/f pattern will be a straight line if there is no difference between n015 and n017 in set value, in which case the set value of n016 will be ignored.</p>	50.0 to 400.0 [60.0]	3-60
	n013	Maximum voltage (VMAX) (see note)		0.1 to 255.0 [200.0] (See note 1.)	3-60
	n014	Maximum voltage frequency (FA)		0.2 to 400.0 [60.0]	3-61
	n015	Intermediate output frequency (FB)		0.1 to 399.9 [3.0]	3-61
	n016	Intermediate output frequency voltage (VC) (see note)		0.1 to 255.0 [15.0] (See note 1, 2.)	3-61
	n017	Minimum output frequency (FMIN)		0.1 to 10.0 [1.5]	3-61
	n018	Minimum output frequency voltage (VMIN) (see note)		0.1 to 50.0 [10.0] (See note 1, 2.)	3-61

**Note 1.** With 400-V Inverters, the setting range upper limits and default settings are double those shown in the table.

**Note 2.** The default settings for Inverters of 55 kW or more are as follows:  
n016 = 12.0/24.0, n018 = 6.0/12.0

Function	No.	Name	Description	Setting range	Reference page
Acceleration/Deceleration time selection	n019	Acceleration time 1	The time required for the output frequency to be 100% from 0% of the maximum frequency.	0.0 to 3,600 [10.0]	3-61
	n020	Deceleration time 1	The time required for the output frequency to be 0% from 100% of the maximum frequency.	0.0 to 3,600 [10.0]	3-61
	n021	Acceleration time 2	Valid if acceleration/deceleration time switching command is selected for multi-function input.	0.0 to 3,600 [10.0]	3-61
	n022	Deceleration time 2	Valid if acceleration/deceleration time switching command is selected for multi-function input.	0.0 to 3,600 [10.0]	3-62
S-shaped characteristic time selection	n023	S-shaped characteristic time selection	0: No s-shaped characteristic time 1: 0.2 s 2: 0.5 s 3: 1.0 s	0 to 3 [1]	3-62
Frequency reference selection	n024	Unit of frequency reference	0: 0.1-Hz units 1: 0.1% units 2to 39: r/min (r/min = 120 x frequency/n024 Set n024 to the number of poles of the motor.) 40 to 3,999: Determine the display method of the maximum frequency set with n012. Example: Set n024 to 1100 so that "10.0" will be displayed at the maximum frequency.	0 to 3,999 [0]	3-62
Frequency reference selection	n025	Frequency reference 1	Set frequency reference using the unit set with n024.	0 to maximum frequency [6.0]	3-63
	n026	Frequency reference 2	Frequency reference with multi-step speed command 1 turned ON.	0 to maximum frequency [0.0]	3-63
	n027	Frequency reference 3	Frequency reference with multi-step speed command 2 turned ON.		3-63
	n028	Frequency reference 4	Frequency reference with multi-step speed command 1 and 2 turned ON.		3-63
	n029	Inching frequency reference	Frequency reference with inching command turned ON.	0 to maximum frequency [6.0]	3-63
Output frequency limit selection	n030	Output frequency upper limit	Set output frequency upper limit with 1% units based on max. frequency set with n012 as 100%.	0 to 109 [100]	3-63
	n031	Output frequency lower limit	Set output frequency lower limit with 1% units based on max. frequency set with n012 as 100%.	0 to 100 [0]	3-63

Function	No.	Name	Description	Setting range	Reference page
Electronic thermal protection function selection	n032	Motor rated current	Set rated input current of motor with 1-A units as motor basic current for electronic thermal protection.	See note 1, 2	3-64
	n033	Electronic thermal protection function selection	0: No protection. 1: For standard motors with standard ratings (with a time constant of 8 min). 2: For standard motors with short-time ratings (with a time constant of 5 min). 3: For Inverter-dedicated motors with standard ratings (with a time constant of 8 min). 4: For Inverter-dedicated motors with short-time ratings (with a time constant of 5 min).	0 to 4 [1]	3-65
Overheating stop mode selection	n034	Selection of stop method for when radiation fin overheats	0: Deceleration stop in deceleration time 1 set with n020 1: Free running stop 2: Deceleration stop in deceleration time 2 set with n022 3: Continuous operation with warning	0 to 3 [3]	3-65

**Note 1.** Default settings vary with the Inverter model.

**Note 2.** The motor's rated current setting range is 10% to 200% of the Inverter's rated current.

■ Group 2: n035 to n049

Function	No.	Name	Description	Setting range	Reference page
Sequential input function selection	n035	Multi-function input 1 (S2)	0: Reverse rotation/Stop 1: Stop command (3-wire sequence selection) S3 will be used for forward/reverse rotation command and value set with n036 will be ignored. 2: External error (NO contact: ON) 3: External error (NC contact: ON) 4: Error reset (ON: Valid) 5: Operation mode selection (ON: Digital Operator; OFF: n002) 6: Not used 7: Emergency stop 8: Analog input selection (ON: Current input through FI terminal; OFF: FV terminal) 9: Multi-step speed command 1 10: Multi-step speed command 2 11: Inching command 12: Acceleration/Deceleration time switching command 13: External baseblock command (ON: Valid) 14: External baseblock command (OFF: Valid) 15: Speed search command from max. frequency 16: Speed search command from set frequency 17: Parameter set-inhibit (ON: Invalid) 18: Integral value of PID control reset command 19: PID control invalidating command (Set point used as frequency reference) 20: Timer function input (Set with n077 and n078) 21: Inverter overheat warning (ON: "OH3" will be displayed) 22: Analog frequency sample hold 23: Power OFF stop input (NO contact) 24: Power OFF stop input (NC contact)	0 to 24 [0]	3-17
	n036	Multi-function input 2 (S3)	Same as n035	2 to 24 [2]	3-17
	n037	Multi-function input 3 (S4)	Same as n035	2 to 24 [4]	3-17
	n038	Multi-function input 4 (S5)	Same as n035	2 to 24 [9]	3-17

Function	No.	Name	Description	Setting range	Reference page
Sequential input function selection	n039	Multi-function input 5 (S6)	0to 22: Same as n035 25: Up/Down command S5 will be used for the up command, S6 will be used for the down command, and value set with n038 will be ignored. 26: Not used. (Do not set.) 27: PID input characteristic selection (ON: Deviation multiplied by -1)	2 to 27 [10]	3-18
Sequential output function selection	n040	Multi-function contact output 1 (MA-MB-MC)	0: Error (ON: Error) 1: Running 2: Frequency agreement 3: Optional frequency agreement 4: Optional frequency detection (ON: Output frequency □ n073) 5: Optional frequency detection (ON: Output frequency □ n073) 6: Overtorque (ON: Detected) 7: Overtorque (OFF: Detected) 8: Baseblock 9: Operation mode (ON: Digital Operator/Frequency reference) 10: Inverter ready 11: Timer function output (Set with n077 and n078) 12: Error retrying 13: Inverter/Motor overload warning 14: Frequency reference loss (ON: Frequency reference has dropped by 90% or more within 0.4 s) 15: Not used 16: PID feedback loss (Detecting method can be set with n093 and n094) 17: Heating heat sink (ON: OH1)	0 to 17 [0]	3-74
	n041	Multi-function contact output 2 (M1-M2)	Same as n040	0 to 17 [1]	3-74

Function	No.	Name	Description	Setting range	Reference page
Frequency reference function selection	n042	Analog frequency reference voltage/current selection	0: The FV terminal can be used for the analog frequency reference within a voltage range from 0 to 10 VDC. 1: The FI terminal can be used for the analog frequency reference. Set the input level with n043.	0, 1 [0]	3-77
	n043	FI input level selection	0: Voltage input within a range from 0 to 10 V. Be sure to cut jumper wire J1. 1: Current input within a range from 4 to 20 mA.	0, 1 [0]	3-78
	n044	Analog frequency reference sample hold selection	0: Frequency reference on hold is saved by n025 1: Frequency reference on hold is not saved.	0, 1 [0]	3-78
	n045	Processing selection when analog frequency reference is lost	0: Inhibits Inverter from processing analog frequency reference loss. 1: Permits Inverter to process analog frequency reference loss.	0, 1 [0]	3-78
	n046	Frequency reference gain	Set analog frequency reference input gain. Set input frequency at 10 V or 20 mA with 1% units based on max. frequency set with n012 as 100%.	0 to 200 [100]	3-79
	n047	Frequency reference bias	Set analog frequency reference input bias. Set input frequency at 0 V or 4 mA with 1% units based on max. frequency set with n012 as 100%.	-100 to 100 [0]	3-79
Analog monitor function selection	n048	Multi-function analog output selection	0: Output frequency (10 V: Max. frequency n012) 1: Output current (10 V: Rated inverter current) 2: Output power (10 V: Rated inverter output capacity) 3: Main circuit DC voltage (10 V: 200-V class: 400 V; 400-V class: 800V)	0 to 3 [0]	3-79
	n049	Multi-function analog output gain	Set voltage level gain of multi-function analog output. Set n049 to result obtained from dividing voltage of full analog output by 10 V.	0.01 to 2.00 [1.00]	3-80

■ Group 3: n050 to n108

Function	No.	Name	Description	Setting range	Reference page
Carrier frequency adjustment	n050	Carrier frequency (See note 1)	1: 2.5 kHz 2: 5.0 kHz 3: 8.0 kHz 4: 10.0 kHz 5: 12.5 kHz 6: 15.0 kHz 7, 8, and 9: Varies in proportion to output frequency up to 2.5 kHz. 10:7.0 kHz	1 to 10 (See note 2)	3-80
Instantaneous power failure processing and speed search control	n051	Selection of running after restoration following a momentary stop	0: Inverter will discontinue running. 1: Inverter will continue running if power is supplied again within instantaneous power failure compensation time set with n055. 2: Inverter will always continue running without detecting UV1 or UV3.	0 to 2 [0]	3-81
	n052	Speed search control level	Set current level enabling speed search in 1% units based on rated output current of Inverter as 100%.	0 to 200 [110]	3-82
	n053	Minimum base-block time	Set time to start speed search after RUN input is ON and instantaneous power failure processing starts.	0.5 to 10.0 (See note)	3-82
	n054	V/f characteristics during speed search	Set percentage of V/f characteristics for speed search.	0 to 100 (See note)	3-82
	n055	Stop compensation time	Set instantaneous power failure compensation time in 1-s units.	0.0 to 2.0 (See note)	3-82
Error retry	n056	Number of error retries	Set number of error retries.	0 to 10 [0]	3-83
	n057	Selection of error output during error retry	0: Turns ON error output while error retry is performed. 1: Turns OFF error output while error retry is performed.	0, 1 [0]	3-83
Frequency jump	n058	Jump frequency 1	Set center value of jumping frequency in 1-Hz units.	0.0 to 400.0 [0.0]	3-83
	n059	Jump frequency 2	Frequency jump function will be invalid if value is set to 0.0.		3-84
	n060	Jump frequency range	Set jump range of jumping frequency in 1-Hz units.	0.0 to 25.5 [1.0]	3-84

**Note 1.** For a 400-V Inverter, if the carrier frequency is set to a value higher than the default setting, the Inverter overload “OL2” detection value will decrease in consideration of an increase in the heat that will be generated by the change in the carrier frequency.

**Note 2.** Default settings vary with the Inverter model.



Function	No.	Name	Description	Setting range	Reference page
Accumulated operation time	n061	Total operating time function selection	0: Accumulates power-on time. 1: Accumulates running time	0, 1 [1]	3-84
	n062	Total operating time 1 (rightmost 4 digits)	Set accumulation start time in 1-h units. Permits accumulated operation time monitor to function. (Same as U-11 and U-12) Accumulated operation time (h) = n063 x 10,000 + n062	0 to 9,999 [0]	3-84
	n063	Total operating time 2 (leftmost 2 digits)	Max. value: 279,620 (h) (Returns to 0 when accumulated operation time exceeds 279,620 h)	0 to 27 [0]	3-84
DC braking	n064	DC braking current	Set DC control current in 1% units based on rated output current of Inverter as 100%.	0 to 100 [50]	3-85
	n065	Stopped DC braking time	Set stop DC control time and start DC control time in 1-s units.	0.0 to 10.0 [0.5]	3-85
	n066	Startup DC braking time	DC control will be invalid if value is set to 0.0.	0.0 to 10.0 [0.0]	3-85
Torque compensation	<b>n067</b>	Automatic torque boost gain	Set automatic torque boost gain. Setting is usually not necessary.	0.0 to 3.0 [1.0]	3-85
	n068	Motor winding resistance	Set motor constant for automatic torque boost operation. Setting is usually not necessary.	0.000 to 65.53 (See note 1)	3-85
	n069	Motor iron loss		0 to 9,999 (See note 1)	3-85
Stall prevention	n070	Decelerating stall prevention selection	0: Inhibits deceleration stall prevention from functioning. 1: Permits deceleration stall prevention to function.	0, 1 [1]	3-86
	n071	Accelerating stall prevention operation level	Set current level enabling acceleration stall prevention in 1% units based on rated output current of Inverter as 100%.	30 to 200 [170] (See note 2)	3-86
	n072	Operating stall prevention operation level	Set current level enabling operation stall prevention in 1% units based on rated output current of Inverter as 100%.	30 to 200 [160] (See note 2)	3-86
Optional frequency detection	n073	Frequency detection level	Set detecting output frequency in 1-Hz units. Valid if multi-function contact output is set to optional frequency agreement or optional frequency detection.	0.0 to 400.0 [0.0]	3-87

**Note 1.** Default settings vary with the Inverter model.

**Note 2.** The default setting for 18.5-kW or higher Inverters is 120%.

Function	No.	Name	Description	Setting range	Reference page
Overtorque detection	n074	Overtorque detection function selection	0: Inhibits Inverter from detecting overtorque. 1: Inverter will detect overtorque only during speed agreement and continue running with warning after detection. 2: Running Inverter will detect overtorque and continue running with warning after detection. 3: Inverter will detect overtorque only during speed agreement and turn OFF output for safety when overtorque is detected. 4: Running Inverter will always detect overtorque and turn OFF output for safety when overtorque is detected.	0 to 4 [0]	3-87
	n075	Overtorque detection level	Set overtorque detection current in 1% units based on rated output current of Inverter as 100%.	30 to 200 [160]	3-87
	n076	Overtorque detection time	Set overtorque detection time in 1-s units. Overtorque will be detected if current larger than value set with n075 flows for the set time or more.	0.1 to 10.0 [0.1]	3-87
Timer function	n077	Timer function ON delay time	Set time lag between moment timer function input turns ON and moment timer function output turns ON. Valid if multi-function input and multi-function contact output are set to timer function.	0.0 to 25.5 [0.0]	3-88
	n078	Timer function OFF delay time	Set time lag between the moment the timer function input turns OFF and the moment the timer function output turns OFF. Valid if multi-function input and multi-function contact output are set to timer function.	0.0 to 25.5 [0.0]	3-88
Braking Resistor Unit overheating protection	n079	Braking resistor overheating protection selection	0: Inhibits overheating protection from functioning. 1: Permits overheating protection to function.	0, 1 [0]	3-88
I/O phase loss detection	n080	Input open-phase detection level	Set input phase loss detection level to percentage of main circuit DC voltage. 200-V class: 200 VDC as 100% 400-V class: 800 VDC as 100%	1 to 100 [7]	3-89
	n081	Input open-phase detection time	Set input phase loss detection time. Detection time = 1.28 x n 081 Inverter will detect input phase loss if voltage as large as or larger than value set with n080 is imposed continuously for period exceeding set time.	2 to 255 [8]	3-89
	n082	Output open-phase detection level	Set output phase loss detection level in 1% units based on rated output current of Inverter as 100%. Output phase loss detection will be invalid if value is set to 0.	0 to 100 [0]	3-89

Function	No.	Name	Description	Setting range	Reference page
I/O phase loss detection	n083	Output open-phase detection time	Set output phase loss detection time in 1-s units. Inverter will detect output phase loss if current as large as or less than value set with n082 flows continuously for period exceeding set time.	0.0 to 2.0 [0.2]	3-89
PID control	n084	PID control function selection	0: No PID control. 1: PID control with deviation derivative control. 2: PID control with feedback derivative control. 3: PID control with negative feedback characteristic control.	0 to 3 [0]	3-33
	n085	Feedback adjustment gain	Fine tuning gain for PID feedback value.	0.00 to 10.00 [1.00]	3-34
	n086	Proportional gain (P)	Set proportional gain for proportional control. Proportional control will be invalid if value set to 0.0.	0.0 to 10.0 [1.0]	3-35
	n087	Integral time (I)	Set integral time with 1 s units for integral control. Integral control will be invalid if value is set to 0.0.	0.0 to 100.0 [0.00]	3-35
	n088	Derivative time (D)	Set derivative time with 1 s units for derivative control. Derivative control will be invalid if value is set to 0.0.	0.00 to 1.00 [0.00]	3-35
	n089	PID offset adjustment	Set PID offset with 1% units based on max. frequency set with n012 as 100%.	-109 to 109 [0]	3-35
	n090	Integral (I) upper limit	Set upper limit of output with 1% units after integral control is performed based on max. frequency set with n012 as 100%.	0 to 109 [100]	3-35
	n091	PID primary delay constant	Set PID primary-delay time constant with 1 s units for frequency reference after PID control is performed.	0.0 to 2.5 [0.0]	3-35
	n092	Feedback loss detection selection	0: Feedback loss is detected. 1: Feedback loss is not detected.	0, 1 [0]	3-36
	n093	Feedback loss detection level	Set feedback loss detection level with 1% units.	0 to 100 [0]	3-36
	n094	Feedback loss detection time	Set feedback loss detection time with 1 s units.	0.0 to 25.5 [1.0]	3-36

Function	No.	Name	Description	Setting range	Reference page
Energy-saving control	n095	Energy-saving control selection	0: Inhibits the Inverter from performing energy-saving control. 1: Permits the Inverter to perform energy-saving control.	0, 1 [0]	3-26
	n096	Energy-saving coefficient K2	Set coefficient so that maximum motor efficiency will be obtained.	0.00 to 655.0 (See note)	3-26
	n097	Energy-saving voltage lower limit for 60 Hz	Set lower limits of energy-saving control output voltage in 1% units at 6 Hz and 60 Hz based on motor rated voltage set with n011 as 100%, in which case, lower limit of energy-saving control output voltage will be on a straight line linking values set with n097 and n098 if energy-saving control output frequency is between 6 and 60 Hz.	0 to 120 [50]	3-27
	n098	Energy-saving voltage lower limit for 6 Hz		0 to 25 [12]	3-28
	n099	Mean power time	Set time to calculate mean output power of Inverter performing energy-saving control. Time (ms) = 25 x n099	1 to 200 [1]	3-28
	n100	Search control voltage limit	Set range of variable voltage in 1% units to be used by Inverter in search control mode based on rated motor input voltage as 100%. Search operation function will be invalid if n101 is set to 0.	0 to 100 [0]	3-27
	n101	Search control voltage step when 100%	Set range of variable voltage in 1% units to be used by Inverter in search control mode with 100% search operation start voltage based on rated motor input voltage as 100%.	0.1 to 10.0 [0.5]	3-28
	n102	Search control voltage step when 5%	Set range of variable voltage in 1% units to be used by Inverter in search control mode with 5% search operation start voltage based on rated motor input voltage as 100%.	0.1 to 10.0 [0.2]	3-28
Not used	n103	Not used	Do not change setting.	1 [1]	---
	n104	Not used	Do not change setting.	1 [1]	---
	n105	Not used	Do not change setting.	0 [0]	---
	n106	Not used	Do not change setting.	0 [0]	---
	n107	Not used	Do not change setting.	2 [2]	---
	n108	Not used	Do not change setting.	1 [1]	---

**Note** Default settings vary with the Inverter model.

Function	No.	Name	Description	Setting range	Reference page
Slip compensation	n109	Slip compensation gain	Slip compensation gain is set as a percentage of the maximum output frequency (n014). Use the following equations to set a value that corresponds to the motor rated slip. $n109 = 100 \times (\text{Synchronization speed} - \text{rated motor speed}) \div \text{synchronization speed}$ Synchronization speed = $120f/P$ P: No. of poles f: Rated frequency Set n014 to the motor's rated frequency. <b>Note</b> The rated motor speed can be confirmed from the motor's nameplate. <b>Note</b> If n109 = 0.0, the slip compensation function is disabled. <b>Note</b> If n032 = 0.0, the slip compensation function is disabled.	0.0 to 9.9 [0.0]	3-90
	n110	Motor no-load current	Set the motor no-load current as a percentage of the motor rated current (n032). <b>Note</b> This setting is used as a parameter of the slip compensation function. <b>Note</b> Set after confirming the motor no-load current with the manufacturer. Alternatively, calculate the value from the current when there is no load and when running at the rated frequency.	0 to 99 [30]	3-90
	n111	Slip compensation primary delay time	Slip compensation primary delay time is set in s units. <b>Note</b> Usually setting is not necessary. Adjust when slip compensation responsiveness is low or when speed has not stabilized. When responsiveness is low, decrease the set value. When speed has not stabilized, increase the set value.	0.0 to 25.5 [2.0]	3-90
Operation selection at Digital Operator interruption	n112	Operation selection at Digital Operator interruption	Set whether an error is detected when the Digital Operator is disconnected. 0: Error not detected 1: Error detected	0, 1 [0]	3-91
Frequency detection width	n113	Frequency detection width	Sets the width of frequency agreement (n040, n041) and frequency detection (n073) in Hz units.	0.0 to 25.5 [2.0]	3-91

Function	No.	Name	Description	Setting range	Reference page
Operation selection at operation mode switching (local/remote switching)	n114	Operation selection at operation mode switching (local/remote switching)	Select whether or not to ignore run signals input while the operation mode is switched using the Operation Mode Selection Key on the Digital Operator or with operation mode selection input from the multi-function inputs.  0: Run signals that are input during mode switching are ignored. (Input run signals after switching the mode.) 1: Run signals become effective immediately after mode.  <b>Note</b> If n114 is set to 1, when the operation mode changes the Inverter may start running immediately. Take steps to ensure safety for such operation.	0, 1 [0]	3-91
(Manufacturer's use)	n115, n116	For the manufacturer's use. (Do not set.)		See note	---

**Note** Setting ranges and default settings vary with the Inverter model.

### 3-5-4 Parameters in Detail

Refer to the following for the functions of the parameters used with the Inverter not in energy-saving or PID control operation.

Parameter Write Prohibit Selection/Parameter Initialization					
<b>Setting range</b>	0, 1, 2, 3, 6, and 7	<b>Unit</b>	---	<b>Default setting</b>	1

- The parameters used by the Inverter are classified into the following three groups.
  - Group 1: n001 to n034
  - Group 2: n035 to n049
  - Group 3: n050 to n108 (Up to n102 can be used.)
- The Inverter is default-set so that only parameters of group 1 can be set and checked and the parameters of groups 2 and 3 can only be checked.

#### Set Values

Set value	Description
0	The parameters n001 can be set and checked and the parameters n002 to n108 can be only checked.
1	The parameters of group 1 (i.e., n001 to n034) can be set and checked and the parameters of groups 2 and 3 (i.e., n035 to n049 and n050 to n108) can be only checked.
2	The parameters of groups 1 and 2 can be set and checked and the parameters of group 3 can be only checked.
3	The parameters of groups 1, 2, and 3 can be set and checked.
6	All parameters will be set to default-set values.
7	All parameters will be initialized with a three-wire sequence. (see note 2)

**Note 1.** Do not set n001 to any value other than the above.

**Note 2.** Refer to n035 on page 3-66 for the 3-wire sequence.

<i>n002</i>	<b>Operation Mode Selection</b>				
<b>Setting range</b>	0 to 3	<b>Unit</b>	---	<b>Default setting</b>	3

- The Inverter has four operation modes. Refer to the following table and select one of the modes with n002.

**Set Values**

Set value	Run command	Frequency reference	Operation mode indicator of Digital Operator	
			Remote operation	Analog input
0	Digital Operator (RUN/STOP Key)	Digital Operator (Frequency reference 1)	Not lit	Not lit
1	Control circuit terminals (Forward/reverse/stop input)	Digital Operator (Frequency reference 1)	Lit	Not lit
2	Digital Operator (RUN/STOP Key)	Control circuit terminals (Analog input) (see note 2)	Not lit	Lit
3	Control circuit terminals (Forward/reverse/stop input)	Control circuit terminals (Analog input) (see note 2)	Lit	Lit

**Note 1.** Do not set n002 to any value other than the above.

**Note 2.** The frequency reference input according to the operation mode selection setting will be used as frequency reference 1 in multi-step step speed operation. If the frequency reference is determined by control circuit terminals, the frequency reference input using the control circuit terminals' analog input will be enabled and the frequency reference 1 parameter setting (n025) will be ignored. (If, however, the mode is changed to Local mode using the Digital Operator, then the value set in n025 will be enabled.)

**Note 3.** Frequency references 2 to 4 (n026 to n028) and the inching frequency reference (n029) used in multi-step speed operation will be determined by the parameter settings, regardless of the operation mode selection setting.

<i>n003</i>	<b>Input Voltage Selection</b>				
<b>Setting range</b>	150.0 to 255.0 (510.0)	<b>Unit</b>	---	<b>Default setting</b>	200.0 (400.0)

**Note** The figures in the parentheses apply to the 400-V Inverter.

- Set the input voltage of the Inverter to determine the voltage protection level of the Inverter.

<i>n004</i>	<b>Interruption Mode Selection</b>				
<b>Setting range</b>	0 to 3	<b>Unit</b>	---	<b>Default setting</b>	0

- Set n004 to the stop mode to be invoked when the STOP/RESET Key is pressed or when the run command is OFF.
- To inhibit the Inverter from performing the next operation until the motor stops, set n004 to 2 or 3.

**Set Values**

Set value	Description
0	Deceleration stop
1	Free running stop
2	Free running stop 1 with timer. The run command during acceleration time 1 or 2 will be ignored.
3	Free running stop 2 with timer. The constant run command is valid. The motor will start running after acceleration time 1 or 2 passes.

**• Deceleration Stop (n004 = 0)**

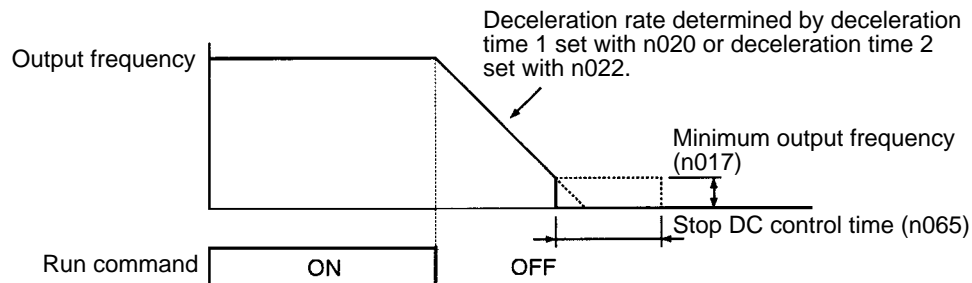

**• Free Running Stop (n004 = 1)**

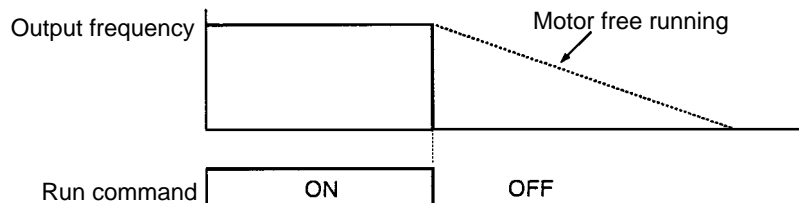

**• Free Running Stop 1 with Timer (n004 = 2)**

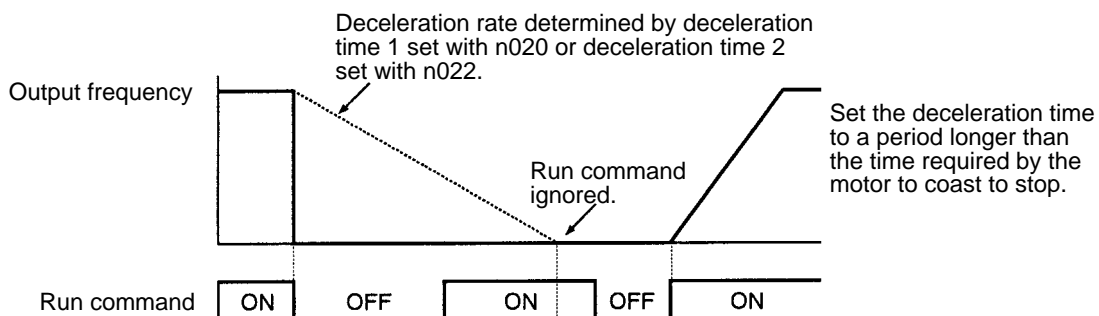

**Note** The run command will not be accepted during the minimum baseblock time set with n053 if the time required by the motor to coast to stop is shorter than the minimum baseblock time.



• Free Running Stop 2 with Timer (n004 = 3)

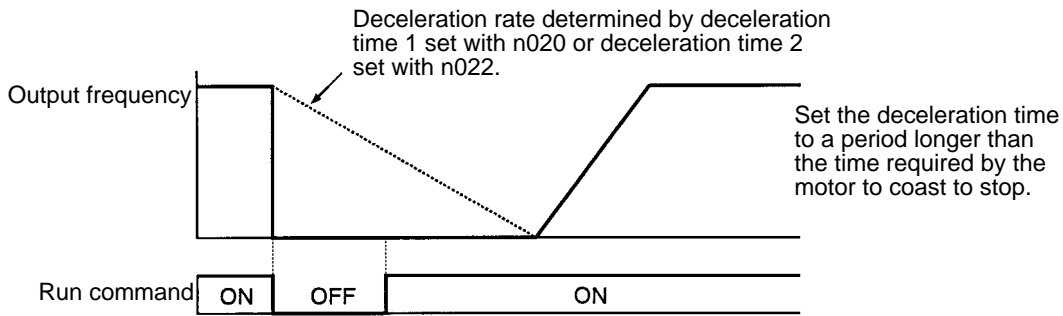

**Note** The run command will not be accepted during the minimum baseblock time set with n053 if the time required by the motor to coast to stop is shorter than the minimum baseblock time.

n005	<b>Forward/Reverse Rotation Selection</b>				
<b>Setting range</b>	0, 1	<b>Unit</b>	---	<b>Default setting</b>	0

- Set the rotation direction of the motor so that the motor will rotate in the set direction when the forward rotation command is input.

**Set Values**

Set value	Description
0	The motor seen from the load side rotates counterclockwise.
1	The motor seen from the load side rotates clockwise.

**Note** If parameter initialization is performed by setting n001 to 6 or 7, n005 will not be initialized. (It will be initialized, however, if a CPF4 error is generated.)

- The motor is deemed to be rotating forward if the motor seen from the load side is rotating counterclockwise unless the forward rotation direction of the motor defined by the manufacturer is opposite.

n006	<b>Reverse Rotation-inhibit Selection</b>				
<b>Setting range</b>	0, 1	<b>Unit</b>	---	<b>Default setting</b>	0

- Select whether reverse rotation will be available or not.

**Set Values**

Set value	Description
0	The motor can rotate in reverse.
1	The motor cannot rotate in reverse.

n007	<b>Operation Direction Selection Key Permit/Inhibit</b>				
<b>Setting range</b>	0, 1	<b>Unit</b>	---	<b>Default setting</b>	1

- Select with n007 to permit the Operation Mode Selection Key to function or inhibit the Operation Mode Selection Key from functioning.

**Set Values**

Set value	Description
0	Operation direction selection key inhibit
1	Operation direction selection key permit

**Note** Press the Operation Mode Selection Key to control the Inverter from the Digital Operator with the run command and frequency reference if n007 is set to 1. The operation mode selected with n002 will be valid if the Operation Mode Selection Key is pressed again.

n008	<b>Stop Key Function Selection</b>				
<b>Setting range</b>	0, 1	<b>Unit</b>	---	<b>Default setting</b>	1

- Set n008 so that the STOP/RESET Key will function properly.

**Set Values**

Set value	Description
0	The STOP/RESET Key will function only when the Inverter is running with the run command through the Digital Operator.
1	The STOP/RESET Key will function anytime.

n009	<b>Frequency Reference Setting Selection</b>				
<b>Setting range</b>	0, 1	<b>Unit</b>	---	<b>Default setting</b>	1

- Select with n009 a method to set a frequency reference with the Digital Operator.

**Set Values**

Set value	Description
0	Permits the frequency reference set with the Digital Operator to be valid without the Enter Key.
1	Permits the frequency reference set with the Digital Operator to be valid with the Enter Key.

**Note** A frequency reference will be valid the moment the frequency reference is set with the Digital Operator if n009 is set to 0.

n010	<b>V/f Pattern Selection</b>				
<b>Setting range</b>	0 to F	<b>Unit</b>	---	<b>Default setting</b>	1

**Set Values**

- The following two methods are available to set the V/f pattern.
  - Select one of the 15 V/f patterns preset with the Inverter, in which case set n010 to 0, 1, 2, 3, 4, 5, 6, 7, 8, 9, A, b, C, d, or E.
  - Set n010 to F for an optional V/f pattern.

- The following are the V/f patterns preset with the Inverter.

Characteristic	Use	Set value	Specification
General purpose	These V/f patterns are mainly used for general purposes, such as the control of straight conveyor lines. Apply these V/f patterns to the motor if the rotation speed of the motor must change in almost direct proportion to the load factor of the motor.	0	50 Hz
		1	60 Hz
		2	60 Hz. Voltage saturation at 50 Hz.
		3	72 Hz. Voltage saturation at 60 Hz.
Reduced torque	These V/f patterns are mainly used for fan pumps. Apply these V/f patterns to the motor if the rotation speed of the motor must change in square or cube proportion to the load factor of the motor.	4	50 Hz with cube reduction.
		5	50 Hz with square reduction.
		6	60 Hz with cube reduction.
		7	60 Hz with square reduction.
High starting torque	These V/f patterns are usually unnecessary because the Inverter has a full automatic torque boost function to supply enough power to meet the starting torque of the motor.	8	50 Hz with low starting torque.
		9	50 Hz with high starting torque.
		A	60 Hz with low starting torque.
		B	60 Hz with high starting torque.
Constant power operation	These V/f patterns are used to rotate the motor with output at 60 Hz or more. Apply these V/f patterns to the motor to impose a constant voltage at 60 Hz minimum on the motor.	C	90 Hz. Voltage saturation at 60 Hz.
		D	120 Hz. Voltage saturation at 60 Hz.
		E	180 Hz. Voltage saturation at 60 Hz.

- Note 1.** Set n010 so that the Inverter will produce high starting torque only in the following cases.
- The wiring distance between the Inverter and the motor is approximately 150 m or more.
  - The motor requires high starting torque. The motor requires high starting torque if the motor is connected a vertical-axis load.
  - Power is input to or output from the Inverter through an AC or DC reactor.

- Note 2.** The set values of n012 to n018 will change automatically if any of the patterns listed in the above table is selected.

- Note 3.** Refer to the following graphs for the characteristics of the V/f patterns. The maximum voltage shown in each of the graphs is 200 V. The actual voltage, however, corresponds to the set value of n011 (i.e., the rated input voltage of the motor). All voltage values will change in proportion to the set value of n011. For example, the default-set value of n011 of the 400-V Inverter is 400 (V). Therefore, double all the voltage values when using the 400-V Inverter.

**Characteristics of V/f Patterns**

- General Characteristics (Set Value: 0 to 3)**

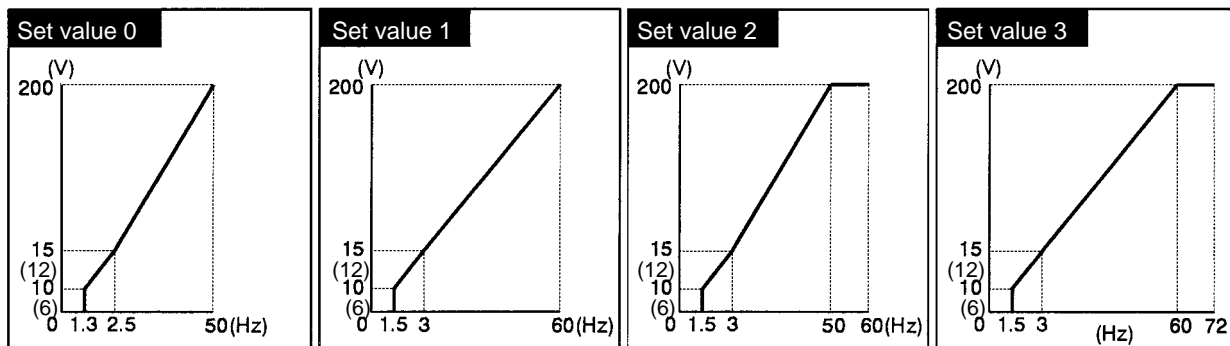

• Reduced Torque Characteristics (Set Value: 4 to 7)

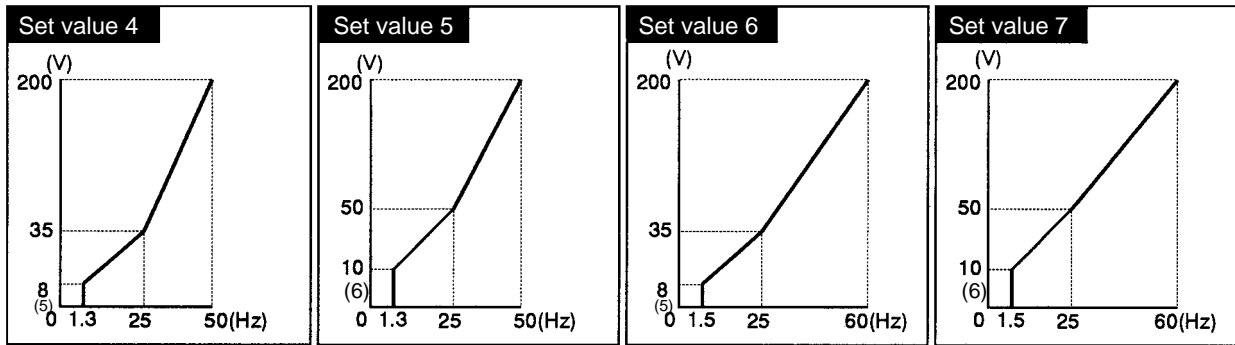

• High Starting Torque Characteristics (Set Value: 8 to b)

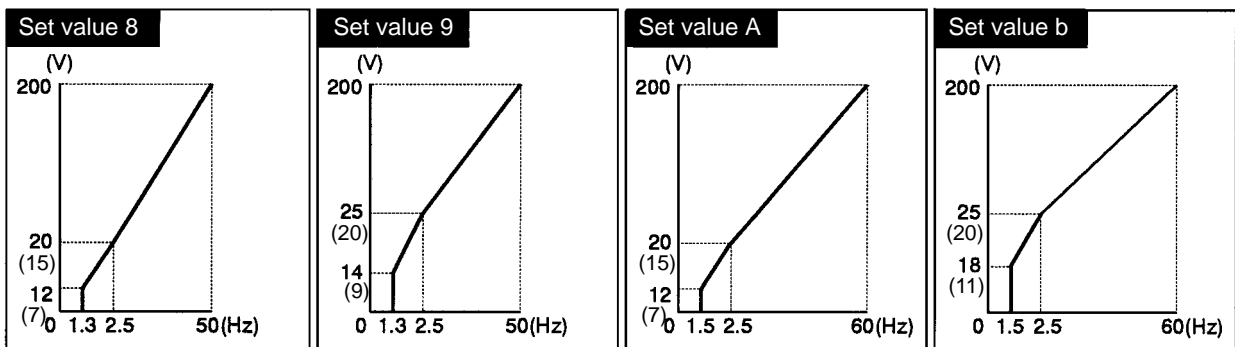

• Constant Power Operation Characteristics (Set Value: C to E)

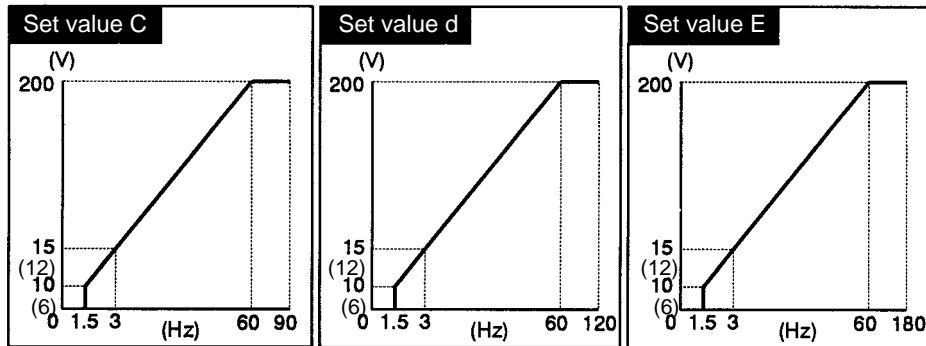

Note Figures in parentheses apply to 55-kW or higher Inverters.

<b>r011</b>	<b>Rated Input Voltage of Motor</b>				
<b>Setting range</b>	150.0 to 255.0 (510.0)	<b>Unit</b>	V	<b>Default setting</b>	200.0 (400.0)

- Set the rated input voltage of the motor according to the rated input voltage of the motor before setting the V/f pattern. This set value will be used to calculate the voltage axis of the V/f pattern.

<b>r012</b>	<b>Maximum Frequency (FMAX)</b>				
<b>Setting range</b>	50.0 to 400.0	<b>Unit</b>	Hz	<b>Default setting</b>	60.0

<b>r013</b>	<b>Maximum Voltage (VMAX)</b>				
<b>Setting range</b>	0.1 to 255.0 (510.0)	<b>Unit</b>	V	<b>Default setting</b>	200.0 (400.0)

n014	<b>Maximum Voltage Frequency (FA)</b>				
<b>Setting range</b>	0.2 to 400.0	<b>Unit</b>	Hz	<b>Default setting</b>	60.0

n015	<b>Intermediate Output Frequency (FB)</b>				
<b>Setting range</b>	0.1 to 399.9	<b>Unit</b>	Hz	<b>Default setting</b>	3.0

n016	<b>Intermediate Output Frequency Voltage (VC)</b>				
<b>Setting range</b>	0.1 to 255.0 (510.0)	<b>Unit</b>	V	<b>Default setting</b>	15.0 (30.0) (See note 2.)

n017	<b>Minimum Output Frequency (FMIN)</b>				
<b>Setting range</b>	0.1 to 10.0	<b>Unit</b>	Hz	<b>Default setting</b>	1.5

n018	<b>Minimum Output Frequency Voltage (VMIN)</b>				
<b>Setting range</b>	0.1 to 50.0 (100.0)	<b>Unit</b>	V	<b>Default setting</b>	10.0 (20.0) (See note 2.)

**Note 1.** Figures in parentheses apply to the 400-V Inverter.

**Note 2.** The default settings for 55-kW or higher Inverters are as follows:

200-V 55-kW or higher Inverters: n016 = 12.0 V, n018 = 6.0 V

400-V 55-kW or higher Inverters: n016 = 24.0 V, n018 = 12.0 V

- An optional V/f pattern will be available and n012 to n018 can be set if the V/f pattern is set to F.

**Optional V/f Pattern in Detail**

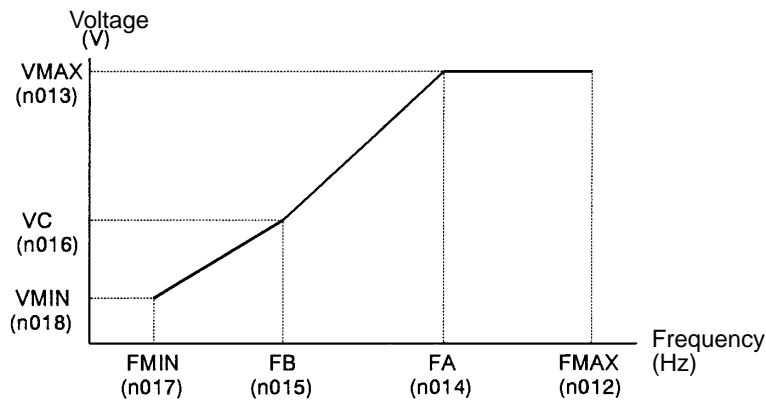

**Note** The V/f pattern will be a straight line if there is no difference between n015 and n017 in set value, in which case the set value of n016 will be ignored.

n019	<b>Acceleration Time 1</b>				
<b>Setting range</b>	0.0 to 3,600	<b>Unit</b>	s	<b>Default setting</b>	10.0

n020	<b>Deceleration Time 1</b>				
<b>Setting range</b>	0.0 to 3,600	<b>Unit</b>	s	<b>Default setting</b>	10.0

n021	<b>Acceleration Time 2</b>				
<b>Setting range</b>	0.0 to 3,600	<b>Unit</b>	s	<b>Default setting</b>	10.0

n022	<b>Deceleration Time 2</b>				
<b>Setting range</b>	0.0 to 3,600	<b>Unit</b>	s	<b>Default setting</b>	10.0

- Acceleration time and deceleration time can be set with n019 to n022.
- The acceleration/deceleration time switching command must be selected to use acceleration time 2 and deceleration time 2. Refer to page 3-66, Multi-function Inputs (n035 to n039) for details.

**Set Values**

- Acceleration time: The time required for the output frequency to be 100% from 0% of the maximum frequency.
- Deceleration time: The time required for the output frequency to be 0% from 100% of the maximum frequency.
- Acceleration time 2 and deceleration time 2 will be available if the acceleration/deceleration time switching command is set.

n023	<b>S-shaped Characteristic Time Selection</b>				
<b>Setting range</b>	0, 1, 2, and 3	<b>Unit</b>	---	<b>Default setting</b>	1

- The shock of the mechanical system resulting the moment the mechanical system starts or stops can be reduced with the S-shaped acceleration and deceleration.

**Set Values**

Set value	Description
0	No s-shaped characteristic time
1	S-shaped characteristic time: 0.2 s
2	S-shaped characteristic time: 0.5 s
3	S-shaped characteristic time: 1.0 s

**Note** The acceleration time and deceleration time of the Inverter will increase by the S-shaped characteristic time set with n023.

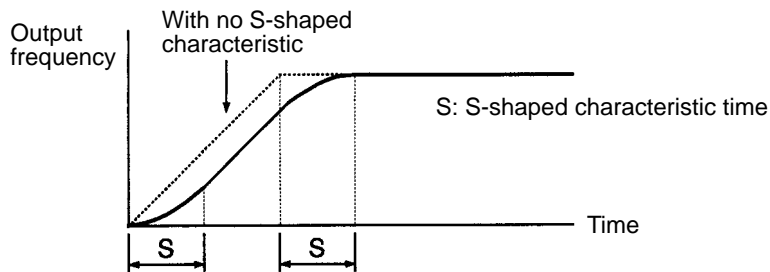

n024	<b>Unit of Frequency Reference</b>				
<b>Setting range</b>	0 to 3,999	<b>Unit</b>	---	<b>Default setting</b>	0

- Set the unit of the frequency references set or checked with the Digital Operator.

**Set Values**

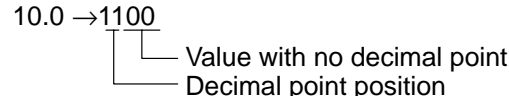
Set value	Description
0	0.1-Hz units
1	0.1% units based on the maximum frequency as 100%.
2 to 39	r/min (r/min = 120 x frequency/n024) Set n024 to the number of poles of the motor.
40 to 3,999	Determine the display method of the maximum frequency set with n012. A frequency less than the maximum frequency will be displayed proportionally. Example: Set n024 to 1100 so that "10.0" will be displayed at the maximum frequency. 10.0 → 1100 <div style="margin-left: 40px;">  </div>

n025 Frequency Reference 1					
<b>Setting range</b>	0 to maximum frequency	<b>Unit</b>	Set with n024	<b>Default setting</b>	6.0

n026 Frequency Reference 2					
<b>Setting range</b>	0 to maximum frequency	<b>Unit</b>	Set with n024	<b>Default setting</b>	0.0

n027 Frequency Reference 3					
<b>Setting range</b>	0 to maximum frequency	<b>Unit</b>	Set with n024	<b>Default setting</b>	0.0

n028 Frequency Reference 4					
<b>Setting range</b>	0 to maximum frequency	<b>Unit</b>	Set with n024	<b>Default setting</b>	0.0

- Set frequency references 1 to 4.
- The multi-step speed command must be selected to use frequency references 2 to 4.

n029 Inching Frequency Reference					
<b>Setting range</b>	0 to maximum frequency	<b>Unit</b>	Set with n024	<b>Default setting</b>	6.0

- The inching frequency reference must be set with n029 if an inching frequency is required.
- The inching command must be selected to use the inching frequency reference.

n030 Output Frequency Upper Limit					
<b>Setting range</b>	0 to 109	<b>Unit</b>	% (Maximum frequency ratio)	<b>Default setting</b>	100

n031 Output Frequency Lower Limit					
<b>Setting range</b>	0 to 100	<b>Unit</b>	% (Maximum frequency ratio)	<b>Default setting</b>	0

- Set the upper limit and lower limit of the output frequency in 1% units based on the maximum frequency set with n012 as 100%.
- The Inverter will operate at the lower limit of the output frequency set with n031 if the frequency reference used by the Inverter is set to 0. The Inverter will not, however, operate if n031 is set to a value smaller than the minimum output frequency set with n017.

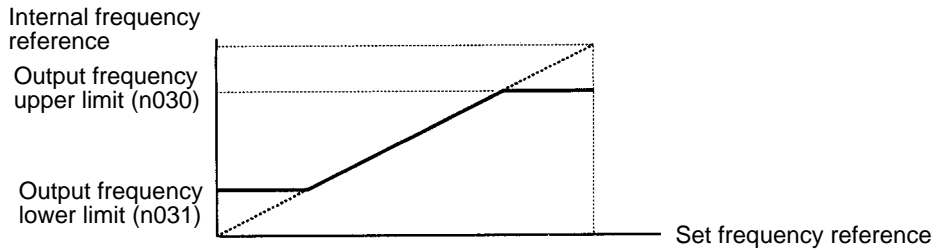

<i>n032</i>	<b>Motor Rated Current</b>				
<b>Setting range</b>	10% to 200% of rated output current of Inverter	<b>Unit</b>	A	<b>Default setting</b>	See note

**Note** The default-set value varies with the Inverter model. Refer to the following table.

**Set Values**

- Set the rated input current of the motor to determine electronic thermal protection characteristics for the motor.
- The parameter n032 is set to the rated input current of the maximum applicable motor before shipping.



200-V class			400-V class		
Model 3G3HV-	Max. motor capacity	Rated current (A) (Default-set)	Model 3G3HV-	Max. motor capacity	Rated current (A) (Default-set)
---	0.4 kW	1.9	---	0.4 kW	1.0
---	0.75 kW	3.3	---	0.75 kW	1.6
---	1.5 kW	6.2	---	1.5 kW	3.1
---	2.2 kW	8.5	---	2.2 kW	4.2
A2037	3.7 kW	14.0	A4037	3.7 kW	7.0
A2055	5.5 kW	19.6	A4055	5.5 kW	9.8
A2075	7.5 kW	26.6	A4075	7.5 kW	13.3
A2110	11 kW	39.7	A4110	11 kW	19.9
A2150	15 kW	53.0	A4150	15 kW	36.5
B2185	18.5 kW	65.8	B4185	18.5 kW	32.9
B2220	22 kW	77.2	B4220	22 kW	38.6
B2300	30 kW	105.0	B4300	30 kW	52.3
B2370	37 kW	131.0	B4370	37 kW	65.6
B2450	45 kW	156.0	B4450	45 kW	79.7
B2550	55 kW	190.0	B4550	55 kW	95.0
B2750	75 kW	260.0	B4750	75 kW	130.0
---	---	---	B411K	110 kW	190.0
---	---	---	B416K	160 kW	270.0
---	---	---	B418K	185 kW	310.0
---	---	---	B422K	220 kW	370.0
---	---	---	B430K	300 kW	500.0

n033	<b>Electronic Thermal Protection Function Selection</b>				
<b>Setting range</b>	0, 1, 2, 3, and 4	<b>Unit</b>	---	<b>Default setting</b>	1

**Set Values**

Set value	Description
0	No protection.
1	For standard motors with standard ratings (with a time constant of 8 min).
2	For standard motors with short-time ratings (with a time constant of 5 min).
3	For dedicated motors with standard ratings (with a time constant of 8 min).
4	For dedicated motors with short-time ratings (with a time constant of 5 min).

**Note** If more than one motor is operated with a single Inverter, install a thermal relay between the Inverter and the motor and set n033 to 0.

n034	<b>Selection of Stop Method for when Radiation Fin Overheats</b>				
<b>Setting range</b>	0, 1, 2, and 3	<b>Unit</b>	---	<b>Default setting</b>	3

- The Inverter will detect the heat sink overheat warning OH1 when the temperature of the heat sink reaches approximately 90°C. Select a method to interrupt the operation of the Inverter with n034.

**Set Values**

Set value	Description
0	Deceleration stop in deceleration time 1 set with n020
1	Free running stop
2	Deceleration stop in deceleration time 2 set with n022
3	Continuous operation with warning

**Note** If n034 is set to 3, the Inverter will display “OH1” when the temperature of the heat sink reaches approximately 90°C and the Inverter will continue running. If “OH1” is displayed, use a cooling fan or air conditioner to cool the Inverter. The Inverter will detect the heat sink overheat warning OH2 if the temperature further rises after “OH1” is displayed. The Inverter will stop running immediately after OH2 is detected to protect its power module from damage so that the motor will coast to stop.

<i>n035</i>	<b>Multi-function Input 1 (S2)</b>				
<b>Setting range</b>	0 to 24	<b>Unit</b>	---	<b>Default setting</b>	0

<i>n036</i>	<b>Multi-function Input 2 (S3)</b>				
<b>Setting range</b>	2 to 24	<b>Unit</b>	---	<b>Default setting</b>	2

<i>n037</i>	<b>Multi-function Input 3 (S4)</b>				
<b>Setting range</b>	2 to 24	<b>Unit</b>	---	<b>Default setting</b>	4

<i>n038</i>	<b>Multi-function Input 4 (S5)</b>				
<b>Setting range</b>	2 to 24	<b>Unit</b>	---	<b>Default setting</b>	9

<i>n039</i>	<b>Multi-function Input 5 (S6)</b>				
<b>Setting range</b>	2 to 27	<b>Unit</b>	---	<b>Default setting</b>	10

- The parameters n035 to n039 can be set to the following.
- Each of the set values of n035 to n039 must be unique.

Set Values

Set value	Description
0	Reverse rotation/Stop (2-wire sequence selection) (Only n035 can be set to 0)
1	Stop command (3-wire sequence selection) (Only n035 can be set to 1) S1 will be used for the run command and S3 will be used for forward/reverse rotation instruction and the value set with n036 will be ignored.
2	External error (NO contact: ON)
3	External error (NC contact: ON)
4	Error reset (ON: Valid) Error reset will be ignored if the Inverter is running normally.
5	Operation mode selection (ON: Digital Operator; OFF: n002)
6	Not used
7	Emergency stop (ON: The Inverter will decelerate to stop the motor according to acceleration time 2 set with n022) To restart the Inverter, turn the run command OFF and ON.
8	Analog input selection (ON: Current input through FI terminal; OFF: FV terminal) Current input through the FI terminal will be valid if the FI terminal is selected with n042 (i.e., analog frequency reference voltage/current selection) set to 1 and no voltage input from the FV terminal will be valid in any case.
9	Multi-step speed command 1
10	Multi-step speed command 2
11	Inching command (ON: Inching command) This command takes precedence over the frequency reference.)
12	Acceleration/Deceleration time switching command (ON: Acceleration/Deceleration time 2 will be used; OFF: Acceleration/Deceleration time 1 will be used)
13	External baseblock command (ON: Valid)
14	External baseblock command (OFF: Valid)
15	Speed search command from max. frequency (ON: Speed search)
16	Speed search command from set frequency (ON: Speed search)
17	Parameter set-inhibit (ON: Invalid) No parameter settings other than frequency reference settings with the FREF indicator will be available if parameter set-inhibit is valid.
18	Integral value of PID control reset command (ON: Integral value reset)
19	PID control invalidating command (ON: The target value from the FV terminal becomes the frequency reference.)
20	Timer function input (Set with n077 and n078)
21	Inverter overheat warning (ON: "OH3" will be displayed and the Inverter will continue running)
22	Analog frequency sample and hold (ON: Sampling and holding)
23	Power OFF stop input (NO contact: Valid when NO contact is ON)
24	Power OFF stop input (NC contact: Valid when NC contact is OFF)
25	Up/Down command (Only n039 can be set to 25) S5 will be used for up command and S6 will be used for down command and the value set with n038 will be ignored.
26	Not used.
27	PID input characteristic selection (NO contact: Deviation multiplied by -1 when NO contact is ON)

● 2-wire Sequence (n035 = 0)

Wiring Example

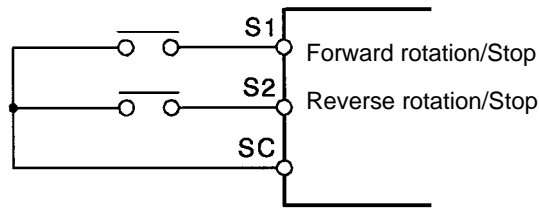

Operation Example

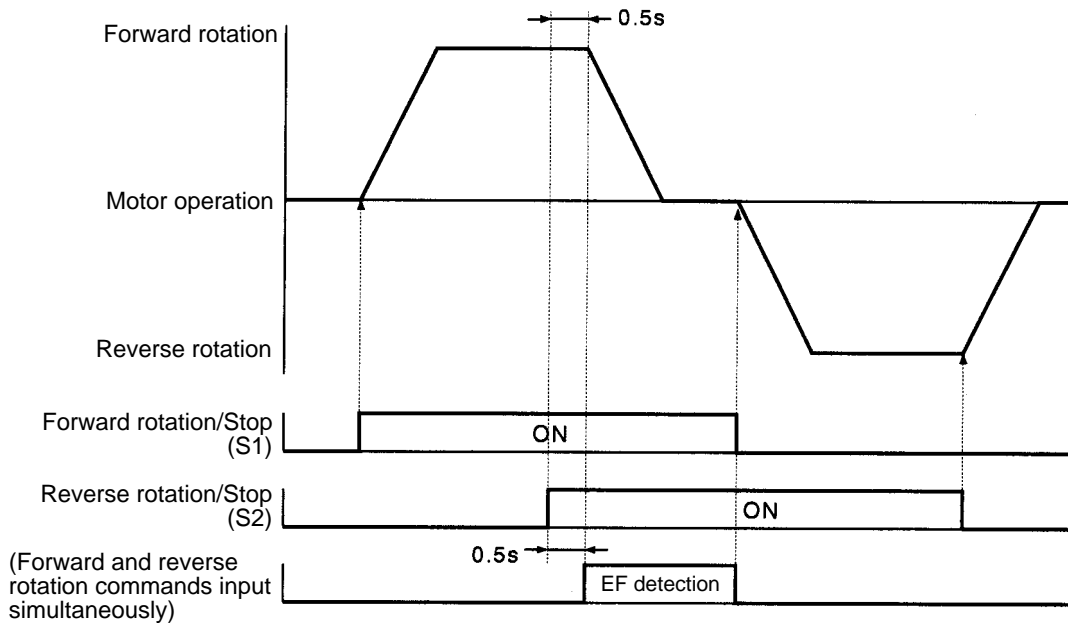

● 3-wire Sequence (n035 = 1)

Wiring Example

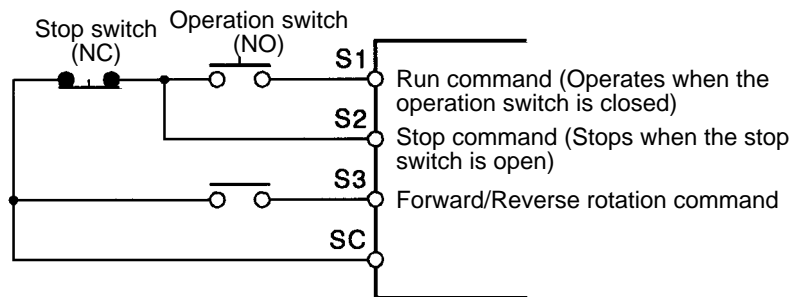

**Operation Example**

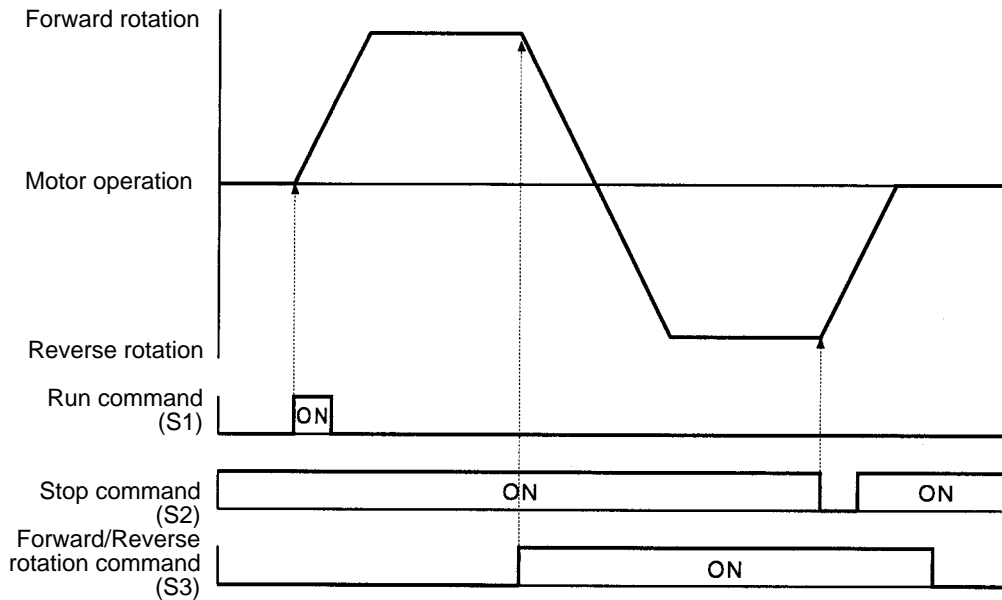

**• Multi-step Speed Command (Set Value = 9 or 10)**

**Operation Example**

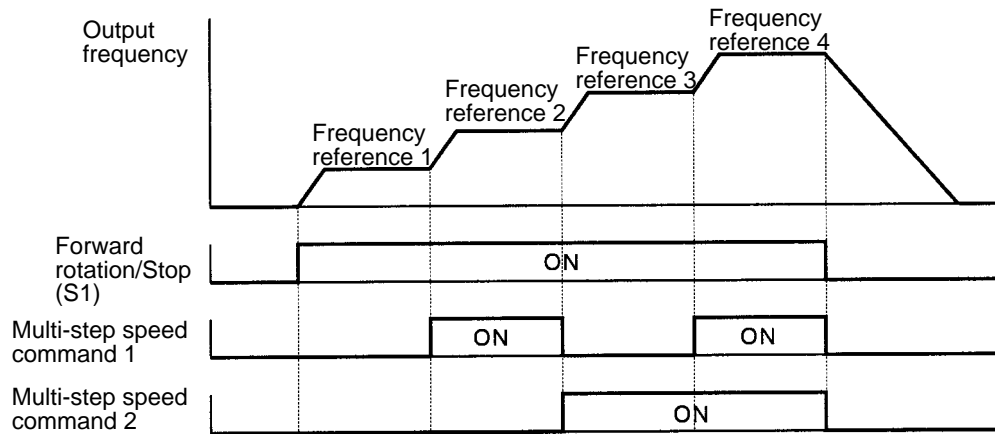

**• Inching Frequency Reference (Set Value = 11)**

**Operation Example**

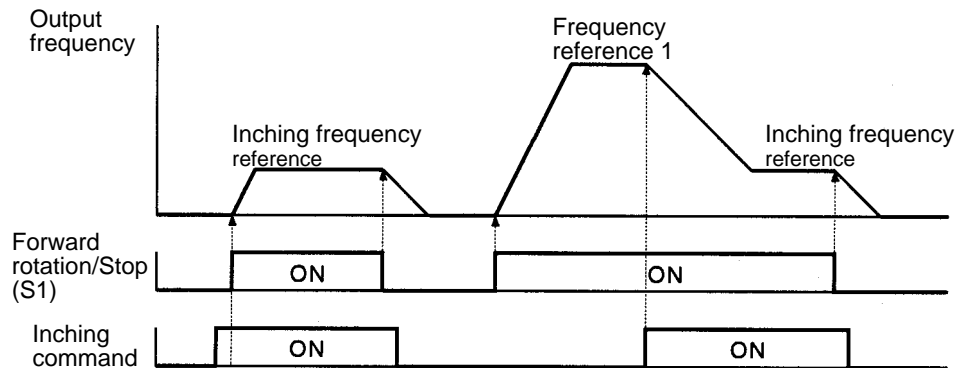

● **Acceleration/Deceleration Time Switching Command (Set Value = 12)**

**Operation Example**

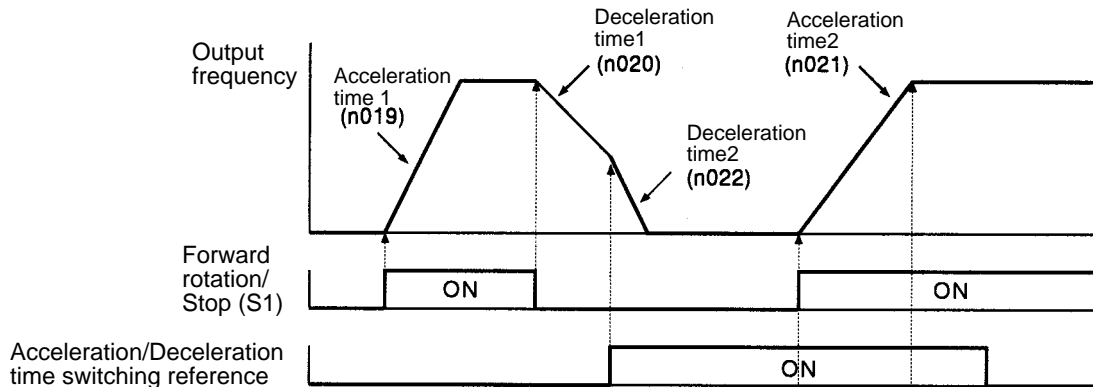

● **External Baseblock Command (Set Value = 13 or 14)**

The baseblock command can be input remotely to the Inverter by setting n035 to 13 (i.e., the NO contact is ON) or to 14 (i.e., the NC contact is OFF).

The baseblock is the status of the Inverter with output turned OFF. The motor will coast to a stop if the baseblock command is input to the Inverter. The Inverter, however, will hold the output frequency and if the baseblock command is released, a speed search will be carried out from the frequency held by the Inverter, and the motor will be restarted. To clear the held frequency, turn OFF the run command. When the run command is turned OFF, the held frequency will change to zero.

● **Speed Search Command (Set Value = 15 or 16)**

The Inverter in speed search operation restarts the motor without stopping the motor while the motor is coasting.

The Inverter in speed search operation makes it possible to smoothly switch over power supply to the motor from commercial power supply to the output power of the Inverter.

Program a sequence to input the run command and speed search command simultaneously or the run command after the speed search command. The speed search command will be ignored if the run command is input earlier than the speed search command.

**Operation Example**

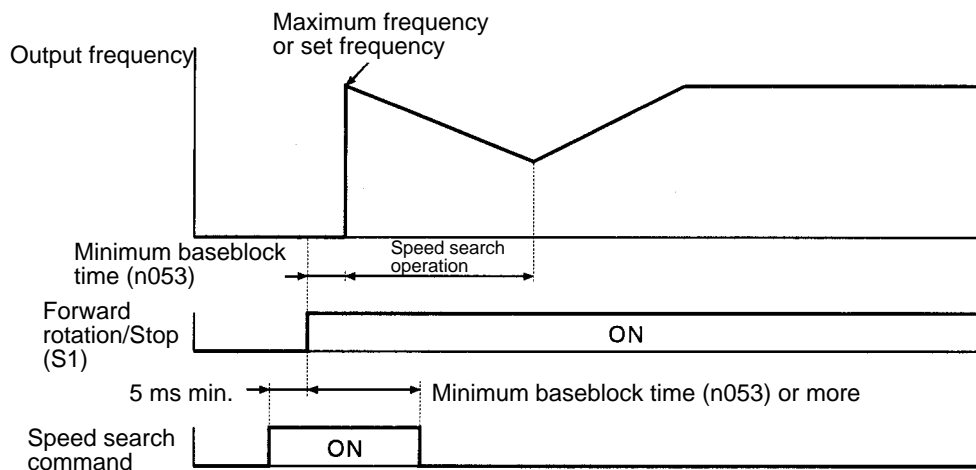

- Note 1.** The Inverter in speed search operation will work according to the speed search V/f characteristics set with n054 and when the output current becomes less than the speed search operation level set with n052, the Inverter will have normal acceleration output.
- Note 2.** The speed search command must be ON for at least the minimum baseblock time set with n053 after the run command is input, otherwise the speed search operation is not available.
- Note 3.** Adjust the minimum baseblock time set with n053 for the most suitable timing to start the speed search operation.
- Note 4.** It is usually not necessary to change the default-set values of n052 and n054. Set n052 to a smaller value if the motor does not restart after the speed search operation completes.
- Note 5.** Input the run command in 5 ms or more after the speed search command is input to permit the Inverter to be in reliable speed search operation.

● **Integral Value of PID Control Reset Command/PID Control Invalidating Command (Set Value = 18 or 19)**

● **Integral Value Reset (Set Value = 18)**

If the integral value reset command is input, the integral value used for PID control will be reset and the integral operation output will be zero.

The integral operation output will remain zero while this command is input.

Input this command to stop the integral operation to temporarily prevent rapid changes of the output of the Inverter.

● **PID Control Invalidating Command (Set Value = 19)**

Use this command to change the type of control performed by the Inverter from PID control, such as JOG control, to the usual control, such as constant speed control with a frequency reference, and vice versa.

The Inverter will stop performing PID control if this command is input and the Inverter will use input to the FV terminal as a frequency reference. If n002 is set to 0 or 1, however, the Inverter will use frequency references 1 to 4.

● **PID Input Characteristic Selection (Set Value: 27)**

**Note** This can only be set in n039.

It is possible to switch the input characteristic for PID control. The PID control deviation can be multiplied by  $-1$  to control sensors with negative characteristics. “Negative characteristic” refers to operation where the feedback value decreases when the Inverter’s output frequency increases. This function is useful for control that alternates between positive and negative characteristics because of the changing direction of the motor. Control that has a constantly negative characteristic can be achieved by setting PID control function selection (n084) to 3.

● **Timer Function Input (Set Value = 20)**

Timer function input is a standard sequential input. By setting appropriate delay time values with n077 and n078, the Inverter can prevent the sensor from chattering.

The Inverter will turn ON timer function output if timer function input to the Inverter is ON for a period longer than the timer function ON-delay time set with n077.

The Inverter will turn OFF timer function output if timer function input to the Inverter is OFF for a period longer than the timer function OFF-delay time set with n078.

**Operation Example**

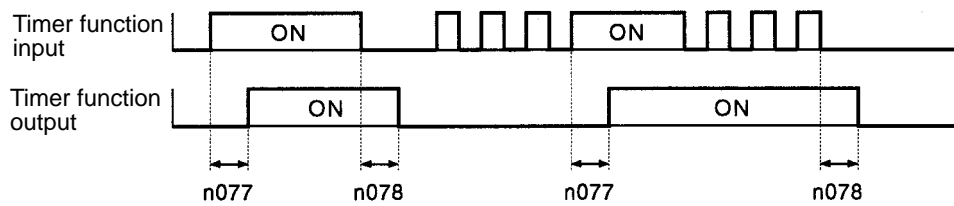

● **Inverter Overheat Warning (Set Value = 21)**

If this signal is input, “OH3” will be displayed by the Inverter.

This signal can be used to detect the overheating of the Braking Resistor Unit, Control Unit, and motor.

● **Analog Frequency Sample and Hold (Set Value = 22)**

If this signal is ON for 0.1 s or more, the Inverter will sample and hold the analog frequency reference being used.

The Inverter will continue to keep the frequency on hold.

The Inverter will save the frequency on hold as frequency reference 1 value of n025 so that the value will not be lost after the Inverter is turned OFF if n044 is set to 1.

**Operation Example**

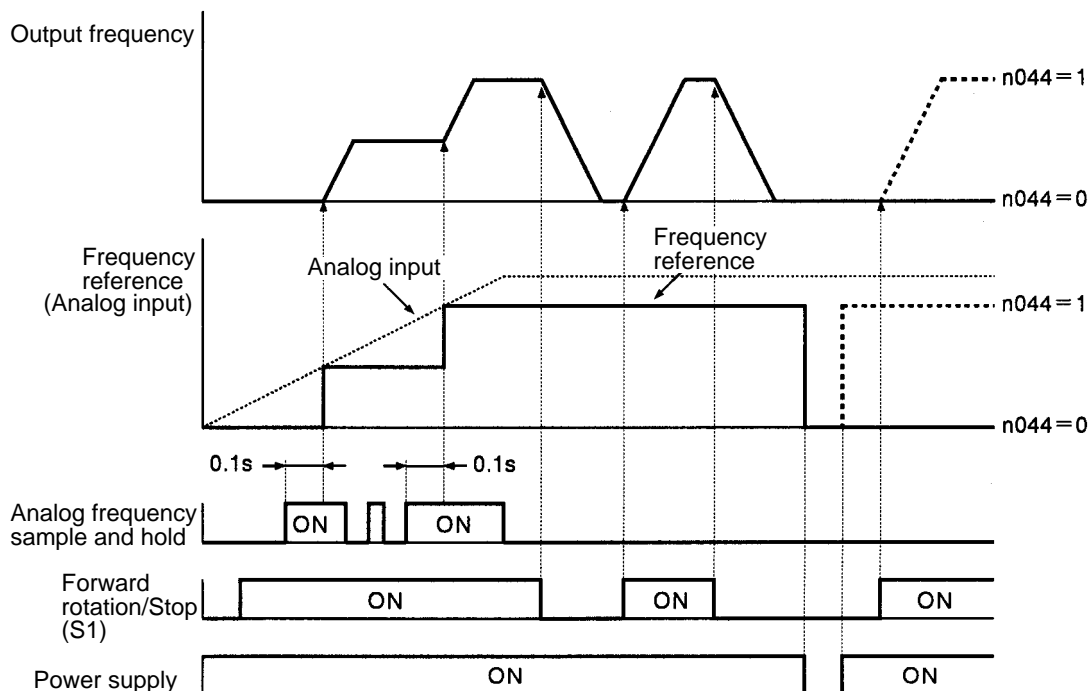

**Note** The frequency on hold will be lost when the Inverter is turned OFF if n044 is set to 0.

● **Power OFF Stop Input (Set Value = 23 or 24)**

Power OFF stop input shortens the deceleration time of the motor when power supply to the Inverter is OFF.



If this signal is ON, the Inverter will decelerate the motor to stop according to deceleration time 2 set with n022 when the Inverter detects a voltage drop of power supply to the Inverter.

**● Up/Down Command (Set Value = 25)**

The up/down command controls the output frequency according to input to S5 and S6.

S5 (multi-function input 4) will be used for the up command, S6 (multi-function input 5) will be used for the down command, and value set with n038 will be ignored if n039 is set to 25.

<b>Multi-function input 4 (S5): Up command</b>	ON	OFF	ON	OFF
<b>Multi-function input 5 (S6): Down command</b>	OFF	ON	ON	OFF
<b>Operation status</b>	Acceleration	Acceleration	Hold	Hold

**Note 1.** The up/down command is valid only if n002 (i.e., operation mode selection) is set to 1 or 3.

**Note 2.** The Inverter will accelerate or decelerate the motor according to the acceleration time or deceleration time set with n019 to n022 if the up/down command is input.

**Note 3.** The following are the upper and lower limits of the output frequency when the Inverter accelerates or decelerates the motor with the up/down command.

Upper limit: Maximum frequency (n012) x output frequency upper limit (n030)/100

Lower limit: Maximum frequency (n012) x output frequency lower limit (n031)/100

If an analog frequency reference is input through the FV or FI terminal and the value of the analog frequency reference is larger than the above lower limit, the lower limit of the output frequency will be determined by the analog frequency reference.

**Note 4.** The initial output frequency is 0.0 Hz if n039 is set to 25. The output frequency will reach the lower limit when the up/down command is input.

**Note 5.** Turn ON input to S5 or S6 while the run command is OFF to set the frequency reference used by the Inverter to zero.

**Note 6.** The multi-step speed command is invalid if n039 is set to 25.

Operation Example

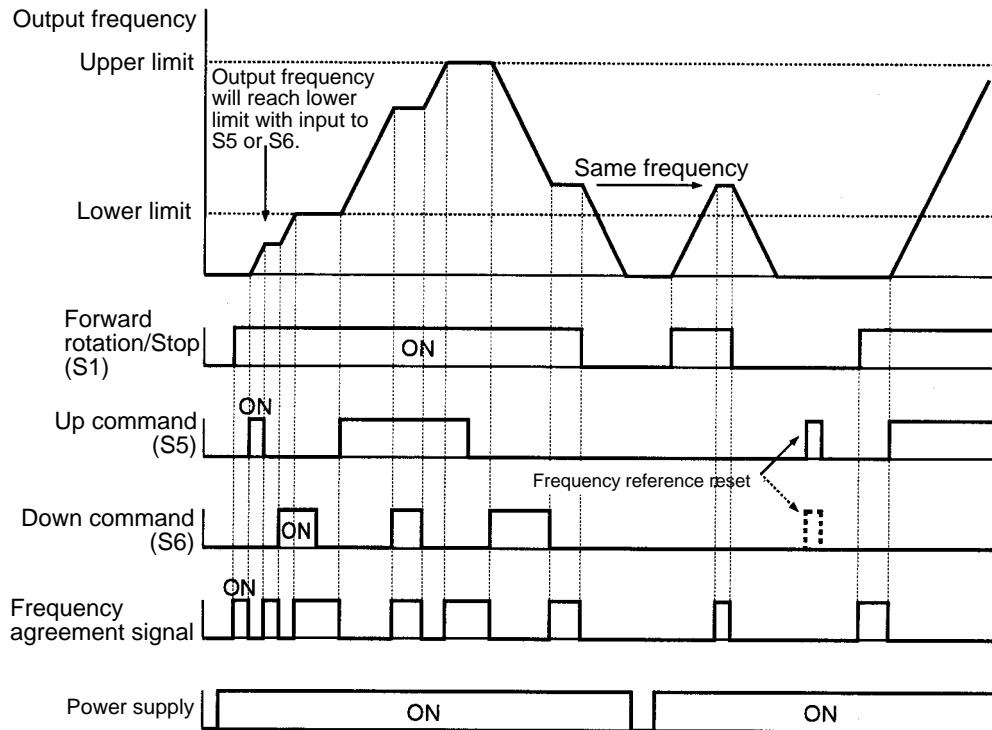

**Note:** The frequency synchronization signal is ON when the run command is ON while the Inverter is not in acceleration or deceleration mode.

<i>r040</i>	<b>Multi-function Contact Output 1 (MA-MB-MC)</b>				
<b>Setting range</b>	0 to 17	<b>Unit</b>	---	<b>Default setting</b>	0

<i>r041</i>	<b>Multi-function Contact Output 2 (M1-M2)</b>				
<b>Setting range</b>	0 to 17	<b>Unit</b>	---	<b>Default setting</b>	1

- The functions of multi-function contact output 1 (MA, MB, and MC) and multi-function contact output 2 (M1 and M2) can be selected from the following.

Set Values

Set value	Description
0	Error (ON: Error)
1	Running (ON: Running) (See note.)
2	Frequency agreement (ON: Frequency agreement)
3	Optional frequency agreement (ON: Optional frequency agreement)
4	Optional frequency detection (ON: Output frequency □ n073) (See note.)
5	Optional frequency detection (ON: Output frequency □ n073) (See note.)
6	Overtorque (ON: Detected) Set the detection method with n074, the detection level with n075, and the detection time with n076.
7	Overtorque (OFF: Detected) Set the detection method with n074, the detection level with n075, and the detection time with n076.
8	Baseblock (ON: Subject to the baseblock.)
9	Operation mode (ON: Digital Operator/Frequency reference)
10	Inverter ready (ON: Ready) Ready: The Inverter is turned ON and ready to operate normally.
11	Timer function output (Set with n077 and n078)
12	Error retrying (Valid if the error retry function is set with n056)
13	Inverter/Motor overload warning (ON: Warning) Inverter overload warning: ON when the output of the Inverter is 150% of the rated output continuously for 48 s. Motor overload warning: ON when the motor is overloaded for a period as long as 80% of the motor overload protective time.
14	Frequency reference loss (ON: Loss) Set n045 (i.e., analog frequency reference loss processing) to 1 (i.e., valid). Frequency reference loss is a phenomenon resulting in a value drop of a frequency reference by 90% or more within 0.4 s. If the Inverter detects frequency reference loss, the Inverter will continue running at a frequency 20% lower than the previous frequency.
15	Not used
16	PID feedback loss (ON: Loss) The Inverter will detect PID feedback loss if n092 (i.e., feedback loss selection) is set to 1. Set the feedback loss detection level with n093 and the feedback loss detection time with n094.
17	Heating heat sink (ON: OH1 will be detected)

**Note** Set values 1, 4, and 5 can be used as timing signals for braking.

● Frequency Agreement (Set Value = 2)

Operation Example

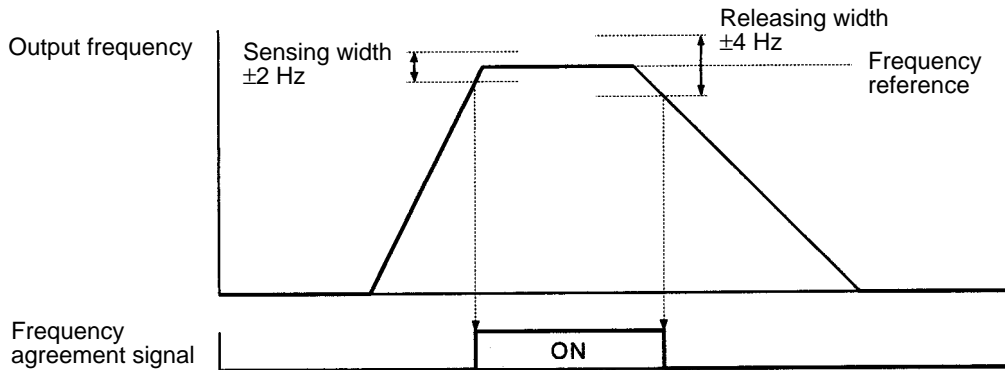

● Optional Frequency Agreement (Set Value = 3)

Operation Example

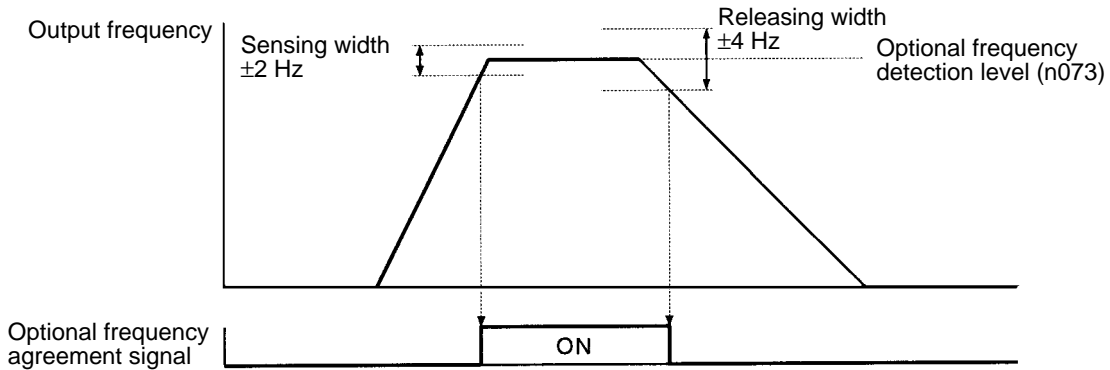

● Optional Frequency Detection: Output Frequency  Frequency Detection Level (Set Value = 4)

Operation Example

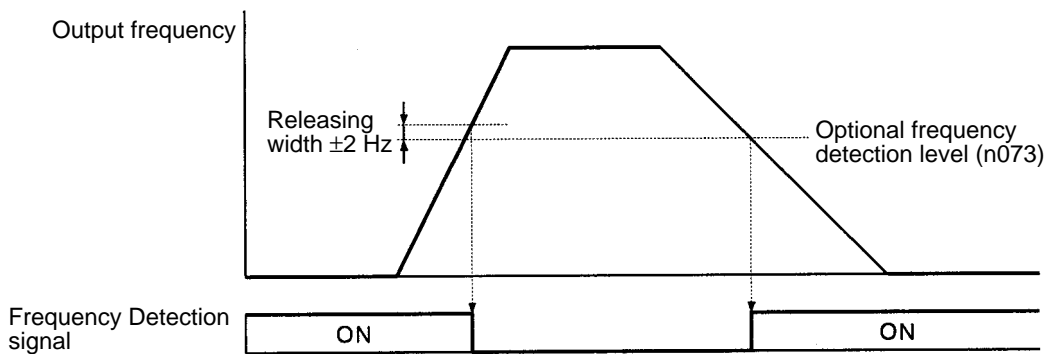

● **Optional Frequency Detection: Output Frequency □ Frequency Detection Level (Set Value = 5)**

**Operation Example**

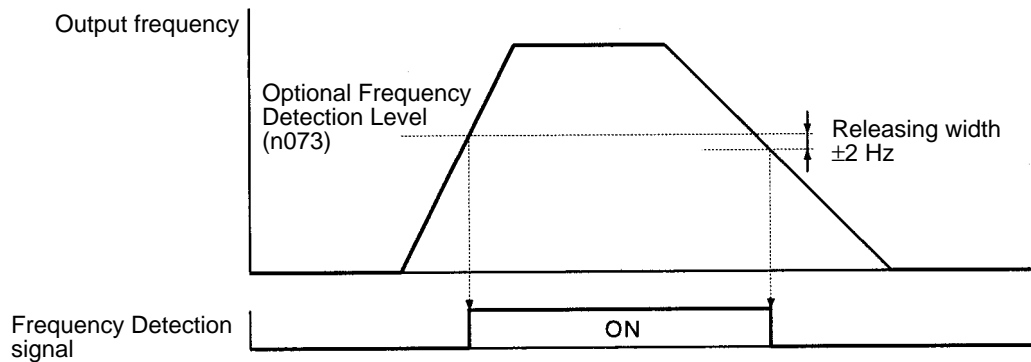

**Note** The detection widths and release widths for frequency agreement, optional frequency agreement, and optional frequency detection can be changed with the settings for the frequency detection width parameter (n113).

Frequency agreement, optional frequency agreement: Detection width = Value set for n113  
 Release width = Twice value set for n113  
 Optional frequency detection: Release width = Value set for n113

● **Overtorque Detection (Set Value = 6 and 7)**

The Inverter will detect an increase in the output current resulted from the motor with an excessive load and output an alarm signal as multi-function contact output if n074 (i.e., overtorque detection function selection) is set to 1, 2, 3, or 4.

**Operation Example**

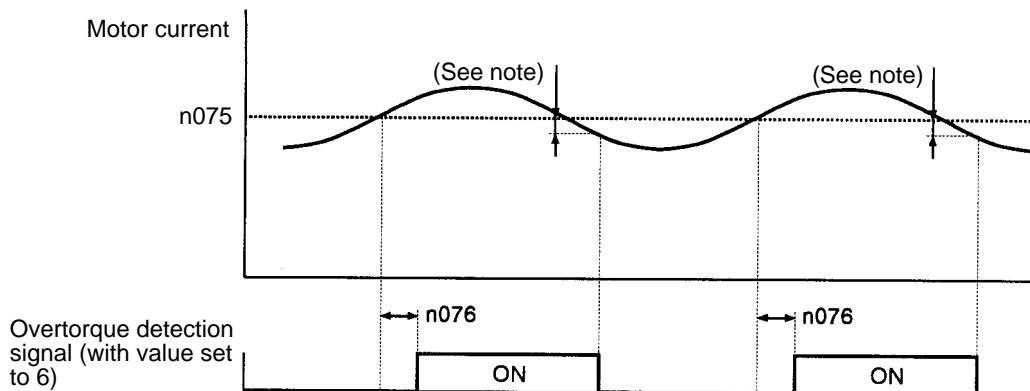

**Note:** The release width of overtorque detection is approximately 5% of the rated output current.

● **Timer Function Output (Set Value = 11)**

Refer to page 3-71, *Timer Function Input (Set Value = 20)*.

n042 <b>Analog Frequency Reference Voltage/Current Selection</b>					
<b>Setting range</b>	0, 1	<b>Unit</b>	---	<b>Default setting</b>	0

- Select the FV terminal to input the frequency reference within a voltage range from 0 to 10 VDC or the FI terminal to input the frequency reference within a current range from 4 to 20 mA with n042.

**Set Values**

Set value	Description
0	The FV terminal can be used for the analog frequency reference within a voltage range from 0 to 10 VDC.
1	The FI terminal can be used for the analog frequency reference. Set the input level with n043.

**Note 1.** The FI terminal is a current input terminal for 4 to 20 mA. The FI terminal can be a voltage input terminal by changing the FI input level with n043 and cutting the jumper wire of the PCB. Do not, however, change the FI terminal to a voltage input terminal unless the Inverter is used for PID control.

**Note 2.** Set n042 according to the type of frequency reference.

n043 FI Input Level Selection					
Setting range	0, 1	Unit	---	Default setting	1

- Set the FI input level with n043 so that the FI terminal will become a current or voltage input.

**Set Values**

Set value	Description
0	Voltage input within a range from 0 to 10 V. Be sure to cut jumper wire J1.
1	Current input within a range from 4 to 20 mA.

**Note** Do not impose voltage on the Inverter without cutting jumper wire J1 if n043 is set to 0, otherwise the input resistor of the Inverter will burn out. Refer to *page 3-34* for the position of the jumper wire.

n044 Analog Frequency Reference Sample Hold Selection					
Setting range	0, 1	Unit	---	Default setting	0

- Set n044 when using the analog frequency sample and hold as multi-function input.

**Set Values**

Set value	Description
0	Frequency reference on hold is saved by n025
1	Frequency reference on hold is not saved.

n045 Processing Selection when Analog Frequency Reference is Lost					
Setting range	0, 1	Unit	---	Default setting	0

- Set n045 to 0 or 1 to determine the operation of the Inverter when the frequency reference input to the FV or FI terminal drops sharply.

**Set Values**

Set value	Description
0	Inhibits Inverter from processing analog frequency reference loss.
1	Permits Inverter to process analog frequency reference loss.

**Note 1.** Frequency reference loss is a phenomenon resulting in a value drop of a frequency reference by 90% or more within 0.4 s.

If the Inverter detects frequency reference loss, the Inverter will continue running at a frequency 20% lower than the previous frequency.

**Note 2.** To permit the Inverter to output a signal indicating that the Inverter is processing frequency reference loss, set n040 (i.e., multi-function contact output 1) or n041 (i.e., multi-function contact output 2) to 14.

n046	<b>Frequency Reference Gain</b>				
<b>Setting range</b>	0 to 200	<b>Unit</b>	%	<b>Default setting</b>	100

n047	<b>Frequency Reference Bias</b>				
<b>Setting range</b>	-100 to 100	<b>Unit</b>	%	<b>Default setting</b>	0

- Set the frequency reference gain with n046 and the frequency reference bias with n047.

**Set Values**

- n046: The frequency for 10 V or 20 mA input can be set in 1% units based on the maximum frequency set with n012 as 100%.
- n047: The frequency for 0 V or 4 mA input can be set in 1% units based on the maximum frequency set with n012 as 100%.

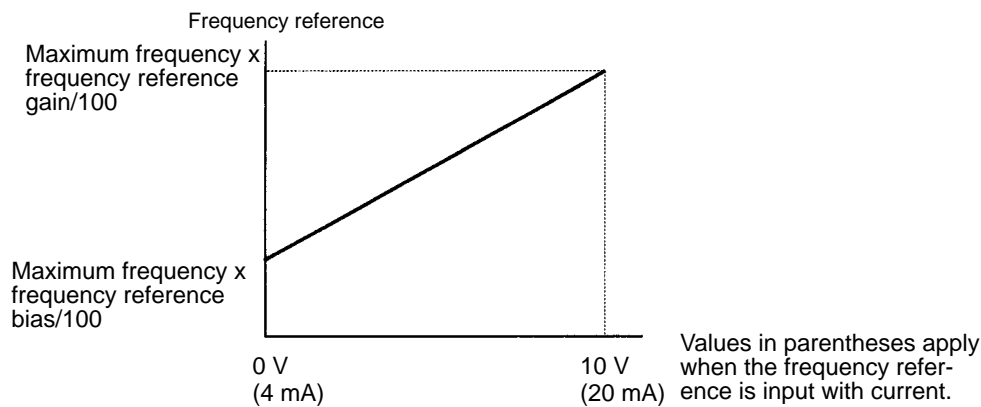

n048	<b>Multi-function Analog Output Selection</b>				
<b>Setting range</b>	0, 1, 2, and 3	<b>Unit</b>	---	<b>Default setting</b>	0

- Set the n048 so that the type of signal of multi-function analog output terminals AM and AC will be determined.

**Set Values (n048)**

Set value	Description
0	Output frequency (10 V: Max. frequency n012)
1	Output current (10 V: Rated inverter current)
2	Output power (10 V: Rated inverter output capacity)
3	Main circuit DC voltage (10 V: 200-V class: 400 V; 400-V class: 800V)

<i>n049</i>	<b>Multi-function Analog Output Gain</b>				
<b>Setting range</b>	0.01 to 2.00	<b>Unit</b>	Times	<b>Default setting</b>	1.00

- The parameter n049 is used to adjust the analog output gain.

**Set Values**

- Set n049 to the result obtained from dividing the voltage of the full analog output by 10 V.
- For example, set n048 to 0 and n049 to 0.30 when connecting multi-function analog output terminals AM and AC to a frequency meter that operates at 3 V maximum. Refer to the following diagram.

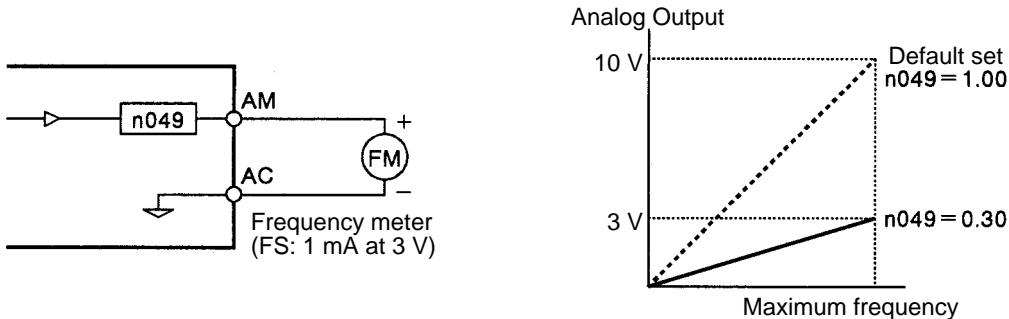

<i>n050</i>	<b>Carrier Frequency</b>				
<b>Setting range</b>	1 to 9	<b>Unit</b>	---	<b>Default setting</b>	See note

**Note** The default-set value of n050 varies with the Inverter model.

- Set the switching frequency (carrier frequency) of the output transistor of the Inverter with n050.
- The noise generation and current leakage of the Inverter will be low if the carrier frequency is set low, in which case, the motor will generate a more metallic noise.

**Set Values**

Set value	Description
1	2.5 kHz
2	5.0 kHz
3	8.0 kHz
4	10.0 kHz
5	12.5 kHz
6	15.0 kHz
7 to 9	Varies in proportion to output frequency up to 2.5 kHz. (Refer to the following graphs)
10	7.0 kHz

- Note 1.** The carrier frequency setting range varies depending on the Inverter capacity.
- |  |                      |
|--|----------------------|
| 200-V class and 400-V class, 22 kW max.:             | 0.4 to 15.0 kHz max. |
| 200-V class, 30 to 75 kW; 400-V class, 30 to 160 kW: | 0.4 to 10.0 kHz max. |
| 400-V class, 185 to 300 kW:                          | 0.4 to 2.5 kHz max.  |

**Note 2.** For a 400-V Inverter, if the carrier frequency is set to a value higher than the default setting, the Inverter’s rated output current will decrease as shown in the following table. If the Inverter overload “OL2” is detected prior to the motor overload “OL1,” decrease the carrier frequency setting.



400-V Inverter capacity	English Models (Japanese Models) 3G3HV-A□-E(-A□)			Models conforming to EN standards 3G3HV-A□-CUE/-CE		
	Default setting	Drop in rating at 10 kHz	Drop in rating at 15 kHz	Default setting	Drop in rating at 10 kHz	Drop in rating at 15 kHz
0.4 to 2.2 kW	---	---	---	6 (15.0 kHz)	100%	95%
3.7 to 5.5 kW	6 (15.0 kHz)	100%	100%	6 (15.0 kHz)	100%	95%
7.5 kW	5 (12.5 kHz)	100%	90%	4 (10.0 kHz)	100%	80%
11 kW	5 (12.5 kHz)	100%	90%	5 (12.5 kHz)	100%	95%
15/18.5 kW	5 (12.5 kHz)	100%	90%	4 (10.0 kHz)	100%	80%
22 kW	4 (10.0 kHz)	100%	80%	4 (10.0 kHz)	85%	50%
30 kW	3 (8.0 kHz)	85%	---	3 (8.0 kHz)	85%	---
37 kW	3 (8.0 kHz)	85%	---	2 (5.0 kHz)	60%	---
45 kW	10 (7.0 kHz)	75%	---	2 (5.0 kHz)	60%	---
55 to 160 kW	2 (5.0 kHz)	60%	---	2 (5.0 kHz)	60%	---
185 to 300 kW	9 (2.5 kHz max.)	---	---			

**n050 = 7**

Carrier frequency (fc)

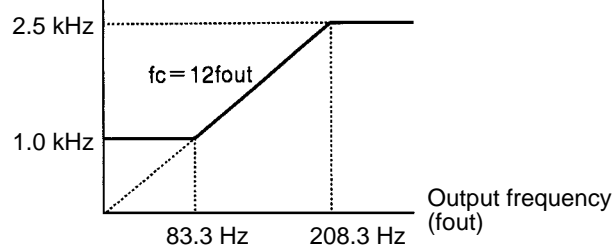

**n050 = 8**

Carrier frequency (fc)

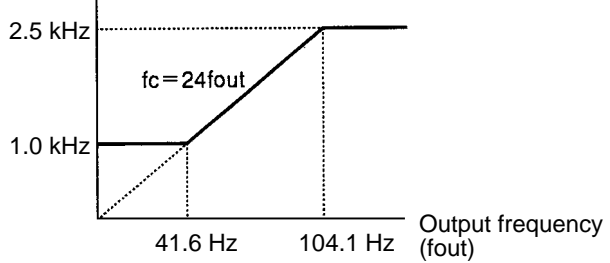

**n050 = 9**

Carrier frequency (fc)

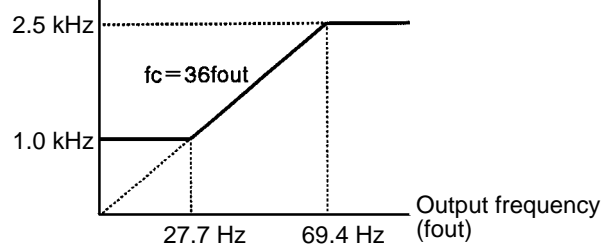

<i>n051</i>	<b>Selection of Running After Restoration Following a Momentary Stop</b>				
<b>Setting range</b>	0, 1, and 2	<b>Unit</b>	---	<b>Default setting</b>	0

- Select with n051 a method to process instantaneous power failure.

**Set Values**

Set value	Description
0	Inverter will discontinue running.
1	Inverter will continue running if power is supplied again within instantaneous power failure compensation time set with n055. (see note 1)
2	Inverter will always continue running without detecting UV1 or UV3. (see notes 1 and 2)

**Note 1.** Keep the run command ON to permit the Inverter to restart operation automatically when power is supplied to the Inverter after the operation of the Inverter is interrupted due to an instantaneous power failure.

**Note 2.** If n051 is set to 2, the Inverter will restart running after supply voltage to the Inverter returns to normal and the Inverter will not detect error output signals.

n052	Speed Search Control Level				
<b>Setting range</b>	0 to 200	<b>Unit</b>	% (Rated output current ratio)	<b>Default setting</b>	110

- Set with n052 a current level in 1% units based on the rated output current as 100% which enables the Inverter to determine the completion of the speed search control.
- It is usually not necessary to change the default-set value.
- To permit the Inverter to use the speed search function, set the multi-function input parameter used by the Inverter to 15 or 16 so that the speed search command will be input to the Inverter.
- When the output current becomes less than the value set with n054, the Inverter in speed search control will detect the synchronous speed and the Inverter will be in acceleration mode.

n053	Minimum Baseblock Time				
<b>Setting range</b>	0.5 to 10.0	<b>Unit</b>	s	<b>Default setting</b>	See note

**Note** The default-set value varies with the Inverter model.

- Set with n053 time in 1-s units to start the speed search control after RUN input is ON and instantaneous power failure processing starts. Refer to *page 3-70, Speed Search Command*.

n054	V/f Characteristics During Speed Search				
<b>Setting range</b>	0 to 100	<b>Unit</b>	% (Usual V/f characteristics ratio)	<b>Default setting</b>	See note

**Note** The default-set value varies with the Inverter model.

- Set percentage of V/f characteristics for speed search.
- It is usually not necessary to change the default-set value.

n055	Stop Compensation Time				
<b>Setting range</b>	0.0 to 2.0	<b>Unit</b>	s	<b>Default setting</b>	See note

**Note** The default-set value varies with the Inverter model.

- Set instantaneous power failure compensation time in 1-s units.
- It is usually not necessary to change the default-set value.

<i>n056</i>	<b>Number of Error Retries</b>				
<b>Setting range</b>	0 to 10	<b>Unit</b>	Times	<b>Default setting</b>	0

**! Caution** The Inverter may be damaged if the error retry function is used.

**! Caution** Given that the Inverter may be damaged if the error retry function is used, connect a no-fuse breaker to the Inverter and program a sequence to interrupt the operation of peripheral devices when the Inverter is error.

- The error retry function permits the Inverter to restart operation automatically, even if the Inverter is error.
- Use the error retry function only in case the interruption of the operation of the mechanical system is not desired, even if the Inverter may be damaged.
- The error retry function is valid for the following errors. A protection function of the Inverter will work if the Inverter has any other error.
  - OC (Overcurrent)
  - OV (Main circuit overvoltage)
  - UV1 (Main circuit undervoltage)
  - GF (Ground fault)
  - RR (Control transistor overheat)
- The number of error retries counted will be cleared in the following cases.
  - When the Inverter is in normal operation for 10 minutes after an error retry.
  - When the Inverter receives error reset input after the Inverter detects an error with a protection function.
  - When the Inverter is turned OFF and ON.
- To permit the Inverter to output an error retry signal, set the multi-function contact output parameter used by the Inverter to 12.

<i>n057</i>	<b>Selection of Error Output during Error Retry</b>				
<b>Setting range</b>	0, 1	<b>Unit</b>	---	<b>Default setting</b>	0

- Select with n057 whether to permit the Inverter to turn ON error output while the Inverter is in error retry operation.
- To permit the Inverter to turn ON error output while the Inverter is in error retry operation, set the multi-function contact output parameter used by the Inverter to 0.

**Set Values**

<b>Set value</b>	<b>Description</b>
0	Turns ON error output while error retry is performed.
1	Turns OFF error output while error retry is performed.

<i>n058</i>	<b>Jump Frequency 1</b>				
<b>Setting range</b>	0.0 to 400.0	<b>Unit</b>	Hz	<b>Default setting</b>	0.0

n059	<b>Jump Frequency 2</b>				
<b>Setting range</b>	0.0 to 400.0	<b>Unit</b>	Hz	<b>Default setting</b>	0.0

n060	<b>Jump Frequency Range</b>				
<b>Setting range</b>	0.0 to 25.5	<b>Unit</b>	Hz	<b>Default setting</b>	1.0

- The frequency jump prevents the Inverter from generating frequencies that make the mechanical system resonate.
- The frequency jump can be used effectively to make dead bands for frequency references.
- Set with n058 and n059 the center values of jumping frequencies.
- The value set with n059 must be as large as or larger than the value set with n058, otherwise OPE6 (improper parameter setting) will result.
- Set with n060 a jump frequency width.

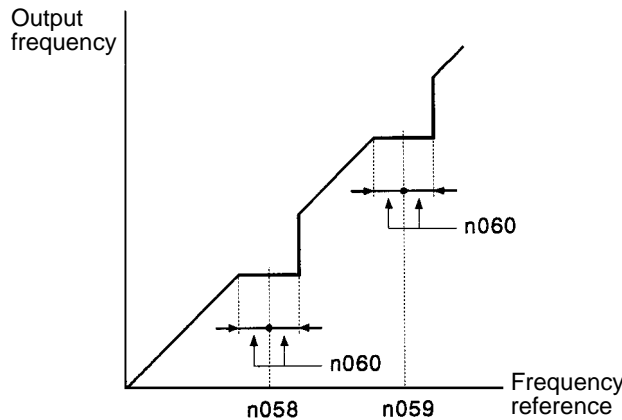

n061	<b>Total Operating Time Function Selection</b>				
<b>Setting range</b>	0, 1	<b>Unit</b>	---	<b>Default setting</b>	1

n062	<b>Total Operating Time 1 (Rightmost 4 Digits)</b>				
<b>Setting range</b>	0 to 9,999	<b>Unit</b>	h	<b>Default setting</b>	0

n063	<b>Total Operating Time 2 (Leftmost 2 Digits)</b>				
<b>Setting range</b>	0 to 27	<b>Unit</b>	x 10,000 h	<b>Default setting</b>	0

- Select with n061 whether to permit the Inverter to accumulate the power-ON time or operation time of the Inverter.

**Set Values (n061)**

Set value	Description
0	Accumulates power-ON time
1	Accumulates operation time

- Set with n062 and n063 the initial operation time of the Inverter. The accumulated operation time of the Inverter can be obtained from the following.  

$$\text{Accumulated operation time (h)} = n063 \times 10,000 + n062$$
- The parameters n062 and n063 can be used to monitor the accumulated operation time of the Inverter.
- The maximum value of the accumulated operation time set with n062 and n063 is 279620 (h). When the value of the accumulated operation time exceeds 279620, n062 and n063 will be set to 0.

<b>n064</b>	<b>DC Braking Current</b>				
<b>Setting range</b>	0 to 100	<b>Unit</b>	% (Rated output current ratio)	<b>Default setting</b>	50

- Set DC control current with 1% units based on rated output current of Inverter as 100%.

<b>n065</b>	<b>Stopped DC Braking Time</b>				
<b>Setting range</b>	0.0 to 10.0	<b>Unit</b>	s	<b>Default setting</b>	0.5

- Set with n065 DC control time in 1-s units to stop the motor.
- The Inverter will not perform DC control to stop the motor if n065 is set to 0.0.
- The DC control time set with n065 is valid if n004 (i.e., stop mode selection) is set to 0 (i.e., deceleration stop mode). The Inverter will not perform DC control if a free running stop mode is selected with n004.

<b>n066</b>	<b>Startup DC Braking Time</b>				
<b>Setting range</b>	0.0 to 10.0	<b>Unit</b>	s	<b>Default setting</b>	0.0

- The parameter n066 is used to stop the motor that is coasting and restart the motor.
- Set with n065 DC control time in 1-s units to start the motor.
- The Inverter will not perform DC control to start the motor if n066 is set to 0.0.

**Stop DC Control**

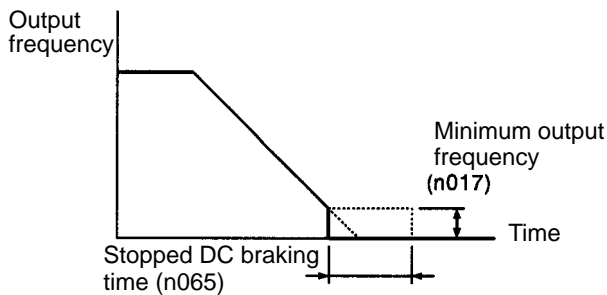

**Start DC Control**

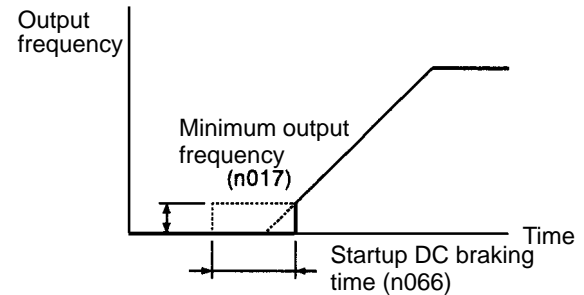

<b>n067</b>	<b>Automatic Torque Boost Gain</b>				
<b>Setting range</b>	0.0 to 3.0	<b>Unit</b>	Times	<b>Default setting</b>	1.0

<b>n068</b>	<b>Motor Winding Resistance</b>				
<b>Setting range</b>	0.000 to 65.53	<b>Unit</b>	$\Omega$	<b>Default setting</b>	See note

<b>n069</b>	<b>Motor Iron Loss</b>				
<b>Setting range</b>	0 to 9,999	<b>Unit</b>	W	<b>Default setting</b>	See note

**Note** The default-set values of n068 and n069 vary with the Inverter model.

- The parameters n067, n068, and n069 are used for torque compensation.
- It is usually not necessary to change the default-set values.
- Set n067 to a larger value if the wiring distance between the Inverter and motor is long and a smaller value if the motor vibrates.
- Set with n068 the coil resistance of the motor and n069 the core loss of the motor if the coil resistance and core loss are known. The parameters n068 and n069 will probably make the torque boost function more effective.

n070	<b>Decelerating Stall Prevention Selection</b>				
<b>Setting range</b>	0, 1	<b>Unit</b>	---	<b>Default setting</b>	1

- Select with n070 a method to process the overvoltage error of the Inverter decelerating the motor.

**Set Values**

Set value	Description
0	Inhibits deceleration stall prevention from functioning.
1	Permits deceleration stall prevention to function.

**Note 1.** Be sure to set n070 to 0 if the Braking Resistor Unit is connected to the Inverter, otherwise the Braking Resistor Unit will not work.

**Note 2.** The Inverter will automatically extend time to decelerate the motor so that no overvoltage error will result if n070 is set to 1.

**Operation Example**

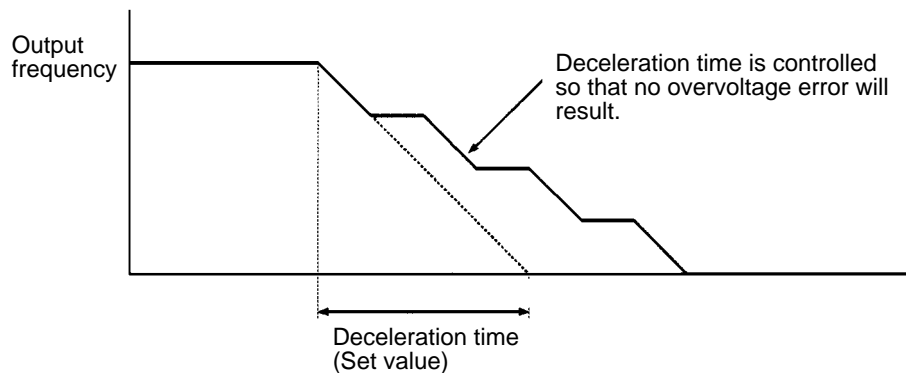

n071	<b>Accelerating Stall Prevention Operation Level</b>				
<b>Setting range</b>	30 to 200	<b>Unit</b>	% (Rated output current ratio)	<b>Default setting</b>	170 (See note.)

n072	<b>Operating Stall Prevention Operation Level</b>				
<b>Setting range</b>	30 to 200	<b>Unit</b>	% (Rated output current ratio)	<b>Default setting</b>	160 (See note.)

**Note** The default setting for 18.5-kW or higher Inverters is 120.

- The parameters n071 and n072 are used to lower the output frequency to levels to enable the Inverter to continue operating the motor without stalling.
- Set with n071 and n072 current levels in 1% units based on the rated output current as 100% to enable the acceleration and operation stall prevention functions to work.

**Acceleration Stall Prevention**

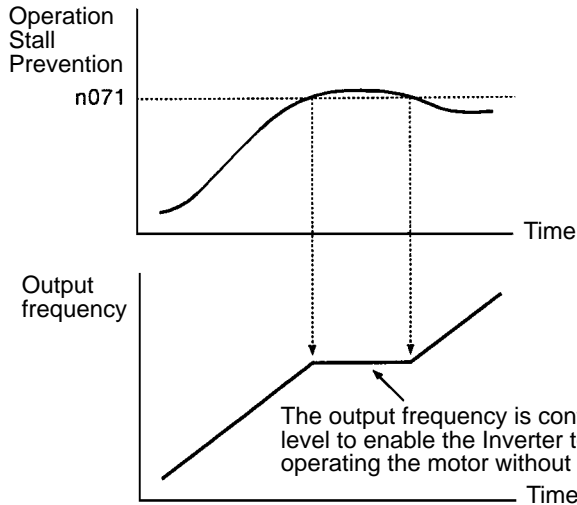

**Operation Stall Prevention**

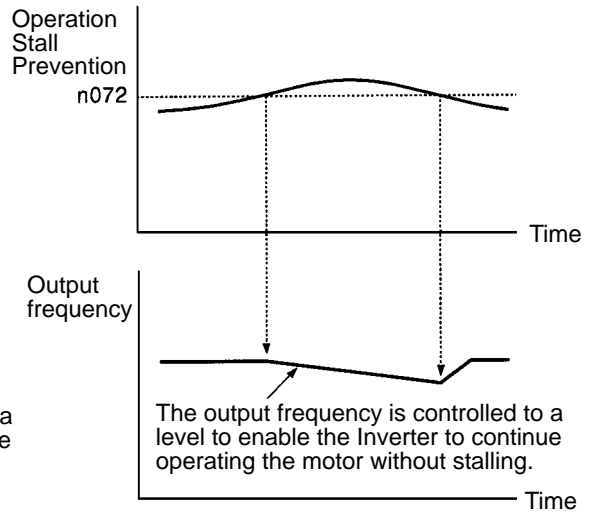

n073	<b>Frequency Detection Level</b>				
<b>Setting range</b>	0.0 to 400.0	<b>Unit</b>	Hz	<b>Default setting</b>	0.0

- The parameter n073 is used to detect the output frequency.
- The Inverter will output a signal as a multi-function contact output while the output frequency is higher than, lower than, or the same as the frequency set with n073.
- Set n040 and n041 (i.e., multi-function contact output selection):
  - To 3 to permit the Inverter to output a signal while the output frequency is the same as the frequency set with n073.
  - To 4 to permit the Inverter to output a signal while the output frequency is the same as or lower than the frequency set with n073.
  - To 5 to permit the Inverter to output a signal while the output frequency is the same as or higher than the frequency set with n073. Refer to *page 3-76*.

n074	<b>Overtorque Detection Function Selection</b>				
<b>Setting range</b>	0 to 4	<b>Unit</b>	---	<b>Default setting</b>	0

n075	<b>Overtorque Detection Level</b>				
<b>Setting range</b>	30 to 200	<b>Unit</b>	% (Rated output current ratio)	<b>Default setting</b>	160

n076	<b>Overtorque Detection Time</b>				
<b>Setting range</b>	0.1 to 10.0	<b>Unit</b>	s	<b>Default setting</b>	0.1

- The parameters n074, n075, and n076 are used to set the overtorque detection function.
- Select with n074 whether to permit the Inverter to detect overtorque and a method to process the over-torque.
- The Inverter will detect overtorque if the output current as large as or larger than the detection level set with n075 flows for a period as long as or longer than the detection time set with n076.
- Set with n075 an overtorque detection current level in 1% units based on the rated output current as 100%.
- Set with n076 overtorque detection time in 1-s units.
- Refer to *page 3-77* to permit the Inverter to output an overtorque detection signal as multi-function contact output.

**Set Values (n074)**

Set value	Description
0	Inhibits Inverter from detecting overtorque.
1	Inverter will detect overtorque only during speed agreement and continue running with a warning after detection.
2	Running Inverter will detect overtorque and continue running with a warning after detection.
3	Inverter will detect overtorque only during speed agreement and turn OFF output for safety when overtorque is detected.
4	Running Inverter will always detect overtorque and turn OFF output for safety when overtorque is detected.

n077	Timer Function ON Delay Time				
Setting range	0.0 to 25.5	Unit	s	Default setting	0.0

n078	Timer Function OFF Delay Time				
Setting range	0.0 to 25.5	Unit	s	Default setting	0.0

- The parameters n077 and n078 are used to set the timer function.
- To permit the Inverter to use the timer function, set the multi-function input parameter used by the Inverter to 20 for timer function input and the multi-function contact output parameter used by the Inverter to 11 for timer function output.
- Set with n077 delay time in 1-s units to permit the Inverter to turn ON timer function output after timer function input is ON.
- Set with n078 delay time in 1-s units to permit the Inverter to turn OFF timer function output after timer function input is OFF.
- Refer to *page 3-71, Timer Function Input (Set Value = 20)* for the timer function in detail.

n079	Braking Resistor Overheating Protection Selection				
Setting range	0, 1	Unit	---	Default setting	0



- Select with n079 whether to permit the Inverter to protect the Braking Resistor Unit connected to the Inverter from overheating.
- The Inverter will display an error and turn OFF the output power when the Inverter detects the overheating of the Braking Resistor Unit with the RH signal if n079 is set to 1.

**Set Values**

Set value	Description
0	Inhibits overheating protection from functioning.
1	Permits overheating protection to function.

n080	Input Open-phase Detection Level				
<b>Setting range</b>	1 to 100	<b>Unit</b>	(400/800 VDC as 100%)	<b>Default setting</b>	7

n081	Input Open-phase Detection Time				
<b>Setting range</b>	2 to 255	<b>Unit</b>	x 1.28 s	<b>Default setting</b>	8

- The parameters n080 and n081 are used to set the input phase loss detection function.
- It is usually not necessary to change the default-set values.
- The Inverter will not detect input phase loss if n080 is set to 100.
- Set n080 of the 200-V Inverter based on 400 VDC as 100% and that of the Inverter of 400-V class based on 800 VDC as 100%.
- The input phase loss detection function is used to detect the voltage ripples that will be generated from the main circuit DC power supply when input phase loss results.  
The Inverter will detect input phase loss if the voltage width of the voltage ripples of the main circuit DC power supply exceeds the range set with n080 for a period exceeding the time set with n081.
- If the power supplied to the Inverter has ripples, set n080 or n081 to a large value so that the Inverter will not detect input phase loss.

n082	Output Open-phase Detection Level				
<b>Setting range</b>	0 to 100	<b>Unit</b>	% (Rated output current ratio)	<b>Default setting</b>	0

n083	Output Open-phase Detection Time				
<b>Setting range</b>	0.0 to 2.0	<b>Unit</b>	s	<b>Default setting</b>	0.2

- The parameters n082 and n083 are used to set the output phase loss detection function.
- The Inverter will not detect output phase loss if n082 is set to 0. The default-set value of n082 is 0.
- When an output phase loss occurs, the Inverter will detect a decrease in the output current of the phase.
- To use the output phase loss detection function, refer to the following procedure and set with n082 an appropriate output phase loss detection level.
  1. Start the motor with no load.
  2. Use the Digital Operator and monitor the amperage of the output current.

3. Calculate the percentage of the output current based on the rated output current as 100%.
4. Set n082 to half the number calculated.

n 109	<b>Slip Compensation Gain</b>				
<b>Setting range</b>	0.0 to 9.9	<b>Unit</b>	% (Motor rated frequency)	<b>Default setting</b>	0.0

n 110	<b>Motor No-load Current</b>				
<b>Setting range</b>	0 to 99	<b>Unit</b>	% (Motor rated current n032)	<b>Default setting</b>	30

n 111	<b>Slip Compensation Primary Delay Time</b>				
<b>Setting range</b>	0.0 to 25.5	<b>Unit</b>	s	<b>Default setting</b>	2.0

- The slip compensation function keeps the rotating speed of the motor constant if the load is heavy. Without this function, the motor will slip and the rotating speed of the motor will decrease if the load is heavy.
- If the output current of the Inverter is equal to the electronic thermal reference current (i.e., the rated current of the motor), add the compensation frequency equivalent to the rated slippage value of the motor to the output frequency.
- Refer to the following formulas to obtain the constants to be set in n109 and n110.  
 $n109 = (\text{Synchronization speed} - \text{rated motor revolution}) / \text{synchronization speed} \times 100$   
 $\text{Synchronization speed} = 120f/P$   
 P: No. of polls  
 f: Rated frequency  
 $n110 = (\text{Output current with no load} / \text{rated current of the motor}) \times 100$
- The compensation frequency (fc) can be obtained from the following.  
 If the output frequency is lower than the constant set in n26 for the maximum voltage frequency, use the following formula to obtain the compensation frequency (fc).  
 $fc = n014 \times n109 \times [\text{output current} - (n032 \times n110/100)] / [n032 - (n032 \times n110/100)]$   
 If the output frequency is equal to or higher than the constant set in n26 for the maximum voltage frequency, use the following formula to obtain the compensation frequency (fc).  
 $fc = \text{output frequency} \times n109 \times [\text{output current} - (n032 \times n110/100)] / [n31 - (n032 \times n110/100)]$   
 n014: Maximum voltage frequency (Hz)  
 n032: Motor rated current (A)
- Slip compensation primary delay time is set in s units.  
 Usually setting is not necessary. Adjust when slip compensation responsiveness is low, or speed has not stabilized.
  - When responsiveness is low, decrease the set value.
  - When speed has not stabilized, increase the set value.

**Note 1.** The slip compensation function does not work if the output frequency is lower than the constant set in n017 for the minimum output frequency.

**Note 2.** The slip compensation function does not work if the Inverter is in regenerative operation.

**Note 3.** The slip compensation function does not work if 0.0 is set for the Motor Rated Current.



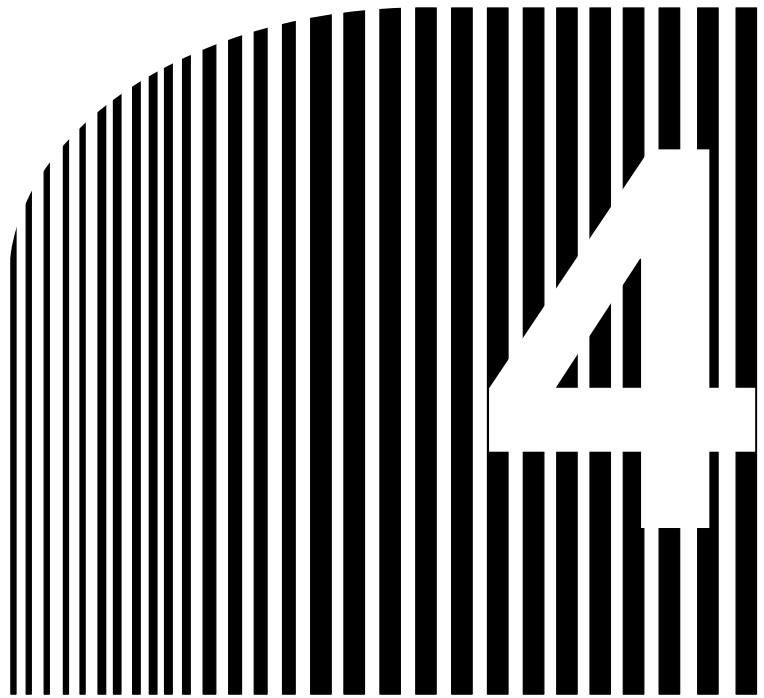

## Chapter 4

### • Operation •

- 4-1 Protective and Diagnostic Functions
- 4-2 Troubleshooting
- 4-3 Maintenance and Inspection

## 4-1 Protective and Diagnostic Functions

### ■ Errors Interrupting Inverter Output

- If the Inverter detects an error, the Inverter will have an error contact output and decelerate the motor to a stop, make the motor coast to a stop, or let the motor continue rotating according to the error processing mode selected while the Digital Operator displays the status of the error.
- If an error results, refer to the following and take the necessary action.
- Before restarting the Inverter, take one of the following actions to reset the Inverter. If the run signal is ON, turn it OFF. The reset signal will be ignored if the run signal is ON.

Turn ON an error reset signal by setting the multi-function input parameter used by the Inverter to 4.

Press the STOP/RESET Key.

Turn the main circuit power supply OFF and ON.

### ● Errors and Actions Taken

Data display	Description	Cause and action
OC	<b>Overcurrent (OC)</b> The Inverter output current instantaneously exceeded the overcurrent detection level.	The output side of the Inverter is shorted or grounded due to motor coil burnout, poor motor coil insulation, or cable damage. The load is excessive. The acceleration and deceleration time settings are too short. A special motor or a motor with a capacity exceeding the maximum output capacity of the Inverter is used. The magnetic contactor on the output side of the Inverter was opened and closed. → Determine the cause of the error, take the necessary action, and reset the system.
GF	<b>Ground fault (GF)</b> A ground fault current exceeding 50% of the rated Inverter output current flowed from the output side of the Inverter.	The output side of the Inverter is grounded due to the motor coil burnout, poor motor coil insulation, or cable damage. → Determine the cause of the error, take the necessary action, and reset the system.
PUF	<b>Fuse pre-arcing (PUF)</b> The fuse of the main circuit blew out.	The output transistor is broken, in which case replace the Inverter. The output transistor will break if the B1 or negative terminal is shorted with the T1 (U), T2 (V), or T3 (W) terminal. The output side of the Inverter is shorted or grounded. → Determine the cause of the error, take the necessary action, and reset the system.
SC	<b>Load short-circuit (SC)</b> The Inverter output or load is shorted.	The output side of the Inverter is shorted or grounded due to motor coil burnout, poor motor coil insulation, or cable damage. → Determine the cause of the error, take the necessary action, and reset the system.

Data display	Description	Cause and action
OV	<p><b>Main circuit overvoltage (OV)</b></p> <p>The DC voltage of the main circuit exceeded the overvoltage detection level (approx. 400 V for 200-V class models and approx. 800 V for 400-V class models).</p>	<p>The deceleration time setting is too short and regenerative energy from the motor is excessive.</p> <p>→ Increase the deceleration time or connect the Braking Resistor Unit.</p> <p>A surge is imposed when the phase advance capacitor is switched.</p> <p>→ Insert an AC reactor into the power input side of the Inverter.</p> <p>The voltage of power supply to the Inverter is too high.</p> <p>→ Lower the voltage within the rated power supply voltage.</p>
UV1	<p><b>Main circuit undervoltage (UV1)</b></p> <p>The DC voltage of the main circuit dropped to or below the undervoltage detection level (approx. 190 V for 200-V class models and approx. 380 V for 400-V class models).</p>	<p>Power supply to the Inverter has phase loss.</p> <p>An instantaneous power interruption occurred.</p> <p>Power input terminal screws are loose.</p> <p>The voltage fluctuation of power supply to the Inverter is excessive.</p> <p>→ Determine the cause of the error, take the necessary action, and reset the system.</p>
UV2	<p><b>Control power supply fault (UV2)</b></p> <p>A voltage fault occurred in control output power supply.</p>	<p>→ Turn power supply to the Inverter OFF and ON.</p> <p>→ If this problem persists, replace the Inverter.</p>
UV3	<p><b>Inrush current preventive circuit fault (UV3)</b></p> <p>The inrush current preventive circuit is malfunctioning.</p>	<p>→ Turn power supply to the Inverter OFF and ON.</p> <p>→ If this problem persists, replace the Inverter.</p>
SP	<p><b>Short-phase input (SPI)</b></p> <p>The DC voltage of the main circuit fluctuates excessively while the Inverter is not affected by regenerative energy. (The input phase loss detection level and time are set with n080 and n081.)</p>	<p>Power supply to the Inverter has phase loss.</p> <p>An instantaneous power interruption occurred.</p> <p>Power input terminal screws are loose.</p> <p>The voltage fluctuation of power supply to the Inverter is excessive.</p> <p>The voltages of the phases of power supply to the Inverter are uneven.</p> <p>→ Determine the cause of the error, take the necessary action, and reset the system.</p>
SPo	<p><b>Short-phase output (SPO)</b></p> <p>The Inverter output has phase loss. (The output phase loss detection level and time are set with n082 and n083.)</p>	<p>The output cable is broken.</p> <p>A motor coil is broken.</p> <p>Motor output terminal screws are loose.</p> <p>→ Determine the cause of the error, take the necessary action, and reset the system.</p>
OH1*	<p><b>Heat sink overheat (OH1)</b></p> <p>The temperature of the heat sink exceeded approx. 90°C.</p>	<p>The ambient temperature is too high.</p> <p>→ Install a cooling fan or air conditioner.</p> <p>A heat generating object exists near the Inverter.</p> <p>→ Remove the object.</p>
OH2	<p><b>Heat sink overheat (OH2)</b></p> <p>The temperature of the heat sink exceeded approx. 100°C.</p>	<p>The cooling fan of the Inverter is not operating.</p> <p>→ The cooling fan must be replaced, in which case contact your OMRON representative.</p> <p>High carrier frequency. (400V-class models)</p> <p>→ Decrease the set value of n050.</p>

Data display	Description	Cause and action
<i>rH</i>	<p><b>Braking resistor overheat (RH)</b> The braking resistor protection function set with n079 worked.</p>	<p>Regenerative energy from the motor is excessive. → Increase the deceleration time, connect a small load, or connect the Braking Resistor Unit to the Inverter. The voltage of power supply to the Inverter is too high. → Lower the voltage within the rated power supply voltage.</p>
<i>rr</i>	<p><b>Control transistor overheat (RR)</b> The control transistor protection function worked.</p>	<p>Regenerative energy from the motor is excessive. → Increase the deceleration time, connect a small load, or use replace the Inverter with a model that has a capacity one rank or two ranks higher. The voltage of power supply to the Inverter is too high. Lower the voltage within the rated power supply voltage.</p>
<i>oL1</i>	<p><b>Motor overload (OL1)</b> The electronic thermal relay actuated the motor overload protection function.</p>	<p>The load is excessive or the acceleration time, deceleration time, and cycle time are too short. → Review the load size, acceleration time, deceleration time, and cycle time. The voltage of the V/f characteristics is excessive. → Review the V/f characteristics. The rated input current of the motor set with n032 is improper. → Set n032 properly.</p>
<i>oL2</i>	<p><b>Inverter overload (OL2)</b> The electronic thermal relay actuated the Inverter overload protection function.</p>	<p>The load size is excessive or the acceleration time, deceleration time, and cycle time are too short. → Review the load size, acceleration time, deceleration time, and cycle time. The voltage of the V/f characteristics is excessive. → Review the V/f characteristics. The capacity of the Inverter is too small. → Replace the Inverter with a model that has a larger capacity. High carrier frequency. (400V-class models) → Decrease the set value of n050.</p>
<i>oL3*</i>	<p><b>Overtorque (OL3)</b> A current exceeding the value set with n075 flowed for more than the time set with n076.</p>	<p>→ Check whether the n075 and n076 settings are appropriate. → Check the machine use status and eliminate the cause of the problem.</p>
<i>EF2</i>	<p><b>External error (Terminal S2)</b></p>	<p>An external error is input.</p>
<i>EF3</i>	<p><b>External error (Terminal S3)</b></p>	<p>→ Remove the cause of the external error.</p>
<i>EF4</i>	<p><b>External error (Terminal S4)</b></p>	
<i>EF5</i>	<p><b>External error (Terminal S5)</b></p>	
<i>EF6</i>	<p><b>External error (Terminal S6)</b></p>	

Data display	Description	Cause and action
<i>OPr</i>	<b>Digital Operator connection error</b> The Digital Operator became disconnected while the Inverter was running. Detected when n112 = 1.	The connecting cable is broken. There is a fault in one of the connectors on the Inverter or the Digital Operator. → Re-insert or clean the connectors before turning ON the power supply again. Parameter incorrectly set. → Set n112 to 0. If this problem persists, replace the cable or the Inverter.
<i>CPF0</i>	<b>Digital Operator transmission error (CPF0)</b> The Inverter could not communicate with the Digital Operator within 5 s after power is supplied to the Inverter.	The Digital Operator is not connected to the Inverter properly. → Reconnect the Digital Operator to the Inverter. The CPU of the Inverter is broken. → Replace the Inverter.
<i>CPF1</i>	<b>Digital Operator transmission error (CPF1)</b> A transmission error lasting longer than 2 s occurred after transmission with the Digital Operator started.	The Digital Operator is not connected to the Inverter properly. → Reconnect the Digital Operator to the Inverter. The CPU of the Inverter is broken. → Replace the Inverter.
<i>CPF4</i>	<b>EEPROM fault (CPF4)</b>	→ Turn power supply to the Inverter OFF and ON. → If this problem persists, replace the Inverter.
<i>CPF5</i>	<b>A/D converter fault (OPF5)</b>	→ Turn power supply to the Inverter OFF and ON. → If this problem persists, replace the Inverter.

**Note** Stopping methods can be selected for the errors with asterisk marks.

■ **Warnings**

- When a warning status arises, the Inverter will not generate an error contact output. Eliminating the cause will recover the system automatically.
- If a warning status arises, refer to the following and take the necessary action.

● **Warnings and Actions Taken**

Data display	Description	Cause and action
<i>EF</i> flashing	<b>Forward and reverse rotation commands input simultaneously</b> The forward and reverse rotation commands were input simultaneously for 0.5 s or more.	→ Review the sequence used for the forward and reverse rotation commands.



Data display	Description	Cause and action
<p><i>uu</i> flashing</p>	<p><b>Main circuit undervoltage (UV)</b> The DC voltage of the main circuit dropped to or below the undervoltage detection level.</p>	<p>→ Check whether the voltage of power supply to the Inverter is proper. If not, impose the proper voltage. → Check whether the power input line to the Inverter is broken or disconnected. If the power input line is broken or disconnected, replace the power input line or connect the power input line properly. → Check the terminal block screws for looseness. If they are loose, tighten them securely.</p>
<p><i>ou</i> flashing</p>	<p><b>Main circuit overvoltage (OV)</b> The DC voltage of the main circuit exceeded the overvoltage detection level while the Inverter had no output.</p>	<p>→ Check whether the voltage of power supply to the Inverter is proper. If not, impose proper voltage.</p>
<p><i>oh1</i> flashing</p>	<p><b>Heat sink overheat (OH1)</b> The temperature of the heat sink exceeded approximately 90°C and n034 was set to 3 for the continuous operation of the Inverter.</p>	<p>The ambient temperature is too high. → Install a cooling fan or air conditioner. A heat generating object exists near the Inverter. → Remove the object.</p>
<p><i>oh3</i> flashing</p>	<p><b>Inverter overheat warning (OH3)</b> Inverter overheat warning as multi-function input was received by the Inverter.</p>	<p>→ Turn OFF inverter overheat warning.</p>
<p><i>ol3</i> flashing</p>	<p><b>Overtorque (OL3)</b> A current exceeding the value set with n075 flowed for more than the time set with n076.</p>	<p>→ Check whether the n075 and n076 settings are appropriate. → Check the machine use status and eliminate the cause of the problem.</p>
<p><i>bb</i> flashing</p>	<p><b>Remote baseblock (bb)</b> The remote baseblock command input as multi-function input was received by the Inverter.</p>	<p>→ Turn OFF the remote baseblock command input.</p>
<p><i>call</i> flashing</p>	<p><b>Operation mode error (CALL)</b> The setting of n002 was improper.</p>	<p>The parameter n002 was set to a value other than 0 to 3. → Reset n002.</p>
<p><i>ope3</i></p>	<p><b>Multi-function input setting error</b> The multi-function input settings of n035 to n039 were improper.</p>	<p>Make sure that the values of n035 to n039 are different from one another. Make sure that a single search mode is selected with n035 to n039 set to 15 or 16. Make sure that both set values 22 and 25 are selected with n035 to n039.</p>
<p><i>pes</i></p>	<p><b>V/f data setting error</b> Optional V/f pattern settings were improper.</p>	<p>Reset the optional V/f pattern to satisfy the following condition. → n017 □ n015 □ n014 □ n012</p>

Data display	Description	Cause and action
<p>oPEE</p>	<p><b>Parameter setting error</b>                      Parameter settings other than the ones used for multi-function input and V/f pattern settings were improper.</p>	<p>Check whether the rated input current of the motor set with n032 satisfies the following condition. If not, check the rated current of the motor and reset n032.</p> <p>→ Rated input current of Inverter x 0.1 □ n032 □ rated input current of Inverter x 2</p> <p>Jumping frequency 1 set with n058 is higher than jumping frequency 2 set with n059. Reset jumping frequencies 1 and 2 to satisfy the following condition.</p> <p>→ n058 □ n059</p> <p>The upper limit of the output frequency set with n030 is lower than the lower limit of the output frequency set with n031. Reset the upper and lower limits of the output frequency to satisfy the following condition.</p> <p>→ n030 □ n031</p>

---

## 4-2 Troubleshooting

---

---

---

If the Inverter or motor does not operate properly when the system is started, parameter settings or wiring may be incorrect. In this case, take the appropriate action as described below. If an error code is displayed, refer to *4-1 Protective and Diagnostic Functions*.

---

---

### ■ Parameters Fail to Set

#### ● Display Does Not Change when Increment or Decrement Key is Pressed

n001 (parameter write-inhibit selection) is set to write-inhibit.  
It is possible to designate the parameters to be set with n001.  
All parameters can be written if n001 is set to 3.

#### ● OPE3, OPE5, or OPE6 is Displayed

Parameter settings are improper.  
Refer to *page 4-5, Warnings* and set the parameters properly.

#### ● CPF0 or CPF5 is Displayed

The Inverter is not properly communicating with the Digital Operator.  
The Digital Operator is not properly connected to the Inverter. Reconnect the Digital Operator to the Inverter.

### ■ Motor Fails to Operate

#### ● Motor Does Not Operate when RUN Key is Pressed

- The operation mode is improper.  
The motor will not operate when the RUN Key on the Digital Operator is pressed if n002 is set to 1 or 3.  
Press the Operation Mode Selection Key to enable the Digital Operator or set n002 to 0 or 2.

**Note** The Operation Mode Selection Key can be enabled or disabled with n007.

- Any of the bottom two lines of the monitor item indicators is lit.  
The Inverter does not start while any indicator on the bottom two lines is lit.  
To start the Inverter, press the Mode Key to light an indicator on the top two lines and press the RUN Key.
- The reference frequency is too low.  
When the reference frequency is less than the minimum output frequency set with n017, the Inverter cannot operate. Change the reference frequency to the minimum output frequency or more.
- The emergency stop signal is input to the Inverter.  
The motor does not operate if the emergency stop signal is input to the Inverter.  
Turn OFF the emergency stop signal and press the RUN Key.

**● Motor Does Not Operate when Run Command is Input**

- The operation mode is improper.

The motor will not operate when the run command is input to the Inverter if n002 is set to 0 or 2 or the Inverter is operated with the Digital Operator. Set n002 to 1 or 3 or press the Operation Mode Selection Key to enable the Inverter to operate with control input.

- The Inverter is in 3-wire sequential operation.

Even if the Inverter is ready to accept remote run input, the motor will not operate when the forward/stop or reverse/stop rotation command is input to the Inverter in 3-wire sequential operation because the meanings of the run signals input to the Inverter in 2-wire sequential operation are different from the meanings of the run signals input to the Inverter in 3-wire sequential operation.

Set with n035 multi-function input selection 1 to 0 when the Inverter is in 2-wire sequential operation.

- Any of the bottom two lines of the monitor item indicators is lit.

The Inverter does not start while any indicator on the bottom two lines is lit.

To start the Inverter, press the Mode Key to light an indicator on the top two lines and input the run command.

- The reference frequency is too low.

When the reference frequency is less than the minimum output frequency set with n017, the Inverter cannot operate. Change the reference frequency to the minimum output frequency or more.

- The emergency stop signal is input to the Inverter.

The motor does not operate if the emergency stop signal is input to the Inverter.

Turn OFF the emergency stop signal and input the run command.

**● Motor Stops During Acceleration or When Load is Connected**

The load is excessive.

The Inverter has a stall preventive function and full automatic torque boost function. If the acceleration of the motor is too high or the load excessive, however, the motor response limit will be exceeded.

To prevent this, increase the acceleration time, reduce the load, or increase the motor capacity.

**● Motor Accelerated and Rotating Stalls to Stop When Motor Rotation Speed Reaches a Certain Level**

The energy-saving control settings of the Inverter are improper.

The output voltage is too small because the lower output voltage limits set with n097 and n098 are too small.

Set the lower output voltage limits at 60 Hz and 6 Hz with n097 and n098 to larger values so that the motor will not stall to a stop.

**● Motor Rotation Direction Cannot Be Changed**

The reverse rotation of the motor is inhibited.

The Inverter will not accept the reverse rotation command in n006 because reverse rotation inhibit selection is set to 1. Set n006 to 0.

**■ Motor Rotates in Wrong Direction**

The motor output line is connected incorrectly.

If terminals T1 (U), T2 (V), and T3 (W) of the Inverter are correctly connected to terminals T1 (U), T2 (V), and T3 (W) of the motor, the motor rotates in the forward direction when the forward rotation command is input. Since the forward direction of rotation depends on the motor manufacturer and model, check the motor specifications.

To reverse the direction of rotation, switch the wires of two phases of T1 (U), T2 (V), and T3 (W) or set n005 for motor rotation direction selection to 1.

## ■ Motor Deceleration Is Too Slow

### ● Deceleration Time is Too Long Even if Braking Resistor Unit is Connected

- Stall prevention during deceleration is selected with n070.  
When the Braking Resistor Unit is connected, always set n070 to 0 (i.e., no stall prevention during deceleration). If n070 is set to 1, the Braking Resistor Unit will not be used. The parameter n070 is set to 1 before shipping.
- The deceleration time set with n020 or n022 is too long.  
Check the deceleration time setting.
- The motor torque is insufficient.  
If the parameter settings are normal and overvoltage does not occur, the motor capacity is insufficient. The motor capacity should be increased.

## ■ Vertical-axis Load Drops When Brakes are Applied

- The sequence is incorrect.  
The Inverter is default-set to remain in DC braking status for 0.5 s after deceleration is complete. To make sure that the brake holds, use the frequency detection function and apply the brake only when the detected frequency drops to 3 to 5 Hz or lower. Also at startup, use the frequency detection function, and release the brake only when the detected frequency is 3 to 5 Hz or higher.
- The DC control current is insufficient.  
If the DC control current is insufficient, set a higher DC control current with n064.
- Inappropriate brakes are used.  
The holding brake is designed only for holding, not for braking. If the holding brake is used for braking, the brake pad will wear out much faster than designed. Use an appropriate brake for braking.

## ■ Motor Burns

- The load is excessive.  
The motor will burn out if the load is excessive and the effective torque of the motor exceeds the rated torque of the motor. The motor may have permissible torque for a limited period, such as an eight-hour rated torque. The motor will burn out if motor is operated with the eight-hour rated torque continuously for more than eight hours.  
Reduce the load or the acceleration and deceleration time of the motor or increase the motor capacity if the load is excessive.
- The ambient temperature is too high.  
The motor will burn out if the motor is operated with its rated torque continuously if the ambient temperature is higher than the permissible ambient temperature of the motor. Always use the motor within the permissible ambient temperature.
- The dielectric strength of each phase of the motor is insufficient.  
Surge occurs between the switching circuit of the Inverter and the coils of the motor if the output of the Inverter is connected to the motor. Normally, the maximum surge voltage is approximately three times the power voltage imposed on the Inverter (i.e., 600 V for the 200-V Inverter and 1,200 V for the 400-V Inverter). Therefore, the dielectric strength of each phase the motor to be used must be higher than the maximum surge voltage.  
Be sure to connect a dedicated motor to the 400-V Inverter.

### ■ Controller Receives Noise When Inverter is Started

Noise derives from Inverter switching.

Take the following actions to prevent noise.

- Reduce the carrier frequency of the Inverter set with n050.  
The number of internal switching times is reduced, so noise can be reduced to some extent.
- Install an output noise filter.  
Install the 3G3IV-PHF Input Noise Filter on the power input side of the Inverter.
- Install an output noise filter.  
Install the 3G3IV-PLF Output Noise Filter on the output side of the Inverter.
- Use a metal box and pipes.  
Metal can block off radio waves. Therefore, enclose the Inverter with a metal (steel) box to prevent radio waves from being emitted from the Inverter.

### ■ Ground Fault Interrupter is Actuated When Inverter is Started.

Leakage current flows through the Inverter.

Because switching is performed inside the Inverter, a leakage current flows through the Inverter. This leakage current may actuate the ground fault interrupter, shutting the power OFF.

Use a ground fault interrupter with a high leakage-current detection value (sensitivity amperage of 200 mA min., operating time of 0.1 s min.) or one with high-frequency countermeasures for inverters. Reducing the carrier frequency value set with n050 is also effective.

A leakage current increases in proportion to the cable length. Normally, an approximately leakage current of 5 mA is generated per meter (cable length).

### ■ Machine Vibrates

#### ● Mechanical System Makes Noise

The carrier frequency and the natural frequency of the mechanical system are resonating.

If the mechanical system is making high-pitch noise while the motor is operating normally, the carrier frequency and the natural frequency of the mechanical system are resonating, in which case, change the carrier frequency with n050 so that the mechanical system will not resonate.

**● Motor Response Speed Waveform Resonates**

- The output frequency of the Inverter and the natural frequency of the mechanical system are resonating.

Use the frequency jump function with n058 to n060 so that the mechanical system will not resonate or install the motor on a rubber vibration insulator.

- PID parameters are improper.

Adjust the PID parameters if the response speed waveform of the motor vibrates while the Inverter is performing PID control. Set n087 to a longer integral time if the cycle of the vibration is long and set n088 to a shorter derivative time if the cycle of the vibration is short. Refer to *page 3-36* for PID adjustments.

- Energy-saving parameters are improper.

If the response speed waveform of the motor vibrates while the Inverter is in energy-saving mode, measure the cycle of the vibration.

If the cycle of the vibration coincides with the mean power time set with n099, the search operation function is not working properly. Set the search operation voltage limit with n100 to 0 to invalidate the search operation mode or set the 100% and 5% search operation voltage steps with n101 and n102 to smaller values so that the output voltage range of the Inverter performing search operation will be narrow.

**● Rotating Motor Drops Rotation Speed for an Instant after Rotation Speed of Motor Is Accelerated.**

Energy-saving parameters are improper.

The value of the energy-saving coefficient K2 set with n092 is improper if the motor drops its rotation speed for an instant after the rotation speed of the motor is accelerated by the Inverter in energy-saving mode.

Reset K2 to the value for the capacity of a motor one rank lower than the motor in use. Refer to *page 3-26*.

**■ Motor Continues to Rotate After Inverter Output is Shut OFF**

The DC control current is insufficient to stop the motor.

Take the following actions to adjust the DC control current.

- Set the DC control current with n064 to a higher current.
- Set the DC braking time with n065 to a longer time.

**■ OV is Detected or Fan Stalls When Operated**

The DC control current is insufficient to start the fan.

OV will be detected or the fan will stall if the fan is operated while the fan is rotating.

To prevent this, reduce the rotation speed of the fan with a sufficient DC control current set with n066.

■ **Output Frequency Does Not Reach Reference Frequency**

- The reference frequency is within the jumping frequency ranges.  
The output frequency will not change within the jumping frequency ranges if the frequency jump function is used.  
Check whether jumping frequency 1 and 2 set with n058 and n059 and the jumping frequency width set with n060 are proper.
- The reference frequency exceeds the output frequency upper limit.  
The output frequency upper limit is obtained from the following.  
Maximum frequency (n021) x output frequency upper limit (n 030)/100  
Check whether the values set with n012 and n030 are proper.

■ **Inverter Overload “OL2” is Detected**

For a 400-V Inverter, if the carrier frequency “n050” is set to a value higher than the default setting, the Inverter overload “OL2” detection value will decrease in consideration of an increase in the heat that will be generated by the change in the carrier frequency. Since the detection value is set to decrease by approximately 15% for every change to a rank higher than the default setting, the Inverter overload “OL2” may be detected prior to the motor overload “OL1” depending on the set value. Set the carrier frequency to a lower level by one rank.

■ **EF (Forward and Reverse Rotation Commands Input Simultaneously) is Detected and the Inverter does not Operate**

● **Incorrect Operation Sequence**

If the forward and reverse commands are input simultaneously for more than 0.5 s, an EF error will be detected. Change the operation sequence.

● **Malfunction due to Unwanted Current Path**

Inverter inputs may remain ON due to an unwanted current path for the controller outputs. With the wiring shown in the following table, if the controller output power supply is less than 24 V DC or if the power is OFF, the current indicated by the arrow will flow and the Inverter inputs will operate. If that occurs, insert a diode as shown in the diagram at point A.

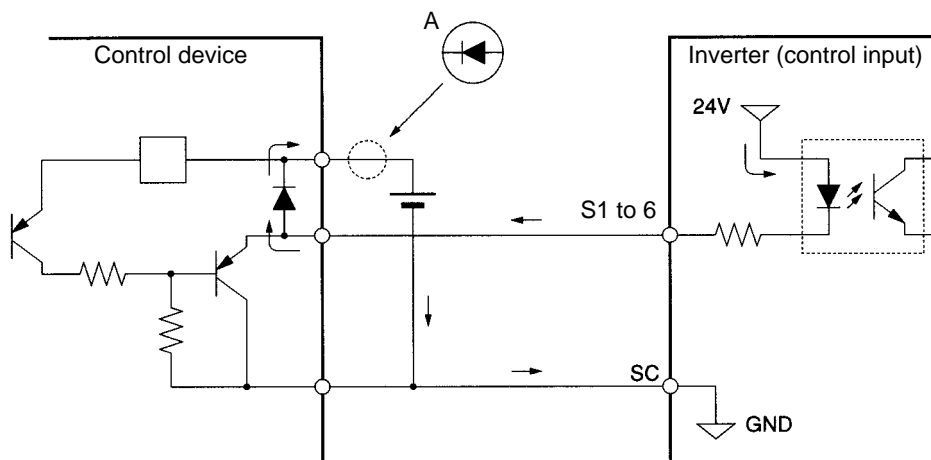









---

## 4-3 Maintenance and Inspection

---

### ● Cautions and Warnings

-  **WARNING** Do not touch the Inverter terminals while the power is being supplied.
-  **WARNING** Maintenance or inspection must be performed only after turning OFF the power supply, confirming that the CHARGE indicator (or status indicators) is turned OFF, and after waiting for the time specified on the front cover. Not doing so may result in electrical shock.
-  **WARNING** Maintenance, inspection, or parts replacement must be performed by authorized personnel. Not doing so may result in electrical shock or injury.
-  **WARNING** Do not attempt to take the Unit apart or repair. Doing either of these may result in electrical shock or injury.
-  **Caution** Carefully handle the Inverter because it uses semiconductor elements. Careless handling may result in malfunction.
-  **Caution** Do not change wiring, disconnect connectors, the Operator, or optional items, or replace fans while power is being supplied. Doing so may result in injury, damage to the product, or malfunction.

### ● Daily Inspection

While the system is operating, check the following items.

- Check the motor for noise.
- Check for error heating.
- Check if the ambient temperature is too high.
- Check if the output current monitor display indicates a higher value than usual.
- Check if the cooling fan mounted to the bottom part of the Inverter is operating normally.

### ● Regular Maintenance

Check the items below during regular maintenance.

Before starting inspection, always turn the power OFF, then wait at least one minute after all indicators on the front panel go OFF. Touching a terminal immediately after turning the power OFF may result in an electric shock.

- Check the terminal block screws for looseness.
- Check if electrically conductive dust or oil mist adheres to the terminal block or interior of the Inverter.
- Check the Inverter mounting screws for looseness.

- Check if dust or dirt is accumulated on the heat sink.
- Check if dust is accumulated in the air vents.
- Check if the appearance is normal.
- Check if the cooling fan for the control panel operates normally. Check for noise or error vibration, and also check if the total hours of operation have exceeded the value shown in the parentheses.

### ● **Regular Parts Maintenance**

The Inverter consists of many different parts. Full performance is possible only when these parts operate normally.

Some electronic parts require maintenance depending on the service conditions. To allow the Inverter to operate normally over an extended period of time, always perform regular inspection and parts replacement according to the service life of each part.

Regular inspection intervals vary according to the Inverter installation environment and service conditions.

The maintenance intervals for this Inverter are shown below. Use this information as a guide to regular maintenance.

The standard intervals for regular maintenance are as follows:

- Cooling fan: 2 to 3 years
- Electrolytic capacitor: 5 years
- Fuse: 10 years

As for service conditions, it is assumed that the ambient temperature of the Inverter is 40°C, and the Inverter is used at a load factor of 80% for eight hours a day and is installed as specified in the Operation Manual.

To extend maintenance intervals, ambient temperatures should be lowered and power-ON time should be minimized.

**Note** Contact your OMRON representative for the maintenance procedure.

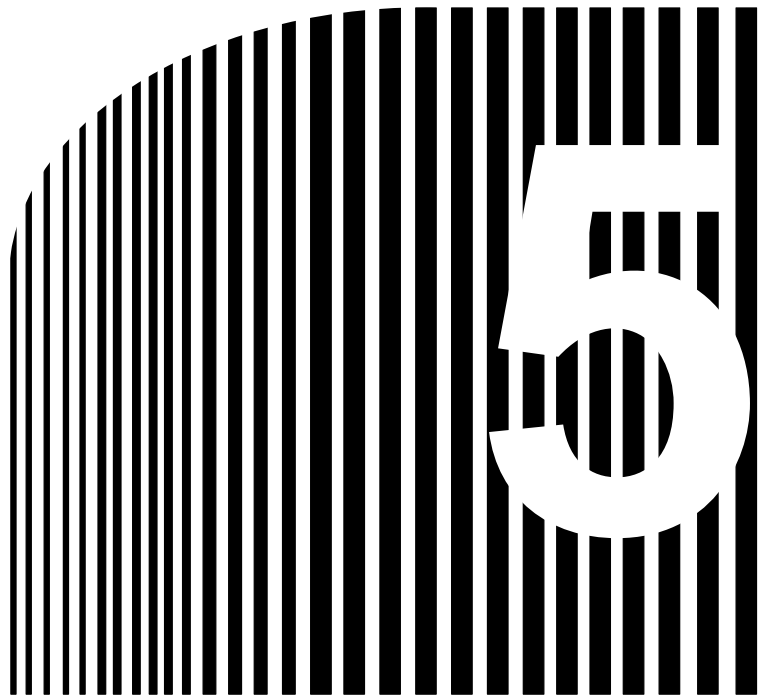

## Chapter 5

### • Specifications •

5-1 Specifications of Inverters

5-2 Specifications of Peripheral Devices

## 5-1 Specifications of Inverters

### General Specifications for 200-V Inverter

Model	3G3HV-	A2037	A2055	A2075	A2110	A2150	B2185	B2220	B2300	B2370	B2450	B2550	B2750
Maximum applicable motor capacity (kW)		3.7	5.5	7.5	11	15	18.5	22	30	37	45	55	75
Output characteristics	Rated output capacity (kVA)	6.7	9.5	13	19	24	30	37	50	61	70	85	110
	Rated output current (A)	17.5	25	33	49	64	80	96	130	160	183	224	300
	Maximum output voltage (V)	3-phase, 200 to 230 VAC (Corresponds to input voltage.)											
	Maximum output frequency (Hz)	400 Hz (Set by parameter constant.)											
Power supply characteristics	Rated voltage (V) Rated frequency (Hz)	3-phase, 200 to 230 VAC, 50/60 Hz											
	Allowable voltage fluctuation	-15% to 10%											
	Allowable frequency fluctuation	±5%											
Heat generated (kW)		0.22	0.30	0.35	0.59	0.73	0.89	1.2	1.4	1.8	2.1	2.7	3.3
Weight (kg)		Approx. 4.5	Approx. 5.5	Approx. 6.0	Approx. 11	Approx. 11	Approx. 28	Approx. 28	Approx. 61	Approx. 62	Approx. 80	Approx. 80	Approx. 135

### Control Characteristics

Model	3G3HV-	A2037	A2055	A2075	A2110	A2150	B2185	B2220	B2300	B2370	B2450	B2550	B2750	
Power supply harmonic countermeasures		DC reactor connection possible.					DC reactor built in. 12-pulse rectification input							
Control method		Sine wave PWM (high-carrier frequency control)												
Carrier frequency		2.5 to 15 kHz (Step setting)							2.5 to 10 kHz (Step setting)					
Frequency control range		0.1 to 400 Hz												
Frequency precision (temperature characteristics)		Digital commands: ±0.01% (-10 to 40°C) Analog commands: ±0.1% (25±10°C)												
Frequency setting resolution		Digital commands: 0.1 Hz Analog commands: 0.6 Hz/60 Hz (1/1,000 or equivalent)												
Output frequency resolution		0.1 Hz												
Overload capacity		150% of rated current for one minute					120% of rated current for one minute							
Frequency setting signal		0- to 10-VDC (20 kΩ) voltage input or 4- to 20-mA (250 Ω) current input												
Acceleration/Deceleration time		0.0 to 3,600 s (acceleration and deceleration set separately)												
Braking torque		Approx. 20% (Up to 125% possible with external braking resistor.)					Approx. 20% (External braking resistor cannot be attached.)							
Voltage/frequency characteristics		Select from 15 types of fixed V/f patterns or set any V/f pattern.												

**Protective Functions**

Model	3G3HV-	A2037	A2055	A2075	A2110	A2150	B2185	B2220	B2300	B2370	B2450	B2550	B2750
Motor protection	Protection by electronic thermal.												
Instantaneous overcurrent protection	Stops at approx. 200% of rated output current.						Stops at approx. 180% of rated output current.						
Overload protection	Stops in one minute at approx. 150% of rated output current.						Stops in one minute at approx. 120% of rated output current.						
Overvoltage protection	Stops when main-circuit DC voltage is approx. 410 V.												
Undervoltage protection	Stops when main-circuit DC voltage is approx. 190 V.												
Momentary power interruption compensation (selection)	Stops at 15 ms or more. By means of an operating mode selection, operation can be continued if recovery occurs within 2 seconds.												
Cooling fin overheating	Protection by thermistor.												
Grounding protection	Protection by electronic circuits.												
Charge indicator (internal LED)	Lit when rated DC voltage is approx. 50 V or more.												

**Environment**

Model	3G3HV-	A2037	A2055	A2075	A2110	A2150	B2185	B2220	B2300	B2370	B2450	B2550	B2750
Location	Indoors (no corrosive gas, oil spray, metallic dust, etc.)												
Ambient operating temperature	-10 to 45°C (NEMA1 type: -10 to 40°C)						-10 to 45°C (Open chassis type)						
Ambient operating humidity	90% RH (with no condensation)												
Storage temperature	-20 to 60°C												
Altitude	1,000 m max.												
Insulation resistance	5 MΩ min. (Do not carry out the insulation resistance test or withstand voltage test.)												
Vibration withstand	Vibration frequency less than 20 Hz, 9.8 m/s <sup>2</sup> , 1G max.; 20 to 50 Hz, 2 m/s <sup>2</sup> , 0.2G max												
Protective structure	Both enclosed NEMA1 type and panel open chassis type: IP10						Open chassis type: IP00						

**General Specifications for 400-V Inverter**

Model	3G3HV-	A4037	A4055	A4075	A4110	A4150	B4185	B4220	B4300	B4370	B4450	B4550	B4750	B411K	B416K	B418K	B422K	B430K	
Maximum applicable motor capacity (kW)	3.7	5.5	7.5	11	15	18.5	22	30	37	45	55	75	110	160	185	220	300		
Output characteristics	Rated output capacity (kVA)	6.1	11	14	21	26	31	40	50	61	73	98	130	170	230	260	340	460	
	Rated output current (A)	8	14	18	27	34	41	52	65	80	96	128	165	224	302	340	450	605	
	Maximum output voltage (V)	3-phase, 380 to 460 VAC (Corresponds to input voltage.)																	
	Maximum output frequency (Hz)	400 Hz (Set by parameter constant.)																	
Power supply characteristics	Rated voltage (V) Rated frequency (Hz)	3-phase, 380 to 460 VAC, 50/60 Hz																	
	Allowable voltage fluctuation	-15 to 10%																	
	Allowable frequency fluctuation	±5%																	
Heat generated (kW)	0.15	0.22	0.36	0.46	0.57	0.66	0.88	1.1	1.3	1.4	1.9	2.4	3.1	4.2	5.0	6.9	9.8		
Weight (kg)	Approx. 4.5	Approx. 6.0	Approx. 6.0	Approx. 11	Approx. 11	Approx. 27	Approx. 27	Approx. 44	Approx. 44	Approx. 44	Approx. 79	Approx. 80	Approx. 135	Approx. 145	Approx. 360	Approx. 360	Approx. 420		

**Control Characteristics**

Model	3G3HV-	A4037	A4055	A4075	A4110	A4150	B4185	B4220	B4300	B4370	B4450	B4550	B4750	B411K	B416K	B418K	B422K	B430K	
Power supply harmonic countermeasures	DC reactor connection possible.						DC reactor built-in 12-pulse rectification input												No item
Control method	Sine wave PWM (high-carrier frequency control)																		
Carrier frequency	2.5 to 15 kHz (Step setting)									2.5 to 10 kHz (Step setting)						2.5 kHz max.			
Frequency control range	0.1 to 400 Hz																		
Frequency precision (temperature characteristics)	Digital commands: ±0.01% (-10 to 40°C) Analog commands: ±0.1% (25±10°C)																		
Frequency setting resolution	Digital commands: 0.1 Hz Analog commands: 0.6 Hz/60 Hz (1/1,000 or equivalent)																		
Output frequency resolution	0.1 Hz																		
Overload capacity	150% of rated current for one minute									120% of rated current for one minute									
Frequency setting signal	0- to 10-VDC (20 kΩ) voltage input or 4- to 20-mA (250 Ω) current input																		
Acceleration/Deceleration time	0.0 to 3,600 s (acceleration and deceleration set separately)																		
Braking torque	Approx. 20% (Up to 125% possible with external braking resistor.)						Approx. 20% (External braking resistor cannot be attached.)												Approx. 20% (Up to 100% possible with external braking resistor.)
Voltage/frequency characteristics	Select from 15 types of fixed V/f patterns or set any V/f pattern.																		

**Protective Functions**

Model	3G3HV-	A4037	A4055	A4075	A4110	A4150	B4185	B4220	B4300	B4370	B4450	B4550	B4750	B411K	B416K	B418K	B422K	B430K	
Motor protection	Protection by electronic thermal.																		
Instantaneous overcurrent protection	Stops at approx. 200% of rated output current.						Stops at approx. 180% of rated output current.												
Overload protection	Stops in one minute at approx. 150% of rated output current.						Stops in one minute at approx. 120% of rated output current.												
Overvoltage protection	Stops when main-circuit DC voltage is approx. 820 V.																		
Undervoltage protection	Stops when main-circuit DC voltage is approx. 380 V.																		
Momentary power interruption compensation (selection)	Stops at 15 ms or more. By means of an operating mode selection, operation can be continued if recovery occurs within 2 seconds.																		
Cooling fin overheating	Protection by thermistor.																		
Grounding protection	Protection by electronic circuits.																		
Charge indicator (internal LED)	Lit when rated DC voltage is approx. 50 V or more.																		

**Environment**

Model	3G3HV-	A4037	A4055	A4075	A4110	A4150	B4185	B4220	B4300	B4370	B4450	B4550	B4750	B411K	B416K	B418K	B422K	B430K	
Location	Indoors (no corrosive gas, oil spray, metallic dust, etc.)																		
Ambient operating temperature	-10 to 45°C (NEMA1 type: -10 to 40°C)						-10 to 45°C (Open chassis type)												
Ambient operating humidity	90% RH (with no condensation)																		
Storage temperature	-20 to 60°C																		
Altitude	1,000 m max.																		
Insulation resistance	5 MΩ min. (Do not carry out the insulation resistance test or withstand voltage test.)																		
Vibration withstand	Vibration frequency less than 20 Hz, 9.8 m/s <sup>2</sup> , 1G max.; 20 to 50 Hz, 2 m/s <sup>2</sup> , 0.2G max																		
Protective structure	Both enclosed NEMA1 type and panel open chassis type: IP10						Open chassis type: IP00												

## 5-2 Specifications of Peripheral Devices

### 5-2-1 Peripheral Devices

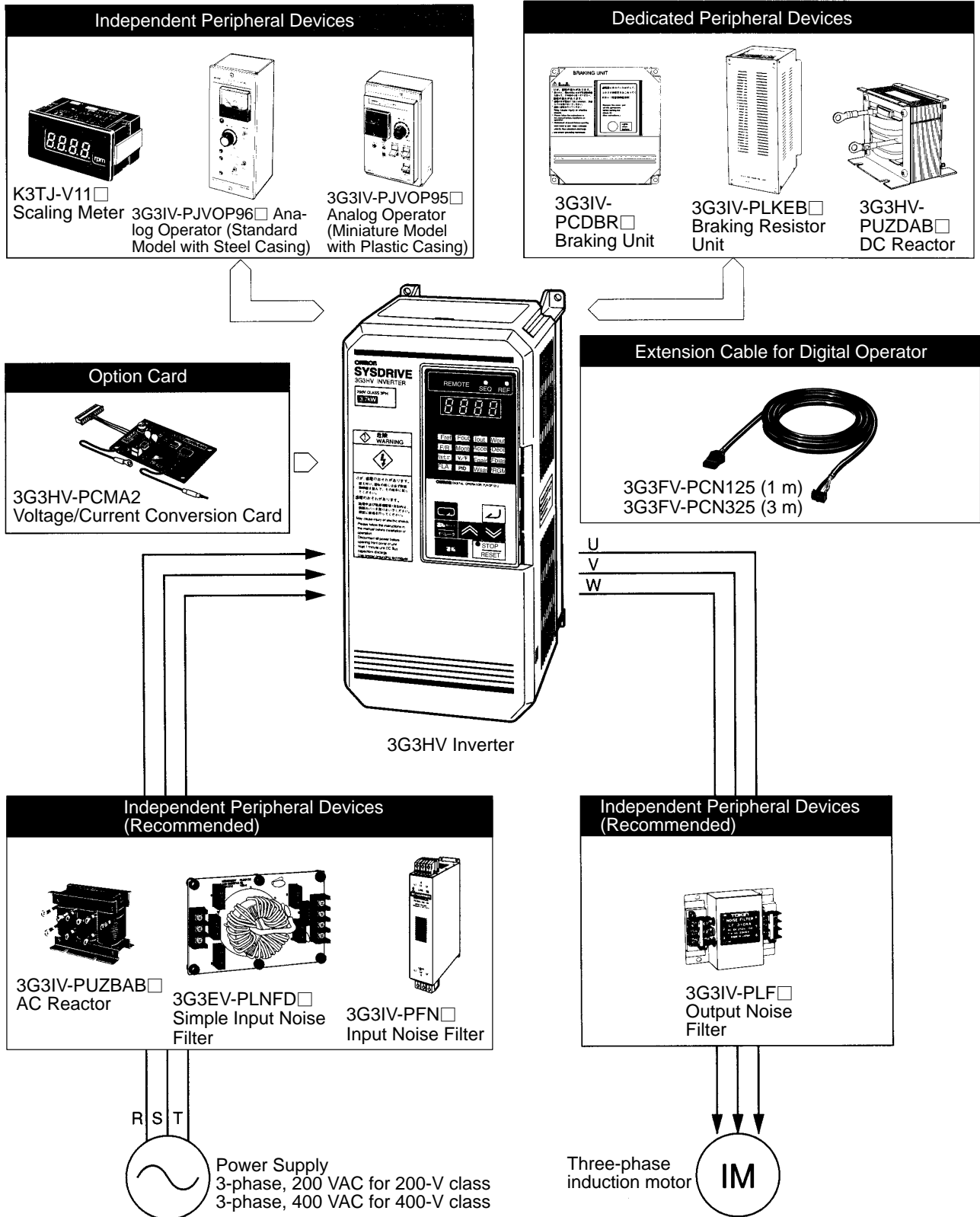

### 5-2-2 3G3HV-PCMA2 Voltage/Current Conversion Card

The 3G3HV-PCMA2 is a dedicated optional device mounted to the control circuit board of the 3G3HV-series Inverter to convert the 0- to 10-VDC multi-function analog outputs of the Inverter to 4- to 20-mA outputs.

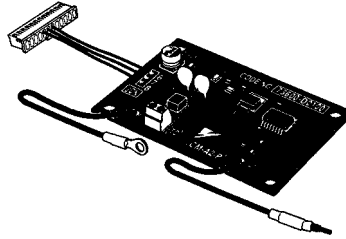

• Standard Models

Model	Specification
3G3HV-PCMA2	Dedicated device for the 3G3HV-series Inverter to convert the 0- to 10-VDC outputs of the Inverter to 4- to 20-mA outputs.

• Wiring Example

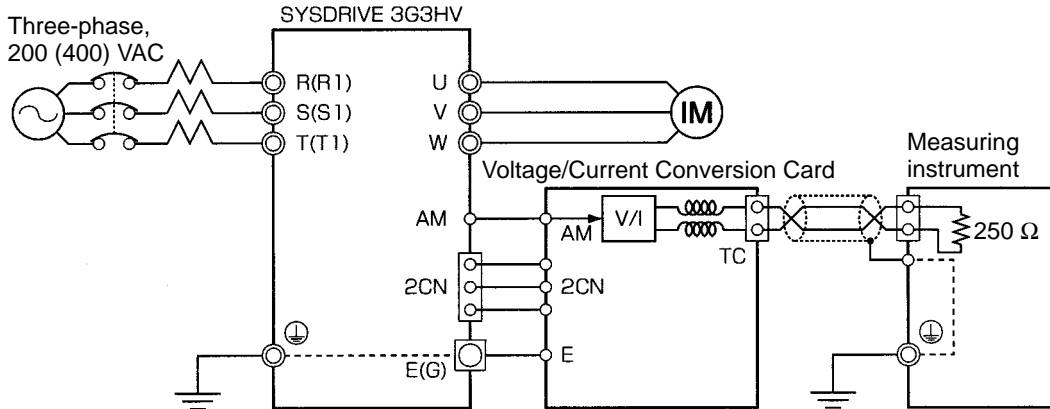

• Mounting Method

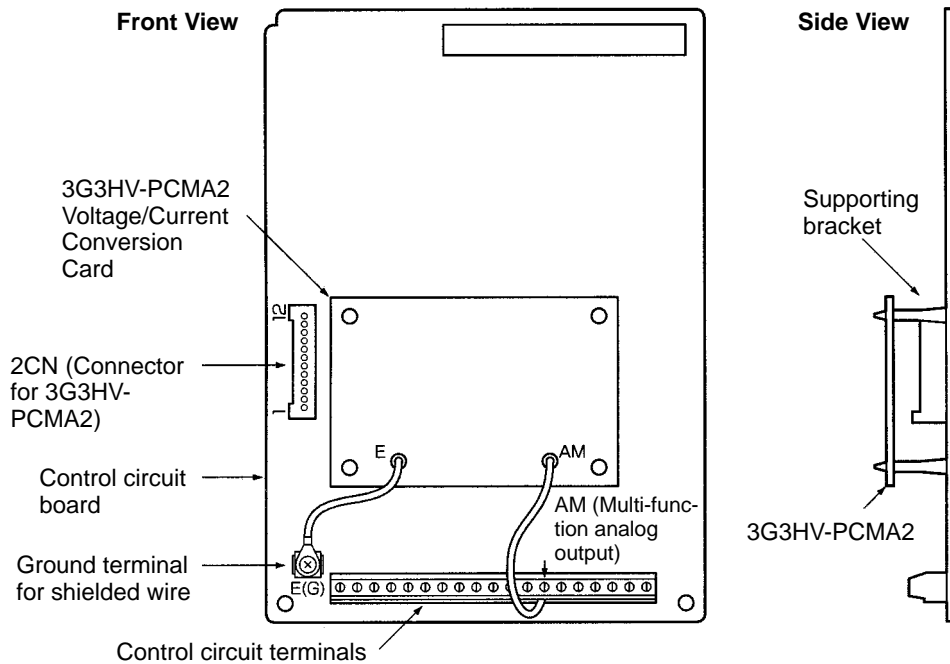



### 5-2-3 K3TJ-V11□ Scaling Meter

Connect the multi-function analog output of the Inverter to the Scaling Meter so that the number of rotations of the motor and the speed of the mechanical system can be monitored in actual units.

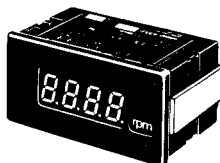

● **Models**

Model	Control power supply	Display
K3TJ-V111R	100 to 200 VAC	Red indicators
K3TJ-V111G		Green indicators
K3TJ-V116R	24 VDC with insulation (see note)	Red indicators
K3TJ-V116G		Green indicators

**Note** The power supply circuit and input circuit are insulated from each other.

● **Standard Specifications**

Sampling cycle	2 times/s
Display refresh cycle	2 times/s
Measured value averaging method	Simple/Moving average
No. of averaging times	1, 2, 4, or 8 times
Maximum no. of display digits	4 (–1999 to 9999)
Display	14.2-mm-high 7-segment LEDs
Decimal point display	Function selector or Up and Down Keys
Scaling method	Function selector or Up and Down Keys
Scaling range	–1999 to 9999
Zero limit range	0 to 99 digits
Over range	Flashing
Zero suppress	Possible
External control	PV hold (with rear terminals shorted)
Enclosure ratings (conforming to IEC)	Front panel: IP51 (see note) Casing: IP20 Terminals: IP00
Memory protection	Non-volatile memory

**Note** IP51 is ensured if the K32-L49SC Drip-proof Cover is attached to the front panel, otherwise IP50 is ensured.

• Wiring Example

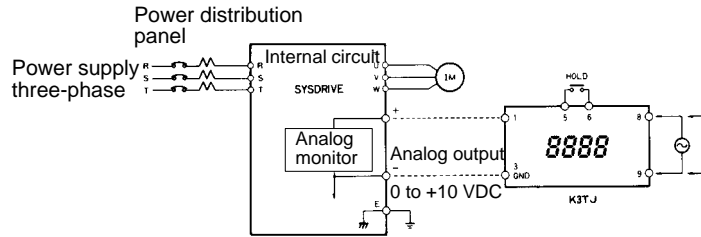

• External Dimensions

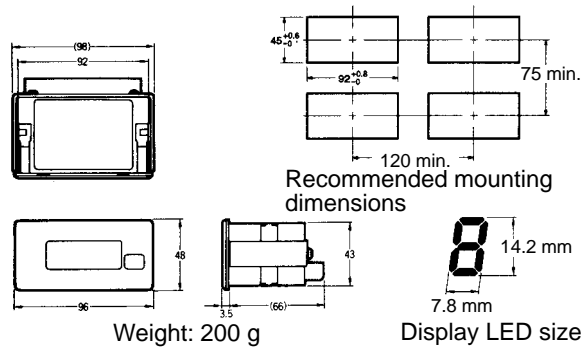

5-2-4 3G3IV-PJVOP96□ Analog Operator (Standard Model with Steel Casing)

The 3G3IV-PJVOP96□ Analog Operator makes it possible to control the operation of the Inverter, including the output frequency, with analog commands at a maximum distance of 50 m.

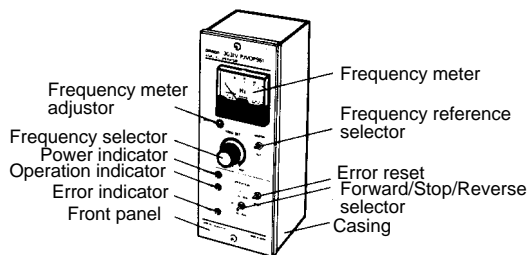

• Standard Models

Model	Frequency meter specification
3G3IV-PJVOP961	DCF-6A: 75 Hz, 1 mA, 3 V
3G3IV-PJVOP962	DCF-6A: 150 Hz, 1 mA, 3 V
3G3IV-PJVOP963	DCF-6A: 220 Hz, 1 mA, 3 V

● External Dimensions

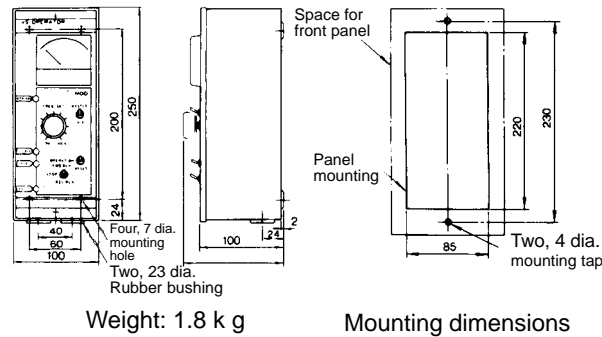

**5-2-5 3G3IV-PJVOP95□ Analog Operator (Miniature Model with Plastic Casing)**

The 3G3IV-PJVOP95□ Analog Operator makes it possible to control the operation of the Inverter, including the output frequency, with analog commands at a maximum distance of 50 m.

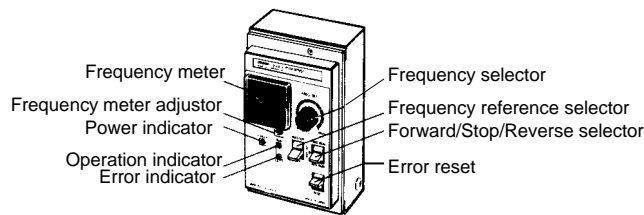

● Standard Models

Model	Frequency meter specification
3G3IV-PJVOP951	TRM-45: 3 V, 1 mA, 60/120 Hz
3G3IV-PJVOP952	TRM-45: 3 V, 1 mA, 90/180 Hz

● External Dimensions

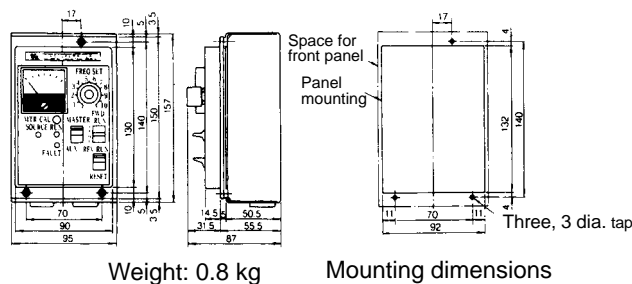



**Note** In the following table, “10% ED” indicates that 10% of the time required for one cycle can be used for braking (deceleration).

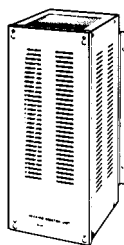

● Standard Models

Inverter		Braking Resistor Unit				Approximate braking torque (10% ED)	Minimum connection resistance (Ω)
Voltage class	Maximum motor capacity (kW)	Model 3G3IV-PLKEB□	Resistor specification (per Unit)	Units			
				No. of Units	Maximum number of Units connected (see note)		
200-V class	3.7	23P7	390 W, 40 Ω	1	2	125	9.6
	5.5	25P5	520 W, 30 Ω	1	3	115	9.6
	7.5	27P5	780 W, 20 Ω	1	2	125	9.6
	11	2011	2,400 W, 13.6 Ω	1	1	125	9.6
	15	2015	3,000 W, 10 Ω	1	1	125	9.6
400-V class	3.7	43P7	390 W, 150 Ω	1	4	135	32
	5.5	45P5	520 W, 100 Ω	1	3	135	32
	7.5	47P5	780 W, 75 Ω	1	2	130	32
	11	4011	1,400 W, 50 Ω	1	2	135	20
	15	4015	1,560 W, 40 Ω	1	2	125	20
	185	4045	9,600 W 13.6 Ω	4	1	120	3.2
	220	4045	9,600 W 13.6 Ω	5	1	125	3.2
	300	4045	9,600 W 13.6 Ω	6	1	110	3.2

**Note 1.** The maximum numbers of Braking Resistor Units connecting to a single Inverter or Braking Unit are indicated.

**Note 2.** Do not use a resistance less than the minimum connection resistance shown in the table. Doing so may result in damage to the Inverter or the Braking Resistor Unit. (The values for minimum connection resistance given in the above table are for one Inverter or one Braking Resistor Unit.)

● External Dimensions

Voltage class	3G3IV-PLKEB□ Braking Resistor Unit	Appearance	Dimensions					Weight (kg)
			A	B	C	D	Mounting screw	
200-V class	23P7	1	130	350	75	335	M5 x 4	5.0
	25P5	1	250	350	200	335	M6 x 4	7.5
	27P5	1	250	350	200	335	M6 x 4	8.5
	2011	2	266	543	246	340	M8 x 4	10
	2015	2	356	543	336	340	M8 x 4	15
400-V class	43P7	1	130	350	75	335	M5 x 4	5.0
	45P5	1	250	350	200	335	M6 x 4	7.5
	47P5	1	250	350	200	335	M6 x 4	8.5
	4011	2	350	412	330	325	M6 x 4	16
	4015	2	350	412	330	325	M6 x 4	18
	4045	2	446	956	426	740	M8 x 4	33

Appearance 1

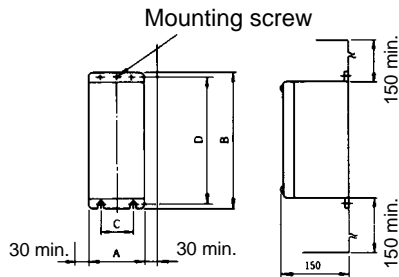

Appearance 2

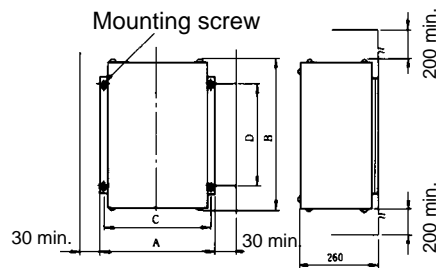

5-2-8 3G3HV-PUZDAB□A□MH DC Reactor

The DC Reactor suppresses the harmonics in the output current of the Inverter.

The DC Reactor suppresses harmonics better than the AC Reactor. The DC Reactor can also be used with the AC Reactor to suppress harmonics more effectively.

Use the DC Reactor with the Inverter with an output of 15 kW max. The Inverter with an output of 18.5 kW or more has a built-in DC Reactor.

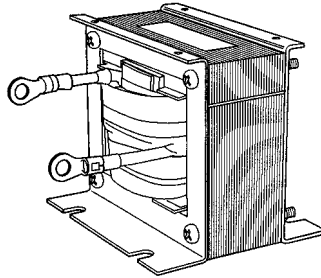

● Standard Models

Inverter		DC Reactor				
Voltage class	Maximum motor capacity (kW)	Model 3G3HV-PUZ-DAB□	Rated voltage (V)	Rated current (A)	Inductance (mH)	Loss (W)
200-V class	3.7	18A3MH	800 VDC	18	3	18
	5.5/7.5	36A1MH		36	1	22
	11/15	72A0.5MH		72	0.5	29
400-V class	3.7	12A6.3MH		12	6.3	16
	5.5/7.5	23A3.6MH		23	3.6	27
	11/15	33A1.9MH		33	1.9	26

● External Dimensions

Model 3G3HV-	Dimensions									Weight (kg)
	H	W	W1	D	D1	D2	t	d1	d2	
PUZDAB18A3MH	76	86	60	72	55	80	1.2	M4	M5	2.0
PUZDAB36A1MH	93	105	64	92	80	90	1.6	M6	M6	3.2
PUZDAB72A0.5MH	93	105	64	112	100	105	1.6	M6	M8	4.9
PUZDAB12A6.3MH	76	86	60	72	55	80	1.2	M4	M5	2.0
PUZDAB23A3.6MH	93	105	64	92	80	90	1.6	M6	M5	3.2
PUZDAB33A1.9MH	93	105	64	102	90	95	1.6	M6	M6	4.0

Appearance

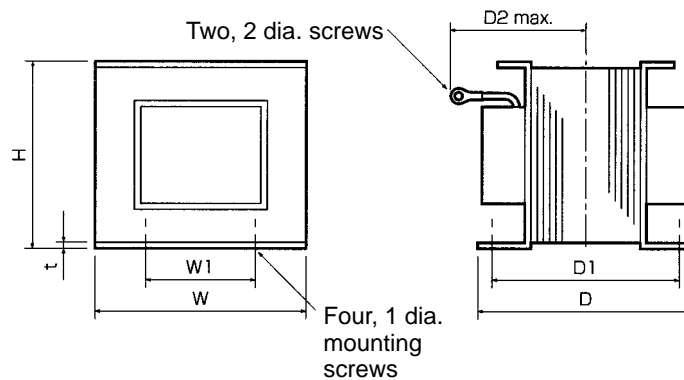

### 5-2-9 3G3IV-PUZBAB□A□MH AC Reactor

Connect the 3G3IV-PUZBAB□A□MH AC Reactor to the power input side of the Inverter to improve the input power factor of the power supply connected to the Inverter or if the power supply capacity is much larger than the Inverter capacity.

Select the AC Reactor model according to the motor capacity from the following tables.

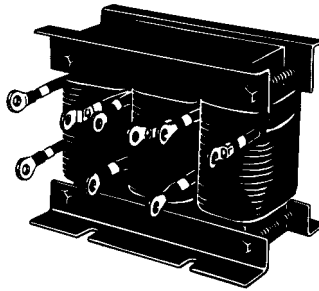

#### ● Connection Example

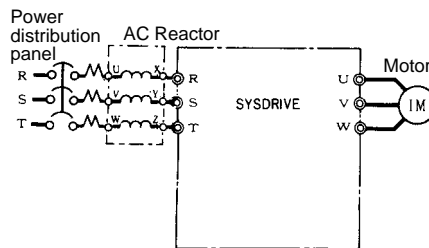

#### ● Applicable Range

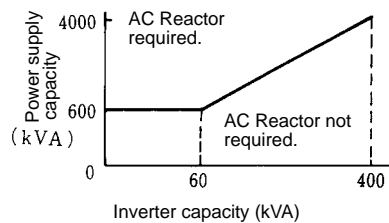



• Standard Specifications and External Dimensions

200-V Class

Maximum motor capacity (kW)	Model 3G3IV-PUZBAB□	Amperage (A)	Inductance (mH)	Loss (W)	Weight (kg)	Appearance
3.7	20 A, 0.53 MH	20	0.53	35	3	2
5.5	30 A, 0.35 MH	30	0.35	45	3	
7.5	40 A, 0.265 MH	40	0.265	50	4	
11	60 A, 0.18 MH	60	0.18	65	6	
15	80 A, 0.13 MH	80	0.13	75	8	
18.5	90 A, 0.12 MH	90	0.12	90	8	
22	120 A, 0.09 MH	120	0.09	90	8	
30	160 A, 0.07 MH	160	0.07	100	12	
37	200 A, 0.05 MH	200	0.05	110	15	
45	240 A, 0.044 MH	240	0.044	125	23	
55	280 A, 0.038 MH	280	0.038	130	23	

Dimensions											
A	B	B1	C	D	E	F	H	J	K	L	M
130	88	114	105	50	65	130	22	M6	11.5	7	M5
130	88	119	105	50	70	130	22	M6	9	7	M5
130	98	139	105	50	75	130	22	M6	11.5	7	M6
160	105	147.5	130	75	85	160	25	M6	10	7	M6
180	100	155	150	75	80	180	25	M6	10	7	M8
180	100	150	150	75	80	180	25	M6	10	7	M8
180	100	155	150	75	80	180	25	M6	10	7	M10
210	100	170	175	75	80	205	25	M6	10	7	M10
210	115	182.8	175	75	95	205	25	M6	10	7	M10
240	126	218	215±5	150	110	240	25	M6	8	7	M10
240	126	218	215±5	150	110	240	25	M8	8	10	M12

400-V Class

Maximum motor capacity (kW)	Model 3G3IV-PUZBAB□	Amperage (A)	Inductance (mH)	Loss (W)	Weight (kg)	Appearance
3.7	10 A, 2.2 MH	10	2.2	43	3	1
5.5	15 A, 1.42 MH	15	1.42	50	4	
7.5	20 A, 1.06 MH	20	1.06	50	5	2
11	30 A, 0.7 MH	30	0.7	65	6	
15	40 A, 0.53 MH	40	0.53	90	8	
18.5	50 A, 0.42 MH	50	0.42	90	8	
22	60 A, 0.36 MH	60	0.36	90	8.5	
30	80 A, 0.26 MH	80	0.26	95	12	
37	90 A, 0.24 MH	90	0.24	110	15	
45	120 A, 0.18 MH	120	0.18	130	23	
55	150 A, 0.15 MH	150	0.15	150	23	

Dimensions											
A	B	B1	C	D	E	F	H	J	K	L	M
130	88	---	130	50	65	130	22	M6	11.5	7	M4
130	98	---	130	50	75	130	22	M6	11.5	7	M4
160	90	115	130	75	70	160	25	M6	10	7	M5
160	105	132.5	130	75	85	160	25	M6	10	7	M5
180	100	140	150	75	80	180	25	M6	10	7	M6
180	100	145	150	75	80	180	25	M6	10	7	M6
180	100	150	150	75	75	180	25	M6	10	7	M6
210	100	150	175	75	80	205	25	M6	10	7	M8
210	115	177.5	175	75	95	205	25	M6	10	7	M8
240	126	193	205±5	150	110	240	25	M8	8	10	M10
240	126	198	205±5	150	110	240	25	M8	8	10	M10

Appearance 1

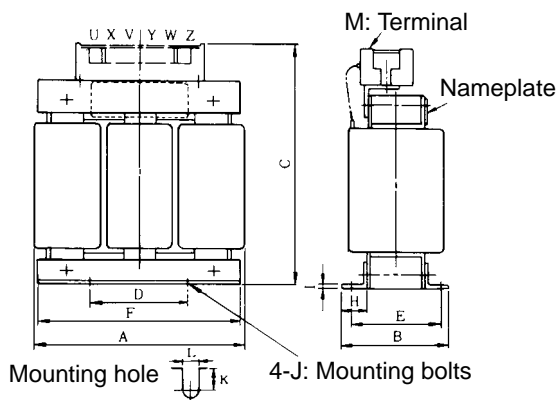

Appearance 2

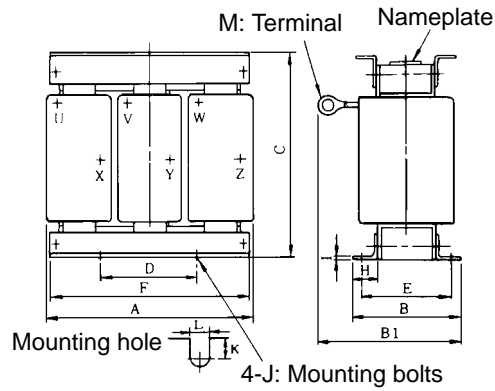

5-2-10 Simple Input Noise Filter and Input Noise Filter

- 3G3EV-PLNFD□ (Yaskawa Electric)/3G3IV-PFN□ (Schaffner)

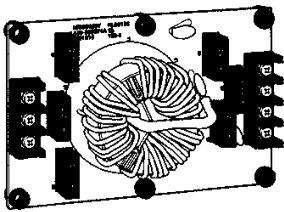

Simple Input Noise Filter



Input Noise Filter

The Simple Input Noise Filter is connected to the power input side to eliminate the noise in the power line connected to the Inverter and suppress noise leaking from the Inverter to the power line.

■ Applicable Models

200-V class			400-V class		
Maximum motor capacity (kW)	New model	Rated current (A)	Maximum motor capacity (kW)	New model	Rated current (A)
0.1 to 0.75	3G3EV-PLNFD2103DY	10	0.2 to 0.75	3G3EV-PLNFD4053DY	5
1.5	3G3EV-PLNFD2153DY	15	1.5/2.2	3G3EV-PLNFD4103DY	10
2.2	3G3EV-PLNFD2203DY	20	3.7	3G3EV-PLNFD4153DY	15
3.7	3G3EV-PLNFD2303DY	30	5.5	3G3EV-PLNFD4203DY	20
5.5	3G3IV-PFN258L4207	42	7.5	3G3EV-PLNFD4303DY	30
7.5	3G3IV-PFN258L5507	55	11	3G3IV-PFN258L4207	42
11	3G3IV-PFN258L7534	75	15/18.5	3G3IV-PFN258L5507	55
15	3G3IV-PFN258L10035	100	22	3G3IV-PFN258L7534	75
18.5/22	3G3IV-PFN258L13035	130	30	3G3IV-PFN258L10035	100
30	3G3IV-PFN258L18007	180	37/45	3G3IV-PFN258L13035	130
37/45	3G3IV-PFN359P25099	250	55	3G3IV-PFN258L18007	180
55	3G3IV-PFN359P30099	300	75/110	3G3IV-PFN359P30099	300
75	3G3IV-PFN359P25099 x 2P	500	160/185	3G3IV-PFN359P25099 x 2P	500
			220	3G3IV-PFN359P30099 x 2P	600
			300	3G3IV-PFN359P30099 x 2P	900

■ Connection Example

3-phase input

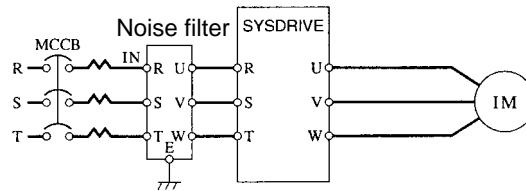

■ Dimensions

Dimensions 1 (Three-phase Input)

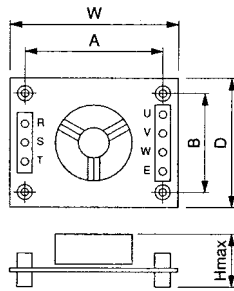

Dimensions 2 (Three-phase Input)

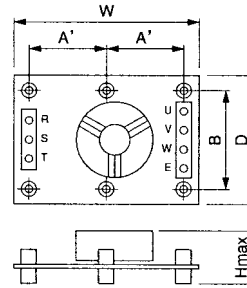

Model 3G3EV-	Figure (above)	Dimension (mm)						Mounting screw
		W	D	H max.	A	A'	B	
PLNFD2103DY	1	120	80	55	108	---	68	M4 × 4, 20 mm
PLNFD2153DY		120	80	55	108	---	68	M4 × 4, 20 mm
PLNFD2203DY		170	90	70	158	---	78	M4 × 4, 20 mm
PLNFD2303DY	2	170	110	70	---	79	98	M4 × 6, 20 mm
PLNFD4053DY		170	130	75	---	79	118	M4 × 6, 30 mm
PLNFD4103DY		170	130	95	---	79	118	M4 × 6, 30 mm
PLNFD4153DY		170	130	95	---	79	118	M4 × 6, 30 mm
PLNFD4203DY		200	145	100	---	94	133	M4 × 6, 30 mm
PLNFD4303DY		200	145	100	---	94	133	M4 × 6, 30 mm

External Figure 1

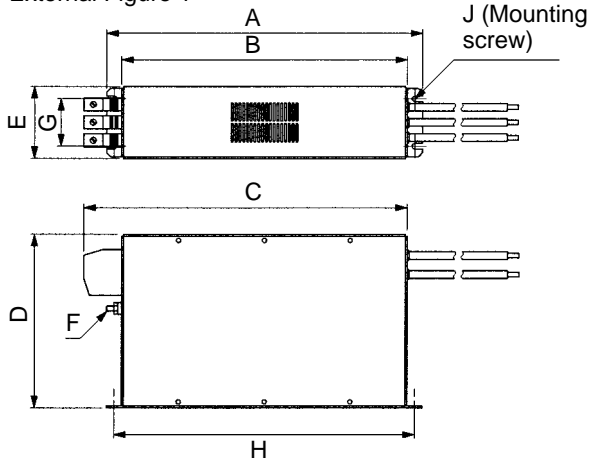

External Figure 2

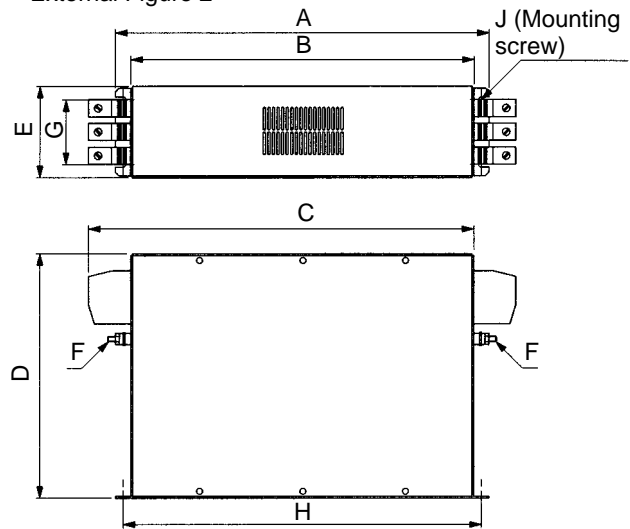

External Figure 3

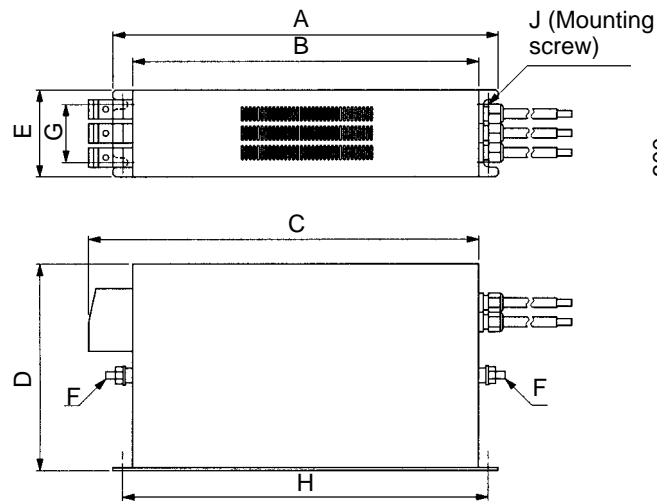

External Figure 4

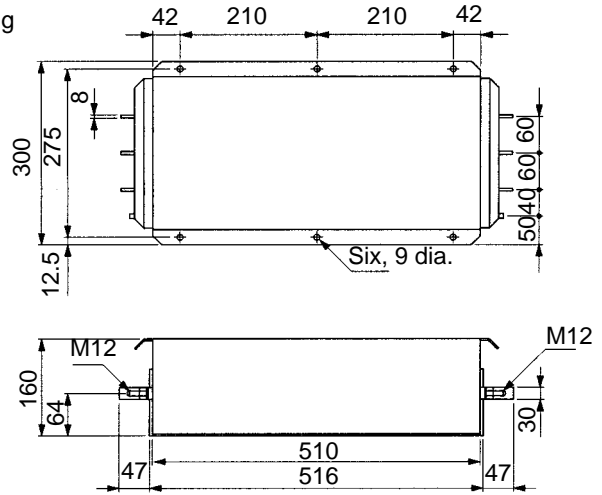

Model 3G3IV-	Figure (above)	Dimensions (mm)									Weight (kg)
		A	B	C	D	E	F	G	H	J	
PFN258L4207	1	329	300	325	185	70	M6	45	314	4-M5	2.8
PFN258L5507		329	300	353	185	80	M6	55	314	4-M5	3.1
PFN258L7534	2	329	300	377	220	80	M6	55	314	4-M5	4
PFN258L10035		379	350	436	220	90	M10	65	364	4-M5	5.5
PFN258L13035		439	400	486	240	110	M10	80	414	4-M5	7.5
PFN258L18007	3	438	400	480	240	110	M10	80	413	4-M5	11
PFN359P25099	4	---	---	---	---	---	---	---	---	---	16
PFN359P30099		---	---	---	---	---	---	---	---	---	16

### 5-2-11 3G3IV-PLF□ Output Noise Filter (Tokin Corp.)

Connect the 3G3IV-PLF□ Output Noise Filter to the motor output side of the Inverter to prevent the noise generated by the Inverter from flowing to the motor.

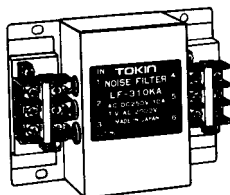

● Standard Specifications and External Dimensions

	Maximum motor capacity (kW)	Inverter capacity (kVA)	Output Noise Filter	
			Model 3G3IV-	Rated current (A)
200-V class	3.7	6.7	PLF320KA	20
	5.5	9.5	PLF350KA	50
	7.5	13	PLF350KA	50
	11	19	PLF350KA x 2P	100
	15	24	PLF350KA x 2P	100
	18.5	30	PLF350KA x 2P	100
	22	37	PLF350KA x 3P	150
	30	50	PLF350KA x 3P	150
	37	61	PLF3110KB x 2P	220
	45	70	PLF3110KB x 2P	220
	55	85	PLF3110KB x 3P	330
75	110	PLF3110KB x 4P	440	
400-V class	3.7	6.1	PLF310KB	10
	5.5	11	PLF320KB	20
	7.5	14	PLF320KB	20
	11	21	PLF335KB	35
	15	26	PLF335KB	35
	18.5	31	PLF345KB	45
	22	37	PLF375KB	75
	30	50	PLF375KB	75
	37	61	PLF3110KB	110
	45	73	PLF3110KB	110
	55	98	PLF375KB x 2P	150
	75	130	PLF3110KB x 2P	220
	110	170	PLF3110KB x 3P	330
	160	230	PLF3110KB x 4P	440
	185	260	PLF3110KB x 4P	440
220	340	PLF3110KB x 5P	550	
300	460	PLF3110KB x 6P	660	

● External Dimensions

Model 3G3IV-	Terminals	Dimensions								Weight (kg)
		A	B	C	D	E	F	G	H	
PLF320KA	TE-K5.5 M4	140	100	100	90	70	45	7 x 4.5 dia.	4.5 dia.	0.6
PLF350KA	TE-K22 M6	260	180	180	160	120	65	7 x 4.5 dia.	4.5 dia.	2.0
PLF310KA	TE-K5.5 M4	140	100	100	90	70	45	7 x 4.5 dia.	4.5 dia.	0.5
PLF320KB	TE-K5.5 M4	140	100	100	90	70	45	7 x 4.5 dia.	4.5 dia.	0.6
PLF335KB	TE-K5.5 M4	140	100	100	90	70	45	7 x 4.5 dia.	4.5 dia.	0.8
PLF345KB	TE-K22 M6	260	180	180	160	120	65	7 x 4.5 dia.	4.5 dia.	2.0
PLF375KB	TE-K22 M6	540	320	480	300	340	240	9 x 6.5 dia.	6.5 dia.	12.0
PLF3110KB	TE-K60 M8	540	340	480	300	340	240	9 x 6.5 dia.	6.5 dia.	19.5

Appearance

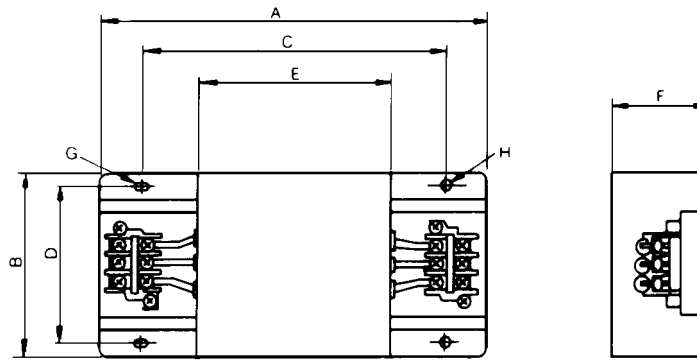



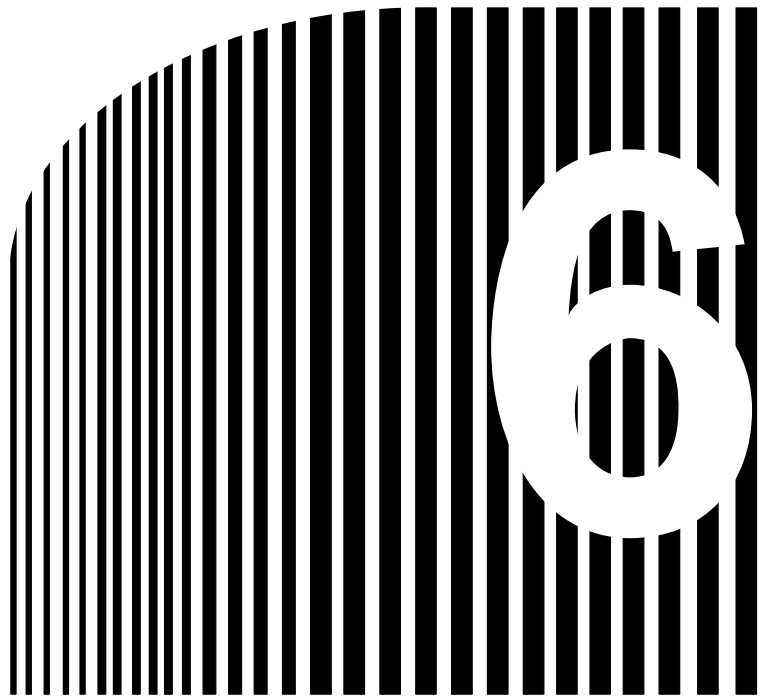

## Chapter 6

### • Appendix •

- 6-1 Notes on Using the Inverter for a Motor
- 6-2 List of Parameters

## 6-1 Notes on Using the Inverter for a Motor

### ■ Using the Inverter for an Existing Standard Motor

When a standard motor is operated with the Inverter, power loss is slightly higher than when operated with a commercial power supply.

In addition, cooling effects also diminish in the low-speed range, resulting in an increase in the motor temperature. Therefore, the motor torque should be reduced in the low speed range.

The following graph shows the allowable load characteristics of a standard motor.

If 100% torque is continuously required in the low-speed range, use a special motor for use with inverters.

### Allowable Load Characteristics of Standard Motor

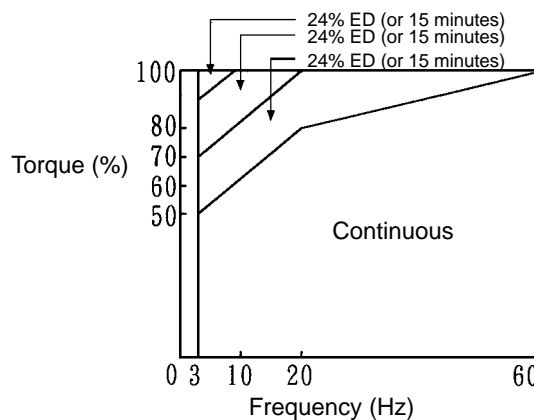

### ● High-speed Operation

When using the motor at a high speed (60 Hz or more), problems may arise in dynamic balance and bearing durability.

### ● Torque Characteristics

The motor may require more acceleration torque when the motor is operated with the Inverter than when operated with a commercial power supply. Check the load torque characteristics of the machine to be used with the motor to set a proper V/f pattern

### ● Vibration

The 3G3HV Series uses a high carrier PWM to reduce motor vibration. When the motor is operated with the Inverter, motor vibration is almost the same as when operated with a commercial power supply. Motor vibration may, however, become greater in the following cases.

#### ● Resonance with the natural frequency of the mechanical system

Take special care when a machine that has been operated at a constant speed is to be operated in variable speed mode.

If resonance occurs, install vibration-proof rubber on the motor base or use the frequency jump function to skip any frequency resonating the machine.

#### ● Imbalanced rotor

Take special care when the motor is operated at a higher speed (60 Hz or more).

- **Noise**

Noise is almost the same as when the motor is operated with a commercial power supply. Motor noise, however, becomes louder when the motor is operated at a speed higher than the rated speed (60 Hz).

- **Using the Inverter for Special Motors**

- **Pole-changing Motor**

The rated input current of pole-changing motors differs from that of standard motors. Select, therefore, an appropriate Inverter according to the maximum input current of the motor to be used.

Before changing the number of poles, always make sure that the motor has stopped. Otherwise, the overvoltage protective or overcurrent protective mechanism will be actuated, resulting in an error.

- **Submersible Motor**

The rated input current of submersible motors is higher than that of standard motors. Therefore, always select an Inverter by checking its rated output current.

When the distance between the motor and Inverter is long, use a cable thick enough to connect the motor and Inverter to prevent motor torque reduction.

- **Explosion-proof Motor**

When an explosion-proof motor or increased safety-type motor is to be used, it must be subject to an explosion-proof test in conjunction with the Inverter. This is also applicable when an existing explosion-proof motor is to be operated with the Inverter.

Since the Inverter itself is, however, not explosion-proof, always install it in a safe place.

- **Gearmotor**

The speed range for continuous operation differs according to the lubrication method and motor manufacturer. In particular, continuous operation of an oil-lubricated motor in the low speed range may result in burning. If the motor is to be operated at a speed higher than 60 Hz, consult with the manufacturer.

- **Synchronous Motor**

A synchronous motor is not suitable for Inverter control.

If a group of synchronous motors is individually turned ON and OFF, synchronism may be lost.

- **Single-phase Motor**

Do not use an inverter for a single-phase motor. The motor should be replaced with a 3-phase motor.

- **Power Transmission Mechanism (Speed Reducers, Belts, and Chains)**

If an oil-lubricated gearbox or speed reducer is used in the power transmission mechanism, oil lubrication will be affected when the motor operates only in the low speed range. The power transmission mechanism will make noise and experience problems with service life and durability if the motor is operated at a speed higher than 60 Hz.

**■ Motor Burnout Due to Insufficient Dielectric Strength of Each Phase of the Motor**

Surge occurs among the phases of the motor when the output voltage is switched. If the dielectric strength of each phase of the motor is insufficient, the motor may burn out. The dielectric strength of each phase of the motor must be higher than the maximum surge voltage. Normally, the maximum surge voltage is approximately three times the power voltage imposed on the Inverter.

Be sure to connect a dedicated motor to the 400-V Inverter. A standard motor may burn out if it is connected to the Inverter due to the insufficient dielectric strength of each phase of the standard motor.

## 6-2 List of Parameters

Values in brackets [ ] are default-set values.

**Note** Parameters that can be changed while the Inverter is running are indicated in bold type.

### ■ Group 1: n001 to n034

Function	No.	Name	Description	Setting range	Reference page										
Parameter group selection	n001	Parameter write prohibit selection/Parameter initialization	0: The parameters n001 can be set and checked and the parameters n002 to n108 can be only checked. The speed and direction of the Digital Operator can be set.) 1: The parameters of group 1 (i.e., n001 to n034) can be set and checked and the parameters of groups 2 and 3 (i.e., n035 to n049 and n050 to n108) can be only checked. 2: The parameters of groups 1 and 2 can be set and checked and the parameters of group 3 can only be checked. 3: The parameters of groups 1, 2, and 3 can be set and checked. 6: All parameters will be set to default-set values. 7: All parameters will be initialized with a three-wire sequence. <b>Note</b> When parameter initialization is performed by setting to 6 or 7, the Forward/Reverse rotation selection (n005) is not initialized. (It is only initialized when a CPF4 error is detected.)	0 to 7 [1]	3-13										
Parameter initialization															
Operation mode selection	n002	Operation mode selection	Selects method to input run command and frequency reference. <table border="0"> <tr> <td><u>Run command</u></td> <td><u>Frequency reference</u></td> </tr> <tr> <td>0: Digital Operator</td> <td>Digital Operator</td> </tr> <tr> <td>1: Control circuit terminals</td> <td>Digital Operator</td> </tr> <tr> <td>2: Digital Operator</td> <td>Control circuit terminals</td> </tr> <tr> <td>3: Control circuit terminals</td> <td>Control circuit terminals</td> </tr> </table>	<u>Run command</u>	<u>Frequency reference</u>	0: Digital Operator	Digital Operator	1: Control circuit terminals	Digital Operator	2: Digital Operator	Control circuit terminals	3: Control circuit terminals	Control circuit terminals	0 to 3 [3]	3-13
<u>Run command</u>	<u>Frequency reference</u>														
0: Digital Operator	Digital Operator														
1: Control circuit terminals	Digital Operator														
2: Digital Operator	Control circuit terminals														
3: Control circuit terminals	Control circuit terminals														
Input voltage selection	n003	Input voltage selection (see note)	Set Inverter input voltage in 1-V units.	150.0 to 255.0 [200.0]	3-23										
Interruption mode selection	n004	Interruption mode selection	0: Deceleration stop 1: Free running stop 2: Free running stop 1 with timer. The run command during deceleration time 1 or 2 will be ignored. 3: Free running stop 2 with timer. The constant run command is valid. The motor will start running after deceleration time 1 or 2 passes.	0 to 3 [0]	3-23										

**Note** With 400-V Inverters, the setting range upper limits and default settings are double those shown in the table.

Function	No.	Name	Description	Setting range	Reference page
Motor rotation direction selection	n005	Forward/Reverse rotation selection	0: When the forward rotation command is input, the motor seen from the load side rotates counterclockwise. 1: When the forward rotation command is input, the motor seen from the load side rotates clockwise. <b>Note</b> This parameter is not initialized when parameter initialization is performed by setting n001 to 6 or 7. (It is only initialized when a CPF4 error is detected.)	0, 1 [0]	3-17
	n006	Reverse rotation-inhibit selection	0: The motor can rotate in reverse. 1: The motor cannot rotate in reverse.	0, 1 [0]	3-17

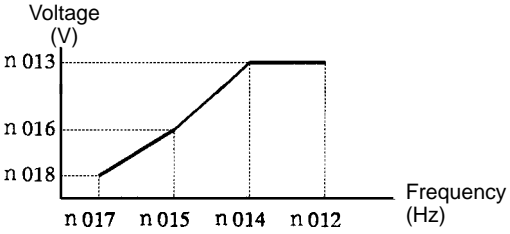
Function	No.	Name	Description	Setting range	Reference page
Digital Operator function selection	n007	Operation direction selection key permit/inhibit	0: Inhibits Operation Mode Selection Key from functioning. 1: Permits Operation Mode Selection Key to function.	0, 1 [1]	3-57
	n008	Stop Key function selection	0: The STOP/RESET Key will function only when the Inverter is running with the run command through the Digital Operator. 1: The STOP/RESET Key will function anytime.	0, 1 [1]	3-58
	n009	Frequency reference setting selection	0: Permits frequency reference set with the Digital Operator to be valid without Enter Key input. 1: Permits frequency reference set with the Digital Operator to be valid with Enter Key input.	0, 1 [1]	3-58
V/f pattern selection	n010	V/f pattern selection	0 to E: Selects from 15 fixed V/f patterns. F: Selects optional V/f pattern with n012 to n018 settings.	0 to F [1]	3-58
	n011	Rated input voltage of motor (see note)	Set rated input voltage of motor with 1 V units.	150.0 to 255.0 [200.0]	3-60
V/f pattern selection	n012	Maximum frequency (FMAX)	 <p>The V/f pattern will be a straight line if there is no difference between n015 and n017 in set value, in which case the set value of n016 will be ignored.</p>	50.0 to 400.0 [60.0]	3-60
	n013	Maximum voltage (VMAX) (see note)		0.1 to 255.0 [200.0] (See note 1.)	3-60
	n014	Maximum voltage frequency (FA)		0.2 to 400.0 [60.0]	3-61
	n015	Intermediate output frequency (FB)		0.1 to 399.9 [3.0]	3-61
	n016	Intermediate output frequency voltage (VC) (see note)		0.1 to 255.0 [15.0] (See note 1, 2.)	3-61
	n017	Minimum output frequency (FMIN)		0.1 to 10.0 [1.5]	3-61
	n018	Minimum output frequency voltage (VMIN) (see note)		0.1 to 50.0 [10.0] (See note 1, 2.)	3-61

**Note 1.** With 400-V Inverters, the setting range upper limits and default settings are double those shown in the table.

**Note 2.** The default settings for Inverters of 55 kW or more are as follows:  
n016 = 12.0/24.0, n018 = 6.0/12.0

Function	No.	Name	Description	Setting range	Reference page
Acceleration/ Deceleration time selection	n019	Acceleration time 1	The time required for the output frequency to be 100% from 0% of the maximum frequency.	0.0 to 3,600 [10.0]	3-61
	n020	Deceleration time 1	The time required for the output frequency to be 0% from 100% of the maximum frequency.	0.0 to 3,600 [10.0]	3-61
	n021	Acceleration time 2	Valid if acceleration/deceleration time switching command is selected for multi-function input.	0.0 to 3,600 [10.0]	3-61
	n022	Deceleration time 2	Valid if acceleration/deceleration time switching command is selected for multi-function input.	0.0 to 3,600 [10.0]	3-62
S-shaped characteristic time selection	n023	S-shaped characteristic time selection	0: No s-shaped characteristic time 1: 0.2 s 2: 0.5 s 3: 1.0 s	0 to 3 [1]	3-62
Frequency reference selection	n024	Unit of frequency reference	0: 0.1-Hz units 1: 0.1% units 2to 39: r/min (r/min = 120 x frequency/n024 Set n024 to the number of poles of the motor.) 40 to 3,999: Determine the display method of the maximum frequency set with n012. Example: Set n024 to 1100 so that "10.0" will be displayed at the maximum frequency.	0 to 3,999 [0]	3-62
Frequency reference selection	n025	Frequency reference 1	Set frequency reference using the unit set with n024.	0 to maximum frequency [6.0]	3-63
	n026	Frequency reference 2	Frequency reference with multi-step speed command 1 turned ON.	0 to maximum frequency [0.0]	3-63
	n027	Frequency reference 3	Frequency reference with multi-step speed command 2 turned ON.		3-63
	n028	Frequency reference 4	Frequency reference with multi-step speed command 1 and 2 turned ON.		3-63
	n029	Inching frequency reference	Frequency reference with inching command turned ON.	0 to maximum frequency [6.0]	3-63
Output frequency limit selection	n030	Output frequency upper limit	Set output frequency upper limit with 1% units based on max. frequency set with n012 as 100%.	0 to 109 [100]	3-63
	n031	Output frequency lower limit	Set output frequency lower limit with 1% units based on max. frequency set with n012 as 100%.	0 to 100 [0]	3-63



Function	No.	Name	Description	Setting range	Reference page
Electronic thermal protection function selection	n032	Motor rated current	Set rated input current of motor with 1-A units as motor basic current for electronic thermal protection.	See note 1, 2.	3-64
	n033	Electronic thermal protection function selection	0: No protection. 1: For standard motors with standard ratings (with a time constant of 8 min). 2: For standard motors with short-time ratings (with a time constant of 5 min). 3: For Inverter-dedicated motors with standard ratings (with a time constant of 8 min). 4: For Inverter-dedicated motors with short-time ratings (with a time constant of 5 min).	0 to 4 [1]	3-65
Overheating stop mode selection	n034	Selection of stop method for when radiation fin overheats	0: Deceleration stop in deceleration time 1 set with n020 1: Free running stop 2: Deceleration stop in deceleration time 2 set with n022 3: Continuous operation with warning	0 to 3 [3]	3-65

**Note 1.** Default settings vary with the Inverter model.

**Note 2.** The motor's rated current setting range is 10% to 200% of the Inverter's rated current.

### ■ Group 2: n035 to n049

Function	No.	Name	Description	Setting range	Reference page
Sequential input function selection	n035	Multi-function input 1 (S2)	0: Reverse rotation/Stop 1: Stop command (3-wire sequence selection) S3 will be used for forward/reverse rotation command and value set with n036 will be ignored. 2: External error (NO contact: ON) 3: External error (NC contact: ON) 4: Error reset (ON: Valid) 5: Operation mode selection (ON: Digital Operator; OFF: n002) 6: Not used 7: Emergency stop 8: Analog input selection (ON: Current input through FI terminal; OFF: FV terminal) 9: Multi-step speed command 1 10: Multi-step speed command 2 11: Inching command 12: Acceleration/Deceleration time switching command 13: External baseblock command (ON: Valid) 14: External baseblock command (OFF: Valid) 15: Speed search command from max. frequency 16: Speed search command from set frequency 17: Parameter set-inhibit (ON: Invalid) 18: Integral value of PID control reset command 19: PID control invalidating command (Set point used as frequency reference) 20: Timer function input (Set with n077 and n078) 21: Inverter overheat warning (ON: "OH3" will be displayed) 22: Analog frequency sample hold 23: Power OFF stop input (NO contact) 24: Power OFF stop input (NC contact)	0 to 24 [0]	3-17
	n036	Multi-function input 2 (S3)	Same as n035	2 to 24 [2]	3-17
	n037	Multi-function input 3 (S4)	Same as n035	2 to 24 [4]	3-17
	n038	Multi-function input 4 (S5)	Same as n035	2 to 24 [9]	3-17

Function	No.	Name	Description	Setting range	Reference page
Sequential input function selection	n039	Multi-function input 5 (S6)	0 to 22: Same as n035 25: Up/Down command S5 will be used for the up command, S6 will be used for the down command, and value set with n038 will be ignored. 26: Not used. (Do not set.) 27: PID input characteristic selection (ON: Deviation multiplied by -1)	2 to 27 [10]	3-18
Sequential output function selection	n040	Multi-function contact output 1 (MA-MB-MC)	0: Error (ON: Error) 1: Running 2: Frequency agreement 3: Optional frequency agreement 4: Optional frequency detection (ON: Output frequency □ n073) 5: Optional frequency detection (ON: Output frequency □ n073) 6: Overtorque (ON: Detected) 7: Overtorque (OFF: Detected) 8: Baseblock 9: Operation mode (ON: Digital Operator/Frequency reference) 10: Inverter ready 11: Timer function output (Set with n077 and n078) 12: Error retrying 13: Inverter/Motor overload warning 14: Frequency reference loss (ON: Frequency reference has dropped by 90% or more within 0.4 s) 15: Not used 16: PID feedback loss (Detecting method can be set with n093 and n094) 17: Heating heat sink (ON: OH1)	0 to 17 [0]	3-74
	n041	Multi-function contact output 2 (M1-M2)	Same as n040	0 to 17 [1]	3-74

Function	No.	Name	Description	Setting range	Reference page
Frequency reference function selection	n042	Analog frequency reference voltage/current selection	0: The FV terminal can be used for the analog frequency reference within a voltage range from 0 to 10 VDC. 1: The FI terminal can be used for the analog frequency reference. Set the input level with n043.	0, 1 [0]	3-77
	n043	FI input level selection	0: Voltage input within a range from 0 to 10 V. Be sure to cut jumper wire J1. 1: Current input within a range from 4 to 20 mA.	0, 1 [1]	3-78
	n044	Analog frequency reference sample hold selection	0: Frequency reference on hold is saved by n025 1: Frequency reference on hold is not saved.	0, 1 [0]	3-78
	n045	Processing selection when analog frequency reference is lost	0: Inhibits Inverter from processing analog frequency reference loss. 1: Permits Inverter to process analog frequency reference loss.	0, 1 [0]	3-78
	n046	Frequency reference gain	Set analog frequency reference input gain. Set input frequency at 10 V or 20 mA with 1% units based on max. frequency set with n012 as 100%.	0 to 200 [100]	3-79
	n047	Frequency reference bias	Set analog frequency reference input bias. Set input frequency at 0 V or 4 mA with 1% units based on max. frequency set with n012 as 100%.	-100 to 100 [0]	3-79
Analog monitor function selection	n048	Multi-function analog output selection	0: Output frequency (10 V: Max. frequency n012) 1: Output current (10 V: Rated inverter current) 2: Output power (10 V: Rated inverter output capacity) 3: Main circuit DC voltage (10 V: 200-V class: 400 V; 400-V class: 800V)	0 to 3 [0]	3-79
	n049	Multi-function analog output gain	Set voltage level gain of multi-function analog output. Set n049 to result obtained from dividing voltage of full analog output by 10 V.	0.01 to 2.00 [1.00]	3-80

### ■ Group 3: n050 to n108

Function	No.	Name	Description	Setting range	Reference page
Carrier frequency adjustment	n050	Carrier frequency (See note 1)	1: 2.5 kHz 2: 5.0 kHz 3: 8.0 kHz 4: 10.0 kHz 5: 12.5 kHz 6: 15.0 kHz 7, 8, and 9: Varies in proportion to output frequency up to 2.5 kHz. 10:7.0 kHz	1 to 10 See note 2	3-80
Instantaneous power failure processing and speed search control	n051	Selection of running after restoration following a momentary stop	0: Inverter will discontinue running. 1: Inverter will continue running if power is supplied again within instantaneous power failure compensation time set with n055. 2: Inverter will always continue running without detecting UV1 or UV3.	0 to 2 [0]	3-81
	n052	Speed search control level	Set current level enabling speed search in 1% units based on rated output current of Inverter as 100%.	0 to 200 [110]	3-82
	n053	Minimum base-block time	Set time to start speed search after RUN input is ON and instantaneous power failure processing starts.	0.5 to 10.0 (See note)	3-82
	n054	V/f characteristics during speed search	Set percentage of V/f characteristics for speed search.	0 to 100 (See note)	3-82
	n055	Stop compensation time	Set instantaneous power failure compensation time in 1-s units.	0.0 to 2.0 (See note)	3-82
Error retry	n056	Number of error retries	Set number of error retries.	0 to 10 [0]	3-83
	n057	Selection of error output during error retry	0: Turns ON error output while error retry is performed. 1: Turns OFF error output while error retry is performed.	0, 1 [0]	3-83

**Note 1.** For a 400-V Inverter, if the carrier frequency is set to a value higher than the default setting, the Inverter overload “OL2” detection value will decrease in consideration of an increase in the heat that will be generated by the change in the carrier frequency.

**Note 2.** Default settings vary with the Inverter model.

Function	No.	Name	Description	Setting range	Reference page
Frequency jump	n058	Jump frequency 1	Set center value of jumping frequency in 1-Hz units.	0.0 to 400.0 [0.0]	3-83
	n059	Jump frequency 2	Frequency jump function will be invalid if value is set to 0.0.		3-84
	n060	Jump frequency range	Set jump range of jumping frequency in 1-Hz units.	0.0 to 25.5 [1.0]	3-84
Accumulated operation time	n061	Total operating time function selection	0: Accumulates power-on time. 1: Accumulates running time	0, 1 [1]	3-84
	n062	Total operating time 1 (rightmost 4 digits)	Set accumulation start time in 1-h units. Permits accumulated operation time monitor to function. (Same as U-11 and U-12) Accumulated operation time (h) = n063 x 10,000 + n062	0 to 9,999 [0]	3-84
	n063	Total operating time 2 (leftmost 2 digits)	Max. value: 279,620 (h) (Returns to 0 when accumulated operation time exceeds 279,620 h)	0 to 27 [0]	3-84
DC braking	n064	DC braking current	Set DC control current in 1% units based on rated output current of Inverter as 100%.	0 to 100 [50]	3-85
	n065	Stopped DC braking time	Set stop DC control time and start DC control time in 1-s units.	0.0 to 10.0 [0.5]	3-85
	n066	Startup DC braking time	DC control will be invalid if value is set to 0.0.	0.0 to 10.0 [0.0]	3-85
Torque compensation	n067	Automatic torque boost gain	Set automatic torque boost gain. Setting is usually not necessary.	0.0 to 3.0 [1.0]	3-85
	n068	Motor winding resistance	Set motor constant for automatic torque boost operation. Setting is usually not necessary.	0.000 to 65.53 (See note 1)	3-85
	n069	Motor iron loss		0 to 9,999 (See note 1)	3-85
Stall prevention	n070	Decelerating stall prevention selection	0: Inhibits deceleration stall prevention from functioning. 1: Permits deceleration stall prevention to function.	0, 1 [1]	3-86
	n071	Accelerating stall prevention operation level	Set current level enabling acceleration stall prevention in 1% units based on rated output current of Inverter as 100%.	30 to 200 [170] (See note 2)	3-86
	n072	Operating stall prevention operation level	Set current level enabling operation stall prevention in 1% units based on rated output current of Inverter as 100%.	30 to 200 [160] (See note 2)	3-86
Optional frequency detection	n073	Frequency detection level	Set detecting output frequency in 1-Hz units. Valid if multi-function contact output is set to optional frequency agreement or optional frequency detection.	0.0 to 400.0 [0.0]	3-87

**Note 1.** Default settings vary with the Inverter model.

**Note 2.** The default setting for 18.5-kW or higher Inverters is 120%.

Function	No.	Name	Description	Setting range	Reference page
Overtorque detection	n074	Overtorque detection function selection	0: Inhibits Inverter from detecting overtorque. 1: Inverter will detect overtorque only during speed agreement and continue running with warning after detection. 2: Running Inverter will detect overtorque and continue running with warning after detection. 3: Inverter will detect overtorque only during speed agreement and turn OFF output for safety when overtorque is detected. 4: Running Inverter will always detect overtorque and turn OFF output for safety when overtorque is detected.	0 to 4 [0]	3-87
	n075	Overtorque detection level	Set overtorque detection current in 1% units based on rated output current of Inverter as 100%.	30 to 200 [160]	3-87
	n076	Overtorque detection time	Set overtorque detection time in 1-s units. Overtorque will be detected if current larger than value set with n075 flows for the set time or more.	0.1 to 10.0 [0.1]	3-87
Timer function	n077	Timer function ON delay time	Set time lag between moment timer function input turns ON and moment timer function output turns ON. Valid if multi-function input and multi-function contact output are set to timer function.	0.0 to 25.5 [0.0]	3-88
	n078	Timer function OFF delay time	Set time lag between the moment the timer function input turns OFF and the moment the timer function output turns OFF. Valid if multi-function input and multi-function contact output are set to timer function.	0.0 to 25.5 [0.0]	3-88
Braking Resistor Unit overheating protection	n079	Braking resistor overheating protection selection	0: Inhibits overheating protection from functioning. 1: Permits overheating protection to function.	0, 1 [0]	3-88
I/O phase loss detection	n080	Input open-phase detection level	Set input phase loss detection level to percentage of main circuit DC voltage. 200-V class: 200 VDC as 100% 400-V class: 800 VDC as 100%	1 to 100 [7]	3-89
	n081	Input open-phase detection time	Set input phase loss detection time. Detection time = 1.28 x n 081 Inverter will detect input phase loss if voltage as large as or larger than value set with n080 is imposed continuously for period exceeding set time.	2 to 255 [8]	3-89
	n082	Output open-phase detection level	Set output phase loss detection level in 1% units based on rated output current of Inverter as 100%. Output phase loss detection will be invalid if value is set to 0.	0 to 100 [0]	3-89

Function	No.	Name	Description	Setting range	Reference page
I/O phase loss detection	n083	Output open-phase detection time	Set output phase loss detection time in 1-s units. Inverter will detect output phase loss if current as large as or less than value set with n082 flows continuously for period exceeding set time.	0.0 to 2.0 [0.2]	3-89
PID control	n084	PID control function selection	0: No PID control. 1: PID control with deviation derivative control. 2: PID control with feedback derivative control. 3: PID control with negative feedback characteristic control.	0 to 3 [0]	3-33
	n085	Feedback adjustment gain	Fine tuning gain for PID feedback value.	0.00 to 10.00 [1.00]	3-34
	n086	Proportional gain (P)	Set proportional gain for proportional control. Proportional control will be invalid if value set to 0.0.	0.0 to 10.0 [1.0]	3-35
	n087	Integral time (I)	Set integral time with 1 s units for integral control. Integral control will be invalid if value is set to 0.0.	0.0 to 100.0 [0.00]	3-35
	n088	Derivative time (D)	Set derivative time with 1 s units for derivative control. Derivative control will be invalid if value is set to 0.0.	0.00 to 1.00 [0.00]	3-35
	n089	PID offset adjustment	Set PID offset with 1% units based on max. frequency set with n012 as 100%.	-109 to 109 [0]	3-35
	n090	Integral (I) upper limit	Set upper limit of output with 1% units after integral control is performed based on max. frequency set with n012 as 100%.	0 to 109 [100]	3-35
	n091	PID primary delay constant	Set PID primary-delay time constant with 1 s units for frequency reference after PID control is performed.	0.0 to 2.5 [0.0]	3-35
	n092	Feedback loss detection selection	0: Feedback loss is detected. 1: Feedback loss is not detected.	0, 1 [0]	3-36
	n093	Feedback loss detection level	Set feedback loss detection level with 1% units.	0 to 100 [0]	3-36
	n094	Feedback loss detection time	Set feedback loss detection time with 1 s units.	0.0 to 25.5 [1.0]	3-36



Function	No.	Name	Description	Setting range	Reference page
Energy-saving control	n095	Energy-saving control selection	0: Inhibits the Inverter from performing energy-saving control. 1: Permits the Inverter to perform energy-saving control.	0, 1 [0]	3-26
	n096	Energy-saving coefficient K2	Set coefficient so that maximum motor efficiency will be obtained.	0.00 to 655.0 (See note)	3-26
	n097	Energy-saving voltage lower limit for 60 Hz	Set lower limits of energy-saving control output voltage in 1% units at 6 Hz and 60 Hz based on motor rated voltage set with n011 as 100%, in which case, lower limit of energy-saving control output voltage will be on a straight line linking values set with n097 and n098 if energy-saving control output frequency is between 6 and 60 Hz.	0 to 120 [50]	3-27
	n098	Energy-saving voltage lower limit for 6 Hz		0 to 25 [12]	3-28
	n099	Mean power time	Set time to calculate mean output power of Inverter performing energy-saving control. Time (ms) = 25 x n099	1 to 200 [1]	3-28
	n100	Search control voltage limit	Set range of variable voltage in 1% units to be used by Inverter in search control mode based on rated motor input voltage as 100%. Search operation function will be invalid if n101 is set to 0.	0 to 100 [0]	3-27
	n101	Search control voltage step when 100%	Set range of variable voltage in 1% units to be used by Inverter in search control mode with 100% search operation start voltage based on rated motor input voltage as 100%.	0.1 to 10.0 [0.5]	3-28
	n102	Search control voltage step when 5%	Set range of variable voltage in 1% units to be used by Inverter in search control mode with 5% search operation start voltage based on rated motor input voltage as 100%.	0.1 to 10.0 [0.2]	3-28
Not used	n103	Not used	Do not change setting.	1 [1]	---
	n104	Not used	Do not change setting.	1 [1]	---
	n105	Not used	Do not change setting.	0 [0]	---
	n106	Not used	Do not change setting.	0 [0]	---
	n107	Not used	Do not change setting.	2 [2]	---
	n108	Not used	Do not change setting.	1 [1]	---

**Note** Default settings vary with the Inverter model.

Function	No.	Name	Description	Setting range	Reference page
Slip compensation	n109	Slip compensation gain	Slip compensation gain is set as a percentage of the maximum output frequency (n014). Use the following equations to set a value that corresponds to the motor rated slip. $n109 = 100 \times (\text{Synchronization speed} - \text{rated motor speed}) \div \text{synchronization speed}$ Synchronization speed = $120f/P$ P: No. of poles f: Rated frequency Set n014 to the motor's rated frequency. <b>Note</b> The rated motor speed can be confirmed from the motor's nameplate. <b>Note</b> If n109 = 0.0, the slip compensation function is disabled. <b>Note</b> If n032 = 0.0, the slip compensation function is disabled.	0.0 to 9.9 [0.0]	3-90
	n110	Motor no-load current	Set the motor no-load current as a percentage of the motor rated current (n032). <b>Note</b> This setting is used as a parameter of the slip compensation function. <b>Note</b> Set after confirming the motor no-load current with the manufacturer. Alternatively, calculate the value from the current when there is no load and when running at the rated frequency.	0 to 99 [30]	3-90
	n111	Slip compensation primary delay time	Slip compensation primary delay time is set in s units. <b>Note</b> Usually setting is not necessary. Adjust when slip compensation responsiveness is low or when speed has not stabilized. When responsiveness is low, decrease the set value. When speed has not stabilized, increase the set value.	0.0 to 25.5 [2.0]	3-90
Operation selection at Digital Operator interruption	n112	Operation selection at Digital Operator interruption	Set whether an error is detected when the Digital Operator is disconnected. 0: Error not detected 1: Error detected	0, 1 [0]	3-91
Frequency detection width	n113	Frequency detection width	Sets the width of frequency agreement (n040, n041) and frequency detection (n073) in Hz units.	0.0 to 25.5 [2.0]	3-91

Function	No.	Name	Description	Setting range	Reference page
Operation selection at operation mode switching (local/remote switching)	n114	Operation selection at operation mode switching (local/remote switching)	<p>Select whether or not to ignore run signals input while the operation mode is switched using the Operation Mode Selection Key on the Digital Operator or with operation mode selection input from the multi-function inputs.</p> <p>0: Run signals that are input during mode switching are ignored. (Input run signals after switching the mode.)</p> <p>1: Run signals become effective immediately after mode.</p> <p><b>Note</b> If n114 is set to 1, when the operation mode changes the Inverter may start running immediately. Take steps to ensure safety for such operation.</p>	0, 1 [0]	3-91
(Manufacturer's use)	n115, n116	For the manufacturer's use. (Do not set.)		See note	---

**Note** Setting ranges and default settings vary with the Inverter model.

# Revision History

A manual revision code appears as a suffix to the catalog number on the front cover of the manual.

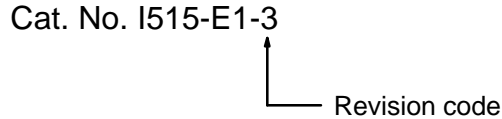

The following table outlines the changes made to the manual during each revision. Page numbers refer to the previous version.

Revision code	Date	Revised content
1	August 1996	Original production
2	April 1997	<p><b>Page 1-2:</b> Inverter model list updated. "Enclosed wall-mounted type" replaced with "NEMA1 type."</p> <p><b>Page 1-4:</b> Low noise and harmonic countermeasure information clarified.</p> <p><b>Page 2-4:</b> Dimensions added for the new models.</p> <p><b>Page 2-5:</b> "Enclosed Wall-mounted Type" replaced with "NEMA1 Type."</p> <p><b>Page 2-7:</b> Terminals U, V, and W replaced with T1 (U), T2 (V), and T3 (W) respectively.</p> <p><b>Pages 2-10, 2-11:</b> Terminals and connections changed for the 200-V Class and 400-V Class tables. New models reflected.</p> <p><b>Page 2-12:</b> Names for the three-phase terminals changed.</p> <p><b>Page 2-13:</b> Names for the three-phase terminals changed. Notes added. New models reflected.</p> <p><b>Pages 2-14, 2-15:</b> Terminal names changed and new models added. New wire sizes and tightening torque added.</p> <p><b>Pages 2-16 to 2-20:</b> Information for <i>Wiring on the Input Side of Main Circuit</i> and <i>Wiring on the Output Side of Main Circuit</i> changed.</p> <p><b>Page 2-22:</b> Second harmonic frequency corrected. Information in <i>Causes of Harmonics Generation</i> corrected at the bottom of the page.</p> <p><b>Page 2-23:</b> Last sentence of <i>DC/AC Reactors</i> corrected. Note added.</p> <p><b>Pages 2-24, 2-25:</b> Terminal names changed. New model information reflected.</p> <p><b>Page 2-26:</b> Inverter models added to the input transformer table.</p> <p><b>Page 2-27:</b> New model information reflected. Information on connecting Braking Units in parallel added. Information removed from <i>Wire Size and Solderless Terminals</i> at the bottom of the page.</p> <p><b>Pages 3-3, 3-9:</b> Terminal names changed.</p> <p><b>Page 3-44:</b> Note added.</p> <p><b>Page 3-58:</b> New model information reflected in the table.</p> <p><b>Page 3-72:</b> Notes added.</p> <p><b>Pages 4-2, 4-8:</b> Terminal names changed.</p> <p><b>Pages 4-3, 4-4:</b> Cause and action for the heat sink overheat and Inverter overload added to.</p> <p><b>Page 4-12:</b> Inverter overload information added.</p> <p><b>Pages 5-2, 5-3:</b> Specifications completely updated.</p> <p><b>Pages 5-5, 5-9, 5-10:</b> "Control Unit" corrected to "Braking Unit."</p> <p><b>Pages 5-9, 5-10:</b> New models added.</p> <p><b>Pages 5-15, 5-18:</b> Noise Filter models added.</p> <p><b>Page 6-5:</b> New models added.</p> <p><b>Page 6-13:</b> Note added.</p>
3	June 2000	<p><b>Preliminary pages:</b> Order changed and safety information added.</p> <p><b>Pages 1-6, 2-33, 3-2, 3-5, 3-7, 3-16, 3-20, 3-21, 3-22, 3-38 to 3-50, 3-52, 3-56, 3-69, 3-71, 3-74, 3-80, 3-84, 5-11:</b> Notes changed or added.</p> <p><b>Page 1-6, 3-2:</b> Explanation for "Operation Mode Selection Key" changed.</p> <p><b>Page 1-7:</b> Information on new functions added.</p> <p><b>Pages 2-6, 2-15, 3-20, 3-31, 3-55, 5-5:</b> Graphics changed or added.</p> <p><b>Pages 2-7, 3-2, 4-13:</b> "Cautions and Warnings" information changed.</p> <p><b>Page 2-9:</b> Information on wiring changed.</p> <p><b>Pages 2-14, 3-5, 3-13, 3-21, 3-31, 3-38 to 3-50, 3-56, 3-62, 3-72, 3-74, 5-11, 5-13, 6-5 to 6-8:</b> Changes made to tables.</p> <p><b>Pages 2-20 to 2-22, 5-17 to 5-19:</b> Major changes.</p> <p><b>Page 2-24:</b> Changes made to information on cable length. Information on single-phase motors added.</p> <p><b>Page 3-8:</b> Information on operation modes added after table.</p> <p><b>Page 3-23, 4-2:</b> Information added to introduction.</p> <p><b>Page 3-58:</b> Setting range for n030 changed.</p> <p><b>Page 3-61:</b> Setting range for n039 changed.</p> <p><b>Page 3-65:</b> Information for external baseblock command changed.</p> <p><b>Page 3-66:</b> Information on PID control added.</p> <p><b>Page 3-75:</b> Default setting for n052 changed.</p> <p><b>Page 3-76:</b> Setting range for n053 changed.</p> <p><b>Page 3-83:</b> "Motor Rated Slip" changed to "Slip Compensation Gain."</p> <p><b>Page 3-84:</b> Information for n112, n113, and n114 changed.</p> <p><b>Page 4-4:</b> Information on connection error added.</p> <p><b>Page 4-12:</b> Information added.</p> <p><b>Pages 5-3, 5-4:</b> "IP00" changed to "IP10."</p> <p><b>Index:</b> Index removed.</p>