

VARISPEED-616G5 OPTION CARD PG SPEED CONTROLLER CARD PG-B2 INSTRUCTIONS

Upon receipt of the product and prior to initial operation, read these instructions thoroughly, and retain for future reference.



YASKAWA

MANUAL NO. TOE-C736-40.2B

AUDIN - 7 bis rue de Tinquaux - 51100 Reims - France

Tel : 03.26.04.20.21 - Fax : 03.26.04.28.20 - Web : [http: www.audin.fr](http://www.audin.fr) - Email : info@audin.fr

NOTES FOR SAFE OPERATION

Read this instruction manual thoroughly before installation, operation, maintenance or inspection. In this manual, the NOTES FOR SAFE OPERATION is classified as “CAUTION”.



Indicates a potentially hazardous situation which, if not avoided, may result in minor or moderate injury to personnel and damage to equipment.

It may also be used to alert against unsafe practices.

Even items described in  CAUTION may result in a vital accident in some situations. In either case, follow these important items.

 : These are steps to be taken to insure proper operation and to avoid malfunctions, etc.

CAUTION

- The option card uses C MOS IC chips. It may break if touched by bare fingers because of static electricity. Be careful when handling.
- SWhen removing the option card from the inverter for transportation or storage, put the card into the anti-static package it was in when delivered.
- Never change wiring or connect or disconnect connectors while the power is ON.

Failure to observe this caution may injure you.

PG speed controller card, PG-B2 is mounted on the control board of the inverter, and performs speed feedback using the pulse generator (PG) on the motor to correct speed fluctuations caused by slipping. Motor rotation direction is detected by phase A and phase B PG pulse inputs. The card is used for flux vector control.

This option card is applicable to the following inverter series:

VS-616G5: Entire series

Name	Code No.	Functions
PG speed controller card PG-B2	73600-A013X	<ul style="list-style-type: none"> • Applicable to complementary output PG • Phase A and phase B pulse (2-phase pulse) inputs for vector control • Maximum input frequency: 32,767Hz • Pulse monitor output: +24V, 30mA (max.) (Open collector output)

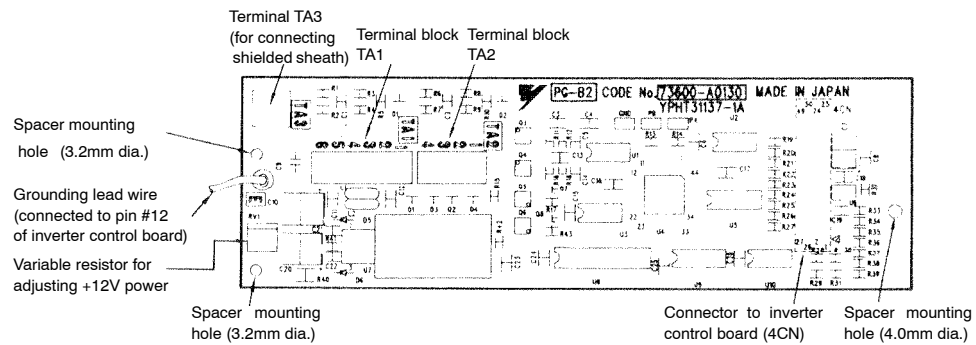

Fig. 1 PG speed controller card PG-B2

Verify that the attachment below is in the package.

- Spacer : 1 pc. (Dimensions in mm)

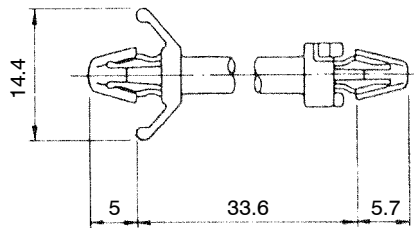

Fig. 2 Spacer (code no. SRNT41028-9)

 NOTE

Before use,

- (1) Before using the PG-B2, read this manual and the manual for the installation of the inverter.
- (2) Before connecting the PG-B2 or external terminals, turn OFF main power of the inverter and verify the CHARGE indicator lamp of the inverter is OFF.
- (3) When ordering the PG-B2, specify the name and code number.

1 Inspection after Delivery



CAUTION

- Verify that ordered products have been delivered.
Installation of a wrong device may lead to injury or damage.

Though the products have undergone rigorous inspection before shipping, check the following for safety.

- Check the name written on the product to verify that ordered products have been delivered.
- Check for damage caused during transportation.

If there is anything uncertain on the structure, contact your YASKAWA representative.

2 Installing to Inverter (See Fig. 3)

2.1 Installation Procedure

- ① Turn OFF the main power and wait for the time specified on the cover of the inverter. Remove the cover and verify that the CHARGE indicator lamp is OFF.
- ② Insert the attached spacer (SRNT41028-9) into the spacer mounting hole in the mounting base of the inverter. (See Fig. 3.)

Inverters of 3.7kW or smaller capacities have two closely placed holes. Insert the spacer into the hole on the 7CN side. Inserting into the wrong hole will stack the spacer. Be careful to insert in the proper hole in the proper inserting direction.

- ③ Align the two holes of PG-B2 and projections as shown in the detailed side view, first at location (a) and then at (b), and precisely place the card on the option A connector. Insert the spacer mounted at ② above into the PG-B2 spacer mounting hole. (See part A of the side view.)
Verify that 4CN is precisely aligned to PG-B2. Gently push the card until it clicks.

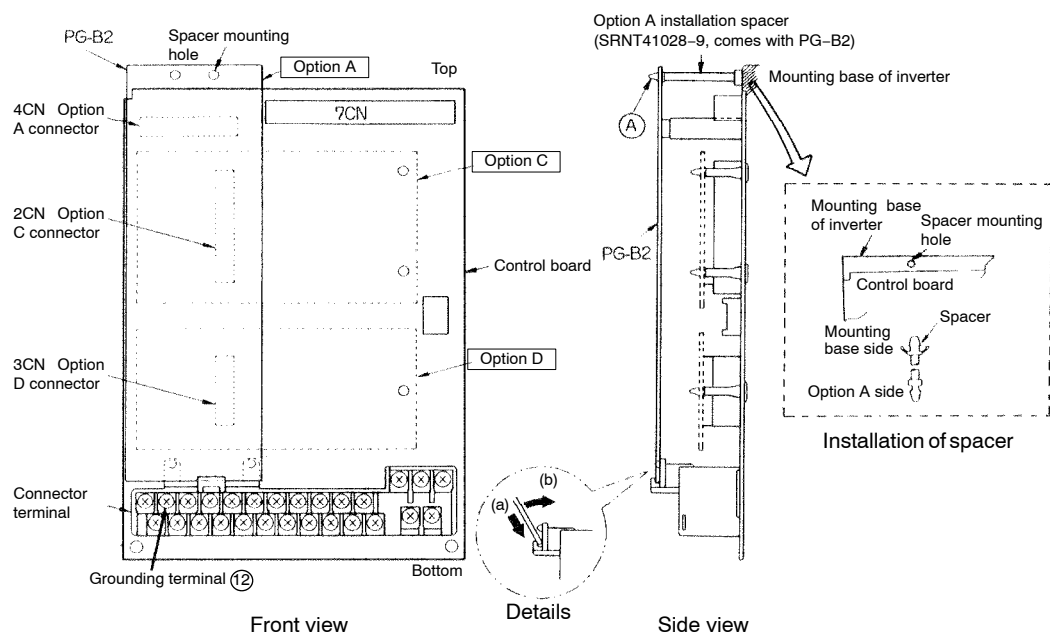

Fig. 3 Installation of PG speed control card PG-B2

3 Interconnection

Fig. 4 shows interconnection between the inverter, PG-B2, and peripheral equipment.

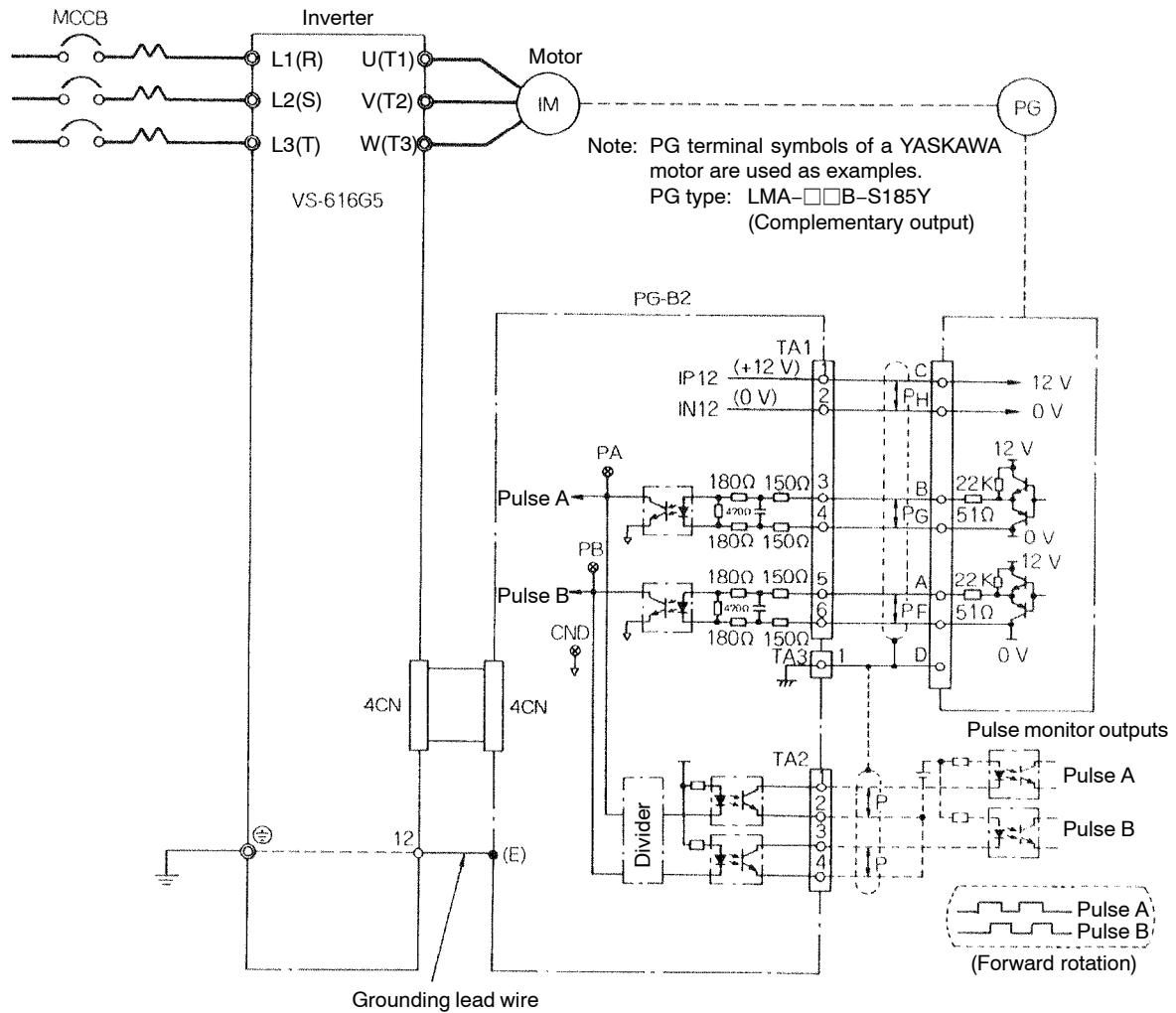

Fig. 4 Interconnection diagram

NOTE

Notes on wiring

- Separate the control signal wires (from terminals TA1 and TA2) of the PG-B2 from the main circuit wires and other power cables.
- Use a shielded wire to connect to the PG. Connect the wire as shown in Fig. 5 to prevent interference by noise. The wire must be 300m or shorter.

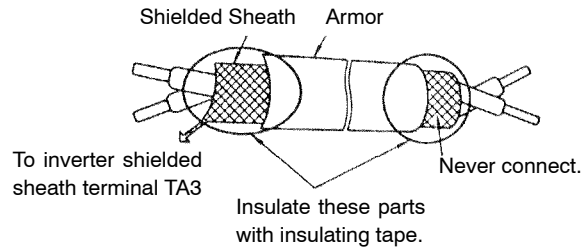

Fig. 5 Shielded wire termination

4 Wiring

See Table 1 for the functions of the external terminals.

Table 1 External terminals

Terminal block symbol	Pin No.	Functions		Remarks	
TA1	1	+12V	+12V power supply (+12V \pm 5%, maximum current 200mA)*	Power supplies for PG	
	2	0V			
	3	+	A pulse	PG input signals	
	4	-			
	5	+	B pulse		
	6	-			
TA2	1	+	A pulse		Pulse monitor outputs
	2	-			
	3	+	B pulse		
	4	-			
TA3	Shielded sheath connection terminal				

* Up to +14V \pm 5% can be supplied by adjusting variable resistor RV1. RV1 is set to 13.0V at the factory prior to shipment.

PG signal output

The PG signal output (phases A and B) may vary according to installation location on the motor. Refer to Fig. 4 for correct wiring.

In general, motor forward direction is counterclockwise (CCW) as viewed from the load shaft. For YASKAWA's motor, phase A of PG output leads phase B by a phase angle of 90° in clockwise (CW) rotation. According to PG, phase A lags phase B by a phase angle of 90° in clockwise (CW) rotation. In this case, when PG is installed at the opposite drive end, connect phases A and B output from PG to the option card as it is.

For YASKAWA's inverter motor with PG, PG is installed at the opposite drive end. Then, phase A lags phase B by a phase angle of 90° at motor forward run. (Motor runs CCW as viewed from PG.) Therefore, when using this motor or similar motors, connect phases A and B to the option card after replacing phase output. The pulse monitor on this option shows phase A leading phase B by a phase angle of 90°.

Make sure the followings when wiring.

- PG cable must be 300m or shorter. If it is 100m or shorter, provide an exclusive cable. (Refer to the table below.)

For wire length of 100m or shorter, use type of KPEV-S, 0.5mm².

For wire length from 100 to 300m, use type of KPEV-S, 1.25mm² and a junction terminal.

Wire specification: Polyethylene insulated wire for instrumentation
manufactured by HIHON ELECTRIC WIRE &
CABLE.

KPEV-S 0.5mm² (1.25mm²) 3-pair wire

Terminal TA1 specification: MKDS1 series manufactured by Phoenix
Contact GmbH & Co.

Cable length	YASKAWA Code No.
10m	72616-W5010
30m	72616-W5030
50m	72616-W5050
100m	72616-W5100

- Cable length for pulse monitor output must be 30m or shorter.

Wire specification: Polyethylene insulated wire for instrumentation
manufactured by NIHON ELECTRIC WIRE &
CABLE.

KPEV-S 0.5mm² 2-pair wire

Terminal TA2 specification: MKDS1 series manufactured by Phoenix
Contact GmbH & Co.

- To prevent noise, use shielded wire and separate from heavy current circuits (200VAC or greater) or relay drive circuits. (Wire length to the PG connector must be 300m or shorter.)
- Connect both ends of the unused wire of the shielded wire to the 0V terminal.
- Connect the grounding lead wire (E) to pin ⑫ of the control board of the inverter.
- Applicable wire sizes for terminal block TA1 are shown below.

[Terminal: MKDS1 series manufactured by Phoenix Contact GmbH & Co.]

	[mm ²]	AWG	I [A]	VAC [V]
Thin twisted wire	1	16	12	125
Solid wire	1.5	16	12	125
UL	—	22-16	10	300
CSA	—	28-16	10	300
CSA	—	28-16	10	150



Terminal block TA1,TA2 side
Connecting wire end

NOTE

Notes on selecting cables

Too thick a cable applies pressure to the option card and may lead to failure.
Too thin a cable may lead to imperfect contact or a break in the wire.

5 Selecting PG

The maximum frequency of PG output pulse that can be detected is 32,767Hz. Therefore, select a PG that outputs about 20kHz at the motor rotation speed at maximum frequency output.

$$\frac{\text{Motor rotation speed (r/min) at max. frequency output}}{60} \times * \text{ PG constant (p/rev)} = 20,000\text{Hz}$$

Table 2 Examples of PG selection

Motor rotation speed at maximum frequency output (r/min)	PG parameter (p/rev)	PG output frequency at maximum frequency output (Hz)
1800	600	18,000
1500	800	20,000
1200	1000	20,000
900	1200	18,000

- Notes:
- The motor rotation speeds at maximum frequency output are represented as synchronous rotation speeds.
 - PG power supply is +12V.
 - If the PG power capacity is 200mA or greater, provide a separate power supply. (If momentary power loss ride-through function is necessary, provide backup capacitor or take other necessary measures.)

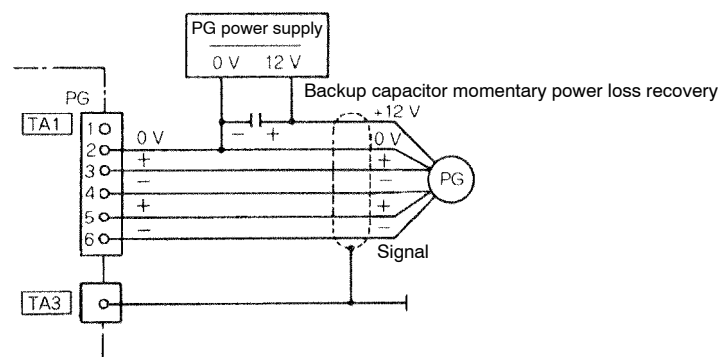

Fig. 6 Connection example with PG when using separate power supply

Table 3 Constants List

Digital Operator Function Display	Digital Operator Display	Constant No.	Constant Name	Setting Range	Factory Setting	Change during Operation (○=Enable, x=Disable)	Data Selection	Control Method (○=Setting enable, x=Setting disable)			
								V/f Control	V/f with PG Feedback	Open Loop Vector	Flux Vector
PG Option Setup	PG Pulse/Rev	F1-01	PG constant	0 to 60000	1624*3	x	0 : Ramp to Stop 1 : Coast to Stop 2 : Fast-Stop 3 : Alarm Only	x	○	x	○
	PG Fdbk Loss Sel	F1-02	Operation selection at PG open circuit	0 to 3	1	x	0 : Ramp to Stop 1 : Coast to Stop 2 : Fast-Stop 3 : Alarm Only	x	○	x	○
	PG Overspeed Sel	F1-03	Operation selection at overspeed	0 to 3	1	x	0 : Ramp to Stop 1 : Coast to Stop 2 : Fast-Stop 3 : Alarm Only	x	○	x	○
	PG Deviation Sel	F1-04	Operation selection at deviation	0 to 3	3	x	0 : Ramp to Stop 1 : Coast to Stop 2 : Fast-Stop 3 : Alarm Only	x	○	x	○
	PG Rotation Sel	F1-05	PG rotation	0/1	0	x	0 : Fwd=C.C.W. 1 : Fwd=C.W.	x	○	x	○
	PG Output Ratio	F1-06	PG division rate	1 to 132	1	x		x	○	x	○
	PG Ramp P/I Sel	F1-07	Integral value during accel/decel enable/disable	0/1	0	x	0 : Disabled 1 : Enabled	x	○	x	x
	PG Overspd Level	F1-08	PG overspeed detection level	0 to 120%	115%	x		x	○	x	○
	PG Overspd Time	F1-09	PG overspeed detection delay time	0 to 2.0s	0.0s*1	x		x	○	x	○
	PG Deviate Level	F1-10	Excessive speed deviation detection level	0 to 50%	10%	x		x	○	x	○
ASR Tuning*5	PG Deviate Time	F1-11	Excessive speed deviation detection delay time	0 to 2.0s	0.5s	x		x	○	x	○
	PG # Gear Teeth 1	F1-12	Number of PG gear teeth 1	0 to 1000	0	x		x	○	x	x
	PG # Gear Teeth 2	F1-13	Number of PG gear teeth 2	0 to 1000	0	x		x	○	x	x
	PGO Detect time*4	F1-14	PG open circuit detection delay time	0.0 to 10.0	2.0s	x		x	○	x	○
	ASR P Gain 1	C5-01	ASR proportional gain 1	0 to 300.00	20.00*1 (0.00)*2	○		x	○	x	○
	ASR I Time 1	C5-02	ASR integral time 1	0 to 10.000s	0.500s*1 (1.000s)*2	○		x	○	x	○
	ASR P Gain 2	C5-03	ASR proportional gain 2	0 to 300.00	20.00*1 (0.20)*2	○		x	○	x	○
ASR I Time 2	C5-04	ASR integral time 2	0 to 10.000s	0.500s*1 (1.000s)*2	○		x	○	x	○	
ASR Limit	C5-05	ASR limit	0.0 to 20.0%	5.0%*2	x		x	○	x	x	
ASR Delay Time	C5-06	ASR primary delay time	0.000 to 0.500s	0.004s*1	x		x	x	x	x	○
ASR Gain SW Freq	C5-07	ASR switching frequency	0.0 to 400.0Hz	0.0Hz	x			x	x	x	○

*1 Flux vector control

*2 V/f with PG feedback control

*3 Value when o2-09=1 or 2

*4 Setting and reference are enabled for the software No. (U1-14) of 0130 or after.

*5 ASR = Automatic Speed Regulation