

Cat No. V029-E1-2

NT11S

Programmable Terminal

OPERATION MANUAL



OMRON

**OMRON Corporation
PT Business Promotion Department
FA Division H.Q.**

Yokohama Business Park
134. Godo-cho, Hodogaya-ku, Yokohama-shi
Kanagawa 240 Japan
Tel: (81) 45-336-6209/Fax: (81) 45-336-6239

Regional Headquarters

OMRON EUROPE B.V.

Wegalaan 69. NL-2132 JD Hoofddorp
The Netherlands
Tel: (31) 2503-81-300/Fax: (31) 2503-81-388

OMRON ELECTRONICS, INC.

1 East Commerce Drive, Schaumburg. IL 60173
U.S.A.
Tel: (1) 708-843-7900/Fax: (1) 708-843-8568

OMRON MANAGEMENT CENTRE OF ASIAPACIFIC PTE LTD.

510 Thomson Road #13-03
SLF Bldg.
1129 Singapore
Tel: (65) 353-2611/Fax: (65) 353-5391

NT-series Programmable Terminal Operation Manual

Produced June 1997

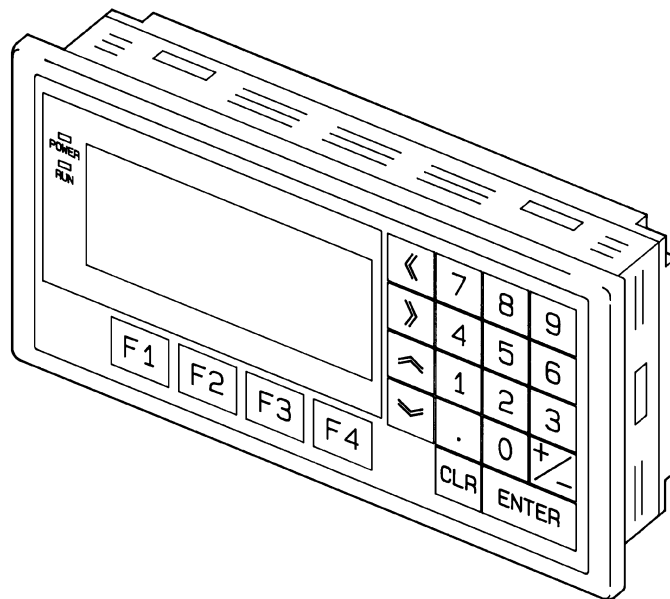

OMRON Product References

All OMRON products are capitalized in this manual. The word "Unit" is also capitalized when it refers to an OMRON product, regardless of whether or not it appears in the proper name of the product.

The abbreviation "Ch," which appears in some displays and on some OMRON products, often means "word" and is abbreviated "Wd" in documentation in this sense.

The abbreviation "PC" means Programmable Controller and is not used as an abbreviation for anything else.

The abbreviation "Host" means PC that controls NT11S.

Visual Aids

The following headings appear in the left column of the manual to help you locate different types of information.

Note Indicates information of particular interest for efficient and convenient operation of the product.

1, 2, 3... 1. Indicates lists of one sort or another, such as procedures, checklists, etc.

□ OMRON, 1997

All rights reserved. No part of this publication may be reproduced, stored in a retrieval system, or transmitted, in any form, or by any means, mechanical, electronic, photocopying, recording, or otherwise, without the prior written permission of OMRON.

No patent liability is assumed with respect to the use of the information contained herein. Moreover, because OMRON is constantly striving to improve its high-quality products, the information contained in this manual is subject to change without notice. Every precaution has been taken in the preparation of this manual. Nevertheless, OMRON assumes no responsibility for errors or omissions. Neither is any liability assumed for damages resulting from the use of the information contained in this publication.

TABLE OF CONTENTS

PRECAUTIONS	xi
1 Intended Audience	xii
2 General Precautions	xii
3 Safety Precautions	xii
SECTION 1	
Functions of the NT11S	1
1-1 Getting Starting	2
1-2 Role and Operation of NT11S	3
1-3 Functions of NT11S	5
1-4 System Configuration	9
1-5 Direct Connection Function	10
1-6 Before Operating	15
SECTION 2	
Hardware Settings and Connections	17
2-1 Description of Parts and Settings	18
2-2 Installation	22
2-3 Connecting to the Support Tool	25
2-4 Connection to a PC by the Host Link (RS-232C Type)	26
2-5 Connection to a PC by the Host Link (RS-422A Type)	31
2-6 Connection to a PC by the NT Link	37
2-7 Connecting a Printer	39
SECTION 3	
System Menu Operation	41
3-1 Operation Flow by the System Menu	42
3-2 Starting the NT11S	43
3-3 Operation Modes and the System Menu	44
3-4 Initializing Memory	48
3-5 Transferring the System Program	51
3-6 Registering the Screen Data	54
3-7 Setting the Conditions of Communications with the PC by Using the Memory Switches	57
3-8 Starting the Operation	62
3-9 Backlight OFF	63
3-10 System Maintenance	65
SECTION 4	
NT11S Functions	71
4-1 Creating and Transmitting Screen Data	72
4-2 Outline of Functions	77
4-3 Screen Display	80
4-4 Memory Tables	81
4-5 Bar Graphs	83
4-6 Numeral Setting	85
4-7 Menu Screen Function	87
4-8 Password Screen Display Function	88
4-9 Display History Screen Function	90

4-10	Daily Report/Display History Printing Function	91
SECTION 5		
Using Host Link/NT Link		95
5-1	Outline of Host Link / NT Link Operation	96
5-2	Memory Tables and Bar Graph	106
5-3	Numeral Setting	119
5-4	NT11S Status Control	122
5-5	Notification of the Operating Status to the PC (Determining the NT11S Operating Status)	126
SECTION 6		
Troubleshooting and Maintenance		131
6-1	Hardware Faults	132
6-2	Responding to Displayed Error Messages	133
6-3	Inspection and Cleaning	137
APPENDICES		139
A.	Specifications	139
B.	Dimensions	144
C.	NT11S Installation Environment	145
D.	Method for Making the Cable for Connection to the PC	146
E.	Making the Cable for Connection to the Support Tool	155
F.	NT11S Internal Processing	156
G.	Model List	158
H.	PC Memory Map	160
I.	Special Characters	161
INDEX		163

About this Manual:

This manual describes the basic functions and operation procedures of the NT-series programmable terminal NT11S, its operations when connected to a PC, and includes the sections described below.

Please read this manual carefully and be sure you understand the information provided before attempting to install and operate the NT-series programmable terminal NT11S.

Section 1 describes the operation functions, system configuration, and the direct connection function of the NT11S.

Section 2 describes the hardware settings, installation to an operation panel, connection to optional devices and PC.

Section 3 describes the operation of the System Menu and the maintenance of the NT11S.

Section 4 describes the functions of the NT11S when it is connected to a PC.

Section 5 describes how to use the NT11S when it is connected to the PC using the host link or NT link.

Section 6 describes the procedures to follow when the NT11S does not operate correctly.

APPENDIX describes the specifications and the method for making connecting cables, and includes an area list for the PC.

Related Manuals and Their Contents:

The related manuals are listed below.

The □ symbol at the end of the manual number is the revision history symbol.

[Operating the programmable terminal and communicating with the host]

- NT11S Programmable Terminal Operation Manual (V029-E1-□)
..... This manual

This operation manual is the manual for the NT11S itself.

The NT11S is a unit which integrates a programmable terminal body. This operation manual describes the functions and handling of the programmable terminal body.

[Creating and transferring screen data]

- NT-series NT11S Support Tool Operation Manual (V030-E1-□)

The screens displayed on the NT11S are created with the support tool and transferred to the NT11S. This manual describes how to create and transfer screen data.

PRECAUTIONS

This section provides general precautions for using the Programmable Terminal.

The information contained in this section is important for the safe and reliable application of the Programmable Terminal. You must read this section and understand the information contained before attempting to set up or operate a Programmable Terminal.

1	Intended Audience	xii
2	General Precautions	xii
3	Safety Precautions	xii

1 Intended Audience

This manual is intended for the following personnel, who must also have knowledge of electrical systems (an electrical engineer or the equivalent).

- Personnel in charge of installing FA systems.
- Personnel in charge of designing FA systems.
- Personnel in charge of managing FA systems and facilities.

2 General Precautions

The user must operate the product according to the performance specifications described in the operation manuals.

Before using the product under conditions which are not described in the manual or applying the product to nuclear control systems, railroad systems, aviation systems, vehicles, combustion systems, medical equipment, amusement machines, safety equipment, and other systems, machines, and equipment that may have a serious influence on lives and property if used improperly, consult your OMRON representative.

Make sure that the ratings and performance characteristics of the product are sufficient for the systems, machines, and equipment, and be sure to provide the systems, machines, and equipment with double safety mechanisms.

This manual provides information for using the Programmable Terminal. Be sure to read this manual before attempting to use the software and keep this manual close at hand for reference during operation.

 **WARNING** It is extremely important that Programmable Terminals and related devices be used for the specified purpose and under the specified conditions, especially in applications that can directly or indirectly affect human life. You must consult with your OMRON representative before applying Programmable Terminals to the abovementioned applications.

 **WARNING** Do not use input functions such as PT touch switches for applications where danger to human life or serious damage is possible, or for emergency switch applications.

3 Safety Precautions

Read these safety precautions carefully and make sure you understand them before using the Programmable Terminal so that you can use it safely and correctly.

Safety Conventions and their Meanings

This operation manual uses the following conventions and symbols to indicate cautions, warnings, and dangers in order to ensure safe use of the PT. The cautions, warnings, and dangers shown here contain important information related to safety. The instructions in these cautions, warnings, and dangers must be observed.

The conventions used and their meanings are presented below.

 **DANGER!** Indicates information that, if not heeded, is likely to result in loss of life or serious injury.

 **WARNING** Indicates information that, if not heeded, could possibly result in loss of life or serious injury.

 **CAUTION** Indicates information that, if not heeded, could result in relatively serious or minor injury, damage to the product, or faulty operation.

 **CAUTION**

- Do not use input functions such as PT function keys for applications where danger to human life or serious property damage is possible, or as the emergency stop switch.
- On unpacking the unit, check its external appearance and confirm that there is no damage. Also confirm that there is no abnormal noise on shaking the unit lightly. The product may malfunction if it is damaged.
- The thickness of applicable operation panel is 1.6 mm to 4.8 mm. All fittings must be tightened uniformly to a torque of 0.5 to 0.6 N·m in order to ensure water- and dust- resistance. The panel must not be soiled or warped, and must be able to support an installation that will remain secure and strong.
- During work at the panel, take care to ensure that no metal scraps enter the unit. Otherwise, the product may malfunction.
- Carefully check the wiring before switching ON the power.
- Do not connect AC power to the DC terminals.
- Use DC power supplies with low voltage and frequency fluctuations.
- For the connection to the power supply terminal block, twisted wires of 2 mm² or greater cross sectional area and M 3.5 size crimp terminals must be used. Tighten the screws on the terminal block to a torque of 0.5 N·m. Otherwise fire may occur.
- After connecting a communication cable, always secure it with the screws. Otherwise the cable may disconnect, causing operation to fail.
- The cable's tensile load is 30 N. Do not subject it to loads greater than this. Otherwise a discontinuity may occur, causing operation to fail.
- Switch off the NT11S power supply before connecting or disconnecting a connector.
- If the connection cable is connected or disconnected while the power of the printer is on, the NT11S may malfunction. Make sure to turn off the power of the printer before connecting or disconnecting the connection cable.
- In addition to the DIP switches, set also the "Comm. Method", "Host Link Speed", "Auto-restart", etc. at the memory switches. For these settings, refer to Section 3-7 "Setting the Conditions of Communications with the PC by Using the Memory Switches" (page 57)
- After changing the switch settings, always press the reset switch or turn the power off and back on. Otherwise the system will not operate as expected.
- Confirm system safety before turning the power ON/OFF or resetting. Otherwise the system may operate unpredictably.
- Carefully check the operation of all screen data and host programs before using them. If incorrect, the system may operate unpredictably. Otherwise the system may operate unpredictably.
- After images may remain if the same pattern is displayed for a long period. To prevent the formation of an afterimage, either use the screen saver function or periodically switch screens.

- Do not disassemble for repairs or modification. Otherwise, the product may malfunction.
- The disposal of the unit may be regulated by national or local authorities. Dispose of them in accordance with the laws and regulations of the relevant country and local authority.
- Set so that there is no overlap between the PT status control area and PT status notify area. Otherwise the system may operate unpredictably.

SECTION 1

Functions of the NT11S

NT11S is a new programmable terminal (PT) which incorporates a host interface unit in a programmable terminal body. It can be easily installed and used.

This section gives the operation examples and characteristics of the NT11S so that you will understand the applications of the NT11S.

1-1	Getting Starting	2
1-2	Role and Operation of NT11S	3
1-2-1	Operations of NT11S	4
1-3	Functions of NT11S	5
1-3-1	Features	5
1-3-2	Principal Functions of NT11S	6
1-3-3	Displays	7
1-3-4	System Keys	8
1-4	System Configuration	9
1-5	Direct Connection Function	10
1-5-1	NT Link	11
1-5-2	Functions of the Allocated Bits and Words	12
1-6	Before Operating	15

1-1 Getting Starting

To ensure that the NT11S works correctly, carefully observe the following when installing and handling it.

Location

Do not install the NT11S in a location subject to the following conditions;

- Near a computer, radio transmitter or receiver, etc.
- Dust, chemicals, or steam
- Severe temperature fluctuations
- High humidity and condensation
- Strong electrical or magnetic fields
- Poor ventilation
- Severe vibration

Handling

Do not;

- Subject the NT11S to strong shocks or vibrations
- Put heavy objects on the NT11S
- Supply a voltage different from the specified voltage
- Disassemble or modify the NT11S

Cautions on Cleaning

To clean the front panel, use a soft, dry cloth. If it is very dirty, use diluted (2%) neutral detergent.

Do not use volatile solvents such as benzene, thinner, or a chemically treated cloth. Their use will cause deformation or discoloration.

Cautions on Afterimage

If the same screen contents are kept displayed for a long time, an afterimage may occur. To prevent this problem, either set the afterimage prevention function or make a program which periodically changes the displayed screen.

Cautions on Operating the System Keys

Do not operate the system keys with sharply pointed objects, such as your fingernails or a screwdriver.

This could break the film.

1-2 Role and Operation of NT11S

NT11S is a programmable terminal used to display and transmit the information in an FA site. The following gives a general description of the role and operation of the NT11S for those who use a programmable terminal (PT) for the first time.

Production Line Status Monitoring

The NT11S displays real-time information about the system and equipment operating status, etc.

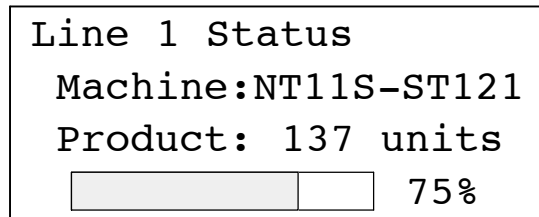

Messages

The NT11S warns of system or equipment failures and prompts the appropriate remedial action.

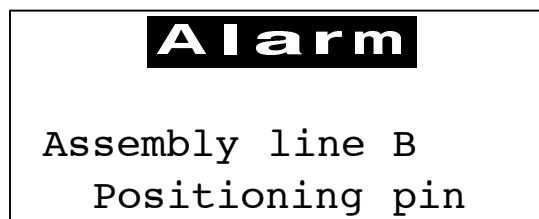

Panel Switch Functions

The NT11S can be used in place of external data input equipment such as an operation panel, to transmit data to a PC.

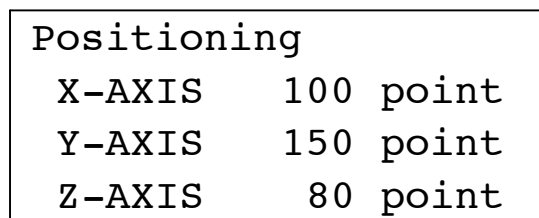

1-2-1 Operations of NT11S

Displays Screens

The information to be displayed (screen data) can be created on a computer by using support tools and stored in the NT11S. The screen data can be displayed on the NT11S in response to the instructions from a PC or system keys operation.

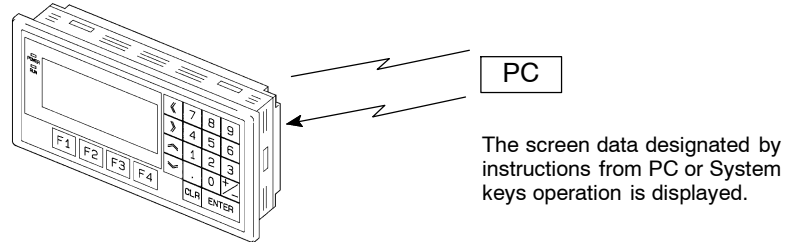

Receives Data from a PC

NT11S can be connected to a PC by a host link or NT link and receive necessary data from the PC.

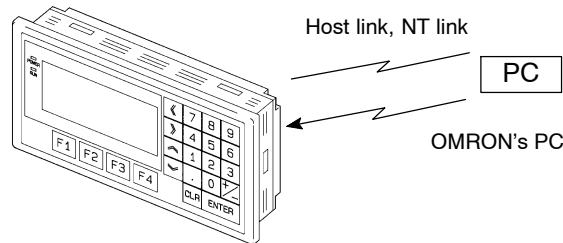

Sends Data to a PC

Data input through a numeric key can be sent to a PC.

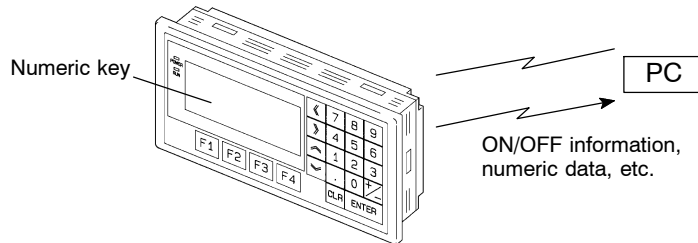

Screen Data

The screen data to be displayed on the NT11S can be created by a computer by using support tools. Connect the NT11S to a PC/AT with an RS-232C cable so that the screen data are transferred to the NT11S.

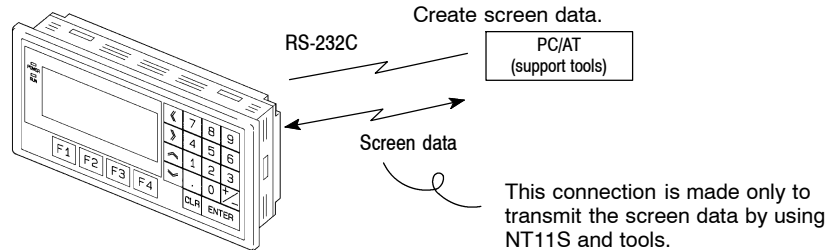

1-3 Functions of NT11S

The NT11S has the following features and functions;

1-3-1 Features

Downsized Body

- The NT11S has the thinnest depth (31 mm or less in the panel) in the NT series.
- It is very compact, with a width of 218 mm and a height of 113 mm.
- Features three ports: for RS-232C, RS-422A, and printer output.
- The tool connectors and the PC communication connectors are used in common.

Construction Best Suited to the FA Environment

- Easy-to-read screen even in direct sunlight.
- Waterproofed to a standard equivalent to IP65 and NEMA4.

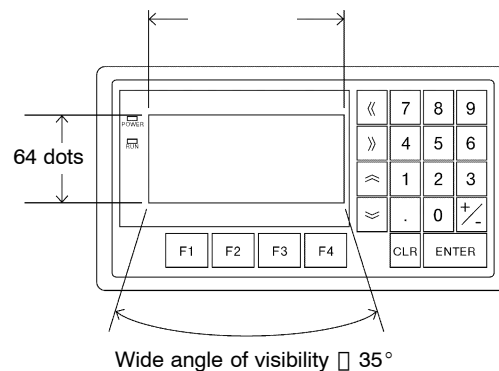

A Host I/F Unit, Screen Data Memory, and a system program transfer ROM are All Incorporated

- There is no complicated installation work except a simple connection to a PC.
- A flash memory is used for the screen data memory. There is no need of backup battery.
- A host link (direct), and an NT link are standard equipment.

1-3-2 Principal Functions of NT11S

Functions Related to the Data Display

- Character display
Characters of standard and double-width can be displayed. Characters can flash or be highlighted.
- Memory data display
Contents of the character-string memory table and the numeral memory table can be displayed. The memory table contents can be changed from the PC.
- Bar graph display
Bar graphs corresponding to the contents of the numeral table can be displayed.

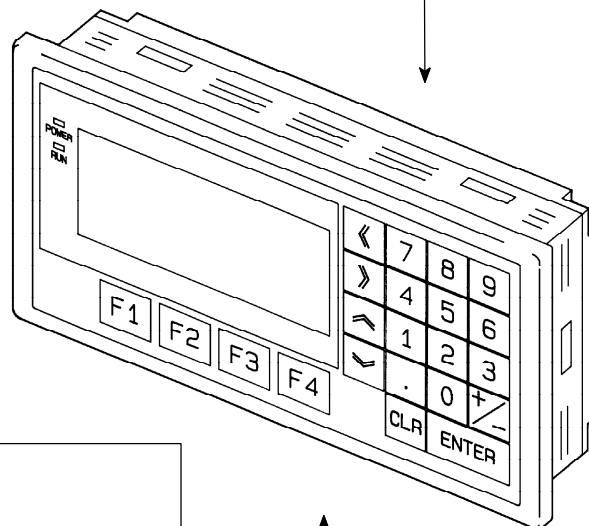

Functions Related to the Data Input

- Input by the system key
Data can be input, and the displayed screen changed, by using the numeric keys, function keys, and arrow keys on the panel of the NT11S.
- Numeric setting function
The numeric values can be input at the operation site by the system key and sent to the PC.

Other Functions

- Communications with a PC
The host link, NT link is used to connect to a PC for data communication.
- System function
The system setting and maintenance can be executed by using the System Menu on the screen.
- Screen data creation
The screen data can be created by using support tools on the computer and stored in the unit.

1-3-3 Displays

The NT11S can display elements such as characters, numeric value, and bar graphs on a screen. The screen data displayed on the NT11S are created by using support tools on a computer.

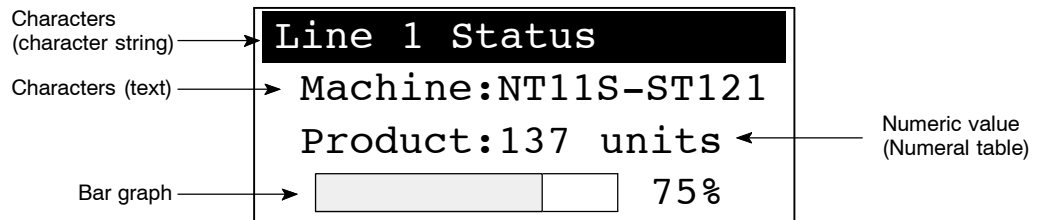

Characters (text) Characters and marks which do not need to be changed can be written directly to the screen.

Characters (character-string memory table)

Character-strings stored in the character-string memory table are displayed. The display characters can be changed by changing the data stored in the character-string memory table.

Numeric Values (numeral memory tables)

Numbers stored in the numeral memory table are displayed. The display numbers can be changed by changing the data stored in the numeral table. Hexadecimal values can also be displayed.

Bar Graphs

The bar graph extends and contracts in proportion to the data stored in the numeral memory table. A percentage value can also be displayed simultaneously.

Marks

Marks can be designed, created, and handled like characters by the user.

1-3-4 System Keys

The NT11S has system keys on its panel for input functions.

The system keys are used for inputting numerical values and for notifications to the PC.

The system keys can be classified into the three types shown below.

- Numeric keys
- Arrow keys
- Function keys

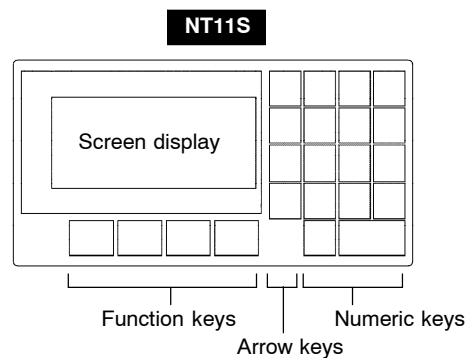

- Numeric keys

These are the numeral keys from [0] to [9], the decimal point key [.] , the sign key [+/-], the [CLR] key and the [ENTER] key. These keys are used for inputting numerical values.

- Arrow keys

Used to select the required numerical value input field when there is more than one on the screen.

- Function keys

Used for notifications from the NT11S to the PC.

Also used to switch between the RUN mode and the system menu when the power is switched on.

⚠ Caution Do not use input functions such as PT function keys for applications where danger to human life or serious property damage is possible, or as the emergency stop switch.

1-4 System Configuration

This section gives the basic configuration of a system which uses an NT11S. Use an RS-232C cable to connect to a PC. Refer to the manual for individual device for information on the equipment other than the NT11S in the system.

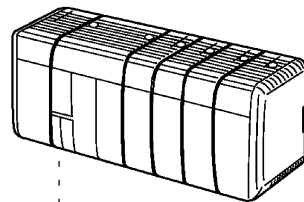

OMRON's PC

Controls NT11S as required while controlling machines and monitoring the production line.

Host link: CQM1, C200H(S) series PC
 CQM1, C200HS series: NT11S can be connected directly to the CPU unit.
 Note that C200H requires a host link unit.

NT link: CQM1, C200H(S) series PC
 CQM1 can be used with CPU41/42/43/44-E.
 C200HS can be used with CPU21/23/31/33-E.

RS-232C cable
 (for host link)
 (Max. 15 m)
 or RS-422A cable
 (for host link)
 (Max. 500 m)

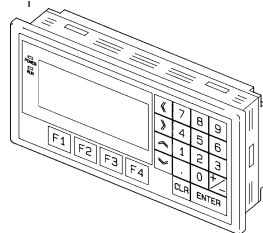

NT11S

Gives displays of production line monitoring and instructions to the operation site and notifies the switch ON/OFF status and numeric value inputs to the PC.

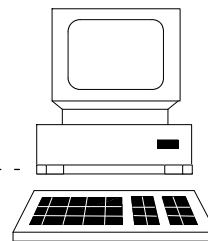

Support tool



Computer (support tool)

Connected to NT11S as required and used to transfer the NT11S screens and make settings for the NT11S.

Computer: IBM PC/AT or compatible (IBM PC DOS Ver.5 or later)

Support tool: NT11S support tool type NT11S-ZA3AT-EV1

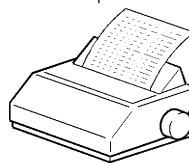

Printer

Prints daily reports and display histories.
 Printer: ESC/P compatible

Reference The following two communication methods are supported for communications between the NT11S and PC: host link, and NT link. For the setting procedure, refer to Section 3-7 Setting the Conditions of Communications with the PC by Using the Memory Switches (page 57). It is impossible to connect a personal computer used to drive the support tool and a PC at the same time.

1-5 Direct Connection Function

The communication method applied between the NT11S and the PC is either a host link or NT link.

The NT11S can be used to refer to the contents necessary for the display information or to allocate the bits and words used for storing the input data to any area in the PC. The NT11S can directly write and read such allocated bits and words so as to change the display elements, control the operating status, and notify the status.

This function is called the “direct connection function”. The NT11S is designed exclusively for use with the direct connection.

The bits and words allocated by the direct connection function are called “allocated bit” and “allocated word” respectively.

This function allows to read the information to be displayed on the NT11S from the memory area in the PC and to write it to the memory table in the NT11S. Also, the data input on the NT11S can be written to the PC’s memory area. The NT11S screen status can be switched according to the PC’s memory area, and the NT11S’s status data can be written to the PC’s memory area.

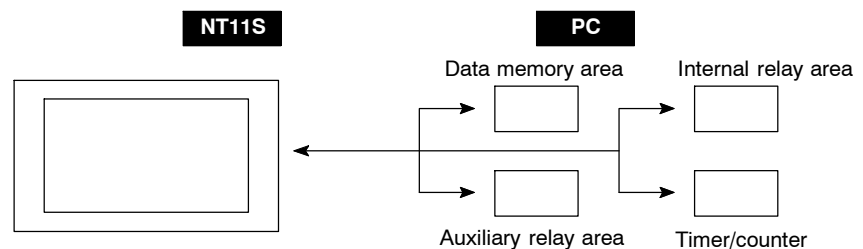

Features of the Direct Connection Function

- The bits and words referring to operating status and work instruction information and those for storing input data can be freely allocated to almost any part of the PC memory. Bits and words in the PC can be referenced from any memory table.
- The NT11S can directly refer to PC bit and word data so that it can be connected to a PC without changing the PC program which controls currently running production line.
- The area to control and notify the NT11S status, including display screens, ON/OFF of the backlight, and printing of daily reports and display histories, can be freely allocated to any part of the PC memory.

The direct connection function allows the NT11S to directly read and write almost all bits and words in the PC and to automatically change the NT11S screen display. This function can reduce the load on the PC so that the program development efficiency of the PC improves.

1-5-1 NT Link

The NT link is a new communication method applied between the NT11S and a PC.

The NT link uses the direct connection function and can execute high speed communications with a CPU (built-in NT link) of the CQM1, and C200HS.

Features of the NT Link

- High speed communications with specific types of PCs can be executed.
- Writing in units of bits to the PC memory area is possible. (*)
- This can be used even when the PC is in the RUN mode.

(*) Except a DM area.

The NT link is compatible with the host link. The NT11S screen data and the PC programs handled by the host link direct connection can be used with for the NT link as they are.

1-5-2 Functions of the Allocated Bits and Words

Elements displayed on the NT11S and the NT11S status can be allocated to the bits and words of the PC. By changing the contents of the bits and words, the NT11S can be controlled by the PC. It is also possible to send data to the PC by pressing the function keys on the panel of the NT11S.

- Controlling the NT11S by a PC

The following NT11S functions can be controlled by a PC.

Screens : Display of designated screens, confirmation of screen numbers, etc.

Memory tables : Writing to a memory table, copying from a memory table to another memory table, etc.

System control : ON/OFF of backlight, control of output of daily reports and display histories at a printer.

- Notifying from the NT11S to a PC

Data in the NT11S is sent to a PC when a numeric key is pressed. The following types of data are sent to a PC.

- NT11S status
- Password input status
- Numeric values input by the numeral keys
- Function key input status

Functions of Display Elements

- Numeral memory table

Allocation destination: Word

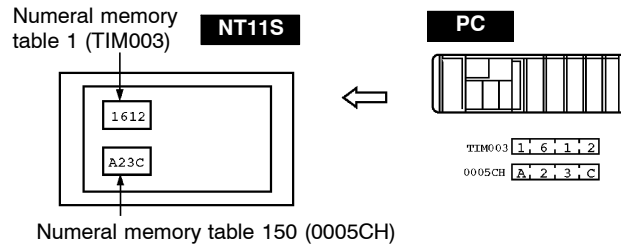

Allocate numeral memory tables to arbitrary words in the PC. If word contents change when corresponding numeral memory table is displayed on the screen, the value on the screen will also change. Monitoring of words can also be made easily.

Reading and writing are executed so that the contents of allocated words are always the same as those of the numeral memory tables.

- Character-string memory table

Allocation destination: Word

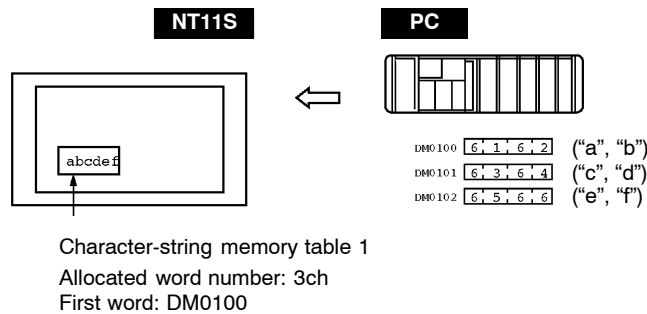

Allocate character-string memory tables to arbitrary words in the PC. If word contents change when corresponding character-string memory table is displayed on the screen, the value on the screen will also change. Messages can be displayed easily.

Reading and writing are executed so that the contents of allocated words are always the same as those of the character-string memory tables.

Functions of the PT Status Control Area (PC to NT11S)

The “PT status control area” is used to control the NT11S status. When data is written to this area in the PC, the NT11S reads the contents and operates according to the contents.

[Example of the PT status control area application]

When data is written to the PT status control area, the NT11S will operate as given below.

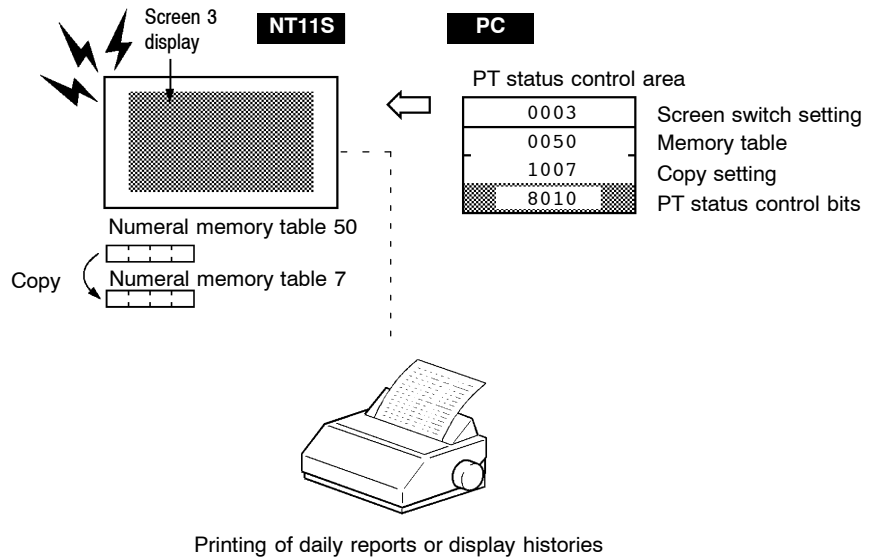

Functions of the PT Status Notify Area (NT11S to PC)

The “PT status notify area” is used to notify the changes of the NT11S status. When a change is made in the NT11S status, the change is written to this area in the PC. By reading the data from the area, the NT11S status can be checked.

[Example of the PT status notify area application]

When a change is made in the NT11S status, such change will be notified to the PT status notify area as mentioned below.

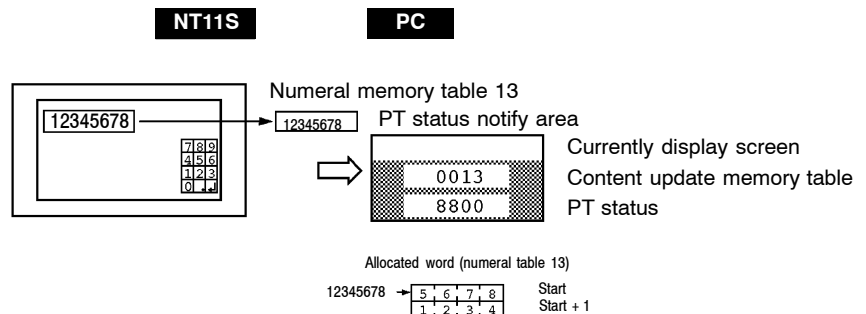

1-6 Before Operating

Follow the procedure given below to start the system of the NT11S.

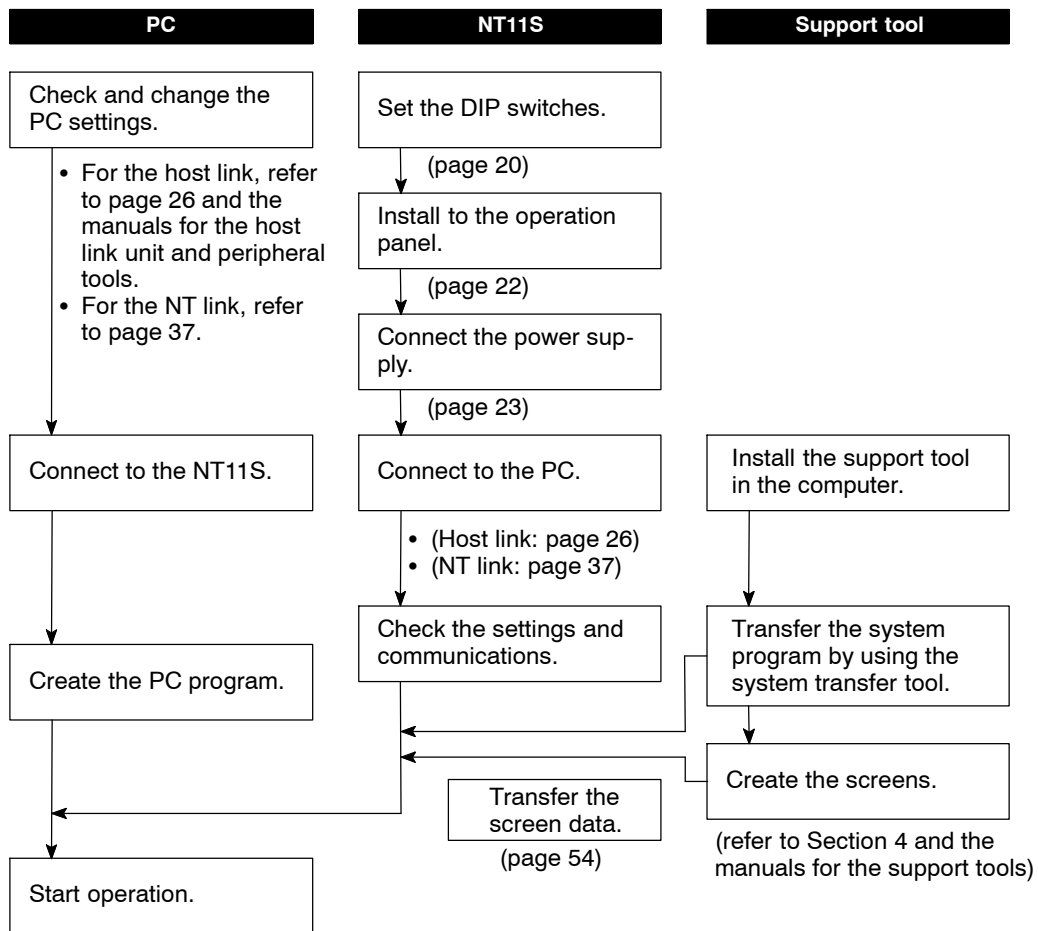

Reference Use support tool NT11S Support Tool (type NT11S-ZA3AT-EV1). Refer to the following manuals for the equipment and software.

Equipment or Software	Manual Title	Manual Number
Support tools	NT-series NT11S Support Tool Operation Manual	V030-E1-□
PCs	SYSMAC C200H Operation Manual	W130-E1-□
	SYSMAC C200HS Operation Manual	W235-E1-□
	SYSMAC CQM1-CPM1 Programming Manual	W228-E1-□
Host link Unit	SYSMAC C Series Host Link Unit User's Manual	W143-E1-□

SECTION 2

Hardware Settings and Connections

This section describes the settings of the NT11S, connections to a PC, and other hardware settings.

2-1	Description of Parts and Settings	18
2-1-1	Description of Parts	18
2-1-2	DIP Switch Settings	20
2-2	Installation	22
2-2-1	Installation to the Operation Panel	22
2-2-2	Power Supply Connection	23
2-2-3	Grounding	24
2-3	Connecting to the Support Tool	25
2-4	Connection to a PC by the Host Link (RS-232C Type)	26
2-4-1	Compatible PCs	26
2-4-2	Connecting the NT11S	27
2-4-3	PC Switch Settings	28
2-5	Connection to a PC by the Host Link (RS-422A Type)	31
2-5-1	Compatible PCs	31
2-5-2	Parts Required for Connection	32
2-5-3	Method for Connection	33
2-5-4	Connector Specifications and Wiring for Each Unit	34
2-5-5	PC Switch Settings	35
2-6	Connection to a PC by the NT Link	37
2-6-1	Compatible PCs	37
2-6-2	Connecting the NT11S	37
2-6-3	PC Switch Settings	38
2-7	Connecting a Printer	39
2-7-1	How to Connect	39

2-1 Description of Parts and Settings

Before getting to the operation, confirm the names and functions of parts. Also set the DIP switches on the NT11S.

2-1-1 Description of Parts

Front View

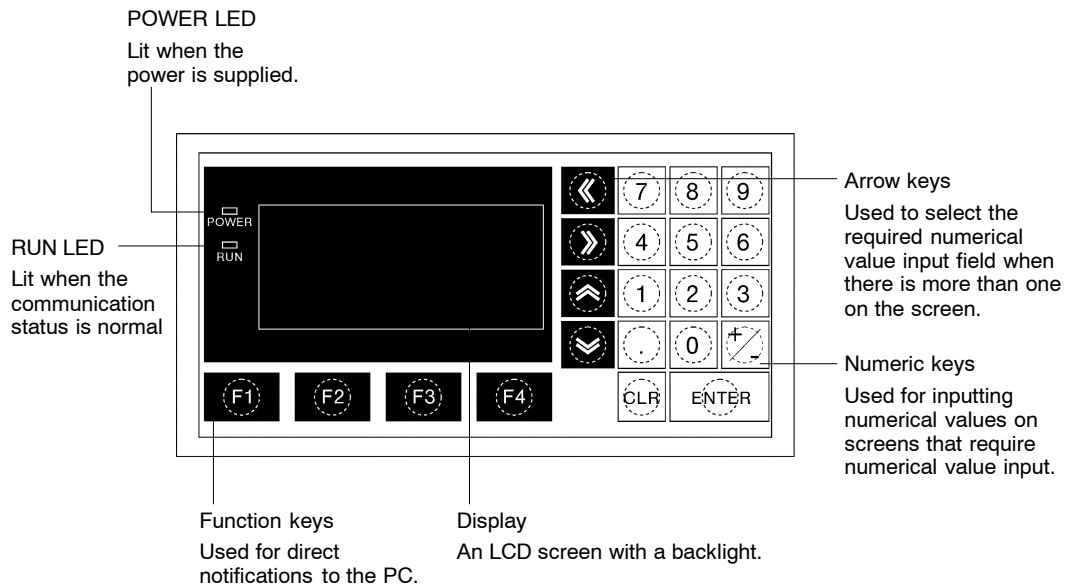

Reference The NT11S comes in two body colors.

- NT11S-ST121 : Beige
- NT11S-ST121B: Black

Rear View

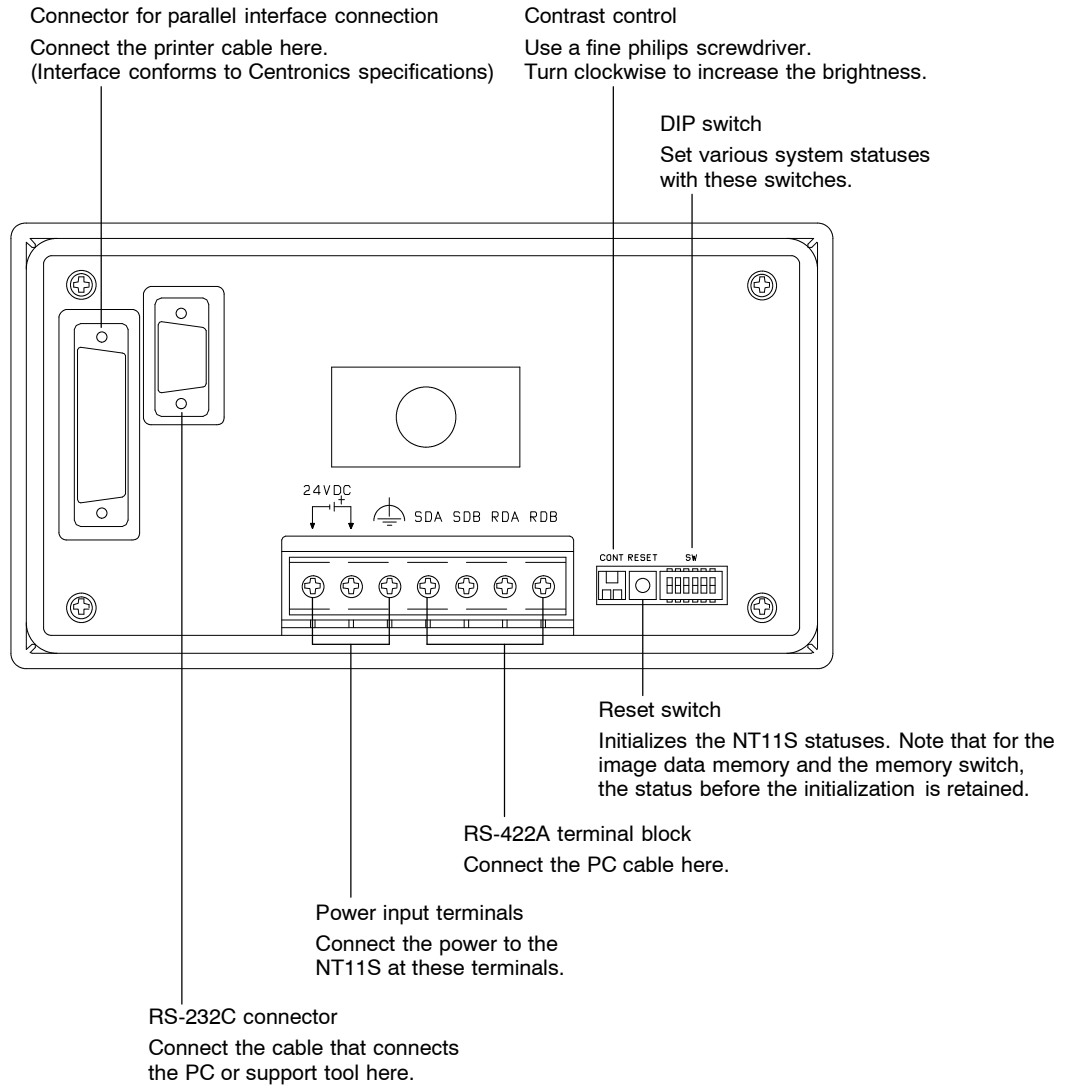

2-1-2 DIP Switch Settings

Set the NT11S operation status with the DIP switches located in the bottom right corner on the rear side of the body.

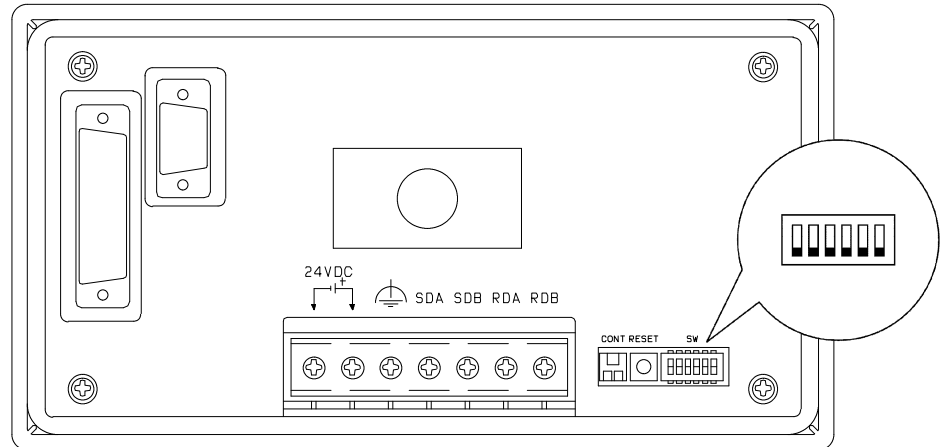

Switch #	Function	
SW2-1	RS-422A terminal resistor connection	
	ON	Terminal resistor used
	[OFF]	Terminal resistor not used
SW2-2	Screen data forced initialize effective/ineffective	
	ON	The NT11S will start in a special RUN mode in which the screen data memory is initialized. When it is started, the memory initialization menu will be displayed. For the initialization procedure, refer to Section 3-4 Initializing Memory (page 48).
	[OFF]	The NT11S will start in normal RUN mode.
SW2-3	Screen display language mode	
	ON	
	[OFF]	Messages are displayed in English.
SW2-4	Switching to the System Menu enabled/disabled	
	ON	The System Menu cannot be displayed. If an error occurs during a start-up, the System Menu will be automatically displayed. However, "RUN Mode" cannot be entered.
	[OFF]	The System Menu can be displayed.
SW2-5	Not used.	
SW2-6	System program erase	
	ON	The menu for deleting the system program is displayed on start-up.
	[OFF]	Start-up proceeds as normal.

[] indicates factory setting.

- ⚠ Caution**
- In addition to the DIP switches, set also the “Comm. Method”, “Host Link Speed”, “Automatic Reset”, etc. at the memory switches. For these settings, refer to Section 3-7 “Setting the Conditions of Communications with the PC by Using the Memory Switches” (page 57)
 - After changing the switch settings, always press the reset switch or turn the power off and back on. Otherwise the system will not operate as expected.
 - Confirm system safety before turning the power ON/OFF or resetting. Otherwise the system may operate unpredictably.

Correct Use Use the “System program erase” function only when changing the system program.
If the system program is erased, it will not be possible to use the functions of the NT11S unless another system program is transferred.
If the DIP switch settings have been changed when the NT11S is powered, reset the power to the NT11S. The changes with the DIP switches become effective only after the power supply is reset.

2-2 Installation

Install the NT11S to the operation panel and connect the power to the NT11S as described below.

Correct Use Do not install the unit at sites subject to the following conditions. Otherwise, the product may malfunction.

- Severe temperature variations
- Temperatures or humidities outside the ranges stated in the specifications
- High humidity, condensation
- Splashing chemical agents
- Severe oil splashing
- Corrosive or flammable gases
- Strong vibrations or shocks
- Direct exposure to wind and rain (outdoor sites)
- Strong ultra-violet irradiation

Take adequate measures to ensure shielding if the unit is used at a location subject to any of the following conditions. Otherwise, the product may malfunction.

- Static electricity, or noise from other equipment
- Strong electromagnetic fields
- Nearby power cables
- Potential exposure to radioactivity

2-2-1 Installation to the Operation Panel

The NT11S can be flush mounted to an operation panel.

Use the panel fittings and tools included in the product package and follow the procedure below.

- ⚠ Caution**
- On unpacking the unit, check its external appearance and confirm that there is no damage. Also confirm that there is no abnormal noise on shaking the unit lightly. The product may malfunction if it is damaged.
 - During work at the panel, take care to ensure that no metal scraps enter the unit. Otherwise, the product may malfunction.
 - The thickness of applicable operation panel is 1.6 mm to 4.8 mm. All fittings must be tightened uniformly to a torque of 0.5 to 0.6 N·m in order to ensure water- and dust- resistance. The panel must not be soiled or warped, and must be able to support an installation that will remain secure and strong.
- (1) Open a hole, shown below, in the panel and install the NT11S from the front side of the panel.

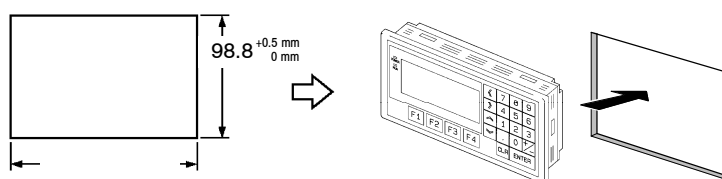

- (2) Attach the panel fittings at four positions for the upper/lower sides and at two positions for the right and left sides, shown below, on the rear side of the NT11S.

Fit the hook of the fitting in the square hole in the body and tighten the screw with a Phillips head screwdriver while lightly pulling the fitting.

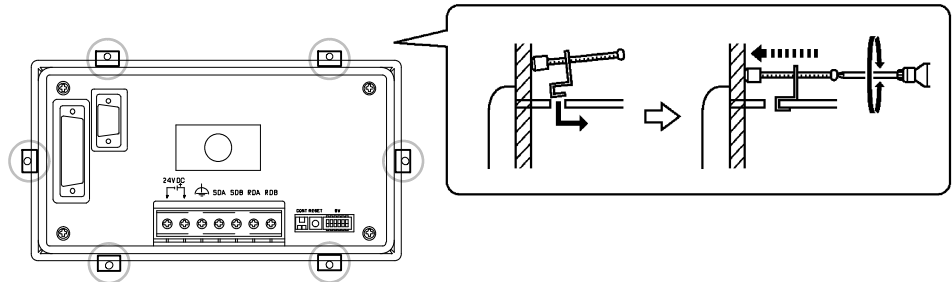

2-2-2 Power Supply Connection

Connect a 24 VDC power supply to the power input terminals.

- Caution** • Carefully check the wiring before switching ON the power.
- Do not connect AC power to the DC terminals.
- Use DC and AC power supplies with low voltage and frequency fluctuations.

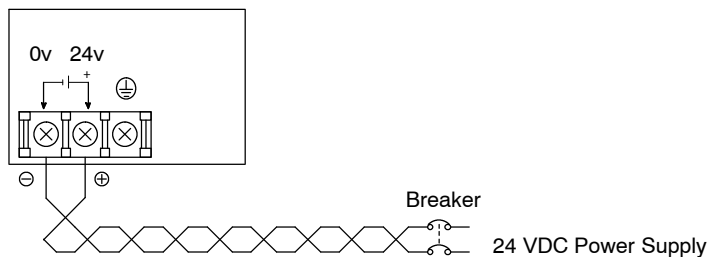

- Noise prevention

The NT11S has a noise preventive feature against the power supply line noise. To further reduce noise, connect a noise filter to the power line. This will drastically reduce the ground noise.

- Power supply

Applicable power supply specifications are as follows.

Item	Value
Power supply voltage	24 VDC
Allowable power supply voltage fluctuation range	20.4 VDC to 26.4 VDC (24 VDC - 15%, + 10%)
Power supply capacity	10 W or lower

- Parts used for connection

Use crimp terminals to connect the power supply to the power input terminals. Recommended crimp terminals for M3.5 are given below.

⚠ Caution For the connection to the power supply terminal block, twisted wires of 2 mm² or greater cross sectional area and M 3.5 size crimp terminals must be used. Tighten the screws on the terminal block to a torque of 0.5 N□m. Otherwise fire may occur.

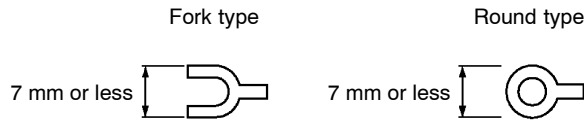

[Recommended terminals]

Maker	Type (fork type)	Type (round type)	Applicable Wire (stranded wire)
Japan Solderless Terminal MFG	2-YS3A	2-3.5	1.04 to 2.63 mm ²
Fuji Terminal	2-YAS3.5	V2-S3.5	
Nichifu Terminal	2Y-3.5	2-3.5	

2-2-3 Grounding

The NT11S has a Grounding terminal .

To prevent malfunctions due to excessive noise, and to prevent electric shock, carry out class 3 grounding (grounding resistance of 100 □ or less) using a special-purpose grounding cable (wire of at least 2 mm²).

Grounding wire length should be less than 20 m.

Note that if grounding wire is used in common with other equipment, or if it is connected to a beam of a building, for example, the NT11S might be adversely affected by this grounding.

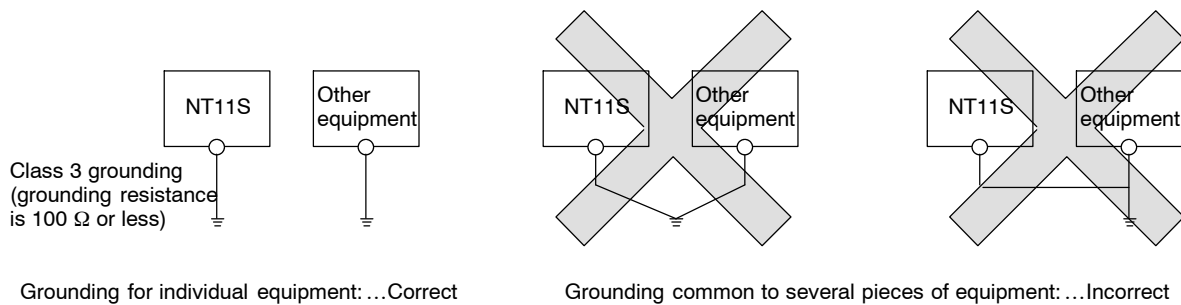

Correct Use (After noting grounding details in this text.)
Carry out grounding correctly in order to prevent misoperation due to noise.

2-3 Connecting to the Support Tool

Connect the NT11S to a computer with an RS-232C cable to transfer the screen data created by using a support tool and the NT11S system program to the NT11S.

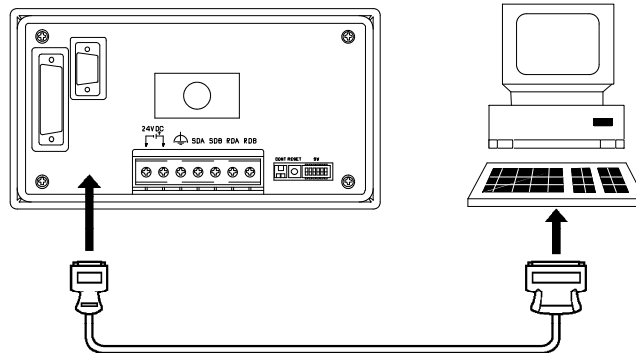

- Communication conditions

Communication conditions are set when a support tool or system transfer tool is started.

- Connecting cable

Make the cable for connecting the NT11S to the support tool or system transfer tool by referring to Appendix E "Making the Cable for Connection to the Support Tool".

Reference It is impossible to connect a computer and a PC at the same time to the NT11S. Connect a computer only to transfer the screen data.

2-4 Connection to a PC by the Host Link (RS-232C Type)

Connect the NT11S to an OMRON PC by using RS-232C type the host link method.

In order to make a connection to the PC using the host link method (RS-232C type), the “Comm. Type” memory switch of the NT11S must be set to “host link”, and the “Comm. Port” memory switch must be set to “RS-232C”. For details on memory switch settings, see “Selecting the Host Communication Method” (page 58)

2-4-1 Compatible PCs

Some models and series of OMRON PCs have the host link function built in. Check the model and series of the PC against the type of host link unit before making the connections.

The compatible PCs are listed in the table below.

PC Series	Units with Built-in Host Link Function		Connectable to
	Host Link Unit	CPU Unit	
C series	C200H-LK201		C200H
	C200H-LK201-V1	C200HS-CPU21-E C200HS-CPU23-E C200HS-CPU31-E C200HS-CPU33-E	C200HS
		CQM1-CPU21-E CQM1-CPU41-E CQM1-CPU42-E CQM1-CPU43-E CQM1-CPU44-E	CQM1

2-4-2 Connecting the NT11S

Refer to the illustrations below to select the appropriate cable for the unit connectors and connect the NT11S to the PC.

To make a connector cable, refer to Appendix D Method for Making the Cable for Connection to the PC (page 146).

- ⚠ Caution**
- Before inserting or removing the connectors, make sure that the NT11S and the PC are turned OFF.
 - After connecting a communication cable, always secure it with the screws. Otherwise the cable may disconnect, causing operation to fail.
 - The cable's tensile load is 30 N. Do not subject it to loads greater than this. Otherwise a discontinuity may occur, causing operation to fail.

Connecting to a PC with a 25-pin Connector

Use a connector cable with a 25-pin connector on one end and a 9-pin connector on the other end (NT11S side) to connect the NT11S to a PC with a 25-pin connector.

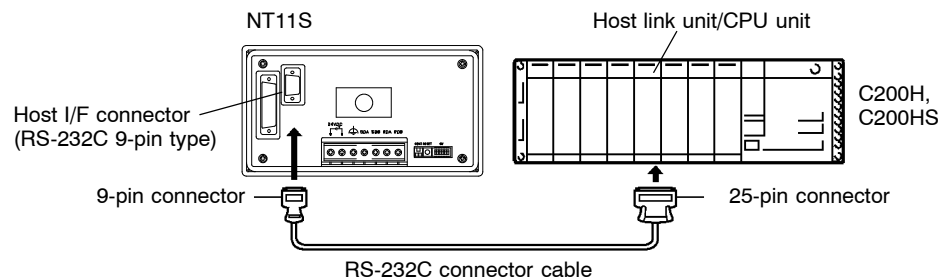

Connecting to a PC with a 9-pin Connector

Use a connector cable with a 9-pin connector on both ends to connect the NT11S to a PC with a 9-pin connector.

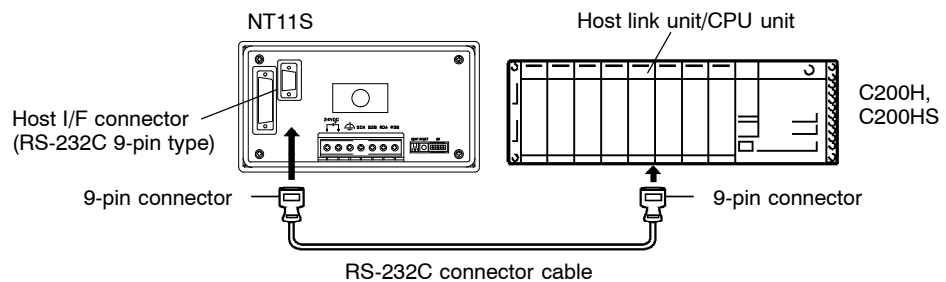

2-4-3 PC Switch Settings

When the NT11S and PC are connected to each other, set the conditions at the PC host link unit or the CPU as given in the table below.

The following is a general description of switch settings.

Refer to the manual for respective units for the details of the switch settings.

Item	Switch Setting
I/O port	RS-232C
Baud rate	Set the same baud rate as the NT11S. (*1)
Transfer code	ASCII 7 data bits, 2 stop bits
Parity	Even
1-to-1/1-to-N	1-to-N (*2)
Instruction level	Level 1, 2, 3
Unit No.	00

Note

- *1. Set the host link baud rate at 9600 bps or 19200 bps with the memory switch for "host link baud rate". For the details, refer to "Selecting the Host Link Communication Speed" (page 59).
- *2. The 1-to-N setting enables BCC (Block Check Character). The 1-to-1 connection cannot be used to connect the NT11S to a host link unit.

Connecting to a Host Link Unit

- C200H rack-mounting type: C200H-LK201(-V1)

[Setting the front switches]

Set each switch with a flat blade screwdriver so that the values or symbols in the setting value window agree with the following.

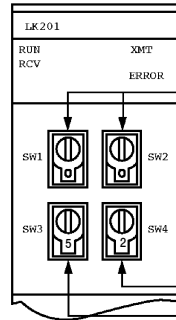

- Unit No. (SW1, SW2)
Set these switches to "0".
- Instruction level, parity, and transfer code (SW4)
Set this switch to "2".
- Baud rate (SW3)
Set this switch to "5" to select 9600 bps.
Set this switch to "6" to select 19200 bps.

[Setting the rear switches]

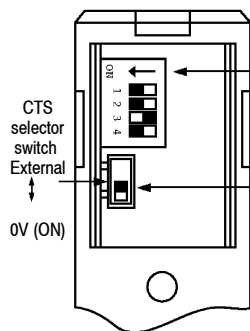

- 1-to-1/1-to-N selection (DIP switch)
Set No.3 to "ON".
- CTS selection (selector switch)
Set this always to "0V" (ON).

Connecting to a CPU

- C-series C200HS, CQM1

Set the operating conditions to the PC system setting area when a C200HS or CQM1 CPU is connected to the NT11S. The PC system setting area (data memory) can be directly accessed from the peripheral tool (LSS etc.).

The following describes the switch settings so as to enable the PC system settings. For the details of the operation with the PC system setting area, refer to the "SYSMAC CQM1-CPM1 Programming Manual" (W228-E1-□).

[Switch setting] (CQM1 only)

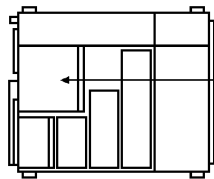

- RS-232C port communication conditions (DIP SW5)
Set SW5 to "ON" to effect the existing settings of the DIP switches.
Set SW5 to "OFF" to effect the existing settings of the PC system setting area.

[PC system setting area settings]

Write settings to the PC system setting area (data memory) according to the port used to connect to the NT11S.

Channel No.	Writing Value	Settings
DM6645	0001	Host link mode and conditions are set.
DM6646	0303	Data length: 7 bits, 2 stop bits, even parity, baud rate: 9600 bps
	0304	Data length: 7 bits, 2 stop bits, even parity, baud rate: 19200 bps
DM6648	0000	Unit No. 0

2-5 Connection to a PC by the Host Link (RS-422A Type)

Connect the NT11S to an OMRON PC by using the RS-422A type host link method.

If the distance between the NT11S and the PC is greater than 15 m, this method should be used. The maximum distance over which a connection can be made is 500 m.

when using the RS-422A method, the host computer and PC are usually connected in a 1 to N ratio (more than one PC), but in the special case of the connection between the NT11S and PC, the ratio is 1 to 1.

In order to make a connection to the PC using the host link method (RS-422A type), the “Comm. Type” memory switch of the NT11S must be set to the host link, and the “Comm. Port” memory switch must be set to RS-422A. For details on memory switch settings, see “Selecting the Host Communication Method” (page 58).

2-5-1 Compatible PCs

Some models and series of OMRON PCs have the host link function built in. Check the model and series of the PC against the type of host link unit before making the connections.

The compatible PCs are listed in the table below.

PC Series	Units with Built-in Host Link Function		Connectable to
	Host Link Unit	CPU Unit	
C series	C200H-LK201-V1 C200H-LK202-V1	C200HS-CPU21-E C200HS-CPU23-E C200HS-CPU31-E C200HS-CPU33-E	C200HS
		CQM1-CPU21-E CQM1-CPU41-E CQM1-CPU42-E CQM1-CPU43-E CQM1-CPU44-E	CQM1

2-5-2 Parts Required for Connection

The RS-422A cable used for RS-422A communications is not supplied by OMRON. Make this cable in accordance with the environment (PC used and transmission distance between the NT11S and PC).

One connector, one connector cover and one cable are required to make up a connecting cable. One connector and one connector cover is supplied with the PC. However, a cable of the type recommended by OMRON must be prepared.

For details on making the cable, refer to “Making the Cable for Connection to the PC (RS-422A Type)” in the appendix (page 150). The table below lists the components supplied with each unit and the recommended cables.

Name	Model	Remarks
Connector	XM2A-0901	9-pin, manufactured by OMRON - Delivered with C series CQM1 - Delivered with the following host link units: C200H-LK202 (-V1)
	DE-9P	9-pin, manufactured by JAE - Delivered with the following host link units: C200H-LK202 (-V1)
Connector cover	XM2S-0911	9-pin, manufactured by OMRON - Delivered with C series CQM1 - Delivered with the following host link units: C200H-LK202 (-V1)
	DE-CI-J6	9-pin, manufactured by JAE - Delivered with the following host link units: C200H-LK202 (-V1)
Cable	H-9293A (CO-HC-ESV-3P × 7/0.2)	For RS-422A, manufactured by Hiramawa Hewtech Corp.

2-5-3 Method for Connection

For RS-422A type communication, an RS-422A cable is used as the transmission channel connecting the NT11S and PC.

As shown in the figure below, the RS-422A cable is connected directly to the NT11S.

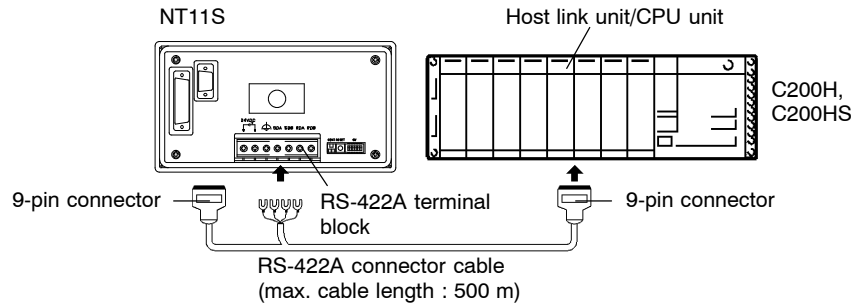

Reference Carry out class 3 grounding at the FG terminal of the PC. For details, refer to the manual for the PC.

Caution Switch off the NT11S power supply before connecting or disconnecting a connector.

2-5-4 Connector Specifications and Wiring for Each Unit

The combination of pin numbers to which the connecting wires are connected differs according to the connector specifications for each unit. Check the connector specifications of the unit to be connected and make the wiring connections by referring to the relevant connection combination among those indicated below.

For details on making the cable, see “Making the Cable for Connection to the PC (RS-422A Type)” (page 150)

[NT11S RS-422A terminal block specifications]

- Connected terminal block: RS-422A terminal block (M3.5 screws)
- Electrical characteristics: Conform to EIA RS-422A
- Signal direction: Signal input and output is relative to the NT11S

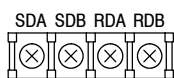

Signal Name	Abbreviation	Signal Direction	
		Input	Output
Send data A	SDA (SD-)		○
Send data B	SDB (SD+)		○
Recive data A	RDA (RD-)	○	
Recive data B	RDB (RD+)	○	

- Connecting an NT11S to a C-series host link unit

[C-series host link connector specifications]

- Applicable host link units: C200H-LK202 (-V1)
- Electrical characteristics: Conform to EIA RS-422A
- Signal direction: Signal input and output is relative to the host link unit.

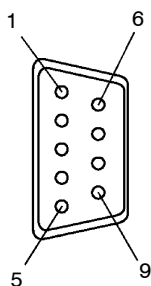

Connector Pin No.	Signal Name	Abbreviation	Signal Direction	
			Input	Output
1	Receive data B	RDB	○	
3	Signal ground	SG	-	-
5	Send data B	SDB		○
6	Receive data A	RDA	○	
7	Frame ground	FG	-	-
9	Send data A	SDA		○

[Wiring connections]

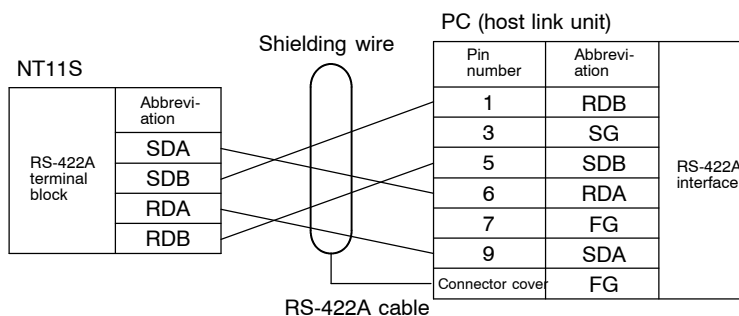

2-5-5 PC Switch Settings

When the NT11S and PC are connected to each other, set the conditions at the PC host link unit or the CPU as given in the table below.

The following is a general description of switch settings.

Refer to the manual for respective units for the details of the switch settings.

Item	Switch Setting
I/O port	RS-422A
Baud rate	Set the same baud rate as the NT11S
Transfer code	ASCII 7 data bits, 2 stop bits
Parity	Even
1-to-1/1-to-N	1-to-N (*1)
Instruction level	Level 1, 2, 3
Unit No.	00

*1. The 1-to-N setting enables BCC (Block Check Character). It is not possible to connect more than one NT11S in a single host link.

Connecting to a Host Link Unit

- C200H rack-mounting type: C200H-LK201 (-V1)
C200H-LK202 (-V1)

[Setting the front switches]

Set each switch with a flat blade screwdriver so that the values or symbols in the setting value window agree with the switch settings indicated in the table above.

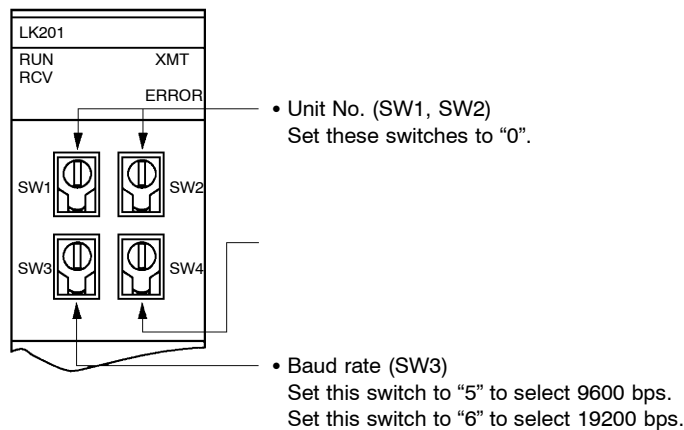

[Setting the rear switches]

C200H-LK201(-V1)

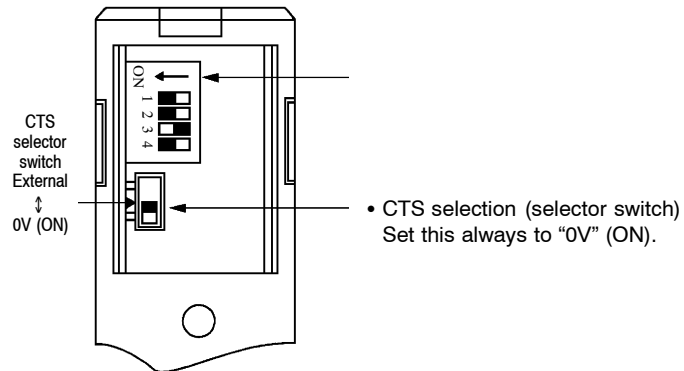

C200H-LK202(-V1)

This type has an RS-422A connector.

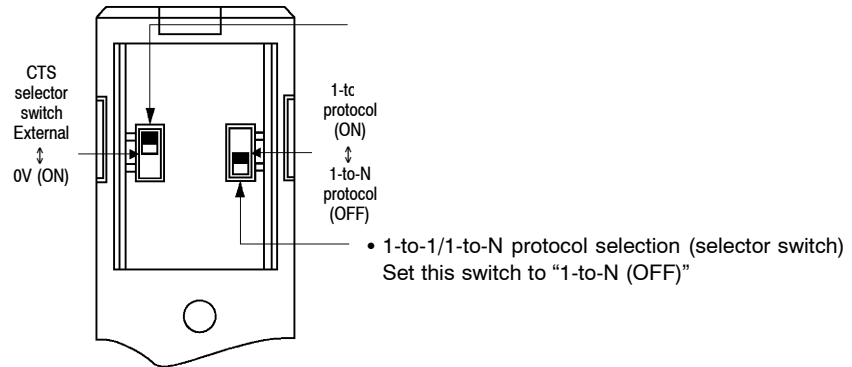

2-6 Connection to a PC by the NT Link

Connect the NT 11S to an OMRON PC by the NT link method.

To connect the NT11S to a PC by the NT link method, the NT11S memory switch for “host communication” must be set for the NT link. For the “host communication” setting, refer to “Selecting the Host Communication Method” (page 58)

2-6-1 Compatible PCs

Some models and series of OMRON PCs have the host link function built in. Check the model and series of the PC against the type of host link unit before marking the connections.

The compatible PCs are listed in the table below.

PC Series	CPU Unit	Connectable to
C series	CQM1-CPU41-E CQM1-CPU42-E CQM1-CPU43-E CQM1-CPU44-E	CQM1
	C200HS-CPU21-E C200HS-CPU23-E C200HS-CPU31-E C200HS-CPU33-E	C200HS

2-6-2 Connecting the NT11S

Refer to the illustrations below to select the appropriate cable for the unit connectors and connect the NT11S to the PC.

To make a connector cable, refer to Appendix D Method for Making the Cable for Connection to the PC (page 146).

- ⚠ Caution**
- After connecting a communication cable, always secure it with the screws. Otherwise the cable may disconnect, causing operation to fail.
 - The cable’s tensile load is 30 N. Do not subject it to loads greater than this. Otherwise a discontinuity may occur, causing operation to fail.

Use a connector cable with a 9-pin connector on both ends to connect the NT11S to a PC with a 9-pin connector.

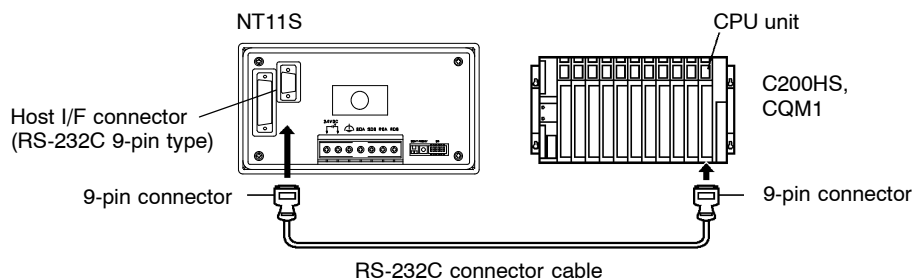

2-6-3 PC Switch Settings

when the NT11S and PC are connected to each other, set the conditions at the PC CPU so as to enable the NT link communications.

- C-series C200HS, CQM1

Set the operating conditions to the PC system setting area when a C200HS or CQM1 CPU is connected to the NT11S. The PC system setting area (data memory) can be directly accessed from the peripheral tool (LSS etc.).

The following describes the switch settings so as to enable the PC system settings. For the details of the operation with the PC system setting area, refer to the "SYSMAC CQM1-CPM1 Programming Manual" (W228-E1-□).

[Switch setting] (CQM1 only)

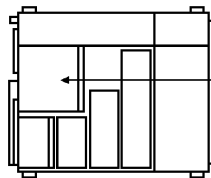

- RS-232C port communication conditions (DIP SW5)
Set SW5 to "OFF" to effect the existing settings of the PC system setting area.

[PC system setting area settings]

Write settings to the PC system setting area (data memory).

Channel No.	Writing value	Settings
DM6645	4000	NT link is used.

2-7 Connecting a Printer

Daily reports and display histories can be printed onto a printer connected to the NT11S.

2-7-1 How to Connect

Connect the printer to the NT11S with a Centronics cable. The length of the cable should not exceed 3 meters.

⚠ Caution If the connection cable is connected or disconnected while the power of the printer is on, the NT11S may malfunction. Make sure to turn off the power of the printer before connecting or disconnecting the connection cable.

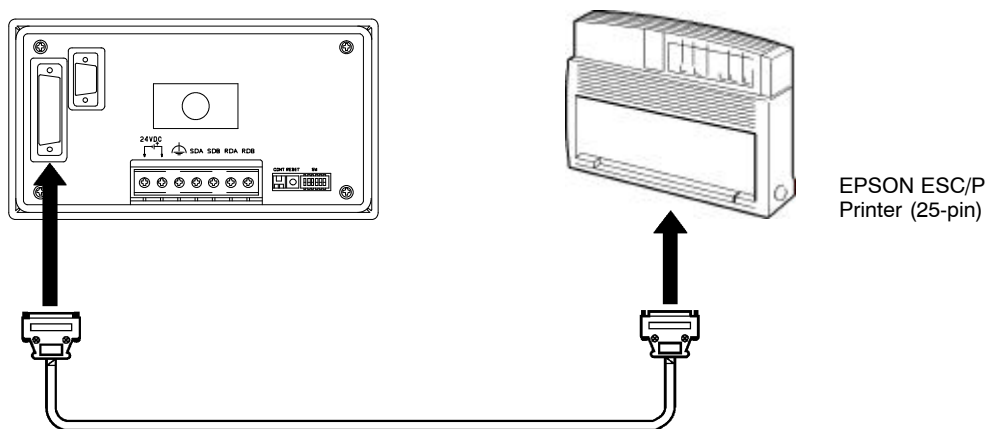

- **Recommended printer**

EPSON ESC/P Printer (25-pin)

If using other printer, such printer should conform to ESC/P 24-J81, which is the printer control standard of Epson.

SECTION 3

System Menu Operation

This section describes the operation of the System Menu focusing on the procedure to start up the NT11S.

Functions which will be convenient to use the NT11S and those which are useful for the system maintenance are also explained here.

3-1	Operation Flow by the System Menu	42
3-2	Starting the NT11S	43
	3-2-1 Changing the System Settings etc.	43
3-3	Operation Modes and the System Menu	44
	3-3-1 System Menu and the Operation Modes	44
	3-3-2 Menu Tree	45
	3-3-3 Operations with the System Menu	46
3-4	Initializing Memory	48
	3-4-1 Initialization of the Screen Data	48
	3-4-2 Initialization by Using the DIP Switch (Forced Initialization)	50
3-5	Transferring the System Program	51
3-6	Registering the Screen Data	54
3-7	Setting the Conditions of Communications with the PC by Using the Memory Switches	57
	3-7-1 Selecting the Host Communication Method	58
	3-7-2 Selecting the Host Link Communication Speed	59
	3-7-3 Selecting the Automatic Reset Function	60
	3-7-4 Selecting the Channel for Communication with the PC	61
3-8	Starting the Operation	62
3-9	Backlight OFF	63
	3-9-1 Turning the Backlight Back ON	63
	3-9-2 Backlight OFF Function	63
3-10	System Maintenance	65
	3-10-1 I/O Check	65
	3-10-2 PT Setting Check	69

3-1 Operation Flow by the System Menu

Follow the procedure below when using the NT11S for the first time or when changing the system.

Create the Screen Data

Create the screen data to be displayed on the NT11S by using a support tool.

For the screen data creation, refer to the "NT-series NT11S Support Tool Operation Manual" (V030-E1-1).

Start Up the NT11S (Display the System Menu.) (page 43)

Turn ON the power to the NT11S.

When no screen data has been registered, the "SYSTEM MENU" will be displayed. If the NT11S enters the RUN mode, press appropriate function keys to display the System Menu.

Initialize Memory (page 48)

Select a System Menu and initialize the NT11S unit memory.

Transfer the System Program

Connect the NT11S to the system transfer tool and transfer the system program from the system transfer tool to the NT11S.

For details on connecting the NT11S to the system transfer tool, see 3-5 "Transferring the System Program" (page 51).

Transfer the Screen Data (page 54)

Connect a support tool to the NT11S and transfer the screen data from the support tool to the NT11S.

For the connection of a support tool, refer to Section 2-3 Connecting to the Support Tool. (page 25)

Memory Switch Setting (page 57)

Select the System Menu and set the conditions for communications with the PC using the memory switch.

Start the Operation (page 62)

Connect to the PC and start the operation.

System Maintenance (page 65)

If an error has occurred during operation, check the I/Os, settings, etc. referring to this guide.

3-2 Starting the NT11S

When the NT11S is started, it will enter the RUN mode if system settings and screen data registration have been completed. If no screen data has been registered or the screen data are destroyed, the System Menu will be displayed.

Before turning ON the power, check the following DIP switch settings on the NT11S.

- SW2-2 “Screen data forced initialize effective/ineffective” is set to OFF (ineffective).
- DIP SW2-6, “system program erase”, is OFF.

For the DIP switch settings of the unit, refer to the “DIP switch settings” (page 20).

3-2-1 Changing the System Settings etc.

Follow the procedure below to change the system settings or screen data contents.

Procedure 1. Switch on the power to the NT11S with two function keys held down to display the System Menu, then change the system settings. For the method for calling the System Menu, refer to the “Operations with the System Menu” (page 46).

Reference If the NT11S has failed to start up normally; an error message is displayed or no screen is displayed, memory needs to be initialized.

For the memory initializing procedure, refer to Section 3-4 Initializing memory (page 48).

3-3 Operation Modes and the System Menu

The NT11S operates in either "RUN", "Transmit", or "Maintenance" mode. The operation modes can be switched by using the System Menu.

3-3-1 System Menu and the Operation Modes

Select an operation mode by locating the cursor on the required item with the [↑] [↓] keys, then press [Enter] to confirm the selection. The operation modes with respect to the System Menu are related to each other as shown below.

For the operations with the System Menu, refer to the "Operations with the System Menu" (page 46).

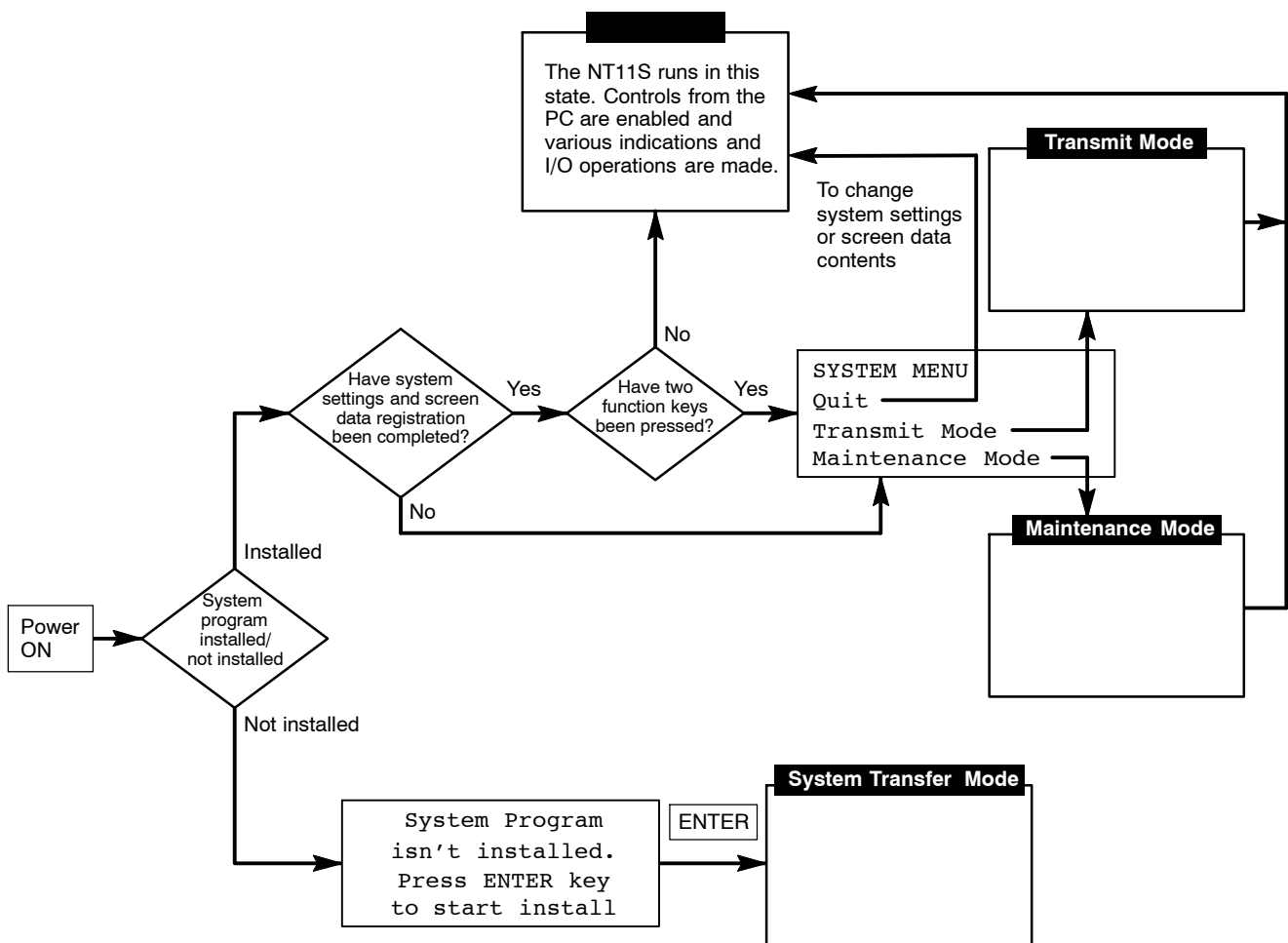

3-3-2 Menu Tree

The System Menu allows to effect various NT11S functions by using the System keys. The NT11S's functions with respect to the System Menu are related as shown below.

For the operations with the System Menu, refer to the "Operations with the System Menu" (page 46).

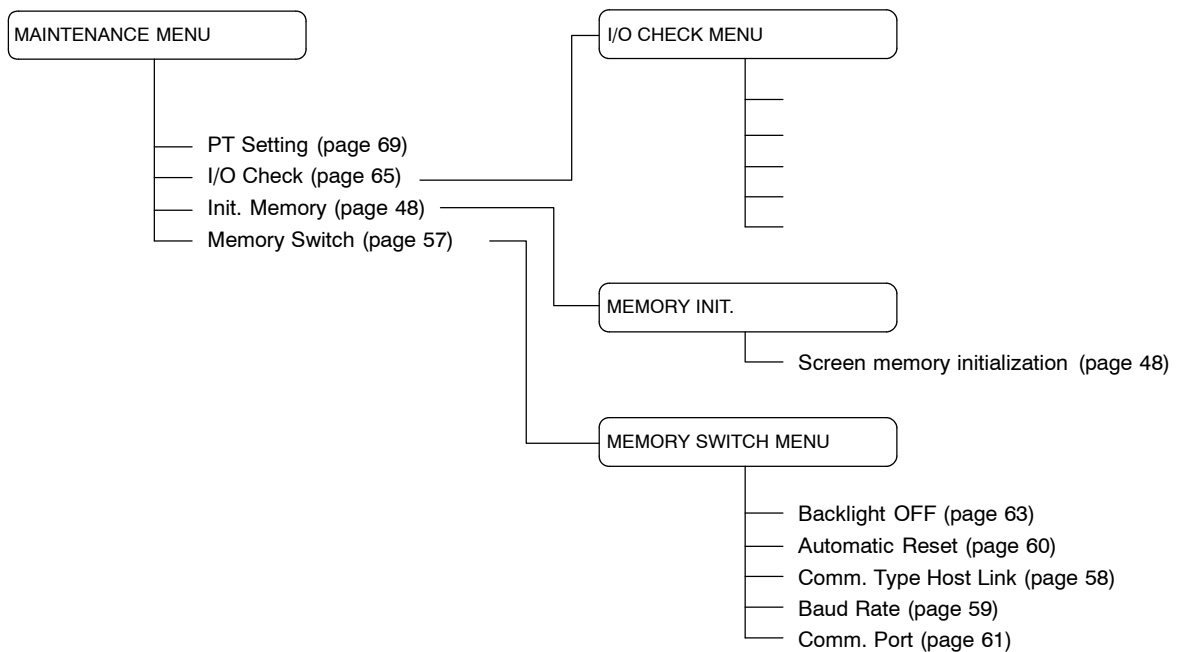
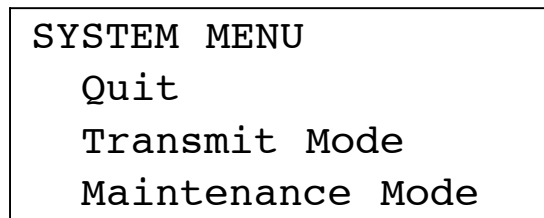

3-3-3 Operations with the System Menu

The following gives the procedure to call the System Menu, select the menu items, and other operations with the System Menu.

Note Make sure that DIP SW2-4 “Switching to the System Menu enabled/disabled” is set to OFF (enabled). If the setting is ON (disabled), the System Menu will not be displayed by following the procedure given below.

Displaying the System Menu The system menu can be displayed by switching on the power while any two of the four function keys are held down.

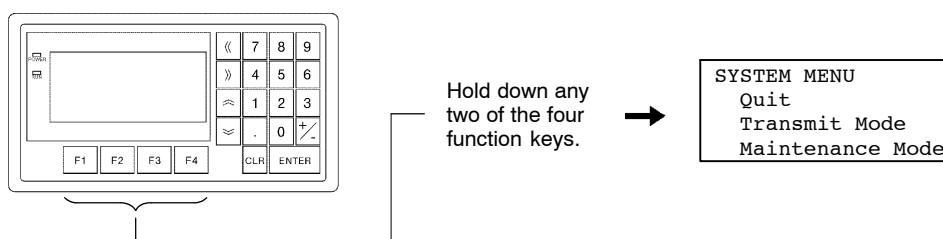

Basic key operations in the maintenance mode

Operation	Function
Any two function keys	Cancel
[ENTER] key	Set/execute
Arrow keys	Cursor motion

Note that on the screen for confirming erasure of the system program, the “Cancel” and “Set/execute” keys are displayed in reverse video in order to prevent mistaken deletion of the program.

Selecting the Menu Items Press the or key on the panel of the NT11S to move the highlighting up or down. When the required item is highlighted, press the “ENTER” key to select it. Menu items allow to make the ON/OFF selection or to call subsequent menu or screen.

Example 1

To call the “Maintenance Mode Menu” by selecting the “Maintenance Mode” on the System Menu screen:

```

SYSTEM MENU
  Quit
  Transmit Mode
  Maintenance Mode
    
```

Select "Maintenance Mode" with the key, then press "ENTER".



```

PT Setting
I/O Check
Initialize Memory
Memory Switch
    
```

System Menu Items

The System Menu items and their functions are given below.

Menu Item	Function
Quit	The System Menu screen is cleared and the NT11S will return to the RUN mode.
Transmit Mode	The Transmit Mode screen will be displayed to allow the transmission of the screen data between the NT11S and the support tool. For the transmission of the screen data, refer to Section 3-6 Registering the Screen Data (page 54).
Maintenance Mode	The Maintenance Mode menu will be displayed to allow the maintenance of the NT11S system.

Switching from the System Menu to the RUN mode

The NT11S will exit the System Menu and switch to the RUN mode in the cases mentioned below.

- Selecting "Quit" in the System Menu.
- The screen (System keys) is not pressed for over 10 seconds.

3-4 Initializing Memory

If the NT11S is used for the first time or if the screen data is ruined and the NT11S cannot be normally started, the memory needs to be initialized.

The memory initialization is required in the cases mentioned below.

- When the NT11S is used for the first time or when an error message indicating that the screen data is ruined etc. when the NT11S is started.
- When the screen has disappeared during the start-up or operation.

Use the NT11S DIP SW2-2 "Screen data forced initialize effective/ineffective"; initializes the memory.

Reference When an error has occurred, the error messages such as "Screen data corrupted" will be displayed. For the error messages displayed on the screen, refer to Section 6-2 "Responding to Displayed Error Messages" (page 133).

Note Initializing the screen data memory will erase entire screen data registered in the NT11S. Make sure that there are backup copies of the screen data on floppy disks before starting the initialization.

3-4-1 Initialization of the Screen Data

The screen data can be initialized by either of the following two methods.

- Initialization by using the System Menu
- Initialization by using the DIP switch

Initialization by using the System Menu

Initialize the image data memory by following the procedure given below.

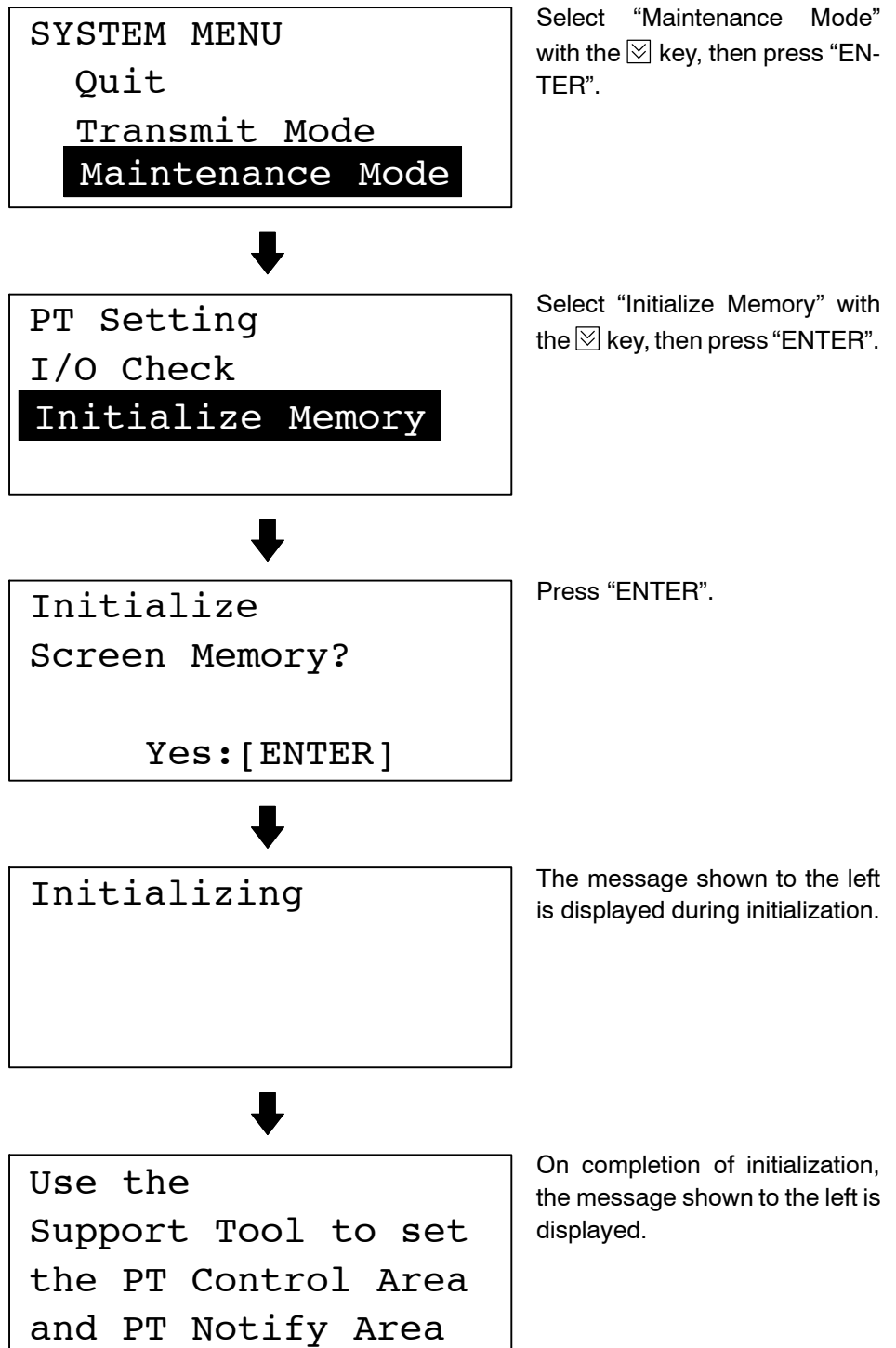

You can quit without initializing the memory by simultaneously pressing any two of the function keys while the "Initialize Screen Memory?" screen is displayed.

When the screen data memory initialization has been completed, transfer the screen data from the support tool.

3-4-2 Initialization by Using the DIP Switch (Forced Initialization)

Note Be sure to turn the power OFF before setting the NT11S DIP switch.

Set the DIP switch as follows to initialize the screen data memory.

Operation 1. Set DIP-SW2-2 on the NT11S to ON and turn the power ON.

Initialize
Screen Memory?

Yes: [ENTER]

Press "ENTER".



Initializing

The message shown to the left is displayed during initialization.



Initialized the
Turn OFF the DIP-SW2-2
and Reset, then
return to RUN mode

On completion of initialization, the message shown to the left is displayed.

2. Turn the NT11S power to OFF.

3. Set NT11S DIP SW2-2 to OFF and turn the power ON.

You can quit without initializing the memory by simultaneously pressing any two of the function keys while the "Initialize Screen Memory?" screen is displayed.

Turn OFF the DIP-SW2-2
and Reset, then
return to RUN mode

Reference To change the system settings or to register the screen data, set DIP-SW2-2 to OFF and call the System Menu screen by turning on the power to the NT11S while pressing two of the four function keys.

The NT11S DIP-SW2-2 is used to set "Screen data forced initialize effective/ineffective". Setting this to ON selects "effective", and OFF "ineffective".

3-5 Transferring the System Program

The system program of NT11S can be changed by the system transfer tool. The system transfer tool is automatically installed in the personal computer when the NT11S support tool is installed.

For details on how to start up the system transfer tool, and the system transfer tool operation, refer to the NT-series NT11S Support Tool Operation Manual (V030-E1-□).

Note An NT11S which has no system program registered in it will be able to execute only installation function.

For details on system transfer tool operations, refer to the NT-series NT11S Support Tool Operation Manual (V030-E1-□).

Transferring the system program from the system transfer tool

In order to transfer the system program from the system transfer tool, first connect the NT11S to a personal computer running the system transfer tool by using the appropriate cable, then proceed as follows.

Reference The NT11S uses one connector for the connection to both a PC and a computer. If it has been connected to a PC, disconnect the PC and connect the system transfer tool (computer) to the NT11S, and then, transmit the screen data.

Operation

1. Connect the NT11S to the personal computer running the system transfer tool, then switch on the power to the NT11S.
2. Switch on the power to the personal computer and start up the system transfer tool.
3. When the power to the NT11S is switched ON, the screen shown below is displayed.

System Program
isn't installed.
Press ENTER key
to start install

4. Press the "return" key to enter the system transfer mode, as shown below.



5. The NT11S is now on standby for reception. Start transfer of the program by using the system transfer tool.

When the NT11S starts reception, the screen shown below is displayed.

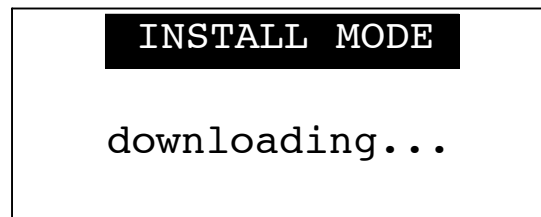

6. When transfer of the system program is completed, the NT11S displays the screen shown below.

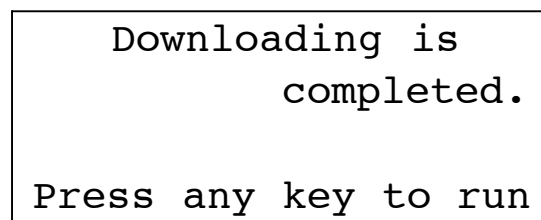

7. Pressing any key when using the system transfer tool will return you to the main menu screen.
8. You can quit the system transfer mode and return to the RUN mode by simultaneously pressing any two of the four function keys on the panel of the NT11S. The same result is achieved when the NT11S receives a transfer end instruction from the system transfer tool.

Points to observe during transfer of the system program

If any of the following events, or a system error, occurs during transfer of the system program, the program will not be installed in the NT11S correctly.

- The power to the NT11S is switched off, or the NT11S is reset, during transfer.
- The power to the personal computer that is running the system transfer tool is switched off, or the personal computer is reset, during transfer.
- The cable connecting the personal computer running the system transfer tool and the NT11S becomes disconnected or sustains a wire breakage during transfer.
- Transfer is terminated by pressing any two of the function keys on the panel of the NT11S.

- Transfer is terminated by pressing the ESC key of the personal computer running the system transfer tool.

In the event of any of the above, there is a possibility that the NT11S will not operate or that unpredictable malfunctions will occur.

To prevent this, switch DIP switch SW2-6 ON to erase the system program after the problem has occurred. For details on erasing the system program with the DIP switch, refer to "Method for Erasing the System Program" (page 53).

Method for Erasing the System Program

In order to erase the system program, the system program area must be cleared. On shipment there is no data in the system program area and therefore the system program can be transferred without having to erase an existing system program first; however, if a system program already exists it must be erased before the new one can be transferred.

The following is the procedure for erasing the system program.

- Operation**
1. Set DIP SW2-6 to the ON position and turn on the power or reset: the following screen will be displayed.

```
Erasing system program
Are you sure?

(Yes:F3+F4, No:ENT)
```

2. Press the "return" key if you want to quit without erasing the program. If you do want to erase the program, press any two of the function keys simultaneously: this will start erasure of the program. During erasure, the screen shown below is displayed:

```
Erasing...
```

3. On completion of erasure, the screen shown below is displayed. At this point set DIP SW2-6 to the OFF position and reset the NT11S.

```
Erasing is completed
Set DIP-SW2-6 to off
and press reset-SW
```

3-6 Registering the Screen Data

The screen data is created by using the support tool and registered to the NT11S screen data memory. This section describes the procedure to register the screen data to the NT11S. For the screen data creation and the support tool operation, refer to the NT-series NT11S Support Tool Operation Manual (V030-E1-1).

Transmission - Transmission in File Units

The NT11S uses several screens which are switched on its display. The screen data of one NT11S unit corresponds to the screens created by using the support tool. Select a file which contains the screen data to be transmitted when selecting the screen data to be transmitted to the NT11S so that the required screen data can be transmitted to the NT11S.

It is not possible to send screen data in screen units.

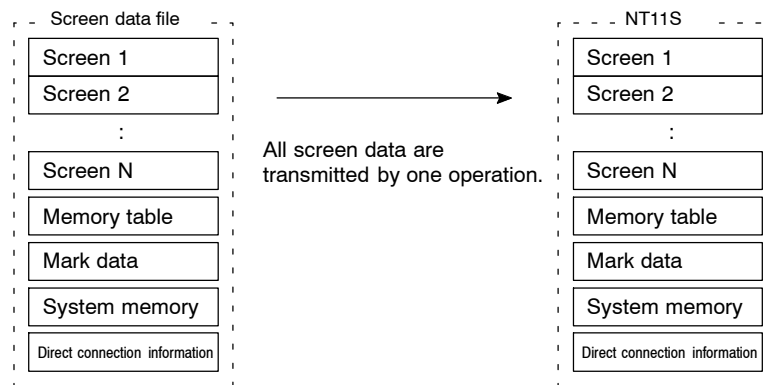

If an error message and the System Menu are displayed immediately after the NT11S has been started, the screen data memory needs to be initialized.

Transmitting the Screen Data from the Support Tool

To transmit the screen data from the support tool to the NT11S, connect the NT11S to the computer on which the support tool is being used, and follow the procedure below.

Reference The NT11S uses one connector for the connection to both a PC and a computer. If it has been connected to a PC, disconnect the PC and connect the support tool (computer) to the NT11S, and then, transmit the screen data.

- Operation**
1. Connect the NT11S to the computer on which the support tool is being used, and turn ON the NT11S.
 2. Turn ON the computer and start up the support tool.
 3. Enter the "Transmit Mode" by operating the menu of the NT11S as mentioned below.

```

SYSTEM MENU
  Quit
  Transmit Mode
  Maintenance Mode
    
```

Select "Transmit Mode" with the key, then press "ENTER".



```

TRANSMIT MODE
    
```

4. Select a screen data to be transmitted to the NT11S in the File Selection screen of the support tool, and press F-6.
5. The NT11S will display the following screen when the screen data is being transmitted.

```

TRANSMIT MODE
  Tool [ ] PT

  0KB
    
```

6. When the screen data transmission is completed, the support tool will display the following screen.

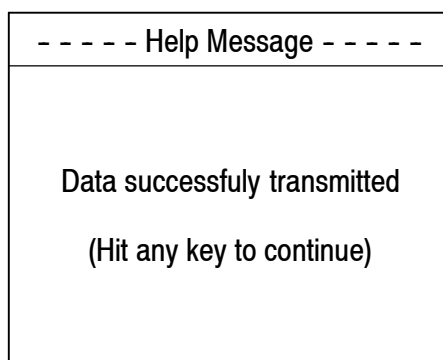

7. Press any key on the support tool to return to the File Selection screen.
8. You can quit the Transmit Mode and return to the RUN mode by simultaneously pressing any two of the four function keys on the panel of the NT11S. The same result is achieved when the NT11S receives a transfer end instruction from the support tool.

Precautions to be Observed During the Screen Data Transmission

When any of the following or a system error occurs during the screen data transmission, the transmitted screen data will not be registered correctly to the NT11S. If an error message is displayed in the System Menu and the Transmit Mode cannot be selected, the screen data memory needs to be initialized.

- The power to the NT11S is interrupted or the NT11S is reset.
- The power to the computer on which the support tool is running is interrupted or the computer is reset.
- The cable connecting the NT11S to the computer on which the support tool is running is disconnected or has a broken wire.
- Screen data transfer is terminated by pressing any two of the function keys on the panel of the NT11S.
- The ESC key on the support tool is pressed to end the transmission.

When the power to the NT11S is turned ON or reset, the screen data is checked. However, if any of the above occurs during the screen data transmission, the screen may disappear and other unexpected problems may occur.

In the case of such problems, set DIP-SW2-2 to ON to initialize the memory.

For the memory initialization by using the DIP switch, refer to the "Initialization by using the DIP switch" (page 50).

3-7 Setting the Conditions of Communications with the PC by Using the Memory Switches

The communications between the NT11S and a PC are called the host communications.

The NT11S can be connected to a PC by the host link or NT link. The link can be selected by setting the memory switch. Also, the host link baud rate, automatic reset function, etc. are set with the memory switches.

This section describes the communications condition settings by using the memory switches.

Memory Switches

The NT11S has the memory areas used to store the PC connection method, communications conditions, system settings, etc. which can be used as the switches and called the "memory switches". Since the memory switches use the flash memory, the stored data can be held even when the power supply is turned OFF.

Setting Functions and the Memory Switch Menu

The memory switches can be set easily by using the memory switch menu in the System Menu.

The following settings can be made with the memory switches. Refer to the subsequent pages for the details of each setting and function.

[Memory switch menu]

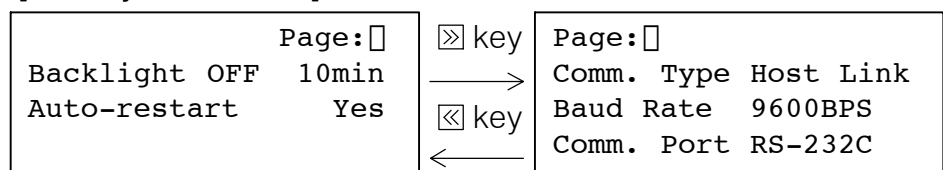

- | | |
|----------------------|---|
| Backlight OFF | 3-9-2 Backlight OFF Functions (page 63) |
| Auto-restart | 3-7-3 Selecting the Automatic Reset Function (page 60) |
| Comm. Type Host Link | 3-7-1 Selecting the Host Communication Method (page 58) |
| Baud Rate | 3-7-2 Selecting the Host Link Communication Speed (page 59) |
| Comm. Port | 3-7-4 Selecting the Channel for Communication with the PC (page 61) |

3-7-1 Selecting the Host Communication Method

The NT11S can be connected to a PC by the host link or NT link. Either link can be selected by setting the "Comm. Type" memory switch. The factory setting has been made to the "Host link".

Select the host communication method by the menu operation from the System Menu as mentioned below.

```

SYSTEM MENU
  Quit
  Transmit Mode
  Maintenance Mode
    
```

Select "Maintenance Mode" with the key, then press "ENTER".



```

PT Setting
I/O Check
Initialize Memory
Memory Switch
    
```

Select "Memory Switch" with the key, then press "ENTER".



```

Page: [ ]
Backlight OFF 10min
Auto-restart Yes
    
```

Display the next screen by pressing the key.



```

Page: [ ]
Host Link
Baud Rate 9600BPS
Comm. Port RS-232C
    
```

Pressing the [+/-] key while "Comm. Type" is highlighted will cause the selection for this item to alternate between "Host Link" and "NT Link".

To quit after setting the selection made, press the "ENTER" key. To quit without setting the selection made, press any two function keys simultaneously.

Reference The communication method must be selected according to the method that the connecting PC supports.

3-7-2 Selecting the Host Link Communication Speed

When the host link is used, the baud rate of the communications with the PC can be set. Use the "Baud Rate" switch and select 9600 bps or 19200 bps.

The factory setting has been made at 9600 bps.

Select the baud rate of the communication with the PC by the menu operation from the System Menu as mentioned below.

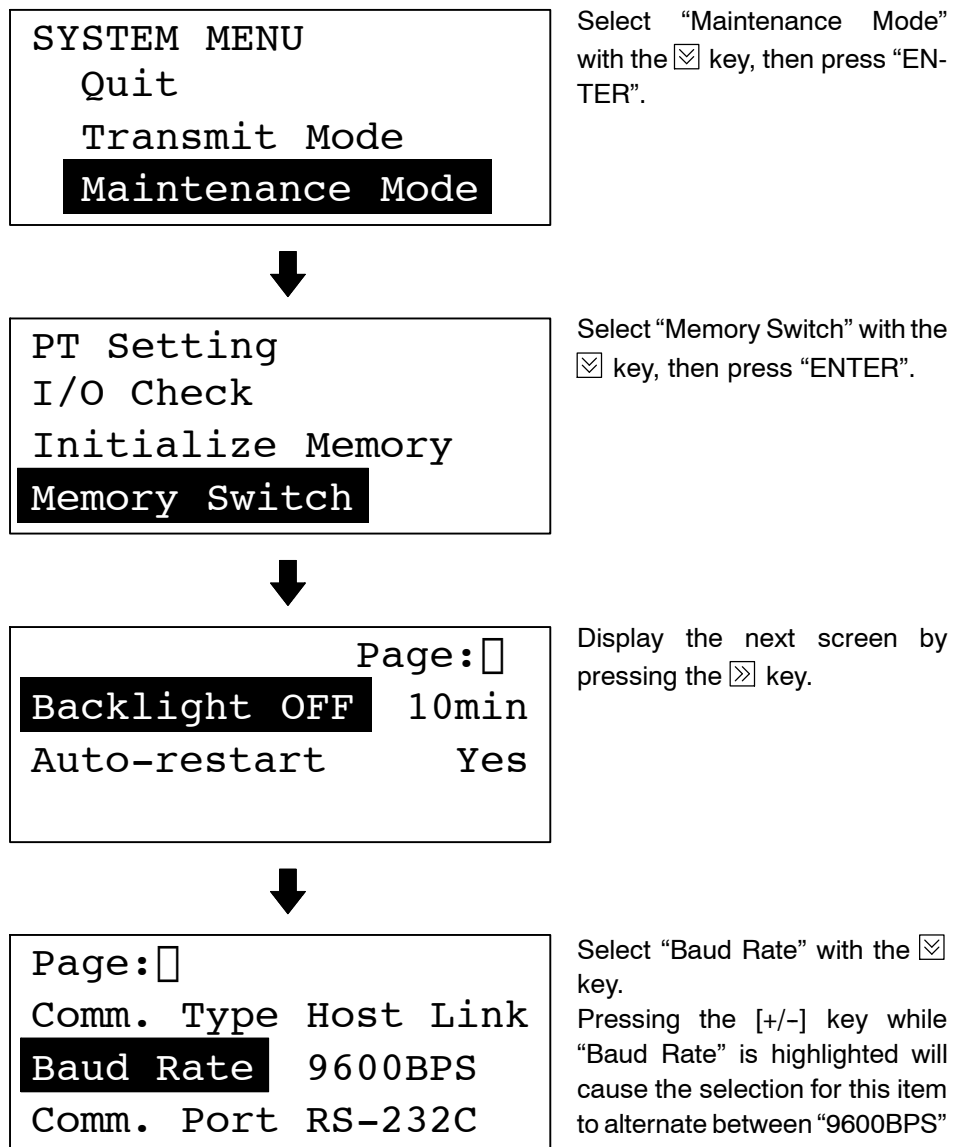

To quit after setting the selection made, press the "ENTER" key. To quit without setting the selection made, press any two function keys simultaneously.

Note If the NT link has been selected, the Baud Rate setting does not make any effect.

3-7-3 Selecting the Automatic Reset Function

The "Auto-restart" memory switch is used to set whether or not the communication is automatically reset after the occurrence of a communication error.

The factory setting has been made at "OFF".

Select the Automatic Reset Function of the communication with the PC by the menu operation from the System Menu as mentioned below.

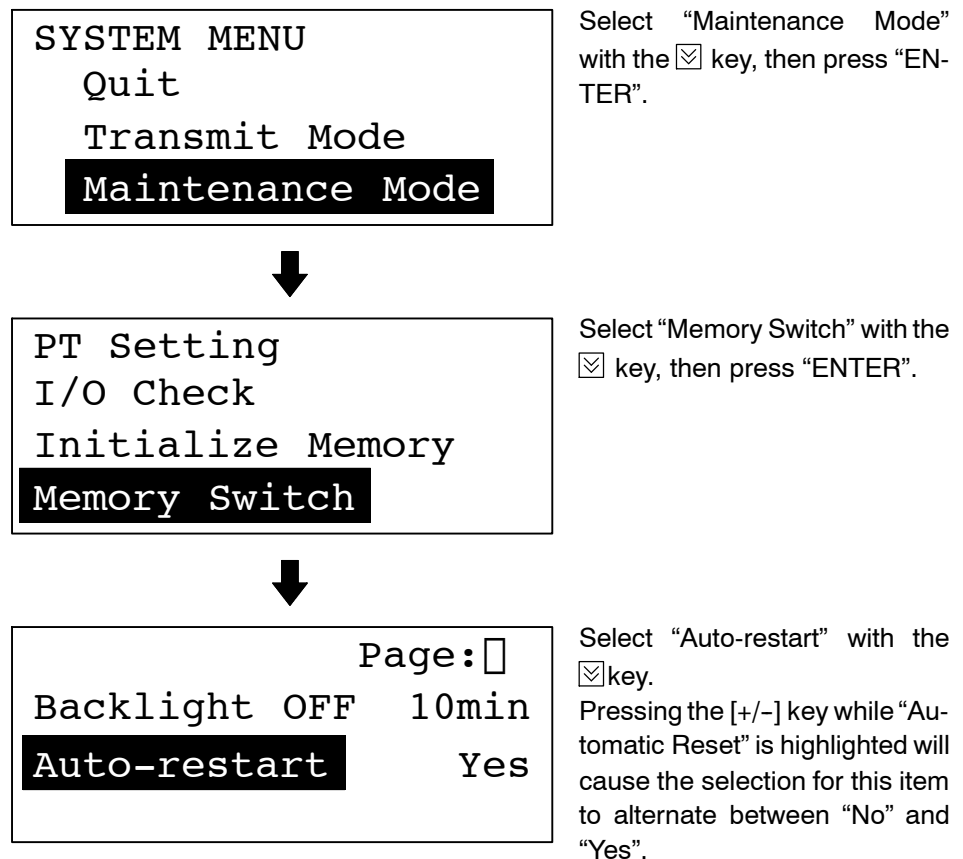

To quit after setting the selection made, press the "ENTER" key. To quit without setting the selection made, press any two function keys simultaneously.

- "OFF": If a communication error has occurred, corresponding error message is displayed and the operation stops.
- "ON": If a communication error has occurred, corresponding error message will not be displayed and the operation will be automatically reset.

3-7-4 Selecting the Channel for Communication with the PC

The NT11S allows selection of RS-232C or RS-422A as the channel (communication port) for communication with the PC. The channel to be used is selected at the "Comm. Port" item in the memory switch menu.

The setting on shipment is "RS-232C".

Select the channel by performing the following operations, starting from the system menu.

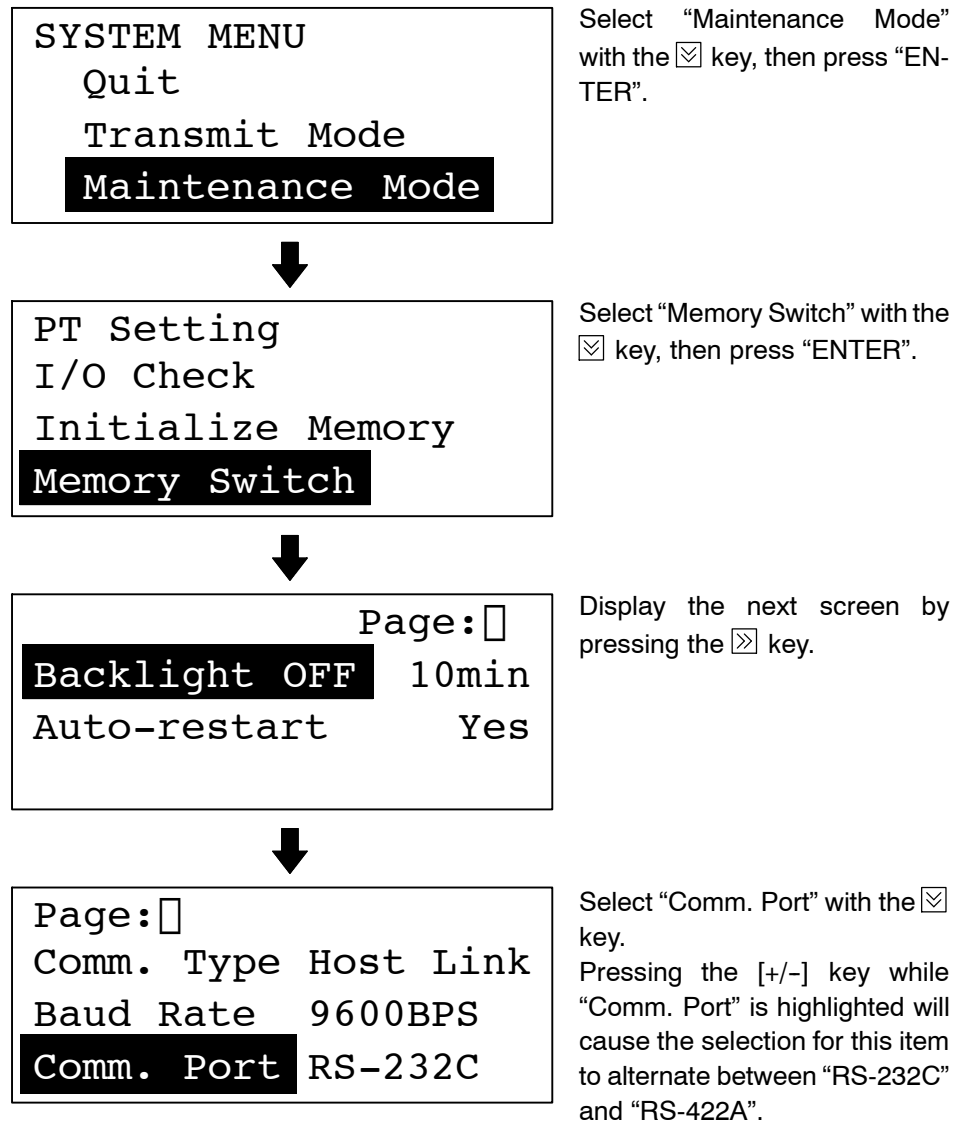

To quit after setting the selection made, press the "ENTER" key. To quit without setting the selection made, press any two function keys simultaneously.

Reference Select the system that is supported by the PC to be connected.

3-8 Starting the Operation

After completing the screen data transmission, connect the NT11S to the PC and start the operation.

⚠ Caution Carefully check the operation of all screen data and host programs before using them. If incorrect, the system may operate unpredictably. Otherwise the system may operate unpredictably.

Switching to the RUN mode Press the Quit in the System Menu. The start-up screen in the RUN mode will be displayed.

Reference If the NT11S has failed to start correctly; e.g., the start-up screen is not displayed, an error message is displayed, or the screen is not displayed at all, refer to Section 6-2 "Responding to Displayed Error Messages" (page 133) and take appropriate action.

Confirming the Communications between the NT11S and the PC

Execute the PC program and confirm that the following operations are normally performed.

- Confirm that the NT11S screens switch according to the PC program execution.

If the screens do not switch correctly, check the connection between the NT11S and the PC and also check the settings.

Refer to Section 2 Hardware Settings and Connections.

- Confirm that the information selected by the NT11S function keys has been set in the PC by displaying the contents of the words and bits using a peripheral tool (LSS etc.). If the information sent from the NT11S has not been correctly received by the PC, check the screen data settings (specifically the switch settings).

For the details of the screen data creation, refer to the NT-series NT11S Support Tool Operation Manual (V030-E1-1).

Reference The start-up screen must be designated when the screen data is created by using the support tool. If the start-up screen has not been designated, the screen with screen number 1 will be displayed. If no screen data has been registered at screen number 1, the "Screen not registered." error message will be displayed. For the screen number setting, refer to Section 4-3 Screen Display (page 80).

3-9 Backlight OFF

In order to prevent the formation of an afterimage on the screen, and to maximize the service life of the backlight, the NT11S has a function for turning off the backlight.

3-9-1 Turning the Backlight Back ON

After the backlight has been switched off by actuation of the backlight OFF function, it will come back on in response to any key operation on the panel of the NT11S, if a screen is switched or redisplayed by the PC, or if a backlight ON instruction is received from the PC.

The backlight will not come back on merely because the numerals or characters displayed on the screen change.

3-9-2 Backlight OFF Function

There are two methods for implementing the backlight OFF function:

- Method whereby the backlight is automatically switched off when there have been no operations for a set length of time.
(Designated with the memory switches)
- Method whereby the backlight is switched off by an instruction from the PC.
(Designated in the PT status control area)

For details on the method for switching the backlight off with an instruction from the PC, see 5-4 "NT11S Status Control" (page 122).

The settings relating to the backlight OFF function that can be made with the memory switches are: whether or not the backlight OFF function is used, and - if it is used - what length of time will elapse before the backlight goes OFF.

The setting on shipment specifies that the backlight will go OFF after a period of ten minutes during which there are no operations.

Select the backlight OFF time by performing the following operations, starting from the system menu.

```
SYSTEM MENU
  Quit
  Transmit Mode
  Maintenance Mode
```

Select "Maintenance Mode" with the key, then press "ENTER".



```
PT Setting
I/O Check
Initialize Memory
Memory Switch
```

Select "Memory Switch" with the key, then press "ENTER".



	Page: □
Backlight OFF	10min
Auto-restart	Yes

Pressing the [+/-] key while "Backlight OFF" is highlighted will cause the selection for this item to change cyclically in the sequence "10m" "1h" "None".

- To quit after setting the selection made, press the "ENTER" key.
To quit without setting the selection made, press any two function keys simultaneously.
- If "None" is selected, the backlight OFF function does not operate. As long as no operations are performed, the same screen will be displayed indefinitely.
- If "10m" is selected, the backlight will be switched OFF if no operations are performed for ten minutes.
- If "1h" is selected, the backlight will be switched OFF if no operations are performed for one hour.

Reference In order to maximize the service life of the backlight, select "10m" or "1h" if possible.

Correct Use After images may remain if the same pattern is displayed for a long period. To prevent the formation of an afterimage, either use the screen saver function or periodically switch screens.

3-10 System Maintenance

In order to facilitate maintenance, the NT11S is provided with functions including the I/O check function and a function for confirming the NT11S settings.

3-10-1 I/O Check

The I/O check function checks whether the inputs and outputs for the following items are normal.

- LEDs
- LCD
- Key input
- Communication interface

LED check

Carry out the LED check by performing the following operations, starting from the system menu.

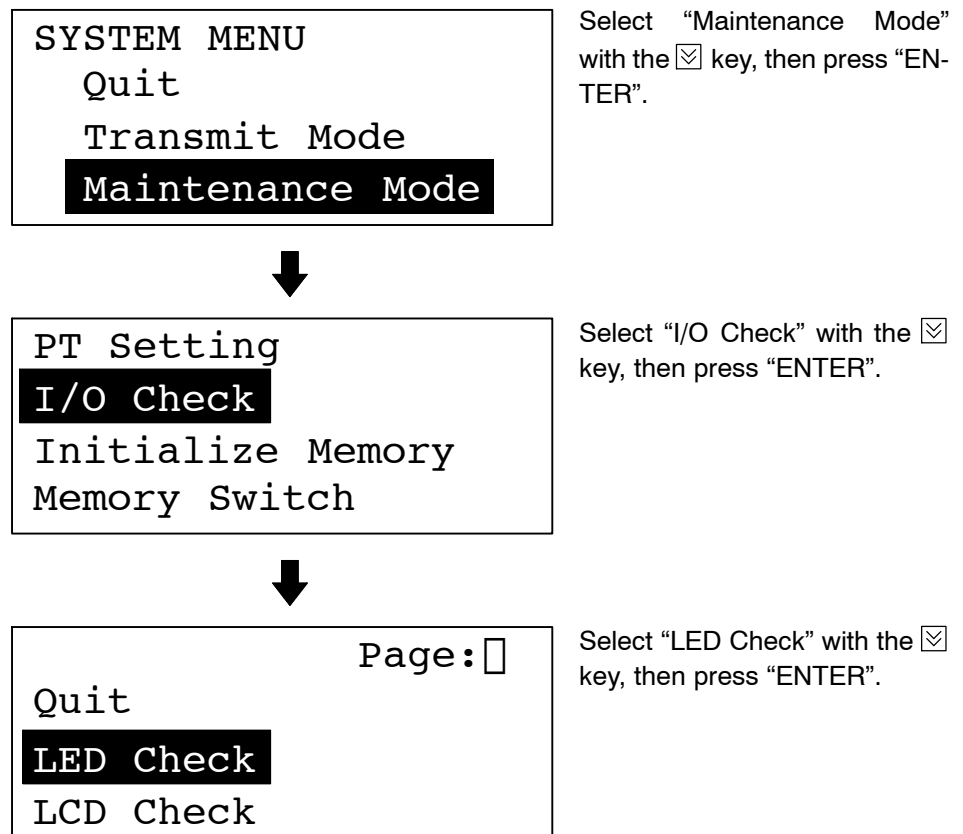

The "RUN" LED on the panel of the NT11S will blink.

- To quit the LED check, press any two of the function keys simultaneously.

LCD check

Check the LCD of the NT11S by performing the following operations, starting from the system menu.

```
SYSTEM MENU
  Quit
  Transmit Mode
  Maintenance Mode
```

Select "Maintenance Mode" with the key, then press "ENTER".



```
PT Setting
  I/O Check
  Initialize Memory
  Memory Switch
```

Select "I/O Check" with the key, then press "ENTER".



```
Quit
LED Check
LCD Check
```

Page:

Select "LCD Check" with the key, then press "ENTER".

- In the LCD check, all of the dots that comprise the screen are displayed, one at a time, starting at the top left corner of the screen. The LCD check is completed when all the dots are displayed.
- To abort the LCD check, press any two function keys simultaneously.

Key input check

Check the numeric keys, arrow keys, and function keys of the NT11S by performing the following operations, starting from the system menu.

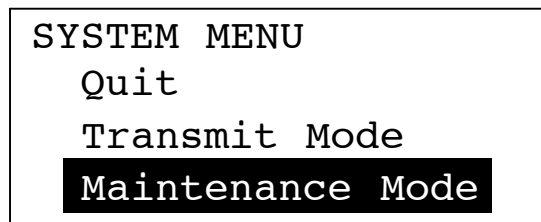

Select "Maintenance Mode" with the key, then press "ENTER".

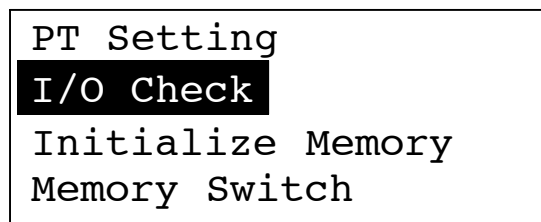

Select "I/O Check" with the key, then press "ENTER".

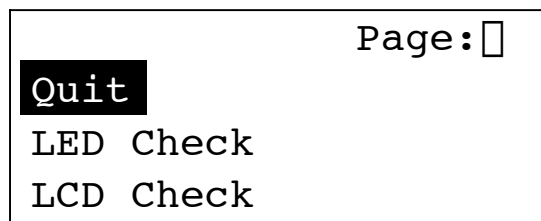

Display the next page by pressing the key.

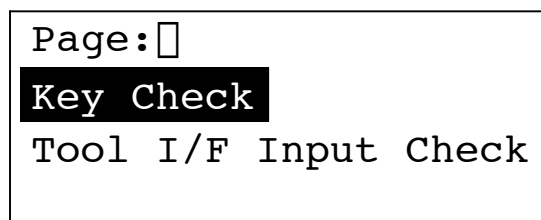

Press "ENTER".

All the keys to be checked are displayed on the screen.

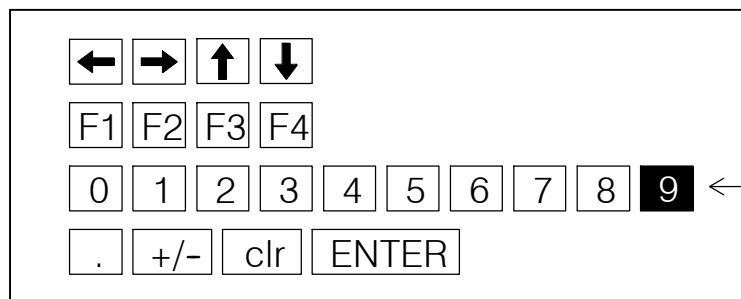

Display when the numeric key [9] is pressed.

- Press each of the numeric keys, arrow keys, and function keys on the panel of the NT11S in turn.
If the corresponding key in the display is highlighted when the panel key is pressed, it indicates that the key is operating normally.
- To quit the key input check, press any two of the function keys simultaneously.

Check on communication with the support tool

Check the communication between the NT11S and support tool by performing the following operations, starting from the system menu.

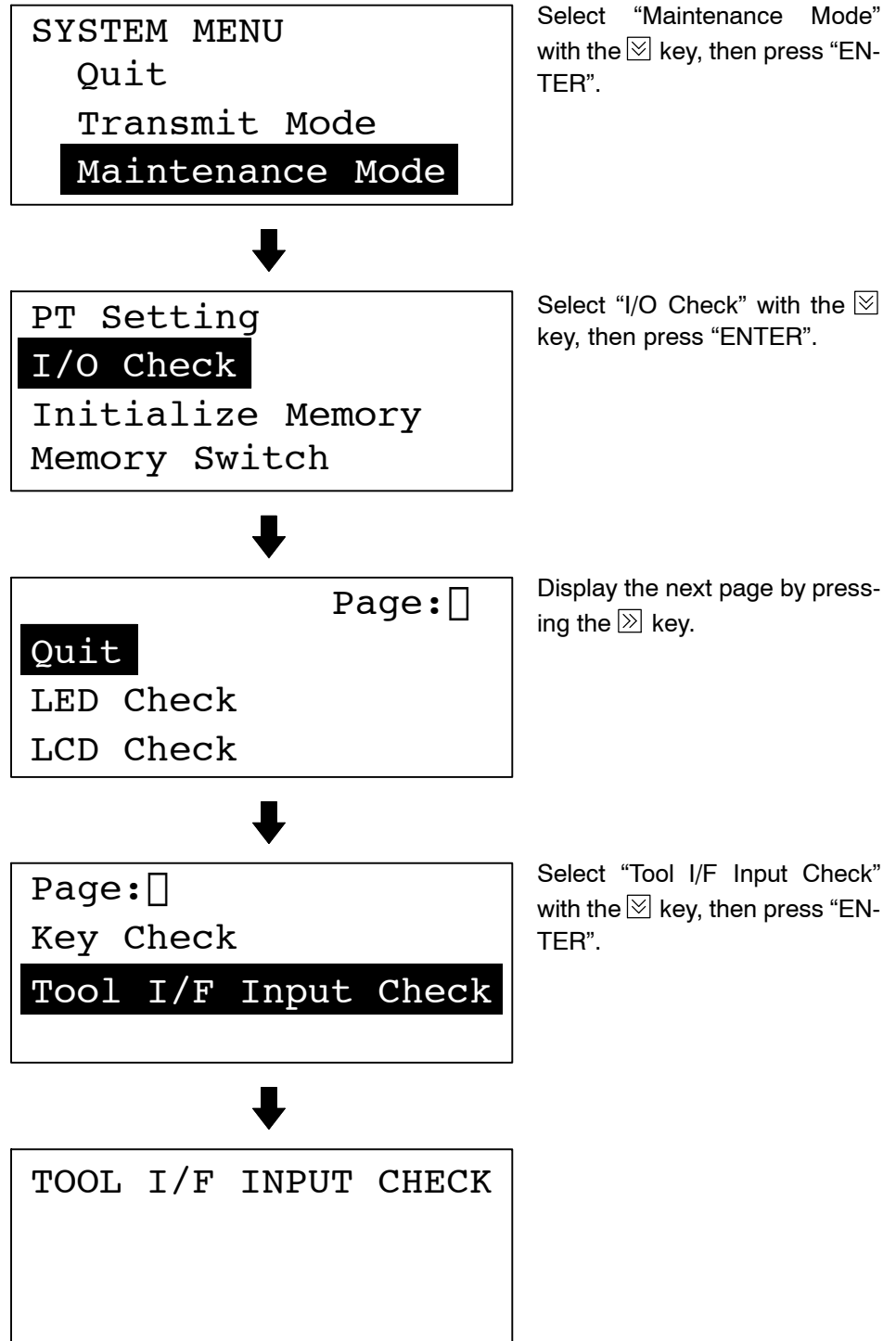

- The data received from the connected support tool is displayed in hexadecimal notation.
- To quit the check on communication with the support tool, press any two function keys simultaneously.

Note The NT11S uses the same connector for connection to the support tool to the PC. If this cable is connected to equipment other than the personal computer running the support tool, disconnect it from this equipment and connect it to the support tool before starting the communications check.

3-10-2 PT Setting Check

Display the settings of the NT11S on the screen by performing the following operations, starting from the system menu.

```

SYSTEM MENU
  Quit
  Transmit Mode
  Maintenance Mode
    
```

Select "Maintenance Mode" with the key, then press "ENTER".



```

PT Setting
I/O Check
Initialize Memory
Memory Switch
    
```

Press "ENTER".



```

Page: [ ]
Control Area DM0200
Notify Area  DM0300
    
```

The PT setting screen comprises two pages. To switch between them, use the and keys.

<pre> Page: [] Control Area DM0200 Notify Area DM0300 </pre>	<p><input type="checkbox"/> key →</p> <p><input type="checkbox"/> key ←</p>	<pre> Page: [] Comm. Type Host Link Baud Rate 9600BPS Comm. Port RS-232C </pre>
--	---	---

- The current settings of the NT11S are displayed.
- To quit the PT setting display, press any two function keys simultaneously.

SECTION 4 NT11S Functions

This section describes the functions of the NT11S.

4-1	Creating and Transmitting Screen Data	72
4-1-1	Setting the Support Tool for Use with the NT11S	72
4-1-2	Creating Screen Data	73
4-2	Outline of Functions	77
4-2-1	NT11S Screen	77
4-2-2	Characters and Figures Which can be Displayed	78
4-3	Screen Display	80
4-3-1	Classification of Screens	80
4-3-2	Screen Attributes	80
4-4	Memory Tables	81
4-4-1	Character-String Memory Table	81
4-4-2	Numeral Memory Table	82
4-5	Bar Graphs	83
4-5-1	Bar Graph Functions	83
4-6	Numeral Setting	85
4-6-1	The Numeral Setting Function	85
4-6-2	Using Numeric Keys	86
4-7	Menu Screen Function	87
4-8	Password Screen Display Function	88
4-9	Display History Screen Function	90
4-10	Daily Report/Display History Printing Function	91
4-10-1	Printing Daily Reports	91
4-10-2	Printing Display Histories	93

4-1 Creating and Transmitting Screen Data

This section describes briefly the support tool settings required for creating screen data and the screen data creation procedure.

Reference For the details of the support tool and screen data creation, refer to the “NT-series NT11S Support Tool Operation Manual” (V030-E1-□).

4-1-1 Setting the Support Tool for Use with the NT11S

To create the screen data for the NT11S, make settings with the support tool for use with the NT11S.

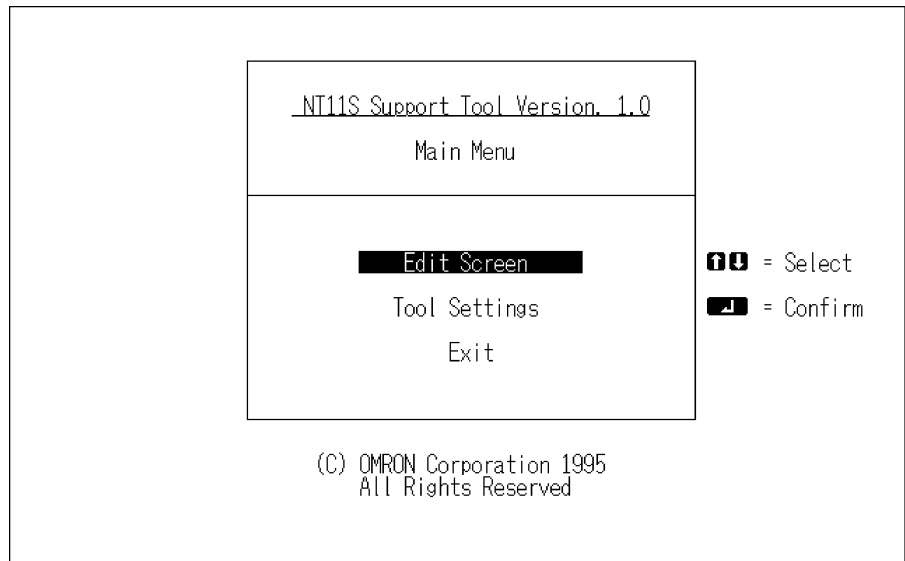

Select “Tool Settings”.

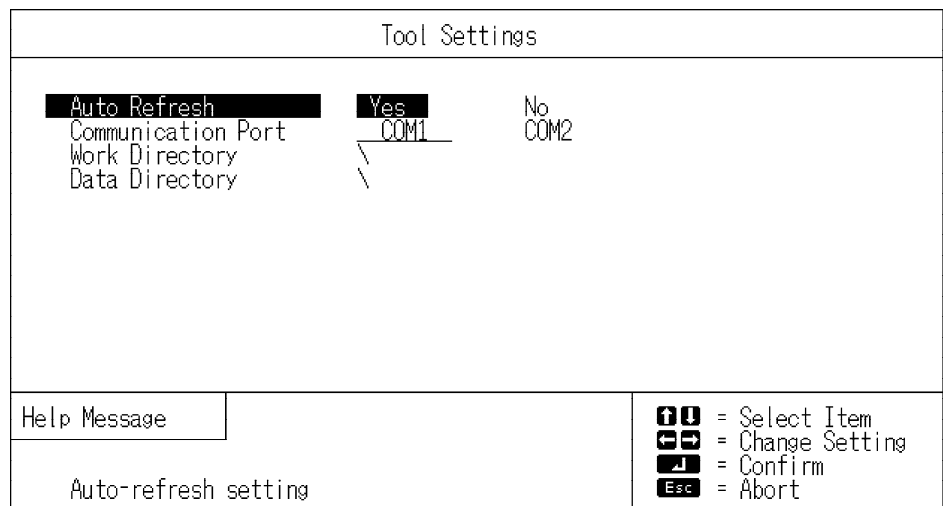

4-1-2 Creating Screen Data

Screen Data Creation Method The screen data is created by using the support tool. The support tool registers the screen data used with one NT11S to one file.

Screen data can be created by one of the following three methods:

- creating a new file;
- editing an existing file;
- reading and editing selected screens from an existing file.

Screen Data Creation Procedure

The following gives the basic screen data creation procedure. Required settings and reference pages are given for each step of the procedure.

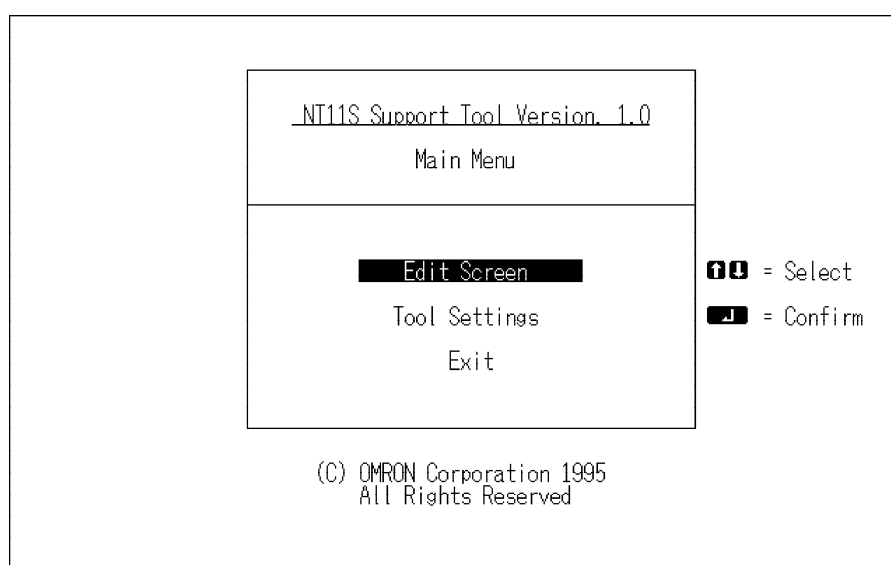

- ➔ Select "Tool Settings" in the Main Menu to display the "Tool Settings" screen. Settings of Auto Refresh, Communication Port, etc. are made in this screen. Refer to "Setting the support tool for use with the NT11S" on the previous page.



Select "Edit Screen".

File List (NT11S) 32KB		----- File Selection -----
FileName	Title	----- Help Message -----
NEW FILE	Creation of New File	↑↓ = Select ↓ = Confirm PaDn = Next Page PaUp = Prev Page Esc = Exit to Main Menu
Copy Delete Print [] [] []		Tmx. Rcv. In.Scr Title []

➔ Select a file used for storing the screen data for the NT11S in the "File List" screen.

To create a new file, select "New File".

To edit an existing file, select a file to edit.

Select "New File" and press [Enter]. Enter filename on completion of creation.



Select "Screen Creation".

[NEW_FILE] Screen List (NT11S) 32KB			----- Screen Selection -----
No.	Status	Comment	----- Help Message -----
1			↑↓ = Select ↓ = Confirm PaDn = Next Page PaUp = Prev Page Space = Mark/Unmark Home = Unmark All Shift+Home = Mark/Unmark All Esc = File Selection Menu
2			----- Screen Status -----
3			Hist. []
4			(0Byte)
5			
6			
7			
8			
9			
10			
11			
12			
13			
14			
15			
16			
Copy Delete Print Attril [] [] []			Mx/Pae Mark Next

Select a screen number to edit in the selected file in the "Screen List" screen.

➔ While in the "Screen List" screen, press the [F10] (Next page) key, and then, the [F4] (Direct) key to display the "Direct Connection Information" window in which the head words in the PC used to allocate the following areas.

- PT status control area: Section 5-4 NT11S Status Control (page 122)
- PT status notify area: Section 5-5 Notification of the Operating Status to the PC (page 126)
- Numeral memory table: 5-2 Memory Tables and Bar Graph (page 106)
- character-string memory table: 5-2 Memory Tables and Bar Graph (page 106)



Select a screen number and press [Enter].

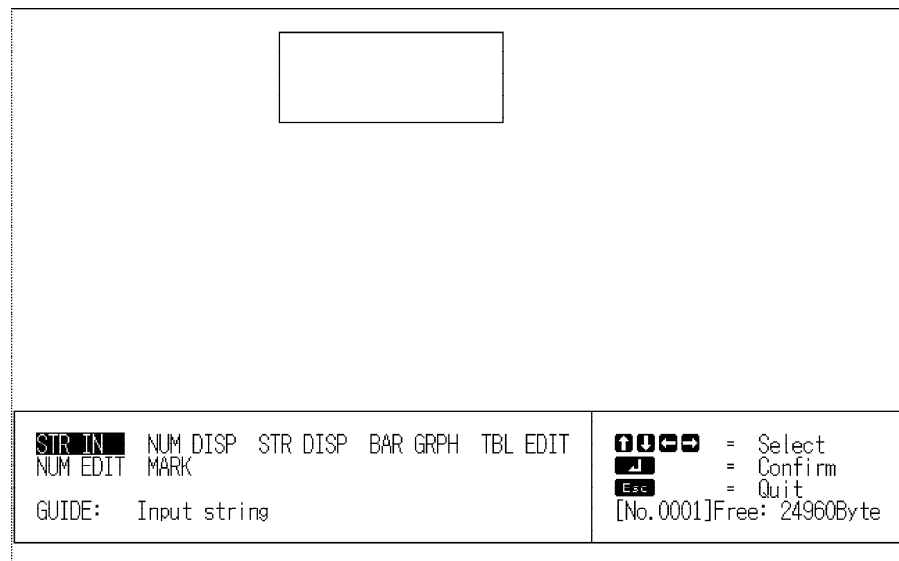

Create screen data in the Edit screen of the support tool. Data of one screen can be created by registering (laying out) the following display elements and attributes on the screen.

- Numeral display:
Set numbers in the numeral memory table.“Numeral Memory Table” (page 82)
- Character-string display:
Set numbers in the character-string memory table.“Character-String Memory Table” (page 81)
- Bar graph:
Set numbers in the numeral memory table. Section 4-5 Bar Graphs (page 83)
- Numeral setting:
Set numbers in the numeral memory table. Section 4-6 Numeral Setting (page 85)
- Character input: Input fixed character-strings.

For the connection procedure to the support tool, refer to Section 2-3 Connecting to the Support Tool (page 25). For the transmission of the screen data, refer to Section 3-6 Registering the Screen Data (page 54).

4-2 Outline of Functions

4-2-1 NT11S Screen

This section gives the outline of the screen which is the basis of all NT11S functions.

For specific operation procedure using host link/NT link such as screen switching, refer to Section 4-3 Screen Display" (page 80).

Composition of the Screen The NT11S screen is composed of horizontal 160 dots x vertical 64 dots. Each dot is set by the combination of the X (horizontal) and Y (vertical) coordinates. The origin of coordinates (0, 0) is set at the top left corner of the screen.

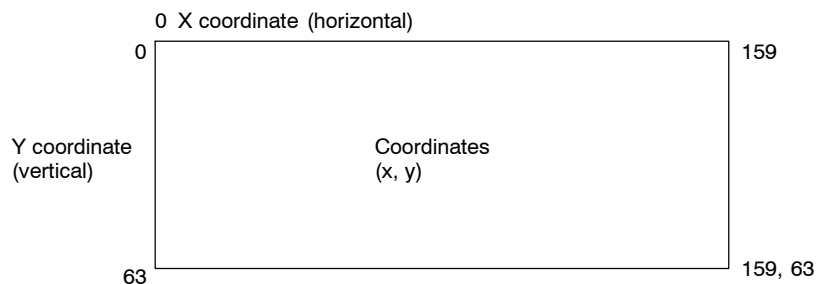

Screen Management

The screens displayed on the NT11S are managed by the screen numbers.

Screen numbers are set when the screen data are created by using the support tool. Up to 250 screens can be set by allocating arbitrarily selected numbers 1 to 250.

The display screens can be switched or the start-up screen can be set by designating the screen number from the PC.

Special Screen Number

Screen number "0" is reserved for the system as the no-display screen. Select this to display nothing on the NT11S screen.

4-2-2 Characters and Figures Which can be Displayed

The NT11S screen can display characters, bar graphs, and other various elements.

This section describes the types and attributes of the characters and figures which can be displayed and do not need to be changed at all.

For the settings, display, and use of the characters, numeric values, and graphs which change according to the system operation status and other conditions, refer to Section 4-4 Memory Tables (page 81) and Section 5-2 Memory Tables and Bar Graph (page 106).

The power of expression of the screen can be increased by giving various attributes such as the enlarged or reverse display to the characters and figures.

The character and figure attributes can be set in the edit screen when creating the screen data by using the support tool.

Types and Attributes of Characters and Figures

The following types of characters can be input by using the support tool and be displayed during operation.

Character Type	Dots (vertical x horizontal)	Character Set	Maximum Number of Characters Displayed in One Screen (without overwriting)
Normal height characters	8 x 16	Alphanumerics and symbols	20 characters x 4 lines (80 characters)
Marks	8 x 16	Create by using the support tool	

- Marks

A mark is a graphic pattern created by 8 (horizontal x16 (vertical) by using the support tool. Marks can be handled the same as the normal size characters. Up to 64 patterns can be defined within the total screen data.

- Enlarged display of the characters and marks

The characters and marks can be enlarged to the following scales.

PT	PT
x1 scale	Double width scale

- Reverse and flashing display

Reverse display: The display brightness of the character and the background is reversed comparing with the normal display.

Flashing display: Characters are displayed as they flash. The normal display alternates with no-display.

Reverse and flashing display: The reverse display alternates with the normal display.

4-3 Screen Display

This section describes the screen information required for the operation with the NT11S.

4-3-1 Classification of Screens

The NT11S is provided with the following types of screens which are classified by the display method.

- Normal screen
- System screen

The screen type is determined by the screen number.

Normal screens (screen numbers 1 to 250)

These screens can be used without restriction by the user to create various kinds of monitor and setting screens, including fixed displays, character displays, numeral displays, and bar graph displays.

System screen (screen number 0)

The system screen is reserved by the NT11S for system applications.

Screen No. 0 Blank screen

4-3-2 Screen Attributes

Assigning an attribute to a screen makes it capable of a special function when it is displayed. For example, when an attempt is made to display a screen for which the "password" attribute is set, a message requesting input of the password will be displayed and the specified screen will not be displayed until the password has been input.

Set screen attributes for each screen by using the "screen selection" screen of the support tool.

It is possible to set more than one of the following attributes for a screen.

Numeral setting attribute This attribute makes it possible to use numeric keys on the panel of the NT11S to input numerical values on screens on which numerical values have to be set. For numeral setting, the write channel, display position, and display method must be set.

Password attribute This attribute ensures security by requesting the input of a password before the screen is displayed. If an incorrect password is input, the screen will not be displayed. The password is set as a four-digit numerical value.

Display history attribute The following three types of data are recorded each time a screen is displayed:

- Display time: Time when the screen was displayed (month, day, hour, minute)
- Screen number: Screen number of the displayed screen
- Screen comment: The comment set for the displayed screen

The recorded data can be printed out using the printing function of the NT11S.

Menu screen attribute This attribute makes it possible to switch to another screen by using the numeric keys.
Assigning the screen numbers of destination screens to numeric keys [1] through [4] enables switching to these screens by numeric key input.

4-4 Memory Tables

The NT11S has the “character-string memory table” for the character data and the “numeral memory table” for numeric data which can be written and updated by the PC.

The contents of the memory tables can be set by using the support tool when displaying the memory tables on the screen or by editing the table.

4-4-1 Character-String Memory Table

The character-string memory table is an NT11S internal memory used to store the character data. Up to 128 character-string memory tables can be used, and up to 20 characters (20 bytes) can be stored in one memory table. The character-string memory tables at up to 8 positions can be registered in one screen.

Displaying a Character-string

The character-string memory tables are registered with table numbers 0 to 127.

When creating the screen data by using the support tool, set the position on the screen to display a character-string and also set a character-string number to be displayed.

When the NT11S is operated, the screen displays the contents of the character-string memory table.

Characters and Figures Which can be Displayed

The power of expression of the screen can be increased by giving various attributes such as the enlarged or reverse display to the characters of the character-string memory table.

The character attributes can be set in the edit screen when creating the screen data by using the support tool.

The following types of characters can be displayed on the NT11S:

Character Type	Dots (vertical x horizontal)	Character Set	Maximum Number of Characters Displayed in One Screen (without overwriting)
Normal height characters	8 x 16	Alphanumerics and symbols	20 characters x 4 lines (80 characters)
Marks	8 x 16	Create by using the support tool	

- Enlarged display of the characters and marks

The characters and marks can be enlarged to the following scales.

Double width scale.

- Reverse and flashing display

Reverse display: The display brightness of the character and the background is reversed comparing with the normal display.

Flashing display: Characters are displayed as they flash. The normal display alternates with no-display.

Reverse and flashing display: The reverse display alternates with the normal display.

4-4-2 Numeral Memory Table

The numeral memory table is an NT11S internal memory used to store the numeral data. Up to 128 numeral memory tables can be used, and up to eight digits (four bytes) of numeral data (including signs) can be stored in one numeral memory table. The numeral memory tables at up to 8 positions can be registered in one screen.

Displaying a Numeral

The numeral memory tables are registered with table numbers 0 to 127.

When creating the screen data by using the support tool, set the position on the screen to display a numeral and also set a numeral number to be displayed.

When the NT11S is operated, the screen displays the contents of the numeral memory table.

Also, by relating the numeral memory tables with the bar graphs, the bar graphs corresponding to the data of the numeral memory tables can be displayed.

Numerals Which can be Displayed

The power of expression of the screen can be increased by giving various attributes such as the enlarged or reverse display to the numerals of the numeral memory table.

The numeral attributes can be set in the edit screen when creating the screen data by using the support tool.

The following types of numerals can be displayed on the NT11S:

- Digits of the whole numbers: 1 to 8 digits
- Digits of the decimal fraction: 0 to 7 digits
- Character sizes: Normal
- Enlarged display: Double width
- Sign display setting
- Decimal/hexadecimal display setting
- Zero suppress setting

Reference Zero suppress setting

The numeral data are displayed in designated display areas as right-aligned. If the number of digits of a numeral data is smaller than that of the display area, number "0"s will be displayed at the vacant digits. These "0"s will not be displayed if the zero suppress setting is made for "Yes".

4-5 Bar Graphs

The contents of the numeral memory tables of the NT11S can be displayed as bar graphs as well as numeral data.

4-5-1 Bar Graph Functions

The bar graph function displays a value in a bar graph form as a percentage to the specified value according to the contents of a numeral memory table. Up to 4 bar graphs can be registered in one screen.

- Reference table

The numeral memory table used as the reference for the bar graph display can be set.

Note

The bar graph display cannot use hexadecimal numbers. If hexadecimal numbers are set in the reference numeral memory table, the bar graph cannot be displayed.

Bar Graph Attributes

The following attributes can be set with the NT11S for the bar graph display:

Use the support tool to make settings for the bar graph display when creating the screen data.

- Position and size

The display position and size (length) of a bar graph can be set.

The width of the bar graph can be set in the range of 8 dots.

- Orientation and incremental direction

The type of bar graph displayed by the NT11S has a horizontal orientation and increments to the right.



Direction: →

- Graph frame

Select whether or not the graph frame (boundary line of a graph display area) which indicates the effective display range is displayed.



← This frame is not displayed if "Graph frame: No" has been set.

- Setting the 100 % value and % display

Set a value which corresponds to 100 % for the “100 % value”. The available value range is “0 to 99999999” (max. eight digits). For the “% display”, whether or not the proportion (percentage) of the reference numeral memory table value to the “100 % value” is displayed in a numeral can be selected. The display value is calculated as follows:

$$\text{“% display” value} = \text{Numeral memory table value} \div \text{“100 % value”} \times 100$$

For the font and attributes used for the numeral display, refer to “Numerals which can be displayed” (page 82).

- Display of negative values (less than 0%)

The bar graph is displayed in the range of 0 % to 100 %. The end of the bar graph indicates 0 %. Values below 0 % are indicated as 0 %.

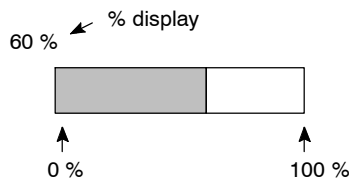

- Display method when the percentage value is in the range 100% to 999%

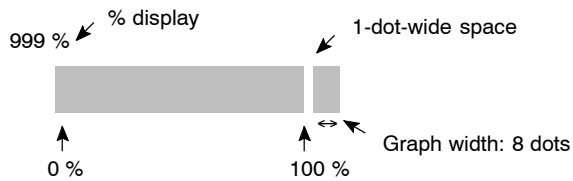

- Display method when the percentage value is 1000% or greater

The bar graph will be displayed the same as (2) above.

The percentage value is indicated by three asterisks:

***%

4-6 Numeral Setting

The NT11S features a numeral setting function which makes it easy to input numerical value on the screen.

4-6-1 The Numeral Setting Function

The numeral setting function is used to enter numerical values directly into a numeral memory table from the screen. Screen upgrading and PC notification are executed simultaneously.

Numerical values are input from the screen by using the numeric keys. A maximum of 8 numeral settings can be registered for one screen.

Basic Procedure

The procedure for numeral setting is as follows.

- (1) Input the numerical value using numeric keys.
- (2) The input numerical value is displayed in the numeral setting area on the screen.
- (3) Confirm the input numerical value (by pressing the [ENTER] key); it will be written to the numeral memory table, and simultaneously notified to the PC.

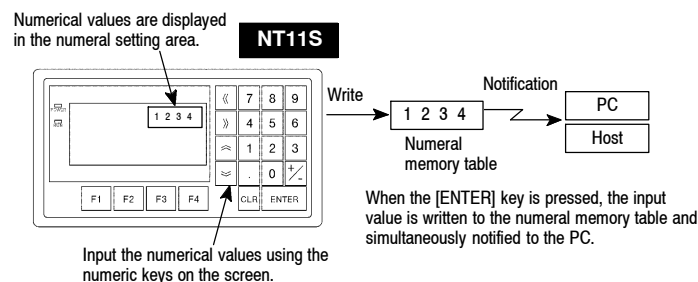

If there is more than one numeral setting area, the one in which the numerical value is to be input can be selected by using \leftarrow , \rightarrow , \uparrow , or \downarrow key.

If the numeral setting area is changed during numerical value input (before pressing the "ENTER" key), the numerical value being input is invalidated. To clear a numerical value, press the [CLR] key.

Restrictions on Input

Using the numeral setting function, decimal values of up to 8 digits (7 digits if a negative value) can be input.

The number of digits and area for the numeral setting function are set using the support tool.

It is also possible to set the following attributes:

- Number of integer digits: 1 to 8
- Number of decimal fraction digits: 0 to 7
- Type of character: Half-size characters
- Character enlargement: Horizontal x2
- Sign display designation
- Zero suppress designation





The details for numeral attributes etc., are largely the same as for numeral display (refer to “Numerals which can be Displayed” (page 82)).

4-6-2 Using Numeric Keys

To input numerical data at a numeral setting area during operation, first select the numeral setting at which the data is to be input, and then input the numerical value by pressing the numeric keys.

Selecting the Numeral Setting Area for Data Input

If there is more than one numeral setting area on the screen, select the one where numerical data is to be input using the arrow keys. The numeral setting area currently selected for input is indicated by a frame (cursor) displayed around the input area.

To select other numeral setting areas, use the , ,  and  arrow keys. By using these keys, the cursor can be shifted between multiple numeral setting areas (to select the one where data is to be input) in the way shown in the figure below.

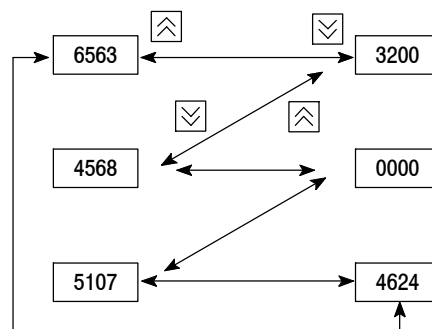

Inputting Numerical Values

Input numerical values using the following numeric keys: numerals (0 to 9), decimal point (.), sign (+,-), clear (CLR), and return ([ENTER]).

- Inputting the integer and decimal fraction parts

Input the integer and decimal fraction separately. First input the integer, then press the decimal point key (.) and input the decimal fraction.

If the integer or decimal fraction exceed their respective allowable numbers of display digits, they are shifted to the left.

4-7 Menu Screen Function

The NT11S has a function whereby screens can be switched even in the absence of a screen switching instruction from the PC, by using numeric keys on the screen. This function is called the menu screen function.

When screen data is created with the support tool, specify “menu screen” as the screen attribute and assign switching destination screen numbers to numeric keys 1 through 4.

If one of these numeric keys is pressed during operation, the screen whose number was assigned to the key will be displayed. At the same time, the screen number of the destination screen is notified to the PC.

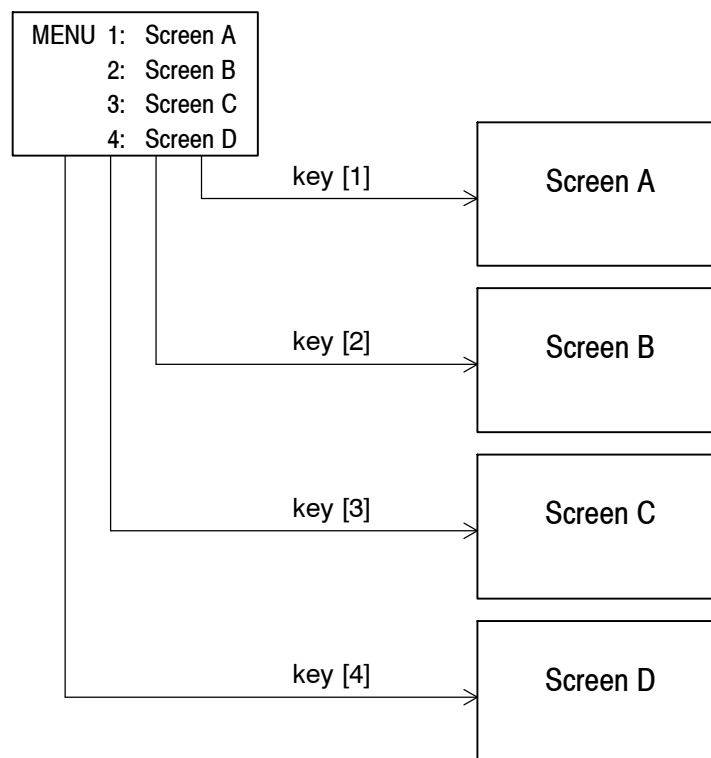

- Up to four destination screens can be registered per screen using the menu screen function. The screen numbers of the destination screens are assigned to numeric keys [1] to [4].
- For details on menu screen setting, refer to the NT11S support tool operation manual.

For the details of the menu screen setting, refer to the “NT-series NT11S Support Tool Operation Manual” (V030-E1-□).

4-8 Password Screen Display Function

For the purposes of security, the NT11S has a function that requires a password to be input before the specified screen can be displayed.

This section explains how to set and use passwords.

Screen transition in password input

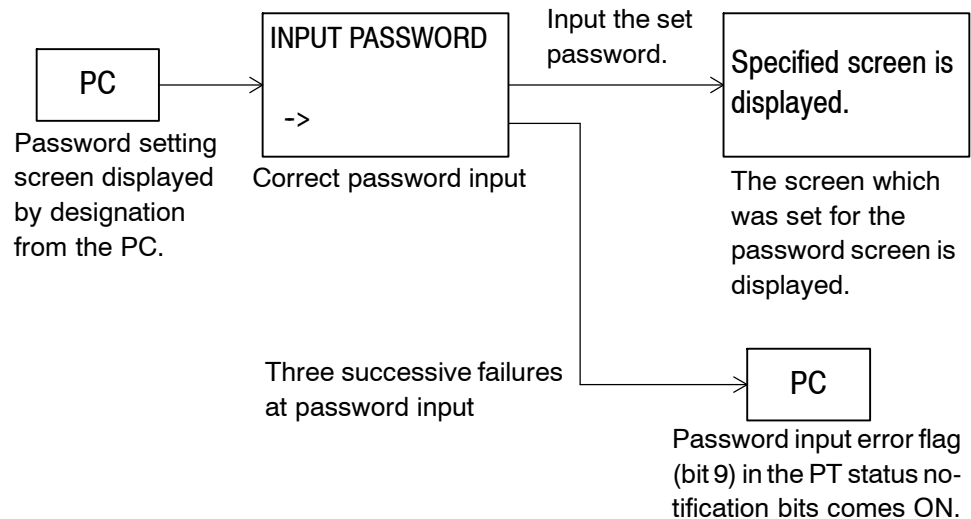

Notes on password input

- The password is set as a four-digit numerical value.
- The password for a password screen is input using the numeric keys on the panel of the NT11S.
- When a password is input, it is not displayed on the screen. Only a box shaped cursor is displayed.
- The input password is checked after input of the fourth digit. There is no need to press the “ENTER” key.
- If the correct password is not input in three successive attempts, the password input error flag (bit 4) in the PT status notification bits comes ON and the specified screen is not displayed.

Password screen setting

The password and switching destination screen setting for the password screen are set using the support tool.

- Setting items
 - Number used as the password
 - Display start position
 - Switching destination screen

Procedure for displaying the password screen

Explained here is the procedure for displaying the password screen by specification from the PC.

The password screen is displayed by writing the screen number of the screen for which the password setting was made into the screen switch setting word of the PT status control area.

[Screen switch setting word of the PT status control area]

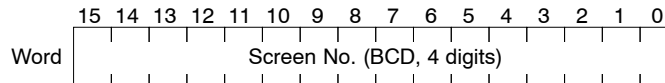

- Setting with the support tool

Make the following settings with the support tool.

PT status control area allocated word: CH0120
 PT status notify area allocated word: CH0130
 Password screen number: 10
 Screen number displayed on password input error: 20

- PC program

Create the following PC ladder program.

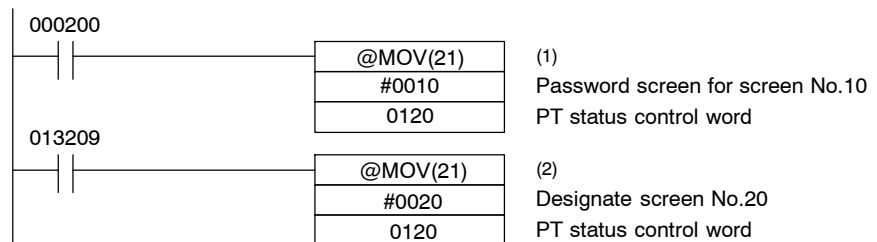

- Program operation

- (1) When contact 000200 comes ON, "10" is set in the screen switch setting word of the PT status control area. As a result, the password screen for screen number 10 is displayed.
- (2) If the correct password is not input in three successive attempts, contact 013209 (the password input error flag (bit 4) in the PT status notification bits) comes ON.
 On occurrence of a password input error, "20" is set in the screen switch setting word of the PT status control area and the screen whose screen number is 20 is displayed.

4-9 Display History Screen Function

The display history screen function is a function that records the display times, screen numbers, and screen comments of screens for which the display history attribute has been set using the support tool, in the order in which they were displayed.

The recorded data can be printed out by using the display history printing function.

Recording a display history

The procedure for recording a display history is presented below.

Operation 1. Set the screen attribute.

When creating screens with the support tool, set the display history attribute for those screens whose display history is to be recorded.

The display history will only be recorded for screens for which the display history attribute is set.

2. Compilation of display history records

When a screen for which the display history attribute is set is displayed during operation, this is recorded in the display history in the NT11S.

- When compiling the display history, the following data relating to displayed screens is recorded in the memory:

Display time: Time when the screen was displayed
(month, day, hour, minute)

Screen number: Screen number of the displayed screen

Screen comment: The comment set for the displayed screen

The screen number of the screen for which the display attribute is registered is recorded in the record data area each time the screen is designated by the PC.

A maximum of 256 records can be made in the display history (the number varies according to the memory capacity).

When the quantity of history data has reached the storage capacity, no new history data will be recorded.

The recorded data is deleted when the power is switched OFF.

If the recorded data is required, print it out before switching the power OFF.

Printing out the display history

The recorded display history can be printed out at a printer connected to the NT11S. For details on how to do this, see section 4-10 "Daily Report/Display History Printing Function" (page 91).

4-10 Daily Report/Display History Printing Function

The NT11S can print daily reports and display histories in response to instructions from the PC.

This section describes the procedure for printing daily reports and display histories.

Reference Printers of the following type can be connected to the NT11S:
Models compatible with EPSON standard code (ESC/P)

4-10-1 Printing Daily Reports

The contents of the designated word are read and printed out in accordance with a format registered in advance with the support tool.

The method used to print the daily report is described below.

Printing format

Create the printing format by using the support tool.

- The following types of characters and numerals can be printed:
 - Fixed characters
 - Character attribute: Normal, Reverse
 - Character size: Equal, Wide
 - Variable characters (characters printed after reading the contents of a designated word device)
 - Character attribute: Normal
 - Character size: Equal, Wide
 - Variable numerical values (numerical values printed after reading the contents of a designated word device)
 - Display sign: Yes
 - Zero suppression: Yes
 - Number of digits: 2 words (8 digits)
- Items set with the support tool
 - Printing format
 - Numerical value/character-string storage word (type of word and head word)
 - Display start position (Designate the top left position. Any line and column can be specified.)
 - Number of integral digits displayed (1 to 8)
 - Number of digits displayed after the decimal point (0 to 7)
 - Number of characters (Specified as the number of words: 1 word = 2 characters.)

• Example printout

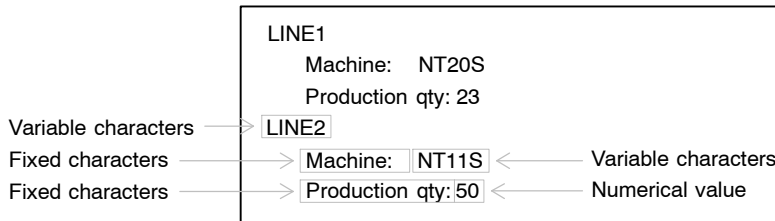

Printing procedure

Explained here is the procedure for printing a daily report in response to an instruction from the PC.

The printing instruction from the PC takes effect by setting the status of bit 4 (daily report printing) of the PT status control area.

To designate printing, bit 4 of the PT status control area is set to "1". One report is printed each time bit 4 is set to "1". To print the report again, the bit status must be returned to "0" and then set to "1" again.

[PT status control bits of the PT status control area]

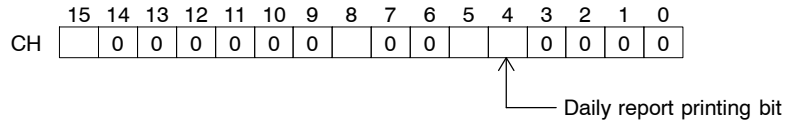

• Setting at the support tool

Perform the following setting with the support tool.

PT status control area allocated word: CH0120

• PC program

Create the following PC ladder program:

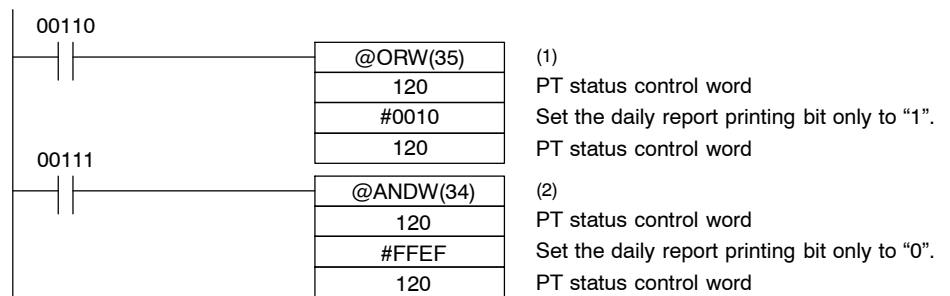

• Program operation

(1) When contact 00110 comes ON, the daily report printing bit (bit 4) of the PT status control area is set to "1". The status of bits other than bit 4 remains unchanged.

When bit 4 is set to "1", the daily report is printed.

(2) When contact 00111 comes ON, the daily report printing bit (bit 4) of the PT status control area is set to "0". The status of bits other than bit 4 remains unchanged.

4-10-2 Printing Display Histories

The data recorded by the display history screen function can be printed. This section explains the procedure for printing display histories.

Printing format

In display history printing, the display number, display time, and comment for the displayed screen are printed in a fixed format.

- Items set with the support tool
 - Attribute of the displayed screen
 - Comment for the displayed screen
- Example printout

NO.	DATA-TIME	SCREEN	COMMENT
0001	02/04-08:32	0001	LINE ERROR
0002	02/04-10:21	0005	MOTOR ERROR
0003	02/04-10:48	0019	COMPRESSER ERROR
0004	02/04-11:50	0005	MOTOR ERROR
0005	02/05-14:28	0019	COMPRESSER ERROR
0006	02/06-13:17	0040	PRESS

Reference The NT11S does not incorporate a clock. Time data is recorded by referring to the PC clock data.

Printing procedure

Explained here is the procedure for printing a display history in response to an instruction from the PC.

The printing instruction from the PC takes effect by setting the status of bit 5 (display history printing) of the PT status control area.

To designate printing, bit 5 of the PT status control area is set to "1". One report is printed each time bit 5 is set to "1". To print the report again, the bit status must be returned to "0" and then set to "1" again.

[PT status control bits of the PT status control area]

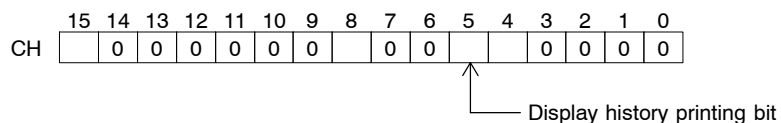

- Setting at the support tool

Perform the following setting with the support tool.

PT status control area allocated word: CH0120

- PC program

Create the following PC ladder program:

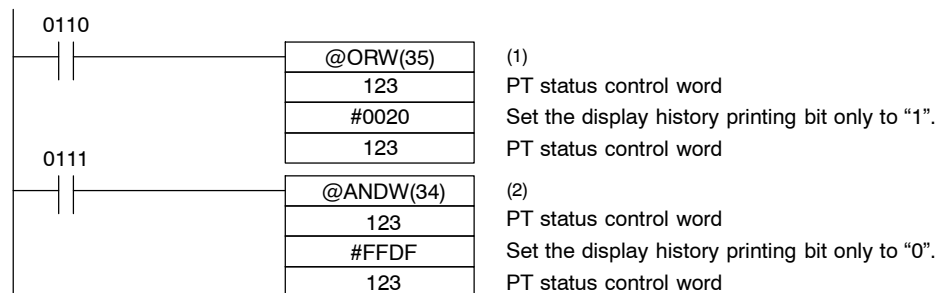

- Program operation

- (1) When contact 0110 comes ON, the display history printing bit (bit 5) of the PT status control area is set to "1". The status of bits other than bit 5 remains unchanged.
When bit 5 is set to "1", the display history is printed.
- (2) When contact 0111 comes ON, the display history printing bit (bit 5) of the PT status control area is set to "0". The status of bits other than bit 5 remains unchanged.

SECTION 5

Using Host Link/NT Link

This section describes how the NT11S can be used when using the host link/NT link.

5-1	Outline of Host Link / NT Link Operation	96
5-1-1	Equipment and Settings Used in This Chapter	96
5-1-2	Allocatable Bits and Words	96
5-1-3	Data Exchange in the Host Link/NT Link	96
5-1-4	NT11S Status Control and Notification to PC	97
5-1-5	Switching the Screen Display	101
5-1-6	Notifying the Display Screen to the PC (To Display the Number of Currently Displayed Screen)	103
5-2	Memory Tables and Bar Graph	106
5-2-1	Allocation Words and Display of the Memory Tables	108
5-2-2	Changing Displayed Numerals or Character Strings (Changing the Contents of Allocated Words Direct Specification)	111
5-2-3	Copying the Memory Table	114
5-2-4	Upgrading Bar Graphs (Changing the Contents of Allocated Words)	118
5-3	Numeral Setting	119
5-3-1	Notification of Numbers to the PC	119
5-4	NT11S Status Control	122
5-4-1	Controllable NT11S Functions	122
5-4-2	How to Control NT11S Functions	124
5-5	Notification of the Operating Status to the PC (Determining the NT11S Operating Status)	126
5-5-1	Ascertainable NT11S Statuses (Notified Operating Statuses)	126
5-5-2	Reading the NT11S Operating Statuses	128

5-1 Outline of Host Link / NT Link Operation

This section describes the basics for operating the NT11S through communications with the PC using the host link/NT link.

5-1-1 Equipment and Settings Used in This Chapter

The following equipment and settings are used in the examples in this Chapter:

[Equipment] PT : NT11S-ST121
 PC : CQM1
 Support tool : NT11S Support Tool

5-1-2 Allocatable Bits and Words

The following bits and words are allocated to the PC and used for the NT11S operation. The range of respective area varies with the type of PC. Refer to Appendix H PC Memory Map (page 160).

The allocations must be made without exceeding respective area range.

[OMRON PCs]

Symbol	Area Name	Allocated Bit	Allocated Word	
			Numeral	Character String
DM	Data Memory	○	○	○
CH	Internal/Special Relay	○	○	○
TIM	Timer		△	
CNT	Counter		△	
HR	Holding Relay	○	○	○
AR	Auxiliary Relay	○	○	○
LR	Link Relay	○	○	○

○: OK △: 1 word only : NG

Reference One allocation word of the memory table can use continuous areas of up to 2 words in the case of numeral memory table or 10 words in the case of character-string memory table.

Note When allocating a memory table to words, the allocation must not exceed the word area.

5-1-3 Data Exchange in the Host Link/NT Link

There are two main methods for data exchange when using the host link/NT link, as follows:

- Using the PT status control area/PT status notify area
- Allocating numeral memory tables/character string memory tables

Using the PT status control area/PT status notify area

Contiguous areas (4 words for the PT status control area and 3 words for the PT status notify area) must be allocated in the PLC memory in advance.

Screen switching, memory table copy and PT status change operations, etc, are possible by using the PT status control area and PT status notify area.

Allocating numeral memory tables/character string memory tables

Allocating memory tables to a data area secured in the PLC memory allows the display to be automatically updated.

5-1-4 NT11S Status Control and Notification to PC

This section describes the fundamentals of the display elements, NT11S status control, and notification which are the basics of the NT11S functions.

For the detail method of use of the PT status control area and the PT status notify area, refer to Sections 5-4 NT11S Status Control (page 122) and 5-5 Notification of the Operating Status to the PC (page 126).

Controlling the Display Elements by Using Allocated Bits and Words

The NT11S will operate as follows in the display element control operation.

[NT11S operation]

- (1) The NT11S checks the allocation bits and words of the display elements and makes an inquiry to the PC.
- (2) The PC answers the NT11S about the bit and word data.
- (3) The NT11S changes the display status according to the bits and words obtained from the PC.

[NT11S operation example]

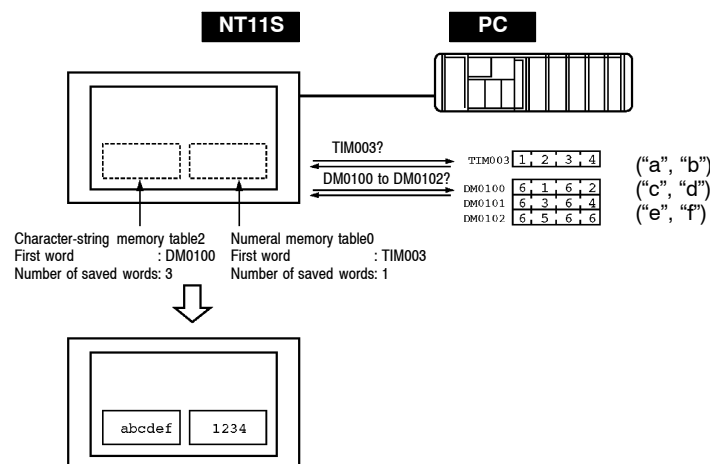

Controlling the NT11S Status by Using Allocated Bits and Words PT Status Control Area (PC to PT)

The PT status control area (PC to PT) is provided to control the NT11S status from the PC. When data is written to this area in the PC, the NT11S will read the data and operates according to the data. The PT status control area is configured as four consecutive words as shown below.

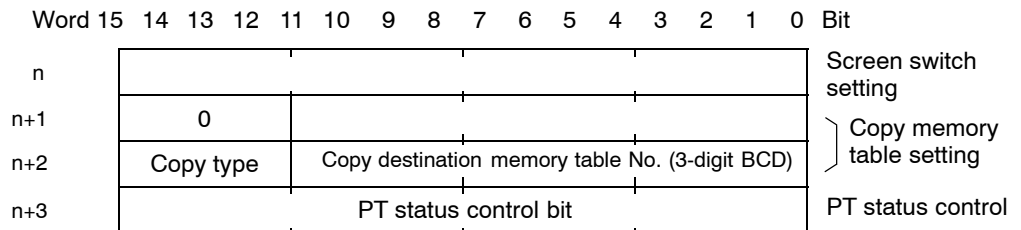

The first word (word n) of the PT status control area must be set with the support tool.

- Screen switch settings (refer to page 101)
Specify the screen No. to switch the screen displayed on the NT11S.
- Copy memory table settings (refer to page 114)
Specify the memory table No. to copy the contents of a memory table internally in the NT11S.
Set the copy type to match the type of memory table to be copied:
0: Character-string memory table
1: Numeral memory table
- PT status control bits (refer to page 122)
Set the bits ON or OFF according to the following table to control the backlighting. For the bit configuration, refer to “5-4-1 Controllable NT11S Functions” (page 122).

The PT status control area (PC to PT) can be allocated to the following PC areas.

Symbol	Area Name	Allocated
DM	Data memory	○
CH	Internal/Special Relay	○
TIM	Timer	
CNT	Counter	
HR	Holding Relay	○
AR	Auxiliary Relay	○
LR	Link Relay	○

○: OK : NG

Notifying the Display Elements by Using Allocated Bits and Words

The NT11S will operate as follows in the display element notification operation.

[NT11S operation]

The NT11S will write any changes in the contents of the numeral or character-string memory table being displayed or pressing of a system keys to the bits and words area in the PC.

[NT11S operation example]

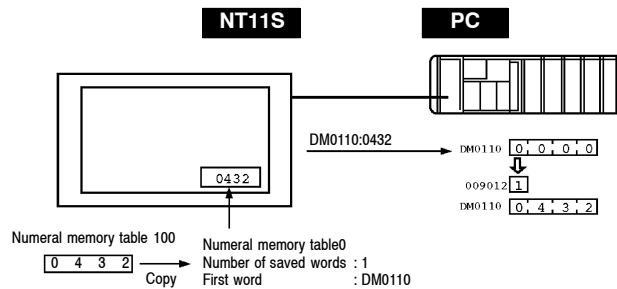

Notifying the NT11S Status by Using Allocated Bits and Words PT Status Notify Area (PT to PC)

The PT status notify area (PT to PC) is provided to notify the NT11S status changes to the PC. When any NT11S status has changed, such change is written to this area in the PC, and the PC will read the data from this area to check the NT11S status.

The PT status notify area is configured as three consecutive words as shown below.

Word	15	14	13	12	11	10	9	8	7	6	5	4	3	2	1	0	Bit
m																Screen being displayed	
m+1	0		Numeral memory table No. (3-digit BCD)														Content upgrade memory table
m+2											0		0				PT status

The first word (word m) of the PT status notify area must be set with the support tool.

- Currently displayed screen (refer to page 101)

The screen number displayed on the NT11S is written to this word.

Simultaneously, the PT status screen switch strobe flag is set to ON (1). After this is notified to the PC, this flag reverts to OFF (0). Checking the status of this flag will provide a simple method of checking if the NT11S display has switched.

- Content upgrade memory table (refer to page 119)

The number of the numeral memory table is written to the word when the numeral memory table contents change due to the System keys operation on the NT11S.

The contents of the word to which the numeral memory table has been allocated also change.

As the number of the numeral table is written, the PT status numeral setting strobe flag is simultaneously set ON (1). After this is notified to the PC, this flag reverts to OFF (0). Checking the status of this flag will provide a simple method of checking if a number has been input from the NT11S.

Note that this function is not available with the character-string memory table.

- PT status (refer to page 126)

The NT11S operation status and other information are written with the ON or OFF of the bits as shown below.

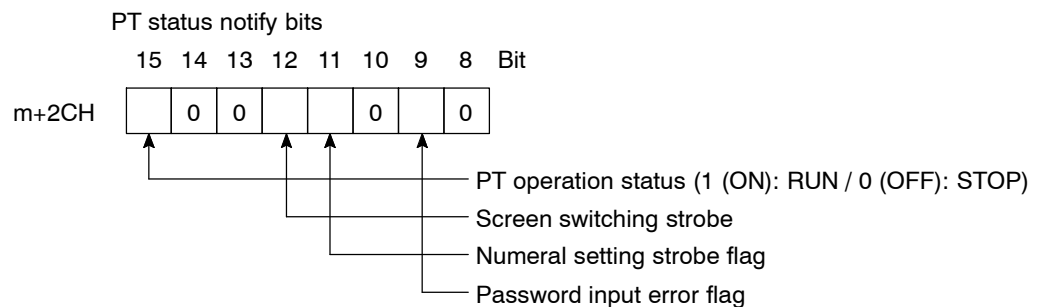

The PT status control area (PC to PT) can be allocated to the following PC areas.

Symbol	Area Name	Allocated
DM	Data Memory	○
CH	Internal/Special Relay	○
TIM	Timer	
CNT	Counter	
HR	Holding Relay	○
AR	Auxiliary Relay	○
LR	Link Relay	○

○: OK : NG

⚠ Caution Set so that there is no overlap between the PT status control area and PT status notify area. Otherwise the system may operate unpredictably.

5-1-5 Switching the Screen Display

The following describes the procedure used to switch the NT11S screen display by controlling from the PC.

Reference The display screen can be switched also by pressing a numeric key during the operation after registering a screen number to the numeric key. For this function, refer to the "4-7 Menu Screen Function" (page 87).

To switch the NT11S screen display by controlling from the PC, write a screen number at the "screen switch setting" in the PT status control area.

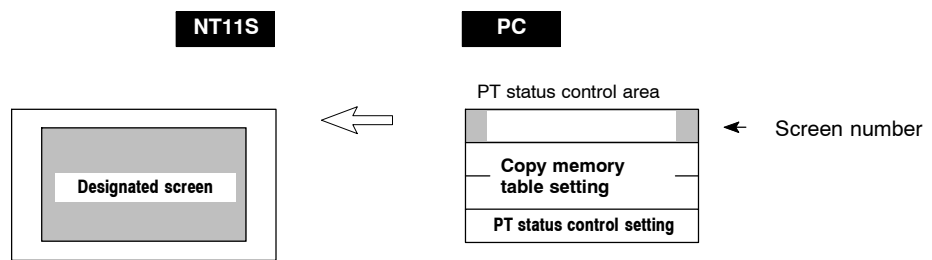

[Screen switch setting in the PT status control area]

PT status notify bits
 15 14 13 12 11 10 9 8 7 6 5 4 3 2 1 0 Bit

Word n Screen No. (4-digit BCD) Screen switch setting

Screen number:0000 (screen clear, no-display)
 0001 to 0250

- Available allocation words

The PT status control area (PC to PT) can be allocated to the following PC areas.

Symbol	Area Name	Allocated
DM	Data Memory	○
CH	Internal/Special Relay	○
TIM	Timer	
CNT	Counter	
HR	Holding Relay	○
AR	Auxiliary Relay	○
LR	Link Relay	○

○: OK : NG

The range of respective area varies with the type of PC. Refer to Appendix H PC Memory Map (page 160).

- Procedure**
1. Use the support tool to allocate the PT status control area (PC to PT) to the PC memory.
 2. Create a PC program to write the number of the displayed screen to the "screen switch setting word" in the PT status control area.

Reference Use a 4-digit BCD (binary-coded decimal) value to set a screen number. If a screen has been switched by operating the PT status control area (PC to PT), the contents of the "currently displayed screen word" in the PT status notify area (PT to PC) also change.

- Screen switching timing

The NT11S screen switches when the contents of the "screen switch setting" have changed. To re-specify the number of the currently specified screen, first write the value 0000 to clear the screen before writing the appropriate screen number.

- Use of the screen switching strobe

Create a program to read the number of the currently displayed screen and to write the number to the "screen switch setting word" at the leading edge of the "screen switching strobe" of the PT status notify area. This program enables screen switching by using the Menu screen on the NT11S and eliminates repeated setting of the same screen number. If the screen switching is not executed on the NT11S, the screen switching strobe does not need to be checked.

For the screen switching strobe, refer to the "notifying the displayed screen to the PC" mentioned below.

Example of Display Screen Switching

This example operates the PC switch (bit) to switch the NT11S display screen.

- Support tool settings

Make the following settings with the support tool:

PT status control area: Word 0100

PT status notify area: Word 0110

Screen number to be created: Screen No.2 and No.3

- PC ladder program

Create a PC ladder program as follows:

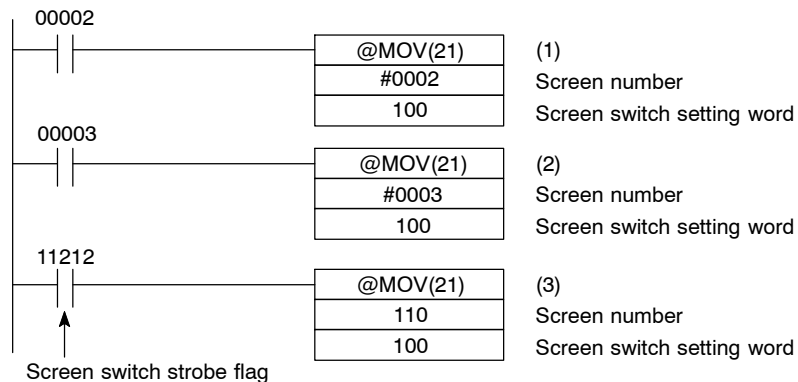

- Program operation

- (1) Screen No.2 is displayed on the NT11S when bit 00002 turns ON.
- (2) Screen No.3 is displayed on the NT11S when bit 00003 turns ON.
- (3) When the screen switch strobe flag turns ON, the number of the currently displayed screen is read and written to the currently displayed screen word in the PT status notify area. In this case, the NT11S will not write the same screen twice.

5-1-6 Notifying the Display Screen to the PC (To Display the Number of Currently Displayed Screen)

The following describes the processing to display the number of currently displayed screen of the NT11S.

This processing reads the data from the PC status notify area.

To indicate that the screen has switched, use the screen switch strobe flag.

To display the number of the currently displayed screen, use the currently displayed screen word.

When the screen has switched, the NT11S notifies the following to PT status notify area (PT to PC) allocated to the PC.

Screen switch notification:	Screen switch strobe flag of the PT status word
New screen number:	Currently displayed screen word

By reading the currently displayed screen word when the screen switch strobe flag has turned ON, the number of the currently displayed screen on the NT11S is displayed.

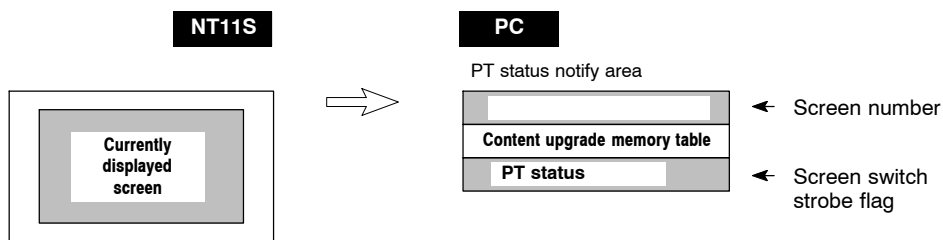

[Currently displayed screen] and [PT status] words in the PT status notify area

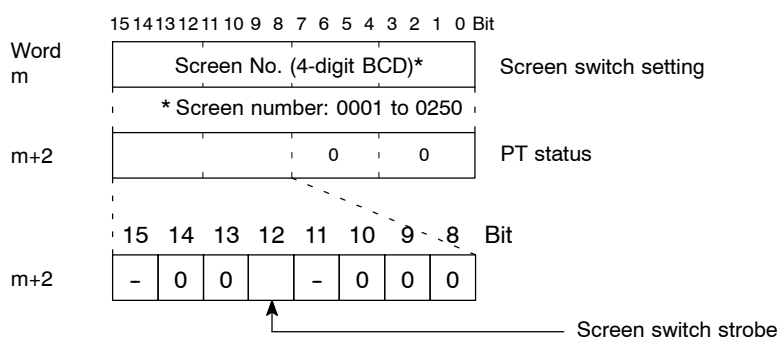

Use a 4-digit BCD (binary-coded decimal) value to set a screen number.

The screen switch strobe bit reverts to OFF (0) after this is notified to the PC.

- Available allocation words

The PT status notify area (PT to PC) can be allocated to the following PC areas.

Symbol	Area Name	Allocated
DM	Data memory	○
CH	Internal/Special Relay	○
TIM	Timer	
CNT	Counter	
HR	Holding Relay	○
AR	Auxiliary Relay	○
LR	Link Relay	○

○: OK : NG

The range of respective area varies with the type of PC. Refer to Appendix H PC Memory Map (page 160).

- Procedure**
1. Use the support tool to allocate the PT status notify area (PT to PC) to the PC memory.
 2. Create a PC program to read the “currently displayed screen word” in the in the PT status notify area when the “screen switch strobe flag” in the PT status notify area has turned ON.

- Reference**
- The contents of the “currently displayed screen word” are updated also by switcheing the screen by using the menu screen function of the NT11S.
 - For details on the menu screen function, refer to 4-7 “Menu Screen Function” (page 87).

Example of Reading the Number of Currently Display Screen

This example gives a PC program that reads the screen number each time the screen is switched. In this example, the number of the previous screen is also stored.

- Support tool settings

Make the following settings with the support tool:

PT status notify area: Word 0110

- PC ladder program

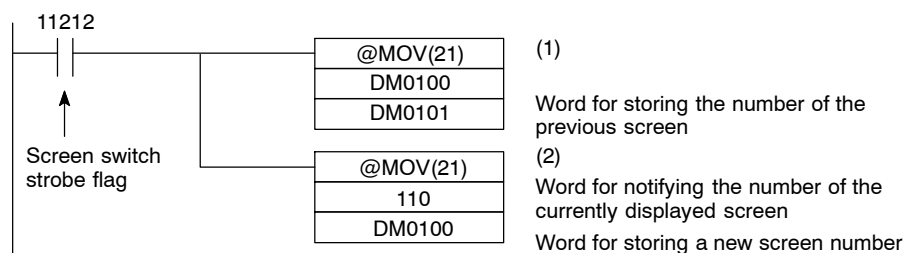

- Program operation

- (1) When the NT11S screen display switches and the screen switch strobe flag (bit 11212) turns ON, the contents of DM0100 are transferred to DM0101. The number of the previously displayed screen is stored in word 0101.
- (2) The new screen number notified by the NT11S is read and transferred to DM0100. The number of the currently displayed screen is stored in DM0100.

5-2 Memory Tables and Bar Graph

This section describes allocation of the memory table to PC words, and changes to the contents of words necessary to display characters, numerals, and graphs by communicating with the PC using the host link/NT link.

For the functions relating to memory tables and bar graphs, refer to 4-4 Memory Tables (page 81) and 4-5 Bar Graphs (page 83), respectively.

Writing Words to the Character-String Memory Table

Since the character-string memory tables can be allocated to the words in the PC, the PC can write data to the character-string memory tables or the initial values can be set when creating the screen data.

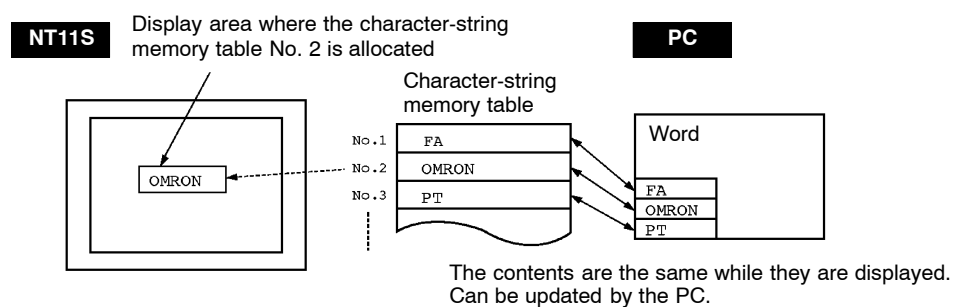

During the operation, the display contents are automatically updated so that the contents of the character-string memory table being displayed are the same as that of the PC word.

Setting the Words of the Character-String Memory Table

When creating the screen data by using the support tool, make the following settings for each numbered character-string:

- Initialization setting

Set whether or not the PC words are initialized with the character-string memory table initial value registered to the screen data memory when the main power supply is turned ON or reset.

- Number of registration words

Set the number of words within 8 words required for registering the character-string data. One word can store two characters.

- Setting the words for the character-string memory tables

The character-string memory tables can be allocated to the following PC words. Set the word type and the first word.

Symbol	Area Name	Allocated
DM	Data memory	<input type="radio"/>
CH	Internal/Special Relay	<input type="radio"/>
TIM	Timer	
CNT	Counter	
HR	Holding Relay	<input type="radio"/>
AR	Auxiliary Relay	<input type="radio"/>
LR	Link Relay	<input type="radio"/>

: OK : NG

If the “number of registration words x 2” (“word setting window”) set with the support tool is larger than the “number of character digits” (“character-string display setting” window), the character-string may be broken halfway.

The range of respective area varies with the type of PC. Refer to Appendix H PC Memory Map (page 160).

Writing Numerals to the Numeral Memory Table

Since numeral memory tables can be allocated to PC words, it is possible to write data into the numeral memory tables from the PC and to set the initial values during screen data creation.

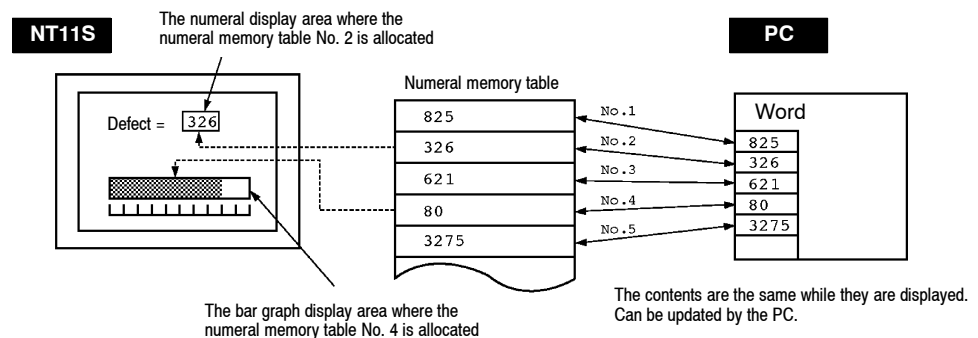

During the operation, the display contents are automatically updated so that the contents of the numeral memory table being displayed are the same as that of the PC word.

Setting the Words of the Numeral Memory Table

When creating the screen data by using the support tool, make the following settings for each numbered numeral:

- Initialization setting

Set whether or not the PC words are initialized with the numeral memory table initial value registered to the screen data memory when the main power supply is turned ON or reset.

- Number of registration words

Set the number of words within 2 words required for registering the numeral data. One word can store up to 4 digits. Two words can store up to 8 digits.

- Setting the words for the numeral memory tables

The numeral memory tables can be allocated to the following PC words. Set the word type and the first word.

Symbol	Area Name	Allocated
DM	Data Memory	○
CH	Internal/Special relay	○
TIM	Timer	△
CNT	Counter	△
HR	Holding Relay	○
AR	Auxiliary Relay	○
LR	Link Relay	○

○: OK △: 1 word only : NG

The range of respective area varies with the type of PC. Refer to Appendix H PC Memory Map (page 160).

5-2-1 Allocation Words and Display of the Memory Tables

The character-string memory table and numeral memory tables can be allocated to the following PC words.

Set the word type and the first word. The number of words required for allocating a memory table and the areas to which a memory table can be allocated vary between the character-string memory table and the numeral memory table.

- Number of words required for the allocation

The number of words used for allocating one memory table is as mentioned below.

Numeral memory table: 1 word (max. 4 digits) or 2 words (max. 8 digits)

Character-string memory table: 1 to 10 words (2 to 20 characters)

- Available allocation words

The memory tables can be allocated to the following PC areas:

Symbol	Area Name	Allocation	
		Numeral	Character
DM	Data Memory	○	○
CH	Internal/Special Relay	○	○
TIM	Timer	△	
CNT	Counter	△	
HR	Holding Relay	○	○
AR	Auxiliary Relay	○	○
LR	Link Relay	○	○

○: OK △: 1 word only : NG

The range of respective area varies with the type of PC. Refer to Appendix H PC Memory Map (page 160).

- Contents of the numeral memory tables

Numerals are stored in the allocated words as shown below.

[Stored as a single word]

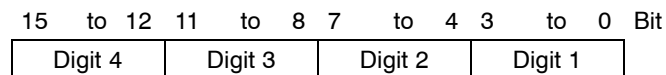

Example: 1234

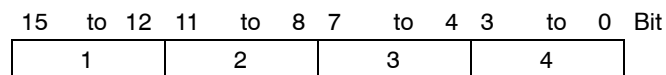

[Stored as a double words]

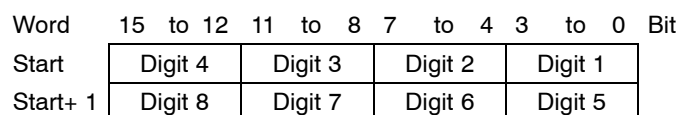

Example: 12345678

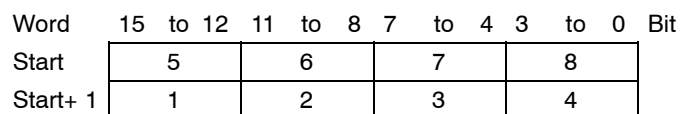

- Displaying the numeral memory table

Numerals can be displayed in three different ways according to the contents of the numeral memory table, as mentioned below.

The most significant digit (digit 4 of a single word or digit 8 of a double word) is processed in different ways.

Hexadecimal display: All digits are handled as stored in the allocated words.

Decimal display without signs: If the most significant digit is “F”, it is handled as “0”, and the most significant digit other than “F” and other digits are handled as stored in the allocated words.

Decimal display with signs: If the most significant digit is “F”, it is handled as “-” (minus sign), and the most significant digit other than “F” and other digits are handled as stored in the allocated words.

[Numeral memory table display examples]

- When the data are numeral data (0 to 9)

Start	3 · 4 · 5 · 6	→	Decimal without sign	123456
Start + 1	F · 0 · 1 · 2		Decimal with sign	-123456
			Hexadecimal	F0123456

- When the data contain characters (A to F)

Start	3 · B · 5 · 6	→	Decimal without sign	123B56
Start + 1	F · 0 · 1 · 2		Decimal with sign	-123B56
			Hexadecimal	F0123B56

If the hexadecimal data (A to F) are stored when the decimal display has been set, the alphabets are displayed.

If the number of display digits has been set to be smaller than the maximum number of digits of the registration words (4 digits for 1 word; 8 digits for 2 words), the contents of the allocated words are not displayed and “*” symbols will be displayed at all digits.

If the most significant digit is “F” when “decimal with signs” has been set, the numeral is handled as a negative number. The maximum number of digits of the negative number becomes smaller than that of the positive number by 1 digit.

Reference The actual display will vary according to the “zero suppress” setting and decimal fraction setting as well as the contents mentioned above. Refer to the “NT-series NT11S Support Tool Operation Manual” (V030-E1-□).

- Contents of the character-string memory table

A character-string is stored in the allocated words beginning with the first word in half-size characters.

Two half-size characters are stored in one word. One memory table can store up to 10 words (20 characters).

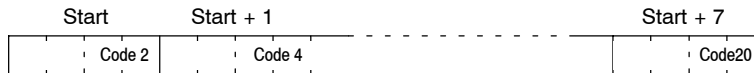

[Character-string memory table display example]

To display the characters in order, allocate the characters as follows.

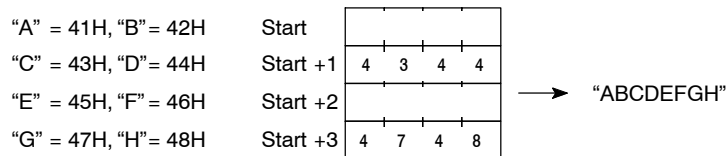

5-2-2 Changing Displayed Numerals or Character Strings (Changing the Contents of Allocated Words....Direct Specification)

The following describes the procedure to change displayed numerals or character-strings by changing the contents of the allocated words.

Numerals and character-strings can be changed also by making a copy of the memory tables. Refer to "Copying the memory table" explained later.

To change the numerals or character-strings displayed on the NT11S, make changes with the numeral or character-string memory table. To make changes with the numeral or character-string memory table of the NT11S, change the contents of words by the PC.

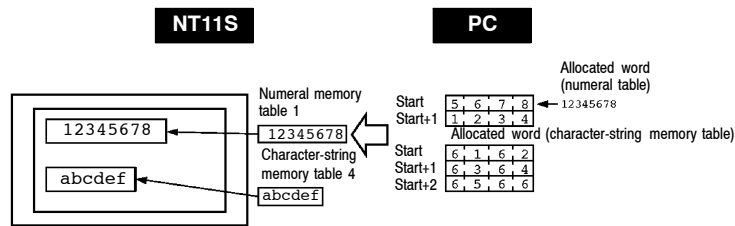

Reference When it is necessary to display changing data such as monitored data of words in the PC, use the numeral and character-string memory tables. This must be used to change the display contents (contents of memory table and words).

- Procedure**
1. Use the support tool to allocate the numeral and character-string memory tables to the PC memory.
 2. Register the memory tables for the numerals and character-strings to be displayed when creating the screen data by using the support tool.
 To display a character-string, use “character display” and specify the character-string memory table by using the support tool.
 To display numerals, use “numeral display” and specify the numeral memory table by using the support tool.
 3. Create a PC program to write the contents of numerals and character-strings to be displayed on the NT11S to the PC words.

Application Example of the Numeral Memory Tables Allocated to the PC Words

This example gives the procedure to directly display the contents of the words allocated as the numeral memory tables in the PC memory. The NT11S screen display will change as the contents of the PC word change.

- Support tool settings

Allocate the memory as shown below by using the support tool.

Numeral memory table entry No.1: DM0000 (allocated words: 2 words)

Numeral memory table entry No.2: DM0002 (allocated words: 1 word)

Screen numbers to be created: No.1 and No.2

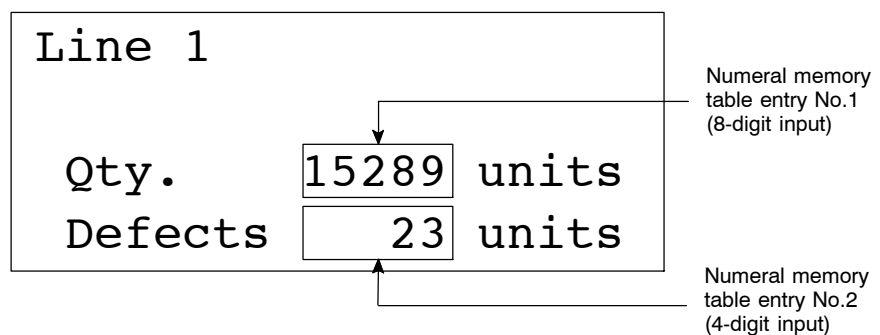

- PC ladder program

Create a PC ladder program as follows:

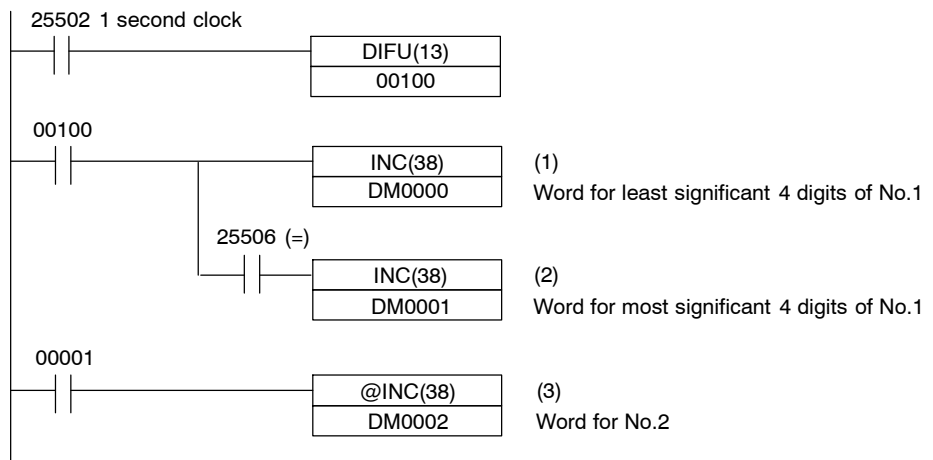

- Program operation

- (1) The contents of word DM0000 are incremented by 1 each second. The value displayed on the NT11S in numeral memory table entry No.1 increases by 1 each second.
- (2) When the counter in (1) above causes an increase in the most significant digits, the contents of word DM0001 are incremented by 1 each second. The value displayed on the NT11S in numeral memory table entry No.1 most significant digits increases by 1.
- (3) When bit 00001 turns ON, the contents of DM0002 are incremented by 1. The value displayed on the NT11S in numeral memory table entry No.2 increases by 1.

5-2-3 Copying the Memory Table

The following describes the procedure to change displayed numerals or character-strings by copying the contents of the memory table.

Numerals and character-strings can be changed also by changing the contents of the allocated words. Refer to “Changing displayed numerals or character-strings” explained before.

To change the numerals or character-strings displayed on the NT11S, copy the data between the numeral or character-string memory tables by using the “copy memory table setting” of the PT status control area.

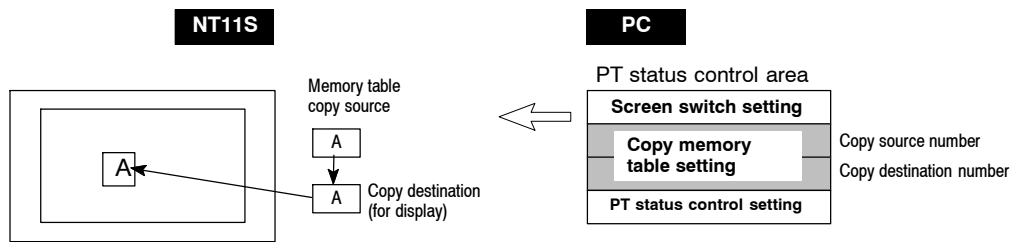

Write a memory table number etc. to the copy memory table setting area in the PT status control area in the PC memory. Data will be copied between the memory tables in the NT11S and the displayed value will change accordingly.

Reference This procedure is convenient to switch predetermined values or character-strings according to the situation. By preparing several units of contents, various contents can be displayed by switching them to suit the situation.

["Copy memory table setting" of the PT status control area]

	15	14	13	12	11	10	9	8	7	6	5	4	3	2	1	0	Bit
Word n+1	0			Copy source memory table No. (3-digit BCD)													
Word n+2																	

) Copy memory table setting

Copy type:

- 0: Copy between the character-string memory tables
- 1: Copy between the numeral memory tables

Copy source and destination memory table numbers:

- Character-string memory table: 000 to 255
- Numeral memory table: 000 to 511

- Available allocation words

The PT status control area can be allocated to the following PC areas:

Symbol	Area Name	Allocated
DM	Data memory	<input type="radio"/>
CH	Internal/Special Relay	<input type="radio"/>
TIM	Timer	
CNT	Counter	
HR	Holding Relay	<input type="radio"/>
AR	Auxiliary Relay	<input type="radio"/>
LR	Link Relay	<input type="radio"/>

: OK : NG

The range of respective area varies with the type of PC. Refer to Appendix H PC Memory Map (page 160).

- Procedure**
1. Use the support tool to allocate the PT status control area (PC to PT) to the PC memory.
 2. Register the memory tables for the numerals and character-strings to be displayed when creating the screen data by using the support tool.

To display a character-string, use “character display” and specify the character-string memory table by using the support tool.

To display numerals, use “numeral display” and specify the numeral memory table by using the support tool.
 3. Set the copy source data to the memory table when creating the screen data by using the support tool.

Use “table edit”.
 4. Create a PC program to write the copy type, copy destination memory table number, and copy source memory table number to the “copy memory table” setting word in the PT status control area.

- Order for writing to the PT status control area (PC to PT)
 First write the “copy destination memory table number”, and then, write the “copy source memory table number” to the PT status control area (PC to PT).
 The NT11S reads the area sometimes when the PC is writing the settings. If the “copy source memory table number” has been written first and is changed, unexpected memory table may possibly be changed.
- Allocated words that the NT11S reads
 The NT11S reads the allocated words in the PC for the memory tables which need to be displayed. If the copy source memory table is allocated to a PC word, it may sometimes be used at the initialization only.
- Use of the “copy type”
 Copy will not be executed when the “copy type” is other than “0” or “1”. The memory table copy is executed only when the contents of the area are changed. To repeat copying of the same copy source and same copy destination, write a value other than “0” or “1” for the copy type, and then, write a correct value again.
- Copying a numeral memory table
 If the display method or the number of registered words include discrepancies, a numeral memory table may not be copied and displayed correctly.

Application Example of Copying of a Character-String Memory Table

This example gives a PC program to switch the character-string display on the screen by using the memory table copy operation as the allocated bit is turned ON and OFF.

- Support tool settings
 Allocate the memory as shown below by using the support tool.
 PT status control area allocation: Word 0100
 Contents registered to the screen: Character-string memory table No.4

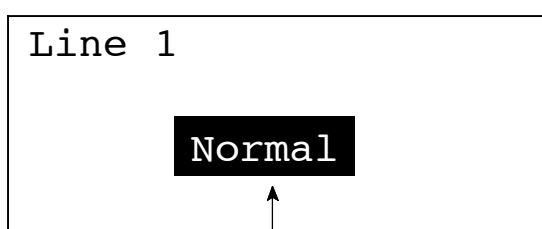

Character-string memory table No.4

Character-string memory table settings

No.	Contents	Number of Character Digits
4	Normal	6 digits
10	Error	6 digits
11	Normal	6 digits

- PC ladder program

Create a PC ladder program as follows:

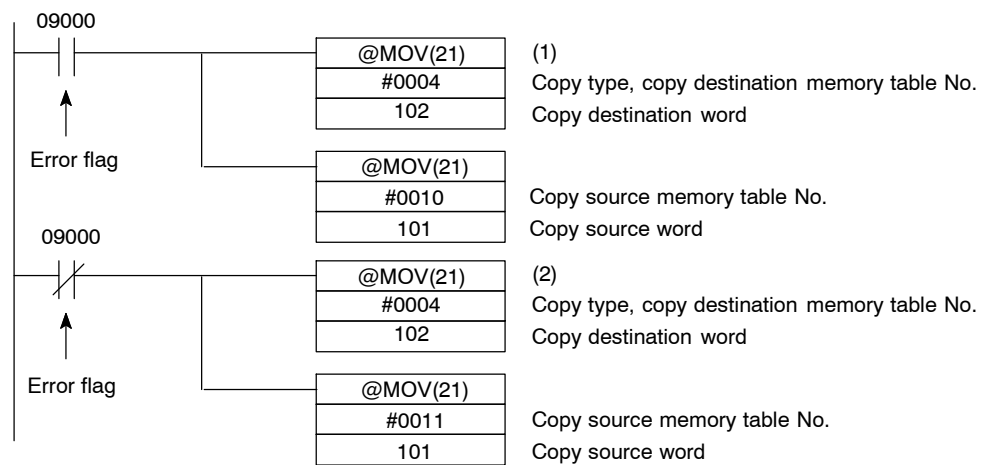

- Program operation

- (1) When an error occurs (bit 09000 turns ON), the NT11S displays the message "Error".
- (2) When the error is cleared (bit 09000 turns OFF), the NT11S display message reverts to "Normal".

5-2-4 Upgrading Bar Graphs (Changing the Contents of Allocated Words)

The following describes the procedure to upgrade the bar graph display on the NT11S by changing the contents of the allocated words.

To change the bar graph display on the NT11S, change the contents of the PC words to which the numeral memory tables have been allocated.

- Available allocation words

The numeral memory tables can be allocated to the following PC areas:

Symbol	Area Name	Allocation
DM	Data Memory	○
CH	Internal/Special Relay	○
TIM	Timer	△
CNT	Counter	△
HR	Holding Relay	○
AR	Auxiliary Relay	○
LR	Link Relay	○

○: OK △: 1 word only : NG

The range of respective area varies with the type of PC. Refer to Appendix H PC Memory Map (page 160).

Reference The bar graph display cannot use hexadecimal numbers. If hexadecimal numbers are set, the bar graph will not be displayed.

By writing a negative number (whose most significant digit is "F") to the allocated word of a graph set as "Sign display "No"", the graph display will become 0 % and the % display will show "*** %".

Reference For the procedure to write numeral values to the allocated words of the numeral memory tables, refer to "Allocation Words and Display of the Memory Tables" (page 108).

For the procedure to change the contents of the numeral memory table (PC words), refer to "Changing Displayed Numerals or Character Strings (Changing the Contents of Allocated Words)" (page 111).

5-3 Numeral Setting

This section describes the method used to find the numeral input using the numeral setting function, when communicating with the PC using the host link/NT link.

For details on the numeral setting function, refer to 4-6 Numeral Setting (page 85).

5-3-1 Notification of Numbers to the PC

This section describes how the numerical data input at an NT11S is ascertained by the PC.

In order to determine when numerical data has been input at the NT11S, the numeral setting strobe flag in the PT status notify area is used. In order to determine the upgraded numeral memory table number, the “content upgrade memory table” in the PT status notify area is used.

When numerical data is input at the NT11S, this is automatically notified to the PT status notify area (PT → PC) allocated in the PC memory as follows.

Notification of upgrade: PT status numeral setting strobe flag turned ON (1)

Upgraded numeral table number: Stored in the “content upgrade memory table”

When the PC reads the “content upgrade memory table” at the leading edge of the numeral setting strobe flag, it determines the numeral memory table number in which the numerical data that was changed at the NT11S is stored.

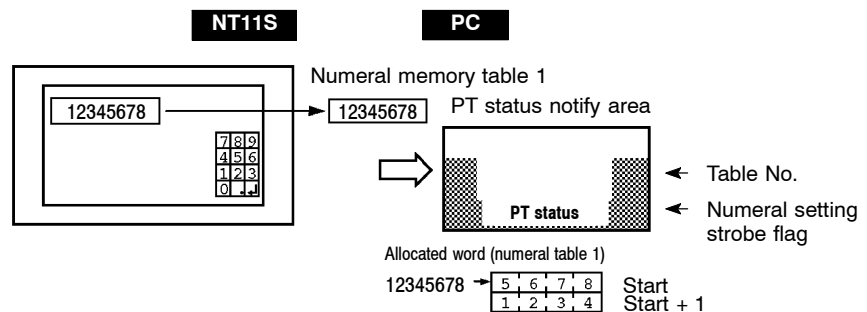

["Content upgrade memory table" in the PT status notify area and PT status]

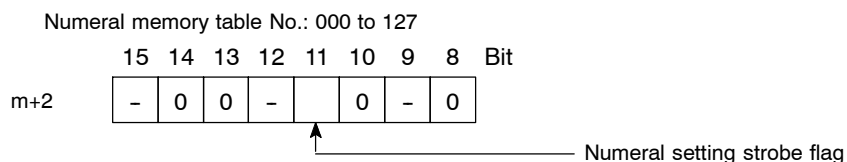
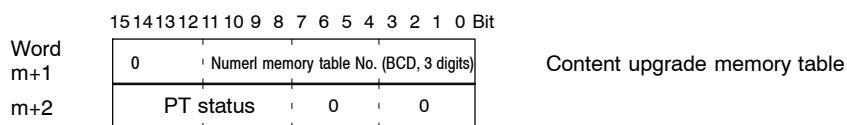

Data is written to the content upgrade memory table as three digits of BCD (binary coded decimal) data.

When the numeral setting strobe flag bit has been notified to the PC it returns to the OFF (0) status.

For details on the method for storing a number in the word allocated for the numeral memory table, see "Allocation Words and Display of the Memory Tables" (page 108).

• Restrictions on allocating words

The PT status notify area can be allocated to the PC memory areas listed in the following table.

Symbol	Area Name	Allocated
DM	Data memory	○
CH	Internal/Special Relay	○
TIM	Timer	
CNT	Counter	
HR	Holding Relay	○
AR	Auxiliary Relay	○
LR	Link Relay	○

○: OK : NG

The range of each memory area differs according to the PC type. See "Appendix H PC Memory Map" (page 160 of the APPENDICES) for more details.

- Procedure**
1. Use the support tool to allocate the PT status notify area (PT → PC) to the PC memory.
 2. Using the support tool, create a numeral setting screen and allocate the numeral memory table to the PC memory.
 3. Create a PC program for reading the "content upgrade memory table" in the PT status notify area when the numeral setting strobe flag in the PT status notify area comes ON (1).
 4. Read the allocated word for the numeral memory table number read in step 3.

Application Example

This example shows the reading of the numeral memory table number after a value has been changed by inputting numerical data at the NT11S.

- Setting at the support tool

Make the following settings using the support tool.

Allocated word for the PT status notify area : CH0110

Numeral memory table entry No.3: DM 0005 (saved word: One)

Numeral memory table entry No.4: DM 0006 (saved word: One)

Data registered for the screens:

Numeral setting 1 ... Reference table “numeral memory table No.3”

Numeral setting 2 ... Reference table “numeral memory table No.4”

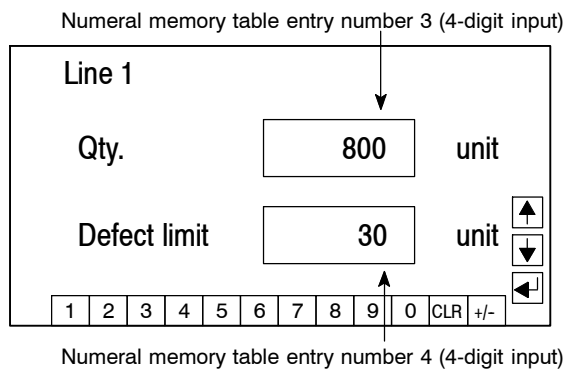

- PC program

Create the following PC ladder program.

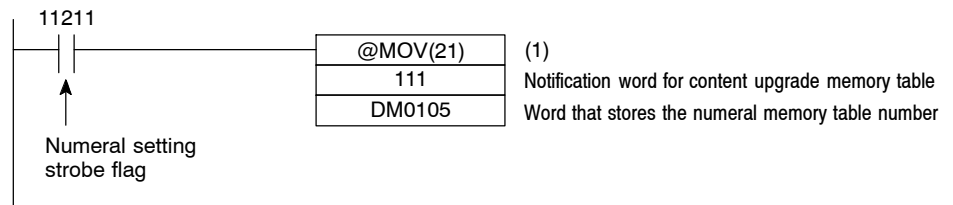

- Program operation

- (1) When the numeral setting strobe flag (bit 11211) comes ON (1), the contents of CH 0111 (the word where the content upgrade memory table is located) are transferred to DM 0105. The number of the numeral memory table that contains the upgraded data is stored in DM 0105 (in this case it is 003 or 004).

If the numeral memory table is allocated to a PC word, the value input to it can be read easily by referring to the allocated word.

In this case, the contents of numeral memory table No.3 are stored in DM 0005 and the contents of numeral memory table No.4 are stored in DM 0006.

5-4 NT11S Status Control

The statuses of the NT11S can be controlled from the PC by writing control data to the "PT status control bits" of the PT status control area allocated in the PC memory.

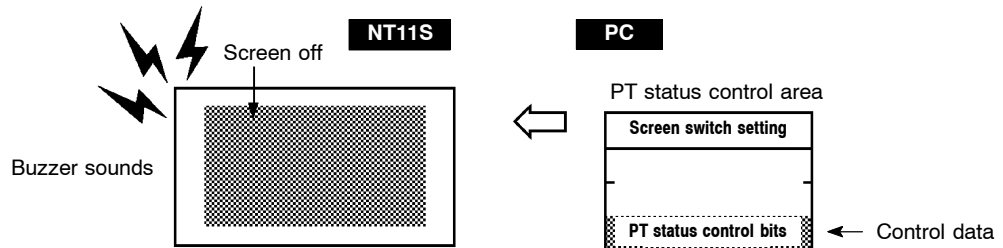

5-4-1 Controllable NT11S Functions

[“PT status control bits” of the PT status control area]

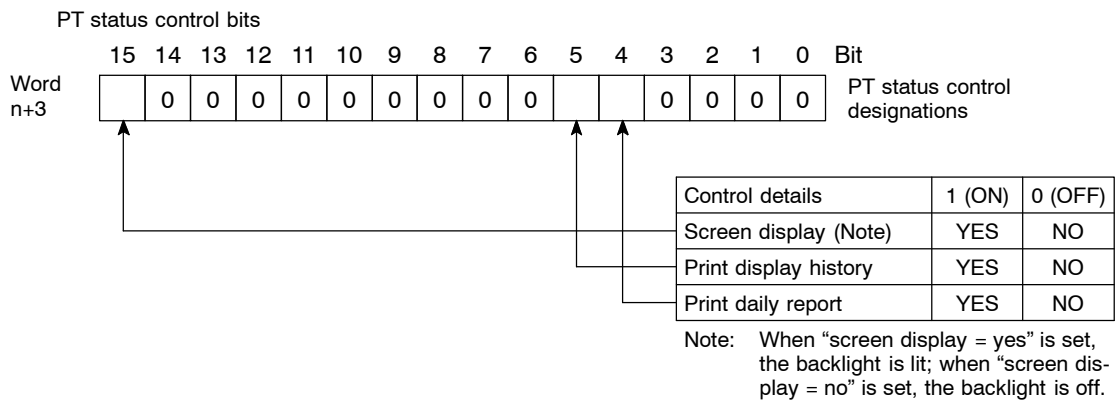

The NT11S functions that can be controlled from the PC are listed below:

- Whether the screen is displayed or not
- Whether display histories are printed or not
- Whether daily reports are printed or not

Note

Since the PT status control bits remain unaffected even if the NT11S status changes in accordance with the screen attribute and memory switch settings, it can happen that the status indicated by the PT status control bits does not agree with the actual status of the NT11S. For example, the screen may be off although the screen display setting is "ON". In situations like this, control the NT11S by using the PT status control bits.

- Screen display (bit 15)

The screen display bit determines whether the backlight is lit or unlit (whether the screen is displayed or not). It is used to prolong the service life of the backlight and prevent the formation of an afterimage. When bit 15 is set to OFF (0), the backlight is switched off.

Once the screen has been switched off, it can be switched back on either by switching bit 15 ON (setting it to "1") or by pressing an NT11s key; this will cause the backlight to come back on.

Reference

- Instead of switching bit 15 ON, a screen number can be specified to switch to that screen, in which case the screen will be displayed. For details on screen switching, refer to "Switching the Screen Display" (page 101).

- By setting an NT11S memory switch, it is possible to make the backlight go off automatically after no operations have been performed for a set length of time.

- Display history print (bit 5)

"Display history printing" designates printing of the display history data recorded in the NT11S at a printer. When bit 5 is set ON (set to "1"), all the recorded display history data is printed out once. To print it out a second time, bit 5 must be switched OFF (set to "0") and then switched back ON (to "1").

Reference

For details on the data recorded in the display history and the printing format, refer to 4-10 Daily Report/Display History Printing Function" (page 91).

- Daily report print (bit 4)

"Daily report print" designates printing of the contents of PC words and set characters in accordance with a format set using the support tool.

When bit 4 is switched ON (set to "1"), the contents of the specified words are read from the PC and output to the printer once in the specified format.

To output the data to the printer again, bit 4 must be switched OFF (set to "0") and then switched back ON (to "1").

Reference

Settings such as the printing format and word settings are made by using the support tool. For details on the support tool setting procedures relating to the daily report printing function, refer to 4-10 "Daily Report/Display History Printing Function" (page 91).

5-4-2 How to Control NT11S Functions

This section describes how to control the functions of the NT11S.

- Restrictions on allocating words

The PT status control area (PC → PT) can be allocated to the PC memory areas listed in the following table.

Symbol	Area Name	Allocated
DM	Data memory	○
CH	Internal/Special Relay	○
TIM	Timer	
CNT	Counter	
HR	Holding Relay	○
AR	Auxiliary Relay	○
LR	Link Relay	○

○: OK : NG

The range of each memory area differs according to the PC type. See “Appendix H PC Memory Map” (page 160 of the APPENDICES) for more details.

- Procedure**
1. Use the support tool to allocate the PT status control area (PC → PT) to the PC memory.
 2. Create a PC program to write control data to the “PT status control bits” of the PT status control area.
- Control timing of PT status control bits

The PT status control area (PC → PT) is not read when the NT11S starts up. It is only read, and control is only executed, when the contents of the PT status control area are changed after the NT11S has been started up.

Since control of the NT11S statuses is executed after the bits corresponding to the PT status control bits have changed, to execute control again the corresponding bits must be specified again.

Example use of the PT status control bits

The example below shows how the PT status control bits are used to execute daily report printing.

- Setting at the support tool

Perform the following setting with the support tool.

PT status control area allocated word: CH0100

- PC program

Create the following PC ladder program:

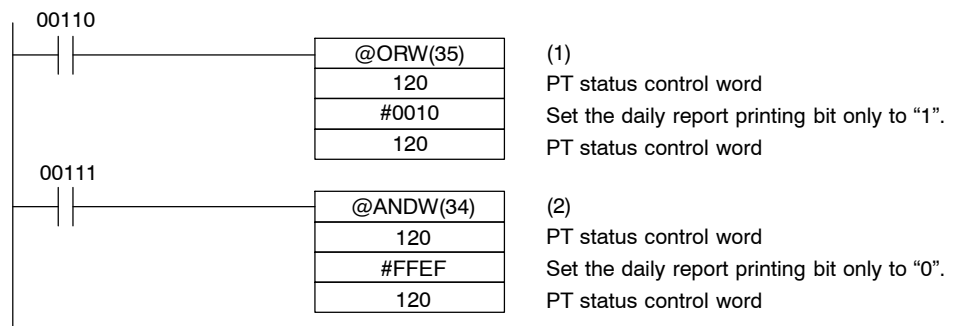

- Program operation

- (1) When contact 00110 comes ON, the daily report printing bit (bit 4) of the PT status control area is set to "1". The status of bits other than bit 4 remains unchanged.
When bit 4 is set to "1", the daily report is printed.
- (2) When contact 00111 comes ON, the daily report printing bit (bit 4) of the PT status control area is set to "0". The status of bits other than bit 4 remains unchanged.

5-5 Notification of the Operating Status to the PC (Determining the NT11S Operating Status)

The status (operating statuses, etc.) of the NT11S can be determined from the PC by reading the "PT status" word in the PT status notify area allocated in the PC memory.

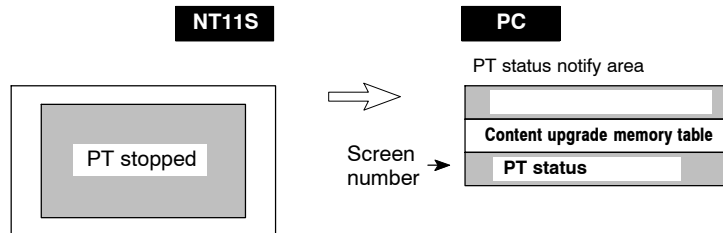

5-5-1 Ascertainable NT11S Statuses (Notified Operating Statuses)

["PT status notification bits" of the PT status notify area]

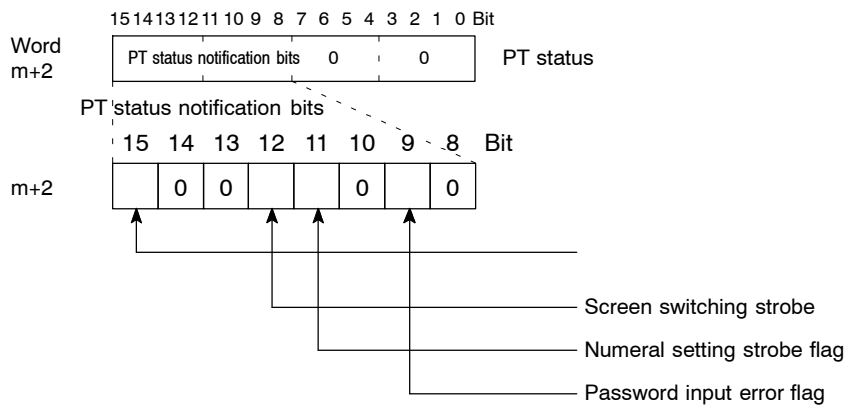

The following are the NT11S statuses that can be notified to the PC:

- RUN/STOP status of the NT11S
- Screen switching events
- Numeral input events
- Input of incorrect passwords

- PT operation status (bit 15)

When the NT11S is in the RUN mode this bit is ON ("1"). In other modes, and when the system menu is displayed, it is OFF ("0"). When it is OFF ("0"), the allocated bits and words cannot be read or written to.

- Screen switching strobe (bit 12)

When the screen displayed by the NT11S is switched by an instruction from the PC, or by the standalone function, the screen switching strobe comes ON ("1"). On notification to the PC, it goes OFF ("0").

- Numeral setting strobe flag (bit 11)

When a numerical value has been set in a numeral memory table using the numeral setting function of the NT11S, the numeral setting strobe flag is ON ("1"). On notification to the PC, it goes OFF ("0").

For details on how the numeral setting strobe flag is used, refer to "Notification of Numbers to the PC".

- Password input error flag (bit 9)

If a value that does not match the password registered in NT11S password setting is input in three successive attempts, the password input error flag comes ON ("1"). On notification to the PC, it goes OFF ("0").

For details on how the password input error flag is used, refer to 4-8 "Password Screen Display Function" (page 88).

5-5-2 Reading the NT11S Operating Statuses

This section explains the actual procedures used to determine the NT11S statuses and operating statuses.

In order to ascertain the NT11S operating statuses, the PT status notification bits are used.

The NT11S automatically notifies information such as operating statuses to the PT status notification bits in the PT status notify area (PT → PC) allocated in the PC memory, as follows:

Notification of operating mode	: "PT operation status"
Notification of screen switching	: "Screen switching strobe"
Notification of numerical value updates	: "Numeral setting strobe flag"
Notification of password input mistakes	: "Password input error flag"

- Restrictions on allocating words

The PT status notify area (PT → PC) can be allocated to the PC memory areas listed in the following table.

Symbol	Area Name	Allocated
DM	Data memory	○
CH	Internal/Special Relay	○
TIM	Timer	
CNT	Counter	
HR	Holding Relay	○
AR	Auxiliary Relay	○
LR	Link Relay	○

○: OK : NG

The range of each memory area differs according to the PC type. See "Appendix H PC Memory Map" (page 160 of the APPENDICES) for more details.

- Procedure**
1. Use the support tool to allocate the PT status notify area (PT → PC) to the PC memory.
 2. Write a PC program to read the "PT status" word of the PT status notify area and check each bit status.
- Report timing of PT status notification bits

The information in the PT status notify area (PT → PC) is written to the PC whenever there is a status change during operation of the NT11S.

Example of use of the PT status notification bits

The example below shows how the PT status notification bits are used to check the NT11S status.

- Setting at the support tool

Perform the following setting with the support tool.

PT status notify area allocated word : CH0112
PT error storage area allocated word : DM0001

- PC program

Create the following PC ladder program:

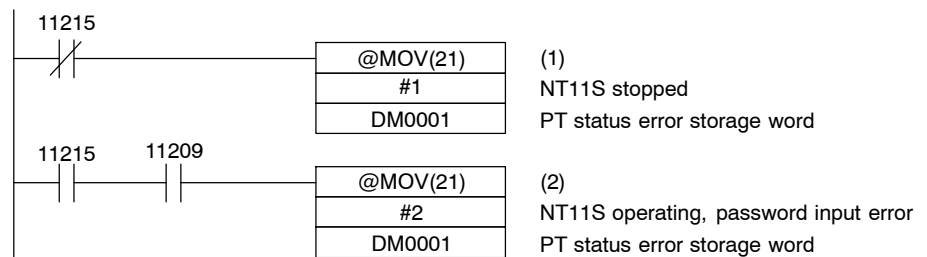

- Program operation

- (1) When "PT operating status" (contact 11215) goes OFF ("0"), "1" (NT11S stopped) is sent to DM0001.
- (2) If "password input error" (contact 11209) comes ON ("1"), while "PT operating status" (contact 11215) is ON ("1"), "2" (NT11S operating, password input error) is sent to DM0001.

SECTION 6

Troubleshooting and Maintenance

This section describes the action to take when NT11S errors occur, and how to carry out maintenance and inspections to prevent the occurrence of errors.

6-1	Hardware Faults	132
6-2	Responding to Displayed Error Messages	133
6-2-1	Errors Occurring when the Power is Switched ON	133
6-2-2	Errors Occurring During Operation	134
6-2-3	Errors Occurring on Screen Data Initialization and Transfer	134
6-2-4	Communication Errors	135
6-3	Inspection and Cleaning	137

6-1 Hardware Faults

When a fault relating to the operation of the NT11S occurs, find the symptoms in the table below and respond by following the corresponding "Remedy" indicated in the table.

NT11S Symptoms	Cause	Remedy
Nothing is displayed on the screen (it is completely green yellow).	Screen No.0 has been read at the host side.	This is not an error. Change the screen number. (Refer to "4-3 Screen Display", page 80.)
Communication with the support tool not possible.	The Transmit Mode has not been established.	Display the system menu and select the Transmit Mode. (Refer to "3-6 Registering the Screen Data", page 54.)
	Not connected to the support tool.	Check the installation of the connector cable. (Refer to "2-3 Connecting to the Support Tool", page 25.)
Cannot communicate with the PC.	Memory switch settings do not match.	Check the communication setting in the "Memory Switch" menu of the Maintenance Mode, and match the PC and NT11S settings. (Refer to "3-7 Setting the Conditions of Communications with the PC by Using the Memory Switches", page 57.)
	NT11S and PC are not correctly connected.	Check that the type, length and installation of the connector cable match the specifications. (Refer to "2-4 Connection to a PC by the Host Link (RS-232C Type)", page 26, and "2-5 Connection to a PC by the Host Link (RS-422A Type)", page 31.)
	In a host link connection, the PC termination resistance setting is incorrect.	Set the PC termination resistance correctly. (Refer to "2-4 Connection to a PC by the Host Link (RS-232C Type)", page 26, and "2-5 Connection to a PC by the NT Link (RS-422A Type)", page 31.)

6-2 Responding to Displayed Error Messages

When the NT11S displays one of the messages indicated below, determine the cause by referring to the table below, and take the action indicated in the "Remedy" column.

6-2-1 Errors Occurring when the Power is Switched ON

The table below shows the errors than can occur when the power is switched ON.

Message	Cause	Remedy
Connecting To Host	Memory switch setting is incorrect.	Check the communication settings by using the "memory switch" option in the maintenance mode, and match the setting of the PC and NT11S. (Refer to 3-7 "Setting the Conditions of Communication with the PC by Using the Memory Switches (page 57).")
	The NT11S and PC are not correctly connected to each other.	Check that the type and length of the connecting cable, and the wiring method, conform with the specifications. (Refer to 2-4 "Connection to a PC by the Host Link (RS-232C Type)" (page 26) and 2-5 "Connection to a PC by the Host Link (RS-422A Type)" (page 31).)
	In the case of a host link connection, the PC's terminal resistor setting is incorrect.	Correct the PC's terminal resistor setting. (Refer to 2-4 "Connection to a PC by the Host Link (RS-232C Type)" (page 26) and 2-5 "Connection to a PC by the Host Link (RS-422A Type)" (page 31).)
No Direct information is set!	Allocated words have not been set for the PT status control area and PT status notify area.	Use the support tool to set the head words of the PT status control area and PT status notify area in the screen data, then transfer the screen data again.
	There is no screen data.	Transfer the screen data from the support tool.
Screen Data Corrupted	There is an error in the registered screen data.	Transfer the screen data from the support tool again after initializing the screen data memory in the maintenance mode.

6-2-2 Errors Occurring During Operation

The table below shows the errors that can occur during operation of the NT11S and their remedies.

Message	Cause	Remedy
QQ command is not available	NT11S connected to an incompatible PC.	Connect the NT11S to a compatible PC.
Setting Error	Bits or words allocated to the PC memory cannot be found in the screen data.	Check the memory area in the PC and correct the bit and word allocations in the screen data.
Specified Screen Cannot Be Saved	An unregistered screen number is specified in screen switching.	Specify a registered screen number.
		Transfer the screen corresponding to the specified number from the support tool.

6-2-3 Errors Occurring on Screen Data Initialization and Transfer

The table below shows the errors that can occur when data is written to the NT11S screen data memory, and their remedies.

Message	Cause	Remedy
Initialization Error	Hardware fault or screen data memory life reached	If the same message is displayed even after executing screen data memory initialization or screen data transmission several times, contact your OMRON service center.

6-2-4 Communication Errors

This section describes the errors relating to communication with the PC that can occur during operation, and their remedies.

- Operation when a communication error occurs

When a communication error occurs, the error message is displayed at the NT11S. Error messages are displayed when the “Automatic Reset” memory switch is not set (OFF) or when an error occurs during communication due to a parameter setting error, communication cable fault, noise, or other problem.

Note

Some error messages are displayed even if the “Automatic Reset” memory switch is set (ON).

- Procedure when a communication error occurs

When an error message is displayed, press any key on the panel of the NT11S. The screen display will return to the RUN mode.

- Display of communication errors

As shown below, communication errors and error messages are displayed in the center of the screen, together with a classification indicating whether they are receive or send errors.

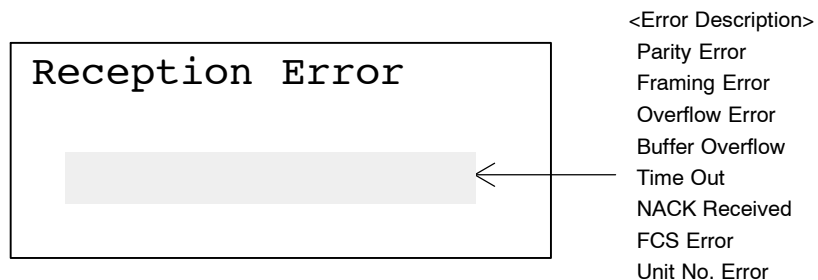

Message	Cause	Remedy
Parity Error Framing Error Overflow Error	Communication parameters set incorrectly.	Check whether the parity bit, data bit length, baud rate, stop bit length, and flow control settings of the PC match the settings of the NT11S.
	Noise caused data corruption during communication.	Use a noise-resistant cable if communication occurs in an environment with high levels of noise.
	The connectors of the connecting cable are not connected correctly.	Reconnect the cable.
Buffer Overflow	The NT11S receive buffer is full.	Lengthen the command transmission intervals. If this error occurs frequently, set flow control for communications.
Time Out	The connectors of the connecting cable have become disconnected.	Reconnect the cable.
	The PC is stopped.	Make sure the PC is able to communicate with the NT11S.
	During transmission of one command, a time lapse exceeding 5 seconds is detected.	Confirm the proper command length. Check the cable connection.
NAK Received	Noise caused data corruption during communication.	Use a noise-resistant cable if communication occurs in an environment with high levels of noise. Check the end code by referring to the PC user's manual.
Unit No. Error	The unit No. does not match that set on the PC.	Set the PC unit No. to "0".
	The PC is transmitting incorrect data.	Check PC operation.
	Noise caused data corruption during communication.	Use a noise-resistant cable if communication occurs in an environment with high levels of noise.
FCS Error	The PC is transmitting incorrect data.	Check PC operation.
	Noise caused data corruption during communication.	Use a noise-resistant cable if communication occurs in an environment with high levels of noise.

- If an error occurs during the execution of a command, that command becomes invalid and it is not executed.

6-3 Inspection and Cleaning

Clean and inspect the NT11S regularly to ensure that it is always used in its optimum condition.

Cleaning Method

If the display is dirty the screen is difficult to see. Clean the screen from time to time as follows.

- In daily cleaning, wipe the display with a soft dry cloth.
- If the soiling cannot be removed with a dry cloth, wet the cloth with diluted neutral detergent (2%), wring it out well and wipe the display with it.
- If rubber or vinyl products, tape, etc. are left stuck to the display for long periods they will cause staining. If such items are stuck to the display, remove them during cleaning.

Correct Use Never use volatile solvents such as benzene or thinners, or chemical dusters.

Inspection Method

In normal environments, inspect the NT11S at intervals of between 6 months and a year. In environments that are extremely hot and humid, or very dusty environments, shorten the inspection interval.

- Items required for the inspection

Prepare the following items before starting the inspection.

- The tools supplied with the NT11S
- Screwdrivers (Philips, flat-head)
- Tester (or digital voltmeter)
- Industrial alcohol
- 100% cotton cloth
- Hygrometer (required in some cases)
- Thermometer (required in some cases)
- Synchroscope (required in some cases)
- Pen-writing oscilloscope (required in some cases)

 **Caution** Do not disassemble for repairs or modification. Otherwise, the product may malfunction.

- Points inspected

Inspect the following points to determine if there is any divergence from the stated criteria. If there is, either improve the surrounding environment so that the values fall within the stated range, or adjust the NT11S.

Point Inspected	Inspection Details	Criterion	Inspection Instrument
Power supply voltage	Fluctuation in power supply terminal voltage	Permissible voltage fluctuation range (24 VDC -15% +10%)	Tester
Ambient environmental conditions	Ambient temperature (temperature in the operation panel)	0 to 50°C	Thermometer
	Ambient humidity (humidity in the operation panel)	35% to 85%RH	Hygrometer
	Presence/absence of dust	Dust must not be settled	Visual inspection
Mounting conditions	Looseness of mounting brackets etc.	To be no looseness	Accessory tools
	Connector connections of connecting cable	To be fully inserted and locked, with no looseness	
	Looseness of screws in external wiring	To be no looseness	Philips screwdriver
	Conditions of external connecting cables	Faults such as incipient disconnections.	Visual inspection
Components with limited lives	Brightness of the backlight	Must be sufficiently bright. Backlight life: 50,000 hours	Visual inspection

Cautions on replacing the NT11S

When replacing the NT11S after discovering a fault during inspections, note the following points:

- Be sure to switch the power OFF before replacement.
- After replacement, check that the new NT11S is not subject to the same error.
- If a faulty unit is returned for repairs, write as detailed a description of the fault as possible and send this description together with the unit to the OMRON address indicated on the back cover of this book.

 **Caution** The disposal of the unit may be regulated by national or local authorities. Dispose of them in accordance with the laws and regulations of the relevant country and local authority.

APPENDIX A

Specifications

General Specifications

Item	Specification
Power supply voltage	24 VDC
Allowable power supply voltage range	20.4 VDC to 26.4 VDC (24 VDC -15% +10%)
Power consumption	Less than 10W
Ambient operating temperature	0 to +50°C (with no freezing)
Storage temperature	-20 to +70°C (with no freezing)
Ambient operating humidity	35 to 85% RH (with no condensation)
Operating environment	No corrosive gases.
Noise resistance	Common mode (between power supply and panel): 1000 Vp-p Normal mode: 300 Vp-p Pulse width: 100 ns to 1 μ s Pulse rise time: 1 ns
Vibration resistance	10 to 22 Hz with 1.5 mm double amplitude for a total of 30 min. in X, Y, and Z directions.
	22 to 500 Hz with 1.5 G {14.7 m/s ² } acceleration in X, Y, and Z directions.
Shock resistance	Durability: 30 G, 3 times each in X, Y, and Z directions.
	Malfunction: 20 G, 3 times each in X, Y, and Z directions.
Dimensions (mm)	218 (W) x 113 (H) x 38.2 (D) mm
Weight	1.0 kg max.
Enclosure ratings	Front panel: Equivalent to IP65 (front face waterproof construction).
	Rear case: IP20
	Terminals: IP00

Performance Specifications

Display Specifications

Item	Specification	
Dot matrix liquid crystal display panel	Number of dots (resolution)	160 dots (vertically) x 64 dots (horizontally)
	Effective display area	100 mm (vertically) x 40 mm (horizontally)
	View angle	Left direction: 35° Right direction: 35°
	Life expectancy	50,000 hours minimum
LED Backlight	Life expectancy	50,000 hours minimum (guaranteed time: 30,000 hours)
	Automatic turn-off	Can be set to turn off in 10 minutes or 1 hour, or to remain on.
Indicators	POWER indicator (Green LED)	Lit while power is being supplied.
	RUN indicator (Green LED)	Lit during operation

Panel Specifications

Item	Specification
Switch	Number of switches: 22
	Input: Pressure-sensitive type
	Operating force: 100 gf min.
	Life expectancy: 1 million operations minimum

Display Capacity

Item	Specification	
Display elements	Character displays	Fixed character data (character strings registered for each screen)
	Character string displays	128 strings per file (20 bytes (20 normal characters) per string), 8 positions per screen
	Numeral displays	128 displays per file, 8 positions per screen, 8-digit display
	Graph displays	4 per screen
	Numeral settings	Display of set numerical values 8 per screen
Screen types	Normal screen	Displays screens registered as normal.
Screen attributes		Numeral setting, password, display history recording, menu screen
Max. number of registered screens		250
Screen registration method		Transfer screen data created using the support tool to the NT11S.
Screen saving method (screen data memory)		Saved to flash memory (recording format unique to NT11S)

Display Element Specifications

Item	Specification
Display characters	Normal characters (8 x 16 dots): Alphanumerics and symbols
	Marks (16 x 16 dots): User-defined pictographs
Enlargement function	Horizontal magnifications
Character display attributes	Normal, inverse, flashing, inverse flashing

Data Quantities

Item	Specification
Strings	128 strings comprising 20 characters each
Numeral data	128 max. (8 digits each)
Marks	64 marks

Special Features

Item	Specification
Maintenance functions	<ul style="list-style-type: none"> • Self-test functions for memory, switches, etc. • Function for checking settings such as communication conditions • Communication check function
Password screen	Password designation when selecting a screen Setting: Set with the support tool Number of password digits: 4
Menu screen	Selecting screens with numeric keys Setting: Set with the support tool Keys used: Keys 1 through 4 Number of destination screens: A maximum of four destination screens can be set for one screen.
Daily report printing	The contents of a designated word are printed out at a printer in the specified format. Setting: set with the support tool Output trigger: 0 → 1 status change of bit 4 of the PT status control area
Display history recording Display history printing	The history of display of the specified screen is recorded in memory and can be printed out. Setting: Support tool Output trigger: 0 → 1 status change of bit 5 of the PT status control area

Communications Specifications

[For a Host Link]

Item	Specification	
Communications standard	EIA RS-232C, RC-422A	
Communications settings	Start-stop synchronization Baud rate: 9600, 19,200 bps Data length: 7 bits Stop bit: 2 bits Parity: Even	
Connector	RS-232C	9-pin, D-SUB connector (male)
	RS-422A	4-pin terminal block
Number of units connected	1 to 1	
Transmission distance	Max. 15 m/RS-232C, Max. 500 m/RS-422A	
Communications protocol	C-series SYSWAY (1:N)	

[For an NT Link]

Item	Specification	
Communications standard	EIA RS-232C	
Connector	9-pin, D-SUB connector (male)	
Number of units connected	1 to 1	
Transmission distance	Max. 15 m	

[For a Printer Port]

Item	Specification	
Communications standard	Centronics	
Connector	25-pin D-SUB connector (female)	
Number of units connected	1 to 1	
Transmission distance	Max. 3 m	

Printer Port Specifications

[Printer Connector Pin Arrangement]

1	-STORBE
2	DATA 0
3	DATA 1
4	DATA 2
5	DATA 3
6	DATA 4
7	DATA 5
8	DATA 6
9	DATA 7
10	-ACK
11	BUSY
12	PAPER EMPTY
13	+SELECT

14	-AUTO FDXT
15	-ERROR
16	-INIT
17	-SLCTIN
18	GROUND
19	GROUND
20	GROUND
21	GROUND
22	GROUND
23	GROUND
24	GROUND
25	GROUND

[Signal Timing]

The NT11S executes communication with a 2-wire handshake system using the STROBE signal and the ACK signal.

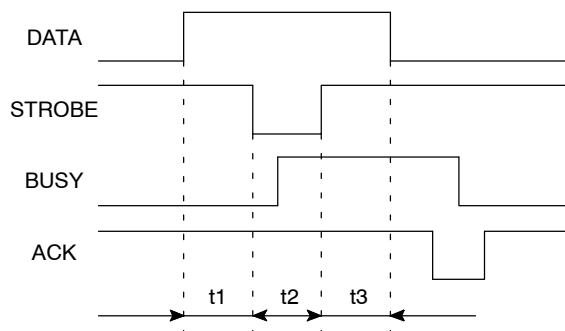

t1, t2 and t3 are each 0.5 μ sec or longer.

APPENDIX B

Dimensions

Body (NT11S-ST121)

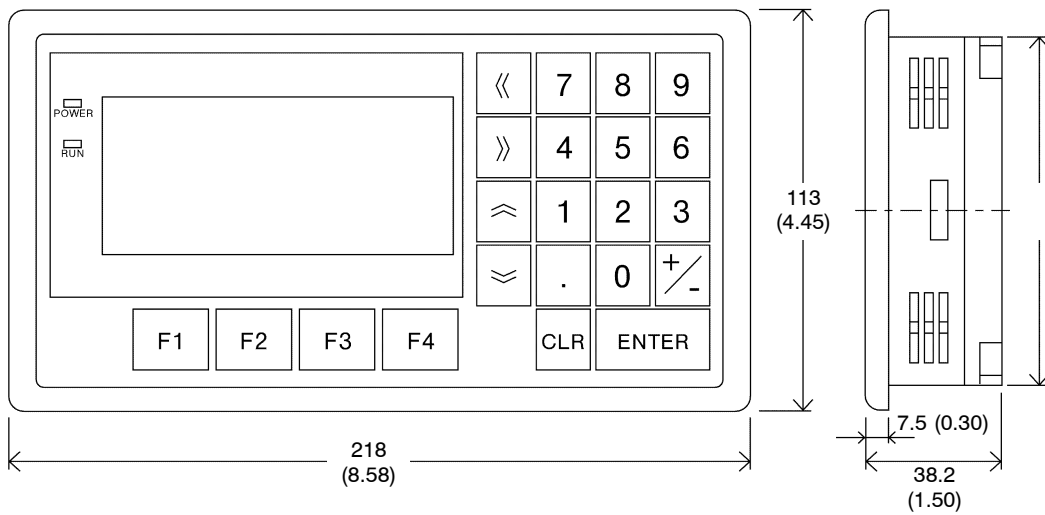
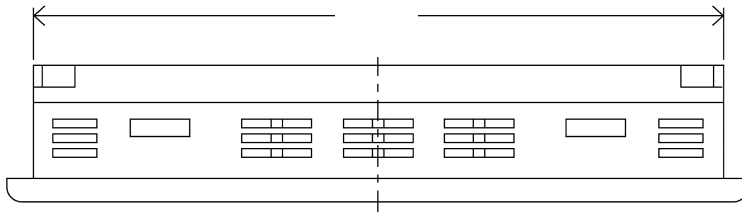

Unit : mm (inch)

APPENDIX C

NT11S Installation Environment

When installing the PT in the operation panel, observe the following points. See also the section “Getting Starting”.

Note

- The view angle of the LCD screen is 35° to the left and 35° to the right. Install it at a position and height where operators will be able to see it well.
- Do not install the unit at locations where the ambient temperature goes outside the range 0 to 50°C or where the relative humidity goes outside the range 35 to 85% RH.

If the ambient temperature exceeds the range indicated above, install a fan or an air conditioner.

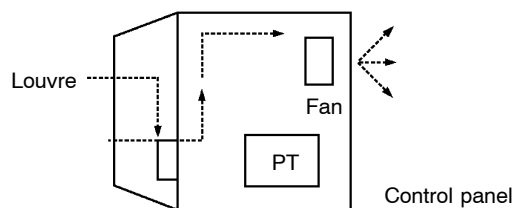

- Provide sufficient space for ventilation
- Do not install the unit directly above equipment that generates a lot of heat (heaters, transformers, large capacity resistors, etc.)
- To ensure that the unit can be operated and maintained without difficulty, install it at a distance from high-voltage equipment and power equipment.
- Install the unit as far as possible from personal computers, amateur radio equipment, radios, etc. The radio waves generated by the unit may cause interference that will affect these types of equipment.
- Take the following points into account in order to prevent noise
 - (1) Avoid installing the unit in panels in which high-voltage equipment is also installed.
 - (2) Install the unit at a distance of at least 200 mm from power lines.

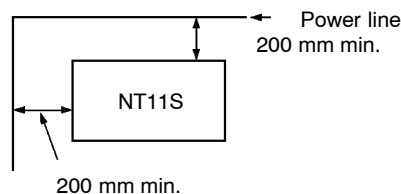

- (3) If the unit is installed next to equipment that generates a strong electric or magnetic field (solenoids, etc.), provide a gap of at least 40 mm.

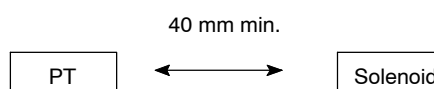

APPENDIX D

Method for Making the Cable for Connection to the PC

Explained below is the method for making the cable that connects the NT11S and the PC/Host.

Connect the wires to the connectors in accordance with the connector specification for each unit.

Making the Cable for Connection to the PC (RS-232C Type)

Parts Required

Two connectors, two connector covers and one cable are required to make up a connecting cable. One connector and one connector cover is supplied with most PCs.

	Name	Model	Delivered with	Remarks
PC	Connector	XM2A-0901	C series CQM1	9-pin, manufactured by OMRON
		XM2A-2501	C200H-LK201	25-pin, manufactured by OMRON
	Connector cover	XM2S-0911	C series CQM1	9-pin, manufactured by OMRON
		XM2S-2511	C200H-LK201	25-pin, manufactured by OMRON
NT11S	Connector	XM2A-0901	—	9-pin, manufactured by OMRON
	Connector cover	XM2S-0911	—	9-pin, manufactured by OMRON

When connecting the NT11S to an OMRON PLC C□□H, the connector and the connector cover must be prepared separately since they are not supplied with the C□□H.

The connector provided in the CPU unit of the C□□H is a 9-pin connector. For the connection, the following connector and connector hood should be prepared.

- Connector: XM2A-0901 (9-pin type, OMRON)
- Connector cover: XM2S-0911 (9-pin type, OMRON)

Prepare the cable recommended by OMRON.

The recommended cables are indicated in the following table.

Name	Type	Remark
Cable	AWG28×5P IFVV-SB	Multiconductor shielded cable (FUJIKURA, Ltd.)
	CO-MA-VV-SB 5P×28AWG	Multiconductor shielded cable (HITACHI Cable, Ltd.)

Connector Specifications and Wiring for OMRON Units (RS-232C Type)

The combination of pin numbers to which the connecting wires are connected differs according to the connector specifications for each unit. Check the connector specifications of the unit to be connected and make the wiring connections for the items in the connection combination indicated below which are applicable.

[NT11S Connector Specifications (9-pin)]

- Electrical characteristics: Complies with EIA RS-232C
- Signal direction: Signal input and output is relative to NT11S.

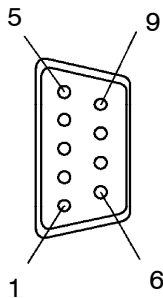

Connector Pin No.	Signal Name	Abbreviation
1	Frame ground	FG (*1)
2	Send data	SD (TXD)
3	Receive data	RD (RXD)
4	Request to send	RS (RTS)
5	Clear to send	CS (CTS)
6	+5V	+5V
9	Signal ground	SG

(*1) FG is not used.

Correct Use Pin 6 is used to supply the internal 5V source of the NT11S to external destinations. Pay special attention to this pin when wiring. Incorrect wiring could cause malfunction or failure of the NT11S.

Connecting an NT11S to a C-Series Host Link

- C-Series Host Link Unit 25-pin Connector Specifications

Applicable Host Link Unit: C200H-LK201

- Electrical characteristics: Complies with EIA RS-232C
- Signal direction: Signal input and output is relative to the PC.

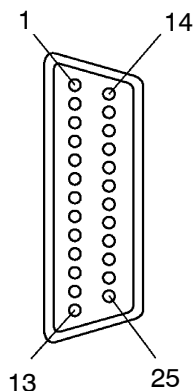

Connector Pin No.	Signal Name	Abbreviation	Signal Direction	
			Input	Output
1	Frame ground	FG	-	-
2	Send data	SD (TXD)		○
3	Receive data	RD (RXD)	○	
4	Request to send	RS (RTS)		○
5	Clear to send	CS (CTS)	○	
7	Signal ground	SG	-	-
14	Optical connector +5V	+5V	-	-
20	Data terminal ready	ER (DTR)		○

• Wiring Connections

Either short the RS and CS pins of the PC connector together or set the CTS setting selector switch at the rear face of the host link unit to "0V" (see □ in the figure).

Connect the cable shielding wire to the connector cover and pin 1 at the host link unit end of the cable only.

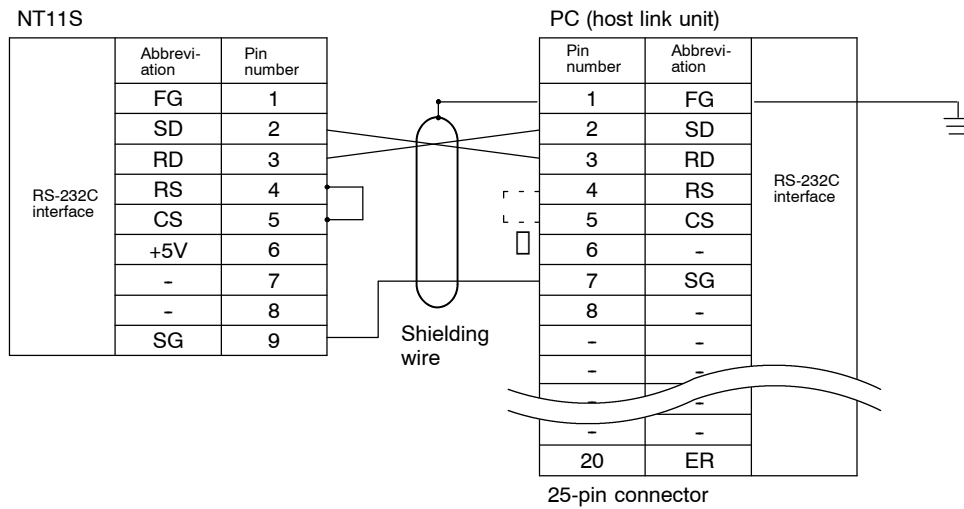

Connecting an NT11S to a C-Series CQM1, C200HS Series CPU

- C-Series CQM1, C200HS Series CPU Unit 9-pin Connector Specifications

Applicable CPU:

CQM1-CPU21-E	C200HS-CPU21-E
CQM1-CPU41-E	C200HS-CPU23-E
CQM1-CPU42-E	C200HS-CPU31-E
CQM1-CPU43-E	C200HS-CPU33-E
CQM1-CPU44-E	

- Electrical characteristics: Complies with EIA RS-232C
- Signal direction: Signal input and output is relative to the PC.

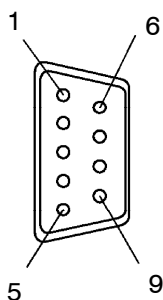

Connector Pin No.	Signal Name	Abbreviation	Signal Direction	
			Input	Output
Connector cover	Frame ground	FG	-	-
2	Send data	SD (TXD)		○
3	Receive data	RD (RXD)	○	
4	Request to send	RS (RTS)		○
5	Clear to send	CS (CTS)	○	
9	Signal ground	SG (GND)	-	-

- Wiring Connections

Either short the RS and CS pins of the PC connector together or set the CTS setting selector switch at the rear face of the host link unit to "0V" (see □ in the figure).

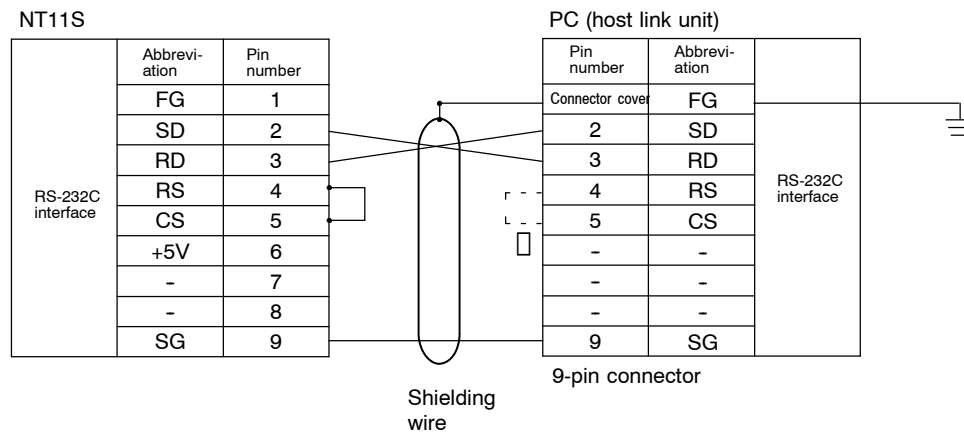

Making the Cable for Connection to the PC (RS-422A Type)

Parts Required

Two connectors, two connector covers and one cable are required to make up a connecting cable. One connector and one connector cover is supplied with most PCs.

Name	Model	Delivered with	Remarks
Connector	XM2A-0901	C series CQM1	9-pin, manufactured by OMRON
	DE-9P	C200H-LK202	9-pin, manufactured by JAE
Connector cover	XM2S-0911	C series CQM1	9-pin, manufactured by OMRON
	DE-C1-J6	C200H-LK202	9-pin, manufactured by JAE

When connecting the NT11S to an OMRON PLC C□□H, the connector and the connector cover must be prepared separately since they are not supplied with the C□□H.

The connector provided in the CPU unit of the C□□H is a 9-pin connector. For the connection, the following connector and connector hood should be prepared.

- Connector: XM2A-0901 (9-pin type, OMRON)
- Connector cover: XM2S-0911 (9-pin type, OMRON)

Prepare the cable recommended by OMRON.

The recommended cables are indicated in the following table.

Name	Type	Remark
Cable	H-9293A (CO-HC-ESV-3P 7/0.2)	For RS-422A (HIRAKAWA Hewtech Corp.)

Connector Specifications and Wiring for OMRON Units (RS-422A Type)

Connecting an NT11S to a C-Series Host Link Unit

- C-Series Host Link Connector Specifications

- Applicable Host Link Unit: C200H-LK202 (-V1)
- Electrical characteristics: Conform to EIA RS-422A
- Signal direction: Signal input and output is relative to the host link unit.

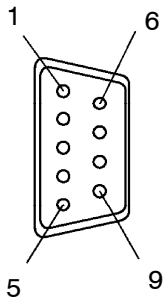

Connector Pin No.	Signal Name	Abbreviation	Signal Direction	
			Input	Output
1	Receive data B	RDB	○	
3	Signal ground	SG	-	-
5	Send data B	SDB		○
6	Receive data A	RDA	○	
7	Frame ground	FG	-	-
9	Send data A	SDA		○

- Wiring Connections

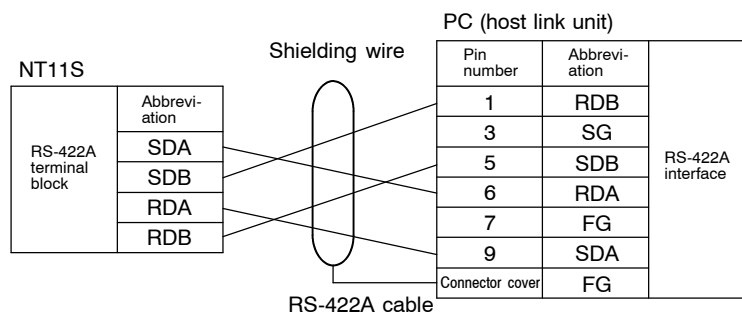

Making the Cable

The procedure to make up the cable is described below.

Cable Preparation

The preparation of the cable differs according to whether or not the shielding wire is to be connected to the FG.

- Cable with Shielding Wire Connected to FG

- (1) Cut the cable to the required length.
- (2) Remove the external vinyl insulation from the cable with a razor blade. Take care not to damage the shielding underneath.
- (3) Cut back the shielding wire with scissors.
- (4) Use wire strippers to strip the insulation from each wire.
- (5) Fold back the shielding wire.
- (6) Wrap aluminum foil tape around the folded-back shielding wire.

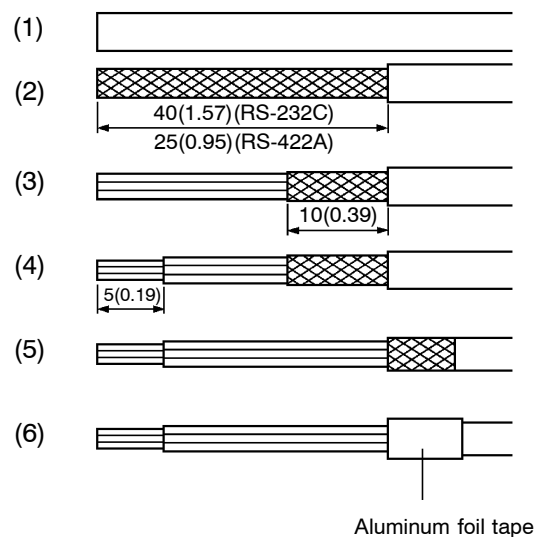

[Units: mm (in.)]

• Cable with Shielding Wire Not Connected to FG

- (1) Cut the cable to the required length.
- (2) Remove the external vinyl insulation from the cable with a razor blade. Take care not to damage the shielding underneath.
- (3) Cut back the shielding wire with scissors.
- (4) Use wire strippers to strip the insulation from each wire.
- (5) Wrap vinyl tape over the cut off end of the shielding wire.

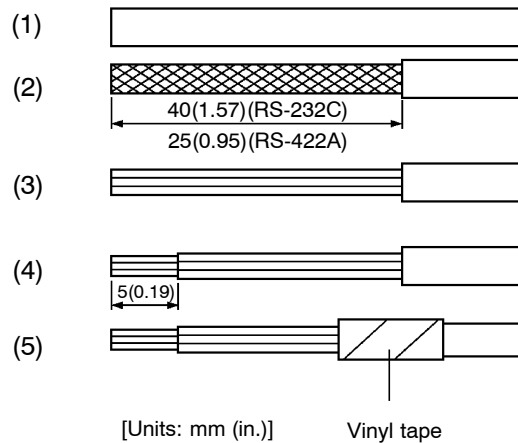

Soldering

- (1) Slide heat-shrink tube over each wire.
- (2) Pre-solder each wire and connector cable.
- (3) Solder each wire to the connector terminal.

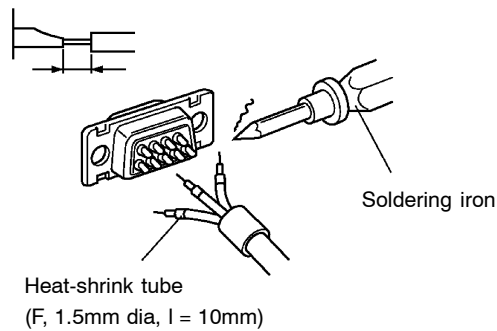

- (4) Push the heat-shrink tube over the soldered joint and heat the tube to shrink it in place.

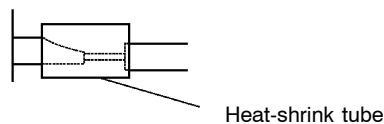

Connector Cover Assembly

Assemble the connector covers as shown in the diagram below.

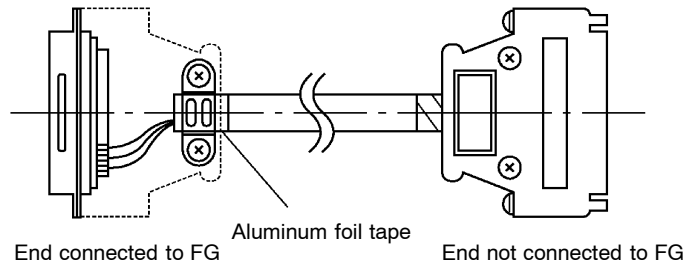

APPENDIX E

Making the Cable for Connection to the Support Tool

The wiring to be done depends on the type of RS-232C connector at the personal computer.

- For a 25-pin connector

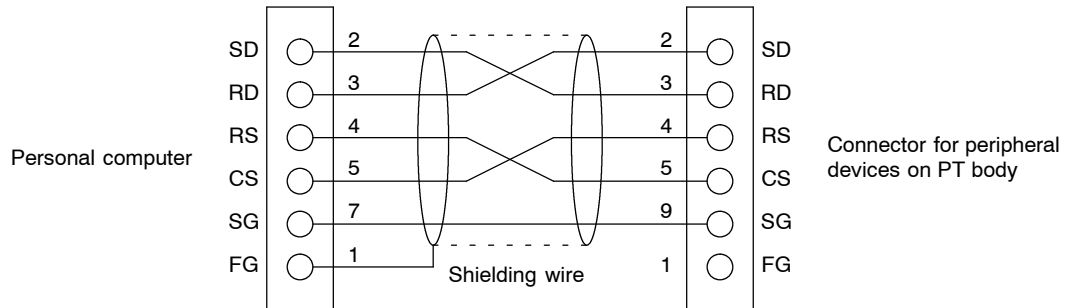

The table below indicates the recommended parts for making the connection cable.

Name	Model	Remarks
Connector	XM2A-2501	25-pin, manufactured by OMRON
	XM2A-0901	9-pin (Plug), manufactured by OMRON
Connector cover	XM2S-2511	25-pin, manufactured by OMRON
	XM2S-0911	9-pin, manufactured by OMRON
Cable	AWG28 × 5P IFVV-SB	Multicore cable, manufactured by Fujikura, Ltd
	CO-MA-VV-SB 5P × 28AWG	Multicore cable, manufactured by Hitachi Cable, Ltd

- For a 9-pin connector

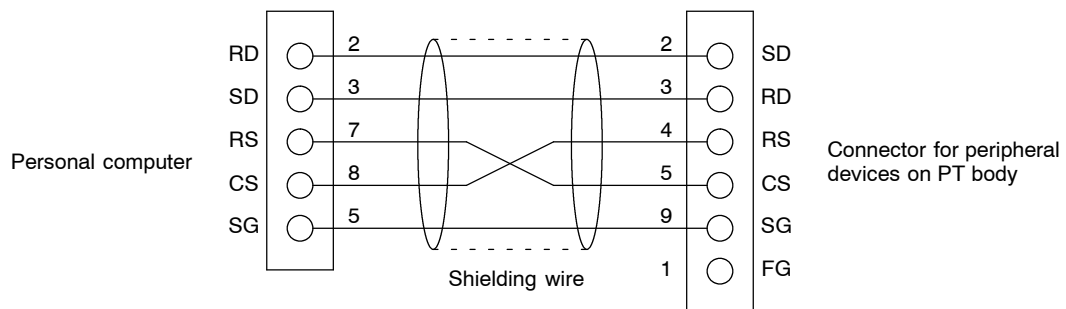

The table below indicates the recommended parts for making the connection cable.

Name	Model	Remarks
Connector	XM2D-0901	9-pin (Socket), manufactured by OMRON
	XM2A-0901	9-pin (Plug), manufactured by OMRON
Connector cover	XM2S-0911	9-pin, manufactured by OMRON
Cable	AWG28 × 5P IFVV-SB	Multicore cable, manufactured by Fujikura, Ltd
	CO-MA-VV-SB 5P × 28AWG	Multicore cable, manufactured by Hitachi Cable, Ltd

APPENDIX F

NT11S Internal Processing

When host link/NT link is used, the following processing is executed inside the NT11S. Processing is divided into two types: periodic processing and event processing.

Periodic Processing

When the NT11S is in the RUN mode it executes the following internal processing cyclically. The contents of all the allocated bits and words used for screen display are read from the PC at one time, allowing high-speed processing.

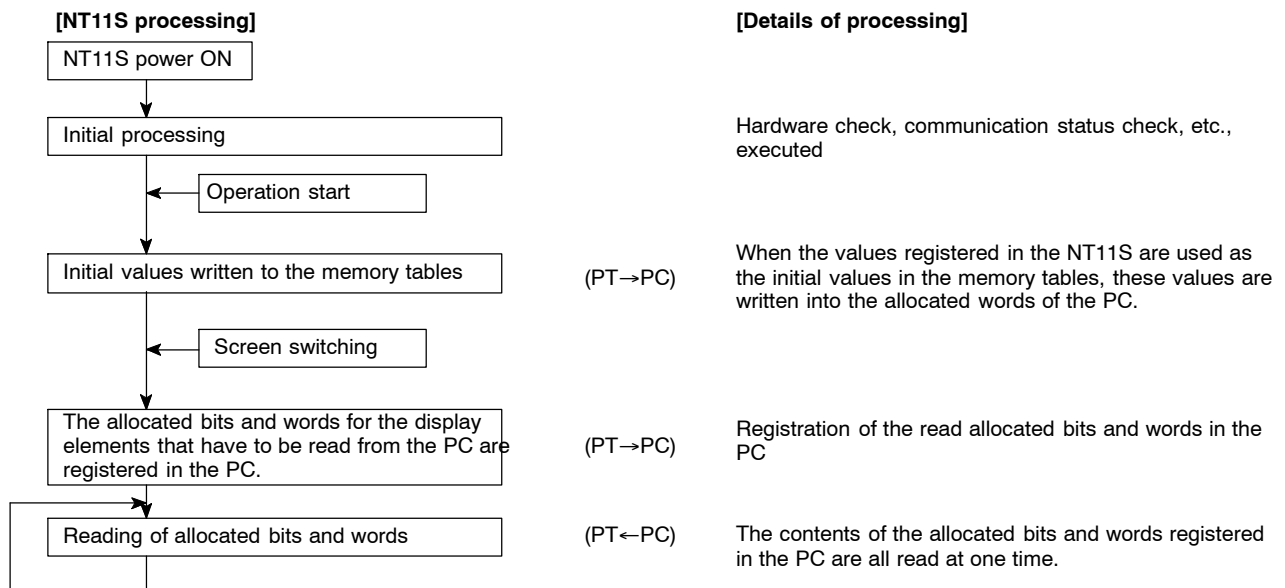

Note

- Only the data of the PC Status Control Area and data for currently displayed screens is read from the PC.
Even if the contents of the PC words allocated as memory tables are changed, the data are not upgraded at the NT11S unless these memory tables are used for screen displays.
- The maximum number of bits/words that can be read is 120 words per screen. If the number that can be read is exceeded, the data are not upgraded.

Event Processing

When the status of the NT11S changes during operation, the processing for writing the changed data to the relevant area of the PC memory is executed.

This kind of processing is only executed when statuses change. When changes occur simultaneously, the processes are executed in accordance with the order of priority.

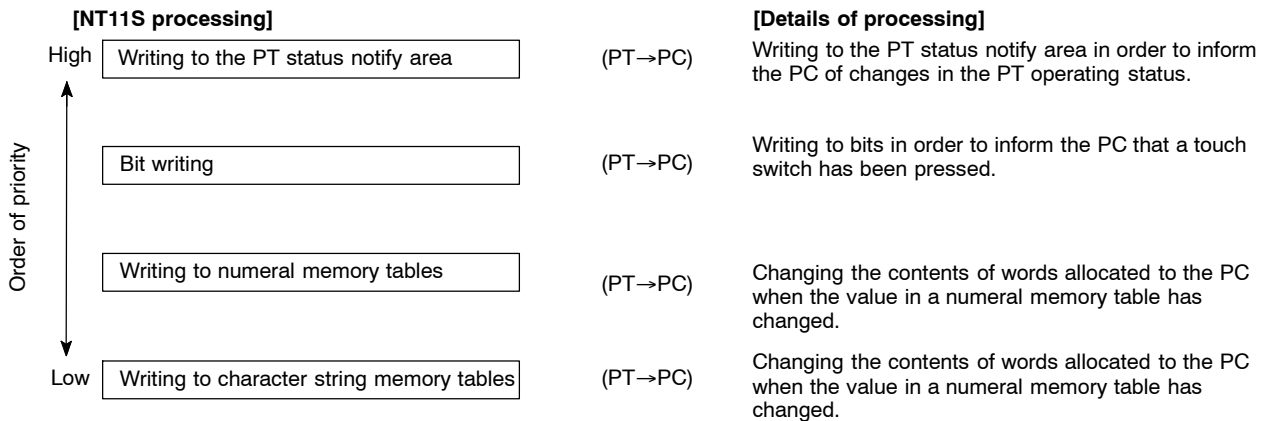

Note

Data is only written to PC bits and numeral/character string memory tables for elements in screens currently being displayed. If the contents of numeral/character string memory tables that are not being displayed change, the changed contents are not written to the PC.

APPENDIX G

Model List

PT

Model	Specification
NT11S-ST121	Beige
NT11S-ST121B	Black

Host Link Unit

Model	Specification	Applicable PC
C200H-LK101-PV1	Rack-mounting Unit with optical-fiber cable connector for C200H	C-series C200H
C200H-LK201-V1	Rack-mounting Unit with RS-232C connector for C200H	
C200H-LK202-V1	Rack-mounting Unit with RS-422C connector for C200H	

CPUs (For Connection Via a Host Link)

Model	Specification	PC Type
CQM1-CPU21-E CQM1-CPU41-E CQM1-CPU42-E CQM1-CPU43-E CQM1-CPU44-E	Features a 9-pin connector for RS-232C connections	C-series CQM1
C200HS-CPU21-E C200HS-CPU23-E C200HS-CPU31-E C200HS-CPU33-E	Features a connector for RS-232C connections (selectable/9-pin)	C200HS

CPUs (For Connection Via an NT Link)

Name	Model	PC Type
CQM1-CPU41-E CQM1-CPU42-E CQM1-CPU43-E CQM1-CPU44-E	Features a 9-pin connector for RS-232C connections	C-series CQM1
C200HS-CPU21-E C200HS-CPU23-E C200HS-CPU31-E C200HS-CPU33-E	Features a 9-pin connector for RS-232C connections	C200HS

Related Parts and Equipment for PT

Name	Model	Remarks
Support Tool	NT11S-ZA3AT-EV1	3.5 inch FD for NT11S series

Parts Used for Connection

Connection cable

Model	Remarks
AWG28×5P IFVV-SB	Multicore cable, manufactured by Fujikura, Ltd.
CO-MA-VV-SB 5P×28AWG	Multicore cable, manufactured by Hitachi Cable, Ltd.
H-9293A (CO-HC-ESV-3P×7/0.2)	For RS-422A, manufactured by HIRAKAWA Hewtech Corp.

Applicable connectors

Name	Model	Remark
Connector	XM2A-2501	25-pin, manufactured by OMRON
	XM2A-0901	9-pin (Plug), manufactured by OMRON
	DE-9P	9-pin, manufactured by JAE
Connector cover	XM2S-2511	25-pin, manufactured by OMRON
	XM2S-0911	9-pin, manufactured by OMRON
	DE-C1-J6	9-pin, manufactured by JAE

APPENDIX H**PC Memory Map****OMRON C-Series Memory Map**

Area		IR Area	HR Area	AR Area	Link Relay Area	Timer/Counter Area	DM Area
Ladder type	C200H	0000 to 0255	0000 to 0099	0000 to 0027	0000 to 0063	0000 to 0511	0000 to 1999
	C200HS	0000 to 0511	0000 to 0099	0000 to 0027	0000 to 0063	0000 to 0511	0000 to 6655 7000 to 9999
	CQM1	0000 to 0255	0000 to 0099	0000 to 0027	0000 to 0063	0000 to 0051	0000 to 6655

APPENDIX I

Special Characters

English Character Codes

Pin 2 of SW2 must be ON to enable English language messages to use the following codes.

Example: Hex code is represented by 30, decimal code by 48, and character by 0.

30	0
48	

Code 20 and 32 in the table represents a space, as indicated by "SP".

Hex Digits 1st → 2nd ↓	2-		3-		4-		5-		6-		7-		8-		9-	
-0	20	SP	30	0	40	@	50	P	60	'	70	p	80	Ç	90	É
	32		48		64		80		96		112		128		144	
-1	21	!	31	1	41	A	51	Q	61	a	71	q	81	ü	91	æ
	33		49		65		81		97		113		129		145	
-2	22	"	32	2	42	B	52	R	62	b	72	r	82	é	92	Æ
	34		50		66		82		98		114		130		146	
-3	23	#	33	3	43	C	53	S	63	c	73	s	83	â	93	ô
	35		51		67		83		99		115		131		147	
-4	24	\$	34	4	44	D	54	T	64	d	74	t	84	ä	94	ö
	36		52		68		84		100		116		132		148	
-5	25	%	35	5	45	E	55	U	65	e	75	u	85	à	95	ò
	37		53		69		85		101		117		133		149	
-6	26	&	36	6	46	F	56	V	66	f	76	v	86	å	96	û
	38		54		70		86		102		118		134		150	
-7	27	'	37	7	47	G	57	W	67	g	77	w	87	ç	97	ù
	39		55		71		87		103		119		135		151	
-8	28	(38	8	48	H	58	X	68	h	78	x	88	ê	98	ÿ
	40		56		72		88		104		120		136		152	
-9	29)	39	9	49	I	59	Y	69	i	79	y	89	ë	99	Ö
	41		57		73		89		105		121		137		153	
-A	2A	*	3A	:	4A	J	5A	Z	6A	j	7A	z	8A	è	9A	Ü
	42		58		74		90		106		122		138		154	
-B	2B	+	3B	;	4B	K	5B	[6B	k	7B	{	8B	ï	9B	ø
	43		59		75		91		107		123		139		155	
-C	2C	,	3C	<	4C	L	5C	\	6C	l	7C		8C	î	9C	£
	44		60		76		92		108		124		140		156	
-D	2D	-	3D	=	4D	M	5D]	6D	m	7D	}	8D	ì	9D	¥
	45		61		77		93		109		125		141		157	
-E	2E	.	3E	>	4E	N	5E	^	6E	n	7E	~	8E	Ë	9E	ƒ
	46		62		78		94		110		126		142		158	
-F	2F	/	3F	?	4F	O	5F	_	6F	o	7F	△	8F	Å	9F	f
	47		63		79		95		111		127		143		159	

Hex Digits 1st → 2nd ↓	A-		B-		C-		D-		E-		F-	
-0	A0	á	B0	⋮	C0	└	D0	≡	E0	α	F0	≡
	160		176	⋮	192	└	208	≡	224		240	
-1	A1	í	B1	■	C1	└	D1	≡	E1	β	F1	□
	161		177		193	└	209	≡	225		241	
-2	A2	ó	B2	⋮	C2	└	D2	≡	E2	Γ	F2	≥
	162		178	⋮	194	└	210	≡	226		242	
-3	A3	ú	B3		C3	└	D3	≡	E3	π	F3	≤
	163		179		195	└	211	≡	227		243	
-4	A4	ñ	B4	└	C4	—	D4	≡	E4	Σ	F4	└
	164		180		196		212	≡	228		244	
-5	A5	Ñ	B5	≡	C5	+	D5	F	E5	σ	F5	J
	165		181		197		213		229		245	
-6	A6	<u>a</u>	B6	≡	C6	F	D6	≡	E6	□	F6	÷
	166		182		198		214	≡	230		246	
-7	A7	<u>o</u>	B7	≡	C7	└	D7	≡	E7	τ	F7	≈
	167		183		199	└	215	≡	231		247	
-8	A8	¿	B8	└	C8	≡	D8	≡	E8	Φ	F8	°
	168		184		200	≡	216	≡	232		248	
-9	A9	└	B9	≡	C9	≡	D9	└	E9	Θ	F9	.
	169		185		201	≡	217	└	233		249	
-A	AA	└	BA	≡	CA	≡	DA	└	EA	Ω	FA	•
	170		186		202	≡	218	└	234		250	
-B	AB	1/2	BB	└	CB	≡	DB	■	EB	δ	FB	√
	171		187		203	≡	219		235		251	
-C	AC	1/4	BC	└	CC	└	DC	■	EC	∞	FC	n
	172		188		204	└	220		236		252	
-D	AD	i	BD	≡	CD	≡	DD	■	ED	ø	FD	2
	173		189		205	≡	221		237		253	
-E	AE	«	BE	≡	CE	≡	DE	■	EE	ε	FE	□
	174		190		206	≡	222		238		254	
-F	AF	»	BF	└	CF	≡	DF	■	EF	∩	FF	□
	175		191		207	≡	223		239		255	

□ : Used as the prefix for mark data codes (2 bytes).

INDEX

A

Allocatable bits and words	96
Allocated bit	10
Allocated word	10
Angle of visibility	5, 145
Auto-restart	135
Automatic reset function	60

B

Backlight OFF function	63
Bar graphs	83
Before operating	15

C

Cannot communicate	132
Changing displayed numerals or character strings	111, 114
Changing the contents of allocated words	111, 118
Changing the settings	43
Character-string	13
Character-string memory table	13, 81, 111
Characters	7, 78, 81
Check on communication	68
Classification of screens	80
Communication is automatically reset	60
Communications with PCs	11
Compatible PCs	26, 37
Connecting the NT11S	27
Connector	27
Connector for parallel interface connection	19
Connector specifications	147
Content upgrade memory table	120

Contrast control	19
Control timing	124
Controlling the NT11S status	98, 122
Controlling the display elements	97
Copy memory table setting	114
Copy type	114, 116
Copying the memory table	114
Creating screen data	73
Crimp terminal	23
Currently displayed screen word	103, 105

D

DIP switch	20
Decimal fraction parts	86
Description of Parts	18
Determine the upgraded numeral memory table number	119
Direct connection	10
Direct connection information	74
Display elements	13
Display history screen	90

E

Edit screen	75
Enlarged display	79
Equivalent to IP65 and NEMA4	5
Error message when NT11S is started	48
Error messages	133

F

Factory setting	20
File list	74
File units	54

Flashing display 79, 82

G

Graph frame 83

H

Host link 10, 58

Host link method 26

Host link unit 29

I

I/O check 65

IP65 22

Init. memory 49

Initialization 48

Initialization by using the DIP switch
(Forced initialization) 50, 56

Initialization by using the system menu 49

Initialization error 134

Initialization of the screen data 48, 49

Initialization setting 106, 108

Initializing memory 48

Input numerical value 85

Installation 22

Integer fraction parts 86

Internal processing 156

L

LCD 145

LCD check 66

LED check 65

LSS 30, 38

M

Maintenance 44

Maintenance mode 47

Making the cable for connection 146

Marks 7, 79, 81

Memory switches 57

Menu screen 87

Menu tree 45

Monitoring 13

N

9-pin 27

NT11S 3

NT11S cannot be normally started 48

NT link 10, 11, 37, 58

Noise filter 23

Noise prevention 23

Normal screens 80

Nothing is displayed 132

Notification of numbers to the PC 119

Notifying the NT11S status 99

Notifying the display elements 99

Notifying the display screen 103

Number of registration words 106, 108

Numeral memory table 82, 110

Numeral setting 85

Numeral setting strobe 119, 127

Numeric values 7, 13

Numerical value is to be input can be
selected 85

O

100 % value 84

Operating status 3, 126, 128

Operation mode 44

Operation panel 3, 22

Operations with the system menu 46

P

% display	84
PC	26
PC memory map	160
PC switch settings	28, 38
PC system setting	30, 38
PT	3
PT operation status	127
PT setting check	69
PT status	126
PT status control area	14, 98
PT status control bits	122
PT status notify area	14, 99
Password screen	88
Percentage	84
Peripheral tool	30, 38
Power input terminals	19, 23
Power is interrupted	56
Printing daily reports	91
Printing display histories	93
Programmable terminal	3

R

RS-232C cable	25
RS-232C connector	19
RS-422A terminal block	19
RUN	44, 65
Reset	56
Reset switch	19
Reverse and flashing display	79, 82
Reverse display	79, 82

S

Screen	77
--------------	----

Screen data	54
Screen data display on the NT11S	7
Screen data memory	48
Screen display	123
Screen display language mode	20
Screen list	74
Screen number	77
Screen number "0"	77, 132
Screen number 1	62
Screen switch setting	101
Screen switching strobe	102, 103, 127
Screen switching timing	102
Selecting the channel for communication with the host	61
Selecting the communication speed	59
Selecting the host communication method	58
Selecting the items	46
Setting	69
Setting error	134
Setting the support tool	72
Setting the words for the numeral memory tables	108
Setting the words of the character-string memory table	106
Start-up screen	77
Starting	43
Support tool	4, 25, 54, 73
Switch predetermined values or character-string according to the situation	114
Switching the screen display	101
Switching to the RUN mode	62
System menu	44

T

Tool I/F	68
----------------	----

Tool settings	73
Transferring the system program	51
Transmit	44
Transmit mode	47, 55, 76
Transmitting screen data	54, 76
Turning on the power	43
25-pin	27

U

Upgrading bar graphs	118
Used for the first time	48

W

Waterproofed	5
Wiring	147

Z

Zero suppress	82
---------------------	----

Revision History

A manual revision code appears as a suffix to the catalog number on the front cover of the manual.

Cat. No. V029-E1-2

↑
Revision code

The following table outlines the changes made to the manual during each revision. Page numbers refer to the previous version.

Revision code	Date	Revised content
1	September 1995	Original production
2	June 1997	Revision due to correction of precautions and correction of errors.