



PRESENTATION SCANNERS

Software Configuration Manual

DATALOGIC

AUDIN - 7 bis rue de Tinquaux - 51100 Reims - France
Tel : 03.26.04.20.21 - Fax : 03.26.04.28.20
Web : <http://www.audin.fr> - Email : info@audin.fr

PRESENTATION SCANNERS

SOFTWARE CONFIGURATION MANUAL



DATALOGIC

DATALOGIC S.p.A.
Via Candini 2
40012 - Lippo di Calderara di Reno
Bologna - Italy

PRESENTATION SCANNERS Software Configuration Manual

Ed.: 07/2005

This manual refers to software version 1.0.0 and later.

ALL RIGHTS RESERVED

Datalogic reserves the right to make modifications and improvements without prior notification.

Datalogic shall not be liable for technical or editorials errors or omissions contained herein, nor for incidental or consequential damages resulting from the use of this material.

Product names mentioned herein are for identification purposes only and may be trademarks and or registered trademarks of their respective companies.

© Datalogic S.p.A. 2005

13/07/05

CONTENTS

	CONFIGURATION METHODS	vi
1	INTRODUCTION	1
1.1	Status Indicators	1
2	INITIAL SETUP	3
2.1	Single Line Mode	3
2.2	Interface Selection	4
2.2.1	USB Interface Configuration	4
2.2.2	RS232 Interface Selection	7
2.2.3	Wedge Interface Selection	8
2.2.4	IBM 46xx Interface Selection	11
3	CONFIGURATION	12
	RS232 PARAMETERS	13
	Baud Rate	14
	Parity	15
	Data Bits	15
	Stop Bits	16
	Handshaking	16
	Ack/Nack Protocol	17
	Inter-character Delay	17
	Rx Timeout	18
	Serial Decode Control	18
	Serial Sleep Control	19
	USB PARAMETERS	20
	Handshaking	21
	Ack/Nack Protocol	21
	Inter-character Delay	22
	Rx Timeout	22
	Serial Decode Control	23
	Serial Sleep Control	23
	Keyboard Nationality	24
	Inter-character Delay	25
	Inter-code Delay	25
	Control Character Emulation	25
	WEDGE PARAMETERS	26
	Keyboard Nationality	27
	Caps Lock	28
	Caps Lock Auto-Recognition (IBM AT compatible only)	28

Num Lock	29
Inter-character Delay	29
Inter-code Delay.....	30
Control Character Emulation.....	30
Keyboard Setting	31
DATA FORMAT.....	33
Code Identifier.....	36
Custom Code Identifier	37
Header	38
Terminator.....	39
Field Adjustment	40
Field Adjustment Character.....	41
Code Length Tx	41
Character Replacement	42
POWER SAVE.....	44
Stand-by State	45
Enter Stand-by Timeout	45
Sleep State	46
Enter Sleep Timeout	46
READING PARAMETERS	47
Timeout between Same Code Readings	48
Single Line Decoding Duration.....	48
Single Line Timeout OFF Before Raster	49
Beeper Intensity	49
Beeper Tone	50
Beeper Type	50
Beeper Length	50
DECODING PARAMETERS.....	51
Ink Spread.....	52
Overflow Control	52
Code 39 Stitching.....	53
Code 128 Stitching.....	53
Interdigit Control.....	54
Decoding Safety.....	54
CODE SELECTION	55
EAN/UPC Family	57
2/5 Family	62
Code 39 Family.....	63
Code 128 Family.....	65
Code 93	66
Codabar Family.....	67
MSI	69

	Plessey	70
	RSS Codes	71
	ADVANCED FORMATTING	72
	Concatenation	73
	Advanced Formatting	76
4	REFERENCES	91
4.1	RS232 Parameters	91
4.1.1	Handshaking	91
4.1.2	ACK/NACK Protocol	92
4.1.3	RX Timeout	92
4.1.4	Serial Decode Control	92
4.1.5	Serial Sleep Control	92
4.2	Data Format	93
4.2.1	Header/Terminator Selection	93
4.2.2	Set Custom Extended Header/Terminator Keys	94
4.3	Power Save	96
4.3.1	Stand-by State	96
4.3.2	Enter Stand-by timeout	96
4.3.3	Sleep State	96
4.3.4	Enter Sleep Timeout	96
4.4	Reading Parameters	97
4.4.1	Timeout between Same Code Readings	97
4.4.2	Single Line Decoding Duration	97
4.4.3	Single Line Timeout OFF before Raster	97
4.5	Decoding Parameters	97
4.5.1	Ink-Spread	97
4.5.2	Overflow Control	98
4.5.3	Interdigit Control	98
4.5.4	Code Stitching	98
4.6	Code Selection	98
4.6.1	Set EAN/UPC Autodiscriminate Decoding Safety	98
4.7	Configuration Editing Commands	99
4.8	Configuration Copy Command	100
4.9	Firmware Upgrades	100
4.10	Default Parameters for POS Systems	101
A	HOST CONFIGURATION STRINGS	102
B	CODE IDENTIFIER TABLE	114
C	HEX AND NUMERIC TABLE	117

CONFIGURATION METHODS

Reading Configuration Barcodes

If you wish to change the default settings, this manual provides complete configuration of your scanner in an easy way:

To configure your scanner:

- 1) Read the **Enter Configuration** code ONCE, available at the top of each page of configuration.
- 2) Modify the desired parameters in one or more sections following the procedures given for each group. Some configuration codes require reading hex or numeric codes from the table in Appendix C.
- 3) Read the **Exit and Save Configuration** code ONCE, available at the top of each page of configuration.

Reference notes describing the operation of the more complex parameters are given in chapter 4.

Using DL Sm@rtSet

DL Sm@rtSet is a Windows-based utility program providing a quick and user-friendly configuration method via the RS232 or USB-COM interfaces.

It also allows upgrading the software of the connected device (see the DL Sm@rtSet User's Manual for more details).

Copy Command

A previously configured scanner (Master device), can be used to send its configuration directly to other scanners of the same type. The particular procedure for each device is given in par. 4.8.

Sending Configuration Strings from Host

An alternative configuration method is provided in Appendix A using the RS232 or USB interfaces. This method is particularly useful when many devices need to be configured with the same settings. Batch files containing the desired parameter settings can be prepared to configure devices quickly and easily.

1 INTRODUCTION

This manual provides all the necessary information for complete software configuration of various Presentation Scanner families.

Your scanner contains a built-in decoder and multi-standard interface.

It is designed for use in a wide variety of applications and environments including **commercial**, **office automation** and **retail** applications where large quantities of information need to be collected rapidly, easily and reliably.

It has several status indicator functions which are described in the next paragraph.

1.1 STATUS INDICATORS

Several status indicators are available. They signal several operating conditions which are described in the tables below.

H = high tone

L = low tone

SCANNER START-UP

Beeper ¹	Meaning
L L L L	Parameters loaded correctly or when exiting sleep mode (wakeup).
H H H H long tones	Parameter loading error, reading or writing error in the non volatile memory
H L H L	Hardware error in EEPROM

SCANNER CONFIGURATION

Beeper ¹	Meaning
H H H H	correct entry in Configuration mode
L	good read of a command
L L L	command read error
L H H H H	exit from Configuration mode

¹ only the Beeper Intensity command can modify these signals.

H = high tone

L = low tone

SCANNER DATA ENTRY

Beeper	LED	Meaning
one beep ²	Green constant	Correct read of a code in normal mode. It remains constant once the decoding process has been successfully completed and the scanner is in <i>Timeout between same code readings</i> .
	Red constant	It is constant in normal mode while the Laser is ON and the scanner is ready to read a new code (not in <i>Timeout between same code readings</i>).
L H ¹	Red constant	No read in single line mode after <i>Single Line Decoding Duration</i> timeout.
	Red blinking fast	It blinks fast when the scanner is in <i>Stand-by</i> mode
	Red blinking slow	It blinks slower when the scanner is in <i>Sleep</i> mode
	Green/Red blinking alternatively	They turn on alternatively during serial configuration

¹ only the Beeper Intensity command can modify these signals.

² the data entry good read tone is user-configurable with all the Beeper commands in the Reading Parameter section.

2 INITIAL SETUP

2.1 SINGLE LINE MODE

When many barcodes are present in the same reading area, like in barcode price lists or in the case of configuration barcodes in this manual, selecting a specific barcode to read is not practical with the large raster pattern emitted by the presentation scanner, so a special single line scanning mode can be easily entered to perform this task. In this mode only a single scanning line is enabled so that aiming and reading barcodes becomes very easy.

To use single line mode for barcode reading follow the procedure below:

1. While the normal raster pattern is present, press the trigger. A single laser line will appear but barcodes cannot be decoded.
2. Position the presentation scanner over the code to read and press the trigger within 5 seconds to decode the code.

When using the scanner for data entry, a programmable timeout is provided to assure that the presentation scanner will return to raster mode if barcode reading is not successful in single line (*Single Line Decoding Duration*). Also a programmable timeout is available to manage how long to wait after successful reading before returning to raster mode (*Single Line Timeout OFF Before Raster*).

If you need to make consecutive readings in single line mode, simply repeat the procedure before the *Single Line Timeout OFF Before Raster* expires.

When in configuration, the scanner will remain in single line until the *Exit Configuration* barcode is read.

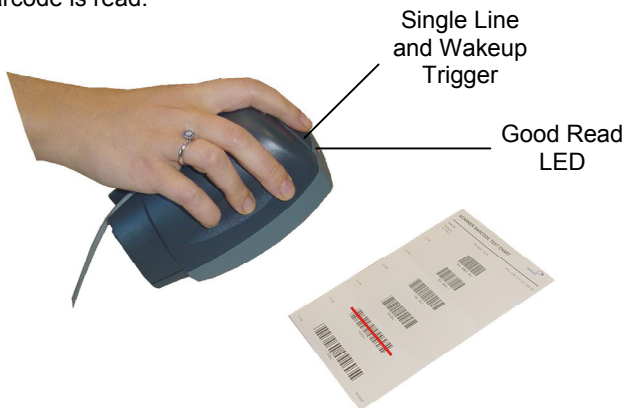

2.2 INTERFACE SELECTION

Follow the procedure to configure the interface required by your application

- USB Interface
- RS232 Interface
- Wedge Interface

2.2.1 USB Interface Configuration

The USB interface is compatible with:

- Windows 98 (and later)
- Mac OS 8.0 (and later)
- IBM POS for Windows
- 4690 Operating System

START-UP

As with all USB devices, upon connection, the Host performs several checks by communicating with the presentation scanner. During this phase the green LED on the scanner blinks and normal operations are suspended. Two basic conditions must be met before the presentation scanner is ready to read codes, the correct USB driver must be loaded and sufficient power must be supplied to the reader.

For all systems, the correct USB driver for the default USB-KBD interface is included in the Host Operating System and will either be loaded automatically or will be suggested by the O.S. and should therefore be selected from the dialog box (the first time only).

If the Host supplies sufficient power to the reader, the start-up phase ends correctly, the green LED stops blinking and the reader emits the beep OK signal.

If the Host does not supply sufficient power to the reader, a dialog box will appear on the Host and the reader will be blocked (green LED continues blinking). In this case, disconnect the USB cable at the Host (green LED stops blinking), connect and power-up an external supply to the USB cable then reconnect the USB cable to the Host and close the dialog box. The reader emits the beep OK signal. You can now read codes. At this point you can read the USB interface configuration code according to your application. Load drivers from the O.S. (if requested). When configuring the USB-COM interface, the relevant files and drivers must be installed from the USB Device Installation software which can be downloaded from the web page <http://www.datalogic.com>.

The presentation scanner is ready.

First Start-Up

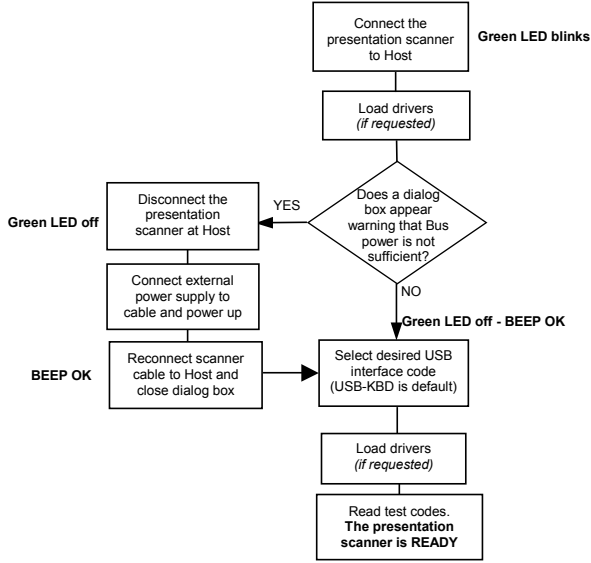

Successive start-ups will automatically recognize the previously loaded drivers. If external power is used, verify that external power is already supplied.

Successive Start-Ups

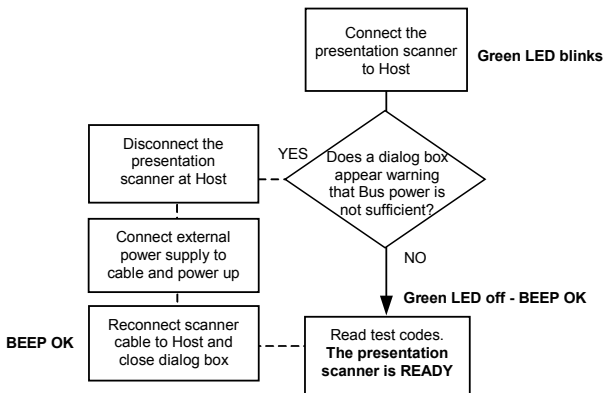

USB INTERFACE

USB-KBD



USB-KBD-ALT-MODE



USB-KBD-APPLE



USB-COM*



USB-IBM-Table Top



USB-IBM-Hand Held



- * When configuring USB-COM, the relevant files and drivers must be installed from the USB Device Installation software which can be downloaded from the web page (see <http://www.datalogic.com>).

2.2.2 RS232 Interface Selection

Using Single Line Mode read the restore default code, then read the interface selection code for your application:

RESTORE DEFAULT



RS232 INTERFACE

Standard



POS SYSTEMS

Nixdorf Mode A



Fujitsu



ICL Mode



For POS system default settings refer to par. 4.10

2.2.3 Wedge Interface Selection

Using Single Line Mode read the restore default code, then read the interface selection code for your application:

RESTORE DEFAULT



WEDGE INTERFACE

IBM AT or PS/2 PCs



IBM XT



PC Notebook



IBM SURE1



IBM Terminal 3153



WEDGE INTERFACE (CONTINUED)

IBM Terminals 31xx, 32xx, 34xx, 37xx:

To select the interface for these IBM Terminals, read the correct KEY TRANSMISSION code. Select the KEYBOARD TYPE if necessary (default = advanced keyboard).

KEY TRANSMISSION MODE

make-only keyboard



make-break keyboard

**KEYBOARD TYPE**

◆ advanced keyboard



typewriter keyboard

**ALT MODE**

The following interface selection allows barcodes sent to the PC to be interpreted correctly independently from the Keyboard Nationality used. **You do not need to make a Keyboard Nationality selection.**

(default = Num Lock Unchanged). **Make sure the Num Lock key on your keyboard is ON.**

IBM AT - ALT mode



PC Notebook - ALT mode



WEDGE INTERFACE (CONTINUED)**WYSE TERMINALS**

ANSI Keyboard



PC Keyboard



ASCII Keyboard



VT220 style Keyboard

**DIGITAL TERMINALS**

VT2xx/VT3xx/VT4xx

**APPLE**

APPLE ADB Bus



2.2.4 IBM 46xx Interface Selection

(IBM Devices only)

PORT 9B

4501 Protocol



(typical)

1520 Protocol



PORT 5B

1520 Protocol



(typical)

4501 Protocol



3 CONFIGURATION

Once your scanner is setup, you can change the default parameters to meet your application needs. Refer to chapter 2 for initial configuration in order to set the default values and select the interface for your application.

In this manual, the configuration parameters are divided into logical groups making it easy to find the desired function based on its reference group.

The first three groups are for Standard Interface parameter configuration, the fourth is only for IBM 46xx models:

- **RS232**
- **USB**
- **WEDGE**
- **IBM**

The following parameter groups are common to all interface applications:

DATA FORMAT parameters regard the messages sent to the Host system.

POWER SAVE manages overall current consumption in the reading device.

READING PARAMETERS control various operating modes and indicator status functioning.

DECODING PARAMETERS maintain correct barcode decoding in certain special reading conditions.

CODE SELECTION parameters allow configuration of a personalized mix of codes, code families and their options.

ADVANCED FORMATTING PARAMETERS allow code concatenation and advanced formatting of messages towards the Host.

RS232 PARAMETERS

⊙	BAUD RATE	⊙
⊙	PARITY	⊙
⊙	DATA BITS	⊙
⊙	STOP BITS	⊙
⊙	HANDSHAKING	⊙
⊙	ACK/NACK PROTOCOL	⊙
⊙	INTER-CHARACTER DELAY	⊙
⊙	RX TIMEOUT	⊙
⊙	SERIAL DECODE CONTROL	⊙
⊙	SERIAL SLEEP CONTROL	⊙

1. Read the **Enter Configuration** code ONCE, available at the top of each page.

2. Read configuration codes from the desired groups.



= Read the code and follow the procedure given



= Default value

3. Read the **Exit and Save Configuration** code ONCE, available at the top of each page.



BAUD RATE

300 baud



600 baud



1200 baud



2400 baud



4800 baud



◆ 9600 baud



19200 baud



38400 baud





PARITY

◆ none



even parity



odd parity



DATA BITS

7 bits



◆ 8 bits





STOP BITS

◆ 1 stop bit



2 stop bits



HANDSHAKING

◆ disable



hardware (RTS/CTS)



software (XON/XOFF)



RTS always ON



See par. 4.1.1 for details.



ACK/NACK PROTOCOL

◆ disable



enable



See par. 4.1.2 for details.

INTER-CHARACTER DELAY

delay between characters transmitted to Host

**Read 2 numbers from the table where:**

00 = DELAY disabled

01-99 = DELAY from 1 to 99 milliseconds

◆ delay disabled



RX TIMEOUT

timeout control in reception from Host



Read 2 numbers from the table where:

- 00 = TIMEOUT disabled
- 01-99 = TIMEOUT from .1 to 9.9 seconds

◆ rx timeout 5 seconds

See par. 4.1.3 for details.

SERIAL DECODE CONTROL

◆ disable



enable and select characters



Read 2 characters from the Hex/Numeric table in the range 00-FE where:

- First Character enables decoding
- Second Character inhibits decoding until the first character is received again.

See par. 4.1.4 for details.



SERIAL SLEEP CONTROL

◆ disable



enable and select characters



Read 2 characters from the Hex/Numeric table in the range 00-FE where:

- First Character immediately puts the scanner in sleep.
- Second Character immediately wakesup the scanner.

See par. 4.1.5 for details.

USB PARAMETERS

⊙	USB-COM	⊙
	Handshaking, Ack/Nack Protocol, Inter-character Delay, Rx Timeout, Serial Decode Control, Serial Sleep Control	
⊙	USB-KBD	⊙
	Keyboard Nationality, Inter-character Delay, Inter-code Delay, Control Character Emulation	
⊙	USB-IBM	⊙
	No parameter selection required.	

1. Read the **Enter Configuration** code ONCE, available at the top of each page.

2. Read configuration codes from the desired groups.



= Read the code and follow the procedure given



= Default value

3. Read the **Exit and Save Configuration** code ONCE, available at the top of each page.



HANDSHAKING

◆ disable



hardware (RTS/CTS)



software (XON/XOFF)



RTS always ON



See par. 4.1.1 for details.

ACK/NACK PROTOCOL

◆ disable



enable



See par. 4.1.2 for details.



INTER-CHARACTER DELAY

delay between characters transmitted to Host



Read 2 numbers from the table where:

- 00 = DELAY disabled
- 01-99 = DELAY from **1** to **99** milliseconds

◆ delay disabled

RX TIMEOUT

timeout control in reception from Host



Read 2 numbers from the table where:

- 00 = TIMEOUT disabled
- 01-99 = TIMEOUT from **.1** to **9.9** seconds

◆ rx timeout 5 seconds

See par. 4.1.3 for details.



SERIAL DECODE CONTROL

◆ disable



enable and select characters



Read 2 characters from the Hex/Numeric table in the range 00-FE where:

- First Character enables decoding
- Second Character inhibits decoding until the first character is received again.

See par. 4.1.4 for details.

SERIAL SLEEP CONTROL

◆ disable



enable and select characters



Read 2 characters from the Hex/Numeric table in the range 00-FE where:

- First Character immediately puts the scanner in sleep.
- Second Character immediately wakesup the scanner.

See par. 4.1.5 for details.

**USB-KBD*****KEYBOARD NATIONALITY*****Not Available for USB-KBD-ALT-MODE Interface**

This parameter default value is restored through the Interface Selection code and not Restore Default.

Belgian



English



French



German



Italian



Japanese



Spanish



Swedish



◆ USA





INTER-CHARACTER DELAY



delay between characters transmitted to Host



Read 2 numbers from the table where:

00 = DELAY disabled
01-99 = DELAY from 1 to 99 milliseconds

◆ delay disabled

INTER-CODE DELAY



delay between codes transmitted to Host



Read 2 numbers from the table where:

00 = DELAY disabled
01-99 = DELAY from 1 to 99 seconds

◆ delay disabled

CONTROL CHARACTER EMULATION

◆ CTRL+ Shift + Key



CTRL + Key



WEDGE PARAMETERS

⊙	KEYBOARD NATIONALITY	⊙
⊙	CAPS LOCK	⊙
⊙	CAPS LOCK AUTO-RECOGNITION	⊙
⊙	NUM LOCK	⊙
⊙	INTER-CHARACTER DELAY	⊙
⊙	INTER-CODE DELAY	⊙
⊙	CONTROL CHARACTER EMULATION	⊙
⊙	KEYBOARD SETTING	⊙

1. Read the **Enter Configuration** code ONCE, available at the top of each page.

2. Read configuration codes from the desired groups.



= Read the code and follow the procedure given



= Default value

3. Read the **Exit and Save Configuration** code ONCE, available at the top of each page.

**WEDGE**

KEYBOARD NATIONALITY

This parameter default value is restored through the Interface Selection code and not Restore Default.

Belgian



English



French



German



Italian



Spanish



Swedish



◆ USA



The Japanese Keyboard Nationality selection is valid only for IBM AT compatible PCs.

Japanese





CAPS LOCK

◆ caps lock OFF



caps lock ON



Select the appropriate code to match your keyboard caps lock status.

Note: Caps lock manual configuration is ignored when Caps Lock Auto-Recognition is enabled.

For **PC Notebook** interface selections, the caps lock status is automatically recognized, therefore this command is not necessary.

CAPS LOCK AUTO-RECOGNITION (IBM AT COMPATIBLE ONLY)

disable



◆ enable





WEDGE

NUM LOCK

toggle num lock



◆ num lock unchanged



This selection is used together with the Alt Mode interface selection for AT or Notebook PCs.

It changes the way the Alt Mode procedure is executed, therefore it should be set as follows:

- if your keyboard Num Lock is normally on use **num lock unchanged**
- if your keyboard Num Lock is normally off use **toggle num lock**

In this way the device will execute the Alt Mode procedure correctly for your application.

INTER-CHARACTER DELAY

delay between characters transmitted to Host



Read 2 numbers from the table where:

00 =	DELAY disabled
01-99 =	DELAY from 1 to 99 milliseconds

◆ delay disabled



INTER-CODE DELAY



delay between codes transmitted to Host



Read 2 numbers from the table where:

- 00 = DELAY disabled
- 01-99 = DELAY from 1 to 99 seconds

◆ delay disabled

CONTROL CHARACTER EMULATION

◆ CTRL+ Shift + Key



CTRL + Key





WEDGE

KEYBOARD SETTING

ALPHANUMERIC KEYBOARD SETTING

The scanner can be used with terminals or PCs with various keyboard types and nationalities through a simple keyboard setting procedure.

The type of computer or terminal must be selected before activating the keyboard setting command.

Keyboard setting consists of communicating to the scanner how to send data corresponding to the keyboard used in the application. The keys must be set in a specific order.

Press and release a key to set it.

Some characters may require more than one key pressed simultaneously during normal use (refer to the manual of your PC or terminal for keyboard use). The exact sequence must be indicated to the scanner in this case pressing and releasing the different keys.

Example:

If one has to press the "Shift" and "4" keys simultaneously on the keyboard to transmit the character "\$" to the video, to set the "\$", press and release "Shift" then press and release "4".

Each pressed and released key must generate an acoustic signal on the scanner, otherwise repress the key. Never press more than one key at the same time, even if this corresponds to the normal use of your keyboard.

Press "Backspace" to correct a wrong key entry. In this case the scanner emits 2 beeps.

Note: "CAPS LOCK" and "NUM LOCK" must be off before starting the keyboard setting procedure. "SHIFT" must be repressed for each character and cannot be substituted by "CAPS LOCK".



setting the alphanumeric keyboard



Read the code above.

Press the keys shown in the following table according to their numerical order:

WEDGE



Some ASCII characters may be missing as this depends on the type of keyboard: these are generally particular characters relative to the various national symbolologies. In this case:

- **The first 4 characters (Shift, Alt, Ctrl, and Backspace) can only be substituted with keys not used, or substituted with each other.**
- characters can be substituted with other single symbols (e.g. "SPACE") even if not included in the barcode set used.
- characters can be substituted with others corresponding to your keyboard.

The scanner signals the end of the procedure with 2 beeps indicating the keys have been registered.

01 : Shift		
02 : Alt		
03 : Ctrl		
04 : Backspace		
05 : SPACE	28 : 7	51 : N
06 : !	29 : 8	52 : O
07 : "	30 : 9	53 : P
08 : #	31 : :	54 : Q
09 : \$	32 : ;	55 : R
10 : %	33 : <	56 : S
11 : &	34 : =	57 : T
12 : '	35 : >	58 : U
13 : (36 : ?	59 : V
14 :)	37 : @	60 : W
15 : *	38 : A	61 : X
16 : +	39 : B	62 : Y
17 : ,	40 : C	63 : Z
18 : -	41 : D	64 : [
19 : .	42 : E	65 : \
20 : /	43 : F	66 :]
21 : 0	44 : G	67 : ^
22 : 1	45 : H	68 : _ (underscore)
23 : 2	46 : I	69 : `
24 : 3	47 : J	70 : {
25 : 4	48 : K	71 :
26 : 5	49 : L	72 : }
27 : 6	50 : M	73 : ~
		74 : DEL

DATA FORMAT

⊙	CODE IDENTIFIER	⊙
⊙	CUSTOM CODE IDENTIFIER	⊙
⊙	HEADER	⊙
⊙	TERMINATOR	⊙
⊙	FIELD ADJUSTMENT	⊙
⊙	FIELD ADJ. CHARACTER	⊙
⊙	CODE LENGTH TX	⊙
⊙	CHARACTER REPLACEMENT	⊙

1. Read the **Enter Configuration** code ONCE, available at the top of each page.

2. Read configuration codes from the desired groups.



= Read the code and follow the procedure given



= Default value

3. Read the **Exit and Save Configuration** code ONCE, available at the top of each page.

CODE IDENTIFIER TABLE

CODE	AIM STANDARD	DATALOGIC STANDARD	Custom
2/5 interleaved] I y	N	
2/5 industrial] X y	P	
2/5 normal 5 bars] S y	O	
2/5 matrix 3 bars] X y	Q	
EAN 8] E 4	A	
EAN 13] E 0	B	
UPC A] X y	C	
UPC E] X y	D	
EAN 8 with 2 ADD ON] E 5	J	
EAN 8 with 5 ADD ON] E 6	K	
EAN 13 with 2 ADD ON] E 1	L	
EAN 13 with 5 ADD ON] E 2	M	
UPC A with 2 ADD ON] X y	F	
UPC A with 5 ADD ON] X y	G	
UPC E with 2 ADD ON] X y	H	
UPC E with 5 ADD ON] X y	I	
Code 39] A y	V	
Code 39 Full ASCII] A y	W	
CODABAR] F y	R	
Code 128] C y	T	
EAN 128] C y	k	
Code 93] G y	U	
CIP/39] X y	Y	
CIP/HR] X y	e	
Code 32] X y	X	
MSI] M y	Z	
Plessey Standard] P 0	a	
Plessey Anker] P 1	o	
RSS Expanded Linear] e 0	t	
RSS Limited] e 0	v	
RSS 14 Linear] e 0	u	

DATA FORMAT

- AIM standard identifiers are not defined for all codes: the X identifier is assigned to the code for which the standard is not defined. The y value depends on the selected options (check digit tested or not, check digit tx or not, etc.).
- When customizing the Datalogic Standard code identifiers, 1 or 2 identifier characters can be defined for each code type. If only 1 identifier character is required, the second character must be selected as **FF** (disabled).
- The code identifier can be singly disabled for any code by simply selecting **FF** as the first identifier character.
- Write in the Custom character identifiers in the table above for your records.



CODE IDENTIFIER

◆ disable



Datalogic standard



AIM standard



custom





CUSTOM CODE IDENTIFIER

define custom code identifier(s)



- ① Read the above code.
(Code Identifiers default to Datalogic standard, see table on previous page).
- ② Select the code type from the code table in Appendix B for the identifier you want to change.
- ③ You can define 1 or 2 identifier characters for each code type. If only 1 identifier character is required, the second character must be selected as **FF** (disabled). Read the hexadecimal value corresponding to the character(s) you want to define as identifiers for the code selected in step ②: valid characters are in the range **00-FE**.

Example: To define Code 39 Code Identifier = @

Read define custom code identifier(s) + Code 39 + 40 + FF





HEADER

no header



one character header



two character header



three character header



four character header



five character header



six character header



seven character header



eight character header



After selecting **one** of the desired Header codes, read the character(s) from the HEX table.

Example:

four character header

 $+ 41 + 42 + 43 + 44 = \text{Header } ABCD$

For more details see par. 4.2.1.



TERMINATOR

no terminator



one character terminator



two character terminator



three character terminator



four character terminator



five character terminator



six character terminator



seven character terminator



eight character terminator



After selecting **one** of the desired Terminator codes, read the character(s) from the HEX table.

Example:

two character terminator



+ 0D + 0A = Terminator CR LF

For more details see par. 4.2.1.

**FIELD ADJUSTMENT**

◆ disable field adjustment



Field adjustment allows a number of characters n , to be added to or subtracted from the barcode read. The adjustment can be different for each enabled code type. To define the field adjustment:

① Read the enable field adjustment code:

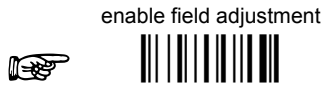
② Select the code type from the Code Identifier Table in Appendix B.

③ Select the type of adjustment to perform:

right addition



left addition



right deletion



left deletion

④ Read a number in the range **01 - 32** from the Hex/Numeric Table to define how many characters to add or delete:**Conditions:**

- Adjustment is only performed on the barcode data, the Code Identifier and Code Length Transmission fields are not modified by the field adjustment parameter.
- If the field setting would subtract more characters than exist in the barcode, the subtraction will take place only to code length 0.
- You can set up to a maximum of 10 different field adjustments on the same barcode family or on different barcode families.

Example: To add 4 characters to the right of Standard Code 39 Codes:



FIELD ADJUSTMENT CHARACTER

- ① Read the field adjustment character code:



- ② Read the hexadecimal value corresponding to the character you want to use for field adjustment. Valid characters are in the range **00-FE**.

Example:

To define the field adjustment character = **A**:



CODE LENGTH TX

- ◆ code length not transmitted



code length transmitted in variable-digit format



code length transmitted in fixed 4-digit format



The code length is transmitted in the message after the Headers and Code Identifier characters. The code length is calculated after performing any field adjustment operations.



CHARACTER REPLACEMENT

◆ disable character replacement



This parameter allows up to three characters to be replaced from the barcode read. These substitutions are stored in memory. To define each character replacement:

- ① Read one of the following character replacement codes:



first character replacement



second character replacement



third character replacement



- ② From the Code Identifier Table in Appendix B, read the Code Identifier for the desired code family.
0 = character replacement will be effective for all code families.
- ③ From the Hex/Numeric Table read two characters corresponding to the Hex value (**00-FE**) which identifies the character to be replaced.
- ④ From the Hex/Numeric Table read two characters corresponding to the Hex value (**00-FE**) which identifies the new character to replace.
FF = the character to be replaced will be substituted with no character, that is, it will be removed from the code.

**Example:**

The following strings define:

1. *First Character Replacement:* substitution in *Code 39 barcodes* of all occurrences of the **0** character with the **1** character.
2. *Second Character Replacement:* substitution in *Code 39 barcodes* of all occurrences of the **A** character with the **B** character.

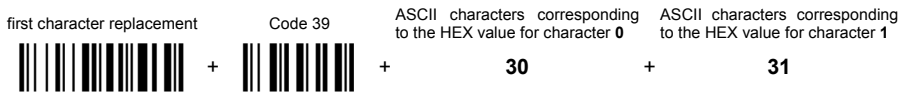

For Code 39 codes containing the string "**0123**", the contents transmitted will be "**1123**".

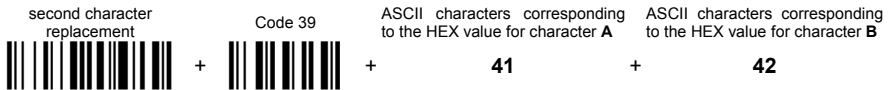

For Code 39 codes containing the string "**ABCD**", the contents transmitted will be "**BBCD**".

POWER SAVE

⊙	STAND-BY STATE	⊙
⊙	ENTER STAND-BY TIMEOUT	⊙
⊙	SLEEP STATE	⊙
⊙	ENTER SLEEP TIMEOUT	⊙

1. Read the **Enter Configuration** code ONCE, available at the top of each page.

2. Read configuration codes from the desired groups.



= Read the code and follow the procedure given



= Default value

3. Read the **Exit and Save Configuration** code ONCE, available at the top of each page.



POWER SAVE

STAND-BY STATE

disable



◆ enable



See par. 4.3.1 for details.

ENTER STAND-BY TIMEOUT

1 minute



◆ 5 minutes



15 minutes



25 minutes



See par. 4.3.2 for details.



POWER SAVE

SLEEP STATE

disable



◆ enable



See par. 4.3.3 for details.

ENTER SLEEP TIMEOUT



enter sleep timeout



Read 2 numbers in the range 01-99:

01-99 = corresponds to a max. 99 min. delay before entering the Sleep state.

See par. 4.3.4 for details.

READING PARAMETERS

⊙	<i>TIMEOUT BETWEEN SAME CODE READINGS</i>	⊙
⊙	<i>SINGLE LINE DECODING DURATION</i>	⊙
⊙	<i>SINGLE LINE TIMEOUT OFF BEFORE RASTER</i>	⊙
⊙	<i>BEEPER INTENSITY</i>	⊙
⊙	<i>BEEPER TONE</i>	⊙
⊙	<i>BEEPER TYPE</i>	⊙
⊙	<i>BEEPER LENGTH</i>	⊙

1. Read the **Enter Configuration** code ONCE, available at the top of each page.

2. Read configuration codes from the desired groups.



= Read the code and follow the procedure given



= Default value

3. Read the **Exit and Save Configuration** code ONCE, available at the top of each page.



TIMEOUT BETWEEN SAME CODE READINGS



timeout between same code readings



Limits same code consecutive reading.

Read 2 numbers in the range 01-99:

01 to 99 = timeout from 1 to 9.9 seconds for which the code must be removed (no decoding) before a consecutive read on same code.

◆ timeout = 0.3 sec

See par. 4.4.1 for details.

SINGLE LINE DECODING DURATION



single line decoding duration



Read 2 numbers in the range 01-20:

01 to 20 = timeout from 1 to 20 seconds before passing to the *Single Line Timeout OFF Before Raster*.

◆ duration = 5 sec

See par. 4.4.2 details.



SINGLE LINE TIMEOUT OFF BEFORE RASTER

single line timeout OFF before raster

**Read 1 number in the range 1-9:**

1 to 9 = timeout from 1 to 9 seconds before re-entering Raster mode.

◆ timeout = 2 sec

See par. 4.4.3 for details.

BEEPER INTENSITY

beeper off *



low intensity



medium intensity



◆ high intensity



* This sets the beeper OFF for data entry, while for all other beeper signals it has the meaning "very low intensity". The Beeper Intensity parameter is effective for all operating conditions described in par. 1.1.



READING PARAMETERS

BEEPER TONE

tone 1



◆ tone 2



tone 3



tone 4



BEEPER TYPE

◆ monotone



bitonal



BEEPER LENGTH

long



◆ short



DECODING PARAMETERS

⊙	INK SPREAD	⊙
⊙	OVERFLOW CONTROL	⊙
⊙	INTERDIGIT CONTROL	⊙
⊙	CODE 39 STITCHING	⊙
⊙	CODE 128 STITCHING	⊙
⊙	DECODING SAFETY	⊙



CAUTION

Before changing these parameter values read the descriptions in par. 4.5.

- 1.** Read the **Enter Configuration** code ONCE, available at the top of each page.
- 2.** Read configuration codes from the desired groups.
◆ = Default value
- 3.** Read the **Exit and Save Configuration** code ONCE, available at the top of each page.



INK SPREAD

disable



◆ enable



See par. 4.5.1 for details.

OVERFLOW CONTROL

disable



◆ enable



See par. 4.5.2 for details.



CODE 39 STITCHING

disable



◆ enable



See par. 4.5.4 for details.

CODE 128 STITCHING

disable



◆ enable



See par. 4.5.4 for details.



DECODING PARAMETERS

INTERDIGIT CONTROL

disable



◆ enable



See par. 4.5.3 for details.

DECODING SAFETY

◆ one read



(decoding safety disabled)

two reads



three reads



four reads



Required number of good reads before accepting code.

CODE SELECTION

⊙	<i>EAN/UPC FAMILY</i>	⊙
⊙	<i>2/5 FAMILY</i>	⊙
⊙	<i>CODE 39 FAMILY</i>	⊙
⊙	<i>CODE 128 FAMILY</i>	⊙
⊙	<i>CODE 93</i>	⊙
⊙	<i>CODABAR FAMILY</i>	⊙
⊙	<i>MSI</i>	⊙
⊙	<i>PLESSEY</i>	⊙
⊙	<i>RSS CODES</i>	⊙

1. Read the **Enter Configuration** code ONCE, available at the top of each page.

2. Read configuration codes from the desired groups.



= Read the code and follow the procedure given



= Default value

3. Read the **Exit and Save Configuration** code ONCE, available at the top of each page.



CODE SELECTION



DISABLES ALL CODE FAMILIES



NOTE

The scanner allows up to 5 code selections. This does not limit the number of CODES enabled to 5, as it depends on the code family.

SINGLE SELECTIONS =

- ONE combination code from the EAN family
- ONE code from the 2/5 family

Example

5 code selections:

1. **2/5 Interleaved**
2. **2/5 Industrial**
3. Code 128 + EAN 128
4. Code 39 Full ASCII + Code 32
5. **UPC A/UPC E**

In this section all SINGLE code selections are underlined and in bold.



CODE SELECTION

EAN/UPC FAMILY

disable the family



① Read the desired family code

Note:

Since the EAN/UPC without ADD ON code selection is enabled by default, to correctly enable another selection, first disable the family.

EAN 8/EAN 13/UPC A/UPC E with and without ADD ON



Set EAN/UPC Autodiscriminate Decoding Safety



Read 2 numbers in the range 02-30:

02 to 30 = from 2 to 30 reads before transmitting the EAN/UPC code without ADD ON.

◆ 15 reads

See par. 4.6.1 for details.



CODE SELECTION



WITHOUT ADD ON

◆ EAN 8/EAN 13/UPC A/UPC E



EAN 8/EAN 13



UPC A/UPC E





CODE SELECTION

WITH ADD ON 2 AND 5

EAN 8/EAN 13/UPC A/UPC E



EAN 8/EAN 13



UPC A/UPC E



WITH ADD ON 2 ONLY

EAN 8/EAN 13



UPC A/UPC E



WITH ADD ON 5 ONLY

EAN 8/EAN 13



UPC A/UPC E



**CODE SELECTION****EAN/UPC CHECK DIGIT TX SELECTIONS**

For each code type in this family you can choose to transmit the check digit or not

CHECK DIGIT TRANSMISSION

◆ EAN 8



◆ EAN 13



◆ UPC A



◆ UPC E

**NO CHECK DIGIT TRANSMISSION**

EAN 8



EAN 13



UPC A



UPC E





CODE SELECTION

CONVERSION OPTIONS

UPC E to UPC A conversion



UPC E to EAN 13 conversion



UPC A to EAN 13 conversion



EAN 8 to EAN 13 conversion



Enable only ISBN conversion



Enable only ISSN conversion



Enable both ISBN and ISSN conversion



Disable both ISBN and ISSN conversion



**CODE SELECTION****2/5 FAMILY**

disables the family



① Read the desired family code

◆ **Interleaved 2/5**◆ **Normal 2/5 (5 Bars)**◆ **Industrial 2/5 (IATA)**◆ **Matrix 2/5 (3 Bars)**

The pharmaceutical code below is part of the 2/5 family but has no check digit or code length selections.

◆ **Code CIP/HR**

French pharmaceutical code

② Read a check digit selection

CHECK DIGIT TABLE

no check digit control



◆ check digit control and transmission



check digit control without transmission

③ Read **4** numbers for the code length where:

- **First 2 digits** = minimum code length.
- **Second 2 digits** = maximum code length.

The maximum code length is **99** characters.

The minimum code length must always be less than or equal to the maximum.

Examples:

0199 = variable from 1 to 99 digits in the code.

1010 = 10 digit code length only.

Default character range: **06-99**



CODE SELECTION

CODE 39 FAMILY

disables the family



① Read the desired family code

② Read a check digit selection

CHECK DIGIT TABLE

◆ Standard Code 39



◆ no check digit control



◆ Full ASCII Code 39



check digit control
and transmission



check digit control
without transmission





CODE SELECTION

The pharmaceutical codes below are part of the Code 39 family but have no check digit selections.

Code CIP39



French pharmaceutical code

Code 32



Italian pharmaceutical code

CODE LENGTH (optional)

The code length selection is valid for the entire Code 39 family

Read the code + 4 numbers for the code length where:

First 2 digits = minimum code length.

Second 2 digits = maximum code length.

set code length



The maximum code length is **99** characters.

The minimum code length must always be less than or equal to the maximum.

Examples: **0199** = variable from 1 to 99 digits in the code. **1010** = 10 digit code length only.

Default character range: **04-99**



CODE SELECTION

CODE 128 FAMILY

disables the family



- ① Read the desired family code

◆ Code 128



control without transmission
of check digit

EAN 128



control without transmission
of check digit

Transmit GS Before Code

Code EAN 128 uses the ASCII <GS> character to separate a variable length code field from the next code field. This character can also be transmitted before the code.

◆ disable



enable



If the <GS> character has been modified in the Character Replacement parameter, the new character is affected by this command.



CODE SELECTION

CODE LENGTH (optional)

The code length selection is valid for the entire Code 128 family.

Read the code + 4 numbers for the code length where:

First 2 digits = minimum code length

Second 2 digits = maximum code length

set code length



The maximum code length is 99 characters. The minimum code length must always be less than or equal to the maximum.

Examples: **0199** = variable from 1 to 99 digits in the code. **1010** = 10 digit code length only.

Default character range: **01-99**

The length is calculated on the output string.

CODE 93

◆ disables the code



Code 93



control without transmission
of check digit



CODE SELECTION

CODABAR FAMILY

◆ disables the family



① Read the desired equality control code

② Read a start/stop transmission selection

Standard Codabar



no start/stop character equality control

START/STOP CHARACTER TRANSMISSION

no transmission



Standard Codabar



start/stop character equality control

transmission



CODE LENGTH (optional)

The code length selection is valid for the entire Codabar family

Read the code + 4 numbers for the code length where:

First 2 digits = minimum code length.

Second 2 digits = maximum code length.

set code length



The maximum code length is **99** characters.

The minimum code length must always be less than or equal to the maximum.

Examples: **0199** = variable from 1 to 99 digits in the code. **1010** = 10 digit code length only.



START/STOP CHARACTER CASE IN TRANSMISSION

The start/stop character case selections below are valid for the entire Codabar family:

transmit start/stop characters in lower case



transmit start/stop characters in upper case





CODE SELECTION

MSI

◆ disables the family



Enable the code by selecting one of the check digit selections.

no check digit control



MOD10 check digit control
no check digit transmission



MOD10 check digit control
check digit transmission



MOD11 - MOD10 check digit control
no check digit transmission



MOD11 - MOD10 check digit control
check digit transmission



MOD10 - MOD10 check digit control
no check digit transmission



MOD10 - MOD10 check digit control
check digit transmission





CODE SELECTION

PLESSEY

◆ disables the family



Enable the code by selecting one of the check digit selections.

Standard Plessey

no check digit control



check digit control
check digit transmitted



check digit control
check digit not transmitted



Anker Plessey

no check digit control



check digit control
check digit transmitted



check digit control
check digit not transmitted





CODE SELECTION

RSS CODES

◆ disables the family



DISABLE CODE

disable RSS Expanded Linear



disable RSS Limited



disable RSS 14 Linear



ENABLE CODE

enable RSS Expanded Linear



enable RSS Limited



enable RSS 14 Linear



ADVANCED FORMATTING

- ⊙ **CONCATENATION** ⊙
- ⊙ **ADVANCED FORMATTING** ⊙



NOTE

Please follow the setup procedure carefully for these parameters.

- 1.** Read the **Enter Configuration** code ONCE, available at the top of page .
- 2.** Read configuration codes **precisely following the numbered procedure given.**
 -  = Read the code and follow the procedure given
 - ◆ = Default value
- 3.** Read the **Exit and Save Configuration** code ONCE, available at the top of page.



CONCATENATION

◆ disable



enable



Permits the concatenation of two codes defined by code type and length. It is possible to set a timeout for the second code reading and to define code transmission if the timeout expires.

The order of transmission is CODE 1-CODE 2.

Define Concatenation

1

Code 1

code ID



Read the code type from the Code Identifier Table beginning in Appendix B.

code length



Read a number in the range **01-99** from the Hex/Numeric Table.

ADVANCED FORMATTING



2

Code 2

code ID



Read the code type from the Code Identifier Table beginning in Appendix B.

code length



Read a number in the range **01-99** from the Hex/Numeric Table.

3

Concatenation Result Code ID

use code 1 ID



use code 2 ID



Since you can concatenate codes from different families, you must select the Code ID character of the resulting code. The Code ID character will be sent in the output message only if it is enabled according to the Code Identifier selection (Datalogic, AIM, or Custom).

4

Concatenation Timeout

timeout



Read two numbers in the range **00 to 99**

00= no timeout

01-99 = timeout from 1 to 99 seconds

Define the timeout, which determines the valid waiting period between the two codes, in order to accept concatenation. If the timeout expires, the resulting action will be based on the following selection.

ADVANCED FORMATTING



5

Transmission after Timeout

no code transmitted
after timeout



only code 1 transmitted
(if read) after timeout



only code 2 transmitted
(if read) after timeout



either code 1 or code 2 transmitted
after timeout



ADVANCED FORMATTING

ADVANCED FORMATTING

Advanced formatting has been designed to offer you complete flexibility in changing the format of barcode data **before** transmitting it to the host system. This formatting will be performed when the barcode data meets certain criteria which you will define in the following procedure.

Up to 4 advanced code management formats can be defined and saved in memory. For each format you must complete the entire configuration procedure:

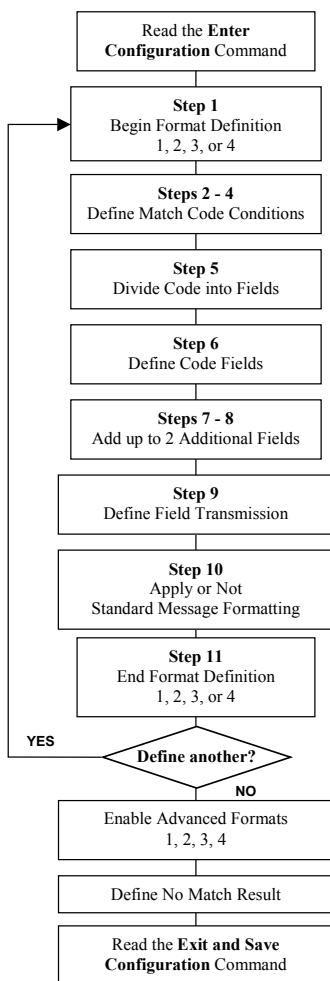



ADVANCED FORMATTING

1

Begin Format Definition

begin Format 1 definition



begin Format 2 definition



begin Format 3 definition



begin Format 4 definition



2

Match Code Type

match code type



Read the above code + the code type to match from the [Code Identifier Table](#) in Appendix B.

OR

any code type



3

Match Code Length

match code length



Read the above code + two numbers in the range **01** to **99** for the exact code length.

OR

any code length



ADVANCED FORMATTING



4

Match with Predefined Characters

no match



OR

match with 1 character



match with a 2-character string



match with a 3-character string



match with a 4-character string



After selecting the predefined match code, read the character(s) from the HEX table. Range of characters = **01-FE**.

Example:

Match code with the 2-character predefined string = "@@".

Read  + 40 + 40

AND

position of first character in predefined string



Read the above code + two numbers in the range **01** to **99** representing the character position in the code where the first character of the predefined string must be found.

Read **00** if the match string can be found in any character position.

ADVANCED FORMATTING



5

Divide Code into Fields



divide code into fields



Read one number in the range 1 to 5 to divide the code into fields.

6

Define Code Fields

define code fields

Each code field length can be set by either:

- a) defining a field separator character to be found in the code itself. In this case you can choose to **discard** the code separator character or **include** it as the last character of the field.

OR BY

- b) defining a match character to be found consecutively repeated in the code itself. In this case the field ends with the first character that does not match.

OR BY

- c) specifying a specific character length up to the maximum of 99 characters.

OR BY



- d) selecting the last field as variable length (if any).

You must define the same number of fields as selected in step 5, including fields that will not be transmitted.



ADVANCED FORMATTING





DEFINE FIELD 1 BY: EITHER

a)  field separator

Read the field separator character from the HEX table. Range of characters = **01-FE**.



discard separator  include separator 

OR

b)  match character

Read the match character from the HEX table. Range of characters = **01-FE**.

OR

c)  field length

Read two numbers in the range **01** to **99** to define the field length.

OR



d)  this is the last field (variable length)

AND

Field 1 Terminators

no field terminators

 1 field terminator

 2 field terminators



Read the field terminator character(s) from the HEX table.

Valid range of characters for all readers = **01-FE**.For readers using Wedge interface, all values from **9C** to **FE** send the Space character.

ADVANCED FORMATTING





DEFINE FIELD 2 BY: EITHER

a)  field separator



Read the field separator character from the HEX table. Range of characters = **01-FE**.

discard separator  include separator 

OR

b)  match character



Read the match character from the HEX table. Range of characters = **01-FE**.

OR

c)  field length



Read two numbers in the range **01** to **99** to define the field length.

OR

d)  this is the last field (variable length)



AND

Field 2 Terminators

no field terminators



1 field terminator



2 field terminators



Read the field terminator character(s) from the HEX table.

Valid range of characters for all readers = **01-FE**.

For readers using Wedge interface, all values from **9C** to **FE** send the Space character.

ADVANCED FORMATTING





DEFINE FIELD 3 BY: EITHER

a)  field separator



Read the field separator character from the HEX table. Range of characters = **01-FE**.

discard separator  include separator 

OR

b)  match character



Read the match character from the HEX table. Range of characters = **01-FE**.

OR

c)  field length



Read two numbers in the range **01** to **99** to define the field length.

OR

d)  this is the last field (variable length)



AND

Field 3 Terminators

no field terminators



1 field terminator



2 field terminators



Read the field terminator character(s) from the HEX table.

Valid range of characters for all readers = **01-FE**.

For readers using Wedge interface, all values from **9C** to **FE** send the Space character.

ADVANCED FORMATTING





DEFINE FIELD 4 BY: EITHER

a)  field separator



Read the field separator character from the HEX table. Range of characters = **01-FE**.

discard separator  include separator 

OR

b)  match character



Read the match character from the HEX table. Range of characters = **01-FE**.

OR

c)  field length



Read two numbers in the range **01** to **99** to define the field length.

OR

d)  this is the last field (variable length)



AND

Field 4 Terminators

no field terminators



1 field terminator



2 field terminators



Read the field terminator character(s) from the HEX table.

Valid range of characters for all readers = **01-FE**.For readers using Wedge interface, all values from **9C** to **FE** send the Space character.

ADVANCED FORMATTING





DEFINE FIELD 5 BY: EITHER

a)  field separator



Read the field separator character from the HEX table. Range of characters = **01-FE**.

discard separator  include separator 

OR

b)  match character



Read the match character from the HEX table. Range of characters = **01-FE**.

OR

c)  field length



Read two numbers in the range **01** to **99** to define the field length.

OR

d)  this is the last field (variable length)



AND

Field 5 Terminators

no field terminators



1 field terminator



2 field terminators



Read the field terminator character(s) from the HEX table.

Valid range of characters for all readers = **01-FE**.

For readers using Wedge interface, all values from **9C** to **FE** send the Space character.

ADVANCED FORMATTING



7

First Additional Fixed Field

no fixed field



1 character fixed field



2 character fixed field



3 character fixed field



4 character fixed field



5 character fixed field



6 character fixed field



After selecting **one** of the Additional Fixed Field codes, read the corresponding character(s) from the HEX table. Range of characters = **01-FE**. For readers using Wedge interface, all values from **9C** to **FE** send the Space character.

Example:

4 Character Fixed Field

 $+ 4D + 41 + 49 + 4E = \text{MAIN}$

ADVANCED FORMATTING



8

Second Additional Fixed Field

no fixed field



1 character fixed field



2 character fixed field



3 character fixed field



4 character fixed field



5 character fixed field



6 character fixed field



After selecting **one** of the Additional Fixed Field codes, read the corresponding character(s) from the HEX table. Range of characters = **01-FE**. For readers using Wedge interface, all values from **9C** to **FE** send the Space character.

Example:

3 Character Fixed Field

 $+ 53 + 45 + 54 = \text{SET}$

ADVANCED FORMATTING



9

Field Transmission

number of fields to transmit



Read one number in the range 1 to 7 for the number of fields to transmit. **Include only fields to be transmitted.**

Field Order Transmission

Read the codes corresponding to the fields to transmit in the order in which they are to be transmitted. A field can be transmitted more than once. See example.

field 1



field 3



field 5



additional field 2



field 2



field 4



additional field 1



Example:

The barcode is divided into 3 defined fields plus 1 additional fixed field.
Transmit in the order: Field 2, Additional Field 1, Field 1, Field 2.

Number of Fields



ADVANCED FORMATTING



10**Standard Formatting**

do not apply standard formatting



apply standard formatting



After performing Advanced Formatting on the barcode read, Standard Formatting (Headers, Code Length, Code ID, Terminators) can be applied to the message to be transmitted.

11**End Format Definition**

end Format 1 definition



end Format 2 definition



end Format 3 definition



end Format 4 definition





ADVANCED FORMATTING

Enable Advanced Format

◆ no Advanced Formats enabled



Advanced Format 1

enable



disable



Advanced Format 2

enable



disable



Advanced Format 3

enable



disable



Advanced Format 4

enable



disable





ADVANCED FORMATTING



No Match Result

clear data - no transmission



transmit data using standard format



This selection determines the action to be taken when codes read do not conform to the advanced format requisites (no match).

- Codes not matching can be ignored, cleared from memory and not transmitted.
- Codes not matching can be transmitted using the Standard formatting (Headers, Code Length, Code ID, Terminators).

4 REFERENCES

4.1 RS232 PARAMETERS

4.1.1 Handshaking

Hardware handshaking: (RTS/CTS)

The RTS line is activated by the decoder before transmitting a character. Transmission is possible only if the CTS line (controlled by the Host) is active.

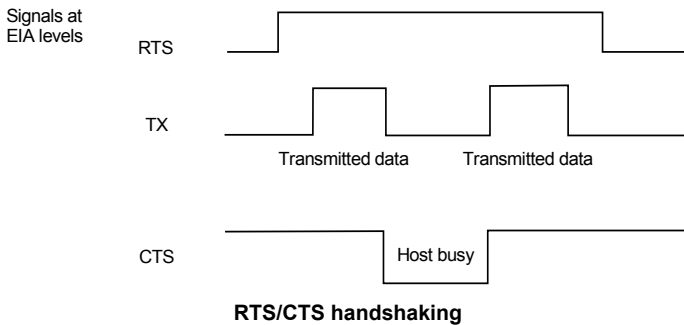

Software handshaking: (XON/XOFF)

During transmission, if the Host sends the XOFF character (13 Hex), the decoder interrupts the transmission with a maximum delay of one character and only resumes when the XON character (11 Hex) is received.

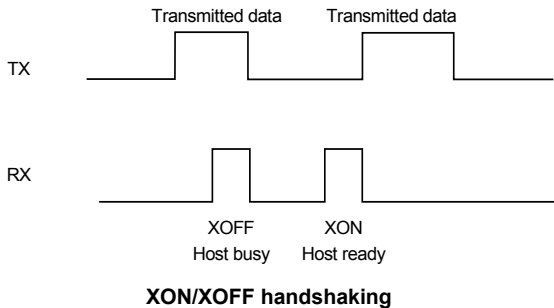

4.1.2 ACK/NACK Protocol

This parameter sets a transmission protocol in which the Host responds to the scanner after every code transmitted. The Host sends an ACK character (06 HEX) in the case of good reception or the NACK character (15 HEX) requesting re-transmission, in the case of bad reception.

If the scanner does not receive an ACK or NACK, transmission is ended after the RX Timeout (see par. 4.1.3).

4.1.3 RX Timeout

When the RS232 interface is selected, the Host can be used to configure the device by sending it command strings (see appendix A).

This parameter can be used to automatically end data reception from the Host after the specified period of time.

If no character is received from the Host, after the timeout expires, any incomplete string (any string not terminated by <CR>) is flushed from the device buffer.

4.1.4 Serial Decode Control

This parameter allows defining two ASCII characters that control whether the scanner is enabled to decode barcodes or not. When this parameter is enabled and the first defined character is sent over the serial line, decoding is enabled. When the second defined character is sent over the serial line, decoding is disabled until the first character is received again.

If Serial Sleep Enabling is used the characters must be different.

4.1.5 Serial Sleep Control

This parameter allows defining two ASCII characters that control when the scanner enters sleep and wakeup states. When this parameter is enabled and the first defined character is sent over the serial line, the scanner immediately enters the sleep state. When the second defined character is sent over the serial line, the scanner immediately wakes up.

If Serial Decode Enabling is used the characters must be different.

4.2 DATA FORMAT

4.2.1 Header/Terminator Selection

The header/terminator selection is not effected by the reading of the restore default code. In fact, header and terminator default values depend on the interface selection:

RS232 and USB-COM:	no header, terminator CR-LF
WEDGE and USB-KBD:	no header, terminator ENTER
WEDGE ALT-MODE and USB-KBD-ALT-MODE:	no header, terminator CR

These default values are always restored through the reading of the relative interface selection code, see chapter 2.2

For the WEDGE interface, the following extended keyboard values can also be configured:

EXTENDED KEYBOARD TO HEX CONVERSION TABLE				
HEX	IBM AT IBM 3153 APPLE ADB	IBM XT	IBM 31xx, 32xx, 34xx, 37xx	Wyse Digital
83	ENTER	ENTER	FIELD EXIT	RETURN
84	TAB	TAB	TAB	TAB
85	F1	F1	F1	F1
86	F2	F2	F2	F2
87	F3	F3	F3	F3
88	F4	F4	F4	F4
89	F5	F5	F5	F5
8A	F6	F6	F6	F6
8B	F7	F7	F7	F7
8C	F8	F8	F8	F8
8D	F9	F9	F9	F9
8E	F10	F10	F10	F10
8F	F11	ESC	F11	F11
90	F12	BACKSPACE	F12	F12
91	HOME	HOME	ENTER	F13
92	END	END	RESET	F14
93	PG UP	PG UP	INSERT	F15
94	PG DOWN	PG DOWN	DELETE	F16
95	↑	↑	FIELD -	UP
96	↓	↓	FIELD +	DOWN
97	←	←	ENTER (Paddle)	LEFT
98	→	→	PRINT	RIGHT
99	ESC	ESC		ESC
9A	CTRL (Right)	CTRL (Right)		CTRL (Right)
9B	Euro	Space	Space	Space

For all scanners using Wedge interface, all values from **9C** to **FE** send the Space character.

4.2.2 Set Custom Extended Header/Terminator Keys

The extended Header/Terminator keys for **Wedge Interface users** can be customized by defining them through a simple keyboard setting procedure.

For example, the Numeric Keypad keys can be set for use as Headers or Terminators by substituting the default extended keys using this procedure.

The type of computer or terminal must be selected before activating the keyboard setting command.

Press and release a key to set it.

Some characters may require more than one key pressed simultaneously during normal use (refer to the manual of your PC or terminal for keyboard use). The exact sequence must be indicated to the scanner in this case pressing and releasing the different keys.

Example:

If one has to press the "Shift" and "4" keys simultaneously on the keyboard to transmit the character "\$" to the video, to set the "\$", press and release "Shift" then press and release "4".

Each pressed and released key must generate an acoustic signal on the scanner, otherwise repress the key. Never press more than one key at the same time, even if this corresponds to the normal use of your keyboard.

Press "Backspace" to correct a wrong key entry. In this case the scanner emits 2 beeps.

Note: "CAPS LOCK" and "NUM LOCK" must be off before starting the keyboard setting procedure. "SHIFT" must be repressed for each character and cannot be substituted by "CAPS LOCK".



Set Custom Extended Header/Terminator Keys



Read the code above.

- If the first 4 KEYS (Shift, Alt, Ctrl, and Backspace) are not available on your keyboard, you can only substitute them with keys not used, or substitute them with each other.
- Keys 5 to 28 must be defined

Press the desired keys in the following order:

The scanner signals the end of the procedure with 2 beeps indicating the keys have been registered.

CUSTOM EXTENDED KEYBOARD SETTING TABLE		
		Custom
Order	HEX	KEY
01	-	Shift
02	-	Alt
03	-	Ctrl
04	-	Backspace
05	83	
06	84	
07	85	
08	86	
09	87	
10	88	
11	89	
12	8A	
13	8B	
14	8C	
15	8D	
16	8E	
17	8F	
18	90	
19	91	
20	92	
21	93	
22	94	
23	95	
24	96	
25	97	
26	98	
27	99	
28	9A	

4.3 POWER SAVE

4.3.1 Stand-by State

This is a low-power operating mode in which the scanner is still operating but decoding cannot take place.

The scanner enters Stand-by after the configured timeout, during which no codes are presented to it.

It is possible to exit Stand-by mode (return to normal operation) by presenting a code to the scanner (the scanner automatically wakes up) or by pressing the trigger.

4.3.2 Enter Stand-by timeout

For scanners that have the *Stand-by* state enabled, this timeout, during which no codes are presented to the scanner, determines when the scanner will enter this state.

The valid values are: 1, 5, 15, and 25 minutes.

4.3.3 Sleep State

This allows the scanner to enter a "Sleep" state for minimum power consumption in which the scanner Laser is OFF and the motor is not rotating.

Before entering Sleep mode, the following are verified:

- no data being transmitted to Host
- Enter Sleep Timeout ended (see par. 4.3.4)

It is possible to exit Sleep mode by pressing the trigger.

4.3.4 Enter Sleep Timeout

For scanners that have the Sleep state enabled, this timeout, during which no codes are presented to the scanner, determines when the scanner will enter this state.

This timeout begins after the Stand-by timeout ends (if Stand-by State is enabled), otherwise it begins immediately.

4.4 READING PARAMETERS

4.4.1 Timeout between Same Code Readings

This timeout prevents the device from immediately decoding one or more codes (of those present in the same reading area) more than once.

Any decoded code must be removed from the reading area for the duration of the configured timeout before it can be decoded again.

4.4.2 Single Line Decoding Duration

Single Line Mode allows aiming a single scan line across a barcode for decoding. The first trigger press allows aiming the single line without decoding. After the second trigger press (which must occur within 5 seconds) the code can be decoded.

The Single Line Decoding Duration parameter sets the timeout during which the scanner continues to attempt code decoding. When the timeout expires, the scanner passes to the Single Line Timeout OFF before Raster parameter before returning to Raster Mode.

4.4.3 Single Line Timeout OFF before Raster

This parameter sets a timeout, after the decoding process has been completed (either due to a good read or Single Line Decoding Duration timeout expired), during which the Laser is OFF before returning to Raster mode.

If the trigger is pressed before this timeout expires, the scanner returns to Single Line Mode (aiming without decoding).

4.5 DECODING PARAMETERS



CAUTION

These parameters are intended to enhance the decoding capability of the scanner for particular applications. Used incorrectly, they can degrade the reading performance or increase the possibility of a decoding error.

4.5.1 Ink-Spread

The ink-spread parameter allows the decoding of codes which are not perfectly printed because the page texture tends to absorb the ink.

4.5.2 Overflow Control

The overflow control parameter can be disabled when decoding codes printed on small surfaces, which don't allow the use of an overflow space.

This command does not effect code families 2/5, Code 128 and Code 93.

4.5.3 Interdigit Control

The interdigit control parameter verifies the interdigit spacing for code families Code 39 and Codabar.

4.5.4 Code Stitching

The code stitching parameter allows decoding codes that are not entirely crossed by a single laser line or are of poor print quality, and/or damaged print. It does this by adding together (stitching), two partial reads of a code to complete the entire code.

For code 39 and code 128, this parameter can be disabled if MISREADS are produced.



4.6 CODE SELECTION

4.6.1 Set EAN/UPC Autodiscriminate Decoding Safety

When EAN/UPC codes are enabled with and without ADD ON, this parameter assures that codes without ADD ON will only be transmitted after decoding them **n** number of times (15 default).

4.7 CONFIGURATION EDITING COMMANDS

The following commands carry out their specific function and then exit the configuration environment.

Command	Description
 \$+\$*	Restore system default configuration (see the relative Quick Reference Manual for default settings)
 \$+\$!	Transmit the Software release.
 \$+\$&	Transmit the device configuration in ASCII format.

4.8 CONFIGURATION COPY COMMAND

Procedure:

- ① Connect the **master** (correctly configured scanner) and the **slave** (scanner to be configured) together through two RS232 serial interface cables and external power supply. Accessory cables and power supply are available from your Datalogic distributor to provide this connection.

RS232 Cables: CAB363 & CAB364 or CAB320 & CAB328

Power Supply: PG5

- ② Using the slave device, read the Restore Default barcode and then the RS232 interface barcode from par. 2.2.2 of this manual or from the Quick Reference Manual.
- ③ With the master device, read the Configuration Copy barcode below.

Copy Configuration



\$+ZZ0\$-

The configuration will be copied from the master to the slave device. The slave device signals the end of the procedure with a series of beeps.

Note: The master device can be configured for any interface.

4.9 FIRMWARE UPGRADES

Device firmware upgrades can be performed using the DL Sm@rtSet external Downloader utility tool from your PC either through RS232 or USB communications. The procedure for downloading is described in the DL Sm@rtSet User's Manual and in the Help window.

4.10 DEFAULT PARAMETERS FOR POS SYSTEMS

The default values for the RS232 and Data Format parameters for POS systems are listed in the following table:

	NIXDORF Mode A	FUJITSU	ICL Mode
RS232 Group			
Baud Rate	9600	9600	9600
Parity	Odd	None	Even
Data Bits	8	8	8
Stop Bits	1	1	1
Handshaking	Hardware (RTS/CTS)	None	RTS always on
ACK/NACK Protocol	Disabled	Disabled	Disabled
Inter-Character Delay	Disabled	Disabled	Disabled
RX Timeout	9.9 sec	2 sec	9.9 sec
Serial Decode Enabling			
Serial Sleep Enabling			
Data Format Group			
Code Identifier	Custom	Custom	Custom
Header	No Header	No Header	No Header
Terminator	CR	CR	CR
Field Adjustment	Disabled	Disabled	Disabled
Code Length TX	Not Transmitted	Not Transmitted	Not Transmitted
Character Replacement	Disabled	Disabled	Disabled

The table below lists all the Code Identifiers available for POS systems:

CODE	NIXDORF Mode A	FUJITSU	ICL Mode
UPC-A	A0	A	A
UPC-E	C	E	E
EAN-8	B	FF	FF
EAN-13	A	F	F
Code 39	M	None	C [code length]
Codabar	N	None	N [code length]
Code 128	K	None	L [code length]
Interleaved 2 of 5	I	None	I [code length]
Code 93	L	None	None
Industrial 2 of 5	H	None	H [code length]
UCC/EAN 128	P	None	L [code length]
MSI/Plessey	O	None	None
RSS	E	None	None
Other	None	None	None

A HOST CONFIGURATION STRINGS

In this section we provide a description of how to modify the device configuration using serial strings sent from the Host.

This method requires either the RS232 or USB-COM interface.

The device configuration can be changed by receiving commands from the Host through the serial interface. When this method is used, the programming sequence format is the following:

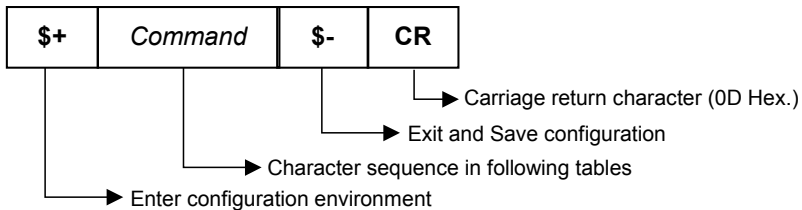

Example:

Multiple command programming sequence:

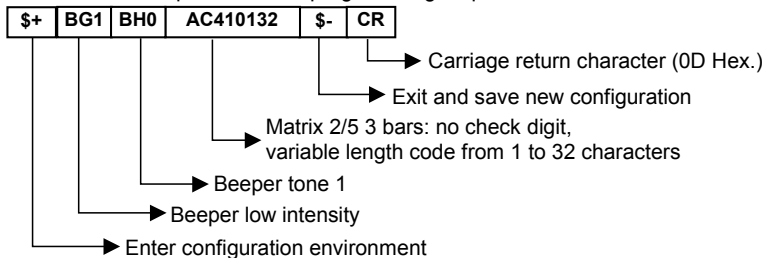

Each configuration parameter setting removes the condition previously active for that parameter.



NOTE

The device buffer can contain about 400 characters. If your programming string goes over this value, you must split it into separate groups and send each group after a delay of at least 3 seconds to give the scanner time to empty the buffer and interpret the commands.

SERIAL CONFIGURATION STRINGS

ENTER/EXIT CONFIGURATION COMMANDS	
DESCRIPTION	STRING
Enter Configuration	\$+
Exit and Save Configuration	\$-
Restore Default	+\$+\$*
Transmit Software Release	+\$+!
Transmit Configuration	+\$+&

INTERFACE SELECTION			
	DESCRIPTION	STRING	
RS232	Standard	CP0	
	ICL Mode	CM0	
	Fujitsu	CM1	
	Nixdorf Mode A	CM2	
USB	USB-KBD	UA03	
	USB-KBD-ALT-MODE	UA04	
	USB-KBD-APPLE	UA05	
	USB-COM	UA02	
	USB-IBM-Table Top	UA00	
	USB-IBM-Hand Held	UA01	
WEDGE	for IBM AT	CP500	
	for IBM Terminals: 31xx, 32xx, 34xx, 37xx; make-break keyboard	CP501	
	for IBM Terminals: 31xx, 32xx, 34xx, 37xx; make-only keyboard	CP502	
	Keyboard Type for IBM Terminals 31xx, 32xx, 34xx, 37xx	typewriter	FK0
		advanced	FK1
	for IBM XT	CP503	
	for IBM Terminal 3153	CP504	
	for IBM PC Notebook	CP505	
	for IBM SURE1	CP506	
	for IBM AT - ALT mode	CP507	
	for IBM PC Notebook - ALT mode	CP508	
	for Wyse Terminal - ANSI Keyboard	CP509	
	for Wyse Terminal - PC Keyboard	CP510	
	for Wyse Terminal - ASCII Keyboard	CP511	
	for Wyse Terminal - VT220 style Keyboard	CP514	
	for Digital Terminals VT2xx/3xx/4xx	CP512	
for Apple ADB Bus	CP513		
IBM 46xx	4501 Protocol	CP800	
	1520 Protocol	CP801	

RS232		
DESCRIPTION		STRING
Baud Rate	300	CD1
	600	CD2
	1200	CD3
	2400	CD4
	4800	CD5
	9600	CD6
	19200	CD7
	38400	CD8
Parity	none	CC0
	even	CC1
	odd	CC2
Data Bits	7	CA0
	8	CA1
Stop Bits	1	CB0
	2	CB1
Handshaking	disable	CE0
	RTS/CTS	CE1
	XON/XOFF	CE2
	RTS always ON	CE3
ACK/NACK Protocol	disable	ER0
	enable	ER1
Inter-character Delay (<i>ms</i>)		CK00 - CK99
RX Timeout (<i>100 ms</i>)		CL00 - CL99
Serial Decode Control	disable	CR0
	enable	CR1 ab
Serial Sleep Control	disable	CS0
	enable	CS1 ab

a = Hex value of the ASCII character from **00** to **FE** enabling the decoding or the serial sleep;

b = Hex value of the ASCII character from **00** to **FE** disabling the decoding or the serial sleep;

USB		
DESCRIPTION		STRING
USB-COM		
Handshaking	disable	CE0
	RTS/CTS	CE1
	XON/XOFF	CE2
	RTS always ON	CE3
ACK/NACK Protocol	disable	ER0
	enable	ER1
Inter-character Delay (<i>ms</i>)		CK00 - CK99
RX Timeout (<i>100 ms</i>)		CL00 - CL99
Serial Decode Control	disable	CR0
	enable	CR1a
Serial Sleep Control	disable	CS0
	enable	CS1a
USB-KBD		
Keyboard Nationality (not for USB-KBD-ALT-MODE)	Belgian	FJ7
	English	FJ4
	French	FJ2
	German	FJ3
	Italian	FJ1
	Spanish	FJ6
	Swedish	FJ5
	USA	FJ0
Delays	Inter-Character (<i>ms</i>)	CK00 - CK99
	Inter-Code (<i>s</i>)	FG00 - FG99
Control Character Emulation	CTRL +Shift + Key	FO0
	Ctrl + Key	FO1

a = Hex value of the ASCII character from **00** to **FE** enabling the decoding or the serial sleep;

b = Hex value of the ASCII character from **00** to **FE** disabling the decoding or the serial sleep;

WEDGE		
DESCRIPTION		STRING
Keyboard Nationality	Belgian	FJ7
	English	FJ4
	French	FJ2
	German	FJ3
	Italian	FJ1
	Spanish	FJ6
	Swedish	FJ5
	USA	FJ0
Caps Lock	Japanese (IBM AT compatible only)	FJ8
	caps Lock ON	FE1
Caps Lock Auto-Recognition (IBM AT compatible only)	caps Lock OFF	FE0
	disable	FP0
Num Lock	enable	FP1
	Toggle Num Lock	FL1
Delays	Num Lock Unchanged	FL0
	Inter-Character (<i>ms</i>)	CK00 - CK99
Control Character Emulation	Inter-Code (<i>s</i>)	FG00 - FG99
	CTRL +Shift + Key	FO0
	Ctrl + Key	FO1

DATA FORMAT		
DESCRIPTION		STRING
Code Identifier	disable	EB0
	Datalogic standard	EB1
	AIM standard	EB2
	Custom	EB3
Custom Code Identifier		EHabc
Headers	no header	EA00
	one character	EA01x
	two characters	EA02xx
	three characters	EA03xxx
	four characters	EA04xxxx
	five characters	EA05xxxxx
	six characters	EA06xxxxxx
	seven characters	EA07xxxxxxxx
eight characters	EA08xxxxxxxxx	
Terminators	no terminator	EA10
	one character	EA11x
	two characters	EA12xx
	three characters	EA13xxx
	four characters	EA14xxxx
	five characters	EA15xxxxx
	six characters	EA16xxxxxx
	seven characters	EA17xxxxxxxx
eight characters	EA18xxxxxxxxx	

a = ASCII character.

b, c, x = HEX values representing an ASCII character.

a = ASCII character of the DATALOGIC STANDARD Code Identifier from the table on page 34.

b = Hex value of the first Custom Code Identifier character from **00** to **FE**;

FF = disable Code Identifier

c = Hex value of the second Custom Code Identifier character from **00** to **FE**;

FF = disable second character of Custom Code Identifier

x = Hex value from **00** to **FE**

DATA FORMAT (continued)		
DESCRIPTION		STRING
Code Length Tx	not transmitted	EE0
	transmitted	EE1
	transmitted in 4-digit format	EE2
Field Adjustment	disabled	EF0
	right addition	EFa0d
	left addition	EFa1d
	right deletion	EFa2d
	left deletion	EFa3d
Field Adjustment Character		EGe
Character Replacement	disable character replacement	EO0
	first character replacement	EO1afg
	second character replacement	EO2afg
	third character replacement	EO3afg

a = ASCII character.

d = a number from the Hex/Numeric Table.

e, f, g = HEX values representing an ASCII character.

a = ASCII character of the DATALOGIC STANDARD Code Identifier from the table on page 34.

d = a number in the range **01 – 32** from the Hex/Numeric Table

e = Hex value from **00** to **FE**

f = Hex value of the character to be replaced from **00** to **FE**

g = Hex value of the new character to insert from **00** to **FE**

FF = replace with no new character (remove character)

POWER SAVE		
DESCRIPTION		STRING
Stand by State	disable	Bf0
	enable	Bf1
Enter Stand by Timeout	1 min	Bg04
	5 mins.	Bg20
	15 mins.	Bg60
	25 mins.	Bg99
Sleep State	disable	BQ0
	enable	BQ1
Enter Sleep Timeout (<i>min</i>)		Bi01-Bi99

READING PARAMETERS		
DESCRIPTION		STRING
Timeout Between Same Code Readings (100 ms)		Bh01 - Bh99
Single Line Decoding Duration		Bd01 – Bd20
Single Line Timeout OFF Before Raster		Be1 – Be9
Beeper Intensity	beeper off	BG0
	low intensity	BG1
	medium intensity	BG2
	high intensity	BG3
Beeper Tone	tone 1	BH0
	tone 2	BH1
	tone 3	BH2
	tone 4	BH3
Beeper Type	monotone	BJ0
	bitonal	BJ1
Beeper Length	long	BI0
	short	BI1

DECODING PARAMETERS		
DESCRIPTION		STRING
Ink-Spread	disable	AX0
	enable	AX1
Overflow Control	disable	AW1
	enable	AW0
Interdigit Control	disable	AV0
	enable	AV1
Code 39 Stitching	disable	Aa0
	enable	Aa1
Code 128 Stitching	disable	Ac0
	enable	Ac1
Decoding Safety	one read	ED0
	two reads	ED1
	three reads	ED2
	four reads	ED3

CODE SELECTION			
DESCRIPTION			STRING
DISABLE ALL FAMILY CODES			AZ0
EAN/UPC	disable EAN/UPC family		AA0
	EAN 8/EAN 13/UPC A/UPC E	without ADD ON	AA1
		with ADD ON	AA5
		with and without ADD ON	AA8
	Set EAN/UPC Autodiscriminate Decoding Safety		ES02-ES30
	EAN 8/EAN 13	without ADD ON	AA3
		with ADD ON 2 ONLY	AAK
		with ADD ON 5 ONLY	AAL
		with ADD ON 2 AND 5	AA6
	UPC A/UPC E	without ADD ON	AA4
		with ADD ON 2 ONLY	AAM
		with ADD ON 5 ONLY	AAN
		with ADD ON 2 AND 5	AA7
	EAN 8 check digit transmission	disable	AAG0
		enable	AAG1
	EAN 13 check digit transmission	disable	AAH0
		enable	AAH1
	UPC A check digit transmission	disable	AAI0
		enable	AAI1
	UPC E check digit transmission	disable	AAJ0
		enable	AAJ1
conversions	UPC E to UPC A	AAA	
	UPC E to EAN 13	AAB	
	UPC A to EAN 13	AAC	
	EAN 8 to EAN 13	AAD	

CODE SELECTION (continued)			
DESCRIPTION		STRING	
	ISBN Conversion codes	enable ISBN	AP1
		enable ISSN	AP2
		enable ISBN and ISSN	AP3
		disable ISBN and ISSN	AP0
Code 39	disable Code 39 family		AB0
	Standard	no check digit control	AB11
		check digit control and transmission	AB12
		check digit control without transmission	AB13
	Full ASCII	no check digit control	AB21
		check digit control and transmission	AB22
		check digit control without transmission	AB23
	CIP 39		AB3
Code 32		AB4	
code length		AB*xxxx	
2/5	disable Code 2/5 family		AC0
	Interleaved 2/5	no check digit control	AC11xxxx
		check digit control and transmission	AC12xxxx
		check digit control without transmission	AC13xxxx
	Normal 2/5 5 bars	no check digit control	AC21xxxx
		check digit control and transmission	AC22xxxx
		check digit control without transmission	AC23xxxx
	Industrial 2/5 (IATA)	no check digit control	AC31xxxx
		check digit control and transmission	AC32xxxx
		check digit control without transmission	AC33xxxx
	Matrix 2/5 3 bars	no check digit control	AC41xxxx
		check digit control and transmission	AC42xxxx
		check digit control without transmission	AC43xxxx
	CIP/HR		AC5

xxxx = ASCII numbers that define the code length where:

- First 2 digits = minimum acceptable code length.
- Second 2 digits = maximum acceptable code length.

The minimum code length must always be less than or equal to the maximum. The maximum code lengths are **99** characters.

Examples:

0132 = variable length from 1 to 32 digits in the code.

1010 = 10 digit code length only.

CODE SELECTION (continued)			
DESCRIPTION		STRING	
Codabar	disable Codabar family		AD0
	Standard	no start/stop character equality control nor transmission	AD111
		no start/stop character equality control but transmission	AD112
		start/stop character equality control but no transmission	AD121
		start/stop character equality control and transmission	AD122
	code length		AD*xxxx
	start/stop character case in transmission	lower case	ADA0
upper case		ADA1	
Code 128	disable Code 128 family		AI0
	enable Code 128 - control without transmission of check digit		AI11
	enable EAN 128 - control without transmission of check digit		AI21
	transmit GS before Code	disable	EQ0
		enable	EQ1
code length		AILxxxx	
Code 93	disable Code 93 family		AK0
	enable Code 93 - control without transmission of check digit		AK1
MSI	disable the family		AE0
	no check		AE1
	MOD10 no tx		AE2
	MOD10 with tx		AE3
	MOD11-MOD10 no tx		AE4
	MOD11-MOD10 with tx		AE5
	MOD10-MOD10 no tx		AE6
	MOD10-MOD10 with tx		AE7

xxxx = ASCII numbers that define the code length where:

- First 2 digits = minimum acceptable code length.
- Second 2 digits = maximum acceptable code length.

The minimum code length must always be less than or equal to the maximum. The maximum code lengths are **99** characters.

Examples:

0132 = variable length from 1 to 32 digits in the code.

1010 = 10 digit code length only.

CODE SELECTION (continued)		
DESCRIPTION		STRING
Plessey	disable the family	AF0
	Standard no check	AF11
	Standard check - with tx	AF12
	Standard check - no tx	AF13
	Anker no check	AF21
	Anker check - with tx	AF22
	Anker check - no tx	AF23
RSS Codes	disable the family	AQ0
	disable RSS Expanded Linear	AQ10
	enable RSS Expanded Linear	AQ11
	disable RSS Limited	AQ20
	enable RSS Limited	AQ21
	disable RSS 14 Linear	AQ30
	enable RSS 14 Linear	AQ31

B CODE IDENTIFIER TABLE

2/5 normal 5 bars



2/5 normal 5 bars



EAN 8



UPC A



EAN 8 with 2 ADD ON



EAN 13 with 2 ADD ON



2/5 Industrial



2/5 matrix 3 bars



EAN 13



UPC E



EAN 8 with 5 ADD ON



EAN 13 with 5 ADD ON



UPC A with 2 ADD ON



UPC A with 5 ADD ON



UPC E with 2 ADD ON



UPC E with 5 ADD ON



Code 39



Code 39 Full ASCII



CODABAR



Code 128



EAN 128



CIP/HR



CIP/39



Code 32**Code 93****MSI****Plessey Anker****Plessey Standard****RSS 14 Linear****RSS Expanded Linear****RSS Limited**

C HEX AND NUMERIC TABLE



0



2



4



6



8



A



C



E



1



3



5



7



9



B



D



F

Backspace



Cancels an incomplete configuration sequence

CHARACTER TO HEX CONVERSION TABLE					
char	hex	char	hex	char	hex
NUL	00	*	2A	U	55
SOH	01	+	2B	V	56
STX	02	,	2C	W	57
ETX	03	-	2D	X	58
EOT	04	.	2E	Y	59
ENQ	05	/	2F	Z	5A
ACK	06	0	30	[5B
BEL	07	1	31	\	5C
BS	08	2	32]	5D
HT	09	3	33	^	5E
LF	0A	4	34	~	5F
VT	0B	5	35	·	60
FF	0C	6	36	a	61
CR	0D	7	37	b	62
SO	0E	8	38	c	63
SI	0F	9	39	d	64
DLE	10	:	3A	e	65
DC1	11	;	3B	f	66
DC2	12	<	3C	g	67
DC3	13	=	3D	h	68
DC4	14	>	3E	i	69
NAK	15	?	3F	j	6A
SYN	16	@	40	k	6B
ETB	17	A	41	l	6C
CAN	18	B	42	m	6D
EM	19	C	43	n	6E
SUB	1A	D	44	o	6F
ESC	1B	E	45	p	70
FS	1C	F	46	q	71
GS	1D	G	47	r	72
RS	1E	H	48	s	73
US	1F	I	49	t	74
SPACE	20	J	4A	u	75
!	21	K	4B	v	76
	22	L	4C	w	77
#	23	M	4D	x	78
\$	24	N	4E	y	79
%	25	O	4F	z	7A
&	26	P	50	{	7B
'	27	Q	51		7C
(28	R	52	}	7D
)	29	S	53	~	7E
		T	54	DEL	7F