

# W 190 L: Application-based Laser Technology, the optimum solution for demanding applications



time delays up to 10 seconds, can be activated. The Teach-in function, available at the push of a button or remotely, permits simple and highly effective sensing and range adjustment. Menu prompting is provided via the clear numeric display. All programming functions may be disabled to prevent unintentional adjustments.

The option of a rotating M8 connector or 2 m cable version is available as standard, as is the compact, industry-standard plastic housing which permits the use of the device even in harsh environments.



What's available?  
WTB 190TL: high resolution utilises CMOS technology. Ideal for the reliable detection of objects with reflective surfaces. Background suppression (BGS) or foreground suppression (FGS) can be programmed.

WLG 190T: ideal for detecting transparent objects, e.g. PET bottles.

Two versions are available: for applications operating under standard conditions, e.g. foil/film, or for applications with increased requirements, e.g. thin-walled bottles.

**D**o your customers require reliable sensors suitable for demanding applications, using Laser Technology?

WLG 190TL and WTB 190TL sensors are reliable, user friendly and very accurate. The sensors have red-light laser diodes, which conform to Protection Class 2. The precise visible light spot allows fast and accurate alignment of the sensors even to the smallest target. The sensors' fast response times make them ideal for most high-speed applications. Light or dark switching can be programmed or, if the application so requires, a timer function with

	<b>Photoelectric proximity switches</b>
	<b>Photoelectric reflex switches</b>



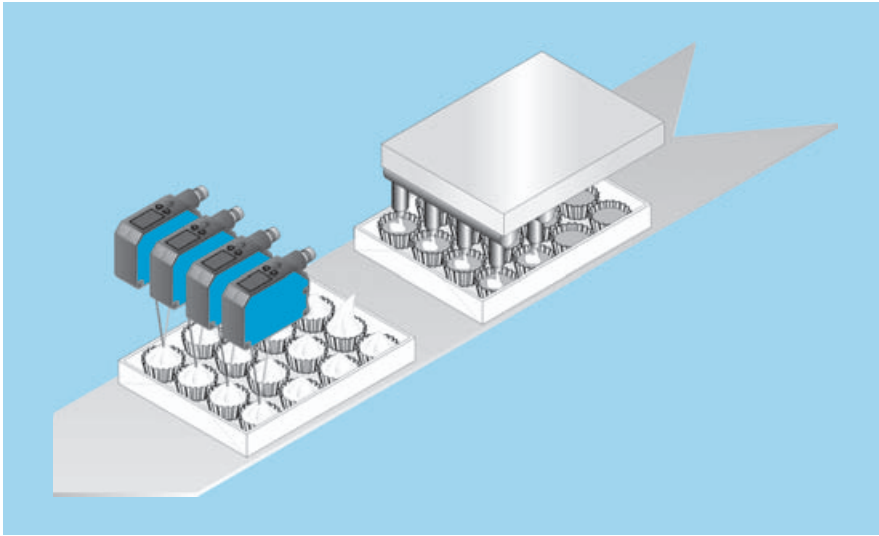

▲ WTB 190TL: 2 point Teach-in, FGS mode, level control.  
Sector: Packaging industry

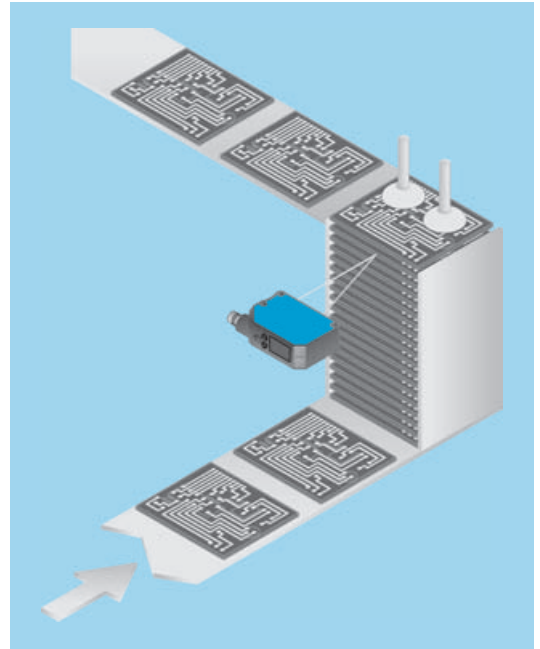

► WTB 190TL: Position Teach-in, BGS mode, checking presence.  
Sector: Electronic and semiconductor industry.

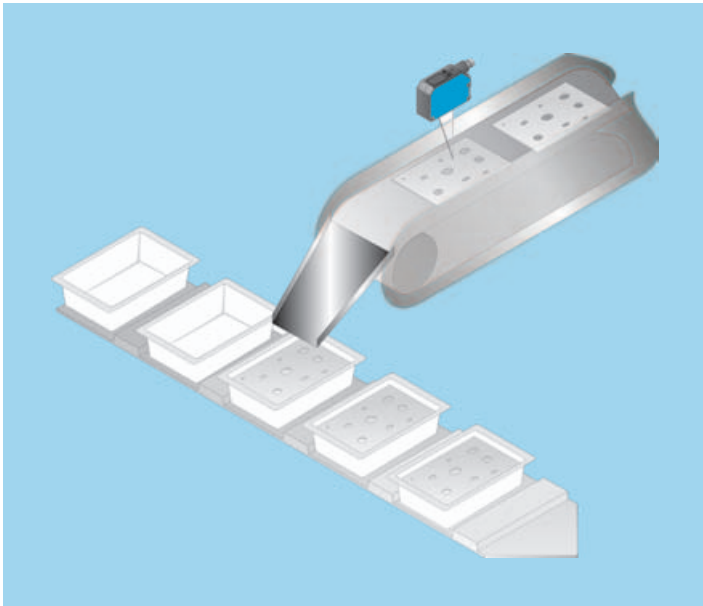

▲ WTB 190TL: 2 point Teach-in, FGS mode, detection of cheese slices.  
Sector: Food industry

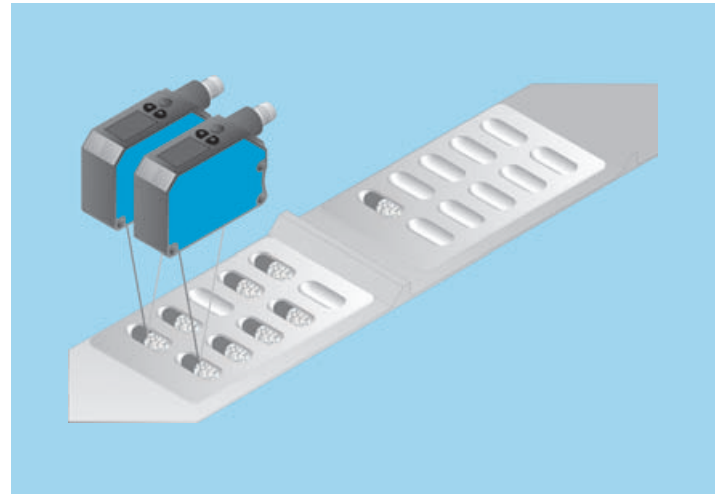

▲ WTB 190TL: 2 point Teach-in, FGS mode, detection of gelatine capsules in blister packs.  
Sector: Pharmaceutical industry.

- WLG 190 T (1): Edge control of transparent packaging material.  
Sector: Packaging industry.
- WTB 190 TL (2): 2 point Teach-in, FGS mode, product detection, correct thickness of packs.  
Sector: Packaging industry.

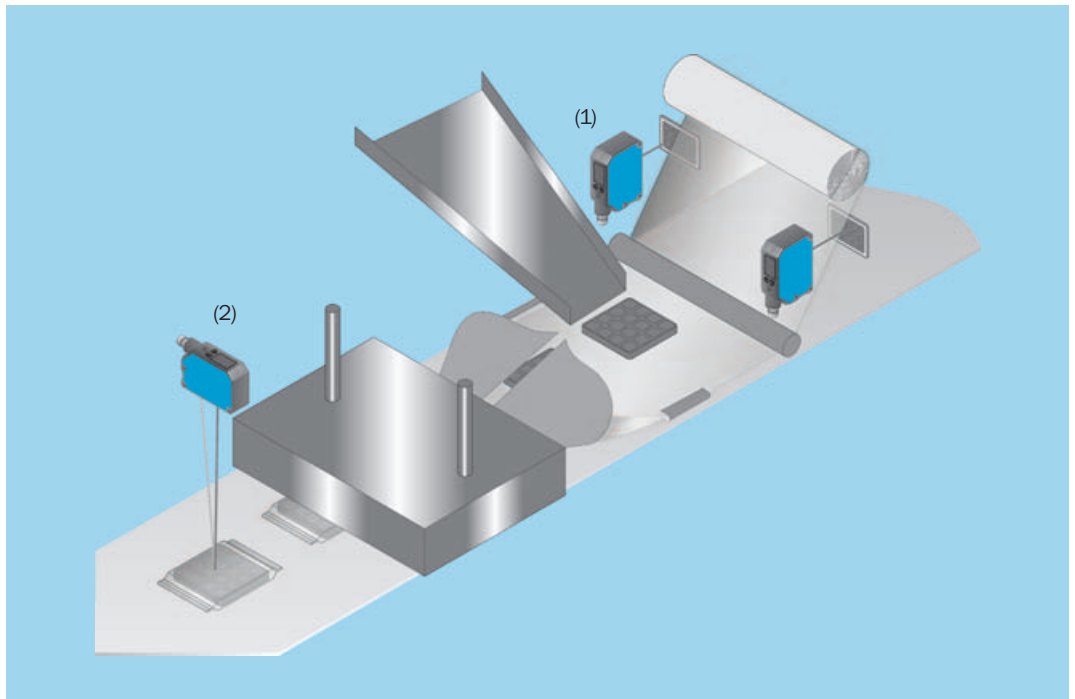

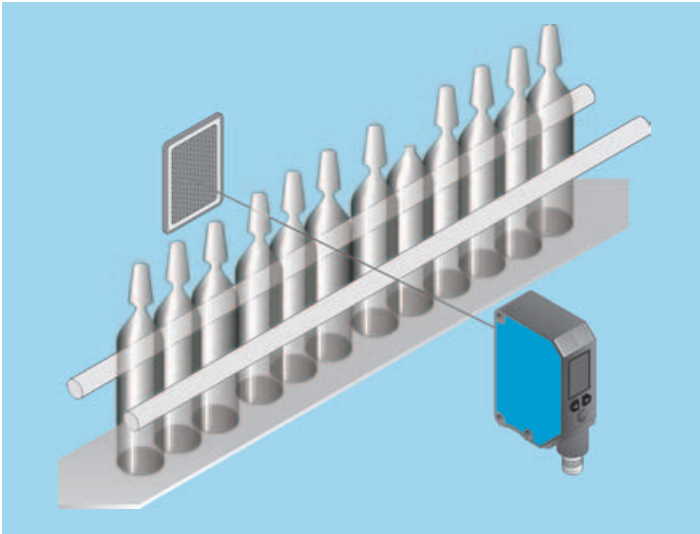

▲ WLG 190T: Ampoule syringes and breakage test.  
Sector: Pharmaceutical industry.

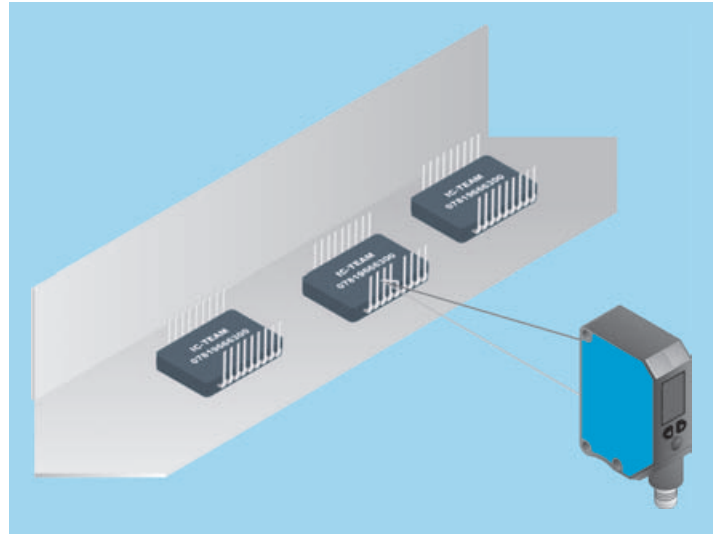

▲ WTB 190TL: 1 point Teach-in, BGS mode, detecting or counting the IC pins.  
Sector: Electronics.

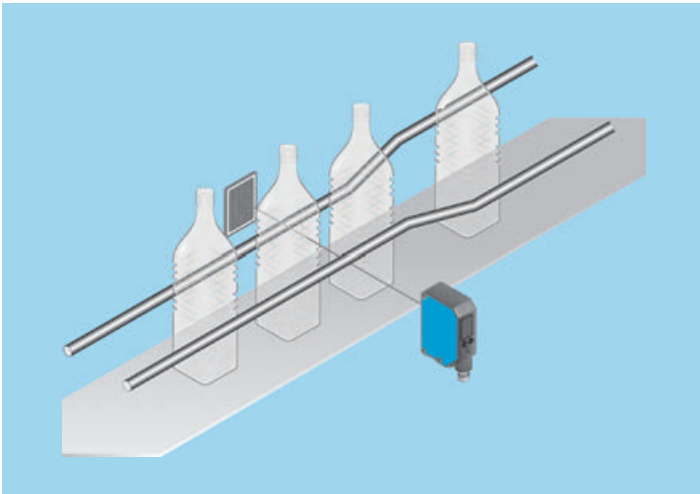

▲ WLG 190T: Transparent bottles.  
Sector: Bottling.

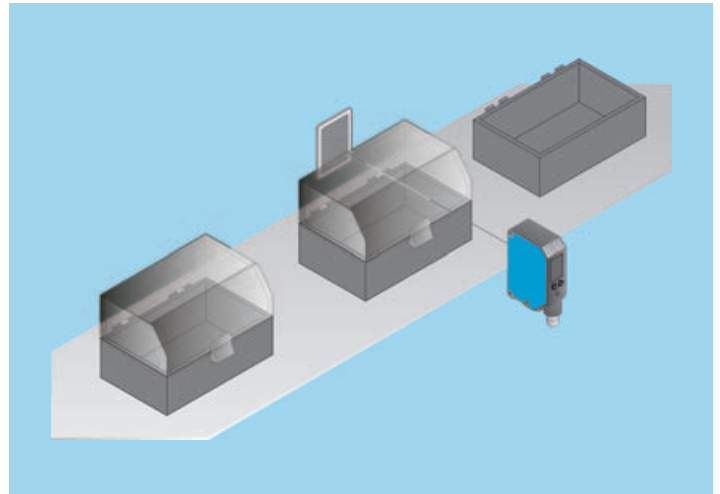



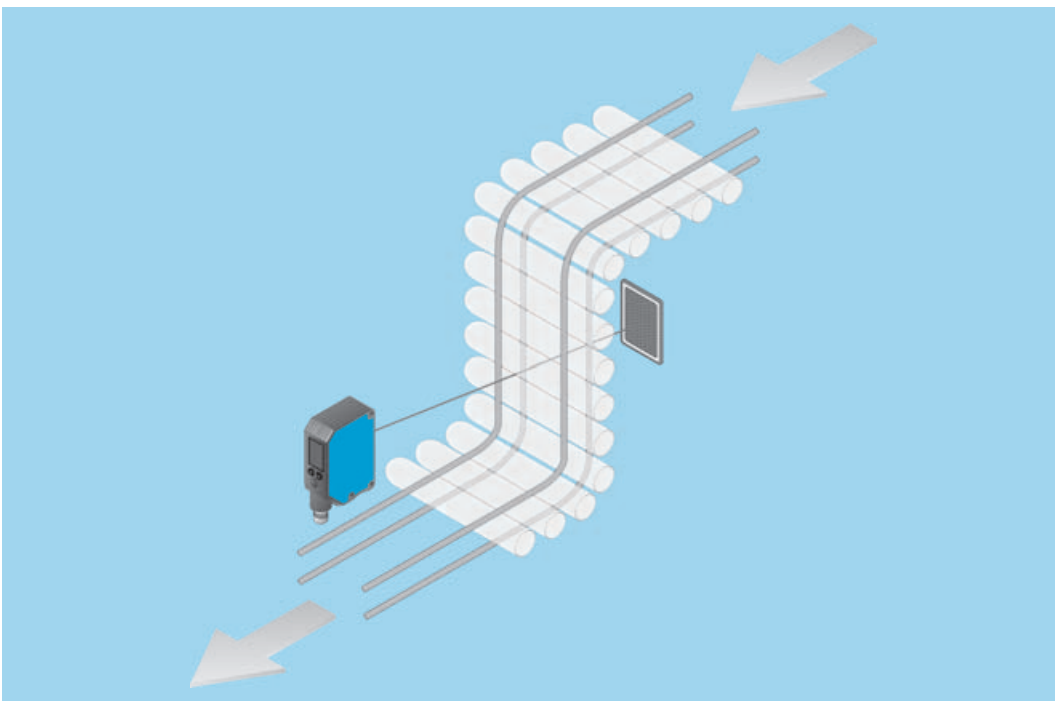







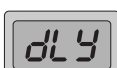
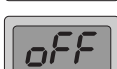

▲ WLG 190T: Detecting whether multi-part objects are assembled correctly.  
In this example: Is the transparent lid on the head?  
Sector: Packaging industry.

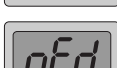
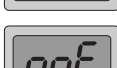
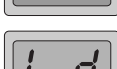
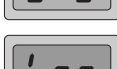
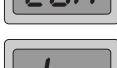
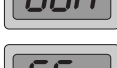
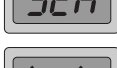
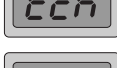
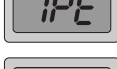
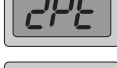
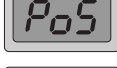

◀ WLG 190T: Detection of thin-walled glass ampoules.  
Sector: Pharmaceutical industry.

## Description of operating panel and functions



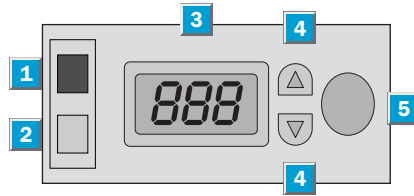

-  **SEL**  
Select
-  **F-b**  
FGS/BGS
-  **FGS**  
FGS/Foreground suppression
-  **BGS**  
BGS/Background suppression
-  **dLY**  
dLY Delay
-  **oFF**  
oFF No Timer
-  **ond**  
ond ON Delay
-  **oFd**  
oFd OFF Delay
-  **onE**  
onE ONE shot
-  **L d**  
L d Light ON/Dark ON
-  **Lon**  
Lon Light ON
-  **don**  
don Dark ON
-  **SEn**  
SEn Sensitivity
-  **tch**  
tch Teaching type
-  **1Pt**  
1Pt 1-point Teach-in
-  **2Pt**  
2Pt 2-point Teach-in
-  **PoS**  
PoS Position Teach-in
-  **dSP**  
dSP Display
-  **on**  
on Display on
-  **oFF**  
oFF Display off
-  **rSt**  
rSt Reset
-  **no**  
no Unreset
-  **YES**  
YES Reset
-  **unL**  
unL Unlock

### Display

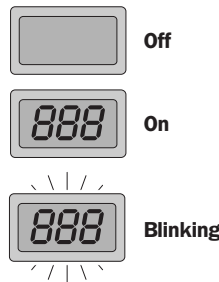

- 1** Status indicator LED, green: Laser on
- 2** Status indicator LED, yellow: output active
- 3** Numerical display
- 4** +/- button; select mode button
- 5** Teach-in button



-  **On (LED yellow)**
-  **On (LED green)**
-  **Select-Mode button**
-  **Select-Mode button**
-  **Teach-in button**

### Setting Mode, Timer, L/D, Display

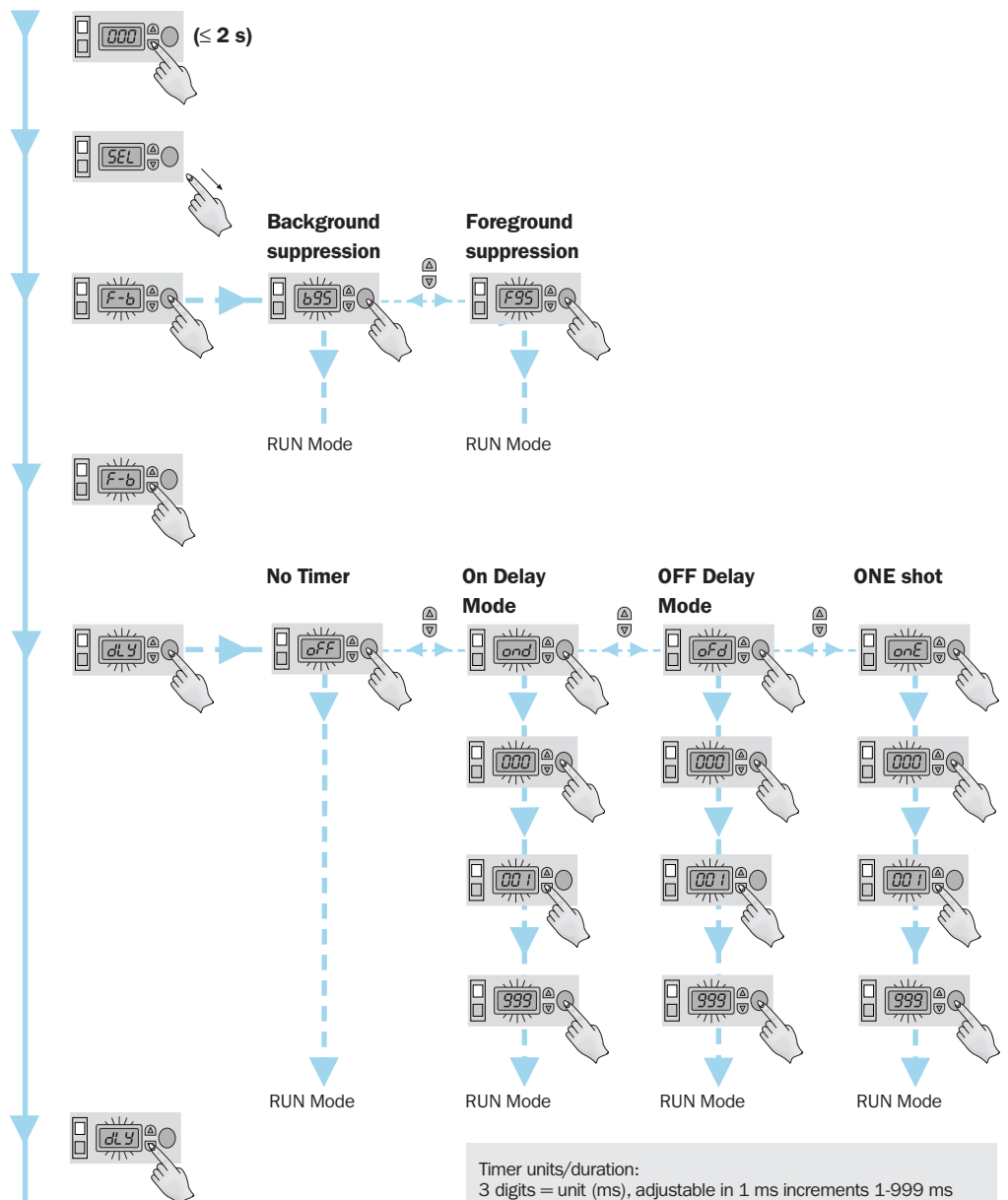

Timer units/duration:  
 3 digits = unit (ms), adjustable in 1 ms increments 1-999 ms  
 2 digits = unit (s), adjustable in 1 s increments 1-0 s

Description of operating panel and functions

Setting Mode, Timer, L/D, Display

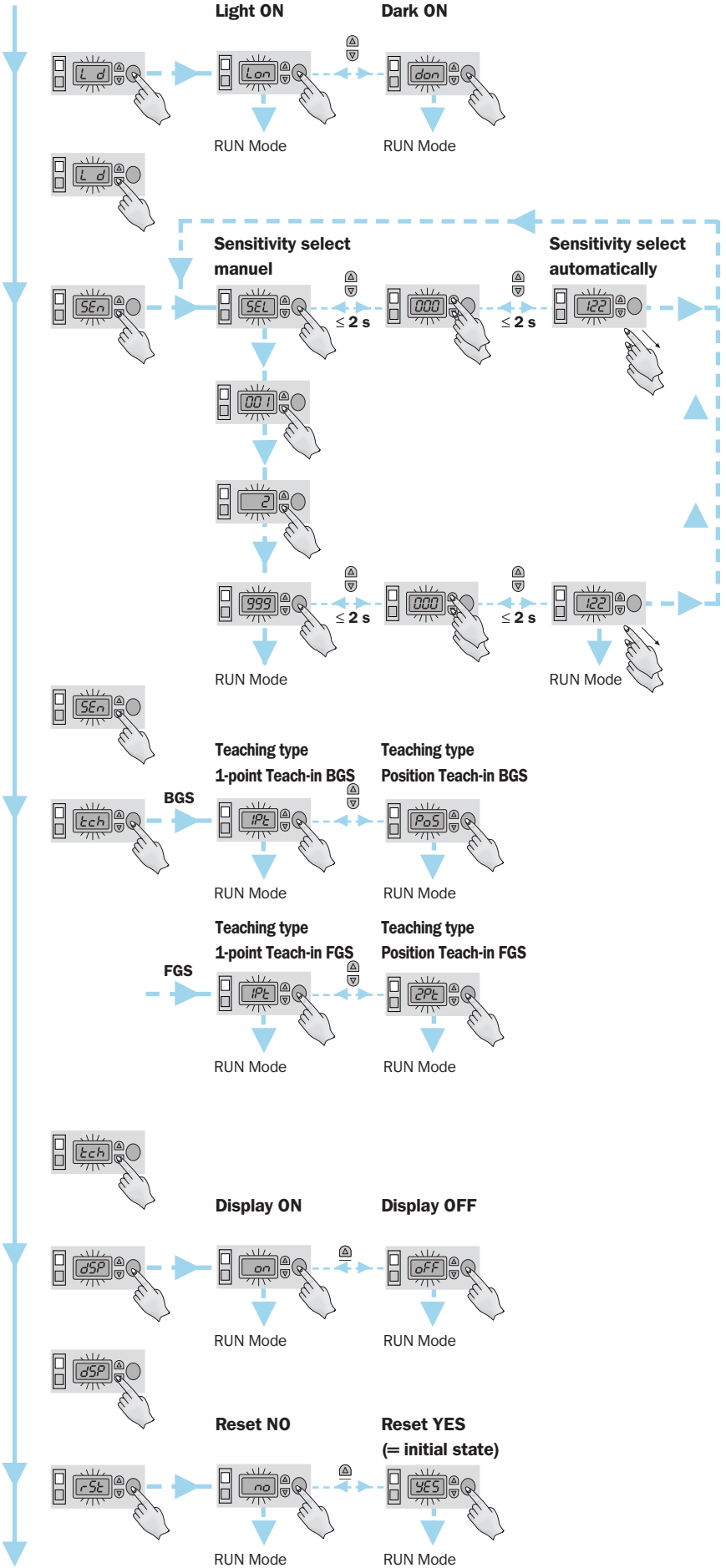

Description of operating panel and functions

Setting Mode, Lock/Unlock

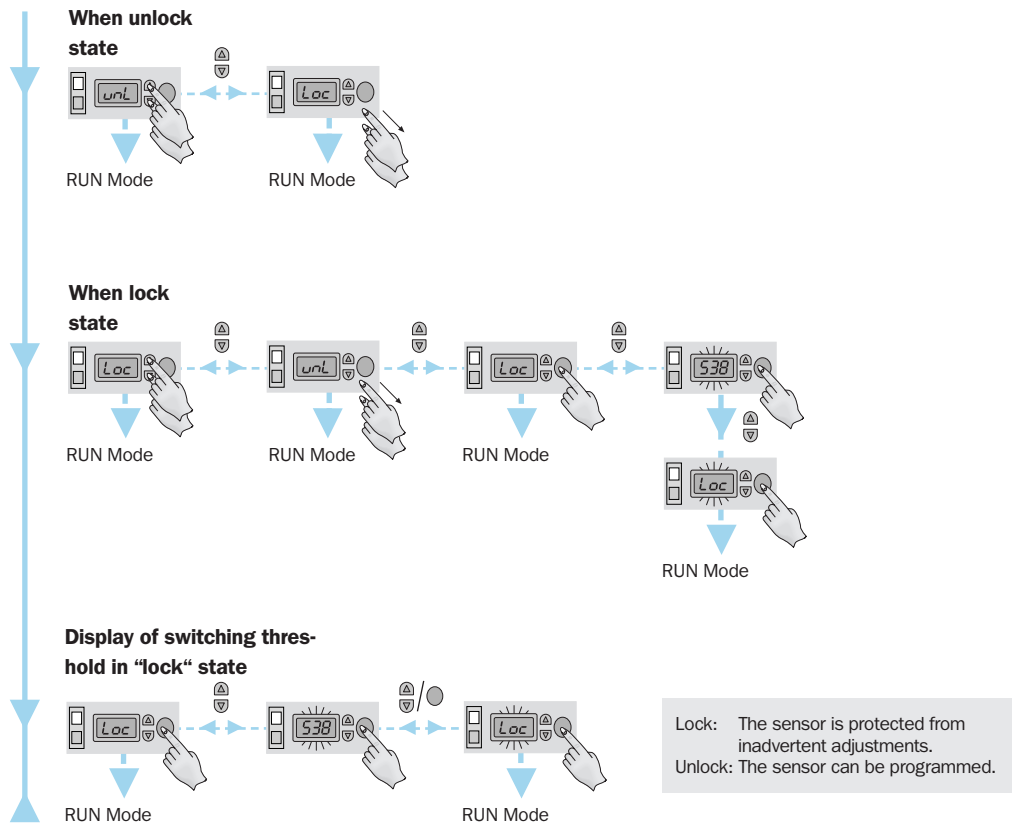

Factory default

	<b>BGS/Background suppression</b>
	<b>oFF</b> No Timer
	<b>Lon</b> Light ON
	<b>SEn</b> Sensitivity
	<b>1Pt</b> 1 point Teach-in
	<b>on</b> Display on



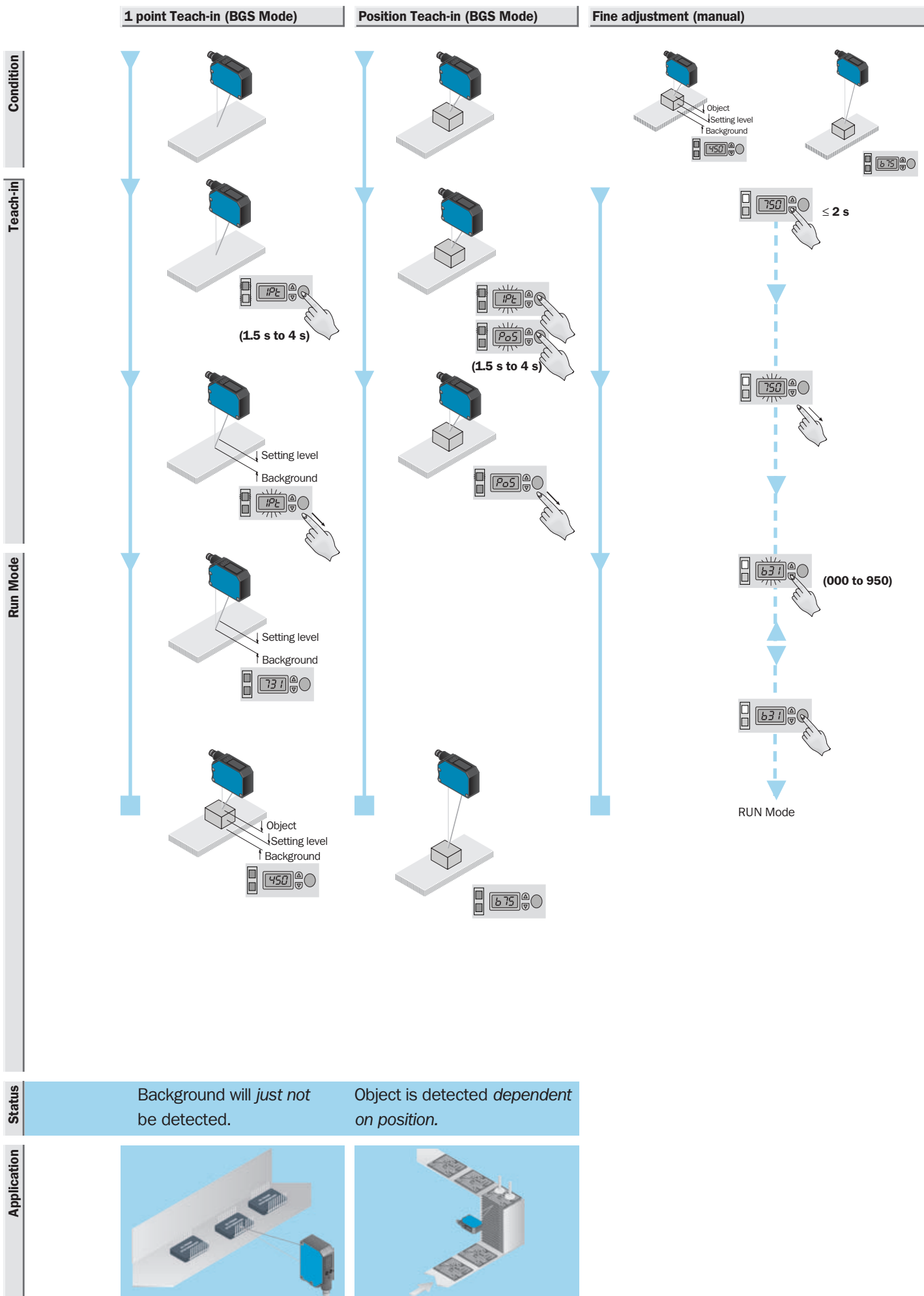

Condition

Teach-in

Run Mode

Status

Application

**1 point Teach-in (FGS Mode)**

**2 point Teach-in (FGS Mode)**

**Fine adjustment (manual)  
1 point Teach-in (FGS Mode)**

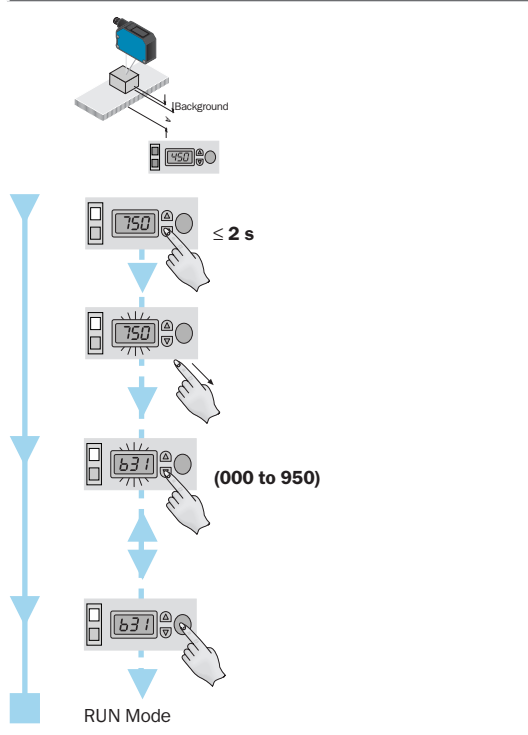
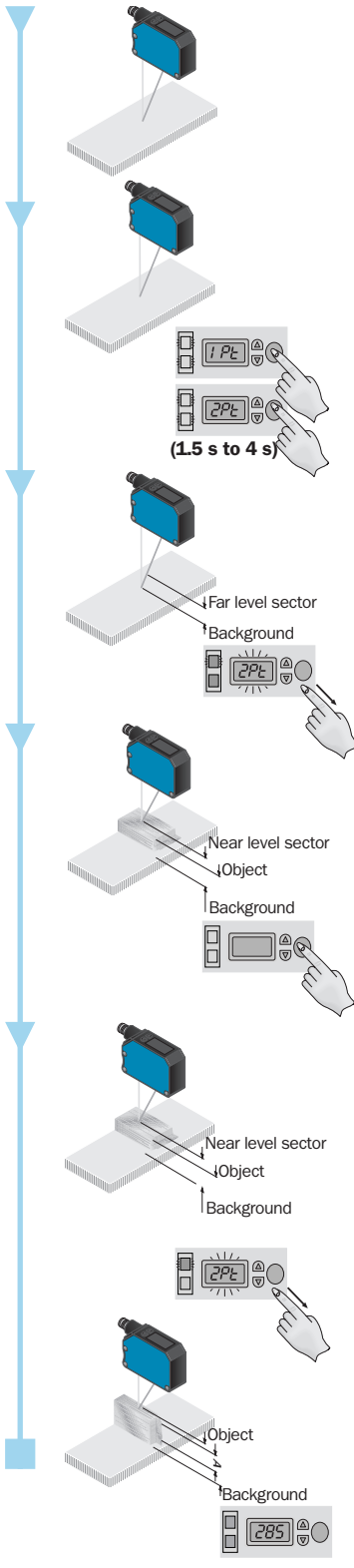
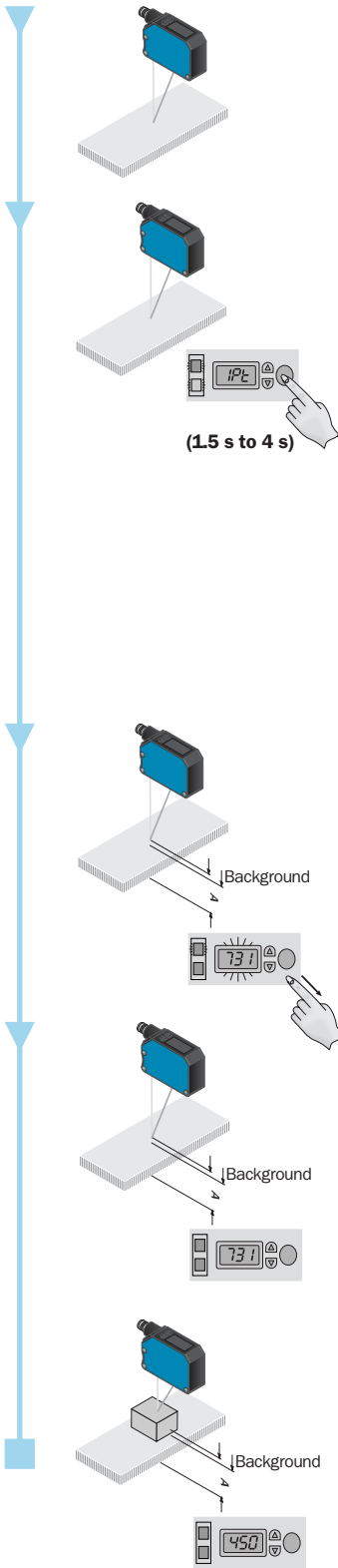

**Fine adjustment (manual)  
2 point Teach-in (FGS Mode)**

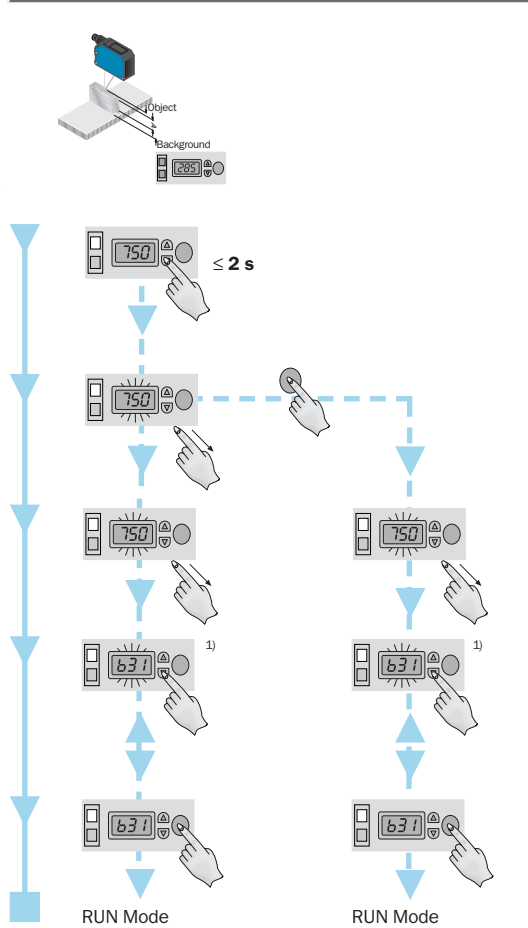

Object in "A" area is detected.



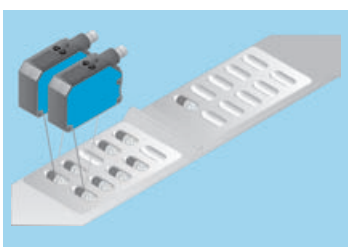
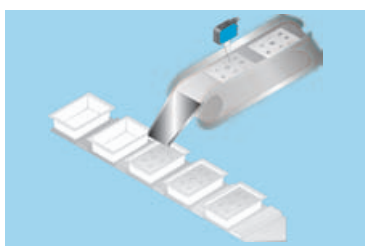





Sensing range "A" between the two levels taught. Objects before or after range "A" are not detected.



<sup>1)</sup> While the display flashes, the switching threshold at close range can be set from 050 to 930 and, at long range, from 070 to 950.

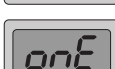
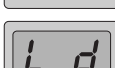
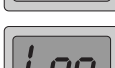
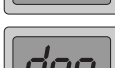
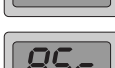
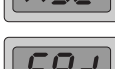
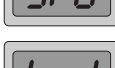
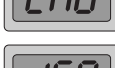

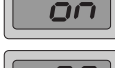
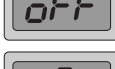
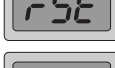
Description of operating panel and functions

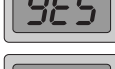
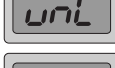

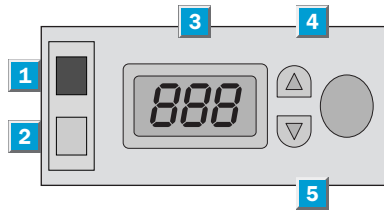

-  SEL  
Select
-  dLY  
Delay
-  oFF  
No Timer
-  ond  
ON Delay
-  oFd  
OFF Delay
-  onE  
ONE shot
-  L d  
Light ON/Dark ON
-  Lon  
Light ON
-  don  
Dark ON
-  ASc  
ASc/Auto sensitivity control
-  SPd  
Response time
-  tnd  
Tresh level
-  dSP  
Display
-  on  
Display on
-  oFF  
Display off
-  rSt  
Reset
-  no  
Unreset
-  YES  
Reset
-  unL  
Unlock
-  Loc  
Lock

Display

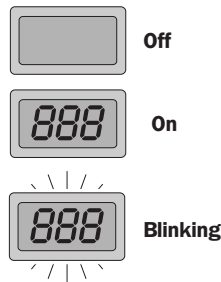

- 1** Status indicator LED, green: Laser on
- 2** Status indicator LED, yellow: output active
- 3** Numerical display
- 4** +/- button; select mode button
- 5** Teach-in button



-  On (LED yellow)
-  On (LED green)
-  Select-Mode button
-  Select-Mode button
-  Teach-in button

Setting Mode, Timer, L/D, Display

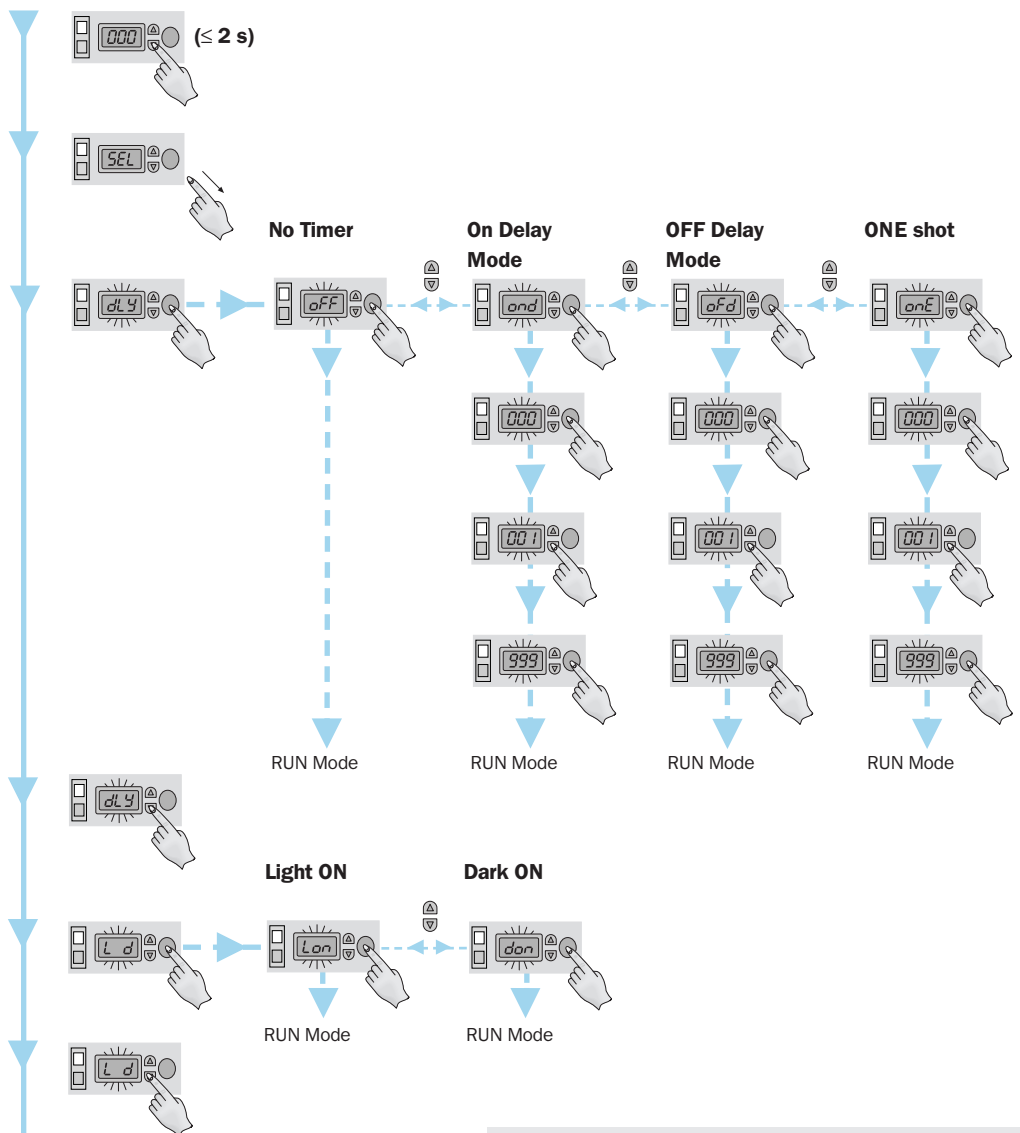



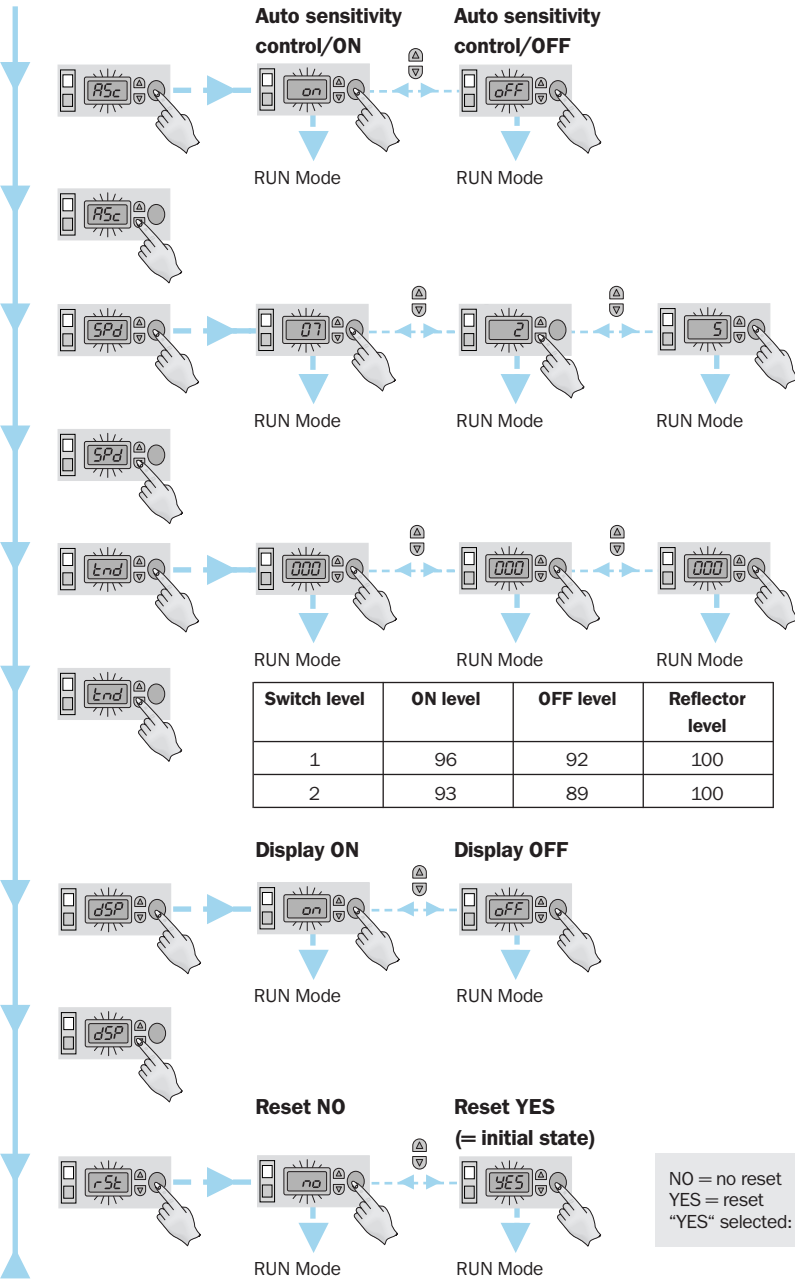

Description of operating panel and functions

Setting Mode, Timer, L/D, Display

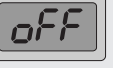

NO = no reset  
 YES = reset  
 "YES" selected: reset to Factory default

Factory default

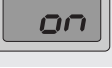
-  **oFF**  
No Timer
-  **don**  
Dark ON
-  **oFF**  
Display off
-  **05**  
0.5 ms
-  **1Pt**  
1 point Teach-in
-  **on**  
Display on

Description of operating panel and functions

Setting Mode, Lock/Unlock

1 point Teach-in

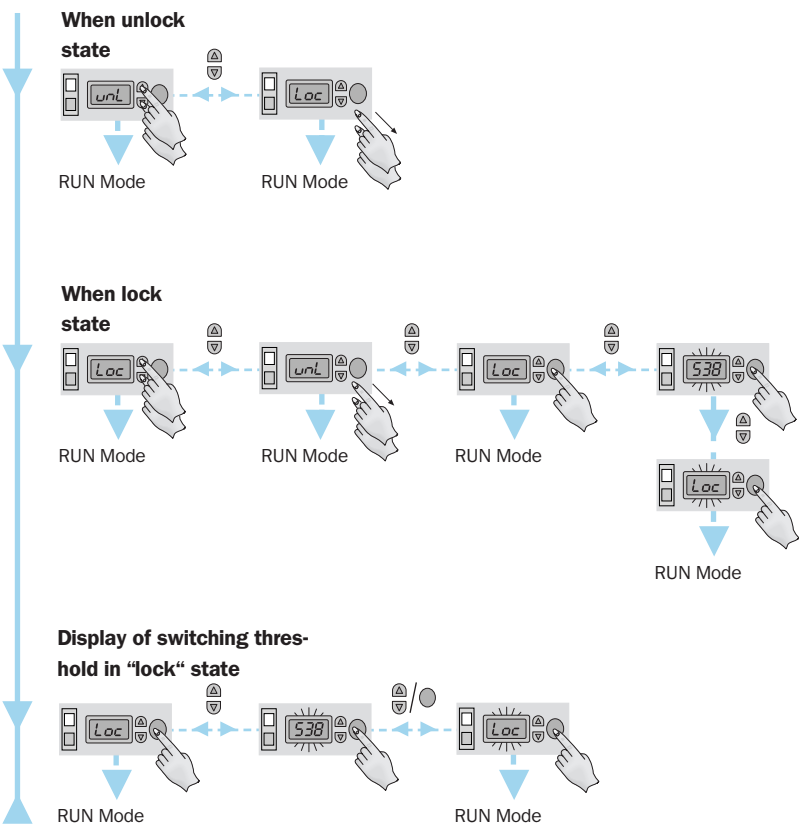

Lock: The sensor is protected from inadvertent adjustments.  
 Unlock: The sensor can be programmed.

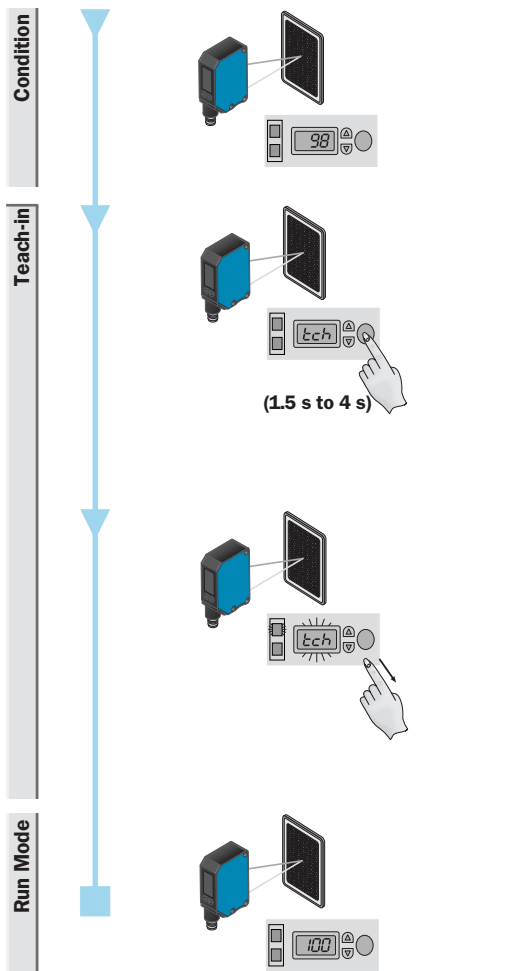

**Status** Reflector is detected without system reserve

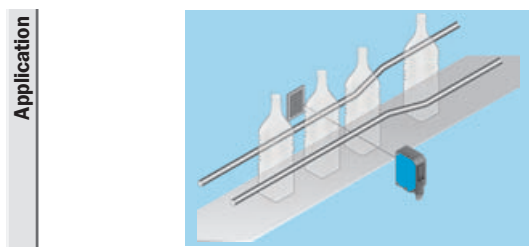

**Scanning distance**  
**100 ... 270 mm**  
 Photoelectric proximity switches

- Laser LED, visible red light, Class 2
- Scanning distance adjustment by Teach-in function
- Programmable background or foreground suppression
- Programmable output: light/dark switching
- Numeric display with menu prompts

**Dimension illustration**

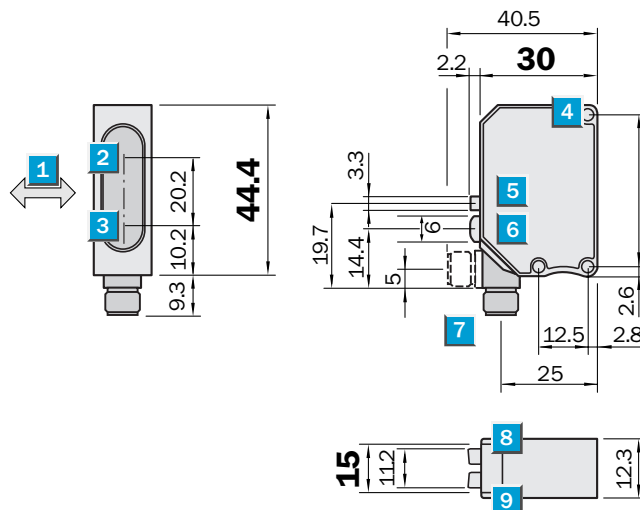

**Setting options**

All types

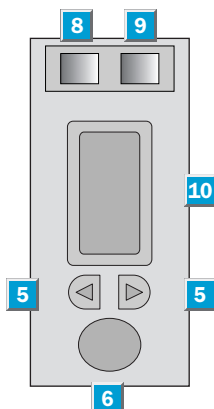

- 1** Standard direction of the material being scanned
- 2** Centre of optical axis, sender
- 3** Centre of optical axis, receiver
- 4** Mounting holes, Ø approx. 3.1 mm
- 5** +/- button; select mode button
- 6** Teach-in button
- 7** Plug 4-pin, M8, 90° rotatable or cable 2 m, 4-wire
- 8** Status indicator LED, green: Laser on
- 9** Status indicator LED, yellow: output active
- 10** Numerical display

**Connection types**

WTB 190TL-P 162	WTB 190TL-P 460
WTB 190TL-N 162	WTB 190TL-N 460

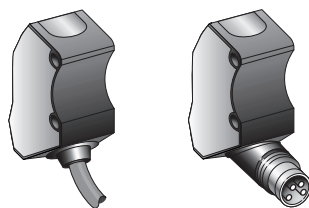

4 x 0.18 mm<sup>2</sup>

4-pin, M8

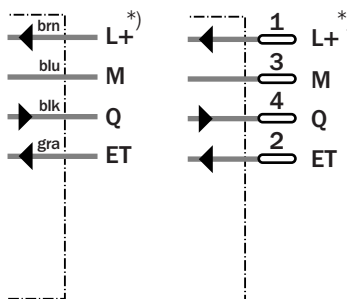

\*) Adjustment via External Teach (ET)

PNP → L+

NPN → M

**Accessories**

Connectors
Mounting systems

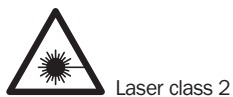

<b>Technical data</b>	WTB 190TL-	P 162	P 460	N 162	N 460						
-----------------------	------------	-------	-------	-------	-------	--	--	--	--	--	--

<b>Scanning distance, adjustable</b>	100 ... 270 mm <sup>1)</sup>				
<b>Device function mode</b>	BGS <sup>2)</sup> or FGS <sup>3)</sup> , programmable				
<b>Scanning distance, adjustable</b>	Teach-in, External Teach (ET)				
	Teach-in via button, menu guided				
<b>Threshold, precise setting</b>	Manually adjustable				
<b>Light source<sup>4)</sup></b>	Laser, red light; class 2				
Light spot diameter	1.5 mm at distance of 200 mm				
<b>Supply voltage V<sub>s</sub></b>	10 ... 30 V DC <sup>5)</sup>				
Ripple <sup>6)</sup>	± 10 %				
Current consumption <sup>7)</sup>	Max. 40 mA				
<b>Switching outputs</b>	PNP				
	NPN				
Output current I <sub>A</sub> max.	< 100 mA				
Switching type	Light-/dark-switching, programmable				
Response time <sup>8)</sup>	1.5 ms				
Switching frequency max. <sup>9)</sup>	300/s				
<b>Timer mode (dLY)</b>	0 ... 10 s, programmable				
<b>Timer function</b>	Nor: normal Mode				
	Ond: On Delay Mode, on delay				
	OFd: Off Delay Mode, off delay				
	OnE: One Shot Mode, one shot				
<b>Numerical display monitoring</b>	Threshold, distance, mode selection				
<b>Connection types</b> Cable	4-wire <sup>10)</sup>				
Plug	4-pin, M8				
<b>VDE protection class<sup>11)</sup></b>	⊕				
<b>Circuit protection<sup>12)</sup></b>	A, B				
<b>Enclosure rating</b>	IP 67				
<b>Ambient temperature</b>	Operation -10 ... +40 °C				
	Storage -20 ... +60 °C				
<b>Weight</b>	With cable 2 m approx. 200 g				
	With plug approx. 120 g				
<b>Housing material</b>	Housing: ABS; optic: PMMA				

1) Object with 90 % reflectance (with reference to standard white according to DIN 5033)  
 2) Background suppression  
 3) Foreground suppression  
 4) Average service life 50,000 h at T<sub>A</sub> = + 25 °C  
 5) Limit values  
 6) Must be within V<sub>s</sub> tolerances  
 7) Without load  
 8) With resistive load  
 9) With light/dark ratio 1:1  
 10) Do not bend below 0 °C  
 11) Reference voltage 50 V DC  
 12) A = V<sub>s</sub> connections reverse-polarity protected  
 B = Output Q short-circuit protected

**Scanning distance**

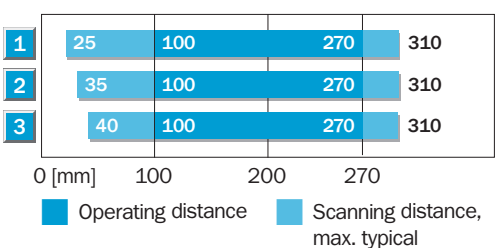

- 1 Scanning range on white, 90 % remission
- 2 Scanning range on grey, 18 % remission
- 3 Scanning range on black, 6 % remission

**Light spot diameter**

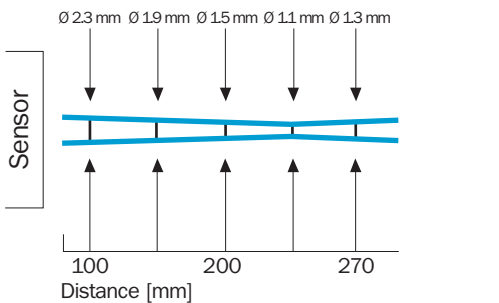

**Order information\*)**

Type	Part no.
WTB 190TL-P 162	6 026 545
WTB 190TL-P 460	6 026 546
WTB 190TL-N 162	6 026 543
WTB 190TL-N 460	6 026 544

\*) Equipment model with 5 m PVC cable or M8 plug, 3-pin on request

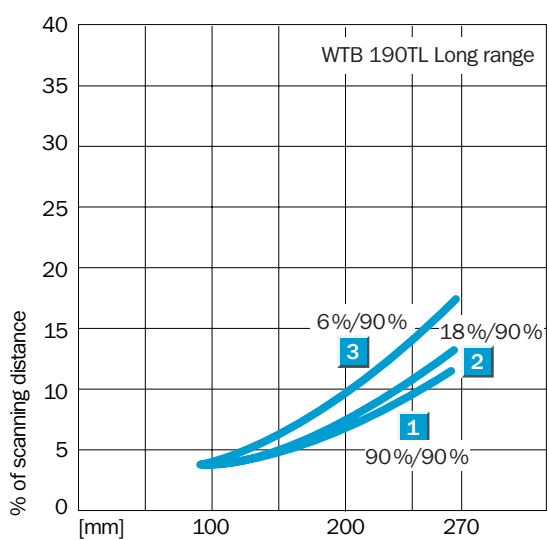

**Scanning distance**  
40 ... 100 mm

Photoelectric proximity switches

- Laser LED, visible red light, Class 2
- Scanning distance adjustment by Teach-in function
- Programmable background or foreground suppression
- Programmable output: light/dark switching
- Numeric display with menu prompts

**Dimension illustration**

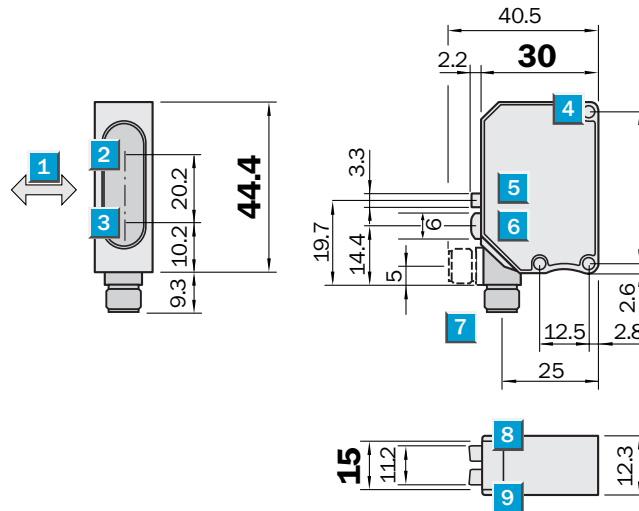

**Setting options**

All types

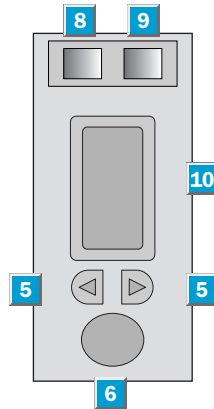

- 1** Standard direction of the material being scanned
- 2** Centre of optical axis, sender
- 3** Centre of optical axis, receiver
- 4** Mounting holes, Ø approx. 3.1 mm
- 5** +/- button; select mode button
- 6** Teach-in button
- 7** Plug 4-pin, M8, 90° rotatable or cable 2 m, 4-wire
- 8** Status indicator LED, green: Laser on
- 9** Status indicator LED, yellow: output active
- 10** Numerical display

**Connection types**

WTB 190TL-P 132	WTB 190TL-P 430
WTB 190TL-N 132	WTB 190TL-N 430

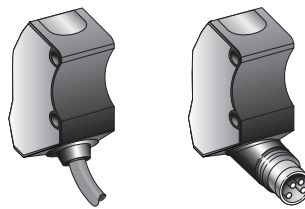

4 x 0.18 mm<sup>2</sup>

4-pin, M8

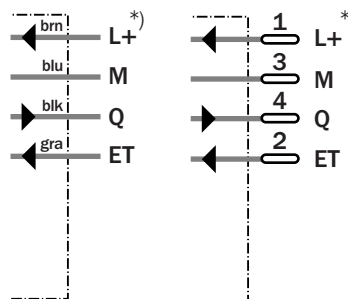

\*) Adjustment via External Teach (ET)

PNP → L+

NPN → M



Laser class 2

**Accessories**

Connectors

Mounting systems



<b>Technical data</b>	WTB 190TL-	P 132	P 430	N 132	N 430						
-----------------------	------------	-------	-------	-------	-------	--	--	--	--	--	--

<b>Scanning distance, adjustable</b>	40 ... 100 mm <sup>1)</sup>				
<b>Device function mode</b>	BGS <sup>2)</sup> or FGS <sup>3)</sup> , programmable				
<b>Scanning distance, adjustable</b>	Teach-in, External Teach (ET)				
	Teach-in via button, menu guided				
<b>Threshold, precise setting</b>	Manually adjustable				
<b>Light source<sup>4)</sup></b>	Laser, red light; class 2				
Light spot diameter	0.8 mm at distance of 80 mm				
<b>Supply voltage V<sub>s</sub></b>	10 ... 30 V DC <sup>5)</sup>				
Ripple <sup>6)</sup>	± 10 %				
Current consumption <sup>7)</sup>	Max. 40 mA				
<b>Switching outputs</b>	PNP				
	NPN				
Output current I <sub>A</sub> max.	< 100 mA				
Switching type	Light-/dark-switching, programmable				
Response time <sup>8)</sup>	1.5 ms				
Switching frequency max. <sup>9)</sup>	300/s				
<b>Timer mode (dLY)</b>	0 ... 10 s, programmable				
<b>Timer function</b>	Nor: normal Mode				
	Ond: On Delay Mode, on delay				
	OFd: Off Delay Mode, off delay				
	OnE: One Shot Mode, one shot				
<b>Numerical display monitoring</b>	Threshold, distance, mode selection				
<b>Connection types</b> Cable	4-wire <sup>10)</sup>				
Plug	4-pin, M8				
<b>VDE protection class<sup>11)</sup></b>	⊕				
<b>Circuit protection<sup>12)</sup></b>	A, B				
<b>Enclosure rating</b>	IP 67				
<b>Ambient temperature</b>	Operation -10 ... +40 °C				
	Storage -20 ... +60 °C				
<b>Weight</b>	With cable 2 m approx. 200 g				
	With plug approx. 120 g				
<b>Housing material</b>	Housing: ABS; optic: PMMA				

1) Object with 90 % reflectance (with reference to standard white according to DIN 5033)  
 2) Background suppression  
 3) Foreground suppression  
 4) Average service life 50,000 h at T<sub>A</sub> = + 25 °C  
 5) Limit values  
 6) Must be within V<sub>s</sub> tolerances  
 7) Without load  
 8) With resistive load  
 9) With light/dark ratio 1:1  
 10) Do not bend below 0 °C  
 11) Reference voltage 50 V DC  
 12) A = V<sub>s</sub> connections reverse-polarity protected  
 B = Output Q short-circuit protected

**Scanning distance**

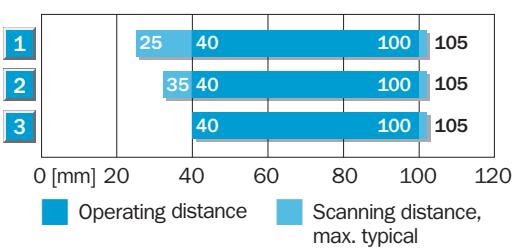

- 1 Scanning range on white, 90 % remission
- 2 Scanning range on grey, 18 % remission
- 3 Scanning range on black, 6 % remission

**Light spot diameter**

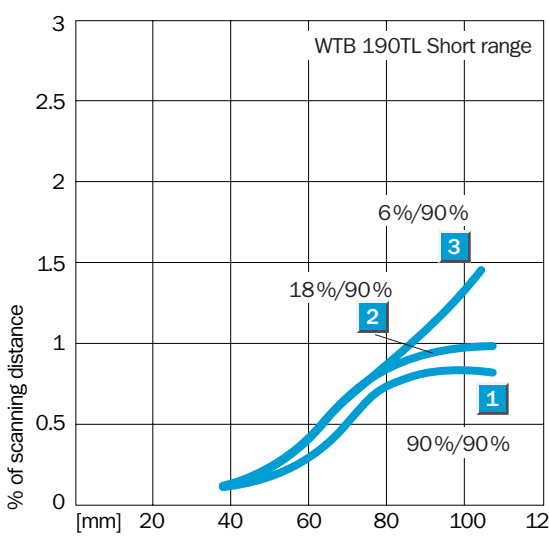
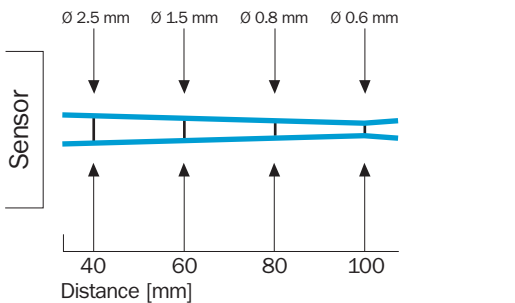

**Order information\*)**

Type	Part no.
WTB 190TL-P 132	6 026 541
WTB 190TL-P 430	6 026 542
WTB 190TL-N 132	6 026 539
WTB 190TL-N 430	6 026 540

\*) Equipment model with 5 m PVC cable or M8 plug, 3-pin on request

	Scanning range
	0.01 ... 5.5 m
Photoelectric reflex switches	

- Laser LED, visible red light, Class 2
- Sensitivity setting by Teach-in
- Precision auto-collimated optics
- Programmable output: light/dark switching
- Numeric display with menu prompts

Dimension illustration

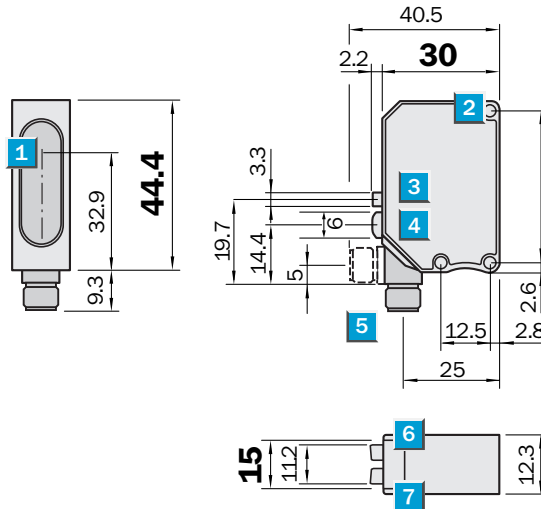

Setting options

All types

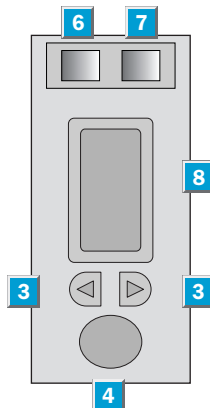

- 1 Centre of optical axis
- 2 Mounting holes, Ø approx. 3.1 mm
- 3 +/- button; select mode button
- 4 Teach-in button
- 5 Plug 4-pin, M8, 90° rotatable or cable 2 m, 4-wire
- 6 Status indicator LED, green: Laser on
- 7 Status indicator LED, yellow: output active
- 8 Numerical display

Connection types

WLG 190T-P 112	WLG 190T-P 410
WLG 190T-N 112	WLG 190T-N 410

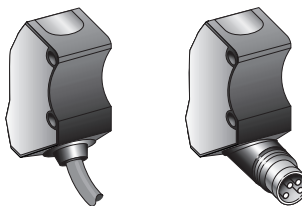

4 x 0.18 mm<sup>2</sup>      4-pin, M8

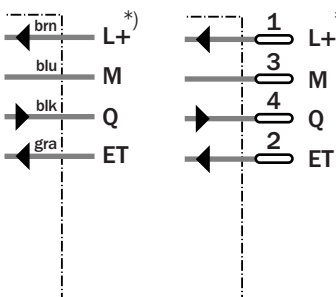

\*) Sensitivity control via External Teach (ET)  
 PNP → L+  
 NPN → M

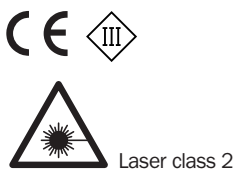

<b>Accessories</b>
Connectors
Reflectors
Mounting systems



**Scanning range**  
0.01 ... 1.8 m

Photoelectric reflex switches

- Laser LED, visible red light, Class 2
- Sensitivity setting by Teach-in
- Precision auto-collimated optics
- Programmable output: light/dark switching
- Numeric display with menu prompts

**Dimension illustration**

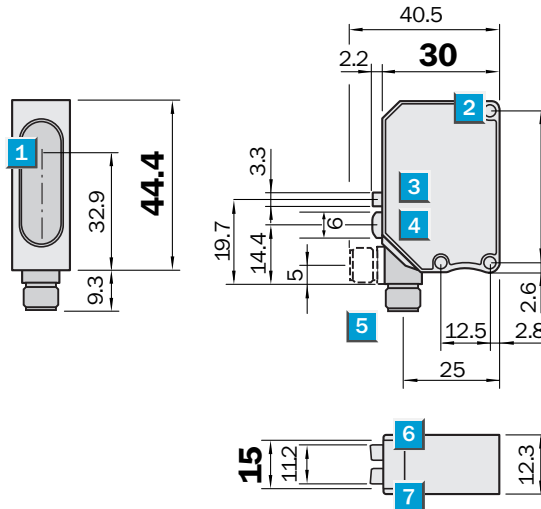

**Setting options**

All types

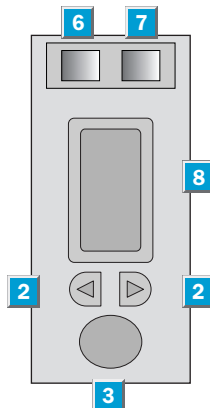

- 1** Mounting holes, Ø approx. 3.1 mm
- 2** +/- button; select mode button
- 3** Teach-in button
- 4** Plug 4-pin, M8, 90° rotatable or cable 2 m, 4-wire
- 5** Centre of optical axis
- 6** Status indicator LED, green: Laser on
- 7** Status indicator LED, yellow: output active
- 8** Numerical display

**Connection types**

WLG 190T-P 122	WLG 190T-P 420
WLG 190T-N 122	WLG 190T-N 420

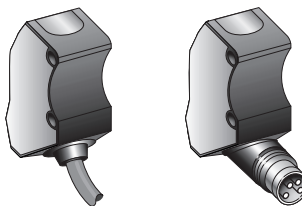

4 x 0.18 mm<sup>2</sup>      4-pin, M8

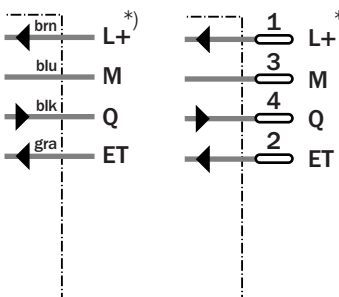

\*) Sensitivity control via External Teach (ET)

PNP → L+

NPN → M



**Accessories**

- Connectors
- Reflectors
- Mounting systems

<b>Technical data</b>	WLG 190T-	P 122	P 420	N 122	N 420						
-----------------------	-----------	-------	-------	-------	-------	--	--	--	--	--	--

<b>Scanning range</b> , max. typ. on reflector <sup>1)</sup>	0.01 ... 1.8 m/PL 80 A, adjustable				
<b>Scanning range</b> , max. typ. on reflector <sup>1)</sup>	0.01 ... 1.2 m/P 250, adjustable				
<b>Sensitivity control</b>	Teach-in, External Teach (ET) Teach-in via button, menu guided				
<b>Fine adjustment</b>	Manually adjustable				
<b>Light source</b> <sup>2)</sup>	Laser, red light; class 2				
Light spot diameter	15 mm at distance of 1 m				
<b>Supply voltage</b> V <sub>s</sub>	10 ... 30 V DC <sup>3)</sup>				
Ripple <sup>4)</sup>	± 10 %				
Current consumption <sup>5)</sup>	Max. 40 mA				
<b>Switching outputs</b>	PNP NPN				
Output current I <sub>A</sub> max.	< 100 mA				
Switching type	Light-/dark-switching, programmable				
Response time <sup>6)</sup>	0.7; 2; 5 ms, programmable				
Switching frequency max. <sup>7)</sup>	700; 200; 100/s				
<b>Timer mode (dLY)</b>	0 ... 10 s, programmable				
<b>Timer function</b>	Nor: normal Mode Ond: On Delay Mode, on delay OFd: Off Delay Mode, off delay OnE: One Shot Mode, one shot				
<b>Numerical display monitoring</b>	Transmission, remission, threshold, distance, mode selection				
<b>Connection types</b> Cable	4-wire <sup>8)</sup>				
Plug	4-pin, M8				
<b>VDE protection class</b> <sup>9)</sup>	⊕				
<b>Circuit protection</b> <sup>10)</sup>	A, B				
<b>Enclosure rating</b>	IP 67				
<b>Ambient temperature</b>	Operation -10 ... +40 °C Storage -20 ... +60 °C				
<b>Weight</b>	With cable 2 m approx. 200 g With plug approx. 120 g				
<b>Housing material</b>	Housing: ABS; optic: PMMA				

1) Reflector P 250 included with delivery      4) Must be within V<sub>s</sub> tolerances      7) With light/dark ratio 1:1  
 2) Average service life 50,000 h      5) Without load      8) Do not bend below 0 °C  
 at T<sub>A</sub> = + 25 °C      6) With resistive load      9) Reference voltage 50 V DC  
 3) Limit values      10) A = V<sub>s</sub> connections reverse-polarity protected  
 B = Output Q short-circuit protected

**Scanning range**

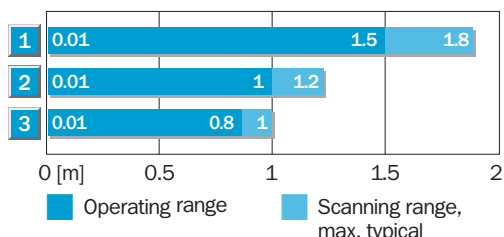

Reflector type	Operating range
1 PL 80 A	0.01 ... 1.5 m
2 P 250/PL 40 A/PL 50 A	0.01 ... 1 m
3 PL 30 A/PL 31 A	0.01 ... 0.8 m

**Light spot diameter**

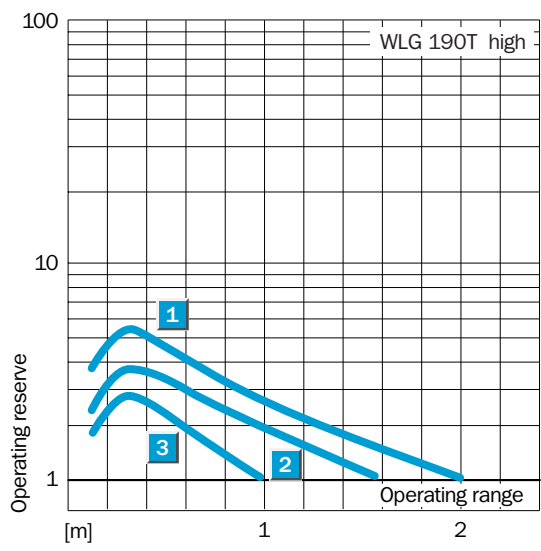
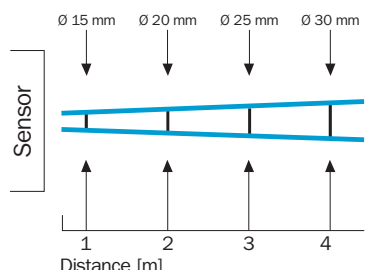

**Order information<sup>\*)</sup>**

Type	Part no.
WLG 190T-P 122	6 022 827
WLG 190T-P 420	6 022 830
WLG 190T-N 122	6 022 823
WLG 190T-N 420	6 022 826

\*) Equipment model with 5 m PVC cable or M 8 plug, 3-pin on request

Dimensional drawings and order information

Contact assignment according to EN 50044

SENSICK screw-in system M8, 4-pin, enclosure rating IP 67

Female connector M8, 4-pin, straight

Type	Part no.
DOS-0804-G	6 009 974

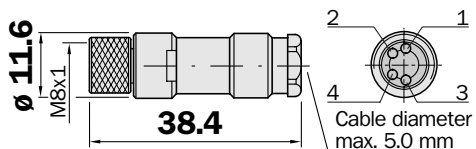

Female connector M8, 4-pin, right angle

Type	Part no.
DOS-0804-W	6 009 975

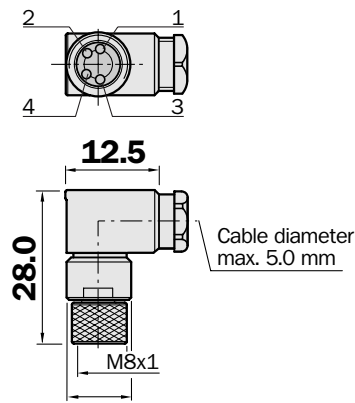

Female connector M8, 4-pin, straight

Cable diameter 5 mm, 4 x 0.25 mm<sup>2</sup>, sheath PVC

Type	Part no.	Cable length
DOL-0804-G02M	6 009 870	2 m
DOL-0804-G05M	6 009 872	5 m
DOL-0804-G10M	6 010 754	10 m

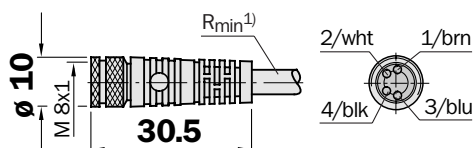

Female connector M8, 4-pin, right angle

Cable diameter 5 mm, 4 x 0.25 mm<sup>2</sup>, sheath PVC

Type	Part no.	Cable length
DOL-0804-W02M	6 009 871	2 m
DOL-0804-W05M	6 009 873	5 m
DOL-0804-W10M	6 010 755	10 m

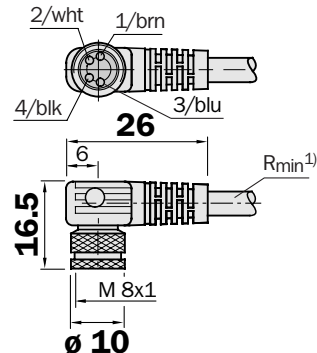

<sup>1)</sup> Minimum bend radius in dynamic use  
 $R_{min} = 20 \times \text{cable diameter}$



Dimensional drawings and order information

Reflectors

Plastic design for temperatures up to 65 °C

Reflector, 47 x 47 mm<sup>2</sup>

Type	Part no.
P 250	5 304 812

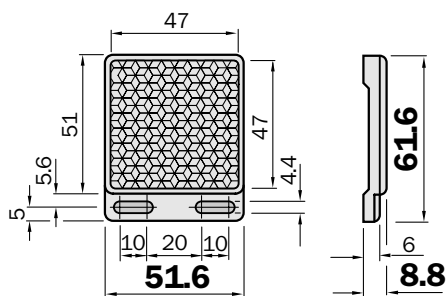

Reflector, 47 x 47 mm<sup>2</sup>

micro triple, 2 hole mounting

Type	Part no.
P 250 F	5 308 843

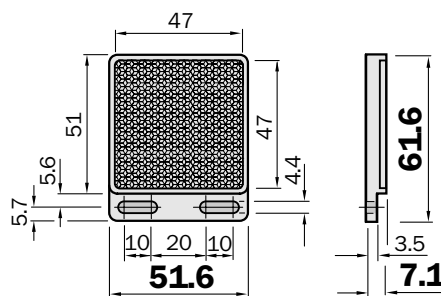

Mounting systems

Mounting bracket for W 190 L (included with delivery)

Type	Part no.
BEF-WK-W190	5 311 362

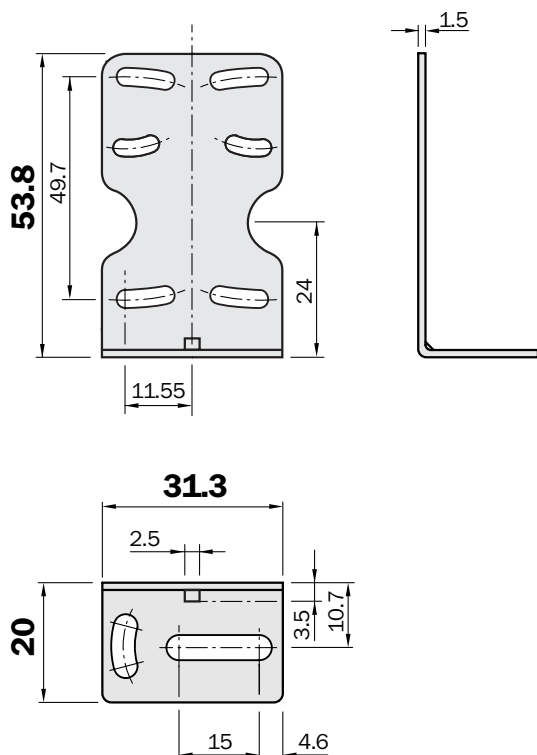

8 010 553/24-02-04 • GO/SM • Printed in Germany (03.04) • Subject to change without prior notice • The specified product features and technical data do not represent any guarantee • 01 DB int14



SICK AG • Industrial Sensors • Waldkirch • Germany • [www.sick.com](http://www.sick.com)