

WF next: Fork sensors for a wide range of applications

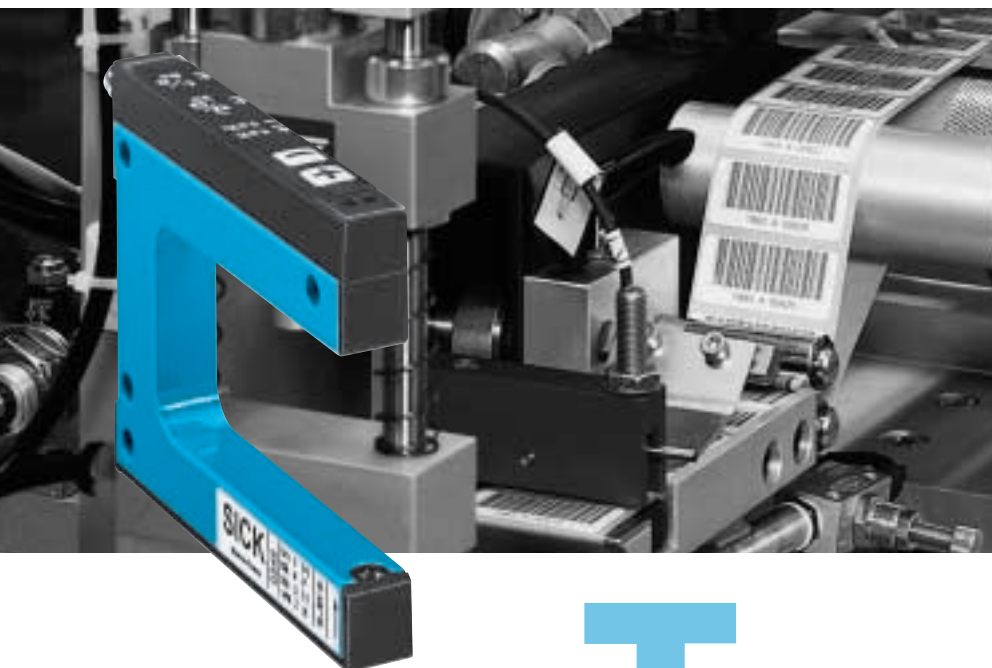

- slot widths between 2 and 120 mm, slot depths of 40, 60 and 95 mm,
- manual adjustment via user-friendly keyboard,
- simple and quick adjustment via Teach-in,
- switching output PNP and NPN,
- L/D adjustable via button,
- rugged metal housing with glass optics,
- shortest response time,
- fine resolution.

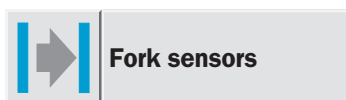

The detection of labels, marks and double sheets, as well as holes and edges are typical applications for the new WF fork sensors.

A complete range of sensors with the following features is available for a variety of operating conditions:

SICK

Fork width
2 ... 120 mm

Fork sensors

- Simple and accurate adjustment via “+” and “-” buttons
- PNP and NPN switching output
- Light/dark switching, adjustable
- Rugged aluminium housing

Dimensional drawing

All types

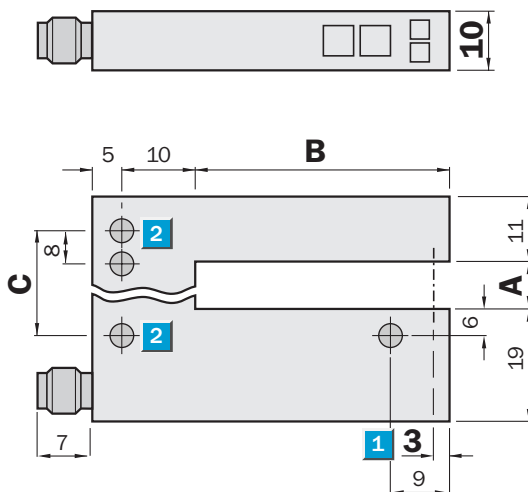

Adjustments possible

All types

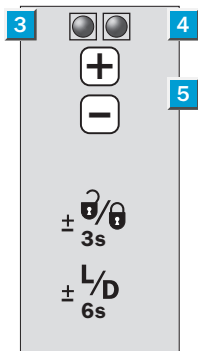

- 1 Optical axis
- 2 Mounting holes, Ø 4.2 mm
- 3 Function indicator (red)
- 4 Function indicator (yellow), switching output
- 5 “+”/“-” buttons and function button

Dimensions

Dimensions (mm)	A Fork width	B Fork depth	C
WF 2	2	42/59/95	14
WF 5	5	42/59/95	14
WF 15	15	42/59/95	27
WF 30	30	42/59/95	42
WF 50	50	42/59/95	40
WF 80	80	42/59/95	70
WF 120	120	42/59/95	110



Connection types

All types

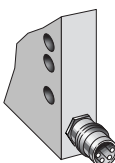

4-pin, M8

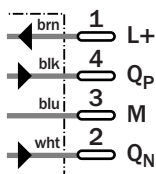

Accessories

Cables and Connectors

Technical data		WF	2-XX ¹⁾	5-XX ¹⁾	15-XX ¹⁾	30-XX ¹⁾	50-XX ¹⁾	80-XX ¹⁾	120-XX ¹⁾			
			B410	B410	B410	B410	B410	B410	B410			
Fork width	2 mm											
	5 mm											
	15 mm											
	30 mm											
	50 mm											
	80 mm											
	120 mm											
Fork depth	40, 60 or 95 mm											
Light source	LED, infra-red modulated											
Minimum detectable object size	0.2 mm											
Supply voltage U_V	10 ... 30 V DC ²⁾											
Current consumption ³⁾	40 mA											
Residual ripple ⁴⁾	< 10 %											
Switching output	PNP and NPN											
	Light/dark adjustable via button											
Signal voltage												
PNP	HIGH = U _V - (< 2 V)/LOW = 0 V											
NPN	HIGH = U _V /LOW = < 2 V											
Output current I _A	100 mA											
Stability of response time ⁵⁾	± 20 µs											
Response time ⁵⁾ , switching frequency ⁶⁾	Max. 100 µs; 10,000/s											
Initialisation time	100 ms											
Ambient light safety												
Incandescent lamp	5,000 Lux											
Sunlight	10,000 Lux											
VDE protection class⁷⁾	III											
Enclosure rating	IP 65											
Circuit protection⁸⁾	A, B, C											
Ambient temperature⁹⁾	Operation -20 °C ... +60 °C											
	Storage -30 °C ... +80 °C											
Housing	Aluminium											
Weight	Approx. 36 g to 160 g ¹⁰⁾											

1) XX = Fork depth (E.g. 40 = fork depth equivalent to 40 mm)
 2) Limit values, reverse-polarity protected
 3) Without load

4) May not exceed or fall short of V_S-tolerances
 5) Signal transit time with resistive load
 6) With light/dark ratio 1:1; no time delay
 7) Reference voltage 50 V DC

8) A = U_V connections reverse-polarity protected
 B = Outputs short-circuit protected
 C = Interference pulse suppression
 9) Do not bend below 0 °C

10) Depending on fork width

Truth table

Switching type	Light-switching (Q)		Dark-switching (Q̄)	
	yes	no	yes	no
Light path free	yes	no	yes	no
PNP/NPN output	HIGH	LOW	LOW	HIGH
Function indicator (yellow)	On	Off	Off	On

Order information

Fork depth 40 mm		Fork depth 60 mm		Fork depth 95 mm	
Type	Part no.	Type	Part no.	Type	Part no.
WF2-40B410	6 028 428	WF2-60B410	6 028 436	WF2-95B410	6 028 443
WF5-40B410	6 028 429	WF5-60B410	6 028 437	WF5-95B410	6 028 444
WF15-40B410	6 028 430	WF15-60B410	6 028 438	WF15-95B410	6 028 445
WF30-40B410	6 028 431	WF30-60B410	6 028 439	WF30-95B410	6 028 446
WF50-40B410	6 028 432	WF50-60B410	6 028 440	WF50-95B410	6 028 447
WF80-40B410	6 028 433	WF80-60B410	6 028 441	WF80-95B410	6 028 448
WF120-40B410	6 028 435	WF120-60B410	6 028 442	WF120-95B410	6 028 449

Fork width
2 ... 120 mm

Fork sensors

- Simple setting using 2-point Teach-in
- PNP and NPN switching output
- Light/dark switching adjustable
- Rugged aluminium housing

Dimensional drawing

All types

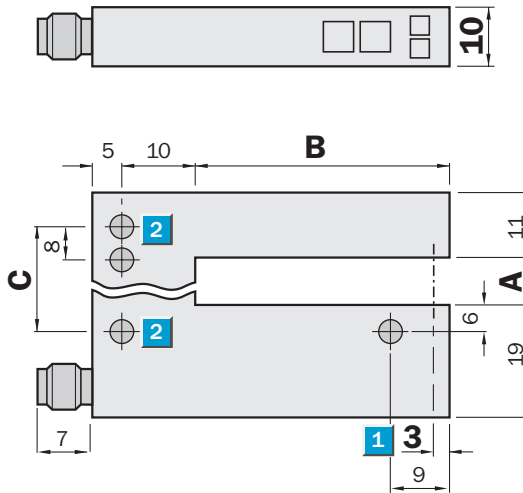

Adjustments possible

All types

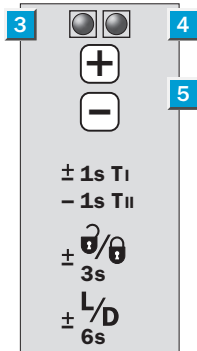

- 1 Optical axis
- 2 Mounting holes, Ø 4.2 mm
- 3 Function indicator (red)
- 4 Function indicator (yellow), switching output
- 5 “+”/“-” buttons and function button

Dimensions

Dimensions (mm)	A Fork width	B Fork depth	C
WF 2	2	42/59/95	14
WF 5	5	42/59/95	14
WF 15	15	42/59/95	27
WF 30	30	42/59/95	42
WF 50	50	42/59/95	40
WF 80	80	42/59/95	70
WF 120	120	42/59/95	110



Connection types

All types

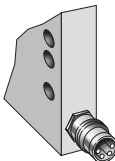

4-pin, M8

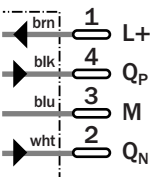

Accessories

Cables and Connectors

Technical data		WF	2-XX ¹⁾	5-XX ¹⁾	15-XX ¹⁾	30-XX ¹⁾	50-XX ¹⁾	80-XX ¹⁾	120-XX ¹⁾			
			B416	B416	B416	B416	B416	B416	B416			
Fork width	2 mm											
	5 mm											
	15 mm											
	30 mm											
	50 mm											
	80 mm											
	120 mm											
Fork depth	40, 60 or 95 mm											
Light source	LED, infra-red modulated											
Minimum detectable object size	0.2 mm											
Supply voltage U_V	10 ... 30 V DC ²⁾											
Current consumption ³⁾	40 mA											
Ripple ⁴⁾	< 10 %											
Switching output	PNP and NPN											
	Light/dark adjustable via button											
Signal voltage												
PNP	HIGH = U _V - (< 2 V)/LOW = 0 V											
NPN	HIGH = U _V /LOW = < 2 V											
Output current I _A	100 mA											
Stability of response time ⁵⁾	± 20 μs											
Response time ⁵⁾ , switching frequency ⁶⁾	Max. 100 μs; 10,000/s											
Teach-in via button												
Initialisation time	100 ms											
Ambient light safety	Incandescent lamp	5,000 Lux										
	Sunlight	10,000 Lux										
	VDE protection class ⁷⁾	III										
Enclosure rating	IP 65											
Circuit protection⁸⁾	A, B, C											
Ambient temperature⁹⁾	Operation	-20 °C ... +60 °C										
	Storage	-30 °C ... +80 °C										
Housing	Aluminium											
Weight	Approx. 36 g to 160 g ¹⁰⁾											

- 1) XX = Fork depth
(E.g. 40 = fork depth equivalent to 40 mm)
- 2) Limit values, reverse-polarity protected
- 3) Without load

- 4) May not exceed or fall short of V_S-tolerances
- 5) Signal transit time with resistive load
- 6) With light/dark ratio 1:1; no time delay
- 7) Reference voltage 50 V DC

- 8) A = U_V connections reverse-polarity protected
B = Outputs short-circuit protected
C = Interference pulse suppression
- 9) Do not bend below 0 °C

- 10) Depending on fork width

Truth table

Switching type	Light-switching (Q)		Dark-switching (\bar{Q})	
	yes	no	yes	no
Light path free	yes	no	yes	no
PNP/NPN output	HIGH	LOW	LOW	HIGH
Function indicator (yellow)	On	Off	Off	On

Order information

Fork depth 40 mm		Fork depth 60 mm		Fork depth 95 mm	
Type	Part no.	Type	Part no.	Type	Part no.
WF2-40B416	6 028 450	WF2-60B416	6 028 457	WF2-95B416	6 028 464
WF5-40B416	6 028 451	WF5-60B416	6 028 458	WF5-95B416	6 028 465
WF15-40B416	6 028 452	WF15-60B416	6 028 459	WF15-95B416	6 028 466
WF30-40B416	6 028 453	WF30-60B416	6 028 460	WF30-95B416	6 028 467
WF50-40B416	6 028 454	WF50-60B416	6 028 461	WF50-95B416	6 028 468
WF80-40B416	6 028 455	WF80-60B416	6 028 462	WF80-95B416	6 028 469
WF120-40B416	6 028 456	WF120-60B416	6 028 463	WF120-95B416	6 028 470

Teach-in: adjusting the switching threshold

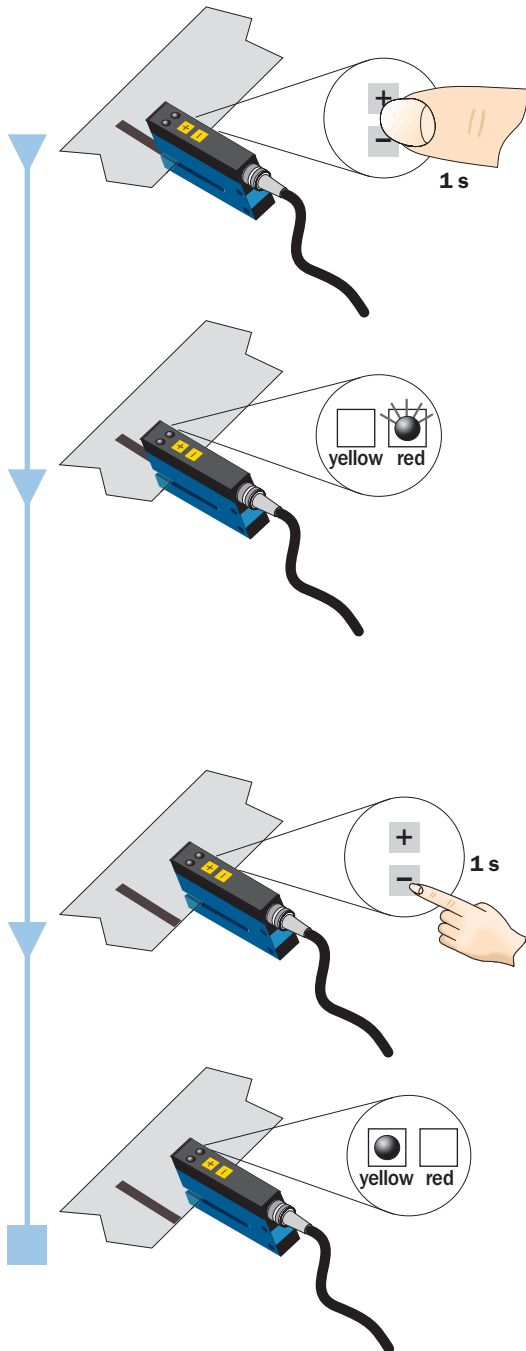

- The material speed during Teach-in must equal zero (machine stationary).

1st operation

- Operate both buttons for 1 sec (on mark or object).

- After the first Teach-in operation, the red function indicator flashes slowly and signals that the second Teach-in operation must now be initiated.

2nd operation

- Briefly operate the “-” button (on carrier material or without scanned object).

- After the second Teach-in operation, the red function indicator extinguishes.
- The Teach-in operation was unsuccessful if the red function indicator flashes.

Notes

- **+** Following completion of the Teach-in operation, the switching threshold can be further adjusted by the “+” or “-” button at any time. For slower adjustment, press the “+” or “-” button once. For faster adjustment, the finger remains on the “+” or “-” button.
- $\pm \frac{3}{3s}$ By simultaneously pressing the “+” and “-” buttons (3 seconds), the unit can be locked against unintentional adjustment
- $\pm \frac{L/D}{6s}$ By simultaneously pressing the “+” and “-” buttons (6 seconds), the switching function (light/dark) can be inverted. Default setting: light switching.

Dimensional drawings and order information

SENSICK screw-in system M8, 4-pin, enclosure rating IP 67

Female connector M8, 4-pin, straight

Type	Part no.
DOS-0804-G	6 009 974

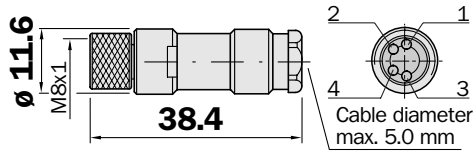

Female connector M8, 4-pin, right angle

Type	Part no.
DOS-0804-W	6 009 975

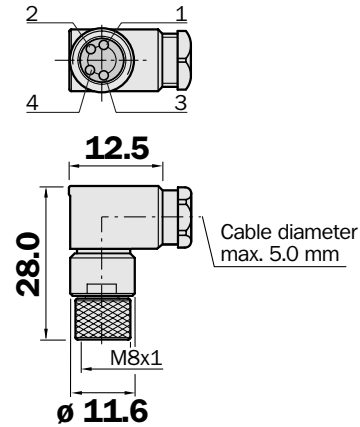

Female connector M8, 4-pin, straight

Cable diameter 5 mm, 4 x 0.25 mm², sheath PVC

Type	Part no.	Cable length
DOL-0804-G02M	6 009 870	2 m
DOL-0804-G05M	6 009 872	5 m
DOL-0804-G10M	6 010 754	10 m

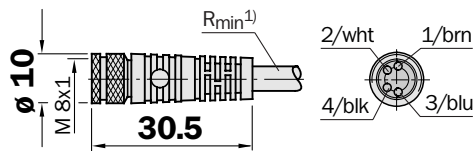

Female connector M8, 4-pin, right angle

Cable diameter 5 mm, 4 x 0.25 mm², sheath PVC

Type	Part no.	Cable length
DOL-0804-W02M	6 009 871	2 m
DOL-0804-W05M	6 009 873	5 m
DOL-0804-W10M	6 010 755	10 m

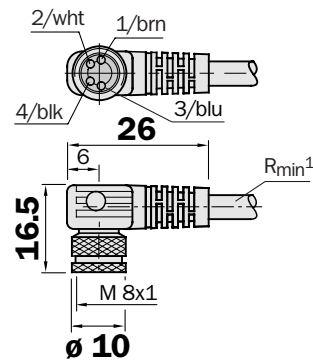

¹⁾ Minimum bend radius in dynamic use
 $R_{min} = 20 \times \text{cable diameter}$



- COMPOSANTS D'AUTOMATISME
- SYSTEMES D'AUTOMATISME
- CONSTITUANTS ELECTROTECHNIQUES
- MESURE ET CONTROLE
- SECURITE MACHINE

8, Avenue de la Malle - ZI Les Coïdes
51370 SAINT BRICE COURCELLES
Tél. : 03.26.04.20.21 - Fax : 03.26.04.28.20
Email : info@audin.fr - Web : <http://www.audin.fr>

SICK

SICK AG • Industrial Sensors • Waldkirch • Germany • www.sick.com