

RZN1

Magnetic cylinder sensor

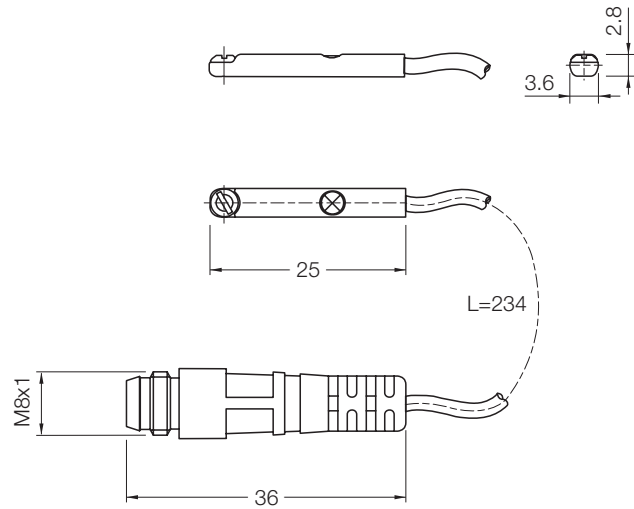

Features



- ▶ Non-contact detection of piston position in pneumatic cylinders
- ▶ **Mountable from the top**
- ▶ For all common used roundslot cylinder e.g. Festo, SMC
- ▶ Plastic housing with clamping screw
- ▶ Connection cable or connector on cable
- ▶ Enclosure rating IP 67
- ▶ LED status indicator

Accessories

Round connector

Connection diagram

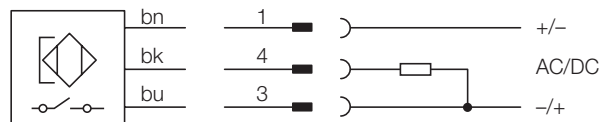

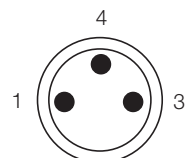

Wire colour	Contact	Assignment
bn brown	1	+ (-)
bk black	4	NO
bu blue	3	- (+)



Electrical and mechanical data

Operating voltage U_b	10 ... 30 V AC/DC	Enclosure rating to DIN 40050	IP 67
Max. switching power	10 W / VA	Shock and vibration stress	30 g, 11 ms 10 to 55 Hz, 1 mm
Continuous current I_a	≤ 500 mA DC/ ≤ 300 mA AC	Ambient temperature T_a	- 25 ... + 75 °C
Switching delay	ON app. 1.0 ms OUT app. 0.5 ms	Housing material	PA 12
Hysteresis H typ.	< 0.7 mT	Connection cable 2 m	PUR 3x 0.09 mm ²
Repeatability R (U_b and T_a constant)	≤ 0.1 mm	Connection cable with M8x1 mm	PUR
EMC	to EN 60 947-5-2		

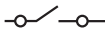
Selection table

Sensing face	Switching-output	Switching function	Connection frequency in Hz	Type	Order	number
	Reed		500	Cable 2 m	RZN1-05ZRS-KUO	1022055
	Reed		500	Cable w. M 8 x 1 mm	RZN1-05ZRS-KPO	1022056

SICK

Great Britain
Erwin Sick Ltd.
Waldkirch House
39 Hedley Road, St. Albans
Hertfordshire AL 1 5BN
☎ +44 17 27-83 11 21
Fax +44 17 27-85 67 67
erwin@sick.co.uk

USA
SICK, Inc.
6900 West 110th Street
Bloomington, MN 55438
☎ +1 (952) 9 41-67 80
Fax +1 (952) 9 41-92 87
WATS: 1-800-325-7425
info@sickoptic.com

Australia
Erwin Sick Optic-Electronic
Pty. Ltd. Head Office, P.O. Box 214
899 Heidelberg Road
Ivanhoe, Vic. 3079, Australia
☎ +61 39 49 74 10 0
(0 08) 33 48 02 - toll free
Fax +61 39 49 71 18 7
sick@werple.net.au