

## ▶▶▶ Advanced Graphic Operator Panels & Flexible Modules

The new Graphite™ series provides the industry's first rugged HMI solution to combine flexible plug-in modules with protocol conversion, data logging and web-based monitoring and control.

From factories to extreme locations, Graphite allows customers to easily connect, monitor and control their processes. Designed to be extremely rugged, Graphite features cast-aluminum construction, wide temperature ratings and superior shock and vibration specifications. Available in eight different models with sizes ranging from 7" to 15", Graphite's sleek design provides full-color touchscreen displays that consume minimal panel space.

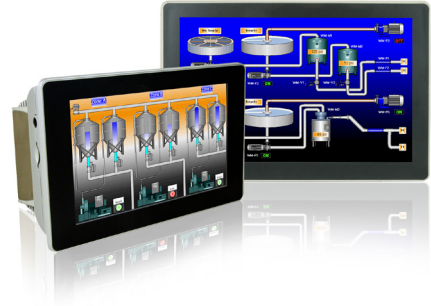

### APPLICATIONS

- > Machine Automation
- > Oil and Gas
- > Water/Wastewater
- > Plastic Extrusion
- > Data Acquisition

### PRODUCT HIGHLIGHTS

- > Protocol conversion with over 250 protocols
- > Built-in web server for remote access
- > On-board data logging to SD card or FTP
- > Industrial construction, die-cast aluminum housing provides extreme protection
- > Extended temperature -20° to 60° C
- > Outdoor/sunlight readable models available
- > Widescreen models available
- > Dual USB host capability
- > Plug-in modules allow expansion beyond normal HMI capabilities

### FEATURES & BENEFITS

- > Significantly reduce programming time using our easy-to-use, drag-and-drop Crimson 3 software
- > Graphite's sleek bezel allows users to save panel or enclosure real estate resulting in real dollar savings
- > Rugged construction provides wide temperature range and shock and vibration specifications for installation in harsh environments
- > Using modular capability, Graphite can easily accept direct inputs from various devices or provide full PID control

- > Modular capabilities include:
  - PID control
  - DC current and voltage
  - RTD/thermocouples
  - Process signals
  - Analog outputs
  - Digital I/O
  - Universal input



# ▶▶▶ Graphite Specifications

## COMMUNICATION PROPERTIES

USB Port: Programming Adheres to USB specification 1.1. Device only using Type B connection.  
USB Host Ports: Comply with Universal Serial Bus Specification Rev 2.0. Support data transfers at full-speed. Hardware over current protected (0.5 A max per port).  
Serial Ports: Format and Baud Rates for each port are individually software programmable up to 115,200 baud.  
PGM Port: RS232 port via RJ12.  
COMMS Ports: RS422/485 port via RJ45, and RS232 port via RJ12.  
DH485 TXEN: Transmit enable; open collector,  $V_{OH} = 15$  VDC,  $V_{OL} = 0.5$  V @ 25 mA max.  
Ethernet Port: 10 BASE-T / 100 BASE-TX  
RJ45 jack is wired as a NIC (Network Interface Card).  
Isolation from Ethernet network to Graphite operator interface: 1500 Vrms

## LCD DISPLAY

Size:  
G07 – 7 inch  
G09 – 9 inch  
G10 – 10 inch  
G12 – 12 inch  
G15 – 15 inch  
Type: TFT  
Colors: 16 M  
Pixels:  
G07 – 800 X 480  
G09 – 800 X 480  
G10C – 640 X 480  
G10R – 800 X 600  
G10S – 640 X 480  
G12 – 1280 X 800  
G15 – 1024 X 768  
Brightness:  
G07C – 500 cd/m<sup>2</sup>  
G07S – 1000 cd/m<sup>2</sup>  
G09 – 400 cd/m<sup>2</sup>  
G10C – 450 cd/m<sup>2</sup>  
G10R – 400 cd/m<sup>2</sup>  
G10S – 1500 cd/m<sup>2</sup>  
G12 – 400 cd/m<sup>2</sup>  
G15 – 400 cd/m<sup>2</sup>  
Backlight\*:  
G07 – 50,000 HR TYP.  
G09 – 70,000 HR TYP.  
G10C – 70,000 HR TYP.  
G10R – 70,000 HR TYP.  
G10S – 35,000 HR TYP.  
G12 – 70,000 HR TYP.  
G15 – 70,000 HR TYP.  
Touchscreen: Resistive analog

## POWER

24 VDC ± 20%  
Typical Power:  
G07C – 9 W  
G07S – 10 W  
G09 – 13 W  
G10C/R – 12 W  
G10S – 18 W  
G12 – 16 W  
G15 – 20 W

Maximum Power:  
G07C – 16 W  
G07S – 17 W  
G09 – 20 W  
G10C/R – 19 W  
G10S – 24 W  
G12 – 23 W  
G15 – 27 W  
With Modules:  
G07C – 37 W  
G07S – 38 W  
G09 – 45 W  
G10C/R – 48 W  
G10S – 53 W  
G12 – 56 W  
G15 – 60 W

Must use a Class 2 circuit according to National Electrical Code (NEC), NFPA-70 or Canadian Electrical Code (CEC), Part I, C22.1 or a Limited Power Supply (LPS) according to IEC 60950-1 or Limited-energy circuit according to IEC 61010-1.  
Power connection via removable three position terminal block.  
Battery: Lithium coin cell. Typical lifetime of 10 years.

## POWER CONNECTION

High compression cage-clamp terminal block  
Wire Strip Length: 0.3" (7.5 mm)  
Wire Gauge Capacity: One 14 AWG (2.55 mm) solid, two 18 AWG (1.02 mm) or four 20 AWG (0.61 mm)

## CERTIFIED

Product Safety:  
UL Safety - Class I, Division 2, Groups A, B, C, D, Class II, Division 2, Groups F and G, Class III Hazardous Locations certificate number #E317425  
CE Approved: EN 61326-1 Immunity to Industrial Locations, Emission CISPR 11 Class A, IEC/EN 61010-1, RoHS Compliant  
Type 4X Outdoor Enclosure rating, UL50 (Face only)  
IP66 Enclosure rating (Face only)  
IP20 Enclosure rating (Rear of unit)

## ENVIRONMENTAL

Operating Temperature Range: -20 to 60 °C  
Storage Temperature Range: -20 to 70 °C  
Vibration to IEC 68-2-6: Operational 5-500 Hz, 4 g (7" model see lit)  
Shock to IEC 68-2-27: Operational 40 g  
Operating and Storage Humidity: 0 to 85% max. RH non-condensing  
Altitude: Up to 2000 meters

## MECHANICAL

Construction: Cast aluminum enclosure with NEMA 4X/IP66 rating for indoor/outdoor use when correctly fitted with the gasket provided. Installation Category II, Pollution Degree 2.  
Weight:  
G07 – 2.26 lb. (1.03 Kg)  
G09 – 3.39 lb. (1.54 Kg)  
G10 – 4.80 lb. (2.18 Kg)  
G12 – 5.06 lb. (2.29 Kg)  
G15 – 7.73 lb. (3.50 Kg)

# ▶▶▶ Graphite Dimensions *In Inches (mm)*

**G07**

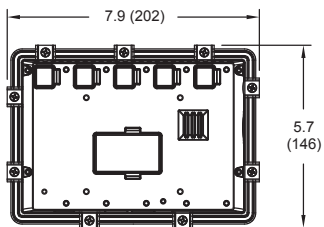
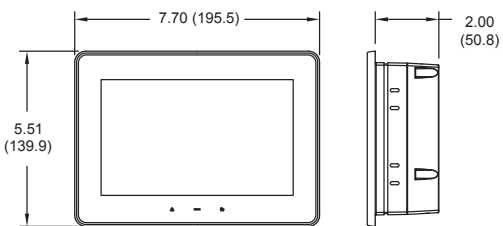

(MOUNTING CLIPS INSTALLED)

**G12**

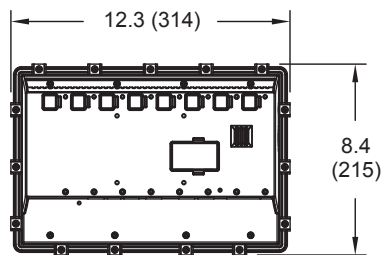
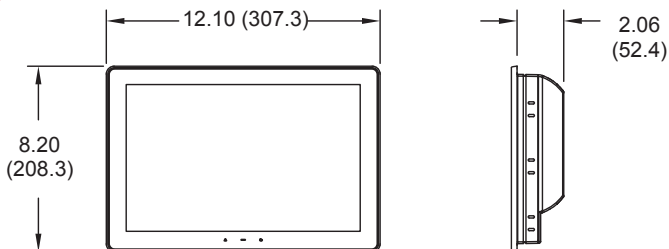

(MOUNTING CLIPS INSTALLED)

**G09**

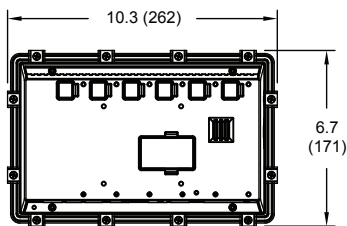
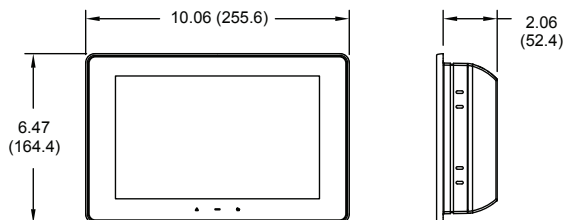

(MOUNTING CLIPS INSTALLED)

**G15**

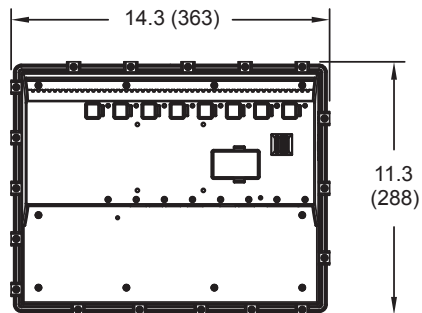
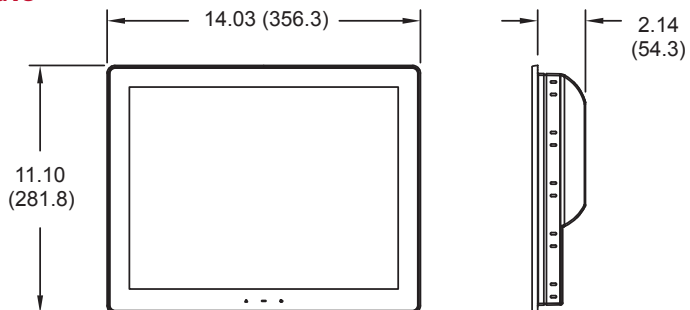

(MOUNTING CLIPS INSTALLED)

**G10**

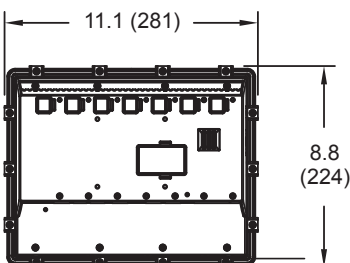
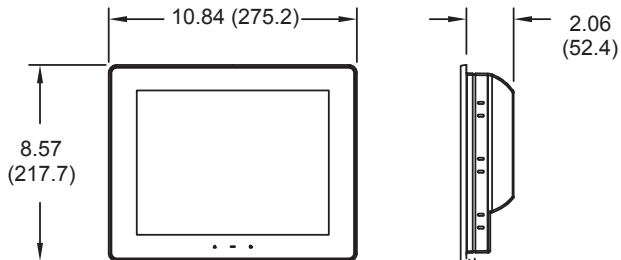

(MOUNTING CLIPS INSTALLED)

# ▶▶▶ Graphite Ordering Guide

PART NUMBER	DESCRIPTION
G07C0000	7" Operator Interface Terminal for Indoor Use
G07S0000	7" Operator Interface Terminal for Outdoor Use
G09C0000	9" Operator Interface Terminal for Indoor Use
G10C0000	10" Operator Interface Terminal for Indoor Use
G10S0000	10" Operator Interface Terminal for Outdoor Use
G10R0000	10" Operator Interface Terminal, High Resolution Display for Indoor Use
G12C0000	12" Operator Interface Terminal for Indoor Use
G12C1100	12" Operator Interface Terminal with Aux. Ethernet and dual RS485 ports
G15C0000	15" Operator Interface Terminal for Indoor Use
G15C1100	15" Operator Interface Terminal with Aux. Ethernet and dual RS485 ports
GMP1RA00	Graphite Module, Single PID, Relay and Analog Outputs
GMP1RM00	Graphite Module, Single PID, Relay Outputs, Heater Current Monitor
GMP1SA00	Graphite Module, Single PID, SSR and Analog Outputs
GMP1SM00	Graphite Module, Single PID, SSR Outputs, Heater Current Monitor

PART NUMBER	DESCRIPTION
GMP2R000	Graphite Module, Dual PID, Relay Outputs
GMP2RM00	Graphite Module, Dual PID, Relay Outputs and Heater Current Monitor
GMP2S000	Graphite Module, Dual PID, SSR Outputs
GMP2SM00	Graphite Module, Dual PID, SSR Outputs and Heater Current Monitor
GMDIOR00	Graphite Module, Digital I/O, 8 Inputs and 6 Relays Outputs
GMDIOS00	Graphite Module, Digital I/O, 8 Inputs and 6 Solid State Outputs
GMUIN400	Graphite Module, 4 Universal Analog Inputs
GMOUT400	Graphite Module, 4 Analog Outputs
GMINI800	Graphite Module, 8 DC Current Inputs
GMINV800	Graphite Module, 8 DC Voltage Inputs
GMTC8000	Graphite Module, 8 Thermocouple Inputs
GMRTD600	Graphite Module, 6 RTD Inputs
GMCAN000	Graphite Module, CAN Protocol Interface
GMJ19390	Graphite Module, J1939 Protocol Interface

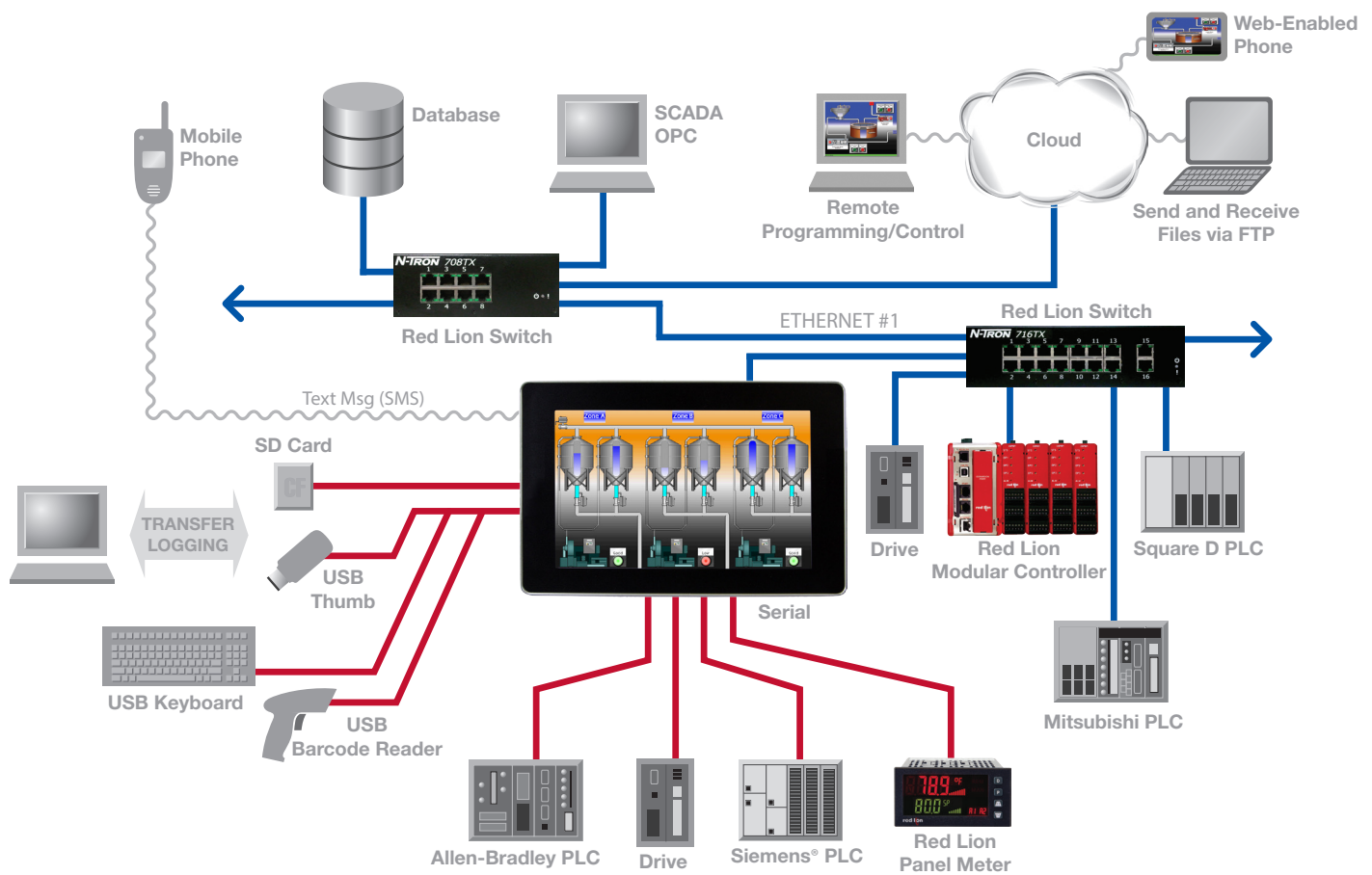

[www.redlion.net](http://www.redlion.net)

Connect. Monitor. Control.

**Americas**  
sales@redlion.net

**Asia-Pacific**  
asia@redlion.net

**Europe**  
**Middle East**  
**Africa**  
europe@redlion.net

+1 (717) 767-6511

As the global experts in communication, monitoring and control for industrial automation and networking, Red Lion has been delivering innovative solutions for over forty years. Our award-winning technology enables companies worldwide to gain real-time data visibility that drives productivity. Product brands include Red Lion, N-Tron and Sixnet. With headquarters in York, Pennsylvania, the company has offices across the Americas, Asia-Pacific and Europe. For more information, please visit [www.redlion.net](http://www.redlion.net). Red Lion is a Spectris company.