

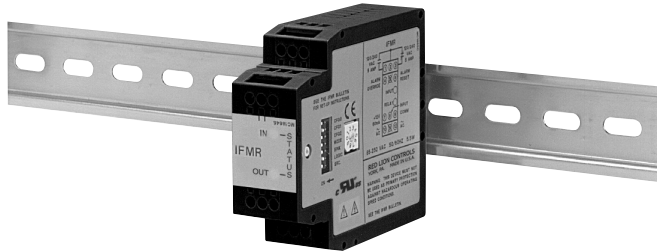

Tel +1 (717) 767-6511
 Fax +1 (717) 764-0839
 www.redlion.net

Bulletin No. IFMR-K
 Drawing No. LP0341
 Released 03/11

MODEL IFMR - DIN-RAIL SPEED SWITCH



- SIMPLE ON-LINE TRIP FREQUENCY SETTING (USING ACTUAL INPUT SIGNAL OR FREQUENCY GENERATOR)
- USER SETTABLE TRIP FREQUENCY FROM 0.1 Hz to 25 KHz
- OVER-SPEED, UNDER-SPEED, AND ZERO-SPEED DETECTION
- RELAY LATCHING, ALARM OVERRIDE, AND ALARM RESET FUNCTIONS
- PROGRAMMABLE INPUT CIRCUIT ACCEPTS OUTPUTS FROM A VARIETY OF SENSORS
- HYSTERESIS AND OFFSET FUNCTIONS AVAILABLE
- 85 to 250 VAC and 9 to 32 VDC VERSIONS AVAILABLE
- INPUT AND RELAY STATUS INDICATION LED'S



UL Recognized Component,
 File # E137808

DESCRIPTION

The Model IFMR accepts a frequency input, and controls a single relay (SPDT) based on the value of the input frequency. The Trip frequency can be set to any value from 0.1 Hz to 25 KHz. The IFMR can be set to trip on overspeed, or underspeed (including zero speed). Offset and hysteresis values can be incorporated into the trip setting to eliminate output chatter. LED indicators for both the Input signal and the Relay status are provided. Two separate input connections for external push-buttons are also provided. One external input overrides the trip detection function, and holds the relay in the release state as long as the input is pulled to common. The other external input clears a latched trip condition when pulled to common.

The IFMR utilizes a seven position DIP switch, a rotary switch, a push-button and two indication LEDs to accomplish input circuit configuration, operational parameter set-up, input signal, and relay status indication. The input circuitry is DIP switch selectable for a variety of sources.

The indication LEDs are used during normal operation to display the input signal and relay status of the IFMR. These LEDs are also used to provide visual feedback to the user of the current parameter settings during parameter set-up.

The IFMR operates in one of six output modes, as selected by the user. The programmable Minimum Response Time provides optimum response vs. input filtering for any input frequency. The offset and hysteresis settings provide flexible adjustment of the relay trip and release points.

The unit is equipped with a universal mounting foot for attachment to standard DIN style mounting rails, including top hat profile rail according to EN 50 022 - 35 x 7.5 and 35 x 15, and G profile rail according to EN 50 035 - G32.

SAFETY SUMMARY

All safety related regulations, local codes and instructions that appear in the manual or on equipment must be observed to ensure personal safety and to prevent damage to either the instrument or equipment connected to it. If equipment is used in a manner not specified by the manufacturer, the protection provided by the equipment may be impaired.



WARNING: SPEED SWITCHES MUST NEVER BE USED AS PRIMARY PROTECTION AGAINST HAZARDOUS OPERATING CONDITIONS. Machinery must first be made safe by inherent design, or the installation of guards, shields, or other devices to protect personnel in the event of a hazardous machine speed condition. The speed switch may be installed to help prevent the machine from entering the unsafe speed.

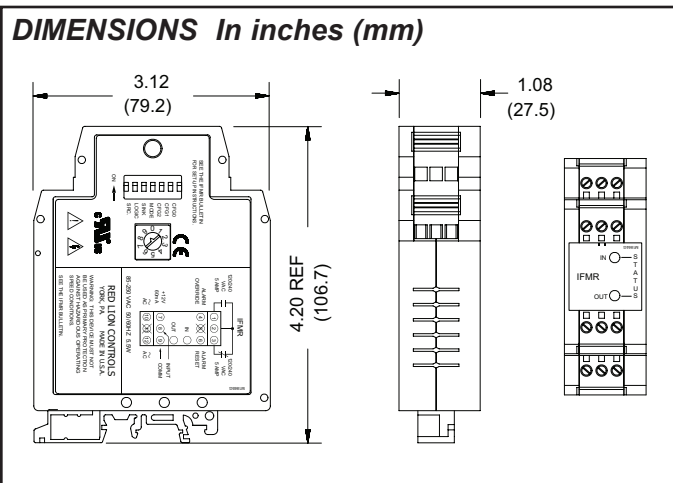

SPECIFICATIONS

- POWER:**
AC Powered Versions: 85 to 250 VAC; 48 to 62 Hz; 5.5 VA
DC Powered Versions: 9 to 32 VDC; 2.0 W
Power Up Current: $I_p = 600$ mA for 50 msec max.
- SENSOR POWER:** (AC version only) +12 VDC $\pm 25\%$ @ 60 mA max.
- OPERATING FREQUENCY RANGE:** 0 Hz to 25 KHz
- SIGNAL INPUT:** DIP switch selectable to accept signals from a variety of sources, including switch contacts, outputs from CMOS or TTL circuits, magnetic pickups, and all standard RLC sensors.
Current Sourcing: Internal 1 K Ω pull-down resistor for sensors with current sourcing output. (Max. sensor output current = 24 mA @ 24 V output.)
Current Sinking: Internal 3.9 K Ω pull-up resistor for sensors with current sinking output. (Max. sensor current = 3 mA.)
Low Bias: Input trigger levels $V_{IL} = 0.25$ V, $V_{IH} = 0.75$ V; for increased sensitivity when used with magnetic pickups.
Hi Bias: Input trigger levels $V_{IL} = 2.5$ V, $V_{IH} = 3.0$ V; for logic level signals.
Max. Input Signal: ± 90 V; 2.75 mA max. (with both Current Sourcing and Current Sinking resistors switched off).

ORDERING INFORMATION

MODEL NO.	DESCRIPTION	PART NUMBERS FOR AVAILABLE SUPPLY VOLTAGES	
		9 to 32 VDC	85 to 250 VAC
IFMR	Speed Switch	IFMR0036	IFMR0066

CAUTION: Risk of Danger.
 Read complete instructions prior to installation and operation of the unit.

CAUTION: Risk of electric shock.

SPECIFICATIONS (Cont'd)

- 5. **CONTROL INPUTS:** Active low ($V_{IL} = 0.5 V$ max.) internally pulled up to 5 VDC through a 100 K Ω resistor ($I_{SNK} = 50 \mu A$). Response Time = 1 msec.
Alarm Reset: Unlatches the relay when pulled to common while the input frequency is in the release region.
Alarm Override: Causes the IFMR to unconditionally release the relay when pulled to common.
- 6. **RELAY CONTACT OUTPUT:** FORM "C" (SPDT) contacts max. rating. 5 A @ 120/240 VAC or 28 VDC (resistive load), 1/8 H.P. @ 120 VAC (inductive load). The operate time is 5 msec nominal and the release time is 3 msec nominal.
- 7. **RELAY LIFE EXPECTANCY:** 100,000 cycles at max. rating. (As load level decreases, life expectancy increases.)
- 8. **ACCURACY:** $\pm 0.1\%$ of the trip frequency setting.
- 9. **INPUT IMPEDANCE:** 33 K Ω min. with the sink and source DIP switches in the OFF positions. (See Block Diagram)
- 10. **MINIMUM RESPONSE TIME:** From 5 msec. +1 period to 10 sec. +1 period in ten steps (excluding relay operate time).
- 11. **HYSTERESIS AND OFFSET:** From 0.25% to 33.33% of Trip Frequency in nine steps. Hysteresis and/or Offset can also be set to 0 (Disabled).
- 12. **INPUT AND POWER CONNECTIONS:** Screw in terminal blocks
- 13. **ISOLATION BREAKDOWN VOLTAGE (Dielectric Withstand):** 2200 V between power & input, and power & output; 500 V between input & output for 1 minute.
- 14. **CERTIFICATIONS AND COMPLIANCES:**

SAFETY

UL Recognized Component, File #E137808, UL508, CSA 22.2 No. 14 Recognized to U.S. and Canadian requirements under the Component Recognition Program of Underwriters Laboratories, Inc.
 IECCE CB Scheme Test Report # 97ME50135-042297
 Issued by Underwriters Laboratories, Inc.
 IEC 61010-1, EN 61010-1: Safety requirements for electrical equipment for measurement, control, and laboratory use, Part 1.

ELECTROMAGNETIC COMPATIBILITY

Immunity to EN 50082-2

Electrostatic discharge	EN 61000-4-2	Level 2; 4 Kv contact Level 3; 8 Kv air
Electromagnetic RF fields	EN 61000-4-3	Level 3; 10 V/m ² 80 MHz - 1 GHz
Fast transients (burst)	EN 61000-4-4	Level 4; 2 Kv I/O Level 3; 2 Kv power
RF conducted interference	EN 61000-4-6	Level 3; 10 V/rms 150 KHz - 80 MHz
Power frequency magnetic fields	EN 61000-4-8	Level 4; 30 A/m

Emissions to EN 50081-2

RF interference	EN 55011	Enclosure class A Power mains class A
-----------------	----------	--

Notes:

- 1. This device was designed for installation in an enclosure. To avoid electrostatic discharge, precautions should be taken when the device is mounted outside an enclosure. When working in an enclosure (ex. making adjustments, setting switches, etc.) typical anti-static precautions should be observed before touching the unit.
- 2. For operation without loss of performance:
 Unit is mounted on a rail in a metal enclosure (Buckeye SM7013-0 or equivalent) and I/O cables are routed in metal conduit connected to earth ground.
 Refer to the EMC Installation Guidelines section of this bulletin for additional information.
- 15. **ENVIRONMENTAL CONDITIONS:**
Operating Temperature: 0 to 50°C
Storage Temperature: -40 to 80°C
Operating and Storage Humidity: 85% max. (non-condensing) from 0°C to 50°C.
Vibration according to IEC 68-2-6: Operational 5 to 150 Hz in X, Y, Z direction for 1.5 hours, 2 g.
Shock according to IEC 68-2-27: Operational 30 g (10 g relay), 11 msec in 3 directions.
Altitude: Up to 2000 meters
- 16. **CONSTRUCTION:** Case body is black, high impact plastic. Installation Category II, Pollution Degree 2
- 17. **WEIGHT:** 6 oz. (0.17 Kg)

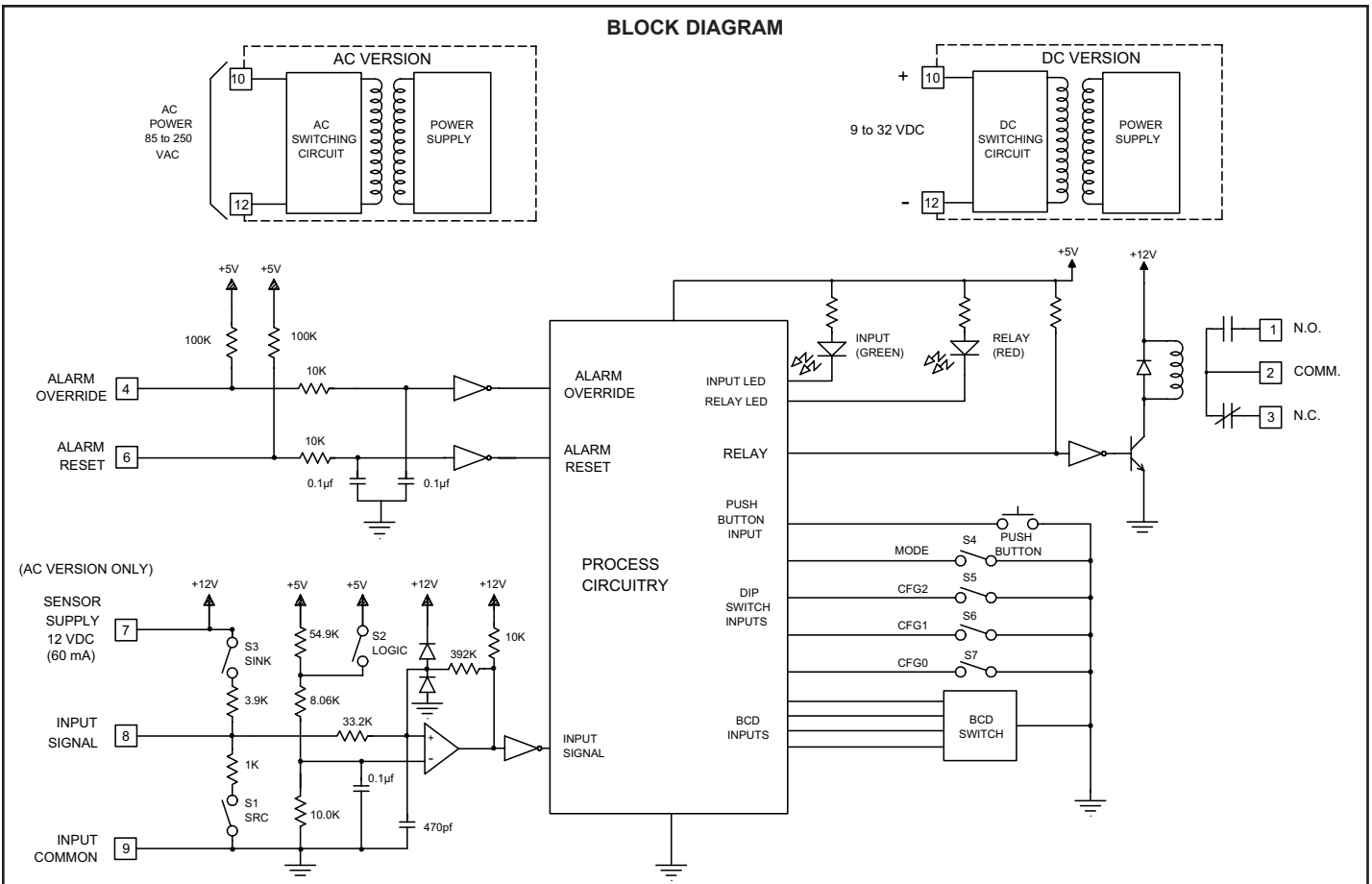

OVERVIEW

The Model IFMR continuously monitors the input signal and controls an output relay based on the frequency of the input signal, the chosen Operation Mode (Underspeed or Overspeed), and the Trip and Release points the user has selected. The green Input LED blinks at the rate of the input frequency. At about 100 Hz, the Input LED will appear to be solid on. At very low frequencies, the Input LED blinks slowly and may also appear to be solid on. A loss of signal may also cause the Input LED to remain on, depending on the DIP switch set-up. In this case, the red Relay LED also turns on. The IFMR indicates the status of the relay with the Relay LED (Red). Whenever the relay is in the Trip state, the IFMR turns ON the Relay LED. In the Release state, the Relay LED is OFF.

For Overspeed detection, when the input frequency (averaged over the Minimum Response Time) exceeds the Trip point, the IFMR trips the relay. With the relay in the Trip condition, the input frequency must fall below the Release point for the relay to release.

For Underspeed detection, the relay trips when the input frequency (averaged over the Minimum Response Time) falls below the Trip point. The relay releases only after the input frequency has exceeded the Release point. Two of the Underspeed operating modes allow the machine or system that supplies the input signal to reach normal operating speed before the IFMR responds to an Underspeed condition. For Zero Speed applications, bear in mind that Zero Speed detection and Underspeed detection are identical.

The Minimum Response Time parameter sets the minimum update time of the output. The actual response time is the Minimum Response Time plus up to one full period of the input signal. The IFMR counts the negative edges occurring during the update time period, and computes the average frequency value for that time. This action filters out any high frequency jitter that may be present in the input signal. The longer the Minimum Response Time, the more filtering occurs.

The Offset value is added to the Trip Frequency to determine the Trip Point for Overspeed operation. For Underspeed operation the Trip point becomes the Trip Frequency minus the Offset value.

If No Hysteresis has been selected, the Trip and Release points are identical, which can lead to cycling or “chattering” of the relay at input frequencies hovering around the Trip point. If Hysteresis is selected, the Release point is set to the Trip point (including Offset) minus the Hysteresis value for Overspeed detection. For Underspeed detection, the Release point is set to the Trip point (including Offset) plus the Hysteresis value.

Two input pins (Alarm Override and Alarm Reset) are provided for the optional connection of push-buttons. The Alarm Override pin causes the IFMR to unconditionally Release the relay, regardless of the input frequency, or the state of the relay, when pulled to common. When the Alarm Override pin is released from common, the operation of the IFMR returns to normal, and the status of the relay is updated based on the input frequency.

The Alarm Reset pin is only active when the IFMR is in one of the Latch operation modes. With the Latch function selected, the relay “latches” into the Trip state whenever a Trip condition is detected. The relay remains latched until the Alarm Reset pin is pulled to common while the input frequency is in the Release region. The Alarm Reset pin is ignored while the input frequency is in the Trip region.

EMC INSTALLATION GUIDELINES

Although this unit is designed with a high degree of immunity to ElectroMagnetic Interference (EMI), proper installation and wiring methods must be followed to ensure compatibility in each application. The type of the electrical noise, source or coupling method into the unit may be different for various installations. The unit becomes more immune to EMI with fewer I/O connections. Cable length, routing, and shield termination are very important and can mean the difference between a successful installation or a troublesome installation.

Listed below are some EMC guidelines for successful installation in an industrial environment.

1. Use shielded (screened) cables for all Signal and Control inputs. The shield (screen) pigtail connection should be made as short as possible. The connection point for the shield depends somewhat upon the application.

Listed below are the recommended methods of connecting the shield, in order of their effectiveness.

- a. Connect the shield only at the rail where the unit is mounted to earth ground (protective earth).
 - b. Connect the shield to earth ground at both ends of the cable, usually when the noise source frequency is above 1 MHz.
 - c. Connect the shield to common of the unit and leave the other end of the shield unconnected and insulated from earth ground.
2. Never run Signal or Control cables in the same conduit or raceway with AC power lines, conductors feeding motors, solenoids, SCR controls, and heaters, etc. The cables should be run in metal conduit that is properly grounded. This is especially useful in applications where cable runs are long and portable two-way radios are used in close proximity or if the installation is near a commercial radio transmitter.
 3. Signal or Control cables within an enclosure should be routed as far away as possible from contactors, control relays, transformers, and other noisy components.
 4. In very electrically noisy environments, the use of external EMI suppression devices, such as ferrite suppression cores, is effective. Install them on Signal and Control cables as close to the unit as possible. Loop the cable through the core several times or use multiple cores on each cable for additional protection. Install line filters on the power input cable to the unit to suppress power line interference. Install them near the power entry point of the enclosure. The following EMI suppression devices (or equivalent) are recommended:
 - Ferrite Suppression Cores for signal and control cables:
 - Fair-Rite # 0443167251 (RLC #FCOR0000)
 - TDK # ZCAT3035-1330A
 - Steward #28B2029-0A0
 - Line Filters for input power cables:
 - Schaffner # FN610-1/07 (RLC #LFIL0000)
 - Schaffner # FN670-1.8/07
 - Corcom #1VR3

Note: Reference manufacturer’s instructions when installing a line filter.
 5. Long cable runs are more susceptible to EMI pickup than short cable runs. Therefore, keep cable runs as short as possible.

WIRING CONNECTIONS

All conductors should meet voltage and current ratings for each terminal. Also cabling should conform to appropriate standards of good installation, local codes and regulations. It is recommended that power supplied to the unit (AC or DC) be protected by a fuse or circuit breaker.

POWER AND OUTPUT CONNECTIONS

AC Power

Primary power is connected to terminals 10 and 12 (labeled AC). For best results, the AC Power should be relatively “clean” and within the specified variation limits. Drawing power from heavily loaded circuits or from circuits that also power loads that cycle on and off, should be avoided.

DC Power

The DC power is connected to Terminals 10 and 12. The DC plus (+) is connected to Terminal 10 and the minus (-) is connected to Terminal 12. It is recommended that separate supplies be used for sensor power and unit power. Using the same supply for both will negate isolation between input and power.

Output Wiring

Terminals 1, 2, and 3 are used to connect to the relay output. Terminal 1 is the normally open contact. Terminal 3 is the normally closed contact, and Terminal 2 is the output relay common.

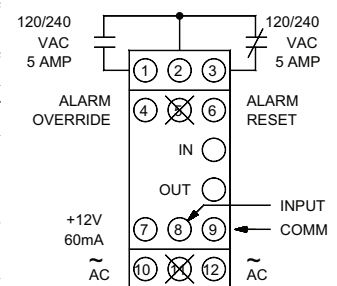

INPUT CIRCUITS, SENSOR CONNECTIONS AND CONFIGURATION SWITCH SET-UP

The Model IFMR Speed Switch uses a comparator amplifier connected as a Schmidt trigger circuit to convert the input wave form into the pulse form required for proper circuit operation. Three set-up switches are used to configure the input circuit to accept signals from a wide variety of sources, as follows:

S1 - ON: Connects a 1 KΩ pull-down resistor for sensors with sourcing outputs. (Maximum sensor output current is 24 mA @ 24 VDC output.)

S2 - ON: For logic level signals, sets the input bias levels to $V_{IL} = 2.5 V$, $V_{IH} = 3.0 V$.

OFF: For increased sensitivity when used with magnetic pickups, sets the input bias levels to $V_{IL} = 0.25 V$, $V_{IH} = 0.75 V$.

S3 - ON: Connects a 3.9 KΩ pull-up resistor for sensors with current sinking output. (Max. sensor current = 3 mA.)

CONNECTIONS & CONFIGURATION SWITCH SET-UP FOR VARIOUS SENSOR OUTPUTS

Note: Separate power supplies must be used for sensor power and input power to maintain the isolation breakdown voltage specification. If isolation between power and input is not needed, then a single supply can be used for both unit and sensor power.

<p>MAGNETIC PICKUPS</p> <p>RECOMMENDED RULES FOR MAGNETIC PICKUP CONNECTIONS</p> <p>1. Connect the shield to the common Terminal "9" at the input of the IFMR. DO NOT connect the shield at the pickup end. Leave the shield "open" at the pickup and insulate the exposed shield to prevent electrical contact with the frame or case. (Shielded cable, supplied on some RLC magnetic pickups, has open shield on pickup end.)</p>	<p>SENSORS WITH CURRENT SINK OUTPUT (NPN O.C.)</p> <div style="display: flex;"> <div style="flex: 1;"> <p>AC VERSION</p> </div> <div style="flex: 1;"> <p>DC VERSION</p> </div> </div> <p>RLC SENSOR MODELS: ASTC, LMPC, PSAC, ZCG, ZFG, ZGG, ZHG, ZBG</p> <p>*Check sensor power requirements before wiring.</p>
<p>2-WIRE PROXIMITY SENSORS</p> <div style="display: flex;"> <div style="flex: 1;"> <p>AC VERSION</p> </div> <div style="flex: 1;"> <p>DC VERSION</p> </div> </div> <p>*Check sensor power requirements before wiring.</p>	<p>SENSORS WITH CURRENT SOURCE OUTPUT (PNP O.C.)</p> <div style="display: flex;"> <div style="flex: 1;"> <p>AC VERSION</p> </div> <div style="flex: 1;"> <p>DC VERSION</p> </div> </div> <p>*Check sensor power requirements before wiring.</p>
<p>OLDER STYLE RLC SENSORS WITH -EF OUTPUT</p> <div style="display: flex;"> <div style="flex: 1;"> <p>AC VERSION</p> </div> <div style="flex: 1;"> <p>DC VERSION</p> </div> </div> <p>*Check sensor power requirements before wiring.</p>	<p>SWITCH CONTACT INPUT</p> <div style="display: flex;"> <div style="flex: 1;"> <p>AC VERSION</p> </div> <div style="flex: 1;"> <p>DC VERSION</p> </div> </div> <p>*Check sensor power requirements before wiring.</p>
<p>INPUT FROM CMOS OR TTL</p>	

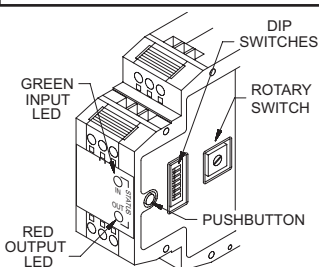

CONFIGURING THE IFMR

Upon entry to a set-up parameter, the Input LED blinks the current numerical value of a setting at a 1 Hz rate. A setting of "1" is indicated by one blink (½ sec on, ½ sec off), through a setting of "9", which is indicated by nine blinks. A setting of "0" is indicated by a single short flash (40 msec on, 1 sec off). After the entire value is indicated, the IFMR pauses two seconds and repeats the value.

During entry of a new value, if the Mode switch (S4) or any of the CFG DIP switch positions are changed before the push button is pressed, the IFMR aborts the entry process and retains the previous setting.

To begin set-up, place DIP switch 4 to the on (up) position. DIP switches 5, 6, and 7 access unit configuration settings.

Note: To return to normal operation, place DIP switch 4 in the down (RUN) position.

() Indicates Configuration Section

DIP SWITCH	DESCRIPTION	SECTION
	Operating Mode	(1.0)
	Set Trip Frequency Using an Input Signal or Frequency Generator	(2.0)
	Set Trip Frequency Using the Rotary Switch	(3.0)
	Set Minimum Response Time	(4.0)
	Set Relay Trip Point	(5.0)
	Set Relay Release Point	(6.0)

RELAY INDICATION

Overspeed: The Relay LED (red) turns on to indicate the input signal has exceeded the trip frequency.

Underspeed: The Relay LED (red) turns on to indicate the input signal is below the trip frequency setting.

Invalid Entry during Set-up: The Input LED (green) and the Relay LED (red) alternately blink until a valid entry is made.

FACTORY SETTINGS		
	Setting	Parameter
Operating Mode	1	Low Speed Operation, Trip on Overspeed
Trip Frequency	10000	10 KHz
Minimum Response	0	5 msec
Trip Point Offset	0	None
Trip Point Hysteresis	1	0.25%

1.0 Operating Mode

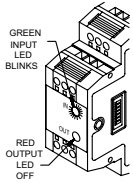

Step 1.2

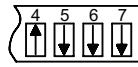

Step 1.1

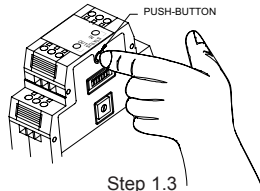

Step 1.3

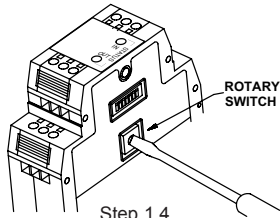

Step 1.4



Setting '2' Selected

- Place DIP switch 4 to the ON (up) position and DIP switches 5, 6, and 7 as shown.
- Green input LED blinks the setting corresponding to the Operating Mode shown below, pauses and repeats the value.

Setting	Operating Mode
1	OVERSPEED trip, automatic Release upon return to normal
2	OVERSPEED latched trip, Release only after ALM Reset pulled to Common
3	UNDERSPEED trip, automatic Release upon return to normal
4	UNDERSPEED trip, start-up condition* ignored, automatic Release upon return to normal
5	UNDERSPEED latched trip, Release only after ALM Reset pulled to Common
6	UNDERSPEED latched trip, start-up condition* ignored, Release only after ALM Reset pulled to Common

* Refers to initial application of power to the IFMR, not the input frequency.

◆ *If existing operating mode setting is your desired requirement, this section is complete*. Otherwise, continue with Step 1.3.*

- Press the push-button. The Green input LED blinks rapidly to indicate the Operating mode setting is now accessed.

- Turn the rotary switch to the selected numerical value for output desired (see the list in Step 1.2).

- Press the push-button. The Green input LED blinks the value entered, pauses, and repeats the new operation setting.

◆ *If the new Operating mode setting is acceptable, this section is complete*.*

◆ *If the new Operating mode setting is not the desired setting, repeat Steps 1.3, 1.4, and 1.5.*

◆ *If Red output LED blinks, the rotary switch numerical value is invalid. Repeat Steps 1.4 and 1.5.*

* Section complete; place DIP switch 4 to the down position for normal operation, or change DIP switches 5, 6, and 7 for the next Configuration Section.

2.0 On-Line Trip Frequency Setting Using Actual Input Signal or Frequency Generator

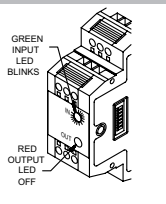

Step 2.2

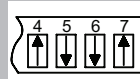

Step 2.1

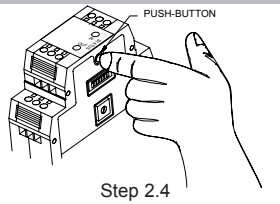

Step 2.4

- Place DIP switch 4 to the ON position and DIP switches 5, 6, and 7 as shown.

- Green input LED blinks the existing Trip Frequency setting as shown in the examples below. Six full digits of numerical information blink with a 2 sec. pause between digits and a 4 sec. pause at the end, before repeating. The first five digits are the existing Trip Frequency magnitude. The sixth digit is the frequency resolution (the number of digits to the right of the decimal point).

Factory Setting Example

1 blink	1	Frequency setting
2 sec pause		
single flash	0	
2 sec pause		
single flash	0	
2 sec pause		Resolution
single flash	0	
2 sec pause		
single flash	0	
4 sec pause		
Frequency	Resolution	
1 0 0 0 0	0	
Result: 10,000 Hz		

Additional Example

2 blinks	2	Frequency setting
2 sec pause		
5 blinks	5	
2 sec pause		
single flash	0	
2 sec pause		Resolution
5 blinks	5	
2 sec pause		
single flash	0	
2 sec pause		
2 blinks	2	
4 sec pause		
Frequency	Resolution	
2 5 0 5 0	2	
Result: 250.50 Hz		

◆ *If existing Trip Frequency setting is your desired requirement, this section is complete*. Otherwise, continue with Step 2.3.*

- Apply the desired Trip Frequency to the signal input pin.

- Press the push-button. The Green input LED blinks rapidly. The acquisition process takes two seconds plus one period of the input signal.

◆ *If the new Trip Frequency setting is valid, the Green input LED turns on solid. Continue to Step 2.5.*

◆ *If Red relay LED blinks, the new Trip Frequency is invalid, outside the acceptable 0.1 Hz to 25 KHz range. Repeat Steps 2.3 and 2.4.*

- Press the push-button. The Green input LED blinks the new Trip Frequency setting. This section is complete*.

◆ *To verify Trip Frequency setting, see Step 2.2.*

* Section complete; place DIP switch 4 to the down position for normal operation, or change DIP switches 5, 6, and 7 for the next Configuration Section.

PREFERRED METHOD

3.0 Set Trip Frequency Using The Rotary Switch

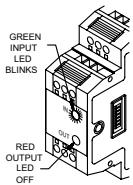

Step 3.2

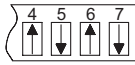

Step 3.1

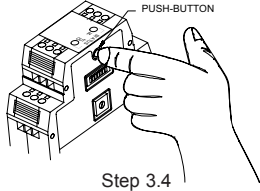

Step 3.4

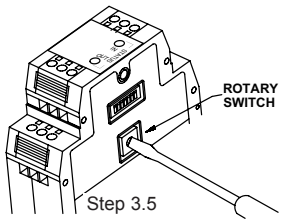

Step 3.5



Setting '2' Selected

ALTERNATIVE METHOD IF INPUT SIGNAL IS NOT AVAILABLE

- 3.1 Place DIP switch 4 to the ON position and DIP switches 5, 6, and 7 as shown.
- 3.2 The Green input LED blinks the existing Trip Frequency setting, pauses and repeats. Six full digits of numerical information blink with a 2 sec. pause between digits and a 4 sec. pause at the end, before repeating. The first five digits are the existing Trip Frequency magnitude. The sixth digit is the frequency resolution (the number of digits to the right of the decimal point).

◆ *If the existing Trip Frequency setting is your desired requirement, this section is complete*. Otherwise, continue with Step 3.3.*

- 3.3 Determine the Trip Frequency and record in the space provided below.

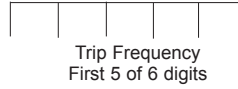

Example: 95.5 Hz

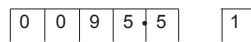
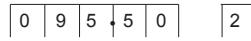
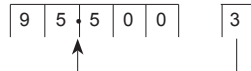

Example: 15,500 Hz

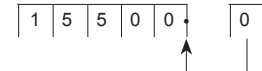

- 3.4 Press the push-button. The Green input LED blinks rapidly. Trip Frequency setting is now accessed.
- 3.5 Turn the rotary switch to the first selected numerical value. Press the push-button. The Green input LED continues to blink rapidly. First of six numerical digits is entered.
- 3.6 Turn the rotary switch to the second selected numerical value. Press the push-button. The Green input LED continues to blink rapidly. Second of six numerical digits is entered.
- 3.7 Repeat Step 3.6 three more times then go to Step 3.8. This enters a total of five of the required six numerical digits.
- 3.8 Turn the rotary switch to the selected numerical value for resolution requirement. Press the push-button. The Green input LED blinks the new Trip Frequency setting (as described in Step 2.2), pauses, and repeats the value.

Ferrite Suppression Cores for signal and control cables:

- ◆ *If the new Trip Frequency setting is acceptable, this section is complete*.*
- ◆ *If the new Trip Frequency setting is not the desired setting, repeat Steps 3.4, through 3.8.*
- ◆ *If the Red relay LED blinks, the numerical value entered is invalid. Repeat Steps 3.3 through 3.8.*

* Section complete; place DIP switch 4 to the down position for normal operation, or change DIP switches 5, 6, and 7 for the next Configuration Section.

4.0 Set Minimum Response Time

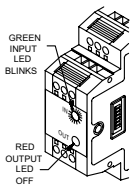

Step 4.2

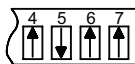

Step 4.1

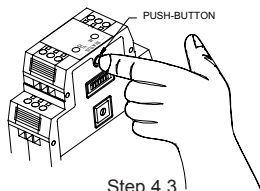

Step 4.3

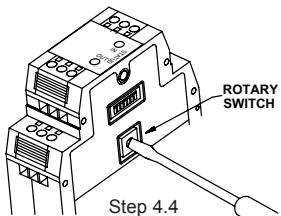

Step 4.4



Setting '2' Selected

- 4.1 Place DIP switch 4 to the ON position and DIP switches 5, 6, and 7 as shown.
- 4.2 The Green input LED blinks the existing Minimum Response Time setting (see following list), pauses and repeats.

Setting	Time
0	5 msec
1	10 msec
2	20 msec
3	50 msec
4	100 msec

Setting	Time
5	200 msec
6	500 msec
7	1 sec
8	5 sec (not valid for trip frequency > 3906 Hz)
9	10 sec (not valid for trip frequency > 3906 Hz)

Note: Minimum Response Times do not include the relay's operate response time of 5 msec., or the release response time of 3 msec.

- 4.3 Press the push-button. The Green input LED blinks rapidly. Minimum Response Time setting is now accessed.
- 4.4 Turn the rotary switch to the selected numerical value for Minimum Response Time desired (see list in Step 4.2).
- 4.5 Press the push-button. The Green input LED blinks the value entered, pauses, and repeats the new setting.

- ◆ *If the new Minimum Response Time setting is acceptable, this section is complete*.*
- ◆ *If the new Minimum Response Time setting is not the desired setting, repeat Steps 4.3, 4.4, and 4.5.*
- ◆ *If the Red relay LED blinks, the rotary switch numerical value is invalid. Repeat Steps 4.4 and 4.5.*

* Section complete; place DIP switch 4 to the down position for normal operation, or change DIP switches 5, 6, and 7 for the next Configuration Section.

5.0 Set Relay Trip Point (Offset)

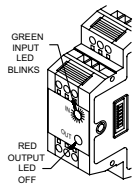

Step 5.2

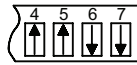

Step 5.1

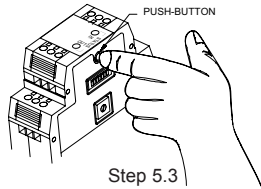

Step 5.3

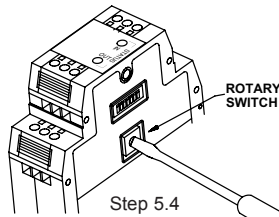

Step 5.4



Setting '9' Selected

For Overspeed operation, the Relay Trip point is internally set to the Trip Frequency plus the Offset value. For Underspeed operation, the Relay Trip point is internally set to the Trip Frequency minus the Offset value. The Offset value is equal to the Trip Frequency multiplied by the selected Offset percentage.

Example: The Offset value is calculated as shown below.

Trip Frequency = 250 Hz
 Rotary Switch Setting = 4 (2.00%)
 Offset Value = 250 Hz x 2.00% (0.02) = 5 Hz

Trip Point:
 OVERSPEED = 250 + 5 = 255 Hz
 UNDERSPEED = 250 - 5 = 245 Hz

5.1 Place DIP switch 4 to the ON position and DIP switches 5, 6, and 7 as shown.

5.2 The Green input LED blinks the existing setting (see following list), pauses and repeats.

Setting	Percentage
0	0.00% (NO Offset)
1	0.25% (0.0025)
2	0.50% (0.0050)
3	1.00% (0.0100)
4	2.00% (0.0200)
5	5.00% (0.0500)
6	10.00% (0.1000)
7	20.00% (0.2000)
8	25.00% (0.2500)
9	33.33% (0.3333)

5.3 Press the push-button. The Green input LED blinks rapidly. Trip Point Offset setting is now accessed.

5.4 Turn the rotary switch to the selected numerical value for Trip Point Offset desired (see list in Step 5.2).

5.5 Press the push-button. The Green input LED blinks the value entered, pauses, and repeats the new setting.

- ◆ If the new Trip Point Offset setting is acceptable, this section is complete*.
- ◆ If the new Trip Point Offset setting is not the desired setting, repeat Steps 5.3, 5.4, and 5.5.
- ◆ If the Red relay LED blinks, the rotary switch numerical value is invalid. Repeat Steps 5.4 and 5.5.

* Section complete; place DIP switch 4 to the down position for normal operation, or change DIP switches 5, 6, and 7 for the next Configuration Section.

6.0 Set Relay Release Point (Hysteresis)

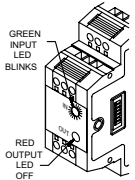

Step 6.2

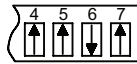

Step 6.1

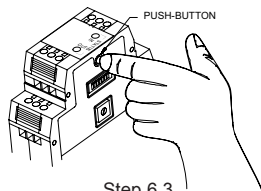

Step 6.3

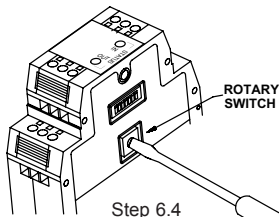

Step 6.4



Setting '9' Selected

For Overspeed operation, the Relay Release point is set to the Relay Trip point minus the Hysteresis value. For Underspeed operation, the Relay Release point is set to the Relay Trip point plus the Hysteresis value. The hysteresis value is calculated by multiplying the hysteresis percentage by the current trip frequency. If No Hysteresis (setting = 0) is selected, the Relay Trip and Release points are identical, which can lead to chattering or cycling of the relay at input frequencies hovering around the Relay Trip point.

Example: Using the Trip Frequency and Offset value as shown in the example above, the hysteresis value is calculated as shown below.

Rotary Switch Setting = 3 (1.00%)
 Hysteresis Value = 250 Hz x 1.00% (0.01) = 2.5 Hz

Release Point:
 OVERSPEED = 250 + 5 - 2.5 = 252.5 Hz
 UNDERSPEED = 250 - 5 + 2.5 = 247.5 Hz

6.1 Place DIP switch 4 to the ON position and DIP switches 5, 6, and 7 as shown.

6.2 The Green input LED blinks the existing setting (see following list), pauses, and repeats.

Setting	Percentage
0	0.00% (NO Hysteresis)
1	0.25% (0.0025)
2	0.50% (0.0050)
3	1.00% (0.0100)
4	2.00% (0.0200)
5	5.00% (0.0500)
6	10.00% (0.1000)
7	20.00% (0.2000)
8	25.00% (0.2500)
9	33.33% (0.3333)

6.3 Press the push-button. The Green input LED blinks rapidly. Trip Point Hysteresis setting is now accessed.

6.4 Turn the rotary switch to the selected numerical value for Hysteresis desired (see list in Step 6.2).

6.5 Press the push-button. The Green input LED blinks the value entered, pauses and repeats the new setting.

- ◆ If the new Trip Point Hysteresis setting is acceptable, this section is complete*.
- ◆ If the new Trip Point Hysteresis setting is not the desired setting, repeat Steps 6.3, 6.4, and 6.5.
- ◆ If the Red relay LED blinks, the rotary switch numerical value is invalid. Repeat Steps 6.4 and 6.5.

* Section complete; place DIP switch 4 to the down position for normal operation, or change DIP switches 5, 6, and 7 for the next Configuration Section.

INSTALLATION

The unit is equipped with a universal mounting foot for attachment to standard DIN style mounting rails, including G profile rail according to EN50035 - G32 , and top hat (T) profile rail according to EN50022 - 35 x 7.5 and 35 x 15. The unit should be installed in a location that does not exceed the maximum operating temperature and provides good air circulation. Placing the unit near devices that generate excessive heat should be avoided.

G Rail Installation

To install the IFMR on a "G" style DIN rail, angle the module so that the upper groove of the "foot" catches under the lip of the top rail. Push the module toward the rail until it snaps into place. To remove a module from the rail, push up on the bottom of the module while pulling out away from the rail.

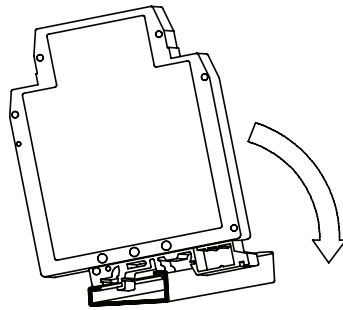

T Rail Installation

To install the IFMR on a "T" style rail, angle the module so that the top groove of the "foot" is located over the lip of the top rail. Push the module toward the rail until it snaps into place. To remove a module from the rail, insert a screwdriver into the slot on the bottom of the "foot", and pry upwards on the module until it releases from the rail.

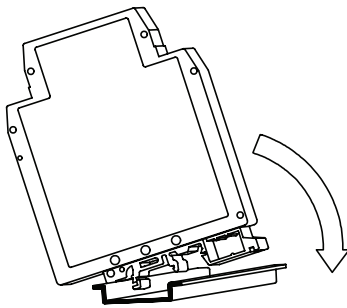

TROUBLESHOOTING

For further technical assistance, contact technical support at the appropriate company numbers listed.

APPLICATION 1

An APLR is connected to an LMPC (logic magnetic pickup) that is sensing the speed of a 60 tooth gear attached to a shaft. The shaft speed should not exceed 2000 RPM.

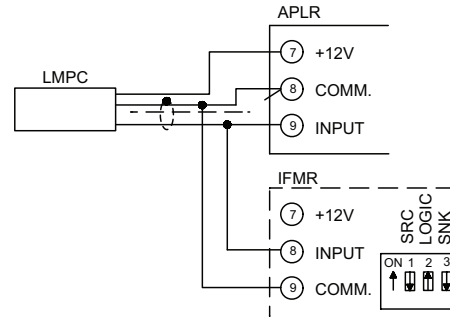

The IFMR is placed in parallel with the APLR to activate an alarm when an overspeed condition is detected, and to turn off the alarm when the speed returns to normal. The Mode of Operation is set for Mode #1 (overspeed trip, automatic release upon return to normal).

To set the value of the alarm, either apply the maximum input signal as described in Section 2.0 or determine the Trip Frequency using the following formula:

$$\text{Trip Freq.} = \frac{\text{units/measure} \times \text{pulses/unit}}{\text{seconds/measure}}$$

$$\text{Trip Freq.} = \frac{2000 \text{ RPM} \times 60 \text{ PPR}}{60 \text{ sec}} = 2000 \text{ Hz}$$

Set the Trip Frequency with the rotary switch for 2000 Hz.

With Trip point Offset set at 0.00% (No Offset) and Trip Point Hysteresis set at 0.25%; activation of the relay occurs at 2000 Hz, and release occurs at 1995 Hz.

APPLICATION 2

The IFMR can be used in a speed monitoring system to detect when the system drops below setpoint.

The IFMR is wired to a PSAC (inductive proximity sensor) that is sensing a key way on the shaft of a motor. The motor is turning at 1750 RPM. When the speed of the motor drops below 1250 RPM, the IFMR latches the output until the user resets the output with an external push button.

The mode of operation of the IFMR is set for 5 (UNDERSPEED Latched trip, release only after Alarm Reset pulled to common). Determine the Trip Frequency using the following formula:

$$\text{Trip Freq.} = \frac{\text{RPM} \times \text{PPR}}{60}$$

$$\text{Trip Freq.} = \frac{1250 \text{ RPM} \times 1 \text{ PPR}}{60 \text{ sec}} = 20.83 \text{ Hz.}$$

Set the Trip Frequency with the rotary switch for 20.83 Hz.

Red Lion Controls
Headquarters
20 Willow Springs Circle
York PA 17406
Tel +1 (717) 767-6511
Fax +1 (717) 764-0839

Red Lion Controls
Europe
Printerweg 10
NL - 3821 AD Amersfoort
Tel +31 (0) 334 723 225
Fax +31 (0) 334 893 793

Red Lion Controls
India
54, Vishvas Tenement
GST Road, New Ranip,
Ahmedabad-382480 Gujarat, India
Tel +91 987 954 0503
Fax +91 79 275 31 350

Red Lion Controls
China
Unit 101, XinAn Plaza
Building 13, No.99 Tianzhou Road
ShangHai, P.R. China 200223
Tel +86 21 6113-3688
Fax +86 21 6113-3683