



PHOTOELECTRIC SENSOR

DIGITAL MARK SENSOR

New

LX-100 SERIES



Introducing the ultimate mark sensor

High resolution A/D converter + Automatic optimal LED selection function



Can detect any mark!



R-G-B light emitting elements all in one

To detect any marking, this unit is equipped with red, green and blue LED light emitting elements all in one.

High precision coaxial reflective optical system

SUNX's unique coaxial reflective optics technology ensures very accurate sensing. The unit is made with a scratchproof glass lens.



MODE NAVI

New Advanced sensor with Visible Indicator

The sensor's basic operations are represented by 6 indicator lamps (MODE NAVI). The user can check what mode the sensor is presently in with a quick glance rendering operation simple.





4-digit digital display

The 4-digit digital display enables numerical sensing control and minute settings.

Operation panel

3 large buttons that click into position making operation easy.

Highest in the industry

12-bit A/D converter

A resolution of 1/4000 is realized to enable high precision mark sensing.

Receiving element

Protection IP67

Washing the machines and production line with water will not affect the sensor thanks to its waterproof construction.

▲ Image schematic

Coaxial reflective optics and a sharp 1×5 mm 0.039×0.197 in spot enable high precision sensing.

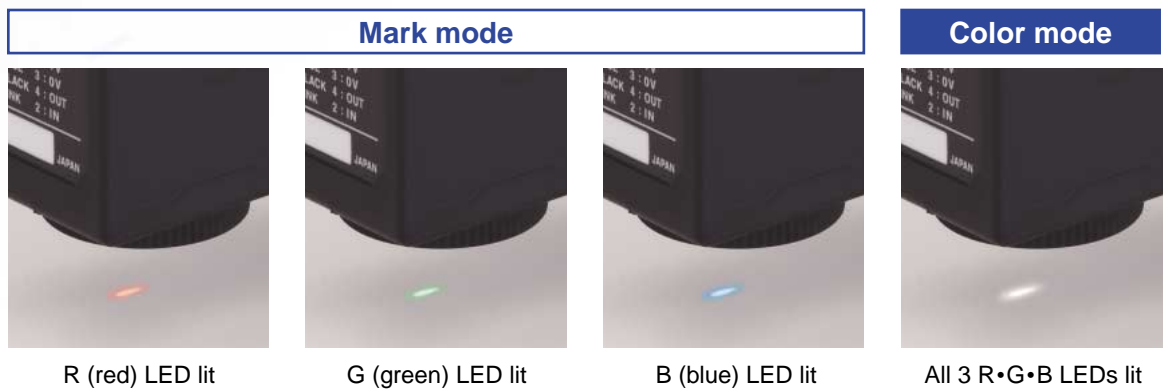

R (red) LED lit

G (green) LED lit

B (blue) LED lit

All 3 R·G·B LEDs lit

2 selectable sensing modes for any application

Mark mode

The sensor automatically selects the most suitable light source color from the 3 R·G·B LEDs offering the largest contrast between the mark and base (non-mark area). The sensor effectuates ultra quick mark detection with a 45 μs response time.

Color mode

The sensor utilizes all 3 R·G·B LEDs to convert the reflective light into an R·G·B ratio. Only the color of the mark indicated by teaching is accurately detected.

Various functions to ensure the best mark sensing. Sensing modes can be selected depending on the application.

Has a built-in 'Mark mode' that realizes a ultra quick 45 μ s response time as well as a 'Color mode' offering the best mark color discrimination capacity. Use either of these modes as per the application.

Mark mode

This sensing mode automatically selects a single color from the 3 R•G•B LEDs to realize an ultra quick 45 μ s response time. The automatic optimal LED selection function automatically selects the LED that is most suitable for the sensing. This function is perfect for ultra quick sensing.

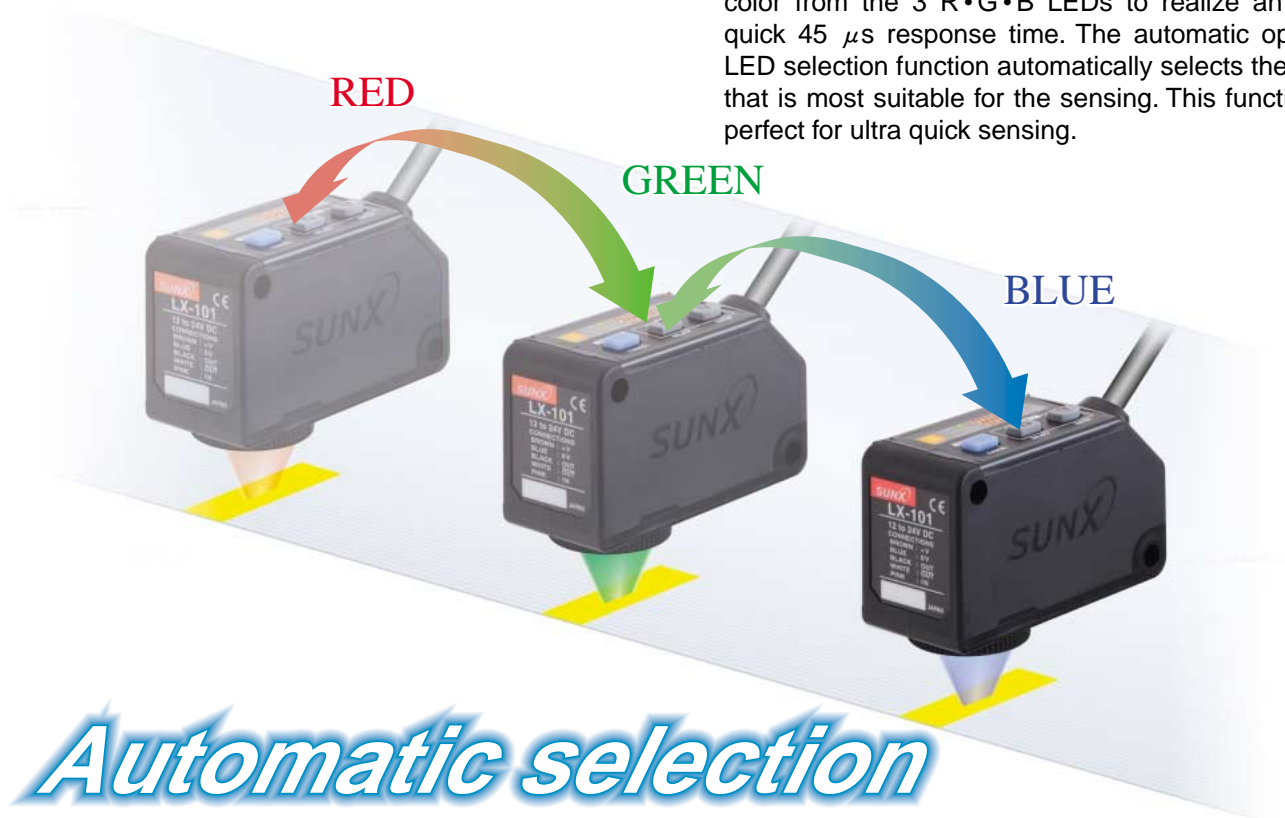

Automatic optimal LED selection function

The 3 colors of the R•G•B LEDs are optimally selected according to the color combination. With the LX-100's Mark mode, the built-in 'Automatic optimal LED selection function' automatically selects the LED for the largest contrast (S / N ratio) between the mark and base (non-mark area) to ensure optimal sensing. For more stable detection, the sensor makes selection according to the contrast and not according to the reflected light variation between the mark and base (non-mark area).

With mark sensing, the larger the received light variation is, the easier sensing becomes. Also, the higher the received light ratio (contrast) is, the more sensing is stabilized. The example on the right deals with reflected light on packing film. Great figures are indicated for the blue LED's light amount ratio and, for even more stable sensing, the blue LED effectuates this mark sensing.

The LX-100 series sensors automatically selects the optimal LED that will ensure the most stable sensing results.

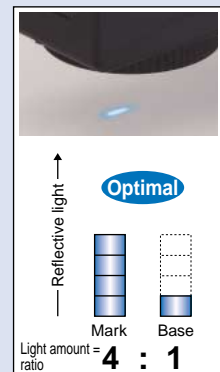
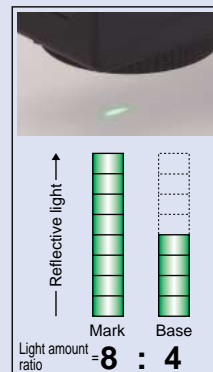
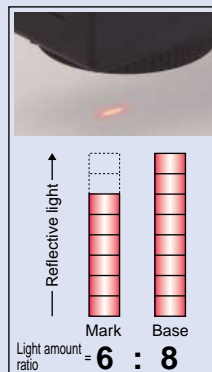

Color mode

All 3 R•G•B LEDs light up and high precision mark color discrimination occurs using the R•G•B reflective light ratio. This function enables effective detection of films with patterns around the area of the mark.

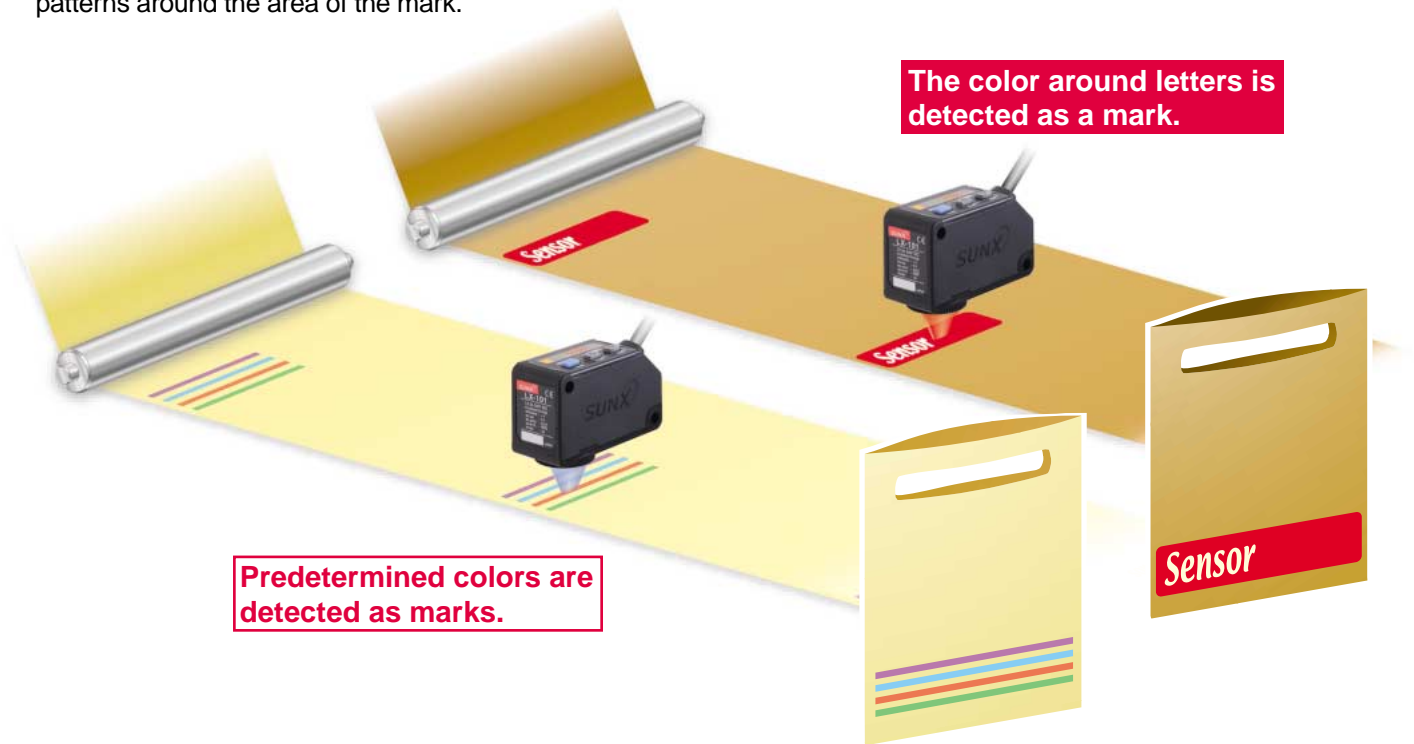

High precision mark color discrimination

The color mode on the **LX-100** series utilizes all 3 R•G•B LEDs to determine the R•G•B ratio of the mark color. The built-in 12-bit A/D converter enables high precision 1/4000-resolution judgments. The figure below is a graphic description of this process.

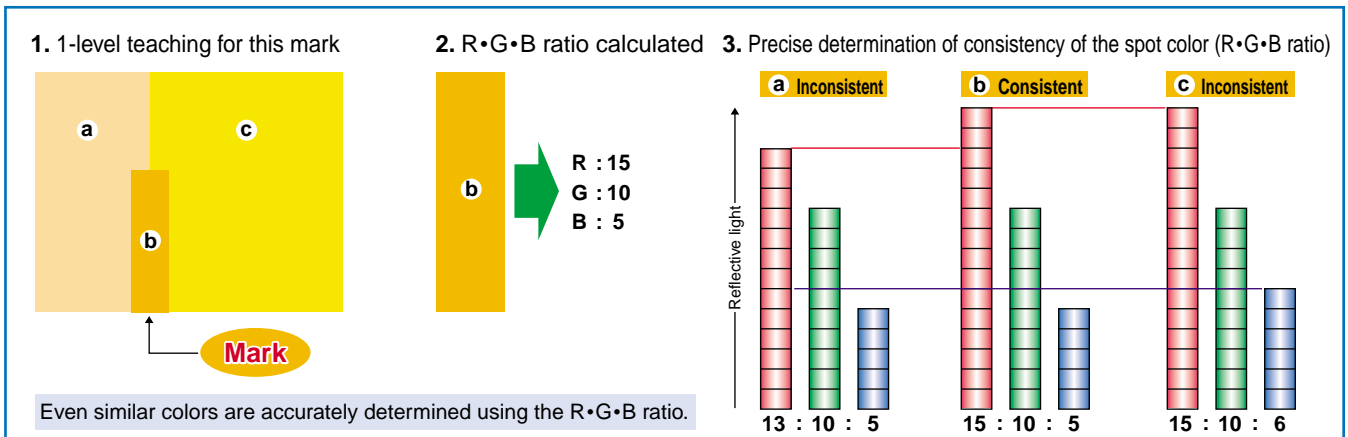

Its digital display makes for easy settings! Numerical control of the settings possible

The 4-digit digital display enables easy verification of received light from marks and base (non-mark area). Also, the threshold value can be controlled numerically enabling setting indication easily. Displaying the direct code enables settings verification. This function is handy for remote maintenance.



Even beginners can quickly master MODE NAVI operation

The sensor's basic operations are represented by 6 indicator lamps (MODE NAVI). The user can check what mode the sensor is presently in with a quick glance rendering operation simple.

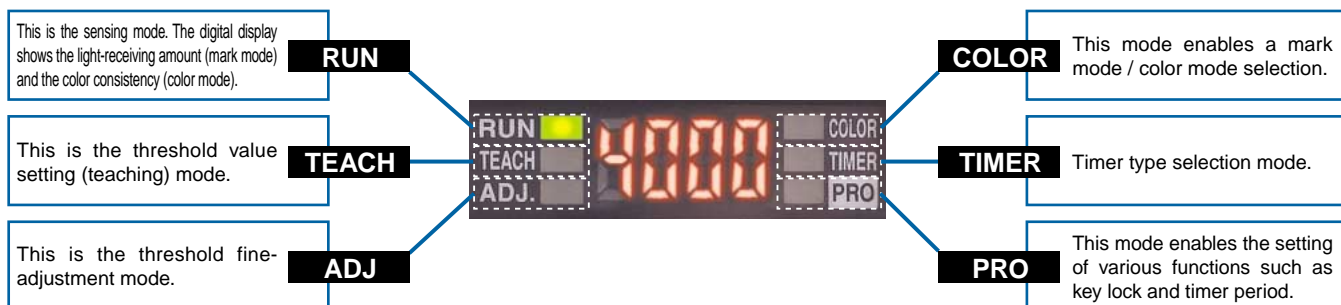

Sensing status digitally controllable

The sensing status, displayed numerically, can be verified at a glance. Also, the sensor settings for each type of packing film can be digitally indicated.

• Example of sensor setting indication

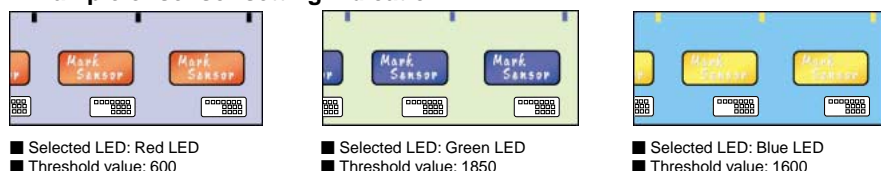

Direct codes enable settings verification at a glance

The settings for the **LX-100** series sensors are displayed using a 4-digit direct code. Direct codes enable easy settings verification and maintenance by phone.



Direct code display example ※For details, refer to p.7 'Direct code table'



- 1st digit : Mark mode (green LED)
- 2nd digit : Standard display / ECO mode disabled / Reverse display disabled
- 3rd digit : Key lock mode ... FULL / No timer
- 4th digit : Timer period set at 20 ms

The above represent default settings.

Super simple teaching

Press the ON button at the targeted mark.

We provided an example of the most basic setting method '2-level teaching'.

Mode selection Press MODE key and select TEACH mode.



Teaching

- ① Align the spot on the mark and press the ON key.
 - ② Align the spot onto the base (non-mark area) and press the OFF key.
- ※The ① ② order can be reversed.



Display showing complete settings

Sensing

Teaching complete. The optimal LED is automatically selected and the sensor automatically returns to RUN mode.

- ① The LEDs light up in order and each LED's reflected light is checked instantaneously.



- ② The LEDs light up in order and each LED's reflected light is checked instantaneously.



Other teaching methods

- Full-auto teaching: In Mark mode, teaching is effectuated without stopping the sensing object.
- 1-level teaching: In Color mode, the color detected is aligned by the spot and teaching is effectuated.

External teaching possible

Teaching is possible by external input using the operation panel or touch panel even for color mark sensors whose position within the equipment is out of reach. Models can be easily interchanged.

Mark mode

2-level teaching and full-auto teaching possible

Color mode

1-level teaching possible



Other features and handy functions

Compact design for significant space savings

High precision sensing and multiple functions provided all in a compact W57 × D24 × H38 mm W2.244 × D0.945 × H1.496 in body. Cable and plug-in connector types are available depending on the equipment used. These sensors can be easily introduced to already existing facilities.



Key lock function

The key lock function enables input operation control that prevents mistaken changes in the sensor settings. Also possible are minute settings such as 'RUN adjust', allowing threshold value adjustment only, and 'RUN teaching', allowing teaching operation only. If setting the sensor to 'RUN adjust' or 'RUN teaching', adjustments and teaching is possible with the sensor left in RUN mode.

※The key lock function is enabled by pressing the MODE key and OFF key simultaneously for at least 2 sec. after having effectuated settings. Press the MODE and OFF keys again simultaneously for at least 2 sec. to release.

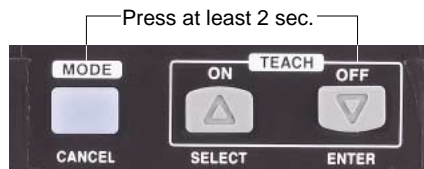

Direct code table (D-Code)

The sensor setting modes can be verified by a 4-digit code (D-Code). The table below shows a list of all available codes.

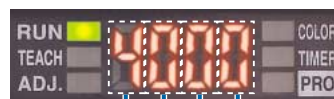

• When in RUN mode, press the MODE key for at least 2 sec. to display the direct code. (Remove your finger from the MODE key and the direct code will disappear.)

1st digit				2nd digit				3rd digit			4th digit				
Display	Sensing mode (light source color)	Operation mode (Note 1)	Sensing (Note 2)	Display	Display mode	ECO mode (Note 4)	Turn mode (Note 5)	Display	Key lock	Timer mode	Display	Timer period			
0	Mark mode (green)	L-ON	FINE	Standard	Standard	OFF	OFF	Full lock (All operations disabled)	non	1 ms	0	1 ms			
			COARSE				ON		OFF-delay	2 ms					
		D-ON	FINE				OFF		ON-delay	5 ms					
			COARSE				ON		non	10 ms					
1	Mark mode (blue)	L-ON	FINE	Percent display (Note 3)	OFF	OFF	RUN teaching (Teaching only enabled)	OFF-delay	20 ms	1	20 ms				
			COARSE			ON		ON-delay	50 ms						
		D-ON	FINE			OFF		non	100 ms						
			COARSE			ON		OFF-delay	200 ms						
2	Mark mode (red)	L-ON	FINE	---	---	---	---	RUN adjust (Threshold value adjustment only enabled)	ON-delay	500 ms	2	500 ms			
			COARSE						---	---			---		
		D-ON	FINE						---	---			---		
			COARSE						---	---			---		
3	Color mode	Consistent-ON	FINE	---	---	---	---	---	---	---	3	---			
			COARSE										---	---	---
		Inconsistent-ON	FINE										---	---	---
			COARSE										---	---	---

Notes: 1) In Mark mode, L-ON / D-ON is automatically set in the sensor. For example, with 2-level teaching, press the ON key at the targeted mark and press the OFF key at the base (non-mark area). When doing so, the operator does not have to consider L-ON / D-ON.

2) Sensing accuracy can be set to either FINE (standard) or COARSE.

3) The percent display is only enabled in mark mode.

4) ECO mode is a function that reduces power consumption by turning off the digital display in the event no button operations are made for a predetermined time (approx. 10 sec. or more) in RUN mode. Press any button to turn the digital display on again.

5) The turn mode is a function that reverses the digital display making it easily viewed in the event the sensor installation renders the display up-side-down.

※Default setting: D-code '0004'.

Cable type



- Built-in output 1 (OUT) and output 2 ($\overline{\text{OUT}}$)
- Built-in teaching input
- NPN and PNP output types available
- With 5-core cable

Plug-in connector type



M12 plug-in connector cable

- Built-in teaching input
- NPN and PNP output types available
- Straight and elbow type M12 plug-in connector cables available (optional)

Timer function

The built-in timer function cancels signals not needed for mark sensing and lengthens the width of signals to control devices.

- ON-delay and OFF-delay timers built-in
- 9 timer levels available: 1 ms / 2 ms / 5 ms / 10 ms / 20 ms / 50 ms / 100 ms / 200 ms / 500 ms

ORDER GUIDE

Sensors Mating cable is not supplied with the plug-in connector type. Please order it separately.

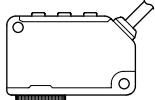
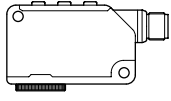
Type	Appearance	Model No.	Output	Sensing range
Cable type		LX-101	NPN open-collector transistor	10 ± 3 mm 0.394 ± 0.118 in
		LX-101-P	PNP open-collector transistor	
Plug-in connector type		LX-101-Z	NPN open-collector transistor	
		LP-101-P-Z	PNP open-collector transistor	

Mating cables for plug-in connector type sensor Mating cable is not supplied with the plug-in connector type sensor. Please order it separately.

Type	Model No.	Description
Straight	CN-24B-C2	Length: 2 m 6.562 ft
	CN-24B-C5	Length: 5 m 16.404 ft
Elbow	CN-24BL-C2	Length: 2 m 6.562 ft
	CN-24BL-C5	Length: 5 m 16.404 ft

0.34 mm² 4-core cabtyre cable, with connector on one end
Cable outer diameter: $\phi 5$ mm $\phi 0.197$ in

Mating cables for plug-in connector type sensor

- CN-24B-C2
- CN-24B-C5
- CN-24BL-C2
- CN-24BL-C5

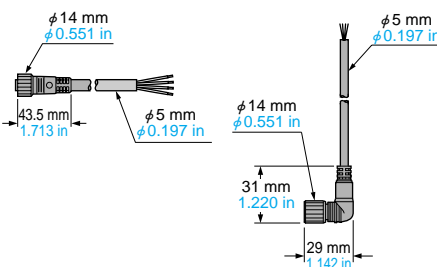

OPTIONS

Type	Model No.	Description
Sensor mounting bracket	MS-LX-1	Mounting bracket made for LX-100 series applicable for various kinds of installations
	MS-LX-2	

Sensor mounting brackets

• MS-LX-1

Two M4 (length 28 mm 1.102 in) screws with washers are attached.

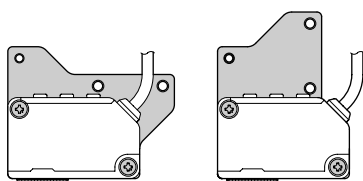

• MS-LX-2

Two M4 (length 30 mm 1.181 in) screws with washers are attached.

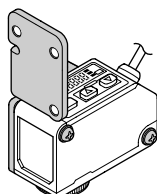

SPECIFICATIONS

Item	Model No.	Type	Cable type	Plug-in connector type	
		NPN output	LX-101	LX-101-Z	
		PNP output	LX-101-P	LX-101-P-Z	
Sensing range		10 ± 3 mm 0.394 ± 0.118 in			
Spot size		1 × 5 mm 0.039 × 0.197 in (at 10 mm 0.394 in setting distance)			
Supply voltage		12 to 24 V DC ± 10 % Ripple P-P 10 % or less			
Current consumption		Normal mode: 750 mW or less (Current consumption 30 mA or less at 24 V supply voltage) ECO mode: 600 mW or less (Current consumption 25 mA or less at 24 V supply voltage)			
Output 1 (OUT)	<NPN output type> NPN open-collector transistor <ul style="list-style-type: none"> • Maximum sink current: 50 mA • Applied voltage: 30 V DC or less (between output and 0 V) • Residual voltage: 1.5 V or less (at 50 mA sink current) <PNP output type> PNP open-collector transistor <ul style="list-style-type: none"> • Maximum source current: 50 mA • Applied voltage: 30 V DC or less (between output and +V) • Residual voltage: 1.5 V or less (at 50 mA source current) 		<NPN output type> NPN open-collector transistor <ul style="list-style-type: none"> • Maximum sink current: 100 mA • Applied voltage: 30 V DC or less (between output and 0 V) • Residual voltage: 1.5 V or less (at 100 mA sink current) <PNP output type> PNP open-collector transistor <ul style="list-style-type: none"> • Maximum source current: 100 mA • Applied voltage: 30 V DC or less (between output and +V) • Residual voltage: 1.5 V or less (at 100 mA source current) 		
	Short-circuit protection	Incorporated			
	Output operation	Mark mode: Light-ON / Dark-ON (Auto-setting on teaching), Color mode: Consistent-ON / Inconsistent-ON (Setting on teaching)			
Output 2 (OUT)	<NPN output type> NPN open-collector transistor <ul style="list-style-type: none"> • Maximum sink current: 50 mA • Applied voltage: 30 V DC or less (between output and 0 V) • Residual voltage: 1.5 V or less (at 50 mA sink current) <PNP output type> PNP open-collector transistor <ul style="list-style-type: none"> • Maximum source current: 50 mA • Applied voltage: 30 V DC or less (between output and +V) • Residual voltage: 1.5 V or less (at 50 mA source current) 				
	Short-circuit protection	Incorporated			
	Output operation	Inverted operation of the output 1			
Response time		Mark mode: 45 μs or less, Color mode: 150 μs or less			
Teaching input		<NPN output type> NPN non-contact input <ul style="list-style-type: none"> • Signal condition: High... +5 V to +V, or open Low... 0 V to +2 V (source current: 0.5 mA or less) • Input impedance: 10 kΩ approx. 	<PNP output type> PNP non-contact input <ul style="list-style-type: none"> • Signal condition: High... +4 V to +V (sink current: 3 mA or less) Low... 0 V to +0.6 V, or open • Input impedance: 10 kΩ approx. 		
Digital display		4-digit red LED display			
Sensitivity setting		Mark mode: 2-level teaching / Full-auto teaching, Color mode: 1-level teaching			
Fine sensitivity adjustment function		Incorporated			
Timer function		Incorporated with variable ON-delay / OFF-delay timer, switchable either effective or ineffective (Timer period: 1 to 500 ms, 9 levels variable)			
Environmental resistance	Protection	IP67 (IEC)			
	Ambient temperature	- 10 to +55 °C + 14 to + 131 °F (No dew condensation or icing allowed), Storage: - 20 to +70 °C - 4 to + 158 °F			
	Ambient humidity	35 to 85 % RH, Storage: 35 to 85 % RH			
	Ambient illuminance	Incandescent light: 3,000 lx at the light-receiving face			
	Voltage withstandability	1,000 V AC for one min. between all supply terminals connected together and enclosure			
	Vibration resistance	10 to 500 Hz frequency, 3.0 mm 0.118 in double amplitude (max. 20 G) in X, Y and Z directions for two hours each			
Shock resistance	500 m/s ² acceleration (50 G approx.) in X, Y and Z directions for three times each				
Emitting element		Combined Red / Green / Blue LEDs (Peak emission wave length: 640 nm 0.025 mil / 525 nm 0.021 mil / 470 nm 0.019 mil)			
Material		Enclosure: PBT, Display: Polycarbonate, Operation buttons: Silicone rubber, Lens: Glass, Lens holder: Aluminum			
Cable		0.34 mm ² 5-core cabtyre cable, 2 m 6.562 ft long	(Note)		
Cable extension		Extension up to total 100 m 328.084 ft is possible with 0.3 mm ² , or more, cable.			
Weight		Net weight: 120 g approx., Gross weight: 180 g approx.	Net weight: 55 g approx., Gross weight: 120 g approx.		
Accessory		M4 (Length 30 mm 1.181 in) screw with washers: 2 pcs.			

Note: Mating cable is not supplied with the plug-in connector type. Please order it separately.

I/O CIRCUIT AND WIRING DIAGRAMS

NPN output type

I/O circuit diagrams

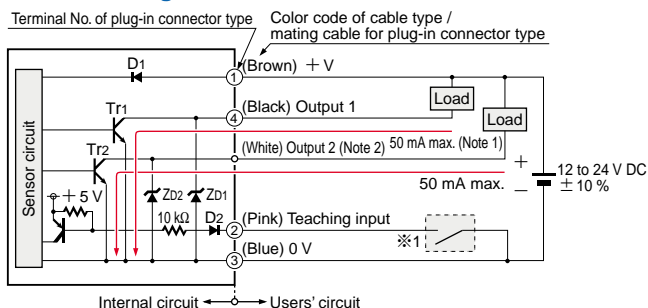

Notes: 1) The current of the plug-in connector type LX-101□-Z is 100 mA max.
2) The output 2 is not incorporated to the plug-in connector type LX-101□-Z.

※1

Non-voltage contact or NPN transistor

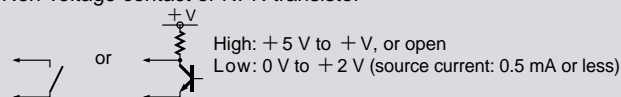

Symbols... D1, D2 : Reverse supply polarity protection diode
Zd1, Zd2: Surge absorption zener diode
Tr1, Tr2 : NPN output transistor

PNP output type

I/O circuit diagrams

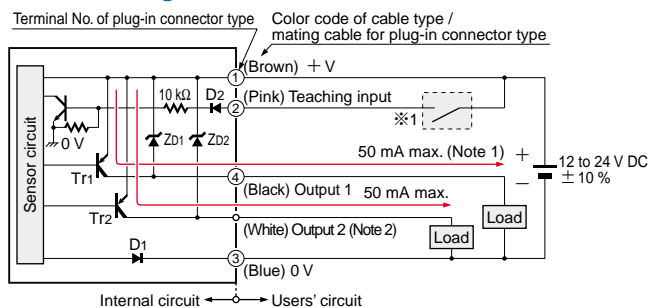

Notes: 1) The current of the plug-in connector type LX-101□-Z is 100 mA max.
2) The output 2 is not incorporated to the plug-in connector type LX-101□-Z.

※1

Non-voltage contact or PNP transistor

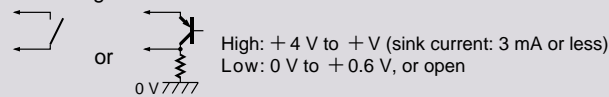

Symbols... D1, D2 : Reverse supply polarity protection diode
Zd1, Zd2: Surge absorption zener diode
Tr1, Tr2 : PNP output transistor

Layout of connector pin of plug-in connector type

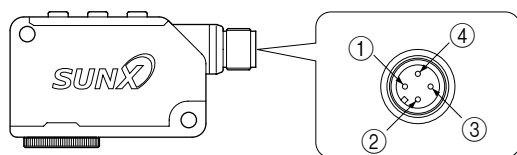

Connector pin No.	Description
①	+ V
②	Teaching input
③	0 V
④	Output

SPOT SIZE CHARACTERISTICS (TYPICAL)

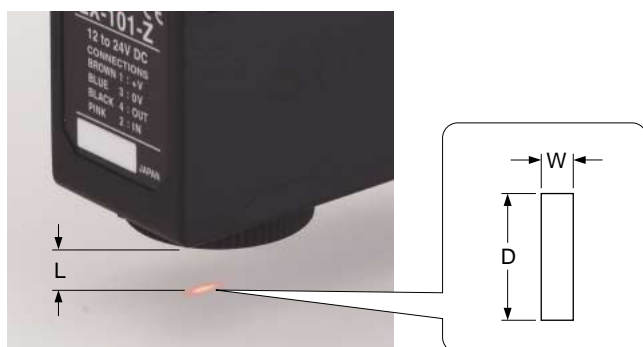

(Unit: mm in)

Setting distance L (Note 1)	Spot size (Note 2)	
	Width (W)	Length (D)
7	0.276	2 0.079 5.5 0.217
8	0.315	1.7 0.067 5.5 0.217
9	0.354	1.2 0.047 5.3 0.209
10	0.394	1.0 0.039 5.0 0.197
11	0.433	1.3 0.051 5.0 0.197
12	0.472	1.5 0.059 5.0 0.197
13	0.512	2.0 0.079 5.0 0.197

Notes: 1) Setting distance 'L' represents the distance from the lens surface to the sensing object.
2) Examples only meant for use as a guideline.

PRECAUTIONS FOR PROPER USE

- This catalog is a guide to select a suitable product. Be sure to read the instruction manual attached to the product prior to its use.



This product is not a safety sensor. Its use is not intended or designed to protect life and prevent body injury or property damage from dangerous parts of machinery. It is a normal object detection sensor.

Mounting

- Care must be taken regarding the sensor mounting direction with respect to the object's direction of movement.

<Correct>

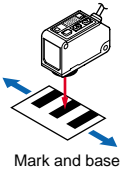

Mark and base

<Incorrect>

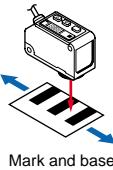

Mark and base

Do not make the sensor detect an object in this direction because it may cause unstable operation.

- The tightening torque should be 0.8 N·m or less.

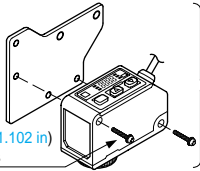

Sensor mounting bracket MS-LX-1 (Optional)

M4 (length 28 mm 1.102 in) screw with washers

Part description

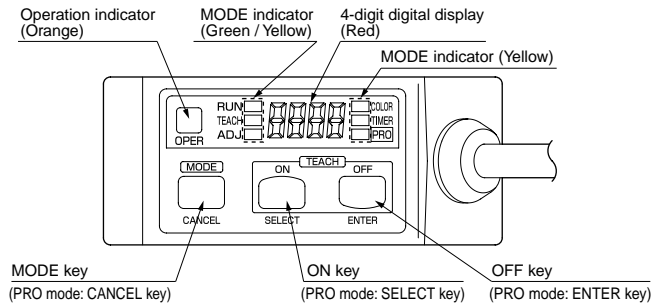

Sensing glossy object

- Objects with a glossy surface have a large amount of specular reflection particles that may destabilize sensing. In such a case, by slightly tilting the sensor's beam axis, this specular reflection can be reduced rendering sensing more stable.
- If the surface of the sensing object has a shine, mount the sensor inclining approx. 10 to 15 degrees against the sensing object.

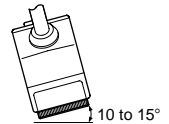
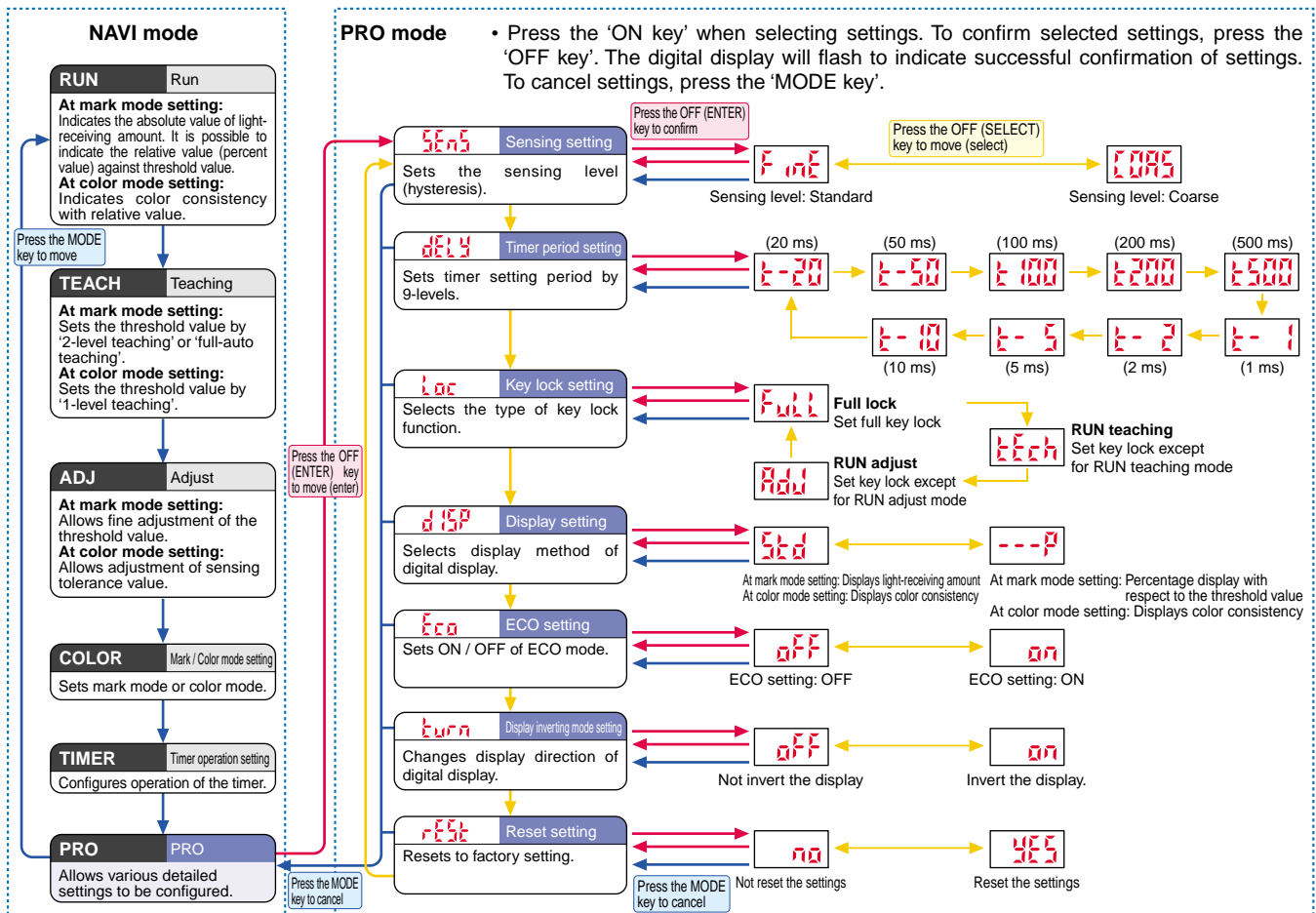
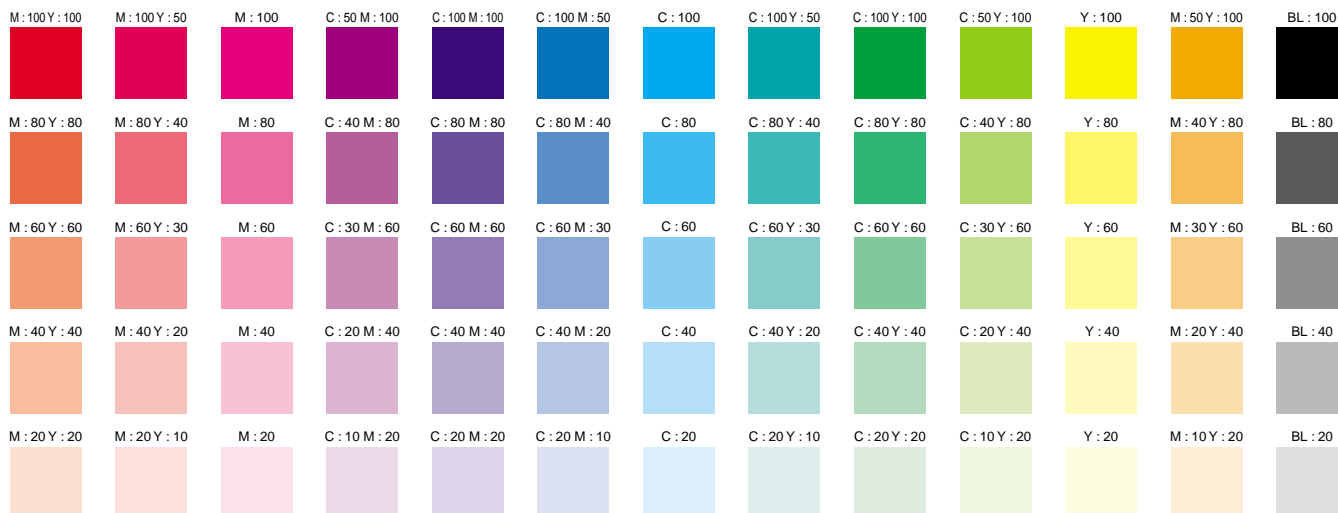

TABLE FOR PRO MODE SETTINGS

- Before performing teaching or each detail setting, perform the setting of either mark mode or color mode with mark / color mode setting of NAVI mode.



COLOR CHART [The color notations are based on the C (cyan) / M (magenta) / Y (yellow) / BL (black) format used for printing.]



Note: Fading after printing may cause color variations. Use the above chart as a guideline.

DIMENSIONS (Unit: mm in)

**LX-101
LX-101-P** Sensor

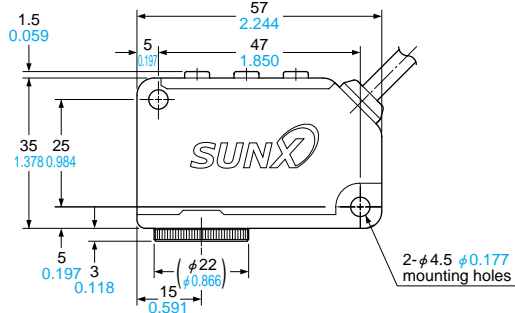
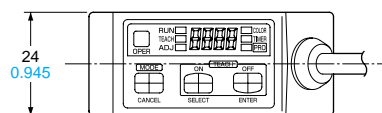

**LX-101-Z
LX-101-P-Z** Sensor

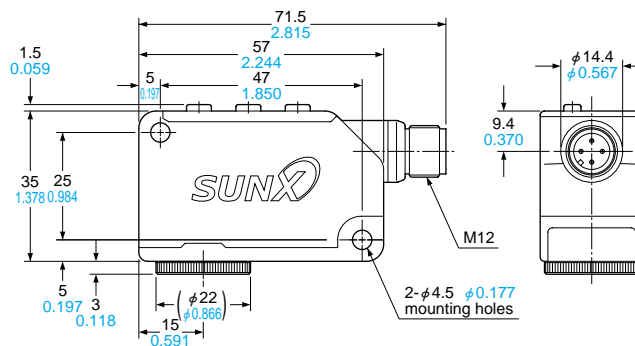
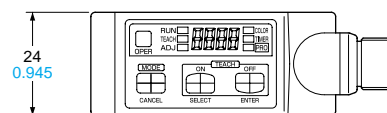

MS-LX-1 Sensor mounting bracket (Optional)

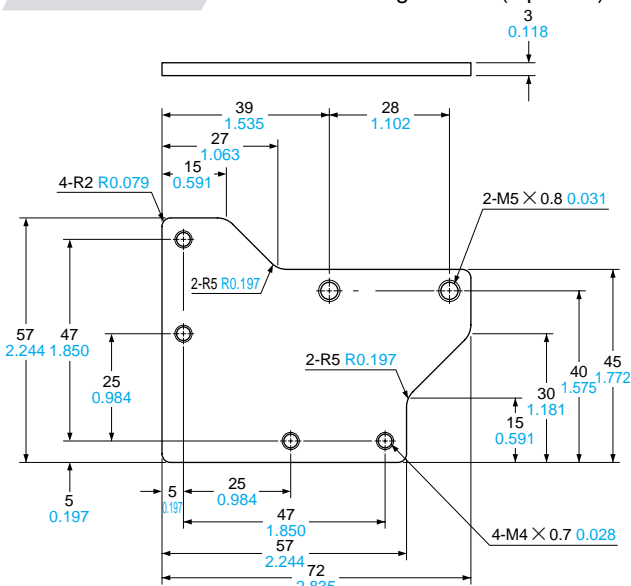

Material: Stainless steel (SUS)

Two M4 (length 28 mm 1.102 in) screws with washers are attached.

MS-LX-2 Sensor mounting bracket (Optional)

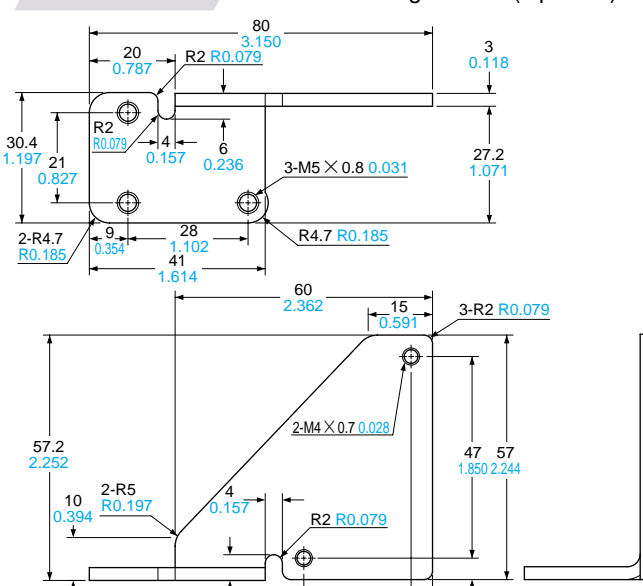

Material: Stainless steel (SUS) 0.236

Two M4 (length 30 mm 1.181 in) screws with washers are attached.

Various mark sensing applications and sensor applications to suit any job are available.

We at SUNX provide every type of sensor for food or drug packaging machines such as the LX-100 series digital mark sensor made for sensing various types of marks.

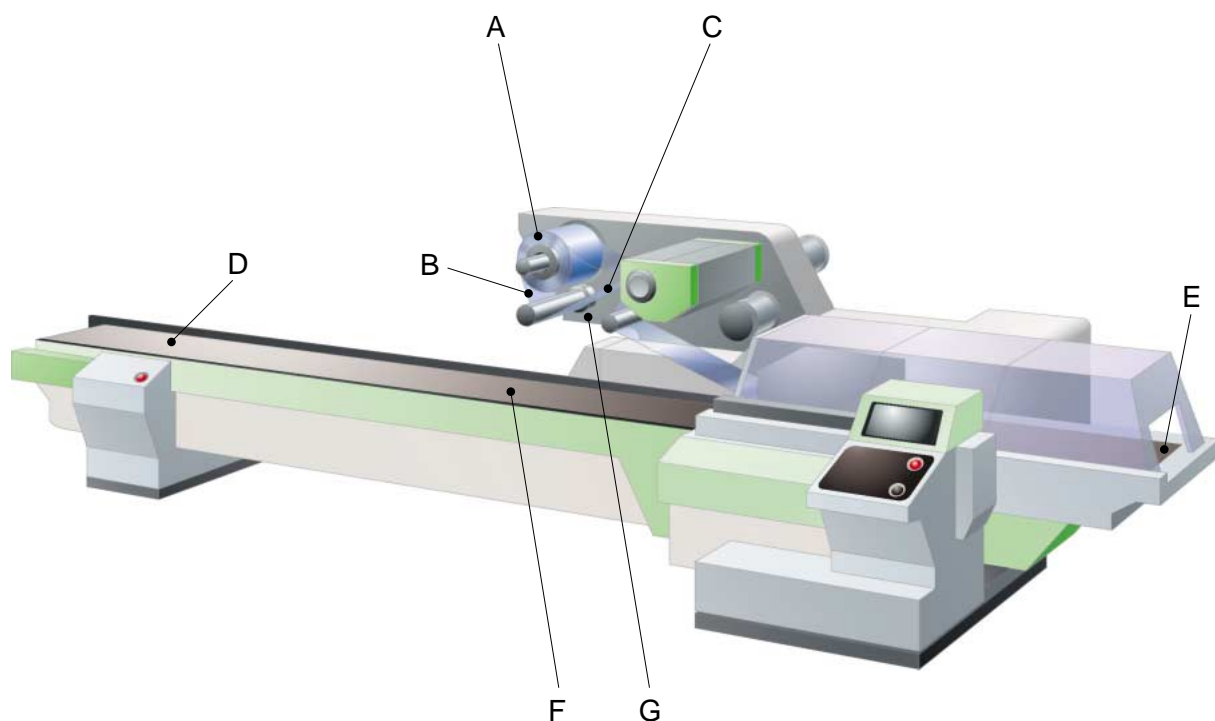

EACH SENSOR TYPE

A: Remaining sheet detection

Retroreflective type photoelectric sensor for transparent object sensing
CX-481

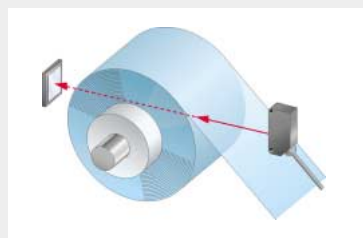

CX-481 is the amplifier built-in photoelectric sensor (**CX-400** series) for transparent objects sensing. It monitors the residual amounts of packing film and announces the periodic replacements of film rolls. These sensors are retroreflective types so they can be installed with ease.

B: Deflecting sheet detection

Ultra-slim photoelectric sensor
EX-13

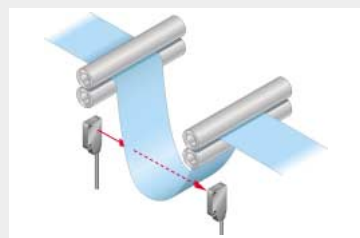

EX-10 series amplifier built-in ultra-slim photoelectric sensor (3.5 mm **0.138 in** thick) that monitors packing film deflection and can be installed in narrow spaces.

C: Meandering sheet detection

Wide beam fiber **FT-A8** Digital fiber sensor **FX-305**

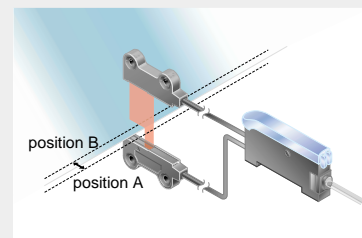

Detects meandering sheets using wide beam fiber. The fiber amplifier is a 2-output type that can detect meandering in both the left and right directions.

DIGITAL MARK SENSOR LX-100 SERIES

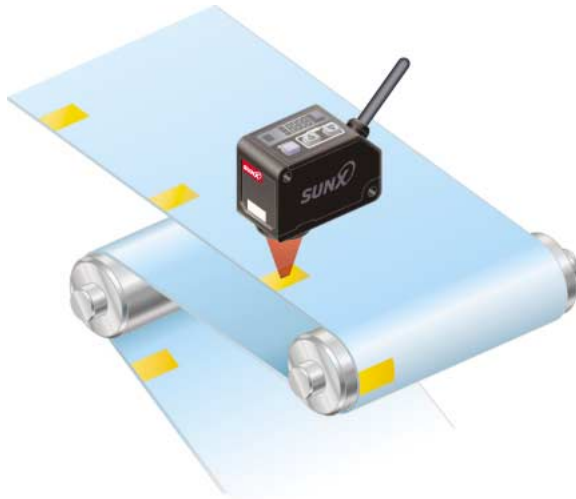

Tube positioning



Detects printed marks to align tubes.

Can be used for various kinds of packing film

• Paper bags



• Transparent film



• Aluminum evaporation film

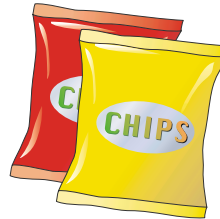

• Carrier bags

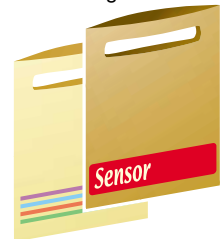

D: Air pressure detection

Digital pressure sensor
DP2 / DP4 series

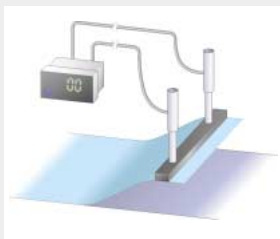

Detects air pressure and displays it digitally. Its semi-conductor transducer ensures high precision and long life. Optimal for controlling the pressure of pneumatic machinery.

E: Packing and content detection

Adjustable range reflective photoelectric sensor
CX-440 series

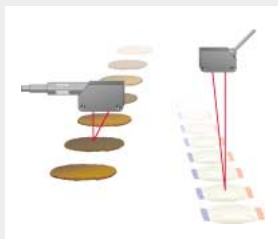

Adjustable range reflective photoelectric sensor not effected by the color of the object. Can be used for checking packaged goods or counting contents.

F: Content detection

Retroreflective photoelectric sensor
CX-491

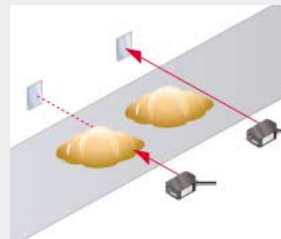

Ideal for sensing objects moving on a conveyor belt.

G: Cut tape verification

Digital laser sensor
LS series

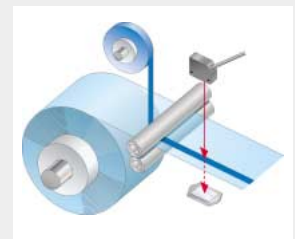

High precision red laser sensor. Its minute spot can effectively detect the presence of narrow cut tape.

Introducing SUNX food or drug packaging machine sensors

Digital Fiber Sensor FX-300SERIES



- Red / Green / Blue / Infrared LED amplifiers available.
- Various fibers available for any application.

Digital Pressure Sensor DP2 / DP4SERIES



- Bright, easy to view dual-color digital display (DP4).
- Improved functions and wide variations (DP2).

Digital Laser Sensor LSERIES

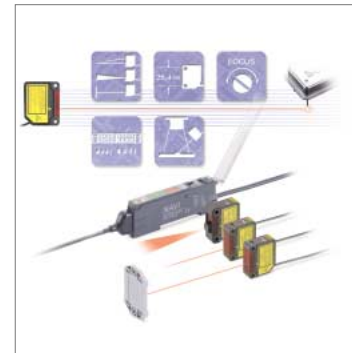

- 3 types of laser sensor heads available.
- General purpose photoelectric sensor CX-400 series installation compatibility.

Compact Photoelectric Sensor CX-400SERIES



- World standard size.
- Wide variation 116 models.

Adjustable Range Reflective Photoelectric Sensor CX-440SERIES



- Can difference as small as 0.4 mm **0.016 in.**
- Not affect by color. The difference in sensing range between black and white is 1 % or less.

Ultra-slim Photoelectric Sensor EX-10SERIES



- Smallest in the industry with 3.5 mm **0.138 in** thickness.
- 1 m **3.281 ft** long-distance sensing (thru-beam type: **EX-19**).
- ※EX-20 made for installation with M3 screws available.

- In addition, micro-size inductive proximity sensors and photoelectric sensors with amplifier-separated available.
Refer to SUNX homepage (<http://www.sunx.co.jp/>).

All information is subject to change without prior notice.

SUNX
Sensing the Future

<http://www.sunx.co.jp/>

SUNX Limited

2431-1 Ushiyama-cho, Kasugai-shi, Aichi,
486-0901, Japan
Phone: +81-(0)568-33-7211
FAX: +81-(0)568-33-2631

Overseas Sales Dept.

Phone: +81-(0)568-33-7861
FAX: +81-(0)568-33-8591