



PHOTOELECTRIC SENSOR

DIGITAL LASER SENSOR

New

LS SERIES



Easy!

More convenient and user friendly high precision laser sensing!

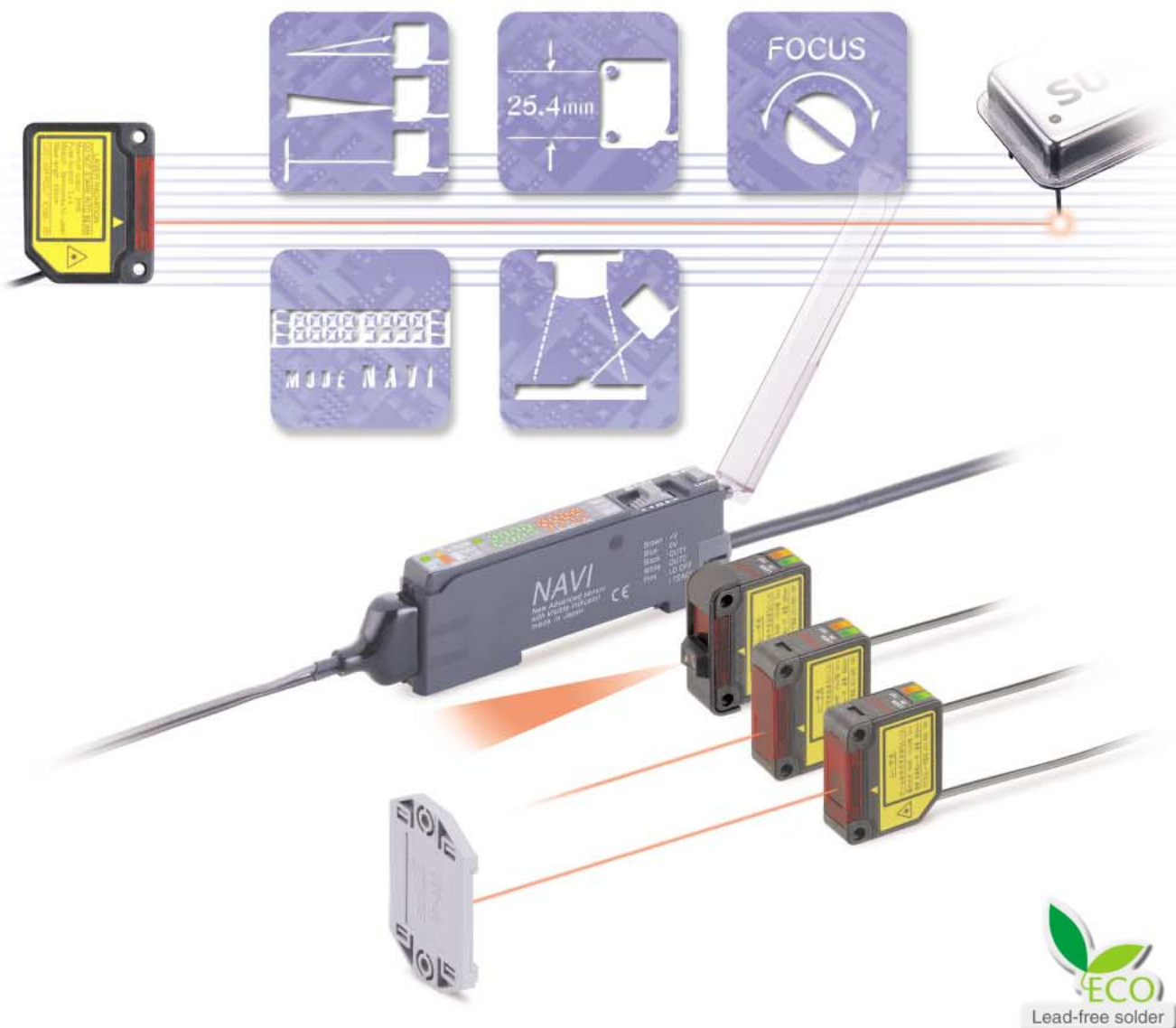

Easy Sensing

We offer 3 types of laser sensor heads for various applications.



A line width of approx. 200 mm
7.874 in (typical) at a 1,000 mm
39.370 in sensing range

A line width of approx. 100 mm
3.937 in (typical) at a 500 mm
19.685 in sensing range

※A spot diameter of approx.
φ0.2 mm φ0.008 in at a
50 mm 1.969 in sensing range

Long sensing range
line reflective type
LS-H22

LS-H22 is the set model No. for LS-H21 long sensing range spot reflective type sensor head combined with the LS-MR1 lens attachment for line reflective. LS-H21 is indicated for the actual product.

Coaxial retroreflective type
LS-H91

Long sensing range
spot reflective type
LS-H21

LS SERIES

Easy 1 Installation



Easy installation

P3 ▶

We designed 3 types of sensor heads about the same size as general purpose beam sensors.



Easy 2 Adjustment



Easy adjustment

P4 ▶

Spot size adjustment made simple.



Easy 3 Operation



Easy operation

P5 ▶

Uses the popular MODE NAVI feature found in fiber sensors ensuring both multi-functionality and superior operability.



Easy 4 High Performance



Easy to use highly functions

P7 ▶

Equipped with all functions handy onsite.

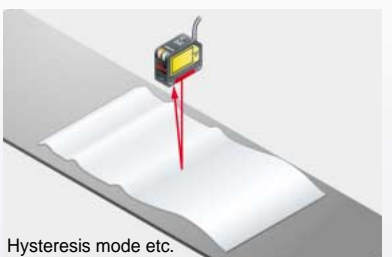

Hysteresis mode etc.

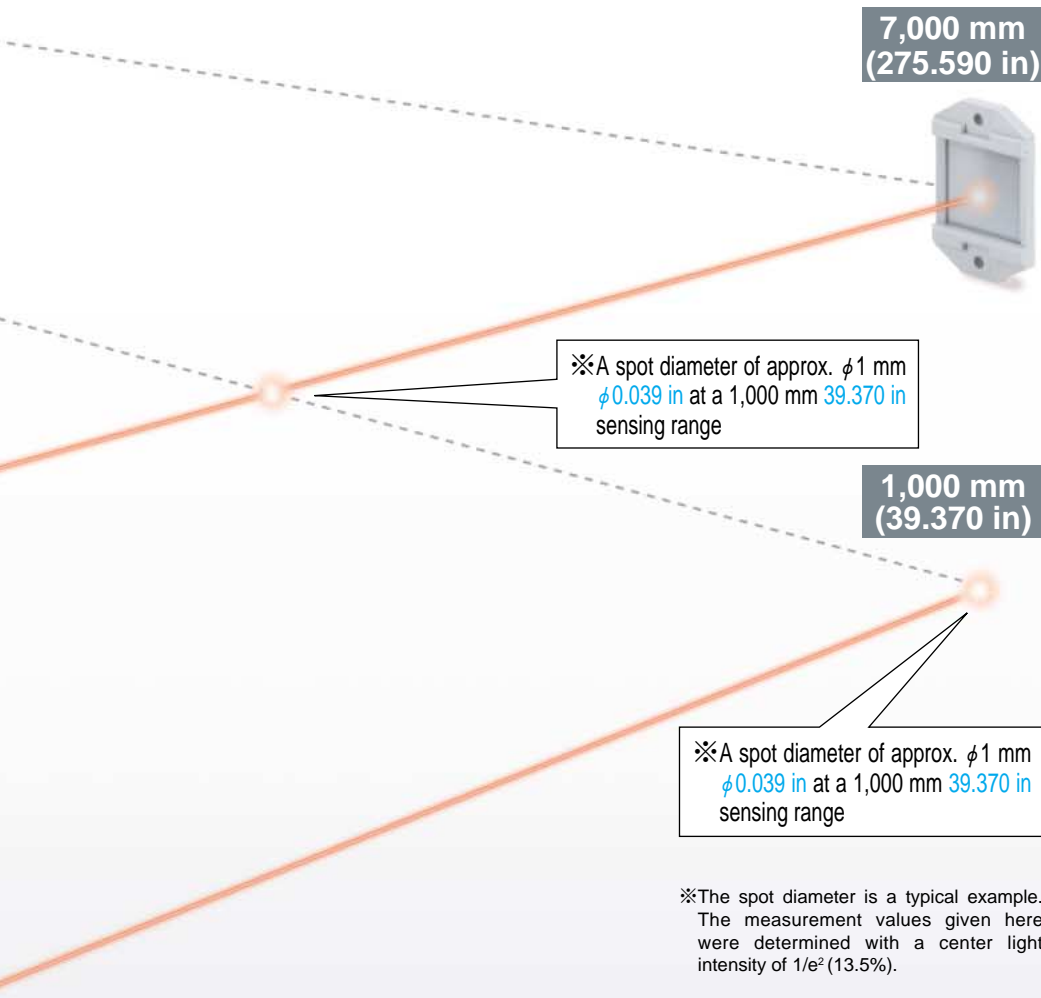

Long sensing range line reflective type **LS-H22**

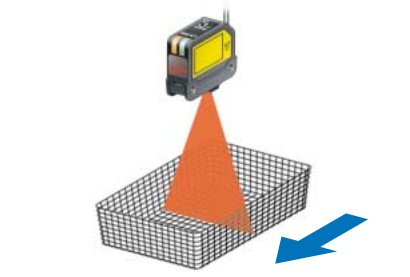

Its linear sensing area enables more stable detection of objects with complex shapes.

Coaxial retroreflective type **LS-H91**



With its built-in polarizing filters and approximate $\phi 1$ mm $\phi 0.039$ in spot diameter (at 1 m 3.281 ft sensing range), this coaxial retroreflective type sensor is optimal for detecting the slightest glass substrate protrusion and other long sensing range, high precision positioning.

Long sensing range spot reflective type **LS-H21**

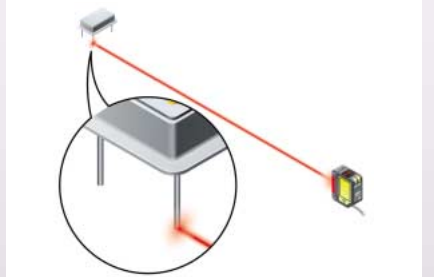

Because its spot diameter can be adjusted in accordance with the object, it can be easily set to detect even the minutest object from a remote location.

Easy 1 Installation



Easy installation

We designed 3 types of sensor heads approximately the same size as general purpose photoelectric sensors with identical mounting method. (Long sensing range spot reflective / Long sensing range line reflective / Coaxial retroreflective types)

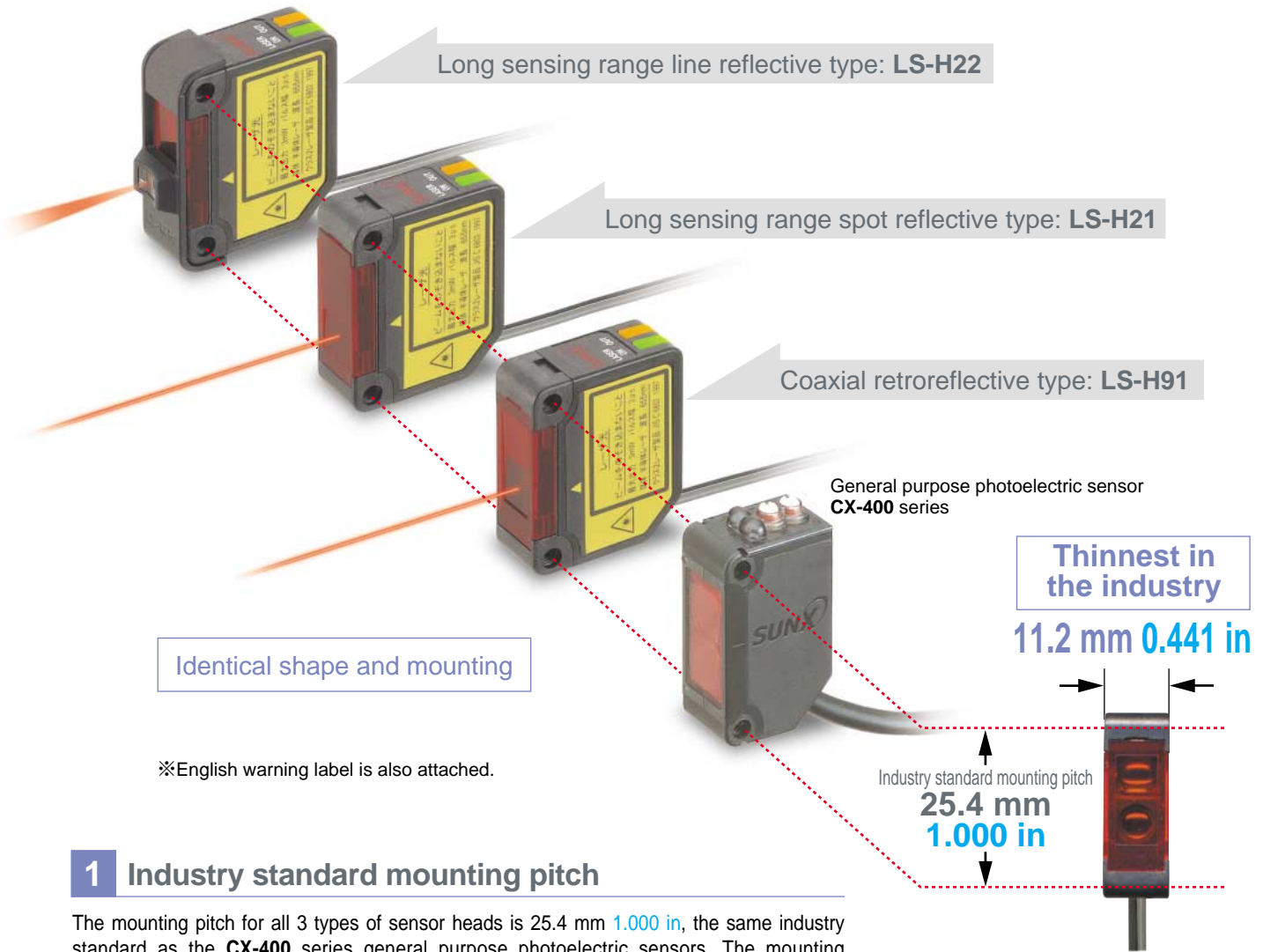

1 Industry standard mounting pitch

The mounting pitch for all 3 types of sensor heads is 25.4 mm **1.000 in**, the same industry standard as the **CX-400** series general purpose photoelectric sensors. The mounting brackets can be used as is even when replacing general purpose sensors with laser sensors.

2 Assorted mounting brackets available

Because their mounting is compatible with general purpose photoelectric sensors, the mounting brackets for the general purpose photoelectric sensors as well as the universal sensor mounting stand can be used.

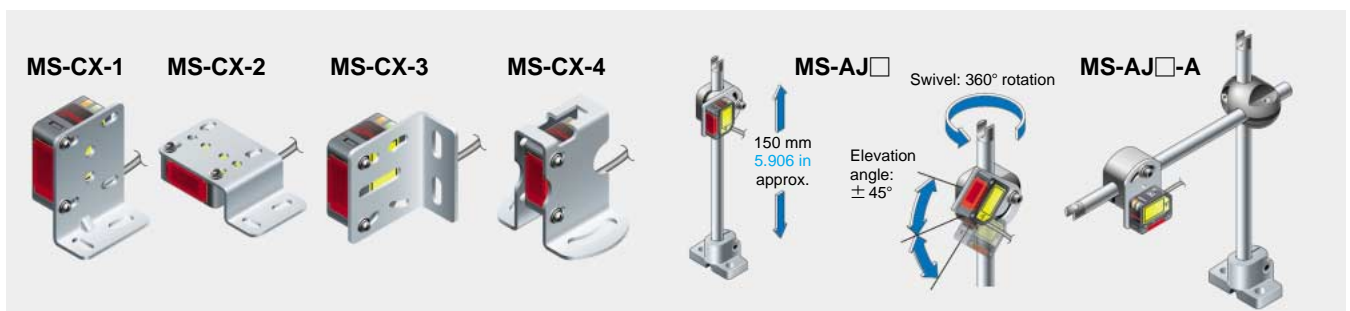

Easy 2

Adjustment



Easy adjustment | Spot size adjustment made simple.

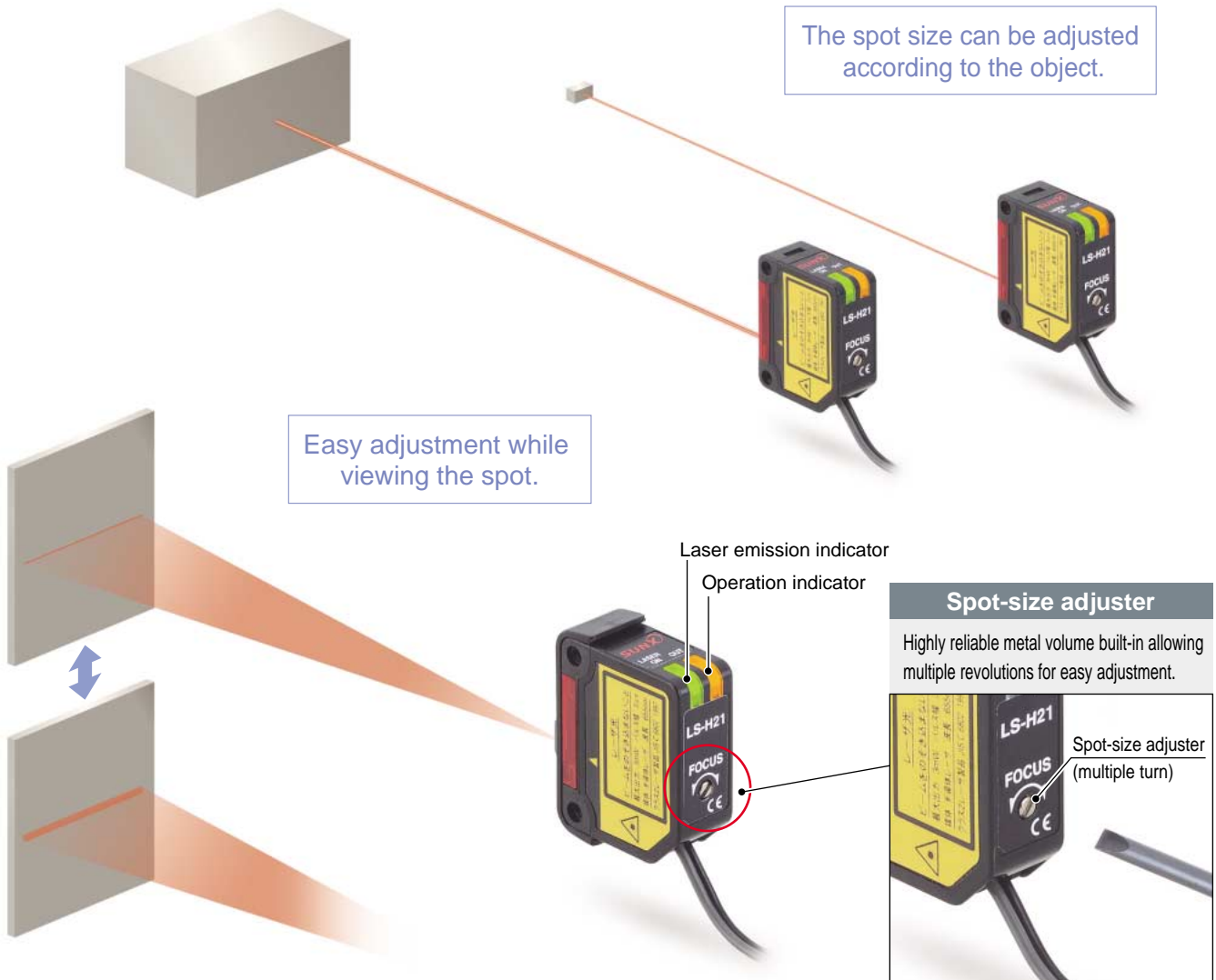

1 Spot size adjustment possible LS-H21, LS-H22

The long sensing range spot reflective type and long sensing range line reflective type have a built-in spot-size adjuster that enables spot size adjustment according to the object for optimal setting.

2 Easy and accurate adjustments LS-H21, LS-H22

A spot-size adjuster is built into the back of the sensor head allowing the user to adjust the sensor easily while viewing the spot. The adjuster is adjustable with a screwdriver to avoid accidents during maintenance or any other time the sensors are handled.

Easy 3 Operation



Easy operation

Uses MODE NAVI, highly praised in the **FX-300** series digital fiber sensors. Along with a dual display screen showing the incident light intensity and threshold value simultaneously, they offer both multi-functionality and superior operability.

10 mm 0.394 in thickness



Threshold value setting display
Green LED, 4 digits
(Max. display: 9999)

1 Easy setting, dual display

Equipped with 2 large 4-digit digital displays. While checking the current incident light intensity (red display), the optimal threshold value (green display) can be set easily.

2 Maximum display of 9999

A maximum display of 9999 was programmed to enable minimum variation setting. More stable sensing is made possible to ensure the detection of the minutest variation for transparent objects.



3 Easy to view guide display

Setting items understood at a glance.

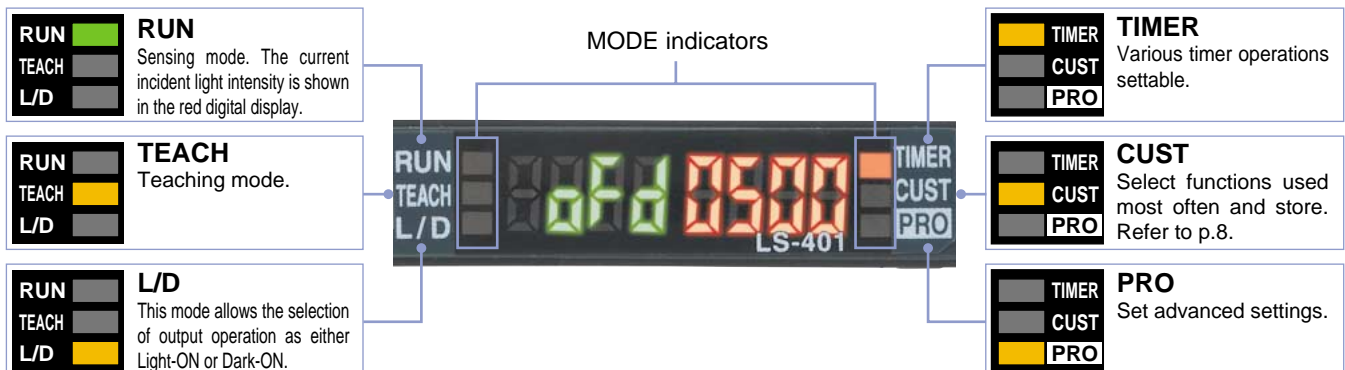

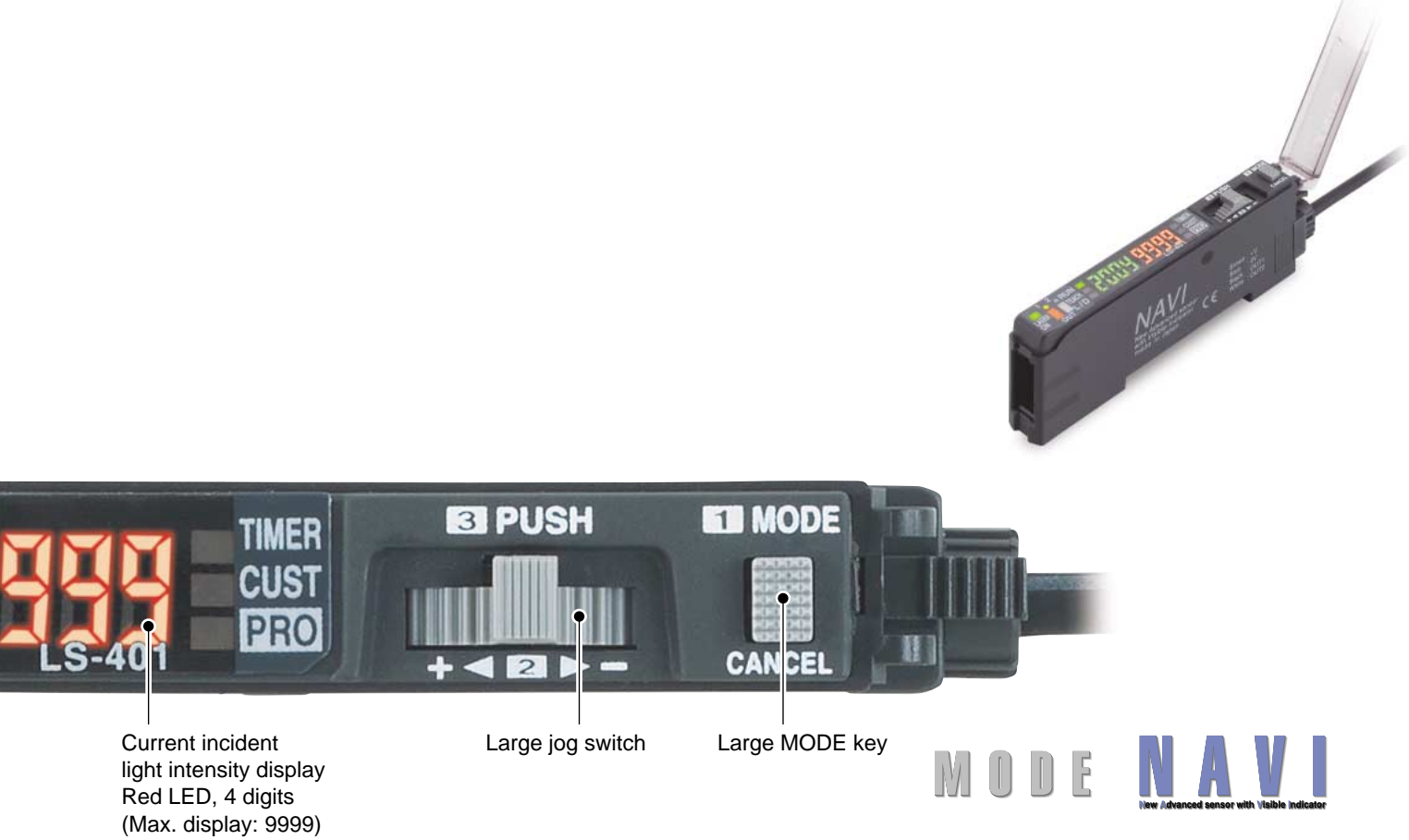

1
Current incident light intensity display
Red LED, 4 digits
(Max. display: 9999)

2
Large jog switch

3
Large MODE key

MODE NAVI
New Advanced sensor with Visible Indicator

4 2 switches enabling simple operation

Only two switches, the large MODE key and the large jog switch, are required for operation.



1
MODE Pressing the switch selects or cancels the operating mode

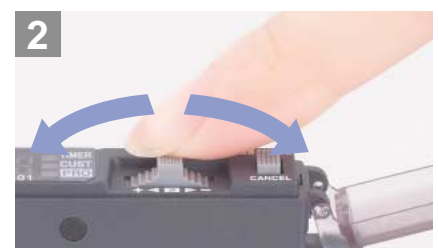

2
Moving the switch from side to side allows items to be selected



3
PUSH Pressing the switch then confirms the selected setting

5 Superior maintainability

Both the sensor head and power supply / output cables use one-touch connectors.

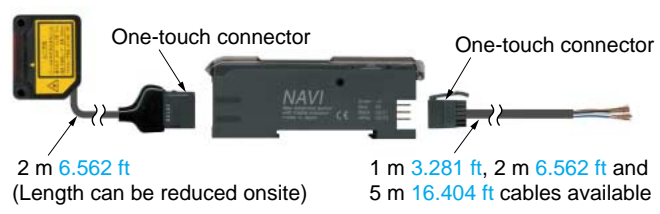

6 Wiring and space saving

The quick-connection cables enable reductions in wiring (connector type). The connections and man-hours for the relay terminal setup can be reduced and valuable space saved. Also, can be connected in a side-by-side with FX-300 series fiber sensors possible.



Easy 4

High Performance



Easy to use highly functions | Handy functions used onsite made simple.

1 Accurately sensing the minutest variations (M.G.S. function)

New recommendation

When sensing at close range or when the target objects are transparent or minute, adjust the sensor receiving sensitivity to one of 3 levels for the optimal setting. In addition, changing the receiving sensitivity will not effect the response time.

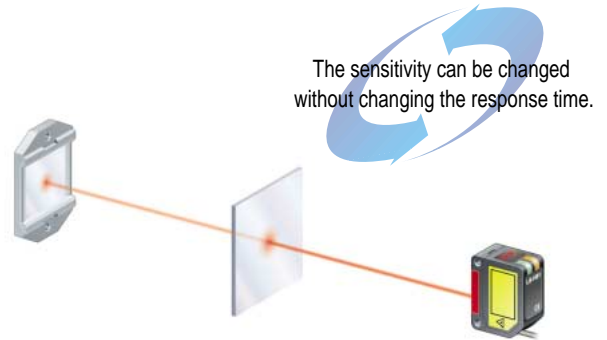
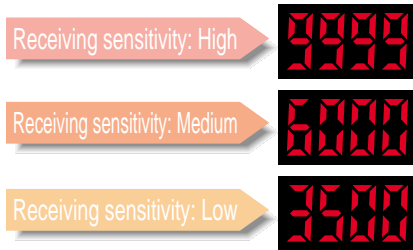

2 4 new modes enabling variegated sensing

Hysteresis mode

New recommendation

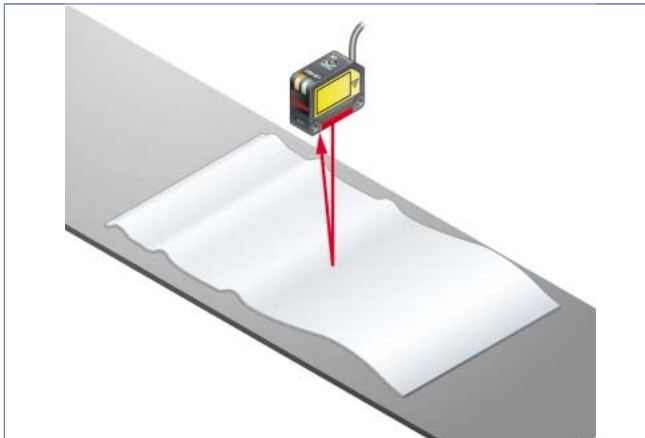

By adjusting the hysteresis, convexo-concave parts of uneven objects can be cancelled enabling more stable sensing.

Window comparator mode

New recommendation

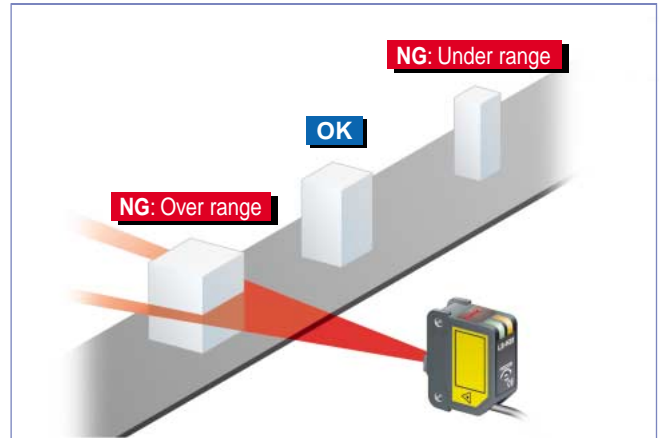

The sensor judges any object as outside the range established by two set threshold values.

2 independent output mode

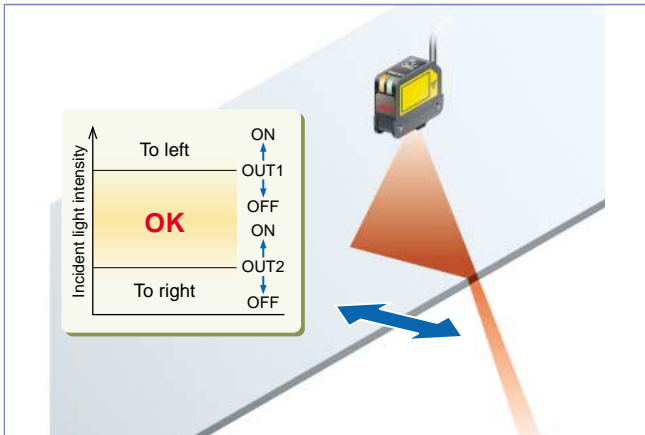

Variegated control possible by combining 2 outputs. This is optimal for meander detection.

Differential sensing mode



Only the drastic changes of received light are detected for accurate edge sensing of glass or other objects. Optimal for positioning.

3 MODE NAVI customized function

New recommendation

Settings can be easily changed by selecting most frequently used response time, M.G.S. function, data bank load, emission halt function and D-CODE values and storing them in the CUSTOM mode.

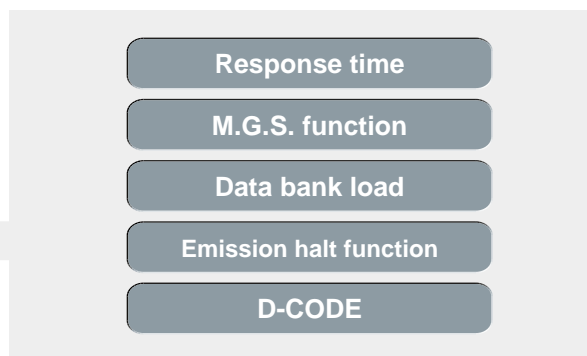
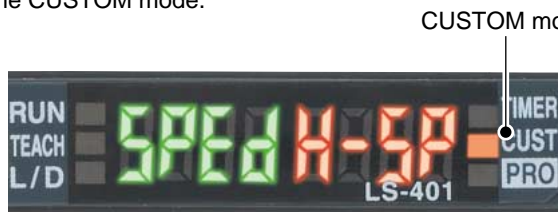

4 Equipped with handy, easy to use functions

Emission halt function

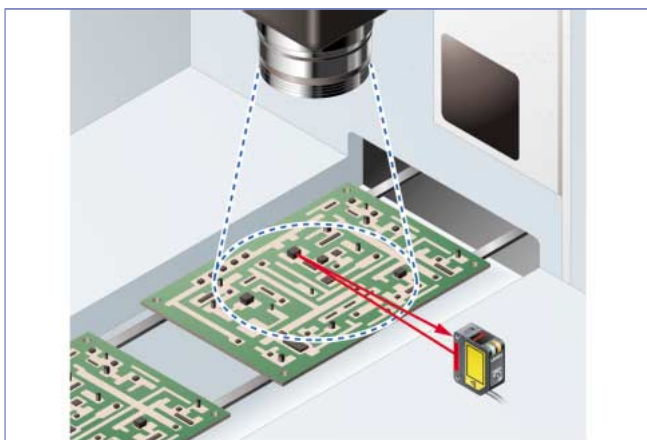

Using the emission halt function, the laser beam can be stopped in such instances as when a spot appears within the visual range of an image processor by external input.

External teaching function

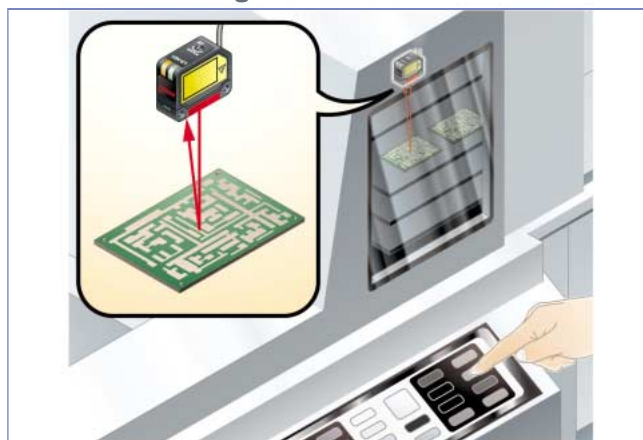

Teaching from an external input outside the device can be achieved even for laser sensors installed into the device.

Interference prevention function

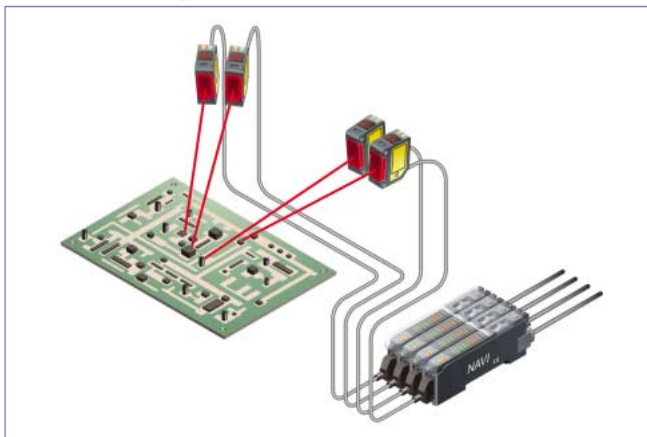

The automatic interference prevention function protects against interference between up to 4 sensors. This is effective when the laser sensors are mounted close together with **FX-301** fiber sensors.

Setting conditions viewed at a glance (D-CODE) New recommendation

<Code setting example>

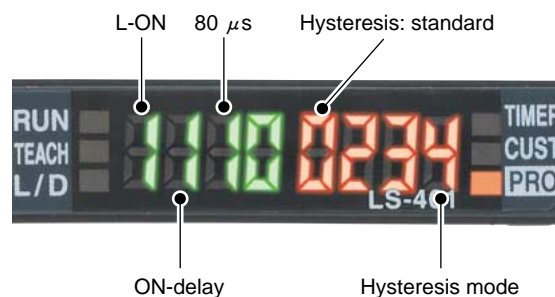



The amplifier setting is shown as an 8-digit code. Handy for remote indications and follow-ups.

LS

ORDER GUIDE

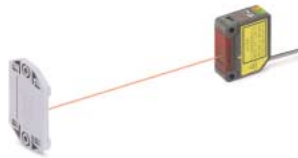

Sensor heads

Type	Appearance	Model No.	Conforming standards	Sensing range	■ : U-LG ■ : STD ■ : FAST ■ : H-SP
Coaxial retroreflective		LS-H91	IEC / JIS	■ 0.1 to 7 m 0.328 to 22.966 ft (Note 2) ■ 0.1 to 5 m 0.328 to 16.404 ft (Note 2) ■ 0.1 to 3 m 0.328 to 9.843 ft (Note 2) ■ 0.1 to 3 m 0.328 to 9.843 ft (Note 2)	
		LS-H91F	FDA (Note 1)		
Diffuse reflective		LS-H21	IEC / JIS	■ 30 to 1,000 mm 1.181 to 39.370 in ■ 30 to 500 mm 1.181 to 19.685 in ■ 30 to 300 mm 1.181 to 11.811 in ■ 30 to 300 mm 1.181 to 11.811 in	
		LS-H21F	FDA (Note 1)		
Diffuse reflective		LS-H22 (Note 3)	IEC / JIS	■ 30 to 1,000 mm 1.181 to 39.370 in ■ 30 to 500 mm 1.181 to 19.685 in ■ 30 to 300 mm 1.181 to 11.811 in ■ 30 to 300 mm 1.181 to 11.811 in	
		LS-H22F (Note 3)	FDA (Note 1)		

NOTE: Mounting bracket is not supplied with the sensor head. Please select from the range of optional sensor head mounting brackets.

Notes: 1) This product complies with 21 CFR 1040.10 and 1040.11 Laser Notice No. 50, dated July 26, 2001, issued by CDRH (Center for Devices and Radiological Health) under the FDA (Food and Drug Administration). For details, refer to the Laser Notice No. 50.
 2) The sensing range is the possible setting range for the reflector. The sensor can detect an object less than 0.1 m **0.328 ft** away.
 3) **LS-H22** is the set model No. for **LS-H21** long sensing range spot reflective type sensor head combined with the **LS-MR1** lens attachment for line reflective. **LS-H21** is indicated for the actual product.

Amplifiers

Type	Appearance	Model No.	Output	Connection method
Connector type		LS-401	NPN open-collector transistor two outputs	Use quick-connection cable (optional)(Note)
		LS-401P	PNP open-collector transistor two outputs	
Cable type		LS-401-C2	NPN open-collector transistor two outputs	2 m 6.562 ft cabtyre cable included Cable outer diameter: ϕ 3.7 mm ϕ 0.146 in
		LS-401P-C2	PNP open-collector transistor two outputs	

Note: Quick-connection cable is not supplied with the connector type amplifier. Please order it separately.

Quick-connection cables Quick-connection cable is not supplied with the connector type amplifier. Please order it separately.

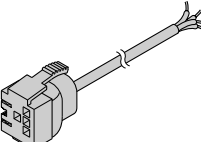
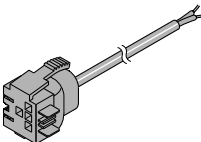
Type	Appearance	Model No.	Description
Main cable		CN-74-C1	Length: 1 m 3.281 ft
		CN-74-C2	Length: 2 m 6.562 ft
		CN-74-C5	Length: 5 m 16.404 ft
Sub cable		CN-72-C1	Length: 1 m 3.281 ft
		CN-72-C2	Length: 2 m 6.562 ft
		CN-72-C5	Length: 5 m 16.404 ft

End plates End plates are not supplied with the amplifier. Please order separately when the amplifiers are mounted in cascade.

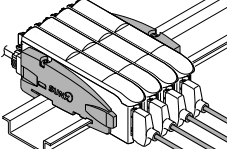
Type	Model No.	Description
	MS-DIN-E	When cascading multiple amplifiers, or when it moves depending on the way it is installed on a DIN rail, these end plates clamp amplifiers into place on both sides. Make sure to use end plates when cascading multiple amplifiers together. Two pcs. per set

ORDER GUIDE

Accessories

RF-330 (Reflector)

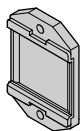

CN-EP1 (Connector for amplifier)

5 pcs. per set (Note)

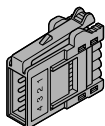

Note: One is attached to each sensor head according to standard.

LS-MR1 (Lens attachment for line reflective)

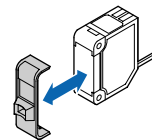

Material: Lens Norbornene resin
Mounting part ... POM

OPTIONS

Designation	Model No.	Description
Sensor head mounting bracket	MS-CX-1	Foot angled mounting bracket
	MS-CX-2	Foot biangled mounting bracket Flat mounting possible to avoid obstructions caused by the height of the sensor.
	MS-CX-3	Back angled mounting bracket
	MS-CX-4	Protective mounting bracket Protects sensors preventing beam axis displacement due to shocks.
Universal sensor mounting stand (Note)	MS-AJ1	Horizontal mounting type
	MS-AJ2	Vertical mounting type
	MS-AJ1-A	Horizontal mounting type
	MS-AJ2-A	Vertical mounting type
Amplifier mounting bracket	MS-DIN-2	Mounting bracket for amplifier
Fiber amplifier protective seal	FX-MB1	10 sets of 2 communication window seals and 1 connector seal Communication window seal: It prevents malfunction due to transmission signal from another amplifier, as well as, prevents effect on another amplifier. Connector seal: It prevents contact of any metal, etc., with the pins of the quick-connection cable.
Reflector	RF-310	Compact reflector Sensing range: 0.1 to 7 m 0.328 to 22.966 ft

Sensor head mounting bracket

• **MS-CX-1**

Two M3 (length 12 mm **0.472 in**) screws with washers are attached.

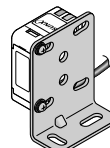

• **MS-CX-2**

Two M3 (length 12 mm **0.472 in**) screws with washers are attached.

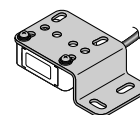

• **MS-CX-3**

Two M3 (length 12 mm **0.472 in**) screws with washers are attached.

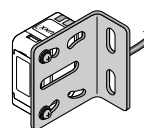

• **MS-CX-4**

Two M3 (length 12 mm **0.472 in**) screws with washers are attached.

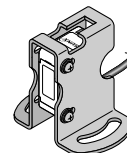

Amplifier mounting bracket

• **MS-DIN-2**

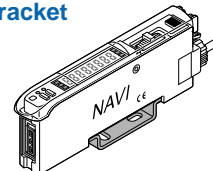

Fiber amplifier protective seal

• **FX-MB1**

Communication window seal

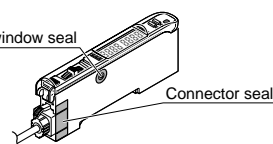

Note: Refer to the 'sensor general catalog 2003-2004' for details of the universal sensor mounting stand.

Universal sensor mounting stand

• **MS-AJ1**

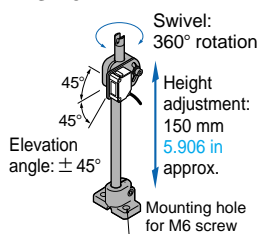

• **MS-AJ1-A**

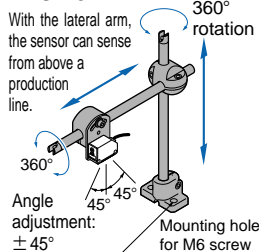

• **MS-AJ2**

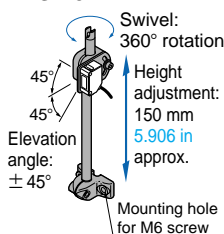

• **MS-AJ2-A**

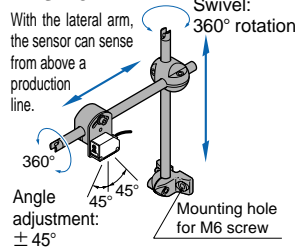

Reflector

• **RF-310**

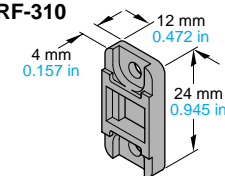

SPECIFICATIONS

Sensor heads

Item	Model No. IEC / JIS standards conforming type FDA standards conforming type (Note 1)	Type	Diffuse reflective	
		Coaxial retroreflective	Long sensing range spot reflective	Long sensing range line reflective
		LS-H91	LS-H21	LS-H22 (Note 2)
		LS-H91F	LS-H21F	LS-H22F (Note 2)
Applicable amplifiers		LS-400 series		
Sensing range	U-LG mode	0.1 to 7 m 0.328 to 22.966 ft	30 to 1,000 mm 1.181 to 39.370 in	30 to 1,000 mm 1.181 to 39.370 in
	STD mode	0.1 to 5 m 0.328 to 16.404 ft	30 to 500 mm 1.181 to 19.685 in	30 to 500 mm 1.181 to 19.685 in
	FAST mode	0.1 to 3 m 0.328 to 9.843 ft	30 to 300 mm 1.181 to 11.811 in	30 to 300 mm 1.181 to 11.811 in
	H-SP mode			
Operation indicator		Orange LED (lights up when the amplifier output is ON)		
Laser emission indicator		Green LED (lights up during laser emission)		
Spot-size adjuster		Multi-turn adjuster		
Ambient temperature		- 10 to + 55 °C (No dew condensation or icing allowed), Storage: - 20 to + 70 °C		
Ambient humidity		35 to 85 % RH, Storage: 35 to 85 % RH		
Emitting element		Red semiconductor laser, Class 2 (IEC / FDA / JIS)(Max. output: 3 mW, peak emission wavelength: 655 nm 0.026 mil)		
Material		Enclosure: PBT (Polybutylene terephthalate)(Mounting part: PEI), Lens cover: Acrylic		
Cable		0.1 mm ² , single core two parallel shielded cables, 2 m 6.562 ft long (Connector for amplifier attached)(Note 3)		
Weight		30 g approx.	30 g approx.	30 g approx.
Accessories		RF-330 (Reflector): 1 pc. Warning label: 2 pcs. (English 1 pc. and Japanese 1 pc.) [FDA conforming type: 1 pc. (Based on IEC)]	Warning label: 2 pcs. (English 1 pc. and Japanese 1 pc.) [FDA conforming type: 1 pc. (Based on IEC)]	LS-MR1 (Lens attachment for line reflective): 1 pc. Warning label: 2 pcs. (English 1 pc. and Japanese 1 pc.) [FDA conforming type: 1 pc. (Based on IEC)]

Notes: 1) FDA approved devices based on Laser Notice No. 50.
 2) **LS-H22**□ is the set model No. for **LS-H21**□ long distance spot reflective type sensor head combined with the **LS-MR1** lens attachment for line reflective.
LS-H21□ is indicated for the actual product.
 3) Cable cannot be extended.

Amplifiers

Item	Model No.	Type	Connector type	Cable type
		NPN output	LS-401	LS-401-C2
		PNP output	LS-401P	LS-401P-C2
Supply voltage		12 to 24 V DC ± 10 % Ripple P-P 10 % or less		
Power consumption		Normal operation: 950 mW or less (Current consumption 40 mA or less at 24 V supply voltage) ECO mode: 780 mW or less (Current consumption 33 mA or less at 24 V supply voltage)		
Output (Output 1, Output 2)	<NPN output type> NPN open-collector transistor		<PNP output type> PNP open-collector transistor	
	<ul style="list-style-type: none"> • Maximum sink current: 100 mA (Note 1) • Applied voltage: 30 V DC or less (between output and 0 V) • Residual voltage: 1.5 V or less [at 100 mA (Note 1) sink current] 		<ul style="list-style-type: none"> • Maximum source current: 100 mA (Note 1) • Applied voltage: 30 V DC or less (between output and + V) • Residual voltage: 1.5 V or less [at 100 mA (Note 1) source current] 	
	Output operation		Selectable either Light-ON or Dark-ON, with jog switch	
Short-circuit protection		Incorporated		
Response time		80 μs or less (H-SP), 150 μs or less (FAST), 500 μs or less (STD), 4 ms or less (U-LG) selectable with jog switch		
External input (Laser emission halt Full-auto teaching / Limit teaching)		<NPN output type> NPN non-contact input <ul style="list-style-type: none"> • Signal condition High: +5V to + V DC or open, Low: 0 to + 2 V DC (sink current 0.5 mA) • Input impedance: 10 kΩ approx. <PNP output type> PNP non-contact input <ul style="list-style-type: none"> • Signal condition High: +4V to + V DC (source current 3 mA or less), Low: 0 to + 0.6 V DC or open • Input impedance: 10 kΩ approx. 		
Digital display		4 digit (green) + 4 digit (red) LED display		
Sensitivity setting		Normal mode: 2-level teaching / Limit teaching / Full auto teaching / Manual adjustment Window comparator mode: Teaching (1-level, 2-level, 3-level) / Manual adjustment Hysteresis mode: Teaching (1-level, 2-level, 3-level) / Manual adjustment Differential mode: 5-level settings		
Fine sensitivity adjustment function		Incorporated		
Timer function		Incorporated with variable ON-delay / OFF-delay / ONE SHOT timer, switchable either effective or ineffective. (Timer period: 1 ms to 9,999 ms approx.)		
Automatic interference prevention function		Incorporated [Up to four sets of sensor heads can be mounted close together (However, disabled when in H-SP mode)]		
Ambient temperature		- 10 to + 55 °C (If 4 to 7 units are mounted close together: - 10 to + 50 °C, if 8 to 16 units are mounted close together: - 10 to + 45 °C) (No dew condensation or icing allowed), Storage: - 20 to + 70 °C		
Ambient humidity		35 to 85 % RH, Storage: 35 to 85 % RH		
Material		Enclosure: Heat-resistant ABS, Transparent cover: Polycarbonate, Push button switch: Acrylic, Jog switch: ABS		
Cable		____ (Note 2) 0.15 mm ² 5-core cabtyre cable, 2 m 6.562 ft long		
Cable extension		Extension up to total 100 m 328.084 ft is possible with 0.3 mm ² , or more, cable.		
Weight		15 g approx.		65 g approx.

Notes: 1) 50 mA if 5 to 8 connector type amplifiers are connected in cascade, and 25 mA if 9 to 16 connector type amplifiers are connected in cascade.
 2) The cable is not supplied as an accessory for connector type **LS-401(P)**. Be sure to use the optional quick-connection cables given below.
 Main cable (4-core): **CN-74-C1** (cable length 1 m **3.281 ft**), **CN-74-C2** (cable length 2 m **6.562 ft**), **CN-74-C5** (cable length 5 m **16.404 ft**)
 Sub cable (2-core): **CN-72-C1** (cable length 1 m **3.281 ft**), **CN-72-C2** (cable length 2 m **6.562 ft**), **CN-72-C5** (cable length 5 m **16.404 ft**)

I/O CIRCUIT AND WIRING DIAGRAMS

NPN output type

I/O circuit diagram

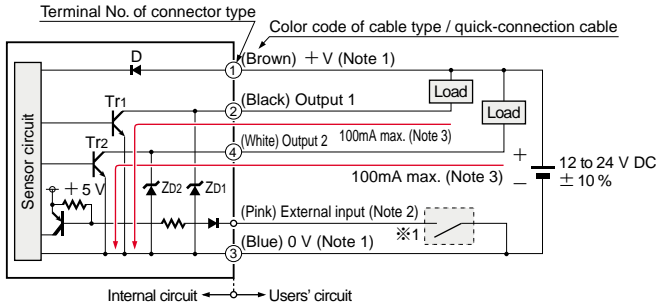

- Notes: 1) The quick-connection sub cable does not have + V (brown) and 0 V (blue).
The power is supplied from the connector of the main cable.
2) Connector type **LS-401(P)** does not incorporate the external input.
3) 50 mA max. if 5 to 8 connector type amplifiers are connected in cascade, and 25 mA max. if 9 to 16 connector type amplifiers are connected in cascade.

※1

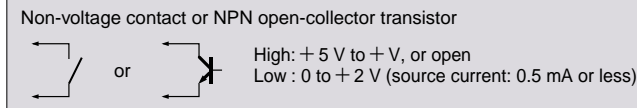

Symbols ... D: Reverse supply polarity protection diode
Zd1, Zd2: Surge absorption zener diode
Tr1, Tr2 : NPN output transistor

Wiring diagram

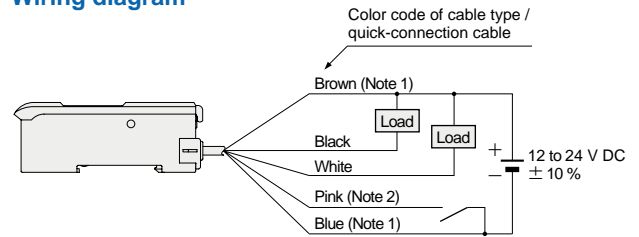

- Notes: 1) The quick-connection sub cable does not have brown lead wire and blue lead wire.
The power is supplied from the connector of the main cable.
2) The quick-connection cable does not have pink lead wire.

Terminal layout of connector type

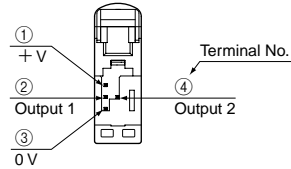

※Connector for amplifier (CN-EP1) pin position

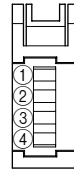

Terminal No.	Connection cable	
①	Conductor core wire: Brown	Cable color: Gray
②	Shield wire	
③	Conductor core wire: Yellow	Cable color: Black
④	Shield wire	

PNP output type

I/O circuit diagram

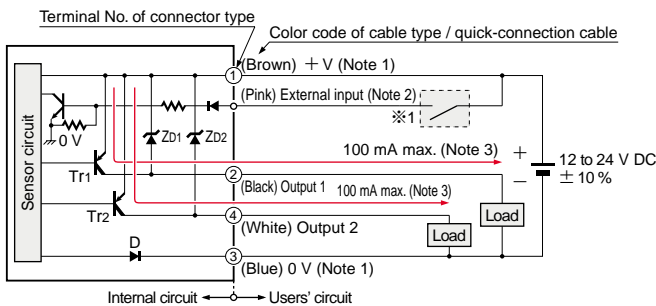

- Notes: 1) The quick-connection sub cable does not have + V (brown) and 0 V (blue).
The power is supplied from the connector of the main cable.
2) Connector type **LS-401(P)** does not incorporate the external input.
3) 50 mA max. if 5 to 8 connector type amplifiers are connected in cascade, and 25 mA max. if 9 to 16 connector type amplifiers are connected in cascade.

※1

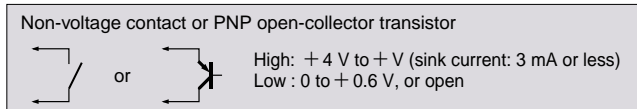

Symbols ... D: Reverse supply polarity protection diode
Zd1, Zd2: Surge absorption zener diode
Tr1, Tr2 : PNP output transistor

Wiring diagram

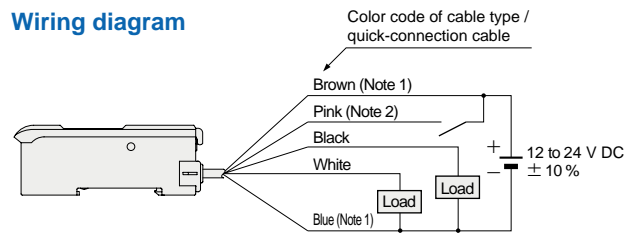

- Notes: 1) The quick-connection sub cable does not have brown lead wire and blue lead wire.
The power is supplied from the connector of the main cable.
2) The quick-connection cable does not have pink lead wire.

Terminal layout of connector type

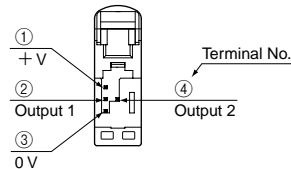

※Connector for amplifier (CN-EP1) pin position

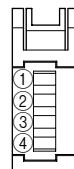

Terminal No.	Connection cable	
①	Conductor core wire: Brown	Cable color: Gray
②	Shield wire	
③	Conductor core wire: Yellow	Cable color: Black
④	Shield wire	

LS

PRECAUTIONS FOR PROPER USE

- This catalog is a guide to select a suitable product. Be sure to read the instruction manual attached to the product prior to its use.



This product is not a safety sensor. Its use is not intended or designed to protect life and prevent body injury or property damage from dangerous parts of machinery. It is a normal object detection sensor.

Cautions for laser beams



- These products are class 2 laser in compliance with IEC / FDA / JIS standards. To reduce the risk of danger, do not look directly at the laser beam or view it through an optical system.
- The right appears on labels adhered to the product. Handle this sensor as per the instruction on the labels. [In addition, both English and Japanese warning labels are included. (IEC / JIS conforming type)]
- The English warning label based on FDA standards is pasted on the FDA standards conforming type. [In addition, English warning label (based on IEC) is included.]



- The safety standard IEC 60825-1 specifies the use of laser beam products. Please read it carefully before using the laser beam sensor.

Part description (Amplifier)

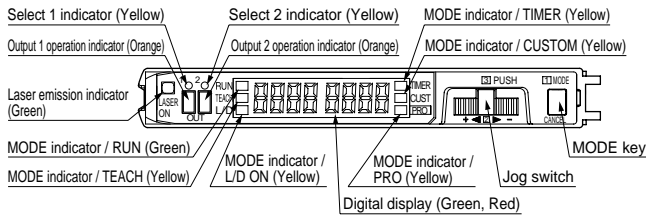

Spot-size adjuster (Only for LS-H21, LS-H22)

- The diffuse reflective type **LS-H21** and **LS-H22** incorporate the spot-size adjuster to adjust the size of spot size.

Spot-size adjuster	Description
	Turn the spot-size adjuster clockwise or counter-clockwise to adjust the spot size at your desired detecting distance. However, if the adjuster is over turned, it may be damaged.

Mounting

Amplifier

<How to mount the amplifier>

- ① Fit the rear part of the mounting section of the amplifier on a 35 mm 1.378 in width DIN rail.
- ② Press down the rear part of the mounting section of the unit on the 35 mm 1.378 in width DIN rail and fit the front part of the mounting section to the DIN rail.

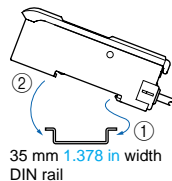

<How to remove the amplifier>

- ① Push the amplifier forward.
- ② Lift up the front part of the amplifier to remove it.

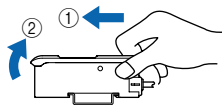

Note: Take care that if the front part is lifted without pushing the amplifier forward, the hook on the rear portion of the mounting section is likely to break.

<How to mount the sensor head>

- ① Insert the sensor head connector into the inlet until it clicks.
- ② Fit the cover to the connector.

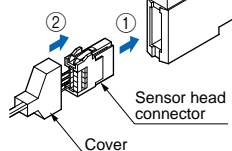

Sensor head

- The tightening torque should be 0.5 N·m or less.

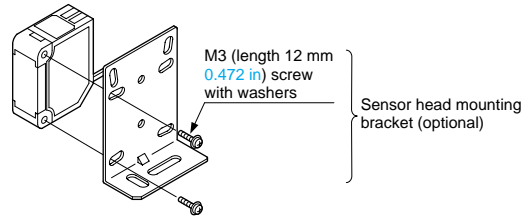

- When placing the sensor head horizontally or vertically, the reflector must also be positioned horizontally or vertically as shown in Fig. 1 below. If the sensor head is placed horizontally or vertically but the mirror is tilted as shown in Fig. 2 below, the reflection amount will decrease, which may cause unstable detection.

Fig. 1 Proper positioning

When placing the sensor head horizontally or vertically, the reflector shall also be positioned horizontally or vertically.

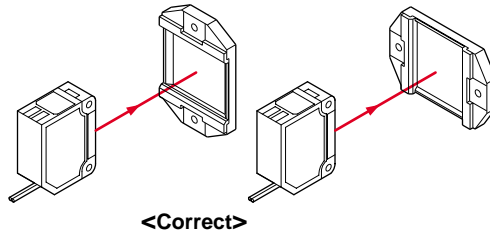
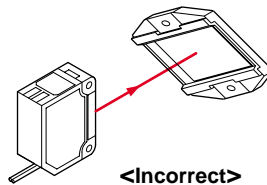

Fig. 2 Improper positioning

When placing the reflector tilted even when the sensor head is positioned horizontally or vertically.



Lens attachment for line reflective type (LS-MR1)

- The lens attachment for line reflective type **LS-MR1** mounted on the long sensing range line reflective type **LS-H22** is removable. When **LS-H22** is used without **LS-MR1**, it will provide the equivalent performance to the long sensing range spot reflective type **LS-H21**. In addition, the optional **LS-MR1** can be attached to **LS-H21** to obtain the performance equivalent to **LS-H22**.
- Keep the lens from dust, dirt, water, oil, grease, etc.
- Do not apply any excessive force to **LS-MR1**. Such force may cause damage.

Removing method

- ① Insert a screwdriver into the fixing slot located at the top of sensor head.
- ② Tilt the screwdriver inserted in Step ① to remove **LS-MR1**.

Mounting method

- ① The size of upper fixing hook of **LS-MR1** is not same as lower fixing hook. After confirming upper and lower fixing hooks, insert **LS-MR1** upper fixing hook into the fixing slot at the top of sensor head and then insert **LS-MR1** lower fixing hook into the fixing slot at the bottom of sensor head.
- ② After mounting, check that **LS-MR1** is properly fixed to the sensor head.

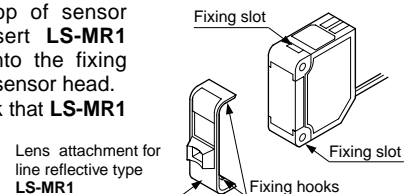

DIMENSIONS (Unit: mm in) The CAD data in the dimensions can be downloaded from the SUNX website: <http://www.sunx.co.jp/>

LS-H91(F) Sensor head

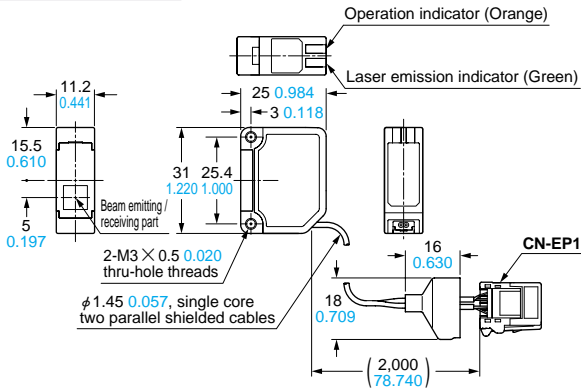

LS-H21(F) Sensor head

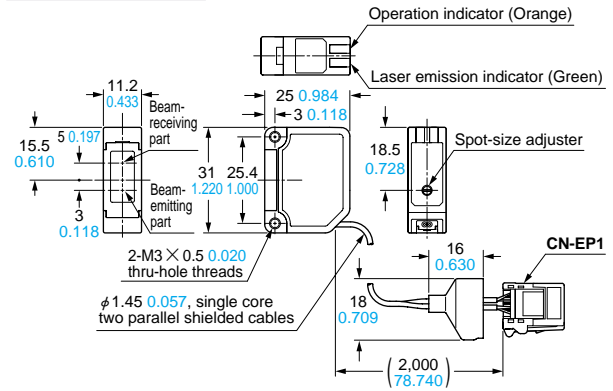

LS-H22(F) Sensor head

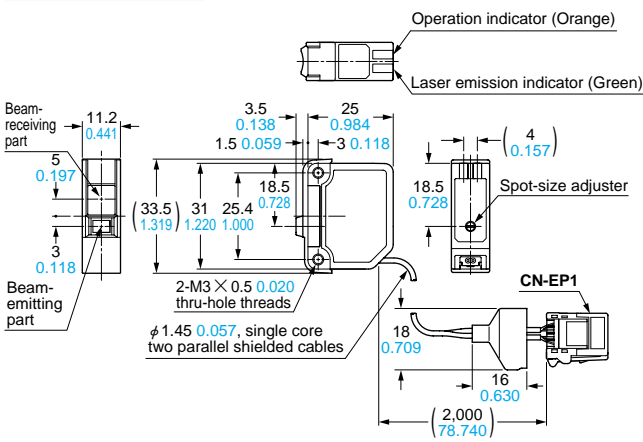

LS-401 LS-401P Amplifier

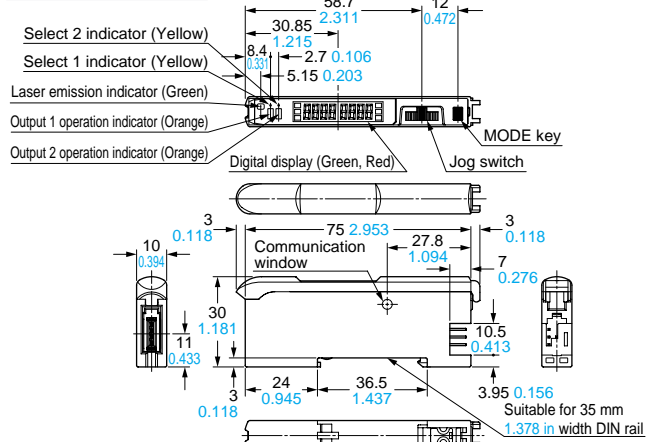

LS-401-C2 LS-401P-C2 Amplifier

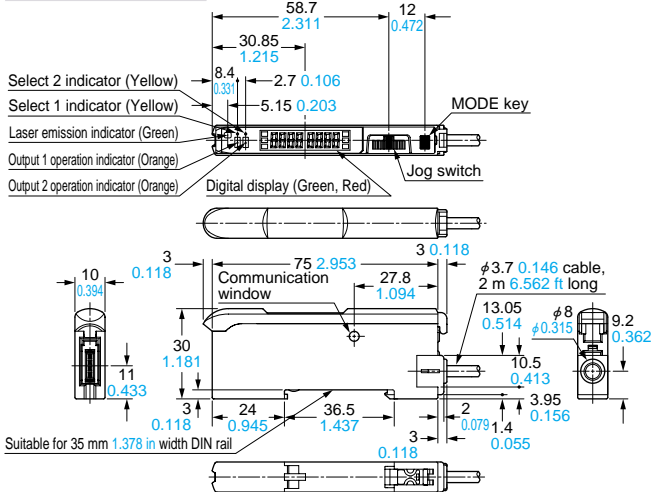

MS-DIN-E End plate (Optional)

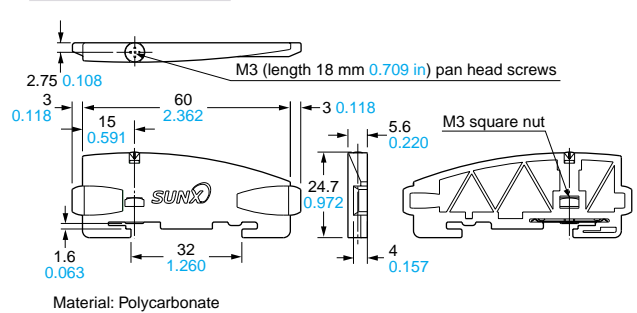

RF-330 Reflector (Accessory for LS-H91)

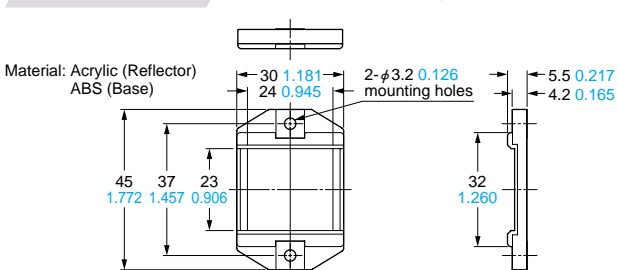

RF-310 Reflector (Optional)

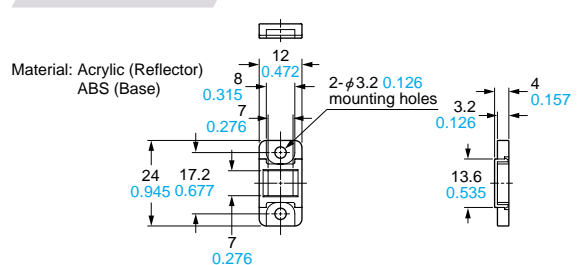

DIMENSIONS (Unit: mm in) The CAD data in the dimensions can be downloaded from the SUNX website: <http://www.sunx.co.jp/>

MS-DIN-2 Amplifier mounting bracket (Optional)

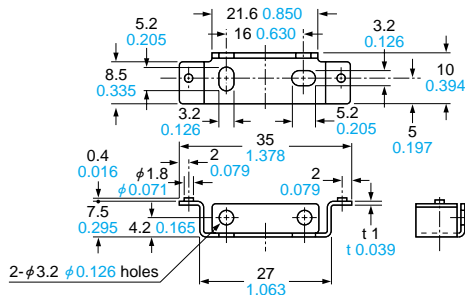

Material: Cold rolled carbon steel (SPCC)
(Uni-chrome plated)

MS-CX-1 Sensor head mounting bracket (Optional)

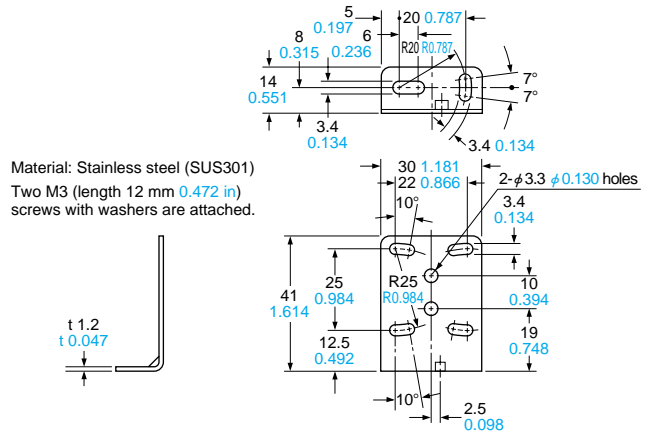

Material: Stainless steel (SUS301)
Two M3 (length 12 mm 0.472 in)
screws with washers are attached.

MS-CX-2 Sensor head mounting bracket (Optional)

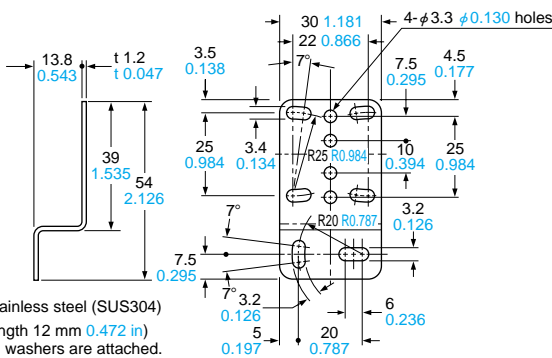

Material: Stainless steel (SUS304)
Two M3 (length 12 mm 0.472 in)
screws with washers are attached.

MS-CX-3 Sensor head mounting bracket (Optional)

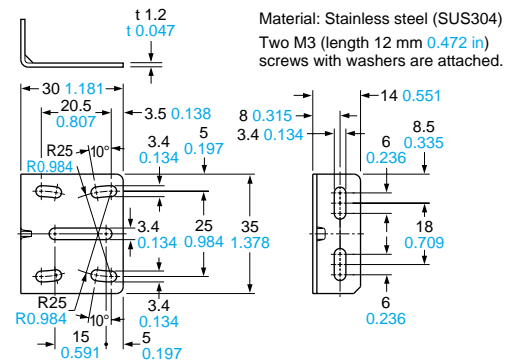

Material: Stainless steel (SUS304)
Two M3 (length 12 mm 0.472 in)
screws with washers are attached.

MS-CX-4 Sensor head mounting bracket (Optional)

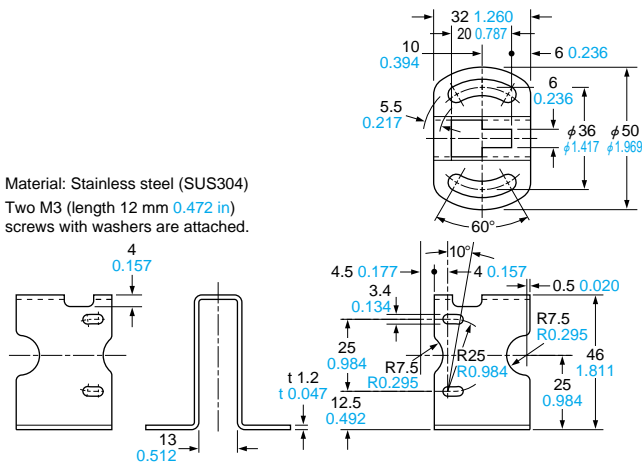

Material: Stainless steel (SUS304)
Two M3 (length 12 mm 0.472 in)
screws with washers are attached.

All information is subject to change without prior notice.



SUNX Limited
2431-1 Ushiyama-cho, Kasugai-shi, Aichi,
486-0901, Japan
Phone: +81-(0)568-33-7211
FAX: +81-(0)568-33-2631

Overseas Sales Dept.
Phone: +81-(0)568-33-7861
FAX: +81-(0)568-33-8591

<http://www.sunx.co.jp/>