

Miniature, High-performance Motor Timer

- Employs high-reliability bifurcated contacts for output.
- Moving pointer provided in all types for confirmation of elapsed time.
- Employs time-out and power ON indicators for all types.
- Wide variety of timing ranges from 5 s to 24 hrs.

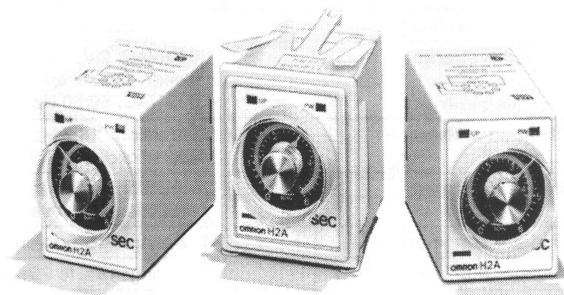

Ordering Information

| Operation/resetting system | Internal connection | Time-limit contact | Instantaneous contact | Mounting |
|---|---|--------------------|-----------------------|-------------------------------|
| | | | | Surface mounting (see note 2) |
| Time-limit operation/ self-resetting | Parallel motor and clutch connection | SPDT | --- | H2A |
| | | | SPST-NO | H2A-H |

- Note:**
1. Specify both the model number and supply voltage when ordering.
 2. Surface mounting models can be used as a flush mounting type by attaching an exclusive adapter (Y92F-40) to the timer.

Specifications

■ Time Ranges

| Rated time | Time setting range | | Time division |
|------------|--------------------|---------------|---------------|
| | 50 Hz | 60 Hz | |
| 5 s | 0.2 to 6 s | 0.2 to 5 s | 0.2 s |
| 10 s | 0.5 to 12 s | 0.5 to 10 s | 0.5 s |
| 30 s | 1 to 36 s | 1 to 30 s | 1.0 s |
| 60 s | 2 to 72 s | 2 to 60 s | 2.0 s |
| 3 min | 1/6 to 3 1/2 min | 1/6 to 3 min | 10.0 s |
| 6 min | 1/4 to 7 1/6 min | 1/4 to 6 min | 15.0 s |
| 12 min | 1/2 to 14 min | 1/2 to 12 min | 30.0 s |
| 30 min | 1 to 36 min | 1 to 30 min | 1.0 min |
| 60 min | 2 to 72 min | 2 to 60 min | 2.0 min |
| 3 hrs | 1/6 to 3 1/2 hrs | 1/6 to 3 hrs | 10.0 min |
| 6 hrs | 1/4 to 7 hrs | 1/4 to 6 hrs | 15.0 min |
| 12 hrs | 1/2 to 14 hrs | 1/2 to 12 hrs | 30.0 min |
| 24 hrs | 1 to 28 hrs | 1 to 24 hrs | 1.0 hrs |

■ Ratings

| | |
|--------------------------------|---|
| Rated supply voltage | 100, 110, 200, or 220 VAC (50 Hz), 100/110, 200/220 VAC (60 Hz) |
| Operating voltage range | 85% to 110% of rated supply voltage |
| Power consumption | Approx. 3 VA |
| Control outputs | Standard type: 2 A at 250 VAC, resistive load (cosφ = 1) |

- Note:** The front panel of the timer is color-coded to identify the following supply voltage classifications:
- 100, 110 V: Blue
 - 200, 220 V: Red
 - Other classes: Black

■ Characteristics

| | |
|----------------------------|--|
| Accuracy of operating time | ±2% max. (±3% max. for the 5-s model) |
| Setting error | ±5% max. |
| Reset time | 0.3 s max. |
| Influence of voltage | ±1% max. |
| Influence of temperature | ±2% max. |
| Insulation resistance | 100 MΩ min. (at 500 VDC) |
| Dielectric strength | 2,000 VAC, 50/60 Hz for 1 min (between current-carrying and non-current-carrying parts, between contact and control circuit and between contacts of different polarities) 1,000 VAC, 50/60 Hz for 1 min (between non-continuous contacts) |
| Vibration resistance | Destruction: 16.7 Hz with 4-mm double amplitude Malfunction: 10 to 55 Hz with 0.5-mm double amplitude |
| Shock resistance | Destruction: 1,000 m/s ² (approx. 100G) Malfunction: 100 m/s ² (approx. 10G) (5G for lateral shocks) |
| Ambient temperature | Operating: -10°C to 50°C |
| Ambient humidity | Operating: 45% to 85% |
| Life expectancy | Mechanical: 1,000,000 operations min. (under no load at operating of 1,800 operations/hr) Electrical: See "Engineering Data" |
| Motor life expectancy | 20,000 hrs |
| Approved standards | UL (File No. E52800-US), CSA (File No. LR22310-US) |
| Weight | Approx. 170 g |

Engineering Data

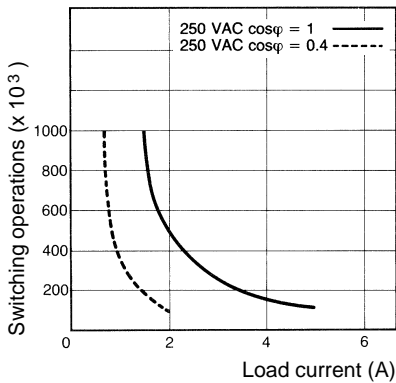

Operation

■ Timing Chart

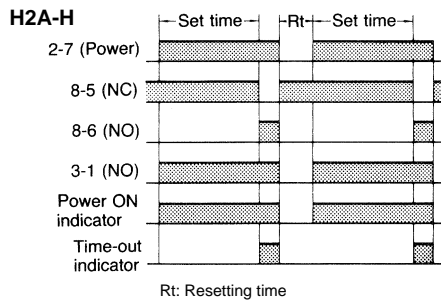
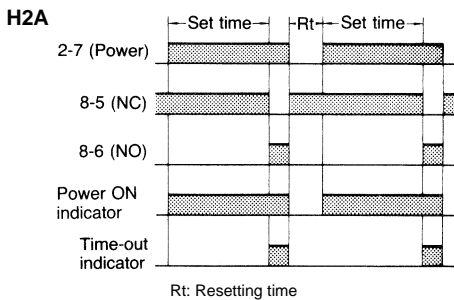

Dimensions

Note: All units are in millimeters unless otherwise indicated.

H2A/H2A-H

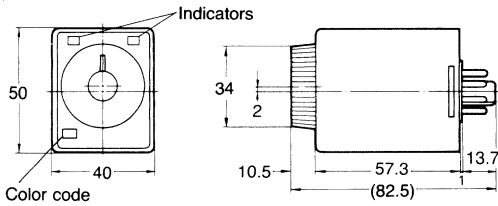

Note: F-shaped hook (PHC-1) for PF085A and L-shaped hook (PHC-4) for PL08 are supplied with the timer.

H2A(-H) with Adapter

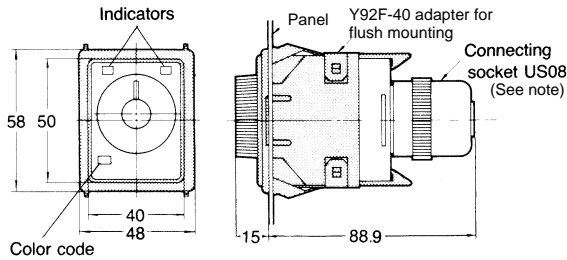

Panel Cutouts

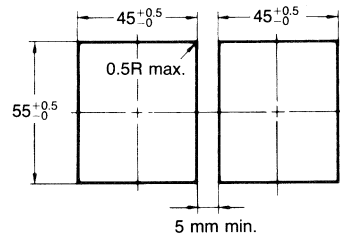

Note: Back connecting socket US08 and Y-shaped hook PHC-3 are supplied with the timers.

■ Accessories (Order Separately)

Adapter for Flush Mounting

Y92F-40

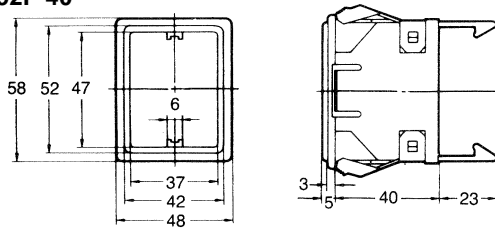

Panel Cutouts

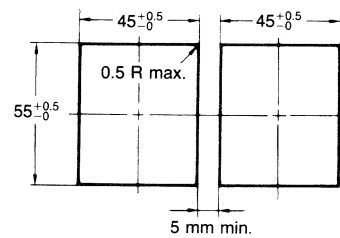

Track Mounted/Front Connecting Socket

PF085A

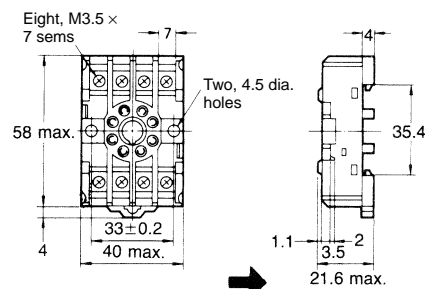

Terminal Arrangement (Top View)

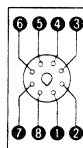

Mounting Holes

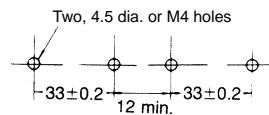

Mounting Height of Timer with Socket

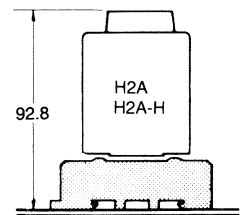

Note: PF085A can be used as a front connecting socket.

Back Connecting Socket

PL08 (Solder Terminals)

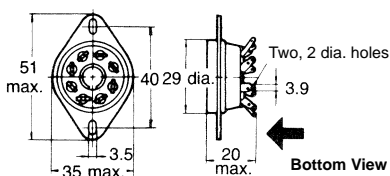

Terminal Arrangement (Bottom View)



Mounting Holes

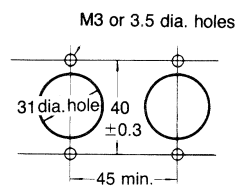

Mounting Height of Timer with Socket

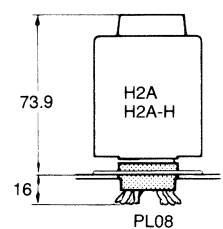

Mounting Track (Meets DIN EN50022)

PFP-100N/PFP-50N

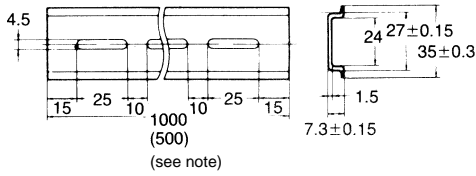

Note: This dimension applied to PFP-50N.

Hold-down Clips (Attached)

PHC-1 For PF085A

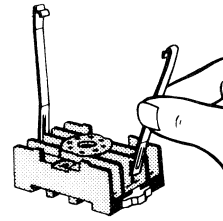

End Plate

PFP-M

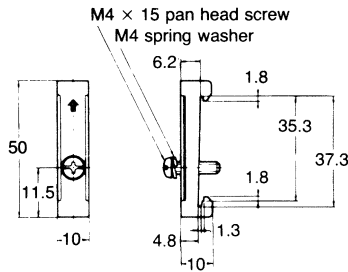

PFP-S

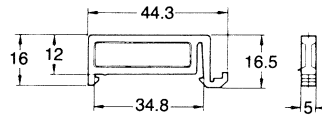

Installation

Terminal Arrangement

H2A

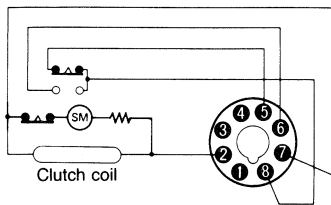

H2A-H

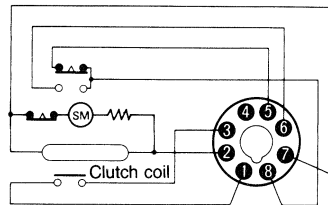

Precautions

Mounting

When two or more timers are to be mounted in line, provide a distance of more than 5 mm between the two adjacent timers.

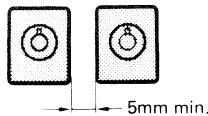

When two or more timers mounted in line are to be continuously energized at the same time after the set time has elapsed, be sure to limit the carry current to less than 1 A.

When using the timers at an ambient temperature of more than 40°C, be sure to reset the timers immediately after the set time has elapsed.

Wiring

When wiring, employ a multi-core cable having a finished outer diameter of less than 10.5 mm, or insulated (twisted) wires with less than a 3 mm outer diameter.

ALL DIMENSIONS SHOWN ARE IN MILLIMETERS.
To convert millimeters into inches, multiply by 0.03937. To convert grams into ounces, multiply by 0.03527.

Cat. No. L04-E1-8 **In the interest of product improvement, specifications are subject to change without notice.**

OMRON Corporation

Systems Components Division
28th Fl., Crystal Tower Bldg.
1-2-27, Shiromi, Chuo-ku,
Osaka 540 Japan
Phone: 06-949-6012 Fax: 06-949-6021

Printed in Japan
0697-0.5C (0696)