



SS - SP series

M18 DC with lateral adjustment



features

- Models with side sens. adjustment on axial and right angle optic
- LO/DO selectable output
- ATEX models, cat. 3, available on request
- LED status indicator for all versions
- Complete protection against electrical damages
- IP67 protection degree for all models
- Approvals: CE and cULus listed

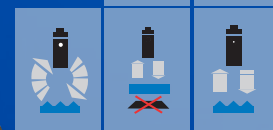

M18 DC with lateral adjustment

web contents

- Application notes
- Photos
- Catalogue / Manuals



code description (*)

background suppression

SS 0 / 0 N - 0 A

series	SS	M18 photoelectric sensors with axial optic
type	0	50 mm background suppr. without sens. adjust.
	1	100 mm background suppr. without sens. adjust.
	T	Focalizer background suppr. 12 mm (with focalizer STF-12) - 25 mm (with focalizer STF-25)
output	0	LO/DO selectable output
	L	3 wires – light on
	D	3 wires – dark on
NPN / PNP output	N	NPN output
	P	PNP output
housing material	0	Plastic housing
	1	Metallic housing
cable / plug exit	A	Axial cable exit 2 m
	E	M12 plug cable exit

(*) ATEX models available, contact our Sales Dept. for further information.



code description

diffuse reflection and retro-reflective

SS 2 / 0 N - 0 A

M18 DC with lateral adjustment

series	SS	M18 photoelectric sensors with axial optic
	SP	M18 photoelectric sensors with right angle optic
type	2	100 mm diffuse reflection without sens. adjust.
	3	100 mm diffuse reflection with sens. adjust.
	7	400 mm diffuse reflection with sens. adjust.
	8	800 mm diffuse reflection with sens. adjust.
	C	5 m retro-reflective without sens. adjust. ⁽¹⁾
	P	4 m polarized retro-reflective without sens. adjust. ⁽¹⁾
output	0	LO/DO selectable output
	L	3 wires - light on
	D	3 wires - dark on
NPN / PNP output	N	NPN output
	P	PNP output
housing material	0	Plastic housing
	1	Metallic housing
cable / plug output	A	Axial cable exit
	E	M12 plug cable exit
	3X	Retro-reflective and polarized with sens. adjust.

⁽¹⁾ Special version with sens. adjust, 3X variant

code description

through beam

SS H / 0 0 - 0 A

series	SS	M18 photoelectric sensors with axial optic
	SP	M18 photoelectric sensors with right angle optic
type	H	14 m emitter without sens. adjust.
	Z	14 m receiver without sens. adjust.
	D	14 m receiver with sens. adjust.
	U	Emitter with reduced visible beam
	G	8 m receiver for small object
	V	3 m receiver for ultra small object
	0	Emitter without check - LO/DO selectable
features	X	Emitter with check
	L	3 wires - light on - S*D and S*Z only
	D	3 wires-dark on - S*D and S*Z only
	A	3 wires - light on - S*G and S*V only
	C	3 wires-dark on - S*G and S*V only
NPN / PNP output	0	Emitter
	N	NPN output
	P	PNP output
housing material	0	Plastic housing
	1	Metallic housing
cable / plug exit	A	Axial cable exit
	E	M12 plug cable exit - S*H, S*D and S*Z" versions only
	H	M12 plug cable exit - S*U, S*G and S*V versions only

SS - SP

available models

plug exit photoelectric sensors axial optic

function	distance	housing	adjustment	3 wires LO NPN	3 wires LO PNP	3 wires DO NPN	3 wires DO PNP	4 wires NPN LO / DO	4 wires PNP LO / DO
background suppression	50 mm	plastic	-	-	SS0/LP-0E	-	-	SS0/0N-0E	SS0/0P-0E
		metallic		-	SS0/LP-1E	-	-	SS0/0N-1E	SS0/0P-1E
	100 mm	plastic		-	SS1/LP-0E	-	-	SS1/0N-0E	SS1/0P-0E
		metallic		-	SS1/LP-1E	-	-	SS1/0N-1E	SS1/0P-1E
	focalized	plastic		-	-	-	-	SST/0N-0E	SST/0P-0E
		metallic		-	-	-	-	SST/0N-1E	SST/0P-1E
diffuse reflection	100 m	plastic	●	SS2/LN-0E	SS2/LP-0E	-	-	SS2/0N-0E	SS2/0P-0E
		metallic	-	-	-	-	-	-	
		plastic	●	SS2/LN-1E	SS2/LP-1E	-	-	SS2/0N-1E	SS2/0P-1E
		metallic	-	-	-	-	-	SS3/0P-1E	
	400 mm	plastic	●	-	SS7/LP-0E	-	-	SS7/0N-0E	SS7/0P-0E
		metallic	-	-	SS7/LP-1E	-	-	SS7/0N-1E	SS7/0P-1E
		800 mm	plastic	●	-	-	-	-	SS8/0P-0E
			metallic	-	-	-	-	-	SS8/0P-1E
retro-reflective	4 m	plastic	-	SSC/LN-0E	SSC/LP-0E	SSC/DN-0E	SSC/DP-0E	SSC/0N-0E	SSC/0P-0E
		metallic	●	-	-	-	-	SSC/0N-0E3X	SSC/0P-0E3X
		plastic	●	SSC/LN-1E	SSC/LP-1E	SSC/DN-1E	SSC/DP-1E	SSC/0N-1E	SSC/0P-1E
		metallic	●	-	-	-	-	SSC/0N-1E3X	SSC/0P-1E3X
polarized	3 m	plastic	-	SSP/LN-0E	SSP/LP-0E	SSP/DN-0E	SSP/DP-0E	SSP/0N-1E	SSP/0P-1E
		metallic	●	-	-	-	-	SSP/0N-1E3X	SSP/0P-1E3X
		plastic	●	SSP/LN-1E	SSP/LP-1E	SSP/DN-1E	SSP/DP-1E	SSP/0N-1E	SSP/0P-1E
		metallic	●	-	-	-	-	SSP/0N-1E3X	SSP/0P-1E3X
through-beam	14 m	plastic	emitter	SSH/00-0E					
			em. with check	SSH/X0-0E					
			receiver	SSZ/LN-0E	SSZ/LP-0E	SSZ/DN-0E	SSZ/DP-0E	SSZ/0N-0E	SSZ/0P-0E
			receiver adj.	SSD/LN-0E	SSD/LP-0E	SSD/DN-0E	SSD/DP-0E	SSD/0N-0E	SSD/0P-0E
		metallic	emitter	SSH/00-1E					
			em. with check	SSH/X0-1E					
			receiver	SSZ/LN-1E	SSZ/LP-1E	SSZ/DN-1E	SSZ/DP-1E	SSZ/0N-1E	SSZ/0P-1E
			receiver adj.	SSD/LN-1E	SSD/LP-1E	SSD/DN-1E	SSD/DP-1E	SSD/0N-1E	SSD/0P-1E
	8 m	plastic	emitter	SSU/00-0E					
			receiver	SSG/AN-0E	SSG/AP-0E	SSG/CN-0E	SSG/CP-0E	-	-
		metallic	emitter	SSU/00-1H					
			receiver	SSG/AN-1H	SSG/AP-1H	SSG/CN-1E	SSG/CP-1H	-	-
3 m	plastic	emitter	SSU/00-0E						
		receiver	SSV/AN-0E	SSV/AP-0E	SSV/CN-0E	SSV/CP-0E	-	-	
	metallic	emitter	SSU/00-1H						
		receiver	-						



M18 DC with lateral
adjustment



available models

cable exit photoelectric sensors axial optic

M18 DC with lateral adjustment

function	distance	housing	adjustment	3 wires LO NPN	3 wires LO PNP	3 wires DO NPN	3 wires DO PNP	4 wires NPN LO / DO	4 wires PNP LO / DO	
background suppression	50 mm	plastic	-	-	-	-	-	SS0/0N-0A	SS0/0P-0A	
		metallic		-	-	-	-	SS0/0N-1A	SS0/0P-1A	
	100 mm	plastic		-	-	-	-	SS1/0N-0A	SS1/0P-0A	
		metallic		-	-	-	-	SS1/0N-1A	SS1/0P-1A	
	focalizzata	plastic		-	-	-	-	SST/0N-0A	SST/0P-0A	
		metallic		-	-	-	-	SST/0N-1A	SST/0P-1A	
diffuse reflection	100 m	plastic	●	SS2/LN-0A	SS2/LP-0A	-	SS2/DP-0A	SS2/0N-0A	SS2/0P-0A	
		metallic	-	-	-	-	SS3/0N-0A	SS3/0P-0A		
		plastic	●	SS2/LN-1A	SS2/LP-1A	SS2/DN-1A	SS2/DP-1A	SS2/0N-1A	SS2/0P-1A	
		metallic	-	-	-	-	SS3/0N-1A	SS3/0P-1A		
	400 mm	plastic	●	-	-	-	-	SS7/0N-0A	SS7/0P-0A	
		metallic	-	-	-	-	-	SS7/0N-1A	SS7/0P-1A	
		plastic	●	-	-	-	-	SS8/0N-0A	SS8/0P-0A	
		metallic	-	-	-	-	-	SS8/0N-1A	SS8/0P-1A	
800 mm	plastic	●	-	-	-	-	SS8/0N-0A	SS8/0P-0A		
	metallic	-	-	-	-	-	SS8/0N-1A	SS8/0P-1A		
	plastic	●	-	-	-	-	SSC/0N-0A	SSC/0P-0A		
	metallic	-	-	-	-	-	SSC/0N-1A	SSC/0P-1A		
retro-reflective	5 m	plastic	●	-	-	-	-	SSC/0N-0A3X	SSC/0P-0A3X	
		metallic	-	-	-	-	-	SSC/0N-1A	SSC/0P-1A	
		plastic	●	-	-	-	-	SSC/0N-1A3X	SSC/0P-1A3X	
		metallic	-	-	-	-	-	SSP/DP-0A	SSP/0N-1A	SSP/0P-1A
polarized	4 m	plastic	●	-	-	-	-	SSP/0N-1A3X	SSP/0P-1A3X	
		metallic	-	-	-	-	-	SSP/DP-1A	SSP/0N-1A	SSP/0P-1A
		plastic	●	-	-	-	-	SSP/0N-1A3X	SSP/0P-1A3X	
		metallic	-	-	-	-	-	SSP/0N-1A3X	SSP/0P-1A3X	
through-beam	14 m	plastic	emitter	SSH/00-0A						
			em. with check	SSH/X0-0A						
			receiver	SSZ/LN-0A	SSZ/LP-0A	SSZ/DN-0A	SSZ/DP-0A	SSZ/0N-0A	SSZ/0P-0A	
			receiver adj.	-	-	-	-	SSD/0N-0A	SSD/0P-0A	
		metallic	emitter	SSH/00-1A						
			em. with check	SSH/X0-1A						
			receiver	-	-	-	-	SSZ/0N-1E	SSZ/0P-1E	
			receiver adj.	-	-	-	-	SSD/0N-1E	SSD/0P-1E	
	8 m	plastic	emitter	SSU/00-0A						
			receiver	SST/AN-0A	SST/AP-0A	SST/CN-0A	SST/CP-0A	-	-	
			emitter	SSU/00-1A						
			em. with check	SSU/X0-1A						
		metallic	receiver	SST/AN-1A	SST/AP-1A	SST/CN-1A	SST/CP-1A	-	-	
			emitter	SSU/00-0A						
			em. with check	SSU/X0-0A						
			receiver	-	SSV/AP-0A	-	-	-	-	
3 m	plastic	emitter	SSU/00-0A							
		em. with check	SSU/X0-0A							
	metallic	emitter	SSU/00-1A							
		receiver	-	SSV/AP-1A	-	-	-	-		



available models

plug exit photoelectric sensors radial optic

function	distance	housing	adjustment	3 wires LO NPN	3 wires LO PNP	3 wires DO NPN	3 wires DO PNP	4 wires NPN LO/DO	4 wires PNP LO/DO
diffuse reflection	100 mm	plastic	-	SP2/LN-0E	SP2/LP-0E	-	-	SP2/ON-0E	SP2/OP-0E
		metallic	●	-	-	-	-	-	SP3/OP-0E
	400 mm	metallic	-	SP2/LN-1E	SP2/LP-1E	-	-	SP2/ON-1E	SP2/OP-1E
		plastic	●	-	-	-	-	-	SP3/OP-1E
				-	-	-	-	-	SP7/OP-0E
		metallic	-	-	-	-	-	SP8/OP-0E	
through-beam	14 m	plastic	emitter	SPH/00-0E					
		metallic	receiver with check	-	-	-	-	SPZ/ON-0E	SPZ/OP-0E
	8 m	plastic	emitter	SPH/00-1E					
		metallic		SPU/00-0E					
		metallic		SPU/00-1E					

available models

cable exit photoelectric sensors radial optic

function	distance	housing	adjustment	3 wires LO NPN	3 wires LO PNP	3 wires DO NPN	3 wires DO PNP	4 wires NPN LO/DO	4 wires PNP LO/DO
diffuse reflection	100 mm	metallic	●	-	-	SP3/DN-1A	-	-	-
	400 mm	plastic		-	-	-	-	SP7/ON-0A	SP7/OP-0A
		metallic		-	-	-	-	SP7/ON-1A	SP7/OP-1A
through-beam	14 m	plastic	emitter	SPH/00-0A					
			em. with check	SPH/X0-0A					
		metallic	receiver	-	-	-	-	SPZ/ON-0A	SPZ/OP-0A
			emitter	SPH/00-1A					
	3 m	metallic	em. with check	SPH/X0-1A					
			receiver	-	-	-	-	SPZ/ON-1A	SPZ/OP-1A
		emitter	SPU/00-1A						



technical specification

background suppression models

M18 DC with lateral adjustment

	SS0/**-**	SS1/**-**	SST/**-**
			
nominal sensing distance	50 mm	100 mm	12/25 mm
emission	red (660 nm)		
spot diameter	see diagram		
minimum detectable object	1 mm	3.5 mm	0.1 mm with STF-12 0.25 mm with STF-25
dfferential travel	≤ 10 %		
repeatability	5 %		
operating voltage	10...30 Vdc		
ripple	≤ 10 %		
supply current	≤ 30 mA		
load current	100 mA		
leakage current	10 µA		
output voltage drop	1.2 V max. IL = 100 mA		
output type	NPN or PNP - LO/DO selectable		
switching frequency	1 kHz		
power on delay	200 ms		
power supply protections	polarity reversal, transient		
output protection	short circuit (autoreset)		
operating temperature range	- 25°C...+ 70°C (without freeze)		
temperature drift	10 % Sr		
protection degree	IP67 (EN60529) ⁽¹⁾		
EMC	in conformity with the EMC Directive according to EN 60947-5-2		
external light interference	3,000 lux (incandescence lamp) 10,000 lux (sunlight)		
LEDs	yellow		
housing material	PBT (plastic) / nicked plated brass (metallic) / PC (cable exit)		
optic material	plastic		
tightening torque	25 Nm (metallic housing), 1 Nm (plastic housing)		
weight (approx)	plastic version: 30 g connector / 70 g cable metallic version: 100 g connector / 130 g cable		

⁽¹⁾ Protection guaranteed only with plug cable well mounted

technical specification

diffuse reflection and retro-reflective models



	diffuse reflection				retro-reflective	polarized
	S*2/**_**	S*3/**_**	S*7/**_**	S*8/**_**	S*C/**_****	S*P/**_****
nominal sensing distance	with white target 100 x 100 mm	400 mm with white target 200 x 200 mm	800 mm with white target 400 x 400 mm	5 m with reflector RL 110	4 m with reflector RL 110	
emission	infrared (880 nm)					red (660 nm)
differential travel	≤ 10 %					
repeatability	5 %					
operating voltage	10...30 Vdc					
ripple	≤ 10 %					
supply current	30 mA					
load current	100 mA					
leakage current	10 µA					
output voltage drop	1.2 V max. IL = 100 mA					
output type	NPN or PNP - LO/DO selectable					
switching frequency	250 Hz					
power on delay	200 ms					
power supply protections	polarity reversal, transient					
output protection	short circuit (autoreset)					
sensibility adjustment	-	●			-	●
operating temperature range	- 25°C...+ 70°C (without freeze)					
temperature drift	10 % Sr					
protection degree	IP67 (EN60529) ⁽¹⁾					
EMC	in conformity with the EMC Directive according to EN 60947-5-2					
external light interference	3,000 lux (incandescence lamp), 10,000 lux (sunlight)					
LEDs	yellow					
housing material	PBT (plastic) / nicked plated brass / PC (cable exit)					
optic material	plastic					
tightening torque	1 Nm (plastic housing), 25 Nm (metal housing)					
weight (approx)	plastic version: 30 g connector / 70 g cable metallic version: 100 g connector / 130 g cable					

⁽¹⁾ Protection guaranteed only with plug cable well mounted



technical specification

through beam models

M18 DC with lateral adjustment

	standard beam			barrier for small and ultra-small objects		
	emitter	receiver	receiver	emitter	receiver	receiver
	S*H/*0-**	S*Z/**_**	S*D/**_**	S*U/*0-**	S*G/**_**	S*V/**_**
nominal sensing distance	14 m			-	8 m	3 m
minimum detectable object	-			-	Ø 4 mm	Ø 1 mm
emission	infrared (880 nm)			red (660 nm)		
tolerance	-			90% - 200% @ Eg = 1,5		
dfferential travel	≤ 10 %					
repeatability	5 %					
operating voltage	10...30 Vdc					
ripple	≤ 10 %					
supply current	40 mA	30 mA		25 mA	20 mA	
load current	100 mA					
leakage current	10 µA					
output voltage drop	2.5 V max. IL = 100 mA					
output type	NPN or PNP - LO/DO selectable			NPN or PNP - NO or NC		
switching frequency	250 Hz					
power on delay	200 ms					
power supply protections	polarity reversal, transient					
output protection	short circuit (autoreset)					
sensibility adjustment	-	●	-			
operating temperature range	- 25°C...+ 75°C (without freeze)					
temperature drift	10 % Sr			≤ 10 % Sr		
protection degree	IP67 (EN60529) ⁽¹⁾					
EMC	in conformity with the EMC Directive according to EN 60947-5-2					
external light interference	3,000 lux (incandescent lamp), 10,000 lux (sunlight)					
LEDs	yellow			red (activated output)		
housing material	PBT (plastic) / nicked plated brass / PC (cable exit)					
optic material	plastic					
tightening torque	1 Nm (plastic housing), 25 Nm (metallic housing)					
weight (approx)	plastic version: 30 g connector / 70 g cable metallic version: 100 g connector / 130 g cable					

⁽¹⁾ Protection guaranteed only with plug cable well mounted

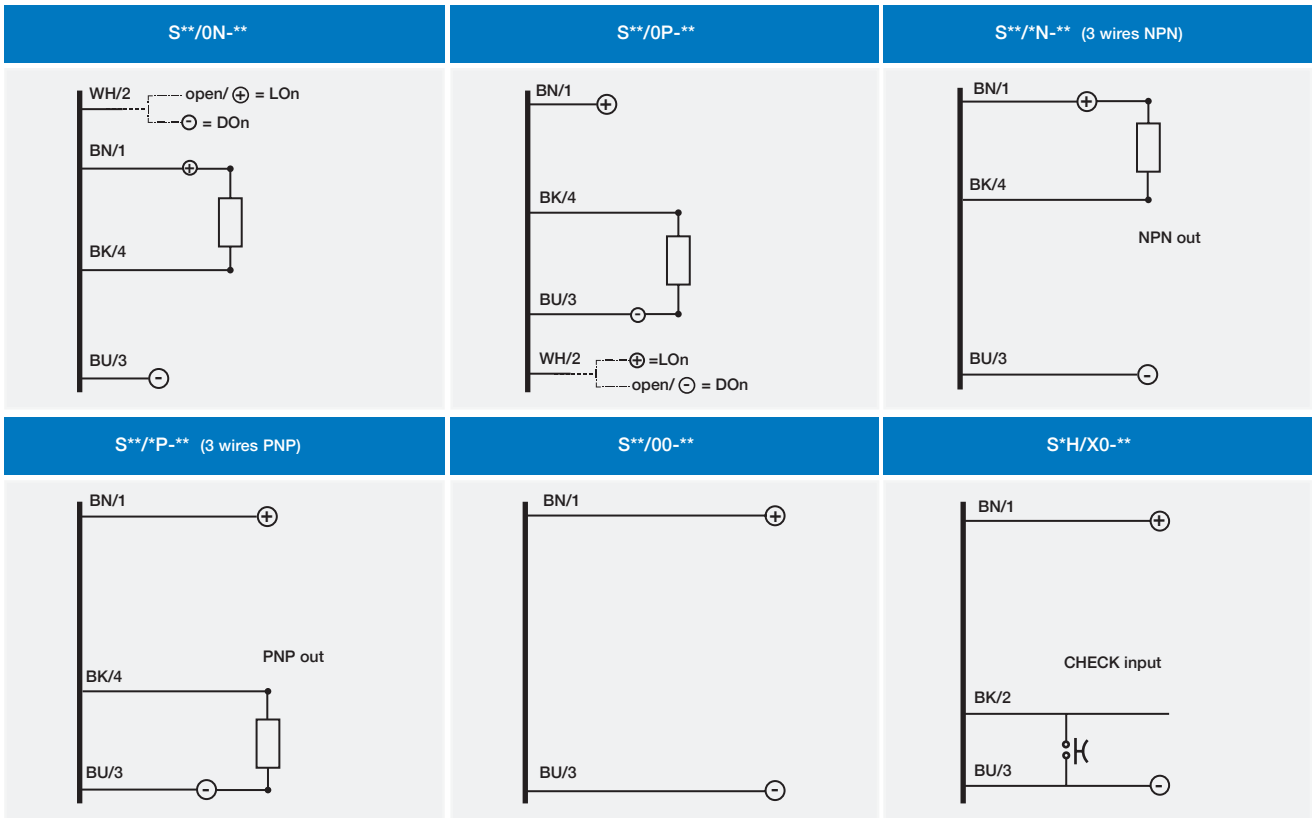

- BN** brown
- BU** blue
- BK** black
- WH** white
- PK** pink
- GY** grey

plug

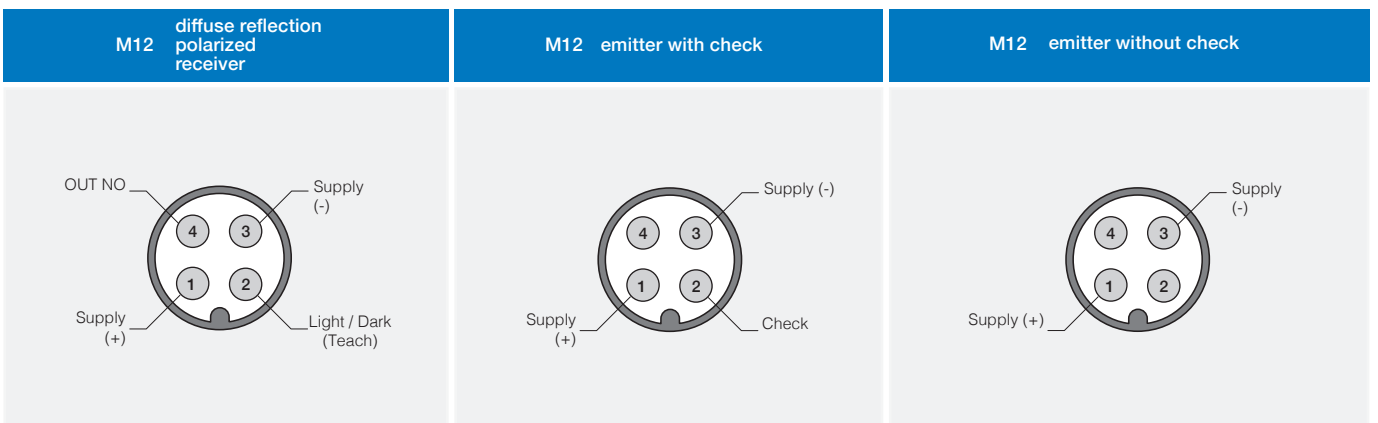



response diagrams

background suppression models

M18 DC with lateral adjustment

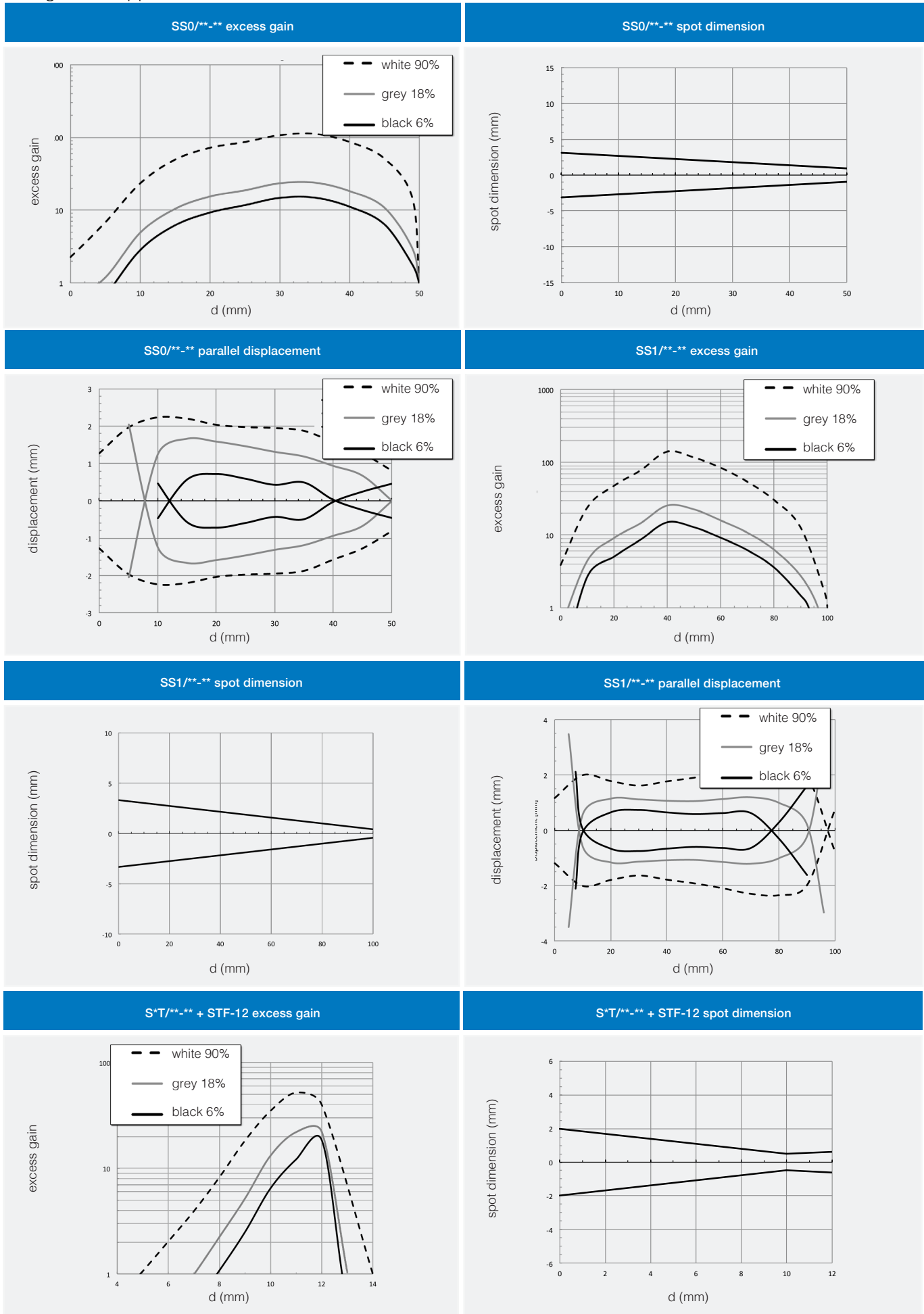

SS - SP



S*T/**-** + STF-12 parallel displacement

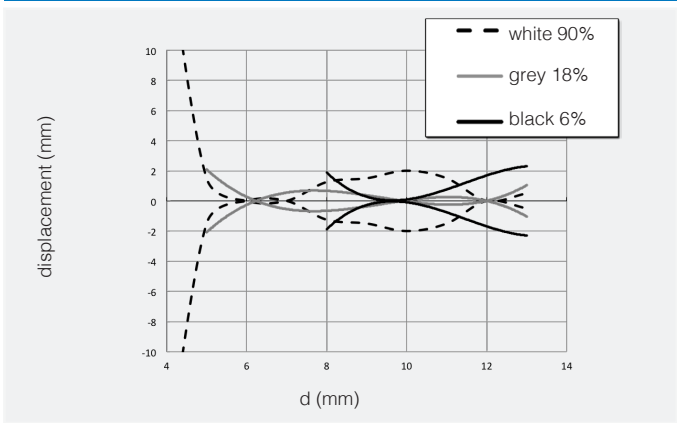

S*T/**-** + STF-25 excess gain

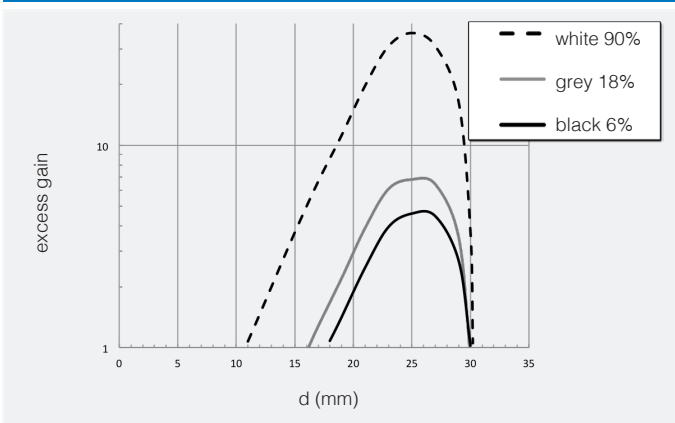

S*T/**-** + STF-25 spot dimension

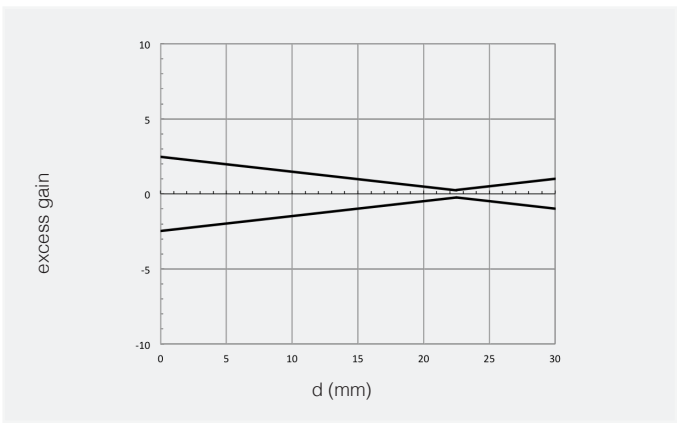

S*T/**-** + STF-25parallel displacementnt

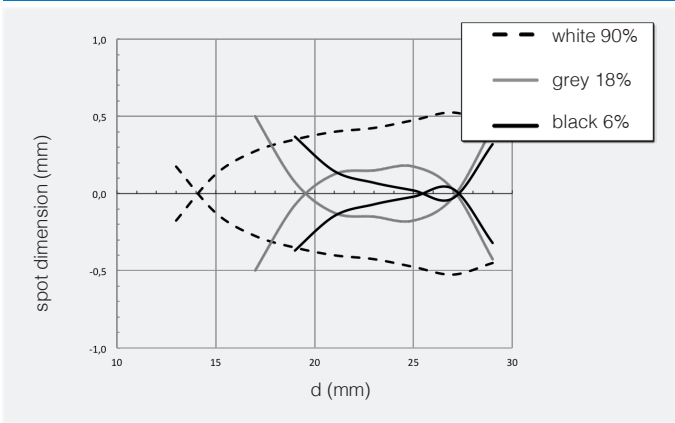

response diagrams

retro-reflective models

S*2,S*3/**-** excess gain

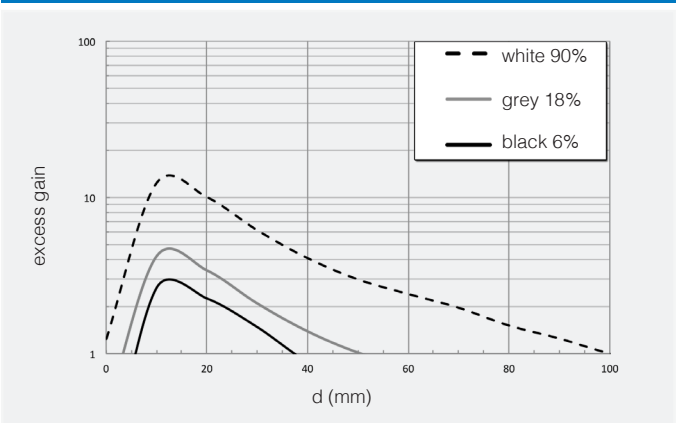

S*2,S*3/**-** spot dimension

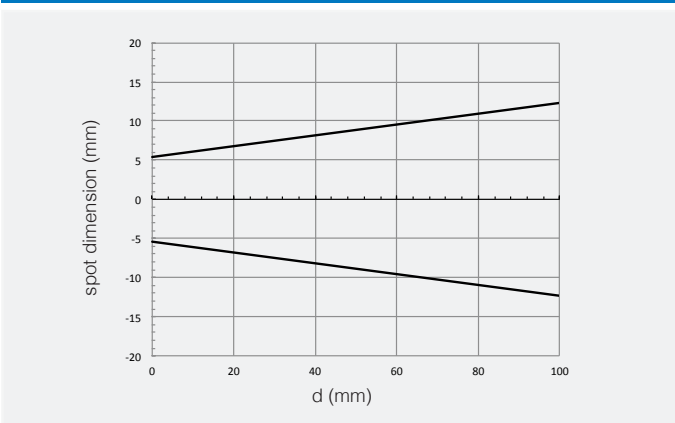

S*2,S*3/**-** parallel displacement

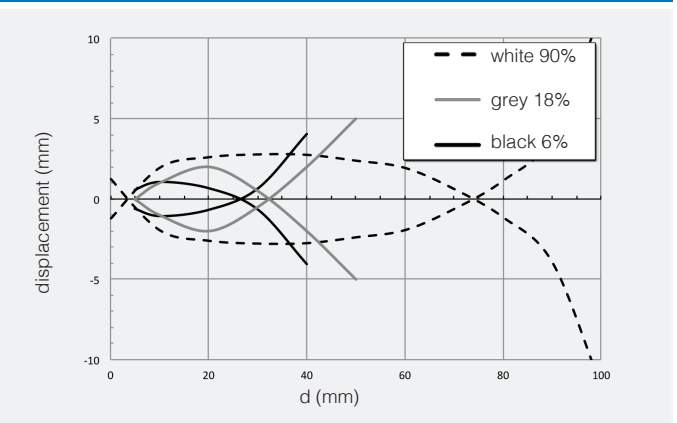

S*6,S*7/**-** excess gain

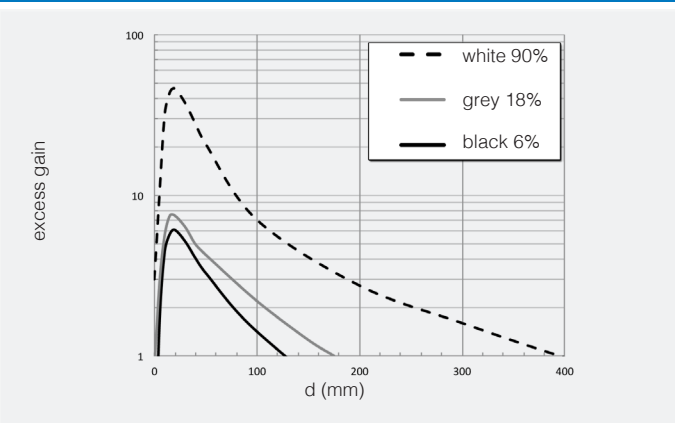



response diagrams

retro-reflective models

M18 DC with lateral adjustment

S*6/**-**,S*7/**-** spot dimension

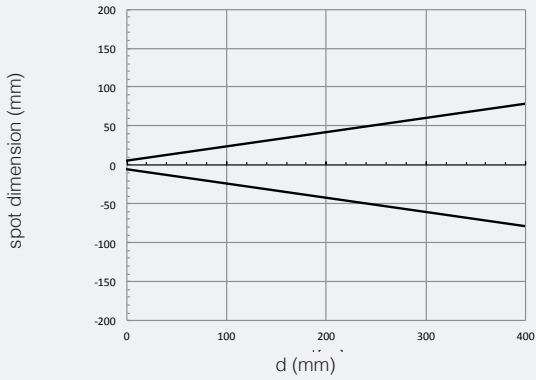

S*6/**-**,S*7/**-** parallel displacement

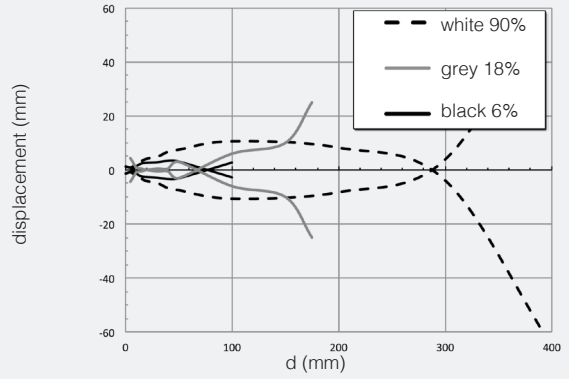

S*8/**-** excess gain

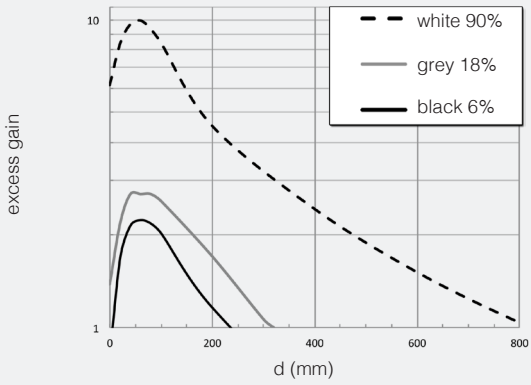

S*8/**-** spot dimension

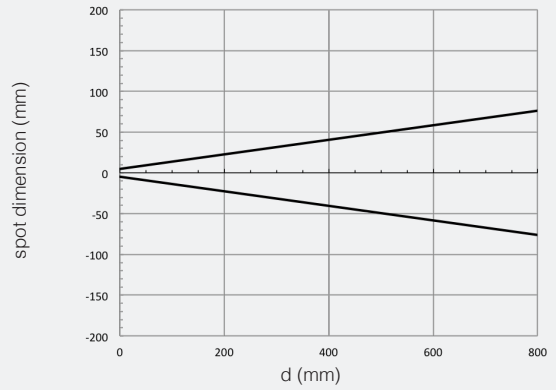

S*8/**-** parallel displacement

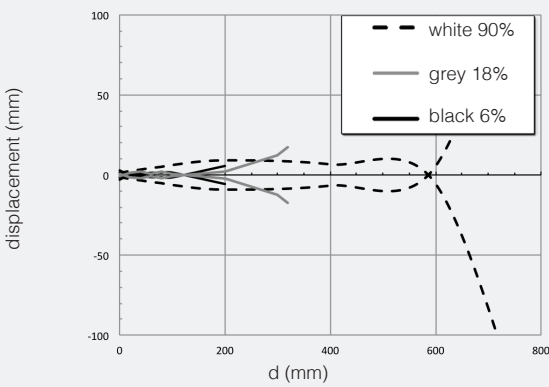

response diagrams

retro-reflective models (diagrams measured using RL100)

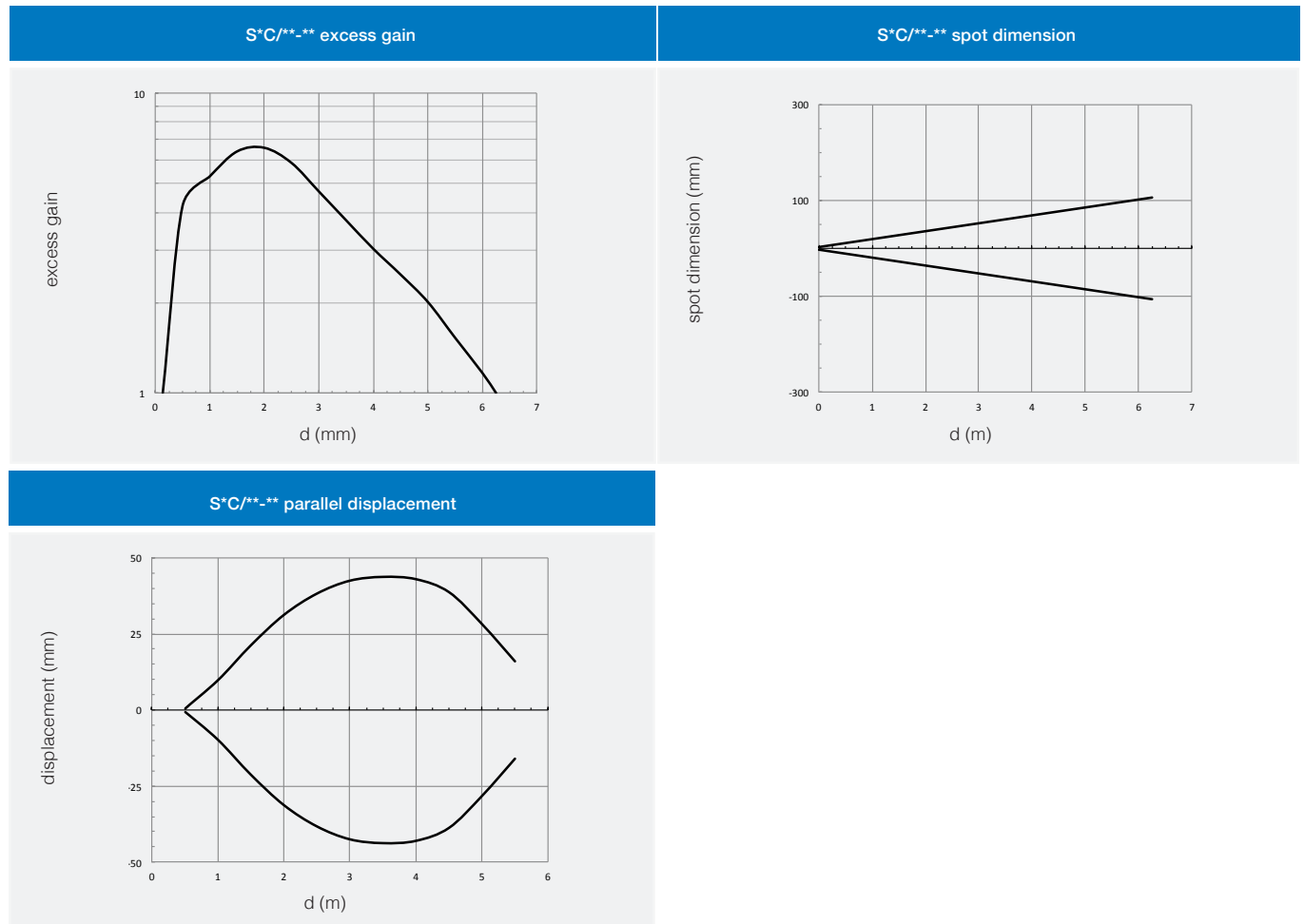

response diagrams

polarized models (diagrams measured using RL100)

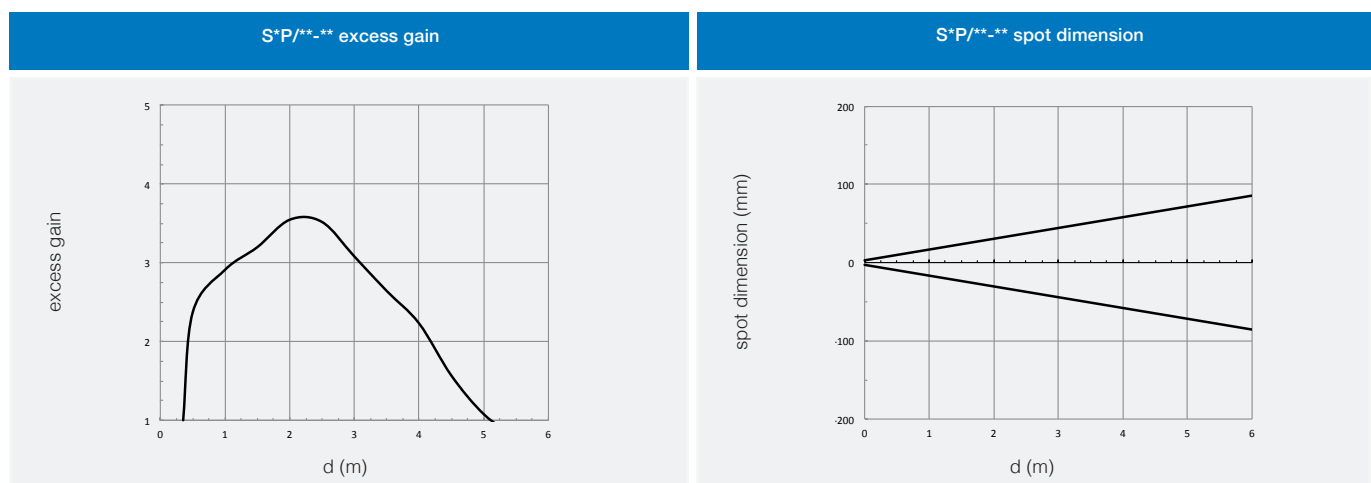



response diagrams

polarized models (diagrams measured using RL100)

M18 DC with lateral adjustment

S*P/**-** parallel displacement

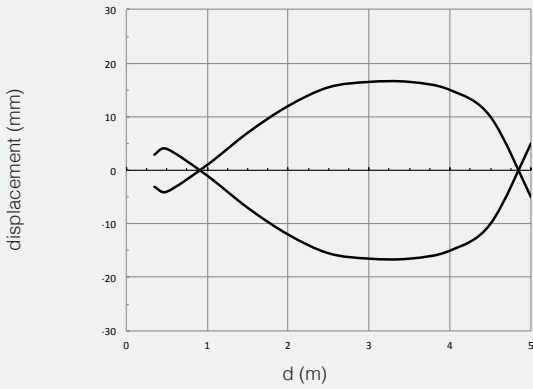

response diagrams

through beam models

S*H/**-(0,1)*, S*D/**-(0,1)* excess gain

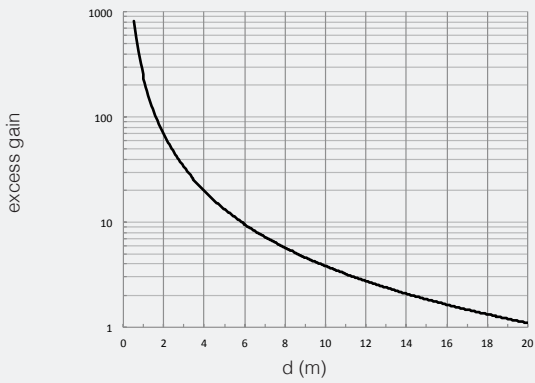

S*H/**-(0,1)*, S*D/**-(0,1)* spot dimension

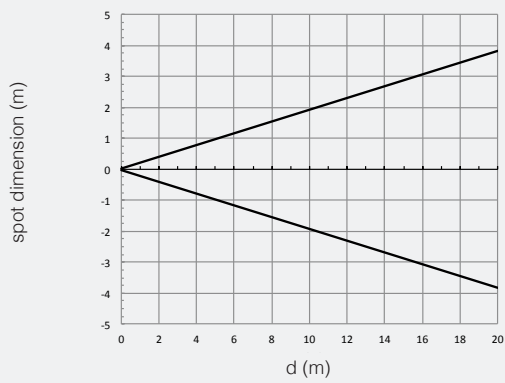

S*H/**-(0,1)*, S*D/**-(0,1)* parallel displacement

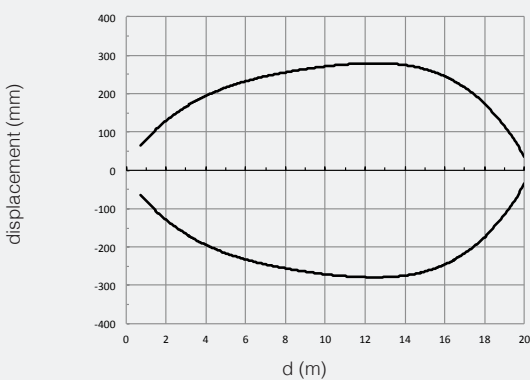

S*U/**-**, S*G/**-** excess gain

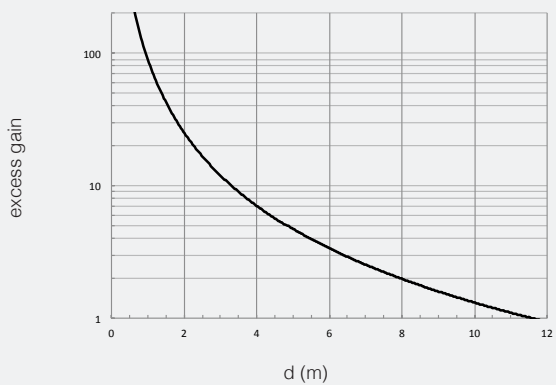

SS - SP



S^*U^{**}, S^*G^{**} spot dimension

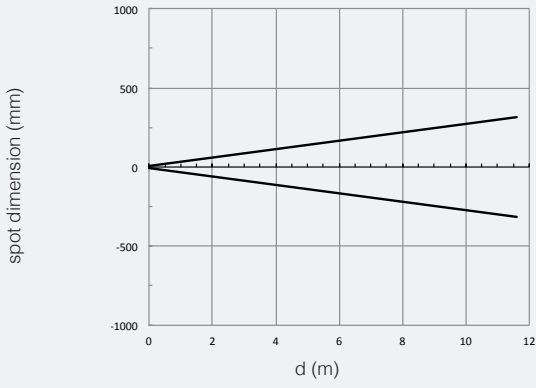

S^*U^{**}, S^*G^{**} parallel displacement

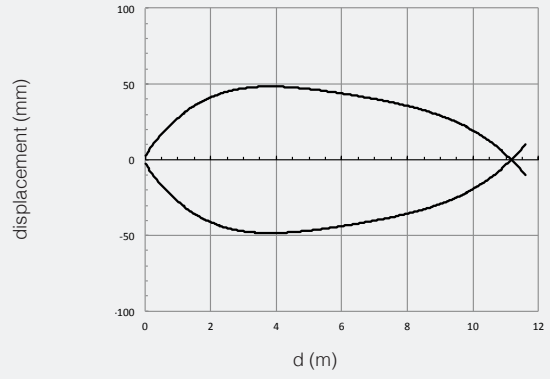

S^*U^{**}, S^*V^{**} excess gain

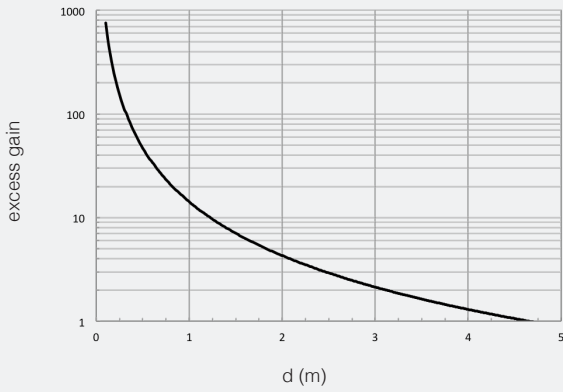

S^*U^{**}, S^*V^{**} excess gain

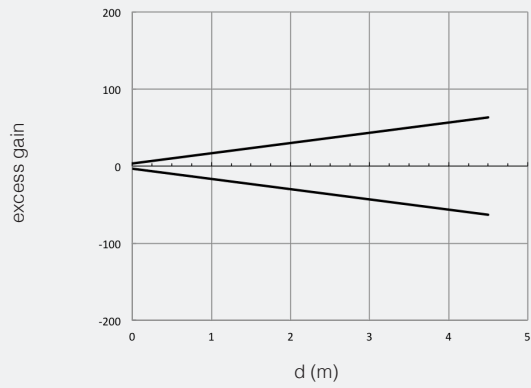

S^*U^{**}, S^*V^{**} spot dimension

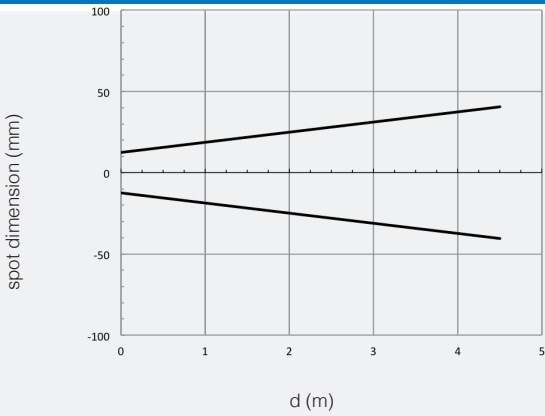



dimensions (mm)

M18 DC with lateral adjustment

SP*/**-*A

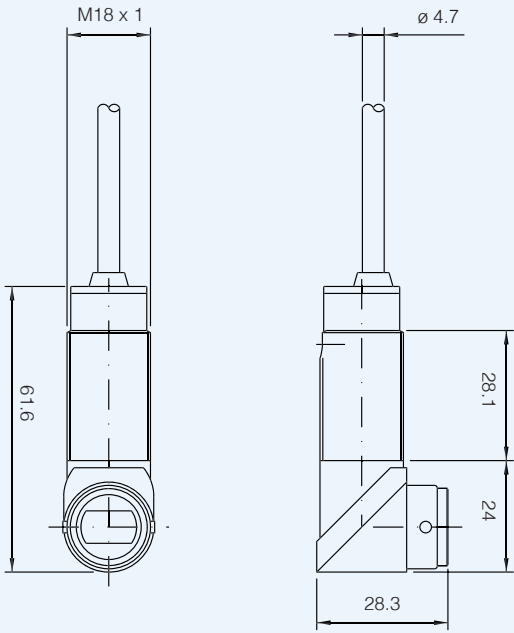

SP*/**-*E

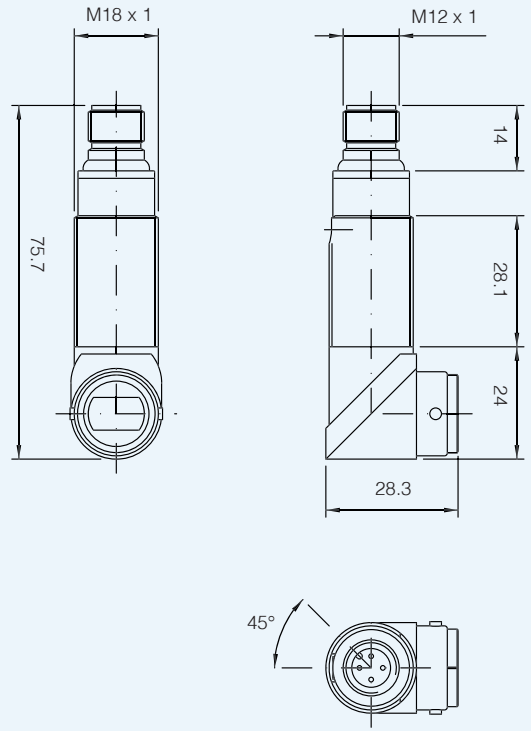

dimensions (mm)

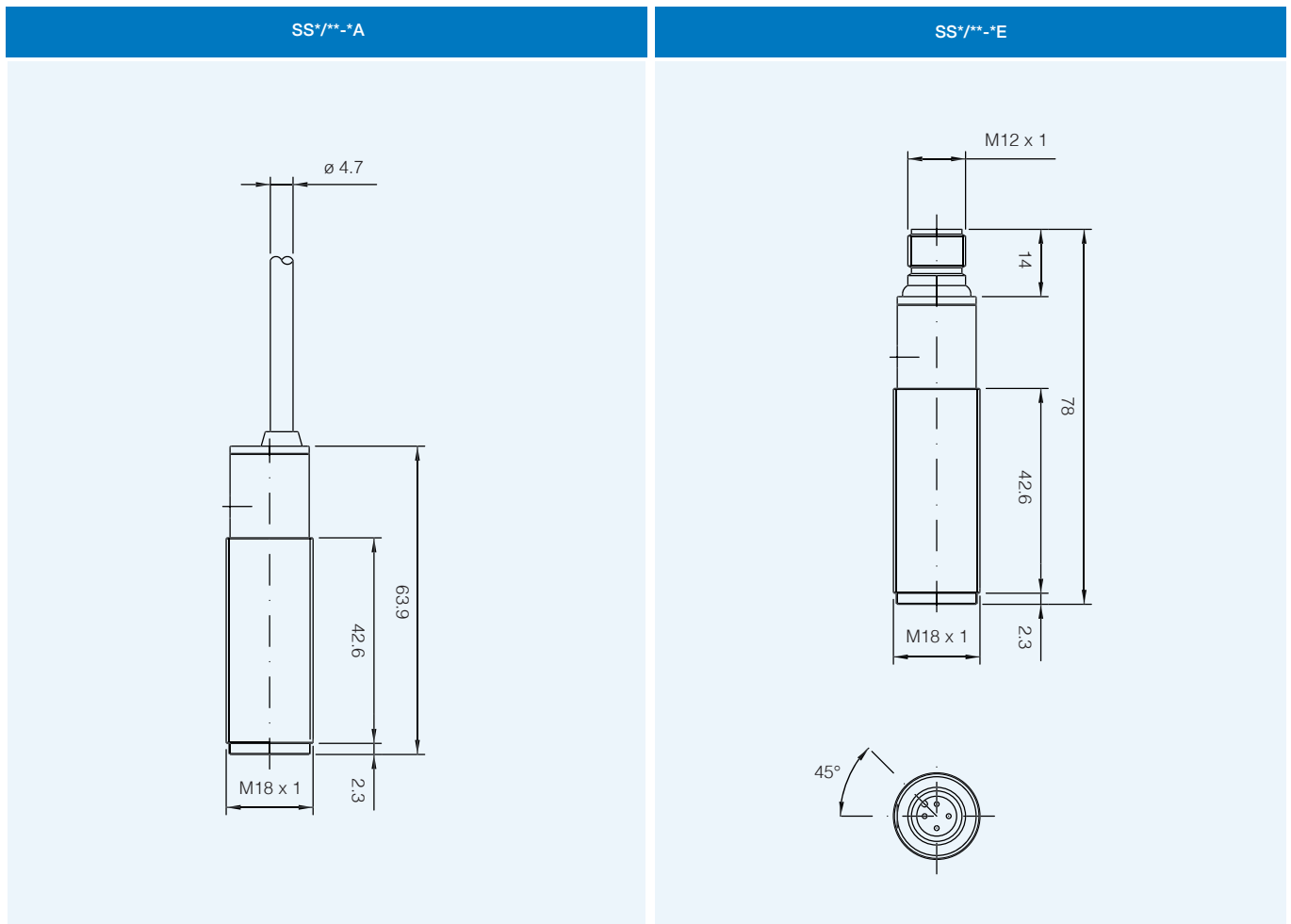

dimensions (mm)

accessories included in all plastic models

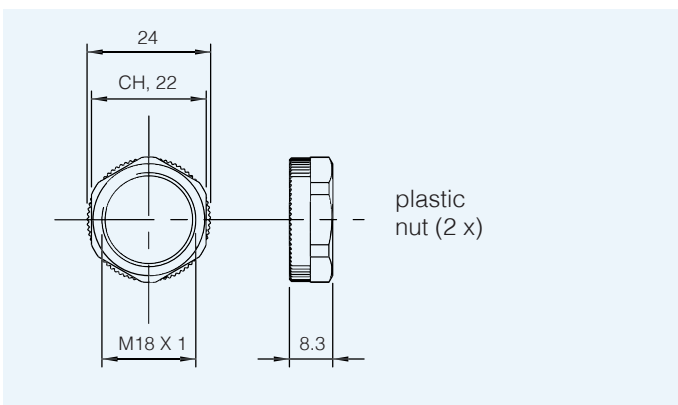

dimensions (mm)

accessories included in all metallic models

