

S3Z



ADVANCED GLOBAL STYLE MINIATURE PHOTOELECTRIC SENSOR



- 50-250 mm background suppression
- 0.7 m proximity, 150 mm with narrow beam
- 4 m polarized retroreflective
- 15 m through beam
- Light and dark trimmer models
- Standard 3-wire output configuration

APPLICATIONS

- Processing and Packaging machinery
- Electronics assembling
- Transportation lines, material handling
- Automatic warehouses
- Cosmetics and Pharmaceutical industry
- Small part detection with maximum accuracy



S3Z		
Through beam	0...15 m 0...30 m (class 1 LASER)	
Polarized retroreflective	0.05...4 m 0,3...10 m (class 1 LASER)	
Retroreflective for transparent (on R2 reflector)	0...2 m	
Diffuse proximity	0...700 mm 50...150 mm (narrow beam)	
Background suppression	50...250 mm 40...300 mm (class 1 LASER)	
Power supply	Vdc	10...30 V
	Vac	
	Vac/dc	
Output	PNP	•
	NPN	•
	NPN/PNP	
	relay	
	other	
Connection	cable	•
	connector	•
	pig-tail	
Approximate dimensions (mm)	11x31x19	
Housing material	PC/PBT	
Mechanical protection	IP67	

TECHNICAL DATA

Consumption (output current excluded)	30 mA max. (LED mod.) 35 mA max. (Laser mod.)
Light emission	red LED 650 nm (mod. S3Z...T51) red LED 665 nm (mod. S3Z...B01/C01) red LED 670 nm (mod. S3Z...M01) IR LED 850 nm (mod. S3Z...C11) IR LED 870 nm (mod. S3Z...F01/G00) red Laser 650 nm (mod. S3Z...B01/F01/G00/M01)
Setting	sensitivity trimmer, 6 turns screw (mod. S3Z...M01), one turn sensitivity trimmer
Operating mode	LIGHT/DARK trimmer (Laser mod. S3Z...-PP, -NN), LIGHT (mod. S3Z...-PL, -NL), DARK (mod. S3Z...-PD, -ND)
Indicators	yellow OUTPUT LED, green STABILITY LED (mod. S3Z...B01/C01/C11/F01), POWER ON LED (mod. S3Z...G00)
Output	PNP or NPN (short circuit protection)
Output current	100 mA max.
Saturation voltage	2 V max. (LED mod.) 1,5 V max. (Laser mod.)
Response time	1 ms max. (LED mod.) 250 µs max. (Laser mod.)
Switching frequency	500 Hz max. (LED mod.) 2 kHz max. (Laser mod.)
Connection	2 m cable Ø 3,5 mm, M8 4-pole connector
Dielectric strength	500 Vac 1 min., between electronics and housing
Insulating resistance	>20 MΩ 500 Vdc, between electronics and housing
Mechanical protection	IP67
Ambient light rejection	according to EN 60947-5-2
Vibration	0.5 mm amplitude, 10 ... 55 Hz frequency, for every axis (EN60068-2-6)
Shock resistance	11 ms (30 G) 6 shock for every axis (EN60068-2-27)
Housing material	body PBT, indicators cover PC
Lens material	PMMA, PC (mod. S3Z...B01)
Operating temperature	-25 ... 55 °C (LED mod.), -10 ... 55 °C (Laser mod.)
Storage temperature	-40 ... 70 °C (LED mod.), -25 ... 70 °C (Laser mod.)
Weight	50 g max. cable vers. , 10 g max. conn. vers.

DIMENSIONS

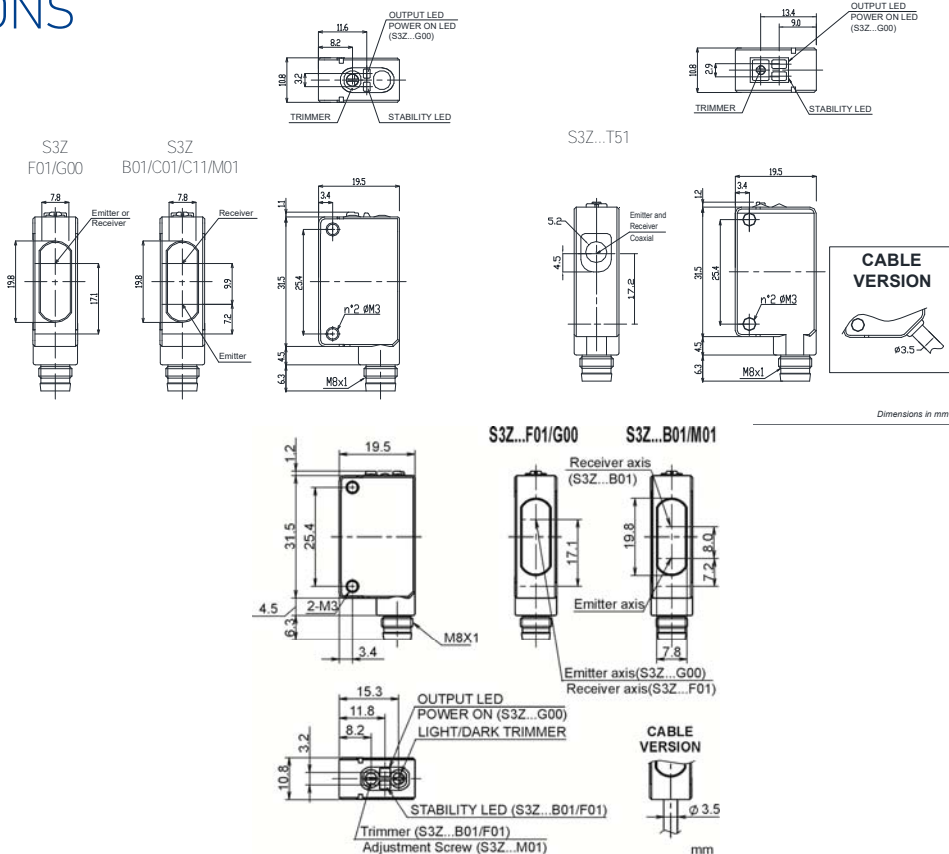

CONNECTIONS

CABLE

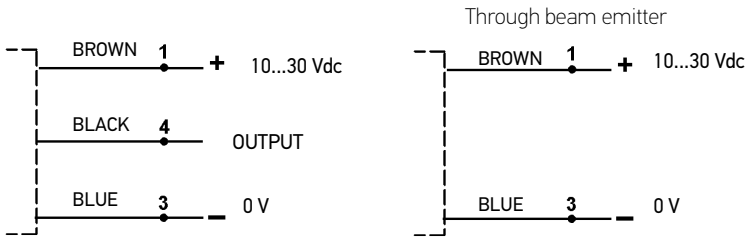

M8 CONNECTOR

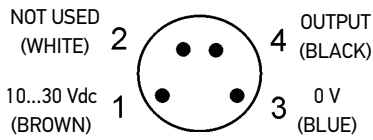

INDICATORS AND SETTINGS

S3Z...F01/G00/B01/C01/M01

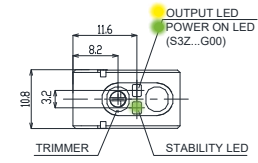

S3Z...T51

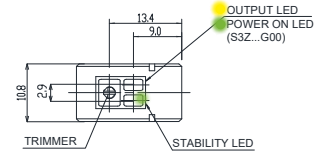

S3Z...F01/G00/B01/M01/S3Z...-PP, -NN

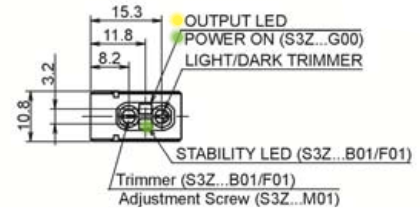
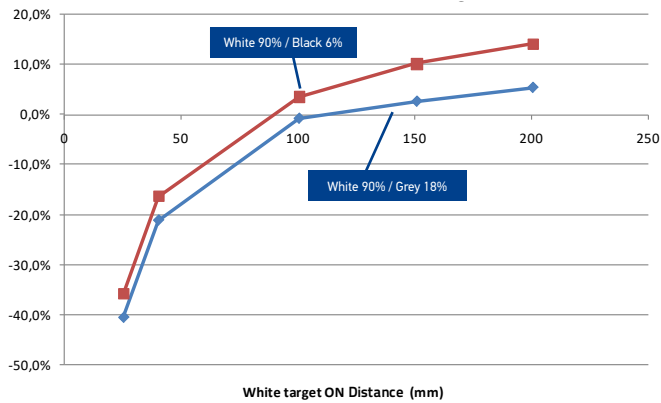
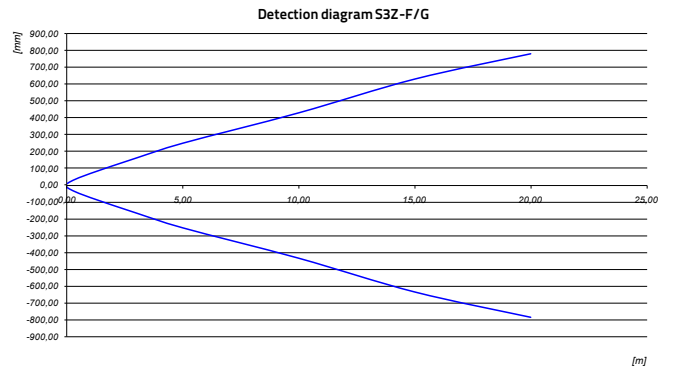

DIAGRAM LED MODELS

BACKGROUND SUPPRESSION - DISTANCE DIFFERENCE VS REFLECTANCE TARGET



THROUGH BEAM - DETECTION AREA



POLARIZED RETROREFLECTIVE - DETECTION AREA

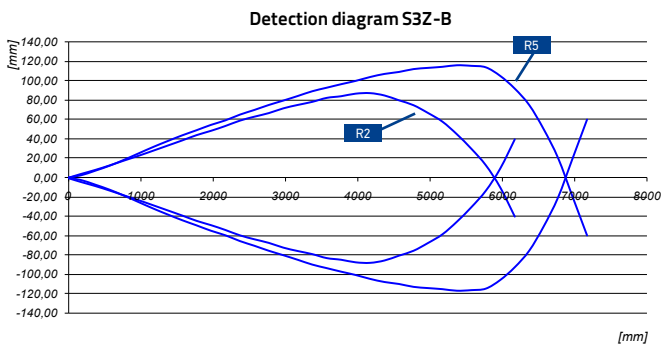

DIFFUSE PROXIMITY - DETECTION AREA

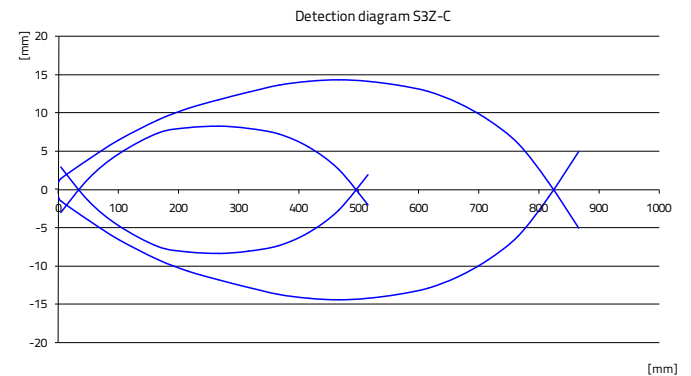

NARROW BEAM PROXIMITY - DETECTION AREA

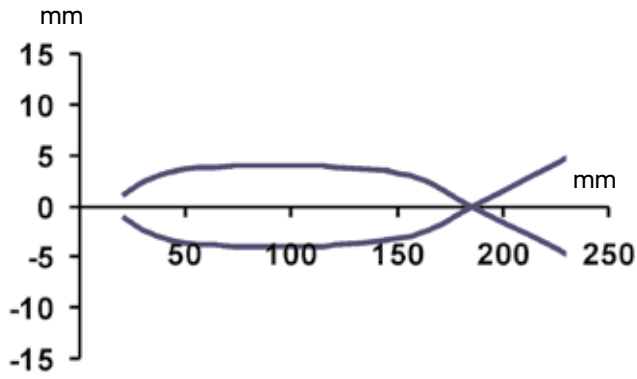

POLARIZED RETROREFLECTIVE FOR TRANSPARENT - DETECTION AREA

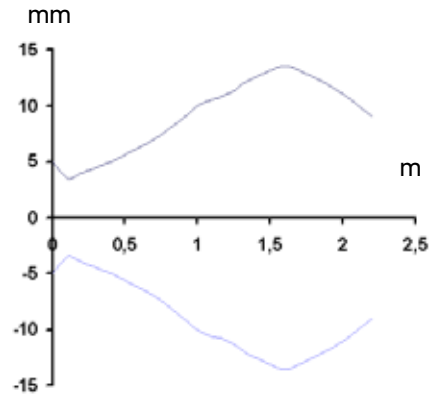

DIAGRAMS LASER MODELS

BACKGROUND SUPPRESSION - DETECTION AREA

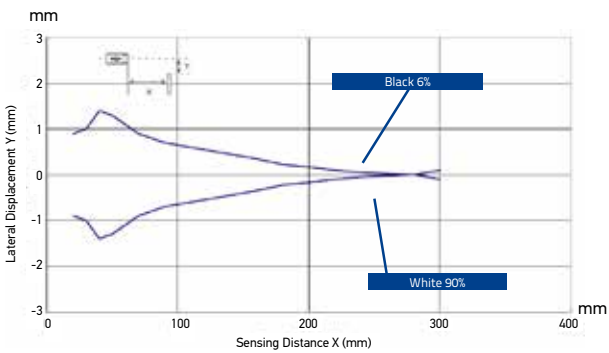

BACKGROUND SUPPRESSION - SPOT DIMENSION

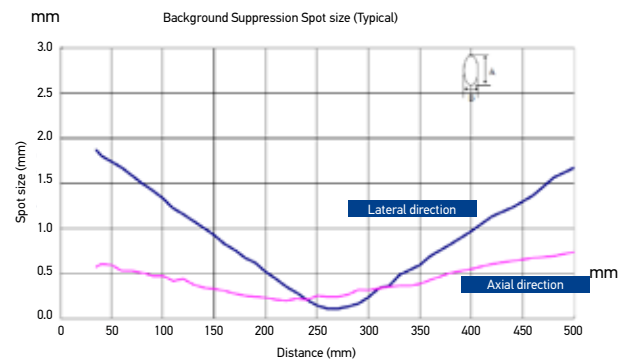

POLARIZED RETROREFLECTIVE - DETECTION AREA

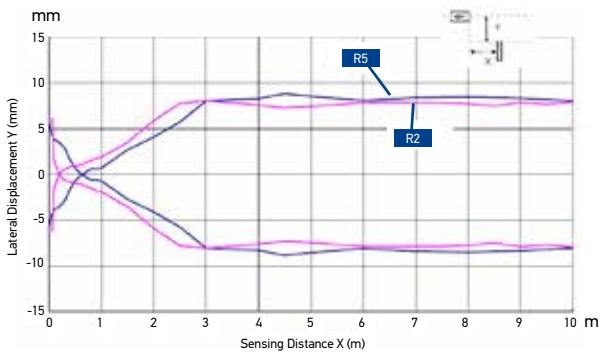

POLARIZED RETROREFLECTIVE - EXCESS GAIN

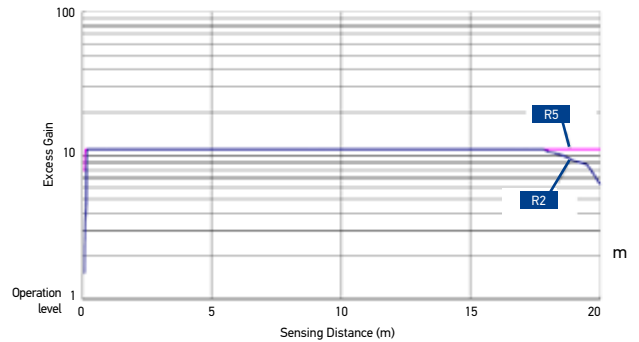

THROUGH BEAM - DETECTION AREA

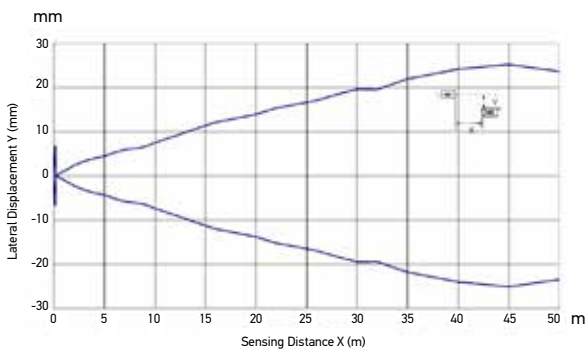

THROUGH BEAM - EXCESS GAIN

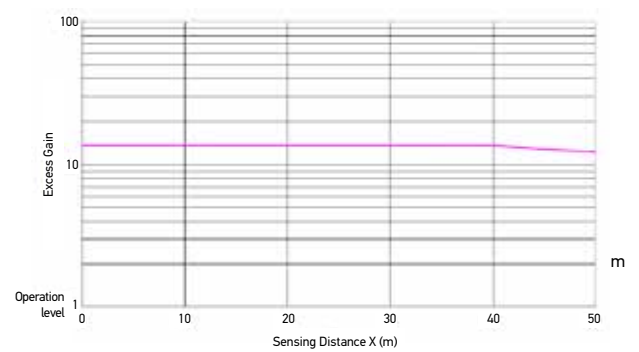

MODEL SELECTION AND ORDER INFORMATION

OPTIC FUNCTION	EMISSION	CONNECTION	OUTPUT	MODEL	ORDER NO.		
Narrow beam diffuse proximity	LED	2 m Cable	PNP - LIGHT	S3Z-PR-2-C01-PL	95B010040		
		M8 Connector	PNP - LIGHT	S3Z-PR-5-C01-PL	95B010050		
		2 m Cable	PNP - DARK	S3Z-PR-2-C01-PD	95B010060		
		M8 Connector	PNP - DARK	S3Z-PR-5-C01-PD	95B010070		
		2 m Cable	NPN - LIGHT	S3Z-PR-2-C01-NL	95B010200		
		M8 Connector	NPN - LIGHT	S3Z-PR-5-C01-NL	95B010210		
		2 m Cable	NPN - DARK	S3Z-PR-2-C01-ND	95B010220		
		M8 Connector	NPN - DARK	S3Z-PR-5-C01-ND	95B010230		
		2 m Cable	PNP - LIGHT/DARK	S3Z-PR-2-C01-PP	95B010670		
		M8 Connector	PNP - LIGHT/DARK	S3Z-PR-5-C01-PP	95B010690		
Long diffuse proximity	LED	2 m Cable	PNP - LIGHT	S3Z-PR-2-C11-PL	95B010001		
		M8 Connector	PNP - LIGHT	S3Z-PR-5-C11-PL	95B010011		
		2 m Cable	PNP - DARK	S3Z-PR-2-C11-PD	95B010021		
		M8 Connector	PNP - DARK	S3Z-PR-5-C11-PD	95B010031		
		2 m Cable	NPN - LIGHT	S3Z-PR-2-C11-NL	95B010161		
		M8 Connector	NPN - LIGHT	S3Z-PR-5-C11-NL	95B010171		
		2 m Cable	NPN - DARK	S3Z-PR-2-C11-ND	95B010181		
		M8 Connector	NPN - DARK	S3Z-PR-5-C11-ND	95B010191		
		2 m Cable	PNP - LIGHT/DARK	S3Z-PR-2-C11-PP	95B010630		
		M8 Connector	PNP - LIGHT/DARK	S3Z-PR-5-C11-PP	95B010650		
Polarized retroreflective	LED	2 m Cable	PNP - LIGHT	S3Z-PR-2-B01-PL	95B010081		
		M8 Connector	PNP - LIGHT	S3Z-PR-5-B01-PL	95B010091		
		2 m Cable	PNP - DARK	S3Z-PR-2-B01-PD	95B010101		
		M8 Connector	PNP - DARK	S3Z-PR-5-B01-PD	95B010111		
		2 m Cable	NPN - LIGHT	S3Z-PR-2-B01-NL	95B010241		
		M8 Connector	NPN - LIGHT	S3Z-PR-5-B01-NL	95B010251		
		2 m Cable	NPN - DARK	S3Z-PR-2-B01-ND	95B010261		
		M8 Connector	NPN - DARK	S3Z-PR-5-B01-ND	95B010271		
		2 m Cable	PNP - LIGHT/DARK	S3Z-PR-2-B01-PP	95B010590		
		M8 Connector	PNP - LIGHT/DARK	S3Z-PR-5-B01-PP	95B010610		
Polarized retroreflective	LASER	2 m Cable	NPN - LIGHT/DARK	S3Z-PR-2-B01-NN	95B010580		
		M8 Connector	NPN - LIGHT/DARK	S3Z-PR-5-B01-NN	95B010600		
		2 m Cable	PNP - LIGHT/DARK	S3Z-PH-2-B01-P	95B010440		
		M8 Connector	PNP - LIGHT/DARK	S3Z-PH-5-B01-P	95B010460		
		2 m Cable	NPN - LIGHT/DARK	S3Z-PH-2-B01-N	95B010450		
		M8 Connector	NPN - LIGHT/DARK	S3Z-PH-5-B01-N	95B010470		
		Through beam	LED	2 m Cable	PNP - LIGHT	S3Z-PR-2-FG01-PL	95B010121
				M8 Connector	PNP - LIGHT	S3Z-PR-5-FG01-PL	95B010131
				2 m Cable	PNP - DARK	S3Z-PR-2-FG01-PD	95B010141
				M8 Connector	PNP - DARK	S3Z-PR-5-FG01-PD	95B010151
2 m Cable	NPN - LIGHT			S3Z-PR-2-FG01-NL	95B010281		
M8 Connector	NPN - LIGHT			S3Z-PR-5-FG01-NL	95B010291		
2 m Cable	NPN - DARK			S3Z-PR-2-FG01-ND	95B010301		
M8 Connector	NPN - DARK			S3Z-PR-5-FG01-ND	95B010311		
2 m Cable	PNP - LIGHT/DARK			S3Z-PR-2-FG01-PP	95B010710		
M8 Connector	PNP - LIGHT/DARK			S3Z-PR-5-FG01-PP	95B010730		
Through beam	LASER	2 m Cable	NPN - LIGHT/DARK	S3Z-PR-2-FG01-NN	95B010700		
		M8 Connector	NPN - LIGHT/DARK	S3Z-PR-5-FG01-NN	95B010720		
		2 m Cable	PNP - LIGHT/DARK	S3Z-PH-2-FG01-P	95B010520		
		M8 Connector	PNP - LIGHT/DARK	S3Z-PH-5-FG01-P	95B010540		
		2 m Cable	NPN - LIGHT/DARK	S3Z-PH-2-FG01-N	95B010530		
		M8 Connector	NPN - LIGHT/DARK	S3Z-PH-5-FG01-N	95B010550		
		Background suPpression	LED	2 m Cable	PNP - LIGHT	S3Z-PR-2-M01-PL	95B010331
				M8 Connector	PNP - LIGHT	S3Z-PR-5-M01-PL	95B010351
				2 m Cable	NPN - LIGHT	S3Z-PR-2-M01-NL	95B010321
				M8 Connector	NPN - LIGHT	S3Z-PR-5-M01-NL	95B010341
2 m Cable	PNP - LIGHT/DARK			S3Z-PR-2-M01-PP	95B010750		
M8 Connector	PNP - LIGHT/DARK			S3Z-PR-5-M01-PP	95B010770		
2 m Cable	NPN - LIGHT/DARK			S3Z-PR-2-M01-NN	95B010740		
M8 Connector	NPN - LIGHT/DARK			S3Z-PR-5-M01-NN	95B010760		
2 m Cable	PNP - LIGHT/DARK			S3Z-PH-2-M01-P	95B010480		
M8 Connector	PNP - LIGHT/DARK			S3Z-PH-5-M01-P	95B010500		
Polarized retroreflective for transparent	LED	2 m Cable	NPN - LIGHT/DARK	S3Z-PH-2-M01-N	95B010490		
		M8 Connector	NPN - LIGHT/DARK	S3Z-PH-5-M01-N	95B010510		
		2 m Cable	NPN - DARK	S3Z-PR-2-T51-ND	95B010390		
		2 m Cable	PNP - DARK	S3Z-PR-2-T51-PD	95B010380		
		M8 Connector	NPN - DARK	S3Z-PR-5-T51-ND	95B010370		
		M8 Connector	PNP - DARK	S3Z-PR-5-T51-PD	95B010360		

ACCESSORIES

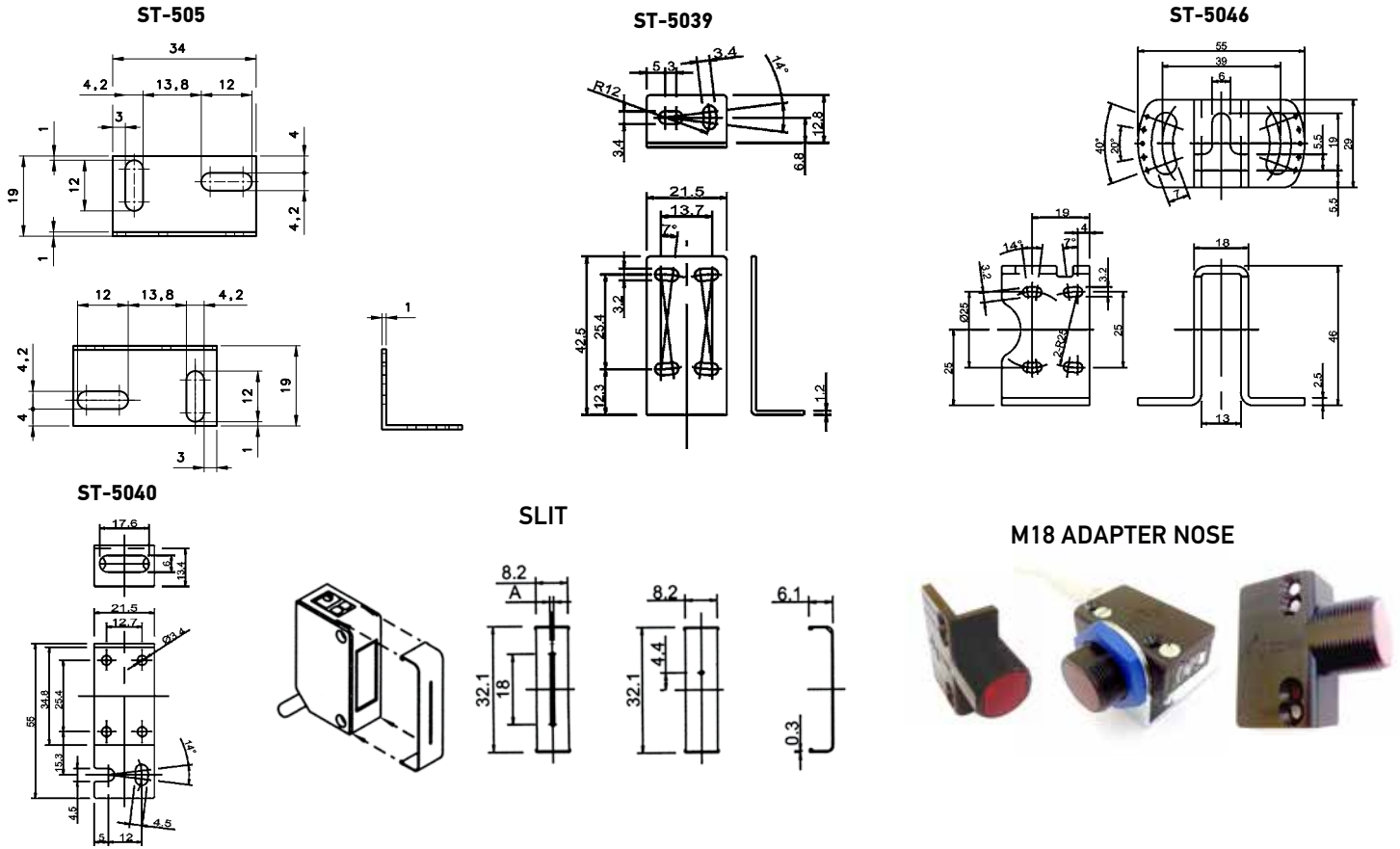

MODEL SELECTION AND ORDER INFORMATION

MODEL	DESCRIPTION	ORDER NO.
ST-505	lateral mounting	95ACC2800
ST-5039	L-shaped fixing bracket	95ACC2270
ST-5040	protection bracket with vertical fixing (only for cable versions)	95ACC2280
ST-5046	protection bracket with horizontal fixing	95ACC2370
S3Z-SLIT1	Ø 0,5 mm slit for through beam	95ACC2470
S3Z-SLIT2	Ø 1 mm slit for through beam	95ACC2480
S3Z-SLIT3	Ø 2 mm slit for through beam	95ACC2490
S3Z-SLIT4	0,5x18 mm slit for through beam	95ACC2500
S3Z-SLIT5	1x18 mm slit for through beam	95ACC2510
S3Z-SLIT6	2x18 mm slit for through beam	95ACC2520
ST-S3Z-M18	S3Z FIX BRK M18 THREADED NOSE	95ACC7850

CABLES

TYPE	DESCRIPTION	LENGTH	MODEL	ORDER No.
Axial M8 Connector	4-pole, grey, PVC.	3 m	CS-B1-02-G-03	95A251420
		5 m	CS-B1-02-G-05	95A251430
		7 m	CS-B1-02-G-07	95A251440
		10 m	CS-B1-02-G-10	95A251480
		2 m	CS-B1-02-R-02	95A251620
Radial M8 Connector	4-pole, grey, PVC.	5 m	CS-B1-02-R-05	95A251640
		3 m	CS-B2-02-G-03	95A251450
		5 m	CS-B2-02-G-05	95A251460
	4-pole, P.U.R.	7 m	CS-B2-02-G-07	95A251470
		10 m	CS-B2-02-G-10	95A251530
		2 m	CS-B2-02-R-02	95A251630
		5 m	CS-B2-02-R-05	95A251650