

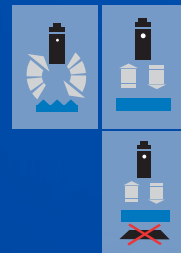

Q50 series

Compact cubic 50 x 50 mm
universal photoelectric sensor



Compact cubic
50 x 50 mm

features

- Universal photoelectric sensor, excellent performances and high versatility due to the wide choice of different versions available
- Cable output or revolving connector, NPN/PNP outputs for Vdc models or SPDT relay output for multi -voltage Vdc / Vac models
- Complementary outputs NO + NC available on the Vdc models or selectable output NO/NC available on the multi-voltage Vdc/Vac models
- Totally protected against electrical damages
- Wide choice of optical functions available: Diffuse: 2 m; background suppression: 500 mm; polarized: 6m; through beam: 20 m. Dual multifunction output state LEDs

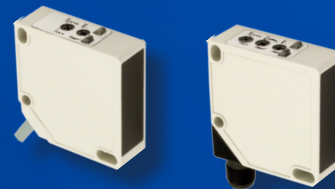

web content



- Application notes
- Photos
- Catalogue / Manuals



code description

Q50 R N / B 0 - 0 E

series	Q50	50 X 50 mm cubic photoelectric sensor
emission	I	LED infrared emission
	R	LED red emission
type	6	Diffuse reflection 1 m
	8	Diffuse reflection 2 m
	S	Background Suppression
	N	Polarized
output	H	Emitter
	D	Receiver
	B	Complementary output NO + NC
emitter	0	Emitter NO/ NC selectable
	0	Emitter, NPN or PNP (Supply Voltage 10 ... 30 Vdc)
housing	T	Emitter, Relay SPDT (Supply Voltage 12... 240 Vdc; 24...240 Vac)
	0	Plastic housing
cable/plug output	0	Emitter, NPN or PNP (Supply Voltage 10 ... 30 Vdc)
	A	Emitter, Relay SPDT (Supply Voltage 12... 240 Vdc; 24...240 Vac)
cable/plug output	0	Emitter, NPN or PNP (Supply Voltage 10 ... 30 Vdc)
	E	Plug M12 4 pins

available models

function	distance	adjustment	DC models		AC / DC models
			cable	M12 connector	cable
diffuse	1 m	●	Q50I6/B0-0A	Q50I6/B0-0E	Q50I6/OT-0A
	2 m		Q50I8/B0-0A	Q50I8/B0-0E	Q50I8/OT-0A
background suppression	120...500 mm		Q50IS/B0-0A	Q50IS/B0-0E	-
polarized	6 m		Q50RN/B0-0A	Q50RN/B0-0E	Q50RN/OT-0A
emitter	20 m	-	Q50IH/00-0A	Q50IH/00-0E	Q50IH/OT-0A
receiver	20 m	●	Q50ID/B0-0A	Q50ID/B0-0E	Q50ID/OT-0A

Q50



technical specification

direct diffuse models

Compact cubic
50 x 50 mm



	Q5016/OT-**	Q5016/B0-**	Q5018/OT-**	Q5018/B0-**
nominal sensing distance ⁽¹⁾	0.1...2 m ⁽¹⁾		0.3...2 m ⁽¹⁾	
sensing range (Sd)	0.2...2 m ⁽¹⁾		0.5...2 m ⁽¹⁾	
sensitivity adjustment	single-turn potentiometer			
emission	infrared LED			
spot dimension	70 mm @ 500 mm		80 mm @ 1 m	
rotary switch	single-turn potentiometer	-	single-turn potentiometer	-
operating voltage	from 12 to 240 Vdc / from 24 to 240 Vac, 50 to 60 Hz	from 10 to 30 Vdc	from 12 to 240 Vdc / from 24 to 240 Vac, 50 to 60 Hz	from 10 to 30 Vdc
ripple	-	≤ 10 %	-	≤ 10 %
no-load supply current	≤ 2.5 VA (relè ON)	≤ 40 mA	≤ 2.5 VA (relè ON)	≤ 40 mA
load current	-	≤ 200 mA	-	≤ 200 mA
output voltage drop Ud	-	≤ 2.5 Vdc @ 200 mA	-	≤ 2.5 Vdc @ 200 mA
maximum load current	3 A/30 Vdc 3 A/240 Vac	-	3 A/30 Vdc 3 A/250 Vac	-
output type	relay SPDT electrically isolated	PNP or NPN	relay SPDT electrically isolated	PNP or NPN
switching frequency	20 Hz	500 Hz	20 Hz	500 Hz
power on delay	≤ 30 ms	-	≤ 30 ms	-
power supply protections	transients	polarity reversal, transient	transients	polarity reversal, transient
output electrical protection	-	short circuit (auto reset) over voltage pulses	-	short circuit (auto reset) over voltage pulses
operating temperature range	- 25°C...+ 60°C ⁽²⁾			
external light interference	5,000 lux			
EMC	in conformity with the EMC Directive according to EN 60947-5-2			
protection degree	IP67 (EN60529) ⁽³⁾			
housing material	body: PC/ABS; optic: PMMA			
weight (approximate)	200 g	105 g plug 200 g cable	200 g	105 g plug 200 g cable

⁽¹⁾ White target 90% 200*200 mm ⁽²⁾ UL omologation: 0...+60 °C ⁽³⁾ Protection guaranteed only with plug cable well mounted



	Q50IS/0B-**
	background suppression
	
distanza di lavoro nominale ⁽¹⁾	120...500 mm ⁽¹⁾
minimum sensing distance	120 mm
sensibility adjustment	single-turn potentiometer
emission	infrared LED
spot dimension	30 mm @ 500 mm
rotary switch	-
operating voltage	10...30 Vdc (ripple included)
ripple	≤ 10 %
no-load supply current	≤ 40 mA
load current	≤ 200 mA
output voltage drop	≤ 2.5 Vdc @ 200 mA
maximum load current	-
output type	PNP or NPN
switching frequency	500 Hz
power on delay	≤ 2 ms
power supply protections	polarity reversal, over voltage pulses
output electrical protection	short circuit (auto reset), over voltage pulses
operating temperature range	- 25°C...+ 60°C ⁽²⁾
external light interference	10,000 lux
protection degree	IP67 (EN60529) ⁽³⁾
EMC	in conformity with the EMC Directive according to EN 60947-5-2
housing material	body: PC/ABS; optic: PMMA
weight (approx)	105 g plug / 200 g cable

⁽¹⁾ White target 90% 200*200 mm ⁽²⁾ UL omologation: 0...+60 °C ⁽³⁾ Protection guaranteed only with plug cable well mounted



technical specification

polarized models

Compact cubic
50 x 50 mm

	Q50RN/OT-**	Q50RN/B0-**
		
nominal sensing distance Sn	0.2...6 m ⁽¹⁾	
minimum sensing distance	200 mm	
sensibility adjustment	single-turn potentiometer	
emission	red visible LED light	
spot dimension	280 mm @ 3 m	
rotary switch	single-turn potentiometer	-
operating voltage	from 12 to 240 Vdc/ from 24 to 240 Vac, 50 a 60 Hz	from 10 to 30 Vdc
ripple	-	≤ 10 %
no-load supply current	≤ 2.5 VA (relay ON)	≤ 40 mA
load current	-	≤ 200 mA
output voltage drop	-	≤ 2.5 VDC @ 200 mA
maximum load current	3 A/30 Vdc 3 A/250 Vac	-
output type	relay SPDT electrically isolated	PNP or NPN
switching frequency	20 Hz	500 Hz
power on delay	-	≤ 1 ms
power supply protections	transients	reverse polarity, transients
output electrical protection	-	overvoltage, short-circuit
operating temperature range	- 25°C...+ 60°C ⁽²⁾	
external light interference	5,000 lux	
protection degree	IP67 (EN60529) ⁽³⁾	
EMC	in conformity with the EMC Directive according to EN 60947-5-2	
housing material	body: PC/ABS; optic: PMMA	
weight (approx)	200 g	200 g cable 105 g plug

⁽¹⁾ With RL 110 reflector ⁽²⁾ UL omologation: 0...+60 °C ⁽³⁾ Protection guaranteed only with plug cable well mounted



	emitter		receiver	
	Q50IH/00-**	Q50IH/0T-**	Q50ID/B0-**	Q50ID/0T-**
nominal sensing distance Sn	20 mm ⁽¹⁾		20 m ⁽¹⁾	
minimum sensing distance	-		-	
sensibility adjustment	-		single-turn potentiometer	
emission	infrared LED		-	
spot dimension	880 mm @ 10 m		-	
rotary switch	-		-	single-turn potentiometer
operating voltage	10...30 Vdc (ripple included)	12 to 240 Vdc / 24 to 240 Vac, 50 to 60 Hz	da 10 a 30 Vdc	12 to 240 Vdc / 24 to 240 Vac, 50 to 60 Hz
ripple	≤ 10 %	-	≤ 10 %	-
no-load supply current	≤ 50 mA	≤ 2.5 VA (relay ON)	≤ 40 mA	≤ 2.5 VA (relay ON)
load current	-		≤ 200 mA	-
output voltage drop	-		≤ 2.5 Vdc @ 200 mA	-
maximum load current	-		-	3 A/30 Vdc 3 A/250 Vac
output type	-		PNP or NPN	relay SPDT electrically isolated
switching frequency	-		500 Hz	20 Hz
power on delay	-		≤ 1 ms	-
power supply protections	reverse polarity, transients	transients	reverse polarity, transients	transients
output electrical protection	-		overvoltage, short-circuit	-
operating temperature range	- 20°C...+ 60°C ⁽²⁾			
external light interference	-		10.000 lux	
protection degree	IP67 (EN60529) ⁽³⁾			
EMC	in conformity with the EMC Directive according to EN 60947-5-2			
housing material	body: PC/ABS; optic: PMMA			
weight (approx)	200 g cable 105 g plug	200 g	200 g cable 105 g plug	200 g

⁽¹⁾ White target 90% 200*200 mm ⁽²⁾ UL omologation: 0...+60 °C ⁽³⁾ Protection guaranteed only with plug cable well mounted



electrical diagrams of the connections

Compact cubic
50 x 50 mm

background suppression, polarized
retroreflection and receiver with PNP output

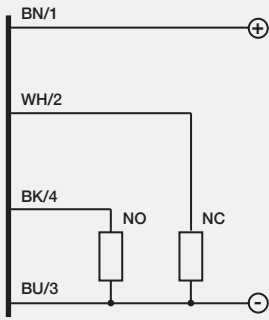

DC emitter

background suppression, polarized
retroreflection and receiver with NPN output

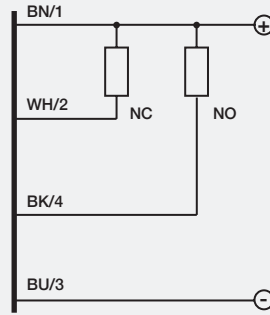

AC/DC emitter

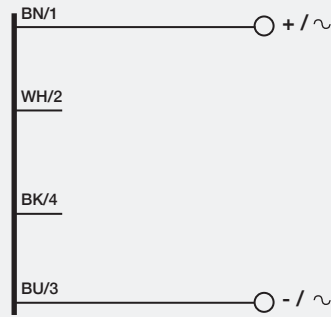
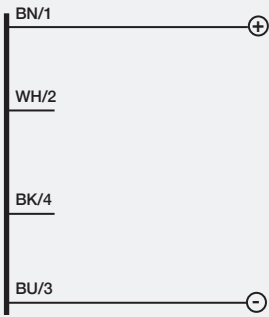

polarized retroreflection and receiver

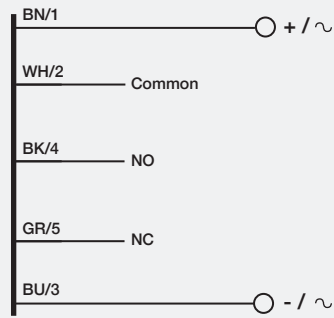

- BN** brown
- BU** blue
- BK** black
- WH** white

plug

M8

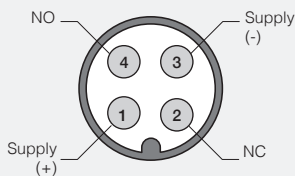

M12

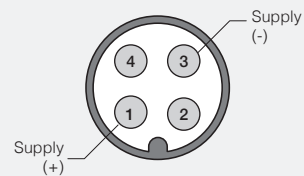

Q50

response diagrams

direct reflection models

Q5016/**-** parallel displacement

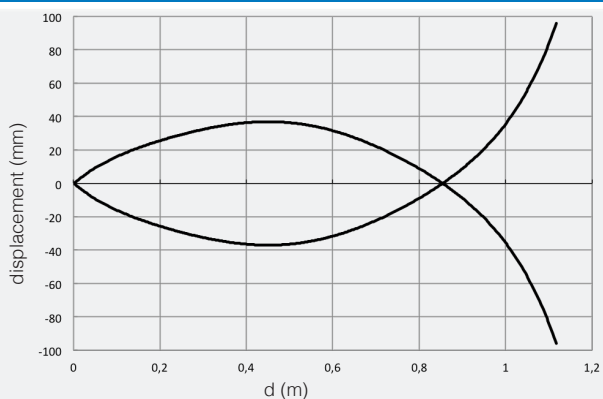

Q5018/**-** parallel displacement

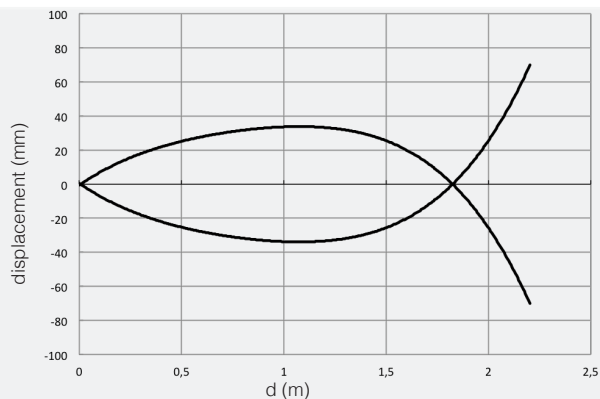

response diagrams

background suppression models

Q501S/**-** reduction of sensing distance

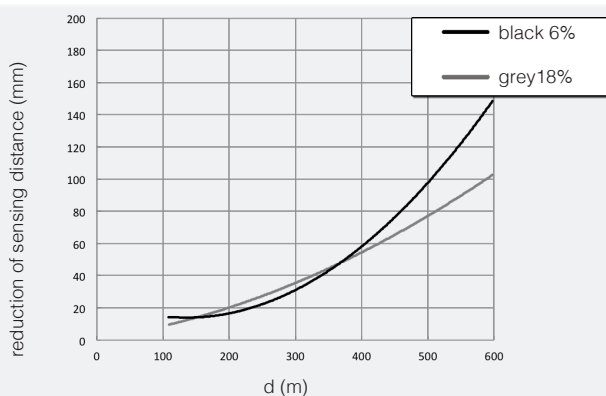

response diagrams

through-beam models

Q501H/**-** & Q501D/**-** Parallel displacement

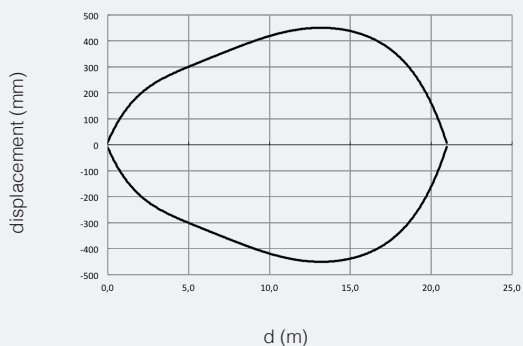

Compact cubic
50 x 50 mm

