

MD-52 AC  
MD-52 DC

# INSTALLATIONSANVISNING INSTALLATION MANUAL INSTALLATIONS ANLEITUNG

6601-2002

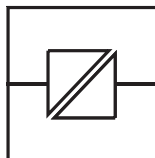

Galvanic  
Isolation



CE  
Approved

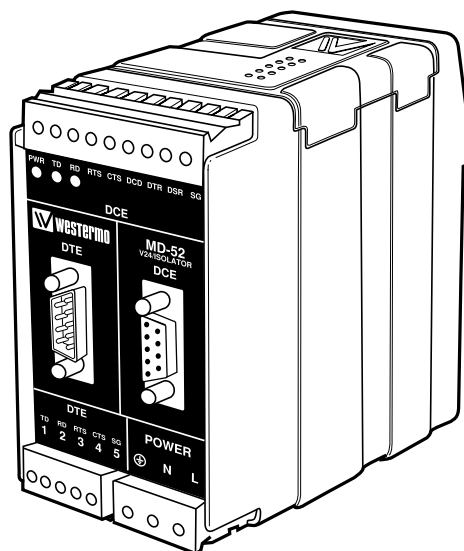

*V.24 Isolator*



[www.westermo.se](http://www.westermo.se)



## Specifikationer

<b>Överföring</b>	Asynkront, full duplex
<b>Gränssnitt A (DCE)</b>	EIA RS-232-C/CCITT V.24/V.28, 9-polig D-sub hylsdon, 9-polig skruvplint
<b>Gränssnitt B (DTE)</b>	EIA RS-232-C/CCITT V.24/V.28, 9-polig D-sub stiftdon, 5-polig skruvplint
<b>Överföringshastighet</b>	Upp till 115 200 bit/s (asynkront)
<b>Lysdioder</b>	Power, TD, RD
<b>Isolation</b>	Fullständig galvanisk isolation med optokopplare (dataöverföring) resp. transformator (matning)
<b>Isolationsspänning</b>	1500 V rms
<b>Överspänningskydd</b>	<b>Nät:</b> Genombrottsspänning 440V vid 230 V AC och 220V vid 115V AC
<b>Strömförsörjning</b>	230 V AC, +15%–10%, 48–62 Hz, 12–36 V DC (MD-52 DC)
<b>Effektförbrukning</b>	Max 17mA vid 230V AC, max 1W (MD-52 DC)
<b>Temperatur</b>	<b>AC:</b> –25°C – 60°C <b>DC:</b> –25°C – 70°C
<b>Fuktighet</b>	0 – 95% RH, utan kondensation
<b>Mått</b>	55 x 100 x 128 mm
<b>Vikt</b>	0,5 kg (AC modell), 0,4 kg DC modell
<b>Montering</b>	På 35 mm DIN-skena

# Anslutningar MD-52







## Nätanslutning AC

Anslutning	Beskrivning
	115/230V AC 48-62 Hz Skyddsjord

## Nätanslutning DC

Anslutning	Spänningsanslutning
-	- Spänning
+	+ Spänning

## Terminalanslutning (RS-232-C/V.24, 9-polig D-sub/skruvanslutningar)

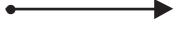
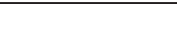
Riktning		Anslutning	9-polig skruvansl.	5-polig skruvansl.	CCITT V.24 Benämning	Beskrivning
DTE	DCE	9-polig D-sub				
		3	8	1	103	TD/Transmitted Data
		2	7	2	104	RD/Received Data
		7	6	3	105	RTS/ Request To Send
		8	5	4	106	CTS/ Clear To Send
		6	2	-	107	DSR/ Data Set Ready
		5	1	5	102	SG/Signal Ground
		1	4	-	109	DCD/Data Carrier Detect
		4	3	-	108/2	DTR/Data Terminal Ready

## Tips

Om det uppkommer något problem vid inkoppling av MD-52 kan lysdiodindikeringarna vara till värdefull hjälp vid felsökning.

- PWR: Indikerar att enheten är spänningsatt
- RD: Indikerar mottagen data på linje B (DTE) och sänd data på linje A (DCE)
- TD Indikerar sänd data på linje B (DTE) och mottagen data på linje A (DCE)

## Specifications

<b>Transmission</b>	Asynchronous, full duplex
<b>Interface A (DCE)</b>	EIA RS-232-C/CCITT V.24/V.28, 9-pin D-sub female, 9-pin screw block
<b>Interface B (DTE)</b>	EIA RS-232-C/CCITT V.24/V.28, 9-pin D-sub male, 5-pin screw block
<b>Transmission rate</b>	Up to 115 200 bit/s (asynchronous)
<b>Indicators</b>	Power, TD, RD
<b>Isolation</b>	Complete galvanic isolation with opto-coupler (data transmission) or transformer (power supply)
<b>Isolation voltage</b>	1500 V rms
<b>Overvoltage protection</b>	<b>Mains:</b> Breakdown voltage 440V at 230V AC and 220V at 115V AC
<b>Power supply</b>	230 V AC, +15%–10%, 48–62 Hz, 12–36 V DC (MD-52 DC)
<b>Power consumption</b>	Max 17mA at 230V AC, max 1W (MD-52 DC)
<b>Temperature</b>	<b>AC:</b> –25°C – 60°C <b>DC:</b> –25°C – 70°C
<b>Humidity</b>	0 – 95% RH, without condensation
<b>Dimension</b>	55 x 100 x 128 mm
<b>Weight</b>	0.5 kg (AC models), 0.4 kg DC model
<b>Mounting</b>	At 35 mm DIN-rail

# Connections MD-52

## Power supply AC

Connection	Description
	115/230V AC 48-62 Hz Protective Earth

## Power supply DC

Connection	Power supply
-	- Voltage
+	+ Voltage

## Terminal connection (RS-232-C/V.24, 9-pin D-sub/screw connections)

Direction DTE    DCE	Connection 9-pin D-sub	9-pin screw connection	5-pin screw connection	CCITT V.24 Circuit no.	Description
→	3	8	1	103	TD/Transmitted Data
←	2	7	2	104	RD/Received Data
→	7	6	3	105	RTS/ Request To Send
←	8	5	4	106	CTS/ Clear To Send
←	6	2	-	107	DSR/ Data Set Ready
•	5	1	5	102	SG/Signal Ground
←	1	4	-	109	DCD/Data Carrier Detect
→	4	3	-	108/2	DTR/Data Terminal Ready

## Hints

If any problems occur on set up of the MD-52, the LED's will be helpful.

- PWR: The unit has power
- RD: Data received on line B (DTE) and data transmitted on line A (DCE)
- TD: Data transmitted on line B (DTE) and data received on A (DCE)

## Technische Daten

<b>Übertragungsarten</b>	Asynchron, voll duplex
<b>Schnittstelle A (DÜE)</b>	EIA RS-232-C/CCITT V.24/V.28 9 poliger Sub-D Buchse, DÜE 9 polige Schraubklemme
<b>Schnittstelle B (DEE)</b>	EIA RS-232-C/CCITT V.24/V.28 9 poliger Sub-D Stecker, DEE 5 polige Schraubklemme
<b>Übertragungsrate</b>	bis zu 115 200 Bit/S (Asynchron)
<b>Leuchtdioden</b>	Power, TD, RD
<b>Isolation</b>	Komplett galvanisch Isoliert mittels Optokoppler (Datenübertragung) und Transformator (Spannungsversorgung)
<b>Isolationsspannung</b>	1500V
<b>Überspannungsschutz</b>	<b>Netz:</b> Durchbruchspannung 440V bei 230 V AC und 220V bei 115V AC
<b>Spannungsversorgung</b>	230 V AC, +15%–10%, 48–62 Hz, 12–36 V DC (MD-52 DC)
<b>Leistungsaufnahme</b>	Max 17mA bei 230V AC, max 1W (MD-52 DC)
<b>Umgebungstemperatur</b>	<b>AC:</b> –25°C – 60°C <b>DC:</b> –25°C – 70°C
<b>Luftfeuchtigkeit</b>	0 – 95% RH, nicht kondensierend
<b>Abmessungen</b>	55 x 100 x 128 mm
<b>Gewicht</b>	0,5 Kg (AC Modelle) 0,4 Kg (DC Modelle)
<b>Montage</b>	auf 35 mm Din-Schiene

# Anschlüsse MD-52

## Spannungsversorgung AC

Anschluß	Beschreibung
	115/230V AC 48-62 Hz Schutzerde

## Spannungsversorgung DC

Klemme Nr.	Spg.-Versorgung
1	-Pol
2	+Pol

## Terminalanschluß (RS-232-C/V.24, 9 poliger Sub-D/Schraub Anschluß)

Richtung		Anschluß	9 poliger Schraub Anschluß	5 poliger Schraub Anschluß	CCITT V.24 Bezeichnung	Beschreibung
DTE	DCE	9 poliger Sub-D				
→		3	8	1	103	TD/Transmitted Data
	←	2	7	2	104	RD/Received Data
→		7	6	3	105	RTS/ Request To Send
	←	8	5	4	106	CTS/ Clear To Send
	←	6	2	–	107	DSR/ Data Set Ready
		5	1	5	102	SG/Signal Ground
	←	1	4	–	109	DCD/Data Carrier Detect
	→	4	3	–	108/2	DTR/Data Terminal Ready

## Tips

Bei Problemen mit der Einstellung des MD-52 können die LED's hilfreich sein.

- PWR Das Gerät hat Versorgungsspannung
- RD Daten Empfang an Schnittstelle B (DEE) und Sendung an Schnittstelle A (DÜE)
- TD Daten Sendung an Schnittstelle B (DEE) und Empfang an Schnittstelle A (DÜE)

## Block diagram

1) J1 och J2 är normalt ej monterade. Använd inte båda anslutningarna på samma linje samtidigt, för de är parallellkopplade.

1) J1 and J2 is normally not mounted. It is not allowed to use both connectors on the same line simultaneously, because they are connected in parallel.

1) J1 und J2 sind normalerweise nicht bestückt. Es ist nicht erlaubt beide Anschlüsse gleichzeitig zu benutzen, da sie parallelschaltet sind.

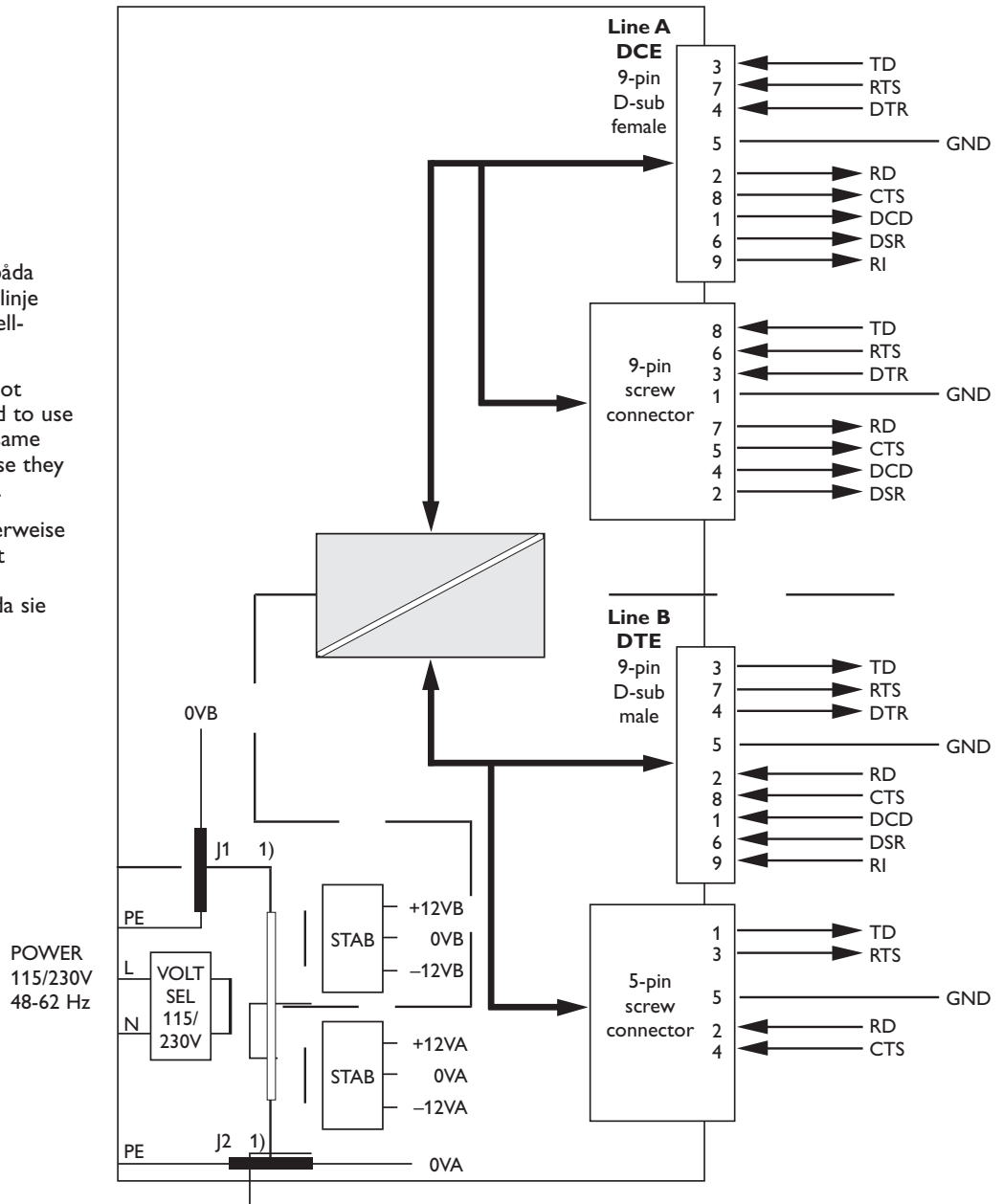

Westermo Teleindustri AB • SE-640 40 Stora Sundby, Sweden

Phone +46 16 42 80 00 Fax +46 16 42 80 01

E-mail: [info@westermo.se](mailto:info@westermo.se) • Westermo Web site: [www.westermo.se](http://www.westermo.se)

### Subsidiaries

Westermo Data Communications Ltd  
Unit 14 Talisman Business Centre • Duncan Road  
Park Gate, Southampton • SO31 7GA  
Phone: +44(0)1489 580 585 • Fax: +44(0)1489 580586  
E-Mail: [sales@westermo.co.uk](mailto:sales@westermo.co.uk) • Web: [www.westermo.co.uk](http://www.westermo.co.uk)

Westermo Data Communications GmbH  
Goethestraße 67, 68753 Waghäusel  
Tel.: +49(0)7254-95400-0 • Fax: +49(0)7254-95400-9  
E-Mail: [info@westermo.de](mailto:info@westermo.de) • Web: [www.westermo.de](http://www.westermo.de)

Westermo Data Communications S.A.R.L.  
9 Chemin de Chilly 91160 CHAMPLAN  
Tél : +33 1 69 10 21 00 • Fax : +33 1 69 10 21 01  
E-mail : [infos@westermo.fr](mailto:infos@westermo.fr) • Site WEB: [www.westermo.fr](http://www.westermo.fr)

Westermo Teleindustri AB have distributors in several countries, contact us for further information.