

FD-10

INSTALLATION MANUAL

6630-2212

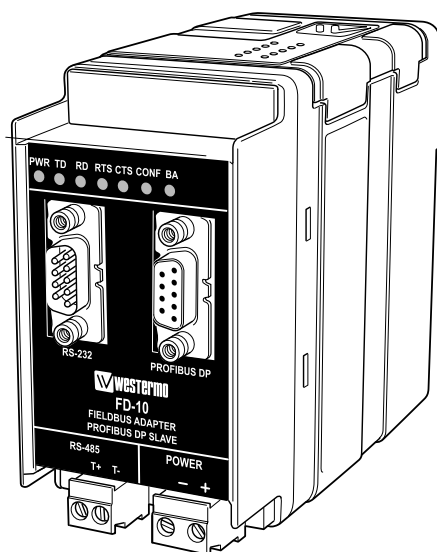
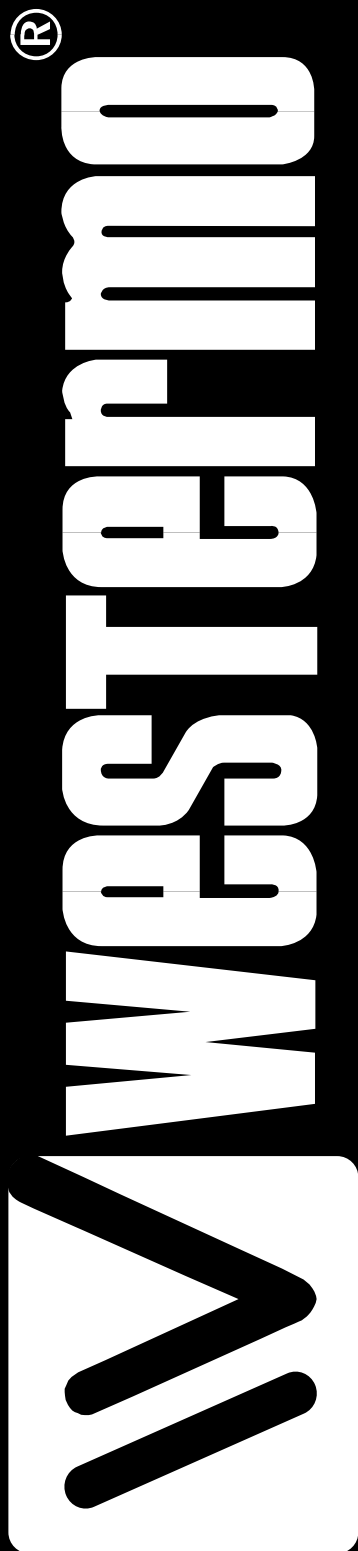

Fieldbus Adapter



Contents

1. Safety	4
2. Approvals	4
2.1. Declaration of Conformity	5
3. Introduction	6
3.1 Device types	6
3.2 When are FD-10 devices useful?	6
3.3 Field of application	7–8
4. Specifications	9–10
4.1 Interfaces	9
4.2 Insulation between interfaces	10
4.3 Climatic environment	10
4.4 Mechanics	10
5. Maintenance	11
6. Installation	11–17
6.1 Mounting /Removal	11
6.2 Connections	12
6.2.2 Power	13
6.2.3 PROFIBUS DP	13
6.2.4 RS-232 (DTE)	13
6.2.5 RS-485	13
6.3 Indicators	14
6.3.1 LED indicators	14
6.4 Configuration	14
6.4.1 DIP switch settings	14–15
6.4.2 On-line configuration by FD-Tool	16
6.4.3 Off-line configuration by FD-Tool	17
6.4.4 Save, load and modify configuration files by FD-Tool	17

7. Functional description	18–29
7.1 Point to point and Addressed, serial transfer slave, FD-10 P	19
7.1.1 Basic configuration	20
7.1.1.1 Expert configuration	21
7.1.2 PROFIBUS DP I/O data	22
7.2 Addressed, serial transfer master, FD-10 A	22
7.2.1 Basic configuration	22
7.2.1.1 Expert configuration	23
7.2.2 PROFIBUS DP I/O data	23
7.2.2.1 Output data word	23–24
7.2.2.2 Input data word	24–25
7.2.2.3 PROFIBUS DP communication	25
7.3 Network, serial sending, FD-10 N	25–26
7.3.1 Basic configuration	26
7.3.1.1 Expert configuration	26
7.3.2 PROFIBUS DP I/O data	26
7.3.2.1 Output data word	27
7.3.2.2 Input data word	27–28
7.3.2.3 PROFIBUS DP communication	29

1. Safety



General:

Before using this unit, read this manual completely and gather all information on the unit. Make sure that you understand it fully. Check that your application does not exceed the safe operating specifications for this unit.



Before installation, maintenance or modification work:

Prevent damage to internal electronics from electrostatic discharges (ESD) by discharging your body to a grounding point (e.g. use of wrist strap).

Prevent access to hazardous voltages by disconnecting the unit from AC/DC mains supply and all other electrical connections.



Installation:

This unit should only be installed by qualified personnel.

This unit should only be installed in a "restricted access area", for example a lockable cabinet where access is restricted to service personnel only.

This unit is intended for permanent connection to the AC/DC mains supply.

The power supply wiring must be sufficiently fused, and if necessary it must be possible to disconnect manually from the AC/DC mains supply. Ensure compliance to national installation regulations.

Unit with the rated voltage exceeding 42.4 V peak or 60 VDC, is defined as class I equipment with a protective earthing conductor terminal.

Unit with the rated voltage up to 42.4 V peak or 60 VDC, is defined as class III equipment and shall be separated from hazardous voltage by double or reinforced insulation.

This unit uses convection cooling. To avoid obstructing the air flow around the unit, follow the spacing recommendations (see under chapter Installation).

2. Approvals

Conformity with the Directive 89/339/EEC (Electromagnetic compatibility) has been assessed by application of standards EN 61000-6-2 (industrial immunity) and EN 61000-6-4 (industrial emission).

2.1. Declaration of Conformity

Westermo Teleindustri AB

Declaration of conformity

The manufacturer Westermo Teleindustri AB
SE-640 40 Stora Sundby, Sweden

herewith declares that the product(s)

Type of product	Model	Art no	Installation manual
DIN-rail Fieldbus adapter	FD-10 P	3630-1100	6630-2212
	FD-10 A	3630-1101	
	FD-10 N	3630-1102	
DIN-rail Fieldbus converter	FD-40	3630-1400	6630-2242

is in conformity with the following EC directive(s).

No	Title
89/336/EEG	Electromagnetic Compatibility (EMC-directive)

References of standards applied for this EC declaration of conformity.

No	Title	Issue
EN 61000-6-2	Immunity for industrial environments	2 (2001)
EN 61000-6-4	Emission standard for industrial environments	1 (2001)



Hans Levin
Technical Manager
26th May 2003

Postadress/Postal address
S-640 40 Stora Sundby
Sweden

Tel.
016-61200
Int+46 1661200

Telefax
016-61180
Int+46 1661180

Postgiro
52 72 79-4

Bankgiro
5671-5550

Org.nr/
Corp. identity number
556385-6367

State
Registered office
Eskilstuna

3. Introduction

The FD-10 is a PROFIBUS DP slave unit that is able to transfer PROFIBUS DP data via leased lines, dialup modems or radio systems. The FD-10 is used to interface different PROFIBUS DP networks.

All Westermo Fieldbus Adapters use the same protocol to communicate with each other via serial interface.

3.1 Device types

There are three different types of FD-10 devices described in this manual:

- FD-10 P Point to point and Addressed, serial transfer slave
- FD-10 A Addressed, serial transfer master
- FD-10 N Network, serial sending

All device types are based on the same hardware architecture, schematically shown below.

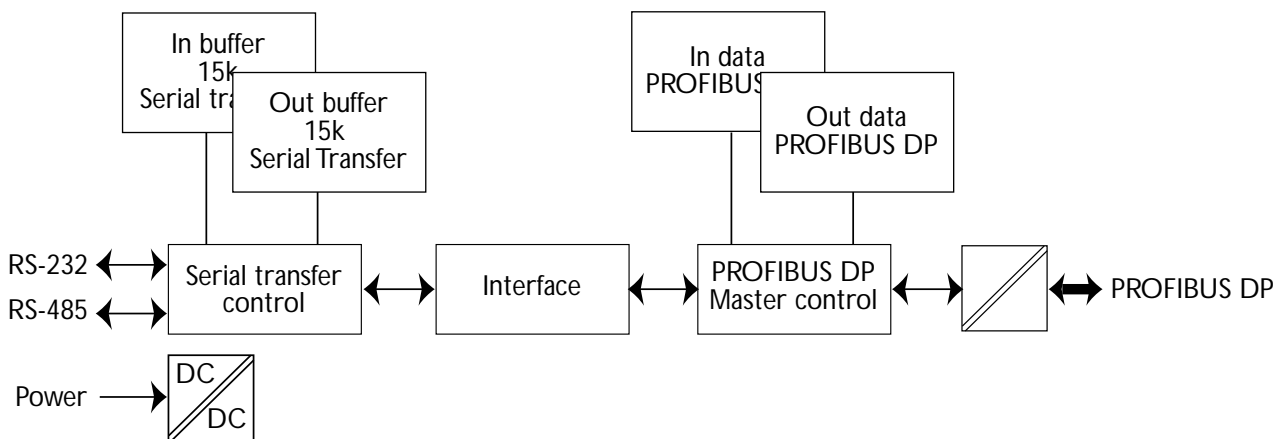

3.2 When are FD-10 devices useful?

Where a PROFIBUS DP net require connection to one or some PROFIBUS DP units which are so located, that they:

- can't be included in the net due to the distance, or
- reduce PROFIBUS DP data rate below the rated required for the system, or
- disturbance in PROFIBUS DP line (transmission line)

FD-10 will, together with the transfer units (modem), act as a interconnecting line between two or many PROFIBUS DP nets. The interconnection line protocol handle retransmission due to disturbances (e.g. due to the use of radio network or moving trolleys), without any limitations at the PROFIBUS DP net. From the PROFIBUS DP master point of view the whole system will be seen as a single PROFIBUS DP net, while the master has all PROFIBUS I/O data handling with FD-10.

3.3 Field of application

Between Fieldbus adapters is PROFIBUS DP I/O data transferred over a transmission line, divided in following type of applications:

- **Point to point transfer**

Continuous transfer of defined PROFIBUS I/O data modules between two FD-10's. This application is ideal when a high speed update of PROFIBUS DP data is required and where no additional measures at installation is desired.

This application is realised by two FD-10 P (point to point mode) with an interconnecting line and modems, if required.

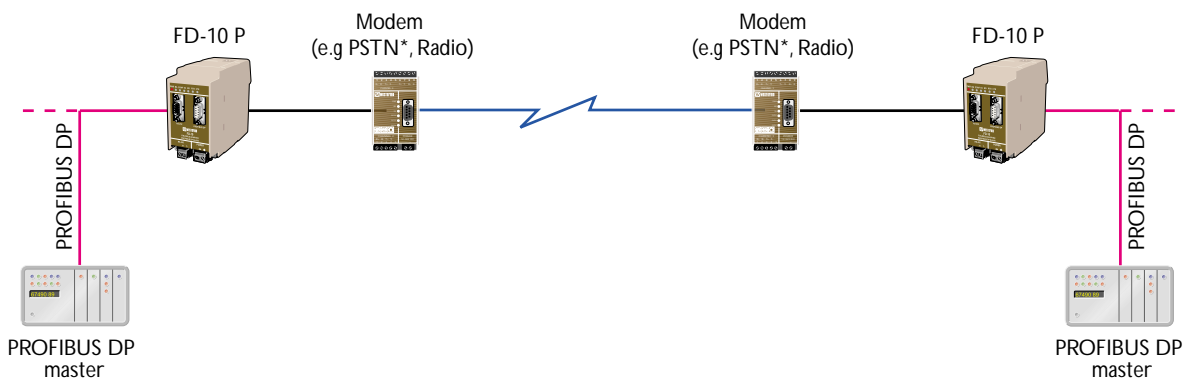

* PSTN = Public Switch Telephone Transfer

- **Master controlled transfer (Addressed)**

One transfer of defined PROFIBUS I/O data modules between two FD-10's, on demand from a PROFIBUS DP master. One FD-10 act as serial transfer master and can transfer I/O data between various FD-10's, selected by serial transfer address. This application is ideal when a PROFIBUS DP master need connection to two, or more, independent remote PROFIBUS DP systems. Radio system or RS-485 is typically used as transfer line. Required additional measures, as serial transfer addressing.

This application is realised by one FD-10 A and one or many FD-10 P (addressed serial transfer slave mode) with an interconnecting line and modems, if required.

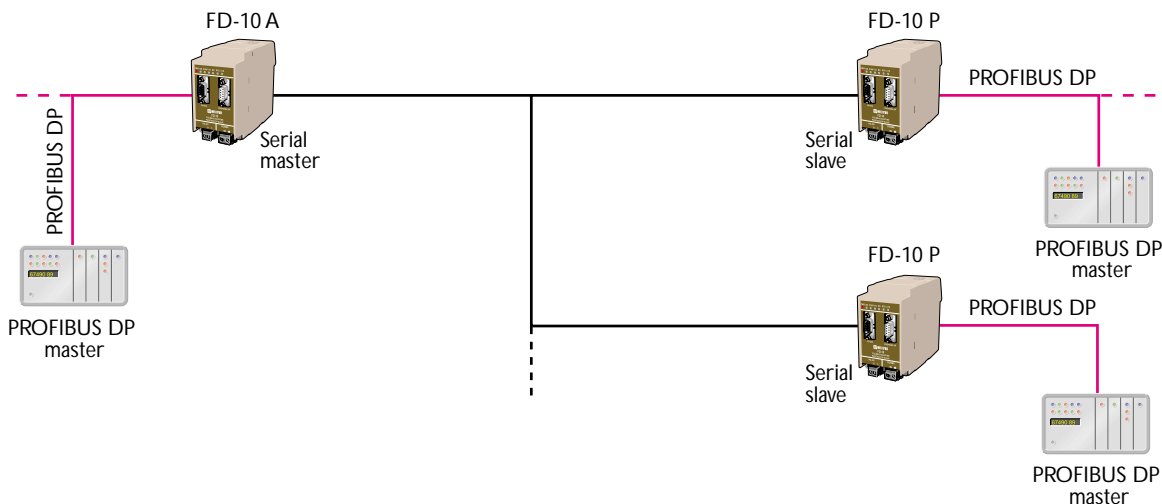

• **Master controlled sending (Network)**

Send defined PROFIBUS I/O data module once, from a FD-10 to an other. Sending data on demand (event) from a PROFIBUS DP master. One of the included FD-10's can send I/O data to any other FD-10, selected by serial transfer address. This application is ideal when data transfer between a number of PROFIBUS DP master systems is required. Radio system or RS-485 is typically used as transfer line. Required additional measures, as serial transfer addressing.

This application is realised by two or many FD-10 N with an interconnecting line and modems, if required.

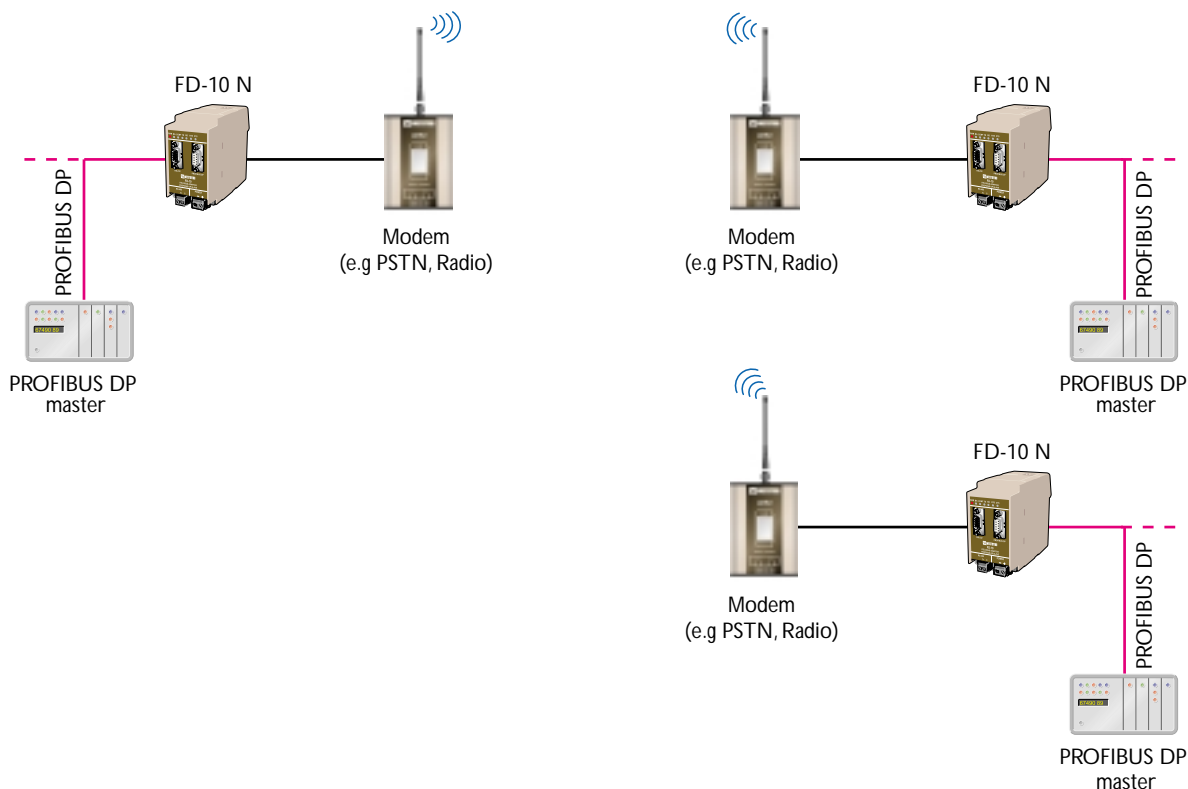

4. Specifications

4.1 Interfaces

Power

Rated voltage	12–48 VDC
Operating voltage	9.6–57.6 VDC
Rated current	250 mA @ 12 V, 120 mA @ 24 V, 60 mA @ 48 V
Rated frequency	DC
Polarity	Reverse polarity protected
Connection	Screw terminal
Connector size	0.2–2.5 mm ² (AWG 24–12)
Fuse	To be externally fused

PROFIBUS DP

Electrical specification	RS-485 / EN 50 170
Data rate	9.6, 19.2, 45.45, 93.75, 187.5, 500, 1 500, 3 000, 6 000 and 12 000 kbit/s
Connection	9-position D-sub (female)
Termination	External
Circuit type	TNV-1

RS-485

Electrical specification	RS-485/V.11
Data rate	1 200, 2 400, 4 800, 9 600, 14 400, 19 200 and 38 400 bit/s
Connection	2-position screw terminal
Connector size	0.2 – 2.5 mm ² (AWG 24-12)
Circuit type	TNV-1

RS-232

Electrical specification	RS-232/V.24
Data rate	1 200, 2 400, 4 800, 9 600, 14 400, 19 200 and 38 400 bit/s
Connection	9-position D-sub, DTE
Circuit type	SELV

4.2 Insulation between interfaces

Power to all other	1.0 kV RMS @ 50Hz and 60 s duration
PROFIBUS DP to all other	1.0 kV RMS @ 50Hz and 60 s duration

Please note that there is no galvanic isolation between the RS-232 and the RS-485 ports so they should not be connected simultaneously.

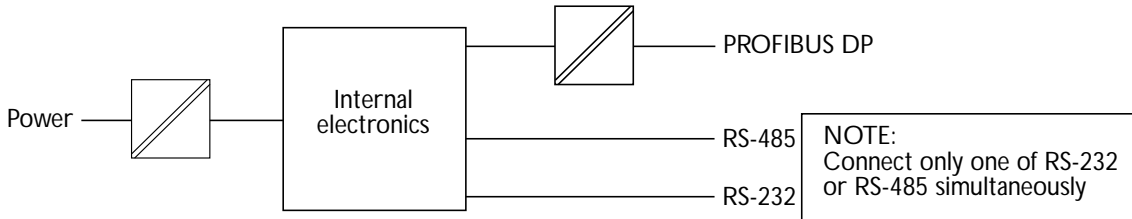

4.3 Climatic environment

Temperature, operating	+5 to +55°C (optional industrial –25 to +70°C)
Temperature, storage and transportation	–25 to +70°C
Relative humidity, operating	5 to 95% (non-condensing)
Relative humidity, storage and transportation	5 to 95% (condensation allowed outside packaging)

4.4 Mechanics

Dimension (W x H x D)	55 x 100 x 132 mm
Weight	0.3 kg
Mounting	35 mm DIN-rail
Degree of protection	IP 20 (IEC 529)

5. Maintenance

No maintenance is required, as long as the unit is used as intended within the specified conditions.

6. Installation

6.1 Mounting /Removal



Before mounting or removing the unit:

Prevent damage to internal electronics from electrostatic discharges (ESD) by discharging your body to a grounding point (e.g. use of wrist strap).

Prevent access to hazardous voltages by disconnecting the unit from AC/DC mains supply and all other electrical connections.

Mounting

This unit should be mounted on 35 mm DIN-rail which is horizontally mounted on a wall or cabinet backplate.

This unit uses convection cooling. To avoid obstructing the air flow around the unit, use the following spacing rules.

Minimum spacing 25 mm (1.0 inch) above/below and 10 mm (0.4 inches) left/right the unit.

Snap on mounting, see figure.

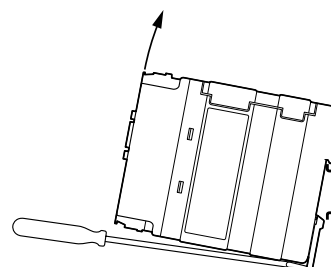
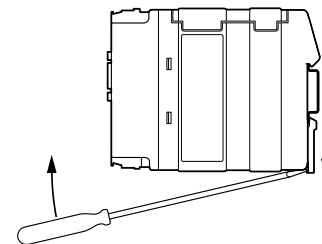
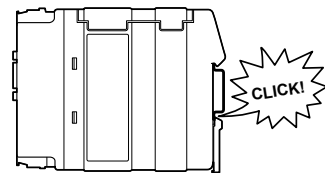
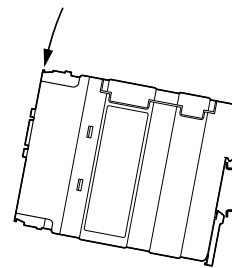
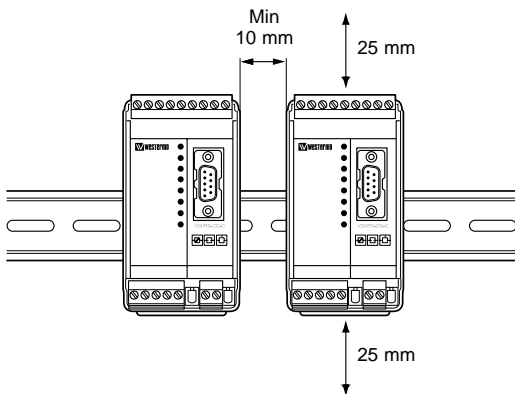

Removal

Press down the black support at the back of the unit using a screwdriver, see figure.

6.2 Connections

RS-232

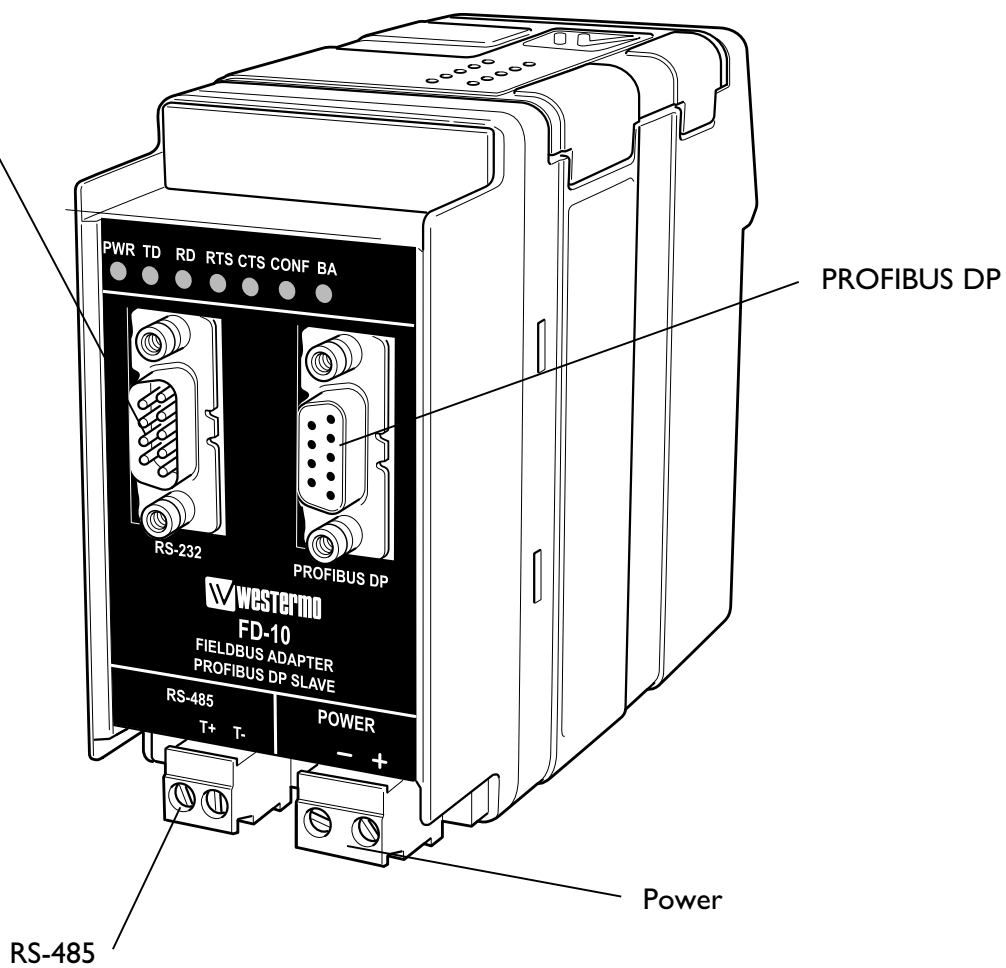

PROFIBUS DP

Power

RS-485

6.2.2 Power

2-pos screw terminal	Direction	Description
No. 1	-	0V DC (-)
No. 2	+	+12 to +48 VDC (+)



6.2.3 PROFIBUS DP

9-pos D-sub	Direction	Description
No. 1	-	-
No. 2	-	-
No. 3	In/Out	RxD/TxD-P
No. 4	Out	CNTR-P
No. 5	-	DGND
No. 6	Out	VP
No. 7	-	-
No. 8	In/Out	RxD/TxD-N
No. 9	-	DGND

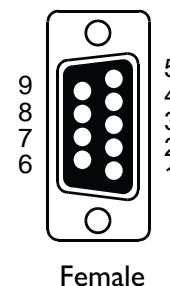

6.2.4 RS-232 (DTE)

9-pos D-sub	Direction	Description
No. 1	-	-
No. 2	In	Receive Data (RD)
No. 3	Out	Transmit Data (TD)
No. 4	Out	Data Terminal Ready (DTR)
No. 5	-	Signal ground (SG)
No. 6	-	-
No. 7	Out	Request To Send (RTS)
No. 8	In	Clear To Send (CTS)
No. 9	-	-

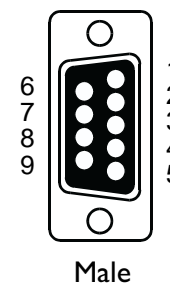

6.2.5 RS-485

2-pos screw terminal	Direction	Description
No. 1	In/out	Transmit/Receive T/R+ (T+)
No. 2	In/out	Transmit/Receive T/R- (T-)



6.3 Indicators

6.3.1 LED indicators

PWR	LED on LED off	In service Out of service
BA	LED on LED off	PROFIBUS DP active PROFIBUS DP inactive
CONF	LED on LED off	Configuration mode Normal operation mode
TD	LED on LED off	Transmit serial (RS-232/485) data –
RD	LED on LED off	Receive serial (RS-232/485) data –
RTS	LED on LED off	Request To Send (RTS) set –
CTS	LED on LED off	Clear To Send (CTS) received active –

6.4 Configuration

Most of the FD-10 settings have to be carried out by Westermo FD-Tool, a PC based configuration software, either on-line or off-line. Only RS-232 or RS-485 transfer settings will be set by DIP switches.

6.4.1 DIP switch settings

DIP-switches are accessible under the lid on top of the unit.



Warning! Prevent damage to internal electronics from electrostatic discharges (ESD) by discharging your body to a grounding point (e.g. use of wrist strap), before the lid on top of the modem is removed.



Warning! Do not open connected equipment. Prevent access to hazardous voltages by disconnecting the unit from AC/DC mains supply and all other electrical connections.

NOTE The change of DIP switch settings are valid only after a power on.

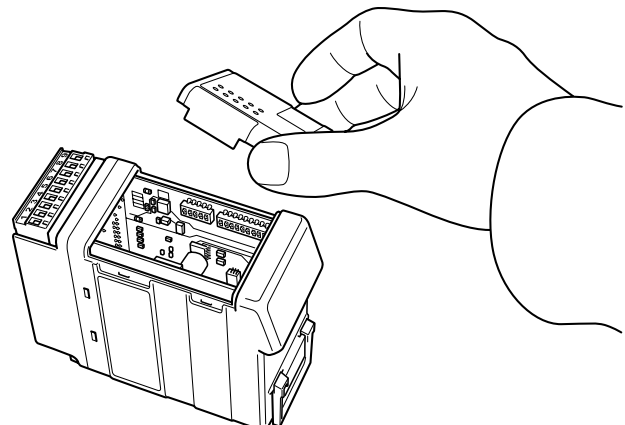

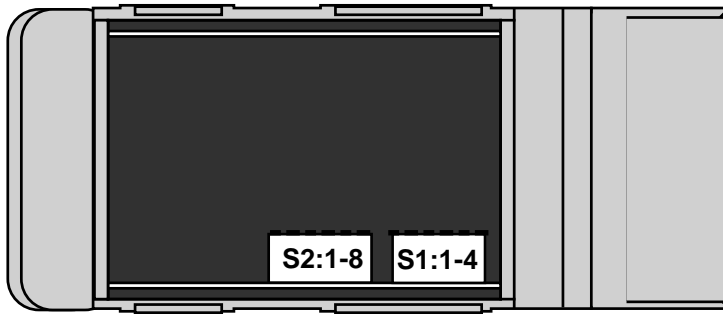

Switch block 1 Serial transfer setting



No RS-485 termination



RS-232 selected as serial transfer port, data control

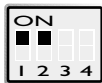

RS-485 terminated by 120 Ω, with fail-safe



RS-232 selected as serial transfer port, RTS/CTS control



RS-485 selected as serial transfer port

Factory setting



S1

RS-232 selected as serial transfer port, data control.
No RS-485 termination

Note 1: Configuration by FD-Tool require factory setting (all S1 switches off).

Note 2: Switch 2 is not used.

6.4.2 On-line configuration by FD-Tool

This part will only describe the usage of FD-Tool to perform an on-line configuration. For FD-Tool installation and general FD-Tool handling, see "FD-Tool installation manual" on the CD, FD-Tool.

The FD-10 goes into configuration mode, a connection with FD-Tool, immediately after a power on. The serial interface is set as follows, and should not be changed.

RS-232	9 600 bit/s	no parity	8 data bits	1 stop bit	data control
--------	-------------	-----------	-------------	------------	--------------

Initiate an on-line configuration

- Start the FD-Tool.
- Connect a DTE-DTE serial cable (zero-modem) to the serial port of the PC and the RS-232 port of the FD-10.
- Initiate communication between the FD-Tool and the FD-10 by selecting **Connect > RS-232**. The FD-Tool will attempt to get communication until a successful connection or a manual cancel.
- Power the connected FD-10. The CONF LED of FD-10 will be active and remain so as long as the FD-10 is in configuration mode. After some seconds, the connection will be established and the Status (to left in lower border of FD-Tool window) will be changed from Disconnected to Connected. If the CONF LED will be inactive (after about 3 seconds), the initiation of on-line configuration is failed. If failed, check the serial cable and that all S2 switches are set to off. Power on the device again.
- The FD-Tool shows the device type of this FD-10, present configuration, or the default configuration whether the FD-10 is used for the first time.

Modify configuration

Configurations are defined per device type, see "Functional description", chapter 7.

FD-10 P	Point to point and Addressed, serial transfer slave
FD-10 A	Addressed, serial transfer master
FD-10 N	Network, serial sending

Load configuration to FD-10

- The present configuration, shown by FD-Tool, will be loaded to the FD-10 by selecting **File > Configuration > Load to device**.
- This loaded configuration will be running in normal operation after a new power on and when the CONF LED has been set to inactive.

6.4.3 Off-line configuration by FD-Tool

This part will only describe the usage of FD-Tool to perform an off-line configuration. For FD-Tool installation and general FD-Tool handling, see "FD-Tool installation manual."

Initiate a new off-line configuration

- Start the FD-Tool.
- Select the device type by selecting **File > Configuration > New (default / device)** and Select Group in Device Selection window. The selected group has to be the same as the FD-10 device, for which the configuration will be used.
- FD-Tool will show the device type of this FD-10 for which all configuration parameters have to be set.

Modify configuration

Configurations are defined per device type, see "Functional description", chapter 7.

FD-10 P	Point to point and Addressed, serial transfer slave
FD-10 A	Addressed, serial transfer master
FD-10 N	Network, serial sending

Load configuration to FD-10

- See "On-line configuration by FD-Tool", chapter 6.4.2.

6.4.4 Save, load and modify configuration files by FD-Tool

Save configuration to disk

- The present configuration can be saved to disk as a file, to be used for future configurations of the same device type, by selecting **File > Configuration > Save to disk**
- An arbitrary file name can be used, saved as a *.cnf file.

Load and modify a disk stored configuration

- Load configuration from disk by selecting **Configuration > Load from disk** and open the wanted configuration file (*.cnf).
- FD-Tool shows the device type of this FD-10 with the present configuration.

7. Functional description

Technical data

Device	Point to point		Addressed	Network
	Device type	FD-10 P		FD-10 A
GSD-file	FD-10.GSD		FD-10.GSD	FD-10.GSD
PROFIBUS DP data	Device type	Slave		Slave
	Address range	0 to 126		0 to 126
	Number of modules	Up to 8		2
	Input data	Up to 65 word/ 130 byte		Up to 65 word
	Output data	Up to 65 word/ 130 byte		Up to 65 word
	Data control programming	-		One word for serial transfer control
Serial transfer	Transfer type	Slave		Master
	Transfer check	16 bit CRC		16 bit CRC
	Transfer mode	Point to point	Addressed transfer	Addressed transfer
	Serial address	-	0 to 254	-
	Connection control	Stat_Diag, number of failed frames 1 to 255	Stat_Diag, timeout without frames 1 to 255 s	Receive timeout, 1 500 ms
			Receive timeout, 0 to 65 535 ms	

7.1 Point to point and Addressed, serial transfer slave, FD-10 P

Point to point transfer

Continuous transfer of defined PROFIBUS I/O data modules from this FD-10 to an other FD-10.

All by FD-Tool defined PROFIBUS I/O modules will be mirrored between the two FD-10's. Input modules of FD-10 at one side will be sent to output modules of FD-10 at the other side, and vice versa. However, note that there will be a time delay which depends on the serial transfer time.

FD-10 continuously transfer I/O data, or try to initiate continuously transfer in the initially stage, when the unit is in normal operation mode and the PROFIBUS DP is active, LED CONF inactive and BA active.

Master controlled transfer (Addressed)

Wait for a received serial transfer frame including this unit's serial transfer address. After a correct received frame, an I/O data frame will be sent back once.

All by FD-Tool defined PROFIBUS I/O modules will be mirrored between this FD-10 and the FD-10 at the other side. Input modules of FD-10 will be sent to output modules of FD-10 at the other side, and vice versa. Note that command and status data (including this unit's serial transfer address) will not be included in PROFIBUS I/O data of this FD-10.

FD-10 can receive frames when the unit is in normal operation mode and the PROFIBUS DP is active, LED CONF inactive and BA active.

7.1.1 Basic configuration

Serial transfer > Transfer mode

Point – point	Select Transfer slave point to point mode, with serial connection to one Fieldbus Adapter. FD-10 will initiate and begin continuous transfer of data with the other Fieldbus Adapter.
Addressed slave	Select Transfer slave addressed mode, with serial connection to one Fieldbus Adapter acting as transfer master. FD-10 will wait for received data (including serial address) from the Fieldbus Adapter master and send back data once.
Address 0–254	Set this FD-10 Transfer slave address. Only needed when Addressed slave has been selected.

Serial transfer > Serial interface

Select the desired parameters of the Serial interface.

PROFIBUS-DP > PROFIBUS DP parameters

PROFIBUS DP Address	Set this FD-10 PROFIBUS DP address.
Number of I/O Modules	Set the number of I/O modules used by this FD-10. Module 1 and up to selected “Number of I/O Modules” will be used by FD-10.

I/O module 1–4 > I/O module 1

Data type	Select data type for I/O module 1.
Module type	Select module type for I/O module 1.
Data length	Set data length of I/O module 1. Note that data length is related to selected data type, byte or word. Byte has a length of 8 bit and word 16 bits.
Identifier [hex]	Show the resulting identifier in hex.

The same content for all I/O modules, 1 to 8. Module 1 and up to selected “Number of I/O Modules” will be used by FD-10.

7.1.1.1 Expert configuration

Serial transfer > Expert parameters

Delay to send first byte in frame [ms]	Set the delay time before switching from send to receive, or vice versa. Default is 0. Used when serial transfer line requires a turning time.
Max time between bytes in frame [ms]	Set the maximum allowed time between bytes in a serial frame. Default is 100. Useful when a frame will be divided by transferring units (modem) which can cause a gap in parts of the frame. Shall be less than “Min random delay at initiation”.

Min/max random delay at initiation [ms]	Create a random delay until sending the initial frame at point to point mode, to avoid collisions after start up or at disturbed communication. Default is min 200 and max 500. For radio communications these times normally need to be increased, min 500 and max 800 is recommended.
Fixed frame length 20 data bytes	Fixed 25 byte frame length. Should not be used. Only when used together with old system.
Fixed frame length 32 data bytes	Fixed 37 byte frame length. Should not be used. Only when used together with old system.
Variable frame length 1..249 data bytes	Should be selected for all Westermo Fieldbus Adapters.

PROFIBUS-DP > Expert parameters

Enable/Disable Stat Diag	When set to enable, the setting of the PROFIBUS DP diagnostic information Stat_Diag (static diagnostics) flag is enabled. Disable may be used when the PROFIBUS DP master don't handle Stat_Diag. Default is Enable.
Failed frames until set Stat Diag	Only for Point to point transfer. Set maximum number of consecutive sent frames without any correct acknowledge. When exceeded will the Stat_Diag flag be set. Default is 3. Can be increased if transmission line is disturbed and that is acceptable.
Timeout until set Stat Diag	Only for Addressed transfer. Set maximum time in seconds since last received frame, or time since device set in normal operation (power on), without any new correct received frame. When time is exceeded will the Stat_Diag flag be set. Default is 3. Can be increased if it is long time between transfer of data with this device and/or the transmission line is disturbed.
ID number	Show the ID number of FD-10. Can't be changed.

7.1.2 PROFIBUS DP I/O data

Ordinary PROFIBUS DP input and output data are used by FD-10. No additional programming of the PROFIBUS DP master is needed for I/O data transfer.

7.2 Addressed, serial transfer master, FD-10 A

Transfer defined PROFIBUS I/O data modules between two FD-10's, each time on demand by a PROFIBUS DP master. FD-10 A is the serial transfer master that transfer I/O data between various FD-10's, selected by serial transfer address. This serial addressing enable access to up to 255 independent remote PROFIBUS DP nets by only one serial transmission line (e.g. radio system or RS-485).

By FD-Tool defined PROFIBUS I/O modules will be mirrored between FD-10 A and the serial addressed FD-10 P at the other side. Input modules of FD-10 will be sent to output modules of FD-10 at the other side, and vice versa. Note that one data word command output and one data word status input has to be included in PROFIBUS I/O data of FD-10 A. The command control the serial transfer and the status return information about the transfer.

FD-10 can transfer frames when the unit is in normal operation mode and the PROFIBUS DP is active, LED CONF inactive and BA active.

7.2.1 Basic configuration

Serial transfer > Serial interface

Select the desired parameters of the Serial interface.

PROFIBUS-DP > PROFIBUS DP parameters

PROFIBUS DP Address	Set this FD-10 PROFIBUS DP address.
Number of I/O Modules	Set the number of I/O modules used by this FD-10. Module 1 and up to selected "Number of I/O Modules" will be used by FD-10.

I/O module 1-4 > I/O module 1

Data type	Select data type for I/O module 1.
Module type	Select module type for I/O module 1.
Data length	Set data length of I/O module 1. Note that data length is related to selected data type, byte or word. Byte has a length of 8 bit and word 16 bits.
Identifier [hex]	Show the resulting identifier in hex.

The same content for all I/O modules, 1 to 8. Module 1 and up to selected "Number of I/O Modules" will be used by FD-10.

7.2.1.1 Expert configuration

Serial transfer > Expert parameters

Max time between bytes in frame [ms]	Set the maximum allowed time between bytes in a serial frame. Default is 100. Useful when a frame will be divided by transferring units (modem) which can cause a gap in parts of the frame.
Fixed frame length 20 data bytes	Fixed 25 byte frame length. Should not be used. Only when used together with old system.
Fixed frame length 32 data bytes	Fixed 37 byte frame length. Should not be used. Only when used together with old system.
Variable frame length 1..249 data bytes	Should be selected for all Westermo Fieldbus Adapters.

PROFIBUS-DP > Expert parameters

ID number	Show the ID number of FD-10. Can't be changed.
CPU type	Hardware information. For service purpose only. Can't be changed.

7.2.2 PROFIBUS DP I/O data

Ordinary PROFIBUS DP I/O data are used by FD-10 A, including one data word in and one out for the serial transfer control. Additional programming of the PROFIBUS DP master to control I/O data transfer is needed, as defined below.

7.2.2.1 Output data word

Data transmitted from PROFIBUS DP master to FD-10 A. The first word is the serial transfer command word and the remaining 2 to 65 words are ordinary output data sent to addressed remote Fieldbus Adapter.

Word	15	High byte						8	7	Low byte		0
1	EN	SDO	–	CNF	RES	–	–	–	Transfer slave address, in range 0–254			
2	Out data word 1, high byte							Out data word 1, low byte				
...				
...				
65	Out data word 64, high byte							Out data word 64, low byte				

Out word 1 high byte (bit 15..8) is the serial transfer command byte, with following content:

EN	ENable FD-10 (bit15). This bit must always be set high (1) for normal operation. When set, FD-10 indicates data set ready by the EN bit being set in the Input status word. EN bit set to low (0) disable FD-10.
SDO	Send actual Data Once, toggle bit (bit 14). When this toggle bit change state, all out words are taken from DP output data words and transmitted directly over the serial transfer interface of FD-10.

- CNF CoNFIGuration mode (bit 12).
For testing purpose only.
This bit is set low (0) during the normal operating mode of the FD-10. This bit is set high (1) in order to switch the FD-10 over from normal operating mode to configuration mode via PROFIBUS DP.
- RES RESet read back status, toggle bit (bit 11).
When this toggle bit change state, it will reset read back status of ACK, TO and all data input words.

Out word 1 low byte (bit 7..0) is the serial transfer address, with following content:
Transfer slave address of the Fieldbus Adapter to which this frame shall be sent. Serial transfer slave address, in range 0 to 254.

Out word 2 to 65 is the output data, with following content:

- Word 2 High: Output byte 1 Low: Output byte 2
Word 3 High: Output byte 3 Low: Output byte 4
.....
Word 65 High: Output byte 127 Low: Output byte 128.

7.2.2.2 Input data word

Data is transmitted from the FD-10 A to the PROFIBUS DP master. The first word is the added status word and the remaining 2 to 65 words are ordinary input data received from the output word addressed remote Fieldbus Adapter.

Word	15	High byte						8	7	Low byte						0
1	ST	-	DV	-	ACK	TO	-	-	-	-	-	-	-	-	-	
2	In data word 1, high byte								In data word 1, low byte							
...							
...							
65	In data word 64, high byte								In data word 64, low byte							

Input word 1 high byte (bit 15..8) is the serial transfer status byte, with following content:

- ST Status of serial transfer command FD-10 (bit15).
Set high (1) when the received command has been accepted by the FD-10. Set low (0) if the received command has not been accepted.
- DV Data Valid (bit 13).
For testing purpose only.
Acknowledgement of the command CNF.
- ACK ACKnowledgement of serial transfer (bit 11).
Set high (1) when serial transfer sent output data to a remote FD-10 has resulted in a received frame with input data from the remote FD-10.
- TO Time Out received serial transfer (bit 10).
Set high (1) when the last serial transfer of output data to a remote FD-10 has not resulted in any received frame within 1500 ms.

In word 1 low byte (bit 7..0) is not used.

In word 2 to 65 is the input data, with following content:

Word 2	High: Input byte 1	Low: Input byte 2
Word 3	High: Input byte 3	Low: Input byte 4
.....
Word 65	High: Input byte 127	Low: Input byte 128.

7.2.2.3 PROFIBUS DP communication

Required PROFIBUS DP communication sequence, from a PROFIBUS DP master unit to FD-10 A, to get access and data exchange with remote Fieldbus Adapters.

Preparing for data exchange:

1. Enable normal operation access with FD-10 by command EN
Out word 1, bit 15 set high (1).
2. Verify accepted EN command by checking status ST.
In word 1, bit 15 shall be high (1).

Data exchange with a remote Fieldbus Adapter:

1. Set the Transfer slave address.
Out word 1, low byte to current serial transfer address.
2. Set Out data (up to 64 words) to this Transfer slave.
Out word 2 ... 65.
3. Reset last received Input data and status by the command RES.
Out word 1, change state of toggle bit 11.
4. Transmit output data over serial transfer line by the command SDO.
Out word 1, change state of toggle bit 14.
5. Verify correct sent and received data by checking status ACK.
In word 1, bit 11 shall be high (1).
 - Or, incorrect sent and received data, has not been received within 1500 ms by checking status TO.
In word 1, bit 10 is set to high (1) in case of time out.
6. If correct received data will ACK be high (1) and TO low (0).
Read In data (up to 64 word) from addressed Fieldbus Adapter.
In word 2 ... 65.

7.3 Network, serial sending, FD-10 N

Send PROFIBUS in data from one FD-10 to an other FD-10 to be set as PROFIBUS out data, on demand (event) by the PROFIBUS DP master in the sending PROFIBUS DP net. One of the included FD-10's can send I/O data to any other FD-10, selected by serial transfer address. Note that the first data word, command output and one data word status input has to be included in PROFIBUS I/O data of FD-10.

Arbitrary FD-10 can send a frame to an other FD-10 at any time. This serial addressing enable access to up to 64 independent remote PROFIBUS DP nets by only one serial transmission line (e.g. radio system or RS-485). To reduce collisions on the transmission line, the frequency or time between events resulting in sending has to be limited. The degree of limitation depend on the number of FD-10's and data rate of the serial transfer.

FD-10 can send frames when the unit is in normal operation mode and the PROFIBUS DP is active, LED CONF inactive and BA active.

7.3.1 Basic configuration

Serial transfer > Transfer mode

Network Address 0–64 Set this Transfer address of this FD-10.

Serial transfer > Serial interface

Select the desired parameters of the Serial interface.

PROFIBUS-DP > PROFIBUS DP parameters

PROFIBUS DP Address Set this FD-10 PROFIBUS DP address.

7.3.1.1 Expert configuration

Serial transfer > Expert parameters

Acknowledge timeout [ms] Set the maximum allowed time from sending a serial transfer frame until received acknowledge. The status TO will be set high (1) when this time has been exceeded without any received acknowledge. Default is 500.

Max time between bytes in frame [ms] Set the maximum allowed time between bytes in a serial frame. Default is 100. Useful when a frame will be divided by transferring units which can cause a gap in parts of the frame.

PROFIBUS-DP > Expert parameters

ID number Show the ID number of FD-10. Can't be changed.

I/O module 1–2 > I/O module 1

Identifier [hex] Show the 16 word input Identifier in hex. Can't be changed.

I/O module 1-2 > I/O module 2

Identifier [hex] Show the 16 word output Identifier in hex.
 Can't be changed.

7.3.2 PROFIBUS DP I/O data

Ordinary 16 word PROFIBUS DP I/O data are used by FD-10 N, including one data word in and one out for the serial transfer control. Additional programming of the PROFIBUS DP master to control I/O data transfer is needed, as defined below.

7.3.2.1 Output data word

Data transmitted from PROFIBUS DP master to FD-10 N. The first word is the serial transfer command word and the remaining 2 to 15 words are ordinary output data sent to addressed remote Fieldbus Adapter.

Word	15	High byte						8	7	Low byte		0
1	EN	SDO	GTL	CNF	RES	-	-	-	Transfer slave address in range 0-63			
2	Out data word 1											
...	...											
...	...											
16	Out data word 15											

Output word 1 high byte (bit 15..8) is the serial transfer command byte, with following content:

- EN ENable FD-10 (bit15).
 This bit must always be set high (1) for normal operation.
 When set the FD-10 indicates data set ready by the EN bit being set in the Input status word. EN bit set to low (0) disable FD-10.
- SDO Send actual Data Once, toggle bit (bit 14).
 When this toggle bit change state, the data words are taken from the DP data words and transmitted directly over the serial transfer interface of FD-10.
- GTL Get TeLegram, toggle bit (bit 13).
 When this toggle bit change state, the received serial transfer frame will be set in the PROFIBUS DP input data.
- CNF CoNfiguration mode (bit 12).
 For testing purposes only.
 This bit is set low (0) during normal operating mode of FD-10.
 This bit is set high (1) in order to switch the FD-10 over from normal operating mode to configuration mode.
- RES RESet read back status, toggle bit (bit 11).
 When this toggle bit change state, it will reset read back status ACK, NAK and TO also in all data in words.

Output word 1 low byte (bit 7..0) is the serial transfer address, with following content:
 Transfer slave address of the Fieldbus Adapter to which this frame will be sent.
 Serial transfer slave address, is in the range 0 to 64.

Output word 2 to 16 is the output data, with following content:

- Word 2 Output data word 1
- Word 3 Output data word 2
-
- Word 16 Output data word 15.

7.3.2.2 Input data word

Data is transmitted from the FD-10 N to the PROFIBUS DP master. The first word is the added status word and the remaining 2 to 15 words are ordinary input data received from the input word transfer slave addressed Fieldbus Adapter.

Word	15	High byte						8	7	Low byte		0
1	ST	DEX	DV	NAK	ACK	TO	-	-	Transfer slave address in range 0-63			
2	In word 1											
...	...											
...	...											
16	In word 15											

Input word 1 high byte (bit 15..8) is the serial transfer status byte, with following content:

- ST** Status of serial transfer command FD-10 (bit15).
Set to high (1) when the received command has been accepted by the FD-10.
Set to low (0) if the received command has not been accepted.
- DEX** Data EXist (bit 14).
Set to high (1) when correct data is located in PROFIBUS DP input data.
- DV** Data Valid toggle bit (bit 13).
This toggle bit change state, when the received serial transfer frame data has been set in the PROFIBUS DP input data.
- NAK** No AcKnowledge (bit 12).
Set to high (1) when last transmitted serial transfer frame to a remote FD-10 resulted in a received no acknowledge (NAK).
- ACK** AcKnowledge of serial transfer (bit 11).
Set to high (1) when last transmitted serial transfer frame to a remote FD-10 resulted in a received acknowledge (ACK).
- TO** Time Out of serial transfer (bit 10).
Set to high (1) when last transmitted serial transfer frame to a remote FD-10 has not resulted in any received ACK or NAK within "Max time to acknowledge frame".

Input word 1 low byte is the serial transfer address, with following content:

Transfer slave address of the Fieldbus Adapter from which this received frame has been transmitted, only valid when DEX is high (1). Serial transfer slave address, in the range 0 to 64.

Input word 2 to 16 is the input data, with following content:

Word 2 Input word 1

Word 3 Input word 2

.....

Word 16 Input word 15.

7.3.2.3 PROFIBUS DP communication

This describes the required PROFIBUS DP communication sequence from a PROFIBUS DP master to an FD-10 N, to get access and data exchange with a remote FD-10 N.

Preparing for data exchange:

1. Enable normal operation access with FD-10 by command EN
Out word 1, bit 15 set high (1).
2. Verify accepted EN command by checking status ST
In word 1, bit 15 shall be high (1).

Send PROFIBUS DP data from local FD-10 N to remote FD-10 N:

1. Set the Transfer slave address.
Out word 1, low byte.
2. Set Out data to this Transfer slave.
Out word 2 ... 16.
3. Reset Input word status by the command RES.
Out word 1, change state of toggle bit 11.
Transmit output data over serial transfer line by the command SDO.
Out word 1, change state of toggle bit 14.
4. Verify correct transmitted serial transfer frame by checking status ACK.
In word 1, bit 11 shall be high (1).
 - Or incorrect transmitted, resulting in no acknowledge by checking status NAK.
In word 1, bit 12 is set to high (1) in case of no acknowledge.
 - Or, incorrect transmitted, resulting in exceeding "Max time to acknowledge frame"
by checking status TO.
In word 1, bit 10 is set to high (1) in case of time out.

Receive PROFIBUS DP data from remote FD-10 N via local FD-10 N:

1. Wait for received frame by checking status DEX.
In word 1, bit 14 shall be high (1).
2. Set the received serial transfer frame in the PROFIBUS DP input data by the command GTL.
Out word 1, change state of toggle bit 13.
3. Wait until serial transfer frame data has been set in the PROFIBUS DP input data, by checking whether the status bit DV has changed.
In word 1, toggle bit 13 shall change state.
4. Read the Transfer slave address of the Fieldbus Adapter from which this received frame has been transmitted.
In word 1, low byte.
5. Read input data of PROFIBUS DP.
In word 2 ... 16.

OWN COMMENTS

A series of 20 horizontal dotted lines spanning the width of the page, intended for handwritten comments.

Application examples

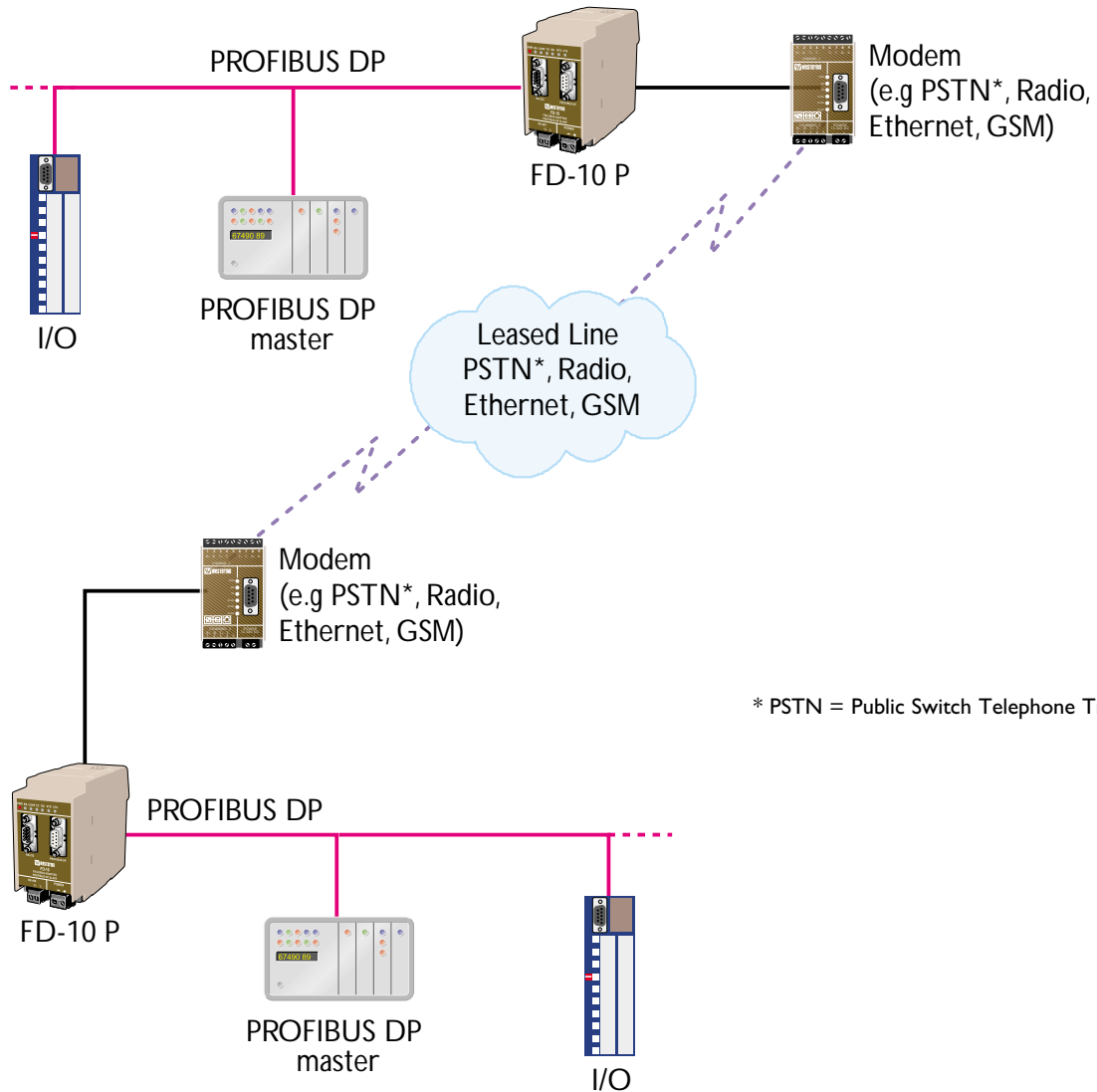

Westermo Teleindustri AB • SE-640 40 Stora Sundby, Sweden
 Phone +46 16 42 80 00 Fax +46 16 42 80 01
 E-mail: info@westermo.se
Westermo Web site: www.westermo.com

Subsidiaries

Westermo Data Communications Ltd
 Unit 14 Talisman Business Centre • Duncan Road
 Park Gate, Southampton • SO31 7GA
 Phone: +44(0)1489 580 585 • Fax: +44(0)1489 580586
 E-Mail: sales@westermo.co.uk

Westermo Data Communications GmbH
 Goethestraße 67, 68753 Waghäusel
 Tel.: +49(0)7254-95400-0 • Fax: +49(0)7254-95400-9
 E-Mail: info@westermo.de

Westermo Data Communications S.A.R.L.
 9 Chemin de Chilly 91160 CHAMPLAN
 Tél : +33 1 69 10 21 00 • Fax : +33 1 69 10 21 01
 E-mail : infos@westermo.fr

Westermo Teleindustri AB have distributors in several countries, contact us for further information.