

User Guide
6621-2212

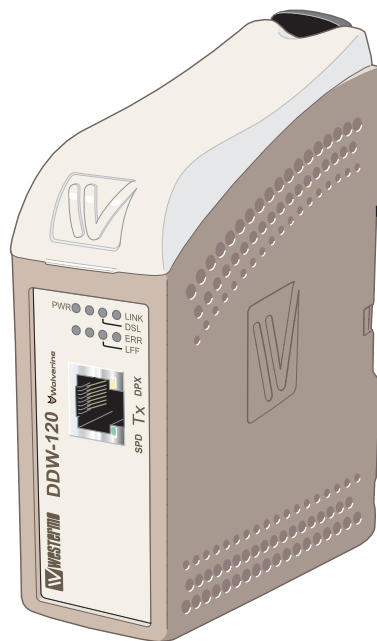

DDW-120



**Industrial Ethernet
SHDSL Extender**

www.westermo.com

AUDIN - 8, avenue de la malle - 51370 Saint Brice Courcelles
Tel : 03.26.04.20.21 - Fax : 03.26.04.28.20 - Web : <http://www.audin.fr> - Email : info@audin.fr

Legal information

The contents of this document are provided “as is”. Except as required by applicable law, no warranties of any kind, either express or implied, including, but not limited to, the implied warranties of merchantability and fitness for a particular purpose, are made in relation to the accuracy and reliability or contents of this document. Westermo reserves the right to revise this document or withdraw it at any time without prior notice.

Under no circumstances shall Westermo be responsible for any loss of data or income or any special, incidental, and consequential or indirect damages howsoever caused.

More information about Westermo can be found at the following Internet address:

<http://www.westermo.com>

Safety



Before using this unit:

Read this manual completely and gather all information on the unit. Make sure that you understand it fully. Check that your application does not exceed the safe operating specifications for this unit.

Hazardous voltage may occur within this unit when connected to power supply or TNV circuits.

Prevent access to hazardous voltage by disconnecting the unit from power supply and all other electrical connections.

Prevent damage to internal electronics from electrostatic discharges (ESD) by discharging your body to a grounding point (e.g. use of wrist strap).



Before installation:

This unit should only be installed by qualified personnel.

This unit should be built-in to an apparatus cabinet, or similar, where access is restricted to service personnel only.

The power supply wiring must be sufficiently fused, and if necessary it must be possible to disconnect manually from the power supply. Ensure compliance to national installation regulations.

This unit uses convection cooling. To avoid obstructing the airflow around the unit, follow the spacing recommendations (see Installation section).

Care recommendations

Follow the care recommendations below to maintain full operation of unit and to fulfil the warranty obligations.

This unit must not be operating with removed covers or lids.

Do not attempt to disassemble the unit. There are no user serviceable parts inside.

Do not drop, knock or shake the unit, rough handling above the specification may cause damage to internal circuit boards.

Do not use harsh chemicals, cleaning solvents or strong detergents to clean the unit.

Do not paint the unit. Paint can clog the unit and prevent proper operation.

Do not expose the unit to any kind of liquids (rain, beverages, etc). The unit is not waterproof. Keep the unit within the specified humidity levels.

Do not use or store the unit in dusty, dirty areas, connectors as well as other mechanical part may be damaged.

If the unit is not working properly, contact the place of purchase, nearest Westermo distributor office or Westermo Tech support.

Maintenance

No maintenance is required, as long as the unit is used as intended within the specified conditions.

Agency approvals and standards compliance

| Type | Approved Agency/ W-mo | Approval / Compliance |
|--------|-----------------------|---|
| EMC | W-mo | EN 61000-6-2, Immunity industrial environments |
| | W-mo | EN 55024, Immunity IT equipment |
| | W-mo | EN 61000-6-3, Emission residential environments |
| | W-mo | FCC part 15 Class B |
| | W-mo | EN 50121-4, Railway signalling and telecommunications apparatus |
| Safety | W-mo | EN 60950-1, IT equipment |
| SHDSL | NEMKO | ITU-T G.991.2, G.SHDSL and G.SHDSL.bis standard |

FCC Part 15.105 Notice:

This equipment has been tested and found to comply with the limits for a Class B digital device, pursuant to Part 15 of the FCC Rules. These limits are designed to provide reasonable protection against harmful interference in a residential installation. This equipment generates, uses and can radiate radio frequency energy and, if not installed and used in accordance with the instructions, may cause harmful interference to radio communications. However, there is no guarantee that interference will not occur in a particular installation. If this equipment does cause harmful interference to radio or television reception, which can be determined by turning the equipment off and on, the user is encouraged to try to correct the interference by one or more of the following measures:

- ⌘ Reorient or relocate the receiving antenna
- ⌘ Increase the separation between the equipment and receiver
- ⌘ Connect the equipment into an outlet on a circuit different from that to which the receiver is connected
- ⌘ Consult the dealer or an experienced radio/TV technician for help.

Declaration of Conformity



Westermo Teleindustri AB

Declaration of conformity

The manufacturer Westermo Teleindustri AB
SE-640 40 Stora Sundby, Sweden

Herewith declares that the product(s)

| Type of product | Model | Art no | From serial no. |
|-----------------|-------------------|-----------|-----------------|
| DIN-rail | Wolverine DDW-120 | 3621-0110 | 1000 |

is in conformity with the following EC directive(s).

| No | Short name |
|-------------|-------------------------------------|
| 2004/108/EC | Electromagnetic Compatibility (EMC) |

References of standards applied for this EC declaration of conformity.

| No | Title | Issue |
|--------------|---|-------|
| EN 61000-6-1 | Immunity for residential, commercial and light-industrial environments | 2007 |
| EN 61000-6-2 | Immunity for industrial environments | 2005 |
| EN 61000-6-3 | Emission standard for residential, commercial and light-industrial environments | 2007 |
| EN 61000-6-4 | Emission standard for industrial environments | 2007 |
| EN 55022 | Information technology equipment. Radio disturbance characteristics. Limits and methods of measurement. | 2006 |
| EN 55022 A1 | | 2007 |
| EN 50121-4 | Railway applications – Electromagnetic compatibility – Emission and Immunity of the signalling and telecommunications apparatus | 2006 |
| EN 55024 | Information technology equipment – Immunity | 1998 |
| EN 55024 A1 | | 2001 |
| EN 55024 A2 | | 2003 |

The last two digits of the year in which the CE marking was affixed: 10

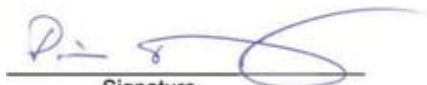
Signature

Pierre Öberg
R&D Manager
11th January 2010

| | | | | | | |
|---------------------------------|-------------------------------|-------------------------------|------------|-----------|----------------------------------|-------------------|
| Postadress/Postal address | Tel. | Telefax | Postgiro | Bankgiro | Org.nr/ Corp. identity number | Registered office |
| S-640 40 Stora Sundby Sweden | 016-428000 Int+46 16428000 | 016-428001 Int+46 16428001 | 52 72 79-4 | 5671-5550 | 556361-2604 | Eskilstuna |

Type tests and environmental conditions

| Phenomena | Test | Description | Test levels |
|--------------------------------|----------------|-------------------------------------|--|
| ESD | EN 61000-4-2 | Enclosure contact | ± 6 kV |
| | | Enclosure air | ± 8 kV |
| RF field AM modulated | IEC 61000-4-3 | Enclosure | 10 V/m 80% AM (1 kHz), 80 – 1 000 MHz 20 V/m 80% AM (1 kHz), 80 – 2 000 MHz |
| RF field 900 MHz | ENV 50204 | Enclosure | 20 V/m pulse modulated 200 Hz, 900 ± 5 MHz |
| Fast transient | EN 61000-4-4 | Signal ports | ± 2 kV |
| | | Power ports | ± 2 kV |
| Surge | EN 61000-4-5 | Signal ports unbalanced | ± 2 kV line to earth, ± 2 kV line to line |
| | | Signal ports balanced | ± 2 kV line to earth, ± 1 kV line to line |
| | | Power ports | ± 2 kV line to earth, ± 2 kV line to line |
| RF conducted | EN 61000-4-6 | Signal ports | 10 V 80% AM (1 kHz), 0.15 – 80 MHz |
| | | Power ports | 10 V 80% AM (1 kHz), 0.15 – 80 MHz |
| Power frequency magnetic field | EN 61000-4-8 | Enclosure | 100 A/m, 50 Hz, 16.7 Hz & 0 Hz |
| Pulse magnetic field | EN 61000-4-9 | Enclosure | 300 A/m, 6.4 / 16 µs pulse |
| Voltage dips and interruption | EN 61000-4-11 | AC power ports | 10 & 5 000 ms, interruption 10 & 500 ms, 30% reduction 100 & 1 000 ms, 60% reduction |
| Mains freq. 50 Hz | EN 61000-4-16 | Signal ports | 100 V 50 Hz line to earth |
| Mains freq. 50 Hz | SS 436 15 03 | Signal ports | 250 V 50 Hz line to earth |
| Voltage dips and interruption | EN 61000-4-29 | DC power ports | 10 & 100 ms, interruption 10 ms, 30% reduction 10 ms, 60% reduction +20% above & -20% below rated voltage |
| Radiated emission | EN 55022 | Enclosure | Class B |
| | FCC part 15 | | Class B |
| Conducted emission | EN 55022 | AC power ports | Class B |
| | FCC part 15 | AC power ports | Class B |
| | EN 55022 | DC power ports | Class B |
| Dielectric strength | EN 60950 | Signal port to other isolated ports | 2 kVrms 50 Hz 1 min |
| | | Power port to other isolated ports | 3 kVrms 50 Hz 1 min 2 kVrms 50 Hz 1 min (@ rated power <60 V) |
| Temperature | | Operating | -40 to +70°C |
| | | Storage & Transport | -40 to +70°C |
| Humidity | | Operating | 5 to 95% relative humidity |
| | | Storage & Transport | 5 to 95% relative humidity |
| Altitude | | Operating | 2 000 m / 70 kPa |
| Reliability prediction (MTBF) | MIL-HDBK- 217F | Operating | 600 000h |
| Service life | | Operating | 10 year |
| Vibration | IEC 60068-2-6 | Operating | 7.5 mm, 5 – 8 Hz 2 g, 8 – 500 Hz |
| Shock | IEC 60068-2-27 | Operating | 15 g, 11 ms |
| Enclosure | UL 94 | PC / ABS | Flammability class V-1 |
| Dimension W x H x D | | | 35 x 121 x 119 mm |
| Weight | | | 0.2 kg |
| Degree of protection | IEC 529 | Enclosure | IP 21 |
| Cooling | | | Convection |
| Mounting | | | Horizontal on 35 mm DIN-rail |

Description

Functional description

The DDW-120 Ethernet Extender is the ideal solution for extending your Ethernet network over copper cables where in the past the only option would have been fibre. At shorter range the transfer rate will be as fast as 15.3 Mbit/s in both directions. Depending on the quality of the cables distances up to 15 km are possible.

DDW-120 is transparent for multicast addressing, VLAN packets, VPN pass-through for IPSec and for protocols like MODBUS/tcp and Profinet. The Link Fault Forward (LFF) functionality in DDW-120 forwards information about the Ethernet link status, this is sent over the SHDSL link between two DDW-120 units. In many applications it is a requirement to disconnect the link on the other side of the SHDSL link if the primary Ethernet link goes down.

The units will auto negotiate the transmission speed but can also be forced to choose a slower (more reliable) or faster (less reliable) data rate.

DDW-120 can be used in point-to-point applications or as start and termination unit together with DDW-22x in a daisy-chain application.

Table showing speed versus distance

| | DDW-120 @ 0.5 mm ² | DDW-120 @ 0.4 mm ² |
|-------------|-------------------------------|-------------------------------|
| Speed bit/s | Distance metre / miles | Distance metre / miles |
| 192000 | 10000 / 6.21 | 6450 / 4.00 |
| 1024000 | 7650 / 4.75 | 4850 / 3.01 |
| 1280000 | 7050 / 4.38 | 4700 / 2.92 |
| 2304000 | 5950 / 3.69 | 4150 / 2.58 |
| 3328000 | 4900 / 3.04 | 3700 / 2.30 |
| 4544000 | 4250 / 2.64 | 3150 / 1.95 |
| 5696000 | 3650 / 2.26 | 2800 / 1.73 |
| 6200000 | 3000 / 1.86 | 2250 / 1.39 |
| 6712000 | 2500 / 1.55 | 1875 / 1.1 |
| 8760000 | 2000 / 1.24 | 1500 / 0.93 |
| 10296000 | 1500 / 0.93 | 1125 / 0.69 |
| 12344000 | 1000 / 0.62 | 750 / 0.46 |
| 15304000 | 700 / 0.43 | 525 / 0.32 |

Distance is tested without noise.

Description of used nomenclature:

Noise margin:

The margin between signal and noise (dB)

CO/CPE:

CO (Central Office) answering central unit, the CO configures the CPE when establishing a connection. CPE (Customer Premises Equipment) is the unit that initiates the connection.

Getting started

The DDW-120 is easy to use and install, the units work in pairs, one as has to be configured as CO (Central Office) and one as CPE (Customer Premises Equipment). This configuration is made with DIP-switches situated under the lid of the DDW-120.

① Connect the SHDSL Line

1) Connect the twisted pair to DSL screw terminal 1 and 2 (polarity independent) situated at the base of the DDW-120.

② Connect the Ethernet Line

Connect Ethernet to the TX port on the front of the DDW-120.

The factory settings for the DDW-120 is plug and play mode where TX port is enabled for:

- ⌘ Ethernet Auto-negotiation enabled.
- ⌘ Auto MDI/MDI-X.
- ⌘ Auto-polarity enabled.

The DDW-120 will automatically sense the data rate of the connected unit and cable type.

③ Settings in the units

The units operate in pairs, one as CO (Central Office) and one as CPE (Customer Premises Equipment). Factory setting in the DDW-120 is as CPE.

Note! Before connection and installation one of the connecting units have to be reconfigured as a CO, see DIP-switch S1:4.

Depending on the quality of the line and the distance there is possibility to select auto-baud function.

This is done via DIP switches in the unit configured as CO.
Factory default is autobaud, reliable mode.

Note!

If the DSL link is not established, the speed might be set to high for the distance.

Diagnostic information:

DDW-tool is a diagnostic tool that can be used to analyse the SHDSL and Ethernet connection. After installing the DDWtool.exe (the installation file is available on the CD) you have to connect your computer (serial USB port) to the diagnostic port under the lid of DDW-120. To run the diagnostic tool the following steps need to be taken.

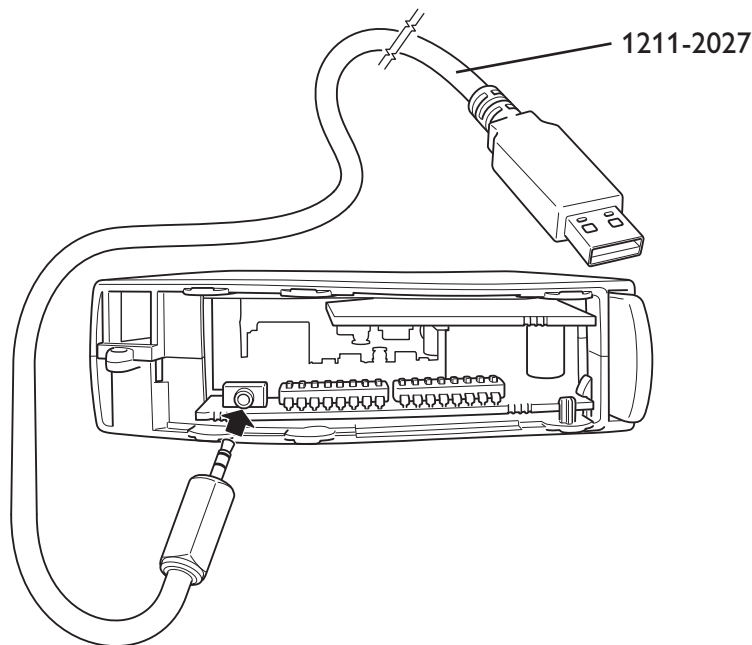

- 1) Connect the standard cable 1211-2027 to the diagnostic port, located under the lid of DDW-120.
- 2) Choose the corresponding Com port in the drop list of the tool. The tool will try to find the port used by the debug cable.
- 3) Click the button connect, if the correct com port is selected DDW-tool will be updated with actual status online information.

Information from diagnostic tool

- Software release
- Serial number
- DIP switch settings
- If the unit is configured as CO or CPE
- Ethernet link status
- Ethernet data rate
- Ethernet duplex
- System uptime
- DSL uptime
- DSL negotiations
- LFF status
- DSL link state
- DSL data rate
- DSL noise margin (information is sampled and continually displayed)

Interface specifications

| Power | |
|----------------------------------|--|
| Rated voltage | 12 to 48 VDC |
| Operating voltage | 10 to 60 VDC |
| Rated current | 240 mA @ 12 VDC 110 mA @ 24 VDC 60 mA @ 48 VDC |
| Rated frequency | DC |
| Inrush current, I ² t | 0.23 A ² s |
| Startup current* | 0.65 A _{peak} |
| Polarity | Reverse polarity protected |
| Redundant power input | Yes |
| Isolation to | All other |
| Connection | Detachable screw terminal |
| Connector size | 0.2 – 2.5 mm ² (AWG 24 – 12) |
| Shielded cable | Not required |

* If external power supply is used it must meet specified start up current

| Service port | |
|--------------------------|--|
| Electrical specification | TTL-level |
| Data rate | 115.2 kbit/s |
| Data format | 8 data bits, none parity, 1 stop bits, no flow control |
| Circuit type | SELV |
| Transmission range | 15 m |
| Isolation to | All other |
| Galvanic connection to | None |
| Connection | 2.5 mm jack, use Westermo cable 1211-2027 |

| DSL | |
|--------------------------|---|
| Electrical specification | IEEE G.991.2 Annex B |
| Data rate | 192 kbit/s to 15304 kbit/s |
| Protocol | EFM according to IEEE 802.3-2004 |
| Transmission range | According to ITU-T G.991.2 depending on the line quality |
| Protection | Overcurrent / overvoltage protection circuit and varistor |
| Isolation to | All other |
| Connection | Detachable screw terminal |
| Connector size | 0.2 – 2.5 mm ² (AWG 24 - 12) |
| Shielded cable | Not required |

| Ethernet TX | |
|--------------------------|--|
| Electrical specification | IEEE std 802.3. 2000 Edition |
| Data rate | 10 Mbit/s, 100 Mbit/s, manual or auto |
| Duplex | Full or half, manual or auto |
| Circuit type | SELV |
| Transmission range | 100 m |
| Isolation to | All other |
| Connection | RJ-45 MDI or auto MDI/MDI-X |
| Shielded cable | Not required, except when installed in Railway applications as signalling and telecommunications apparatus and located close to rails* |
| Conductive housing | Isolated to all other circuits |
| Miscellaneous | If Auto-Neg. is disabled then this interface will be set MDI |
| Number of ports | 1 |

* To minimise the risk of interference, a shielded cable is recommended when the cable is located inside 3 m boundary to the rails and connected to this port.

The cable shield should be properly connected (360°) to an earthing point within 1 m from this port. This earthing point should have a low impedance connection to the conductive enclosure of the apparatus cabinet, or similar, where the unit is built-in. This conductive enclosure should be connected to the earthing system of an installation and may be directly connected to the protective earth.

Connections

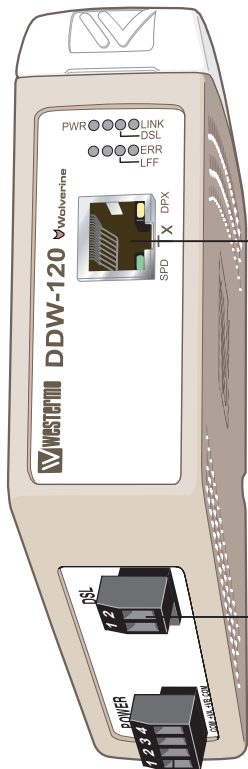

Ethernet TX connection (RJ-45 connector) 1 – 4**

| Position | Direction* | Description |
|----------|------------|---------------|
| 1 | In/Out | TD+ |
| 2 | In/Out | TD- |
| 3 | In/Out | RD+ |
| 4 | - | Not Connected |
| 5 | - | Not Connected |
| 6 | In/Out | RD- |
| 7 | - | Not Connected |
| 8 | - | Not Connected |

CAT 5 cable is recommended.
Unshielded (UTP) or shielded (STP) connectors can be used.

DSL screw connector 1 & 2

| Position | Direction | Description |
|----------|-----------|--------------------------------|
| 1 | In/Out | 2-wire Receive/ Transmit SHDSL |
| 2 | In/Out | 2-wire Receive/ Transmit SHDSL |

Power connection

| Position | Direction* | Description |
|----------|------------|-------------|
| 1 | In | Common |
| 2 | In | + Voltage A |
| 3 | In | + Voltage B |
| 4 | In | Common |

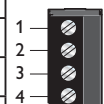

* Direction relative this unit

** To minimise the risk of interference, a shielded cable is recommended when the cable is located inside 3 m boundary to the rails and connected to this port. The cable shield should be properly connected (360°) to an earthing point within 1 m from this port. This earthing point should have a low impedance connection to the conductive enclosure of the apparatus cabinet, or similar, where the unit is built-in. This conductive enclosure should be connected to the earthing system of an installation and may be directly connected to the protective earth.

LED indicators

| LED | Status | Description |
|----------------|--------|---|
| PWR (green) | OFF | No internal power |
| | ON | Internal power ok / boot ok |
| LFF (green) | OFF | LFF disabled |
| | ON | LFF enabled |
| ERR (red) | OFF | LFF not active |
| | ON | LFF active, link fault on this unit |
| | Flash | LFF active, link fault on opposite unit |
| DSL | OFF | No DSL link |
| | ON | DSL link established |
| | Flash | DSL link negotiating |
| LINK | OFF | No Ethernet link |
| | ON | Ethernet link established |
| | Flash | Ethernet traffic indication |
| SPD | OFF | Ethernet speed, 10 Mbit/s |
| | ON | Ethernet speed, 100 Mbit/s |
| DPX | OFF | Ethernet duplex, half |
| | ON | Ethernet duplex, full |

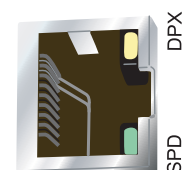
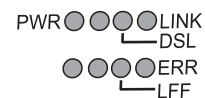

DIP-switch settings



Before DIP-switch settings:

Prevent damage to internal electronics from electrostatic discharges (ESD) by discharging your body to a grounding point (e.g. use of wrist strap).

NOTE DIP-switch alterations are only effective after a power on.

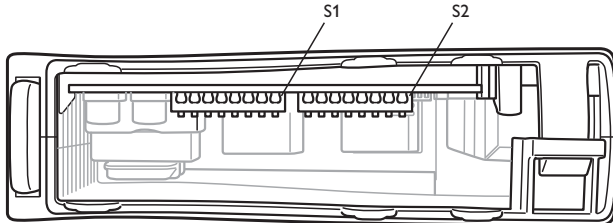

S1 DIP-switch

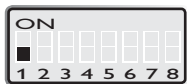

Standard speed



CPE,
Customer Premises Equipment

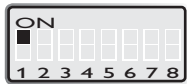

Turbo speed

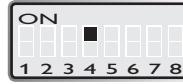

CO,
Central Office



Manual speed locked
according to S2:4-8*



LFF disabled



Autobaud, normal mode**
(Standard speed 192 kbit/s – 5.7 Mbit/s)
(Turbo speed 192 kbit/s – 15.3 Mbit/s)



LFF enabled



Autobaud, high speed mode**
(Standard speed 192 kbit/s – 5.7 Mbit/s)
(Turbo speed 192 kbit/s – 15.3 Mbit/s)

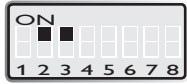

Autobaud, reliable mode**
(Standard speed 192 kbit/s – 5.7 Mbit/s)
(Turbo speed 192 kbit/s – 15.3 Mbit/s)

S1: 1, 6, 7 and 8 not used

* Autobaud is recommended. When using manual locked speed user must make sure a correct noise margin is achieved. Westermo recommends at least 3 dB noise margin for reliable operation.

** Autobaud in complete speed range (192 kbit/s – 15.3 Mbit/s) using turbo speed dip S1:1 may take up to 3 minutes to complete

S2 DIP-switch

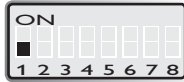

Ethernet auto-negotiation disabled

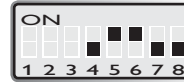

DSL-speed 2048kbit/s*
DSL-speed 9272kbit/s**

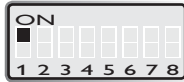

Ethernet auto-negotiation enabled

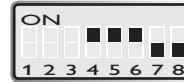

DSL-speed 2304kbit/s*
DSL-speed 9784kbit/s**

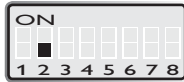

Ethernet speed 10 Mbit/s
(if auto-neg. disabled)

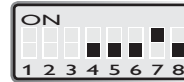

DSL-speed 2688kbit/s*
DSL-speed 10296kbit/s**



Ethernet speed 100 Mbit/s
(if auto-neg. disabled)



DSL-speed, 3072 kbit/s*
DSL-speed 10808kbit/s**

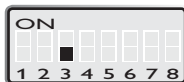

Ethernet half duplex
(if auto-neg. disabled)



DSL-speed, 3456 kbit/s*
DSL-speed 11320kbit/s**



Ethernet full duplex
(if auto-neg. disabled)



DSL-speed, 3840 kbit/s*
DSL-speed 11832kbit/s**



DSL-speed 192 kbit/s*
DSL-speed 6200 kbit/s**



DSL-speed, 4224 kbit/s*
DSL-speed 12344kbit/s**



DSL-speed 384 kbit/s*
DSL-speed 6712 kbit/s**



DSL-speed, 4608 kbit/s*
DSL-speed 13112kbit/s**



DSL-speed 512 kbit/s*
DSL-speed 7224 kbit/s**



DSL-speed, 4992 kbit/s*
DSL-speed 13880kbit/s**



DSL-speed 768 kbit/s*
DSL-speed 7736 kbit/s**



DSL-speed, 5376 kbit/s*
DSL-speed 14648kbit/s**



DSL-speed 1024 kbit/s*
DSL-speed 8248 kbit/s**



DSL-speed 5760kbit/s*
DSL-speed 15304kbit/s**



DSL-speed 1280 kbit/s*
DSL-speed 8760 kbit/s**

* Standard speed S1:1 OFF

** Turbo speed S1:1 ON

Factory settings



Mounting

This unit should be mounted on 35 mm DIN-rail, which is horizontally mounted inside an apparatus cabinet, or similar. Snap on mounting, see figure.

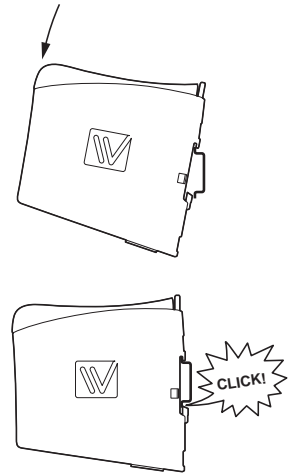

Cooling

This unit uses convection cooling. To avoid obstructing the air-flow around the unit, use the following spacing rules. Minimum spacing 25 mm (1.0 inch) above /below and 10 mm (0.4 inches) left /right the unit. Spacing is recommended for the use of unit in full operating temperature range and service life.

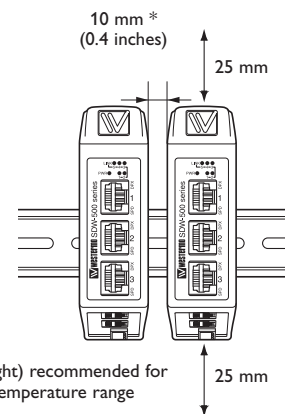

Removal

Press down the black support at the top of the unit. See figure.

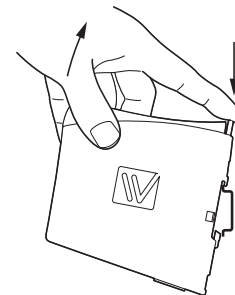



Westermo Teleindustri AB • SE-640 40 Stora Sundby, Sweden
Phone +46 16 42 80 00 Fax +46 16 42 80 01
E-mail: info@westermo.se
Westermo Web site: www.westermo.com

Subsidiaries

Westermo Data Communications AB
Svalgängen 1
SE-724 81 Västerås
Phone: +46 (0)21 548 08 00 • Fax: +46 (0)21 35 18 50
info.sverige@westermo.se

Westermo Data Communications Ltd
Talisman Business Centre • Duncan Road
Park Gate, Southampton • SO31 7GA
Phone: +44(0)1489 580-585 • Fax: +44(0)1489 580586
E-Mail: sales@westermo.co.uk

Westermo Data Communications GmbH
Goethestraße 67, 68753 Waghäusel
Tel.: +49(0)7254-95400-0 • Fax: +49(0)7254-95400-9
E-Mail: info@westermo.de

Westermo Data Communications S.A.R.L.
9 Chemin de Chilly 91160 CHAMPLAN
Tél : +33 1 69 10 21 00 • Fax : +33 1 69 10 21 01
E-mail : infos@westermo.fr

Westermo Data Communications Pte Ltd
2 Soon Wing Road #08-05
Soon Wing Industrial Building
Singapore 347893
Phone +65 6743 9801 • Fax +65 6745 0670
E-mail: earnestphua@westermo.com.sg

Westermo Teleindustri AB have distributors in several countries, contact us for further information.