



**EUROTHERM
DRIVES**

690+ Series Frequency Inverter

Software Product Manual

HA465038U005 Issue 2

Compatible with Version 5.x Software

© Copyright Eurotherm Drives Limited 2003

All rights strictly reserved. No part of this document may be stored in a retrieval system, or transmitted in any form or by any means to persons not employed by a Eurotherm Drives company without written permission from Eurotherm Drives Ltd.

Although every effort has been taken to ensure the accuracy of this document it may be necessary, without notice, to make amendments or correct omissions. Eurotherm Drives cannot accept responsibility for damage, injury, or expenses resulting therefrom.

WARRANTY

Eurotherm Drives warrants the goods against defects in design, materials and workmanship for the period of 12 months from the date of delivery on the terms detailed in Eurotherm Drives Standard Conditions of Sale IA058393C.

Eurotherm Drives reserves the right to change the content and product specification without notice.

Safety Information



Requirements

IMPORTANT: Please read this information BEFORE installing the equipment.

Intended Users

This manual is to be made available to all persons who are required to install, configure or service equipment described herein, or any other associated operation.

The information given is intended to highlight safety issues, and to enable the user to obtain maximum benefit from the equipment.

Complete the following table for future reference detailing how the unit is to be installed and used.

INSTALLATION DETAILS	
Serial Number <i>(see product label)</i>	
Where installed <i>(for your own information)</i>	
Unit used as a: <i>(refer to Certification for the Inverter)</i>	<input type="checkbox"/> Component <input type="checkbox"/> Relevant Apparatus
Unit fitted:	<input type="checkbox"/> Wall-mounted <input type="checkbox"/> Enclosure

Application Area

The equipment described is intended for industrial motor speed control utilising AC induction or AC synchronous machines.

Personnel

Installation, operation and maintenance of the equipment should be carried out by qualified personnel. A qualified person is someone who is technically competent and familiar with all safety information and established safety practices; with the installation process, operation and maintenance of this equipment; and with all the hazards involved.

Safety Information



Hazards

WARNING!

This equipment can endanger life through rotating machinery and high voltages. Failure to observe the following will constitute an ELECTRICAL SHOCK HAZARD. This is a product of the restricted sales distribution class according to IEC 61800-3. In a domestic environment this product may cause radio interference in which case the user may be required to take adequate measures. This product is designated as "professional equipment" as defined in EN61000-3-2. Permission of the supply authority shall be obtained before connection to the low voltage supply.

- The equipment must be **permanently earthed** due to the high earth leakage current.
- The drive motor must be connected to an appropriate safety earth.
- The equipment contains high value capacitors which take time to discharge after removal of the mains supply.
- Before working on the equipment, ensure isolation of the mains supply from terminals L1, L2 and L3. Wait for at least 3 minutes for the dc link terminals (DC+ and DC-) to discharge to safe voltage levels (<50V). Measure the DC+ and DC- terminal voltage with a meter to confirm that the voltage is less than 50V.
- Never perform high voltage resistance checks on the wiring without first disconnecting the drive from the circuit being tested.
- When replacing a drive in an application and before returning to use, it is essential that all user defined parameters for the product's operation are correctly installed.
- This equipment contains electrostatic discharge (ESD) sensitive parts. Observe static control precautions when handling, installing and servicing this product.

IMPORTANT: Metal parts may reach a temperature of 90 degrees centigrade in operation.

Application Risk

The specifications, processes and circuitry described herein are for guidance only and may need to be adapted to the user's specific application.

Eurotherm Drives does not guarantee the suitability of the equipment described in this Manual for individual applications.

Risk Assessment

Under fault conditions, power loss or other operating conditions not intended, the equipment may not operate as specified. In particular:

- The motor speed may not be controlled
- The direction of rotation of the motor may not be controlled
- The motor may be energised

Guards

The user must provide guarding and /or additional safety systems to prevent risk of injury and electric shock.

Protective Insulation

- All control and signal terminals are SELV, i.e. protected by double insulation. Ensure all wiring is rated for the highest system voltage.

Note: *Thermal sensors contained within the motor must be double insulated.*

- All exposed metalwork in the Inverter is protected by basic insulation and bonding to a safety earth.

RCDs

These are not recommended for use with this product but, where their use is mandatory, only Type B RCDs should be used.

Contents

Chapter 1 PROGRAMMING YOUR APPLICATION

Introducing the Macro	1-1
Programming with Block Diagrams	1-1
Modifying a Block Diagram	1-1
• Configuration and Parameterisation Modes	1-1
• Making and Breaking Links in Configuration Mode	1-2
• Programming Rules	1-4
• Execution Rules	1-4
• Saving Your Modifications	1-4
SETUP Menu - Function Block Descriptions	1-5
Understanding the Function Block Description	1-5
MMI Menu Maps.....	1-5
Function Blocks by Category.....	1-6
Function Blocks in Alphabetical Order.....	1-7
• 5703 INPUT.....	1-7
• 5703 OUTPUT.....	1-8
• ACCESS CONTROL	1-9
• ANALOG INPUT	1-10
• ANALOG OUTPUT.....	1-12
• AUTO RESTART	1-14
• AUTOTUNE	1-16
• BRAKE CONTROL	1-17
• COMMS CONTROL.....	1-18
• COMPENSATION	1-19
• CURRENT LIMIT	1-21
• DEMULTIPLEXER.....	1-22
• DIAMETER CALC.....	1-23
• DIGITAL INPUT	1-26
• DIGITAL OUTPUT	1-28
• DISPLAY SCALE.....	1-29
• DYNAMIC BRAKING	1-31
• ENCODER SPEED.....	1-32
• ENERGY METER	1-33
• FEEDBACKS	1-34
• FILTER.....	1-36
• FLUXING	1-37
• FLYCATCHING	1-40
• HOME	1-42
• INJ BRAKING	1-44
• I/O TRIPS.....	1-45
• INVERSE TIME	1-46
• LINEAR RAMP.....	1-47
• LOCAL CONTROL	1-48
• LOGIC FUNCTION.....	1-49
• MINIMUM SPEED	1-54
• MOTOR DATA	1-55
• MULTIPLEXER.....	1-57

Contents

<i>Contents</i>	<i>Page</i>
• OP STATION	1-58
• OPERATOR MENU	1-59
• PATTERN GEN	1-62
• PHASE AUTO GEAR	1-63
• PHASE CONFIGURE	1-66
• PHASE CONTROL	1-69
• PHASE INCH	1-71
• PHASE MOVE	1-72
• PHASE OFFSET	1-73
• PHASE PID	1-74
• PHASE REGISTER	1-76
• PHASE TUNING	1-78
• PID	1-79
• PID (TYPE 2)	1-81
• POSITION	1-83
• PRESET	1-84
• POWER LOSS CNTRL	1-86
• RAISE/LOWER	1-87
• REFERENCE	1-88
• REFERENCE JOG	1-90
• REFERENCE RAMP	1-91
• REFERENCE STOP	1-93
• REGEN CONTROL	1-94
• SEQUENCING LOGIC	1-96
• SETPOINT SCALE	1-99
• SKIP FREQUENCIES	1-100
• SLEW RATE LIMIT	1-102
• SLIP COMP	1-103
• SPD FBK TRIP	1-104
• SPEED CALC	1-105
• SPEED LOOP	1-107
• S-RAMP	1-110
• STABILISATION	1-111
• STALL TRIP	1-112
• SYSTEM OPTION	1-113
• SYSTEM PORT (P3)	1-114
• TAPER CALC	1-115
• TEC OPTION	1-118
• TIMER	1-119
• TORQUE CALC	1-121
• TORQUE LIMIT	1-122
• TRIPS HISTORY	1-123
• TRIPS STATUS	1-124
• VALUE FUNCTION	1-126
• VOLTAGE CONTROL	1-134
• ZERO SPEED	1-135
Quadratic/Constant Torque Selection	1-136

Contents

Contents

Page

Chapter 2 PARAMETER SPECIFICATION

Specification Table: Tag Name Order	2-2
Specification Table: Tag Number Order	2-13
6053 Technology Box Dependent Parameters	2-39
Product-Related Default Values	2-39
* Frequency Dependent Defaults.....	2-39
** Power Dependent Defaults	2-39

Chapter 3 SERIAL COMMUNICATIONS

Communications Technology Option	3-1
ConfigEd Lite	3-1
Connection to the P3 Port	3-1
File Transfer	3-2
• File Read (FR)	3-3
• File Write (FW)	3-3
Interaction with the 6901 Operator Station	3-4
File Names	3-4

Chapter 4 SEQUENCING LOGIC

Principle State Machine	4-1
Main Sequencing States	4-1
State Outputs of the SEQUENCING LOGIC Function Block.....	4-1
Transition of States.....	4-2
State Diagram.....	4-3
External Control of the Inverter	4-4
Communications Command.....	4-4
• Example Commands	4-5
Communications Status	4-6

Chapter 5 APPLICATION MACROS

The Default Application	5-1
How to Load a Macro	5-1
Macro Descriptions	5-1
Macro 1: Basic Speed Control (default)	5-3
Macro 2: Raise/Lower	5-5
Macro 3: PID	5-7
Macro 4: Speed Programmed Winder (SPW)	5-9
Macro 5: Preset Speeds.....	5-13
Macro 6: "System" Macro.....	5-15
Macro 7: Phase/Register	5-17
Macro 8: 4-Q Regen.....	5-21
Macro Control Blocks.....	5-23

PROGRAMMING YOUR APPLICATION

Introducing the Macro

You can program the Inverter for specific applications.

The Inverter is supplied with macros (set-ups) which can be used as starting points for application-specific programming. This programming could simply involve the inputting of parameter values, or it may require the making or breaking of programmable links, which is a feature of this unit.

Each macro recalls a pre-programmed set of default parameters and links when it is loaded.

Refer to Chapter 5: “Application Macros” for further information.

Programming with Block Diagrams

Block diagram programming provides a visual method of planning the software to suit your application. There are block diagrams provided at the end of this chapter, each showing the software connections for an application macro. These pages replicate the ConfigED Lite programming screens. ConfigEd Lite is Eurotherm’s own programming tool.

The processes performed by a macro are represented as a block diagram, consisting of *function blocks* and *links*:

- Each function block contains the parameters required for setting-up a particular processing feature. Sometimes more than one instance of a function block is provided for a feature, i.e. for multiple digital inputs.
- Software links are used to connect the function blocks. Each link transfers the value of an output parameter to an input parameter of another (or the same) function block.

Each individual block is a processing feature, i.e. it takes the input parameter, processes the information, and makes the result available as one or more output parameters.

Modifying a Block Diagram

Configuration and Parameterisation Modes

There are two modes of operation used while modifying a block diagram: *Configuration* and *Parameterisation* modes.

Configuration Mode

In the configuration mode you can modify the links in the function block diagram. You can also change parameter values, as above. This mode is indicated by all the LEDs on the operator station flashing at once. The Inverter cannot run in this mode.

When you attempt to change a parameter value requiring Configuration Mode to be enabled, the Operator Station immediately displays ENABLE CONFIG. Refer to Figure 1-1, page 1-2. Press the **E** key at this point if you do not want to enter Configuration Mode. Press the **▲** (up) key as instructed to enter Configuration Mode. This is indicated by all LEDs flashing.

Parameterisation Mode

In parameterisation mode you can change parameter values. The Inverter can be running or stopped. Note that some parameters can only be changed when the Inverter is stopped. It is not possible to modify the internal links when the Inverter is in parameterisation mode.

Once in Configuration Mode, to return to Parameterisation Mode simply press the **E** key repeatedly until the Welcome screen is displayed. Press the **E** key again and Configuration Mode will be disabled. This is indicated by LEDs ceasing to flash.

DEFAULT

1-2 Programming Your Application

Making and Breaking Links in Configuration Mode

Links can be moved, added or deleted from a block diagram whilst in the Configuration mode. There are 80 links available, each has its own identification number ("link" number). You make a link by setting the link's SOURCE and DESTINATION to be the two parameter names to be linked. The outputs of function blocks are not updated whilst in this mode.

Note: Menus and parameters are displayed in alphabetical order. NULL is placed between A and Z. Setting both SOURCE and DESTINATION to NULL disables the link.

The LINK Parameter

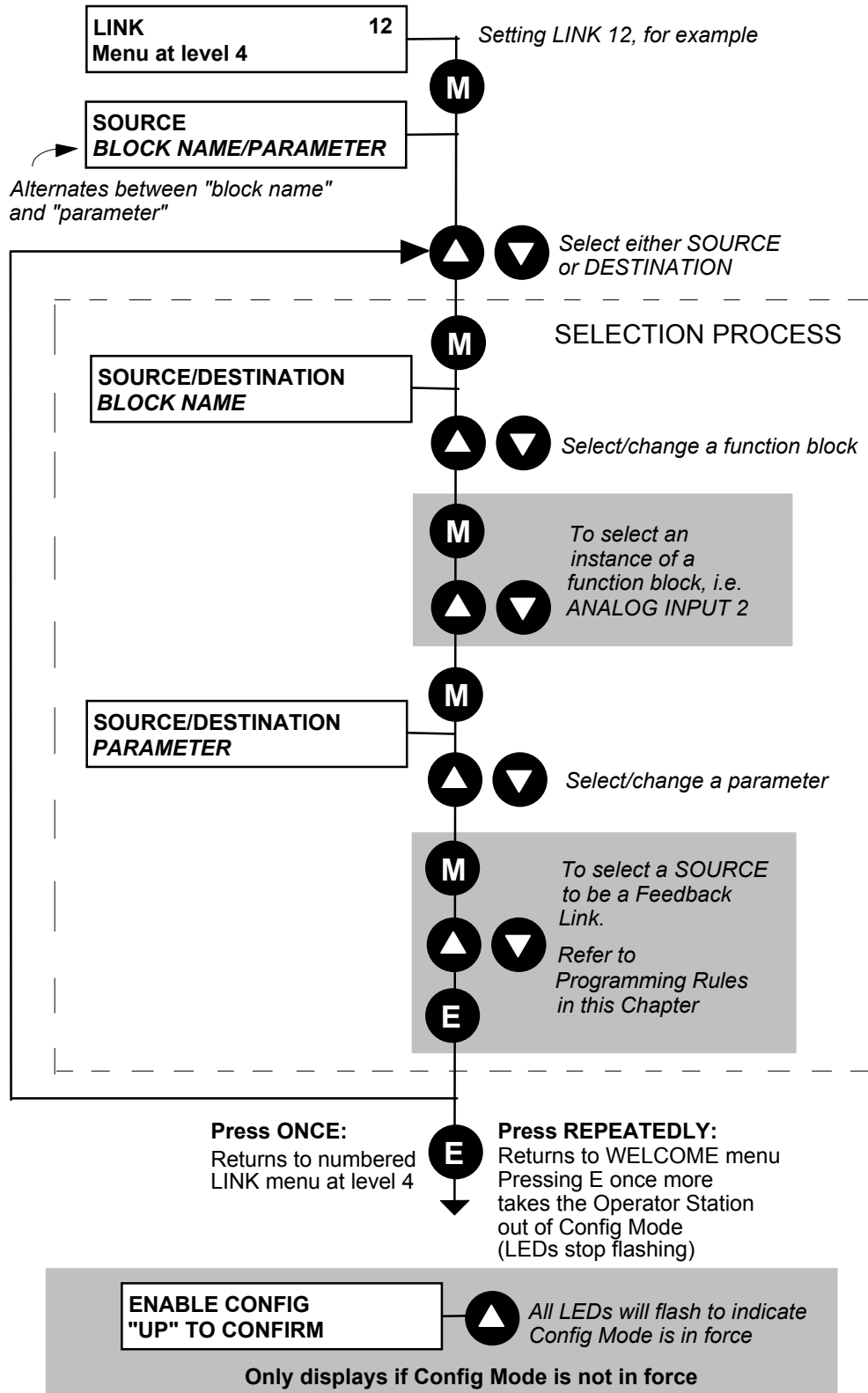
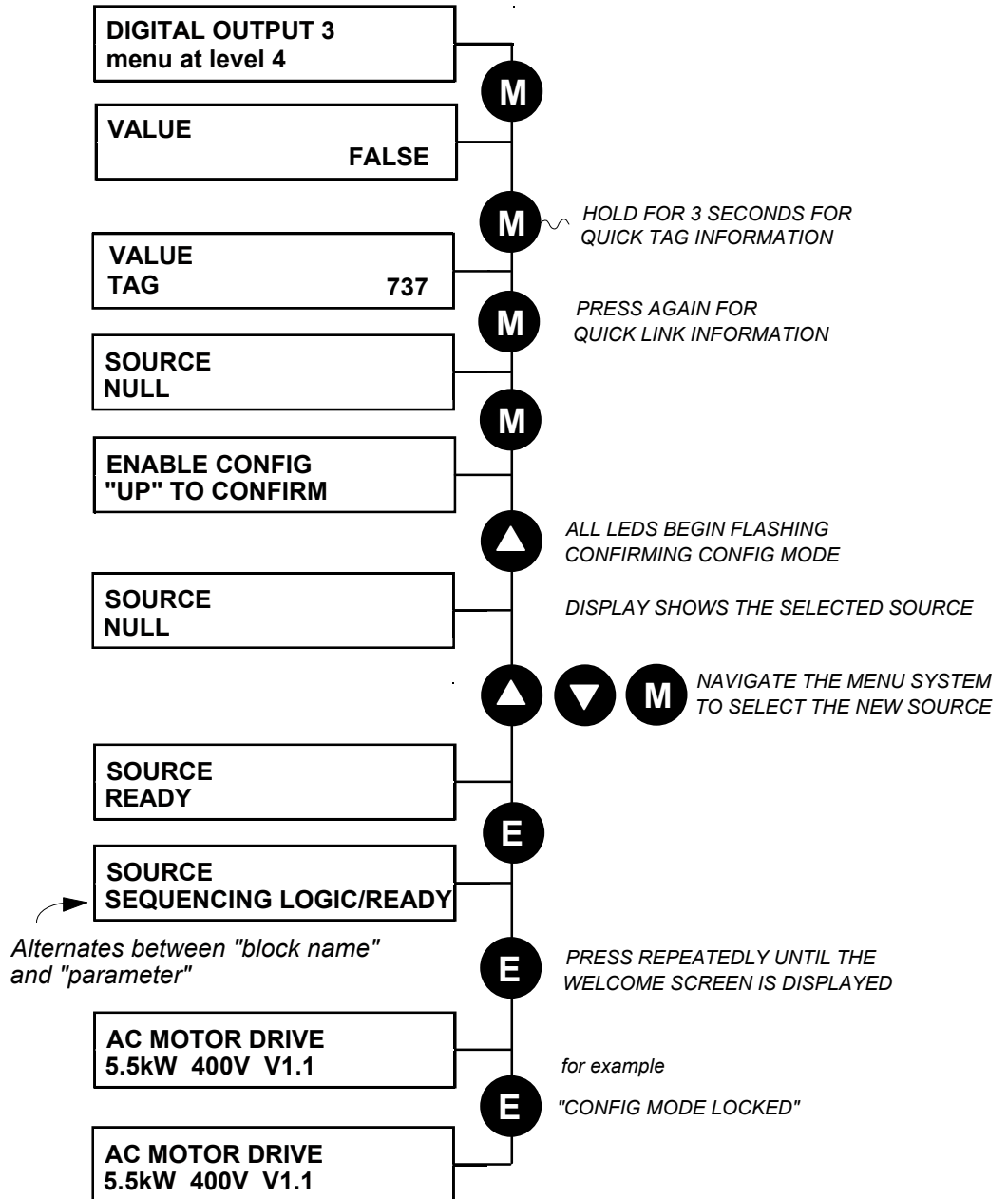

Figure 1-1 Diagram showing Key Presses for Making/Breaking Links

Any Configurable "Destination" Parameter

A similar process can be used to apply or edit a link to any configurable parameter that is to be the intended "destination". The process selects the "source" for the link.

Note: It is possible for several "destination" parameters to share the same "source".



1-4 Programming Your Application

Programming Rules

The following rules apply when programming:

Parameterisation Mode

- Function block output parameter values cannot be changed (because they are a result of the function block's processing)
- Function block input parameter values that receive their values from a link cannot be changed (as they will change back to the value they receive from the link when the Inverter is running).

Configuration Mode

- A link's DESTINATION must be set to an input parameter (only one link per input parameter).
- A link's SOURCE may be set to any parameter. Both input and output parameters can be used as a source.
- Disable a link by setting both DESTINATION and SOURCE to NULL.
- Setting a link's SOURCE to be a *feedback link* forces the link to be executed first. This is used to reduce execution timing delays in a feedback loop situation. A feedback link is indicated by "←" appearing to the right of the source parameter's name.

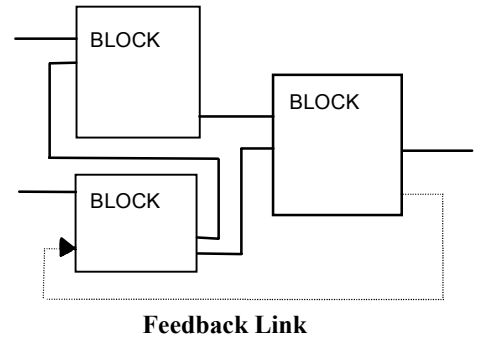

Execution Rules

The complete block diagram is executed every 5ms, with individual control blocks executing within 1ms. Just before a function block is executed, all the links that have that block as their destination are executed, thereby copying new values in to the block's parameter inputs. The input parameters are then processed to produce a new set of output parameters. The execution order of the blocks is automatically arranged for minimal delay.

- The output value transferred by a link on execution is clamped to be between the maximum and minimum value for its destination input parameter.
- If a link's SOURCE and DESTINATION parameters have different decimal point positions, there is no automatic adjustment. Use a VALUE FUNCTION block to modify the input into the correct destination format. Refer to the table below for the result of linking different parameters types.

Source Value (the input)	Source Type	Destination Type	Destination Value (the result)
TRUE	Boolean	Real	0.01
FALSE	Boolean	Real	0.00
≥ 0.005	Real	Boolean	TRUE
≤ 0.005	Real	Boolean	FALSE
LOCAL ONLY (1)	Enumerated	Real	1.00
2.00	Real	Enumerated	REMOTE ONLY (2) (Note that (2) will not always return Remote Only)

Table 1-1 Execution Rules

Saving Your Modifications

If parameter values or links have been modified or a macro has been loaded, the new settings must be saved. The Inverter will then retain the new settings during power-down. Refer to the Installation Product Manual, Chapter 5: "The Operator Station" - Saving/Restoring/Deleting Your Application.

SETUP Menu - Function Block Descriptions

Note: To view the SETUP Menu, ADVANCED view level must be selected.

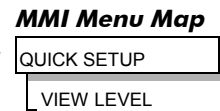

Understanding the Function Block Description

The following function blocks show the parameter information necessary for programming the Inverter.

Input parameters are shown on the left hand side, and output parameters are shown on the right hand side of the block.

The diagrams assume that the UK country code is selected and that a 400V 5.5kW Frame C power board is fitted. This is reflected in the values of certain parameters, see “*” and “**” in the table below.

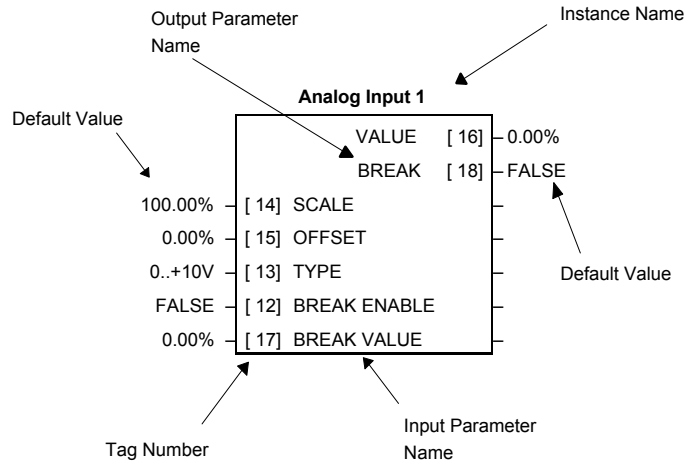

Figure 1-2 Function Block Parameter Information

Instance Name	Names the function block and MMI menu
Default Value	The default value of the unmodified macro, Macro 0
Input/Output Parameter Name	The name shown on ConfigEd Lite
Tag Number	Unique identification used for communications
*	Parameters marked with “*” are set to a value depending upon the “operating frequency” of the drive. Refer to Chapter 2: “Parameter Specification” - Frequency Dependent Defaults; and the Installation Product Manual, Chapter 5: “The Operator Station” - Changing the Product Code (3-button reset).
**	Parameters marked with “**” are set to a value depending on the overall “power build” of the Inverter indicated by the product code. Refer to Chapter 2: “Parameter Specification” - Power Dependent Defaults; and the Installation Product Manual: Chapter 2: “Understanding the Product Code”.

Note: The “Range” for a parameter value is given in the Parameter Description Table on each Function Block page. Ranges for outputs are given as “—.xx%”, for example, indicating an indeterminate integer for the value, to two decimal places.

MMI Menu Maps

The function block descriptions include an easy-find menu showing the menu levels and titles encountered to find the appropriate menu title, and the parameters contained in the menu(s).

Where there is more than one instance, i.e. ANALOG INPUT as illustrated, the parameters shown will be for the last instance.

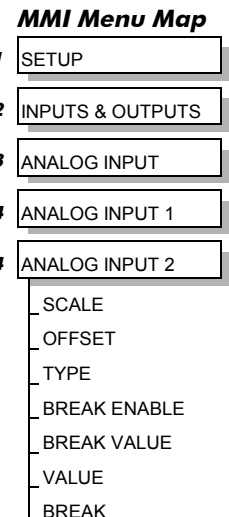

1-6 Programming Your Application

Function Blocks by Category

The function block descriptions in this chapter are arranged in alphabetical order, however, they are listed below by Category. They each appear as a Menu in the SETUP menu at level 1. To view the SETUP Menu, ADVANCED view level must be selected.

Communications			
5703 INPUT	1-7	SYSTEM PORT (P3)	1-114
5703 OUTPUT	1-8	TEC OPTION	1-118
Encoder Functions			
ENCODER SPEED	1-32	PHASE MOVE	1-72
PHASE AUTO GEAR	1-63	PHASE OFFSET	1-73
PHASE CONFIGURE	1-66	PHASE PID	1-74
PHASE CONTROL	1-69	PHASE REGISTER	1-76
PHASE INCH	1-71	PHASE TUNING	1-78
Fans/Pumps			
ENERGY METER	1-33	MOTOR DATA	1-55
FLUXING	1-37	VOLTAGE CONTROL	1-134
Hoist/Lift			
BRAKE CONTROL	1-17		
Inputs/Outputs			
ANALOG INPUT	1-10	DIGITAL OUTPUT	1-28
ANALOG OUTPUT	1-12	SYSTEM OPTION	1-113
DIGITAL INPUT	1-26		
Menus			
ACCESS CONTROL	1-9	OPERATOR MENU	1-59
DISPLAY SCALE	1-29	OP STATION	1-58
Miscellaneous			
DEMULTIPLEXER	1-22	MULTIPLEXER	1-57
HOME	1-42	POSITION	1-81
LOGIC FUNCTION	1-49	VALUE FUNCTION	1-126
Motor Control			
AUTOTUNE	1-16	PATTERN GEN	1-62
CURRENT LIMIT	1-21	POWER LOSS CNTRL	1-86
DYNAMIC BRAKING	1-31	SETPOINT SCALE	1-99
ENERGY METER	1-33	SLEW RATE LIMIT	1-102
FEEDBACKS	1-32	SLIP COMP	1-103
FLUXING	1-37	SPEED LOOP	1-107
FLYCATCHING	1-40	STABILISATION	1-111
INJ BRAKING	1-44	TORQUE LIMIT	1-122
INVERSE TIME	1-46	VOLTAGE CONTROL	1-134
MOTOR DATA	1-55		
Sequencing and Referencing			
AUTO RESTART	1-14	REFERENCE JOG	1-90
COMMS CONTROL	1-18	REFERENCE RAMP	1-91
LOCAL CONTROL	1-48	REFERENCE STOP	1-93
REFERENCE	1-88	SEQUENCING LOGIC	1-94
Setpoint Functions			
FILTER	1-36	PRESET	1-84
LINEAR RAMP	1-47	RAISE/LOWER	1-86
MINIMUM SPEED	1-54	SKIP FREQUENCIES	1-100
PID	1-79	S-RAMP	1-110
PID (TYPE 2)	1-81	ZERO SPEED	1-135
Trips			
I/O TRIPS	1-45	TRIPS HISTORY	1-123
STALL TRIP	1-112	TRIPS STATUS	1-124
Winder			
COMPENSATION	1-19	TAPER CALC	1-115
DIAMETER CALC	1-23	TORQUE CALC	1-119
SPEED CALC	1-104		

Function Blocks in Alphabetical Order

MMI Menu Map

- 1 **SETUP**
- 2 **COMMUNICATIONS**
- 3 **5703 INPUT**
 - RATIO
 - NEGATE
 - SCALED VALUE
 - RAW VALUE
 - BREAK

5703 INPUT

Supports the receiving of data from a Eurotherm 5703 Setpoint Repeater.

This block is only operational when the SYSTEM PORT (P3) :: MODE parameter is set to 5703. Refer to page 1-114.

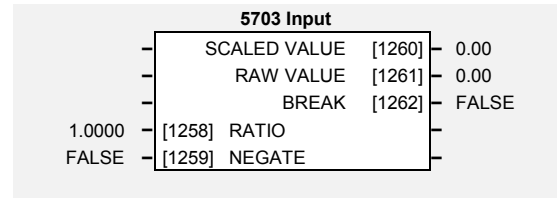

Parameter Descriptions

RATIO

Range: -3.0000 to 3.0000 %

Scaler applied to RAW VALUE to produce SCALED VALUE output.

NEGATE

Range: FALSE / TRUE

When TRUE, changes the sign of SCALED VALUE

SCALED VALUE

Range: _.xx

Received value with RATIO and NEGATE applied.

RAW VALUE

Range: _.xx

Received value before any processing. Reset to zero when there are no valid received messages.

BREAK

Range: FALSE / TRUE

Set TRUE when there are no valid 5703 messages received during the previous 2 seconds.

Functional Description

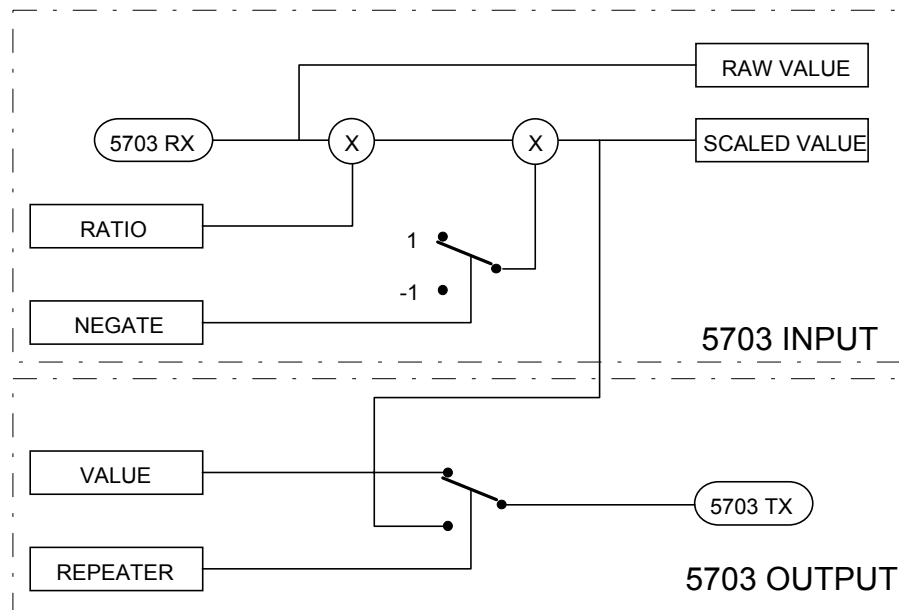

1-8 Programming Your Application

MMI Menu Map

- 1 SETUP
- 2 COMMUNICATIONS
- 3 5703 OUTPUT
 - VALUE
 - REPEATER

5703 OUTPUT

Supports the sending of data to a Eurotherm 5703 Setpoint Repeater.

This block is only operational when the SYSTEM PORT (P3) :: MODE parameter is set to 5703. Refer to page 1-114.

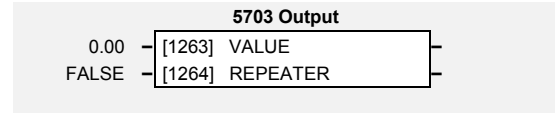

Parameter Descriptions

VALUE

Range: -300.00 to 300.00 %

The value to be sent when not configured as a repeater.

REPEATER

Range: FALSE / TRUE

When TRUE, sends the SCALED VALUE from the 5703 INPUT block instead of the VALUE input.

Note: This is performed at a faster rate than the block diagram execution to minimise the transmission delay between drives.

Functional Description

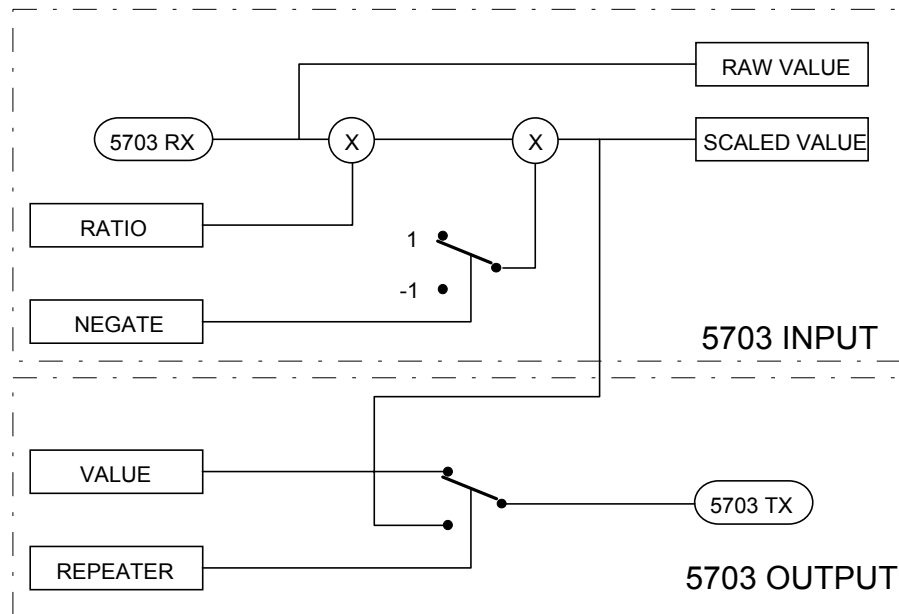

MMI Menu Map

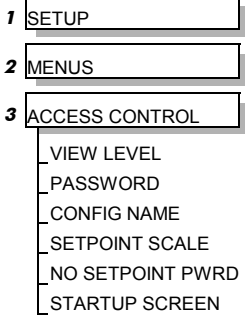

ACCESS CONTROL

This function block contains options associated with operator station password protection, view levels, setpoint display and initial Operator Menu selection.

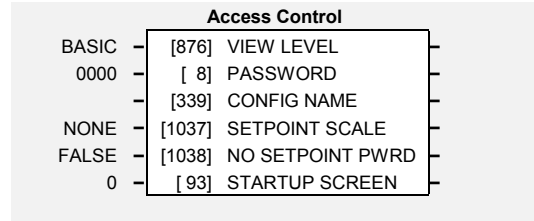

Parameter Descriptions

VIEW LEVEL

Range: FALSE / TRUE

The menu to be displayed by the Operator Station. Refer to the Installation Product Manual, Chapter 5: "The Operator Station" - Menu Viewing Levels.

Enumerated Value : View Level

- 0 : OPERATOR
- 1 : BASIC
- 2 : ADVANCED

PASSWORD

Range: 0000 to FFFF

Setting a non-zero value enables the password feature.

CONFIG NAME

Range: max length is 16 chars

When not blank, the string is displayed as the top line of the Welcome screen.

SETPOINT SCALE

Range: See below

A scaling factor applied to the speed setpoint and feedback displays. Selects a DISPLAY SCALE function block to be applied.

Enumerated Value : DISPLAY SCALE function block

- 0 : NONE
- 1 : DISPLAY SCALE 1
- 2 : DISPLAY SCALE 2
- 3 : DISPLAY SCALE 3
- 4 : DISPLAY SCALE 4

NO SETPOINT PWRD

Range: FALSE / TRUE

When TRUE, the local setpoint is not password protected, regardless of the PASSWORD value. When FALSE, the local setpoint is password protected just like all other parameters.

STARUP SCREEN

Range: See below

Selects which of the Operator Menu parameters will be displayed after the Welcome screen.

Enumerated Value : Startup Screen

- 0 : selects REMOTE SETPOINT or LOCAL SETPOINT
- 1 : selects parameter defined by OPERATOR MENU 1
- 2 : selects parameter defined by OPERATOR MENU 2
- : etc.
- 16 : selects parameter defined by OPERATOR MENU 16

ANALOG INPUT

The analog input block converts the input voltage or current into a value expressed as a percentage of a configurable range.

MMI Menu Map

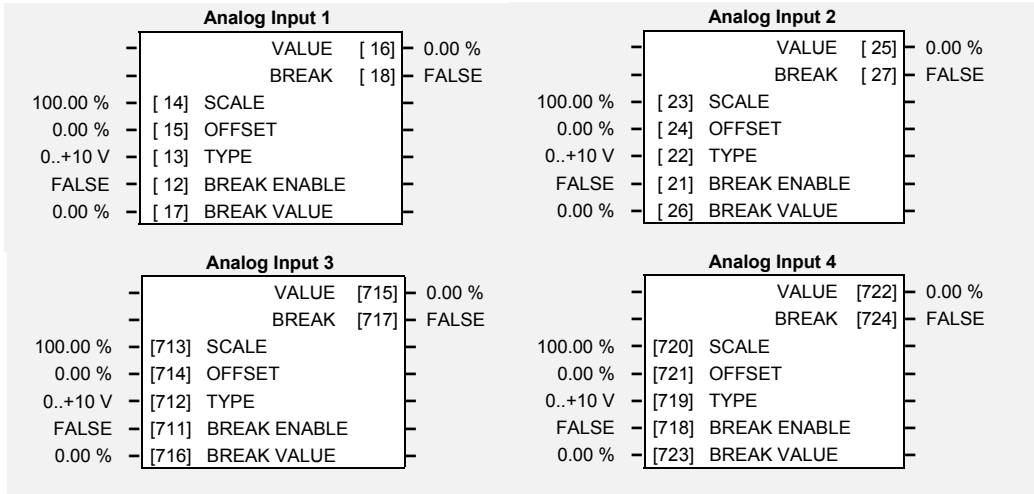
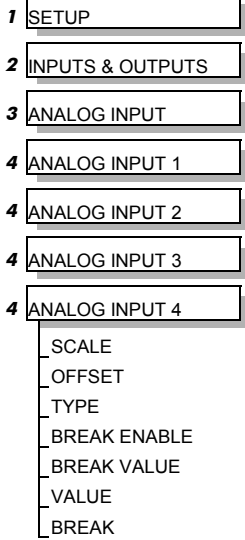

Parameter Descriptions

SCALE

Range: -300.00 to 300.00 %

A scaling factor applied to the raw input. With a scaling factor of 100.00% and an offset of 0.00%, an input equal to the low input range will appear as a value of 0.00%. Similarly, an input equal to the high input range will appear as a value of 100.00%.

OFFSET

Range: -300.00 to 300.00 %

An offset added to the input after the scaling factor has been applied.

TYPE

Range: Enumerated - see below

The input range and type.

- ANALOG INPUT 1 and ANALOG INPUT 2 support all types.
- ANALOG INPUT 3 and ANALOG INPUT 4 are used for voltage measurement only.

Enumerated Value : Type

- 0 : 0..+10 V
- 1 : +2..+10 V
- 2 : 0..+5 V
- 3 : +1..+5 V
- 4 : -10..+10 V
- 5 : 0..20 mA
- 6 : 4..20 mA
- 7 : 20..4 mA
- 8 : 20..0 mA
- 9 : 0..+20 V

BREAK ENABLE

Range: *FALSE / TRUE*

For input types that support sensor break detection (see Functional Description below), this parameter may be used to disable sensor break detection. For input types that do not support break detection, this parameter is FALSE.

BREAK VALUE

Range: *-300.00 to 300.00 %*

The value that will appear as the VALUE output when BREAK is TRUE

VALUE

Range: *— .xx %*

The input reading with scaling and offset applied.

BREAK

Range: *FALSE / TRUE*

Indicates that the input sensor signal is not present. See below for more details on break detection.

Functional Description

The Inverter has four analog inputs. There is an analog input function block for each:

- ANALOG INPUT 1 is associated with the signal on terminal 2
- ANALOG INPUT 2 is associated with the signal on terminal 3
- ANALOG INPUT 3 is associated with the signal on terminal 4
- ANALOG INPUT 4 is associated with the signal on terminal 5

The input voltage is pre-processed and converted into a numeric value by the analog input electronics of the Inverter. The analog input function blocks further process this reading so that a value of 0.00% represents an input equal to the low input range, while a value of 100.00% represents an input equal to the high input range. The SCALE and OFFSET factors are then applied as shown to produce a value suitable for use in the application.

The break detect facility may only be used in conjunction with the following hardware ranges: 2 to 10V, 1 to 5V, 4 to 20mA and 20 to 4mA. An input break is defined as an input reading less than either 0.1V or 0.45mA. When an input break has been detected, the VALUE output is forced to be the BREAK VALUE.

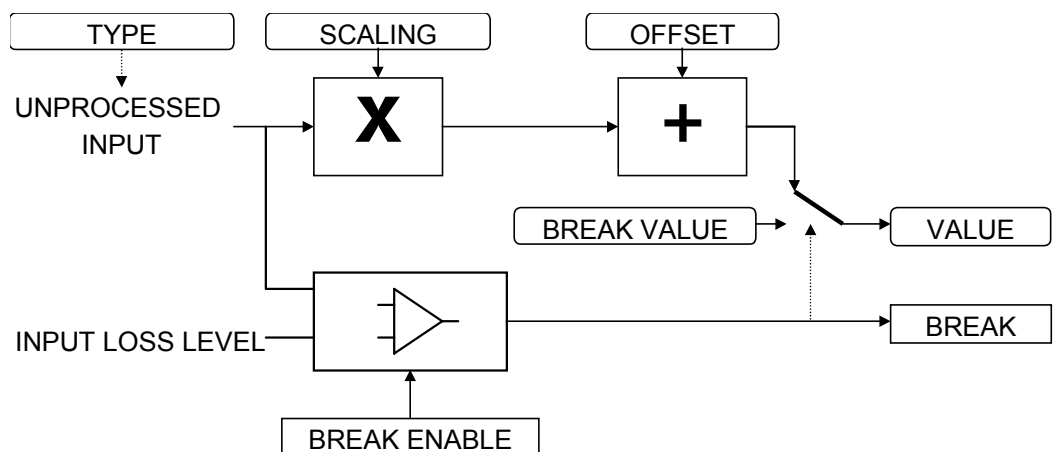

1-12 Programming Your Application

ANALOG OUTPUT

The analog output blocks converts the demand percentage into a form suitable for driving the analog output electronics of the Inverter.

MMI Menu Map

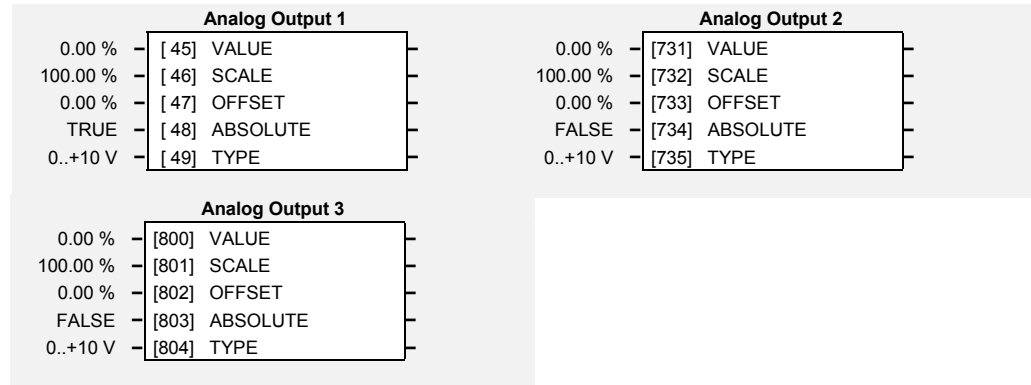
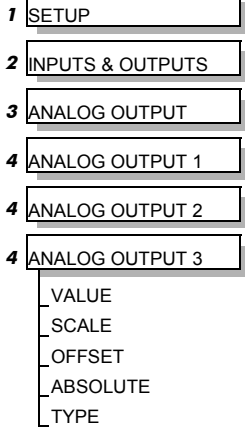

Parameter Descriptions

VALUE

Range: -300.00 to 300.00 %

The demanded value to output.

SCALE

Range: -300.00 to 300.00 %

A scaling factor to apply to VALUE . A scaling factor of 100.00% has no effect.

OFFSET

Range: -300.00 to 300.00 %

An offset added to VALUE after the scaling factor has been applied. An offset factor of 0.00% has no effect.

ABS

Range: FALSE / TRUE

When true the output sign is ignored.

TYPE

Range: Enumerated - see below

The output hardware type, either Volts or Amps.

- ANALOG OUTPUT 1 supports all types, except -10..+10V.
- ANALOG OUTPUT 2 and ANALOG OUTPUT 3 are used as voltage outputs only.

An incorrect selection will force the VALUE to be set to zero.

Enumerated Value : Type

- 0 : 0..+10 V
- 1 : 0..20 mA
- 2 : 4..20 mA
- 3 : -10..+10 V
- 4 : 20..4 mA
- 5 : 20..0 mA
- 6 : +2..+10 V
- 7 : 0..+5 V
- 8 : +1..+5 V

Functional Description

The Inverter has three analog outputs. There is an ANALOG OUTPUT function block associated with each of these:

ANALOG OUTPUT 1 is associated with terminal 6

ANALOG OUTPUT 2 is associated with terminal 7

ANALOG OUTPUT 3 is associated with terminal 8

The scaling and offset parameters are applied to the demand value as shown.

If ABS is TRUE then the final output is the magnitude of value after being scaled and offset.

If ABS is FALSE then the final output will be limited to be within the range selected by TYPE.

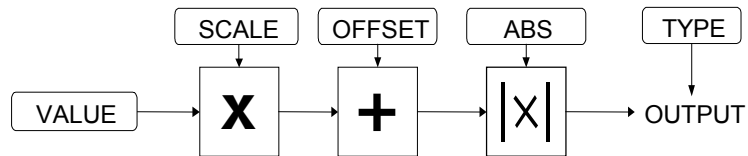

MMI Menu Map

1	SETUP
2	SEQ & REF
3	AUTO RESTART
	ENABLE
	ATTEMPTS
	INITIAL DELAY 1
	ATTEMPT DELAY 1
	TRIGGERS 1
	TRIGGERS 1+
	INITIAL DELAY 2
	ATTEMPT DELAY 2
	TRIGGERS 2
	TRIGGERS 2+
	PENDING
	RESTARTING
	ATTEMPTS LEFT
	TIME LEFT

AUTO RESTART

Auto Restart (or Auto Reset) provides the facility to automatically reset a choice of trip events and restart the drive with a programmed number of attempts, after which, a manual or remote trip reset is required if the drive is not successfully restarted. The number of attempted restarts are recorded. This count is cleared after a trip-free period of operation (5 minutes or 4 x ATTEMPT DELAY 1, whichever is the longer), or after a successful manual or remote trip reset, or by removing the Run signal, or by setting the ENABLE input to this block FALSE.

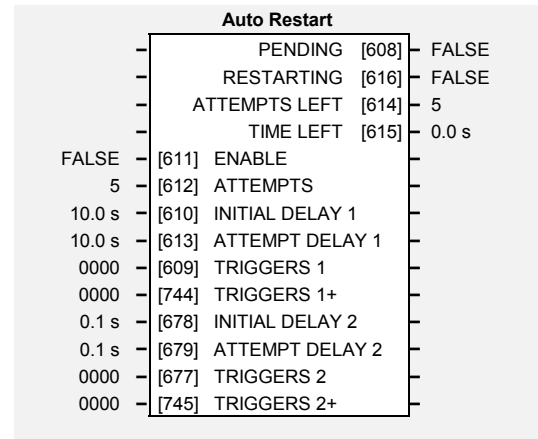

Parameter Descriptions

ENABLE

Range: FALSE / TRUE

Enables operation of the auto restart feature.

ATTEMPTS

Range: 1 to 10

Determines the number of restarts that will be permitted before requiring an external fault reset.

INITIAL DELAY 1

Range: 0.0 to 600.0 s

Determines the delay for the first restart attempt when the trip is included in TRIGGERS 1 . The delay is measured from all error conditions clearing.

ATTEMPT DELAY 1

Range: 0.0 to 600.0 s

Determines the delay between restart attempts for a trip included in TRIGGERS 1 . The delay is measured from all error conditions clearing.

TRIGGERS 1 and TRIGGERS+ 1

Range: 0000 to FFFF

Allows Auto Restart to be enabled for a selection of trip conditions.

Refer to the Installation Product Manual, Chapter 6: “Hexadecimal Representation of Trips” for an explanation of the four-digit codes.

INITIAL DELAY 2

Range: 0.0 to 600.0 s

Determines the delay for the first restart attempt when the trip is included in TRIGGERS 2 . The delay is measured from all error conditions clearing.

ATTEMPT DELAY 2

Range: 0.0 to 600.0 s

Determines the delay between restart attempts for a trip included in TRIGGERS 2 . The delay is measured from all error conditions clearing.

TRIGGERS 2 and TRIGGERS+ 2

Range: 0000 to FFFF

Allows Auto Restart to be enabled for a selection of trip conditions.

If a trip is included in both TRIGGERS 1 and TRIGGERS 2, then the times associated with TRIGGERS 1 will take priority.

Refer to the Installation Product Manual, Chapter 6: “Hexadecimal Representation of Trips” for an explanation of the four-digit codes.

PENDING*Range: FALSE / TRUE*

Indicates that an auto restart will occur after the programmed delay.

RESTARTING*Range: FALSE / TRUE*

Indicates that an auto restart is occurring. TRUE for a single block diagram execution cycle.

ATTEMPTS LEFT*Range: —.*

Indicates the number of attempts left before an external fault reset is required.

TIME LEFT*Range: —.x s*

When in the Restarting state, this parameter indicates the time left before an auto restart attempt will be permitted. When non-zero, this value is unaffected by changes to ATTEMPT DELAY 1.

AUTOTUNE

Designed for SENSORLESS VEC and CLOSED-LOOP VEC Motor Control Modes.

The auto-tune is an automatic test sequence performed by the inverter to identify motor model parameters. The motor model is used by the Sensorless Vector and Closed-Loop Vector control modes. You **MUST** perform an auto-tune before operating the inverter in either of the Vector control modes.

Refer to the Installation Product Manual, Chapter 4: “Operating the Inverter” - Set-up using the Sensorless Vector Fluxing Mode.

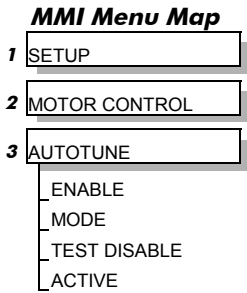
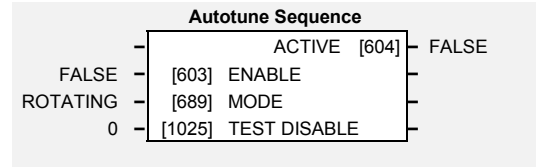

Parameter Descriptions

ENABLE

Range: FALSE / TRUE

Determines whether the Autotune sequence is operational or not. The Autotune sequence is operational when set to TRUE and the drive is run. Refer to the Installation Product Manual, Chapter 4: “Operating the Inverter” - The Autotune Feature.

MODE

Range: Enumerated - see below

Selects the Autotune operating mode. Refer to the Installation Product Manual, Chapter 4: “Operating the Inverter” – The Autotune Feature.

Enumerated Value : Mode

- 0 : STATIONARY
- 1 : ROTATING

TEST DISABLE

Range: 0 to 4

This parameter expands on the MMI to show four tests. Each test can be individually disabled by setting to TRUE.

Enumerated Value : Mode

- 0 : STATOR RES
- 1 : LEAKAGE IND
- 2 : ENCODER DIR
- 3 : MAG CURRENT
- 4 : ROTOR TIME CONST

ACTIVE

Range: FALSE / TRUE

This indicates the current state of the Autotune sequence. The Autotune sequence is operational when displaying TRUE.

Functional Description

The autotune sequence identifies the following motor parameters:-

- Per-phase stator resistance (STATOR RES)
- Per-phase leakage inductance (LEAKAGE INDUC)
- Per-phase mutual inductance (MUTUAL INDUC)
- Rotor time constant (ROTOR TIME CONST)
- No-load magnetising line current (MAG CURRENT)
- The encoder direction (ENCODER INVERT)

The Rotating autotune sequence rotates the motor up to the user-programmed MAX SPEED (SETPOINT SCALE function block) in order to identify these parameters.

The Stationary autotune sequence does not rotate the motor and requires the correct value of Magnetising Current to be entered.

The values of the above are stored in the MOTOR DATA function block. Autotune will overwrite any previous entry made for these parameters.

Autotune can only be initiated from the “stopped” condition. When the test is complete, the stack is disabled and ENABLE is set to FALSE.

BRAKE CONTROL

This is used to control electro-mechanical motor brakes in hoist and lift applications.

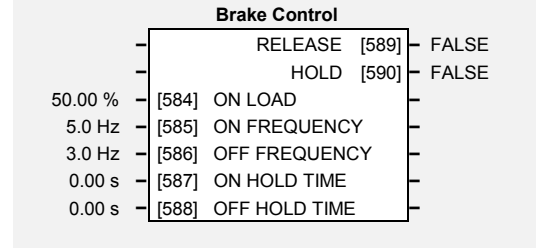
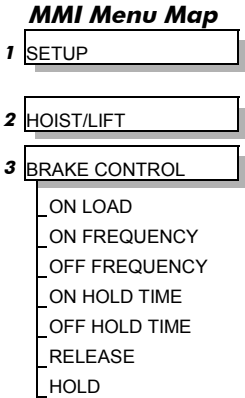

Parameter Descriptions

ON LOAD

Range: 0.00 to 150.00 %

Load level at which the external motor brake is released.

ON FREQUENCY

Range: 0.0 to 500.0 Hz

The output electrical frequency at which the external motor brake is released.

OFF FREQUENCY

Range: 0.0 to 500.0 Hz

The output electrical frequency at which the external motor brake is applied.

ON HOLD TIME

Range: 0.00 to 60.00 s

Sets the duration of the pulse output on HOLD when RELEASE becomes TRUE.

OFF HOLD TIME

Range: 0.00 to 60.00 s

Sets the duration of the pulse output on HOLD when RELEASE becomes FALSE.

RELEASE

Range: FALSE / TRUE

Boolean output providing a signal to operate the brake delay. Note RELEASE is forced FALSE if the drive is not in Run mode, or if Autotune, Flycatching or Injection Braking are active.

HOLD

Range: FALSE / TRUE

Becomes TRUE when the brake is toggled On or Off by the function block, and remains TRUE for the duration set by OFF HOLD TIME or ON HOLD TIME.

Functional Description

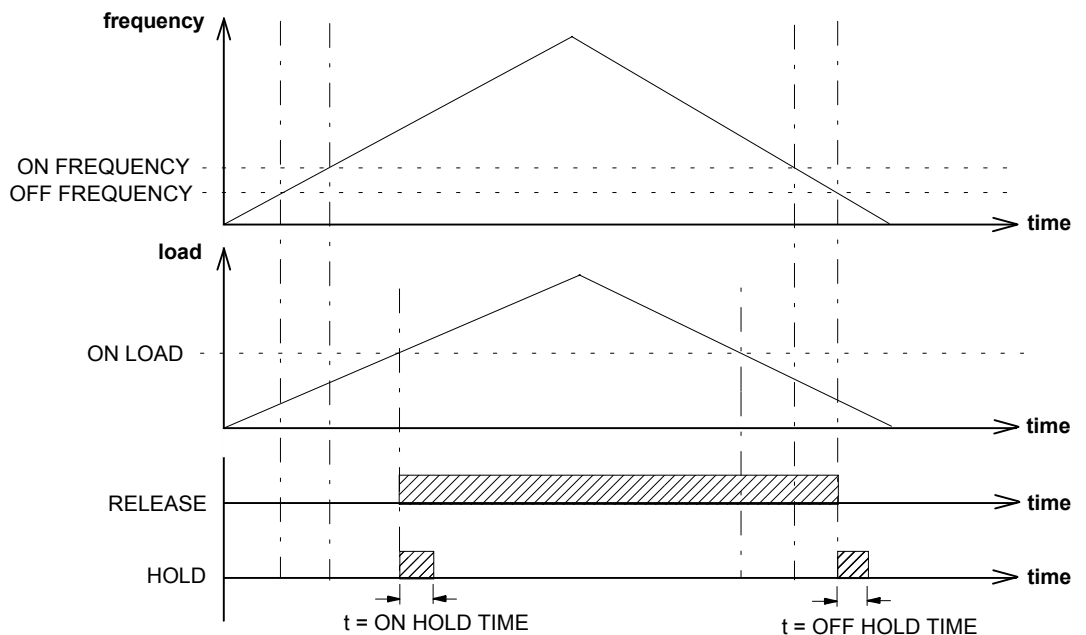

COMMS CONTROL

MMI Menu Map

1	SETUP
2	SEQ & REF
3	COMMS CONTROL
	REMOTE COMMS SEL
	REMOTE SEQ MODES
	REMOTE REF MODES
	COMMS TIMEOUT
	COMMS SEQ
	COMMS REF
	COMMS STATUS
	COMMS COMMAND

This block switches between Remote Terminal and Remote Comms operating modes.

The Inverter must be in Remote mode for selection to be made - REMOTE mode is enabled in the LOCAL CONTROL function block (REF MODES) and selected by the Operator Station. Refer to the outputs of the LOCAL CONTROL function block for the mode in use.

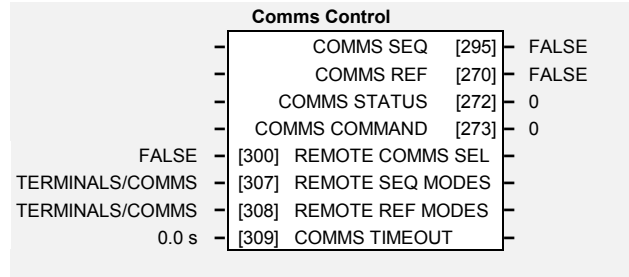

Parameter Descriptions

REMOTE COMMS SEL

Range: FALSE / TRUE

Selects the type of remote communications mode:

0 : FALSE, and in REMOTE mode then control is from the terminals.

1 : TRUE, and in REMOTE mode then control is from the communications.

REMOTE SEQ MODES

Range: Enumerated - see below

Selects the type of remote sequencing mode:

Enumerated Value : Mode

0 : TERMINALS/COMMS

1 : TERMINALS ONLY

2 : COMMS ONLY

REMOTE REF MODES

Range: Enumerated - see below

Selects the type of remote reference mode:

Enumerated Value : Mode

0 : TERMINALS/COMMS

1 : TERMINALS ONLY

2 : COMMS ONLY

COMMS TIMEOUT

Range: 0.0 to 600.0 s

Sets the maximum time allowed between refreshing the COMMS COMMAND parameter. The drive will trip if this time is exceeded. Set the time to 0.00 seconds to disable this feature.

COMMS SEQ

Range: FALSE / TRUE

Diagnostic indicating if operating in Remote Sequencing Comms Mode.

If FALSE (0), the Inverter may be in Local Sequencing mode or Remote Sequencing Terminal mode.

COMMS REF

Range: FALSE / TRUE

Diagnostic indicating if operating in Remote Reference Comms Mode.

If FALSE (0), the Inverter may be in Local Reference mode or Remote Reference Terminal mode.

COMMS STATUS

Range: 0000 to FFFF

Diagnostic showing the 16-bit Status word as seen by the communications.

Refer to Chapter 4: "Sequencing Logic".

COMMS COMMAND

Range: 0000 to FFFF

Diagnostic showing the 16-bit Command as written by the communications.

Refer to Chapter 4: "Sequencing Logic".

MMI Menu Map

1	SETUP
2	WINDER
3	COMPENSATION
	DIAMETER
	MINIMUM DIAMETER
	VARIABLE INERTIA
	FIXED INERTIA
	WIDTH
	REWIND
	LINE SPD DEMAND
	RATE CAL
	REVERSE
	DYNAMIC COMP
	STATIC COMP
	MOD REEL SPEED
	COMPENSATIONS
	INERTIA COMP
	SCALED RATE
	LINE SPEED RATE

COMPENSATION

This function block calculates the torque required to accelerate the mechanical inertia.

This block is used in Macro 4.

Compensation			
	COMPENSATIONS	[817]	0.00 %
	INERTIA COMP	[818]	0.00 %
	SCALED RATE	[819]	0.00 %
	LINE SPEED RATE	[820]	0.00 %
10.00 %	[805]	DIAMETER	
10.00 %	[806]	MINIMUM DIAMETER	
0.00 %	[807]	VARIABLE INERTIA	
0.00 %	[808]	FIXED INERTIA	
100.00 %	[809]	WIDTH	
	[810]	REWIND	
0.00 %	[811]	LINE SPD DEMAND	
10.00	[812]	RATE CAL	
FALSE	[813]	REVERSE	
0.00 %	[814]	DYNAMIC COMP	
0.00 %	[815]	STATIC COMP	
0.00 %	[816]	MOD REEL SPEED	

Parameter Descriptions

DIAMETER

Range: 0.00 to 100.00 %

Calculated diameter from diameter calculator.

MINIMUM DIAMETER

Range: 0.00 to 100.00 %

Min Diameter from diameter calculator.

VARIABLE INERTIA

Range: 0.00 to 100.00 %

The Variable Inertia is the Inertia of reel.

FIXED INERTIA

Range: 0.00 to 100.00 %

This is the inertia of the motor, gearbox and core.

WIDTH

Range: 0.00 to 100.00 %

The width input sets the web width and scales the variable inertia.

REWIND

Range: FALSE / TRUE

Selects between unwind and re-wind. Selected to REWIND when TRUE.

LINE SPD DEMAND

Range: -100.00 to 100.00 %

Line Speed demand is differentiated to calculate the rate of change of speed for inertia compensation.

RATE CAL

Range: -300.00 to 300.00

Scales differentiated LINE SPD DEMAND

REVERSE

Range: FALSE / TRUE

Sets the direction of the line speed.

DYNAMIC COMP

Range: 0.00 to 300.00 %

The compensation required to drive the winder at full speed.

STATIC COMP

Range: 0.00 to 300.00 %

The compensation required to drive the winder at minimum speed (zero)

MOD REEL SPEED

Range: 0.00 to 300.00 %

Reel speed feedback.

COMPENSATIONS

Range: —.00 %

Total open loop torque compensation.

1-20 Programming Your Application

INERTIA COMP

Range: —.00 %

Unscaled inertia compensation diagnostic.

SCALED RATE

Range: —.00 %

Scaled rate diagnostic.

LINE SPEED RATE

Range: —.00 %

Differential of line speed.

Functional Description

The FIXED INERTIA is the inertia of the motor, gearbox and core. The VARIABLE INERTIA is the inertia of the roll. A WIDTH input is available for setting the web width.

The total inertia (INERTIA COMP) is multiplied by the scaled acceleration rate to produce the torque demand. The polarity is set by the unwind/re-wind selection.

Accelerating a rewind requires additional torque in the same direction as the tension producing torque, whereas an unwind will require accelerating torque in the opposite direction to the tension torque. The acceleration rate comes from the line speed demand input. The line speed demand input is differentiated to produce a rate.

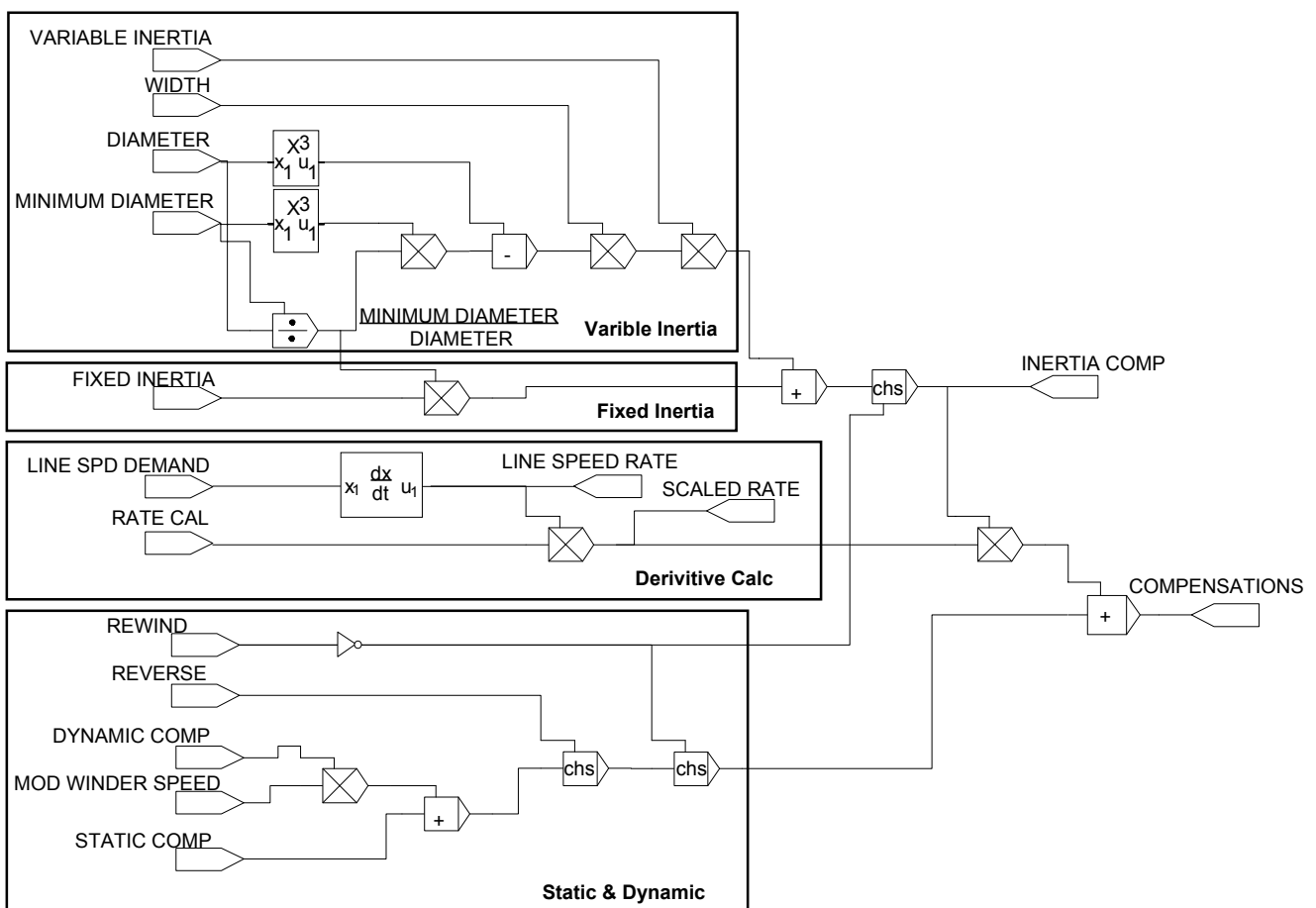

CURRENT LIMIT

Designed for all Motor Control Modes.

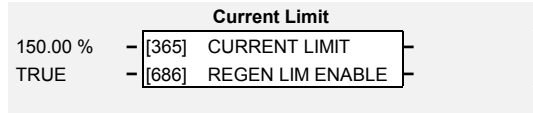

MMI Menu Map

- 1 SETUP
- 2 MOTOR CONTROL
- 3 CURRENT LIMIT
 - CURRENT LIMIT
 - REGEN LIM ENABLE

This function block allows you to set the maximum level of motor rated current (as a % of the user-set MOTOR CURRENT) which is allowed to flow before current limit action occurs. If the measured motor current exceeds the current limit value with a motoring load, the motor speed is reduced to shed the excess load. If the measured motor current exceeds the current limit value with a regenerating load, the motor speed is increased up to a maximum of MAX SPEED (SETPOINT SCALE function block).

Note: *The maximum value of current limit for a particular motor is limited by the 690+ current rating. If a motor of larger rating than the 690+ is connected, then the current limit applies to the 690+ and not the motor. In this case, the maximum value of the CURRENT LIMIT parameter is 150.00%.*

Parameter Descriptions

CURRENT LIMIT *Range: 0.00 to 300.00 %*

This parameter sets the level of motor current, as a % of MOTOR CURRENT (refer to the MOTOR DATA function block) at which the Inverter begins to take current limit action.

Refer also to “Quadratic/Constant Torque Selection”, page 1-136.

REGEN LIM ENABLE *Range: FALSE / TRUE*

This parameter enables or disables regenerative current limit action.

Note that this parameter only works in open-loop VOLTS / Hz motor control mode.

DEMULTIPLEXER

The demultiplexer function block splits the input word into 16 individual bits.

This may be used to extract the individual trip bits from the ACTIVE TRIPS parameter, for example.

MMI Menu Map

- 1 SETUP
- 2 MISCELLANEOUS
- 3 DEMULTIPLEXER
- 4 DEMULTIPLEXER 1
- 4 DEMULTIPLEXER 2
- INPUT
- OUTPUT 0
- OUTPUT 1
- OUTPUT 2
- OUTPUT 3
- OUTPUT 4
- OUTPUT 5
- OUTPUT 6
- OUTPUT 7
- OUTPUT 8
- OUTPUT 9
- OUTPUT 10
- OUTPUT 11
- OUTPUT 12
- OUTPUT 13
- OUTPUT 14
- OUTPUT 15

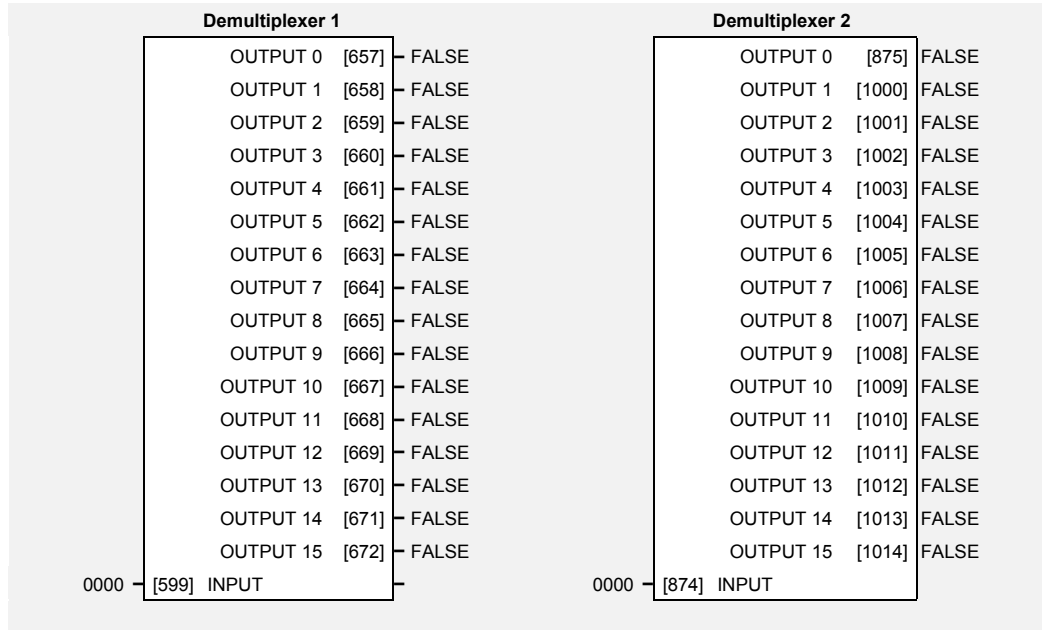

Parameter Descriptions

INPUT

The input to be split into its component bits.

Range: 0000 to FFFF

OUTPUT 0 TO OUTPUT 15

Each output returns the corresponding bit of the 16 bit input word.

Range: FALSE / TRUE

MMI Menu Map

1	SETUP
2	WINDER
3	DIAMETER CALC
	DIAMETER HOLD
	PRESET ENABLE
	SELECT CORE 2
	SEL EXT DIAMETER
	TENSION ENABLE
	CORE 1
	CORE 2
	DIAMETER TC
	EXT DIAMETER
	LINE SPEED
	MINIMUM DIAMETER
	MINIMUM SPEED
	REEL SPEED
	CURRENT CORE DIAMETER
	MOD LINE SPEED
	MOD REEL SPEED

DIAMETER CALC

This block calculates reel diameter by dividing line speed by winder speed for centre wind applications.

The line and winder speeds are forced to be of positive sign, independent of the input speed sign. This ensures that the calculated diameter is always positive.

The line speed input should be the actual web speed from the previous section motor speed (the next section in the case of an unwind).

The winder speed is the spindle motor speed.

Refer to Macro 4.

Diameter Calc			
	CURRENT CORE	[834]	10.00 %
	DIAMETER	[835]	10.00 %
	MOD LINE SPEED	[836]	0.00 %
	MOD REEL SPEED	[837]	0.00 %
FALSE	[821] DIAMETER HOLD		
FALSE	[822] PRESET ENABLE		
FALSE	[823] SELECT CORE 2		
FALSE	[824] SEL EXT DIAMETER		
FALSE	[825] TENSION ENABLE		
10.00 %	[826] CORE 1		
10.00 %	[827] CORE 2		
5.00 s	[828] DIAMETER TC		
100.00 %	[829] EXT DIAMETER		
0.00 %	[830] LINE SPEED		
10.00 %	[831] MINIMUM DIAMETER		
5.00 %	[832] MINIMUM SPEED		
0.00 %	[833] REEL SPEED		

Parameter Descriptions

DIAMETER HOLD

Range: FALSE / TRUE

Freezes the output of the filter when TRUE.

PRESET ENABLE

Range: FALSE / TRUE

Presets the filter to core or external diameter. Enabled when TRUE.

SELECT CORE 2

Range: FALSE / TRUE

Selects between CORE 1 and CORE2 for use when PRESET ENABLE is TRUE. CORE 1 is selected when FALSE. CORE 2 is selected when TRUE.

SEL EXT DIAMETER

Range: FALSE / TRUE

Selects external diameter input for PRESET ENABLE when TRUE.

TENSION ENABLE

Range: FALSE / TRUE

Enables Tension Control.

CORE 1

Range: 0.00 to 120.00 %

Core size as a percentage of the maximum diameter.

CORE 2

Range: 0.00 to 120.00 %

Alternative core size (as a percentage of the maximum diameter).

DIAMETER TC	<i>Range: 0.00 to 300.00 s</i>
Filter time constant for DIAMETER output.	
EXT DIAMETER	<i>Range: 0.00 to 120.00 %</i>
External diameter input.	
LINE SPEED	<i>Range: -110.00 to 110.00 %</i>
Line speed input.	
MINIMUM DIAMETER	<i>Range: 0.00 to 120.00 %</i>
Sets the smallest reel diameter (calculated diameter value at full (100%) line speed and full (100%) winder speed).	
MINIMUM SPEED	<i>Range: 0.00 to 110.00 %</i>
The threshold below which the diameter output is held.	
REEL SPEED	<i>Range: -110.00 to 110.00 %</i>
Reel speed feedback.	
CURRENT CORE	<i>Range: —.00 %</i>
Diagnostic indicating the currently selected core size.	
DIAMETER	<i>Range: —.00 %</i>
Diameter output.	
MOD LINE SPEED	<i>Range: —.00 %</i>
Modulus of line speed.	
MOD REEL SPEED	<i>Range: —.00 %</i>
Modulus of reel speed.	

Functional Description

This function block performs the diameter calculation used by the other function blocks to enable the control of centre wind applications.

The diameter is calculated by dividing the absolute value of LINE SPEED by the absolute value of REEL SPEED. This result is scaled by the MINIMUM DIAMETER parameter. The filtered output tracks the diameter when TENSION ENABLE is True and LINE SPEED is above MINIMUM SPEED, otherwise the diameter is held at its current value.

When the diameter is held, a preset value is used as both the input and output of the filter. This is the value of CORE 1 or CORE 2, or the value of EXTERNAL DIAMETER.

The preset value is also loaded into the filter whenever the block diagram is restarted.

Note: *The diameter calculator will only operate with the web under some tension. The diameter filter prevents the diameter from changing quickly in the case of web break situations. The diameter output is clamped at the minimum diameter constant value.*

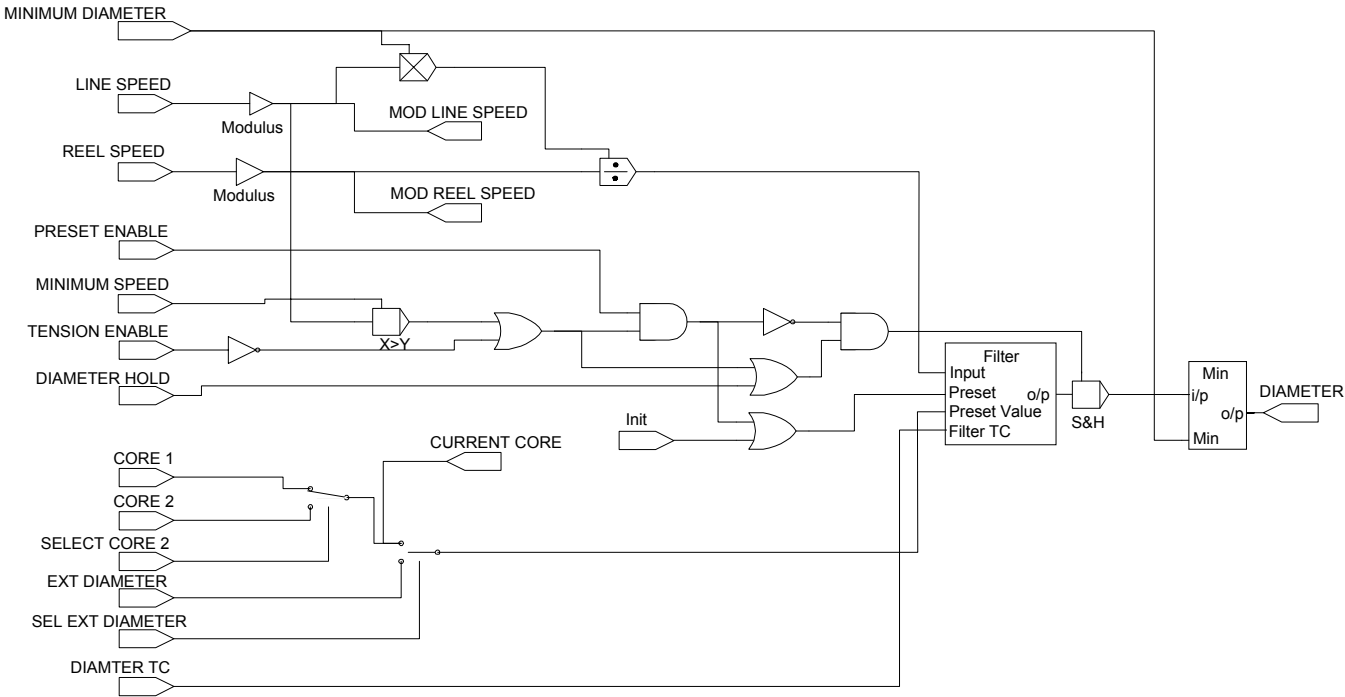

DIGITAL INPUT

The digital input block converts the physical input voltage to TRUE or FALSE control signals.

MMI Menu Map

- 1 SETUP
- 2 INPUTS & OUTPUTS
- 3 DIGITAL INPUT
- 4 DIGITAL INPUT 1
- 4 DIGITAL INPUT 2
- 4 DIGITAL INPUT 3
- 4 DIGITAL INPUT 4
- 4 DIGITAL INPUT 5
- 4 DIGITAL INPUT 6
- 4 DIGITAL INPUT 7
- 4 DIGITAL INPUT 11
- 4 DIGITAL INPUT 12
- 4 DIGITAL INPUT 13
- 4 DIGITAL INPUT 14
- 4 DIGITAL INPUT 15
- INVERT
- VALUE

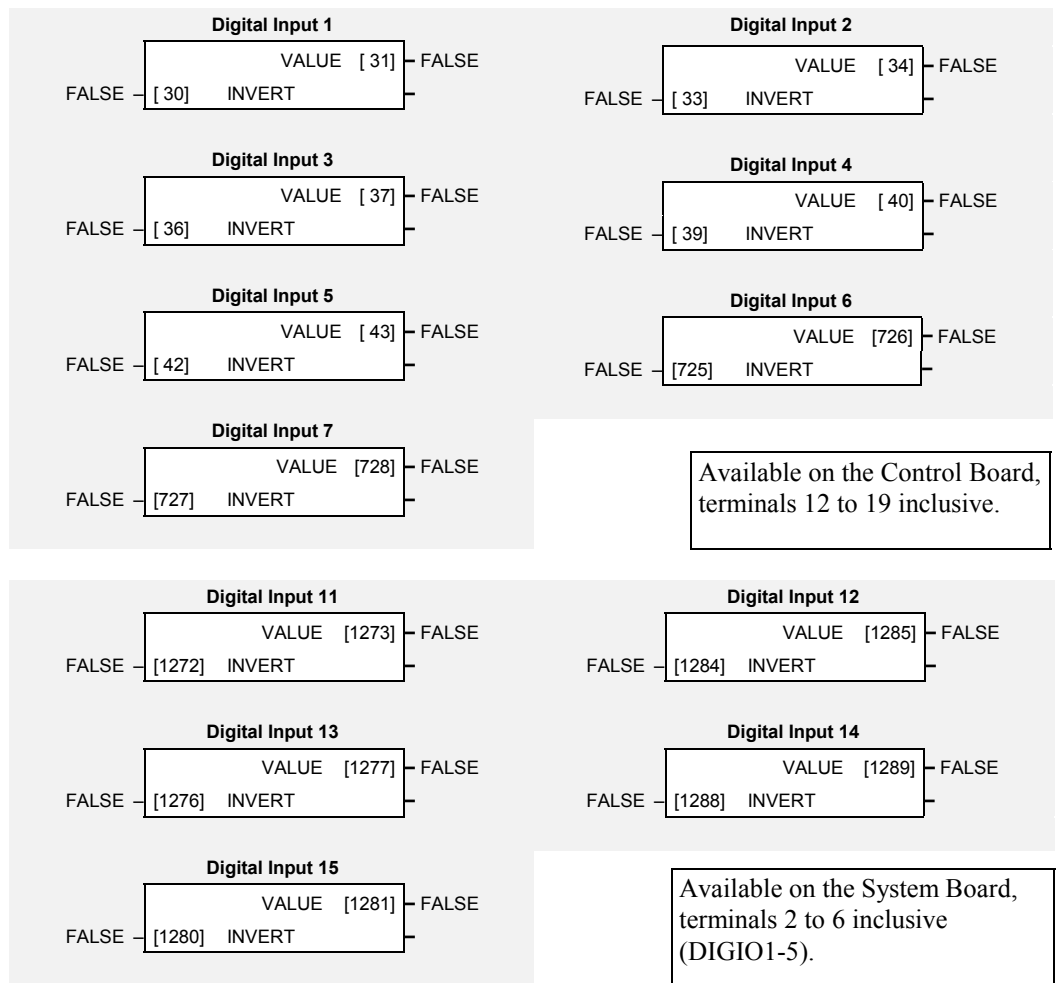

Parameter Descriptions

INVERT

Controls the optional inversion of the VALUE output.

Range: FALSE / TRUE

VALUE

The TRUE or FALSE input, (after any inversion).

Range: FALSE / TRUE

Functional Description

There is a DIGITAL INPUT function block associated with each of the following terminals:

The Control Board has seven configurable digital inputs:

- DIGITAL INPUT 1 is associated with terminal 12
- DIGITAL INPUT 2 is associated with terminal 13
- DIGITAL INPUT 3 is associated with terminal 14
- DIGITAL INPUT 4 is associated with terminal 15
- DIGITAL INPUT 5 is associated with terminal 16
- DIGITAL INPUT 6 is associated with terminal 17
- DIGITAL INPUT 7 is associated with terminal 18

Note: Terminal 19 is permanently configured as the EXTERNAL TRIP input. Refer to I/O TRIPS, page 1-45.

DIGITAL INPUT 8 is associated with terminal 19

Programming Your Application 1-27

The System Board (optional) has 5 configurable digital inputs/outputs (DIGIO 1 to 5).

Each DIGIO can be configured to operate as either a Digital Input or a Digital Output.

Refer to DIGITAL OUTPUT, page 1-28.

The input electronics of the Inverter converts the input signal to a TRUE or FALSE logic value. The digital input block takes this value and optionally inverts it before providing the VALUE output.

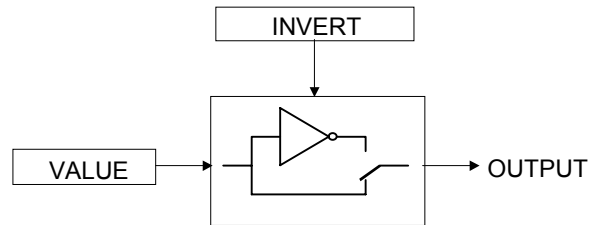

DIGITAL OUTPUT

The digital output block converts a logic TRUE or FALSE demand to a physical output signal.

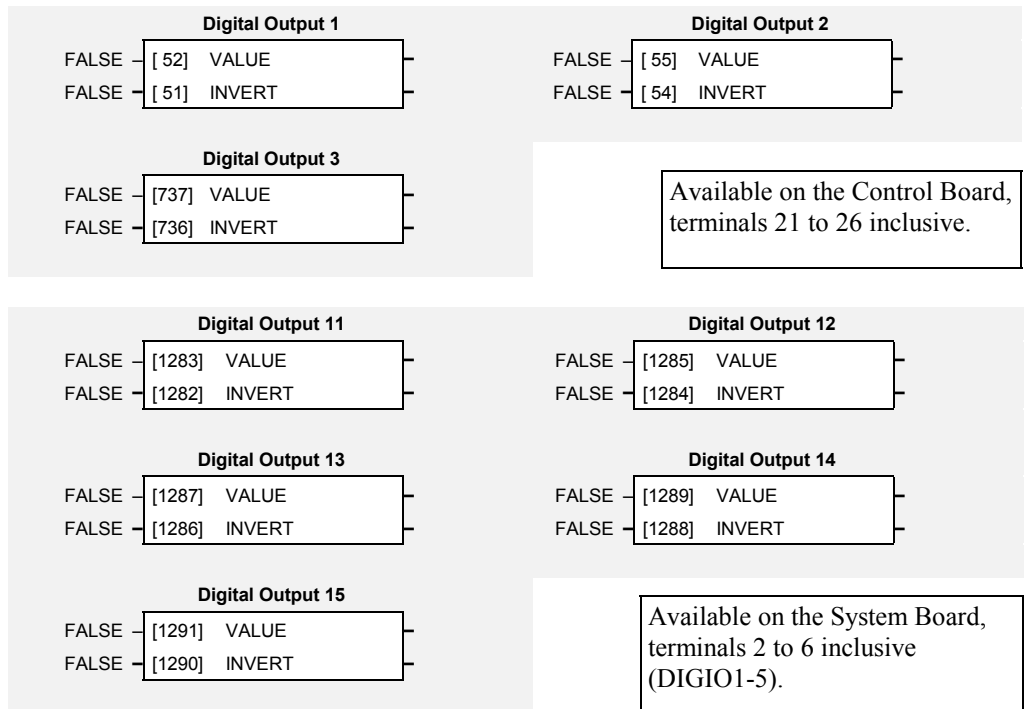
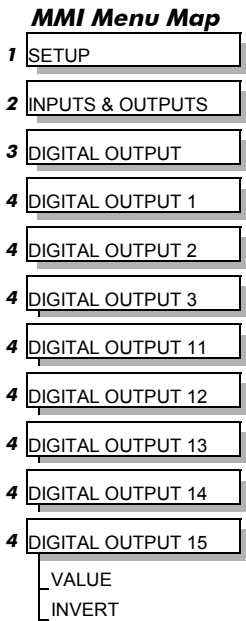

Parameter Descriptions

VALUE

The TRUE or FALSE output demand.

Range: FALSE / TRUE

INVERT

Controls the optional inversion of the VALUE output.

Range: FALSE / TRUE

Functional Description

There is a DIGITAL OUTPUT function block associated with each of the following terminals:

The Control Board has three digital outputs (volt-free relay contacts):

- DIGITAL OUTPUT 1 is associated with terminals 21 & 22
- DIGITAL OUTPUT 2 is associated with terminals 23 & 24
- DIGITAL OUTPUT 3 is associated with terminals 25 & 26

The System Board (optional) has 5 configurable digital inputs/outputs (DIGIO 1 to 5):

- DIGITAL OUTPUT 11 is associated with DIGIO1, terminal block A, terminal 2
- DIGITAL OUTPUT 12 is associated with DIGIO2, terminal block A, terminal 3
- DIGITAL OUTPUT 13 is associated with DIGIO3, terminal block A, terminal 4
- DIGITAL OUTPUT 14 is associated with DIGIO4, terminal block A, terminal 5
- DIGITAL OUTPUT 15 is associated with DIGIO5, terminal block A, terminal 6

The default status for these 5 DIGIO is to act as inputs. Setting either VALUE or INVERT to TRUE will individually configure the block to be an output. Note that because INVERT reverses the output logic, setting both VALUE and INVERT to TRUE will configure the block to be an input.

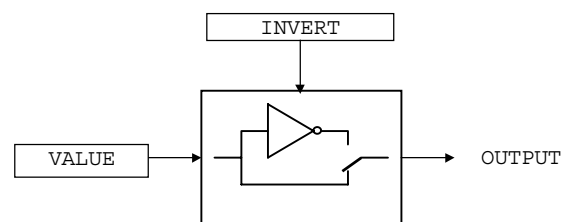

Also refer to DIGITAL INPUT, page 1-26.

DISPLAY SCALE

These function blocks can be used to display any floating point parameter with an applied scaling factor, formulae and your preferred units.

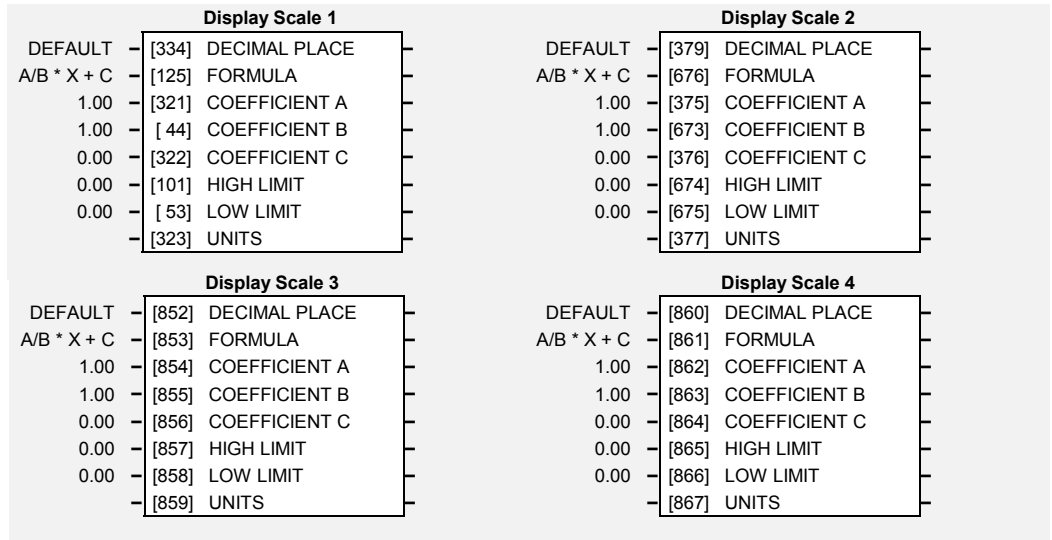
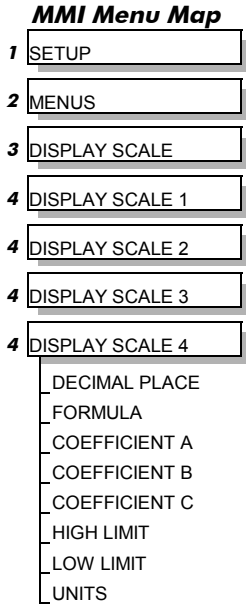

Parameter Descriptions

DECIMAL PLACE

Range: See below

Select the position of the decimal point.

Enumerated Value : Position

- 0 : DEFAULT
- 1 : X.XXXXX
- 2 : X.XXX
- 3 : X.XX
- 4 : X.X
- 5 : X.

FORMULA

Range: See below

Select a formula where A, B and C are the coefficients listed below, and X is the value to modify.

Enumerated Value : Formula

- 0 : A/B * X + C
- 1 : A/B * (X+C)
- 2 : A/(B * X) + C
- 3 : A/(B * (X+C))

COEFFICIENT A

Range: -300.00 to 300.00

Coefficient used as defined by the formula.

COEFFICIENT B

Range: -300.00 to 300.00

Coefficient used as defined by the formula.

COEFFICIENT C

Range: -300.00 to 300.00

Coefficient used as defined by the formula.

HIGH LIMIT

Range: -300.00 to 300.00

Use high limit to set a maximum value for the modified parameter on the keypad. Setting the HIGH LIMIT lower than or equal to the LOW LIMIT makes the parameter "read-only".

LOW LIMIT

Range: -300.00 to 300.00

Use low limit to set a minimum value for the modified parameter on the keypad. Setting the HIGH LIMIT higher than or equal to the HIGH LIMIT makes the parameter "read-only".

UNITS

Range: max length is 6 chars

A 6 character label that is displayed as the parameter units.

1-30 Programming Your Application

Functional Description

The DISPLAY SCALE blocks are selected in the ACCESS CONTROL and OPERATOR MENU function blocks for use with the Speed Setpoint and Operator Menu respectively.

For display purposes, the parameter is modified according to the formula chosen:

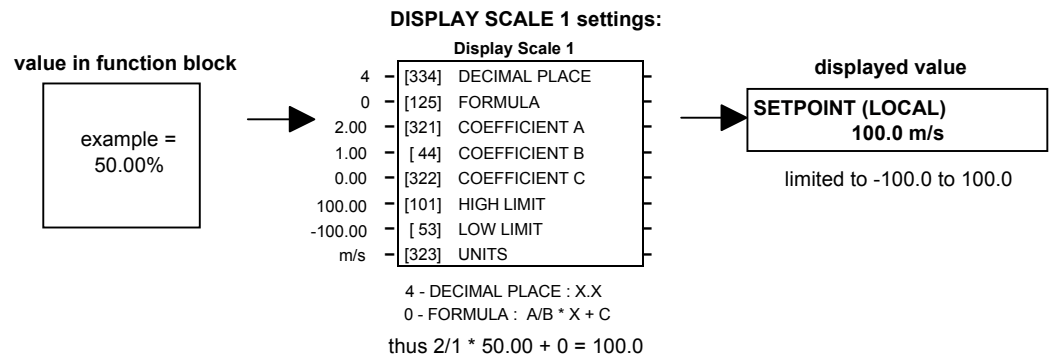

When adjusting parameters, the inverse of the formula is applied to the displayed value:

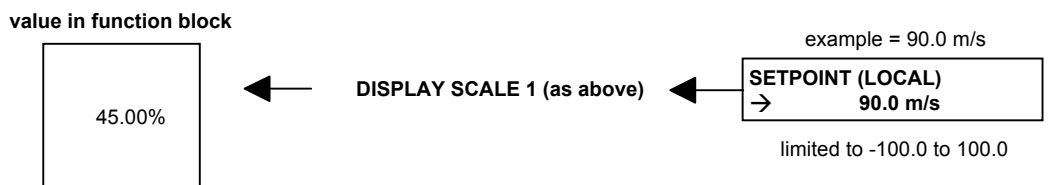

Character Sets

The table below lists the characters supported by the software in decimal and hexadecimal.

	HEX	DEC		HEX	DEC		HEX	DEC		HEX	DEC		HEX	DEC		HEX	DEC
	20	32	0	30	48	@	40	64	P	50	80	,	60	96	p	70	112
!	21	33	1	31	49	A	41	65	Q	51	81	a	61	97	q	71	113
"	22	34	2	32	50	B	42	66	R	52	82	b	62	98	r	72	114
#	23	35	3	33	51	C	43	67	S	53	83	c	63	99	s	73	115
\$	24	36	4	34	52	D	44	68	T	54	84	d	64	100	t	74	116
%	25	37	5	35	53	E	45	69	U	55	85	e	65	101	u	75	117
&	26	38	6	36	54	F	46	70	V	56	86	f	66	102	v	76	118
'	27	39	7	37	55	G	47	71	W	57	87	g	67	103	w	77	119
(28	40	8	38	56	H	48	72	X	58	88	h	68	104	x	78	120
)	29	41	9	39	57	I	49	73	Y	59	89	i	69	105	y	79	121
*	2A	42	:	3A	58	J	4A	74	Z	5A	90	j	6A	106	z	7A	122
+	2B	43	;	3B	59	K	4B	75	[5B	91	k	6B	107	{	7B	123
,	2C	44	<	3C	60	L	4C	76				l	6C	108		7C	124
-	2D	45	=	3D	61	M	4D	77]	5D	93	m	6D	109	}	7D	125
.	2E	46	>	3E	62	N	4E	78	^	5E	94	n	6E	110			
/	2F	47	?	3F	63	O	4F	79	_	5F	95	o	6F	111	■	0	0

MMI Menu Map

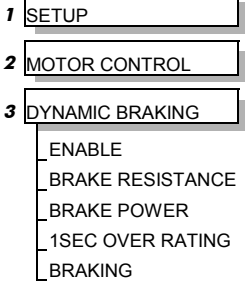

DYNAMIC BRAKING

Designed for all Motor Control Modes.

The dynamic braking function block controls the rate at which energy from a regenerating motor is dumped into a resistive load. This dumping prevents the dc link voltage reaching levels which would cause an Overvoltage trip.

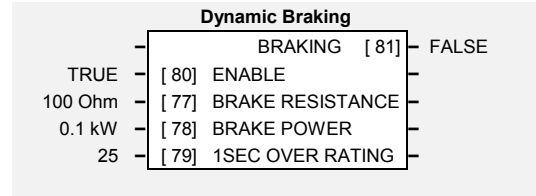

Parameter Descriptions

ENABLE

Enables operation of the dynamic braking block.

Range: FALSE / TRUE

BRAKE RESISTANCE

The value of the load resistance.

Range: 1 to 1000 Ohm

BRAKE POWER

The power that the load resistance may continually dissipate.

Range: 0.1 to 510.0 kW

1SEC OVER RATING

Multiplier that may be applied to BRAKE POWER for power overloads lasting no more than 1 second.

Range: 1 to 40

BRAKING

A read-only parameter indicating the state of the brake switch.

Range: FALSE / TRUE

Functional Description

When enabled, the DYNAMIC BRAKING block monitors the internal dc link voltage every milli-second and sets the state of the brake switch accordingly.

The dynamic braking block provides a control signal that is used by the SLEW RATE LIMIT block. This causes the setpoint to be temporarily frozen whenever the dynamic brake is operating because the dc link voltage exceeds the internal comparison level. This allows the stop rate to be automatically tuned to the characteristics of the load, motor, Inverter and brake resistor.

The DYNAMIC BRAKING block operates even when the motor output is not enabled. This allows the block to continually monitor the energy dumped into the braking resistor, and the energy dissipated across the brake switch. With this information the Inverter is able to deduce the loading on the brake resistor. Optional trips may be enabled should the switch or resistor be loaded beyond its capabilities.

Refer also to the Installation Product Manual, Chapter 10: “Application Notes” - Dynamic Braking.

ENCODER SPEED

Designed for use with the System Board option, all Motor Control Modes.

MMI Menu Map

1	SETUP
2	SYSTEM BOARD
3	ENCODER SPEED
	SOURCE
	LINES
	INVERT
	MAX SPEED
	FILTER TIME
	SPEED HZ
	SPEED

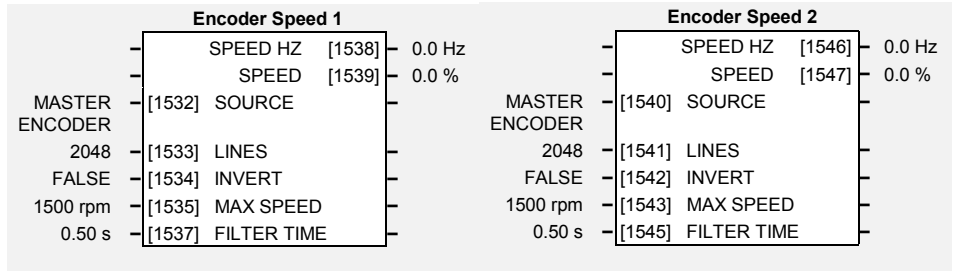

This block allows Speed Feedback to be measured using a quadrature encoder when the System Board option is fitted.

Parameter Descriptions

SOURCE Range: See below

Determines the encoder channel from which the speed is calculated.

Enumerated Value : Source

- 0 : MASTER ENCODER
- 1 : SLAVE ENCODER

LINES Range: 1 to 32767

The number of lines must be set to match the type of encoder being used. Incorrect setting of this parameter will result in an erroneous speed measurement.

INVERT Range: FALSE/TRUE

When TRUE, changes the sign of the measured speed and the direction of the position count.

MAX SPEED Range: 0 to 32000 rpm

Sets the 100 % value in RPM. Refer to SPEED below.

FILTER TIME Range: 0.00 to 300.00 s

Filter time constant for SPEED HZ and SPEED % outputs. Setting to zero will remove the filter.

SPEED HZ Range: —. Hz

Speed Feedback in Hertz (revolutions per second).

SPEED Range: —.x %

$$\text{SPEED \%} = \frac{\text{SPEED Hz} \times 60}{\text{MAX SPEED}} \times 100$$

Functional Description

A quadrature encoder uses 2 input signals (A and B), phase shifted by a quarter of a cycle (90°). Direction is obtained by looking at the combined state of A and B.

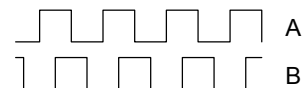

Speed is calculated using the following function:

$$\text{SPEED HZ} = \text{filter} \left[\frac{\text{CountsPerSecond}}{\text{Lines} \times 4}, \text{FilterTime} \right]$$

where counts per second are the number of edges received from the encoder. There are 4 counts per line.

MMI Menu Map

1	SETUP
2	MOTOR CONTROL
3	ENERGY METER
	RESET
	POWER
	POWER
	REACTIVE POWER
	ENERGY USED

ENERGY METER

This block measures the electrical energy used by the load.

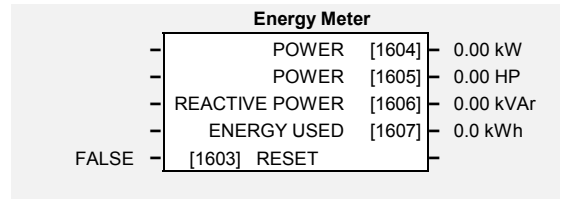

Parameter Descriptions

RESET

Range: FALSE / TRUE

When RESET is set to TRUE, the ENERGY USED parameter is reset to zero automatically when the maximum value is reached.

When RESET is set to FALSE, the ENERGY USED parameter is held at the maximum value when the maximum value has been reached

Changing this from FALSE to TRUE at anytime will cause the ENERGY USED parameter to be reset to zero.

POWER

Range: -32768.00 to 32767.00 kW

This diagnostic shows the power being delivered to the load in kilowatts.

POWER

Range: -32768.00 to 32767.00 HP

This diagnostic shows the power being delivered to the load in horsepower.

REACTIVE POWER

Range: -32768.00 to 32767.00 kVAr

This diagnostic shows the reactive power being delivered to the load in kilovolt-amperes reactive.

ENERGY USED

Range: 0.00 to 32767.00 kWh

This diagnostic shows the total energy consumed by the load in kilowatt hours.

FEEDBACKS

Designed for all Motor Control Modes.

The FEEDBACKS block allows you to view speed feedback and motor current related diagnostics. It also allows you to setup the encoder parameters, if one is fitted. These are ENCODER SUPPLY, ENCODER LINES, ENCODER INVERT and ENCODER MODE. An encoder requires the 6054 Speed Feedback Technology Option.

It also contains parameters for setting up the encoder used with the 6054 option.

Feedbacks		
-	DC LINK VOLTS	[75] 0 V
-	TERMINAL VOLTS	[1020] 0 V
-	SPEED FEEDBACK RPM	[569] 0.00 rpm
-	SPEED FBK REV/S	[568] 0.00 rev/s
-	SPEED FEEDBACK %	[749] 0.00 %
-	ENCODER FBK %	[1238] 0.00 %
-	ENCODER COUNT	[1016] 0
-	TORQUE FEEDBACK	[70] 0.00 %
-	FIELD FEEDBACK	[73] 0.00 %
-	MOTOR CURRENT %	[66] 0.00 %
-	MOTOR CURRENT	[67] 0.0 A
** 10.0 V	[761] ENCODER SUPPLY	
** 2048	[566] ENCODER LINES	
**FALSE	[567] ENCODER INVERT	
QUADRATURE	[565] ENCODER MODE	
**FALSE	[50] QUADRATIC TORQUE	

MMI Menu Map

- 1 **SETUP**
- 2 **MOTOR CONTROL**
- 3 **FEEDBACKS**
 - ENCODER SUPPLY
 - ENCODER LINES
 - ENCODER INVERT
 - ENCODER MODE
 - QUADRATIC TORQUE
 - DC LINK VOLTS
 - TERMINAL VOLTS
 - SPEED FBK RPM
 - SPEED FBK REV/S
 - SPEED FBK %
 - ENCODER FBK %
 - ENCODER COUNT
 - TORQUE FEEDBACK
 - FIELD FEEDBACK
 - MOTOR CURRENT &
 - MOTOR CURRENT A

Parameter Descriptions

ENCODER SUPPLY

Range: 10.0 to 20.0V

Set this approximately to the supply voltage required by the Tech Box encoder, if supported.

ENCODER LINES

Range: 250 to 32767

The number of lines must be set to match the type of encoder being used. Incorrect setting of this parameter will result in an erroneous speed measurement.

ENCODER INVERT

Range: FALSE/TRUE

Used to match the encoder direction to the motor direction. When TRUE, it changes the sign of the measured speed and the direction of the position count.

It is necessary to set up this parameter when in CLOSED-LOOP VEC mode, as the encoder direction must be correct for this mode to operate.

ENCODER MODE

Range: Enumerated-see below

This parameter defines the type of encoder being used. If the System Board option is fitted, this parameter must be set to QUADRATURE.

Enumerated Value : Encoder Mode

- 0 : QUADRATURE
- 1 : CLOCK/DIR
- 2 : CLOCK

QUADRATIC TORQUE

Range: FALSE/TRUE

When TRUE, selects QUADRATIC allowing higher continuous ratings with less overload capability. Quadratic Torque operation is especially suited to fan or pump applications.

When FALSE, selects CONSTANT duty.

DC LINK VOLTS

Range: —. V

This shows the voltage on the dc link capacitors.

TERMINAL VOLTS

Range: —. V

This shows the rms voltage, between phases, applied by the inverter to the motor terminals. This should be 90% of MOTOR VOLTS at base speed if the motor is unloaded.

SPEED FEEDBACK RPM

Range: —.xx rpm

This parameter changes according to the CONTROL MODE (MOTOR DATA function block):

- In CLOSED-LOOP VEC mode the parameter shows the mechanical speed of the motor shaft in revolutions per minute as calculated from the Encoder Technology Box.
- In SENSORLESS VEC mode the parameter shows the calculated mechanical speed of the motor shaft in revolutions per minute.

SPEED FEEDBACK REV/S

Range: —.xx rev/s

This parameter changes according to the CONTROL MODE (MOTOR DATA function block):

- In CLOSED-LOOP VEC mode the parameter shows the mechanical speed of the motor shaft in revolutions per second as calculated from the Encoder Technology Box.
- In SENSORLESS VEC mode the parameter shows the calculated mechanical speed of the motor shaft in revolutions per second.
- In VOLTS / Hz mode, the parameter shows the motor synchronous speed in revolutions per second.

SPEED FEEDBACK %

Range: —.xx %

This parameter changes according to the CONTROL MODE (MOTOR DATA function block):

- In CLOSED-LOOP VEC mode the parameter shows the mechanical speed of the motor shaft as a percentage of the user maximum speed setting (MAX SPEED in the SETPOINT SCALE function block) as calculated from the Encoder Technology Box.
- In SENSORLESS VEC mode the parameter shows the calculated mechanical speed of the motor shaft as a percentage of the user maximum speed setting (MAX SPEED in the SETPOINT SCALE function block).
- In VOLTS / Hz mode, the parameter shows the electrical drive output frequency as a percentage of the user maximum speed setting (MAX SPEED in the SETPOINT SCALE function block).

ENCODER FBK %

Range: —.xx %

This parameter shows the mechanical speed of the motor shaft, calculated from the Encoder Technology Box, as a percentage of the user maximum speed setting (MAX SPEED in the SETPOINT SCALE function block).

ENCODER COUNT

Range: —.

In QUADRATURE MODE (see ENCODER MODE parameter) this increments/decrements @ 4 x line rate, i.e. 1 revolution = 4000 for a 1000 line encoder. In other modes it increments/decrements @ line rate, i.e. 1 revolution = 1000 for a 1000 line encoder.

This is a 16-bit register which is incremented or decremented by the pulses from the encoder. It is useful to check that the encoder is operating, and to measure the encoder lines, if this is not known. Rotate the motor shaft through 1 revolution and note the difference between readings at the start and finish.

In QUADRATURE MODE the difference should be 4 times the encoder lines, in other modes the difference should be equal to the encoder lines.

For greater accuracy, rotate the shaft through several revolutions.

The direction of count is unaffected by ENCODER INVERT.

TORQUE FEEDBACK

Range: —.xx %

Shows the estimated motor torque, as a percentage of rated motor torque.

FIELD FEEDBACK

Range: —.xx %

A value of 100% indicates the motor is operating at rated magnetic flux (field).

MOTOR CURRENT %

Range: —.xx %

This diagnostic contains the level of rms line current being drawn from the Inverter and is seen as a % of the MOTOR CURRENT parameter setting in the MOTOR DATA function block.

MOTOR CURRENT

Range: —.xx A

This diagnostic contains the level of rms line current being drawn from the Inverter.

MMI Menu Map

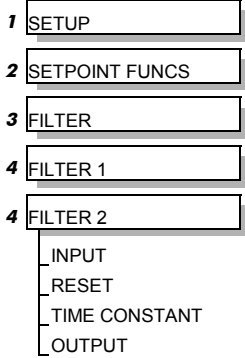

FILTER

This function block contains two, simple order filters of the type: $\frac{1}{1 + ST}$

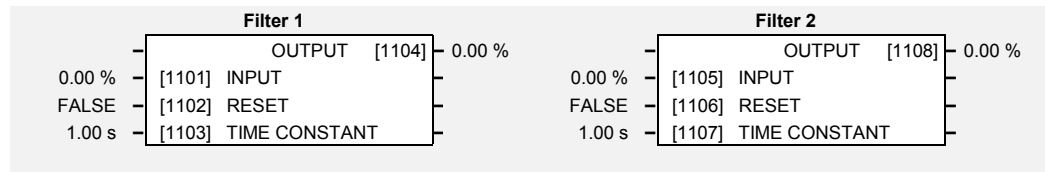

Parameter Descriptions

INPUT

Filter input.

Range: -300.00 to 300.00 %

RESET

If TRUE, the output is set equal to the input and the filter is disabled.

Range: FALSE / TRUE

TIME CONSTANT

Time constant. If less than 0.05s the filter is disabled.

Range: 0.00 to 300.00 s

OUTPUT

Filtered output.

Range: —.00 %

FLUXING

Designed for VOLTS/Hz motor Control Mode.

MMI Menu Map

- 1 SETUP
- 2 MOTOR CONTROL
- 3 FLUXING
 - V/F SHAPE
 - BASE FREQUENCY
 - FIXED BOOST
 - AUTO BOOST
 - ACCELRTN BOOST
 - ENERGY SAVING
 - USER FREQ 1
 - USER VOLTAGE 1
 - USER FREQ 2
 - USER VOLTAGE 2
 - USER FREQ 3
 - USER VOLTAGE 3
 - USER FREQ 4
 - USER VOLTAGE 4
 - USER FREQ 5
 - USER VOLTAGE 5
 - USER FREQ 6
 - USER VOLTAGE 6
 - USER FREQ 7
 - USER VOLTAGE 7
 - USER FREQ 8
 - USER VOLTAGE 8
 - USER FREQ 9
 - USER VOLTAGE 9
 - USER FREQ 10
 - USER VOLTAGE 10

This function block allows user parameterisation of the conventional (volts/hertz) fluxing strategy of the Inverter. This is achieved through three flexible Volts-to-frequency templates. Starting torque performance can also be tailored through the FIXED BOOST, ACCELRTN BOOST and AUTO BOOST parameters.

Fluxing

LINEAR LAW	-	[104]	V/F SHAPE
* 50.0 Hz	-	[106]	BASE FREQUENCY
** 0.00 %	-	[107]	FIXED BOOST
** 0.00 %	-	[108]	AUTO BOOST
0.00 %	-	[1656]	ACCELRTN BOOST
FALSE	-	[1655]	ENERGY SAVING
10.00 %	-	[1657]	USER FREQ 1
10.00 %	-	[1658]	USER VOLTAGE 1
20.00 %	-	[1659]	USER FREQ 2
20.00 %	-	[1660]	USER VOLTAGE 2
30.00 %	-	[1661]	USER FREQ 3
30.00 %	-	[1662]	USER VOLTAGE 3
40.00 %	-	[1663]	USER FREQ 4
40.00 %	-	[1664]	USER VOLTAGE 4
50.00 %	-	[1665]	USER FREQ 5
50.00 %	-	[1666]	USER VOLTAGE 5
60.00 %	-	[1667]	USER FREQ 6
60.00 %	-	[1668]	USER VOLTAGE 6
70.00 %	-	[1669]	USER FREQ 7
70.00 %	-	[1670]	USER VOLTAGE 7
80.00 %	-	[1671]	USER FREQ 8
80.00 %	-	[1672]	USER VOLTAGE 8
90.00 %	-	[1673]	USER FREQ 9
90.00 %	-	[1674]	USER VOLTAGE 9
100.00 %	-	[1675]	USER FREQ 10
100.00 %	-	[1676]	USER VOLTAGE 10

Parameter Descriptions

V/F SHAPE

Range: Enumerated - see below

This parameter determines the type of volts to frequency template is used to flux the motor. The choices of this parameter are:

Enumerated Value : V/F Shape

- 0 : LINEAR LAW
- 1 : FAN LAW
- 2 : USER DEFINED

LINEAR LAW : This gives a constant flux characteristic up to the BASE FREQUENCY

FAN LAW: This gives a quadratic flux characteristic up to the BASE FREQUENCY. This matches the load requirement for fan and most pump applications

USER DEFINED : This gives a user defined flux characteristic up to the BASE FREQUENCY.

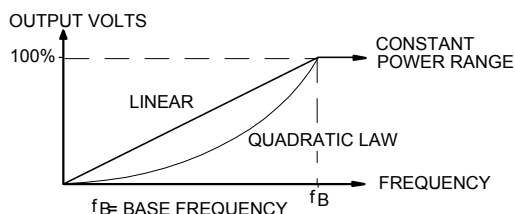

BASE FREQUENCY

Range: 7.5 to 1000.0 Hz

(See MOTOR DATA function block)

This parameter determines the frequency at which maximum output volts is generated. Below base frequency, the volts will vary with frequency as determined by the V/F SHAPE parameter. Above base frequency, the volts will saturate at the maximum value. Refer to MOTOR DATA (BASE FREQUENCY parameter), page 1-55.

Refer to Chapter 2: "Parameter Specification" - Frequency Dependent Defaults

FIXED BOOST

Range: 0.00 to 25.00 %

This parameter allows for no-load stator resistance voltage drop compensation. This correctly fluxes the motor (under no-load conditions) at low output frequencies, thereby increasing available motor torque. Fixed boost can be set in addition to auto boost.

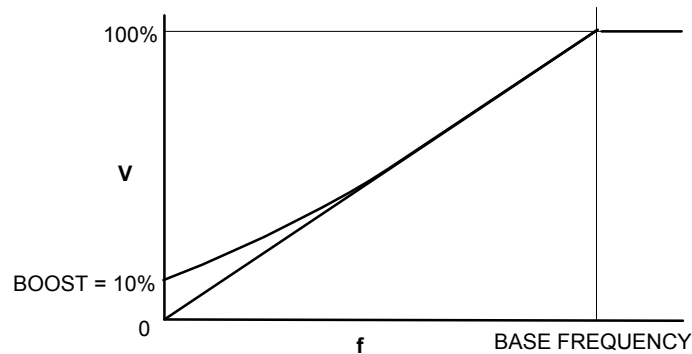

AUTO BOOST

Range: 0.00 to 25.00 %

This parameter allows for load dependent stator resistance voltage drop compensation. This correctly fluxes the motor (under load conditions) at low output frequencies, thereby increasing available motor torque. Auto boost can be set in addition to fixed boost.

The value of the AUTO BOOST parameter determines level of additional volts supplied to the motor for 100% load.

Setting the value of auto boost too high can cause the Inverter to enter current limit. If this occurs, the Inverter will be unable to ramp up in speed. Reducing the value of auto boost will eliminate this problem.

ACCELRTN BOOST

Range: 0.00 to 25.00 %

This parameter provides an additional amount of fixed boost when the drive is accelerating. This can help when starting heavy/high stiction loads.

ENERGY SAVING

Range: FALSE / TRUE

When set TRUE, the demanded volts are reduced to minimise energy consumption if the drive is operating in a steady state at light load.

USER FREQ 1 to 10

Range: 0.0 to 100.0 %

These parameters provide 10 frequency points, which together with the USER VOLTAGE parameters, provide the user defined voltage profile. (USER FREQ n, USER VOLTAGE n) provide up to 10 (x,y) points on this profile. The USER FREQ parameters are defined as a percentage of the BASE FREQUENCY parameter (refer to the MOTOR DATA function block).

USER VOLTAGE 1 to 10

Range: 0.0 to 100.0 %

These parameters provide 10 voltage points, which together with the USER FREQ parameters, provide the user defined voltage profile. (USER FREQ n, USER VOLTAGE n) provide up to 10 (x,y) points on this profile. The USER VOLTAGE parameters are defined as a percentage of the MOTOR VOLTAGE parameter (refer to the MOTOR DATA function block).

Functional Description

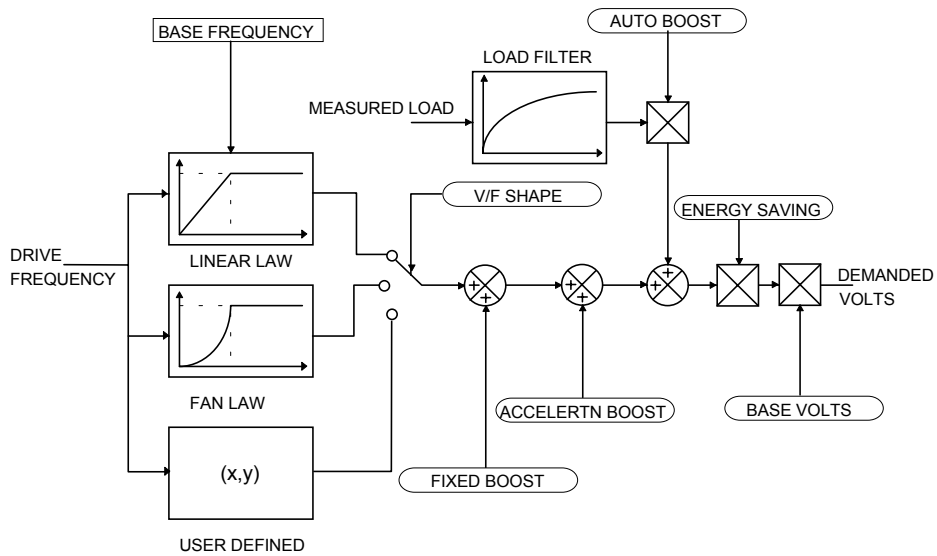

V/F Shape

The function block allows the user to parameterise the Inverter's conventional V/F motor fluxing scheme. Three V/F shapes are available, LINEAR LAW, FAN LAW and USER DEFINED:

- Linear Law V/F shape should be used in applications requiring constant motor torque though out the speed range (e.g. machine tools or hoists).
- Fan Law V/F shape provides extra energy savings for fan or pump applications.
- User Defined V/F shape provides a method for the user to define any profile. 10 user defineable (x,y) points are provided. Linear interpolation is used between each point. The drive also assumes the following points - (0%,0%) and (100%,100%) - though these may be overridden. For example, (USER FREQ 1 = 0%, USER VOLTAGE 1 = 5%) takes precedence over (0%, 0%).

For any of these V/F shapes the BASE FREQUENCY parameter (in the MOTOR DATA function block) which is the value of Inverter output frequency at which maximum output volts is provided, can be set by the user.

Boost Parameters

- Correct no-load motor fluxing at low Inverter output frequencies can be achieved by setting the FIXED BOOST parameter.
- Correct motor fluxing under load conditions is achieved by setting the AUTO BOOST parameter. The motor is correctly fluxed when the FIELD FBK diagnostic in the FEEDBACKS function block reads 100.0% .
- Additional FIXED BOOST can be applied during acceleration by setting the ACCELRTN BOOST parameter. This can be useful for starting heavy/high stiction loads.

Saving Energy

An ENERGY SAVING mode is provided which, when enables under low load conditions in the steady state, attempts to reduce the output voltage so that minimum energy is used.

FLYCATCHING

Designed for all Motor Control Modes.

MMI Menu Map

1	SETUP
2	MOTOR CONTROL
3	FLY CATCHING
	VHZ ENABLE
	VECTOR ENABLE
	START MODE
	SEARCH MODE
	SEARCH VOLTS
	SEARCH BOOST
	SEARCH TIME
	MIN SEARCH SPEED
	REFLUX TIME
	ACTIVE
	SETPOINT

This block performs a directional speed search. It allows the Inverter to seamlessly catch a spinning motor before controlling the motor to the desired setpoint.

This is especially useful for large inertia fan loads, where drafts in building air ducts can cause a fan to 'windmill'.

Flycatching	
ACTIVE	[576] FALSE
SETPOINT	[28] 0.00 %
FALSE [570]	VHZ ENABLE
TRUE [1553]	VECTOR ENABLE
ALWAYS [571]	START MODE
BIDIRECTIONAL [572]	SEARCH MODE
** 9.00 % [573]	SEARCH VOLTS
** 40.00 % [32]	SEARCH BOOST
** 10.0 s [574]	SEARCH TIME
5.0 Hz [575]	MIN SEARCH SPEED
** 3.0 s [709]	REFLUX TIME

Parameter Descriptions

VHZ ENABLE

Range: FALSE / TRUE

Enables flycatching in Volts/Hz Control mode when TRUE.

VECTOR ENABLE

Range: FALSE / TRUE

Enables flycatching in Vector Control mode when TRUE.

START MODE

Range: Enumerated - see below

The mode of operation for the flycatching sequence software.

Enumerated Value : Start Mode

- 0 : ALWAYS
- 1 : TRIP OR POWERUP
- 2 : TRIP

SEARCH MODE

Range: Enumerated - see below

The type of speed search carried out by the flycatching sequence.

Enumerated Value : Search Mode

- 0 : BIDIRECTIONAL
- 1 : UNIDIRECTIONAL

SEARCH VOLTS

Range: 0.00 to 100.00 %

The percentage level of the search volts applied to the motor during the speed search phase of the flycatching sequence. Increasing this parameter improves the accuracy of the discovered motor speed but increases the braking influence of the speed search on the rotating motor.

SEARCH BOOST

Range: 0.00 to 50.00 %

The level of search boost applied to the motor during the speed search phase of the flycatching sequence.

SEARCH TIME

Range: 0.1 to 60.0 s

The search rate during the speed search phase of the flycatching sequence. Performing the flycatching speed search too quickly can cause the drive to inaccurately identify the motor speed. Refluxing at an inaccurate motor speed can cause the drive to trip on overvoltage. If this occurs, increasing this parameter will reduce the risk of tripping.

MIN SEARCH SPEED

Range: 0.0 to 500.0 Hz

The lowest search speed before the speed search phase of the flycatching sequence is considered to have failed.

REFLUX TIME

Range: 0.1 to 20.0 s

The rate of rise of volts from the search level to the working level after a successful speed search. Refluxing the motor too quickly can cause the drive to trip on either overvoltage or overcurrent. In either case, increasing this parameter will reduce the risk of tripping.

ACTIVE*Range: FALSE / TRUE*

A diagnostic output indicating whether the flycatching sequence is active.

SETPOINT*Range xxx.xx %*

This diagnostic output is the setpoint caught at the end of a successful flycatching sequence.

Functional Description

The flycatching function enables the drive to be restarted smoothly into a spinning motor. It applies small search voltages to the motor whilst ramping the Inverter frequency from maximum speed to zero. When the motor load goes from motoring to regenerating, the speed search has succeeded and is terminated. If the search frequency falls below the minimum search speed, the speed search has failed and the Inverter will ramp to the speed setpoint from zero.

The flycatching sequence can be triggered by different starting conditions:

ALWAYS: All starts (after controlled or uncontrolled stop, or after a power-up)
TRIP or POWER-UP: After uncontrolled stop, i.e. trip or coast, or after a power-up
TRIP: After uncontrolled stop, i.e. trip or coast

The type of speed sequence may be Bidirectional or Unidirectional:

Bidirectional

Initially, the search is performed in the direction of the speed setpoint. If the drive fails to identify the motor speed in this direction, a second speed search is performed in the reverse direction.

Unidirectional

The search is performed only in the direction of the speed setpoint.

MMI Menu Map

1	SETUP
2	MISCELLANEOUS
3	HOME
	ENABLE
	INPUT
	DISTANCE
	DISTANCE FINE
	GAIN
	CORRECTION LIMIT
	DECEL LIMIT
	ACTIVE
	OUTPUT
	ERROR
	ERROR COUNT
	DONE
	DECELERATION

HOME

This function block uses a position loop to stop the drive in a set distance.

The distance is set in revolutions based on the number of lines on the encoder, usually from a mark at a fixed distance from the home position.

For accurate positioning the drive must be in closed loop vector mode, if the drive is in any other mode then an open loop home algorithm will be used.

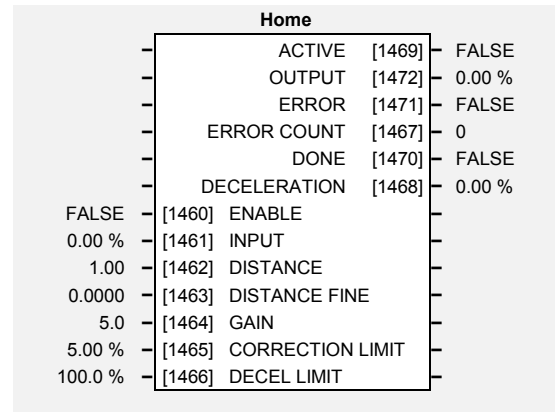

Parameter Descriptions

ENABLE

Range: FALSE / TRUE

ENABLE going from FALSE to TRUE latches the current position and time and initiates a position home operation. If set to FALSE then INPUT is passed straight through to OUTPUT. ENABLE must be held TRUE throughout the homing process, returning it to FALSE aborts the home function.

INPUT

Range: -300.00 to 300.00 %

The input to the block from REFERENCE :: SPEED DEMAND.

DISTANCE

Range: 0.00 to 300.00

Sets the homing distance in revolutions, a revolution calculated from the number of lines on the encoder and maximum speed (see MOTOR DATA for more information on these parameters).

DISTANCE FINE

Range: 0.0000 to 1.0000

Fine adjustment of homing distance. The actual homing distance is the sum of DISTANCE and DISTANCE FINE.

GAIN

Range: 0.0 to 1000.0

In closed loop homing, GAIN is used to stabilise the closed loop position trim signal. A value of zero disables closed loop homing.

CORRECTION LIMIT

Range: 0.00 to 100.00 %

Sets the maximum value of the closed loop position trim signal.

DECEL LIMIT

Range: 0.0 to 3000.0 %

Sets the maximum allowable deceleration for closed loop homing. The actual required deceleration is calculated from the value of the input and homing distance when the block is enabled. If this is exceeded then the block will perform an open loop home with the calculated deceleration.

The HOME function block will only operate efficiently if the controller is operating within its capabilities i.e. not limiting.

If the Deceleration limit is exceeded then the ERROR output will be set.

ACTIVE

Range: FALSE / TRUE

Active is set TRUE whenever the block is enabled.

OUTPUT

Range: .xx

This is connected directly to INPUT if the block is not enabled. When enabled, OUTPUT is ramped to zero at a calculated rate to bring the motor to rest in a defined distance. OUTPUT is connected to SETPOINT SCALE :: INPUT, this will override the REFERENCE RAMP block.

ERROR

Range: FALSE / TRUE

Set TRUE if the maximum deceleration rate exceeded. Set FALSE if the block is not enabled.

ERROR COUNT

Range: ..

This diagnostic is only valid in closed loop mode and shows the actual position error in encoder counts. It is this error that is used to correct for positional errors in the speed setpoint generation.

DONE

Range: FALSE / TRUE

Set TRUE when the position has been reached or the output is at zero in open loop operation.

DECELERATION

Range: ..xx

A diagnostic showing the actual deceleration used during the current / last home operation.

Functional Description

It is intended that homing be used to bring the motor to reset from a low speed (10%) over a relatively small distance (1 revolution). To achieve this the input should be connected to Reference :: Speed Demand and the output to Setpoint Scale :: Input, this will override the reference ramp.

Position Error is the distance in encoder pulses between the current position and Target position.

The homing distance is the stopping distance in encoder pulses.

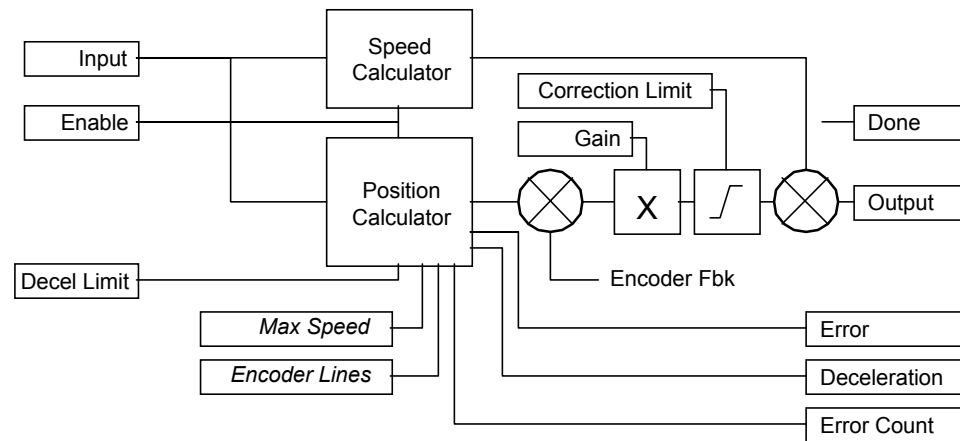

Possible Causes of Homing Errors

Take the example of lift (elevator) with the following parameters

Motor:

100% Speed = 1500 RPM

5000 line encoder.

Gearbox 18:1 @ 2.5m/s)

Pulley 650mm diameter @ 2.5 m/s 1 revolution = 110 mm

How far does the car travel between the detection of the homing sensor and the drive seeing the ENABLE command?

It will be assumed that the drive will be travelling relatively slowly when it receives the home command 1.5Hz = 0.75 RPM = 0.0825 mm / ms.

Typically the worst case levelling error will therefore be:

$$\begin{aligned}
 & 0.08 * (\text{cycle time of lift controller} + \text{cycle time of the vector drive}) \\
 & = 0.08 * (10+5) \\
 & = 1.2\text{mm.}
 \end{aligned}$$

MMI Menu Map

1	SETUP
2	MOTOR CONTROL
3	INJ BRAKING
	INJ DEFLUX TIME
	INJ FREQUENCY
	INJ I-LIM LEVEL
	INJ DC PULSE
	INJ FINAL DC
	INJ DC LEVEL
	INJ TIMEOUT
	INJ BASE VOLTS
	INJ ACTIVE

INJ BRAKING

Designed for VOLTS/Hz Motor Control Mode.

The injection braking block provides a method of stopping spinning induction motors without returning the kinetic energy of the motor and load back in to the dc link of the Inverter. This is achieved by running the motor highly inefficiently so that all the energy stored in the load is dissipated in the motor. Thus, high inertia loads can be stopped without the need for an external dynamic braking resistor.

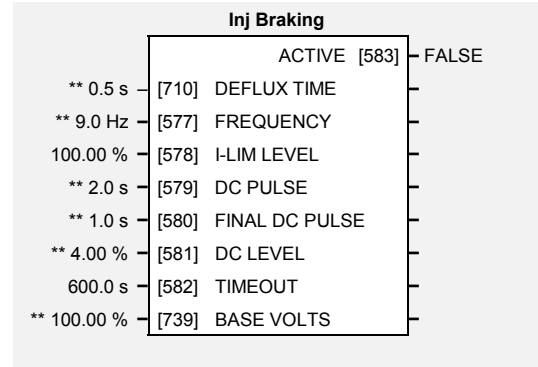

Parameter Descriptions

DEFLUX TIME

Range: 0.1 to 20.0 s

Determines the time in which the Inverter defluxes the motor prior injection braking.

FREQUENCY

Range: 1.0 to 480.0 Hz

Determines the maximum frequency applied to the motor for the low frequency injection braking mode. It is also clamped internally so as never to exceed 50% of base speed value.

I-LIM LEVEL

Range: 50.00 to 150.00 %

Determines the level of motor current flowing during low frequency injection braking.

DC PULSE

Range: 0.0 to 100.0 s

Determines the duration of the dc pulse applied to the motor when injection braking is required for motor speeds below 20% of base speed. The actual dc pulse time applied to the motor is dependent on the ratio of initial motor speed to 20% of base speed.

FINAL DC PULSE

Range: 0.0 to 10.0 s

Determines the duration of the final dc holding pulse applied to the motor after either low frequency injection braking or timed dc pulse.

DC LEVEL

Range: 0.00 to 25.00 %

Determines the level of dc pulse applied to the motor during either the timed or final dc pulse.

TIMEOUT

Range: 0.0 to 600.0 s

Determines the maximum amount of time the sequence is allowed to remain in the low frequency injection braking state.

BASE VOLTS

Range: 0.00 to 115.47 %

Determines the maximum volts at base speed applied to the motor during injection braking.

ACTIVE

Range: FALSE / TRUE

Indicates the state of the Inverter. TRUE when injection braking.

MMI Menu Map

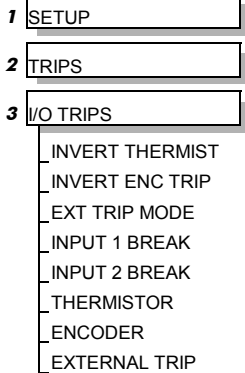

I/O TRIPS

This function block is designed to operate in conjunction with the Analog and Digital Input function blocks to trip the Inverter on a loss of setpoint input or safety control input.

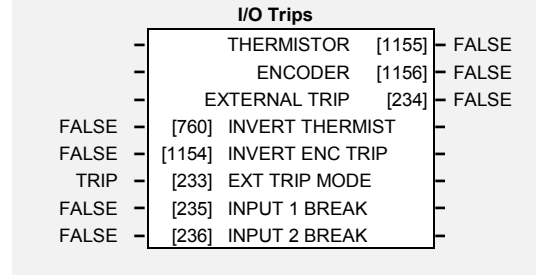

Parameter Descriptions

INVERT THERMIST

Range: FALSE / TRUE

Inverts the sense of the motor thermistor input. The default FALSE is normally-closed/low impedance.

INVERT ENC TRIP

Range: FALSE / TRUE

Inverts the sense of the encoder fail input on the encoder Technology Box. FALSE for normally-closed.

EXT TRIP MODE

Range: TRIP / COAST

When set to TRIP, DIN8 (EXT TRIP) will trip the drive when +24V is not present, causing EXTERNAL TRIP to be displayed on the MMI.

When set to COAST the drive will not trip, but “coasts to stop” when +24V is not present.

INPUT 1 BREAK

Range: FALSE / TRUE

A general purpose signal designed to be internally wired to the function block ANALOG INPUT 1, BREAK parameter. When this signal goes TRUE this causes an INPUT 1 BREAK trip to occur, (unless this trip is disabled within the TRIPS STATUS function block, see the DISABLE TRIPS parameter).

This parameter is not saved in the Inverter’s non-volatile memory and thus is reset to the default setting at power-up.

INPUT 2 BREAK

Range: FALSE / TRUE

A general purpose signal designed to be internally wired to the function block ANALOG INPUT 2, BREAK parameter. When this signal goes TRUE this causes an INPUT 2 BREAK trip to occur, (unless this trip is disabled within the TRIPS STATUS function block, see the DISABLE TRIPS parameter).

This parameter is not saved in the Inverter’s non-volatile memory and thus is reset to the default setting at power-up.

THERMISTOR

Range: FALSE / TRUE

The current state of the motor thermistor trip input, modified by INVERT THERMIST input.

ENCODER

Range: FALSE / TRUE

The current state of the encoder Technology Box error trip input. TRUE is tripped.

EXTERNAL TRIP

Range: FALSE / TRUE

The current state of the External Trip input (terminal 19). Note that this input is inverted, so is TRUE if 0V is on the terminal.

Functional Description

The I/O TRIPS function block allows trips to be generated by signals on the input terminals of the Inverter. Refer to the Installation Product Manual, Chapter 6 for a description of the trips supported by the Inverter.

INVERSE TIME

Designed for all Motor Control Modes.

MMI Menu Map

- 1 SETUP
- 2 MOTOR CONTROL
 - AIMING POINT
 - DELAY
 - DOWN RATE
 - UP RATE
 - IT LIMITING
 - INVERSE TIME OP
- 3 INVERSE TIME

The purpose of the inverse time is to automatically reduce the inverter current limit in response to prolonged overload conditions. As the motor current exceeds the AIMING POINT level, the excess current is integrated. Motor current is allowed to flow at the CURRENT LIMIT (refer to the Current Limit function block) for a period defined by the DELAY parameter. At this point the inverse time current limit is ramped down from the CURRENT LIMIT. The rate at which the inverse time current limit is ramped to the AIMING POINT is defined by DOWN TIME.

Inverse Time		
IT LIMITING	[1152]	FALSE
INVERSE TIME OP	[1153]	0.00 %
105.00 %	[1148]	AIMING POINT
60.0 s	[1149]	DELAY
10.0 s	[1150]	DOWN TIME
120.0 s	[1151]	UP TIME

Once the overload condition is removed, the inverse time current limit level is ramped back toward the CURRENT LIMIT.

In Quadratic Torque mode, the allowed overload is reduced to 115.0 % for 60.0 s before inverse time current limit action occurs.

Parameter Descriptions

AIMING POINT

Range: 50.00 to 150.00%

Determines the final level of the inverse time current limit after a period of prolonged motor overload

DELAY

Range: 5.0 to 60.0s

Determines the maximum allowed overload duration for 150.0 % motor current (110.0% in QUADRATIC TORQUE mode) before inverse time current limit action is taken.

Refer also to “Quadratic/Constant Torque Selection”, page 1-136.

DOWN TIME

Range: 1.0 to 10.0s

Determines the rate at which the inverse time current limit is ramped to the AIMING POINT after a period of prolonged overload.

UP TIME

Range: 1.0 to 600.0s

Determines the rate at which the inverse time current limit is ramped back to the CURRENT LIMIT (refer to the Current limit function block) once the overload is removed.

IT LIMITING

Range: FALSE / TRUE

This diagnostic indicates if the inverse time current limit is active.

INVERSE TIME OP

Range: —.00 %

This diagnostic indicates the present level of the inverse time current limit.

MMI Menu Map

1	SETUP
2	SETPOINT FUNCS
3	LINEAR RAMP
	INPUT
	ACCEL TIME
	DECEL TIME
	SYMMETRIC MODE
	SYMMETRIC TIME
	HOLD
	RESET
	RESET VALUE
	OUTPUT
	RAMPING

LINEAR RAMP

This function block limits the rate of change of an input.

Refer to REFERENCE RAMP, page 1-91.

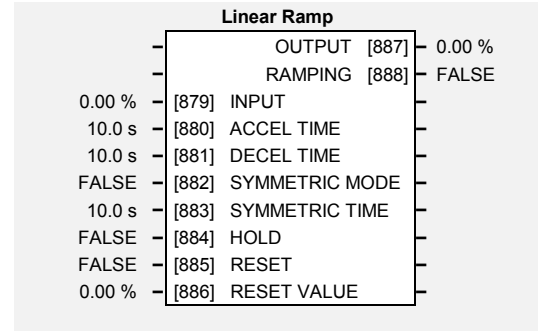

Parameter Descriptions

INPUT

Range: -300.00 to 300.00%

Ramp input.

ACCEL TIME

Range: 0.0 to 3000.0 s

The time that the Inverter will take to ramp the setpoint from 0.00% to 100.00%.

DECEL TIME

Range: 0.0 to 3000.0 s

The time that the Inverter will take to ramp the setpoint from 100.00% to 0.00%.

SYMMETRIC MODE

Range: FALSE / TRUE

Select whether to use the ACCEL TIME and DECEL TIME pair of ramp rates, or to use the SYMMETRIC RATE parameter to define the ramp rate for the Inverter.

SYMMETRIC TIME

Range: 0.0 to 3000.0 s

The time that the inverter will take to ramp from 0.00% to 100.00% and from 100.00% to 0.00% when SYMMETRIC MODE is TRUE.

HOLD

Range: FALSE / TRUE

When TRUE the output of the ramp is held at its last value.

RESET

Range: FALSE / TRUE

If TRUE, the output is made equal to the input.

RESET VALUE

Range: -300.00 to 300.00 %

The value that the output is set to while RESET is TRUE.

OUTPUT

Range: —.00 %

The ramp output.

RAMPING

Range: FALSE / TRUE

This is set TRUE when ramping.

LOCAL CONTROL

MMI Menu Map

1	SETUP
2	SEQ & REF
3	LOCAL CONTROL
	SEQ MODES
	REF MODES
	POWER UP MODE
	SEQ DIRECTION
	REMOTE SEQ
	REMOTE REF

This block allows the available modes of Local and Remote operation to be customised. It also indicates the selected mode.

You can only switch between Local and Remote modes using the Operator Station. Refer to the Installation Product Manual, Chapter 5: "The Operator Station" - The L/R Key.

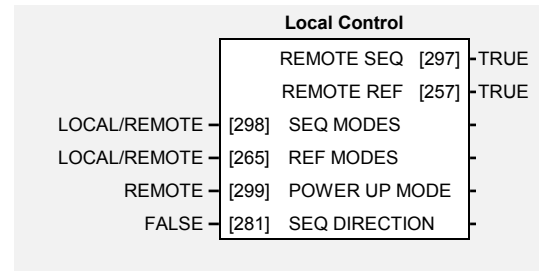

Parameter Descriptions

SEQ MODES

Range: Enumerated - see below

Allows the source of sequencing commands to be selected. Local is the Operator Station, Remote is an external signal. The modes supported are:

Enumerated Value : Seq Mode

- 0 : LOCAL/REMOTE
- 1 : LOCAL ONLY
- 2 : REMOTE ONLY

REF MODES

Range: Enumerated - see below

Allows the source of the reference signal to be selected. Local is the Operator Station, Remote is an external signal. The modes supported are:

Enumerated Value : Ref Mode

- 0 : LOCAL/REMOTE
- 1 : LOCAL ONLY
- 2 : REMOTE ONLY

POWER UP MODE

Range: Enumerated - see below

Allows the power-up operating mode of the Inverter to be selected. Local is the Operator Station, Remote is an external signal, Automatic is the same mode as at power-down. The modes supported are:

Enumerated Value : Power Up Mode

- 0 : LOCAL
- 1 : REMOTE
- 2 : AUTOMATIC

SEQ DIRECTION

Range: FALSE / TRUE

When TRUE, direction is a Sequencing command.

When FALSE, direction is a Reference command.

REMOTE SEQ

Range: FALSE / TRUE

This parameter indicates the present source of the sequencing commands.

REMOTE REF

Range: FALSE / TRUE

This parameter indicates the present source of the reference signal.

LOGIC FUNCTION

These generic function blocks can be configured to perform one of a number of simple functions upon a fixed number of inputs.

MMI Menu Map

- 1 SETUP
- 2 MISCELLANEOUS
- 3 LOGIC FUNC
- 4 LOGIC FUNC 1
- 4 LOGIC FUNC 2
- 4 LOGIC FUNC 3
- 4 LOGIC FUNC 4
- 4 LOGIC FUNC 5
- 4 LOGIC FUNC 6
- 4 LOGIC FUNC 7
- 4 LOGIC FUNC 8
- 4 LOGIC FUNC 9
- 4 LOGIC FUNC 10
 - INPUT A
 - INPUT B
 - INPUT C
 - TYPE
 - OUTPUT

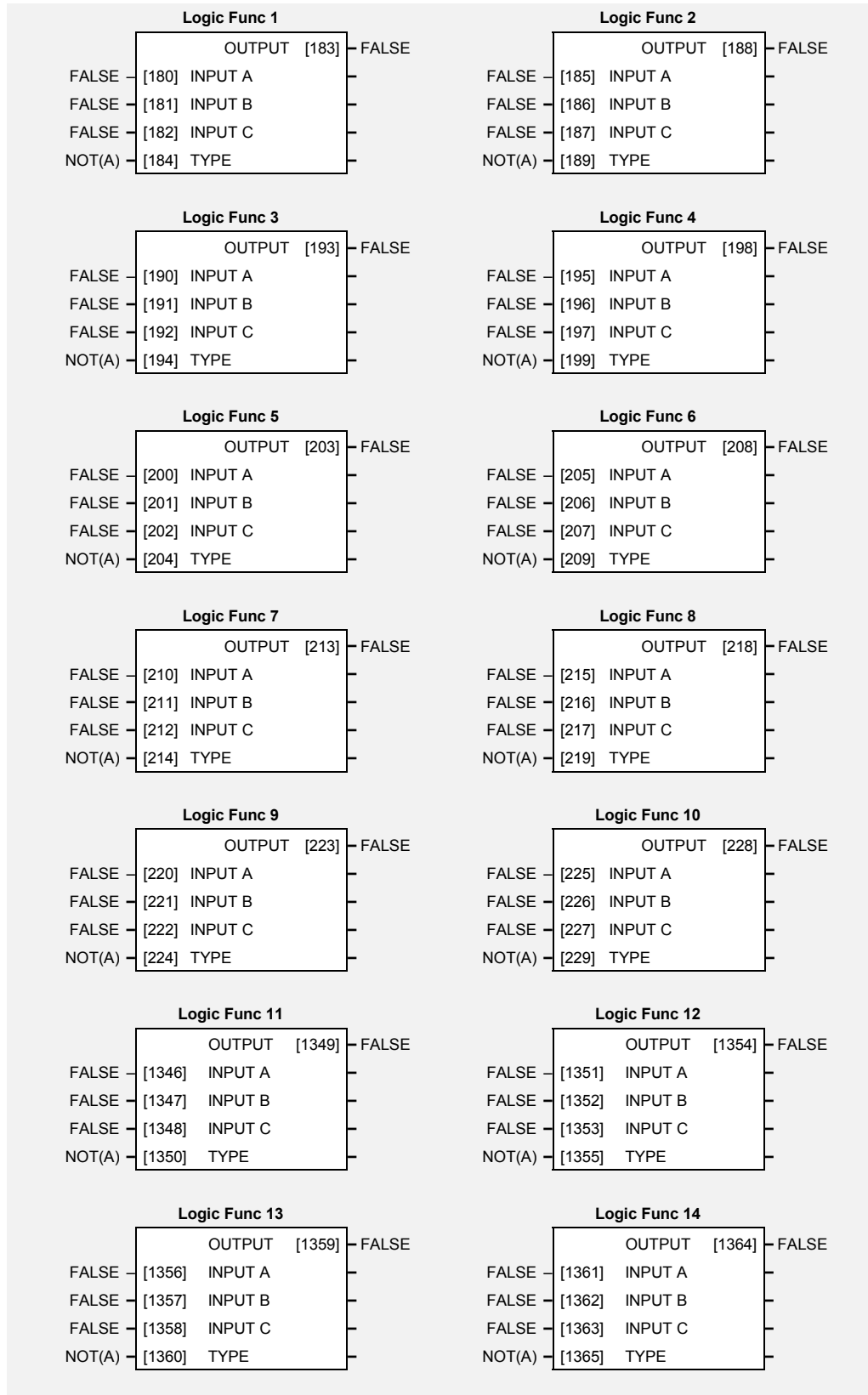

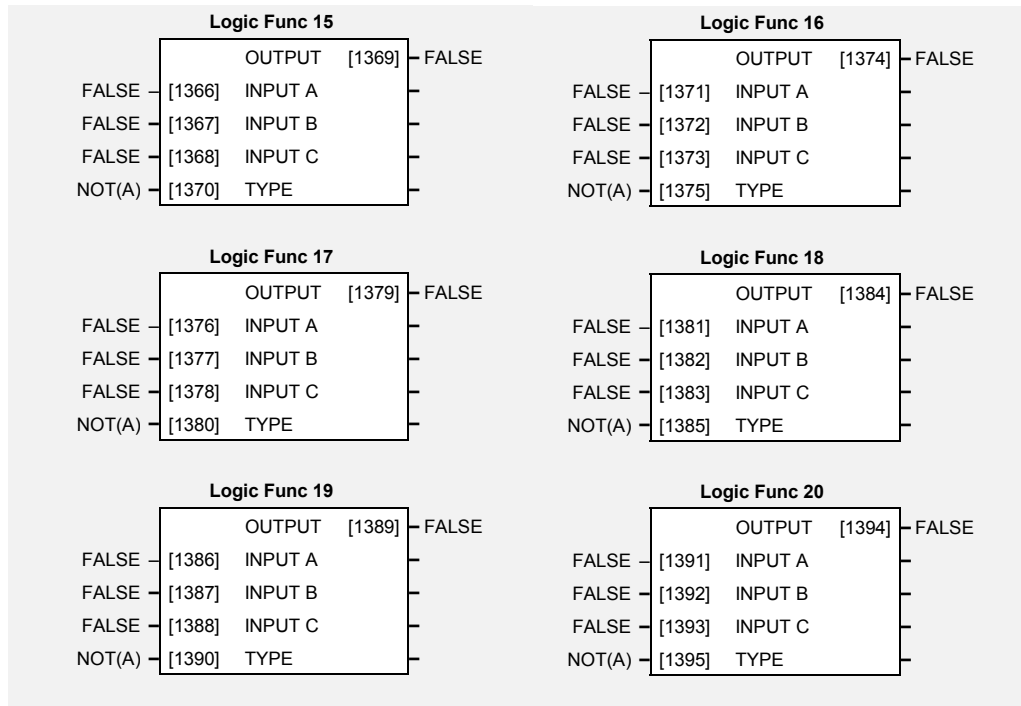

Parameter Descriptions

INPUT A

General purpose logic input.

Range: FALSE / TRUE

INPUT B

General purpose logic input.

Range: FALSE / TRUE

INPUT C

General purpose logic input.

Range: FALSE / TRUE

TYPE

The operation to be performed on the three inputs to produce the output value. The operations that can be selected are:

Range: Enumerated - see below

Enumerated Value : Type

- 0 : NOT(A)
- 1 : AND(A,B,C)
- 2 : NAND(A,B,C)
- 3 : OR(A,B,C)
- 4 : NOR(A,B,C)
- 5 : XOR(A,B)
- 6 : 0-1 EDGE(A)
- 7 : 1-0 EDGE(A)
- 8 : AND(A,B,!C)
- 9 : OR(A,B,!C)
- 10 : S FLIP-FLOP
- 11 : R FLIP-FLOP

OUTPUT

The result of performing the selected operation on the inputs.

Range: FALSE / TRUE

Functional Description

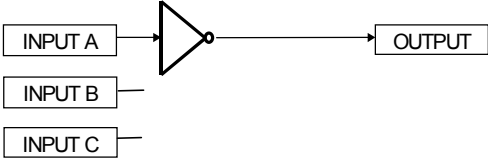
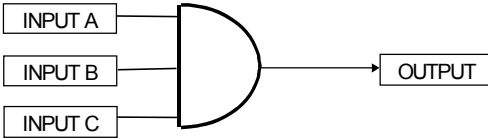
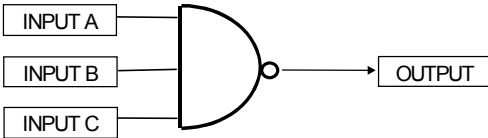
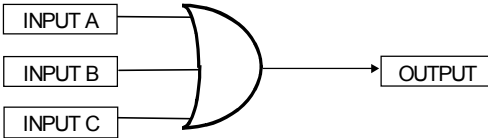
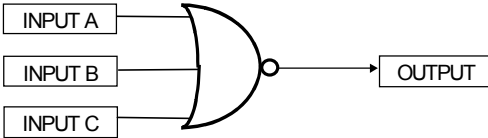
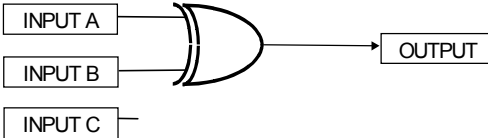
Operation	Description
NOT(A)	<p>NOT(A)</p>  <p>If INPUT A is TRUE the OUTPUT is FALSE, otherwise the OUTPUT is TRUE.</p>
AND(A,B,C)	<p>AND(A,B,C)</p>  <p>If A and B and C are all TRUE then the OUTPUT is TRUE, otherwise the OUTPUT is FALSE.</p>
NAND(A,B,C)	<p>NAND(A,B,C)</p>  <p>If A and B and C are all TRUE then the OUTPUT is FALSE, otherwise the OUTPUT is TRUE.</p>
OR(A,B,C)	<p>OR(A,B,C)</p>  <p>If at least one of A or B or C is TRUE then the OUTPUT is TRUE, otherwise the OUTPUT is FALSE.</p>
NOR(A,B,C)	<p>NOR(A,B,C)</p>  <p>If at least one of A or B or C is TRUE then the OUTPUT is FALSE, otherwise the OUTPUT is TRUE.</p>
XOR(A,B)	<p>XOR(A,B)</p>  <p>If A and B are the same, (both TRUE or both FALSE), then the output is FALSE, otherwise the output is TRUE.</p>

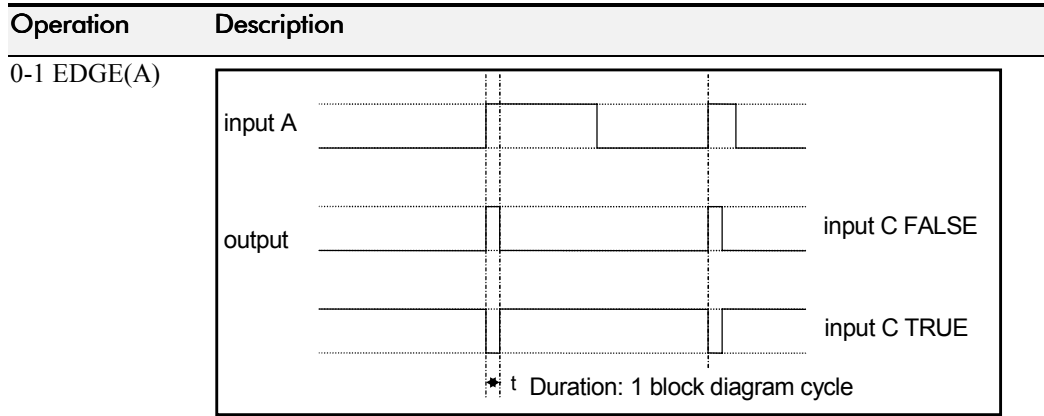

Rising Edge Trigger

Input B is not used.

This function outputs a pulse of 5ms duration when INPUT A to the block becomes TRUE. When INPUT C is TRUE, the output is inverted. The output is held TRUE for one execution of the function block diagram.

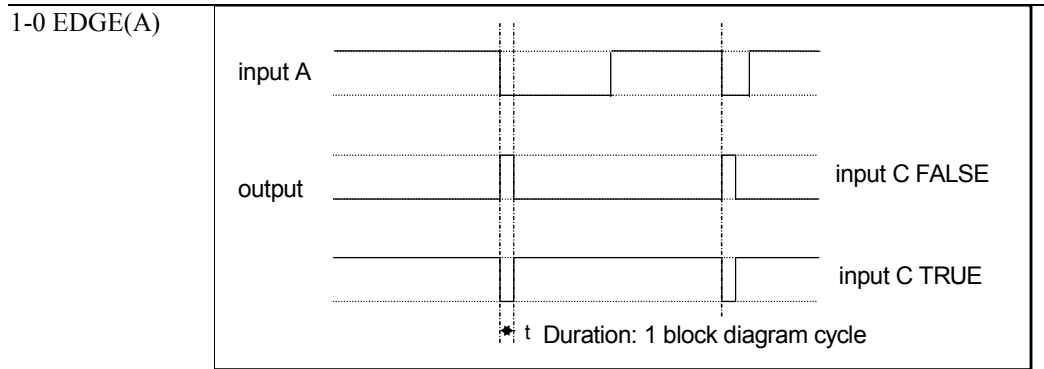

Falling Edge Trigger

Input B is not used.

This function outputs a pulse of 5ms duration when INPUT A to the block becomes FALSE. When INPUT C is TRUE, the output is inverted. The output is held TRUE for one execution of the function block diagram.

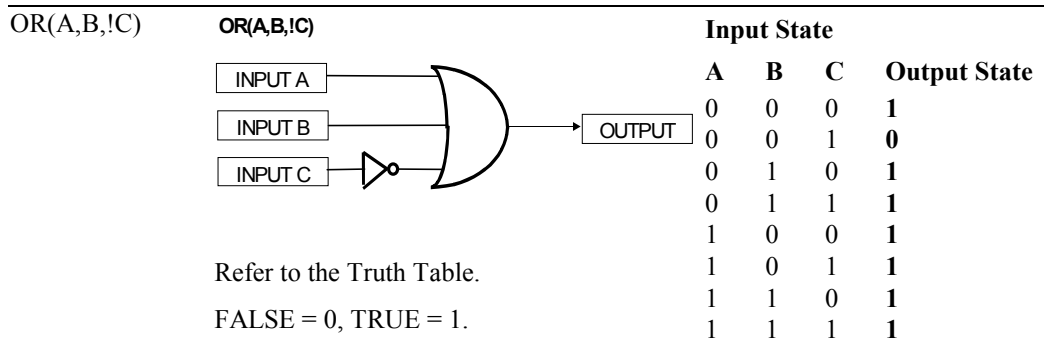
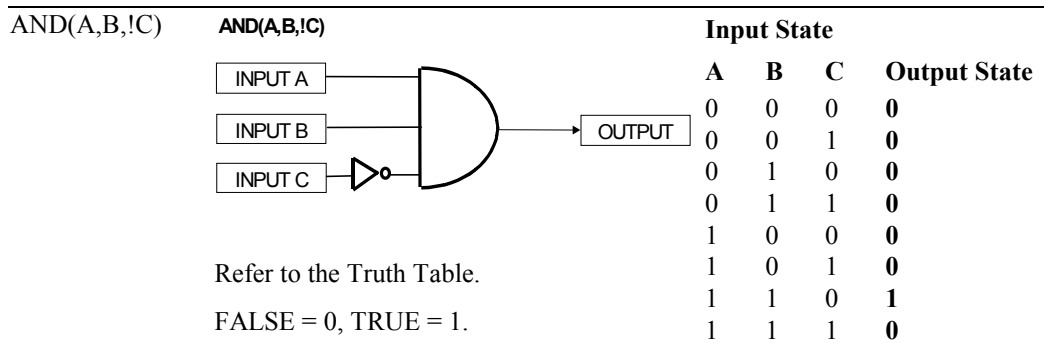

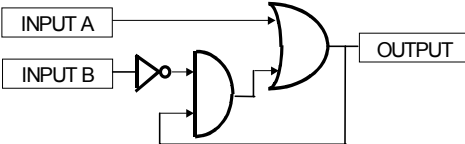
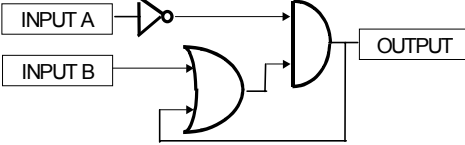
Operation	Description
S FLIP-FLOP	<p>S FLIP-FLOP</p>  <p>This is a set dominant flip-flop. INPUT A functions as <i>set</i>, and INPUT B as <i>reset</i>.</p>
R FLIP-FLOP	<p>R FLIP-FLOP</p>  <p>This is a reset dominant flip-flop. INPUT A functions as <i>reset</i>, and INPUT B as <i>set</i>.</p>

MMI Menu Map

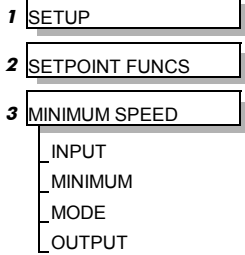

MINIMUM SPEED

The minimum speed block is used to determine how the Inverter will follow a reference. There are two modes

1. Proportional : minimum limit
2. Linear : between min and max.

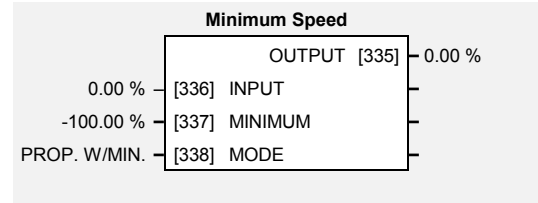

Parameter Descriptions

INPUT

The input for this block.

Range: -300.00 to 300.00 %

MINIMUM

This parameter determines the minimum output value from this block

Range: -100.00 to 100.00 %

MODE

This parameter represents the operating mode of the block. There are two modes:

Range: Enumerated - see below

Enumerated Value : Operating Mode

0 : PROP. W/MIN.

1 : LINEAR

OUTPUT

The output is determined by the MODE selected, see below.

Range: —.xx %

Functional Description

There are two operating modes for the MINIMUM SPEED block:

Proportional with Minimum

In this mode the MINIMUM SPEED block behaves like a simple clamp. The minimum value has the valid range -100% to 100% and the output is always greater than or equal to the minimum value.

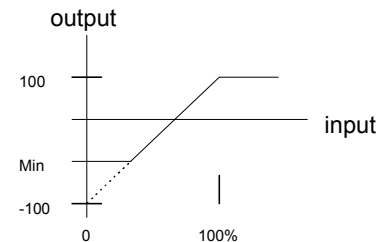

Linear

In this mode the MINIMUM SPEED block first clamps the input to zero then rescales the input such that the output goes linearly between minimum and 100% for an input that goes from 0 to 100%.

Note the constraints:-

- min ≥ 0
- input ≥ 0
- max = 100%

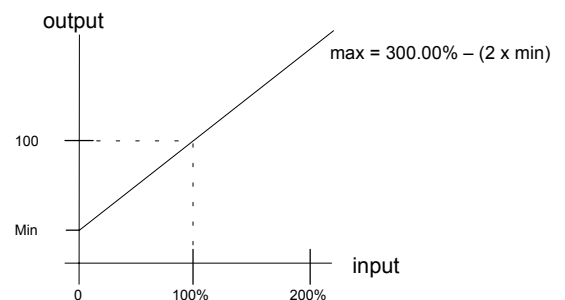

MMI Menu Map

1	SETUP
2	MOTOR CONTROL
3	MOTOR DATA
	CONTROL MODE
	POWER
	BASE FREQUENCY
	MOTOR VOLTAGE
	MOTOR CURRENT
	MAG CURRENT
	NAMEPLATE RPM
	MOTOR CONNECTION
	MOTOR POLES
	POWER FACTOR
	OVERLOAD
	STATOR RES
	LEAKAGE INDUC
	MUTUAL INDUC
	ROTOR TIME CONST

MOTOR DATA

Designed for all Motor Control Modes.

In this function block you enter the details of the motor under control and any available motor nameplate information.

The Autotune feature will determine the MAG CURRENT, STATOR RES, LEAKAGE INDUC, MUTUAL INDUC and ROTOR TIME CONST motor model parameter.

The OVERLOAD parameter determines the allowed level of motor overload. This can be especially useful when operating with motors smaller than the inverter rating.

Motor Data

** VOLTS / HZ	[1157]	CONTROL MODE
** 5.50 kW	[1158]	POWER
** 50.0 Hz	[1159]	BASE FREQUENCY
** 400.0 V	[1160]	MOTOR VOLTAGE
** 11.30 A	[64]	MOTOR CURRENT
** 3.39 A	[65]	MAG CURRENT
** 1445.0 rpm	[83]	NAMEPLATE RPM
** STAR	[124]	MOTOR CONNECTION
** 4 POLE	[84]	MOTOR POLES
** 0.90	[242]	POWER FACTOR
** 2.0	[1164]	OVERLOAD
** 1.3625 Ohm	[119]	STATOR RES
** 43.37 mH	[120]	LEAKAGE INDUC
** 173.48 mH	[121]	MUTUAL INDUC
276.04 ms	[1163]	ROTOR TIME CONST

Parameter Descriptions

CONTROL MODE

Range: Enumerated - see below

Determines the main method of motor control used by the inverter.

Enumerated Value : Control Mode

- 0 : VOLTS / HZ
- 1 : SENSORLESS VEC
- 2 : CLOSED-LOOP VEC
- 3 : 4-Q REGEN

POWER

Range: 0.00 to 355.00kW

This parameter contains the motor nameplate power.

BASE FREQUENCY

Range: 7.5 to 1000.0Hz

This parameter contains the motor nameplate base frequency. Refer to FLUXING, page 1-37.

MOTOR VOLTAGE

Range: 0.0 to 575.0V

This parameter contains the motor nameplate voltage at base frequency. Refer to VOLTAGE CONTROL, page 1-134.

MOTOR CURRENT

Range: 0.00 to 595.00A

This parameter contains the motor nameplate full-load line current.

MAG CURRENT

Range: 0.00 to 595.00A

This parameter contains the motor model no-load line current as determined by the auto-tune.

1-56 Programming Your Application

NAMEPLATE RPM

Range: 0.0 to 32000.0 rpm

This parameter contains the motor nameplate full-load rated speed. This is the motor speed in rpm at base frequency minus full load slip.

MOTOR CONNECTION

Range: Enumerated - see below

This parameter contains the motor nameplate connection.

Enumerated Value : Motor Connection

0 : DELTA

1 : STAR

MOTOR POLES

Range: Enumerated - see below

This parameter contains the motor nameplate pole-pairs.

Enumerated Value : Motor Poles

0 : 2 pole

1 : 4 pole

2 : 6 pole

3 : 8 pole

4 : 10 pole

5 : 12 pole

POWER FACTOR

Range: 0.50 to 0.99

This parameter contains the motor nameplate full-load power factor.

OVERLOAD

Range: 1.0 to 5.0

This parameter contains the allowable motor overload factor. It is used to match the inverter current measurement range to the motor. The inverter is set up so that the **Motor Current x Overload** can be measured up to a maximum of 2 x the Inverter constant torque current rating.

The OVERLOAD parameter has no effect on the current, inverse time or torque limits.

STATOR RES

Range: 0.00 to 250.00 Ohm

This parameter contains the motor model per-phase stator resistance as determined by Autotune.

LEAKAGE INDUC

Range: 0.0 to 300.0 mH

This parameter contains the motor model per-phase leakage inductance as determined by Autotune.

MUTUAL INDUC

Range: 0.0 to 3000.0 mH

This parameter contains the motor model per-phase mutual inductance as determined by Autotune.

ROTOR TIME CONST

Range: 10.00 to 3000.00

This parameter contains the motor model rotor time constant as determined by Autotune.

MULTIPLEXER

Each block collects together 16 Boolean input values into a single word.

For example, one may be used to set and clear individual bits within a word such as the TRIGGERS 1 word for the AUTO RESTART function block.

MMI Menu Map

- 1 SETUP
- 2 MISCELLANEOUS
- 3 MULTIPLEXER
- 4 MULTIPLEXER 1
 - INPUT 0
 - INPUT 1
 - INPUT 2
 - INPUT 3
 - INPUT 4
 - INPUT 5
 - INPUT 6
 - INPUT 7
 - INPUT 8
 - INPUT 9
 - INPUT 10
 - INPUT 11
 - INPUT 12
 - INPUT 13
 - INPUT 14
 - INPUT 15
 - OUTPUT
- 4 MULTIPLEXER 2

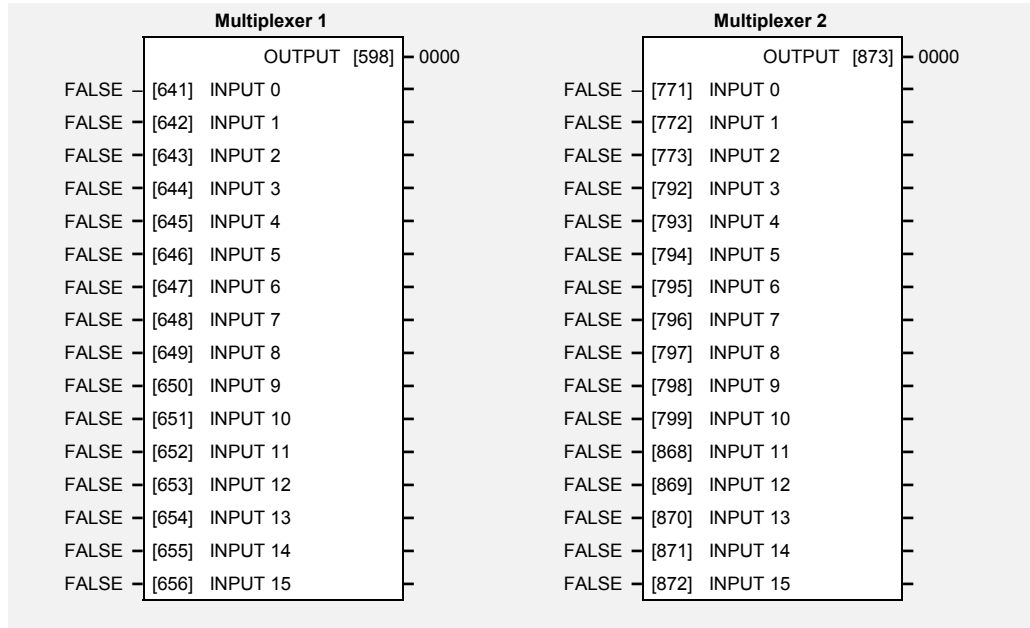

Parameter Descriptions

INPUT 0 TO INPUT 15

The Boolean inputs to be assembled into a single word.

Range: FALSE / TRUE

OUTPUT

The resulting word.

Range: 0000 to FFFF

1-58 Programming Your Application

MMI Menu Map

- 1 SETUP
- 2 MENUS
- 3 OP STATION
- 4 OP STATION 1
- 4 OP STATION 2
- ENABLED KEYS
- OP VERSION

OP STATION

The operator station blocks allow the operation of the Operator Station control keys to be customised.

OP STATION 1 is associated with the Operator Station port.

OP STATION 2 is associated with the Communications port (P3).

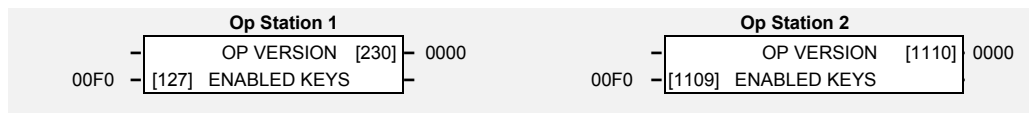

Parameter Descriptions

ENABLED KEYS

Range: 0000 to FFFF

The following keys on the Operator Station can be enabled or disabled separately. The combination produces the parameter setting as in the table below.

Parameter Setting	RUN	L/R	JOG	DIR
0000	-	-	-	-
0010	-	-	-	ENABLED
0020	-	-	ENABLED	-
0030	-	-	ENABLED	ENABLED
0040	-	ENABLED	-	-
0050	-	ENABLED	-	ENABLED
0060	-	ENABLED	ENABLED	-
0070	-	ENABLED	ENABLED	ENABLED
0080	ENABLED	-	-	-
0090	ENABLED	-	-	ENABLED
00A0	ENABLED	-	ENABLED	-
00B0	ENABLED	-	ENABLED	ENABLED
00C0	ENABLED	ENABLED	-	-
00D0	ENABLED	ENABLED	-	ENABLED
00E0	ENABLED	ENABLED	ENABLED	-
00F0	ENABLED	ENABLED	ENABLED	ENABLED

OP VERSION

Range: 0000 to FFFF

Displays the software version of the Operator Station. It is cleared to 0000 if no Operator Station is connected.

OPERATOR MENU

These function blocks are used to configure the Operator menu. This feature provides quick access to frequently used parameters. Any parameter may be “promoted” to the Operator menu, and the parameter is then automatically saved on power-down.

In addition, parameters displayed in the Operator menu may be given a different name, and may be rescaled for display using the DISPLAY SCALE function blocks.

MMI Menu Map

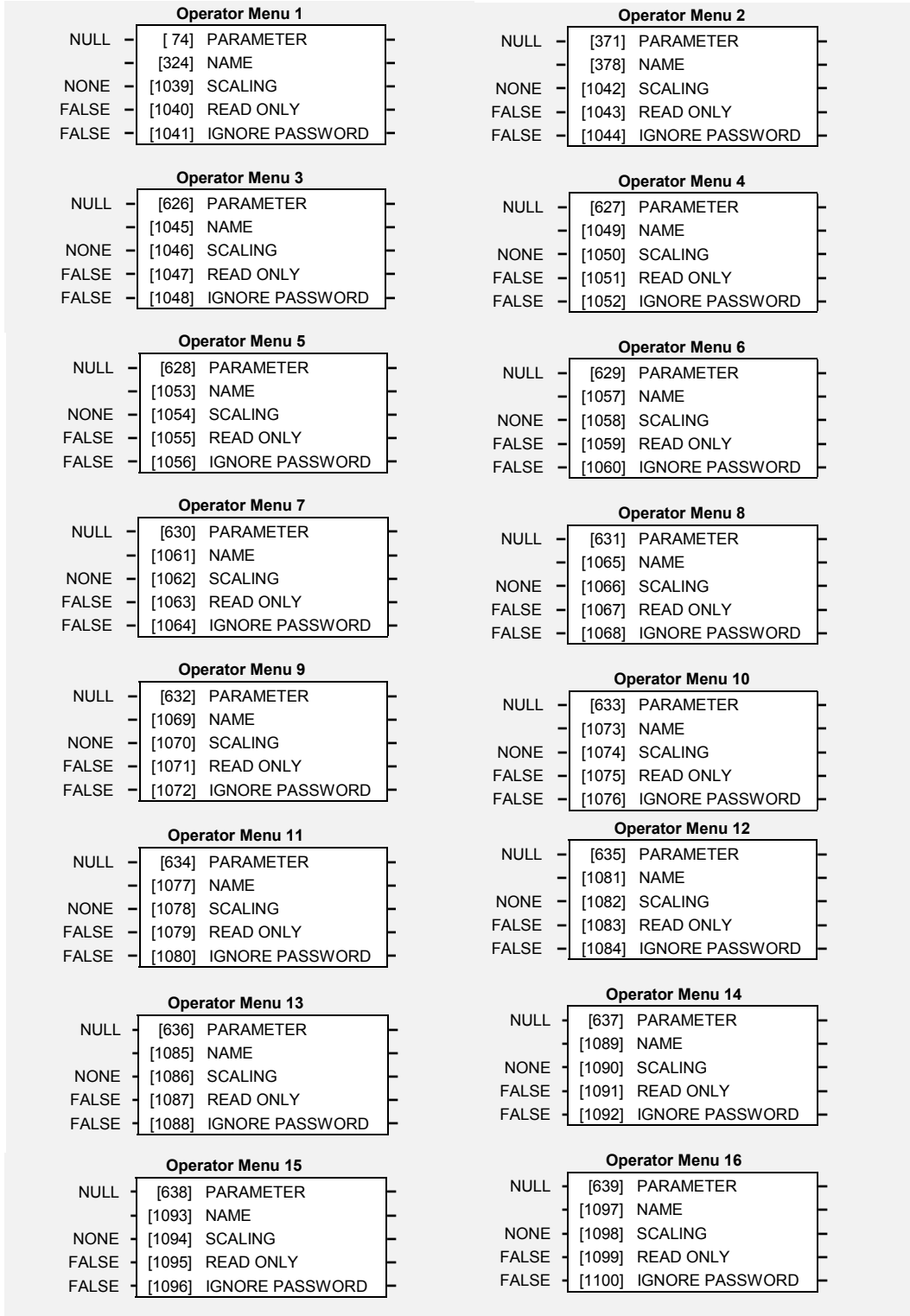
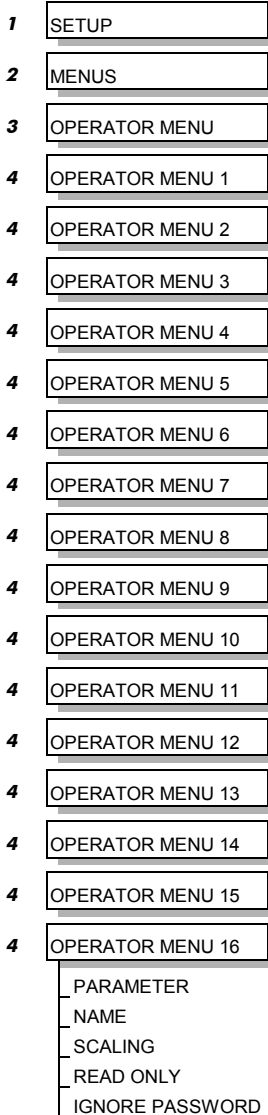

Operator Menu 17		Operator Menu 18	
NULL	[1740] PARAMETER	NULL	[1745] PARAMETER
	[1741] NAME		[1746] NAME
NONE	[1742] SCALING	NONE	[1747] SCALING
FALSE	[1743] READ ONLY	FALSE	[1748] READ ONLY
FALSE	[1744] IGNORE PASSWORD	FALSE	[1749] IGNORE PASSWORD
Operator Menu 19		Operator Menu 20	
NULL	[1750] PARAMETER	NULL	[1755] PARAMETER
	[1751] NAME		[1756] NAME
NONE	[1752] SCALING	NONE	[1757] SCALING
FALSE	[1753] READ ONLY	FALSE	[1758] READ ONLY
FALSE	[1754] IGNORE PASSWORD	FALSE	[1759] IGNORE PASSWORD
Operator Menu 21		Operator Menu 22	
NULL	[1760] PARAMETER	NULL	[1765] PARAMETER
	[1761] NAME		[1766] NAME
NONE	[1762] SCALING	NONE	[1767] SCALING
FALSE	[1763] READ ONLY	FALSE	[1768] READ ONLY
FALSE	[1764] IGNORE PASSWORD	FALSE	[1769] IGNORE PASSWORD
Operator Menu 23		Operator Menu 24	
NULL	[1770] PARAMETER	NULL	[1775] PARAMETER
	[1771] NAME		[1776] NAME
NONE	[1772] SCALING	NONE	[1777] SCALING
FALSE	[1773] READ ONLY	FALSE	[1778] READ ONLY
FALSE	[1774] IGNORE PASSWORD	FALSE	[1779] IGNORE PASSWORD
Operator Menu 25		Operator Menu 26	
NULL	[1780] PARAMETER	NULL	[1785] PARAMETER
	[1781] NAME		[1786] NAME
NONE	[1782] SCALING	NONE	[1787] SCALING
FALSE	[1783] READ ONLY	FALSE	[1788] READ ONLY
FALSE	[1784] IGNORE PASSWORD	FALSE	[1789] IGNORE PASSWORD
Operator Menu 27		Operator Menu 28	
NULL	[1790] PARAMETER	NULL	[1795] PARAMETER
	[1791] NAME		[1796] NAME
NONE	[1792] SCALING	NONE	[1797] SCALING
FALSE	[1793] READ ONLY	FALSE	[1798] READ ONLY
FALSE	[1794] IGNORE PASSWORD	FALSE	[1799] IGNORE PASSWORD
Operator Menu 29		Operator Menu 30	
NULL	[1800] PARAMETER	NULL	[1805] PARAMETER
	[1801] NAME		[1806] NAME
NONE	[1802] SCALING	NONE	[1807] SCALING
FALSE	[1803] READ ONLY	FALSE	[1808] READ ONLY
FALSE	[1804] IGNORE PASSWORD	FALSE	[1809] IGNORE PASSWORD
Operator Menu 31		Operator Menu 32	
NULL	[1810] PARAMETER	NULL	[1815] PARAMETER
	[1811] NAME		[1816] NAME
NONE	[1812] SCALING	NONE	[1817] SCALING
FALSE	[1813] READ ONLY	FALSE	[1818] READ ONLY
FALSE	[1814] IGNORE PASSWORD	FALSE	[1819] IGNORE PASSWORD

Parameter Descriptions

PARAMETER

Range: 0 to 1999

Enter the parameter to be displayed in the Operator menu. The parameter may be selected by first choosing the block that the parameter is within, then choosing the parameter itself.

NAME

Range: 16 characters maximum

Enter your customised parameter name, the maximum length is 16 characters. If this name is left blank, then default parameter name will be used.

SCALING

Range: See below

Selects a DISPLAY SCALE function block to be applied to the value of PARAMETER.

Enumerated Value : DISPLAY SCALE function block

- 0 : NONE
- 1 : DISPLAY SCALE 1
- 2 : DISPLAY SCALE 2
- 3 : DISPLAY SCALE 3
- 4 : DISPLAY SCALE 4

READ ONLY

Range: FALSE / TRUE

When TRUE, this entry in the Operator Menu will not be adjustable.

IGNORE PASSWORD

Range: FALSE / TRUE

When TRUE, this entry in the Operator Menu may be adjusted regardless of the password protection feature.

PATTERN GEN

Designed for all Motor Control Modes.

The pattern generator function block allows you to configure the Inverter PWM (Pulse Width Modulator) operation.

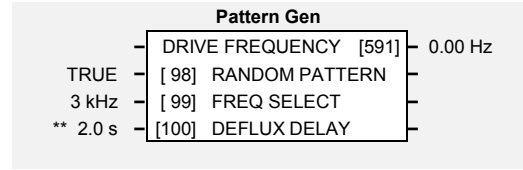

MMI Menu Map

- 1 SETUP
- 2 MOTOR CONTROL
- 3 PATTERN GEN
 - RANDOM PATTERN
 - FREQ SELECT
 - DEFLUX DELAY
 - DRIVE FREQUENCY

Parameter Descriptions

RANDOM PATTERN

Range: FALSE / TRUE

This parameter selects between random pattern (quiet motor noise) or the more conventional fixed carrier PWM strategies. When TRUE, random pattern is enabled.

FREQ SELECT

Range: Enumerated - see below

This parameter selects the base switching frequency of the output power stack. The choices of switching frequency are:

Enumerated Value : Frequency

- 0 : 3 kHz
- 1 : 6 kHz
- 2 : 9kHz

Note: The highest selectable frequency is product dependent

The higher the switching frequency, the lower the level of motor audible noise. However, this is only achieved at the expense of increased Inverter losses.

Refer also to “Quadratic/Constant Torque Selection”, page 1-136.

DEFLUX DELAY

Range: 0.1 to 10.0 s

Sets the minimum allowed delay between disabling and then re-enabling PWM production (i.e. stopping and starting the drive).

DRIVE FREQUENCY

Range: —.x Hz

The Inverter output frequency.

Functional Description

The Inverter provides a unique quiet pattern PWM strategy in order to reduce audible motor noise. The user is able to select between the quiet pattern or the more conventional fixed carrier frequency method. With the quiet pattern strategy selected (random pattern enabled), audible motor noise is reduced to a dull hiss.

In addition, the user is able to select the PWM carrier frequency. This is the main switching frequency of the power output stage of the Frequency Inverter. A high setting of carrier frequency (e.g. 6kHz) reduces audible motor noise but only at the expense of higher Inverter losses and smooth motor rotation at low output frequencies. A low setting of carrier frequency (e.g. 3kHz), reduces Inverter losses but increases audible motor noise.

PHASE AUTO GEAR

Designed for use with the System Board.

MMI Menu Map

1	SETUP
2	SYSTEM BOARD
3	PHASE AUTO GEAR
	RESET
	ENABLE
	HOLD
	NOM MASTER LEN
	NOM SLAVE LENGTH
	TOLERANCE
	INITIAL REPEATS
	INITIAL FILTER
	FILTER
	RESET COUNTERS
	SLAVE MARKS
	MASTER MARKS
	MISSED S MARKS
	MISSED M MARKS
	FALSE S MARKS
	FALSE M MARKS
	EXT MARK MASTER
	EXT MARK SLAVE
	GEAR CORRECTION
	MASTER LENGTH
	SLAVE LENGTH
	READY
	SLAVE MARK POS
	MASTER MARK POS

This function block calculates the gear ratio between the master and slave shafts from the relative repeat lengths calculated from the marker inputs.

The relative repeat lengths are then used to calculate the relative velocities of the master and slave in order to synchronise them; without this, register control is not possible.

Included in this block is logic for discriminating against missing and false (premature) marks (Windowing).

The results of the gearing calculation are filtered and then applied using the Gearing in the Phase Control Block.

This function block must be enabled in order to use the PHASE REGISTER function block.

Phase Auto Gear		
-	SLAVE LENGTH	[1599] 0.0000
-	MASTER LENGTH	[1598] 0.0000
-	GEAR CORRECTION	[1597] 0.0000
-	EXT MARK SLAVE	[1596] FALSE
-	EXT MARK MASTER	[1595] FALSE
-	FALSE M MARKS	[1594] 0
-	FALSE S MARKS	[1593] 0
-	MISSED M MARKS	[1592] 0
-	MISSED S MARKS	[1591] 0
-	MASTER MARKS	[1590] 0
-	SLAVE MARKS	[1589] 0
-	READY	[1602] FALSE
-	SLAVE MARK POS	[1832] 0
-	MASTER MARK POS	[1833] 0
TRUE	[1579] RESET	
FALSE	[1580] ENABLE	
FALSE	[1581] HOLD	
1.0000	[1582] NOM MASTER LEN	
1.0000	[1583] NOM SLAVE LENGTH	
0.1000	[1584] TOLERANCE	
20	[1585] INITIAL REPEATS	
0.100	[1586] INITIAL FILTER	
1.000	[1587] FILTER	
FALSE	[1588] RESET COUNTERS	

Parameter Descriptions

SLAVE LENGTH

Range: —.0000

Connect to GEARING A in the PHASE CONTROL function block. See MASTER LENGTH below.

MASTER LENGTH

Range: —.0000

Connect to GEARING B in the PHASE CONTROL function block.

Length is calculated by measuring the distance between good marks and filtering the result. Two filter time constants are available: the first is to allow minimal filtering during the start-up phase, and the second is typically higher to allow the smooth tracking of any changes to web length. The length outputs are persistent as long as no RESET is applied. The last calculated value is saved on power-down.

GEAR CORRECTION

Range: —.0000

A gear correction factor diagnostic, calculated by dividing SLAVE LENGTH by MASTER LENGTH.

EXT MARK SLAVE

Range: FALSE / TRUE

Diagnostic, displays the state of the Slave Mark input.

EXT MARK MASTER

Range: FALSE / TRUE

Diagnostic, displays the state of the Master Mark input.

FALSE M MARKS

Range: 0 -

Diagnostic counter for false (early) marks. False marks are those that occur before the window is open.

FALSE S MARKS

Range: 0 -

Diagnostic counter for false (early) marks. False marks are those that occur before the window is open.

MISSED M MARKS

Range: 0 -

Diagnostic counter for missing (late) marks. Missing marks are those that occur after the window.

MISSED S MARKS	<i>Range: 0 -</i>
Diagnostic counter for missing (late) marks. Missing marks are those that occur after the window.	
MASTER MARKS	<i>Range: 0 -</i>
Diagnostic counter for valid marks. If the block is not in reset, length is calculated when a new valid mark has arrived.	
SLAVE MARKS	<i>Range: 0 -</i>
Diagnostic counter for valid marks. If the block is not in reset, length is calculated when a new valid mark has arrived.	
READY	<i>Range: FALSE / TRUE</i>
This is set FALSE by reset or power-on. It goes TRUE after the initial repeat counter is passed.	
SLAVE MARK POS	<i>Range: —.xxxx</i>
Indicates the distance to the slave mark.	
MASTER MARK POS	<i>Range: —.xxxx</i>
Indicates the distance to the slave mark.	
RESET	<i>Range: FALSE / TRUE</i>
If TRUE, then the length counters are reset to zero. The length outputs are set to their nominal values and the repeat counter is reset setting the filter time constant to INITIAL FILTER. When the function block comes out of reset, the counters and length calculation will become active again.	
ENABLE	<i>Range: FALSE / TRUE</i>
If FALSE, then the length counters are reset to zero. RESET and ENABLE are functionally equivalent. RESET being the inverse of ENABLE.	
HOLD	<i>Range: FALSE / TRUE</i>
If TRUE the length calculation is suspended and the last outputs are held..	
NOM MASTER LEN	<i>Range: 0.0000 to 100.0000</i>
The nominal length to the next required mark.	
NOM SLAVE LENGTH	<i>Range: 0.0000 to 100.0000</i>
The nominal length to the next required mark.	
INITIAL REPEATS	
The number of valid marks that must be seen on both channels before the block is “READY” during which time the Initial Filter Value is used.	
INITIAL FILTER	<i>Range: —.000</i>
The length filter value used during the start-up phase (while the block is not “READY”) See also “FILTER”	
FILTER	<i>Range: —.000</i>
The filter is run only when a new valid mark has arrived (this ties the filter Tc to the number of marks per second, and not time).	
RESET COUNTERS	<i>Range: FALSE / TRUE</i>
Resetting the counters (TRUE) clears the error counters but does not clear the repeat counters and so leaves the filter Tc unchanged.	

Functional Description

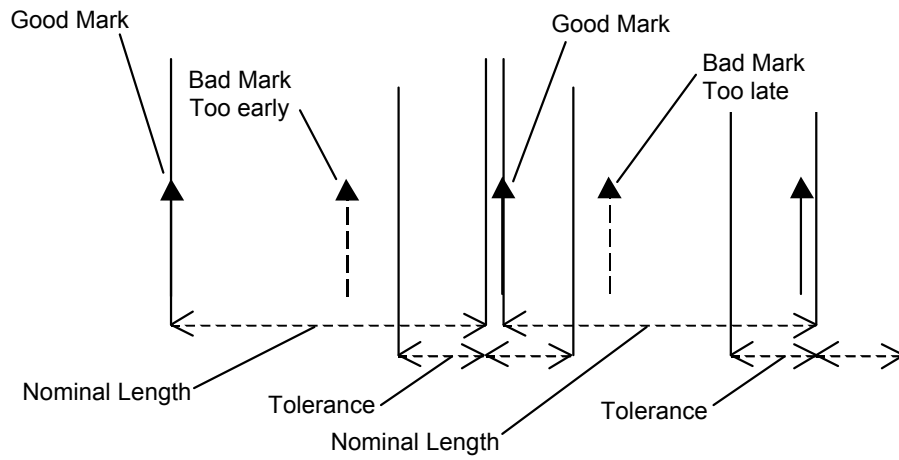

Setting a window using the nominal repeat length and tolerance eliminates rogue marks. The window opens before the expected arrival point and remains open until a mark arrives. If the new mark is inside the window it is accepted and a new mark is looked for, otherwise it is rejected.

This form of windowing allows for the rejection of repetitive marks that fall regularly between repeats on the other channel. An example of this would be a knife that cut every N marks on the web. In this case it would not matter which mark the knife synchronised to.

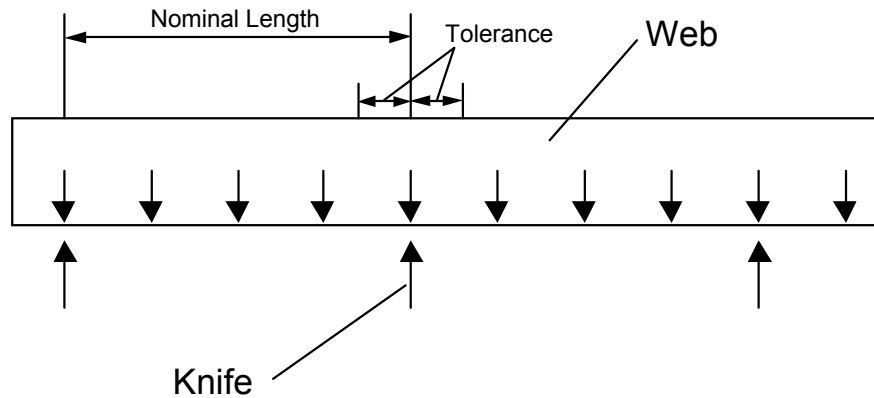

This form of windowing will not work as a means of discriminating against noise between marks. If used in a system like this, a missing mark may result in the system synchronising to the noise. For more complex forms of mark discrimination, an intelligent eye must be used.

A large number of false marks will indicate that the system may not work reliably. Check the quality of the sensors and increase measures to reduce EMC interference.

PHASE CONFIGURE

Designed for use with the System Board.

MMI Menu Map

1	SETUP
2	SYSTEM BOARD
3	PHASE CONFIGURE
	SLAVE CNT SOURCE
	SPD LOOP SPD FBK
	COUNTS PER UNIT
	HIPER COUNT/REV
	1ms CYCLE RATE
	MAX SPEED
	MASTER SCALE A
	MASTER SCALE B
	SLAVE INVERT
	MASTER INVERT
	MASTER MARK TYPE
	SLAVE MARK TYPE
	MASTER POSITION
	SLAVE POSITION
	FAULT

This function block configures the Encoder functions for use with a dual encoder. The parameters in this block allow you to set up which encoder inputs are used for which function, as well as the normalisation parameters.

The slave axis is defined as the axis that the controller is controlling. The "Master" axis also known as the "Reference" axis is the axis that is used as the setpoint, or the axis that the slave follows.

Note: Without the System Board fitted, the SLAVE CNT SOURCE may be set to TB ENCODER. This will allow all blocks that rely on the Slave Encoder only to function as expected. The MARK inputs **do not** function without a System Board.

Phase Configure			
	MASTER POSITION	[1529]	0
	SLAVE POSITION	[1530]	0
	FAULT	[1531]	FALSE
SLAVE ENCODER	[1524]	SLAVE CNT SOURCE	
TB ENCODER	[1525]	SPD LOOP SPD FBK	
8192	[1526]	COUNTS PER UNIT	
32768	[1836]	HIPER COUNT/REV	
FALSE	[1835]	1ms CYCLE RATE	
1500 upm	[1560]	MAX SPEED	
2048	[1527]	MASTER SCALE A	
2048	[1528]	MASTER SCALE B	
FALSE	[1834]	SLAVE INVERT	
FALSE	[1837]	MASTER INVERT	
PULSE	[1561]	MASTER MARK TYPE	
PULSE	[1562]	SLAVE MARK TYPE	

Parameter Descriptions

SLAVE CNT SOURCE

Range: Enumerated – see below

The slave encoder counter may be "clocked" using either the SLAVE ENCODER encoder quadrature input or the TB ENCODER TechBox encoder quadrature input. The counter is used for the calculation of the slave position.

Enumerated Value : Slave Count Source

- 0 : SLAVE ENCODER
- 1 : TB ENCODER
- 2 : DISABLE

SPD LOOP SPD FBK

Range: Enumerated – see below

The slave axis may use either the SLAVE ENCODER encoder quadrature input or the TB ENCODER TechBox encoder quadrature input for its speed feedback source for closed loop speed control.

The speed feedback encoder should always be directly mounted to the motor that the controller is powering. The speed feedback encoder may be different from the encoder used for position control i.e. the SLAVE CNT SOURCE.

Enumerated Value : Speed Loop Speed Feedback

- 0 : SLAVE ENCODER
- 1 : TB ENCODER

COUNTS PER UNIT

Range: 0 to 32767

This parameter sets the global scaling of position setpoint and feedback. For example, if you wished to work in revolutions and had a 2048 line encoder on the slave then you would set "COUNTS PER UNIT" to $2048 * 4 = 8192$. This is the number of lines per revolution times 4, it is times 4 because there are 2 edges (1 rising and 1 falling) from both the A and B input of a quadrature encoder.

HIPER COUNT/REV

Range: 0 to 32767

Hiperface counts per revolution. This scales the Sin Cos encoder to have the equivalent number of lines as on incremental encoders. Setting a value of 32768 is equivalent to having an 8192 line encoder (32768 counts per revolution).

Enumerated Value : Hiper Count/Rev

0	: 1024
1	: 2048
2	: 4096
3	: 8192
4	: 16384
5	: 32768
6	: 65536
7	: 131072
8	: 262144
9	: 524288
10	: 1048576
11	: 2097152
12	: 4194304

1ms CYCLE RATE

Range: 0 to 32767

Setting this TRUE boosts the execution rate of the phase loop to 1ms, thus improving response.

Note: Changing from 1ms back to the block diagram rate may make the loops unstable.

MAX SPEED

Range: 0 to 32000 upm

This is used to scale the velocity feed forward terms from the PHASE INCH, PHASE MOVE and PHASE REGISTER blocks. It is important that this matches the full speed of the drive.

MASTER SCALE A

Range: -30000 to 30000

The master encoder counts are scaled by MASTER SCALE A and MASTER SCALE B where A is the multiplier and B is the divisor.

$$MasterPosition = ActualPosition \times \left(\frac{MasterScaleA}{MasterScaleB} \right)$$

It is not possible to scale the slave encoder.

MASTER SCALE B

Range: -30000 to 30000

Master encoder scaling parameter, see MASTER SCALE A

SLAVE INVERT

Range: FALSE / TRUE

Inverts the sign of the slave encoder input at source when set to TRUE.

MASTER INVERT

Range: FALSE / TRUE

Inverts the sign of the slave encoder input at source when set to TRUE.

MASTER MARK TYPE

Range: See below

Selects the mark type. As used to capture master/slave position. Only select PULSE is the mark comes from the Master Encoder.

Enumerated Value : Mark Type

- 0 : PULSE
- 1 : POSITIVE EDGE
- 2 : NEGATIVE EDGE

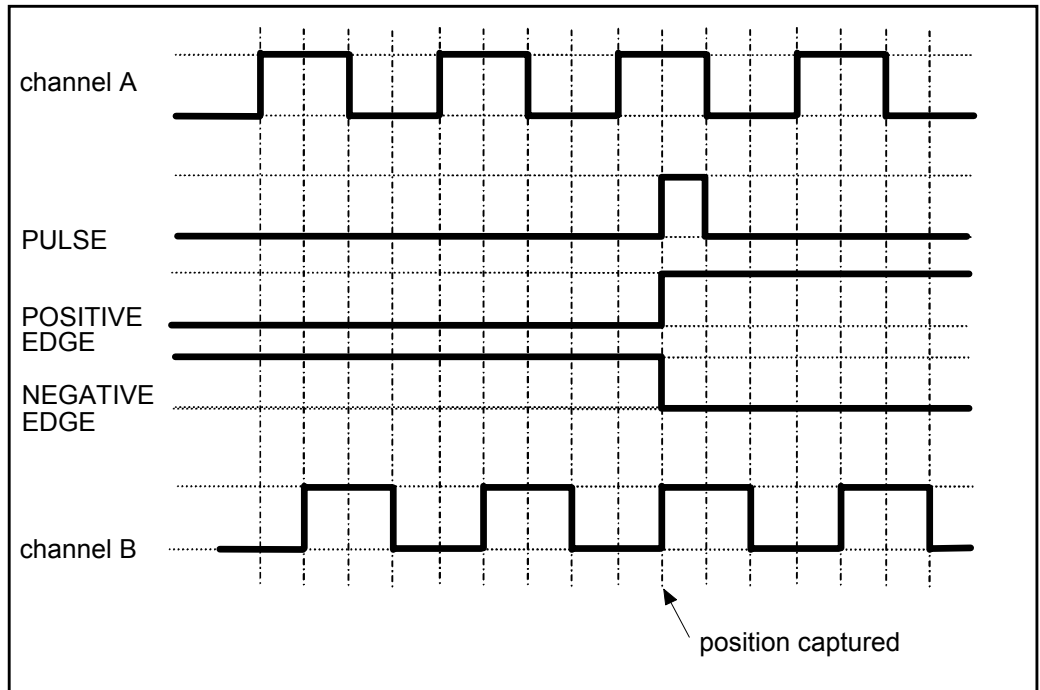

SLAVE MARK TYPE

Range: See below

See MASTER MARK TYPE above.

MASTER POSITION

Range: —.

Diagnostic output in encoder counts from the master quadrature encoder. This is the scaled master counter value and will wrap around from maximum positive to minimum negative if the counter overflows.

SLAVE POSITION

Range: — .

Diagnostic output in encoder counts from the slave quadrature encoder. This is the raw counter value and will wrap around from maximum positive to minimum negative if the counter overflows.

FAULT

Range: NONE / OVERFLOW

This is a general error flag used by the under lying encoder function blocks. The error will be set to OVERFLOW if the position error counter overflows and counts are lost.

PHASE CONTROL

This is the principal phase function block and controls the error generation as well as the feed-forward calculation.

MMI Menu Map

- 1 SETUP
- 2 SYSTEM BOARD
- 3 PHASE CONTROL
 - RESET (TOTAL)
 - POSITION ENABLE
 - SPEED INPUT
 - INVERT SPEED OP
 - GEARING A
 - GEARING B
 - DFWD SCALE
 - OUTPUT SCALE
 - INVERT OUTPUT
 - OUTPUT
 - SPEED OUTPUT
 - POS FEED FWD
 - SLAVE POS (INT)
 - MASTER POS (INT)
 - MASTER POSITION
 - MSTR POS+OFFSET
 - SLAVE POSITION
 - POS ERROR INT
 - POSITION ERROR

Phase Control			
-	OUTPUT	[1488]	0.00
-	SPEED OUTPUT	[1489]	0.00
-	POS FEED FWD	[1490]	0.00
-	SLAVE POS (INT)	[1841]	0
-	MASTER POS (INT)	[1491]	0
-	MASTER POSITION	[1492]	0.00
-	MSTR POS+OFFSET	[1842]	0
-	SLAVE POSITION	[1493]	0.00
-	POS ERROR INT	[1494]	0
-	POSITION ERROR	[1495]	0.00
FALSE	[1479] RESET (TOTAL)		
FALSE	[1480] POSITION ENABLE		
0.00	[1481] SPEED INPUT		
FALSE	[1482] INVERT SPEED OP		
0	[1483] GEARING A		
0	[1484] GEARING B		
0	[1485] FDFWD SCALE		
0.00	[1486] OUTPUT SCALE		
FALSE	[1487] INVERT OUTPUT		

Parameter Descriptions

RESET (TOTAL)

Range: FALSE / TRUE

Total Reset, disables both the SPEED OUPUT and PHASE LOOP, see POSITION ENABLE.

POSITION ENABLE

Range: FALSE / TRUE

The position enable input. Enables the operation of the accumulator. If set FALSE, then the accumulator is set to zero and any phase information is reset. See also RESET (TOTAL).

SPEED INPUT

Range: —.xx

Input to the speed feed-forward calculator, to obtain good phase locking it is important that this input is used. The speed input will usually be the master line speed, this input should be set such that the slave will follow the master even with the phase loop disabled.

INVERT SPEED OP

Range: FALSE / TRUE

Invert the speed output.

GEARING A

Range: -30000 to 30000

Gearing allows the slave to run at a ratio of the master speed / position.

$$MasterPosition = ActualMasterPosition \times \left(\frac{GearingA}{GearingB} \right)$$

$$SpeedOutput = SpeedInput \times \left(\frac{GearingA}{GearingB} \right)$$

GEARING B

Range: -30000 to 30000

See Gearing A

DFWD SCALE

Range: -300.00 to 300.00

Scale position feed-forward. Scaled with PHASE CONFIG::MAX SPEED. This feed forward works only for position setpoint changes and is designed to reduce the following error of the system by predicting the torque required to accelerate the motor.

OUTPUT SCALE

Range: 0.00 to 300.00

Scales the position output.

INVERT OUTPUT

Range: FALSE / TRUE

Inverts the position output.

1-70 Programming Your Application

OUTPUT

Range: —.xx

Position output used for PHASE PID. Note: The output of this block contains valid information beyond the final decimal place, the information is passed to PHASE PID and is used for maximum precision.

SPEED OUTPUT

Range: —.xx

Speed output, used for PHASE PID:: FEED FWD input. Includes POS FEED FWD.

POS FEED FWD

Range: —.xx

Position feed-forward output.

SLAVE POS (INT)

Range: 0 -

Slave position in encoder units.

MASTER POS (INT)

Range: 0 -

G geared master position in encoder units.

MASTER POS

Range: —.

G geared Master position as a scaled integer.

MASTER POSITION

Range: —.xx

G geared Master position scaled in encoder units.

MSTR POS+OFFSET

Range: —.xx

G geared Master position + offset. This is master position demand.

SLAVE POSITION

Range: —.xx

Slave position scaled in encoder units.

POS ERROR INT

Range: —.

Position error scaled in scaled counts.

POSITION ERROR

Range: —.xx

Position error scaled in encoder units.

Functional Description

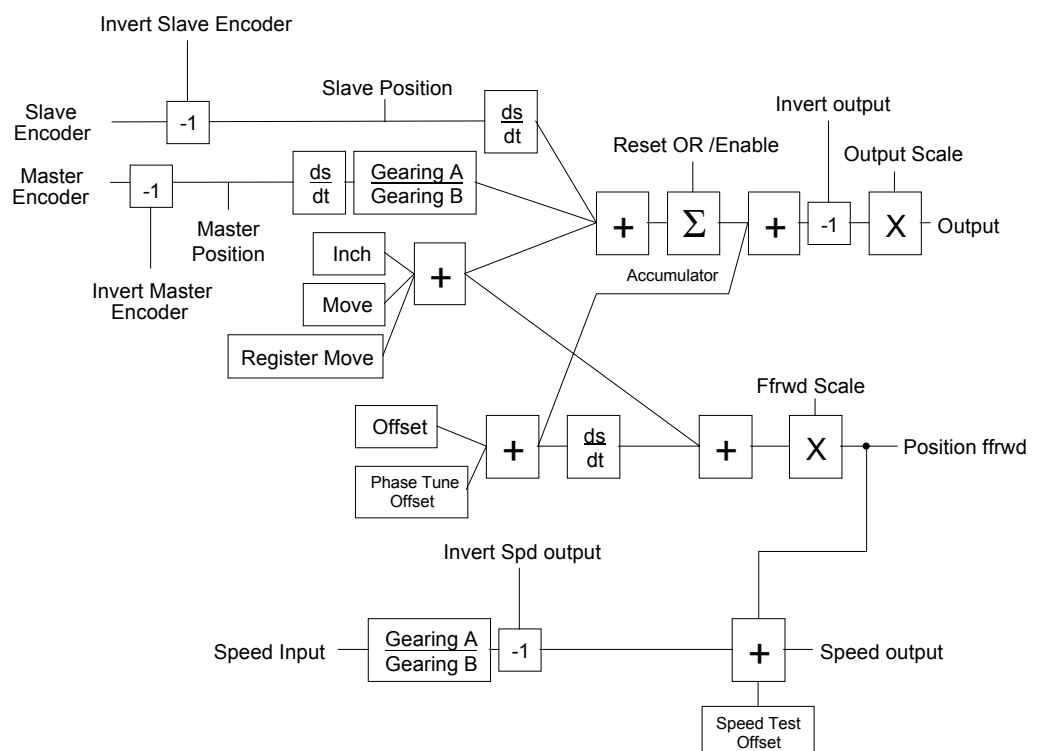

MMI Menu Map

- 1 SETUP
- 2 SYSTEM BOARD
- 3 PHASE INCH
 - ADVANCE
 - RETARD
 - RATE
 - RATE SCALE
 - ACTIVE

PHASE INCH

When in Phase control, the Phase Inch function block may be used to advance or retard the relative position on the slave axis with respect to the master axis. This is achieved by feeding extra counts into the position error calculator at a rate given by RATE in units per second.

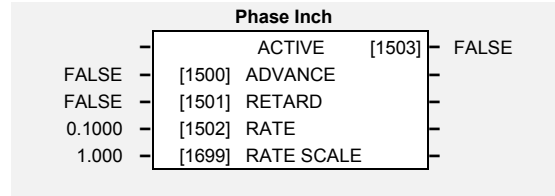

If Register Mode is enabled, the MARK OFFSET is also effected.

ADVANCE and RETARD are usually linked to operator controlled, momentary-action push buttons.

Parameter Descriptions

ADVANCE

Range: FALSE / TRUE

While TRUE, counts are added to the error calculator at a rate give by RATE. Note: if both ADVANCE and RETARD are TRUE then no action is taken.

RETARD

Range: FALSE / TRUE

While TRUE, counts are subtracted from the error calculator at a rate given by RATE.

RATE

Range: 0.0001 to 30.0000

The rate at which counts are added to the Error calculator. A rate of 0.05 with a system scaled in revolutions would cause the drive to advance at a rate of 0.05 revolutions a second with respect to the master.

RATE SCALE

Range: 0.001 to 30.000

This allows fine control over the inch rate by scaling the value of RATE.

$$\text{Actual Rate} = \text{RATE} \times \text{RATE SCALE}$$

ACTIVE

Range: FALSE / TRUE

This diagnostic displays TRUE while Advance or Retard actions are active.

MMI Menu Map

1	SETUP
2	SYSTEM BOARD
3	PHASE MOVE
	ENABLE
	DISTANCE
	DISTANCE FINE
	VELOCITY
	ACCELERATION
	ACTIVE
	DISTANCE LEFT

PHASE MOVE

This is a simple trapezoidal relative move function, which acts on each rising edge of the Enable input. The slave shaft is moved a fixed distance at a rate given by the VELOCITY parameter. A move must be complete before a new move will be registered.

If Register Mode is enabled, the MARK OFFSET is also effected.

The move operation is aborted by the RESET (TOTAL) and POSITION ENABLE parameters in the PHASE CONTROL function block.

The move operation will automatically generate a velocity feed forward signal. It is important to verify that is correct. The PHASE PID function block output, PID OUTPUT, should remain near zero. If this is not the case, check the MAX SPEED parameter in the PHASE CONFIGURE function block.

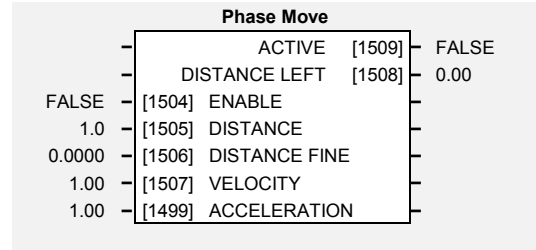

Parameter Descriptions

ENABLE

Range: FALSE / TRUE

If the function block is not already Active, ENABLE starts the Move operation when going from FALSE to TRUE. Setting ENABLE to FALSE while a move is active will **NOT** abort the operation.

DISTANCE

Range: -3000.0 to 3000.0

The course distance that the move command will add to the phase loop.

DISTANCE FINE

Range: -1.0000 to 1.0000

Additional distance to allow fine control of position.

VELOCITY

Range: 0.10 to 3000.00

The maximum velocity at which the distance is added to the phase loop, set in units per second.

ACCELERATION

Range: 0.10 to 3000.00

The acceleration at which the distance is added to the phase loop, set in units per second².

ACTIVE

Range: FALSE / TRUE

TRUE while the block is Active, i.e. the move distance is none zero.

DISTANCE LEFT

Range: —.xx

Diagnostic showing the distance remaining before the move is complete.

Functional Description

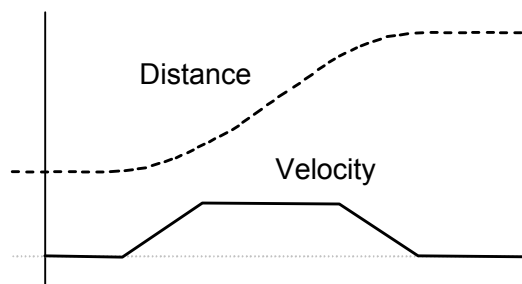

MMI Menu Map

- 1 SETUP
- 2 SYSTEM BOARD
- 3 PHASE OFFSET
 - OFFSET
 - OFFSET FINE
 - ACTIVE

PHASE OFFSET

The Offset function block adds an offset to the error calculator. This is unramped.

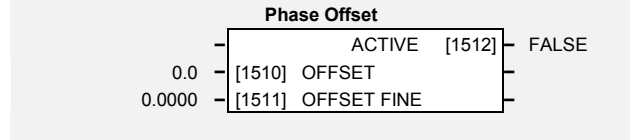

$$PhaseOutput = Error + Offset + OffsetFine$$

Parameter Descriptions

OFFSET

Range: -3000.0 to 3000.0

A course offset added to the phase error, allowing an absolute phase correction to be applied. The Offset is added to the Phase at a maximum rate of +/-32768 counts.

OFFSET FINE

Range: -1.0000 to 1.0000

Additional correction added to OFFSET to allow fine control of position.

ACTIVE

Range: FALSE / TRUE

TRUE while offset count is being added.

MMI Menu Map

1	SETUP
2	SYSTEM BOARD
3	PHASE PID
	ERROR unused
	FEED FWD unused
	FEED FWD GAIN
	P GAIN
	INT DEFEAT
	I GAIN
	D GAIN
	LIMIT
	ENABLE PID
	D FILTER TC
	OUTPUT
	PID OUTPUT
	LIMITING
	ERROR
	FEED FWD

PHASE PID

This function block is an alternative, simplified version of the process PID controller and is dedicated to phase control.

The PID correction, PID OUTPUT, is internally connected to PHASE INPUT in the SPEED LOOP function block.

Phase PID		
OUTPUT	[1522]	0.00 %
PID OUTPUT	[1549]	0.00 %
LIMITING	[1523]	FALSE
ERROR	[1679]	0.00%
FEED FWD	[1680]	0.00%
FALSE	[1520]	ENABLE
0.00 %	[1513]	ERROR unused
0.00%	[1514]	FEED FWD unused
1.00	[1515]	FEED FWD GAIN
0.10	[1516]	P GAIN
FALSE	[1843]	INT DEFEAT
1.00	[1517]	I GAIN
0.00	[1518]	D GAIN
0.05 s	[1521]	D FILTER TC
300.00%	[1519]	LIMIT

Parameter Descriptions

OUTPUT

Range: *__ .xx%*

Output of the PHASE PID function block - scaled feed forward. This is a new feature for software version 5.x and the correction is now connected directly to the PHASE INPUT parameter in the SPEED LOOP function block.

PID OUTPUT

Range: *__ .xx%*

Output of PID without FEED FWD.

LIMITING

Range: *FALSE / TRUE*

This output is TRUE if the OUTPUT is at the LIMIT value.

ERROR

Range: *— .xx*

This diagnostic position error is internally connected to OUTPUT in the PHASE CONTROL function block.

FEED FWD

Range: *— .xx*

This diagnostic feed forward is internally connected to POS FEED FWD in the PHASE CONTROL function block.

ENABLE PID

Range: *FALSE / TRUE*

This parameter globally resets the PID output and integral term when FALSE. This parameter must be TRUE for the PID to operate.

ERROR unused

Range: *-300.00 to 300.00 %*

Previously used for connection to PHASE CONTROL::OUTPUT. This connection is now made internally.

FEED FWD unused

Range: *-300.00 to 300.00 %*

Previously used for connection to PHASE CONTROL::POS FEED FWD. This connection is now made internally.

FEED FWD GAIN

Range: *-300.00 to 300.00*

Feed forward gain of the PHASE PID block.

P GAIN

Range: *0.00 to 3000.00*

The proportional gain of the PHASE PID block.

INT DEFEAT

Range: *FALSE / TRUE*

The PID Integral term is defeated when set to TRUE.

I GAIN

Range: 0.00 to 100.00

The integral gain of the PHASE PID block.

D GAIN

Range: 0.00 to 100.00

The derivative gain of the PHASE PID block.

D FILTER TC

Range: 0.05 to 10.00 s

In order to help attenuate high frequency noise on the derivative term, a first order lag has been provided. This parameter determines the filter time constant.

LIMIT

Range: 0.00 to 300.00%

This parameter determines the maximum positive and negative excursion (Limit) of the PID output.

Functional Description

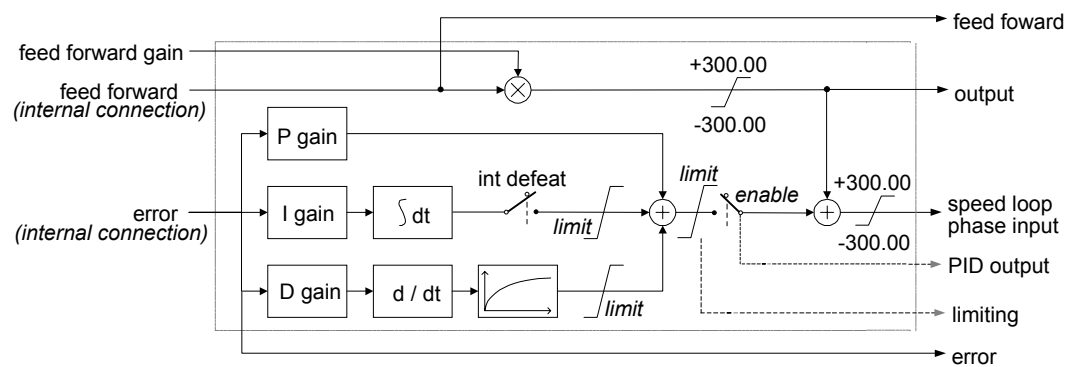

- Functions as P, PI, PD and PID with filtering.
- Single symetric limit on output.

PID Stage

The formula which describes the action of the PID in the 'S' domain is as follows:

$$PID = K_P + \frac{K_I}{S} + K_D \frac{S}{1 + S T_F}$$

where: K_P is the proportional gain
 K_I is the integral gain
 K_D is the derivative gain
 T_F is the filter time constant

PHASE REGISTER

Designed for use with System Board, V1.2 only.

The register loop takes master and slave marks in and attempts to align them.

Corrections are applied to the slave access by means of trapezoidal move. In this way, the total error may be corrected within a repeat.

The rate at which the move takes place is set by the VELOCITY and ACCELERATION parameters.

Phase Register			
-	CORRECTIONS	[1570]	0
-	STATUS	[1571]	0
-	INCH OFFSET	[1565]	0.0000
-	ERROR COUNTS	[1572]	0
-	ERROR	[1573]	0.0000
TRUE	[1563]	RESET	
FALSE	[1564]	ENABLE	
0.0000	[1566]	MARK OFFSET	
1.0000	[1567]	SLAVE NOM LENGTH	
10.00	[1568]	VELOCITY	
10.00	[1569]	ACCELERATION	

Note: The System Board version is identified by `SYSTEM OPTION::VERSION`.

MMI Menu Map

1	SETUP
2	WINDER
3	PHASE REGISTER
	RESET
	ENABLE
	MARK OFFSET
	SLAVE NOM LENGTH
	VELOCITY
	ACCELERATION
	CORRECTIONS
	STATUS
	INCH OFFSET
	ERROR COUNTS
	ERROR

Parameter Descriptions

CORRECTIONS

Range: —.

Diagnostic counter of valid mark master/slave pairs.

STATUS

Range: —.

Displays the current mode, RESET or ALIGN. When in RESET, the outputs and counters are reset. When in ALIGN, a correction is applied after each new pair of marks have arrived, assuming that the previous correction has been completed.

INCH OFFSET

Range: —.xxxx %

Offset as generated by INCH and MOVE blocks. This is summed with MARK OFFSET to calculate the real offset. INCH OFFSET is only zeroed with a RESET. INCH OFFSET is persistent and so its value will be retained on power-down.

ERROR COUNTS

Range: —.

Error, given in slave encoder counts.

ERROR

Range: —.00

Error, given in units (sometimes so small that it does not register, hence ERROR COUNTS)

RESET

Range: FALSE / TRUE

Disables the block and prevents any corrections taking place. Reset also resets the Inch Offset value leaving.

ENABLE

Range: FALSE / TRUE

When TRUE, corrections are made. When FALSE, corrections are prevented from taking place, but the diagnostic outputs are computed.

MARK OFFSET

Range: -100.0000 to 100.0000

Offsets the slave mark by this fixed distance. The total of the offset is the sum of the offset variable and internal Inch Offset variable. The Inch Offset is calculated from the output of the inch function block and the move function block. Inch offset and offset are both persistent.

SLAVE NOM LENGTH

Range: 0.0000 to 100.0000

The nominal repeat length in units. The nominal length is usually the slave length and is used to calculate the maximum allowed correction.

VELOCITY

Range: 0.10 to 300.00 %

The maximum velocity in % (of PHASE CONFIGURE::MAX SPEED) /s that the correction will be applied.

ACCELERATION

Range: 0.01 to 3000.00 %

The maximum acceleration/deceleration in % (of PHASE CONFIGURE::MAX SPEED) /s² that the correction will be applied.

Functional Description

The registration loop works using an Instantaneous Registration technique. The error in counts is measured between master and slave marks. This error is then added to the slave position to correct the error. The correction is applied using a move function to limit disturbance to the machine. Ideally the move should be completed before the next mark pair is due.

The correction is limited to \pm nominal length / 2.

MMI Menu Map

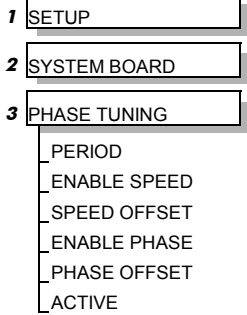

PHASE TUNING

The Tuning function block provides a means of injecting a speed offset or a phase offset in the form of a square wave to assist the tuning of the speed and phase loops. It would be unusual for both tests to be active together.

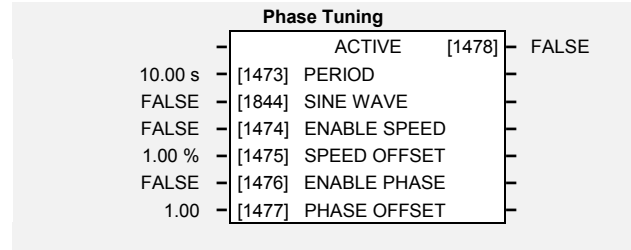

Parameter Descriptions

PERIOD

The wave form period in seconds.

Range: 0.10 to 300.00 s

ENABLE SPEED

Enables SPEED OFFSET to be added to the SPEED INPUT (of the Phase Control function block).

Range: FALSE / TRUE

SINE WAVE

Selects a sine wave or square wave stimulus. Sine wave = TRUE.

Range: FALSE / TRUE

SPEED OFFSET

The speed offset value.

Range: -300.00 to 300.00 %

ENABLE PHASE

Enable PHASE OFFSET to be added to the POSITION OUTPUT (of the Phase Control function block).

Range: FALSE / TRUE

PHASE OFFSET

Phase offset value. Small values should be used to prevent the torque loop from saturating.

Range: -300.00 to 300.00

ACTIVE

Diagnostic. TRUE when either ENABLE SPEED or ENABLE PHASE are active.

Range: FALSE / TRUE

MMI Menu Map

1	SETUP
2	SETPOINT FUNCS
3	PID
	SETPOINT
	FEEDBACK
	SETPOINT NEGATE
	FEEDBACK NEGATE
	ENABLE
	INTEGRAL DEFEAT
	GAIN
	I TIME CONSTANT
	D TIME CONSTANT
	FILTER TC
	OUTPUT POS LIMIT
	OUTPUT NEG LIMIT
	OUTPUT SCALING
	PID OUTPUT
	PID ERROR

PID

This function block allows the Inverter to be used in applications requiring a trim to the setpoint, depending on feedback from an external measurement device. Typically this will be used for process control, i.e. pressure or flow.

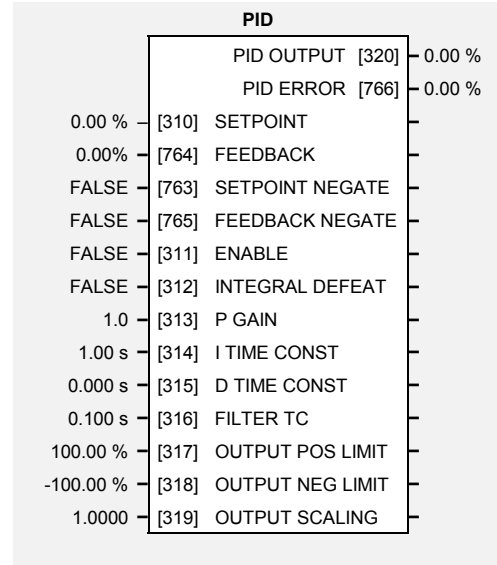

Parameter Descriptions

SETPOINT

An input to the PID block.

Range: -300.00 to 300.00 %

FEEDBACK

An input to the PID block.

Range: -300.00 to 300.00 %

SETPOINT NEGATE

Changes the sign of SETPOINT.

Range: FALSE / TRUE

FEEDBACK NEGATE

Changes the sign of FEEDBACK.

Range: FALSE / TRUE

ENABLE

This parameter globally resets the PID output and integral term when FALSE. This parameter must be TRUE for the PID to operate.

Range: FALSE / TRUE

INTEGRAL DEFEAT

This parameter resets the PID integral term when TRUE.

Range: FALSE / TRUE

P GAIN

This parameter is the true proportional gain of the PID controller. With a P gain of zero, the PID output would be zero.

Range: 0.0 to 100.0

I TIME CONST

The integral time constant of the PID controller.

Range: 0.01 to 100.00 s

1-80 Programming Your Application

D TIME CONST

Range: 0.000 to 10.000 s

The derivative time constant of the PID controller.

FILTER TC

Range: 0.000 to 10.000 s

In order to help attenuate high frequency noise on the PID output, a first order output filter has been provided. This parameter determines the output filter time constant.

OUTPUT POS LIMIT

Range: 0.00 to 105.00 %

This parameter determines the maximum positive excursion (Limit) of the PID output.

OUTPUT NEG LIMIT

Range: -105.00 to 0.00 %

This parameter determines the maximum negative excursion (Limit) of the PID output.

OUTPUT SCALING

Range: -3.0000 to 3.0000

This parameter represents an overall scaling factor which is applied after the PID positive and negative limit clamps.

PID OUTPUT

Range: —.xx %

The output of the PID function.

PID ERROR

Range: —.xx %

The result of SETPOINT - FEEDBACK, clamped to between $\pm 100.00\%$.

Functional Description

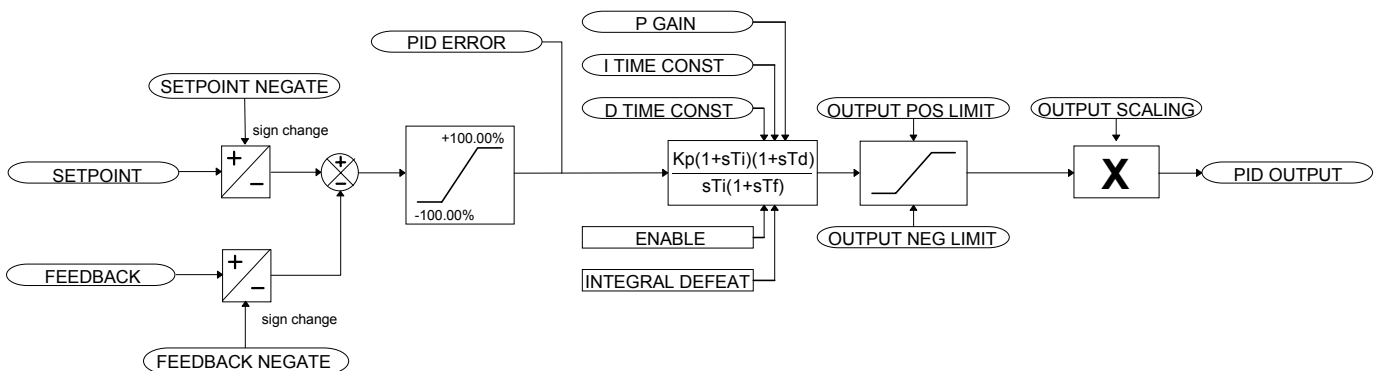

For an application that requires closed loop control, the error term may be derived from the setpoint and feedback using a value function block. This error term is then used by the PID. The output of the PID may be used to trim the demand setpoint via the SPEED TRIM parameter in the REFERENCE function block.

MMI Menu Map

1	SETUP
2	SETPOINT FUNCS
3	PID (TYPE 2)
	ENABLE
	ERROR
	FEED FWD
	FEED FWD GAIN
	P GAIN
	I GAIN
	D GAIN
	D FILTER TC
	LIMIT
	OUTPUT
	PID OUTPUT
	LIMITING

PID (TYPE 2)

This function block is an alternative, simplified version of the process PID controller. The function block is suitable for general closed-loop control and is typically used in phase control applications.

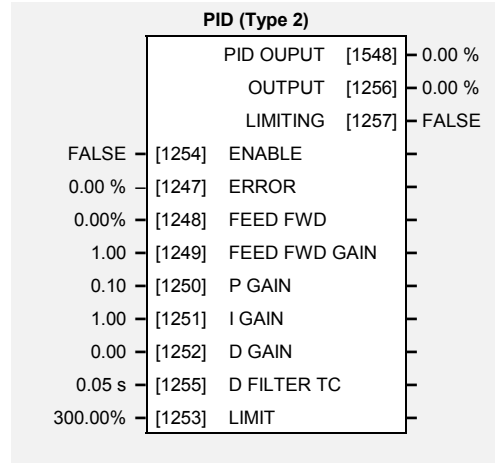

Parameter Descriptions

ERROR

Error input to the PID (TYPE 2) block.

Range: -300.00 to 300.00 %

FEED FWD

Feed forward input to the PID (TYPE 2) block.

Range: -300.00 to 300.00 %

FEED FWD GAIN

Feed forward gain of the PID (TYPE 2) block.

Range: -300.00 to 300.00

P GAIN

The proportional gain of the PID (TYPE 2) block.

Range: 0.00 to 100.00

I GAIN

The integral gain of the PID (TYPE 2) block.

Range: 0.00 to 100.00

D GAIN

The derivative gain of the PID (TYPE 2) block.

Range: 0.00 to 100.00

LIMIT

This parameter determines the maximum positive and negative excursion (Limit) of the PID output.

Range: 0.00 to 300.00%

ENABLE

This parameter globally resets the PID output and integral term when FALSE. This parameter must be TRUE for the PID to operate.

Range: FALSE / TRUE

D FILTER TC

In order to help attenuate high frequency noise on the derivative term, a first order lag has been provided. This parameter determines the filter time constant.

Range: 0.05 to 10.00 s

OUTPUT

Output of the PID (TYPE 2) function block.

Range: __.xx%

PID OUTPUT

Output of PID without FEED FWD

Range: __.xx%

LIMITING

This output is TRUE if the OUTPUT is at the LIMIT value.

Range: FALSE / TRUE

Functional Description

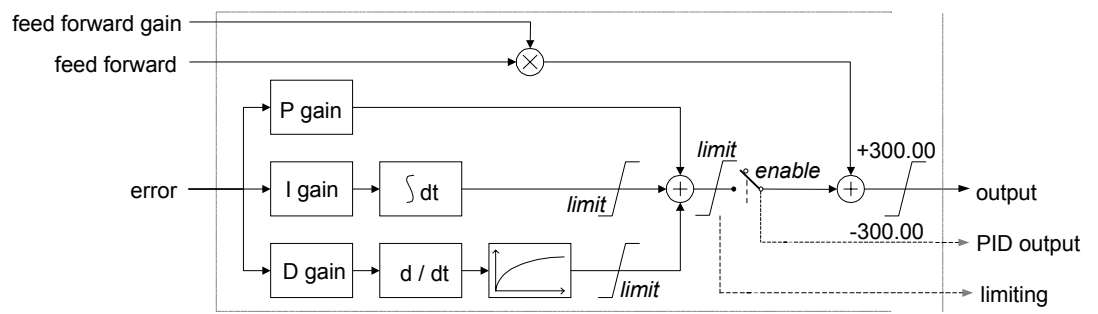

- Functions as P, PI, PD and PID with filtering.
- Single symmetric limit on output.

PID Stage

The formula which describes the action of the PID in the 'S' domain is as follows:

$$PID = K_p + \frac{K_i}{S} + K_D \frac{S}{1 + S T_F}$$

where: K_p is the proportional gain
 K_i is the integral gain
 K_D is the derivative gain
 T_F is the filter time constant

MMI Menu Map

1	SETUP
2	MISCELLANEOUS
3	POSITION
	RESET
	PRESET
	LIMIT
	COUNTS PER UNIT
	OUTPUT (INT)
	SCALED OUTPUT
	ENCODER FBK RPM
	ENCODER FBK %

POSITION

The Position function block counts the encoder position from reset.

It provides a scaleable output as well as encoder speed diagnostics

If the ENCODER MODE is set to QUADRATURE (refer to the FEEDBACKS function block), then the output will count at 4x the number of lines on the encoder per revolution, otherwise it will count at 1x.

Position		
-	OUTPUT (INT)	[748] 0
-	SCALED OUTPUT	[1685] 0.0000
-	ENCODER FBK RPM	[1687] 0.00 rpm
-	ENCODER FBK %	[1688] 0.00 %
FALSE	[747] RESET	
0.00	[1682] PRESET	
100.00	[1683] LIMIT	
8192	[1684] COUNTS PER UNIT	

Parameter Descriptions

RESET

Range: FALSE / TRUE

Resets OUTPUT (INT) to zero and SCALED OUTPUT to Preset when set to True.

PRESET

Range: -32767.00 to 32767.00

The value to which the SCALED OUTPUT is set when RESET is True

LIMIT

Range: 0.00 to 32767.00

A symmetric limit that clamps the value of SCALED OUTPUT, i.e. SCALED OUTPUT can be no greater than LIMIT and no less than -LIMIT

COUNTS PER UNIT

Range: -2147483647 to 2147483647

The number of encoder counts that are equal to a SCALED OUTPUT of 1.0.

OUTPUT (INT)

Range: —.

The number of counts on the encoder since the block was last reset. The output is preserved during power-down of the Inverter.

SCALED OUTPUT

Range: —.0000

An output scaled such that $1.0 = \frac{\text{encoder counts}}{\text{counts per unit}}$

ENCODER FBK RPM

Range: —.00 rpm

Provides an encoder speed diagnostic in rpm.

ENCODER FBK %

Range: —.00 %

This parameter shows the mechanical speed of the motor shaft, calculated from the Encoder Technology Box, as a percentage of the user maximum speed setting (MAX SPEED in the SETPOINT SCALE function block).

PRESET

The Inverter has eight Preset function blocks. These are used to select a value from one of eight inputs, depending on the value of another input. A second output is provided to allow the block to be used as two banks of four inputs.

MMI Menu Map

- 1 SETUP
 - 2 SETPOINT FUNCS
 - 3 PRESET
 - 4 PRESET 1
 - 4 PRESET 2
 - 4 PRESET 3
 - 4 PRESET 4
 - 4 PRESET 5
 - 4 PRESET 6
 - 4 PRESET 7
 - 4 PRESET 8
- SELECT INPUT
 - INPUT 0
 - INPUT 1
 - INPUT 2
 - INPUT 3
 - INPUT 4
 - INPUT 5
 - INPUT 6
 - INPUT 7
 - OUTPUT 1
 - OUTPUT 2

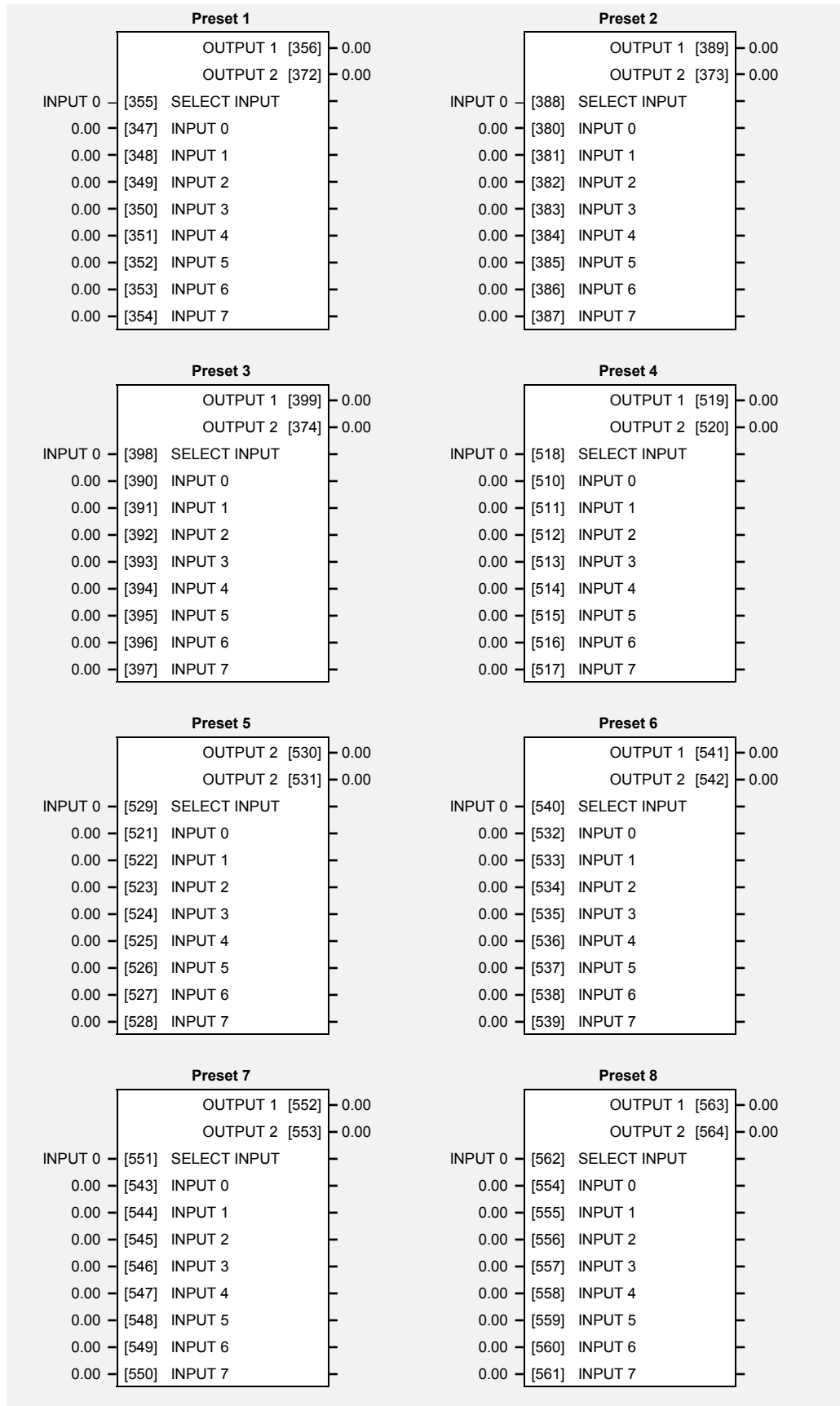

Parameter Descriptions

SELECT INPUT

Range: Enumerated - see below

Determines which of the inputs is routed to OUTPUT 1 . In addition, if SELECT INPUT is in the range 0 to 3, INPUT 4 to INPUT 7 respectively is routed to OUTPUT 2.

Enumerated Value : Select Input

- 0 : INPUT 0
- 1 : INPUT 1
- 2 : INPUT 2
- 3 : INPUT 3
- 4 : INPUT 4
- 5 : INPUT 5
- 6 : INPUT 6
- 7 : INPUT 7

INPUT 0 TO INPUT 7

Inputs to the Preset block.

Range: -300.00 to 300.00

OUTPUT 1

Selected input.

Range: —.xx

OUTPUT 2

Selected input (if SELECT INPUT is in the correct range).

Range: —.xx

Functional Description

The Preset function block is a de-multiplexer.

OUTPUT 1 and OUTPUT 2 return the values at selected inputs set by SELECT INPUT.

OUTPUT 2 returns the value of a different input to OUTPUT 1 , i.e:

if SELECT INPUT = 0 then OUTPUT 1 = INPUT 0, OUTPUT 2 = INPUT 4

if SELECT INPUT = 1 then OUTPUT 1 = INPUT 1, OUTPUT 2 = INPUT 5 etc.

When SELECT INPUT is set to 4, 5, 6 or 7, OUTPUT 2 will return a value of zero.

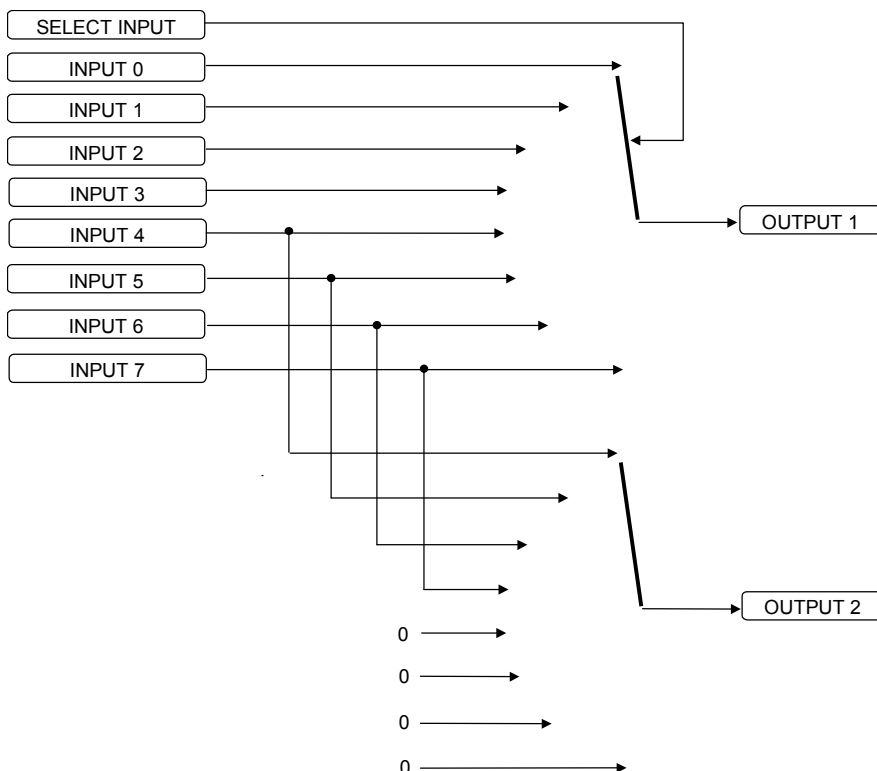

MMI Menu Map

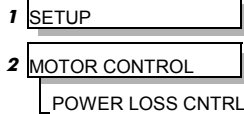

POWER LOSS CNTRL

Designed for all Motor Control Modes.

This function block controls the behaviour of the drive during a power outage

When enabled, the drive attempts to keep the dc link high by regeneratively recovering the kinetic energy in the motor load in the event of mains supply loss.

This is achieved by ramping the speed setpoint to zero during the power outage. If during the outage the supply returns, the speed setpoint is automatically ramped back to the speed setpoint.

When disabled, the drive will trip on UNDERVOLTS if the mains supply is removed.

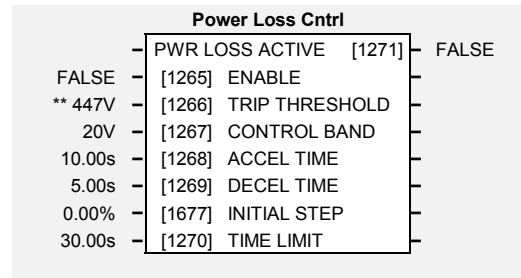

Parameter Descriptions

ENABLE

Range: FALSE / TRUE

When TRUE, the Power Loss Ride-Through functionality is enabled.

TRIP THRESHOLD

Range: 0V to 1000V

Determines the dc link volts at which the Power Loss Ride-Through sequence is triggered.

CONTROL BAND

Range: 0V to 1000V

Sets the dc link voltage above the TRIP THRESHOLD at which the setpoint Ramp to Stop is paused. If the dc link volts remain above this level for a period greater than 500ms, the setpoint is ramped back to the speed demand.

ACCEL TIME

Range: 0.01 to 300.00s

Determines the time in which the speed setpoint is ramped back to the speed demand. This is expressed as the time to ramp from zero to MAX SPEED.

DECEL TIME

Range: 0.01 to 300.00s

Determines the time in which the speed setpoint is ramped to zero. This is expressed as the time to ramp from MAX SPEED to zero.

INITIAL STEP

Range: 0.00 to 100.00%

This parameter sets the initial speed reduction step at the start of the power loss control sequence.

TIME LIMIT

Range: 0.00 to 300.00s

Determines the maximum allowed time of the Power Loss Ride-Through sequence. Once timeout is reached, the drive is allowed to Coast to Stop and eventually trip on UNDERVOLTS.

PWR LOSS ACTIVE

Range: FALSE / TRUE

This diagnostic is set to TRUE while the Power Loss Ride-Through sequence is active.

MMI Menu Map

1	SETUP
2	SETPOINT FUNCS
3	RAISE/LOWER
	RAISE INPUT
	LOWER INPUT
	RAMP TIME
	MAX VALUE
	MIN VALUE
	RESET VALUE
	RESET
	OUTPUT

RAISE/LOWER

This function block acts as an internal motorised potentiometer (MOP).

The OUTPUT is preserved during the power-down of the Inverter.

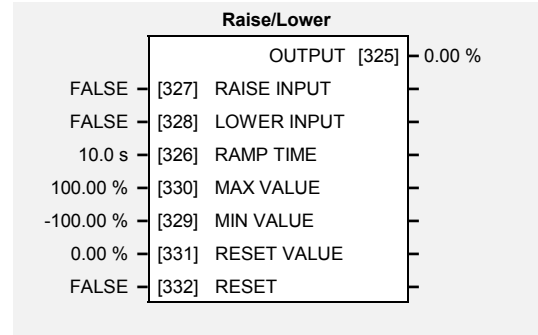

Parameter Descriptions

RAISE INPUT

When TRUE causes OUTPUT to ramp up.

Range: FALSE / TRUE

LOWER INPUT

When TRUE causes OUTPUT to ramp down.

Range: FALSE / TRUE

RAMP TIME

Rate of change of the OUTPUT . Defined as time to change from 0.00% to 100.00% . Note that the raise and lower rates are always the same.

Range: 0.0 to 600.0 s

MAX VALUE

The maximum value to which OUTPUT will ramp up to.

Range: -300.00 to 300.00 %

MIN VALUE

The minimum value to which OUTPUT will ramp down to.

Range: -300.00 to 300.00 %

RESET VALUE

The value the OUTPUT is set to when RESET is TRUE.

Range: -300.00 to 300.00 %

RESET

When TRUE, forces OUTPUT to track RESET VALUE .

Range: FALSE / TRUE

OUTPUT

The ramped output. This parameter is persistent, that is, it is saved throughout a power failure.

Range: —.xx %

Functional Description

The table below describes how OUTPUT is controlled by the RAISE INPUT, LOWER INPUT and RESET inputs.

RESET	RAISE INPUT	LOWER INPUT	Action
TRUE	Any	Any	OUTPUT tracks RESET VALUE
FALSE	TRUE	FALSE	OUTPUT ramps up to MAX VALUE at RAMP TIME
FALSE	FALSE	TRUE	OUTPUT ramps down to MIN VALUE at RAMP TIME
FALSE	FALSE	FALSE	OUTPUT not changed. *
FALSE	TRUE	TRUE	OUTPUT not changed. *

* If OUTPUT is greater than MAX VALUE the OUTPUT will ramp down to MAX VALUE at RAMP TIME. If OUTPUT is less than MIN VALUE the OUTPUT will ramp up to MIN VALUE at RAMP TIME.

IMPORTANT: If MAX VALUE is less than or equal to MIN VALUE, then OUTPUT is set to MAX VALUE.

MMI Menu Map

1	SETUP
2	SEQ & REF
3	REFERENCE
	REMOTE SETPOINT
	SPEED TRIM
	MAX SPEED CLAMP
	MIN SPEED CLAMP
	TRIM IN LOCAL
	REMOTE REVERSE
	SPEED DEMAND
	SPEED SETPOINT
	REVERSE
	LOCAL SETPOINT
	LOCAL REVERSE
	COMMS SETPOINT

REFERENCE

This function block holds all the parameters concerning the generation of the setpoint reference.

The generation of reference setpoint is described in the Installation Product Manual, Chapter 4: “Operating the Inverter” - Control Philosophy.

Reference		
SPEED DEMAND	[255]	0.00 %
SPEED SETPOINT	[254]	0.00 %
REVERSE	[256]	FALSE
LOCAL SETPOINT	[247]	0.00 %
LOCAL REVERSE	[250]	FALSE
COMMS SETPOINT	[770]	0.00 %
0.00 %	[245]	REMOTE SETPOINT
0.00 %	[248]	SPEED TRIM
110.00 %	[252]	MAX SPEED CLAMP
-110.00 %	[253]	MIN SPEED CLAMP
FALSE	[243]	TRIM IN LOCAL
FALSE	[249]	REMOTE REVERSE

Parameter Descriptions

REMOTE SETPOINT

Range: -300.00 to 300.00 %

This is the target reference that the Inverter will ramp to in remote reference mode (not including trim), direction is taken from REMOTE REVERSE and the sign of REMOTE SETPOINT.

SPEED TRIM

Range: -300.00 to 300.00 %

The trim is added to the ramp output in remote mode (or if TRIM IN LOCAL is TRUE) to form SPEED DEMAND . The trim is typically connected to the output of a PID in a closed loop system.

Note: *The output of the REFERENCE RAMP is set to -SPEED TRIM when the drive is started to ensure that the SPEED DEMAND ramps from zero.*

MAX SPEED CLAMP

Range: 0.00 to 110.00 %

Maximum value for SPEED DEMAND.

MIN SPEED CLAMP

Range: -110.00 to 0.00 %

Minimum value for SPEED DEMAND.

TRIM IN LOCAL

Range: FALSE / TRUE

When TRUE, SPEED TRIM is always added to the ramp output. When FALSE, SPEED TRIM is added only to Remote mode.

REMOTE REVERSE

Range: FALSE / TRUE

Demanded direction when in Remote Reference mode. This is usually connected directly to the Sequencing Logic.

SPEED DEMAND

Range: — .x %

Indicates actual speed demand. This is the input to the frequency controller.

SPEED SETPOINT

Range: — .x %

Indicates target speed. This will be equal to either LOCAL SETPOINT, REMOTE SETPOINT, JOG SETPOINT or COMMS SETPOINT . (Refer to the REFERENCE JOG function block for the JOG SETPOINT parameter).

REVERSE

Range: FALSE / TRUE

Indicates demanded direction. This may not be the actual direction as no account of setpoint sign is taken.

LOCAL SETPOINT

Range: — .xx %

Indicates the Operator Station setpoint. It is always a positive quantity; saved on power down. Direction is taken from LOCAL REVERSE.

LOCAL REVERSE

Range: FALSE / TRUE

Indicates demanded direction in Local Reference mode, saved on power down.

COMMS SETPOINT

Range: —.xx %

This setpoint is the target reference that the Inverter will ramp to in Remote Reference Comms mode (not including trim). The direction is always positive, i.e. forward.

Functional Description

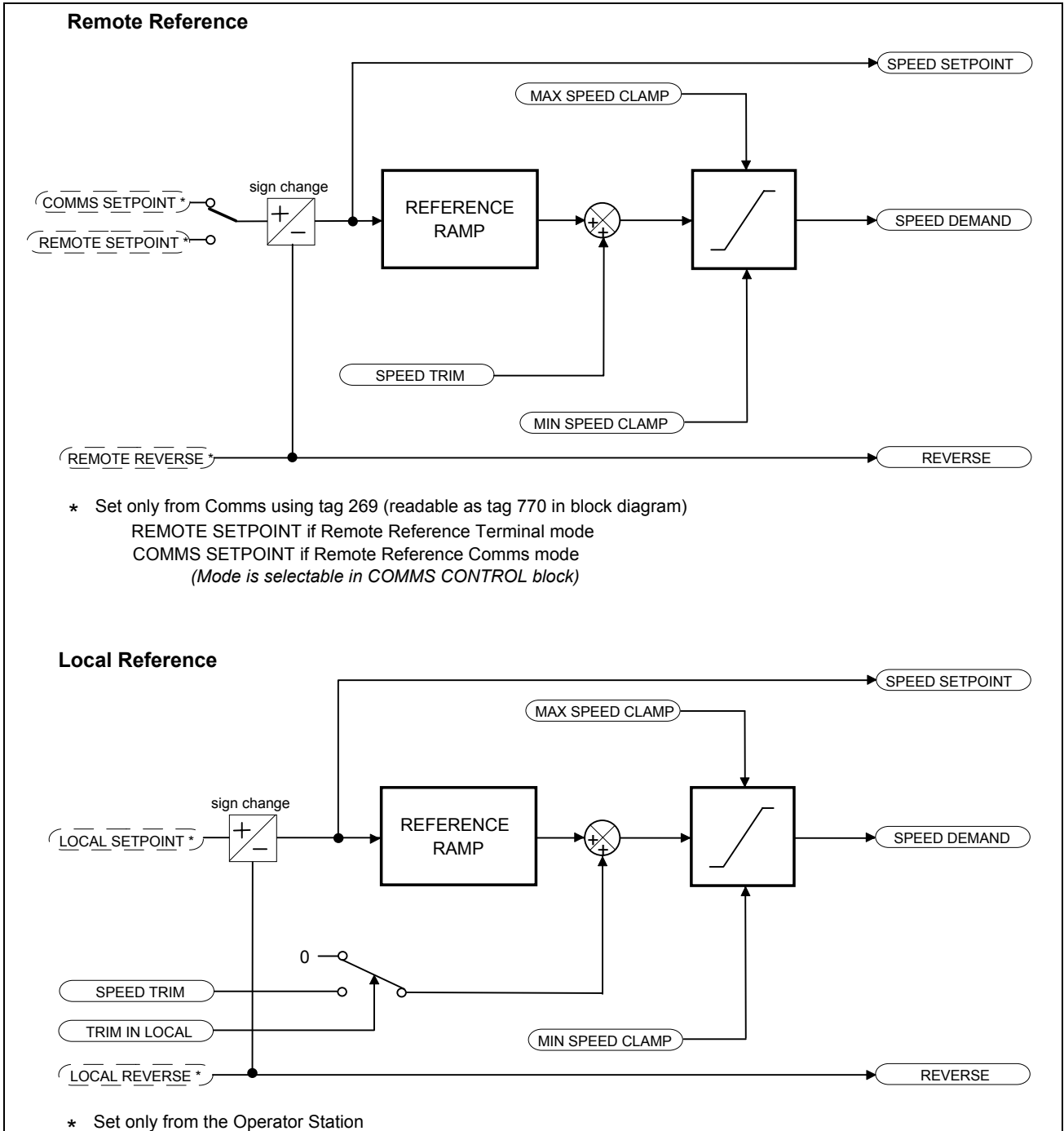

1-90 Programming Your Application

MMI Menu Map

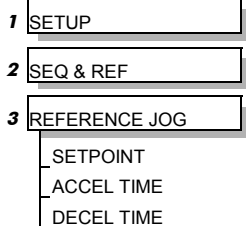

REFERENCE JOG

This block holds all the parameters that concern the Jog functionality on the Inverter.

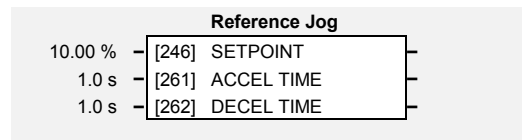

Parameter Descriptions

SETPOINT

Range: -100.00 to 100.00 %

The setpoint is the target reference that the Inverter will ramp to.

ACCEL TIME

Range: 0.0 to 3000.0 s

The time that the Inverter will take to ramp the jog setpoint from 0.00% to 100.00%.

DECEL TIME

Range: 0.0 to 3000.0 s

The time that the Inverter will take to ramp the jog setpoint from 100.00% to 0.00%.

Functional Description

The REFERENCE JOG function block is used to configure the action of the Inverter when used in jog mode. The various operating modes are described in more detail in the Installation Product Manual, Chapter 4: "Operating the Inverter" - The Start/Stop Mode Explained.

MMI Menu Map

1	SETUP
2	SEQ & REF
3	REFERENCE RAMP
	RAMP TYPE
	ACCEL TIME
	DECEL TIME
	SYMMETRIC MODE
	SYMMETRIC TIME
	SRAMP ACCEL
	SRAMP DECEL
	SRAMP JERK 1
	SRAMP JERK 2
	SRAMP JERK 3
	SRAMP JERK 4
	SRAMP CONTINUOUS
	HOLD
	RAMPING

REFERENCE RAMP

This function block forms part of the reference generation. It provides the facility to control the rate at which the Inverter will respond to a changing setpoint demand.

Reference Ramp		
	RAMPING	[698] FALSE
LINEAR	[244] RAMP TYPE	
** 10.0 s	[258] ACCEL TIME	
** 10.0 s	[259] DECEL TIME	
FALSE	[268] SYMMETRIC MODE	
** 10.0 s	[267] SYMMETRIC TIME	
10.00 /s^2	[692] SRAMP ACCEL	
10.00 /s^2	[693] SRAMP DECEL	
10.00 /s^3	[694] SRAMP JERK 1	
10.00 /s^3	[695] SRAMP JERK 2	
10.00 /s^3	[696] SRAMP JERK 3	
10.00 /s^3	[697] SRAMP JERK 4	
TRUE	[691] SRAMP CONTINUOUS	
FALSE	[260] HOLD	

Parameter Descriptions

RAMP TYPE

Range: Enumerated - see below

Select the ramp type:

Enumerated Value : Ramp Type

0 : LINEAR
1 : S

ACCEL TIME

Range: 0.0 to 3000.0 s

The time that the Inverter will take to ramp the setpoint from 0.00% to 100.00%.

DECEL TIME

Range: 0.0 to 3000.0 s

The time that the Inverter will take to ramp the setpoint from 100.00% to 0.00%.

SYMETRIC MODE

Range: FALSE / TRUE

Select whether to use the ACCEL TIME and DECEL TIME pair of ramp rates, or to use the SYMETRIC RATE parameter to define the ramp rate for the Inverter.

SYMETRIC TIME

Range: 0.0 to 3000.0 s

The time that the Inverter will take to ramp from 0.00% to 100.00% and from 100.00% to 0.00% when SYMETRIC MODE is TRUE.

SRAMP ACCEL

Range: 0.00 to 100.00 /s²

Sets the acceleration rate in units of percent per second², i.e. if the full speed of the machine is 1.25m/s then the acceleration will be:

$$1.25 \times 75.00\% = 0.9375\text{m/s}^2$$

SRAMP DECEL

Range: 0.00 to 100.00 /s²

This functions in the same way as SRAMP ACCEL above.

SRAMP JERK 1

Range: 0.00 to 100.00 /s³

Rate of change of acceleration for the first segment of the curve in units per second³, i.e. if the full speed of the machine is 1.25m/s then the acceleration will be:

$$1.25 \times 50.00\% = 0.625\text{m/s}^3$$

SRAMP JERK 2

Range: 0.00 to 100.00 /s³

Rate of change of acceleration in units of percent per second³ for segment 2.

SRAMP JERK 3

Range: 0.00 to 100.00 /s³

Rate of change of acceleration in units of percent per second³ for segment 3.

SRAMP JERK 4

Range: 0.00 to 100.00 /s³

Rate of change of acceleration in units of percent per second³ for segment 4.

SRAMP CONTINUOUS

Range: FALSE / TRUE

When TRUE, and S ramp is selected in RAMP TYPE, forces a smooth transition if the speed setpoint is changed when ramping. The curve is controlled by the SRAMP ACCEL and SRAMP JERK 1 to SRAMP JERK 4 parameters. When FALSE, there is an immediate transition from the old curve to the new curve.

RAMP HOLD

Range: FALSE / TRUE

When TRUE the output of the ramp is held at its last value.

RAMPING

Range: FALSE / TRUE

Set TRUE when ramping.

Functional Description

Installation Product Manual, Chapter 4: "Operating the Inverter" - Starting and Stopping Methods, describes the use of the system ramp.

The ramp output takes the form shown below.

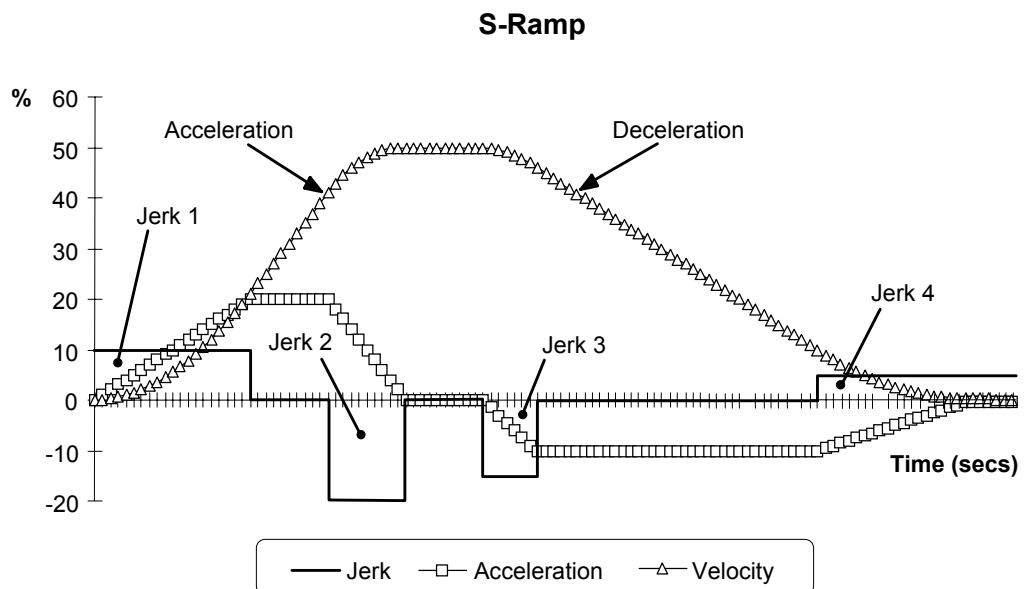

MMI Menu Map

1	SETUP
2	SEQ & REF
3	REFERENCE STOP
	RUN STOP MODE
	STOP TIME
	STOP ZERO SPEED
	STOP DELAY
	FAST STOP MODE
	FAST STOP LIMIT
	FAST STOP TIME
	FINAL STOP RATE

REFERENCE STOP

This function block holds all the parameters concerning the stopping method of the Inverter.

The stopping methods of the Inverter are described in more detail in the Installation Product Manual, Chapter 4: "Operating the Inverter" - Starting and Stopping Methods..

Reference Stop	
RUN RAMP	[279] RUN STOP MODE
10.0 s	[263] STOP TIME
0.10 %	[266] STOP ZERO SPEED
0.500 s	[284] STOP DELAY
RAMPED	[304] FAST STOP MODE
30.0 s	[275] FAST STOP LIMIT
0.1 s	[264] FAST STOP TIME
1200 Hz/s	[126] FINAL STOP RATE

Parameter Descriptions

RUN STOP MODE

Range: Enumerated - see below

Selects stopping mode that the controller will use once the run command has been removed. The choices are:

Enumerated Value : Stopping Mode

- 0 : RUN RAMP
- 1 : COAST
- 2 : DC INJECTION
- 3 : STOP RAMP

When RUN RAMP is selected the Inverter will decelerate using the reference ramp deceleration time, provided it is non zero. When COAST is selected the motor will free-wheel. When DC INJECTION is selected the motor is stopped by applying dc current. When STOP RAMP is selected the motor will decelerate in STOP TIME.

STOP TIME

Range: 0.0 to 600.0 s

Rate at which the demand is ramped to zero after the ramp has been quenched.

STOP ZERO SPEED

Range: 0.00 to 100.00 %

Threshold for zero speed detection used by stop sequences.

STOP DELAY

Range: 0.000 to 30.000 s

Sets the time at which the Inverter holds zero speed before quenching after a normal stop or a jog stop. This may be particularly useful if a mechanical brake requires time to operate at zero speed, or for jogging a machine to position.

FAST STOP MODE

Range: Enumerated - see below

Selects stopping mode used during a fast stop, two options ramped or coast.

Enumerated Value : Stopping Mode

- 0 : RAMPED
- 1 : COAST

FAST STOP LIMIT

Range: 0.0 to 3000.0 s

Maximum time that the Inverter will try to Fast Stop, before quenching.

FAST STOP TIME

Range: 0.0 to 600.0 s

Rate at which the SPEED DEMAND is ramped to zero (see REFERENCE function block)

FINAL STOP RATE

Range: 12 to 4800 Hz/s

Rate at which any internally generated setpoint trims are removed. For example, the trim due to the slip compensation block.

REGEN CONTROL

Designed for 4Q Regen Control Mode.

This function block is used to setup, sequence and monitor the operation of the drive when used in 4Q Regen Control Mode.

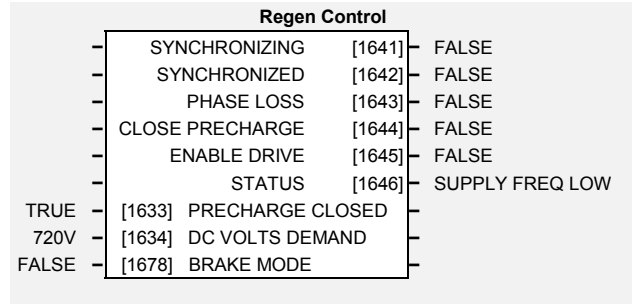

MMI Menu Map

- 1 SETUP
- 2 MOTOR CONTROL
- 3 REGEN CNTROL
 - PRECHARGE CLOSED
 - DC VOLTS DEMAND
 - BRAKE MODE
 - SYNCHRONIZING
 - SYNCHRONIZED
 - PHASE LOSS
 - CLOSE PRECHARGE
 - ENABLE DRIVE
 - STATUS

Parameter Descriptions

PRECHARGE CLOSED

Range: FALSE / TRUE

This parameter is used to indicate the external precharge contactor is closed, i.e. the external precharge resistor is no longer in circuit.

DC VOLTS DEMAND

Range: 0 to 1000V

Use this to set the demanded dc link volts for the common dc bus. It must be set higher than the peak of the mains supply, but lower than the overvolts (820V on 400V products, 410V on 230V products).

BRAKE MODE

Range: FALSE / TRUE

Setting this parameter True allows the drive to generate energy into the mains in common dc link systems. The regeneration occurs when the dc link is higher than the DC VOLTS DEMAND level. In this mode the drive will not draw energy from the mains. The drive acts purely as a braking unit.

SYNCHRONIZING

Range: FALSE / TRUE

This diagnostic reads True during the mains synchronisation period. This occurs when the drive is first run in 4Q Regen Control Mode. This synchronising period lasts for 100ms.

SYNCHRONIZED

Range: FALSE / TRUE

This diagnostic reads True when mains synchronisation has been successfully completed.

PHASE LOSS

Range: FALSE / TRUE

This diagnostic reads True if the drive suspects there is a missing input phase from the mains supply.

CLOSE PRECHARGE

Range: FALSE / TRUE

This diagnostic controls the operation of the external precharge contactor required by the 4Q Regen Control Mode.

ENABLE DRIVE

Range: Enumerated - see below

This diagnostic is used to enable drives on a common dc link system supplied by a drive using the 4Q Regen Control Mode. The diagnostic reads True if mains synchronisation has been successful and the drive is Healthy.

STATUS

Range: Enumerated - see below

This diagnostic indicates the status of operation of the drive.

Enumerated Value : Status

- 0 : INACTIVE
- 1 : SYNCHRONIZING
- 2 : SYNCHRONIZED
- 3 : SUPPLY FREQ HIGH
- 4 : SUPPLY FREQ LOW
- 5 : SYNCH FAILED

INACTIVE : Indicates when the 4Q drive is not running

SYNCHRONIZING : Indicates during mains synchronisation period (first 100ms after Run command)

SYNCHRONIZED : Indicates successful synchronisation is complete

SUPPLY FREQ HIGH : Indicates 4Q drive output frequency is greater than 70Hz. This is a fault condition

SUPPLY FREQ LOW : Indicates the 4Q drive output frequency is less than 40Hz. This is a fault condition

SYNCH FAILED : Indicates the 4Q drive has failed to synchronise on to the mains supply. This is a fault condition

SEQUENCING LOGIC

MMI Menu Map

1	SETUP
2	SEQ & REF
3	SEQUENCING LOGIC
	START DELAY
	RUN FORWARD
	RUN REVERSE
	NOT STOP
	JOG
	CONTACTOR CLOSED
	DRIVE ENABLE
	NOT FAST STOP
	NOT COAST STOP
	REMOTE REVERSE
	REM TRIP RESET
	TRIP RST BY RUN
	POWER UP START
	TRIPPED
	RUNNING
	JOGGING
	STOPPING
	OUTPUT CONTACTOR
	SWITCH ON ENABLE
	SWITCHED ON
	READY
	SYSTEM RESET
	SEQUENCER STATE
	REMOTE REV OUT
	HEALTHY
	FAN RUNNING

This function block contains all the parameters relating to the sequencing (start and stop) of the Inverter.

Before the Inverter will respond to the RUN FWD, RUN REV or JOG parameters (cause the Inverter to run or jog), the parameters DRIVE ENABLE, NOT FAST STOP and NOT COAST STOP need to be set to TRUE. In addition, the Inverter needs to be healthy (HEALTHY is TRUE). The Inverter will only respond to RUN FWD, RUN REV and JOG if the Inverter is in the Remote Sequencing mode.

If RUN FWD and RUN REV are TRUE, both are ignored and the Inverter will stop.

Sequencing Logic			
-	TRIPPED	[289]	FALSE
-	RUNNING	[285]	FALSE
-	JOGGING	[302]	FALSE
-	STOPPING	[303]	FALSE
-	OUTPUT CONTACTOR	[286]	FALSE
-	SWITCH ON ENABLE	[288]	FALSE
-	SWITCHED ON	[306]	FALSE
-	READY	[287]	FALSE
-	SYSTEM RESET	[305]	FALSE
-	SEQUENCER STATE	[301]	START DISABLED
-	REMOTE REV OUT	[296]	FALSE
-	HEALTHY	[274]	TRUE
-	FAN RUNNING	[620]	FALSE
0.000s	[1686]	START DELAY	
FALSE	[291]	RUN FORWARD	
FALSE	[292]	RUN REVERSE	
FALSE	[293]	NOT STOP	
FALSE	[280]	JOG	
TRUE	[1235]	CONTACTOR CLOSED	
TRUE	[276]	DRIVE ENABLE	
TRUE	[277]	NOT FAST STOP	
TRUE	[278]	NOT COAST STOP	
FALSE	[294]	REMOTE REVERSE	
FALSE	[282]	REM TRIP RESET	
TRUE	[290]	TRIP RST BY RUN	
FALSE	[283]	POWER UP START	

Parameter Descriptions

START DELAY

Range: 0.000 to 30.000s

Delays the action of "ramping to setpoint" from the Run command. This can allow a period for motor flux to establish before the ramp to setpoint.

RUN FWD

Range: FALSE / TRUE

Setting this parameter to TRUE causes the Inverter to run in the forward direction.

RUN REV

Range: FALSE / TRUE

Setting this parameter to TRUE causes the Inverter to run in the reverse direction.

NOT STOP

Range: FALSE / TRUE

Setting this parameter TRUE will latch the RUN FWD or RUN REV commands. Once latched, they can be reset to FALSE and the Inverter will continue to run. Setting NOT STOP to FALSE causes the run commands to be unlatched.

JOG

Range: FALSE / TRUE

Setting this parameter TRUE causes the Inverter to run at the speed set by JOG SETPOINT (refer to the REFERENCE JOG function block). Once jogging, setting JOG to FALSE causes the Inverter to ramp to zero.

CONTACTOR CLOSED

Range: FALSE / TRUE

Feedback used to indicate that the external contactor has been closed. It must be TRUE for the sequencer to proceed from the SWITCHED ON state to the READY STATE, refer to SEQUENCER STATE.

DRIVE ENABLE

Range: FALSE / TRUE

This provides a means of electronically inhibiting Inverter operation. Whilst running, setting this parameter to FALSE disables the Inverter operation and causes the motor to coast.

NOT FAST STOP

Range: FALSE / TRUE

Whilst running or jogging, setting this parameter to FALSE causes the Inverter to ramp to zero. The rate is set by FAST STOP RATE in the STOP function block. The action of setting NOT FAST STOP to TRUE is latched. The Inverter cannot be restarted until fast stop is completed.

NOT COAST STOP

Range: FALSE / TRUE

Setting this parameter to FALSE disables the Inverter operation and causes the motor to coast. The action of setting this parameter to TRUE is latched. The Inverter can not be restarted until the coast stop is completed.

A detailed description of the sequencer states, as indicated by the MAIN SEQ STATE parameter, is described in Chapter 4. The sequence logic is described in the Installation Product Manual, Chapter 4: “Operating the Inverter” - Selecting Local or Remote Control.

REMOTE REVERSE

Range: FALSE / TRUE

For remote setpoints, setting this parameter TRUE inverts the demanded direction of motor rotation.

REM TRIP RESET

Range: FALSE / TRUE

On a transition to TRUE, this input clears latched trips.

TRIP RST BY RUN

Range: FALSE / TRUE

This allows the rising edge of run command to clear latched trips.

POWER UP START

Range: FALSE / TRUE

If TRUE, this allows the Inverter to go directly to run mode if in remote and a run command is present. If FALSE, a low to high transition of the run command is required.

TRIPPED

Range: FALSE / TRUE

Indicates that there is a latched trip present.

RUNNING

Range: FALSE / TRUE

Indicates that that the Inverter is in the enabled state.

JOGGING

Range: FALSE / TRUE

Indicates that the Inverter is in the JOG mode.

STOPPING

Range: FALSE / TRUE

Indicates that the Inverter is stopping.

OUTPUT CONTACTOR

Range: FALSE / TRUE

Output to be used to drive an external contactor in the motor output. This contactor is normally closed unless a Trip condition has occurred or the Inverter goes into the re-configuration mode.

SWITCH ON ENABLE

Range: FALSE / TRUE

Sometimes referred to as READY TO SWITCH ON, this parameter indicates that the Inverter will accept a run command.

SWITCHED ON

Range: FALSE / TRUE

Run accepted. Waiting for CONTACTOR CLOSED and deflux to be completed

READY

Range: FALSE / TRUE

Indicates that the Inverter’s power stack is operable and the Inverter will run if enabled.

SYSTEM RESET

Range: FALSE / TRUE

TRUE for a single block diagram execution cycle after the Inverter enters either RUN or JOG mode.

SEQUENCER STATE

Range: Enumerated - see below

This parameter indicates the current sequencing state:

Enumerated Value : State

- 0 : START DISABLED
- 1 : START ENABLED
- 2 : SWITCHED ON
- 3 : READY
- 4 : ENABLED
- 5 : F-STOP ACTIVE
- 6 : TRIP ACTIVE
- 7 : TRIPPED

Refer to Chapter 4: “Sequencing Logic States”.

REMOTE REV OUT

Range: FALSE / TRUE

This parameter indicates the current state of remote direction and RUN REV. Note - this is the demanded direction, not the actual direction.

HEALTHY

Range: FALSE / TRUE

Set FALSE when the Inverter trips, and set TRUE when the run command is removed.

FAN RUNNING

Range: FALSE / TRUE

This can be used to control the running of externally supplied fans. True when the drive is running, goes FALSE 60 seconds after the drive has stopped.

MMI Menu Map

- 1 SETUP
- 2 MOTOR CONTROL
- 3 SETPOINT SCALE
 - INPUT
 - MAX SPEED
 - OUTPUT

SETPOINT SCALE

Designed for all Motor Control Modes.

This function block simply converts the way the setpoint is expressed from being a percentage of the MAX SPEED to an absolute frequency in electrical Hertz.

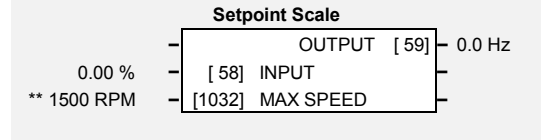

Parameter Descriptions

INPUT

Range: -300.00 to 300.00 %

The setpoint delivered by the re-wired function block portion of the Inverter's application.

MAX SPEED

Range: 0 to 32000 rpm

The physical motor speed equivalent to a setpoint demand of 100.00%. Note that although INPUT may be set between ±300%, the input value is clamped before being used to ±110%. Hence, the greatest input speed which can be demanded is ±110% of MAX SPEED.

Refer to Chapter 2: "Parameter Specification" - Frequency Dependent Defaults

OUTPUT

Range: —.x %

$$\text{Output} = \frac{\text{max speed} \times \text{input}}{100\%} \times \frac{\text{number of motor poles}}{2} \times \frac{1}{60}$$

Functional Description

The setpoint scale block changes the format in which the setpoint is expressed. The function blocks on the input side of this block process the setpoint as a percentage of maximum RPM. The function blocks on the output side of this block process the setpoint as an absolute frequency of rotation of the electric field in Hertz.

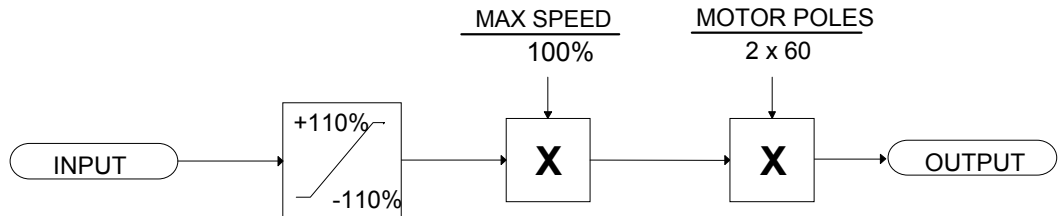

SKIP FREQUENCIES

This function block may be used to prevent the Inverter operating at frequencies that cause mechanical resonance in the load.

MMI Menu Map

1	SETUP
2	SETPOINT FUNCS
3	SKIP FREQUENCIES
	INPUT
	BAND 1
	FREQUENCY 1
	BAND 2
	FREQUENCY 2
	BAND 3
	FREQUENCY 3
	BAND 4
	FREQUENCY 4
	OUTPUT
	OUTPUT Hz
	INPUT Hz

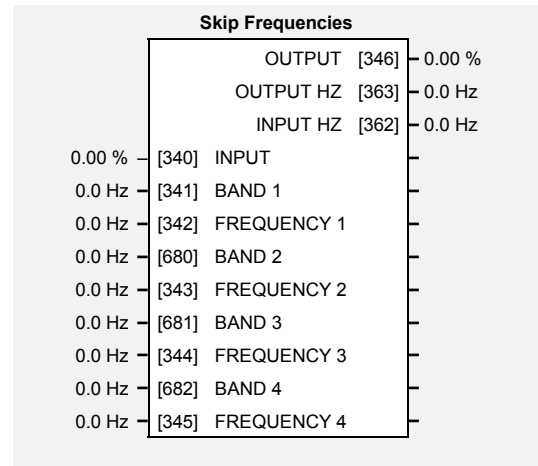

Parameter Descriptions

INPUT

The value of the block input in %.

Range: -300.00 to 300.00 %

BAND 1

The width of each skip band in Hz.

Range: 0.0 to 480.0 Hz

FREQUENCY 1

This parameter contains the centre frequency of each skip band in Hz.

Range: 0.0 to 480.0 Hz

BAND 2

The width of each skip band in Hz.

Range: 0.0 to 480.0 Hz

FREQUENCY 2

This parameter contains the centre frequency of each skip band in Hz.

Range: 0.0 to 480.0 Hz

BAND 3

The width of each skip band in Hz.

Range: 0.0 to 480.0 Hz

FREQUENCY 3

This parameter contains the centre frequency of each skip band in Hz.

Range: 0.0 to 480.0 Hz

BAND 4

The width of each skip band in Hz.

Range: 0.0 to 480.0 Hz

FREQUENCY 4

This parameter contains the centre frequency of each skip band in Hz.

Range: 0.0 to 480.0 Hz

OUTPUT

Diagnostic on the output of the function block in %

Range: —.xx %

OUTPUT HZ

Diagnostic on the output of the function block in Hz

Range: —.x Hz

INPUT HZ

Diagnostic on the input of the function block in Hz

Range: —.x Hz

Functional Description

Four programmable skip frequencies are available to avoid resonances within the mechanical system. Enter the value of frequency that causes the resonance using the "FREQUENCY" parameter and then programme the width of the skip band using its "BAND" parameter. The Inverter will then avoid sustained operation within the forbidden band as shown in the diagram. The skip frequencies are symmetrical and thus work in forward and reverse.

Note: Setting the FREQUENCY to 0 disables the corresponding band.
Setting the BAND to 0 causes the value of BAND 1 to be used for this band.

The behaviour of this function block is illustrated below.

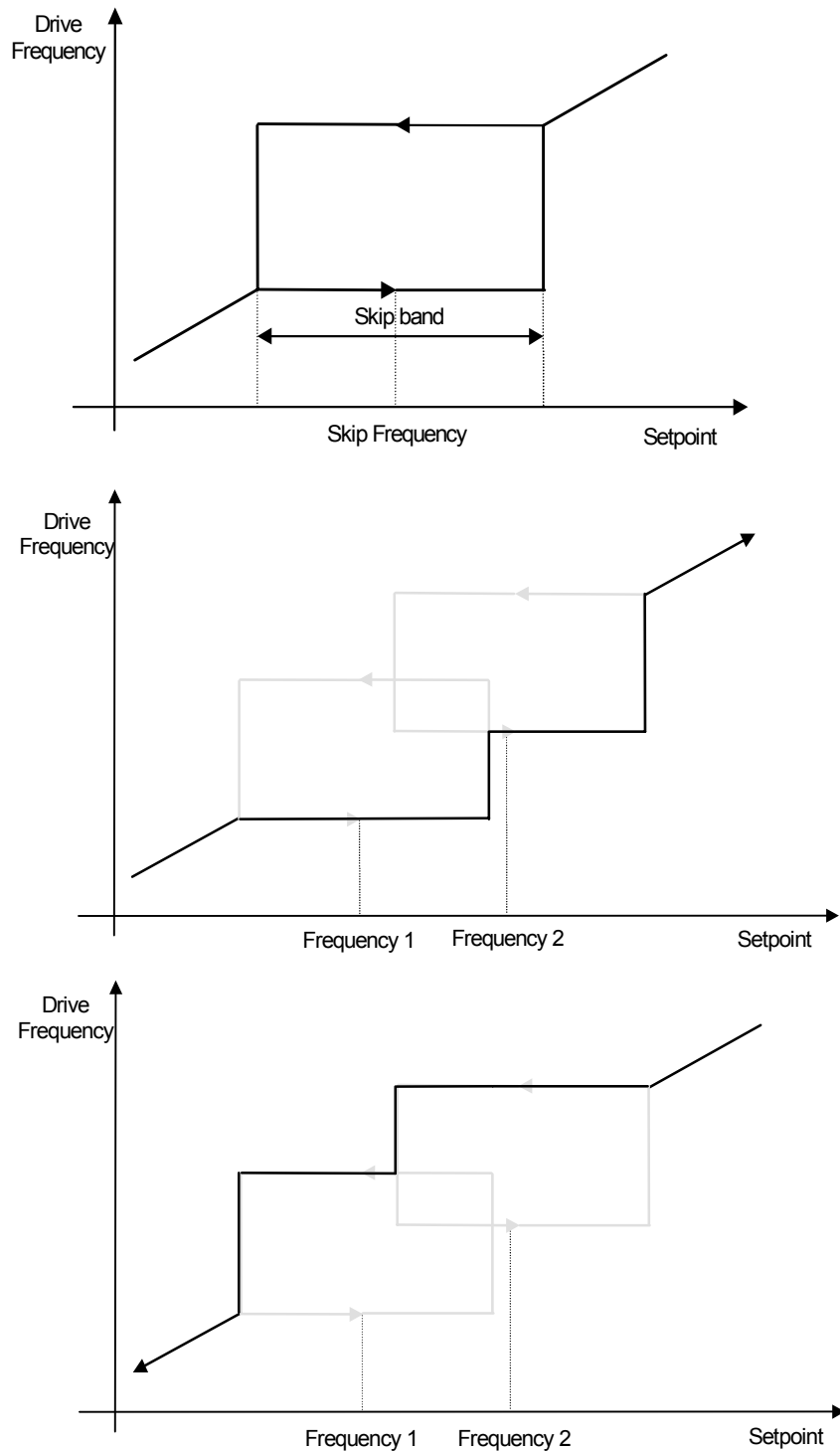

SLEW RATE LIMIT

Designed for all Motor Control Modes.

This function block prevents over-current and over-voltage faults occurring due to a rapidly changing setpoint.

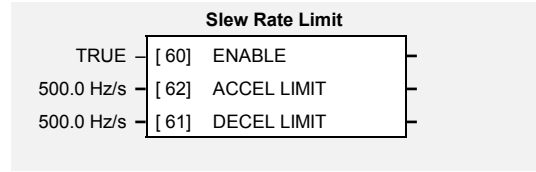

MMI Menu Map

- 1 SETUP
- 2 MOTOR CONTROL
- 3 SLEW RATE LIMIT
 - ENABLE
 - ACCEL LIMIT
 - DECEL LIMIT

Parameter Descriptions

ENABLE

Range: FALSE / TRUE

When this parameter is FALSE, this function block is disabled and the setpoint is unaffected by this function block.

ACCEL LIMIT

Range: 1.0 to 1200.0 Hz/s

The maximum rate at which the setpoint may accelerate away from zero.

DECEL LIMIT

Range: 1.0 to 1200.0 Hz/s

The maximum rate at which the setpoint may decelerate towards zero.

Functional Description

The SLEW RATE LIMIT block obtains the setpoint from the output of the application, correctly scaled by the SETPOINT SCALE block. The rate of change limits are applied and the setpoint is then passed on for further processing.

When the braking block determines that the internal dc link voltage is too high it issues a Hold signal. This causes the SLEW RATE LIMIT block to hold the setpoint at its current value. This typically lasts for only 1ms, time for the excess energy to be dumped into the braking resistor.

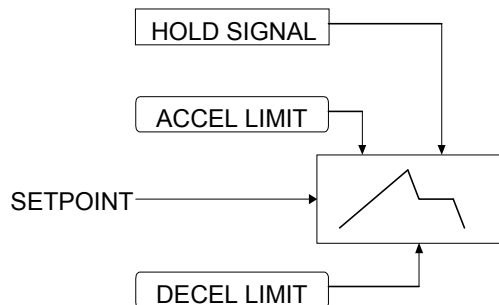

Note: *If the drive is part of a common DC link/bus system set the ENABLE parameter to FALSE. This disables ramp-hold during deceleration on high link volts feature.*

SLIP COMP

Designed for VOLTS/Hz motor Control Mode.

The slip compensation function block allows the Inverter to maintain motor speed in the presence of load disturbances.

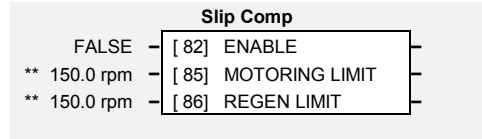

MMI Menu Map

- 1 SETUP
- 2 MOTOR CONTROL
- 3 SLIP COMP
 - ENABLE
 - MOTORING LIMIT
 - REGEN LIMIT

Parameter Descriptions

ENABLE

Range: FALSE / TRUE

For the slip compensation to be operational this must be TRUE.

MOTORING LIMIT

Range: 0.0 to 600.0 rpm

The maximum trim that will be produced by the slip compensation block when the motor is driving the load (motoring).

REGEN LIMIT

Range: 0.0 to 600.0 rpm

The maximum trim that will be produced by the slip compensation block when the motor is being driven by the load, (regenerating).

Functional Description

Based on the rated speed, the no load speed and the rated load of the motor, the slip compensation block adjusts the demand frequency to compensate for any speed slippage resulting from the load.

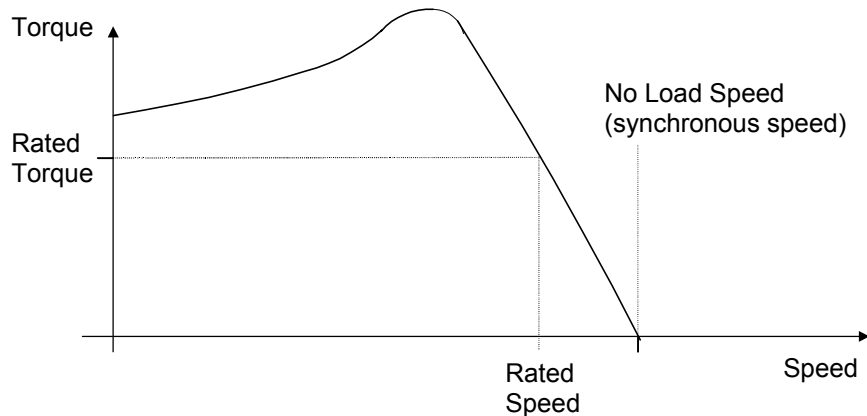

MMI Menu Map

- 1 SETUP
- 2 TRIPS
- 3 SPD FBK TRIP
 - INHIBIT
 - THRESHOLD
 - DELAY
 - TRIPPED

SPD FBK TRIP

Designed for CLOSED-LOOP VEC Motor Control Mode.

The speed feed back trip operates by looking at speed error and comparing it against THRESHOLD.

If the error exceeds this threshold for a period greater than DELAY, then a trip is triggered. The trip is only active while the drive is operating in Closed-Loop Vector Control and not in Autotune. When using the drive in torque control, this trip should be disabled to prevent nuisance tripping by setting INHIBIT to TRUE.

Torque control is defined as operating in torque or current limit, or if the TORQ DMD ISOLATE parameter in the SPEED LOOP function block is TRUE.

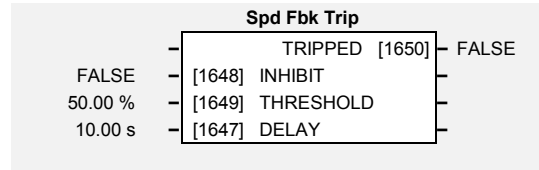

Parameter Descriptions

INHIBIT

Range: FALSE / TRUE

Set this parameter to TRUE to disable the speed feedback trip.

THRESHOLD

Range: 0.00 to 300.00 %

Sets a threshold below which the trip will not operate. The value of THRESHOLD is compared to the value of SPEED ERROR (from the SPEED LOOP function block).

DELAY

Range: 0.00 to 300.00 s

Sets the time the trip must be present for before a trip is triggered.

TRIPPED

Range: FALSE / TRUE

This is a diagnostic output indicating the current state of the speed feedback trip.

MMI Menu Map

1	SETUP
2	WINDER
3	SPEED CALC
	REWIND
	OVER-WIND
	OVER SPD ENABLE
	UTS THRESHOLD
	LINE SPEED
	MOD REEL SPEED
	DIAMETER
	MINIMUM DIAMETER
	OVER SPEED
	SPEED TRIM
	SPEED DEMAND
	UP TO SPD (UTS)

SPEED CALC

In this function block line speed is summed with the over speed input (only if in open-loop mode) and the closed loop trim (for closed loop winders) from the PID output SPEED TRIM. The combined speed demand is divided by the diameter to produce the SPEED DEMAND to the drive.

Refer to Macro 4.

Speed Calc			
	SPEED DEMAND	[784]	0.00 %
	UP TO SPD (UTS)	[785]	TRUE
TRUE	[774]	REWIND	
TRUE	[775]	OVER-WIND	
FALSE	[776]	OVER SPD ENABLE	
5.00 %	[777]	UTS THRESHOLD	
0.00 %	[778]	LINE SPEED	
0.00 %	[779]	MOD REEL SPEED	
10.00 %	[780]	DIAMETER	
10.00 %	[781]	MINIMUM DIAMETER	
10.00 %	[782]	OVER SPEED	
0.00 %	[783]	SPEED TRIM	

Parameter Descriptions

REWIND

Range: FALSE / TRUE

The Rewind mode is selected when TRUE.

OVER-WIND

Range: FALSE / TRUE

The Overwind mode is selected when TRUE.

OVER SPD ENABLE

Range: FALSE / TRUE

When TRUE, Over Speed is enabled which saturates the speed loop.

UTS THRESHOLD

Range: 0.00 to 110.00 %

Threshold level which defines the state of UP TO SPD (UTS).

LINE SPEED

Range: 0.00 to 110.00 %

Actual line speed (from the DIAMETER CALC function block).

MOD REEL SPEED

Range: 0.00 to 110.00 %

The absolute value of the WINDER SPEED (from the DIAMETER CALC function block).

DIAMETER

Range: 0.00 to 110.00 %

The diameter input (from the DIAMETER CALC function block).

MINIMUM DIAMETER

Range: 0.00 to 120.00 %

The minimum diameter input (from the DIAMETER CALC function block).

OVER SPEED

Range: -100.00 to 120.00 %

A value of over speed which, when added to the calculated speed, will saturate the speed loop.

SPEED TRIM

Range: -100.00 to 110.00 %

An additional speed loop input.

SPEED DEMAND

Range: —.00 %

The speed demand output.

UP TO SPD (UTS)

Range: FALSE / TRUE

The up-to-speed detector compares LINE SPEED with MOD REEL SPEED multiplied by DIAMETER. When they are the same, within the UTS THRESHOLD, then UP TO SPD (UTS) is TRUE.

Functional Description

The speed demand calculator takes its reference from the line speed setpoint.

The polarity is determined by OVER-WIND, this is positive for Over (OVER-WIND = TRUE).

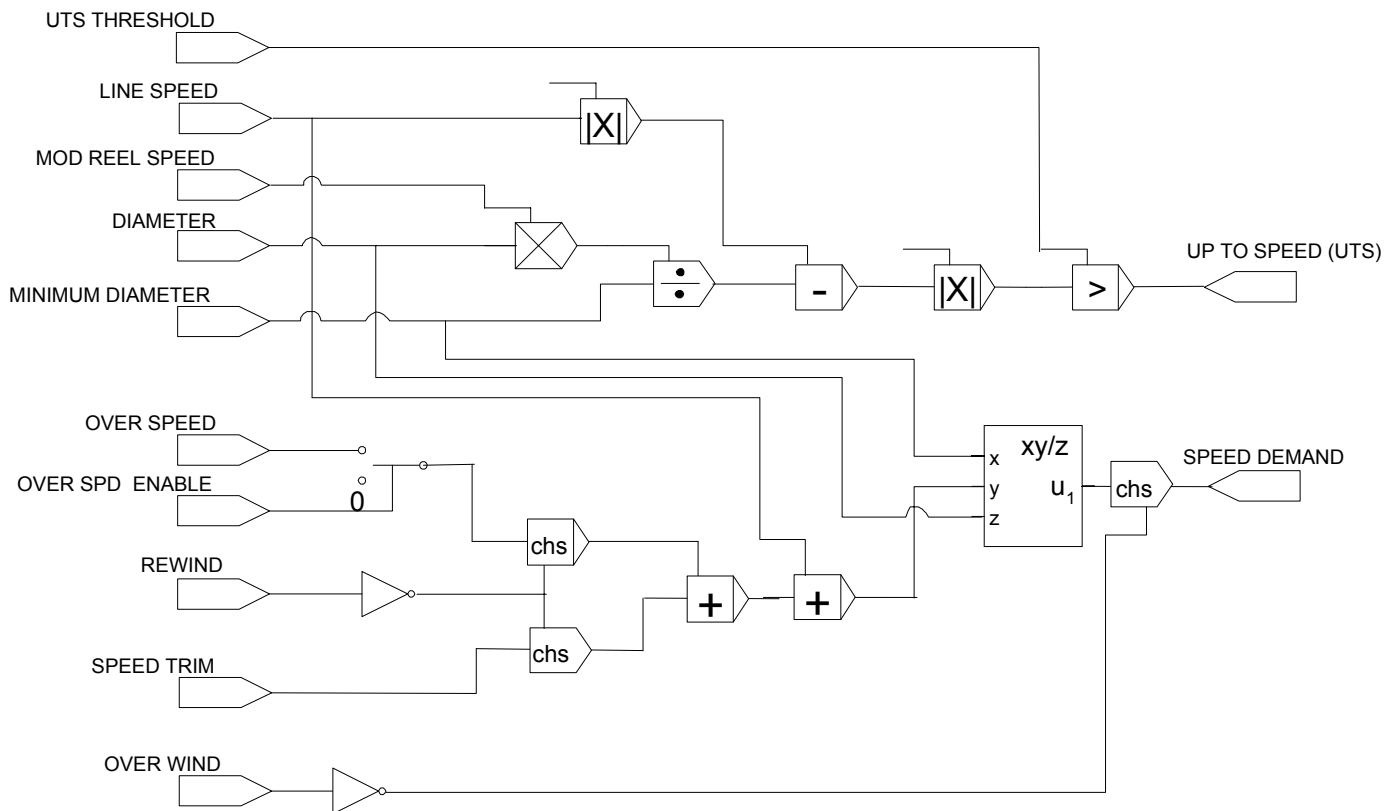

SPEED LOOP

Designed for SENSORLESS VEC and CLOSED-LOOP VEC Motor Control Modes.

This function block controls the speed of the motor by comparing the actual speed to the demanded speed, and applying more or less torque in response to the error.

Fixed Inputs and Outputs **Speed Demand**

This is connected to the output of the SETPOINT SCALE function block.

Speed Feedback

The speed feedback is derived from the encoder when the Control Mode is configured as CLOSED-LOOP VEC. When configured as SENSORLESS VEC, the speed feedback is calculated from the voltages and currents in the motor.

Torque Demand

The output of the SPEED LOOP function block is a torque demand. This torque demand is passed on to the TORQUE LIMIT function block, which causes the torque to be generated in the motor.

Parameter Descriptions

SPEED PROP GAIN

Range: 0.00 to 300.00

Sets the proportional gain of the loop.
Speed error (revolutions per second) x proportional gain = torque percent.

SPEED INT TIME

Range: 1 to 15000 ms

This is the integral time constant of the speed loop. A speed error which causes the proportional term to produce a torque demand T, will cause the integral term to also ramp up to a torque demand T after a time equal to "speed int time".

INT DEFEAT

Range: FALSE / TRUE

When TRUE, the integral term does not operate.

SPEED INT PRESET

Range: -500.00 to 500.00 %

The integral term will be preset to this value when the drive starts.

SPEED DMD FILTER

Range: 0.0 to 14.0 ms

The speed demand is filtered to reduce ripple. The filter is first order with time constant equal to the value of this parameter.

SPEED FBK FILTER

Range: 0.0 to 15.0 ms

The speed feedback is filtered to reduce ripple, such as that caused by low line count encoders. The filter is first order with time constant equal to the value of this parameter.

AUX TORQUE DMD

Range: -300.00 to 300.00 %

When the drive is operating in speed control mode, the value of this parameter is added on to the torque demand produced by the speed loop PI. When the drive is operating in torque control mode (i.e. "torque demand isolate is TRUE) the speed loop PI does not operate, and the torque demand becomes the sum of this parameter plus the DIRECT INPUT (if selected).

ADAPTIVE THRESH

Range: 0.00 to 10.00 %

This function is not implemented.

Speed Loop

-	TOTAL SPD DMD RPM	[1203]	0.00 RPM
-	TOTAL SPD DMD %	[1206]	0.00 %
-	SPEED ERROR	[1207]	0.00 %
-	TORQUE DEMAND	[1204]	0.00 %
-	DIRECT INPUT	[1205]	0.00 %
-	PHASE INPUT	[1397]	0.00 %
** 20.00	[1187]	SPEED PROP GAIN	
** 100 ms	[1188]	SPEED INT TIME	
FALSE	[1189]	INT DEFEAT	
0.00 %	[1190]	SPEED INT PRESET	
3.0 ms	[1191]	SPEED DMD FILTER	
1.5 ms	[1192]	SPEED FBK FILTER	
0.00 %	[1193]	AUX TORQUE DMD	
0.00 %	[1194]	ADAPTIVE THRESH	
0.00	[1195]	ADAPTIVE P-GAIN	
NONE	[1196]	DIRECT IP SELECT	
1.0000	[1197]	DIRECT RATIO	
110.00 %	[1198]	DIRCT IP POS LIM	
-110.00 %	[1199]	DIRCT IP NEG LIM	
110.00 %	[1200]	SPEED POS LIM	
-110.00 %	[1201]	SPEED NEG LIM	
FALSE	[1202]	TORQ DMD ISOLATE	

MMI Menu Map

1	SETUP
2	MOTOR CONTROL
3	SPEED LOOP
	SPEED PROP GAIN
	SPEED INT TIME
	INT DEFEAT
	SPEED INT PRESET
	SPEED DMD FILTER
	SPEED FBK FILTER
	AUX TORQUE DMD
	ADAPTIVE THRESH
	ADAPTIVE P-GAIN
	DIRECT IP SELECT
	DIRECT RATIO
	DIRCT IP POS LIM
	DIRCT IP NEG LIM
	SPEED POS LIM
	SPEED NEG LIM
	TORQ DMD ISOLATE
	TOTAL SPEED RPM
	TOTAL SPEED %
	SPEED ERROR
	TORQUE DEMAND
	DIRECT INPUT
	PHASE INPUT

ADAPTIVE P-GAIN

Range: 0.00 to 300.00

This function is not implemented.

DIRECT IP SELECT

Range: See below

The direct input to the speed loop is an analog input which is sampled synchronously with the speed loop. This ensures that the speed loop always has the most up-to-date value of the input, allowing it to respond faster. Any one of the four analog inputs can be selected as the direct input. If NONE is selected, the input is set to zero. When not in use, it should be disabled by selecting NONE.

- 0 : NONE
- 1 : ANIN 1
- 2 : ANIN 2
- 3 : ANIN 3
- 4 : ANIN 4

DIRECT RATIO

Range: -10.0000 to 10.0000

The Direct Input is multiplied by this parameter.

DIRCT IP POS LIM

Range: -110.00 to 110.00 %

This limits the upper value of the Direct Input.

DIRCT IP NEG LIM

Range: -110.00 to 110.00 %

This limits the lower value of the Direct Input.

SPEED POS LIM

Range: -110.00 to 110.00 %

This sets the upper limit of the speed demand.

SPEED NEG LIM

Range: -110.00 to 110.00 %

This sets the lower limit of the speed demand.

TORQ DMD ISOLATE

Range: FALSE / TRUE

Selects between Speed Control mode and Torque Control mode. When TRUE, (Torque Control mode) the torque demand output from the speed loop block is the sum of the Direct Input plus the AUX TORQUE DMD parameter.

TOTAL SPD DMD RPM

Range: —.xx rpm

This diagnostic shows the final values of the speed demand obtained after summing all sources. This is the value which is presented to the speed loop.

TOTAL SPD DMD %

Range: —.00 %

This diagnostic shows the final values of the speed demand obtained after summing all sources. This is the value which is presented to the speed loop.

SPEED ERROR

Range: —.00 %

Shows the difference between the demanded speed and the actual speed.

TORQUE DEMAND

Range: —.00 %

Shows the demanded motor torque as a percentage of rated motor torque.

DIRECT INPUT

Range: —.00 %

Shows the value of the Direct Input, after scaling and clamping.

PHASE INPUT

Range: —.00 %

Shows the value of the Phase PID Ouput connected internally.

Functional Description

The speed error (speed demand minus speed feedback) is calculated and processed via a proportional + integral (PI) controller. The output of the PI controller is a torque demand, which is passed directly to the torque control block.

The speed demand is derived from the Setpoint Scale block. The speed feedback is derived from the encoder when the drive is in CLOSED-LOOP VEC mode. This mode gives the best control, as the feedback is fast and accurate. When the drive is in SENSORLESS VEC mode, the speed feedback is calculated from the voltages and currents in the motor.

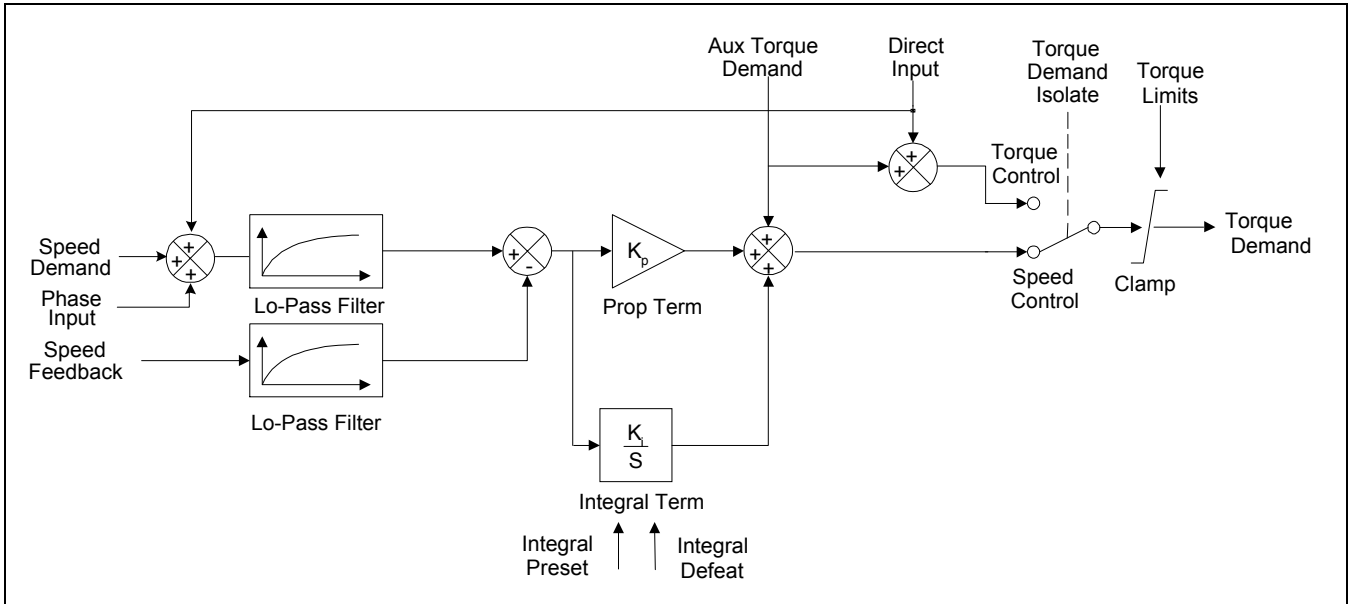

MMI Menu Map

- 1 SETUP
- 2 SETPOINT FUNCS
- 3 S-RAMP
 - INPUT
 - ACCELERATION
 - DECELERATION
 - JERK 1
 - JERK 2
 - JERK 3
 - JERK 4
 - CONTINUOUS
 - HOLD
 - RESET
 - RESET VALUE
 - OUTPUT
 - RAMPING

S-RAMP

This function block limits the rate of change of an input by limiting the acceleration and jerk.

Refer to REFERENCE RAMP, page 1-91.

An example acceleration graph for a velocity 60 %/s maximum, acceleration of 20 %/s² and a jerk of 10 %/s³ is shown below.

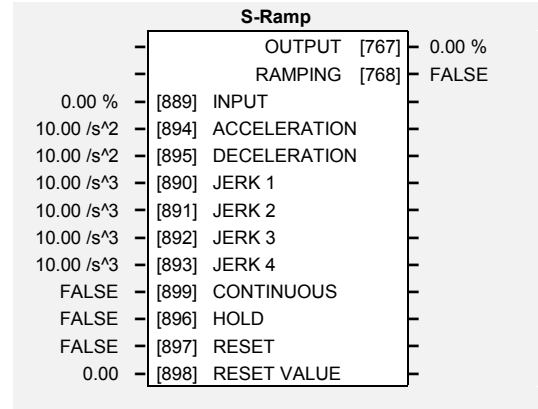

Parameter Descriptions

INPUT

Ramp input.

Range: -100.00 to 100.00 %

ACCELERATION

Sets the acceleration rate in units of percent per second², i.e. if the full speed of the machine is 1.25m/s then the acceleration will be: 1.25 x 75.00% = 0.9375m/s²

Range: 0.00 to 100.00 /s²

DECELERATION

This functions in the same way as ACCELERATION above.

Range: 0.00 to 100.00 /s²

JERK 1 to JERK 4

Rate of change of acceleration for the relevant segment of the curve, i.e. JERK 1 is for segment 1, etc.

Range: 0.00 to 100.00 /s³

CONTINUOUS

When TRUE, it forces a smooth transition if the speed point is changed when ramping. The curve is controlled by the ACCELERATION and JERK 1 to JERK 4 parameters. When FALSE, there is an immediate transition from the old curve to the new curve.

Range: FALSE / TRUE

HOLD

When TRUE, the output of the ramp is held at its last value.

Range: FALSE / TRUE

RESET

If TRUE, the output is made equal to the input.

Range: FALSE / TRUE

RESET VALUE

The value that the output is set to while RESET is TRUE.

Range: -100.00 to 100.00

OUTPUT

The ramp output.

Range: —.00 %

RAMPING

This is set TRUE when ramping.

Range: FALSE / TRUE

Functional Description

The time needed to stop or accelerate is: $t = \frac{V}{A} + \frac{A}{J}$ [Seconds]

As the speed is symmetrical, the average speed is V/2 therefore the stopping / acceleration distance can be calculated:

$$s = \frac{V}{2} \left[\frac{V}{A} + \frac{A}{J} \right] \text{ [Meters]}$$

V is the maximum speed the drive must reach. In % / sec.

A is the maximum allowable acceleration in %/sec².

J is the maximum allowable value for jerk, in %/sec³

Note: These only hold true if Jerk = Jerk2 for acceleration or Jerk 3 = Jerk 4 for deceleration.

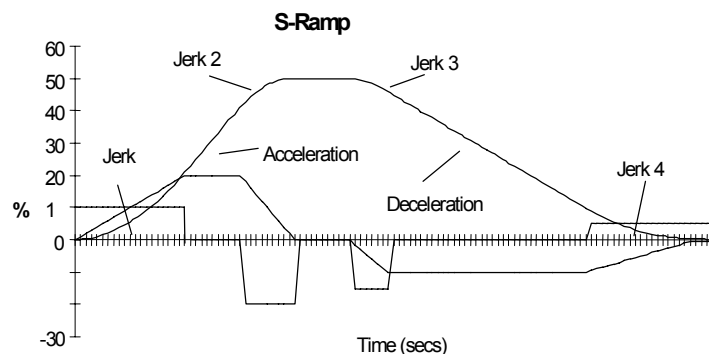

MMI Menu Map

- 1 SETUP
- 2 MOTOR CONTROL
- 3 STABILISATION
 - ENABLE

STABILISATION

Designed for VOLTS/Hz motor Control Mode.

Enabling this function reduces the problem of unstable running in induction motors. This can be experienced at approximately half full speed, and under low load conditions.

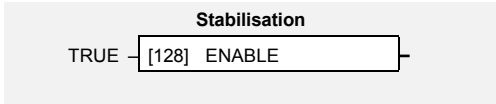

Parameter Descriptions

ENABLE

Enables (or disables) the stabilisation function.

Range: FALSE / TRUE

MMI Menu Map

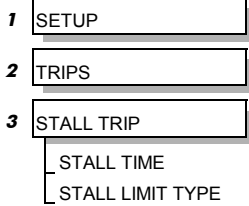

STALL TRIP

The function block protects the motor from damage that may be caused by continuous operation beyond specification.

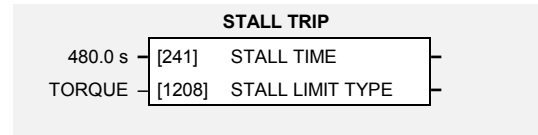

Parameter Descriptions

STALL TIME

Range: 0.1 to 3000.0 s

The time after which a stall condition will cause a trip.

STALL LIMIT TYPE

Range:

This parameter determines whether the stall trip operates on motor torque or motor current.

Enumerated Value : Stall Limit Type

0 : TORQUE

1 : CURRENT

Functional Description

If STALL LIMIT TYPE is set to TORQUE and the estimated load exceeds the active TORQUE LIMIT (refer to the TORQUE LIMIT function block) for a time greater than STALL TIME then the stall trip will become active. The timer is reset whenever the estimated load is less than the active Torque Limit.

Similarly, if the STALL LIMIT TYPE is set to CURRENT and the measured current exceeds the active Current limit (i.e. the drive is in current limit) for a time greater than STALL TIME then the stall trip will become active. The timer is reset whenever the measured current is less than the active Current Limit.

Refer to the Installation Product Manual, Chapter 6 for a description of the trips supported by the Inverter.

MMI Menu Map

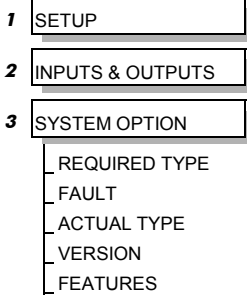

SYSTEM OPTION

This function block is used to select the System Board option required.

If a System Board is fitted, the block reports the type, version and working status of the option.

If a System Board is present when defaults are loaded, the REQUIRED TYPE parameter is automatically set.

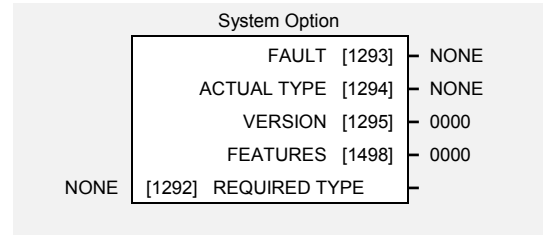

Parameter Descriptions

REQUIRED TYPE

Range: Enumerated - see below

Selects the type of System Board option required to be fitted for the application to operate correctly.

Enumerated Value : Option Type

- 0 : NONE
- 1 : DUAL ENCODER
- 2 : TYPE 2
- 3 : TYPE 3
- 4 : TYPE 4
- 5 : TYPE 5
- 6 : TYPE 6
- 7 : TYPE 7
- 8 : TYPE 8

FAULT

Range: Enumerated - see below

The fault state of the System Board Option.

Enumerated Value : Fault State

- 0 : NONE
- 1 : PARAMETER VALUE
- 2 : TYPE MISMATCH
- 3 : SELFTEST
- 4 : HARDWARE
- 5 : MISSING

ACTUAL TYPE

Range: 0000 to FFFF

The type of System Board option fitted.

Enumerated Value : Option Type

- 0 : NONE
- 1 : DUAL ENCODER
- 2 : TYPE 2
- 3 : TYPE 3
- 4 : TYPE 4
- 5 : TYPE 5
- 6 : TYPE 6
- 7 : TYPE 7
- 8 : TYPE 8

VERSION

Range: 0000 to FFFF

The version of the System Board Option. If no option is fitted, or it is faulty, then the version is reset to zero.

FEATURES

Range: 0000 to FFFF

A diagnostic bit field parameter indicating the features supported by the System Board.

Enumerated Value : Features

- Bit 0 : 12 BIT ANALOG IN (FALSE / TRUE)
- Bit 1 : DIGITAL IO (FALSE / TRUE)
- Bit 2 : ENCODER INPUTS (FALSE / TRUE)
- Bit 3 : MARK INPUTS (FALSE / TRUE)

MMI Menu Map

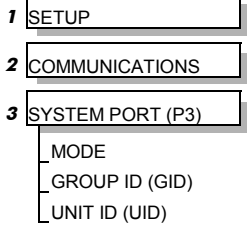

SYSTEM PORT (P3)

The unisolated RS232 programming port(s) allows for connection to the Operator Station, or to a personal computer for drive configuration and storage of parameters. The parameters below are used to identify the Inverter to the controlling software.

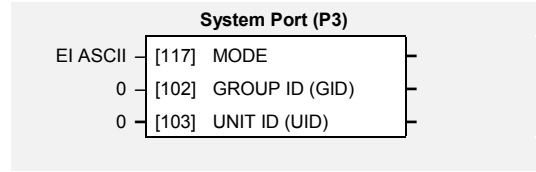

The port uses the Eurotherm standard EI BISYNCH ASCII protocol.

Parameter Descriptions

MODE

Range: 0 to 1

Selects the P3 port to operate with the Operator Station (EI ASCII), or a Eurotherm 5703 Setpoint Repeater.

This parameter must be set to 5703 for the 5703 INPUT and 5703 OUTPUT function blocks to operate. Refer to pages 1-7 and 1-8.

Note: The P3 port always operates in the EI ASCII mode when in Configuration Mode.

Enumerated Value : Mode

- 0 : EI ASCII
- 1 : 5703

GROUP ID (GID)

Range: 0 to 9

The Eurotherm protocol group identity address.

UNIT ID (UID)

Range: 0 to 15

The Eurotherm protocol unit identity address

Functional Description

The unit will always respond to GID = 0 and UID = 0, as this is the “broadcast” address used by the Operator Station.

Note: The Technology Option uses a different port and address. It does not respond to the “broadcast” address.

MMI Menu Map

1	SETUP
2	WINDER
3	TAPER CALC
	HYPERBOLIC TAPER
	STALL ENABLE
	BOOST ENABLE
	FIXED BOOST
	FIXED STALL TEN
	CURRENT CORE
	DIAMETER
	BOOST
	TENSION RAMP
	STALL TENSION
	TAPER SPT
	TENSION SPT
	TAPERED DEMAND
	TENSION DEMAND

TAPER CALC

This function block profiles tension demand with reel diameter for centre wind applications.

This special block processes the tension and taper set points to produce a composite tension demand value as the diameter builds.

The TENSION DEMAND value is used to set the motor current. This must be connected to the DIAMETER and MINIMUM DIAMETER parameters in the SPEED CALC function block.

Refer to Macro 4.

Taper Calc		
	TAPERED DEMAND [850]	0.00 %
	TENSION DEMAND [851]	0.00 %
TRUE	[838] HYPERBOLIC TAPER	
FALSE	[839] STALL ENABLE	
FALSE	[840] BOOST ENABLE	
FALSE	[841] FIXED BOOST	
FALSE	[842] FIXED STALL TEN	
0.00 %	[843] CURRENT CORE	
10.00 %	[844] DIAMETER	
0.00 %	[845] BOOST	
1.000 s	[846] TENSION RAMP	
50.00 %	[847] STALL TENSION	
0.00 %	[848] TAPER SPT	
0.00 %	[849] TENSION SPT	

Parameter Descriptions

HYPERBOLIC TAPER

Range: FALSE / TRUE

If set TRUE, a Hyperbolic Taper profile is applied which reduces the diameter more quickly near the core and less as the diameter approaches the full roll.

If set FALSE, a Linear Taper profile is applied which linearly reduces the tension as the diameter increases.

STALL ENABLE

Range: FALSE / TRUE

When TRUE, the tension demand is either:

STALL TENSION if FIXED STALL TEN is TRUE

or STALL TENSION x TENSION SPT if FIXED STALL TEN is FALSE

When FALSE, Stall Tension is disabled.

BOOST ENABLE

Range: FALSE / TRUE

When TRUE, the tension demand is either:

BOOST if FIXED BOOST is TRUE

or BOOST x TENSION SPT if FIXED BOOST is FALSE

When FALSE, Boost is disabled.

FIXED BOOST

Range: FALSE / TRUE

When TRUE and BOOST ENABLE is TRUE, then the tension demand is the value of BOOST.

FIXED STALL TEN

Range: FALSE / TRUE

When TRUE and STALL ENABLE is TRUE, then the tension demand is the value of STALL TENSION.

CURRENT CORE

Range: 0.00 to 120.00 %

The current core size (from the DIAMETER CALC function block).

DIAMETER

Range: 0.00 to 120.00 %

The calculated diameter (from the DIAMETER CALC function block).

BOOST

Range: -200.00 to 200.00 %

Sets a fixed boost, enabled by FIXED BOOST.

TENSION RAMP

The time taken for TENSION SPT to change from 0 to 100%.

Range: 0.000 to 300.000 s

STALL TENSION

Sets a fixed stall tension, enabled by FIXED STALL TEN.

Range: -100.00 to 100.00 %

TAPER SPT

The taper setpoint input.

Range: -100.00 to 100.00 %

TENSION SPT

The tension setpoint input.

Range: -200.00 to 200.00 %

TAPERED DEMAND

The tapered demand diagnostic.

Range: —.00 %

TENSION DEMAND

The tension demand diagnostic.

Range: —.00 %

Functional Description

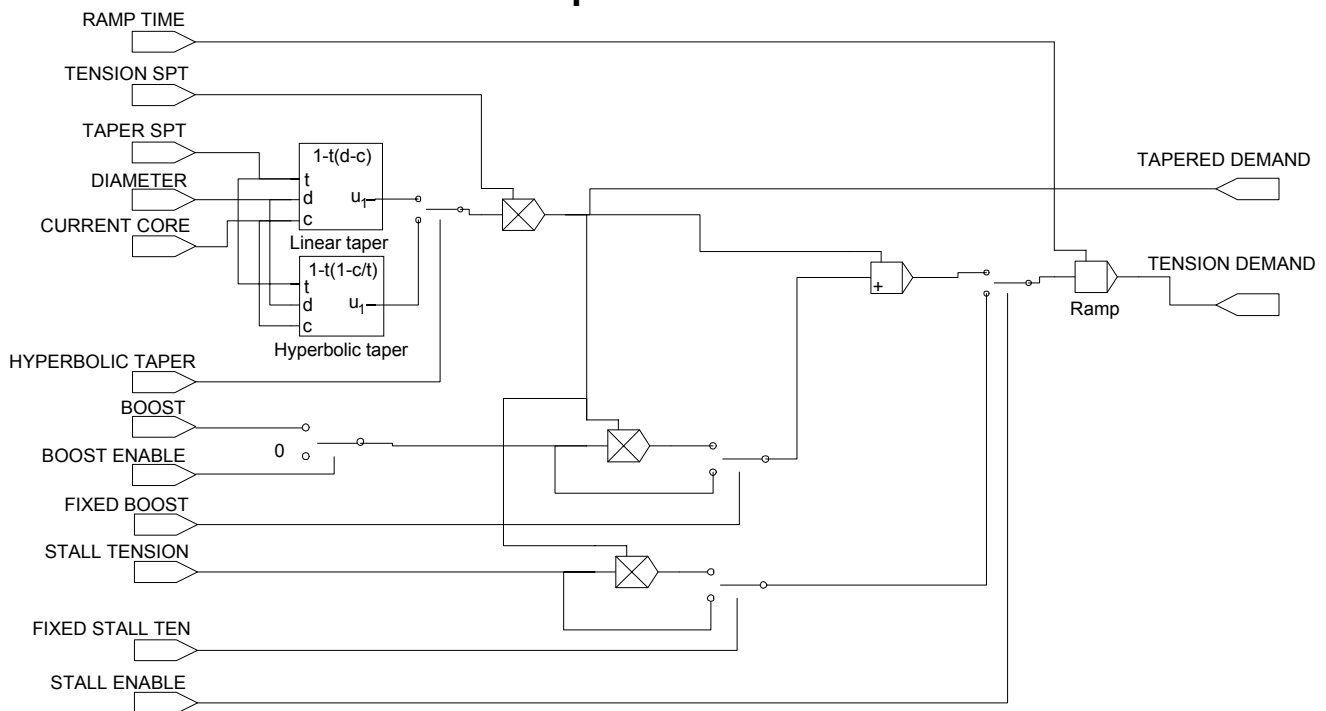

Hyperbolic Taper

A fixed hyperbolic taper characteristic is supplied with this block which gives the following tension characteristics:-

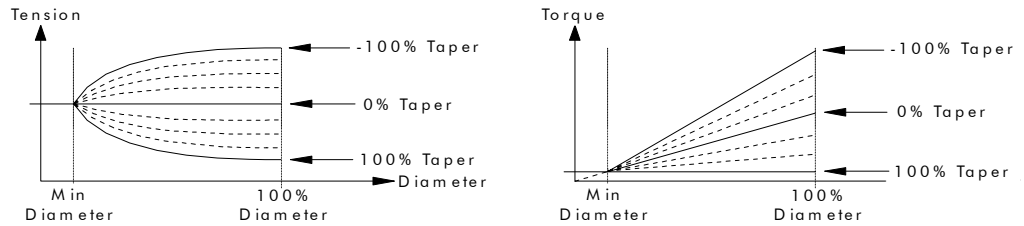

- If the Taper input is 0% this gives a constant tension characteristic with diameter.
- If the taper input is between 0 and 100%, this gives tension falling with increasing diameter. This is sometimes known as negative taper.
- If the taper input is between 0 and -100%, this gives tension rising with increasing diameter. This is sometimes known as positive taper.

All taper characteristics start at the tension setpoint, at minimum diameter.

The following equation shows the actual taper calculation (ignoring boost and stall).

$$\text{Tapered Demand} = \text{Tension Spt} \times \left\{ 100\% - \text{Taper} \times \left(1 - \frac{\text{Core}}{\text{Diameter}} \right) \right\}$$

Linear Taper

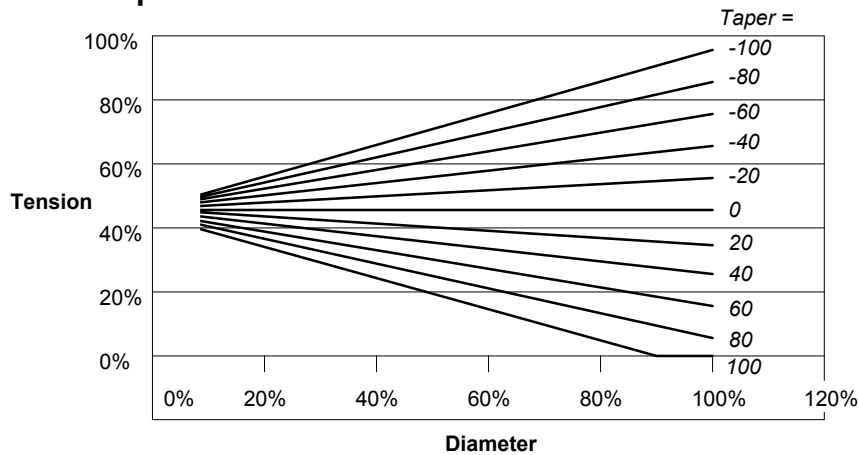

$$\text{Tapered Demand} = \text{Tension Spt} \times \{ 100\% - \text{Taper} \times (\text{Diameter} - \text{Core}) \}$$

MMI Menu Map

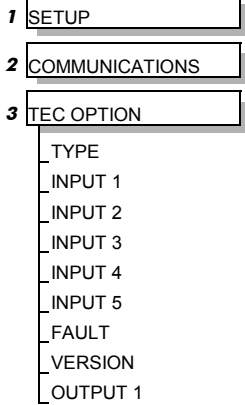

TEC OPTION

This function block is used to configure the various Technology Options that can be fitted. The Technology Option provides a communications interface for external control of the Inverter.

If a Technology Option is present when defaults are loaded, the TYPE parameter is automatically set. The parameter names change when the selection for the TYPE parameter matches the Technology Option fitted.

Refer to the appropriate Technology Option Technical Manual supplied with the option for further details.

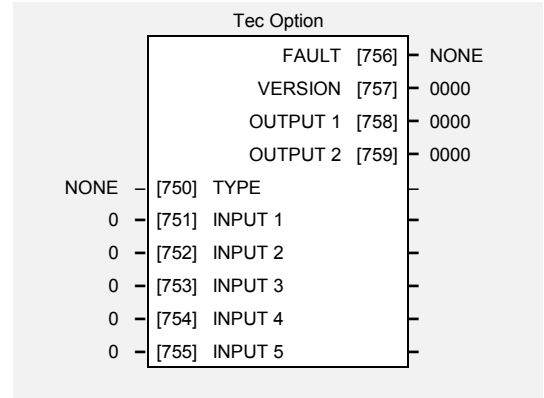

Parameter Descriptions

TYPE

Selects the type of Technology Option.

Range: Enumerated - see below

Enumerated Value : Technology Option

- 0 : NONE
- 1 : RS485
- 2 : PROFIBUS
- 3 : LINK
- 4 : DEVICE NET
- 5 : CAN OPEN
- 6 : LONWORKS
- 7 : CONTROLNET
- 8 : MODBUS PLUS
- 9 : ETHERNET
- 10 : TYPE 10
- 11 : TYPE 11
- 12 : TYPE 12
- 13 : TYPE 13
- 14 : TYPE 14
- 15 : TYPE 15

INPUT 1 to INPUT 5

The use of these input parameters depends on the type of Technology Option fitted. Refer to the Technology Option Technical Manual.

Range: -32768 to 32767

FAULT

The fault state of the Technology Option.

Range: Enumerated - see below

Enumerated Value : Fault State

- 0 : NONE
- 1 : PARAMETER VALUE
- 2 : TYPE MISMATCH
- 3 : SELFTEST
- 4 : HARDWARE
- 5 : MISSING

VERSION

The version of the Technology Option. If no option is fitted then the version is reset to zero.

Range: 0000 to FFFF

OUTPUT 1 and OUTPUT 2

The use of these output parameters depends on the type of Technology Option fitted. Refer to the Technology Option Technical Manual.

Range: 0000 to FFFF

TIMER

This block records the total time that an application has been running.

The function block maintains the elapsed time as a count of seconds. This value is updated at the function block execution period and is accurate to within one second. The elapsed time is preserved during the power-down of the drive.

MMI Menu Map

1	SETUP
2	MISCELLANEOUS
3	TIMER
	ENABLE
	RESET
	RESET VALUE
	SCALE
	THRESHOLD
	ABOVE THRESHOLD
	SCALED TIME
	TOTAL HOURS
	TOTAL SECONDS

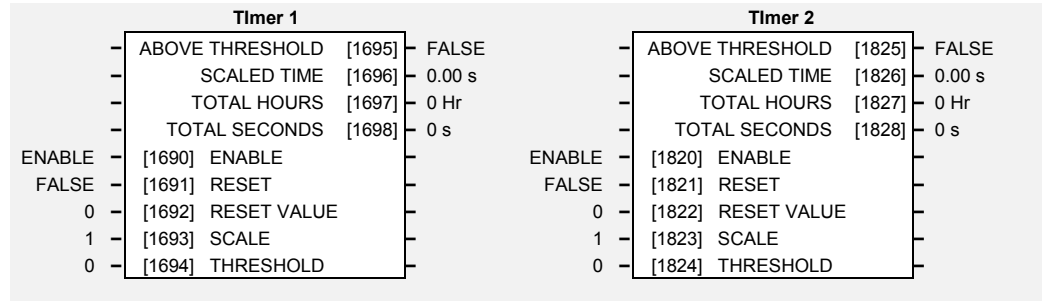

Parameter Descriptions

ENABLE

Range: ENABLE/HOLD

This input is used to enable counting. The block is enabled by default. If ENABLE is False, the elapsed time is held at the present value. When ENABLE is set True, the elapsed time continues to increment from the held value.

RESET

Range: FALSE / TRUE

This input is used to preset the elapsed time counter to a desired value. The default for RESET VALUE is 0, so setting RESET to True will set the elapsed time to 0. The RESET input is level sensitive, (not edge). Setting RESET to False has no effect.

RESET VALUE

Range: 1 to 214748364

This input is used to preset the elapsed time counter to a desired value. Setting RESET VALUE to say 30 and setting RESET to True will set the elapsed time to 30.

SCALE

Range: 0 to 2147483647

This input is used to generate the customised timer output called SCALED TIME.

THRESHOLD

Range: -2147483647 to +2147483647

The THRESHOLD input is used in conjunction with the ABOVE THRESHOLD output.

Set THRESHOLD to zero or a positive value and the elapsed time will count up to 2147483647 and then stop, (68 years).

This input may also be used to define the maximum value that the elapsed time may count up to. Set THRESHOLD to a negative value and the elapsed time will count up to the absolute value of THRESHOLD and then automatically reset to 0 and continue counting. The output will be held at the THRESHOLD value for one function block update period.

ABOVE THRESHOLD

Range: FALSE / TRUE

The ABOVE THRESHOLD Boolean output is set True when the elapsed time is greater than or equal to the absolute value of THRESHOLD.

SCALED TIME

Range: 0.00 to 32767.00

The result of TOTAL SECONDS / SCALE.

TOTAL HOURS

Range: 0 to 65535 Hr

The TOTAL HOURS output is elapsed time expressed in hours, with no fractional part. This is limited to 65535 hours, (7 ½ years), to allow reliable access using 16-bit fieldbus comms.

TOTAL SECONDS

Range: 0 to 2147483647 s

The TOTAL SECONDS output is the elapsed time expressed in seconds

Functional Description

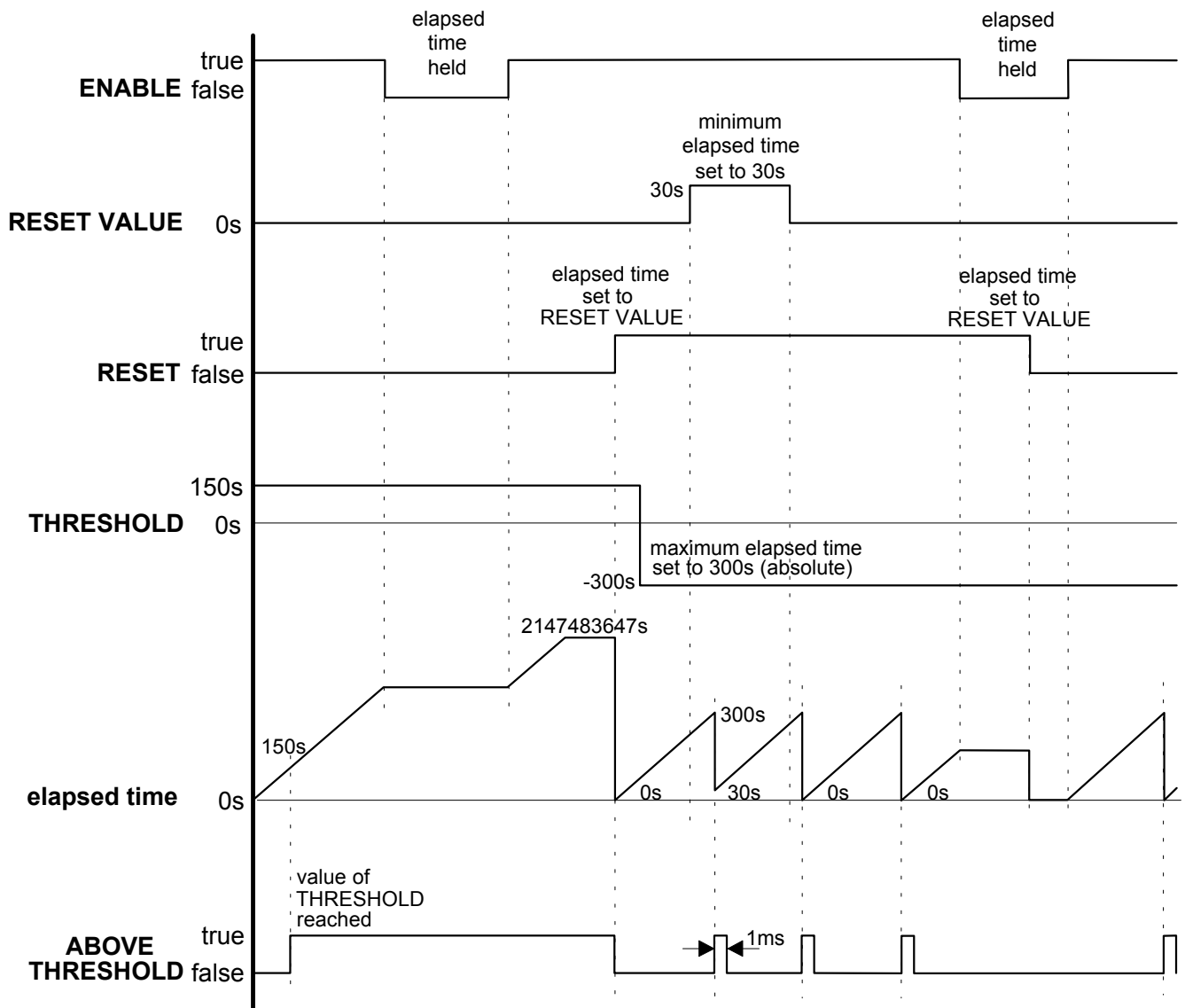

MMI Menu Map

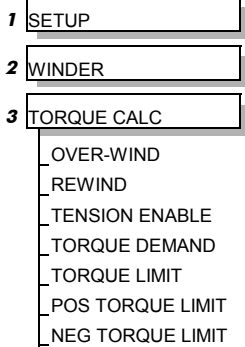

TORQUE CALC

This function block interfaces the calculated winder tension demand to the torque loop, for open-loop centre wind applications.

Refer to Macro 4.

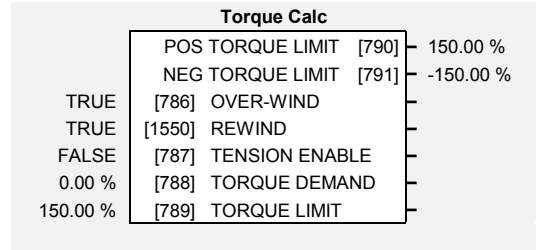

Parameter Descriptions

OVER-WIND

Overwind mode selected when TRUE.

Range: FALSE / TRUE

REWIND

The Rewind mode is selected when TRUE.

Range: FALSE / TRUE

TENSION ENABLE

Set FALSE, the drive is speed controlled with the speed compensated by the roll diameter to provide the roll surface speed matched to line speed. This also provides jog with constant surface speed. In this mode the diameter can be preset. This mode is used when the web is not connected to the winder.

Range: FALSE / TRUE

Set TRUE, the closed loop trim PID trim is enabled to maintain tension or dancer position. The diameter is calculated as the roll builds up (or builds down for an unwind).

TORQUE DEMAND

The tension demand input (usually calculated by the TAPER CALC function block).

Range: -200.00 to 200.00 %

TORQUE LIMIT

The torque limit applied when TENSION ENABLE is set FALSE.

Range: 0.00 to 200.00 %

POS TORQUE LIMIT

The positive torque limit when TENSION ENABLE is FALSE.

Range: —.00 %

NEG TORQUE LIMIT

The negative torque limit when TENSION ENABLE is FALSE.

Range: —.00 %

Functional Description

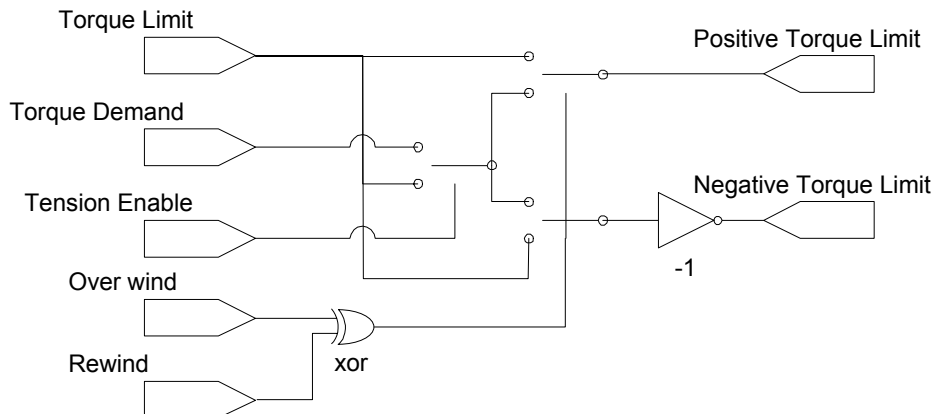

The torque calculator controls web tension by limiting the torque that the controller can produce, this must be used in conjunction with the SPEED CALC function block, which ensures that the speed loop is saturated.

This combination of saturated speed loop and torque limits ensures that, in the event of a web break, the reel will remain under speed control and be limited in speed to:

$$\text{calculated winder speed} + \text{over speed.}$$

TORQUE LIMIT

Designed for all Motor Control Modes.

Torque Limit		
	ACTUAL POS LIM [1212]	0.00 %
	ACTUAL NEG LIM [1213]	0.00 %
150.00 %	[1208] POS TORQUE LIM	
-150.00 %	[1209] NEG TORQUE LIM	
150.00 %	[1210] MAIN TORQUE LIM	
150.00 %	[1554] FAST STOP T-LIM	
FALSE	[1211] SYMMETRIC LIM	

MMI Menu Map

- 1 SETUP
- 2 MOTOR CONTROL
- 3 TORQUE LIMIT
 - POS TORQUE LIM
 - NEG TORQUE LIM
 - MAIN TORQUE LIM
 - FAST STOP T-LIM
 - SYMMETRIC LIM
 - ACTUAL POS LIM
 - ACTUAL NEG LIM

This function block allows you to set the maximum level of motor rated torque which is allowed before torque limit action occurs.

If the estimated motor torque is greater than the ACTUAL POS LIM value, the motor speed is controlled to maintain the torque at this level. A similar situation occurs if the estimated motor torque is less than the ACTUAL NEG LIM value.

The torque limit function block has separate positive and negative torque limits. In addition, a symmetric main torque limit is also provided.

The lowest positive and negative torque limits (including any current limit or inverse time current limit action) is indicated in the ACTUAL POS LIM and ACTUAL NEG LIM diagnostic. These are the final limits used to limit motor torque.

Parameter Descriptions

POS TORQUE LIM *Range: -300.00 to 300.00 %*

This parameter sets the maximum allowed level of positive motor torque.

NEG TORQUE LIM *Range: -300.00 to 300.00 %*

This parameter sets the maximum allowed level of negative motor torque.

MAIN TORQUE LIM *Range: 0.00 to 300.00 %*

This parameter sets the symmetric limit on the maximum allowed motor torque.

FAST STOP T-LIM *Range: 0.00 to 300.00 %*

This parameter sets the torque limit used during a Fast Stop.

SYMMETRIC LIM *Range: FALSE / TRUE/*

When TRUE, the NEG TORQUE LIM is forced to reflect the POS TORQUE LIM parameter.

ACTUAL POS LIM *Range: —.00 %*

This diagnostic indicates the final actual positive torque limit including any current limit or inverse time current limit action.

ACTUAL NEG LIM *Range: —.00 %*

This diagnostic indicates the final actual negative torque limit including any current limit or inverse time current limit action.

MMI Menu Map

1	SETUP
2	TRIPS
3	TRIPS HISTORY
	TRIP 1 (NEWEST)
	TRIP 2
	TRIP 3
	TRIP 4
	TRIP 5
	TRIP 6
	TRIP 7
	TRIP 8
	TRIP 9
	TRIP 10 (OLDEST)

TRIPS HISTORY

This function block records the last ten trips that caused the Inverter to stop.

To do this, it stores the value of the FIRST TRIP parameter, tag number 6, taken from the TRIPS STATUS function block.

TRIP 1 (NEWEST [500])	NO TRIP
TRIP 2 [501]	NO TRIP
TRIP 3 [502]	NO TRIP
TRIP 4 [503]	NO TRIP
TRIP 5 [504]	NO TRIP
TRIP 6 [505]	NO TRIP
TRIP 7 [506]	NO TRIP
TRIP 8 [507]	NO TRIP
TRIP 9 [508]	NO TRIP
TRIP 10 (OLDEST [509])	NO TRIP

Parameter Descriptions

TRIP 1 (NEWEST)

Range: Enumerated

Records the most recent trip that caused the Inverter to stop. The values that this (and the parameters below) may take are the same as tag number 6, FIRST TRIP, detailed in the TRIPS STATUS function block.

TRIP 2

Range: As above

Records the second most recent trip that caused the Inverter to stop.

TRIP 3

Range: As above

Records the third most recent trip that caused the Inverter to stop.

TRIP 4

Range: As above

Records the fourth most recent trip that caused the Inverter to stop.

TRIP 5

Range: As above

Records the fifth most recent trip that caused the Inverter to stop.

TRIP 6

Range: As above

Records the sixth most recent trip that caused the Inverter to stop.

TRIP 7

Range: As above

Records the seventh most recent trip that caused the Inverter to stop.

TRIP 8

Range: As above

Records the eighth most recent trip that caused the Inverter to stop.

TRIP 9

Range: As above

Records the ninth most recent trip that caused the Inverter to stop.

TRIP 10 (OLDEST)

Range: As above

Records the tenth most recent trip that caused the Inverter to stop.

Functional Description

This function block provides a view of the ten most recent trips that caused the Inverter to stop. Every time a new trip occurs this is entered as TRIP 1 (NEWEST and the other recorded trips are moved down. If more than ten trips have occurred since the Inverter was configured then only the ten most recent trips will be available for inspection.

These parameters are preserved through a power failure.

MMI Menu Map

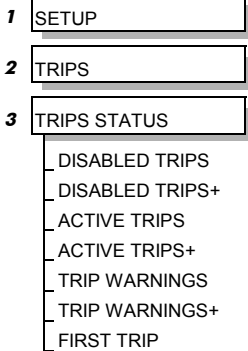

TRIPS STATUS

The Inverter supports advanced and flexible trip logic to support monitoring of the Inverter itself, the motor and the load. This function block provides a view into the current trip condition(s) and allows some trips to be disabled.

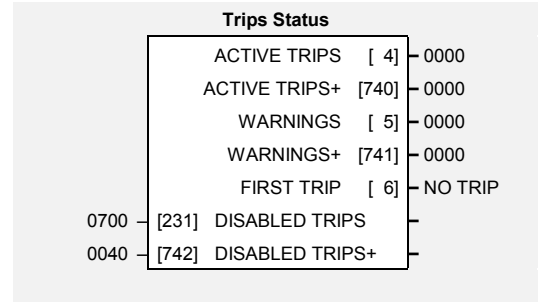

Parameter Descriptions

DISABLED TRIPS and DISABLED TRIPS+

Range: 0000 to FFFF

Indicates which trips have been disabled. Not all trips may be disabled, the DISABLED TRIPS mask is ignored for trips that cannot be disabled. See below for which trips may be disabled and how this parameter is formed.

ACTIVE TRIPS and ACTIVE TRIPS+

Range: 0000 to FFFF

Indicates which trips are currently active. These parameters are a coded representation of the trip status. See below for a description of how this parameter is formed.

WARNINGS and WARNINGS+

Range: 0000 to FFFF

Indicates which conditions are likely to cause a trip. These parameters are a coded representation of the warning status. See below for a description of how this parameter is formed.

FIRST TRIP

Range: Enumerated – see table below

From when a trip occurs until that trip is reset, this parameter indicates the trip source. When several trips have occurred, this parameter indicates the first one that was detected.

Functional Description

The tables below shows the possible parameter values for FIRST TRIP, and the TRIPS HISTORY function block.

The ACTIVE TRIPS, WARNINGS, DISABLED TRIPS, TRIGGERS 1 and TRIGGERS 2 parameters use a four digit hexadecimal number to identify individual trips. Each trip has a unique corresponding number as shown below.

Trip Name (MMI)	Value	Mask	User Disable	Auto-restart
NO TRIP	0	0x0000	N/A	N/A
OVERVOLTAGE	1	0x0001	No	Yes
UNDERVOLTAGE	2	0x0002	No	Yes
OVERCURRENT	3	0x0004	No	Yes
HEATSINK	4	0x0008	No	Yes
EXTERNAL TRIP	5	0x0010	No	Yes
INPUT 1 BREAK	6	0x0020	Yes	Yes
INPUT 2 BREAK	7	0x0040	Yes	Yes
MOTOR STALLED	8	0x0080	Yes	Yes
INVERSE TIME	9	0x0100	Yes	Yes
BRAKE RESISTOR	10	0x0200	Yes	Yes
BRAKE SWITCH	11	0x0400	Yes	Yes
OP STATION	12	0x0800	Yes	Yes
LOST COMMS	13	0x1000	Yes	Yes
CONTACTOR FBK	14	0x2000	Yes	Yes
SPEED FEEDBACK	15	0x4000	Yes	Yes
AMBIENT TEMP	16	0x8000	No	Yes
MOTOR OVERTEMP	17	0x0001	Yes	Yes
CURRENT LIMIT	18	0x0002	No	Yes

Trip Name (MMI)	Value	Mask +	User Disable	Auto-restart
TRIP 19 (Reserved)	19	0x0004	No	No
24V FAILURE	20	0x0008	Yes	Yes
LOW SPEED OVER I	21	0x0010	No	Yes
TRIP 22 (Reserved)	22	0x0020	No	No
ENCODER 1 FAULT	23	0x0040	Yes	Yes
DESAT (OVER I)	24	0x0080	No	Yes
VDC RIPPLE	25	0x0100	No	Yes
BRAKE SHORT CCT	26	0x0200	No	Yes
OVERSPEED	27	0x0400	Yes	Yes
TRIP 28 (Reserved)	28	0x0800	No	No
TRIP 29 (Reserved)	29	0x1000	No	No
TRIP 30 (Reserved)	30	0x2000	No	No
UNKNOWN	31	0x4000	No	Yes
OTHER	32	0x8000	No	Yes
MAX SPEED LOW	33	0x8000	N/A	N/A
MAINS VOLTS LOW	34	0x8000	N/A	N/A
NOT AT SPEED	35	0x8000	N/A	N/A
MAG CURRENT FAIL	36	0x8000	N/A	N/A
NEGATIVE SLIP F	37	0x8000	N/A	N/A
TR TOO LARGE	38	0x8000	N/A	N/A
TR TOO SMALL	39	0x8000	N/A	N/A
MAX RPM DATA ERR	40	0x8000	N/A	N/A
STACK TRIP	41	0x8000	N/A	N/A
LEAKGE L TIMEOUT	42	0x8000	N/A	N/A
POWER LOSS STOP	43	0x0002	No	Yes

The ACTIVE TRIPS+, WARNINGS+, DISABLED TRIPS+, TRIGGERS+ 1 and TRIGGERS+ 2 parameters use a four digit hexadecimal number to identify individual trips. Each trip has a unique corresponding number as shown below.

Decimal number	Display
10	A
11	B
12	C
13	D
14	E
15	F

Hexadecimal Representation of Trips

When more than one trip is to be represented at the same time then the trip codes are simply added together to form the value displayed. Within each digit, values between 10 and 15 are displayed as letters A to F

For example referring to the tables above, if the ACTIVE TRIPS parameter is **02A8**, then this represents:

- a “2” in digit 3
- an “8” and a “2” in digit 2
(8+2 = 10, displayed as A)
- an “8” in digit 1

This in turn represents the active trips BRAKE RESISTOR, MOTOR STALLED, INPUT 1 BREAK and HEATSINK TEMP, (an unlikely situation).

In the same way, the ACTIVE TRIPS + parameter displaying **02A8** would represent CURRENT LIMIT, DESAT (OVER I), TRIP 22 and 24V failure, (another unlikely situation).

Note: The hexadecimal value is used over comms, however, pressing the **M** key whilst displaying the hexadecimal trip value will show the list of all trips and their current values.

VALUE FUNCTION

The value function blocks can be configured to perform one of a number of functions upon a fixed number of inputs.

MMI Menu Map

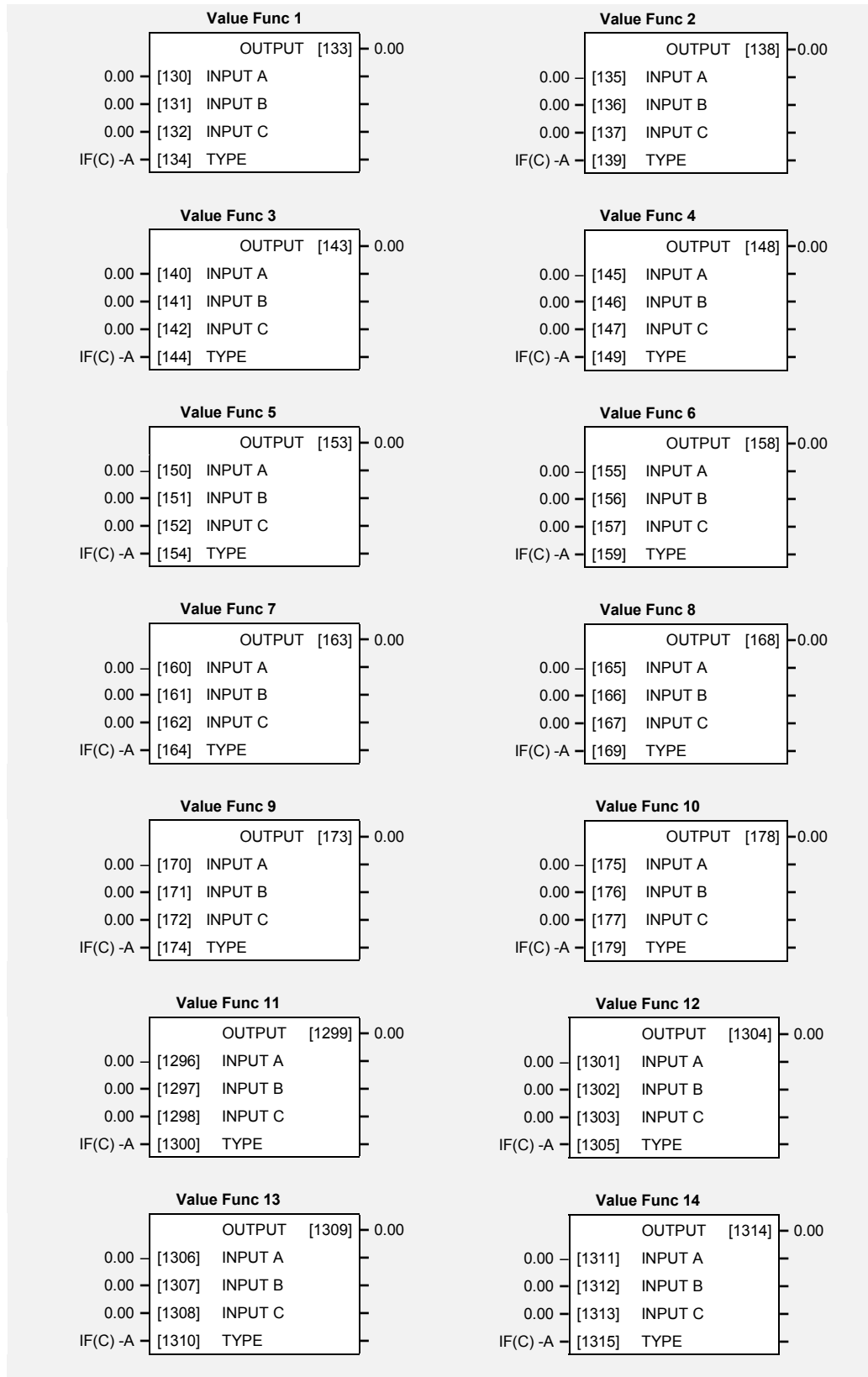
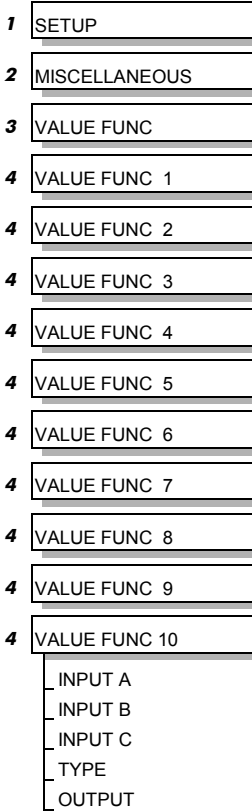

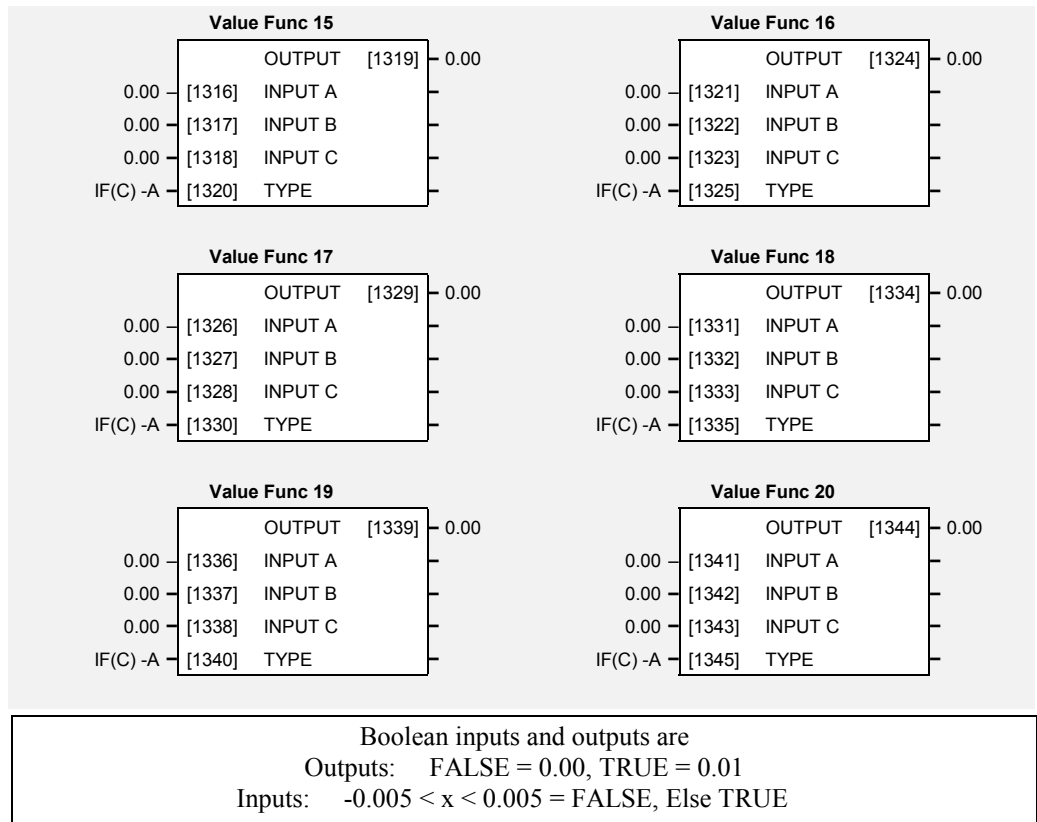

Parameter Descriptions

INPUT A

General purpose input.

Range: -32768.00 to 32767.00

INPUT B

General purpose input.

Range: -32768.00 to 32767.00

INPUT C

General purpose input.

Range: -32768.00 to 32767.00

TYPE

Range: Enumerated - see below

The operation to be performed on the three inputs to produce the output value.

Enumerated Value : Type

Enumerated Value : Type

0 : IF(C) -A

21 : (A*B)/C ROUND

1 : ABS(A+B+C)

22 : WINDOW NO HYST

2 : SWITCH(A,B)

23 : WINDOW B<=A<=C

3 : (A*B)/C

24 : A<=B

4 : A+B+C

25 : ((A*B)/100) + C

5 : A-B-C

26 : MIN (A,B,C)

6 : B<=A<=C

27 : MAX (A,B,C)

7 : A>B+/-C

28 : PROFILE SQRT

8 : A>=B

29 : PROFILE LINEAR

9 : ABS(A)>B+/-C

30 : PROFILE X^2

10 : ABS(A)>=B

31 : PROFILE X^3

11 : A(1+B)

32 : PROFILE X^4

12 : IF(C) HOLD(A)

13 : BINARY DECODE

14 : ON DELAY

15 : OFF DELAY

16 : TIMER

17 : MINIMUM PULSE

18 : PULSE TRAIN

19 : WINDOW

20 : UP/DWN COUNTER

OUTPUT

Range: —.xx

The result of performing the selected operation on the inputs.

Functional Description

OUTPUT is generated from the inputs according to the operation type selected. The output is always limited to be within the range -32768.00 to +32767.00.

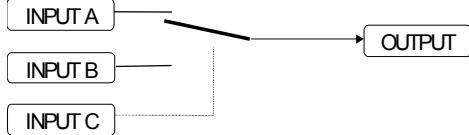
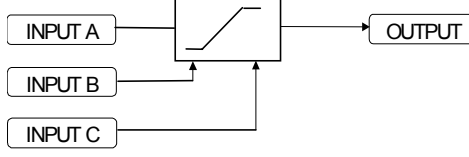
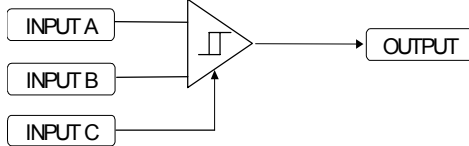
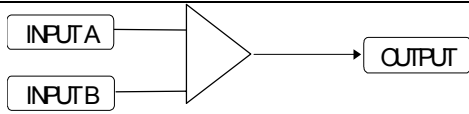
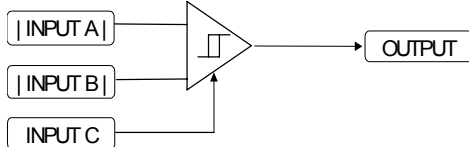
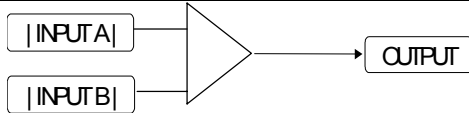
Operation	Description
IF(C) -A	If INPUT C is not zero the OUTPUT is minus INPUT A, otherwise the OUTPUT is the same as INPUT A.
ABS(A+B+C)	The OUTPUT is set to the absolute value of INPUT A + INPUT B + INPUT C.
SWITCH(A,B)	 <p>If INPUT C is zero the OUTPUT is set to INPUT A, otherwise the output is set to INPUT B</p>
(A*B)/C	The OUTPUT is set to (INPUT A * INPUT B) / (INPUT C). The algorithm compensates for the remainder term.
A+B+C	The OUTPUT is set to (INPUT A + INPUT B + INPUT C).
A-B-C	The OUTPUT is set to (INPUT A - INPUT B - INPUT C).
$B \leq A \leq C$	 <p>The OUTPUT is set to the value of INPUT A, limited to between a maximum value of INPUT C and a minimum value of INPUT B. If INPUT B is greater than INPUT C the output is undefined.</p>
$A > B +/- C$	 <p>The OUTPUT is TRUE if INPUT A is greater than INPUT B + INPUT C. The OUTPUT is FALSE if INPUT A is less than INPUT B - INPUT C.</p> <p>Otherwise the OUTPUT is unchanged. In this way the block acts as a simple comparator with a comparison level of INPUT B and a hysteresis band equal to +/- INPUT C.</p>
$A \geq B$	 <p>The OUTPUT is TRUE if INPUT A is greater than or equal to INPUT B, otherwise the OUTPUT is FALSE.</p>
$ABS(A) > ABS(B) +/- C$	 <p>The OUTPUT is TRUE if the magnitude of INPUT A is greater than or equal to the magnitude of INPUT B - INPUT C.</p> <p>The OUTPUT is FALSE if the magnitude of INPUT A is less than the magnitude of INPUT B + INPUT C. Otherwise the OUTPUT is unchanged. In this way the block acts as a magnitude comparator with a comparison level of INPUT B and a hysteresis band equal to +/- INPUT C.</p>
$ABS(A) \geq ABS(B)$	 <p>The OUTPUT is TRUE if the magnitude of INPUT A is greater than or equal to the magnitude of INPUT B, otherwise the OUTPUT is FALSE.</p>
A(1+B)	The OUTPUT is set to INPUT A + (INPUT A * INPUT B / 100.00).

Operation	Description
-----------	-------------

IF(C) HOLD A	<p>If INPUT C is zero, the OUTPUT is set to INPUT A, otherwise the OUTPUT is unchanged.</p> <p>On powering up the drive, the output will be pre-loaded with the last saved value of input B.</p>
--------------	--

BINARY DECODE	The OUTPUT is set according to which of the INPUTs are non-zero.
---------------	--

INPUT C	INPUT B	INPUT A	OUTPUT
0	0	0	0.00
0	0	≠0	1.00
0	≠0	0	2.00
0	≠0	≠0	3.00
≠0	0	0	4.00
≠0	0	≠0	5.00
≠0	≠0	0	6.00
≠0	≠0	≠0	7.00

In the above table, ≠0 indicates that the corresponding input is not zero.

ON DELAY

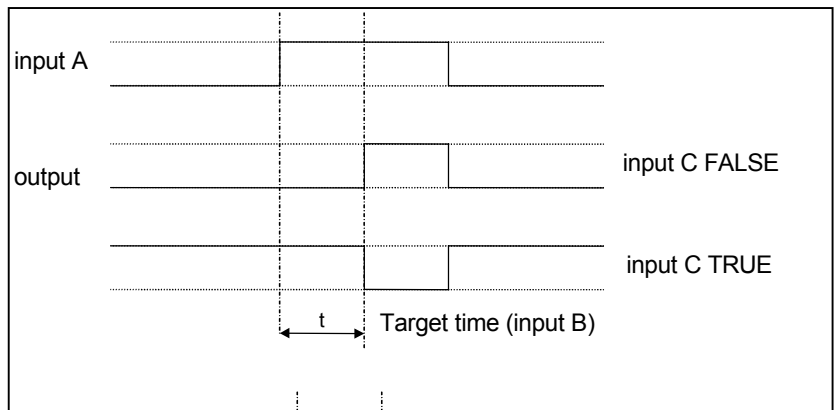

A programmable delay between receiving and outputting a Boolean TRUE signal.

INPUT A becoming TRUE starts the delay timer. INPUT B sets the duration of the delay in seconds (1 = 1 second). At the end of the duration, OUTPUT becomes TRUE unless INPUT A has reverted to FALSE. Setting INPUT C to TRUE (≠0) inverts the output.

OFF DELAY

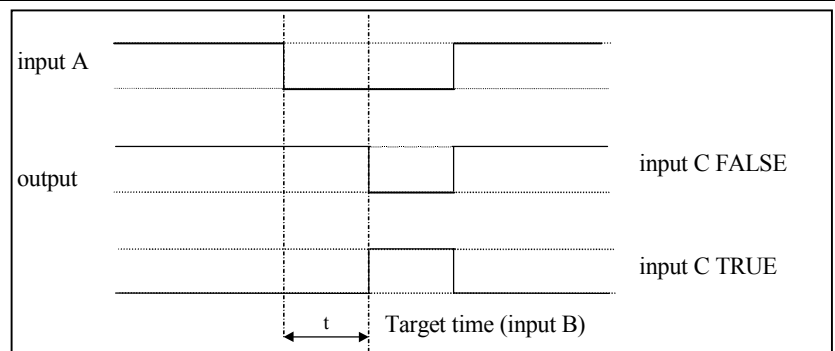

A programmable delay between receiving and outputting a Boolean FALSE signal.

INPUT A becoming FALSE starts the delay timer. INPUT B sets the duration of the delay in seconds (1 = 1 second). Setting INPUT C to TRUE (≠0) inverts the output. At the end of the duration, OUTPUT becomes FALSE unless INPUT A has reverted to TRUE.

1-130 Programming Your Application

Operation	Description
-----------	-------------

TIMER

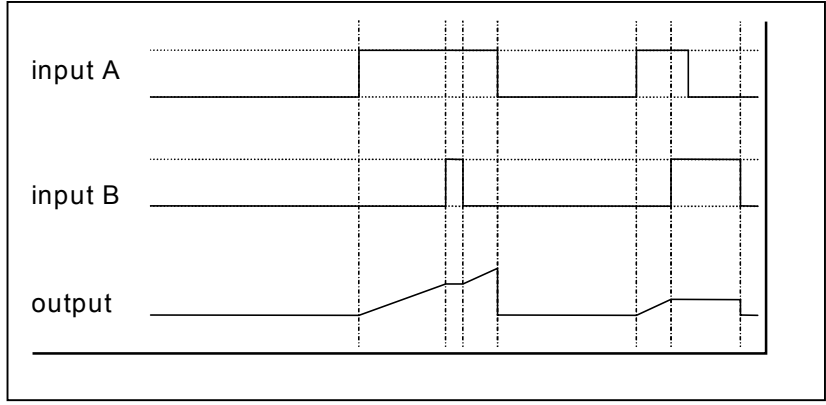

Times the period elapsed from when INPUT A is set TRUE and held TRUE, to when INPUT B becomes TRUE.

OUTPUT is the duration of the timer in seconds (1 = 1 second), starting from zero. If INPUT B is TRUE, the value for OUTPUT is held until INPUT B is released. If on release INPUT A is still TRUE, the timer will continue from the held value. Setting INPUT A and INPUT B to FALSE resets the timer.

INPUT C is not used.

MINIMUM PULSE

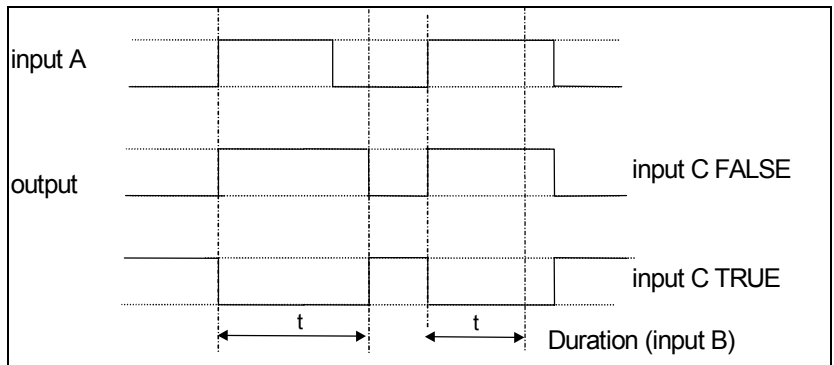

Creates an output of adjustable minimum time when INPUT A is TRUE. (INPUT A is assumed to be a sequence of TRUE pulses and FALSE off periods.)

INPUT B sets the length of the minimum pulse required in seconds (1 = 1 second). INPUT C inverts the output when TRUE. The duration of the pulse is *at least* the period set by INPUT B.

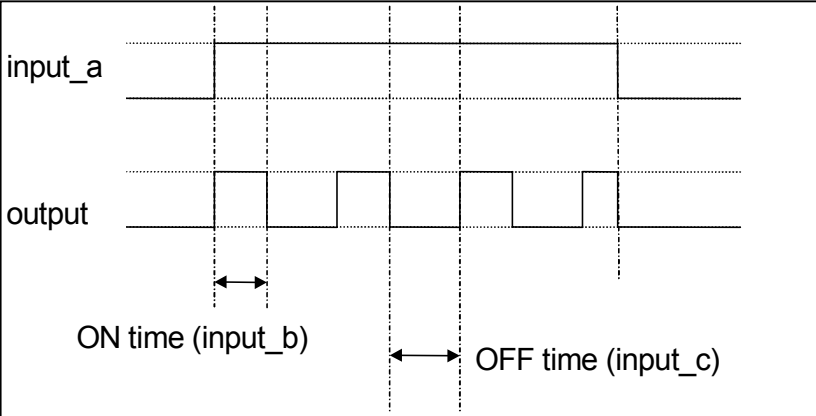
Operation	Description
PULSE TRAIN	

Creates a pulsed FALSE / TRUE output of programmable frequency.

INPUT A enables the pulse train when TRUE, disables when FALSE.

INPUT B sets the length of the *on* part of the pulse in seconds (1 = 1 second).

INPUT C sets the length of the *off* part of the pulse in seconds (1 = 1 second).

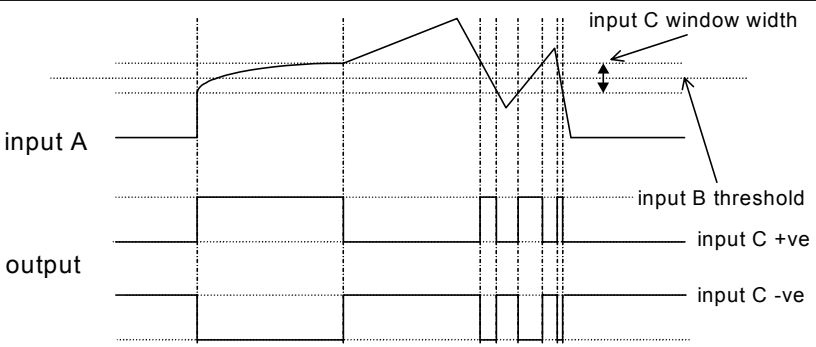
WINDOW	
--------	---

This function outputs TRUE when INPUT A is within a programmable range, and FALSE otherwise.

INPUT B sets the threshold of the window to be monitored. INPUT C defines the range of the window around the threshold. When the value of INPUT A is inside the window, the window expands by 0.01 to avoid flutter on output if noisy, i.e. if INPUT B = 5 and INPUT C = 4 then the range is 3 to 7, expanded to 2.5 to 7.5 when the value if INPUT A is inside the window.

If INPUT C is set to zero, the output will only be TRUE if INPUT A is exactly equal to INPUT B (this is fulfilled in the default condition when inputs A, B & C are all zero)

If INPUT C is set to a negative value, its absolute value defines the window range, and the output is inverted.

Operation	Description
UP/DOWN COUNTER	

INPUT A provides a rising edge trigger to increment the output count by one.

INPUT B provides a rising edge trigger to decrement the output count by one.

INPUT C holds the output at zero.

The output starts at zero. The output is limited at ± 300.00 .

(A*B)/C ROUND The OUTPUT is set to $(\text{INPUT A} * \text{INPUT B}) / (\text{INPUT C})$. This is the same as $(A*B)/C$ (enumerated value 3) except that the result is rounded.

WINDOW NO HYST This is the same as WINDOW (enumerated value 19) except that there is no hysteresis when inside the 'window'. Thus, from the diagram given in WINDOW, if INPUT B = 5 and INPUT C = 4 then the range is 3 to 7.

WINDOW B<=A<=C

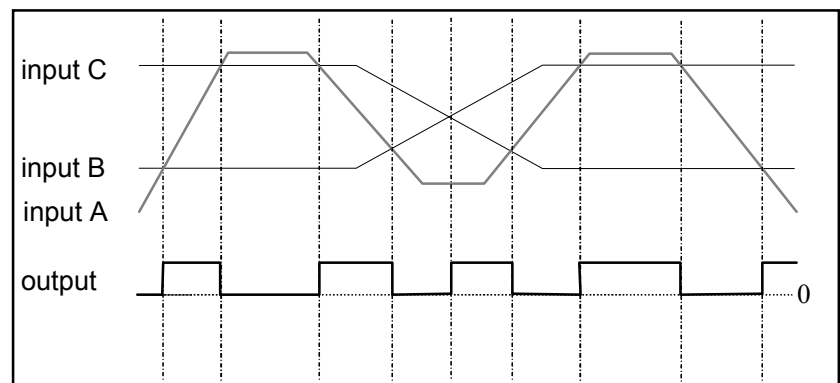

INPUT B and INPUT C are the upper and lower levels of the band.

If $B \leq C$ and A is in the band then the OUTPUT is TRUE, else OUTPUT is FALSE

If $C < B$ and A is in the band then the OUTPUT is FALSE, else OUTPUT is TRUE (i.e. output is inverted)

Note: OUTPUT is set to FALSE if the TYPE is changed or is in initialisation.

A<=B

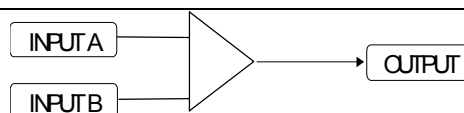

The OUTPUT is TRUE if INPUT A is less than or equal to INPUT B, otherwise the OUTPUT is FALSE.

((A*B)/100)+C

The OUPUT is set to $((\text{INPUT A} * \text{INPUT B})/100)+C$.

MIN (A,B,C)

The OUTPUT is set to the smallest of INPUT A, INPUT B and INPUT C.

MAX (A,B,C)

The OUTPUT is set to the largest of INPUT A, INPUT B and INPUT C.

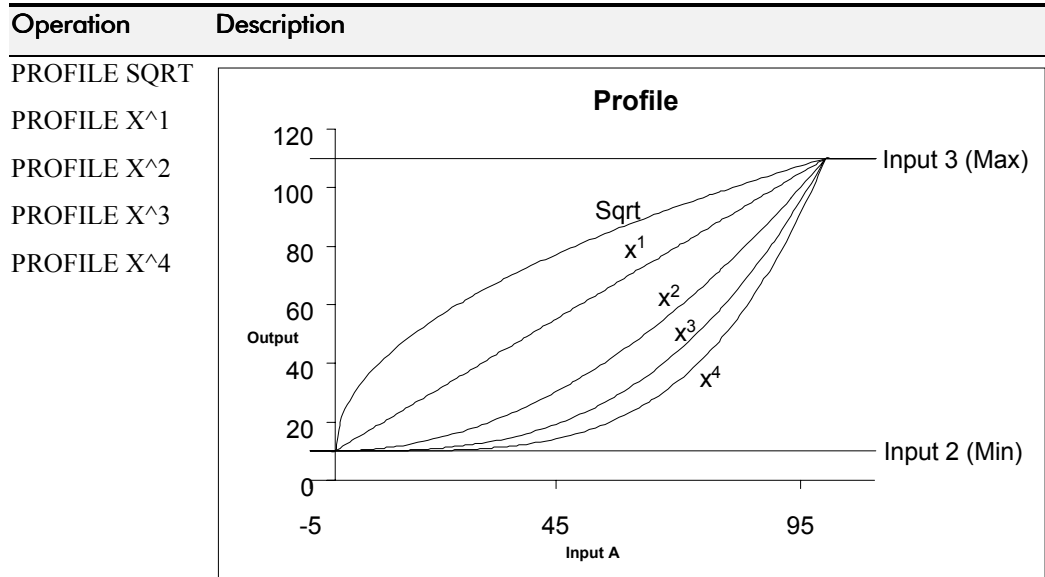

Example : Profile Min = 10, Max = 110

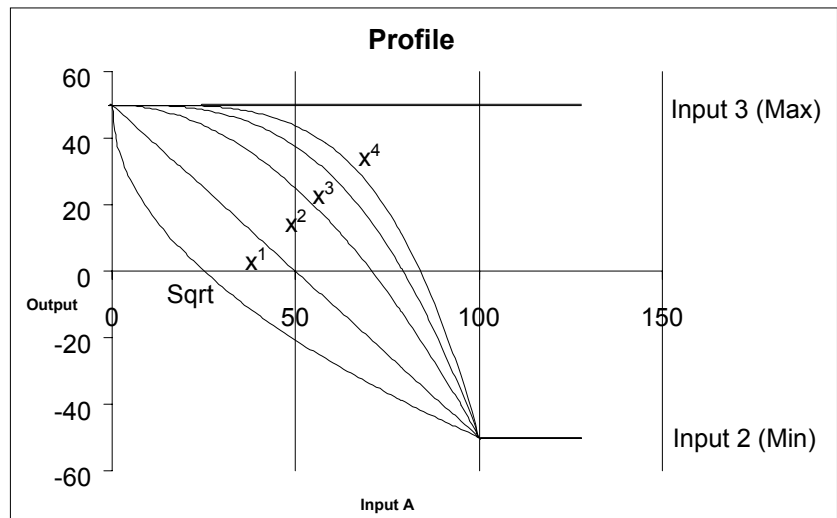

Example : Profile Min = 50, Max = -50

Profile functions convert an input (0-1) to an output with $(\text{min}) + ((\text{max}-\text{min}) * \text{fn}(\text{input}))$ where $\text{fn}()$ is Sqrt (square root), Linear (X^1), X^2 , X^3 or X^4 . The output is clamped between Min and Max. The input is clamped 0-100.

The profiles are calculated from 100 point tables and linearly interpreted between the points.

PROFILE SQRT	$y = \text{min} + (\text{max} - \text{min})x^{0.5}$
PROFILE X^1	$y = \text{min} + (\text{max} - \text{min})x$
PROFILE X^2	$y = \text{min} + (\text{max} - \text{min})x^2$
PROFILE X^3	$y = \text{min} + (\text{max} - \text{min})x^3$
PROFILE X^4	$y = \text{min} + (\text{max} - \text{min})x^4$

where INPUT A : Input x
 INPUT B : Min
 INPUT C : Max

VOLTAGE CONTROL

MMI Menu Map

- 1 SETUP
- 2 MOTOR CONTROL
- 3 VOLTAGE CONTROL
 - VOLTAGE MODE
 - BASE VOLTS

Designed for VOLTS/Hz motor Control Mode.

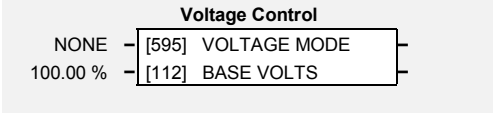

This function block allows the motor output volts to be controlled in the presence of dc link voltage variations. This is achieved by controlling the level of PWM modulation as a function of measured dc link volts. The dc link volts may vary either due to supply variations or regenerative braking by the motor.

Three control modes are available, None, Fixed and Automatic.

Parameter Descriptions

VOLTAGE MODE

Range: Enumerated - see below

Set to NONE, no attempt is made to control the PWM modulation depth for variations in dc link voltage.

Set to FIXED, the Inverter's output volts are maintained, regardless of variations in the dc link voltage. The Inverter's product code sets the default value for demanded maximum output voltage.

Set to AUTOMATIC, the voltage is controlled as above, but the output voltage is allowed to rise smoothly as dc link volts vary. This allows the motor to be overfluxed during deceleration, thereby increasing braking performance.

Enumerated Value : Voltage Mode

- 0 : NONE
- 1 : FIXED
- 2 : AUTOMATIC

BASE VOLTS

Range: 0.00 to 115.47 %

This parameter directly scales the output of the voltage control function block, thus allowing further scaling of the Inverter output volts if required.

Refer also to "Quadratic/Constant Torque Selection", page 1-136.

ZERO SPEED

This function block detects when the speed is at or close to zero. HYSTERESIS and THRESHOLD are user-definable.

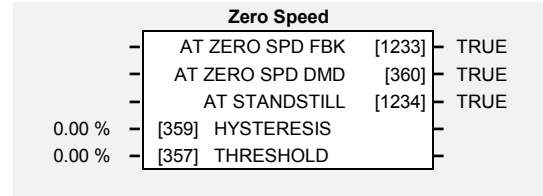

MMI Menu Map

- 1 SETUP
- 2 SETPOINT FUNCS
- 3 ZERO SPEED
 - HYSTERESIS
 - THRESHOLD
 - AT ZERO SPD FBK
 - AT ZERO SPD DMD
 - AT STANDSTILL

Parameter Descriptions

HYSTERESIS

Range: 0.00 to 300.00 %

Provides a hysteresis band about which the outputs are stable.

IF the hysteresis value is \geq to the Threshold
 THEN the level is set to 2 x the hysteresis value and the Off level is set to zero,
 ELSE the On level = Threshold + Hysteresis and the Off level = Threshold - Hysteresis.

THRESHOLD

Range: 0.00 to 300.00 %

The nominal level below which the outputs are set.

AT ZERO SPD FBK

Range: FALSE / TRUE

Speed feedback. TRUE when at zero speed feedback, as defined by THRESHOLD and HYSTERESIS.

IF $(\text{abs}(\text{speed feedback})) > \text{On Level at zero speed} = \text{FALSE}$
 ELSE if $(\text{abs}(\text{speed feedback})) \leq \text{Off Level at zero speed} = \text{TRUE}$
 ELSE at zero speed is unchanged

AT ZERO SPD DMD

Range: FALSE / TRUE

Speed demand. TRUE when at zero speed demand, as defined by THRESHOLD and HYSTERESIS.

AT STANDSTILL

Range: FALSE / TRUE

TRUE when both AT ZERO SPD FBK and AT ZERO SPD DMD are TRUE.

Functional Description

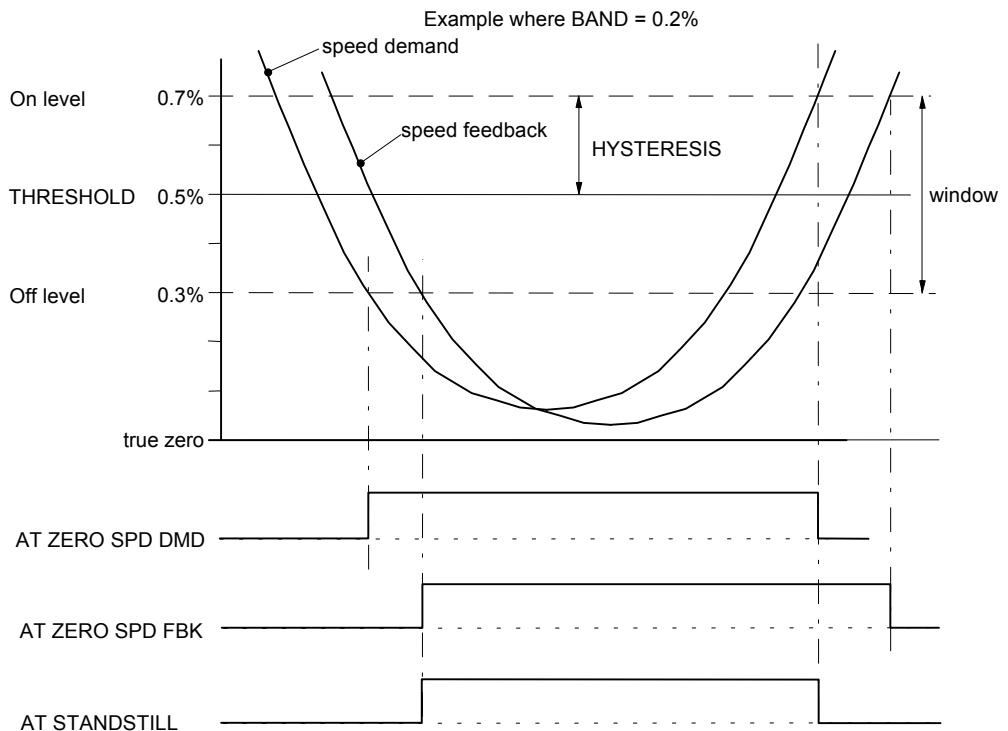

Quadratic/Constant Torque Selection

MMI Menu Map

- 1
-

When selecting or de-selecting Quadratic Torque mode, several parameter values and their limits are modified.

The parameters affected are shown in the table below.

or

MMI Menu Map

- 1
- 2
- 3
-

Note: When changing to or from Quadratic Torque mode, you will be requested to confirm your actions on the MMI. This is intended to remind you of the effects detailed below.

Change from CONSTANT TORQUE to QUADRATIC TORQUE			
Function Block	Parameter	Set to	Note
PATTERN GEN	FREQ SELECT	3 kHz	Cannot be changed
INVERSE TIME	DELAY	60.0 s	High Limit 60.0 s
INVERSE TIME	Max Overload Level	110.0 %	Internal Parameter
CURRENT LIMIT	CURRENT LIMIT	100.0 %	High Limit set 110.0 %
VOLTAGE CONTROL	BASE VOLTS	115.0 %	High Limit 115.47 %

Change from QUADRATIC TORQUE to CONSTANT TORQUE			
Function Block	Parameter	Set to	Note
PATTERN GEN	FREQ SELECT	3 kHz	Can be changed
INVERSE TIME	DELAY	60.0 s	High Limit 60.0 s
INVERSE TIME	Max Overload Level	150.0 %	Internal Parameter
CURRENT LIMIT	CURRENT LIMIT	150.0 %	High Limit set 150.0 %
VOLTAGE CONTROL	BASE VOLTS	100.0 %	High Limit 115.47 %

PARAMETER SPECIFICATION

The headings for the Tag No. table are described below.

Tag	A numeric identification of the parameter. It is used to identify the source and destinations of internal links.
Name	The parameter name as it appears on the MMI.
Block	The menu page and function block under which the parameter is stored.
Type	<p>REAL Floating point value</p> <p>INT Integer value</p> <p>BOOL A Boolean (bit) representing FALSE or TRUE</p> <p>ENUM An enumerated value representing a selection</p> <p>STRING An ASCII string</p> <p>TAG A value representing a choice of TAG</p> <p>D_TAG A value representing a choice of Destination tag as an internal link</p> <p>S_TAG A value representing a choice of Source tag as an internal link</p> <p>WORD 16 Bit hexadecimal number</p>
Range	<p>This varies with parameter type:</p> <p>REAL, INT The upper and lower limits of the parameter</p> <p>BOOL 0 = FALSE, 1 = TRUE</p> <p>ENUM A list of possible selections for that parameter</p> <p>STRING Specified number of characters</p> <p>TAG The tag number of any parameter</p> <p>D_TAG The tag number of an input parameter</p> <p>S_TAG The tag number of an input or output parameter.</p> <p>WORD 0000 to FFFF (hexadecimal), numbered lists show Bit numbers</p> <p>Note: Decimal Places: “—” signifies an indeterminable number of units. An “x” signifies a decimal place, e.g. —.xx % could represent 100.00 %.</p>
ID	Serial Communications Mnemonic: Refer to Chapter 3: “Serial Communications”
Notes	<p>You can record your application’s settings here.</p> <p>Output parameters are not saved in non-volatile memory unless indicated.</p> <ol style="list-style-type: none"> 1. This input parameter is not saved in non-volatile memory. 2. This parameter is automatically saved in non-volatile memory. 3. This parameter forms part of the motor configuration. 4. This parameter is not adjustable from the operator station. 5. This parameter cannot be the destination of a link. 6. This parameter cannot be the source of a link. 7. This input parameter can only be written to when the Inverter is stopped. 8. This input parameter can only be written to when the Inverter is in configuration mode. 9. This input parameter is not writable from serial comms. 10. This parameter uses special scaling rules when accessed using certain Comms options of the 6053 Technology Box. Refer to page 2-39.

2-2 Parameter Specification

Specification Table: Tag Name Order

TAG	MMI Name	Block
1835	1mS CYCLE RATE	PHASE CONFIGURE
79	1SEC OVER RATING	DYNAMIC BRAKING
1695	ABOVE THRESHOLD	TIMER 1
1825	ABOVE THRESHOLD	TIMER 2
48	ABSOLUTE	ANALOG OUTPUT 1
734	ABSOLUTE	ANALOG OUTPUT 2
803	ABSOLUTE	ANALOG OUTPUT 3
62	ACCEL LIMIT	SLEW RATE LIMIT
880	ACCEL TIME	LINEAR RAMP
1268	ACCEL TIME	POWER LOSS CNTRL
261	ACCEL TIME	REFERENCE JOG
258	ACCEL TIME	REFERENCE RAMP
1499	ACCELERATION	PHASE MOVE
1569	ACCELERATION	PHASE REGISTER
894	ACCELERATION	S-RAMP
1656	ACCELRTN BOOST	FLUXING
604	ACTIVE	AUTOTUNE
576	ACTIVE	FLYCATCHING
1469	ACTIVE	HOME
583	ACTIVE	INJ BRAKING
1503	ACTIVE	PHASE INCH
1509	ACTIVE	PHASE MOVE
1512	ACTIVE	PHASE OFFSET
1478	ACTIVE	PHASE TUNING
4	ACTIVE TRIPS	TRIPS STATUS
740	ACTIVE TRIPS+	TRIPS STATUS
1294	ACTUAL TYPE	SYSTEM OPTION
1195	ADAPTIVE P-GAIN	SPEED LOOP
1194	ADAPTIVE THRESH	SPEED LOOP
1500	ADVANCE	PHASE INCH
1148	AIMING POINT	INVERSE TIME
1234	AT STANDSTILL	ZERO SPEED
360	AT ZERO SPD DMD	ZERO SPEED
1233	AT ZERO SPD FBK	ZERO SPEED
613	ATTEMPT DELAY 1	AUTO RESTART
679	ATTEMPT DELAY 2	AUTO RESTART
612	ATTEMPTS	AUTO RESTART
614	ATTEMPTS LEFT	AUTO RESTART
108	AUTO BOOST	FLUXING
1193	AUX TORQUE DMD	SPEED LOOP
341	BAND 1	SKIP FREQUENCIES
680	BAND 2	SKIP FREQUENCIES
681	BAND 3	SKIP FREQUENCIES
682	BAND 4	SKIP FREQUENCIES
1159	BASE FREQUENCY	MOTOR DATA
739	BASE VOLTS	INJ BRAKING
845	BOOST	TAPER CALC
840	BOOST ENABLE	TAPER CALC
1678	BRAKE MODE	REGEN CNTRL
78	BRAKE POWER	DYNAMIC BRAKING
77	BRAKE RESISTANCE	DYNAMIC BRAKING
81	BRAKING	DYNAMIC BRAKING
1262	BREAK	5703 INPUT
18	BREAK	ANALOG INPUT 1
27	BREAK	ANALOG INPUT 2
717	BREAK	ANALOG INPUT 3
724	BREAK	ANALOG INPUT 4
12	BREAK ENABLE	ANALOG INPUT 1
21	BREAK ENABLE	ANALOG INPUT 2

TAG	MMI Name	Block
711	BREAK ENABLE	ANALOG INPUT 3
718	BREAK ENABLE	ANALOG INPUT 4
17	BREAK VALUE	ANALOG INPUT 1
26	BREAK VALUE	ANALOG INPUT 2
716	BREAK VALUE	ANALOG INPUT 3
723	BREAK VALUE	ANALOG INPUT 4
1644	CLOSE PRECHARGE	REGEN CNTRL
321	COEFFICIENT A	DISPLAY SCALE 1
375	COEFFICIENT A	DISPLAY SCALE 2
854	COEFFICIENT A	DISPLAY SCALE 3
862	COEFFICIENT A	DISPLAY SCALE 4
44	COEFFICIENT B	DISPLAY SCALE 1
673	COEFFICIENT B	DISPLAY SCALE 2
855	COEFFICIENT B	DISPLAY SCALE 3
863	COEFFICIENT B	DISPLAY SCALE 4
322	COEFFICIENT C	DISPLAY SCALE 1
376	COEFFICIENT C	DISPLAY SCALE 2
856	COEFFICIENT C	DISPLAY SCALE 3
864	COEFFICIENT C	DISPLAY SCALE 4
273	COMMS COMMAND	COMMS CONTROL
270	COMMS REF	COMMS CONTROL
295	COMMS SEQ	COMMS CONTROL
770	COMMS SETPOINT	REFERENCE
272	COMMS STATUS	COMMS CONTROL
309	COMMS TIMEOUT	COMMS CONTROL
817	COMPENSATIONS	COMPENSATION
339	CONFIG NAME	ACCESS CONTROL
1235	CONTACTOR CLOSED	SEQUENCING LOGIC
899	CONTINUOUS	S-RAMP
1267	CONTROL BAND	POWER LOSS CNTRL
1157	CONTROL MODE	MOTOR DATA
826	CORE 1	DIAMETER CALC
827	CORE 2	DIAMETER CALC
1631	CORRECTION GAIN	PHASE REGISTER
1465	CORRECTION LIMIT	HOME
1570	CORRECTIONS	PHASE REGISTER
1526	COUNTS PER UNIT	PHASE CONFIGURE
1684	COUNTS PER UNIT	POSITION
834	CURRENT CORE	DIAMETER CALC
843	CURRENT CORE	TAPER CALC
365	CURRENT LIMIT	CURRENT LIMIT
1521	D FILTER TC	PHASE PID
1255	D FILTER TC	PID (TYPE 2)
1518	D GAIN	PHASE PID
1252	D GAIN	PID (TYPE 2)
315	D TIME CONSTANT	PID
581	DC LEVEL	INJ BRAKING
75	DC LINK VOLTS	FEEDBACKS
579	DC PULSE	INJ BRAKING
1634	DC VOLTS DEMAND	REGEN CNTRL
1466	DECEL LIMIT	HOME
61	DECEL LIMIT	SLEW RATE LIMIT
881	DECEL TIME	LINEAR RAMP
1269	DECEL TIME	POWER LOSS CNTRL
262	DECEL TIME	REFERENCE JOG
259	DECEL TIME	REFERENCE RAMP
1468	DECELERATION	HOME
895	DECELERATION	S-RAMP
334	DECIMAL PLACE	DISPLAY SCALE 1
379	DECIMAL PLACE	DISPLAY SCALE 2
852	DECIMAL PLACE	DISPLAY SCALE 3
860	DECIMAL PLACE	DISPLAY SCALE 4
100	DEFLUX DELAY	PATTERN GEN
710	DEFLUX TIME	INJ BRAKING
1149	DELAY	INVERSE TIME
1647	DELAY	SPD FBK TRIP

Parameter Specification 2-3

TAG	MMI Name	Block
401	DESTINATION	LINK 1
419	DESTINATION	LINK 10
1739	DESTINATION	LINK 100
421	DESTINATION	LINK 11
423	DESTINATION	LINK 12
425	DESTINATION	LINK 13
427	DESTINATION	LINK 14
429	DESTINATION	LINK 15
431	DESTINATION	LINK 16
433	DESTINATION	LINK 17
435	DESTINATION	LINK 18
437	DESTINATION	LINK 19
403	DESTINATION	LINK 2
439	DESTINATION	LINK 20
441	DESTINATION	LINK 21
443	DESTINATION	LINK 22
445	DESTINATION	LINK 23
447	DESTINATION	LINK 24
449	DESTINATION	LINK 25
451	DESTINATION	LINK 26
453	DESTINATION	LINK 27
455	DESTINATION	LINK 28
457	DESTINATION	LINK 29
405	DESTINATION	LINK 3
459	DESTINATION	LINK 30
461	DESTINATION	LINK 31
463	DESTINATION	LINK 32
465	DESTINATION	LINK 33
467	DESTINATION	LINK 34
469	DESTINATION	LINK 35
471	DESTINATION	LINK 36
473	DESTINATION	LINK 37
475	DESTINATION	LINK 38
477	DESTINATION	LINK 39
407	DESTINATION	LINK 4
479	DESTINATION	LINK 40
481	DESTINATION	LINK 41
483	DESTINATION	LINK 42
485	DESTINATION	LINK 43
487	DESTINATION	LINK 44
489	DESTINATION	LINK 45
491	DESTINATION	LINK 46
493	DESTINATION	LINK 47
495	DESTINATION	LINK 48
497	DESTINATION	LINK 49
409	DESTINATION	LINK 5
499	DESTINATION	LINK 50
1401	DESTINATION	LINK 51
1403	DESTINATION	LINK 52
1405	DESTINATION	LINK 53
1407	DESTINATION	LINK 54
1409	DESTINATION	LINK 55
1411	DESTINATION	LINK 56
1413	DESTINATION	LINK 57
1415	DESTINATION	LINK 58
1417	DESTINATION	LINK 59
411	DESTINATION	LINK 6
1419	DESTINATION	LINK 60
1421	DESTINATION	LINK 61
1423	DESTINATION	LINK 62
1425	DESTINATION	LINK 63
1427	DESTINATION	LINK 64
1429	DESTINATION	LINK 65
1431	DESTINATION	LINK 66
1433	DESTINATION	LINK 67
1435	DESTINATION	LINK 68
1437	DESTINATION	LINK 69

TAG	MMI Name	Block
413	DESTINATION	LINK 7
1439	DESTINATION	LINK 70
1441	DESTINATION	LINK 71
1443	DESTINATION	LINK 72
1445	DESTINATION	LINK 73
1447	DESTINATION	LINK 74
1449	DESTINATION	LINK 75
1451	DESTINATION	LINK 76
1453	DESTINATION	LINK 77
1455	DESTINATION	LINK 78
1457	DESTINATION	LINK 79
415	DESTINATION	LINK 8
1459	DESTINATION	LINK 80
1701	DESTINATION	LINK 81
1703	DESTINATION	LINK 82
1705	DESTINATION	LINK 83
1707	DESTINATION	LINK 84
1709	DESTINATION	LINK 85
1711	DESTINATION	LINK 86
1713	DESTINATION	LINK 87
1715	DESTINATION	LINK 88
1717	DESTINATION	LINK 89
417	DESTINATION	LINK 9
1719	DESTINATION	LINK 90
1721	DESTINATION	LINK 91
1723	DESTINATION	LINK 92
1725	DESTINATION	LINK 93
1727	DESTINATION	LINK 94
1729	DESTINATION	LINK 95
1731	DESTINATION	LINK 96
1733	DESTINATION	LINK 97
1735	DESTINATION	LINK 98
1737	DESTINATION	LINK 99
805	DIAMETER	COMPENSATION
835	DIAMETER	DIAMETER CALC
780	DIAMETER	SPEED CALC
844	DIAMETER	TAPER CALC
821	DIAMETER HOLD	DIAMETER CALC
828	DIAMETER TC	DIAMETER CALC
1199	DIRCT IP NEG LIM	SPEED LOOP
1198	DIRCT IP POS LIM	SPEED LOOP
1205	DIRECT INPUT	SPEED LOOP
1196	DIRECT IP SELECT	SPEED LOOP
1197	DIRECT RATIO	SPEED LOOP
231	DISABLE TRIPS	TRIPS STATUS
742	DISABLE TRIPS+	TRIPS STATUS
1462	DISTANCE	HOME
1505	DISTANCE	PHASE MOVE
1463	DISTANCE FINE	HOME
1506	DISTANCE FINE	PHASE MOVE
1508	DISTANCE LEFT	PHASE MOVE
1470	DONE	HOME
1150	DOWN TIME	INVERSE TIME
276	DRIVE ENABLE	SEQUENCING LOGIC
591	DRIVE FREQUENCY	PATTERN GEN
814	DYNAMIC COMP	COMPENSATION
611	ENABLE	AUTO RESTART
603	ENABLE	AUTOTUNE
80	ENABLE	DYNAMIC BRAKING
1460	ENABLE	HOME
1580	ENABLE	PHASE AUTO GEAR
1504	ENABLE	PHASE MOVE
1520	ENABLE	PHASE PID
1564	ENABLE	PHASE REGISTER
311	ENABLE	PID
1254	ENABLE	PID (TYPE 2)
1265	ENABLE	POWER LOSS CNTRL

2-4 Parameter Specification

TAG	MMI Name	Block
60	ENABLE	SLEW RATE LIMIT
82	ENABLE	SLIP COMP
1690	ENABLE	TIMER 1
1820	ENABLE	TIMER 2
1645	ENABLE DRIVE	REGEN CNTRL
1476	ENABLE PHASE	PHASE TUNING
1474	ENABLE SPEED	PHASE TUNING
127	ENABLED KEYS	OP STATION 1
1109	ENABLED KEYS	OP STATION 2
1156	ENCODER	I/O TRIPS
1016	ENCODER COUNT	FEEDBACKS
1238	ENCODER FBK %	FEEDBACKS
1688	ENCODER FBK %	POSITION
1687	ENCODER FBK RPM	POSITION
567	ENCODER INVERT	FEEDBACKS
566	ENCODER LINES	FEEDBACKS
565	ENCODER MODE	FEEDBACKS
761	ENCODER SUPPLY	FEEDBACKS
1655	ENERGY SAVING	FLUXING
1607	ENERGY USED	ENERGY METER
1471	ERROR	HOME
1679	ERROR	PHASE PID
1573	ERROR	PHASE REGISTER
1247	ERROR	PID (TYPE 2)
1572	ERROR (COUNTS)	PHASE REGISTER
1467	ERROR COUNT	HOME
1513	ERROR unused	PHASE PID
829	EXT DIAMETER	DIAMETER CALC
1595	EXT MARK MASTER	PHASE AUTO GEAR
1596	EXT MARK SLAVE	PHASE AUTO GEAR
233	EXT TRIP MODE	I/O TRIPS
234	EXTERNAL TRIP	I/O TRIPS
1594	FALSE M MARKS	PHASE AUTO GEAR
1593	FALSE S MARKS	PHASE AUTO GEAR
620	FAN RUNNING	SEQUENCING LOGIC
275	FAST STOP LIMIT	REFERENCE STOP
304	FAST STOP MODE	REFERENCE STOP
264	FAST STOP TIME	REFERENCE STOP
1531	FAULT	PHASE CONFIGURE
1293	FAULT	SYSTEM OPTION
756	FAULT	TEC OPTION
1485	FDWWD SCALE	PHASE CONTROL
1498	FEATURES	SYSTEM OPTION
1680	FEED FWD	PHASE PID
1248	FEED FWD	PID (TYPE 2)
1515	FEED FWD GAIN	PHASE PID
1249	FEED FWD GAIN	PID (TYPE 2)
1514	FEED FWD unused	PHASE PID
764	FEEDBACK	PID
765	FEEDBACK NEGATE	PID
73	FIELD FEEDBACK	FEEDBACKS
1587	FILTER	PHASE AUTO GEAR
316	FILTER TC	PID
1537	FILTER TIME	ENCODER SPEED 1
1545	FILTER TIME	ENCODER SPEED 2
580	FINAL DC PULSE	INJ BRAKING
126	FINAL STOP RATE	REFERENCE STOP
6	FIRST TRIP	TRIPS STATUS
107	FIXED BOOST	FLUXING
841	FIXED BOOST	TAPER CALC
808	FIXED INERTIA	COMPENSATION
842	FIXED STALL TEN	TAPER CALC
125	FORMULA	DISPLAY SCALE 1
676	FORMULA	DISPLAY SCALE 2
853	FORMULA	DISPLAY SCALE 3
861	FORMULA	DISPLAY SCALE 4
99	FREQ SELECT	PATTERN GEN

TAG	MMI Name	Block
577	FREQUENCY	INJ BRAKING
342	FREQUENCY 1	SKIP FREQUENCIES
343	FREQUENCY 2	SKIP FREQUENCIES
344	FREQUENCY 3	SKIP FREQUENCIES
345	FREQUENCY 4	SKIP FREQUENCIES
1464	GAIN	HOME
313	GAIN	PID
1597	GEAR CORRECTION	PHASE AUTO GEAR
1483	GEARING A	PHASE CONTROL
1484	GEARING B	PHASE CONTROL
102	GROUP ID (GID)	SYSTEM PORT (P3)
274	HEALTHY	SEQUENCING LOGIC
101	HIGH LIMIT	DISPLAY SCALE 1
674	HIGH LIMIT	DISPLAY SCALE 2
857	HIGH LIMIT	DISPLAY SCALE 3
865	HIGH LIMIT	DISPLAY SCALE 4
1836	HIPER COUNTS/REV	PHASE CONFIGURE
590	HOLD	BRAKE CONTROL
884	HOLD	LINEAR RAMP
1581	HOLD	PHASE AUTO GEAR
260	HOLD	REFERENCE RAMP
896	HOLD	S-RAMP
838	HYPERBOLIC TAPER	TAPER CALC
359	HYSTERISIS	ZERO SPEED
1517	I GAIN	PHASE PID
1251	I GAIN	PID (TYPE 2)
314	I TIME CONSTANT	PID
1041	IGNORE PASSWORD	OPERATOR MENU 1
1076	IGNORE PASSWORD	OPERATOR MENU 10
1080	IGNORE PASSWORD	OPERATOR MENU 11
1084	IGNORE PASSWORD	OPERATOR MENU 12
1088	IGNORE PASSWORD	OPERATOR MENU 13
1092	IGNORE PASSWORD	OPERATOR MENU 14
1096	IGNORE PASSWORD	OPERATOR MENU 15
1100	IGNORE PASSWORD	OPERATOR MENU 16
1744	IGNORE PASSWORD	OPERATOR MENU 17
1749	IGNORE PASSWORD	OPERATOR MENU 18
1754	IGNORE PASSWORD	OPERATOR MENU 19
1044	IGNORE PASSWORD	OPERATOR MENU 2
1759	IGNORE PASSWORD	OPERATOR MENU 20
1764	IGNORE PASSWORD	OPERATOR MENU 21
1769	IGNORE PASSWORD	OPERATOR MENU 22
1774	IGNORE PASSWORD	OPERATOR MENU 23
1779	IGNORE PASSWORD	OPERATOR MENU 24
1784	IGNORE PASSWORD	OPERATOR MENU 25
1789	IGNORE PASSWORD	OPERATOR MENU 26
1794	IGNORE PASSWORD	OPERATOR MENU 27
1799	IGNORE PASSWORD	OPERATOR MENU 28
1804	IGNORE PASSWORD	OPERATOR MENU 29
1048	IGNORE PASSWORD	OPERATOR MENU 3
1809	IGNORE PASSWORD	OPERATOR MENU 30
1814	IGNORE PASSWORD	OPERATOR MENU 31
1819	IGNORE PASSWORD	OPERATOR MENU 32
1052	IGNORE PASSWORD	OPERATOR MENU 4
1056	IGNORE PASSWORD	OPERATOR MENU 5
1060	IGNORE PASSWORD	OPERATOR MENU 6
1064	IGNORE PASSWORD	OPERATOR MENU 7
1068	IGNORE PASSWORD	OPERATOR MENU 8
1072	IGNORE PASSWORD	OPERATOR MENU 9
578	I-LIM LEVEL	INJ BRAKING
1565	INCH OFFSET	PHASE REGISTER
818	INERTIA COMP	COMPENSATION
1648	INHIBIT	SPD FBK TRIP
610	INITIAL DELAY 1	AUTO RESTART
678	INITIAL DELAY 2	AUTO RESTART
1586	INITIAL FILTER	PHASE AUTO GEAR
1585	INITIAL REPEATS	PHASE AUTO GEAR

Parameter Specification 2-5

TAG	MMI Name	Block
1677	INITIAL STEP	POWER LOSS CNTRL
599	INPUT	DEMULTIPLEXER 1
874	INPUT	DEMULTIPLEXER 2
1101	INPUT	FILTER 1
1105	INPUT	FILTER 2
1461	INPUT	HOME
879	INPUT	LINEAR RAMP
336	INPUT	MINIMUM SPEED
58	INPUT	SETPOINT SCALE
340	INPUT	SKIP FREQUENCIES
889	INPUT	S-RAMP
641	INPUT 0	MULTIPLEXER 1
771	INPUT 0	MULTIPLEXER 2
347	INPUT 0	PRESET 1
380	INPUT 0	PRESET 2
390	INPUT 0	PRESET 3
510	INPUT 0	PRESET 4
521	INPUT 0	PRESET 5
532	INPUT 0	PRESET 6
543	INPUT 0	PRESET 7
554	INPUT 0	PRESET 8
642	INPUT 1	MULTIPLEXER 1
772	INPUT 1	MULTIPLEXER 2
348	INPUT 1	PRESET 1
381	INPUT 1	PRESET 2
391	INPUT 1	PRESET 3
511	INPUT 1	PRESET 4
522	INPUT 1	PRESET 5
533	INPUT 1	PRESET 6
544	INPUT 1	PRESET 7
555	INPUT 1	PRESET 8
751	INPUT 1	TEC OPTION
235	INPUT 1 BREAK	I/O TRIPS
651	INPUT 10	MULTIPLEXER 1
799	INPUT 10	MULTIPLEXER 2
652	INPUT 11	MULTIPLEXER 1
868	INPUT 11	MULTIPLEXER 2
653	INPUT 12	MULTIPLEXER 1
869	INPUT 12	MULTIPLEXER 2
654	INPUT 13	MULTIPLEXER 1
870	INPUT 13	MULTIPLEXER 2
655	INPUT 14	MULTIPLEXER 1
871	INPUT 14	MULTIPLEXER 2
656	INPUT 15	MULTIPLEXER 1
872	INPUT 15	MULTIPLEXER 2
643	INPUT 2	MULTIPLEXER 1
773	INPUT 2	MULTIPLEXER 2
349	INPUT 2	PRESET 1
382	INPUT 2	PRESET 2
392	INPUT 2	PRESET 3
512	INPUT 2	PRESET 4
523	INPUT 2	PRESET 5
534	INPUT 2	PRESET 6
545	INPUT 2	PRESET 7
556	INPUT 2	PRESET 8
752	INPUT 2	TEC OPTION
236	INPUT 2 BREAK	I/O TRIPS
644	INPUT 3	MULTIPLEXER 1
792	INPUT 3	MULTIPLEXER 2
350	INPUT 3	PRESET 1
383	INPUT 3	PRESET 2
393	INPUT 3	PRESET 3
513	INPUT 3	PRESET 4
524	INPUT 3	PRESET 5
535	INPUT 3	PRESET 6
546	INPUT 3	PRESET 7
557	INPUT 3	PRESET 8

TAG	MMI Name	Block
753	INPUT 3	TEC OPTION
645	INPUT 4	MULTIPLEXER 1
793	INPUT 4	MULTIPLEXER 2
351	INPUT 4	PRESET 1
384	INPUT 4	PRESET 2
394	INPUT 4	PRESET 3
514	INPUT 4	PRESET 4
525	INPUT 4	PRESET 5
536	INPUT 4	PRESET 6
547	INPUT 4	PRESET 7
558	INPUT 4	PRESET 8
754	INPUT 4	TEC OPTION
646	INPUT 5	MULTIPLEXER 1
794	INPUT 5	MULTIPLEXER 2
352	INPUT 5	PRESET 1
385	INPUT 5	PRESET 2
395	INPUT 5	PRESET 3
515	INPUT 5	PRESET 4
526	INPUT 5	PRESET 5
537	INPUT 5	PRESET 6
548	INPUT 5	PRESET 7
559	INPUT 5	PRESET 8
755	INPUT 5	TEC OPTION
647	INPUT 6	MULTIPLEXER 1
795	INPUT 6	MULTIPLEXER 2
353	INPUT 6	PRESET 1
386	INPUT 6	PRESET 2
396	INPUT 6	PRESET 3
516	INPUT 6	PRESET 4
527	INPUT 6	PRESET 5
538	INPUT 6	PRESET 6
549	INPUT 6	PRESET 7
560	INPUT 6	PRESET 8
648	INPUT 7	MULTIPLEXER 1
796	INPUT 7	MULTIPLEXER 2
354	INPUT 7	PRESET 1
387	INPUT 7	PRESET 2
397	INPUT 7	PRESET 3
517	INPUT 7	PRESET 4
528	INPUT 7	PRESET 5
539	INPUT 7	PRESET 6
550	INPUT 7	PRESET 7
561	INPUT 7	PRESET 8
649	INPUT 8	MULTIPLEXER 1
797	INPUT 8	MULTIPLEXER 2
650	INPUT 9	MULTIPLEXER 1
798	INPUT 9	MULTIPLEXER 2
180	INPUT A	LOGIC FUNC 1
225	INPUT A	LOGIC FUNC 10
1346	INPUT A	LOGIC FUNC 11
1351	INPUT A	LOGIC FUNC 12
1356	INPUT A	LOGIC FUNC 13
1361	INPUT A	LOGIC FUNC 14
1366	INPUT A	LOGIC FUNC 15
1371	INPUT A	LOGIC FUNC 16
1376	INPUT A	LOGIC FUNC 17
1381	INPUT A	LOGIC FUNC 18
1386	INPUT A	LOGIC FUNC 19
185	INPUT A	LOGIC FUNC 2
1391	INPUT A	LOGIC FUNC 20
190	INPUT A	LOGIC FUNC 3
195	INPUT A	LOGIC FUNC 4
200	INPUT A	LOGIC FUNC 5
205	INPUT A	LOGIC FUNC 6
210	INPUT A	LOGIC FUNC 7
215	INPUT A	LOGIC FUNC 8
220	INPUT A	LOGIC FUNC 9

2-6 Parameter Specification

TAG	MMI Name	Block
130	INPUT A	VALUE FUNC 1
175	INPUT A	VALUE FUNC 10
1296	INPUT A	VALUE FUNC 11
1301	INPUT A	VALUE FUNC 12
1306	INPUT A	VALUE FUNC 13
1311	INPUT A	VALUE FUNC 14
1316	INPUT A	VALUE FUNC 15
1321	INPUT A	VALUE FUNC 16
1326	INPUT A	VALUE FUNC 17
1331	INPUT A	VALUE FUNC 18
1336	INPUT A	VALUE FUNC 19
135	INPUT A	VALUE FUNC 2
1341	INPUT A	VALUE FUNC 20
140	INPUT A	VALUE FUNC 3
145	INPUT A	VALUE FUNC 4
150	INPUT A	VALUE FUNC 5
155	INPUT A	VALUE FUNC 6
160	INPUT A	VALUE FUNC 7
165	INPUT A	VALUE FUNC 8
170	INPUT A	VALUE FUNC 9
181	INPUT B	LOGIC FUNC 1
226	INPUT B	LOGIC FUNC 10
1347	INPUT B	LOGIC FUNC 11
1352	INPUT B	LOGIC FUNC 12
1357	INPUT B	LOGIC FUNC 13
1362	INPUT B	LOGIC FUNC 14
1367	INPUT B	LOGIC FUNC 15
1372	INPUT B	LOGIC FUNC 16
1377	INPUT B	LOGIC FUNC 17
1382	INPUT B	LOGIC FUNC 18
1387	INPUT B	LOGIC FUNC 19
186	INPUT B	LOGIC FUNC 2
1392	INPUT B	LOGIC FUNC 20
191	INPUT B	LOGIC FUNC 3
196	INPUT B	LOGIC FUNC 4
201	INPUT B	LOGIC FUNC 5
206	INPUT B	LOGIC FUNC 6
211	INPUT B	LOGIC FUNC 7
216	INPUT B	LOGIC FUNC 8
221	INPUT B	LOGIC FUNC 9
131	INPUT B	VALUE FUNC 1
176	INPUT B	VALUE FUNC 10
1297	INPUT B	VALUE FUNC 11
1302	INPUT B	VALUE FUNC 12
1307	INPUT B	VALUE FUNC 13
1312	INPUT B	VALUE FUNC 14
1317	INPUT B	VALUE FUNC 15
1322	INPUT B	VALUE FUNC 16
1327	INPUT B	VALUE FUNC 17
1332	INPUT B	VALUE FUNC 18
1337	INPUT B	VALUE FUNC 19
136	INPUT B	VALUE FUNC 2
1342	INPUT B	VALUE FUNC 20
141	INPUT B	VALUE FUNC 3
146	INPUT B	VALUE FUNC 4
151	INPUT B	VALUE FUNC 5
156	INPUT B	VALUE FUNC 6
161	INPUT B	VALUE FUNC 7
166	INPUT B	VALUE FUNC 8
171	INPUT B	VALUE FUNC 9
182	INPUT C	LOGIC FUNC 1
227	INPUT C	LOGIC FUNC 10
1348	INPUT C	LOGIC FUNC 11
1353	INPUT C	LOGIC FUNC 12
1358	INPUT C	LOGIC FUNC 13
1363	INPUT C	LOGIC FUNC 14
1368	INPUT C	LOGIC FUNC 15

TAG	MMI Name	Block
1373	INPUT C	LOGIC FUNC 16
1378	INPUT C	LOGIC FUNC 17
1383	INPUT C	LOGIC FUNC 18
1388	INPUT C	LOGIC FUNC 19
187	INPUT C	LOGIC FUNC 2
1393	INPUT C	LOGIC FUNC 20
192	INPUT C	LOGIC FUNC 3
197	INPUT C	LOGIC FUNC 4
202	INPUT C	LOGIC FUNC 5
207	INPUT C	LOGIC FUNC 6
212	INPUT C	LOGIC FUNC 7
217	INPUT C	LOGIC FUNC 8
222	INPUT C	LOGIC FUNC 9
132	INPUT C	VALUE FUNC 1
177	INPUT C	VALUE FUNC 10
1298	INPUT C	VALUE FUNC 11
1303	INPUT C	VALUE FUNC 12
1308	INPUT C	VALUE FUNC 13
1313	INPUT C	VALUE FUNC 14
1318	INPUT C	VALUE FUNC 15
1323	INPUT C	VALUE FUNC 16
1328	INPUT C	VALUE FUNC 17
1333	INPUT C	VALUE FUNC 18
1338	INPUT C	VALUE FUNC 19
137	INPUT C	VALUE FUNC 2
1343	INPUT C	VALUE FUNC 20
142	INPUT C	VALUE FUNC 3
147	INPUT C	VALUE FUNC 4
152	INPUT C	VALUE FUNC 5
157	INPUT C	VALUE FUNC 6
162	INPUT C	VALUE FUNC 7
167	INPUT C	VALUE FUNC 8
172	INPUT C	VALUE FUNC 9
362	INPUT Hz	SKIP FREQUENCIES
1843	INT DEFEAT	PHASE PID
1189	INT DEFEAT	SPEED LOOP
312	INTEGRAL DEFEAT	PID
1153	INVERSE TIME OP	INVERSE TIME
30	INVERT	DIGITAL INPUT 1
1272	INVERT	DIGITAL INPUT 11
1274	INVERT	DIGITAL INPUT 12
1276	INVERT	DIGITAL INPUT 13
1278	INVERT	DIGITAL INPUT 14
1280	INVERT	DIGITAL INPUT 15
33	INVERT	DIGITAL INPUT 2
36	INVERT	DIGITAL INPUT 3
39	INVERT	DIGITAL INPUT 4
42	INVERT	DIGITAL INPUT 5
725	INVERT	DIGITAL INPUT 6
727	INVERT	DIGITAL INPUT 7
51	INVERT	DIGITAL OUTPUT 1
1282	INVERT	DIGITAL OUTPUT 11
1284	INVERT	DIGITAL OUTPUT 12
1286	INVERT	DIGITAL OUTPUT 13
1288	INVERT	DIGITAL OUTPUT 14
1290	INVERT	DIGITAL OUTPUT 15
54	INVERT	DIGITAL OUTPUT 2
736	INVERT	DIGITAL OUTPUT 3
1534	INVERT	ENCODER SPEED 1
1542	INVERT	ENCODER SPEED 2
1154	INVERT ENC TRIP	I/O TRIPS
1487	INVERT OUTPUT	PHASE CONTROL
1482	INVERT SPEED OP	PHASE CONTROL
760	INVERT THERMIST	I/O TRIPS
1152	IT LIMITING	INVERSE TIME
890	JERK 1	S-RAMP
891	JERK 2	S-RAMP

Parameter Specification 2-7

TAG	MMI Name	Block
892	JERK 3	S-RAMP
893	JERK 4	S-RAMP
280	JOG	SEQUENCING LOGIC
302	JOGGING	SEQUENCING LOGIC
1608	kW min	ENERGY METER
120	LEAKAGE INDUC	MOTOR DATA
1519	LIMIT	PHASE PID
1253	LIMIT	PID (TYPE 2)
1683	LIMIT	POSITION
1523	LIMITING	PHASE PID
1257	LIMITING	PID (TYPE 2)
811	LINE SPD DEMAND	COMPENSATION
830	LINE SPEED	DIAMETER CALC
778	LINE SPEED	SPEED CALC
820	LINE SPEED RATE	COMPENSATION
1533	LINES	ENCODER SPEED 1
1541	LINES	ENCODER SPEED 2
250	LOCAL REVERSE	REFERENCE
247	LOCAL SETPOINT	REFERENCE
53	LOW LIMIT	DISPLAY SCALE 1
675	LOW LIMIT	DISPLAY SCALE 2
858	LOW LIMIT	DISPLAY SCALE 3
866	LOW LIMIT	DISPLAY SCALE 4
328	LOWER INPUT	RAISE/LOWER
65	MAG CURRENT	MOTOR DATA
1566	MARK OFFSET	PHASE REGISTER
1837	MASTER INVERT	PHASE CONFIGURE
1598	MASTER LENGTH	PHASE AUTO GEAR
1833	MASTER MARK POS	PHASE AUTO GEAR
1561	MASTER MARK TYPE	PHASE CONFIGURE
1590	MASTER MARKS	PHASE AUTO GEAR
1491	MASTER POS (INT)	PHASE CONTROL
1529	MASTER POSITION	PHASE CONFIGURE
1492	MASTER POSITION	PHASE CONTROL
1527	MASTER SCALE A	PHASE CONFIGURE
1528	MASTER SCALE B	PHASE CONFIGURE
1535	MAX SPEED	ENCODER SPEED 1
1543	MAX SPEED	ENCODER SPEED 2
1560	MAX SPEED	PHASE CONFIGURE
1032	MAX SPEED	SETPOINT SCALE
252	MAX SPEED CLAMP	REFERENCE
330	MAX VALUE	RAISE/LOWER
575	MIN SEARCH SPEED	FLYCATCHING
253	MIN SPEED CLAMP	REFERENCE
329	MIN VALUE	RAISE/LOWER
337	MINIMUM	MINIMUM SPEED
806	MINIMUM DIAMETER	COMPENSATION
831	MINIMUM DIAMETER	DIAMETER CALC
781	MINIMUM DIAMETER	SPEED CALC
832	MINIMUM SPEED	DIAMETER CALC
1592	MISSED M MARKS	PHASE AUTO GEAR
1591	MISSED S MARKS	PHASE AUTO GEAR
836	MOD LINE SPEED	DIAMETER CALC
816	MOD WINDER SPEED	COMPENSATION
837	MOD WINDER SPEED	DIAMETER CALC
779	MOD WINDER SPEED	SPEED CALC
689	MODE	AUTOTUNE
338	MODE	MINIMUM SPEED
117	MODE	SYSTEM PORT (P3)
124	MOTOR CONNECTION	MOTOR DATA
64	MOTOR CURRENT	MOTOR DATA
66	MOTOR CURRENT %	FEEDBACKS
67	MOTOR CURRENT A	FEEDBACKS
84	MOTOR POLES	MOTOR DATA
1160	MOTOR VOLTAGE	MOTOR DATA
85	MOTORING LIMIT	SLIP COMP
1842	MSTR POS+OFFSET	PHASE CONTROL

TAG	MMI Name	Block
121	MUTUAL INDUC	MOTOR DATA
324	NAME	OPERATOR MENU 1
1073	NAME	OPERATOR MENU 10
1077	NAME	OPERATOR MENU 11
1081	NAME	OPERATOR MENU 12
1085	NAME	OPERATOR MENU 13
1089	NAME	OPERATOR MENU 14
1093	NAME	OPERATOR MENU 15
1097	NAME	OPERATOR MENU 16
1741	NAME	OPERATOR MENU 17
1746	NAME	OPERATOR MENU 18
1751	NAME	OPERATOR MENU 19
378	NAME	OPERATOR MENU 2
1756	NAME	OPERATOR MENU 20
1761	NAME	OPERATOR MENU 21
1766	NAME	OPERATOR MENU 22
1771	NAME	OPERATOR MENU 23
1776	NAME	OPERATOR MENU 24
1781	NAME	OPERATOR MENU 25
1786	NAME	OPERATOR MENU 26
1791	NAME	OPERATOR MENU 27
1796	NAME	OPERATOR MENU 28
1801	NAME	OPERATOR MENU 29
1045	NAME	OPERATOR MENU 3
1806	NAME	OPERATOR MENU 30
1811	NAME	OPERATOR MENU 31
1816	NAME	OPERATOR MENU 32
1049	NAME	OPERATOR MENU 4
1053	NAME	OPERATOR MENU 5
1057	NAME	OPERATOR MENU 6
1061	NAME	OPERATOR MENU 7
1065	NAME	OPERATOR MENU 8
1069	NAME	OPERATOR MENU 9
83	NAMEPLATE RPM	MOTOR DATA
791	NEG TORQUE LIMIT	TORQUE CALC
1259	NEGATE	5703 INPUT
1038	NO SETPOINT PWRD	ACCESS CONTROL
1582	NOM MASTER LEN	PHASE AUTO GEAR
1583	NOM SLAVE LENGTH	PHASE AUTO GEAR
278	NOT COAST STOP	SEQUENCING LOGIC
277	NOT FAST STOP	SEQUENCING LOGIC
293	NOT STOP	SEQUENCING LOGIC
586	OFF FREQUENCY	BRAKE CONTROL
588	OFF HOLD TIME	BRAKE CONTROL
15	OFFSET	ANALOG INPUT 1
24	OFFSET	ANALOG INPUT 2
714	OFFSET	ANALOG INPUT 3
721	OFFSET	ANALOG INPUT 4
47	OFFSET	ANALOG OUTPUT 1
733	OFFSET	ANALOG OUTPUT 2
802	OFFSET	ANALOG OUTPUT 3
1510	OFFSET	PHASE OFFSET
1511	OFFSET FINE	PHASE OFFSET
585	ON FREQUENCY	BRAKE CONTROL
587	ON HOLD TIME	BRAKE CONTROL
584	ON LOAD	BRAKE CONTROL
115	OP DATABASE	OP STATION 1
1497	OP DATABASE	OP STATION 2
230	OP VERSION	OP STATION 1
1110	OP VERSION	OP STATION 2
1104	OUTPUT	FILTER 1
1108	OUTPUT	FILTER 2
1472	OUTPUT	HOME
887	OUTPUT	LINEAR RAMP
183	OUTPUT	LOGIC FUNC 1
228	OUTPUT	LOGIC FUNC 10
1349	OUTPUT	LOGIC FUNC 11

2-8 Parameter Specification

TAG	MMI Name	Block
1354	OUTPUT	LOGIC FUNC 12
1359	OUTPUT	LOGIC FUNC 13
1364	OUTPUT	LOGIC FUNC 14
1369	OUTPUT	LOGIC FUNC 15
1374	OUTPUT	LOGIC FUNC 16
1379	OUTPUT	LOGIC FUNC 17
1384	OUTPUT	LOGIC FUNC 18
1389	OUTPUT	LOGIC FUNC 19
188	OUTPUT	LOGIC FUNC 2
1394	OUTPUT	LOGIC FUNC 20
193	OUTPUT	LOGIC FUNC 3
198	OUTPUT	LOGIC FUNC 4
203	OUTPUT	LOGIC FUNC 5
208	OUTPUT	LOGIC FUNC 6
213	OUTPUT	LOGIC FUNC 7
218	OUTPUT	LOGIC FUNC 8
223	OUTPUT	LOGIC FUNC 9
335	OUTPUT	MINIMUM SPEED
598	OUTPUT	MULTIPLEXER 1
873	OUTPUT	MULTIPLEXER 2
1488	OUTPUT	PHASE CONTROL
1522	OUTPUT	PHASE PID
1256	OUTPUT	PID (TYPE 2)
325	OUTPUT	RAISE/LOWER
59	OUTPUT	SETPOINT SCALE
346	OUTPUT	SKIP FREQUENCIES
767	OUTPUT	S-RAMP
133	OUTPUT	VALUE FUNC 1
178	OUTPUT	VALUE FUNC 10
1299	OUTPUT	VALUE FUNC 11
1304	OUTPUT	VALUE FUNC 12
1309	OUTPUT	VALUE FUNC 13
1314	OUTPUT	VALUE FUNC 14
1319	OUTPUT	VALUE FUNC 15
1324	OUTPUT	VALUE FUNC 16
1329	OUTPUT	VALUE FUNC 17
1334	OUTPUT	VALUE FUNC 18
1339	OUTPUT	VALUE FUNC 19
138	OUTPUT	VALUE FUNC 2
1344	OUTPUT	VALUE FUNC 20
143	OUTPUT	VALUE FUNC 3
148	OUTPUT	VALUE FUNC 4
153	OUTPUT	VALUE FUNC 5
158	OUTPUT	VALUE FUNC 6
163	OUTPUT	VALUE FUNC 7
168	OUTPUT	VALUE FUNC 8
173	OUTPUT	VALUE FUNC 9
748	OUTPUT (INT)	POSITION
657	OUTPUT 0	DEMUTIPLEXER 1
875	OUTPUT 0	DEMUTIPLEXER 2
658	OUTPUT 1	DEMUTIPLEXER 1
1000	OUTPUT 1	DEMUTIPLEXER 2
356	OUTPUT 1	PRESET 1
389	OUTPUT 1	PRESET 2
399	OUTPUT 1	PRESET 3
519	OUTPUT 1	PRESET 4
530	OUTPUT 1	PRESET 5
541	OUTPUT 1	PRESET 6
552	OUTPUT 1	PRESET 7
563	OUTPUT 1	PRESET 8
758	OUTPUT 1	TEC OPTION
667	OUTPUT 10	DEMUTIPLEXER 1
1009	OUTPUT 10	DEMUTIPLEXER 2
668	OUTPUT 11	DEMUTIPLEXER 1
1010	OUTPUT 11	DEMUTIPLEXER 2
669	OUTPUT 12	DEMUTIPLEXER 1
1011	OUTPUT 12	DEMUTIPLEXER 2

TAG	MMI Name	Block
670	OUTPUT 13	DEMUTIPLEXER 1
1012	OUTPUT 13	DEMUTIPLEXER 2
671	OUTPUT 14	DEMUTIPLEXER 1
1013	OUTPUT 14	DEMUTIPLEXER 2
672	OUTPUT 15	DEMUTIPLEXER 1
1014	OUTPUT 15	DEMUTIPLEXER 2
659	OUTPUT 2	DEMUTIPLEXER 1
1001	OUTPUT 2	DEMUTIPLEXER 2
372	OUTPUT 2	PRESET 1
373	OUTPUT 2	PRESET 2
374	OUTPUT 2	PRESET 3
520	OUTPUT 2	PRESET 4
531	OUTPUT 2	PRESET 5
542	OUTPUT 2	PRESET 6
553	OUTPUT 2	PRESET 7
564	OUTPUT 2	PRESET 8
759	OUTPUT 2	TEC OPTION
660	OUTPUT 3	DEMUTIPLEXER 1
1002	OUTPUT 3	DEMUTIPLEXER 2
661	OUTPUT 4	DEMUTIPLEXER 1
1003	OUTPUT 4	DEMUTIPLEXER 2
662	OUTPUT 5	DEMUTIPLEXER 1
1004	OUTPUT 5	DEMUTIPLEXER 2
663	OUTPUT 6	DEMUTIPLEXER 1
1005	OUTPUT 6	DEMUTIPLEXER 2
664	OUTPUT 7	DEMUTIPLEXER 1
1006	OUTPUT 7	DEMUTIPLEXER 2
665	OUTPUT 8	DEMUTIPLEXER 1
1007	OUTPUT 8	DEMUTIPLEXER 2
666	OUTPUT 9	DEMUTIPLEXER 1
1008	OUTPUT 9	DEMUTIPLEXER 2
286	OUTPUT CONTACTOR	SEQUENCING LOGIC
363	OUTPUT Hz	SKIP FREQUENCIES
318	OUTPUT NEG LIMIT	PID
317	OUTPUT POS LIMIT	PID
1486	OUTPUT SCALE	PHASE CONTROL
319	OUTPUT SCALING	PID
776	OVER SPD ENABLE	SPEED CALC
782	OVER SPEED	SPEED CALC
1164	OVERLOAD	MOTOR DATA
775	OVER-WIND	SPEED CALC
786	OVER-WIND	TORQUE CALC
1516	P GAIN	PHASE PID
1250	P GAIN	PID (TYPE 2)
74	PARAMETER	OPERATOR MENU 1
633	PARAMETER	OPERATOR MENU 10
634	PARAMETER	OPERATOR MENU 11
635	PARAMETER	OPERATOR MENU 12
636	PARAMETER	OPERATOR MENU 13
637	PARAMETER	OPERATOR MENU 14
638	PARAMETER	OPERATOR MENU 15
639	PARAMETER	OPERATOR MENU 16
1740	PARAMETER	OPERATOR MENU 17
1745	PARAMETER	OPERATOR MENU 18
1750	PARAMETER	OPERATOR MENU 19
371	PARAMETER	OPERATOR MENU 2
1755	PARAMETER	OPERATOR MENU 20
1760	PARAMETER	OPERATOR MENU 21
1765	PARAMETER	OPERATOR MENU 22
1770	PARAMETER	OPERATOR MENU 23
1775	PARAMETER	OPERATOR MENU 24
1780	PARAMETER	OPERATOR MENU 25
1785	PARAMETER	OPERATOR MENU 26
1790	PARAMETER	OPERATOR MENU 27
1795	PARAMETER	OPERATOR MENU 28
1800	PARAMETER	OPERATOR MENU 29
626	PARAMETER	OPERATOR MENU 3

Parameter Specification 2-9

TAG	MMI Name	Block
1805	PARAMETER	OPERATOR MENU 30
1810	PARAMETER	OPERATOR MENU 31
1815	PARAMETER	OPERATOR MENU 32
627	PARAMETER	OPERATOR MENU 4
628	PARAMETER	OPERATOR MENU 5
629	PARAMETER	OPERATOR MENU 6
630	PARAMETER	OPERATOR MENU 7
631	PARAMETER	OPERATOR MENU 8
632	PARAMETER	OPERATOR MENU 9
8	PASSWORD	ACCESS CONTROL
608	PENDING	AUTO RESTART
1473	PERIOD	PHASE TUNING
1397	PHASE INPUT	SPEED LOOP
1643	PHASE LOSS	REGEN CNTRL
1477	PHASE OFFSET	PHASE TUNING
766	PID ERROR	PID
1549	PID OUTPUT	PHASE PID
320	PID OUTPUT	PID
1548	PID OUTPUT	PID (TYPE 2)
1494	POS ERROR (INT)	PHASE CONTROL
1490	POS FEED FWD	PHASE CONTROL
790	POS TORQUE LIMIT	TORQUE CALC
1480	POSITION ENABLE	PHASE CONTROL
1495	POSITION ERROR	PHASE CONTROL
1604	POWER	ENERGY METER
1605	POWER	ENERGY METER
1158	POWER	MOTOR DATA
242	POWER FACTOR	MOTOR DATA
299	POWER UP MODE	LOCAL CONTROL
283	POWER UP START	SEQUENCING LOGIC
1633	PRECHARGE CLOSED	REGEN CNTRL
1682	PRESET	POSITION
822	PRESET ENABLE	DIAMETER CALC
1271	PWR LOSS ACTIVE	POWER LOSS CNTRL
50	QUADRATIC TORQUE	FEEDBACKS
327	RAISE INPUT	RAISE/LOWER
326	RAMP TIME	RAISE/LOWER
244	RAMP TYPE	REFERENCE RAMP
888	RAMPING	LINEAR RAMP
698	RAMPING	REFERENCE RAMP
768	RAMPING	S-RAMP
98	RANDOM PATTERN	PATTERN GEN
1502	RATE	PHASE INCH
812	RATE CAL	COMPENSATION
1699	RATE SCALE	PHASE INCH
1258	RATIO	5703 INPUT
1261	RAW VALUE	5703 INPUT
1606	REACTIVE POWER	ENERGY METER
1040	READ ONLY	OPERATOR MENU 1
1075	READ ONLY	OPERATOR MENU 10
1079	READ ONLY	OPERATOR MENU 11
1083	READ ONLY	OPERATOR MENU 12
1087	READ ONLY	OPERATOR MENU 13
1091	READ ONLY	OPERATOR MENU 14
1095	READ ONLY	OPERATOR MENU 15
1099	READ ONLY	OPERATOR MENU 16
1743	READ ONLY	OPERATOR MENU 17
1748	READ ONLY	OPERATOR MENU 18
1753	READ ONLY	OPERATOR MENU 19
1043	READ ONLY	OPERATOR MENU 2
1758	READ ONLY	OPERATOR MENU 20
1763	READ ONLY	OPERATOR MENU 21
1768	READ ONLY	OPERATOR MENU 22
1773	READ ONLY	OPERATOR MENU 23
1778	READ ONLY	OPERATOR MENU 24
1783	READ ONLY	OPERATOR MENU 25
1788	READ ONLY	OPERATOR MENU 26

TAG	MMI Name	Block
1793	READ ONLY	OPERATOR MENU 27
1798	READ ONLY	OPERATOR MENU 28
1803	READ ONLY	OPERATOR MENU 29
1047	READ ONLY	OPERATOR MENU 3
1808	READ ONLY	OPERATOR MENU 30
1813	READ ONLY	OPERATOR MENU 31
1818	READ ONLY	OPERATOR MENU 32
1051	READ ONLY	OPERATOR MENU 4
1055	READ ONLY	OPERATOR MENU 5
1059	READ ONLY	OPERATOR MENU 6
1063	READ ONLY	OPERATOR MENU 7
1067	READ ONLY	OPERATOR MENU 8
1071	READ ONLY	OPERATOR MENU 9
1602	READY	PHASE AUTO GEAR
287	READY	SEQUENCING LOGIC
265	REF MODES	LOCAL CONTROL
709	REFLUX TIME	FLYCATCHING
686	REGEN LIM ENABLE	CURRENT LIMIT
86	REGEN LIMIT	SLIP COMP
589	RELEASE	BRAKE CONTROL
282	REM TRIP RESET	SEQUENCING LOGIC
300	REMOTE COMMS SEL	COMMS CONTROL
257	REMOTE REF	LOCAL CONTROL
308	REMOTE REF MODES	COMMS CONTROL
296	REMOTE REV OUT	SEQUENCING LOGIC
249	REMOTE REVERSE	REFERENCE
294	REMOTE REVERSE	SEQUENCING LOGIC
297	REMOTE SEQ	LOCAL CONTROL
307	REMOTE SEQ MODES	COMMS CONTROL
245	REMOTE SETPOINT	REFERENCE
1264	REPEATER	5703 OUTPUT
1292	REQUIRED TYPE	SYSTEM OPTION
1603	RESET	ENERGY METER
1102	RESET	FILTER 1
1106	RESET	FILTER 2
885	RESET	LINEAR RAMP
1579	RESET	PHASE AUTO GEAR
1563	RESET	PHASE REGISTER
747	RESET	POSITION
332	RESET	RAISE/LOWER
897	RESET	S-RAMP
1691	RESET	TIMER 1
1821	RESET	TIMER 2
1479	RESET (TOTAL)	PHASE CONTROL
1588	RESET COUNTERS	PHASE AUTO GEAR
886	RESET VALUE	LINEAR RAMP
331	RESET VALUE	RAISE/LOWER
898	RESET VALUE	S-RAMP
1692	RESET VALUE	TIMER 1
1822	RESET VALUE	TIMER 2
616	RESTARTING	AUTO RESTART
1501	RETARD	PHASE INCH
813	REVERSE	COMPENSATION
256	REVERSE	REFERENCE
810	REWIND	COMPENSATION
774	REWIND	SPEED CALC
1550	REWIND	TORQUE CALC
1163	ROTOR TIME CONST	MOTOR DATA
291	RUN FORWARD	SEQUENCING LOGIC
292	RUN REVERSE	SEQUENCING LOGIC
279	RUN STOP MODE	REFERENCE STOP
285	RUNNING	SEQUENCING LOGIC
14	SCALE	ANALOG INPUT 1
23	SCALE	ANALOG INPUT 2
713	SCALE	ANALOG INPUT 3
720	SCALE	ANALOG INPUT 4
46	SCALE	ANALOG OUTPUT 1

2-10 Parameter Specification

TAG	MMI Name	Block
732	SCALE	ANALOG OUTPUT 2
801	SCALE	ANALOG OUTPUT 3
1693	SCALE	TIMER 1
1823	SCALE	TIMER 2
1685	SCALED OUTPUT	POSITION
819	SCALED RATE	COMPENSATION
1696	SCALED TIME	TIMER 1
1826	SCALED TIME	TIMER 2
1260	SCALED VALUE	5703 INPUT
1039	SCALING	OPERATOR MENU 1
1074	SCALING	OPERATOR MENU 10
1078	SCALING	OPERATOR MENU 11
1082	SCALING	OPERATOR MENU 12
1086	SCALING	OPERATOR MENU 13
1090	SCALING	OPERATOR MENU 14
1094	SCALING	OPERATOR MENU 15
1098	SCALING	OPERATOR MENU 16
1742	SCALING	OPERATOR MENU 17
1747	SCALING	OPERATOR MENU 18
1752	SCALING	OPERATOR MENU 19
1042	SCALING	OPERATOR MENU 2
1757	SCALING	OPERATOR MENU 20
1762	SCALING	OPERATOR MENU 21
1767	SCALING	OPERATOR MENU 22
1772	SCALING	OPERATOR MENU 23
1777	SCALING	OPERATOR MENU 24
1782	SCALING	OPERATOR MENU 25
1787	SCALING	OPERATOR MENU 26
1792	SCALING	OPERATOR MENU 27
1797	SCALING	OPERATOR MENU 28
1802	SCALING	OPERATOR MENU 29
1046	SCALING	OPERATOR MENU 3
1807	SCALING	OPERATOR MENU 30
1812	SCALING	OPERATOR MENU 31
1817	SCALING	OPERATOR MENU 32
1050	SCALING	OPERATOR MENU 4
1054	SCALING	OPERATOR MENU 5
1058	SCALING	OPERATOR MENU 6
1062	SCALING	OPERATOR MENU 7
1066	SCALING	OPERATOR MENU 8
1070	SCALING	OPERATOR MENU 9
32	SEARCH BOOST	FLYCATCHING
572	SEARCH MODE	FLYCATCHING
574	SEARCH TIME	FLYCATCHING
573	SEARCH VOLTS	FLYCATCHING
824	SEL EXT DIAMETER	DIAMETER CALC
823	SELECT CORE 2	DIAMETER CALC
355	SELECT INPUT	PRESET 1
388	SELECT INPUT	PRESET 2
398	SELECT INPUT	PRESET 3
518	SELECT INPUT	PRESET 4
529	SELECT INPUT	PRESET 5
540	SELECT INPUT	PRESET 6
551	SELECT INPUT	PRESET 7
562	SELECT INPUT	PRESET 8
281	SEQ DIRECTION	LOCAL CONTROL
298	SEQ MODES	LOCAL CONTROL
301	SEQUENCER STATE	SEQUENCING LOGIC
28	SETPOINT	FLYCATCHING
310	SETPOINT	PID
246	SETPOINT	REFERENCE JOG
763	SETPOINT NEGATE	PID
1037	SETPOINT SCALE	ACCESS CONTROL
1844	SINE WAVE	PHASE TUNING
1524	SLAVE CNT SRC	PHASE CONFIGURE
1834	SLAVE INVERT	PHASE CONFIGURE
1599	SLAVE LENGTH	PHASE AUTO GEAR

TAG	MMI Name	Block
1832	SLAVE MARK POS	PHASE AUTO GEAR
1562	SLAVE MARK TYPE	PHASE CONFIGURE
1589	SLAVE MARKS	PHASE AUTO GEAR
1567	SLAVE NOM LENGTH	PHASE REGISTER
1841	SLAVE POS (INT)	PHASE CONTROL
1530	SLAVE POSITION	PHASE CONFIGURE
1493	SLAVE POSITION	PHASE CONTROL
1532	SOURCE	ENCODER SPEED 1
1540	SOURCE	ENCODER SPEED 2
400	SOURCE	LINK 1
418	SOURCE	LINK 10
1738	SOURCE	LINK 100
420	SOURCE	LINK 11
422	SOURCE	LINK 12
424	SOURCE	LINK 13
426	SOURCE	LINK 14
428	SOURCE	LINK 15
430	SOURCE	LINK 16
432	SOURCE	LINK 17
434	SOURCE	LINK 18
436	SOURCE	LINK 19
402	SOURCE	LINK 2
438	SOURCE	LINK 20
440	SOURCE	LINK 21
442	SOURCE	LINK 22
444	SOURCE	LINK 23
446	SOURCE	LINK 24
448	SOURCE	LINK 25
450	SOURCE	LINK 26
452	SOURCE	LINK 27
454	SOURCE	LINK 28
456	SOURCE	LINK 29
404	SOURCE	LINK 3
458	SOURCE	LINK 30
460	SOURCE	LINK 31
462	SOURCE	LINK 32
464	SOURCE	LINK 33
466	SOURCE	LINK 34
468	SOURCE	LINK 35
470	SOURCE	LINK 36
472	SOURCE	LINK 37
474	SOURCE	LINK 38
476	SOURCE	LINK 39
406	SOURCE	LINK 4
478	SOURCE	LINK 40
480	SOURCE	LINK 41
482	SOURCE	LINK 42
484	SOURCE	LINK 43
486	SOURCE	LINK 44
488	SOURCE	LINK 45
490	SOURCE	LINK 46
492	SOURCE	LINK 47
494	SOURCE	LINK 48
496	SOURCE	LINK 49
408	SOURCE	LINK 5
498	SOURCE	LINK 50
1400	SOURCE	LINK 51
1402	SOURCE	LINK 52
1404	SOURCE	LINK 53
1406	SOURCE	LINK 54
1408	SOURCE	LINK 55
1410	SOURCE	LINK 56
1412	SOURCE	LINK 57
1414	SOURCE	LINK 58
1416	SOURCE	LINK 59
410	SOURCE	LINK 6
1418	SOURCE	LINK 60

Parameter Specification 2-11

TAG	MMI Name	Block
1420	SOURCE	LINK 61
1422	SOURCE	LINK 62
1424	SOURCE	LINK 63
1426	SOURCE	LINK 64
1428	SOURCE	LINK 65
1430	SOURCE	LINK 66
1432	SOURCE	LINK 67
1434	SOURCE	LINK 68
1436	SOURCE	LINK 69
412	SOURCE	LINK 7
1438	SOURCE	LINK 70
1440	SOURCE	LINK 71
1442	SOURCE	LINK 72
1444	SOURCE	LINK 73
1446	SOURCE	LINK 74
1448	SOURCE	LINK 75
1450	SOURCE	LINK 76
1452	SOURCE	LINK 77
1454	SOURCE	LINK 78
1456	SOURCE	LINK 79
414	SOURCE	LINK 8
1458	SOURCE	LINK 80
1700	SOURCE	LINK 81
1702	SOURCE	LINK 82
1704	SOURCE	LINK 83
1706	SOURCE	LINK 84
1708	SOURCE	LINK 85
1710	SOURCE	LINK 86
1712	SOURCE	LINK 87
1714	SOURCE	LINK 88
1716	SOURCE	LINK 89
416	SOURCE	LINK 9
1718	SOURCE	LINK 90
1720	SOURCE	LINK 91
1722	SOURCE	LINK 92
1724	SOURCE	LINK 93
1726	SOURCE	LINK 94
1728	SOURCE	LINK 95
1730	SOURCE	LINK 96
1732	SOURCE	LINK 97
1734	SOURCE	LINK 98
1736	SOURCE	LINK 99
1525	SPD LOOP SPD FBK	PHASE CONFIGURE
1539	SPEED	ENCODER SPEED 1
1547	SPEED	ENCODER SPEED 2
255	SPEED DEMAND	REFERENCE
784	SPEED DEMAND	SPEED CALC
1191	SPEED DMD FILTER	SPEED LOOP
1207	SPEED ERROR	SPEED LOOP
749	SPEED FBK %	FEEDBACKS
1192	SPEED FBK FILTER	SPEED LOOP
568	SPEED FBK REV/S	FEEDBACKS
569	SPEED FBK RPM	FEEDBACKS
1538	SPEED Hz	ENCODER SPEED 1
1546	SPEED Hz	ENCODER SPEED 2
1481	SPEED INPUT	PHASE CONTROL
1190	SPEED INT PRESET	SPEED LOOP
1188	SPEED INT TIME	SPEED LOOP
1201	SPEED NEG LIM	SPEED LOOP
1475	SPEED OFFSET	PHASE TUNING
1489	SPEED OUTPUT	PHASE CONTROL
1200	SPEED POS LIM	SPEED LOOP
1187	SPEED PROP GAIN	SPEED LOOP
254	SPEED SETPOINT	REFERENCE
248	SPEED TRIM	REFERENCE
783	SPEED TRIM	SPEED CALC
692	SRAMP ACCEL	REFERENCE RAMP

TAG	MMI Name	Block
691	SRAMP CONTINUOUS	REFERENCE RAMP
693	SRAMP DECEL	REFERENCE RAMP
694	SRAMP JERK 1	REFERENCE RAMP
695	SRAMP JERK 2	REFERENCE RAMP
696	SRAMP JERK 3	REFERENCE RAMP
697	SRAMP JERK 4	REFERENCE RAMP
839	STALL ENABLE	TAPER CALC
1632	STALL LIMIT TYPE	STALL TRIP
847	STALL TENSION	TAPER CALC
241	STALL TIME	STALL TRIP
1686	START DELAY	SEQUENCING LOGIC
571	START MODE	FLYCATCHING
93	STARTUP SCREEN	ACCESS CONTROL
815	STATIC COMP	COMPENSATION
119	STATOR RES	MOTOR DATA
1571	STATUS	PHASE REGISTER
1646	STATUS	REGEN CNTRL
284	STOP DELAY	REFERENCE STOP
263	STOP TIME	REFERENCE STOP
266	STOP ZERO SPEED	REFERENCE STOP
303	STOPPING	SEQUENCING LOGIC
288	SWITCH ON ENABLE	SEQUENCING LOGIC
306	SWITCHED ON	SEQUENCING LOGIC
882	SYMMETRIC MODE	LINEAR RAMP
268	SYMMETRIC MODE	REFERENCE RAMP
883	SYMMETRIC TIME	LINEAR RAMP
267	SYMMETRIC TIME	REFERENCE RAMP
1642	SYNCHRONIZED	REGEN CNTRL
1641	SYNCHRONIZING	REGEN CNTRL
305	SYSTEM RESET	SEQUENCING LOGIC
848	TAPER SPT	TAPER CALC
850	TAPERED DEMAND	TAPER CALC
851	TENSION DEMAND	TAPER CALC
825	TENSION ENABLE	DIAMETER CALC
787	TENSION ENABLE	TORQUE CALC
846	TENSION RAMP	TAPER CALC
849	TENSION SPT	TAPER CALC
1020	TERMINAL VOLTS	FEEDBACKS
1025	TEST DISABLE	AUTOTUNE
1155	THERMISTOR	I/O TRIPS
1649	THRESHOLD	SPD FBK TRIP
1694	THRESHOLD	TIMER 1
1824	THRESHOLD	TIMER 2
357	THRESHOLD	ZERO SPEED
1103	TIME CONSTANT	FILTER 1
1107	TIME CONSTANT	FILTER 2
615	TIME LEFT	AUTO RESTART
1270	TIME LIMIT	POWER LOSS CNTRL
582	TIMEOUT	INJ BRAKING
1584	TOLERANCE	PHASE AUTO GEAR
1202	TORQ DMD ISOLATE	SPEED LOOP
1204	TORQUE DEMAND	SPEED LOOP
788	TORQUE DEMAND	TORQUE CALC
70	TORQUE FEEDBACK	FEEDBACKS
789	TORQUE LIMIT	TORQUE CALC
1697	TOTAL HOURS	TIMER 1
1827	TOTAL HOURS	TIMER 2
1698	TOTAL SECONDS	TIMER 1
1828	TOTAL SECONDS	TIMER 2
1206	TOTAL SPD DMD %	SPEED LOOP
1203	TOTL SPD DMD RPM	SPEED LOOP
609	TRIGGERS 1	AUTO RESTART
744	TRIGGERS 1+	AUTO RESTART
677	TRIGGERS 2	AUTO RESTART
745	TRIGGERS 2+	AUTO RESTART
243	TRIM IN LOCAL	REFERENCE
500	TRIP 1 (NEWEST)	TRIPS HISTORY

2-12 Parameter Specification

TAG	MMI Name	Block
509	TRIP 10 (OLDEST)	TRIPS HISTORY
501	TRIP 2	TRIPS HISTORY
502	TRIP 3	TRIPS HISTORY
503	TRIP 4	TRIPS HISTORY
504	TRIP 5	TRIPS HISTORY
505	TRIP 6	TRIPS HISTORY
506	TRIP 7	TRIPS HISTORY
507	TRIP 8	TRIPS HISTORY
508	TRIP 9	TRIPS HISTORY
290	TRIP RST BY RUN	SEQUENCING LOGIC
1266	TRIP THRESHOLD	POWER LOSS CNTRL
289	TRIPPED	SEQUENCING LOGIC
1650	TRIPPED	SPD FBK TRIP
13	TYPE	ANALOG INPUT 1
22	TYPE	ANALOG INPUT 2
712	TYPE	ANALOG INPUT 3
719	TYPE	ANALOG INPUT 4
49	TYPE	ANALOG OUTPUT 1
735	TYPE	ANALOG OUTPUT 2
804	TYPE	ANALOG OUTPUT 3
184	TYPE	LOGIC FUNC 1
229	TYPE	LOGIC FUNC 10
1350	TYPE	LOGIC FUNC 11
1355	TYPE	LOGIC FUNC 12
1360	TYPE	LOGIC FUNC 13
1365	TYPE	LOGIC FUNC 14
1370	TYPE	LOGIC FUNC 15
1375	TYPE	LOGIC FUNC 16
1380	TYPE	LOGIC FUNC 17
1385	TYPE	LOGIC FUNC 18
1390	TYPE	LOGIC FUNC 19
189	TYPE	LOGIC FUNC 2
1395	TYPE	LOGIC FUNC 20
194	TYPE	LOGIC FUNC 3
199	TYPE	LOGIC FUNC 4
204	TYPE	LOGIC FUNC 5
209	TYPE	LOGIC FUNC 6
214	TYPE	LOGIC FUNC 7
219	TYPE	LOGIC FUNC 8
224	TYPE	LOGIC FUNC 9
750	TYPE	TEC OPTION
134	TYPE	VALUE FUNC 1
179	TYPE	VALUE FUNC 10
1300	TYPE	VALUE FUNC 11
1305	TYPE	VALUE FUNC 12
1310	TYPE	VALUE FUNC 13
1315	TYPE	VALUE FUNC 14
1320	TYPE	VALUE FUNC 15
1325	TYPE	VALUE FUNC 16
1330	TYPE	VALUE FUNC 17
1335	TYPE	VALUE FUNC 18
1340	TYPE	VALUE FUNC 19
139	TYPE	VALUE FUNC 2
1345	TYPE	VALUE FUNC 20
144	TYPE	VALUE FUNC 3
149	TYPE	VALUE FUNC 4
154	TYPE	VALUE FUNC 5
159	TYPE	VALUE FUNC 6
164	TYPE	VALUE FUNC 7
169	TYPE	VALUE FUNC 8
174	TYPE	VALUE FUNC 9
103	UNIT ID (UID)	SYSTEM PORT (P3)
323	UNITS	DISPLAY SCALE 1
377	UNITS	DISPLAY SCALE 2
859	UNITS	DISPLAY SCALE 3
867	UNITS	DISPLAY SCALE 4
1151	UP TIME	INVERSE TIME

TAG	MMI Name	Block
785	UP TO SPD (UTS)	SPEED CALC
1657	USER FREQ 1	FLUXING
1676	USER FREQ 10	FLUXING
1659	USER FREQ 2	FLUXING
1661	USER FREQ 3	FLUXING
1664	USER FREQ 4	FLUXING
1666	USER FREQ 5	FLUXING
1668	USER FREQ 6	FLUXING
1670	USER FREQ 7	FLUXING
1672	USER FREQ 8	FLUXING
1674	USER FREQ 9	FLUXING
1658	USER VOLTAGE 1	FLUXING
1660	USER VOLTAGE 2	FLUXING
1663	USER VOLTAGE 3	FLUXING
1665	USER VOLTAGE 4	FLUXING
1667	USER VOLTAGE 5	FLUXING
1669	USER VOLTAGE 6	FLUXING
1671	USER VOLTAGE 7	FLUXING
1673	USER VOLTAGE 8	FLUXING
1675	USER VOLTAGE 9	FLUXING
777	UTS THRESHOLD	SPEED CALC
104	V/F SHAPE	FLUXING
1263	VALUE	5703 OUTPUT
16	VALUE	ANALOG INPUT 1
25	VALUE	ANALOG INPUT 2
715	VALUE	ANALOG INPUT 3
722	VALUE	ANALOG INPUT 4
45	VALUE	ANALOG OUTPUT 1
731	VALUE	ANALOG OUTPUT 2
800	VALUE	ANALOG OUTPUT 3
31	VALUE	DIGITAL INPUT 1
1273	VALUE	DIGITAL INPUT 11
1275	VALUE	DIGITAL INPUT 12
1277	VALUE	DIGITAL INPUT 13
1279	VALUE	DIGITAL INPUT 14
1281	VALUE	DIGITAL INPUT 15
34	VALUE	DIGITAL INPUT 2
37	VALUE	DIGITAL INPUT 3
40	VALUE	DIGITAL INPUT 4
43	VALUE	DIGITAL INPUT 5
726	VALUE	DIGITAL INPUT 6
728	VALUE	DIGITAL INPUT 7
52	VALUE	DIGITAL OUTPUT 1
1283	VALUE	DIGITAL OUTPUT 11
1285	VALUE	DIGITAL OUTPUT 12
1287	VALUE	DIGITAL OUTPUT 13
1289	VALUE	DIGITAL OUTPUT 14
1291	VALUE	DIGITAL OUTPUT 15
55	VALUE	DIGITAL OUTPUT 2
737	VALUE	DIGITAL OUTPUT 3
807	VARIABLE INERTIA	COMPENSATION
1553	VECTOR ENABLE	FLYCATCHING
1507	VELOCITY	PHASE MOVE
1568	VELOCITY	PHASE REGISTER
1295	VERSION	SYSTEM OPTION
757	VERSION	TEC OPTION
570	VHZ ENABLE	FLYCATCHING
876	VIEW LEVEL	ACCESS CONTROL
5	WARNINGS	TRIPS STATUS
741	WARNINGS+	TRIPS STATUS
809	WIDTH	COMPENSATION
833	WINDER SPEED	DIAMETER CALC

Specification Table: Tag Number Order

TAG	MMI Name	Block	Type	Range	ID	Notes
TAG	MMI NAME	Block	TYPE	RANGE	ID	NOTES
4	ACTIVE TRIPS	TRIPS STATUS	WORD	0000 to FFFF	4	Output
5	WARNINGS	TRIPS STATUS	WORD	0000 to FFFF	5	Output
6	FIRST TRIP	TRIPS STATUS	ENUM	Same as Tag 500	6	Output
8	PASSWORD	ACCESS CONTROL	WORD	0000 to FFFF	8	
12	BREAK ENABLE	ANALOG INPUT 1	BOOL	FALSE / TRUE	0c	
13	TYPE	ANALOG INPUT 1	ENUM	0 : 0..+10 V 1 : +2..+10 V 2 : 0..+5 V 3 : +1..+5 V 4 : -10..+10 V 5 : 0..20 mA 6 : 4..20 mA 7 : 20..4 mA 8 : 20..0 mA 9 : 0..+20 V	0d	
14	SCALE	ANALOG INPUT 1	REAL	-300.00 to 300.00 %	0e	
15	OFFSET	ANALOG INPUT 1	REAL	-300.00 to 300.00 %	0f	
16	VALUE	ANALOG INPUT 1	REAL	_.xx	0g	Output
17	BREAK VALUE	ANALOG INPUT 1	REAL	-300.00 to 300.00 %	0h	
18	BREAK	ANALOG INPUT 1	BOOL	FALSE / TRUE	0i	Output
21	BREAK ENABLE	ANALOG INPUT 2	BOOL	FALSE / TRUE	0l	
22	TYPE	ANALOG INPUT 2	ENUM	Same as Tag 13	0m	
23	SCALE	ANALOG INPUT 2	REAL	-300.00 to 300.00 %	0n	
24	OFFSET	ANALOG INPUT 2	REAL	-300.00 to 300.00 %	0o	
25	VALUE	ANALOG INPUT 2	REAL	_.xx	0p	Output
26	BREAK VALUE	ANALOG INPUT 2	REAL	-300.00 to 300.00 %	0q	
27	BREAK	ANALOG INPUT 2	BOOL	FALSE / TRUE	0r	Output
28	SETPOINT	FLYCATCHING	REAL	_.xx	0s	Output
30	INVERT	DIGITAL INPUT 1	BOOL	FALSE / TRUE	0u	
31	VALUE	DIGITAL INPUT 1	BOOL	FALSE / TRUE	0v	Output
32	SEARCH BOOST	FLYCATCHING	REAL	0.00 to 50.00 %	0w	3
33	INVERT	DIGITAL INPUT 2	BOOL	FALSE / TRUE	0x	
34	VALUE	DIGITAL INPUT 2	BOOL	FALSE / TRUE	0y	Output
36	INVERT	DIGITAL INPUT 3	BOOL	FALSE / TRUE	10	
37	VALUE	DIGITAL INPUT 3	BOOL	FALSE / TRUE	11	Output
39	INVERT	DIGITAL INPUT 4	BOOL	FALSE / TRUE	13	
40	VALUE	DIGITAL INPUT 4	BOOL	FALSE / TRUE	14	Output
42	INVERT	DIGITAL INPUT 5	BOOL	FALSE / TRUE	16	
43	VALUE	DIGITAL INPUT 5	BOOL	FALSE / TRUE	17	Output
44	COEFFICIENT B	DISPLAY SCALE 1	REAL	-32768.0000 to 32767.0000	18	10
45	VALUE	ANALOG OUTPUT 1	REAL	-300.00 to 300.00 %	19	
46	SCALE	ANALOG OUTPUT 1	REAL	-300.00 to 300.00 %	1a	
47	OFFSET	ANALOG OUTPUT 1	REAL	-300.00 to 300.00 %	1b	
48	ABSOLUTE	ANALOG OUTPUT 1	BOOL	FALSE / TRUE	1c	
49	TYPE	ANALOG OUTPUT 1	ENUM	0 : 0..+10 V 1 : 0..20 mA 2 : 4..20 mA 3 : -10..+10 V 4 : 20..4 mA 5 : 20..0 mA 6 : +2..+10 V 7 : 0..+5 V 8 : +1..+5 V	1d	
50	QUADRATIC TORQUE	FEEDBACKS	BOOL	FALSE / TRUE	1e	3
51	INVERT	DIGITAL OUTPUT 1	BOOL	FALSE / TRUE	1f	
52	VALUE	DIGITAL OUTPUT 1	BOOL	FALSE / TRUE	1g	
53	LOW LIMIT	DISPLAY SCALE 1	REAL	-32768.0000 to 32767.0000	1h	10
54	INVERT	DIGITAL OUTPUT 2	BOOL	FALSE / TRUE	1i	
55	VALUE	DIGITAL OUTPUT 2	BOOL	FALSE / TRUE	1j	
58	INPUT	SETPOINT SCALE	REAL	-300.00 to 300.00 %	1m	
59	OUTPUT	SETPOINT SCALE	REAL	_.x	1n	Output
60	ENABLE	SLEW RATE LIMIT	BOOL	FALSE / TRUE	1o	
61	DECEL LIMIT	SLEW RATE LIMIT	REAL	1.0 to 1200.0 Hz/s	1p	
62	ACCEL LIMIT	SLEW RATE LIMIT	REAL	1.0 to 1200.0 Hz/s	1q	
64	MOTOR CURRENT	MOTOR DATA	REAL	0.00 to 999.99 A	1s	3,7,10

2-14 Parameter Specification

TAG	MMI Name	Block	Type	Range	ID	Notes
65	MAG CURRENT	MOTOR DATA	REAL	0.00 to 999.99 A	1t	3,10
66	MOTOR CURRENT %	FEEDBACKS	REAL	_.xx	1u	Output
67	MOTOR CURRENT A	FEEDBACKS	REAL	_.x	1v	Output
70	TORQUE FEEDBACK	FEEDBACKS	REAL	_.xx	1y	Output
73	FIELD FEEDBACK	FEEDBACKS	REAL	_.xx	21	Output
74	PARAMETER	OPERATOR MENU 1	PREF	-1871 to 1871	22	
75	DC LINK VOLTS	FEEDBACKS	REAL	_.	23	Output
77	BRAKE RESISTANCE	DYNAMIC BRAKING	REAL	1 to 1000 Ohm	25	7
78	BRAKE POWER	DYNAMIC BRAKING	REAL	0.1 to 510.0 kW	26	7
79	1SEC OVER RATING	DYNAMIC BRAKING	REAL	1 to 40	27	7
80	ENABLE	DYNAMIC BRAKING	BOOL	FALSE / TRUE	28	
81	BRAKING	DYNAMIC BRAKING	BOOL	FALSE / TRUE	29	Output
82	ENABLE	SLIP COMP	BOOL	FALSE / TRUE	2a	7
83	NAMEPLATE RPM	MOTOR DATA	REAL	0.0 to 30000.0 RPM	2b	3,10
84	MOTOR POLES	MOTOR DATA	ENUM	0 : 2 POLE 1 : 4 POLE 2 : 6 POLE 3 : 8 POLE 4 : 10 POLE 5 : 12 POLE	2c	3
85	MOToring LIMIT	SLIP COMP	REAL	0.0 to 600.0 RPM	2d	3
86	REGEN LIMIT	SLIP COMP	REAL	0.0 to 600.0 RPM	2e	3
93	STARTUP SCREEN	ACCESS CONTROL	INT	0 to 16	2l	
98	RANDOM PATTERN	PATTERN GEN	BOOL	FALSE / TRUE	2q	
99	FREQ SELECT	PATTERN GEN	ENUM	0 : 3 kHz 1 : 6 kHz 2 : 9 kHz	2r	7
100	DEFLUX DELAY	PATTERN GEN	REAL	0.1 to 10.0 s	2s	3
101	HIGH LIMIT	DISPLAY SCALE 1	REAL	-32768.0000 to 32767.0000	2t	10
102	GROUP ID (GID)	SYSTEM PORT (P3)	INT	0 to 9	2u	
103	UNIT ID (UID)	SYSTEM PORT (P3)	INT	0 to 15	2v	
104	V/F SHAPE	FLUXING	ENUM	0 : LINEAR LAW 1 : FAN LAW 2 : USER DEFINED	2w	
107	FIXED BOOST	FLUXING	REAL	0.00 to 25.00 %	2z	3
108	AUTO BOOST	FLUXING	REAL	0.00 to 25.00 %	30	3
115	OP DATABASE	OP STATION 1	BOOL	FALSE / TRUE	37	Output
117	MODE	SYSTEM PORT (P3)	ENUM	0 : EI ASCII 1 : 5703	39	
119	STATOR RES	MOTOR DATA	REAL	0.0000 to 250.0000 Ohm	3b	3,10
120	LEAKAGE INDUC	MOTOR DATA	REAL	0.00 to 300.00 mH	3c	3
121	MUTUAL INDUC	MOTOR DATA	REAL	0.00 to 3000.00 mH	3d	3,10
124	MOTOR CONNECTION	MOTOR DATA	ENUM	0 : DELTA 1 : STAR	3g	3
125	FORMULA	DISPLAY SCALE 1	ENUM	0 : A/B * X + C 1 : A/B * (X+C) 2 : A/(B * X) + C 3 : A/(B * (X+C))	3h	
126	FINAL STOP RATE	REFERENCE STOP	REAL	12 to 4800 Hz/s	3i	
127	ENABLED KEYS	OP STATION 1	WORD	4 : DIRECTION 5 : JOG 6 : L/R 7 : START	3j	
130	INPUT A	VALUE FUNC 1	REAL	-32768.00 to 32767.00	3m	
131	INPUT B	VALUE FUNC 1	REAL	-32768.00 to 32767.00	3n	
132	INPUT C	VALUE FUNC 1	REAL	-32768.00 to 32767.00	3o	
133	OUTPUT	VALUE FUNC 1	REAL	_.xx	3p	Output

Parameter Specification 2-15

TAG	MMI Name	Block	Type	Range	ID	Notes
134	TYPE	VALUE FUNC 1	ENUM	0 : IF(C) -A 1 : ABS(A+B+C) 2 : SWITCH(A,B) 3 : (A*B)/C 4 : A+B+C 5 : A-B-C 6 : B<=A<=C 7 : A>B+/-C 8 : A>=B 9 : ABS(A)>B+/-C 10 : ABS(A)>=B 11 : A(1+B) 12 : IF(C) HOLD(A) 13 : BINARY DECODE 14 : ON DELAY 15 : OFF DELAY 16 : TIMER 17 : MINIMUM PULSE 18 : PULSE TRAIN 19 : WINDOW 20 : UP/DWN COUNTER 21 : (A*B)/C ROUND 22 : WINDOW NO HYST 23 : WINDOW B<=A<=C 24 : A<=B 25 : ((A*B)/100)+C 26 : MIN(A,B,C) 27 : MAX(A,B,C) 28 : PROFILE SQRT 29 : PROFILE LINEAR 30 : PROFILE x^2 31 : PROFILE x^3 32 : PROFILE x^4	3q	
135	INPUT A	VALUE FUNC 2	REAL	-32768.00 to 32767.00	3r	
136	INPUT B	VALUE FUNC 2	REAL	-32768.00 to 32767.00	3s	
137	INPUT C	VALUE FUNC 2	REAL	-32768.00 to 32767.00	3t	
138	OUTPUT	VALUE FUNC 2	REAL	_.xx	3u	Output
139	TYPE	VALUE FUNC 2	ENUM	Same as Tag 134	3v	
140	INPUT A	VALUE FUNC 3	REAL	-32768.00 to 32767.00	3w	
141	INPUT B	VALUE FUNC 3	REAL	-32768.00 to 32767.00	3x	
142	INPUT C	VALUE FUNC 3	REAL	-32768.00 to 32767.00	3y	
143	OUTPUT	VALUE FUNC 3	REAL	_.xx	3z	Output
144	TYPE	VALUE FUNC 3	ENUM	Same as TAG 134	40	
145	INPUT A	VALUE FUNC 4	REAL	-32768.00 to 32767.00	41	
146	INPUT B	VALUE FUNC 4	REAL	-32768.00 to 32767.00	42	
147	INPUT C	VALUE FUNC 4	REAL	-32768.00 to 32767.00	43	
148	OUTPUT	VALUE FUNC 4	REAL	_.xx	44	Output
149	TYPE	VALUE FUNC 4	ENUM	Same as TAG 134	45	
150	INPUT A	VALUE FUNC 5	REAL	-32768.00 to 32767.00	46	
151	INPUT B	VALUE FUNC 5	REAL	-32768.00 to 32767.00	47	
152	INPUT C	VALUE FUNC 5	REAL	-32768.00 to 32767.00	48	
153	OUTPUT	VALUE FUNC 5	REAL	_.xx	49	Output
154	TYPE	VALUE FUNC 5	ENUM	Same as TAG 134	4a	
155	INPUT A	VALUE FUNC 6	REAL	-32768.00 to 32767.00	4b	
156	INPUT B	VALUE FUNC 6	REAL	-32768.00 to 32767.00	4c	
157	INPUT C	VALUE FUNC 6	REAL	-32768.00 to 32767.00	4d	
158	OUTPUT	VALUE FUNC 6	REAL	_.xx	4e	Output
159	TYPE	VALUE FUNC 6	ENUM	Same as TAG 134	4f	
160	INPUT A	VALUE FUNC 7	REAL	-32768.00 to 32767.00	4g	
161	INPUT B	VALUE FUNC 7	REAL	-32768.00 to 32767.00	4h	
162	INPUT C	VALUE FUNC 7	REAL	-32768.00 to 32767.00	4i	
163	OUTPUT	VALUE FUNC 7	REAL	_.xx	4j	Output
164	TYPE	VALUE FUNC 7	ENUM	Same as TAG 134	4k	
165	INPUT A	VALUE FUNC 8	REAL	-32768.00 to 32767.00	4l	
166	INPUT B	VALUE FUNC 8	REAL	-32768.00 to 32767.00	4m	
167	INPUT C	VALUE FUNC 8	REAL	-32768.00 to 32767.00	4n	
168	OUTPUT	VALUE FUNC 8	REAL	_.xx	4o	Output
169	TYPE	VALUE FUNC 8	ENUM	Same as TAG 134	4p	
170	INPUT A	VALUE FUNC 9	REAL	-32768.00 to 32767.00	4q	
171	INPUT B	VALUE FUNC 9	REAL	-32768.00 to 32767.00	4r	
172	INPUT C	VALUE FUNC 9	REAL	-32768.00 to 32767.00	4s	
173	OUTPUT	VALUE FUNC 9	REAL	_.xx	4t	Output
174	TYPE	VALUE FUNC 9	ENUM	Same as TAG 134	4u	
175	INPUT A	VALUE FUNC 10	REAL	-32768.00 to 32767.00	4v	

2-16 Parameter Specification

TAG	MMI Name	Block	Type	Range	ID	Notes
176	INPUT B	VALUE FUNC 10	REAL	-32768.00 to 32767.00	4w	
177	INPUT C	VALUE FUNC 10	REAL	-32768.00 to 32767.00	4x	
178	OUTPUT	VALUE FUNC 10	REAL	_.xx	4y	Output
179	TYPE	VALUE FUNC 10	ENUM	Same as TAG 134	4z	
180	INPUT A	LOGIC FUNC 1	BOOL	FALSE / TRUE	50	
181	INPUT B	LOGIC FUNC 1	BOOL	FALSE / TRUE	51	
182	INPUT C	LOGIC FUNC 1	BOOL	FALSE / TRUE	52	
183	OUTPUT	LOGIC FUNC 1	BOOL	FALSE / TRUE	53	Output
184	TYPE	LOGIC FUNC 1	ENUM	0 : NOT(A) 1 : AND(A,B,C) 2 : NAND(A,B,C) 3 : OR(A,B,C) 4 : NOR(A,B,C) 5 : XOR(A,B) 6 : 0-1 EDGE(A) 7 : 1-0 EDGE(A) 8 : AND(A,B,!C) 9 : OR(A,B,!C) 10 : S FLIP-FLOP 11 : R FLIP-FLOP	54	
185	INPUT A	LOGIC FUNC 2	BOOL	FALSE / TRUE	55	
186	INPUT B	LOGIC FUNC 2	BOOL	FALSE / TRUE	56	
187	INPUT C	LOGIC FUNC 2	BOOL	FALSE / TRUE	57	
188	OUTPUT	LOGIC FUNC 2	BOOL	FALSE / TRUE	58	Output
189	TYPE	LOGIC FUNC 2	ENUM	Same as Tag 184	59	
190	INPUT A	LOGIC FUNC 3	BOOL	FALSE / TRUE	5a	
191	INPUT B	LOGIC FUNC 3	BOOL	FALSE / TRUE	5b	
192	INPUT C	LOGIC FUNC 3	BOOL	FALSE / TRUE	5c	
193	OUTPUT	LOGIC FUNC 3	BOOL	FALSE / TRUE	5d	Output
194	TYPE	LOGIC FUNC 3	ENUM	Same as TAG 184	5e	
195	INPUT A	LOGIC FUNC 4	BOOL	FALSE / TRUE	5f	
196	INPUT B	LOGIC FUNC 4	BOOL	FALSE / TRUE	5g	
197	INPUT C	LOGIC FUNC 4	BOOL	FALSE / TRUE	5h	
198	OUTPUT	LOGIC FUNC 4	BOOL	FALSE / TRUE	5i	Output
199	TYPE	LOGIC FUNC 4	ENUM	Same as TAG 184	5j	
200	INPUT A	LOGIC FUNC 5	BOOL	FALSE / TRUE	5k	
201	INPUT B	LOGIC FUNC 5	BOOL	FALSE / TRUE	5l	
202	INPUT C	LOGIC FUNC 5	BOOL	FALSE / TRUE	5m	
203	OUTPUT	LOGIC FUNC 5	BOOL	FALSE / TRUE	5n	Output
204	TYPE	LOGIC FUNC 5	ENUM	Same as TAG 184	5o	
205	INPUT A	LOGIC FUNC 6	BOOL	FALSE / TRUE	5p	
206	INPUT B	LOGIC FUNC 6	BOOL	FALSE / TRUE	5q	
207	INPUT C	LOGIC FUNC 6	BOOL	FALSE / TRUE	5r	
208	OUTPUT	LOGIC FUNC 6	BOOL	FALSE / TRUE	5s	Output
209	TYPE	LOGIC FUNC 6	ENUM	Same as TAG 184	5t	
210	INPUT A	LOGIC FUNC 7	BOOL	FALSE / TRUE	5u	
211	INPUT B	LOGIC FUNC 7	BOOL	FALSE / TRUE	5v	
212	INPUT C	LOGIC FUNC 7	BOOL	FALSE / TRUE	5w	
213	OUTPUT	LOGIC FUNC 7	BOOL	FALSE / TRUE	5x	Output
214	TYPE	LOGIC FUNC 7	ENUM	Same as TAG 184	5y	
215	INPUT A	LOGIC FUNC 8	BOOL	FALSE / TRUE	5z	
216	INPUT B	LOGIC FUNC 8	BOOL	FALSE / TRUE	60	
217	INPUT C	LOGIC FUNC 8	BOOL	FALSE / TRUE	61	
218	OUTPUT	LOGIC FUNC 8	BOOL	FALSE / TRUE	62	Output
219	TYPE	LOGIC FUNC 8	ENUM	Same as TAG 184	63	
220	INPUT A	LOGIC FUNC 9	BOOL	FALSE / TRUE	64	
221	INPUT B	LOGIC FUNC 9	BOOL	FALSE / TRUE	65	
222	INPUT C	LOGIC FUNC 9	BOOL	FALSE / TRUE	66	
223	OUTPUT	LOGIC FUNC 9	BOOL	FALSE / TRUE	67	Output
224	TYPE	LOGIC FUNC 9	ENUM	Same as TAG 184	68	
225	INPUT A	LOGIC FUNC 10	BOOL	FALSE / TRUE	69	
226	INPUT B	LOGIC FUNC 10	BOOL	FALSE / TRUE	6a	
227	INPUT C	LOGIC FUNC 10	BOOL	FALSE / TRUE	6b	
228	OUTPUT	LOGIC FUNC 10	BOOL	FALSE / TRUE	6c	Output
229	TYPE	LOGIC FUNC 10	ENUM	Same as TAG 184	6d	
230	OP VERSION	OP STATION 1	WORD	0000 to FFFF	6e	Output

Parameter Specification 2-17

TAG	MMI Name	Block	Type	Range	ID	Notes
231	DISABLE TRIPS	TRIPS STATUS	WORD	5 : INPUT 1 BREAK 6 : INPUT 2 BREAK 7 : MOTOR STALLED 8 : INVERSE TIME 9 : BRAKE RESISTOR 10 : BRAKE SWITCH 11 : OP STATION 12 : LOST COMMS 13 : CONTACTOR FBK 14 : SPEED FEEDBACK	6f	
233	EXT TRIP MODE	I/O TRIPS	ENUM	0 : TRIP 1 : COAST	6h	
234	EXTERNAL TRIP	I/O TRIPS	BOOL	FALSE / TRUE	6i	Output
235	INPUT 1 BREAK	I/O TRIPS	BOOL	FALSE / TRUE	6j	
236	INPUT 2 BREAK	I/O TRIPS	BOOL	FALSE / TRUE	6k	
241	STALL TIME	STALL TRIP	REAL	0.1 to 3000.0 s	6p	
242	POWER FACTOR	MOTOR DATA	REAL	0.50 to 0.99	6q	3
243	TRIM IN LOCAL	REFERENCE	BOOL	FALSE / TRUE	6r	
244	RAMP TYPE	REFERENCE RAMP	ENUM	0 : LINEAR 1 : S	6s	
245	REMOTE SETPOINT	REFERENCE	REAL	-300.00 to 300.00 %	6t	
246	SETPOINT	REFERENCE JOG	REAL	-100.00 to 100.00 %	6u	
247	LOCAL SETPOINT	REFERENCE	REAL	_.xx	6v	Output
248	SPEED TRIM	REFERENCE	REAL	-300.00 to 300.00 %	6w	
249	REMOTE REVERSE	REFERENCE	BOOL	FALSE / TRUE	6x	
250	LOCAL REVERSE	REFERENCE	BOOL	FALSE / TRUE	6y	Output
252	MAX SPEED CLAMP	REFERENCE	REAL	0.00 to 110.00 %	70	
253	MIN SPEED CLAMP	REFERENCE	REAL	-110.00 to 0.00 %	71	
254	SPEED SETPOINT	REFERENCE	REAL	_.xx	72	Output
255	SPEED DEMAND	REFERENCE	REAL	_.xx	73	Output
256	REVERSE	REFERENCE	BOOL	FALSE / TRUE	74	Output
257	REMOTE REF	LOCAL CONTROL	BOOL	FALSE / TRUE	75	Output
258	ACCEL TIME	REFERENCE RAMP	REAL	0.0 to 3000.0 s	76	3
259	DECEL TIME	REFERENCE RAMP	REAL	0.0 to 3000.0 s	77	3
260	HOLD	REFERENCE RAMP	BOOL	FALSE / TRUE	78	
261	ACCEL TIME	REFERENCE JOG	REAL	0.0 to 3000.0 s	79	
262	DECEL TIME	REFERENCE JOG	REAL	0.0 to 3000.0 s	7a	
263	STOP TIME	REFERENCE STOP	REAL	0.0 to 600.0 s	7b	
264	FAST STOP TIME	REFERENCE STOP	REAL	0.0 to 600.0 s	7c	
265	REF MODES	LOCAL CONTROL	ENUM	Same as Tag 298	7d	
266	STOP ZERO SPEED	REFERENCE STOP	REAL	0.00 to 100.00 %	7e	
267	SYMMETRIC TIME	REFERENCE RAMP	REAL	0.0 to 3000.0 s	7f	3
268	SYMMETRIC MODE	REFERENCE RAMP	BOOL	FALSE / TRUE	7g	
270	COMMS REF	COMMS CONTROL	BOOL	FALSE / TRUE	7i	Output
272	COMMS STATUS	COMMS CONTROL	WORD	0000 to FFFF	7k	Output
273	COMMS COMMAND	COMMS CONTROL	WORD	0000 to FFFF	7l	Output
274	HEALTHY	SEQUENCING LOGIC	BOOL	FALSE / TRUE	7m	Output
275	FAST STOP LIMIT	REFERENCE STOP	REAL	0.0 to 3000.0 s	7n	
276	DRIVE ENABLE	SEQUENCING LOGIC	BOOL	FALSE / TRUE	7o	
277	NOT FAST STOP	SEQUENCING LOGIC	BOOL	FALSE / TRUE	7p	
278	NOT COAST STOP	SEQUENCING LOGIC	BOOL	FALSE / TRUE	7q	
279	RUN STOP MODE	REFERENCE STOP	ENUM	0 : RUN RAMP 1 : COAST 2 : DC INJECTION 3 : STOP RAMP	7r	
280	JOG	SEQUENCING LOGIC	BOOL	FALSE / TRUE	7s	
281	SEQ DIRECTION	LOCAL CONTROL	BOOL	FALSE / TRUE	7t	
282	REM TRIP RESET	SEQUENCING LOGIC	BOOL	FALSE / TRUE	7u	
283	POWER UP START	SEQUENCING LOGIC	BOOL	FALSE / TRUE	7v	
284	STOP DELAY	REFERENCE STOP	REAL	0.000 to 30.000 s	7w	
285	RUNNING	SEQUENCING LOGIC	BOOL	FALSE / TRUE	7x	Output
286	OUTPUT CONTACTOR	SEQUENCING LOGIC	BOOL	FALSE / TRUE	7y	Output
287	READY	SEQUENCING LOGIC	BOOL	FALSE / TRUE	7z	Output
288	SWITCH ON ENABLE	SEQUENCING LOGIC	BOOL	FALSE / TRUE	80	Output
289	TRIPPED	SEQUENCING LOGIC	BOOL	FALSE / TRUE	81	Output
290	TRIP RST BY RUN	SEQUENCING LOGIC	BOOL	FALSE / TRUE	82	
291	RUN FORWARD	SEQUENCING LOGIC	BOOL	FALSE / TRUE	83	
292	RUN REVERSE	SEQUENCING LOGIC	BOOL	FALSE / TRUE	84	
293	NOT STOP	SEQUENCING LOGIC	BOOL	FALSE / TRUE	85	
294	REMOTE REVERSE	SEQUENCING LOGIC	BOOL	FALSE / TRUE	86	

2-18 Parameter Specification

TAG	MMI Name	Block	Type	Range	ID	Notes
295	COMMS SEQ	COMMS CONTROL	BOOL	FALSE / TRUE	87	Output
296	REMOTE REV OUT	SEQUENCING LOGIC	BOOL	FALSE / TRUE	88	Output
297	REMOTE SEQ	LOCAL CONTROL	BOOL	FALSE / TRUE	89	Output
298	SEQ MODES	LOCAL CONTROL	ENUM	0 : LOCAL/REMOTE 1 : LOCAL ONLY 2 : REMOTE ONLY	8a	
299	POWER UP MODE	LOCAL CONTROL	ENUM	0 : LOCAL 1 : REMOTE 2 : AUTOMATIC	8b	
300	REMOTE COMMS SEL	COMMS CONTROL	BOOL	FALSE / TRUE	8c	
301	SEQUENCER STATE	SEQUENCING LOGIC	ENUM	0 : START DISABLED 1 : START ENABLED 2 : SWITCHED ON 3 : READY 4 : ENABLED 5 : F-STOP ACTIVE 6 : TRIP ACTIVE 7 : TRIPPED	8d	Output
302	JOGGING	SEQUENCING LOGIC	BOOL	FALSE / TRUE	8e	Output
303	STOPPING	SEQUENCING LOGIC	BOOL	FALSE / TRUE	8f	Output
304	FAST STOP MODE	REFERENCE STOP	ENUM	0 : RAMP 1 : COAST	8g	
305	SYSTEM RESET	SEQUENCING LOGIC	BOOL	FALSE / TRUE	8h	Output
306	SWITCHED ON	SEQUENCING LOGIC	BOOL	FALSE / TRUE	8i	Output
307	REMOTE SEQ MODES	COMMS CONTROL	ENUM	0 : TERMINALS/COMMS 1 : TERMINALS ONLY 2 : COMMS ONLY	8j	
308	REMOTE REF MODES	COMMS CONTROL	ENUM	Same as Tag 307	8k	
309	COMMS TIMEOUT	COMMS CONTROL	REAL	0.0 to 600.0 s	8l	
310	SETPOINT	PID	REAL	-300.00 to 300.00 %	8m	
311	ENABLE	PID	BOOL	FALSE / TRUE	8n	
312	INTEGRAL DEFEAT	PID	BOOL	FALSE / TRUE	8o	
313	GAIN	PID	REAL	0.0 to 100.0	8p	
314	I TIME CONSTANT	PID	REAL	0.01 to 100.00 s	8q	
315	D TIME CONSTANT	PID	REAL	0.000 to 10.000 s	8r	
316	FILTER TC	PID	REAL	0.000 to 10.000 s	8s	
317	OUTPUT POS LIMIT	PID	REAL	0.00 to 105.00 %	8t	
318	OUTPUT NEG LIMIT	PID	REAL	-105.00 to 0.00 %	8u	
319	OUTPUT SCALING	PID	REAL	-3.0000 to 3.0000	8v	
320	PID OUTPUT	PID	REAL	_.xx	8w	Output
321	COEFFICIENT A	DISPLAY SCALE 1	REAL	-32768.0000 to 32767.0000	8x	10
322	COEFFICIENT C	DISPLAY SCALE 1	REAL	-32768.0000 to 32767.0000	8y	10
323	UNITS	DISPLAY SCALE 1	STRING	max length is 6 chars	8z	
324	NAME	OPERATOR MENU 1	STRING	max length is 16 chars	90	
325	OUTPUT	RAISE/LOWER	REAL	_.xx	91	Output
326	RAMP TIME	RAISE/LOWER	REAL	0.0 to 600.0 s	92	
327	RAISE INPUT	RAISE/LOWER	BOOL	FALSE / TRUE	93	
328	LOWER INPUT	RAISE/LOWER	BOOL	FALSE / TRUE	94	
329	MIN VALUE	RAISE/LOWER	REAL	-300.00 to 300.00 %	95	
330	MAX VALUE	RAISE/LOWER	REAL	-300.00 to 300.00 %	96	
331	RESET VALUE	RAISE/LOWER	REAL	-300.00 to 300.00 %	97	
332	RESET	RAISE/LOWER	BOOL	FALSE / TRUE	98	
334	DECIMAL PLACE	DISPLAY SCALE 1	ENUM	0 : DEFAULT 1 : X.XXXX 2 : X.XXX 3 : X.XX 4 : X.X 5 : X.	9a	
335	OUTPUT	MINIMUM SPEED	REAL	_.xx	9b	Output
336	INPUT	MINIMUM SPEED	REAL	-300.00 to 300.00 %	9c	
337	MINIMUM	MINIMUM SPEED	REAL	-100.00 to 100.00 %	9d	
338	MODE	MINIMUM SPEED	ENUM	0 : PROP. W/MIN 1 : LINEAR	9e	
339	CONFIG NAME	ACCESS CONTROL	STRING	max length is 16 chars	9f	
340	INPUT	SKIP FREQUENCIES	REAL	-300.00 to 300.00 %	9g	
341	BAND 1	SKIP FREQUENCIES	REAL	0.0 to 500.0 Hz	9h	
342	FREQUENCY 1	SKIP FREQUENCIES	REAL	0.0 to 500.0 Hz	9i	
343	FREQUENCY 2	SKIP FREQUENCIES	REAL	0.0 to 500.0 Hz	9j	
344	FREQUENCY 3	SKIP FREQUENCIES	REAL	0.0 to 500.0 Hz	9k	
345	FREQUENCY 4	SKIP FREQUENCIES	REAL	0.0 to 500.0 Hz	9l	
346	OUTPUT	SKIP FREQUENCIES	REAL	_.xx	9m	Output

Parameter Specification 2-19

TAG	MMI Name	Block	Type	Range	ID	Notes
347	INPUT 0	PRESET 1	REAL	-32768.00 to 32767.00	9n	
348	INPUT 1	PRESET 1	REAL	-32768.00 to 32767.00	9o	
349	INPUT 2	PRESET 1	REAL	-32768.00 to 32767.00	9p	
350	INPUT 3	PRESET 1	REAL	-32768.00 to 32767.00	9q	
351	INPUT 4	PRESET 1	REAL	-32768.00 to 32767.00	9r	
352	INPUT 5	PRESET 1	REAL	-32768.00 to 32767.00	9s	
353	INPUT 6	PRESET 1	REAL	-32768.00 to 32767.00	9t	
354	INPUT 7	PRESET 1	REAL	-32768.00 to 32767.00	9u	
355	SELECT INPUT	PRESET 1	ENUM	0 : INPUT 0 1 : INPUT 1 2 : INPUT 2 3 : INPUT 3 4 : INPUT 4 5 : INPUT 5 6 : INPUT 6 7 : INPUT 7	9v	
356	OUTPUT 1	PRESET 1	REAL	_.xx	9w	Output
357	THRESHOLD	ZERO SPEED	REAL	0.00 to 300.00 %	9x	
359	HYSTERISIS	ZERO SPEED	REAL	0.00 to 300.00 %	9z	
360	AT ZERO SPD DMD	ZERO SPEED	BOOL	FALSE / TRUE	a0	Output
362	INPUT Hz	SKIP FREQUENCIES	REAL	_.x	a2	Output
363	OUTPUT Hz	SKIP FREQUENCIES	REAL	_.x	a3	Output
365	CURRENT LIMIT	CURRENT LIMIT	REAL	0.00 to 300.00 %	a5	
371	PARAMETER	OPERATOR MENU 2	PREF	-1871 to 1871	ab	
372	OUTPUT 2	PRESET 1	REAL	_.xx	ac	Output
373	OUTPUT 2	PRESET 2	REAL	_.xx	ad	Output
374	OUTPUT 2	PRESET 3	REAL	_.xx	ae	Output
375	COEFFICIENT A	DISPLAY SCALE 2	REAL	-32768.0000 to 32767.0000	af	10
376	COEFFICIENT C	DISPLAY SCALE 2	REAL	-32768.0000 to 32767.0000	ag	10
377	UNITS	DISPLAY SCALE 2	STRING	max length is 6 chars	ah	
378	NAME	OPERATOR MENU 2	STRING	max length is 16 chars	ai	
379	DECIMAL PLACE	DISPLAY SCALE 2	ENUM	Same as Tag 334	aj	
380	INPUT 0	PRESET 2	REAL	-32768.00 to 32767.00	ak	
381	INPUT 1	PRESET 2	REAL	-32768.00 to 32767.00	al	
382	INPUT 2	PRESET 2	REAL	-32768.00 to 32767.00	am	
383	INPUT 3	PRESET 2	REAL	-32768.00 to 32767.00	an	
384	INPUT 4	PRESET 2	REAL	-32768.00 to 32767.00	ao	
385	INPUT 5	PRESET 2	REAL	-32768.00 to 32767.00	ap	
386	INPUT 6	PRESET 2	REAL	-32768.00 to 32767.00	aq	
387	INPUT 7	PRESET 2	REAL	-32768.00 to 32767.00	ar	
388	SELECT INPUT	PRESET 2	ENUM	Same as Tag 355	as	
389	OUTPUT 1	PRESET 2	REAL	_.xx	at	Output
390	INPUT 0	PRESET 3	REAL	-32768.00 to 32767.00	au	
391	INPUT 1	PRESET 3	REAL	-32768.00 to 32767.00	av	
392	INPUT 2	PRESET 3	REAL	-32768.00 to 32767.00	aw	
393	INPUT 3	PRESET 3	REAL	-32768.00 to 32767.00	ax	
394	INPUT 4	PRESET 3	REAL	-32768.00 to 32767.00	ay	
395	INPUT 5	PRESET 3	REAL	-32768.00 to 32767.00	az	
396	INPUT 6	PRESET 3	REAL	-32768.00 to 32767.00	b0	
397	INPUT 7	PRESET 3	REAL	-32768.00 to 32767.00	b1	
398	SELECT INPUT	PRESET 3	ENUM	Same as TAG 355	b2	
399	OUTPUT 1	PRESET 3	REAL	_.xx	b3	Output
400	SOURCE	LINK 1	PREF	-1871 to 1871	b4	8
401	DESTINATION	LINK 1	PREF	0 to 1871	b5	8
402	SOURCE	LINK 2	PREF	-1871 to 1871	b6	8
403	DESTINATION	LINK 2	PREF	0 to 1871	b7	8
404	SOURCE	LINK 3	PREF	-1871 to 1871	b8	8
405	DESTINATION	LINK 3	PREF	0 to 1871	b9	8
406	SOURCE	LINK 4	PREF	-1871 to 1871	ba	8
407	DESTINATION	LINK 4	PREF	0 to 1871	bb	8
408	SOURCE	LINK 5	PREF	-1871 to 1871	bc	8
409	DESTINATION	LINK 5	PREF	0 to 1871	bd	8
410	SOURCE	LINK 6	PREF	-1871 to 1871	be	8
411	DESTINATION	LINK 6	PREF	0 to 1871	bf	8
412	SOURCE	LINK 7	PREF	-1871 to 1871	bg	8
413	DESTINATION	LINK 7	PREF	0 to 1871	bh	8
414	SOURCE	LINK 8	PREF	-1871 to 1871	bi	8
415	DESTINATION	LINK 8	PREF	0 to 1871	bj	8

2-20 Parameter Specification

TAG	MMI Name	Block	Type	Range	ID	Notes
416	SOURCE	LINK 9	PREF	-1871 to 1871	bk	8
417	DESTINATION	LINK 9	PREF	0 to 1871	bl	8
418	SOURCE	LINK 10	PREF	-1871 to 1871	bm	8
419	DESTINATION	LINK 10	PREF	0 to 1871	bn	8
420	SOURCE	LINK 11	PREF	-1871 to 1871	bo	8
421	DESTINATION	LINK 11	PREF	0 to 1871	bp	8
422	SOURCE	LINK 12	PREF	-1871 to 1871	bq	8
423	DESTINATION	LINK 12	PREF	0 to 1871	br	8
424	SOURCE	LINK 13	PREF	-1871 to 1871	bs	8
425	DESTINATION	LINK 13	PREF	0 to 1871	bt	8
426	SOURCE	LINK 14	PREF	-1871 to 1871	bu	8
427	DESTINATION	LINK 14	PREF	0 to 1871	bv	8
428	SOURCE	LINK 15	PREF	-1871 to 1871	bw	8
429	DESTINATION	LINK 15	PREF	0 to 1871	bx	8
430	SOURCE	LINK 16	PREF	-1871 to 1871	by	8
431	DESTINATION	LINK 16	PREF	0 to 1871	bz	8
432	SOURCE	LINK 17	PREF	-1871 to 1871	c0	8
433	DESTINATION	LINK 17	PREF	0 to 1871	c1	8
434	SOURCE	LINK 18	PREF	-1871 to 1871	c2	8
435	DESTINATION	LINK 18	PREF	0 to 1871	c3	8
436	SOURCE	LINK 19	PREF	-1871 to 1871	c4	8
437	DESTINATION	LINK 19	PREF	0 to 1871	c5	8
438	SOURCE	LINK 20	PREF	-1871 to 1871	c6	8
439	DESTINATION	LINK 20	PREF	0 to 1871	c7	8
440	SOURCE	LINK 21	PREF	-1871 to 1871	c8	8
441	DESTINATION	LINK 21	PREF	0 to 1871	c9	8
442	SOURCE	LINK 22	PREF	-1871 to 1871	ca	8
443	DESTINATION	LINK 22	PREF	0 to 1871	cb	8
444	SOURCE	LINK 23	PREF	-1871 to 1871	cc	8
445	DESTINATION	LINK 23	PREF	0 to 1871	cd	8
446	SOURCE	LINK 24	PREF	-1871 to 1871	ce	8
447	DESTINATION	LINK 24	PREF	0 to 1871	cf	8
448	SOURCE	LINK 25	PREF	-1871 to 1871	cg	8
449	DESTINATION	LINK 25	PREF	0 to 1871	ch	8
450	SOURCE	LINK 26	PREF	-1871 to 1871	ci	8
451	DESTINATION	LINK 26	PREF	0 to 1871	cj	8
452	SOURCE	LINK 27	PREF	-1871 to 1871	ck	8
453	DESTINATION	LINK 27	PREF	0 to 1871	cl	8
454	SOURCE	LINK 28	PREF	-1871 to 1871	cm	8
455	DESTINATION	LINK 28	PREF	0 to 1871	cn	8
456	SOURCE	LINK 29	PREF	-1871 to 1871	co	8
457	DESTINATION	LINK 29	PREF	0 to 1871	cp	8
458	SOURCE	LINK 30	PREF	-1871 to 1871	cq	8
459	DESTINATION	LINK 30	PREF	0 to 1871	cr	8
460	SOURCE	LINK 31	PREF	-1871 to 1871	cs	8
461	DESTINATION	LINK 31	PREF	0 to 1871	ct	8
462	SOURCE	LINK 32	PREF	-1871 to 1871	cu	8
463	DESTINATION	LINK 32	PREF	0 to 1871	cv	8
464	SOURCE	LINK 33	PREF	-1871 to 1871	cw	8
465	DESTINATION	LINK 33	PREF	0 to 1871	cx	8
466	SOURCE	LINK 34	PREF	-1871 to 1871	cy	8
467	DESTINATION	LINK 34	PREF	0 to 1871	cz	8
468	SOURCE	LINK 35	PREF	-1871 to 1871	d0	8
469	DESTINATION	LINK 35	PREF	0 to 1871	d1	8
470	SOURCE	LINK 36	PREF	-1871 to 1871	d2	8
471	DESTINATION	LINK 36	PREF	0 to 1871	d3	8
472	SOURCE	LINK 37	PREF	-1871 to 1871	d4	8
473	DESTINATION	LINK 37	PREF	0 to 1871	d5	8
474	SOURCE	LINK 38	PREF	-1871 to 1871	d6	8
475	DESTINATION	LINK 38	PREF	0 to 1871	d7	8
476	SOURCE	LINK 39	PREF	-1871 to 1871	d8	8
477	DESTINATION	LINK 39	PREF	0 to 1871	d9	8
478	SOURCE	LINK 40	PREF	-1871 to 1871	da	8
479	DESTINATION	LINK 40	PREF	0 to 1871	db	8
480	SOURCE	LINK 41	PREF	-1871 to 1871	dc	8
481	DESTINATION	LINK 41	PREF	0 to 1871	dd	8
482	SOURCE	LINK 42	PREF	-1871 to 1871	de	8

Parameter Specification 2-21

TAG	MMI Name	Block	Type	Range	ID	Notes
483	DESTINATION	LINK 42	PREF	0 to 1871	df	8
484	SOURCE	LINK 43	PREF	-1871 to 1871	dg	8
485	DESTINATION	LINK 43	PREF	0 to 1871	dh	8
486	SOURCE	LINK 44	PREF	-1871 to 1871	di	8
487	DESTINATION	LINK 44	PREF	0 to 1871	dj	8
488	SOURCE	LINK 45	PREF	-1871 to 1871	dk	8
489	DESTINATION	LINK 45	PREF	0 to 1871	dl	8
490	SOURCE	LINK 46	PREF	-1871 to 1871	dm	8
491	DESTINATION	LINK 46	PREF	0 to 1871	dn	8
492	SOURCE	LINK 47	PREF	-1871 to 1871	do	8
493	DESTINATION	LINK 47	PREF	0 to 1871	dp	8
494	SOURCE	LINK 48	PREF	-1871 to 1871	dq	8
495	DESTINATION	LINK 48	PREF	0 to 1871	dr	8
496	SOURCE	LINK 49	PREF	-1871 to 1871	ds	8
497	DESTINATION	LINK 49	PREF	0 to 1871	dt	8
498	SOURCE	LINK 50	PREF	-1871 to 1871	du	8
499	DESTINATION	LINK 50	PREF	0 to 1871	dv	8
500	TRIP 1 (NEWEST)	TRIPS HISTORY	ENUM	0 : NO TRIP 1 : OVERVOLTAGE 2 : UNDERVOLTAGE 3 : OVERCURRENT 4 : HEATSINK 5 : EXTERNAL TRIP 6 : INPUT 1 BREAK 7 : INPUT 2 BREAK 8 : MOTOR STALLED 9 : INVERSE TIME 10 : BRAKE RESISTOR 11 : BRAKE SWITCH 12 : OP STATION 13 : LOST COMMS 14 : CONTACTOR FBK 15 : SPEED FEEDBACK 16 : AMBIENT TEMP 17 : MOTOR OVERTEMP 18 : CURRENT LIMIT 19 : TRIP 19 20 : 24V FAILURE 21 : LOW SPEED OVER I 22 : TRIP 22 23 : ENCODER 1 FAULT 24 : DESAT (OVER I) 25 : VDC RIPPLE 26 : BRAKE SHORT CCT 27 : OVERSPEED 28 : TRIP 28 29 : TRIP 29 30 : TRIP 30 31 : UNKNOWN 32 : OTHER 33 : MAX SPEED LOW 34 : MAINS VOLTS LOW 35 : NOT AT SPEED 36 : MAG CURRENT FAIL 37 : NEGATIVE SLIP F 38 : TR TOO LARGE 39 : TR TOO SMALL 40 : MAX RPM DATA ERR 41 : STACK TRIP 42 : LEAKGE L TIMEOUT 43 : POWER LOSS STOP 44 : MOTR TURNING ERR 45 : MOTR STALLED ERR	dw	Output
501	TRIP 2	TRIPS HISTORY	ENUM	Same as TAG 500	dx	Output
502	TRIP 3	TRIPS HISTORY	ENUM	Same as TAG 500	dy	Output
503	TRIP 4	TRIPS HISTORY	ENUM	Same as TAG 500	dz	Output
504	TRIP 5	TRIPS HISTORY	ENUM	Same as TAG 500	e0	Output
505	TRIP 6	TRIPS HISTORY	ENUM	Same as TAG 500	e1	Output
506	TRIP 7	TRIPS HISTORY	ENUM	Same as TAG 500	e2	Output
507	TRIP 8	TRIPS HISTORY	ENUM	Same as TAG 500	e3	Output
508	TRIP 9	TRIPS HISTORY	ENUM	Same as TAG 500	e4	Output
509	TRIP 10 (OLDEST)	TRIPS HISTORY	ENUM	Same as TAG 500	e5	Output
510	INPUT 0	PRESET 4	REAL	-32768.00 to 32767.00	e6	
511	INPUT 1	PRESET 4	REAL	-32768.00 to 32767.00	e7	
512	INPUT 2	PRESET 4	REAL	-32768.00 to 32767.00	e8	
513	INPUT 3	PRESET 4	REAL	-32768.00 to 32767.00	e9	
514	INPUT 4	PRESET 4	REAL	-32768.00 to 32767.00	ea	

2-22 Parameter Specification

TAG	MMI Name	Block	Type	Range	ID	Notes
515	INPUT 5	PRESET 4	REAL	-32768.00 to 32767.00	eb	
516	INPUT 6	PRESET 4	REAL	-32768.00 to 32767.00	ec	
517	INPUT 7	PRESET 4	REAL	-32768.00 to 32767.00	ed	
518	SELECT INPUT	PRESET 4	ENUM	Same as TAG 355	ee	
519	OUTPUT 1	PRESET 4	REAL	_.xx	ef	Output
520	OUTPUT 2	PRESET 4	REAL	_.xx	eg	Output
521	INPUT 0	PRESET 5	REAL	-32768.00 to 32767.00	eh	
522	INPUT 1	PRESET 5	REAL	-32768.00 to 32767.00	ei	
523	INPUT 2	PRESET 5	REAL	-32768.00 to 32767.00	ej	
524	INPUT 3	PRESET 5	REAL	-32768.00 to 32767.00	ek	
525	INPUT 4	PRESET 5	REAL	-32768.00 to 32767.00	el	
526	INPUT 5	PRESET 5	REAL	-32768.00 to 32767.00	em	
527	INPUT 6	PRESET 5	REAL	-32768.00 to 32767.00	en	
528	INPUT 7	PRESET 5	REAL	-32768.00 to 32767.00	eo	
529	SELECT INPUT	PRESET 5	ENUM	Same as TAG 355	ep	
530	OUTPUT 1	PRESET 5	REAL	_.xx	eq	Output
531	OUTPUT 2	PRESET 5	REAL	_.xx	er	Output
532	INPUT 0	PRESET 6	REAL	-32768.00 to 32767.00	es	
533	INPUT 1	PRESET 6	REAL	-32768.00 to 32767.00	et	
534	INPUT 2	PRESET 6	REAL	-32768.00 to 32767.00	eu	
535	INPUT 3	PRESET 6	REAL	-32768.00 to 32767.00	ev	
536	INPUT 4	PRESET 6	REAL	-32768.00 to 32767.00	ew	
537	INPUT 5	PRESET 6	REAL	-32768.00 to 32767.00	ex	
538	INPUT 6	PRESET 6	REAL	-32768.00 to 32767.00	ey	
539	INPUT 7	PRESET 6	REAL	-32768.00 to 32767.00	ez	
540	SELECT INPUT	PRESET 6	ENUM	Same as TAG 355	f0	
541	OUTPUT 1	PRESET 6	REAL	_.xx	f1	Output
542	OUTPUT 2	PRESET 6	REAL	_.xx	f2	Output
543	INPUT 0	PRESET 7	REAL	-32768.00 to 32767.00	f3	
544	INPUT 1	PRESET 7	REAL	-32768.00 to 32767.00	f4	
545	INPUT 2	PRESET 7	REAL	-32768.00 to 32767.00	f5	
546	INPUT 3	PRESET 7	REAL	-32768.00 to 32767.00	f6	
547	INPUT 4	PRESET 7	REAL	-32768.00 to 32767.00	f7	
548	INPUT 5	PRESET 7	REAL	-32768.00 to 32767.00	f8	
549	INPUT 6	PRESET 7	REAL	-32768.00 to 32767.00	f9	
550	INPUT 7	PRESET 7	REAL	-32768.00 to 32767.00	fa	
551	SELECT INPUT	PRESET 7	ENUM	Same as TAG 355	fb	
552	OUTPUT 1	PRESET 7	REAL	_.xx	fc	Output
553	OUTPUT 2	PRESET 7	REAL	_.xx	fd	Output
554	INPUT 0	PRESET 8	REAL	-32768.00 to 32767.00	fe	
555	INPUT 1	PRESET 8	REAL	-32768.00 to 32767.00	ff	
556	INPUT 2	PRESET 8	REAL	-32768.00 to 32767.00	fg	
557	INPUT 3	PRESET 8	REAL	-32768.00 to 32767.00	fh	
558	INPUT 4	PRESET 8	REAL	-32768.00 to 32767.00	fi	
559	INPUT 5	PRESET 8	REAL	-32768.00 to 32767.00	fj	
560	INPUT 6	PRESET 8	REAL	-32768.00 to 32767.00	fk	
561	INPUT 7	PRESET 8	REAL	-32768.00 to 32767.00	fl	
562	SELECT INPUT	PRESET 8	ENUM	Same as TAG 355	fm	
563	OUTPUT 1	PRESET 8	REAL	_.xx	fn	Output
564	OUTPUT 2	PRESET 8	REAL	_.xx	fo	Output
565	ENCODER MODE	FEEDBACKS	ENUM	0 : QUADRATURE 1 : CLOCK / DIR 2 : CLOCK	fp	3
566	ENCODER LINES	FEEDBACKS	INT	250 to 32767	fq	3
567	ENCODER INVERT	FEEDBACKS	BOOL	FALSE / TRUE	fr	3
568	SPEED FBK REV/S	FEEDBACKS	REAL	_.xx	fs	Output,10
569	SPEED FBK RPM	FEEDBACKS	REAL	_.xx	ft	Output,10
570	VHZ ENABLE	FLYCATCHING	BOOL	FALSE / TRUE	fu	
571	START MODE	FLYCATCHING	ENUM	0 : ALWAYS 1 : TRIP OR POWER UP 2 : TRIP	fv	
572	SEARCH MODE	FLYCATCHING	ENUM	0 : BIDIRECTIONAL 1 : UNIDIRECTION	fw	
573	SEARCH VOLTS	FLYCATCHING	REAL	0.00 to 100.00 %	fx	3
574	SEARCH TIME	FLYCATCHING	REAL	0.1 to 60.0 s	fy	3
575	MIN SEARCH SPEED	FLYCATCHING	REAL	0.0 to 500.0 Hz	fz	
576	ACTIVE	FLYCATCHING	BOOL	FALSE / TRUE	g0	Output
577	FREQUENCY	INJ BRAKING	REAL	1.0 to 500.0 Hz	g1	3

Parameter Specification 2-23

TAG	MMI Name	Block	Type	Range	ID	Notes
578	I-LIM LEVEL	INJ BRAKING	REAL	50.00 to 150.00 %	g2	
579	DC PULSE	INJ BRAKING	REAL	0.0 to 100.0 s	g3	3
580	FINAL DC PULSE	INJ BRAKING	REAL	0.0 to 10.0 s	g4	3
581	DC LEVEL	INJ BRAKING	REAL	0.00 to 25.00 %	g5	3
582	TIMEOUT	INJ BRAKING	REAL	0.0 to 600.0 s	g6	
583	ACTIVE	INJ BRAKING	BOOL	FALSE / TRUE	g7	Output
584	ON LOAD	BRAKE CONTROL	REAL	0.00 to 150.00 %	g8	
585	ON FREQUENCY	BRAKE CONTROL	REAL	0.0 to 500.0 Hz	g9	
586	OFF FREQUENCY	BRAKE CONTROL	REAL	0.0 to 500.0 Hz	ga	
587	ON HOLD TIME	BRAKE CONTROL	REAL	0.00 to 60.00 s	gb	
588	OFF HOLD TIME	BRAKE CONTROL	REAL	0.00 to 60.00 s	gc	
589	RELEASE	BRAKE CONTROL	BOOL	FALSE / TRUE	gd	Output
590	HOLD	BRAKE CONTROL	BOOL	FALSE / TRUE	ge	Output
591	DRIVE FREQUENCY	PATTERN GEN	REAL	_.xx	gf	Output
598	OUTPUT	MULTIPLEXER 1	WORD	0000 to FFFF	gm	Output
599	INPUT	DEMULTIPLEXER 1	WORD	0000 to FFFF	gn	
603	ENABLE	AUTOTUNE	BOOL	FALSE / TRUE	gr	
604	ACTIVE	AUTOTUNE	BOOL	FALSE / TRUE	gs	Output
608	PENDING	AUTO RESTART	BOOL	FALSE / TRUE	gw	Output
609	TRIGGERS 1	AUTO RESTART	WORD	0 : OVERVOLTAGE 1 : UNDERVOLTAGE 2 : OVERCURRENT 3 : HEATSINK 4 : EXTERNAL TRIP 5 : INPUT 1 BREAK 6 : INPUT 2 BREAK 7 : MOTOR STALLED 8 : INVERSE TIME 9 : BRAKE RESISTOR 10 : BRAKE SWITCH 11 : OP STATION 12 : LOST COMMS 13 : CONTACTOR FBK 14 : SPEED FEEDBACK 15 : AMBIENT TEMP	gx	
610	INITIAL DELAY 1	AUTO RESTART	REAL	0.0 to 600.0 s	gy	
611	ENABLE	AUTO RESTART	BOOL	FALSE / TRUE	gz	
612	ATTEMPTS	AUTO RESTART	INT	1 to 10	h0	
613	ATTEMPT DELAY 1	AUTO RESTART	REAL	0.0 to 600.0 s	h1	
614	ATTEMPTS LEFT	AUTO RESTART	INT	_	h2	Output
615	TIME LEFT	AUTO RESTART	REAL	_.x	h3	Output
616	RESTARTING	AUTO RESTART	BOOL	FALSE / TRUE	h4	Output
620	FAN RUNNING	SEQUENCING LOGIC	BOOL	FALSE / TRUE	h8	Output
626	PARAMETER	OPERATOR MENU 3	PREF	-1871 to 1871	he	
627	PARAMETER	OPERATOR MENU 4	PREF	-1871 to 1871	hf	
628	PARAMETER	OPERATOR MENU 5	PREF	-1871 to 1871	hg	
629	PARAMETER	OPERATOR MENU 6	PREF	-1871 to 1871	hh	
630	PARAMETER	OPERATOR MENU 7	PREF	-1871 to 1871	hi	
631	PARAMETER	OPERATOR MENU 8	PREF	-1871 to 1871	hj	
632	PARAMETER	OPERATOR MENU 9	PREF	-1871 to 1871	hk	
633	PARAMETER	OPERATOR MENU 10	PREF	-1871 to 1871	hl	
634	PARAMETER	OPERATOR MENU 11	PREF	-1871 to 1871	hm	
635	PARAMETER	OPERATOR MENU 12	PREF	-1871 to 1871	hn	
636	PARAMETER	OPERATOR MENU 13	PREF	-1871 to 1871	ho	
637	PARAMETER	OPERATOR MENU 14	PREF	-1871 to 1871	hp	
638	PARAMETER	OPERATOR MENU 15	PREF	-1871 to 1871	hq	
639	PARAMETER	OPERATOR MENU 16	PREF	-1871 to 1871	hr	
641	INPUT 0	MULTIPLEXER 1	BOOL	FALSE / TRUE	ht	
642	INPUT 1	MULTIPLEXER 1	BOOL	FALSE / TRUE	hu	
643	INPUT 2	MULTIPLEXER 1	BOOL	FALSE / TRUE	hv	
644	INPUT 3	MULTIPLEXER 1	BOOL	FALSE / TRUE	hw	
645	INPUT 4	MULTIPLEXER 1	BOOL	FALSE / TRUE	hx	
646	INPUT 5	MULTIPLEXER 1	BOOL	FALSE / TRUE	hy	
647	INPUT 6	MULTIPLEXER 1	BOOL	FALSE / TRUE	hz	
648	INPUT 7	MULTIPLEXER 1	BOOL	FALSE / TRUE	i0	
649	INPUT 8	MULTIPLEXER 1	BOOL	FALSE / TRUE	i1	
650	INPUT 9	MULTIPLEXER 1	BOOL	FALSE / TRUE	i2	
651	INPUT 10	MULTIPLEXER 1	BOOL	FALSE / TRUE	i3	
652	INPUT 11	MULTIPLEXER 1	BOOL	FALSE / TRUE	i4	
653	INPUT 12	MULTIPLEXER 1	BOOL	FALSE / TRUE	i5	

2-24 Parameter Specification

TAG	MMI Name	Block	Type	Range	ID	Notes
654	INPUT 13	MULTIPLEXER 1	BOOL	FALSE / TRUE	i6	
655	INPUT 14	MULTIPLEXER 1	BOOL	FALSE / TRUE	i7	
656	INPUT 15	MULTIPLEXER 1	BOOL	FALSE / TRUE	i8	
657	OUTPUT 0	DEMULTIPLEXER 1	BOOL	FALSE / TRUE	i9	Output
658	OUTPUT 1	DEMULTIPLEXER 1	BOOL	FALSE / TRUE	ia	Output
659	OUTPUT 2	DEMULTIPLEXER 1	BOOL	FALSE / TRUE	ib	Output
660	OUTPUT 3	DEMULTIPLEXER 1	BOOL	FALSE / TRUE	ic	Output
661	OUTPUT 4	DEMULTIPLEXER 1	BOOL	FALSE / TRUE	id	Output
662	OUTPUT 5	DEMULTIPLEXER 1	BOOL	FALSE / TRUE	ie	Output
663	OUTPUT 6	DEMULTIPLEXER 1	BOOL	FALSE / TRUE	if	Output
664	OUTPUT 7	DEMULTIPLEXER 1	BOOL	FALSE / TRUE	ig	Output
665	OUTPUT 8	DEMULTIPLEXER 1	BOOL	FALSE / TRUE	ih	Output
666	OUTPUT 9	DEMULTIPLEXER 1	BOOL	FALSE / TRUE	ii	Output
667	OUTPUT 10	DEMULTIPLEXER 1	BOOL	FALSE / TRUE	ij	Output
668	OUTPUT 11	DEMULTIPLEXER 1	BOOL	FALSE / TRUE	ik	Output
669	OUTPUT 12	DEMULTIPLEXER 1	BOOL	FALSE / TRUE	il	Output
670	OUTPUT 13	DEMULTIPLEXER 1	BOOL	FALSE / TRUE	im	Output
671	OUTPUT 14	DEMULTIPLEXER 1	BOOL	FALSE / TRUE	in	Output
672	OUTPUT 15	DEMULTIPLEXER 1	BOOL	FALSE / TRUE	io	Output
673	COEFFICIENT B	DISPLAY SCALE 2	REAL	-32768.0000 to 32767.0000	ip	10
674	HIGH LIMIT	DISPLAY SCALE 2	REAL	-32768.0000 to 32767.0000	iq	10
675	LOW LIMIT	DISPLAY SCALE 2	REAL	-32768.0000 to 32767.0000	ir	10
676	FORMULA	DISPLAY SCALE 2	ENUM	Same as Tag 125	is	
677	TRIGGERS 2	AUTO RESTART	WORD	0 : OVERVOLTAGE 1 : UNDERVOLTAGE 2 : OVERCURRENT 3 : HEATSINK 4 : EXTERNAL TRIP 5 : INPUT 1 BREAK 6 : INPUT 2 BREAK 7 : MOTOR STALLED 8 : INVERSE TIME 9 : BRAKE RESISTOR 10 : BRAKE SWITCH 11 : OP STATION 12 : LOST COMMS 13 : CONTACTOR FBK 14 : SPEED FEEDBACK 15 : AMBIENT TEMP	it	
678	INITIAL DELAY 2	AUTO RESTART	REAL	0.0 to 600.0 s	iu	
679	ATTEMPT DELAY 2	AUTO RESTART	REAL	0.0 to 600.0 s	iv	
680	BAND 2	SKIP FREQUENCIES	REAL	0.0 to 500.0 Hz	iw	
681	BAND 3	SKIP FREQUENCIES	REAL	0.0 to 500.0 Hz	ix	
682	BAND 4	SKIP FREQUENCIES	REAL	0.0 to 500.0 Hz	iy	
686	REGEN LIM ENABLE	CURRENT LIMIT	BOOL	FALSE / TRUE	j2	
689	MODE	AUTOTUNE	ENUM	0 : STATIONARY 1 : ROTATING	j5	
691	SRAMP CONTINUOUS	REFERENCE RAMP	BOOL	FALSE / TRUE	j7	
692	SRAMP ACCEL	REFERENCE RAMP	REAL	0.00 to 100.00 /s ²	j8	
693	SRAMP DECEL	REFERENCE RAMP	REAL	0.00 to 100.00 /s ²	j9	
694	SRAMP JERK 1	REFERENCE RAMP	REAL	0.00 to 100.00 /s ³	ja	
695	SRAMP JERK 2	REFERENCE RAMP	REAL	0.00 to 100.00 /s ³	jb	
696	SRAMP JERK 3	REFERENCE RAMP	REAL	0.00 to 100.00 /s ³	jc	
697	SRAMP JERK 4	REFERENCE RAMP	REAL	0.00 to 100.00 /s ³	jd	
698	RAMPING	REFERENCE RAMP	BOOL	FALSE / TRUE	je	Output
709	REFLUX TIME	FLYCATCHING	REAL	0.1 to 20.0 s	jp	3
710	DEFLUX TIME	INJ BRAKING	REAL	0.1 to 20.0 s	jq	3
711	BREAK ENABLE	ANALOG INPUT 3	BOOL	FALSE / TRUE	jr	
712	TYPE	ANALOG INPUT 3	ENUM	Same as TAG 13	js	
713	SCALE	ANALOG INPUT 3	REAL	-300.00 to 300.00 %	jt	
714	OFFSET	ANALOG INPUT 3	REAL	-300.00 to 300.00 %	ju	
715	VALUE	ANALOG INPUT 3	REAL	_.xx	jv	Output
716	BREAK VALUE	ANALOG INPUT 3	REAL	-300.00 to 300.00 %	jw	
717	BREAK	ANALOG INPUT 3	BOOL	FALSE / TRUE	ix	Output
718	BREAK ENABLE	ANALOG INPUT 4	BOOL	FALSE / TRUE	iy	
719	TYPE	ANALOG INPUT 4	ENUM	Same as TAG 13	jz	
720	SCALE	ANALOG INPUT 4	REAL	-300.00 to 300.00 %	k0	
721	OFFSET	ANALOG INPUT 4	REAL	-300.00 to 300.00 %	k1	
722	VALUE	ANALOG INPUT 4	REAL	_.xx	k2	Output
723	BREAK VALUE	ANALOG INPUT 4	REAL	-300.00 to 300.00 %	k3	

Parameter Specification 2-25

TAG	MMI Name	Block	Type	Range	ID	Notes
724	BREAK	ANALOG INPUT 4	BOOL	FALSE / TRUE	k4	Output
725	INVERT	DIGITAL INPUT 6	BOOL	FALSE / TRUE	k5	
726	VALUE	DIGITAL INPUT 6	BOOL	FALSE / TRUE	k6	Output
727	INVERT	DIGITAL INPUT 7	BOOL	FALSE / TRUE	k7	
728	VALUE	DIGITAL INPUT 7	BOOL	FALSE / TRUE	k8	Output
731	VALUE	ANALOG OUTPUT 2	REAL	-300.00 to 300.00 %	kb	
732	SCALE	ANALOG OUTPUT 2	REAL	-300.00 to 300.00 %	kc	
733	OFFSET	ANALOG OUTPUT 2	REAL	-300.00 to 300.00 %	kd	
734	ABSOLUTE	ANALOG OUTPUT 2	BOOL	FALSE / TRUE	ke	
735	TYPE	ANALOG OUTPUT 2	ENUM	Same as Tag 49	kf	
736	INVERT	DIGITAL OUTPUT 3	BOOL	FALSE / TRUE	kg	
737	VALUE	DIGITAL OUTPUT 3	BOOL	FALSE / TRUE	kh	
739	BASE VOLTS	INJ BRAKING	REAL	0.00 to 115.47 %	kj	3
740	ACTIVE TRIPS+	TRIPS STATUS	WORD	0000 to FFFF	kk	Output
741	WARNINGS+	TRIPS STATUS	WORD	0000 to FFFF	kl	Output
742	DISABLE TRIPS+	TRIPS STATUS	WORD	0 : MOTOR OVERTEMP 3 : 24V FAILURE 6 : ENCODER 1 FAULT 10 : OVERSPEED	km	
744	TRIGGERS 1+	AUTO RESTART	WORD	0 : MOTOR OVERTEMP 1 : CURRENT LIMIT 3 : 24V FAILURE 4 : LOW SPEED OVER I 6 : ENCODER 1 FAULT 7 : DESAT (OVER I) 8 : VDC RIPPLE 9 : BRAKE SHORT CCT 10 : OVERSPEED 14 : UNKNOWN 15 : OTHER	ko	
745	TRIGGERS 2+	AUTO RESTART	WORD	Same as Tag 744	kp	
747	RESET	POSITION	BOOL	FALSE / TRUE	kr	
748	OUTPUT (INT)	POSITION	INT	-	ks	Output
749	SPEED FBK %	FEEDBACKS	REAL	_.xx	kt	Output
750	TYPE	TEC OPTION	ENUM	0 : NONE 1 : RS485 2 : PROFIBUS 3 : LINK 4 : DEVICE NET 5 : CAN OPEN 6 : LONWORKS 7 : CONTROLNET 8 : MODBUS PLUS 9 : ETHERNET 10 : TYPE 10 11 : TYPE 11 12 : TYPE 12 13 : TYPE 13 14 : TYPE 14 15 : TYPE 15	ku	
751	INPUT 1	TEC OPTION	INT	-32768 to 32767	kv	
752	INPUT 2	TEC OPTION	INT	-32768 to 32767	kx	
753	INPUT 3	TEC OPTION	INT	-32768 to 32767	ky	
754	INPUT 4	TEC OPTION	INT	-32768 to 32767	kz	
755	INPUT 5	TEC OPTION	INT	-32768 to 32767	l0	
756	FAULT	TEC OPTION	ENUM	0 : NONE 1 : PARAMETER VALUE 2 : TYPE MISMATCH 3 : SELFTEST 4 : HARDWARE 5 : MISSING	l0	Output
757	VERSION	TEC OPTION	WORD	0000 to FFFF	l1	Output
758	OUTPUT 1	TEC OPTION	WORD	0000 to FFFF	l2	Output
759	OUTPUT 2	TEC OPTION	WORD	0000 to FFFF	l3	Output
760	INVERT THERMIST	I/O TRIPS	BOOL	FALSE / TRUE	l4	
761	ENCODER SUPPLY	FEEDBACKS	REAL	10.0 to 20.0 V	l5	3
763	SETPOINT NEGATE	PID	BOOL	FALSE / TRUE	l7	
764	FEEDBACK	PID	REAL	-300.00 to 300.00 %	l8	
765	FEEDBACK NEGATE	PID	BOOL	FALSE / TRUE	l9	
766	PID ERROR	PID	REAL	_.xx	la	Output
767	OUTPUT	S-RAMP	REAL	_.xx	lb	Output
768	RAMPING	S-RAMP	BOOL	FALSE / TRUE	lc	Output
770	COMMS SETPOINT	REFERENCE	REAL	_.xx	le	Output
771	INPUT 0	MULTIPLEXER 2	BOOL	FALSE / TRUE	lf	

2-26 Parameter Specification

TAG	MMI Name	Block	Type	Range	ID	Notes
772	INPUT 1	MULTIPLEXER 2	BOOL	FALSE / TRUE	lg	
773	INPUT 2	MULTIPLEXER 2	BOOL	FALSE / TRUE	lh	
774	REWIND	SPEED CALC	BOOL	FALSE / TRUE	li	
775	OVER-WIND	SPEED CALC	BOOL	FALSE / TRUE	lj	
776	OVER SPD ENABLE	SPEED CALC	BOOL	FALSE / TRUE	lk	
777	UTS THRESHOLD	SPEED CALC	REAL	0.00 to 110.00 %	ll	
778	LINE SPEED	SPEED CALC	REAL	-110.00 to 110.00 %	lm	
779	MOD WINDER SPEED	SPEED CALC	REAL	0.00 to 110.00 %	ln	
780	DIAMETER	SPEED CALC	REAL	0.00 to 110.00 %	lo	
781	MINIMUM DIAMETER	SPEED CALC	REAL	0.00 to 120.00 %	lp	
782	OVER SPEED	SPEED CALC	REAL	-120.00 to 120.00 %	lq	
783	SPEED TRIM	SPEED CALC	REAL	-110.00 to 110.00 %	lr	
784	SPEED DEMAND	SPEED CALC	REAL	_.xx	ls	Output
785	UP TO SPD (UTS)	SPEED CALC	BOOL	FALSE / TRUE	lt	Output
786	OVER-WIND	TORQUE CALC	BOOL	FALSE / TRUE	lu	
787	TENSION ENABLE	TORQUE CALC	BOOL	FALSE / TRUE	lv	
788	TORQUE DEMAND	TORQUE CALC	REAL	-200.00 to 200.00 %	lw	
789	TORQUE LIMIT	TORQUE CALC	REAL	0.00 to 200.00 %	lx	
790	POS TORQUE LIMIT	TORQUE CALC	REAL	_.xx	ly	Output
791	NEG TORQUE LIMIT	TORQUE CALC	REAL	_.xx	lz	Output
792	INPUT 3	MULTIPLEXER 2	BOOL	FALSE / TRUE	m0	
793	INPUT 4	MULTIPLEXER 2	BOOL	FALSE / TRUE	m1	
794	INPUT 5	MULTIPLEXER 2	BOOL	FALSE / TRUE	m2	
795	INPUT 6	MULTIPLEXER 2	BOOL	FALSE / TRUE	m3	
796	INPUT 7	MULTIPLEXER 2	BOOL	FALSE / TRUE	m4	
797	INPUT 8	MULTIPLEXER 2	BOOL	FALSE / TRUE	m5	
798	INPUT 9	MULTIPLEXER 2	BOOL	FALSE / TRUE	m6	
799	INPUT 10	MULTIPLEXER 2	BOOL	FALSE / TRUE	m7	
800	VALUE	ANALOG OUTPUT 3	REAL	-300.00 to 300.00 %	m8	
801	SCALE	ANALOG OUTPUT 3	REAL	-300.00 to 300.00 %	m9	
802	OFFSET	ANALOG OUTPUT 3	REAL	-300.00 to 300.00 %	ma	
803	ABSOLUTE	ANALOG OUTPUT 3	BOOL	FALSE / TRUE	mb	
804	TYPE	ANALOG OUTPUT 3	ENUM	Same as TAG 49	mc	
805	DIAMETER	COMPENSATION	REAL	0.00 to 100.00 %	md	
806	MINIMUM DIAMETER	COMPENSATION	REAL	0.00 to 100.00 %	me	
807	VARIABLE INERTIA	COMPENSATION	REAL	0.00 to 100.00 %	mf	
808	FIXED INERTIA	COMPENSATION	REAL	0.00 to 100.00 %	mg	
809	WIDTH	COMPENSATION	REAL	0.00 to 100.00 %	mh	
810	REWIND	COMPENSATION	BOOL	FALSE / TRUE	mi	
811	LINE SPD DEMAND	COMPENSATION	REAL	-100.00 to 100.00 %	mj	
812	RATE CAL	COMPENSATION	REAL	-300.00 to 300.00	mk	
813	REVERSE	COMPENSATION	BOOL	FALSE / TRUE	ml	
814	DYNAMIC COMP	COMPENSATION	REAL	0.00 to 300.00 %	mm	
815	STATIC COMP	COMPENSATION	REAL	0.00 to 300.00 %	mn	
816	MOD WINDER SPEED	COMPENSATION	REAL	0.00 to 300.00 %	mo	
817	COMPENSATIONS	COMPENSATION	REAL	_.xx	mp	Output
818	INERTIA COMP	COMPENSATION	REAL	_.xx	mq	Output
819	SCALED RATE	COMPENSATION	REAL	_.xx	mr	Output
820	LINE SPEED RATE	COMPENSATION	REAL	_.xx	ms	Output
821	DIAMETER HOLD	DIAMETER CALC	BOOL	FALSE / TRUE	mt	
822	PRESET ENABLE	DIAMETER CALC	BOOL	FALSE / TRUE	mu	
823	SELECT CORE 2	DIAMETER CALC	BOOL	FALSE / TRUE	mv	
824	SEL EXT DIAMETER	DIAMETER CALC	BOOL	FALSE / TRUE	mw	
825	TENSION ENABLE	DIAMETER CALC	BOOL	FALSE / TRUE	mx	
826	CORE 1	DIAMETER CALC	REAL	0.00 to 120.00 %	my	
827	CORE 2	DIAMETER CALC	REAL	0.00 to 120.00 %	mz	
828	DIAMETER TC	DIAMETER CALC	REAL	0.00 to 300.00 s	n0	
829	EXT DIAMETER	DIAMETER CALC	REAL	0.00 to 120.00 %	n1	
830	LINE SPEED	DIAMETER CALC	REAL	-110.00 to 110.00 %	n2	
831	MINIMUM DIAMETER	DIAMETER CALC	REAL	0.00 to 120.00 %	n3	
832	MINIMUM SPEED	DIAMETER CALC	REAL	0.00 to 110.00 %	n4	
833	WINDER SPEED	DIAMETER CALC	REAL	-110.00 to 110.00 %	n5	
834	CURRENT CORE	DIAMETER CALC	REAL	_.xx	n6	Output
835	DIAMETER	DIAMETER CALC	REAL	_.xx	n7	Output
836	MOD LINE SPEED	DIAMETER CALC	REAL	_.xx	n8	Output
837	MOD WINDER SPEED	DIAMETER CALC	REAL	_.xx	n9	Output
838	HYPERBOLIC TAPER	TAPER CALC	BOOL	FALSE / TRUE	na	

Parameter Specification 2-27

TAG	MMI Name	Block	Type	Range	ID	Notes
839	STALL ENABLE	TAPER CALC	BOOL	FALSE / TRUE	nb	
840	BOOST ENABLE	TAPER CALC	BOOL	FALSE / TRUE	nc	
841	FIXED BOOST	TAPER CALC	BOOL	FALSE / TRUE	nd	
842	FIXED STALL TEN	TAPER CALC	BOOL	FALSE / TRUE	ne	
843	CURRENT CORE	TAPER CALC	REAL	0.00 to 120.00 %	nf	
844	DIAMETER	TAPER CALC	REAL	0.00 to 120.00 %	ng	
845	BOOST	TAPER CALC	REAL	-200.00 to 200.00 %	nh	
846	TENSION RAMP	TAPER CALC	REAL	0.000 to 300.000 s	ni	10
847	STALL TENSION	TAPER CALC	REAL	-100.00 to 100.00 %	nj	
848	TAPER SPT	TAPER CALC	REAL	-100.00 to 100.00 %	nk	
849	TENSION SPT	TAPER CALC	REAL	-200.00 to 200.00 %	nl	
850	TAPERED DEMAND	TAPER CALC	REAL	_.xx	nm	Output
851	TENSION DEMAND	TAPER CALC	REAL	_.xx	nn	Output
852	DECIMAL PLACE	DISPLAY SCALE 3	ENUM	Same as TAG 334	no	
853	FORMULA	DISPLAY SCALE 3	ENUM	Same as TAG 125	np	
854	COEFFICIENT A	DISPLAY SCALE 3	REAL	-32768.0000 to 32767.0000	nq	10
855	COEFFICIENT B	DISPLAY SCALE 3	REAL	-32768.0000 to 32767.0000	nr	10
856	COEFFICIENT C	DISPLAY SCALE 3	REAL	-32768.0000 to 32767.0000	ns	10
857	HIGH LIMIT	DISPLAY SCALE 3	REAL	-32768.0000 to 32767.0000	nt	10
858	LOW LIMIT	DISPLAY SCALE 3	REAL	-32768.0000 to 32767.0000	nu	10
859	UNITS	DISPLAY SCALE 3	STRING	max length is 6 chars	nv	
860	DECIMAL PLACE	DISPLAY SCALE 4	ENUM	Same as TAG 334	nw	
861	FORMULA	DISPLAY SCALE 4	ENUM	Same as TAG 125	nx	
862	COEFFICIENT A	DISPLAY SCALE 4	REAL	-32768.0000 to 32767.0000	ny	10
863	COEFFICIENT B	DISPLAY SCALE 4	REAL	-32768.0000 to 32767.0000	nz	10
864	COEFFICIENT C	DISPLAY SCALE 4	REAL	-32768.0000 to 32767.0000	o0	10
865	HIGH LIMIT	DISPLAY SCALE 4	REAL	-32768.0000 to 32767.0000	o1	10
866	LOW LIMIT	DISPLAY SCALE 4	REAL	-32768.0000 to 32767.0000	o2	10
867	UNITS	DISPLAY SCALE 4	STRING	max length is 6 chars	o3	
868	INPUT 11	MULTIPLEXER 2	BOOL	FALSE / TRUE	o4	
869	INPUT 12	MULTIPLEXER 2	BOOL	FALSE / TRUE	o5	
870	INPUT 13	MULTIPLEXER 2	BOOL	FALSE / TRUE	o6	
871	INPUT 14	MULTIPLEXER 2	BOOL	FALSE / TRUE	o7	
872	INPUT 15	MULTIPLEXER 2	BOOL	FALSE / TRUE	o8	
873	OUTPUT	MULTIPLEXER 2	WORD	0000 to FFFF	o9	Output
874	INPUT	DEMUTIPLEXER 2	WORD	0000 to FFFF	oa	
875	OUTPUT 0	DEMUTIPLEXER 2	BOOL	FALSE / TRUE	ob	Output
876	VIEW LEVEL	ACCESS CONTROL	ENUM	0 : OPERATOR 1 : BASIC 2 : ADVANCED	oc	
879	INPUT	LINEAR RAMP	REAL	-300.00 to 300.00 %	of	
880	ACCEL TIME	LINEAR RAMP	REAL	0.0 to 3000.0 s	og	
881	DECEL TIME	LINEAR RAMP	REAL	0.0 to 3000.0 s	oh	
882	SYMMETRIC MODE	LINEAR RAMP	BOOL	FALSE / TRUE	oi	
883	SYMMETRIC TIME	LINEAR RAMP	REAL	0.0 to 3000.0 s	oj	
884	HOLD	LINEAR RAMP	BOOL	FALSE / TRUE	ok	
885	RESET	LINEAR RAMP	BOOL	FALSE / TRUE	ol	
886	RESET VALUE	LINEAR RAMP	REAL	-300.00 to 300.00 %	om	
887	OUTPUT	LINEAR RAMP	REAL	_.xx	on	Output
888	RAMPING	LINEAR RAMP	BOOL	FALSE / TRUE	oo	Output
889	INPUT	S-RAMP	REAL	-100.00 to 100.00 %	op	
890	JERK 1	S-RAMP	REAL	0.00 to 100.00 /s ³	oq	
891	JERK 2	S-RAMP	REAL	0.00 to 100.00 /s ³	or	
892	JERK 3	S-RAMP	REAL	0.00 to 100.00 /s ³	os	
893	JERK 4	S-RAMP	REAL	0.00 to 100.00 /s ³	ot	
894	ACCELERATION	S-RAMP	REAL	0.00 to 100.00 /s ²	ou	
895	DECELERATION	S-RAMP	REAL	0.00 to 100.00 /s ²	ov	
896	HOLD	S-RAMP	BOOL	FALSE / TRUE	ow	
897	RESET	S-RAMP	BOOL	FALSE / TRUE	ox	
898	RESET VALUE	S-RAMP	REAL	-100.00 to 100.00 %	oy	
899	CONTINUOUS	S-RAMP	BOOL	FALSE / TRUE	oz	
1000	OUTPUT 1	DEMUTIPLEXER 2	BOOL	FALSE / TRUE	rs	Output
1001	OUTPUT 2	DEMUTIPLEXER 2	BOOL	FALSE / TRUE	rt	Output
1002	OUTPUT 3	DEMUTIPLEXER 2	BOOL	FALSE / TRUE	ru	Output
1003	OUTPUT 4	DEMUTIPLEXER 2	BOOL	FALSE / TRUE	rv	Output
1004	OUTPUT 5	DEMUTIPLEXER 2	BOOL	FALSE / TRUE	rw	Output
1005	OUTPUT 6	DEMUTIPLEXER 2	BOOL	FALSE / TRUE	rx	Output

2-28 Parameter Specification

TAG	MMI Name	Block	Type	Range	ID	Notes
1006	OUTPUT 7	DEMULTIPLEXER 2	BOOL	FALSE / TRUE	ry	Output
1007	OUTPUT 8	DEMULTIPLEXER 2	BOOL	FALSE / TRUE	rz	Output
1008	OUTPUT 9	DEMULTIPLEXER 2	BOOL	FALSE / TRUE	s0	Output
1009	OUTPUT 10	DEMULTIPLEXER 2	BOOL	FALSE / TRUE	s1	Output
1010	OUTPUT 11	DEMULTIPLEXER 2	BOOL	FALSE / TRUE	s2	Output
1011	OUTPUT 12	DEMULTIPLEXER 2	BOOL	FALSE / TRUE	s3	Output
1012	OUTPUT 13	DEMULTIPLEXER 2	BOOL	FALSE / TRUE	s4	Output
1013	OUTPUT 14	DEMULTIPLEXER 2	BOOL	FALSE / TRUE	s5	Output
1014	OUTPUT 15	DEMULTIPLEXER 2	BOOL	FALSE / TRUE	s6	Output
1016	ENCODER COUNT	FEEDBACKS	INT	-	s8	Output
1020	TERMINAL VOLTS	FEEDBACKS	REAL	-	sc	Output
1025	TEST DISABLE	AUTOTUNE	WORD	0 : STATOR RES 1 : LEAKAGE IND 2 : ENCODER DIR 3 : MAG CURRENT 4 : ROTOR TIME CONST	sh	
1032	MAX SPEED	SETPOINT SCALE	REAL	0 to 32000 RPM	so	3
1037	SETPOINT SCALE	ACCESS CONTROL	ENUM	0 : NONE 1 : DISPLAY SCALE 1 2 : DISPLAY SCALE 2 3 : DISPLAY SCALE 3 4 : DISPLAY SCALE 4	st	
1038	NO SETPOINT PWRD	ACCESS CONTROL	BOOL	FALSE / TRUE	su	
1039	SCALING	OPERATOR MENU 1	ENUM	Same as Tag 1037	sv	
1040	READ ONLY	OPERATOR MENU 1	BOOL	FALSE / TRUE	sw	
1041	IGNORE PASSWORD	OPERATOR MENU 1	BOOL	FALSE / TRUE	sx	
1042	SCALING	OPERATOR MENU 2	ENUM	Same as TAG 1037	sy	
1043	READ ONLY	OPERATOR MENU 2	BOOL	FALSE / TRUE	sz	
1044	IGNORE PASSWORD	OPERATOR MENU 2	BOOL	FALSE / TRUE	t0	
1045	NAME	OPERATOR MENU 3	STRING	max length is 16 chars	t1	
1046	SCALING	OPERATOR MENU 3	ENUM	Same as TAG 1037	t2	
1047	READ ONLY	OPERATOR MENU 3	BOOL	FALSE / TRUE	t3	
1048	IGNORE PASSWORD	OPERATOR MENU 3	BOOL	FALSE / TRUE	t4	
1049	NAME	OPERATOR MENU 4	STRING	max length is 16 chars	t5	
1050	SCALING	OPERATOR MENU 4	ENUM	Same as TAG 1037	t6	
1051	READ ONLY	OPERATOR MENU 4	BOOL	FALSE / TRUE	t7	
1052	IGNORE PASSWORD	OPERATOR MENU 4	BOOL	FALSE / TRUE	t8	
1053	NAME	OPERATOR MENU 5	STRING	max length is 16 chars	t9	
1054	SCALING	OPERATOR MENU 5	ENUM	Same as TAG 1037	ta	
1055	READ ONLY	OPERATOR MENU 5	BOOL	FALSE / TRUE	tb	
1056	IGNORE PASSWORD	OPERATOR MENU 5	BOOL	FALSE / TRUE	tc	
1057	NAME	OPERATOR MENU 6	STRING	max length is 16 chars	td	
1058	SCALING	OPERATOR MENU 6	ENUM	Same as TAG 1037	te	
1059	READ ONLY	OPERATOR MENU 6	BOOL	FALSE / TRUE	tf	
1060	IGNORE PASSWORD	OPERATOR MENU 6	BOOL	FALSE / TRUE	tg	
1061	NAME	OPERATOR MENU 7	STRING	max length is 16 chars	th	
1062	SCALING	OPERATOR MENU 7	ENUM	Same as TAG 1037	ti	
1063	READ ONLY	OPERATOR MENU 7	BOOL	FALSE / TRUE	tj	
1064	IGNORE PASSWORD	OPERATOR MENU 7	BOOL	FALSE / TRUE	tk	
1065	NAME	OPERATOR MENU 8	STRING	max length is 16 chars	tl	
1066	SCALING	OPERATOR MENU 8	ENUM	Same as TAG 1037	tm	
1067	READ ONLY	OPERATOR MENU 8	BOOL	FALSE / TRUE	tn	
1068	IGNORE PASSWORD	OPERATOR MENU 8	BOOL	FALSE / TRUE	to	
1069	NAME	OPERATOR MENU 9	STRING	max length is 16 chars	tp	
1070	SCALING	OPERATOR MENU 9	ENUM	Same as TAG 1037	tq	
1071	READ ONLY	OPERATOR MENU 9	BOOL	FALSE / TRUE	tr	
1072	IGNORE PASSWORD	OPERATOR MENU 9	BOOL	FALSE / TRUE	ts	
1073	NAME	OPERATOR MENU 10	STRING	max length is 16 chars	tt	
1074	SCALING	OPERATOR MENU 10	ENUM	Same as TAG 1037	tu	
1075	READ ONLY	OPERATOR MENU 10	BOOL	FALSE / TRUE	tv	
1076	IGNORE PASSWORD	OPERATOR MENU 10	BOOL	FALSE / TRUE	tw	
1077	NAME	OPERATOR MENU 11	STRING	max length is 16 chars	tx	
1078	SCALING	OPERATOR MENU 11	ENUM	Same as TAG 1037	ty	
1079	READ ONLY	OPERATOR MENU 11	BOOL	FALSE / TRUE	tz	
1080	IGNORE PASSWORD	OPERATOR MENU 11	BOOL	FALSE / TRUE	u0	
1081	NAME	OPERATOR MENU 12	STRING	max length is 16 chars	u1	
1082	SCALING	OPERATOR MENU 12	ENUM	Same as TAG 1037	u2	
1083	READ ONLY	OPERATOR MENU 12	BOOL	FALSE / TRUE	u3	

TAG	MMI Name	Block	Type	Range	ID	Notes
1084	IGNORE PASSWORD	OPERATOR MENU 12	BOOL	FALSE / TRUE	u4	
1085	NAME	OPERATOR MENU 13	STRING	max length is 16 chars	u5	
1086	SCALING	OPERATOR MENU 13	ENUM	Same as TAG 1037	u6	
1087	READ ONLY	OPERATOR MENU 13	BOOL	FALSE / TRUE	u7	
1088	IGNORE PASSWORD	OPERATOR MENU 13	BOOL	FALSE / TRUE	u8	
1089	NAME	OPERATOR MENU 14	STRING	max length is 16 chars	u9	
1090	SCALING	OPERATOR MENU 14	ENUM	Same as TAG 1037	ua	
1091	READ ONLY	OPERATOR MENU 14	BOOL	FALSE / TRUE	ub	
1092	IGNORE PASSWORD	OPERATOR MENU 14	BOOL	FALSE / TRUE	uc	
1093	NAME	OPERATOR MENU 15	STRING	max length is 16 chars	ud	
1094	SCALING	OPERATOR MENU 15	ENUM	Same as TAG 1037	ue	
1095	READ ONLY	OPERATOR MENU 15	BOOL	FALSE / TRUE	uf	
1096	IGNORE PASSWORD	OPERATOR MENU 15	BOOL	FALSE / TRUE	ug	
1097	NAME	OPERATOR MENU 16	STRING	max length is 16 chars	uh	
1098	SCALING	OPERATOR MENU 16	ENUM	Same as TAG 1037	ui	
1099	READ ONLY	OPERATOR MENU 16	BOOL	FALSE / TRUE	uj	
1100	IGNORE PASSWORD	OPERATOR MENU 16	BOOL	FALSE / TRUE	uk	
1101	INPUT	FILTER 1	REAL	-300.00 to 300.00 %	ul	
1102	RESET	FILTER 1	BOOL	FALSE / TRUE	um	
1103	TIME CONSTANT	FILTER 1	REAL	0.00 to 300.00 s	un	
1104	OUTPUT	FILTER 1	REAL	_.xx	uo	Output
1105	INPUT	FILTER 2	REAL	-300.00 to 300.00 %	up	
1106	RESET	FILTER 2	BOOL	FALSE / TRUE	uq	
1107	TIME CONSTANT	FILTER 2	REAL	0.00 to 300.00 s	ur	
1108	OUTPUT	FILTER 2	REAL	_.xx	us	Output
1109	ENABLED KEYS	OP STATION 2	WORD	4 : DIRECTION 5 : JOG 6 : L/R 7 : START	ut	
1110	OP VERSION	OP STATION 2	WORD	0000 to FFFF	uu	Output
1148	AIMING POINT	INVERSE TIME	REAL	50.00 to 150.00 %	vw	
1149	DELAY	INVERSE TIME	REAL	5.0 to 60.0 s	vx	
1150	DOWN TIME	INVERSE TIME	REAL	1.0 to 10.0 s	vy	
1151	UP TIME	INVERSE TIME	REAL	1.0 to 600.0 s	vz	
1152	IT LIMITING	INVERSE TIME	BOOL	FALSE / TRUE	w0	Output
1153	INVERSE TIME OP	INVERSE TIME	REAL	_.xx	w1	Output
1154	INVERT ENC TRIP	I/O TRIPS	BOOL	FALSE / TRUE	w2	
1155	THERMISTOR	I/O TRIPS	BOOL	FALSE / TRUE	w3	Output
1156	ENCODER	I/O TRIPS	BOOL	FALSE / TRUE	w4	Output
1157	CONTROL MODE	MOTOR DATA	ENUM	0 : VOLTS / Hz 1 : SENSORLESS VEC 2 : CLOSED-LOOP VEC 3 : 4-Q REGEN	w5	3,7
1158	POWER	MOTOR DATA	REAL	0.00 to 355.00 kW	w6	3,10
1159	BASE FREQUENCY	MOTOR DATA	REAL	7.5 to 1000.0 Hz	w7	3,7
1160	MOTOR VOLTAGE	MOTOR DATA	REAL	0.0 to 575.0 V	w8	3
1163	ROTOR TIME CONST	MOTOR DATA	REAL	10.00 to 3000.00 ms	wb	3,10
1164	OVERLOAD	MOTOR DATA	REAL	1.0 to 5.0	wc	3
1187	SPEED PROP GAIN	SPEED LOOP	REAL	0.0 to 3000.0	wz	3,10
1188	SPEED INT TIME	SPEED LOOP	REAL	1 to 15000 ms	x0	3
1189	INT DEFEAT	SPEED LOOP	BOOL	FALSE / TRUE	x1	
1190	SPEED INT PRESET	SPEED LOOP	REAL	-500.00 to 500.00 %	x2	10
1191	SPEED DMD FILTER	SPEED LOOP	REAL	0.0 to 14.0 ms	x3	
1192	SPEED FBK FILTER	SPEED LOOP	REAL	0.0 to 15.0 ms	x4	
1193	AUX TORQUE DMD	SPEED LOOP	REAL	-300.00 to 300.00 %	x5	
1194	ADAPTIVE THRESH	SPEED LOOP	REAL	0.00 to 10.00 %	x6	
1195	ADAPTIVE P-GAIN	SPEED LOOP	REAL	0.00 to 300.00	x7	
1196	DIRECT IP SELECT	SPEED LOOP	ENUM	0 : NONE 1 : ANIN 1 2 : ANIN 2 3 : ANIN 3 4 : ANIN 4	x8	
1197	DIRECT RATIO	SPEED LOOP	REAL	-10.0000 to 10.0000	x9	10
1198	DIRCT IP POS LIM	SPEED LOOP	REAL	-110.00 to 110.00 %	xa	
1199	DIRCT IP NEG LIM	SPEED LOOP	REAL	-110.00 to 110.00 %	xb	
1200	SPEED POS LIM	SPEED LOOP	REAL	-110.00 to 110.00 %	xc	
1201	SPEED NEG LIM	SPEED LOOP	REAL	-110.00 to 110.00 %	xd	
1202	TORQ DMD ISOLATE	SPEED LOOP	BOOL	FALSE / TRUE	xe	
1203	TOTL SPD DMD RPM	SPEED LOOP	REAL	_.xx	xf	Output,10

2-30 Parameter Specification

TAG	MMI Name	Block	Type	Range	ID	Notes
1204	TORQUE DEMAND	SPEED LOOP	REAL	_.xx	xg	Output
1205	DIRECT INPUT	SPEED LOOP	REAL	_.xx	xh	Output
1206	TOTAL SPD DMD %	SPEED LOOP	REAL	_.xx	xi	Output
1207	SPEED ERROR	SPEED LOOP	REAL	_.xx	xj	Output
1233	AT ZERO SPD FBK	ZERO SPEED	BOOL	FALSE / TRUE	y9	Output
1234	AT STANDSTILL	ZERO SPEED	BOOL	FALSE / TRUE	ya	Output
1235	CONTACTOR CLOSED	SEQUENCING LOGIC	BOOL	FALSE / TRUE	yb	
1238	ENCODER FBK %	FEEDBACKS	REAL	_.xx	ye	Output
1247	ERROR	PID (TYPE 2)	REAL	-300.00 to 300.00 %	yn	
1248	FEED FWD	PID (TYPE 2)	REAL	-300.00 to 300.00 %	yo	
1249	FEED FWD GAIN	PID (TYPE 2)	REAL	-300.00 to 300.00	yp	
1250	P GAIN	PID (TYPE 2)	REAL	0.00 to 100.00	yq	
1251	I GAIN	PID (TYPE 2)	REAL	0.00 to 100.00	yr	
1252	D GAIN	PID (TYPE 2)	REAL	0.00 to 100.00	ys	
1253	LIMIT	PID (TYPE 2)	REAL	0.00 to 300.00 %	yt	
1254	ENABLE	PID (TYPE 2)	BOOL	FALSE / TRUE	yu	
1255	D FILTER TC	PID (TYPE 2)	REAL	0.05 to 10.00 s	yv	
1256	OUTPUT	PID (TYPE 2)	REAL	_.xx	yw	Output
1257	LIMITING	PID (TYPE 2)	BOOL	FALSE / TRUE	yx	Output
1258	RATIO	5703 INPUT	REAL	-3.0000 to 3.0000 %	yy	
1259	NEGATE	5703 INPUT	BOOL	FALSE / TRUE	yz	
1260	SCALED VALUE	5703 INPUT	REAL	_.xx	z0	Output
1261	RAW VALUE	5703 INPUT	REAL	_.xx	z1	Output
1262	BREAK	5703 INPUT	BOOL	FALSE / TRUE	z2	Output
1263	VALUE	5703 OUTPUT	REAL	-300.00 to 300.00 %	z3	
1264	REPEATER	5703 OUTPUT	BOOL	FALSE / TRUE	z4	
1265	ENABLE	POWER LOSS CNTRL	BOOL	FALSE / TRUE	z5	
1266	TRIP THRESHOLD	POWER LOSS CNTRL	REAL	0 to 1000 V	z6	3
1267	CONTROL BAND	POWER LOSS CNTRL	REAL	0 to 1000 V	z7	
1268	ACCEL TIME	POWER LOSS CNTRL	REAL	0.01 to 300.00 s	z8	
1269	DECEL TIME	POWER LOSS CNTRL	REAL	0.01 to 300.00 s	z9	
1270	TIME LIMIT	POWER LOSS CNTRL	REAL	0.00 to 300.00 s	za	
1271	PWR LOSS ACTIVE	POWER LOSS CNTRL	BOOL	FALSE / TRUE	zb	Output
1272	INVERT	DIGITAL INPUT 11	BOOL	FALSE / TRUE	zc	
1273	VALUE	DIGITAL INPUT 11	BOOL	FALSE / TRUE	zd	Output
1274	INVERT	DIGITAL INPUT 12	BOOL	FALSE / TRUE	ze	
1275	VALUE	DIGITAL INPUT 12	BOOL	FALSE / TRUE	zf	Output
1276	INVERT	DIGITAL INPUT 13	BOOL	FALSE / TRUE	zg	
1277	VALUE	DIGITAL INPUT 13	BOOL	FALSE / TRUE	zh	Output
1278	INVERT	DIGITAL INPUT 14	BOOL	FALSE / TRUE	zi	
1279	VALUE	DIGITAL INPUT 14	BOOL	FALSE / TRUE	zj	Output
1280	INVERT	DIGITAL INPUT 15	BOOL	FALSE / TRUE	zk	
1281	VALUE	DIGITAL INPUT 15	BOOL	FALSE / TRUE	zl	Output
1282	INVERT	DIGITAL OUTPUT 11	BOOL	FALSE / TRUE	zm	
1283	VALUE	DIGITAL OUTPUT 11	BOOL	FALSE / TRUE	zn	
1284	INVERT	DIGITAL OUTPUT 12	BOOL	FALSE / TRUE	zo	
1285	VALUE	DIGITAL OUTPUT 12	BOOL	FALSE / TRUE	zp	
1286	INVERT	DIGITAL OUTPUT 13	BOOL	FALSE / TRUE	zq	
1287	VALUE	DIGITAL OUTPUT 13	BOOL	FALSE / TRUE	zr	
1288	INVERT	DIGITAL OUTPUT 14	BOOL	FALSE / TRUE	zs	
1289	VALUE	DIGITAL OUTPUT 14	BOOL	FALSE / TRUE	zt	
1290	INVERT	DIGITAL OUTPUT 15	BOOL	FALSE / TRUE	zu	
1291	VALUE	DIGITAL OUTPUT 15	BOOL	FALSE / TRUE	zv	
1292	REQUIRED TYPE	SYSTEM OPTION	ENUM	0 : NONE 1 : DUAL ENCODER 2 : DUAL HIPERFACE 3 : FIREWIRE 4 : TYPE 4 5 : TYPE 5 6 : TYPE 6 7 : TYPE 7 8 : TYPE 8	zw	
1293	FAULT	SYSTEM OPTION	ENUM	Same as Tag 756	zx	Output
1294	ACTUAL TYPE	SYSTEM OPTION	ENUM	Same as Tag 1292	zy	Output
1295	VERSION	SYSTEM OPTION	WORD	0000 to FFFF	zz	Output
1296	INPUT A	VALUE FUNC 11	REAL	-32768.00 to 32767.00	aA	
1297	INPUT B	VALUE FUNC 11	REAL	-32768.00 to 32767.00	aB	
1298	INPUT C	VALUE FUNC 11	REAL	-32768.00 to 32767.00	aC	

Parameter Specification 2-31

TAG	MMI Name	Block	Type	Range	ID	Notes
1299	OUTPUT	VALUE FUNC 11	REAL	_.xx	aD	Output
1300	TYPE	VALUE FUNC 11	ENUM	Same as TAG 134	aE	
1301	INPUT A	VALUE FUNC 12	REAL	-32768.00 to 32767.00	aF	
1302	INPUT B	VALUE FUNC 12	REAL	-32768.00 to 32767.00	aG	
1303	INPUT C	VALUE FUNC 12	REAL	-32768.00 to 32767.00	aH	
1304	OUTPUT	VALUE FUNC 12	REAL	_.xx	aI	Output
1305	TYPE	VALUE FUNC 12	ENUM	Same as TAG 134	aJ	
1306	INPUT A	VALUE FUNC 13	REAL	-32768.00 to 32767.00	aK	
1307	INPUT B	VALUE FUNC 13	REAL	-32768.00 to 32767.00	aL	
1308	INPUT C	VALUE FUNC 13	REAL	-32768.00 to 32767.00	aM	
1309	OUTPUT	VALUE FUNC 13	REAL	_.xx	aN	Output
1310	TYPE	VALUE FUNC 13	ENUM	Same as TAG 134	aO	
1311	INPUT A	VALUE FUNC 14	REAL	-32768.00 to 32767.00	aP	
1312	INPUT B	VALUE FUNC 14	REAL	-32768.00 to 32767.00	aQ	
1313	INPUT C	VALUE FUNC 14	REAL	-32768.00 to 32767.00	aR	
1314	OUTPUT	VALUE FUNC 14	REAL	_.xx	aS	Output
1315	TYPE	VALUE FUNC 14	ENUM	Same as TAG 134	aT	
1316	INPUT A	VALUE FUNC 15	REAL	-32768.00 to 32767.00	aU	
1317	INPUT B	VALUE FUNC 15	REAL	-32768.00 to 32767.00	aV	
1318	INPUT C	VALUE FUNC 15	REAL	-32768.00 to 32767.00	aW	
1319	OUTPUT	VALUE FUNC 15	REAL	_.xx	aX	Output
1320	TYPE	VALUE FUNC 15	ENUM	Same as TAG 134	aY	
1321	INPUT A	VALUE FUNC 16	REAL	-32768.00 to 32767.00	aZ	
1322	INPUT B	VALUE FUNC 16	REAL	-32768.00 to 32767.00	bA	
1323	INPUT C	VALUE FUNC 16	REAL	-32768.00 to 32767.00	bB	
1324	OUTPUT	VALUE FUNC 16	REAL	_.xx	bC	Output
1325	TYPE	VALUE FUNC 16	ENUM	Same as TAG 134	bD	
1326	INPUT A	VALUE FUNC 17	REAL	-32768.00 to 32767.00	bE	
1327	INPUT B	VALUE FUNC 17	REAL	-32768.00 to 32767.00	bF	
1328	INPUT C	VALUE FUNC 17	REAL	-32768.00 to 32767.00	bG	
1329	OUTPUT	VALUE FUNC 17	REAL	_.xx	bH	Output
1330	TYPE	VALUE FUNC 17	ENUM	Same as TAG 134	bI	
1331	INPUT A	VALUE FUNC 18	REAL	-32768.00 to 32767.00	bJ	
1332	INPUT B	VALUE FUNC 18	REAL	-32768.00 to 32767.00	bK	
1333	INPUT C	VALUE FUNC 18	REAL	-32768.00 to 32767.00	bL	
1334	OUTPUT	VALUE FUNC 18	REAL	_.xx	bM	Output
1335	TYPE	VALUE FUNC 18	ENUM	Same as TAG 134	bN	
1336	INPUT A	VALUE FUNC 19	REAL	-32768.00 to 32767.00	bO	
1337	INPUT B	VALUE FUNC 19	REAL	-32768.00 to 32767.00	bP	
1338	INPUT C	VALUE FUNC 19	REAL	-32768.00 to 32767.00	bQ	
1339	OUTPUT	VALUE FUNC 19	REAL	_.xx	bR	Output
1340	TYPE	VALUE FUNC 19	ENUM	Same as TAG 134	bS	
1341	INPUT A	VALUE FUNC 20	REAL	-32768.00 to 32767.00	bT	
1342	INPUT B	VALUE FUNC 20	REAL	-32768.00 to 32767.00	bU	
1343	INPUT C	VALUE FUNC 20	REAL	-32768.00 to 32767.00	bV	
1344	OUTPUT	VALUE FUNC 20	REAL	_.xx	bW	Output
1345	TYPE	VALUE FUNC 20	ENUM	Same as TAG 134	bX	
1346	INPUT A	LOGIC FUNC 11	BOOL	FALSE / TRUE	bY	
1347	INPUT B	LOGIC FUNC 11	BOOL	FALSE / TRUE	bZ	
1348	INPUT C	LOGIC FUNC 11	BOOL	FALSE / TRUE	cA	
1349	OUTPUT	LOGIC FUNC 11	BOOL	FALSE / TRUE	cB	Output
1350	TYPE	LOGIC FUNC 11	ENUM	Same as TAG 184	cC	
1351	INPUT A	LOGIC FUNC 12	BOOL	FALSE / TRUE	cD	
1352	INPUT B	LOGIC FUNC 12	BOOL	FALSE / TRUE	cE	
1353	INPUT C	LOGIC FUNC 12	BOOL	FALSE / TRUE	cF	
1354	OUTPUT	LOGIC FUNC 12	BOOL	FALSE / TRUE	cG	Output
1355	TYPE	LOGIC FUNC 12	ENUM	Same as TAG 184	cH	
1356	INPUT A	LOGIC FUNC 13	BOOL	FALSE / TRUE	cI	
1357	INPUT B	LOGIC FUNC 13	BOOL	FALSE / TRUE	cJ	
1358	INPUT C	LOGIC FUNC 13	BOOL	FALSE / TRUE	cK	
1359	OUTPUT	LOGIC FUNC 13	BOOL	FALSE / TRUE	cL	Output
1360	TYPE	LOGIC FUNC 13	ENUM	Same as TAG 184	cM	
1361	INPUT A	LOGIC FUNC 14	BOOL	FALSE / TRUE	cN	
1362	INPUT B	LOGIC FUNC 14	BOOL	FALSE / TRUE	cO	
1363	INPUT C	LOGIC FUNC 14	BOOL	FALSE / TRUE	cP	
1364	OUTPUT	LOGIC FUNC 14	BOOL	FALSE / TRUE	cQ	Output
1365	TYPE	LOGIC FUNC 14	ENUM	Same as TAG 184	cR	

2-32 Parameter Specification

TAG	MMI Name	Block	Type	Range	ID	Notes
1366	INPUT A	LOGIC FUNC 15	BOOL	FALSE / TRUE	cS	
1367	INPUT B	LOGIC FUNC 15	BOOL	FALSE / TRUE	cT	
1368	INPUT C	LOGIC FUNC 15	BOOL	FALSE / TRUE	cU	
1369	OUTPUT	LOGIC FUNC 15	BOOL	FALSE / TRUE	cV	Output
1370	TYPE	LOGIC FUNC 15	ENUM	Same as TAG 184	cW	
1371	INPUT A	LOGIC FUNC 16	BOOL	FALSE / TRUE	cX	
1372	INPUT B	LOGIC FUNC 16	BOOL	FALSE / TRUE	cY	
1373	INPUT C	LOGIC FUNC 16	BOOL	FALSE / TRUE	cZ	
1374	OUTPUT	LOGIC FUNC 16	BOOL	FALSE / TRUE	dA	Output
1375	TYPE	LOGIC FUNC 16	ENUM	Same as TAG 184	dB	
1376	INPUT A	LOGIC FUNC 17	BOOL	FALSE / TRUE	dC	
1377	INPUT B	LOGIC FUNC 17	BOOL	FALSE / TRUE	dD	
1378	INPUT C	LOGIC FUNC 17	BOOL	FALSE / TRUE	dE	
1379	OUTPUT	LOGIC FUNC 17	BOOL	FALSE / TRUE	dF	Output
1380	TYPE	LOGIC FUNC 17	ENUM	Same as TAG 184	dG	
1381	INPUT A	LOGIC FUNC 18	BOOL	FALSE / TRUE	dH	
1382	INPUT B	LOGIC FUNC 18	BOOL	FALSE / TRUE	dI	
1383	INPUT C	LOGIC FUNC 18	BOOL	FALSE / TRUE	dJ	
1384	OUTPUT	LOGIC FUNC 18	BOOL	FALSE / TRUE	dK	Output
1385	TYPE	LOGIC FUNC 18	ENUM	Same as TAG 184	dL	
1386	INPUT A	LOGIC FUNC 19	BOOL	FALSE / TRUE	dM	
1387	INPUT B	LOGIC FUNC 19	BOOL	FALSE / TRUE	dN	
1388	INPUT C	LOGIC FUNC 19	BOOL	FALSE / TRUE	dO	
1389	OUTPUT	LOGIC FUNC 19	BOOL	FALSE / TRUE	dP	Output
1390	TYPE	LOGIC FUNC 19	ENUM	Same as TAG 184	dQ	
1391	INPUT A	LOGIC FUNC 20	BOOL	FALSE / TRUE	dR	
1392	INPUT B	LOGIC FUNC 20	BOOL	FALSE / TRUE	dS	
1393	INPUT C	LOGIC FUNC 20	BOOL	FALSE / TRUE	dT	
1394	OUTPUT	LOGIC FUNC 20	BOOL	FALSE / TRUE	dU	Output
1395	TYPE	LOGIC FUNC 20	ENUM	Same as TAG 184	dV	
1397	PHASE INPUT	SPEED LOOP	REAL	_.xx	dX	Output
1400	SOURCE	LINK 51	PREF	-1871 to 1871	eA	8
1401	DESTINATION	LINK 51	PREF	0 to 1871	eB	8
1402	SOURCE	LINK 52	PREF	-1871 to 1871	eC	8
1403	DESTINATION	LINK 52	PREF	0 to 1871	eD	8
1404	SOURCE	LINK 53	PREF	-1871 to 1871	eE	8
1405	DESTINATION	LINK 53	PREF	0 to 1871	eF	8
1406	SOURCE	LINK 54	PREF	-1871 to 1871	eG	8
1407	DESTINATION	LINK 54	PREF	0 to 1871	eH	8
1408	SOURCE	LINK 55	PREF	-1871 to 1871	eI	8
1409	DESTINATION	LINK 55	PREF	0 to 1871	eJ	8
1410	SOURCE	LINK 56	PREF	-1871 to 1871	eK	8
1411	DESTINATION	LINK 56	PREF	0 to 1871	eL	8
1412	SOURCE	LINK 57	PREF	-1871 to 1871	eM	8
1413	DESTINATION	LINK 57	PREF	0 to 1871	eN	8
1414	SOURCE	LINK 58	PREF	-1871 to 1871	eO	8
1415	DESTINATION	LINK 58	PREF	0 to 1871	eP	8
1416	SOURCE	LINK 59	PREF	-1871 to 1871	eQ	8
1417	DESTINATION	LINK 59	PREF	0 to 1871	eR	8
1418	SOURCE	LINK 60	PREF	-1871 to 1871	eS	8
1419	DESTINATION	LINK 60	PREF	0 to 1871	eT	8
1420	SOURCE	LINK 61	PREF	-1871 to 1871	eU	8
1421	DESTINATION	LINK 61	PREF	0 to 1871	eV	8
1422	SOURCE	LINK 62	PREF	-1871 to 1871	eW	8
1423	DESTINATION	LINK 62	PREF	0 to 1871	eX	8
1424	SOURCE	LINK 63	PREF	-1871 to 1871	eY	8
1425	DESTINATION	LINK 63	PREF	0 to 1871	eZ	8
1426	SOURCE	LINK 64	PREF	-1871 to 1871	fA	8
1427	DESTINATION	LINK 64	PREF	0 to 1871	fB	8
1428	SOURCE	LINK 65	PREF	-1871 to 1871	fC	8
1429	DESTINATION	LINK 65	PREF	0 to 1871	fD	8
1430	SOURCE	LINK 66	PREF	-1871 to 1871	fE	8
1431	DESTINATION	LINK 66	PREF	0 to 1871	fF	8
1432	SOURCE	LINK 67	PREF	-1871 to 1871	fG	8
1433	DESTINATION	LINK 67	PREF	0 to 1871	fH	8
1434	SOURCE	LINK 68	PREF	-1871 to 1871	fI	8
1435	DESTINATION	LINK 68	PREF	0 to 1871	fJ	8

TAG	MMI Name	Block	Type	Range	ID	Notes
1436	SOURCE	LINK 69	PREF	-1871 to 1871	fK	8
1437	DESTINATION	LINK 69	PREF	0 to 1871	fL	8
1438	SOURCE	LINK 70	PREF	-1871 to 1871	fM	8
1439	DESTINATION	LINK 70	PREF	0 to 1871	fN	8
1440	SOURCE	LINK 71	PREF	-1871 to 1871	fO	8
1441	DESTINATION	LINK 71	PREF	0 to 1871	fP	8
1442	SOURCE	LINK 72	PREF	-1871 to 1871	fQ	8
1443	DESTINATION	LINK 72	PREF	0 to 1871	fR	8
1444	SOURCE	LINK 73	PREF	-1871 to 1871	fS	8
1445	DESTINATION	LINK 73	PREF	0 to 1871	fT	8
1446	SOURCE	LINK 74	PREF	-1871 to 1871	fU	8
1447	DESTINATION	LINK 74	PREF	0 to 1871	fV	8
1448	SOURCE	LINK 75	PREF	-1871 to 1871	fW	8
1449	DESTINATION	LINK 75	PREF	0 to 1871	fX	8
1450	SOURCE	LINK 76	PREF	-1871 to 1871	fY	8
1451	DESTINATION	LINK 76	PREF	0 to 1871	fZ	8
1452	SOURCE	LINK 77	PREF	-1871 to 1871	gA	8
1453	DESTINATION	LINK 77	PREF	0 to 1871	gB	8
1454	SOURCE	LINK 78	PREF	-1871 to 1871	gC	8
1455	DESTINATION	LINK 78	PREF	0 to 1871	gD	8
1456	SOURCE	LINK 79	PREF	-1871 to 1871	gE	8
1457	DESTINATION	LINK 79	PREF	0 to 1871	gF	8
1458	SOURCE	LINK 80	PREF	-1871 to 1871	gG	8
1459	DESTINATION	LINK 80	PREF	0 to 1871	gH	8
1460	ENABLE	HOME	BOOL	FALSE / TRUE	gI	
1461	INPUT	HOME	REAL	-300.00 to 300.00 %	gJ	
1462	DISTANCE	HOME	REAL	0.00 to 300.00	gK	
1463	DISTANCE FINE	HOME	REAL	0.0000 to 1.0000	gL	
1464	GAIN	HOME	REAL	0.0 to 1000.0	gM	
1465	CORRECTION LIMIT	HOME	REAL	0.00 to 100.00 %	gN	
1466	DECEL LIMIT	HOME	REAL	0.0 to 3000.0 %	gO	
1467	ERROR COUNT	HOME	INT	_	gP	Output
1468	DECELERATION	HOME	REAL	_.xx	gQ	Output
1469	ACTIVE	HOME	BOOL	FALSE / TRUE	gR	Output
1470	DONE	HOME	BOOL	FALSE / TRUE	gS	Output
1471	ERROR	HOME	BOOL	FALSE / TRUE	gT	Output
1472	OUTPUT	HOME	REAL	_.xx	gU	Output
1473	PERIOD	PHASE TUNING	REAL	0.10 to 300.00 s	gV	
1474	ENABLE SPEED	PHASE TUNING	BOOL	FALSE / TRUE	gW	
1475	SPEED OFFSET	PHASE TUNING	REAL	-300.00 to 300.00 %	gX	
1476	ENABLE PHASE	PHASE TUNING	BOOL	FALSE / TRUE	gY	
1477	PHASE OFFSET	PHASE TUNING	REAL	-300.00 to 300.00	gZ	
1478	ACTIVE	PHASE TUNING	BOOL	FALSE / TRUE	hA	Output
1479	RESET (TOTAL)	PHASE CONTROL	BOOL	FALSE / TRUE	hB	
1480	POSITION ENABLE	PHASE CONTROL	BOOL	FALSE / TRUE	hC	
1481	SPEED INPUT	PHASE CONTROL	REAL	-300.00 to 300.00	hD	
1482	INVERT SPEED OP	PHASE CONTROL	BOOL	FALSE / TRUE	hE	
1483	GEARING A	PHASE CONTROL	REAL	-30000.00 to 30000.00	hF	10
1484	GEARING B	PHASE CONTROL	REAL	-30000.00 to 30000.00	hG	10
1485	DFDWD SCALE	PHASE CONTROL	REAL	-300.00 to 300.00	hH	
1486	OUTPUT SCALE	PHASE CONTROL	REAL	0.00 to 300.00	hI	
1487	INVERT OUTPUT	PHASE CONTROL	BOOL	FALSE / TRUE	hJ	
1488	OUTPUT	PHASE CONTROL	REAL	_.xx	hK	Output
1489	SPEED OUTPUT	PHASE CONTROL	REAL	_.xx	hL	Output
1490	POS FEED FWD	PHASE CONTROL	REAL	_.xx	hM	Output
1491	MASTER POS (INT)	PHASE CONTROL	INT	_	hN	Output
1492	MASTER POSITION	PHASE CONTROL	REAL	_.xx	hO	Output
1493	SLAVE POSITION	PHASE CONTROL	REAL	_.xx	hP	Output
1494	POS ERROR (INT)	PHASE CONTROL	INT	_	hQ	Output
1495	POSITION ERROR	PHASE CONTROL	REAL	_.xx	hR	Output
1497	OP DATABASE	OP STATION 2	BOOL	FALSE / TRUE	hT	Output
1498	FEATURES	SYSTEM OPTION	WORD	0000 to FFFF	hU	Output
1499	ACCELERATION	PHASE MOVE	REAL	0.01 to 3000.00 %	hV	
1500	ADVANCE	PHASE INCH	BOOL	FALSE / TRUE	hW	
1501	RETARD	PHASE INCH	BOOL	FALSE / TRUE	hX	
1502	RATE	PHASE INCH	REAL	0.0001 to 30.0000	hY	
1503	ACTIVE	PHASE INCH	BOOL	FALSE / TRUE	hZ	Output

2-34 Parameter Specification

TAG	MMI Name	Block	Type	Range	ID	Notes
1504	ENABLE	PHASE MOVE	BOOL	FALSE / TRUE	iA	
1505	DISTANCE	PHASE MOVE	REAL	-3000.0 to 3000.0	iB	
1506	DISTANCE FINE	PHASE MOVE	REAL	-1.0000 to 1.0000	iC	
1507	VELOCITY	PHASE MOVE	REAL	0.10 to 300.00 %	iD	
1508	DISTANCE LEFT	PHASE MOVE	REAL	._xx	iE	Output
1509	ACTIVE	PHASE MOVE	BOOL	FALSE / TRUE	iF	Output
1510	OFFSET	PHASE OFFSET	REAL	-3000.0 to 3000.0	iG	
1511	OFFSET FINE	PHASE OFFSET	REAL	-1.0000 to 1.0000	iH	
1512	ACTIVE	PHASE OFFSET	BOOL	FALSE / TRUE	iI	Output
1513	ERROR unused	PHASE PID	REAL	-300.00 to 300.00 %	iJ	1
1514	FEED FWD unused	PHASE PID	REAL	-300.00 to 300.00 %	iK	1
1515	FEED FWD GAIN	PHASE PID	REAL	-300.00 to 300.00	iL	
1516	P GAIN	PHASE PID	REAL	0.0 to 3000.0	iM	10
1517	I GAIN	PHASE PID	REAL	0.00 to 300.00	iN	
1518	D GAIN	PHASE PID	REAL	0.00 to 100.00	iO	
1519	LIMIT	PHASE PID	REAL	0.000 to 300.000 %	iP	10
1520	ENABLE	PHASE PID	BOOL	FALSE / TRUE	iQ	
1521	D FILTER TC	PHASE PID	REAL	0.00 to 10.00 s	iR	
1522	OUTPUT	PHASE PID	REAL	._xx	iS	Output
1523	LIMITING	PHASE PID	BOOL	FALSE / TRUE	iT	Output
1524	SLAVE CNT SRC	PHASE CONFIGURE	ENUM	0 : SLAVE ENCODER 1 : TB ENCODER 2 : DISABLE	iU	
1525	SPD LOOP SPD FBK	PHASE CONFIGURE	ENUM	0 : SLAVE ENCODER 1 : TB ENCODER	iV	
1526	COUNTS PER UNIT	PHASE CONFIGURE	INT	0 to 65536	iW	
1527	MASTER SCALE A	PHASE CONFIGURE	INT	-30000 to 30000	iX	
1528	MASTER SCALE B	PHASE CONFIGURE	INT	-30000 to 30000	iY	
1529	MASTER POSITION	PHASE CONFIGURE	INT	_	iZ	Output
1530	SLAVE POSITION	PHASE CONFIGURE	INT	_	jA	Output
1531	FAULT	PHASE CONFIGURE	ENUM	0 : NONE 1 : OVERFLOW 2 : MASTR DELTA OV 3 : MASTR SCALE OV 4 : MASTR SCALE DIVO	jB	Output
1532	SOURCE	ENCODER SPEED 1	ENUM	0 : MASTER ENCODER 1 : SLAVE ENCODER	jC	
1533	LINES	ENCODER SPEED 1	INT	250 to 32767	jD	
1534	INVERT	ENCODER SPEED 1	BOOL	FALSE / TRUE	jE	
1535	MAX SPEED	ENCODER SPEED 1	REAL	0 to 32000 RPM	jF	
1537	FILTER TIME	ENCODER SPEED 1	REAL	0.00 to 300.00 s	jH	
1538	SPEED Hz	ENCODER SPEED 1	REAL	._xx	jI	Output
1539	SPEED	ENCODER SPEED 1	REAL	._xx	jJ	Output
1540	SOURCE	ENCODER SPEED 2	ENUM	Same as Tag 1532	jK	
1541	LINES	ENCODER SPEED 2	INT	250 to 32767	jL	
1542	INVERT	ENCODER SPEED 2	BOOL	FALSE / TRUE	jM	
1543	MAX SPEED	ENCODER SPEED 2	REAL	0 to 32000 RPM	jN	
1545	FILTER TIME	ENCODER SPEED 2	REAL	0.00 to 300.00 s	jP	
1546	SPEED Hz	ENCODER SPEED 2	REAL	._xx	jQ	Output
1547	SPEED	ENCODER SPEED 2	REAL	._xx	jR	Output
1548	PID OUTPUT	PID (TYPE 2)	REAL	._xx	iS	Output
1549	PID OUTPUT	PHASE PID	REAL	._xx	iT	Output
1550	REWIND	TORQUE CALC	BOOL	FALSE / TRUE	jU	
1553	VECTOR ENABLE	FLYCATCHING	BOOL	FALSE / TRUE	jX	
1560	MAX SPEED	PHASE CONFIGURE	REAL	0 to 32000 upm	kE	
1561	MASTER MARK TYPE	PHASE CONFIGURE	ENUM	0 : PULSE 1 : POSITIVE EDGE 2 : NEGATIVE EDGE	kF	
1562	SLAVE MARK TYPE	PHASE CONFIGURE	ENUM	Same as Tag 1561	kG	
1563	RESET	PHASE REGISTER	BOOL	FALSE / TRUE	kH	
1564	ENABLE	PHASE REGISTER	BOOL	FALSE / TRUE	kI	
1565	INCH OFFSET	PHASE REGISTER	REAL	._xxxx	kJ	Output
1566	MARK OFFSET	PHASE REGISTER	REAL	-100.0000 to 100.0000	kK	
1567	SLAVE NOM LENGTH	PHASE REGISTER	REAL	0.0000 to 100.0000	kL	
1568	VELOCITY	PHASE REGISTER	REAL	0.10 to 300.00 %	kM	
1569	ACCELERATION	PHASE REGISTER	REAL	0.01 to 3000.00 %	kN	
1570	CORRECTIONS	PHASE REGISTER	INT	_	kO	Output

Parameter Specification 2-35

TAG	MMI Name	Block	Type	Range	ID	Notes
1571	STATUS	PHASE REGISTER	ENUM	0 : RESET 1 : ALIGN 2 : ALIGNED	kP	Output
1572	ERROR (COUNTS)	PHASE REGISTER	INT	-	kQ	Output
1573	ERROR	PHASE REGISTER	REAL	_.xxxx	kR	Output
1579	RESET	PHASE AUTO GEAR	BOOL	FALSE / TRUE	kX	
1580	ENABLE	PHASE AUTO GEAR	BOOL	FALSE / TRUE	kY	
1581	HOLD	PHASE AUTO GEAR	BOOL	FALSE / TRUE	kZ	
1582	NOM MASTER LEN	PHASE AUTO GEAR	REAL	0.0000 to 100.0000	IA	
1583	NOM SLAVE LENGTH	PHASE AUTO GEAR	REAL	0.0000 to 100.0000	IB	
1584	TOLERANCE	PHASE AUTO GEAR	REAL	0.0000 to 10.0000	IC	
1585	INITIAL REPEATS	PHASE AUTO GEAR	INT	0 to 1000	ID	
1586	INITIAL FILTER	PHASE AUTO GEAR	REAL	0.000 to 300.000	IE	
1587	FILTER	PHASE AUTO GEAR	REAL	0.000 to 300.000	IF	
1588	RESET COUNTERS	PHASE AUTO GEAR	BOOL	FALSE / TRUE	IG	
1589	SLAVE MARKS	PHASE AUTO GEAR	INT	-	IH	Output
1590	MASTER MARKS	PHASE AUTO GEAR	INT	-	II	Output
1591	MISSED S MARKS	PHASE AUTO GEAR	INT	-	IJ	Output
1592	MISSED M MARKS	PHASE AUTO GEAR	INT	-	IK	Output
1593	FALSE S MARKS	PHASE AUTO GEAR	INT	-	IL	Output
1594	FALSE M MARKS	PHASE AUTO GEAR	INT	-	IM	Output
1595	EXT MARK MASTER	PHASE AUTO GEAR	BOOL	FALSE / TRUE	IN	Output
1596	EXT MARK SLAVE	PHASE AUTO GEAR	BOOL	FALSE / TRUE	IO	Output
1597	GEAR CORRECTION	PHASE AUTO GEAR	REAL	_.xxxx	IP	Output
1598	MASTER LENGTH	PHASE AUTO GEAR	REAL	_.xxxx	IQ	Output
1599	SLAVE LENGTH	PHASE AUTO GEAR	REAL	_.xxxx	IR	Output
1602	READY	PHASE AUTO GEAR	BOOL	FALSE / TRUE	IU	Output
1603	RESET	ENERGY METER	BOOL	FALSE / TRUE	IV	
1604	POWER	ENERGY METER	REAL	_.xx	IW	Output,10
1605	POWER	ENERGY METER	REAL	_.xx	IX	Output,10
1606	REACTIVE POWER	ENERGY METER	REAL	_.xx	IY	Output,10
1607	ENERGY USED	ENERGY METER	REAL	_.x	IZ	Output
1608	kW min	ENERGY METER	REAL	_.x	mA	Output
1631	CORRECTION GAIN	PHASE REGISTER	REAL	-100.00 to 100.00 %	mX	
1632	STALL LIMIT TYPE	STALL TRIP	ENUM	0 : TORQUE 1 : CURRENT	mY	3
1633	PRECHARGE CLOSED	REGEN CNTRL	BOOL	FALSE / TRUE	mZ	
1634	DC VOLTS DEMAND	REGEN CNTRL	REAL	0 to 1000 V	nA	
1641	SYNCHRONIZING	REGEN CNTRL	BOOL	FALSE / TRUE	nH	Output
1642	SYNCHRONIZED	REGEN CNTRL	BOOL	FALSE / TRUE	nI	Output
1643	PHASE LOSS	REGEN CNTRL	BOOL	FALSE / TRUE	nJ	Output
1644	CLOSE PRECHARGE	REGEN CNTRL	BOOL	FALSE / TRUE	nK	Output
1645	ENABLE DRIVE	REGEN CNTRL	BOOL	FALSE / TRUE	nL	Output
1646	STATUS	REGEN CNTRL	ENUM	0 : INACTIVE 1 : SYNCHRONIZING 2 : SYNCHRONIZED 3 : SUPPLY FRQ HIGH 4 : SUPPLY FRQ LOW 5 : SYNCH FAILED	nM	Output
1647	DELAY	SPD FBK TRIP	REAL	0.00 to 300.00 s	nN	
1648	INHIBIT	SPD FBK TRIP	BOOL	FALSE / TRUE	nO	
1649	THRESHOLD	SPD FBK TRIP	REAL	0.00 to 300.00 %	nP	
1650	TRIPPED	SPD FBK TRIP	BOOL	FALSE / TRUE	nQ	Output
1655	ENERGY SAVING	FLUXING	BOOL	FALSE / TRUE	nV	3
1656	ACCELRTN BOOST	FLUXING	REAL	0.00 to 25.00 %	nW	3
1657	USER FREQ 1	FLUXING	REAL	0.0 to 100.0 %	nX	3,10
1658	USER VOLTAGE 1	FLUXING	REAL	0.0 to 100.0 %	nY	3,10
1659	USER FREQ 2	FLUXING	REAL	0.0 to 100.0 %	nZ	3,10
1660	USER VOLTAGE 2	FLUXING	REAL	0.0 to 100.0 %	oA	3,10
1661	USER FREQ 3	FLUXING	REAL	0.0 to 100.0 %	oB	3,10
1663	USER VOLTAGE 3	FLUXING	REAL	0.0 to 100.0 %	oD	3,10
1664	USER FREQ 4	FLUXING	REAL	0.0 to 100.0 %	oE	3,10
1665	USER VOLTAGE 4	FLUXING	REAL	0.0 to 100.0 %	oF	3,10
1666	USER FREQ 5	FLUXING	REAL	0.0 to 100.0 %	oG	3,10
1667	USER VOLTAGE 5	FLUXING	REAL	0.0 to 100.0 %	oH	3,10
1668	USER FREQ 6	FLUXING	REAL	0.0 to 100.0 %	oI	3,10
1669	USER VOLTAGE 6	FLUXING	REAL	0.0 to 100.0 %	oJ	3,10
1670	USER FREQ 7	FLUXING	REAL	0.0 to 100.0 %	oK	3,10

2-36 Parameter Specification

TAG	MMI Name	Block	Type	Range	ID	Notes
1671	USER VOLTAGE 7	FLUXING	REAL	0.0 to 100.0 %	oL	3,10
1672	USER FREQ 8	FLUXING	REAL	0.0 to 100.0 %	oM	3,10
1673	USER VOLTAGE 8	FLUXING	REAL	0.0 to 100.0 %	oN	3,10
1674	USER FREQ 9	FLUXING	REAL	0.0 to 100.0 %	oO	3,10
1675	USER VOLTAGE 9	FLUXING	REAL	0.0 to 100.0 %	oP	3,10
1676	USER FREQ 10	FLUXING	REAL	0.0 to 100.0 %	oQ	3,10
1677	INITIAL STEP	POWER LOSS CNTRL	REAL	0.00 to 100.00 %	oR	
1678	BRAKE MODE	REGEN CNTRL	BOOL	FALSE / TRUE	oS	
1679	ERROR	PHASE PID	REAL	_.xx	oT	Output
1680	FEED FWD	PHASE PID	REAL	_.xx	oU	Output
1682	PRESET	POSITION	REAL	-32767.00 to 32767.00	oW	
1683	LIMIT	POSITION	REAL	0.00 to 32767.00	oX	
1684	COUNTS PER UNIT	POSITION	INT	-2147483647 to 2147483647	oY	
1685	SCALED OUTPUT	POSITION	REAL	_.xxxx	oZ	Output,10
1686	START DELAY	SEQUENCING LOGIC	REAL	0.000 to 30.000 s	pA	
1687	ENCODER FBK RPM	POSITION	REAL	_.xx	pB	Output,10
1688	ENCODER FBK %	POSITION	REAL	_.xx	pC	Output
1690	ENABLE	TIMER 1	BOOL	FALSE / TRUE	pE	
1691	RESET	TIMER 1	BOOL	FALSE / TRUE	pF	
1692	RESET VALUE	TIMER 1	INT	0 to 2147483647	pG	
1693	SCALE	TIMER 1	INT	1 to 2147483647	pH	
1694	THRESHOLD	TIMER 1	INT	-2147483647 to 2147483647	pl	
1695	ABOVE THRESHOLD	TIMER 1	BOOL	FALSE / TRUE	pJ	Output
1696	SCALED TIME	TIMER 1	REAL	_.xx	pK	Output
1697	TOTAL HOURS	TIMER 1	INT	_	pL	Output
1698	TOTAL SECONDS	TIMER 1	INT	_	pM	Output
1699	RATE SCALE	PHASE INCH	REAL	0.001 to 30.000	pN	
1700	SOURCE	LINK 81	PREF	-1871 to 1871	pO	8
1701	DESTINATION	LINK 81	PREF	0 to 1871	pP	8
1702	SOURCE	LINK 82	PREF	-1871 to 1871	pQ	8
1703	DESTINATION	LINK 82	PREF	0 to 1871	pR	8
1704	SOURCE	LINK 83	PREF	-1871 to 1871	pS	8
1705	DESTINATION	LINK 83	PREF	0 to 1871	pT	8
1706	SOURCE	LINK 84	PREF	-1871 to 1871	pU	8
1707	DESTINATION	LINK 84	PREF	0 to 1871	pV	8
1708	SOURCE	LINK 85	PREF	-1871 to 1871	pW	8
1709	DESTINATION	LINK 85	PREF	0 to 1871	pX	8
1710	SOURCE	LINK 86	PREF	-1871 to 1871	pY	8
1711	DESTINATION	LINK 86	PREF	0 to 1871	pZ	8
1712	SOURCE	LINK 87	PREF	-1871 to 1871	qA	8
1713	DESTINATION	LINK 87	PREF	0 to 1871	qB	8
1714	SOURCE	LINK 88	PREF	-1871 to 1871	qC	8
1715	DESTINATION	LINK 88	PREF	0 to 1871	qD	8
1716	SOURCE	LINK 89	PREF	-1871 to 1871	qE	8
1717	DESTINATION	LINK 89	PREF	0 to 1871	qF	8
1718	SOURCE	LINK 90	PREF	-1871 to 1871	qG	8
1719	DESTINATION	LINK 90	PREF	0 to 1871	qH	8
1720	SOURCE	LINK 91	PREF	-1871 to 1871	qI	8
1721	DESTINATION	LINK 91	PREF	0 to 1871	qJ	8
1722	SOURCE	LINK 92	PREF	-1871 to 1871	qK	8
1723	DESTINATION	LINK 92	PREF	0 to 1871	qL	8
1724	SOURCE	LINK 93	PREF	-1871 to 1871	qM	8
1725	DESTINATION	LINK 93	PREF	0 to 1871	qN	8
1726	SOURCE	LINK 94	PREF	-1871 to 1871	qO	8
1727	DESTINATION	LINK 94	PREF	0 to 1871	qP	8
1728	SOURCE	LINK 95	PREF	-1871 to 1871	qQ	8
1729	DESTINATION	LINK 95	PREF	0 to 1871	qR	8
1730	SOURCE	LINK 96	PREF	-1871 to 1871	qS	8
1731	DESTINATION	LINK 96	PREF	0 to 1871	qT	8
1732	SOURCE	LINK 97	PREF	-1871 to 1871	qU	8
1733	DESTINATION	LINK 97	PREF	0 to 1871	qV	8
1734	SOURCE	LINK 98	PREF	-1871 to 1871	qW	8
1735	DESTINATION	LINK 98	PREF	0 to 1871	qX	8
1736	SOURCE	LINK 99	PREF	-1871 to 1871	qY	8
1737	DESTINATION	LINK 99	PREF	0 to 1871	qZ	8
1738	SOURCE	LINK 100	PREF	-1871 to 1871	rA	8
1739	DESTINATION	LINK 100	PREF	0 to 1871	rB	8

Parameter Specification 2-37

TAG	MMI Name	Block	Type	Range	ID	Notes
1740	PARAMETER	OPERATOR MENU 17	PREF	-1871 to 1871	rC	
1741	NAME	OPERATOR MENU 17	STRING	max length is 16 chars	rD	
1742	SCALING	OPERATOR MENU 17	ENUM	Same as TAG 1037	rE	
1743	READ ONLY	OPERATOR MENU 17	BOOL	FALSE / TRUE	rF	
1744	IGNORE PASSWORD	OPERATOR MENU 17	BOOL	FALSE / TRUE	rG	
1745	PARAMETER	OPERATOR MENU 18	PREF	-1871 to 1871	rH	
1746	NAME	OPERATOR MENU 18	STRING	max length is 16 chars	rI	
1747	SCALING	OPERATOR MENU 18	ENUM	Same as TAG 1037	rJ	
1748	READ ONLY	OPERATOR MENU 18	BOOL	FALSE / TRUE	rK	
1749	IGNORE PASSWORD	OPERATOR MENU 18	BOOL	FALSE / TRUE	rL	
1750	PARAMETER	OPERATOR MENU 19	PREF	-1871 to 1871	rM	
1751	NAME	OPERATOR MENU 19	STRING	max length is 16 chars	rN	
1752	SCALING	OPERATOR MENU 19	ENUM	Same as TAG 1037	rO	
1753	READ ONLY	OPERATOR MENU 19	BOOL	FALSE / TRUE	rP	
1754	IGNORE PASSWORD	OPERATOR MENU 19	BOOL	FALSE / TRUE	rQ	
1755	PARAMETER	OPERATOR MENU 20	PREF	-1871 to 1871	rR	
1756	NAME	OPERATOR MENU 20	STRING	max length is 16 chars	rS	
1757	SCALING	OPERATOR MENU 20	ENUM	Same as TAG 1037	rT	
1758	READ ONLY	OPERATOR MENU 20	BOOL	FALSE / TRUE	rU	
1759	IGNORE PASSWORD	OPERATOR MENU 20	BOOL	FALSE / TRUE	rV	
1760	PARAMETER	OPERATOR MENU 21	PREF	-1871 to 1871	rW	
1761	NAME	OPERATOR MENU 21	STRING	max length is 16 chars	rX	
1762	SCALING	OPERATOR MENU 21	ENUM	Same as TAG 1037	rY	
1763	READ ONLY	OPERATOR MENU 21	BOOL	FALSE / TRUE	rZ	
1764	IGNORE PASSWORD	OPERATOR MENU 21	BOOL	FALSE / TRUE	sA	
1765	PARAMETER	OPERATOR MENU 22	PREF	-1871 to 1871	sB	
1766	NAME	OPERATOR MENU 22	STRING	max length is 16 chars	sC	
1767	SCALING	OPERATOR MENU 22	ENUM	Same as TAG 1037	sD	
1768	READ ONLY	OPERATOR MENU 22	BOOL	FALSE / TRUE	sE	
1769	IGNORE PASSWORD	OPERATOR MENU 22	BOOL	FALSE / TRUE	sF	
1770	PARAMETER	OPERATOR MENU 23	PREF	-1871 to 1871	sG	
1771	NAME	OPERATOR MENU 23	STRING	max length is 16 chars	sH	
1772	SCALING	OPERATOR MENU 23	ENUM	Same as TAG 1037	sI	
1773	READ ONLY	OPERATOR MENU 23	BOOL	FALSE / TRUE	sJ	
1774	IGNORE PASSWORD	OPERATOR MENU 23	BOOL	FALSE / TRUE	sK	
1775	PARAMETER	OPERATOR MENU 24	PREF	-1871 to 1871	sL	
1776	NAME	OPERATOR MENU 24	STRING	max length is 16 chars	sM	
1777	SCALING	OPERATOR MENU 24	ENUM	Same as TAG 1037	sN	
1778	READ ONLY	OPERATOR MENU 24	BOOL	FALSE / TRUE	sO	
1779	IGNORE PASSWORD	OPERATOR MENU 24	BOOL	FALSE / TRUE	sP	
1780	PARAMETER	OPERATOR MENU 25	PREF	-1871 to 1871	sQ	
1781	NAME	OPERATOR MENU 25	STRING	max length is 16 chars	sR	
1782	SCALING	OPERATOR MENU 25	ENUM	Same as TAG 1037	sS	
1783	READ ONLY	OPERATOR MENU 25	BOOL	FALSE / TRUE	sT	
1784	IGNORE PASSWORD	OPERATOR MENU 25	BOOL	FALSE / TRUE	sU	
1785	PARAMETER	OPERATOR MENU 26	PREF	-1871 to 1871	sV	
1786	NAME	OPERATOR MENU 26	STRING	max length is 16 chars	sW	
1787	SCALING	OPERATOR MENU 26	ENUM	Same as TAG 1037	sX	
1788	READ ONLY	OPERATOR MENU 26	BOOL	FALSE / TRUE	sY	
1789	IGNORE PASSWORD	OPERATOR MENU 26	BOOL	FALSE / TRUE	sZ	
1790	PARAMETER	OPERATOR MENU 27	PREF	-1871 to 1871	tA	
1791	NAME	OPERATOR MENU 27	STRING	max length is 16 chars	tB	
1792	SCALING	OPERATOR MENU 27	ENUM	Same as TAG 1037	tC	
1793	READ ONLY	OPERATOR MENU 27	BOOL	FALSE / TRUE	tD	
1794	IGNORE PASSWORD	OPERATOR MENU 27	BOOL	FALSE / TRUE	tE	
1795	PARAMETER	OPERATOR MENU 28	PREF	-1871 to 1871	tF	
1796	NAME	OPERATOR MENU 28	STRING	max length is 16 chars	tG	
1797	SCALING	OPERATOR MENU 28	ENUM	Same as TAG 1037	tH	
1798	READ ONLY	OPERATOR MENU 28	BOOL	FALSE / TRUE	tI	
1799	IGNORE PASSWORD	OPERATOR MENU 28	BOOL	FALSE / TRUE	tJ	
1800	PARAMETER	OPERATOR MENU 29	PREF	-1871 to 1871	tK	
1801	NAME	OPERATOR MENU 29	STRING	max length is 16 chars	tL	
1802	SCALING	OPERATOR MENU 29	ENUM	Same as TAG 1037	tM	
1803	READ ONLY	OPERATOR MENU 29	BOOL	FALSE / TRUE	tN	
1804	IGNORE PASSWORD	OPERATOR MENU 29	BOOL	FALSE / TRUE	tO	
1805	PARAMETER	OPERATOR MENU 30	PREF	-1871 to 1871	tP	
1806	NAME	OPERATOR MENU 30	STRING	max length is 16 chars	tQ	

2-38 Parameter Specification

TAG	MMI Name	Block	Type	Range	ID	Notes
1807	SCALING	OPERATOR MENU 30	ENUM	Same as TAG 1037	tR	
1808	READ ONLY	OPERATOR MENU 30	BOOL	FALSE / TRUE	tS	
1809	IGNORE PASSWORD	OPERATOR MENU 30	BOOL	FALSE / TRUE	tT	
1810	PARAMETER	OPERATOR MENU 31	PREF	-1871 to 1871	tU	
1811	NAME	OPERATOR MENU 31	STRING	max length is 16 chars	tV	
1812	SCALING	OPERATOR MENU 31	ENUM	Same as TAG 1037	tW	
1813	READ ONLY	OPERATOR MENU 31	BOOL	FALSE / TRUE	tX	
1814	IGNORE PASSWORD	OPERATOR MENU 31	BOOL	FALSE / TRUE	tY	
1815	PARAMETER	OPERATOR MENU 32	PREF	-1871 to 1871	tZ	
1816	NAME	OPERATOR MENU 32	STRING	max length is 16 chars	uA	
1817	SCALING	OPERATOR MENU 32	ENUM	Same as TAG 1037	uB	
1818	READ ONLY	OPERATOR MENU 32	BOOL	FALSE / TRUE	uC	
1819	IGNORE PASSWORD	OPERATOR MENU 32	BOOL	FALSE / TRUE	uD	
1820	ENABLE	TIMER 2	BOOL	FALSE / TRUE	uE	
1821	RESET	TIMER 2	BOOL	FALSE / TRUE	uF	
1822	RESET VALUE	TIMER 2	INT	0 to 2147483647	uG	
1823	SCALE	TIMER 2	INT	1 to 2147483647	uH	
1824	THRESHOLD	TIMER 2	INT	-2147483647 to 2147483647	uI	
1825	ABOVE THRESHOLD	TIMER 2	BOOL	FALSE / TRUE	uJ	Output
1826	SCALED TIME	TIMER 2	REAL	_.xx	uK	Output
1827	TOTAL HOURS	TIMER 2	INT	_	uL	Output
1828	TOTAL SECONDS	TIMER 2	INT	_	uM	Output
1832	SLAVE MARK POS	PHASE AUTO GEAR	REAL	_.xxxx	uQ	Output
1833	MASTER MARK POS	PHASE AUTO GEAR	REAL	_.xxxx	uR	Output
1834	SLAVE INVERT	PHASE CONFIGURE	BOOL	FALSE / TRUE	uS	
1835	1mS CYCLE RATE	PHASE CONFIGURE	BOOL	FALSE / TRUE	uT	
1836	HIPER COUNTS/REV	PHASE CONFIGURE	ENUM	0 : 1024 1 : 2048 2 : 4096 3 : 8192 4 : 16384 5 : 32768 6 : 65536 7 : 131072 8 : 262144 9 : 524288 10 : 1048576 11 : 2097152 12 : 4194304	uU	
1837	MASTER INVERT	PHASE CONFIGURE	BOOL	FALSE / TRUE	uV	
1841	SLAVE POS (INT)	PHASE CONTROL	INT	_	uZ	Output
1842	MSTR POS+OFFSET	PHASE CONTROL	REAL	_.xx	vA	Output
1843	INT DEFEAT	PHASE PID	BOOL	FALSE / TRUE	vB	
1844	SINE WAVE	PHASE TUNING	BOOL	FALSE / TRUE	vC	

6053 Technology Box Dependent Parameters

The parameters shown below have special scaling rules applied when using 6053 Technology Box comms options.

TAG	MMI Name	Block	Decimal Point position used by Comms Interface
64	MOTOR CURRENT	MOTOR DATA	_.x
65	MAG CURRENT	MOTOR DATA	_.x
83	NAMEPLATE RPM	MOTOR DATA	._
119	STATOR RES	MOTOR DATA	_.xx
121	MUTUAL INDUC	MOTOR DATA	_.x
568	SPEED FBK REV/S	FEEDBACKS	._
569	SPEED FBK RPM	FEEDBACKS	._
846	TENSION RAMP	TAPER CALC	_.xx
1158	POWER	MOTOR DATA	_.x
1163	ROTOR TIME CONST	MOTOR DATA	_.x
1190	SPEED INT PRESET	SPEED LOOP	_.x
1197	DIRECT RATIO	SPEED LOOP	_.xxx
1203	TOTL SPD DMD RPM	SPEED LOOP	._
1483	GEARING A	PHASE CONTROL	._
1484	GEARING B	PHASE CONTROL	._
1519	LIMIT	PHASE PID	_.xx

Product-Related Default Values

All examples given in this book are based on a UK, 400V, 50Hz, 7.5kW Inverter.

* Frequency Dependent Defaults

These parameter values (marked with “*” in function block descriptions and macro diagrams) are dependent upon the drive’s default motor base frequency. The following table lists the changes to the “** Power Dependent Defaults” tables below for those parameters whose settings are adjusted for operation at 60Hz.

Parameter	Function Block	Tag	60Hz Operation
BASE FREQUENCY	MOTOR DATA	1159	60Hz
MOTOR CONNECTION	MOTOR DATA	124	STAR
MOTOR VOLTAGE	MOTOR DATA	1160	*
NAMEPLATE RPM	MOTOR DATA	83	1750 RPM
MAX SPEED	SETPOINT SCALE	1032	1800 RPM
BASE FREQUENCY	FLUXING	106	60.0Hz
* 230V unit : 230V, 400V unit : 460V, 500V unit : 500V			

** Power Dependent Defaults

These parameters (marked with “**” in function block descriptions and macro diagrams) are set to a value depending on the overall “power-build” of the Inverter indicated by the Product Code.

FRAME B - 230V Build Power Dependent Defaults									
Parameter	Function Block	Tag	Single Phase			Three Phase			
			0.75kW	1.5kW	2.2kW	0.75kW	1.5kW	2.2kW	4kW
ACCEL TIME	REFERENCE RAMP	258	10.0	10.0	10.0	10.0	10.0	10.0	10.0
AUTO BOOST	FLUXING	108	0.00	0.00	0.00	0.00	0.00	0.00	0.00
BASE FREQUENCY	MOTOR DATA	1159	50.0	50.0	50.0	50.0	50.0	50.0	50.0
CONTROL MODE	MOTOR DATA	1157	VOLTS / HZ	VOLTS / HZ	VOLTS / HZ	VOLTS / HZ	VOLTS / HZ	VOLTS / HZ	VOLTS / HZ

2-40 Parameter Specification

FRAME B - 230V Build Power Dependent Defaults									
Parameter	Function Block	Tag	Single Phase			Three Phase			
			0.75kW	1.5kW	2.2kW	0.75kW	1.5kW	2.2kW	4kW
DECEL TIME	REFERENCE RAMP	259	10.0	10.0	10.0	10.0	10.0	10.0	10.0
DEFLUX DELAY	PATTERN GEN	100	2.0	2.0	2.0	2.0	2.0	2.0	2.0
ENCODER INVERT	FEEDBACKS	567	FALSE	FALSE	FALSE	FALSE	FALSE	FALSE	FALSE
ENCODER LINES	FEEDBACKS	566	2048	2048	2048	2048	2048	2048	2048
ENCODER SUPPLY	FEEDBACKS	761	10.0	10.0	10.0	10.0	10.0	10.0	10.0
FIXED BOOST	FLUXING	107	0.00	0.00	0.00	0.00	0.00	0.00	0.00
INJ BASE VOLTS	INJ BRAKING	739	100.0	100.0	100.0	100.0	100.0	100.0	100.0
INJ DC LEVEL	INJ BRAKING	581	3.0	3.0	3.0	3.0	3.0	3.0	3.0
INJ DC PULSE	INJ BRAKING	579	2.0	2.0	2.0	2.0	2.0	2.0	2.0
INJ DEFLUX TIME	INJ BRAKING	710	0.5	0.5	0.5	0.5	0.5	0.5	0.5
INJ FINAL DC	INJ BRAKING	580	1.0	1.0	1.0	1.0	1.0	1.0	1.0
INJ FREQUENCY	INJ BRAKING	577	9.0	9.0	9.0	9.0	9.0	9.0	9.0
LEAKAGE INDUC	MOTOR DATA	120	62.32	33.76	24.80	62.32	33.76	24.80	24.80
MAG CURRENT	MOTOR DATA	65	1.36	2.50	3.41	1.36	2.50	3.41	5.84
MAX SPEED	SETPOINT SCALE	1032	1500	1500	1500	1500	1500	1500	1500
MOTOR CONNECTION	MOTOR DATA	124	STAR	STAR	STAR	STAR	STAR	STAR	STAR
MOTOR CURRENT	MOTOR DATA	64	3.39	6.26	8.52	3.39	6.26	8.52	14.61
MOTOR POLES	MOTOR DATA	84	4	4	4	4	4	4	4
MOTOR VOLTAGE	MOTOR DATA	1160	230.0	230.0	230.0	230.0	230.0	230.0	230.0
MOTOR VOLTS	VOLTAGE CONTROL	122	230.0	230.0	230.0	230.0	230.0	230.0	230.0
MOTORING LIMIT	SLIP COMP	85	150.0	150.0	150.0	150.0	150.0	150.0	150.0
MUTUAL INDUC	MOTOR DATA	121	249.28	135.02	99.20	249.28	135.02	99.20	57.87
NAMEPLATE RPM	MOTOR DATA	83	1400	1420	1420	1400	1420	1420	1420
OVERLOAD	MOTOR DATA	1164	2.0	2.0	2.0	2.0	2.0	2.0	2.0
POWER	MOTOR DATA	1158	0.75	1.50	2.20	0.75	1.50	2.20	4.00
POWER FACTOR	MOTOR DATA	242	0.70	0.71	0.78	0.70	0.71	0.78	0.80
QUADRATIC TORQUE	FEEDBACKS	50	FALSE	FALSE	FALSE	FALSE	FALSE	FALSE	FALSE
REFLUX TIME	FLYCATCHING	709	3.0	3.0	3.0	3.0	3.0	3.0	3.0
REGEN LIMIT	SLIP COMP	86	150.0	150.0	150.0	150.0	150.0	150.0	150.0
ROTOR TIME CONST	MOTOR DATA	1163	109.40	136.75	136.75	109.40	136.75	136.75	136.75
SEARCH BOOST	FLYCATCHING	32	40.0	40.0	40.0	40.0	40.0	40.0	40.0
SEARCH TIME	FLYCATCHING	574	5.0	5.0	5.0	5.0	5.0	5.0	5.0
SEARCH VOLTS	FLYCATCHING	573	9.0	9.0	9.0	9.0	9.0	9.0	9.0
SPEED INT TIME	SPEED LOOP	1188	100	100	100	100	100	100	100
SPEED PROP GAIN	SPEED LOOP	1187	20.00	20.00	20.00	20.00	20.00	20.00	20.00
STATOR RES	MOTOR DATA	119	2.9367	1.5907	1.1687	2.9367	1.5907	1.1687	0.6817
SYMMETRIC TIME	REFERENCE RAMP	267	10.0	10.0	10.0	10.0	10.0	10.0	10.0
TRIP THRESHOLD	PWR LOSS CNTRL	1266	243	243	243	243	243	243	243
VHZ BASE FREQ	FLUXING	106	50.0	50.0	50.0	50.0	50.0	50.0	50.0

FRAME B – 400V Build Power Dependent Defaults						
Parameter	Function Block	Tag	Three Phase			
			0.75kW	1.5kW	2.2kW	4kW
ACCEL TIME	REFERENCE RAMP	258	10.0	10.0	10.0	10.0
AUTO BOOST	FLUXING	108	0.00	0.00	0.00	0.00
BASE FREQUENCY	MOTOR DATA	1159	50.0	50.0	50.0	50.0
CONTROL MODE	MOTOR DATA	1157	VOLTS / HZ	VOLTS / HZ	VOLTS / HZ	VOLTS / HZ
DECEL TIME	REFERENCE RAMP	259	10.0	10.0	10.0	10.0
DEFLUX DELAY	PATTERN GEN	100	2.0	2.0	2.0	2.0
ENCODER INVERT	FEEDBACKS	567	FALSE	FALSE	FALSE	FALSE
ENCODER LINES	FEEDBACKS	566	2048	2048	2048	2048
ENCODER SUPPLY	FEEDBACKS	761	10.0	10.0	10.0	10.0
FIXED BOOST	FLUXING	107	0.00	0.00	0.00	0.00
INJ BASE VOLTS	INJ BRAKING	739	100.0	100.0	100.0	100.0
INJ DC LEVEL	INJ BRAKING	581	2.5	2.5	2.5	2.5
INJ DC PULSE	INJ BRAKING	579	2.0	2.0	2.0	2.0
INJ DEFLUX TIME	INJ BRAKING	710	0.5	0.5	0.5	0.5
INJ FINAL DC	INJ BRAKING	580	1.0	1.0	1.0	1.0
INJ FREQUENCY	INJ BRAKING	577	9.0	9.0	9.0	9.0
LEAKAGE INDUC	MOTOR DATA	120	188.49	102.10	75.01	43.76
MAG CURRENT	MOTOR DATA	65	0.78	1.44	1.96	3.36
MAX SPEED	SETPOINT SCALE	1032	1500	1500	1500	1500
MOTOR CONNECTION	MOTOR DATA	124	STAR	STAR	STAR	STAR
MOTOR CURRENT	MOTOR DATA	64	1.95	3.60	4.90	8.40
MOTOR POLES	MOTOR DATA	84	4	4	4	4
MOTOR VOLTAGE	MOTOR DATA	1160	400.0	400.0	400.0	400.0
MOTOR VOLTS	VOLTAGE CONTROL	122	400.0	400.0	400.0	400.0
MOTORING LIMIT	SLIP COMP	85	150.0	150.0	150.0	150.0
MUTUAL INDUC	MOTOR DATA	121	753.95	408.39	300.04	175.03
NAMEPLATE RPM	MOTOR DATA	83	1400	1420	1420	1420
OVERLOAD	MOTOR DATA	1164	2.0	2.0	2.0	2.0
POWER	MOTOR DATA	1158	0.75	1.50	2.20	4.00
POWER FACTOR	MOTOR DATA	242	0.70	0.71	0.78	0.80
QUADRATIC TORQUE	FEEDBACKS	50	FALSE	FALSE	FALSE	FALSE
REFLUX TIME	FLYCATCHING	709	3.0	3.0	3.0	3.0
REGEN LIMIT	SLIP COMP	86	150.0	150.0	150.0	150.0
ROTOR TIME CONST	MOTOR DATA	1163	109.40	136.75	136.75	136.75
SEARCH BOOST	FLYCATCHING	32	40.0	40.0	40.0	40.0
SEARCH TIME	FLYCATCHING	574	10.0	10.0	10.0	10.0
SEARCH VOLTS	FLYCATCHING	573	9.0	9.0	9.0	9.0
SPEED INT TIME	SPEED LOOP	1188	100	100	100	100
SPEED PROP GAIN	SPEED LOOP	1187	20.00	20.00	20.00	20.00
STATOR RES	MOTOR DATA	119	8.8823	4.8113	3.5348	2.0620
SYMMETRIC TIME	REFERENCE RAMP	267	10.0	10.0	10.0	10.0
TRIP THRESHOLD	PWR LOSS CNTRL	1266	447	447	447	447
VHZ BASE FREQ	FLUXING	106	50.0	50.0	50.0	50.0

2-42 Parameter Specification

FRAME C – 400V Build Power Dependent Defaults								
Parameter	Function Block	Tag	Constant Torque			Quadratic Torque		
			5.5kW	7.5kW	11kW	7.5kW	11kW	15kW
ACCEL TIME	REFERENCE RAMP	258	10.0	10.0	10.0	10.0	10.0	10.0
AUTO BOOST	FLUXING	108	0.00	0.00	0.00	0.00	0.00	0.00
BASE FREQUENCY	MOTOR DATA	1159	50.0	50.0	50.0	50.0	50.0	50.0
CONTROL MODE	MOTOR DATA	1157	VOLTS / HZ	VOLTS / HZ	VOLTS / HZ	VOLTS / HZ	VOLTS / HZ	VOLTS / HZ
DECEL TIME	REFERENCE RAMP	259	10.0	10.0	10.0	10.0	10.0	10.0
DEFLUX DELAY	PATTERN GEN	100	2.0	2.0	2.0	2.0	2.0	2.0
ENCODER INVERT	FEEDBACKS	567	FALSE	FALSE	FALSE	FALSE	FALSE	FALSE
ENCODER LINES	FEEDBACKS	566	2048	2048	2048	2048	2048	2048
ENCODER SUPPLY	FEEDBACKS	761	10.0	10.0	10.0	10.0	10.0	10.0
FIXED BOOST	FLUXING	107	0.00	0.00	0.00	0.00	0.00	0.00
INJ BASE VOLTS	INJ BRAKING	739	100.0	100.0	100.0	100.0	100.0	100.0
INJ DC LEVEL	INJ BRAKING	581	2.5	2.5	2.5	2.5	2.5	2.5
INJ DC PULSE	INJ BRAKING	579	2.0	2.0	2.0	2.0	2.0	2.0
INJ DEFLUX TIME	INJ BRAKING	710	0.5	0.5	0.5	0.5	0.5	0.5
INJ FINAL DC	INJ BRAKING	580	1.0	1.0	1.0	1.0	1.0	1.0
INJ FREQUENCY	INJ BRAKING	577	9.0	9.0	9.0	9.0	9.0	9.0
LEAKAGE INDUC	MOTOR DATA	120	43.37	33.57	24.50	43.37	33.57	24.50
MAG CURRENT	MOTOR DATA	65	3.39	4.38	6.00	3.39	4.38	6.00
MAX SPEED	SETPOINT SCALE	1032	1500	1500	1500	1500	1500	1500
MOTOR CONNECTION	MOTOR DATA	124	STAR	STAR	STAR	STAR	STAR	STAR
MOTOR CURRENT	MOTOR DATA	64	11.30	14.60	20.00	11.30	14.60	20.00
MOTOR POLES	MOTOR DATA	84	4	4	4	4	4	4
MOTOR VOLTAGE	MOTOR DATA	1160	400.0	400.0	400.0	400.0	400.0	400.0
MOTOR VOLTS	VOLTAGE CONTROL	122	400.0	400.0	400.0	400.0	400.0	400.0
MOTORING LIMIT	SLIP COMP	85	150.0	150.0	150.0	150.0	150.0	150.0
MUTUAL INDUC	MOTOR DATA	121	173.48	134.27	98.01	173.48	134.27	98.01
NAMEPLATE RPM	MOTOR DATA	83	1445	1450	1460	1445	1450	1460
OVERLOAD	MOTOR DATA	1164	2.0	2.0	2.0	2.0	2.0	2.0
POWER	MOTOR DATA	1158	5.50	7.50	11.00	5.50	7.50	11.00
POWER FACTOR	MOTOR DATA	242	0.80	0.83	0.86	0.80	0.83	0.86
QUADRATIC TORQUE	FEEDBACKS	50	FALSE	FALSE	FALSE	FALSE	FALSE	FALSE
REFLUX TIME	FLYCATCHING	709	3.0	3.0	3.0	3.0	3.0	3.0
REGEN LIMIT	SLIP COMP	86	150.0	150.0	150.0	150.0	150.0	150.0
ROTOR TIME CONST	MOTOR DATA	1163	276.04	303.65	379.56	276.04	303.65	379.56
SEARCH BOOST	FLYCATCHING	32	40.0	40.0	40.0	40.0	40.0	40.0
SEARCH TIME	FLYCATCHING	574	10.0	10.0	10.0	10.0	10.0	10.0
SEARCH VOLTS	FLYCATCHING	573	9.0	9.0	9.0	9.0	9.0	9.0
SPEED INT TIME	SPEED LOOP	1188	100	100	100	100	100	100
SPEED PROP GAIN	SPEED LOOP	1187	20.00	20.00	20.00	20.00	20.00	20.00
STATOR RES	MOTOR DATA	119	1.3625	1.0545	0.7698	1.3625	1.0545	0.7698
SYMMETRIC TIME	REFERENCE RAMP	267	10.0	10.0	10.0	10.0	10.0	10.0
TRIP THRESHOLD	PWR LOSS CNTRL	1266	447	447	447	447	447	447
VHZ BASE FREQ	FLUXING	106	50.0	50.0	50.0	50.0	50.0	50.0

FRAME C – 500V Build Power Dependent Defaults								
Parameter	Function Block	Tag	Constant Torque			Quadratic Torque		
			5.5kW	7.5kW	11kW	7.5kW	11kW	15kW
ACCEL TIME	REFERENCE RAMP	258	10.0	10.0	10.0	10.0	10.0	10.0
AUTO BOOST	FLUXING	108	0.00	0.00	0.00	0.00	0.00	0.00
BASE FREQUENCY	MOTOR DATA	1159	50.0	50.0	50.0	50.0	50.0	50.0
CONTROL MODE	MOTOR DATA	1157	VOLTS / HZ	VOLTS / HZ	VOLTS / HZ	VOLTS / HZ	VOLTS / HZ	VOLTS / HZ
DECEL TIME	REFERENCE RAMP	259	10.0	10.0	10.0	10.0	10.0	10.0
DEFLUX DELAY	PATTERN GEN	100	2.0	2.0	2.0	2.0	2.0	2.0
ENCODER INVERT	FEEDBACKS	567	FALSE	FALSE	FALSE	FALSE	FALSE	FALSE
ENCODER LINES	FEEDBACKS	566	2048	2048	2048	2048	2048	2048
ENCODER SUPPLY	FEEDBACKS	761	10.0	10.0	10.0	10.0	10.0	10.0
FIXED BOOST	FLUXING	107	0.00	0.00	0.00	0.00	0.00	0.00
INJ BASE VOLTS	INJ BRAKING	739	100.0	100.0	100.0	100.0	100.0	100.0
INJ DC LEVEL	INJ BRAKING	581	2.5	2.5	2.5	2.5	2.5	2.5
INJ DC PULSE	INJ BRAKING	579	2.0	2.0	2.0	2.0	2.0	2.0
INJ DEFLUX TIME	INJ BRAKING	710	0.5	0.5	0.5	0.5	0.5	0.5
INJ FINAL DC	INJ BRAKING	580	1.0	1.0	1.0	1.0	1.0	1.0
INJ FREQUENCY	INJ BRAKING	577	9.0	9.0	9.0	9.0	9.0	9.0
LEAKAGE INDUC	MOTOR DATA	120	67.76	52.45	38.29	67.76	52.45	38.29
MAG CURRENT	MOTOR DATA	65	2.71	3.50	4.80	2.71	3.50	4.80
MAX SPEED	SETPOINT SCALE	1032	1500	1500	1500	1500	1500	1500
MOTOR CONNECTION	MOTOR DATA	124	STAR	STAR	STAR	STAR	STAR	STAR
MOTOR CURRENT	MOTOR DATA	64	9.04	11.68	16.00	9.04	11.68	16.00
MOTOR POLES	MOTOR DATA	84	4	4	4	4	4	4
MOTOR VOLTAGE	MOTOR DATA	1160	500.0	500.0	500.0	500.0	500.0	500.0
MOTOR VOLTS	VOLTAGE CONTROL	122	500.0	500.0	500.0	500.0	500.0	500.0
MOTORING LIMIT	SLIP COMP	85	150.0	150.0	150.0	150.0	150.0	150.0
MUTUAL INDUC	MOTOR DATA	121	271.06	209.76	153.15	271.06	209.76	153.15
NAMEPLATE RPM	MOTOR DATA	83	1445	1450	1460	1445	1450	1460
OVERLOAD	MOTOR DATA	1164	2.0	2.0	2.0	2.0	2.0	2.0
POWER	MOTOR DATA	1158	5.50	7.50	11.00	5.50	7.50	11.00
POWER FACTOR	MOTOR DATA	242	0.80	0.83	0.86	0.80	0.83	0.86
QUADRATIC TORQUE	FEEDBACKS	50	FALSE	FALSE	FALSE	FALSE	FALSE	FALSE
REFLUX TIME	FLYCATCHING	709	3.0	3.0	3.0	3.0	3.0	3.0
REGEN LIMIT	SLIP COMP	86	150.0	150.0	150.0	150.0	150.0	150.0
ROTOR TIME CONST	MOTOR DATA	1163	276.04	303.65	379.56	276.04	303.65	379.56
SEARCH BOOST	FLYCATCHING	32	40.0	40.0	40.0	40.0	40.0	40.0
SEARCH TIME	FLYCATCHING	574	10.0	10.0	10.0	10.0	10.0	10.0
SEARCH VOLTS	FLYCATCHING	573	9.0	9.0	9.0	9.0	9.0	9.0
SPEED INT TIME	SPEED LOOP	1188	100	100	100	100	100	100
SPEED PROP GAIN	SPEED LOOP	1187	20.00	20.00	20.00	20.00	20.00	20.00
STATOR RES	MOTOR DATA	119	2.1289	1.6477	1.2028	2.1289	1.6477	1.2028
SYMMETRIC TIME	REFERENCE RAMP	267	10.0	10.0	10.0	10.0	10.0	10.0
TRIP THRESHOLD	PWR LOSS CNTRL	1266	447	447	447	447	447	447
VHZ BASE FREQ	FLUXING	106	50.0	50.0	50.0	50.0	50.0	50.0

2-44 Parameter Specification

FRAME D - 400V Build Power Dependent Defaults								
Parameter	Function Block	Tag	Constant Torque			Quadratic Torque		
			15kW	18.5kW	22kW	18.5kW	22kW	30kW
ACCEL TIME	REFERENCE RAMP	258	10.0	10.0	10.0	10.0	10.0	10.0
AUTO BOOST	FLUXING	108	0.00	0.00	0.00	0.00	0.00	0.00
BASE FREQUENCY	MOTOR DATA	1159	50.0	50.0	50.0	50.0	50.0	50.0
CONTROL MODE	MOTOR DATA	1157	VOLTS / HZ	VOLTS / HZ	VOLTS / HZ	VOLTS / HZ	VOLTS / HZ	VOLTS / HZ
DECEL TIME	REFERENCE RAMP	259	10.0	10.0	10.0	10.0	10.0	10.0
DEFLUX DELAY	PATTERN GEN	100	3.0	3.0	3.0	3.0	3.0	3.0
ENCODER INVERT	FEEDBACKS	567	FALSE	FALSE	FALSE	FALSE	FALSE	FALSE
ENCODER LINES	FEEDBACKS	566	2048	2048	2048	2048	2048	2048
ENCODER SUPPLY	FEEDBACKS	761	10.0	10.0	10.0	10.0	10.0	10.0
FIXED BOOST	FLUXING	107	0.00	0.00	0.00	0.00	0.00	0.00
INJ BASE VOLTS	INJ BRAKING	739	100.0	100.0	100.0	100.0	100.0	100.0
INJ DC LEVEL	INJ BRAKING	581	1.75	1.75	1.75	1.75	1.75	1.75
INJ DC PULSE	INJ BRAKING	579	2.0	2.0	2.0	2.0	2.0	2.0
INJ DEFLUX TIME	INJ BRAKING	710	1.0	1.0	1.0	1.0	1.0	1.0
INJ FINAL DC	INJ BRAKING	580	3.0	3.0	3.0	3.0	3.0	3.0
INJ FREQUENCY	INJ BRAKING	577	9.0	9.0	9.0	9.0	9.0	9.0
LEAKAGE INDUC	MOTOR DATA	120	18.15	14.85	12.90	18.15	14.85	12.90
MAG CURRENT	MOTOR DATA	65	8.10	9.90	11.40	8.10	9.90	11.40
MAX SPEED	SETPOINT SCALE	1032	1500	1500	1500	1500	1500	1500
MOTOR CONNECTION	MOTOR DATA	124	STAR	STAR	STAR	STAR	STAR	STAR
MOTOR CURRENT	MOTOR DATA	64	27.00	33.00	38.00	27.00	33.00	38.00
MOTOR POLES	MOTOR DATA	84	4	4	4	4	4	4
MOTOR VOLTAGE	MOTOR DATA	1160	400.0	400.0	400.0	400.0	400.0	400.0
MOTOR VOLTS	VOLTAGE CONTROL	122	400.0	400.0	400.0	400.0	400.0	400.0
MOTORING LIMIT	SLIP COMP	85	150.0	150.0	150.0	150.0	150.0	150.0
MUTUAL INDUC	MOTOR DATA	121	72.60	59.40	51.59	72.60	59.40	51.59
NAMEPLATE RPM	MOTOR DATA	83	1470	1460	1460	1470	1460	1460
OVERLOAD	MOTOR DATA	1164	2.0	2.0	2.0	2.0	2.0	2.0
POWER	MOTOR DATA	1158	15.00	18.50	22.00	15.00	18.50	22.00
POWER FACTOR	MOTOR DATA	242	0.87	0.88	0.88	0.87	0.88	0.88
QUADRATIC TORQUE	FEEDBACKS	50	FALSE	FALSE	FALSE	FALSE	FALSE	FALSE
REFLUX TIME	FLYCATCHING	709	4.0	4.0	4.0	4.0	4.0	4.0
REGEN LIMIT	SLIP COMP	86	150.0	150.0	150.0	150.0	150.0	150.0
ROTOR TIME CONST	MOTOR DATA	1163	506.08	379.56	379.56	506.08	379.56	379.56
SEARCH BOOST	FLYCATCHING	32	15.0	15.0	15.0	15.0	15.0	15.0
SEARCH TIME	FLYCATCHING	574	15.0	15.0	15.0	15.0	15.0	15.0
SEARCH VOLTS	FLYCATCHING	573	9.0	9.0	9.0	9.0	9.0	9.0
SPEED INT TIME	SPEED LOOP	1188	100	100	100	100	100	100
SPEED PROP GAIN	SPEED LOOP	1187	20.00	20.00	20.00	20.00	20.00	20.00
STATOR RES	MOTOR DATA	119	0.5702	0.4665	0.4052	0.5702	0.4665	0.4052
SYMMETRIC TIME	REFERENCE RAMP	267	10.0	10.0	10.0	10.0	10.0	10.0
TRIP THRESHOLD	PWR LOSS CNTRL	1266	447	447	447	447	447	447
VHZ BASE FREQ	FLUXING	106	50.0	50.0	50.0	50.0	50.0	50.0

FRAME D - 500V Build Power Dependent Defaults								
Parameter	Function Block	Tag	Constant Torque			Quadratic Torque		
			15kW	18.5kW	22kW	18.5kW	22kW	30kW
ACCEL TIME	REFERENCE RAMP	258	10.0	10.0	10.0	10.0	10.0	10.0
AUTO BOOST	FLUXING	108	0.00	0.00	0.00	0.00	0.00	0.00
BASE FREQUENCY	MOTOR DATA	1159	50.0	50.0	50.0	50.0	50.0	50.0
CONTROL MODE	MOTOR DATA	1157	VOLTS / HZ	VOLTS / HZ	VOLTS / HZ	VOLTS / HZ	VOLTS / HZ	VOLTS / HZ
DECEL TIME	REFERENCE RAMP	259	10.0	10.0	10.0	10.0	10.0	10.0
DEFLUX DELAY	PATTERN GEN	100	3.0	3.0	3.0	3.0	3.0	3.0
ENCODER INVERT	FEEDBACKS	567	FALSE	FALSE	FALSE	FALSE	FALSE	FALSE
ENCODER LINES	FEEDBACKS	566	2048	2048	2048	2048	2048	2048
ENCODER SUPPLY	FEEDBACKS	761	10.0	10.0	10.0	10.0	10.0	10.0
FIXED BOOST	FLUXING	107	0.00	0.00	0.00	0.00	0.00	0.00
INJ BASE VOLTS	INJ BRAKING	739	100.0	100.0	100.0	100.0	100.0	100.0
INJ DC LEVEL	INJ BRAKING	581	1.75	1.75	1.75	1.75	1.75	1.75
INJ DC PULSE	INJ BRAKING	579	2.0	2.0	2.0	2.0	2.0	2.0
INJ DEFLUX TIME	INJ BRAKING	710	1.0	1.0	1.0	1.0	1.0	1.0
INJ FINAL DC	INJ BRAKING	580	3.0	3.0	3.0	3.0	3.0	3.0
INJ FREQUENCY	INJ BRAKING	577	9.0	9.0	9.0	9.0	9.0	9.0
LEAKAGE INDUC	MOTOR DATA	120	28.36	23.20	20.15	28.36	23.20	20.15
MAG CURRENT	MOTOR DATA	65	6.48	7.92	9.12	6.48	7.92	9.12
MAX SPEED	SETPOINT SCALE	1032	1500	1500	1500	1500	1500	1500
MOTOR CONNECTION	MOTOR DATA	124	STAR	STAR	STAR	STAR	STAR	STAR
MOTOR CURRENT	MOTOR DATA	64	21.60	26.40	30.40	21.60	26.40	30.40
MOTOR POLES	MOTOR DATA	84	4	4	4	4	4	4
MOTOR VOLTAGE	MOTOR DATA	1160	500.0	500.0	500.0	500.0	500.0	500.0
MOTOR VOLTS	VOLTAGE CONTROL	122	500.0	500.0	500.0	500.0	500.0	500.0
MOTORING LIMIT	SLIP COMP	85	150.0	150.0	150.0	150.0	150.0	150.0
MUTUAL INDUC	MOTOR DATA	121	113.44	92.82	80.60	113.44	92.82	80.60
NAMEPLATE RPM	MOTOR DATA	83	1470	1460	1460	1470	1460	1460
OVERLOAD	MOTOR DATA	1164	2.0	2.0	2.0	2.0	2.0	2.0
POWER	MOTOR DATA	1158	15.00	18.50	22.00	15.00	18.50	22.00
POWER FACTOR	MOTOR DATA	242	0.87	0.88	0.88	0.87	0.88	0.88
QUADRATIC TORQUE	FEEDBACKS	50	FALSE	FALSE	FALSE	FALSE	FALSE	FALSE
REFLUX TIME	FLYCATCHING	709	4.0	4.0	4.0	4.0	4.0	4.0
REGEN LIMIT	SLIP COMP	86	150.0	150.0	150.0	150.0	150.0	150.0
ROTOR TIME CONST	MOTOR DATA	1163	506.08	379.56	379.56	506.08	379.56	379.56
SEARCH BOOST	FLYCATCHING	32	15.0	15.0	15.0	15.0	15.0	15.0
SEARCH TIME	FLYCATCHING	574	15.0	15.0	15.0	15.0	15.0	15.0
SEARCH VOLTS	FLYCATCHING	573	9.0	9.0	9.0	9.0	9.0	9.0
SPEED INT TIME	SPEED LOOP	1188	100	100	100	100	100	100
SPEED PROP GAIN	SPEED LOOP	1187	20.00	20.00	20.00	20.00	20.00	20.00
STATOR RES	MOTOR DATA	119	0.8910	0.7290	0.6331	0.8910	0.7290	0.6331
SYMMETRIC TIME	REFERENCE RAMP	267	10.0	10.0	10.0	10.0	10.0	10.0
TRIP THRESHOLD	PWR LOSS CNTRL	1266	447	447	447	447	447	447
VHZ BASE FREQ	FLUXING	106	50.0	50.0	50.0	50.0	50.0	50.0

2-46 Parameter Specification

FRAME E - 400V Build Power Dependent Defaults								
Parameter	Function Block	Tag	Constant Torque			Quadratic Torque		
			30kW	37kW	45kW	37kW	45kW	55kW
ACCEL TIME	REFERENCE RAMP	258	20.0	20.0	20.0	20.0	20.0	20.0
AUTO BOOST	FLUXING	108	0.00	0.00	0.00	0.00	0.00	0.00
BASE FREQUENCY	MOTOR DATA	1159	50.0	50.0	50.0	50.0	50.0	50.0
CONTROL MODE	MOTOR DATA	1157	VOLTS / HZ	VOLTS / HZ	VOLTS / HZ	VOLTS / HZ	VOLTS / HZ	VOLTS / HZ
DECEL TIME	REFERENCE RAMP	259	20.0	20.0	20.0	20.0	20.0	20.0
DEFLUX DELAY	PATTERN GEN	100	4.0	4.0	4.0	4.0	4.0	4.0
ENCODER INVERT	FEEDBACKS	567	FALSE	FALSE	FALSE	FALSE	FALSE	FALSE
ENCODER LINES	FEEDBACKS	566	2048	2048	2048	2048	2048	2048
ENCODER SUPPLY	FEEDBACKS	761	10.0	10.0	10.0	10.0	10.0	10.0
FIXED BOOST	FLUXING	107	0.00	0.00	0.00	0.00	0.00	0.00
INJ BASE VOLTS	INJ BRAKING	739	75.0	75.0	75.0	75.0	75.0	75.0
INJ DC LEVEL	INJ BRAKING	581	1.25	1.25	1.25	1.25	1.25	1.25
INJ DC PULSE	INJ BRAKING	579	2.0	2.0	2.0	2.0	2.0	2.0
INJ DEFLUX TIME	INJ BRAKING	710	1.0	1.0	1.0	1.0	1.0	1.0
INJ FINAL DC	INJ BRAKING	580	3.0	3.0	3.0	3.0	3.0	3.0
INJ FREQUENCY	INJ BRAKING	577	6.0	6.0	6.0	6.0	6.0	6.0
LEAKAGE INDUC	MOTOR DATA	120	9.08	7.43	6.20	9.08	7.43	6.20
MAG CURRENT	MOTOR DATA	65	16.20	19.80	23.70	16.20	19.80	23.70
MAX SPEED	SETPOINT SCALE	1032	1500	1500	1500	1500	1500	1500
MOTOR CONNECTION	MOTOR DATA	124	STAR	STAR	STAR	STAR	STAR	STAR
MOTOR CURRENT	MOTOR DATA	64	54.00	66.00	79.00	54.00	66.00	79.00
MOTOR POLES	MOTOR DATA	84	4	4	4	4	4	4
MOTOR VOLTAGE	MOTOR DATA	1160	400.0	400.0	400.0	400.0	400.0	400.0
MOTOR VOLTS	VOLTAGE CONTROL	122	400.0	400.0	400.0	400.0	400.0	400.0
MOTORING LIMIT	SLIP COMP	85	150.0	150.0	150.0	150.0	150.0	150.0
MUTUAL INDUC	MOTOR DATA	121	36.30	29.70	24.81	36.30	29.70	24.81
NAMEPLATE RPM	MOTOR DATA	83	1470	1470	1470	1470	1470	1470
OVERLOAD	MOTOR DATA	1164	2.0	2.0	2.0	2.0	2.0	2.0
POWER	MOTOR DATA	1158	30.00	37.00	45.00	30.00	37.00	45.00
POWER FACTOR	MOTOR DATA	242	0.86	0.85	0.87	0.86	0.85	0.87
QUADRATIC TORQUE	FEEDBACKS	50	FALSE	FALSE	FALSE	FALSE	FALSE	FALSE
REFLUX TIME	FLYCATCHING	709	5.0	5.0	5.0	5.0	5.0	5.0
REGEN LIMIT	SLIP COMP	86	150.0	150.0	150.0	150.0	150.0	150.0
ROTOR TIME CONST	MOTOR DATA	1163	506.08	506.08	506.08	506.08	506.08	506.08
SEARCH BOOST	FLYCATCHING	32	15.0	15.0	15.0	15.0	15.0	15.0
SEARCH TIME	FLYCATCHING	574	15.0	15.0	15.0	15.0	15.0	15.0
SEARCH VOLTS	FLYCATCHING	573	8.0	8.0	8.0	8.0	8.0	8.0
SPEED INT TIME	SPEED LOOP	1188	100	100	100	100	100	100
SPEED PROP GAIN	SPEED LOOP	1187	20.00	20.00	20.00	20.00	20.00	20.00
STATOR RES	MOTOR DATA	119	0.2851	0.2333	0.1949	0.2851	0.2333	0.1949
SYMMETRIC TIME	REFERENCE RAMP	267	20.0	20.0	20.0	20.0	20.0	20.0
TRIP THRESHOLD	PWR LOSS CNTRL	1266	447	447	447	447	447	447
VHZ BASE FREQ	FLUXING	106	50.0	50.0	50.0	50.0	50.0	50.0

FRAME E – 500V Build Power Dependent Defaults								
Parameter	Function Block	Tag	Constant Torque			Quadratic Torque		
			30kW	37kW	45kW	37kW	45kW	55kW
ACCEL TIME	REFERENCE RAMP	258	20.0	20.0	20.0	20.0	20.0	20.0
AUTO BOOST	FLUXING	108	0.00	0.00	0.00	0.00	0.00	0.00
BASE FREQUENCY	MOTOR DATA	1159	50.0	50.0	50.0	50.0	50.0	50.0
CONTROL MODE	MOTOR DATA	1157	VOLTS / HZ	VOLTS / HZ	VOLTS / HZ	VOLTS / HZ	VOLTS / HZ	VOLTS / HZ
DECEL TIME	REFERENCE RAMP	259	20.0	20.0	20.0	20.0	20.0	20.0
DEFLUX DELAY	PATTERN GEN	100	4.0	4.0	4.0	4.0	4.0	4.0
ENCODER INVERT	FEEDBACKS	567	FALSE	FALSE	FALSE	FALSE	FALSE	FALSE
ENCODER LINES	FEEDBACKS	566	2048	2048	2048	2048	2048	2048
ENCODER SUPPLY	FEEDBACKS	761	10.0	10.0	10.0	10.0	10.0	10.0
FIXED BOOST	FLUXING	107	0.00	0.00	0.00	0.00	0.00	0.00
INJ BASE VOLTS	INJ BRAKING	739	75.0	75.0	75.0	75.0	75.0	75.0
INJ DC LEVEL	INJ BRAKING	581	1.25	1.25	1.25	1.25	1.25	1.25
INJ DC PULSE	INJ BRAKING	579	2.0	2.0	2.0	2.0	2.0	2.0
INJ DEFLUX TIME	INJ BRAKING	710	1.0	1.0	1.0	1.0	1.0	1.0
INJ FINAL DC	INJ BRAKING	580	3.0	3.0	3.0	3.0	3.0	3.0
INJ FREQUENCY	INJ BRAKING	577	6.0	6.0	6.0	6.0	6.0	6.0
LEAKAGE INDUC	MOTOR DATA	120	14.18	11.60	9.69	14.18	11.60	9.69
MAG CURRENT	MOTOR DATA	65	12.96	15.84	18.96	12.96	15.84	18.96
MAX SPEED	SETPOINT SCALE	1032	1500	1500	1500	1500	1500	1500
MOTOR CONNECTION	MOTOR DATA	124	STAR	STAR	STAR	STAR	STAR	STAR
MOTOR CURRENT	MOTOR DATA	64	43.20	52.80	63.20	43.20	52.80	63.20
MOTOR POLES	MOTOR DATA	84	4	4	4	4	4	4
MOTOR VOLTAGE	MOTOR DATA	1160	500.0	500.0	500.0	500.0	500.0	500.0
MOTOR VOLTS	VOLTAGE CONTROL	122	500.0	500.0	500.0	500.0	500.0	500.0
MOToring LIMIT	SLIP COMP	85	150.0	150.0	150.0	150.0	150.0	150.0
MUTUAL INDUC	MOTOR DATA	121	56.72	46.41	38.77	56.72	46.41	38.77
NAMEPLATE RPM	MOTOR DATA	83	1470	1470	1470	1470	1470	1470
OVERLOAD	MOTOR DATA	1164	2.0	2.0	2.0	2.0	2.0	2.0
POWER	MOTOR DATA	1158	30.00	37.00	45.00	30.00	37.00	45.00
POWER FACTOR	MOTOR DATA	242	0.86	0.85	0.87	0.86	0.85	0.87
QUADRATIC TORQUE	FEEDBACKS	50	FALSE	FALSE	FALSE	FALSE	FALSE	FALSE
REFLUX TIME	FLYCATCHING	709	5.0	5.0	5.0	5.0	5.0	5.0
REGEN LIMIT	SLIP COMP	86	150.0	150.0	150.0	150.0	150.0	150.0
ROTOR TIME CONST	MOTOR DATA	1163	506.08	506.08	506.08	506.08	506.08	506.08
SEARCH BOOST	FLYCATCHING	32	15.0	15.0	15.0	15.0	15.0	15.0
SEARCH TIME	FLYCATCHING	574	15.0	15.0	15.0	15.0	15.0	15.0
SEARCH VOLTS	FLYCATCHING	573	8.0	8.0	8.0	8.0	8.0	8.0
SPEED INT TIME	SPEED LOOP	1188	100	100	100	100	100	100
SPEED PROP GAIN	SPEED LOOP	1187	20.00	20.00	20.00	20.00	20.00	20.00
STATOR RES	MOTOR DATA	119	0.4455	0.3645	0.3045	0.4455	0.3645	0.3045
SYMMETRIC TIME	REFERENCE RAMP	267	20.0	20.0	20.0	20.0	20.0	20.0
TRIP THRESHOLD	PWR LOSS CNTRL	1266	447	447	447	447	447	447
VHZ BASE FREQ	FLUXING	106	50.0	50.0	50.0	50.0	50.0	50.0

2-48 Parameter Specification

FRAME F - 400V Build Power Dependent Defaults								
Parameter	Function Block	Tag	Constant Torque			Quadratic Torque		
			55kW	75kw	90kw	75kW	90kW	110kW
ACCEL TIME	REFERENCE RAMP	258	30.0	30.0	30.0	30.0	30.0	30.0
AUTO BOOST	FLUXING	108	0.00	0.00	0.00	0.00	0.00	0.00
BASE FREQUENCY	MOTOR DATA	1159	50.0	50.0	50.0	50.0	50.0	50.0
CONTROL MODE	MOTOR DATA	1157	VOLTS / HZ	VOLTS / HZ	VOLTS / HZ	VOLTS / HZ	VOLTS / HZ	VOLTS / HZ
DECEL TIME	REFERENCE RAMP	259	30.0	30.0	30.0	30.0	30.0	30.0
DEFLUX DELAY	PATTERN GEN	100	4.0	4.0	4.0	4.0	4.0	4.0
ENCODER INVERT	FEEDBACKS	567	FALSE	FALSE	FALSE	FALSE	FALSE	FALSE
ENCODER LINES	FEEDBACKS	566	2048	2048	2048	2048	2048	2048
ENCODER SUPPLY	FEEDBACKS	761	10.0	10.0	10.0	10.0	10.0	10.0
FIXED BOOST	FLUXING	107	0.00	0.00	0.00	0.00	0.00	0.00
INJ BASE VOLTS	INJ BRAKING	739	75.00	75.00	75.00	75.00	75.00	75.00
INJ DC LEVEL	INJ BRAKING	581	1.25	1.25	1.25	1.25	1.25	1.25
INJ DC PULSE	INJ BRAKING	579	2.0	2.0	2.0	2.0	2.0	2.0
INJ DEFLUX TIME	INJ BRAKING	710	2.0	2.0	2.0	2.0	2.0	2.0
INJ FINAL DC	INJ BRAKING	580	3.0	3.0	3.0	3.0	3.0	3.0
INJ FREQUENCY	INJ BRAKING	577	6.0	6.0	6.0	6.0	6.0	6.0
LEAKAGE INDUC	MOTOR DATA	120	5.05	3.71	3.25	5.05	3.71	3.25
MAG CURRENT	MOTOR DATA	65	29.10	39.60	45.30	29.10	39.60	45.30
MAX SPEED	SETPOINT SCALE	1032	1500	1500	1500	1500	1500	1500
MOTOR CONNECTION	MOTOR DATA	124	STAR	STAR	STAR	STAR	STAR	STAR
MOTOR CURRENT	MOTOR DATA	64	97.00	132.00	151.00	97.00	132.00	151.00
MOTOR POLES	MOTOR DATA	84	4	4	4	4	4	4
MOTOR VOLTAGE	MOTOR DATA	1160	400.0	400.0	400.0	400.0	400.0	400.0
MOTOR VOLTS	VOLTAGE CONTROL	122	400.0	400.0	400.0	400.0	400.0	400.0
MOTORING LIMIT	SLIP COMP	85	150.0	150.0	150.0	150.0	150.0	150.0
MUTUAL INDUC	MOTOR DATA	121	20.21	14.85	12.98	20.12	14.85	12.98
NAMEPLATE RPM	MOTOR DATA	83	1475.0	1475.0	1480.0	1475.0	1475.0	1480.0
OVERLOAD	MOTOR DATA	1164	2.2	2.2	2.2	2.2	2.2	2.2
POWER	MOTOR DATA	1158	55.00	75.00	90.00	55.00	75.00	90.00
POWER FACTOR	MOTOR DATA	242	0.86	0.87	0.90	0.86	0.87	0.90
QUADRATIC TORQUE	FEEDBACKS	50	FALSE	FALSE	FALSE	FALSE	FALSE	FALSE
REFLUX TIME	FLYCATCHING	709	6.0	6.0	6.0	6.0	6.0	6.0
REGEN LIMIT	SLIP COMP	86	150.0	150.0	150.0	150.0	150.0	150.0
ROTOR TIME CONST	MOTOR DATA	1163	607.30	607.30	759.12	607.30	607.30	759.12
SEARCH BOOST	FLYCATCHING	32	15.00	15.00	15.00	15.00	15.00	15.00
SEARCH TIME	FLYCATCHING	574	15.0	15.0	15.0	15.0	15.0	15.0
SEARCH VOLTS	FLYCATCHING	573	8.00	8.00	8.00	8.00	8.00	8.00
SPEED INT TIME	SPEED LOOP	1188	100	100	100	100	100	100
SPEED PROP GAIN	SPEED LOOP	1187	20.00	20.00	20.00	20.00	20.00	20.00
STATOR RES	MOTOR DATA	119	0.1587	0.1166	0.1020	0.1587	0.1166	0.1020
SYMMETRIC TIME	REFERENCE RAMP	267	30.0	30.0	30.0	30.0	30.0	30.0
TRIP THRESHOLD	PWR LOSS CNTRL	1266	447.0	447.0	447.0	447.0	447.0	447.0
VHZ BASE FREQ	FLUXING	106	50.0	50.0	50.0	50.0	50.0	50.0

FRAME F – 500V Build Power Dependent Defaults								
Parameter	Function Block	Tag	Constant Torque			Quadratic Torque		
			55kW	75kW	90kW	75kW	90kW	110kW
ACCEL TIME	REFERENCE RAMP	258	30.0	30.0	30.0	30.0	30.0	30.0
AUTO BOOST	FLUXING	108	0.00	0.00	0.00	0.00	0.00	0.00
BASE FREQUENCY	MOTOR DATA	1159	50.0	50.0	50.0	50.0	50.0	50.0
CONTROL MODE	MOTOR DATA	1157	VOLTS / HZ	VOLTS / HZ	VOLTS / HZ	VOLTS / HZ	VOLTS / HZ	VOLTS / HZ
DECEL TIME	REFERENCE RAMP	259	30.0	30.0	30.0	30.0	30.0	30.0
DEFLUX DELAY	PATTERN GEN	100	4.0	4.0	4.0	4.0	4.0	4.0
ENCODER INVERT	FEEDBACKS	567	FALSE	FALSE	FALSE	FALSE	FALSE	FALSE
ENCODER LINES	FEEDBACKS	566	2048	2048	2048	2048	2048	2048
ENCODER SUPPLY	FEEDBACKS	761	10.0	10.0	10.0	10.0	10.0	10.0
FIXED BOOST	FLUXING	107	0.00	0.00	0.00	0.00	0.00	0.00
INJ BASE VOLTS	INJ BRAKING	739	75.00	75.00	75.00	75.00	75.00	75.00
INJ DC LEVEL	INJ BRAKING	581	1.25	1.25	1.25	1.25	1.25	1.25
INJ DC PULSE	INJ BRAKING	579	2.0	2.0	2.0	2.0	2.0	2.0
INJ DEFLUX TIME	INJ BRAKING	710	2.0	2.0	2.0	2.0	2.0	2.0
INJ FINAL DC	INJ BRAKING	580	3.0	3.0	3.0	3.0	3.0	3.0
INJ FREQUENCY	INJ BRAKING	577	6.0	6.0	6.0	6.0	6.0	6.0
LEAKAGE INDUC	MOTOR DATA	120	7.89	5.80	5.07	7.89	5.80	5.07
MAG CURRENT	MOTOR DATA	65	23.28	31.68	36.24	23.28	31.68	36.24
MAX SPEED	SETPOINT SCALE	1032	1500	1500	1500	1500	1500	1500
MOTOR CONNECTION	MOTOR DATA	124	STAR	STAR	STAR	STAR	STAR	STAR
MOTOR CURRENT	MOTOR DATA	64	77.60	105.60	120.80	77.60	105.60	120.80
MOTOR POLES	MOTOR DATA	84	4	4	4	4	4	4
MOTOR VOLTAGE	MOTOR DATA	1160	500.0	500.0	500.0	500.0	500.0	500.0
MOTOR VOLTS	VOLTAGE CONTROL	122	500.0	500.0	500.0	500.0	500.0	500.0
MOToring LIMIT	SLIP COMP	85	150.0	150.0	150.0	150.0	150.0	150.0
MUTUAL INDUC	MOTOR DATA	121	31.58	23.20	20.28	31.58	23.20	20.28
NAMEPLATE RPM	MOTOR DATA	83	1475.0	1475.0	1480.0	1475.0	1475.0	1480.0
OVERLOAD	MOTOR DATA	1164	2.2	2.2	2.2	2.2	2.2	2.2
POWER	MOTOR DATA	1158	55.00	75.00	90.00	55.00	75.00	90.00
POWER FACTOR	MOTOR DATA	242	0.86	0.87	0.90	0.86	0.87	0.90
QUADRATIC TORQUE	FEEDBACKS	50	FALSE	FALSE	FALSE	FALSE	FALSE	FALSE
REFLUX TIME	FLYCATCHING	709	6.0	6.0	6.0	6.0	6.0	6.0
REGEN LIMIT	SLIP COMP	86	150.0	150.0	150.0	150.0	150.0	150.0
ROTOR TIME CONST	MOTOR DATA	1163	607.30	607.30	759.12	607.30	607.30	759.12
SEARCH BOOST	FLYCATCHING	32	15.00	15.00	15.00	15.00	15.00	15.00
SEARCH TIME	FLYCATCHING	574	15.0	15.0	15.0	15.0	15.0	15.0
SEARCH VOLTS	FLYCATCHING	573	8.00	8.00	8.00	8.00	8.00	8.00
SPEED INT TIME	SPEED LOOP	1188	100	100	100	100	100	100
SPEED PROP GAIN	SPEED LOOP	1187	20.00	20.00	20.00	20.00	20.00	20.00
STATOR RES	MOTOR DATA	119	0.2480	0.1822	0.1593	0.2480	0.1822	0.1593
SYMMETRIC TIME	REFERENCE RAMP	267	30.0	30.0	30.0	30.0	30.0	30.0
TRIP THRESHOLD	PWR LOSS CNTRL	1266	447.0	447.0	447.0	447.0	447.0	447.0
VHZ BASE FREQ	FLUXING	106	50.0	50.0	50.0	50.0	50.0	50.0

2-50 Parameter Specification

FRAME G - 400V Build Power Dependent Defaults						
Parameter	Function Block	Tag	Constant Torque			
			110W	132kW	160kW	180kW
ACCEL TIME	REFERENCE RAMP	258	50.0	50.0	50.0	50.0
AUTO BOOST	FLUXING	108	0.00	0.00	0.00	0.00
BASE FREQUENCY	MOTOR DATA	1159	50.0	50.0	50.0	50.0
CONTROL MODE	MOTOR DATA	1157	VOLTS / HZ	VOLTS / HZ	VOLTS / HZ	VOLTS / HZ
DECEL TIME	REFERENCE RAMP	259	50.0	50.0	50.0	50.0
DEFLUX DELAY	PATTERN GEN	100	5.0	5.0	5.0	5.0
ENCODER INVERT	FEEDBACKS	567	FALSE	FALSE	FALSE	FALSE
ENCODER LINES	FEEDBACKS	566	2048	2048	2048	2048
ENCODER SUPPLY	FEEDBACKS	761	10.0	10.0	10.0	10.0
FIXED BOOST	FLUXING	107	0.00	0.00	0.00	0.00
INJ BASE VOLTS	INJ BRAKING	739	50.0	50.0	50.0	50.0
INJ DC LEVEL	INJ BRAKING	581	1.00	1.00	1.00	1.00
INJ DC PULSE	INJ BRAKING	579	3.0	3.0	3.0	3.0
INJ DEFLUX TIME	INJ BRAKING	710	2.0	2.0	2.0	2.0
INJ FINAL DC	INJ BRAKING	580	5.0	5.0	5.0	5.0
INJ FREQUENCY	INJ BRAKING	577	4.0	4.0	4.0	4.0
LEAKAGE INDUC	MOTOR DATA	120	2.66	2.27	2.00	1.66
MAG CURRENT	MOTOR DATA	65	55.20	64.80	73050	88.80
MAX SPEED	SETPOINT SCALE	1032	1500	1500	1500	1500
MOTOR CONNECTION	MOTOR DATA	124	STAR	STAR	STAR	STAR
MOTOR CURRENT	MOTOR DATA	64	184.00	216.00	245.00	296.00
MOTOR POLES	MOTOR DATA	84	4	4	4	4
MOTOR VOLTAGE	MOTOR DATA	1160	400.0	400.0	400.0	400.0
MOTOR VOLTS	VOLTAGE CONTROL	122	400.0	400.0	400.0	400.0
MOTORING LIMIT	SLIP COMP	85	150.0	150.0	150.0	150.0
MUTUAL INDUC	MOTOR DATA	121	10.65	9.08	8.00	6.62
NAMEPLATE RPM	MOTOR DATA	83	1480	1485	1485	1485
OVERLOAD	MOTOR DATA	1164	2.2	2.2	2.2	2.2
POWER	MOTOR DATA	1158	110.0	132.0	160.0	180.0
POWER FACTOR	MOTOR DATA	242	0.87	0.89	0.89	0.89
QUADRATIC TORQUE	FEEDBACKS	50	FALSE	FALSE	FALSE	FALSE
REFLUX TIME	FLYCATCHING	709	6.0	6.0	6.0	6.0
REGEN LIMIT	SLIP COMP	86	150.0	150.0	150.0	150.0
ROTOR TIME CONST	MOTOR DATA	1163	759.12	1012.16	1012.16	1012.16
SEARCH BOOST	FLYCATCHING	32	10.0	10.0	10.0	10.0
SEARCH TIME	FLYCATCHING	574	15.0	15.0	15.0	15.0
SEARCH VOLTS	FLYCATCHING	573	8.0	8.0	8.0	8.0
SPEED INT TIME	SPEED LOOP	1188	100	100	100	100
SPEED PROP GAIN	SPEED LOOP	1187	20.00	20.00	20.00	20.00
STATOR RES	MOTOR DATA	119	0.0418	0.0356	0.0314	0.0260
SYMMETRIC TIME	REFERENCE RAMP	267	50.0	50.0	50.0	50.0
TRIP THRESHOLD	PWR LOSS CNTRL	1266	447	447	447	447
VHZ BASE FREQ	FLUXING	106	50.0	50.0	50.0	50.0

FRAME G - 400V Build Power Dependent Defaults						
Parameter	Function Block	Tag	Quadratic Torque			
			132kW	150kW	180kW	220kW
ACCEL TIME	REFERENCE RAMP	258	50.0	50.0	50.0	50.0
AUTO BOOST	FLUXING	108	0.00	0.00	0.00	0.00
BASE FREQUENCY	MOTOR DATA	1159	50.0	50.0	50.0	50.0
CONTROL MODE	MOTOR DATA	1157	VOLTS / HZ	VOLTS / HZ	VOLTS / HZ	VOLTS / HZ
DECEL TIME	REFERENCE RAMP	259	50.0	50.0	50.0	50.0
DEFLUX DELAY	PATTERN GEN	100	5.0	5.0	5.0	5.0
ENCODER INVERT	FEEDBACKS	567	FALSE	FALSE	FALSE	FALSE
ENCODER LINES	FEEDBACKS	566	2048	2048	2048	2048
ENCODER SUPPLY	FEEDBACKS	761	10.0	10.0	10.0	10.0
FIXED BOOST	FLUXING	107	0.00	0.00	0.00	0.00
INJ BASE VOLTS	INJ BRAKING	739	50.0	50.0	50.0	50.0
INJ DC LEVEL	INJ BRAKING	581	1.00	1.00	1.00	1.00
INJ DC PULSE	INJ BRAKING	579	3.0	3.0	3.0	3.0
INJ DEFLUX TIME	INJ BRAKING	710	2.0	2.0	2.0	2.0
INJ FINAL DC	INJ BRAKING	580	5.0	5.0	5.0	5.0
INJ FREQUENCY	INJ BRAKING	577	4.0	4.0	4.0	4.0
LEAKAGE INDUC	MOTOR DATA	120	2.66	2.27	2.00	1.66
MAG CURRENT	MOTOR DATA	65	55.20	64.80	73050	88.80
MAX SPEED	SETPOINT SCALE	1032	1500	1500	1500	1500
MOTOR CONNECTION	MOTOR DATA	124	STAR	STAR	STAR	STAR
MOTOR CURRENT	MOTOR DATA	64	184.00	216.00	245.00	296.00
MOTOR POLES	MOTOR DATA	84	4	4	4	4
MOTOR VOLTAGE	MOTOR DATA	1160	400.0	400.0	400.0	400.0
MOTOR VOLTS	VOLTAGE CONTROL	122	400.0	400.0	400.0	400.0
MOTORING LIMIT	SLIP COMP	85	150.0	150.0	150.0	150.0
MUTUAL INDUC	MOTOR DATA	121	10.65	9.08	8.00	6.62
NAMEPLATE RPM	MOTOR DATA	83	1480	1485	1485	1485
OVERLOAD	MOTOR DATA	1164	2.2	2.2	2.2	2.2
POWER	MOTOR DATA	1158	110.0	132.0	160.0	180.0
POWER FACTOR	MOTOR DATA	242	0.87	0.89	0.89	0.89
QUADRATIC TORQUE	FEEDBACKS	50	FALSE	FALSE	FALSE	FALSE
REFLUX TIME	FLYCATCHING	709	6.0	6.0	6.0	6.0
REGEN LIMIT	SLIP COMP	86	150.0	150.0	150.0	150.0
ROTOR TIME CONST	MOTOR DATA	1163	759.12	1012.16	1012.16	1012.16
SEARCH BOOST	FLYCATCHING	32	10.0	10.0	10.0	10.0
SEARCH TIME	FLYCATCHING	574	15.0	15.0	15.0	15.0
SEARCH VOLTS	FLYCATCHING	573	8.0	8.0	8.0	8.0
SPEED INT TIME	SPEED LOOP	1188	100	100	100	100
SPEED PROP GAIN	SPEED LOOP	1187	20.00	20.00	20.00	20.00
STATOR RES	MOTOR DATA	119	0.0418	0.0356	0.0314	0.0260
SYMMETRIC TIME	REFERENCE RAMP	267	50.0	50.0	50.0	50.0
TRIP THRESHOLD	PWR LOSS CNTRL	1266	447	447	447	447
VHZ BASE FREQ	FLUXING	106	50.0	50.0	50.0	50.0

2-52 Parameter Specification

FRAME H - 400V Build Power Dependent Defaults						
Parameter	Function Block	Tag	Constant Torque			
			200kW	220W	250kW	280kW
ACCEL TIME	REFERENCE RAMP	258	50.0	50.0	50.0	50.0
AUTO BOOST	FLUXING	108	0.00	0.00	0.00	0.00
BASE FREQUENCY	MOTOR DATA	1159	50.0	50.0	50.0	50.0
CONTROL MODE	MOTOR DATA	1157	VOLTS / HZ	VOLTS / HZ	VOLTS / HZ	VOLTS / HZ
DECEL TIME	REFERENCE RAMP	259	50.0	50.0	50.0	50.0
DEFLUX DELAY	PATTERN GEN	100	5.0	5.0	5.0	5.0
ENCODER INVERT	FEEDBACKS	567	FALSE	FALSE	FALSE	FALSE
ENCODER LINES	FEEDBACKS	566	2048	2048	2048	2048
ENCODER SUPPLY	FEEDBACKS	761	10.0	10.0	10.0	10.0
FIXED BOOST	FLUXING	107	0.00	0.00	0.00	0.00
INJ BASE VOLTS	INJ BRAKING	739	50.0	50.0	50.0	50.0
INJ DC LEVEL	INJ BRAKING	581	1.00	1.00	1.00	1.00
INJ DC PULSE	INJ BRAKING	579	3.0	3.0	3.0	3.0
INJ DEFLUX TIME	INJ BRAKING	710	2.0	2.0	2.0	2.0
INJ FINAL DC	INJ BRAKING	580	5.0	5.0	5.0	5.0
INJ FREQUENCY	INJ BRAKING	577	4.0	4.0	4.0	4.0
LEAKAGE INDUC	MOTOR DATA	120	1.49	1.32	1.20	1.08
MAG CURRENT	MOTOR DATA	65	99.00	111.30	122.10	136.50
MAX SPEED	SETPOINT SCALE	1032	1500	1500	1500	1500
MOTOR CONNECTION	MOTOR DATA	124	STAR	STAR	STAR	STAR
MOTOR CURRENT	MOTOR DATA	64	330.00	371.00	407.00	445.00
MOTOR POLES	MOTOR DATA	84	4	4	4	4
MOTOR VOLTAGE	MOTOR DATA	1160	400.0	400.0	400.0	400.0
MOTOR VOLTS	VOLTAGE CONTROL	122	400.0	400.0	400.0	400.0
MOToring LIMIT	SLIP COMP	85	150.0	150.0	150.0	150.0
MUTUAL INDUC	MOTOR DATA	121	5.94	5.28	4.82	4.31
NAMEPLATE RPM	MOTOR DATA	83	1485	1485	1485	1485
OVERLOAD	MOTOR DATA	1164	2.2	2.2	2.2	2.2
POWER	MOTOR DATA	1158	200.0	220.0	250.0	280.0
POWER FACTOR	MOTOR DATA	242	0.88	0.88	0.89	0.89
QUADRATIC TORQUE	FEEDBACKS	50	FALSE	FALSE	FALSE	FALSE
REFLUX TIME	FLYCATCHING	709	6.0	6.0	6.0	6.0
REGEN LIMIT	SLIP COMP	86	150.0	150.0	150.0	150.0
ROTOR TIME CONST	MOTOR DATA	1163	1012.16	1012.16	1012.16	1012.16
SEARCH BOOST	FLYCATCHING	32	10.0	10.0	10.0	10.0
SEARCH TIME	FLYCATCHING	574	15.0	15.0	15.0	15.0
SEARCH VOLTS	FLYCATCHING	573	8.0	8.0	8.0	8.0
SPEED INT TIME	SPEED LOOP	1188	100	100	100	100
SPEED PROP GAIN	SPEED LOOP	1187	20.00	20.00	20.00	20.00
STATOR RES	MOTOR DATA	119	0.0233	0.0207	0.0189	0.0169
SYMMETRIC TIME	REFERENCE RAMP	267	50.0	50.0	50.0	50.0
TRIP THRESHOLD	PWR LOSS CNTRL	1266	447	447	447	447
VHZ BASE FREQ	FLUXING	106	50.0	50.0	50.0	50.0

FRAME H - 400V Build Power Dependent Defaults						
Parameter	Function Block	Tag	Quadratic Torque			
			250kW	250W	300kW	315kW
ACCEL TIME	REFERENCE RAMP	258	50.0	50.0	50.0	50.0
AUTO BOOST	FLUXING	108	0.00	0.00	0.00	0.00
BASE FREQUENCY	MOTOR DATA	1159	50.0	50.0	50.0	50.0
CONTROL MODE	MOTOR DATA	1157	VOLTS / HZ	VOLTS / HZ	VOLTS / HZ	VOLTS / HZ
DECEL TIME	REFERENCE RAMP	259	50.0	50.0	50.0	50.0
DEFLUX DELAY	PATTERN GEN	100	5.0	5.0	5.0	5.0
ENCODER INVERT	FEEDBACKS	567	FALSE	FALSE	FALSE	FALSE
ENCODER LINES	FEEDBACKS	566	2048	2048	2048	2048
ENCODER SUPPLY	FEEDBACKS	761	10.0	10.0	10.0	10.0
FIXED BOOST	FLUXING	107	0.00	0.00	0.00	0.00
INJ BASE VOLTS	INJ BRAKING	739	50.0	50.0	50.0	50.0
INJ DC LEVEL	INJ BRAKING	581	1.00	1.00	1.00	1.00
INJ DC PULSE	INJ BRAKING	579	3.0	3.0	3.0	3.0
INJ DEFLUX TIME	INJ BRAKING	710	2.0	2.0	2.0	2.0
INJ FINAL DC	INJ BRAKING	580	5.0	5.0	5.0	5.0
INJ FREQUENCY	INJ BRAKING	577	4.0	4.0	4.0	4.0
LEAKAGE INDUC	MOTOR DATA	120	1.49	1.32	1.20	1.08
MAG CURRENT	MOTOR DATA	65	99.00	111.30	122.10	136.50
MAX SPEED	SETPOINT SCALE	1032	1500	1500	1500	1500
MOTOR CONNECTION	MOTOR DATA	124	STAR	STAR	STAR	STAR
MOTOR CURRENT	MOTOR DATA	64	330.00	371.00	407.00	445.00
MOTOR POLES	MOTOR DATA	84	4	4	4	4
MOTOR VOLTAGE	MOTOR DATA	1160	400.0	400.0	400.0	400.0
MOTOR VOLTS	VOLTAGE CONTROL	122	400.0	400.0	400.0	400.0
MOTORING LIMIT	SLIP COMP	85	150.0	150.0	150.0	150.0
MUTUAL INDUC	MOTOR DATA	121	5.94	5.28	4.82	4.31
NAMEPLATE RPM	MOTOR DATA	83	1485	1485	1485	1485
OVERLOAD	MOTOR DATA	1164	2.2	2.2	2.2	2.2
POWER	MOTOR DATA	1158	200.0	220.0	250.0	280.0
POWER FACTOR	MOTOR DATA	242	0.88	0.88	0.89	0.89
QUADRATIC TORQUE	FEEDBACKS	50	FALSE	FALSE	FALSE	FALSE
REFLUX TIME	FLYCATCHING	709	6.0	6.0	6.0	6.0
REGEN LIMIT	SLIP COMP	86	150.0	150.0	150.0	150.0
ROTOR TIME CONST	MOTOR DATA	1163	1012.16	1012.16	1012.16	1012.16
SEARCH BOOST	FLYCATCHING	32	10.0	10.0	10.0	10.0
SEARCH TIME	FLYCATCHING	574	15.0	15.0	15.0	15.0
SEARCH VOLTS	FLYCATCHING	573	8.0	8.0	8.0	8.0
SPEED INT TIME	SPEED LOOP	1188	100	100	100	100
SPEED PROP GAIN	SPEED LOOP	1187	20.00	20.00	20.00	20.00
STATOR RES	MOTOR DATA	119	0.0233	0.0207	0.0189	0.0169
SYMMETRIC TIME	REFERENCE RAMP	267	50.0	50.0	50.0	50.0
TRIP THRESHOLD	PWR LOSS CNTRL	1266	447	447	447	447
VHZ BASE FREQ	FLUXING	106	50.0	50.0	50.0	50.0

2-54 Parameter Specification

FRAME J - 400V Build Power Dependent Defaults				
Parameter	Function Block	Tag	Constant Torque	Quadratic Torque
			315kW	355kW
ACCEL TIME	REFERENCE RAMP	258	50.0	50.0
AUTO BOOST	FLUXING	108	0.00	0.00
BASE FREQUENCY	MOTOR DATA	1159	50.0	50.0
CONTROL MODE	MOTOR DATA	1157	VOLTS / HZ	VOLTS / HZ
DECEL TIME	REFERENCE RAMP	259	50.0	50.0
DEFLUX DELAY	PATTERN GEN	100	5.0	5.0
ENCODER INVERT	FEEDBACKS	567	FALSE	FALSE
ENCODER LINES	FEEDBACKS	566	2048	2048
ENCODER SUPPLY	FEEDBACKS	761	10.0	10.0
FIXED BOOST	FLUXING	107	0.00	0.00
INJ BASE VOLTS	INJ BRAKING	739	50.0	50.0
INJ DC LEVEL	INJ BRAKING	581	1.00	1.00
INJ DC PULSE	INJ BRAKING	579	3.0	3.0
INJ DEFLUX TIME	INJ BRAKING	710	2.0	2.0
INJ FINAL DC	INJ BRAKING	580	5.0	5.0
INJ FREQUENCY	INJ BRAKING	577	4.0	4.0
LEAKAGE INDUC	MOTOR DATA	120	0.96	0.96
MAG CURRENT	MOTOR DATA	65	153.30	153.30
MAX SPEED	SETPOINT SCALE	1032	1500	1500
MOTOR CONNECTION	MOTOR DATA	124	STAR	STAR
MOTOR CURRENT	MOTOR DATA	64	511.00	511.00
MOTOR POLES	MOTOR DATA	84	4	4
MOTOR VOLTAGE	MOTOR DATA	1160	400.0	400.0
MOTOR VOLTS	VOLTAGE CONTROL	122	400.0	400.0
MOTORING LIMIT	SLIP COMP	85	150.0	150.0
MUTUAL INDUC	MOTOR DATA	121	3.84	3.84
NAMEPLATE RPM	MOTOR DATA	83	1485	1485
OVERLOAD	MOTOR DATA	1164	2.2	2.2
POWER	MOTOR DATA	1158	315.0	315.0
POWER FACTOR	MOTOR DATA	242	0.89	0.89
QUADRATIC TORQUE	FEEDBACKS	50	FALSE	FALSE
REFLUX TIME	FLYCATCHING	709	6.0	6.0
REGEN LIMIT	SLIP COMP	86	150.0	150.0
ROTOR TIME CONST	MOTOR DATA	1163	1012.16	1012.16
SEARCH BOOST	FLYCATCHING	32	10.0	10.0
SEARCH TIME	FLYCATCHING	574	15.0	15.0
SEARCH VOLTS	FLYCATCHING	573	8.0	8.0
SPEED INT TIME	SPEED LOOP	1188	100	100
SPEED PROP GAIN	SPEED LOOP	1187	20.00	20.00
STATOR RES	MOTOR DATA	119	0.0151	0.0151
SYMMETRIC TIME	REFERENCE RAMP	267	50.0	50.0
TRIP THRESHOLD	PWR LOSS CNTRL	1266	447.0	447.0
VHZ BASE FREQ	FLUXING	106	50.0	50.0

SERIAL COMMUNICATIONS

Communications Technology Option

The plug-in COMMS Technology Option provides a serial data port, allowing Inverters to be linked to form a network. Using a PLC/SCADA or other intelligent device, this network can be continuously controlled to provide supervision and monitoring for each Inverter in the system.

Refer to the Communications Interface Technical Manual for further details.

ConfigEd Lite

This is Eurotherm Drives' Windows-based block programming software. It has a graphical user-interface and drawing tools to allow you to create block programming diagrams quickly and easily. Contact your local Eurotherm Drives sales office.

Connection to the P3 Port

The port is an un-isolated RS232, 19200 Baud, supporting the standard EI bisynch ASCII communications protocol. Contact Eurotherm Drives for further information.

- **Frame B** : The P3 port is on the front of the unit and is used by the Operator Station.
- **Frame C, D & E** : There are two ports - one is used by the Operator Station, and the second is under the terminal cover to the right of the Control Terminals.

Using any P3 port on the drive, parameters can be monitored and updated by a suitable PC programming tool, e.g. ConfigEd Lite.

P3 Port

A standard P3 lead is used to connect to the Inverter.

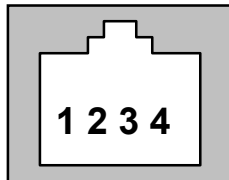

P3 Port Pin	Lead	Signal
1	Black	0V
2	Red	5V
3	Green	TX
4	Yellow	RX

6-Way Lead to DB9/DB25 Connector

Note: There is 5V present on pin 2 of the P3 port - do not connect this to your PC.

P3 Port Pin	Lead	Female DB9 Pin	Female DB25 Pin
1	Black	5	7
2	Red	not connected	not connected
3	Green	2	3
4	Yellow	3	2

3-2 Serial Communications

File Transfer

When you perform a SAVE CONFIG, the settings for all parameters (except motor and frame size specific parameters) are written to a Configuration file. Settings for motor and frame size specific parameters are written to the file "MOTOR1.MOT".

Drives using Software Version 5.x onwards can transfer these files between the drive and a PC.

For further information about Configuration files, refer to the Installation Product Manual, Chapter 5: "The Operator Station" - Saving/Restoring/Deleting Your Application.

Protocol Description

The file transfer protocol is supported by the EI ASCII communications. Connection from the PC is made to either the Operator Station port (P3), or the RS232 programming port (P3) which is located on the control board.

There are two new mnemonics: FR for read and FW for write. Both these commands have the same format:

```
Address [STX]  Mn    [FS] action
                [GS] block_no [RS] 'ascii_block_data
                [GS] 'file_name [RS] file_length [RS] >file_protected_flag
[ETX] [BCC]
```

Where:

[STX] is the start of text code, 0x02

Mn is the mnemonic, either FR (read) or FW (write)

[FS] is the field separator, 0x1C

Action is an integer value. This specifies the action. 0 for start transfer, 1 for continue transfer, -1 for end transfer.

[GS] is the group separator, 0x1D

Block_no is an integer. It is set to 0 at the start of a data transfer and increments by one for each block received.

[RS] is the record separator, 0x1E

Ascii_block_data is an ascii field. It contains up to 64 ascii characters, (equivalent to 32 bytes of hex data).

File_name an ascii field. It is the name of the file to read or write.

File_length is an integer value. It is the length of file data that is to be written to the file store or was read from the file store. This is the length of binary data and should be half the total number of ascii hex file data bytes transferred

File_protected_flag is a boolean value and may take the value of 0 or 1. A value of 0 indicates that the file is not protected. A value of 1 indicates that the file is protected. At present, protected files may not be read from the drive so a value of 1 will never be returned.

[ETX] is the end of text code, 0x04

[BCC] is the binary check character, the value depends on the message contents.

File Read (FR)

Reading a file is achieved using the FR mnemonic. The FR write command is used to specify the name of the file to read. For example, to read the Configuration file "APPLICATION" from a drive at address 00 (note the address is always entered twice, so if the address is 01 you enter 0011):

Request:

0 0 0 0 [STX] F R [FS] 0 [GS] [GS] ' A P P L I C A T I O N . C F G [ETX] [BCC]

On receiving this command the drive will read the specified file from the file-store into a RAM buffer. If the file is protected or is not found then the drive will reply with a NAK.

Request:

The FR read command is then used to read the file from the RAM buffer:

0 0 0 0 F R [ENQ]

[ENQ] is the enquiry character, 0x05

Response:

A: [STX] F R [FS] 0 [GS] [GS] file_name [RS] file length [RS] protected flag [EXT] [BCC]

B: [STX] F R [FS] 1 [GS] block_number [RS] block_data [EXT] [BCC]

C: [STX] F R [FS] -1 [EXT] [BCC]

Response A is returned following the first FR read command after a FR write. It has an action of 0 indicating that this is the start of the read process. This reply contains the file name, the file length and the file protected flag.

Response B is returned while data is being transferred.

Response C is returned once all data has been transferred. This has an action of -1 indicating that file transfer has finished.

Should the receiving equipment notice a communications failure, such as a missing block, a transfer may be restarted using the FR write command. The FR write command may contain a block number if you want to restart the transfer from a block other than 0.

File Write (FW)

The file write command FW is used to write file data to the drive. This mirrors the use of the FR command. The format of the message is:

Request:

A: 0000 [STX] F W [FS] 0 [GS] [GS] name [RS] length [RS] protected [EXT] [BCC]

B: 0000 [STX] F W [FS] 1 [GS] block_number [RS] block_data [EXT] [BCC]

C: 0000 [STX] F W [FS] -1 [EXT] [BCC]

Request A is used to initiate a write. This has an action of 0 and contains the file name, the file length and the file protected flag.

Request B is used to transfer the file data in blocks of up to 64 ascii hex characters.

Request C is used to indicate that the file transfer is complete and that the file should be committed to non-volatile data. On receiving this request the drive validates the contents of the file data. The data is expected to be in the same format as that returned by the FR command. This includes a checksum that is used by this validation process. If the file data is valid then it is written to the file store. As part of this process, the file store automatically creates a backup of any existing configuration of the same name as that being written. This backup copy will be used if the file save fails.

3-4 Serial Communications

Interaction with the 6901 Operator Station

The file transfer process shares a RAM buffer with the operator station cloning feature. If a clone save or restore is started while a file transfer is in progress, then the file transfer will be aborted.

Note: *The file transfer feature may not be used to directly read a file from the operator station or to write a file to the operator station.*

File Names

The drive may contain several Configuration files. Each of these contains all application data with the exception of those parameters that are motor or frame size specific. Configuration file names may be between one and eleven characters long and have an extension of ".CFG". The default Configuration file name is "APPLICATION.CFG".

Motor and frame size specific data is held in the file "MOTOR 1.MOT".

SEQUENCING LOGIC STATES

Principle State Machine

The Inverter's reaction to commands is defined by a state machine. This determines which commands provide the demanded action, and in which sequence.

Main Sequencing States

The main sequencing state of the unit is indicated by an enumerated value given by the parameter SEQUENCER STATE under SEQUENCING LOGIC menu at level 3.

Enumerated Value	Main Seq State	Standard Name	Description
0	START DISABLED	Switch On Disabled	The Inverter will not accept a switch on command
1	START ENABLED	Ready To Switch On	The Inverter will accept a switch on command
2	SWITCHED ON	Switched On	The Inverter's stack is enabled
3	READY	Ready	Waiting for Contactor to be closed
4	ENABLED	Enabled	The Inverter is enabled and operational
5	F-STOP ACTIVE	Fast-Stop Active	Fast stop is active
6	TRIP ACTIVE	Trip Active	The Inverter is processing a trip event
7	TRIPPED	Tripped	The Inverter is tripped awaiting trip reset

Table 4-1 Enumerated Values for the SEQUENCING LOGIC Function Block

State Outputs of the SEQUENCING LOGIC Function Block

The following table shows the states of individual parameters for the SEQUENCING LOGIC function block required to produce the condition of the MAIN SEQ STATE parameter.

	START DISABLED	START ENABLED	SWITCHED ON	READY	ENABLED	F-STOP ACTIVE	TRIP ACTIVE	TRIPPED
Tripped	FALSE	FALSE	FALSE	FALSE	FALSE	FALSE	TRUE	TRUE
Running	FALSE	FALSE	FALSE	FALSE	TRUE	FALSE	FALSE	FALSE
Jogging	FALSE	FALSE	FALSE	FALSE	Note 1	FALSE	FALSE	FALSE
Stopping	FALSE	FALSE	FALSE	FALSE	Note 2	TRUE	FALSE	FALSE
Output Contactor	Depends on previous state	Depends on previous state	TRUE	TRUE	TRUE	TRUE	TRUE	FALSE
Switch On Enable	FALSE	TRUE	TRUE	TRUE	TRUE	TRUE	TRUE	FALSE
Switched On	FALSE	FALSE	TRUE	TRUE	TRUE	TRUE	TRUE	FALSE
Ready	FALSE	FALSE	FALSE	TRUE	TRUE	TRUE	TRUE	FALSE
Healthy	TRUE	TRUE	TRUE	TRUE	TRUE	TRUE	FALSE	FALSE Note 3

Table 4-2 Parameter States for the MAIN SEQ STATE Parameter

4-2 Sequencing Logic

- Note:**
1. *JOGGING* is set **TRUE** once the jog cycle has started, and remains **TRUE** until the jog cycle has finished which is when either the stop delay has finished or another mode is demanded.
 2. *STOPPING* is set **TRUE** during the stopping cycles commanded by either *RUNNING* going low, *JOGGING* going low or if Fast Stop is active, i.e. *SEQUENCING LOGIC* is **F-STOP ACTIVE**.
 3. Once Run and Jog are both **FALSE**, *HEALTHY O/P* will be set **TRUE**.

Transition of States

The transition matrix describes what causes the transition from one state to another, for example see no. 4 below: the transition from “Ready To Switch On” to “Trip Active” is triggered by “TRIP” going **TRUE**. Note – where a state has more than one exit transition, the transition with the lowest number has priority.

Refer to the following table and state diagram.

	Current State	Next State	Cause (FALSE to TRUE)
1	Power Up	Switch On Disabled	Power-Up, Restore Configuration or exit from Configuration mode.
2	Switch On Disabled	Trip Active	Trip
3	Switch On Disabled	Ready To Switch On	RUN = FALSE, JOG = FALSE, NOT FAST STOP = TRUE and NOT COAST STOP = TRUE
4	Ready To Switch On	Trip Active	Trip
5	Ready To Switch On	Switch On Disabled	NOT COAST STOP = FALSE or NOT FAST STOP = FALSE
6	Ready To Switch On	Switched On	RUN = TRUE or JOG = TRUE
7	Switched On	Trip Active	Trip (includes CONTACTOR CLOSED = FALSE after 10 seconds)
8	Switched On	Switch On Disabled	NOT COAST STOP = FALSE or NOT FAST STOP = FALSE
9	Switched On	Ready To Switch On	RUN = FALSE and JOG = FALSE
10	Switched On	Ready	CONTACTOR CLOSED = TRUE and defluxed
11	Ready	Trip Active	Trip (includes CONTACTOR CLOSED = FALSE)
12	Ready	Switch On Disabled	NOT COAST STOP = FALSE or NOT FAST STOP = FALSE
13	Ready	Ready To Switch On	RUN = FALSE and JOG = FALSE
14	Ready	Enabled	ENABLE = TRUE
15	Enabled	Trip Active	Trip (includes CONTACTOR CLOSED = FALSE)
16	Enabled	Switch On Disabled	NOT COAST STOP = FALSE
17	Enabled	Fast Stop Active	NOT FAST STOP = FALSE
18	Enabled	Ready To Switch On	RUN = FALSE, JOG = FALSE and stopping complete
19	Enabled	Ready	ENABLE = FALSE
20	Fast Stop Active	Trip Active	Trip (includes CONTACTOR CLOSED = FALSE)
21	Fast Stop Active	Switch On Disabled	Fast Stop timer expired or FAST STOP MODE = Coast Stop OR Inverter at zero setpoint
22	Trip Active	Tripped	Stack quenched
23	Tripped	Switch On Disabled	Trip = FALSE and TRIP RESET 0->1 transition

Table 4-3 Transition Matrix

State Diagram

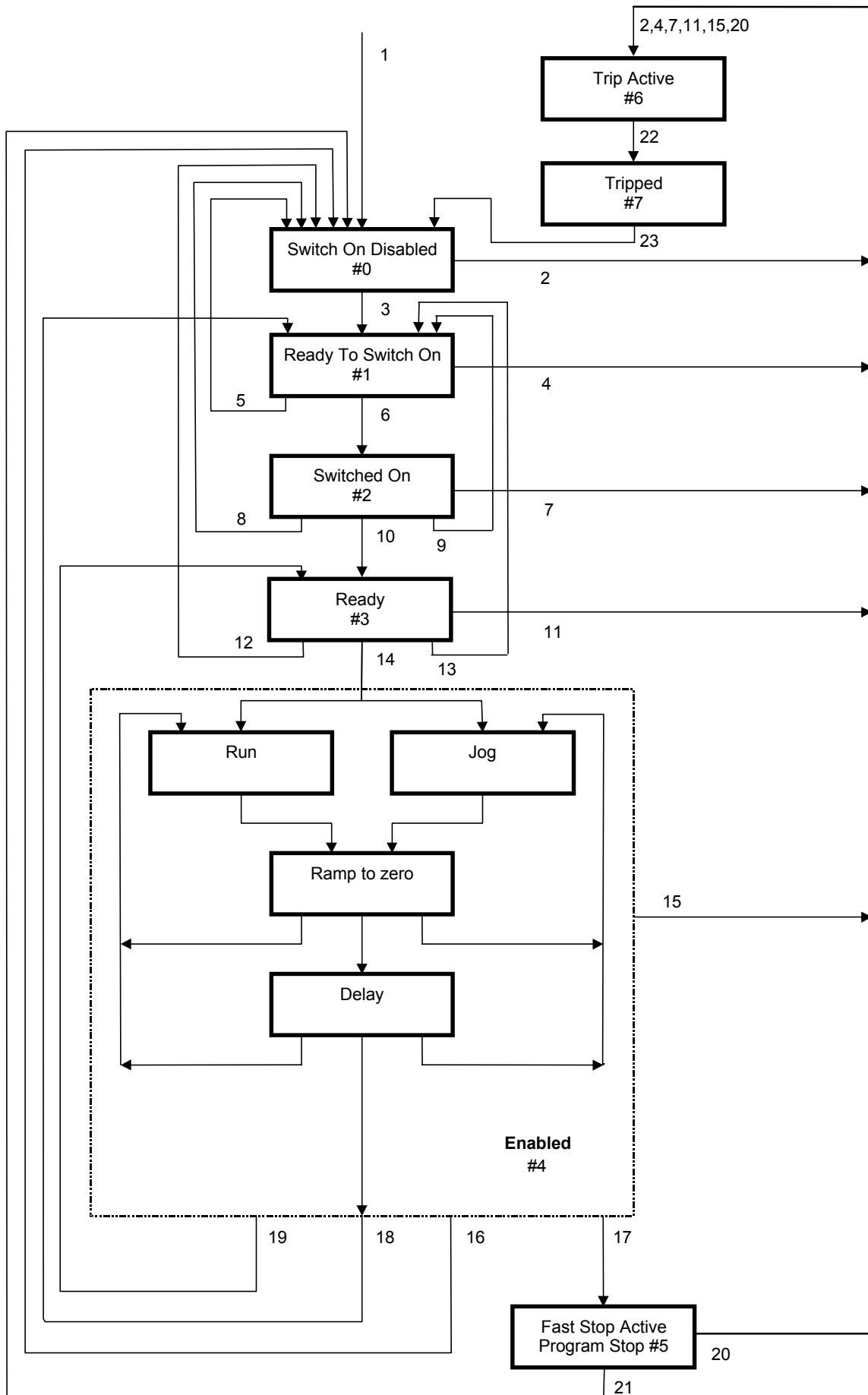

External Control of the Inverter

Communications Command

When sequencing is in the Remote Comms mode, the sequencing of the Inverter is controlled by writing to the hidden parameter COMMS COMMAND (Tag 271). This parameter can only be written to using a communications interface. The output parameter (Tag 273) COMMS COMMAND of the COMMS CONTROL function block is provided as a diagnostic.

The COMMS COMMAND parameter is a 16-bit word based on standard fieldbus drive profiles. Some bits are not implemented in this release (see “Supported” column of the table below).

Bit	Name	Description	Supported	Required Value
0	Switch On	OFF1 Operational	√	
1	(Not) Disable Voltage	OFF2 Coast Stop	√	
2	(Not) Quick Stop	OFF3 Fast Stop	√	
3	Enable Operation		√	
4	Enable Ramp Output	=0 to set ramp output to zero		1
5	Enable Ramp	=0 to hold ramp		1
6	Enable Ramp Input	=0 to set ramp input to zero		1
7	Reset Fault	Reset on 0 to 1 transition	√	
8				0
9				0
10	Remote	=1 to control remotely		1
11				0
12				0
13				0
14				0
15				0

Switch On

Replaces the RUN FWD, RUN REV and NOT STOP parameters of the SEQUENCING LOGIC function block. When Set (=1) is the same as :

RUN FWD = TRUE
 RUN REV = FALSE
 NOT STOP = FALSE

When Cleared (= 0) is the same as :

RUN FWD = FALSE
 RUN REV = FALSE
 NOT STOP = FALSE

(Not) Disable Voltage

ANDed with the NOT COAST STOP parameter of the SEQUENCING LOGIC function block. When both Set (=1) is the same as:

NOT COAST STOP = TRUE

When either or both Cleared (= 0) is the same as :

NOT COAST STOP = FALSE

(Not) Quick Stop

ANDed with the NOT FAST STOP parameter on the SEQUENCING LOGIC function block.
When both Set (=1) is the same as:

NOT FAST STOP = TRUE

When either or both Cleared (= 0) is the same as :

NOT FAST STOP = FALSE

Enable Operation

ANDed with the DRIVE ENABLE parameter on the SEQUENCING LOGIC function block.
When both Set (=1) is the same as:

DRIVE ENABLE = TRUE

When either or both Cleared (= 0) is the same as :

DRIVE ENABLE = FALSE

Enable Ramp Output, Enable Ramp, Enable Ramp Input

Not implemented. The state of these bits must be set (=1) to allow this feature to be added in the future.

Reset Fault

Replaces the REM TRIP RESET parameter on the SEQUENCING LOGIC function block.
When Set (=1) is the same as:

REM TRIP RESET = TRUE

When Cleared (= 0) is the same as :

REM TRIP RESET = FALSE

Remote

Not implemented. It is intended to allow the PLC to toggle between local and remote. The state of this must be set (=1) to allow this feature to be added in the future.

Example Commands

047F hexadecimal to RUN

047E hexadecimal to STOP

4-6 Sequencing Logic

Communications Status

The COMMS STATUS parameter (Tag 272) in the COMMS CONTROL function block monitors the sequencing of the Inverter. It is a 16-bit word based on standard fieldbus drive profiles. Some bits are not implemented in the initial release and are set to 0 (see “Supported” column of the table below).

Bit	Name	Description	Supported
0	Ready To Switch On		√
1	Switched On	Ready for operation (refer control bit 0)	√
2	Operation Enabled	(refer control bit 3)	√
3	Fault	Tripped	√
4	(Not) Voltage Disabled	OFF 2 Command pending	√
5	(Not) Quick Stop	OFF 3 Command pending	√
6	Switch On Disable	Switch On Inhibited	√
7	Warning		
8	SP / PV in Range		
9	Remote	= 1 if Drive will accept Command Word	√
10	Setpoint Reached		
11	Internal Limit Active		
12			
13			
14			
15			

Ready To Switch On

Same as the SWITCH ON ENABLE output parameter of the SEQUENCING LOGIC function block.

Switched On

Same as the SWITCHED ON output parameter of the SEQUENCING LOGIC function block.

Operation Enabled

Same as the RUNNING output parameter of the SEQUENCING LOGIC function block.

Fault

Same as the TRIPPED output parameter of the SEQUENCING LOGIC function block.

(Not) Voltage Disabled

If in Remote Comms mode, this is the same as Bit 1 of the COMMS COMMAND parameter. Otherwise it is the same as the NOT COAST STOP input parameter of the SEQUENCING LOGIC function block.

(Not) Quick Stop

If in Remote Comms mode, this is the same as Bit 2 of the COMMS COMMAND parameter. Otherwise it is the same as the NOT FAST STOP input parameter of the SEQUENCING LOGIC function block.

Switch On Disable

Set (=1) only when in START DISABLED state, refer to Table 4-1.

Remote

This bit is set (= 1) if the Inverter is in Remote mode **AND** the parameter REMOTE COMMS SEL of the COMMS CONTROL function block is Set (= 1).

APPLICATION MACROS

The Default Application

The Inverter is supplied with 8 macros, Macro 0 to Macro 7. Each macro recalls a pre-programmed set of parameters when it is loaded.

- Macro 0 will not control a motor. Loading Macro 0 removes all links, and sets all parameters to the values defined for each function block in Chapter 1 “Programming Your Application”.
- Macro 1 is the factory default macro, providing for basic speed control
- Macro 2 is a set-up providing speed control with Raise/Lower Trim
- Macro 3 is for PID process control
- Macro 4 is a Speed Programmed Winder (SPW) macro.
- Macro 5 supplies speed control using preset speeds.
- Macro 6 provides for basic speed control with similar functionality to the 620 and 590+ Series Drives.
- Macro 7 is for Phase/Register applications.

How to Load a Macro

RESTORE CONFIG

This menu restores the displayed application to the drive. The information is saved on power-down.

Also listed with your application names are the factory macros.

To restore an application see below.

MMI Menu Map

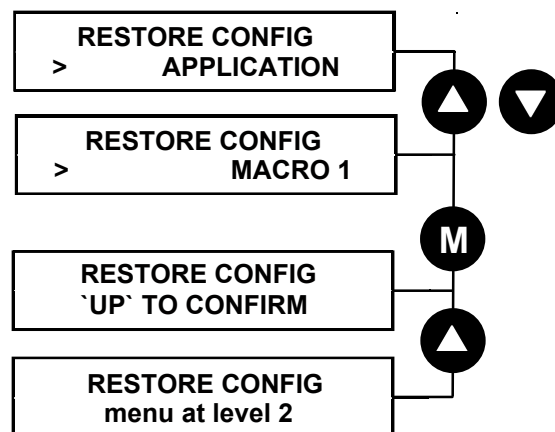
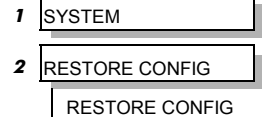

Now update the non-volatile memory within the Inverter by performing a SAVE CONFIG. Refer to the Installation Product Manual, Chapter 5: “The Operator Station” - Saving/Restoring/Deleting Your Application

Macro Descriptions

Note: Parameters whose default values are product-related are indicated in the block diagrams with * or **. Refer to Chapter 2: “Parameter Specification” - Product-Related Default Values.

5-2 Application Macros

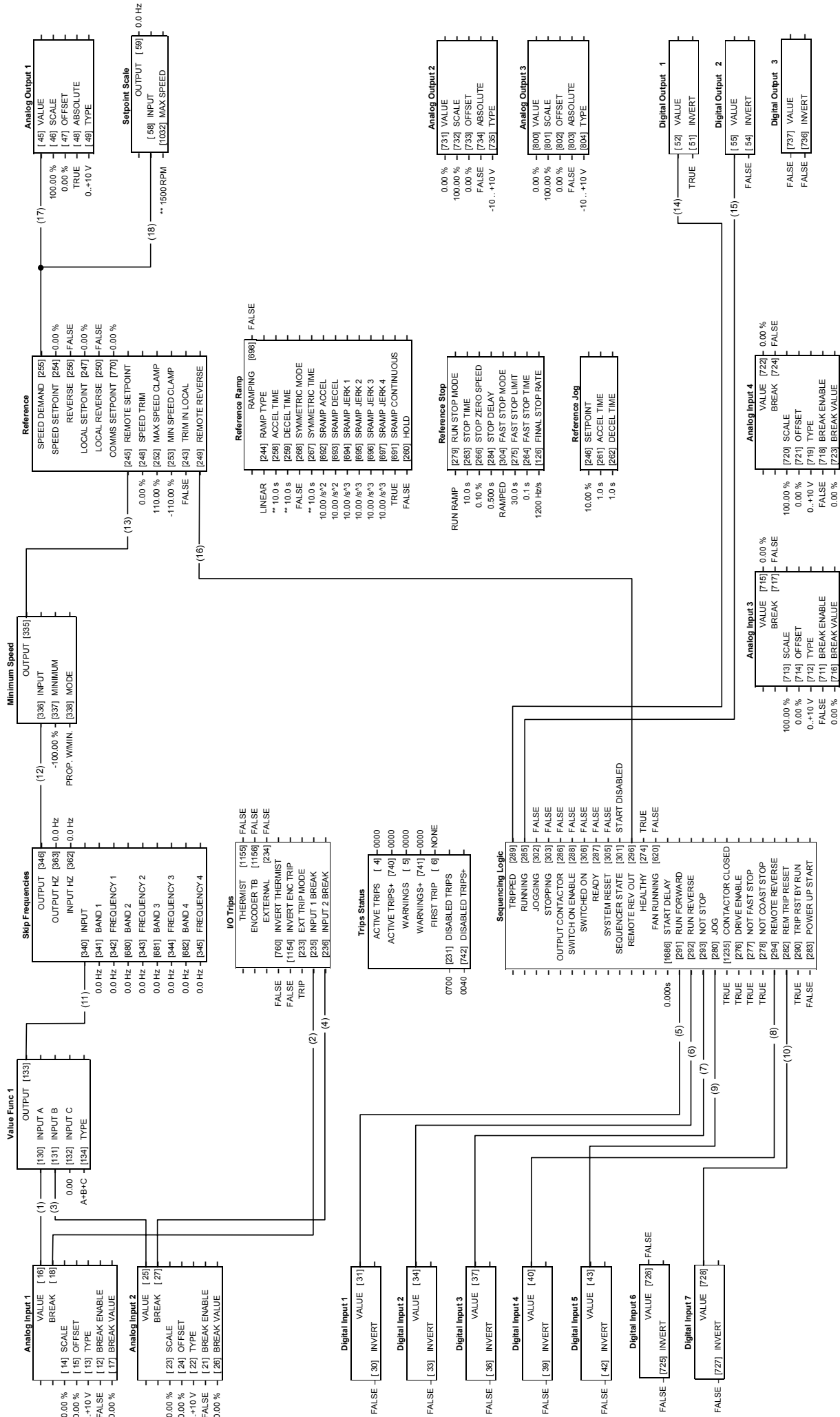

Macro 1: Basic Speed Control (default)

Macro 1: Basic Speed Control (default)

This macro provides standard control of the inverter.

Control Wiring I/O			
Terminal	Name	Purpose	Comment
2	ANALOG INPUT 1	Speed Setpoint	0V = 0%, 10V = 100%
3	ANALOG INPUT 2	Speed Trim	0V = 0%, 10V = 100%
6	ANALOG OUTPUT 1	Ramp Output	absolute speed demand 0V = 0%, 10V = 100%
12	DIGITAL INPUT 1	Run Forward	24V = run forward
13	DIGITAL INPUT 2	Run Reverse	24V = run reverse
14	DIGITAL INPUT 3	Not Stop	24V = RUN FWD and RUN REV signals latched 0V = RUN FWD and RUN REV signals not latched
15	DIGITAL INPUT 4	Remote Reverse	0V = remote forward 24V = remote reverse
16	DIGITAL INPUT 5	Jog	24V = jog
18	DIGITAL INPUT 7	Remote Trip Reset	24V = reset trips
19	DIGITAL INPUT 8	External Trip	<i>Non-configurable</i> 0V = Trip (connect to terminal 20)
21, 22	DIGITAL OUTPUT 1	Health	0V = tripped, i.e. not healthy
23, 24	DIGITAL OUTPUT 2	Running	0V = stopped, 24V = running

The Operator Menu for Macro 1

The default Operator Menu is shown below.

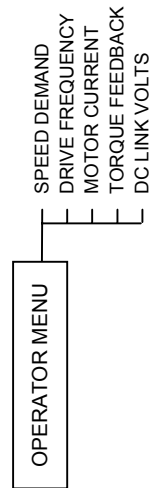

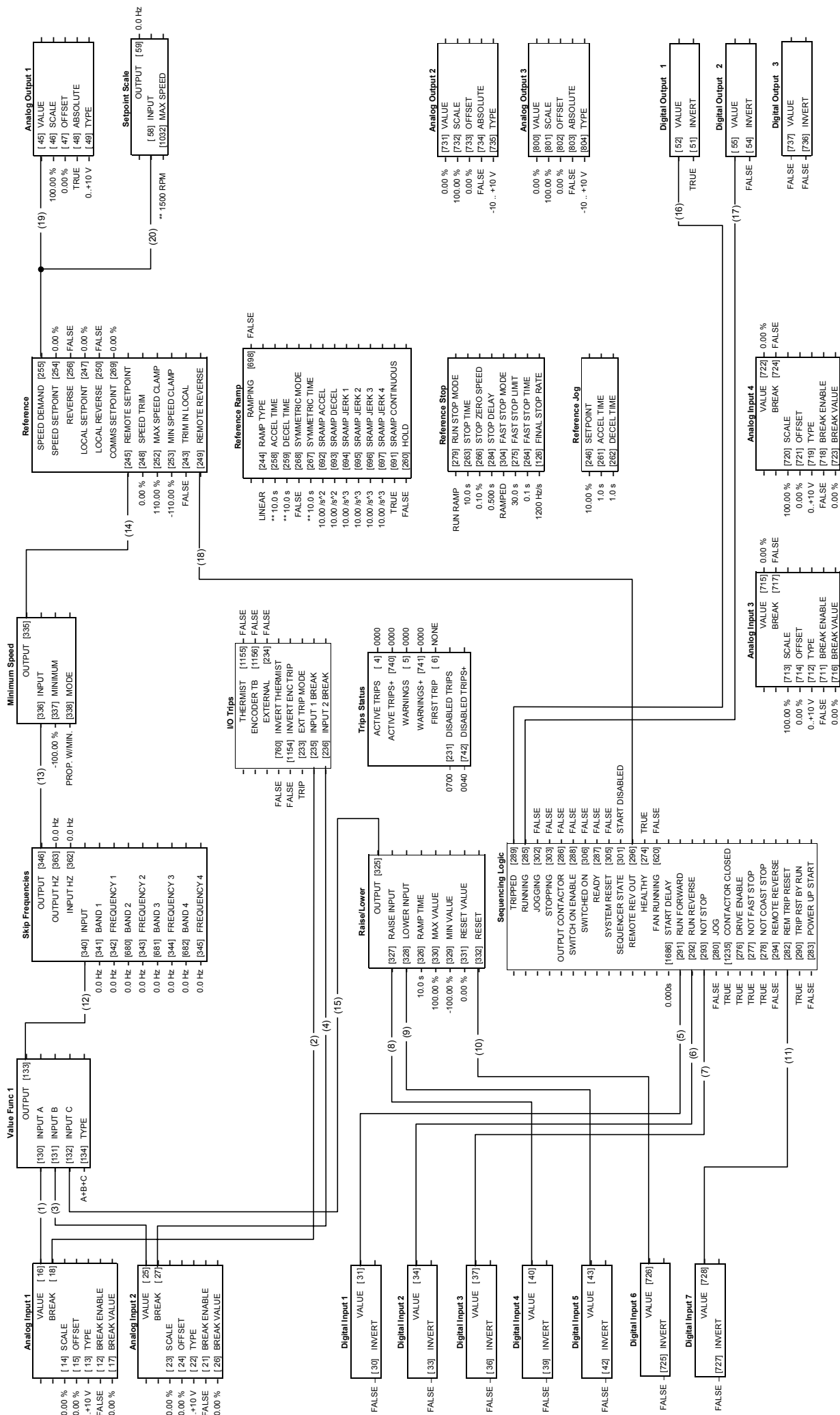

Macro 2: Raise/Lower

Macro 2: Raise/Lower Trim

This macro provides a raise/lower (push button) interface for an additional Setpoint Trim. The Setpoint is derived from the sum of the ANALOG INPUT 1, ANALOG INPUT 2 and the output of the raise/lower ramp. This ramp is controlled by the 3 digital inputs RAISE INPUT, RAISE LOWER and RESET of the RAISE/LOWER function block.

The raise/lower trim is restricted to be +/- 10.00%. This limit is set by the MIN VALUE and MAX VALUE parameters in the RAISE/LOWER function block.

Note that the raise/lower ramp output is automatically preserved in non-volatile memory during a power-down.

Control Wiring I/O			
Terminal	Name	Purpose	Comment
2	ANALOG INPUT 1	Speed Setpoint	0V = 0%, 10V = 100%
3	ANALOG INPUT 2	Speed Trim	0V = 0%, 10V = 100%
6	ANALOG OUTPUT 1	Ramp Output	absolute speed demand 0V = 0%, 10V = 100%
12	DIGITAL INPUT 1	Run Forward	24V = run forward
13	DIGITAL INPUT 2	Run Reverse	24V = run reverse
14	DIGITAL INPUT 3	Not Stop	24V = RUN FWD and RUN REV signals latched 0V = RUN FWD and RUN REV signals not latched
15	DIGITAL INPUT 4	Raise	24V = raise input
16	DIGITAL INPUT 5	Lower	24V = lower input
17	DIGITAL INPUT 6	Reset	24V = reset raise/lower
18	DIGITAL INPUT 7	Remote Trip Reset	24V = reset trips
19	DIGITAL INPUT 8	External Trip	<i>Non-configurable</i> 0V = Trip (connect to terminal 20)
21, 22	DIGITAL OUTPUT 1	Health	0V = tripped, i.e. not healthy
23, 24	DIGITAL OUTPUT 2	Running	0V = stopped, 24V = running

The Operator Menu for Macro 2

The default Operator Menu is shown below.

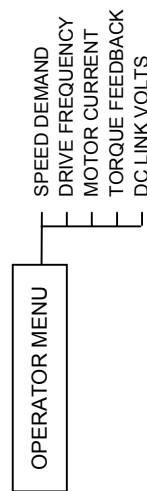

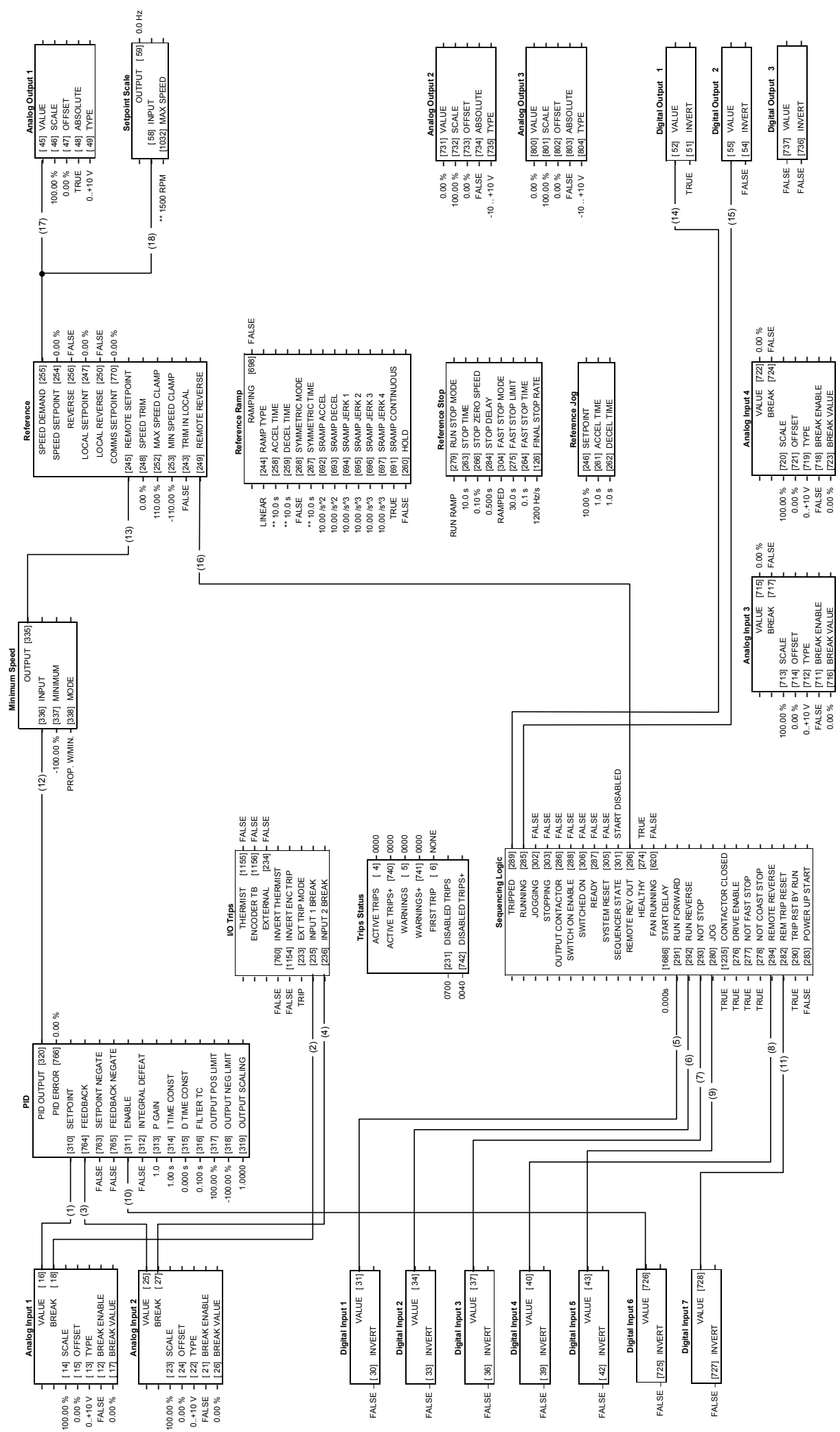

Macro 3: PID

Macro 3: PID

PID error derived from the difference of 2 analog inputs.

Digital input to disable PID.

Additional Operator Menu display parameters.

Control Wiring I/O		Purpose	Comment
Terminal	Name		
2	ANALOG INPUT 1	Process Setpoint	0V = 0%, 10V = 100%
3	ANALOG INPUT 2	Process Setpoint Trim	0V = 0%, 10V = 100%
6	ANALOG OUTPUT 1	Ramp Output	absolute speed demand 0V = 0%, 10V = 100%
12	DIGITAL INPUT 1	Run Forward	24V = run forward
13	DIGITAL INPUT 2	Run Reverse	24V = run reverse
14	DIGITAL INPUT 3	Not Stop	24V = RUN FWD and RUN REV signals latched 0V = RUN FWD and RUN REV signals not latched
15	DIGITAL INPUT 4	Remote Reverse	0V = remote forward 24V = remote reverse
16	DIGITAL INPUT 5	Jog	24V = jog
17	DIGITAL INPUT 6	PID Enable	24V = PID enable
18	DIGITAL INPUT 7	Remote Trip Reset	24V = reset trips
19	DIGITAL INPUT 8	External Trip	Non-configurable 0V = Trip (connect to terminal 20)
21, 22	DIGITAL OUTPUT 1	Health	0V = tripped, i.e. not healthy
23, 24	DIGITAL OUTPUT 2	Running	0V = stopped, 24V = running

The Operator Menu for Macro 3

The default Operator Menu is shown below.

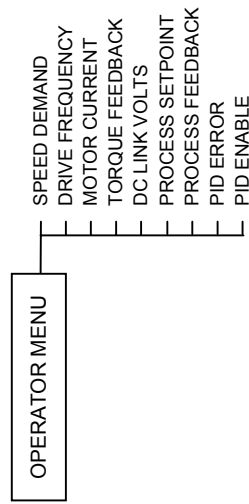

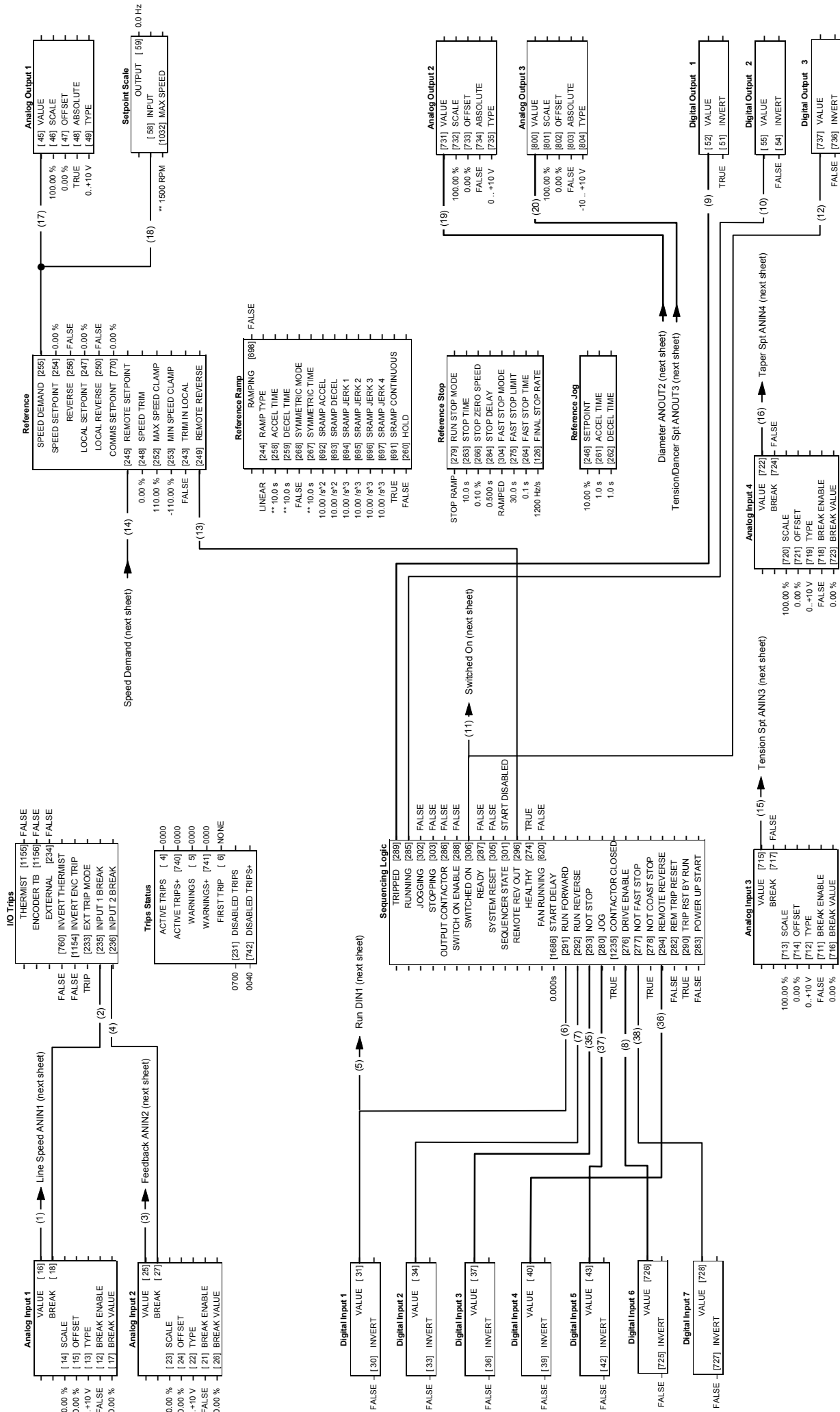

Macro 4: Speed Programmed Winder (SPW)

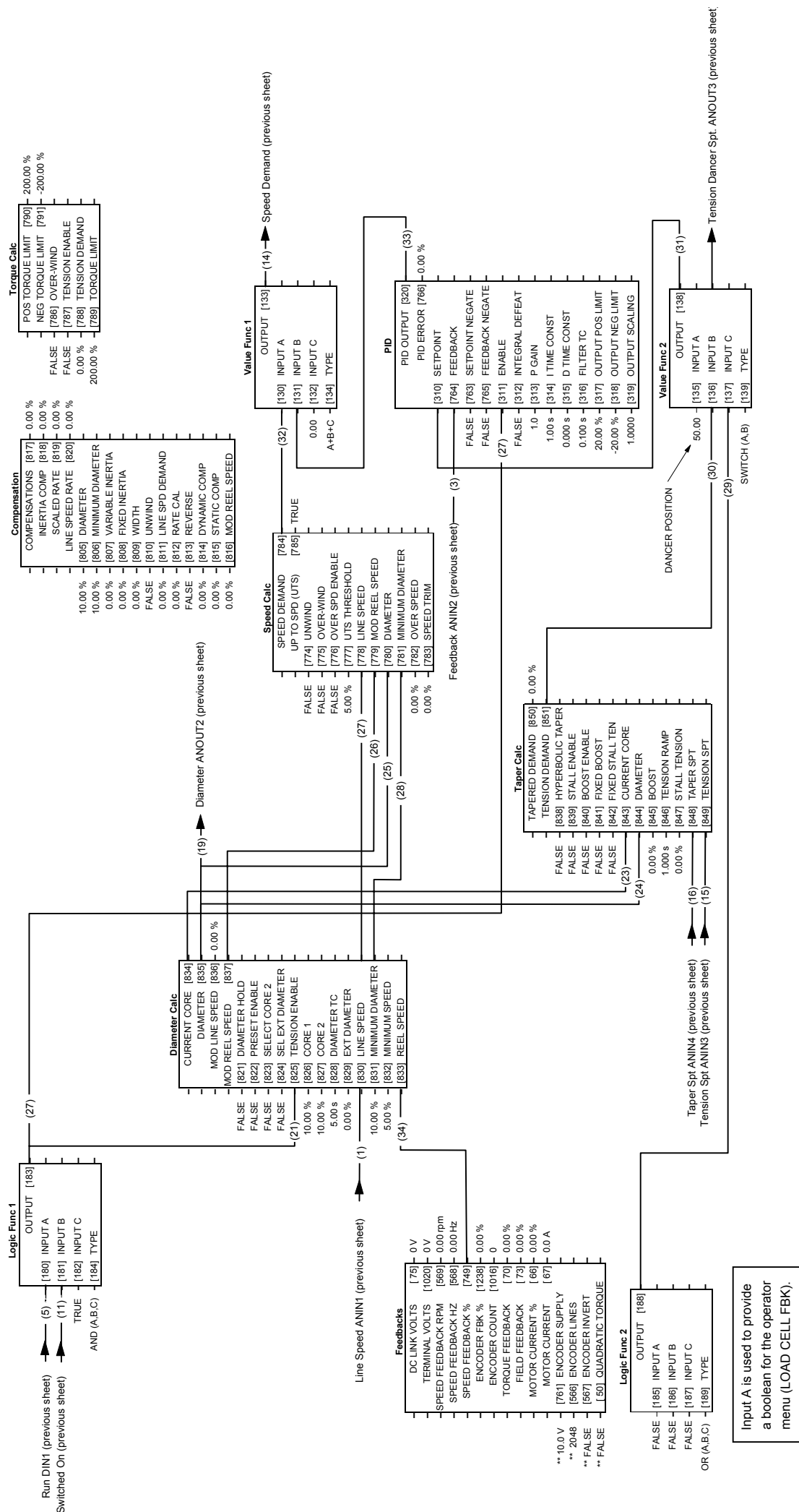

Input A is used to provide a boolean for the operator menu (LOAD CELL FBK).

Macro 4: Speed Programmed Winder (SPW)

Macro 4: Speed Programmed Winder (SPW)

The winder macro is for tension control of closed loop winders. The function blocks control the motor speed with a closed loop trim to provide constant tension throughout the roll.

The basic tension control controls the motor speed, compensated for diameter, trimmed by a dancer position loop or a loadcell tension loop, to produce constant web tension.

Other features provide Taper Tension, Stall Tension, Tension Boost, and Inertia Compensation.

Additional Operator Menu display parameters.

Control Wiring I/O			
Terminal	Name	Purpose	Comment
2	ANALOG INPUT 1	Line Speed	-10V = -100%, 10V = 100%
3	ANALOG INPUT 2	Feedback	-10V = -100%, 10V = 100%
4	ANALOG INPUT 3	Tension Setpoint	0V = 0%, 10V = 100%
5	ANALOG INPUT 4	Taper Setpoint	0V = 0%, 10V = 100%
6	ANALOG OUTPUT 1	Speed Demand	absolute speed demand 0V = 0%, 10V = 100%
7	ANALOG OUTPUT 2	Diameter	diameter 0V = 0%, 10V = 100%
8	ANALOG OUTPUT 3	Tension/Dancer Setpoint	tension diagnostic in load cell mode, or load setpoint for dancer -10V = -100%, 10V = 100%
12	DIGITAL INPUT 1	Run Forward	24V = run forward
13	DIGITAL INPUT 2	Run Reverse	24V = run reverse
14	DIGITAL INPUT 3	Not Stop	24V = RUN FWD and RUN REV signals latched 0V = RUN FWD and RUN REV signals not latched
15	DIGITAL INPUT 4	Remote Reverse	0V = remote forward 24V = remote reverse
16	DIGITAL INPUT 5	Jog	24V = jog
17	DIGITAL INPUT 6	Drive Enable	24V = drive enable
18	DIGITAL INPUT 7	Fast Stop	0V = fast stop
19	DIGITAL INPUT 8	External Trip	Non-configurable 0V = Trip (connect to terminal 20)
21, 22	DIGITAL OUTPUT 1	Health	0V = tripped, i.e. not healthy
23, 24	DIGITAL OUTPUT 2	Running	0V = stopped, 24V = running
25, 26	DIGITAL OUTPUT 3	Switched On	0V = not ready, 24V = switched on

The Operator Menu for Macro 4

The default Operator Menu is shown below.

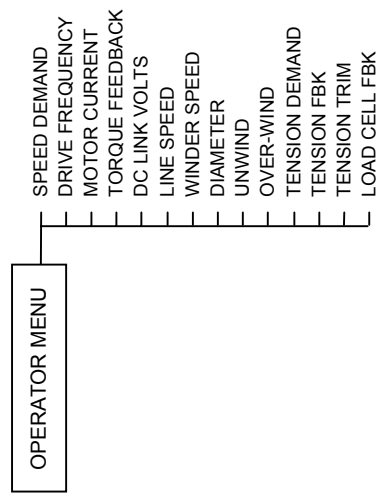

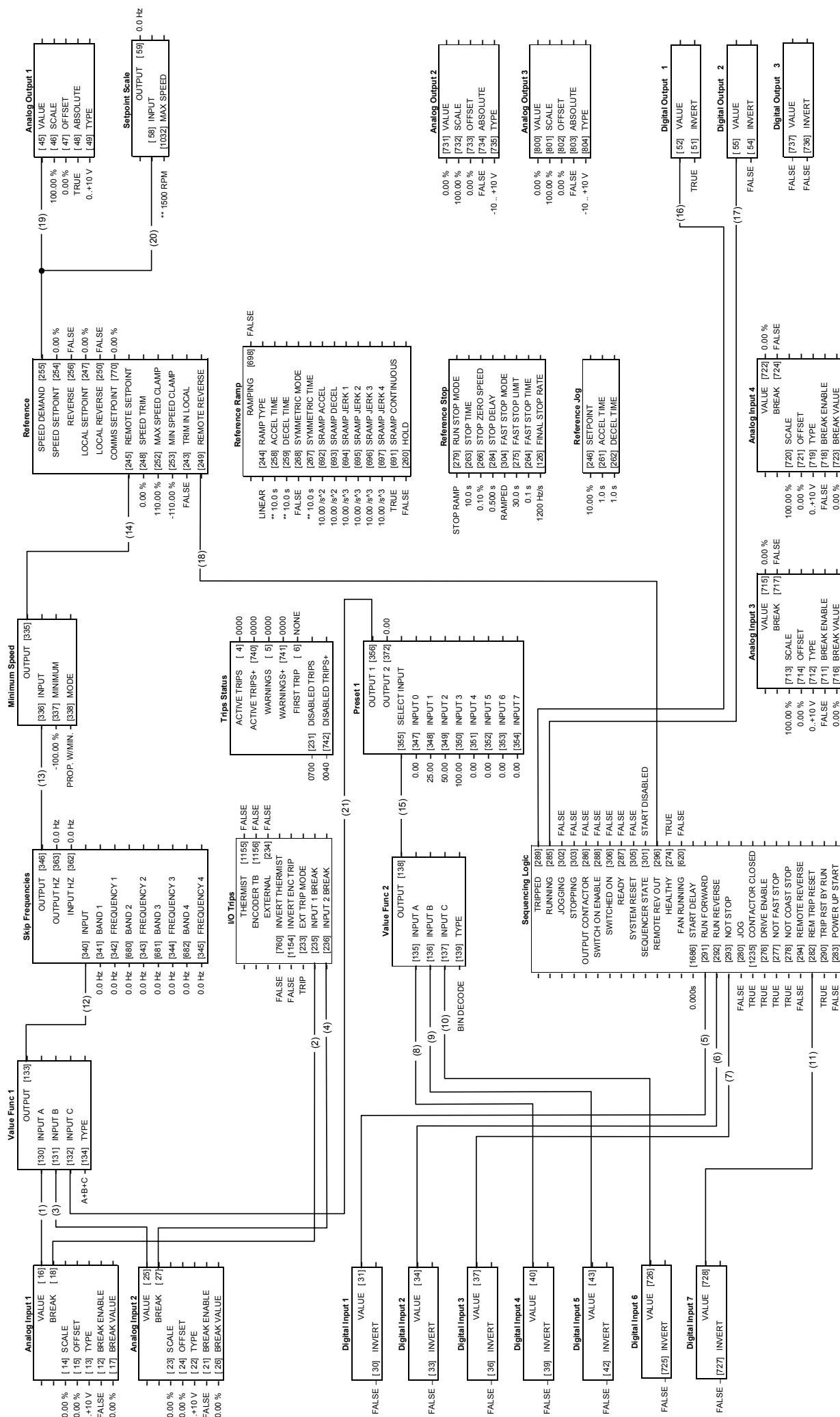

Macro 5: Preset Speeds

Macro 5: Preset Speeds

Digital inputs select up to 8 preset speeds.
Additional Operator Menu display parameters.

Control Wiring I/O			
Terminal	Name	Purpose	Comment
2	ANALOG INPUT 1	Speed Setpoint	0V = 0%, 10V = 100%
3	ANALOG INPUT 2	Speed Trim	0V = 0%, 10V = 100%
6	ANALOG OUTPUT 1	Ramp Output	absolute speed demand 0V = 0%, 10V = 100%
12	DIGITAL INPUT 1	Run Forward	24V = run forward
13	DIGITAL INPUT 2	Run Reverse	24V = run reverse
14	DIGITAL INPUT 3	Not Stop	24V = RUN FWD and RUN REV signals latched 0V = RUN FWD and RUN REV signals not latched
15	DIGITAL INPUT 4	Preset 1	Preset Speed Select
16	DIGITAL INPUT 5	Preset 2	Preset Speed Select
17	DIGITAL INPUT 6	Preset 3	Preset Speed Select
18	DIGITAL INPUT 7	Remote Trip Reset	24V = reset trips
19	DIGITAL INPUT 8	External Trip	Non-configurable 0V = Trip (connect to terminal 20)
21, 22	DIGITAL OUTPUT 1	Health	0V = tripped, i.e. not healthy
23, 24	DIGITAL OUTPUT 2	Running	0V = stopped, 24V = running

The Operator Menu for Macro 5

The default Operator Menu is shown below.

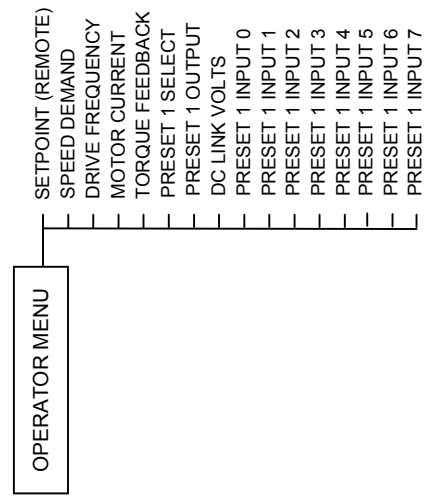

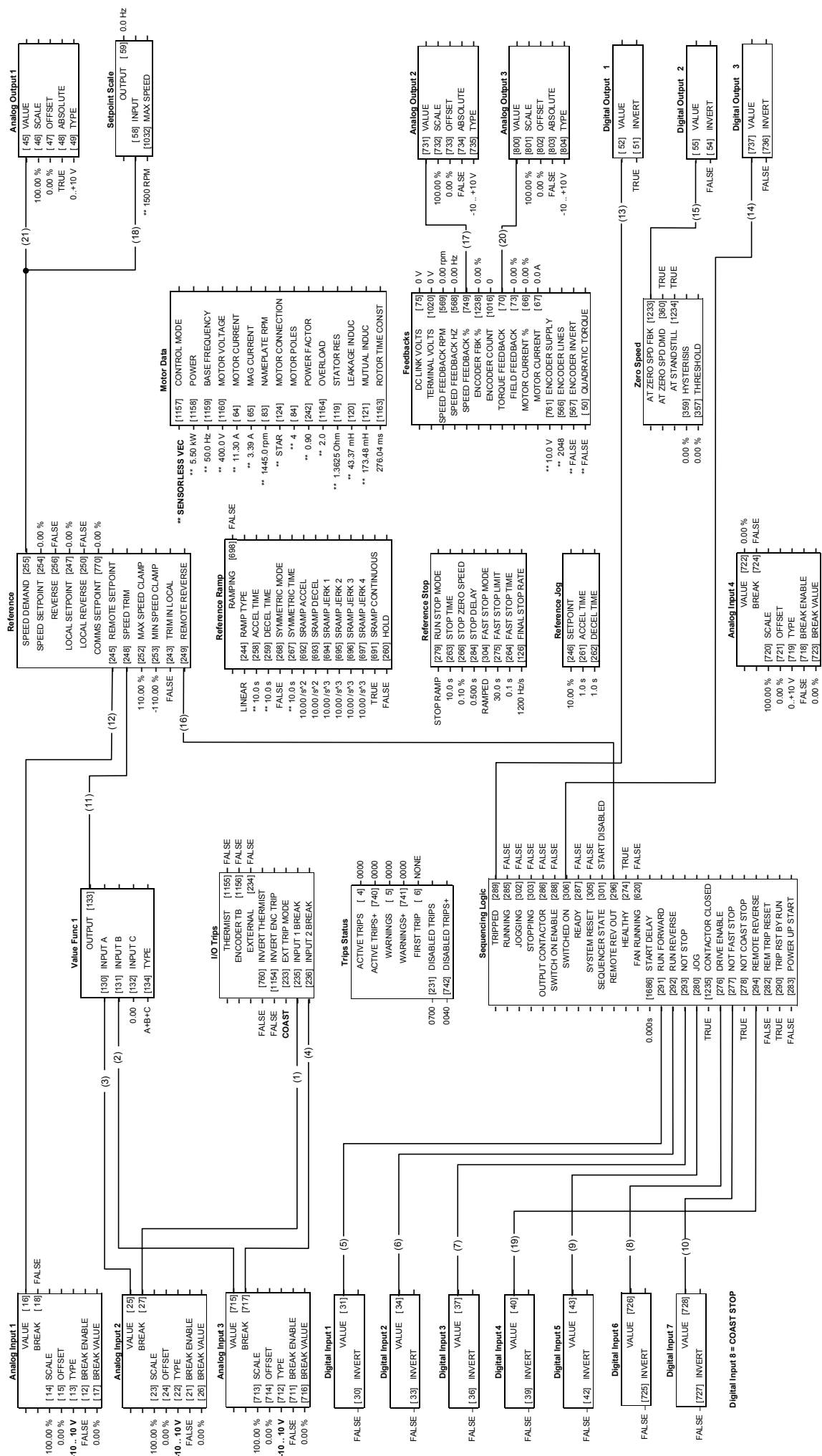

Macro 6: "System" Drive

Macro 6: "System" Drive

Provides for basic speed control with similar functionality to the 620 and 590+ Series Drives.

Control Wiring I/O		
Terminal	Name	Purpose
2	ANALOG INPUT 1	Speed Setpoint
3	ANALOG INPUT 2	Speed Trim 1
4	ANALOG INPUT 3	Speed Trim 2
6	ANALOG OUTPUT 1	Ramp Output
7	ANALOG OUTPUT 2	Speed Feedback
8	ANALOG OUTPUT 3	Torque Feedback
12	DIGITAL INPUT 1	Run Forward
13	DIGITAL INPUT 2	Run Reverse
14	DIGITAL INPUT 3	Not Stop
15	DIGITAL INPUT 4	Reverse
16	DIGITAL INPUT 5	Jog
17	DIGITAL INPUT 6	Drive Enable
18	DIGITAL INPUT 7	Fast Stop
19	DIGITAL INPUT 8	Coast Stop
21, 22	DIGITAL OUTPUT 1	Health
23, 24	DIGITAL OUTPUT 2	At Zero Speed
25, 26	DIGITAL OUTPUT 3	Switched On
		Comment
		-10V = -100%, 10V = 100%
		-10V = -100%, 10V = 100%
		-10V = -100%, 10V = 100%
		absolute speed demand 0V = 0%, 10V = 100%
		-10V = -100%, 10V = 100%
		-10V = -100%, 10V = 100%
		24V = Run forward
		24V = Run reverse
		24V = RUN FWD and RUN REV signals latched
		0V = RUN FWD and RUN REV signals not latched
		24V = Reverse
		24V = Jog
		24V = Drive Enable
		0V = Fast Stop
		0V = Coast Stop
		0V = Tripped, i.e. not healthy
		0V = At Zero Speed Feedback
		0V = Open, 24V = Switched On

The Operator Menu for Macro 6

The default Operator Menu is shown below.

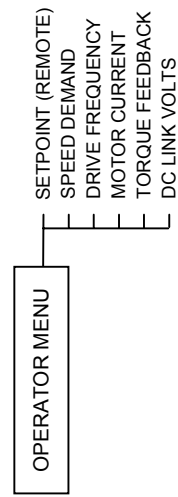

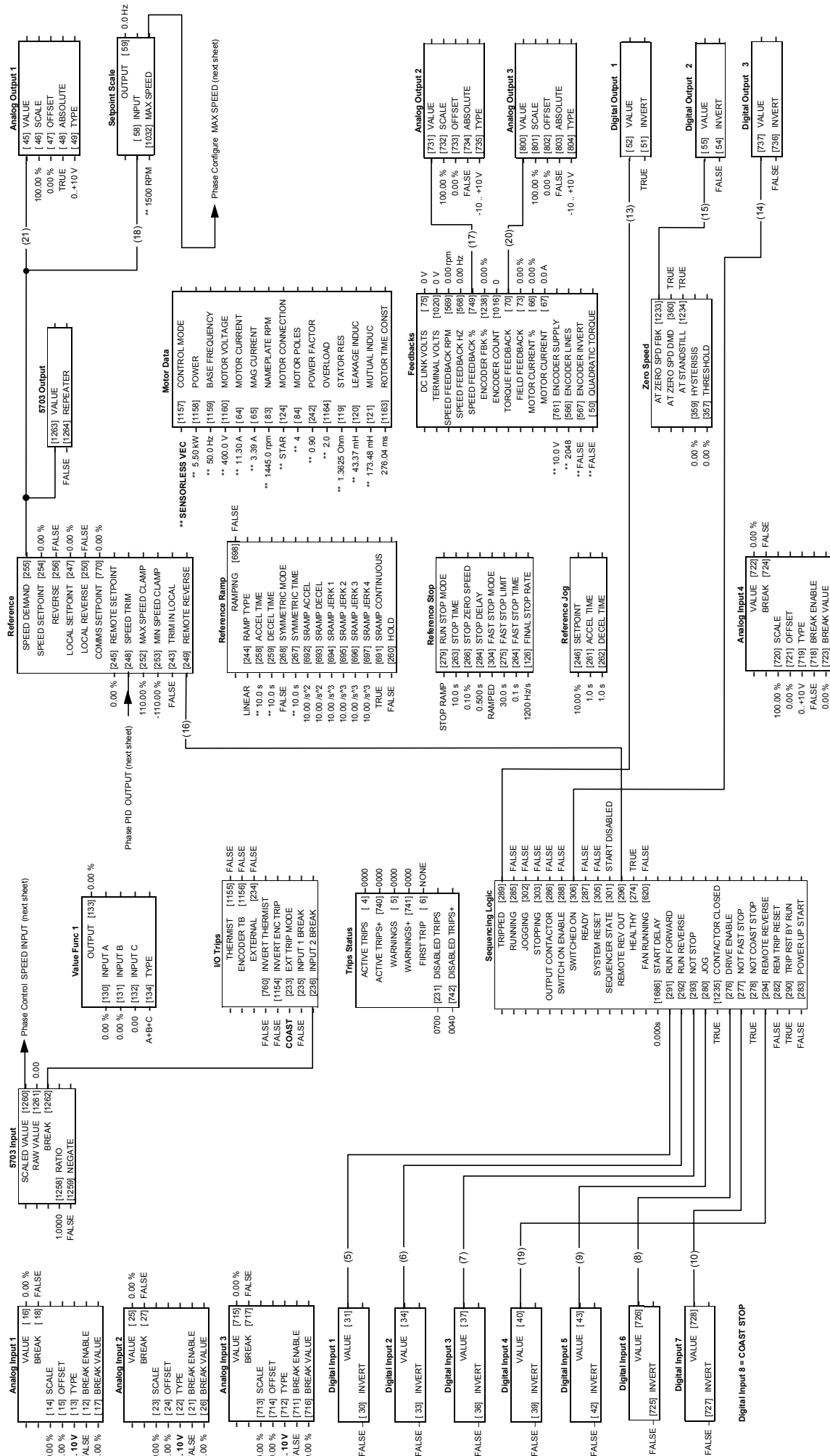

Note: Download from CeLite using the Operator Station Comms port (not the P3 port)

Macro 7: Phase/Register

System Board

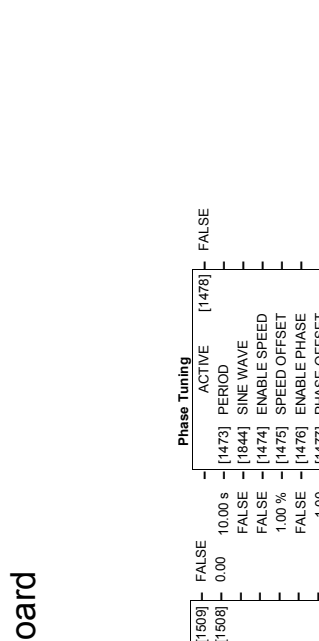
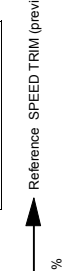
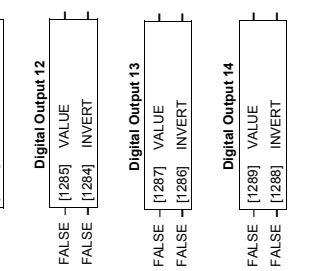
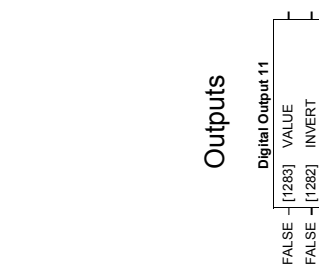
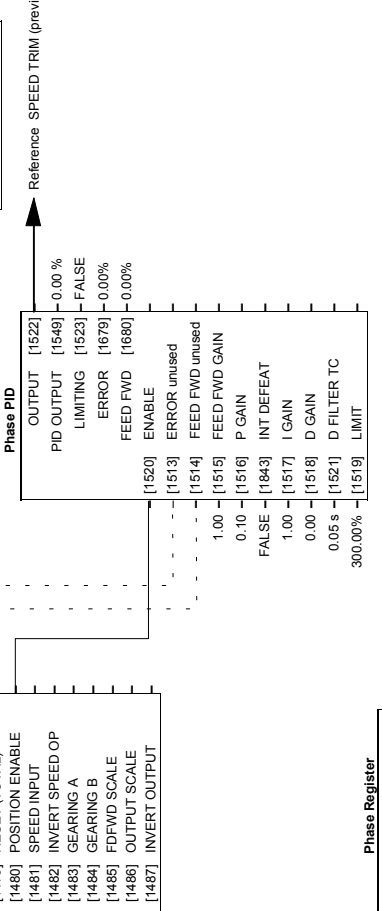
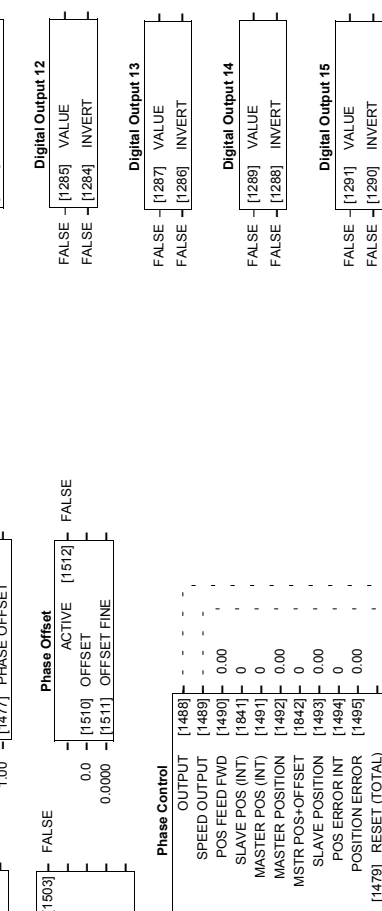
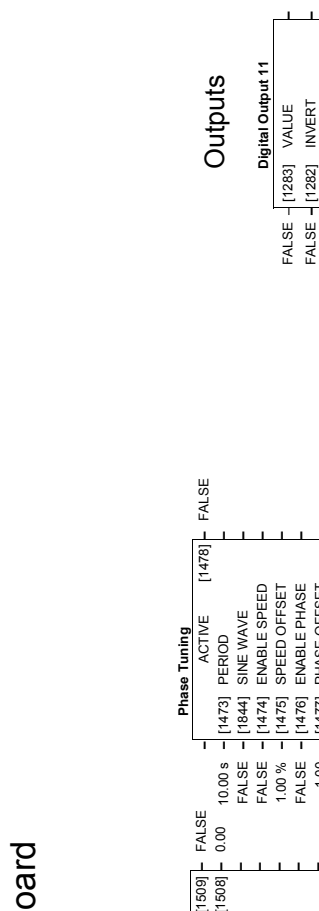
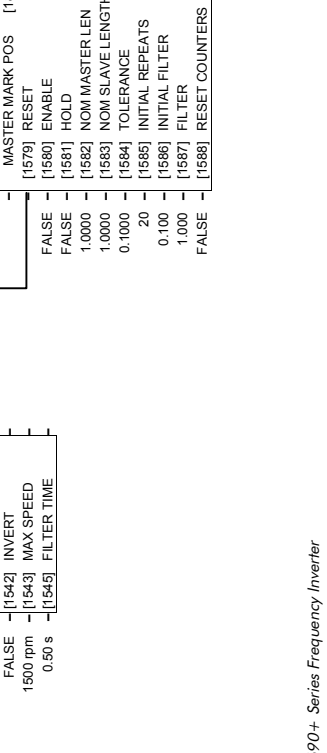
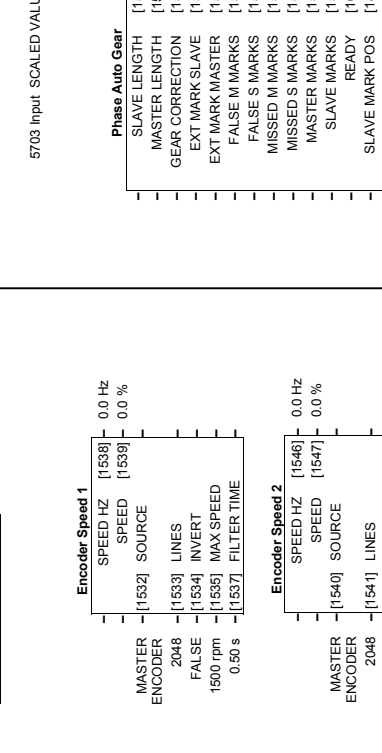
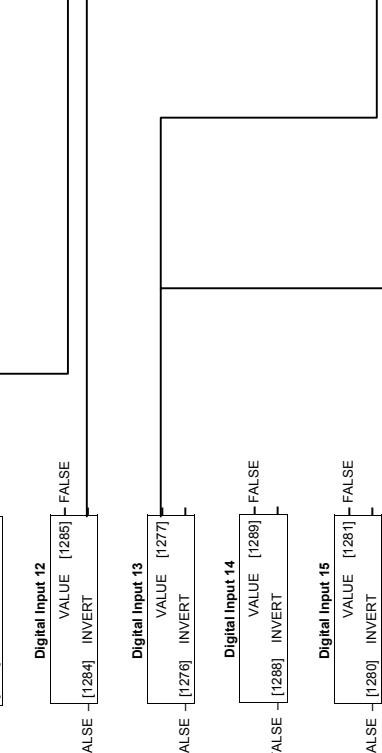
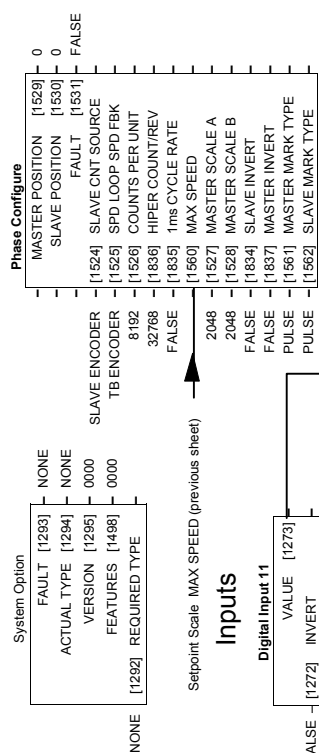

Macro 7: Phase/Register

This macro is to be used in a slave drive set up for phase/register control. The slave will get the line speed setpoint from the master drive via the system port (serial port using the 5703 setpoint repeater). This provides the highest accuracy and least lag. If this is not possible, the speed demand should be derived from the master encoder using the Encoder Speed function block, or over the network.

Note: Register control is enabled by setting REGISTER::RESET = FALSE
 If Auto-gearing is enabled, then it is important that
 PHASE CONFIGURE::SCALE A = PHASE CONFIGURE::SCALE B

Control Wiring I/O			
Terminal	Name	Purpose	Comment
6	ANALOG OUTPUT 1	Ramp Output	absolute speed demand 0V = 0%, 10V = 100%
7	ANALOG OUTPUT 2	Speed Feedback	-10V = -100%, 10V = 100%
8	ANALOG OUTPUT 3	Torque Feedback	-10V = -100%, 10V = 100%
12	DIGITAL INPUT 1	Run Forward	24V = Run forward
13	DIGITAL INPUT 2	Run Reverse	24V = Run reverse
14	DIGITAL INPUT 3	Not Stop	24V = RUN FWD and RUN REV signals latched 0V = RUN FWD and RUN REV signals not latched
15	DIGITAL INPUT 4	Reverse	24V = Reverse
16	DIGITAL INPUT 5	Jog	24V = Jog
17	DIGITAL INPUT 6	Drive Enable	24V = Drive Enable
18	DIGITAL INPUT 7	Fast Stop	0V = Fast Stop
21, 22	DIGITAL OUTPUT 1	Health	0V = Tripped, i.e. not healthy
23, 24	DIGITAL OUTPUT 2	At Zero Speed	0V = At Zero Speed Feedback
25, 26	DIGITAL OUTPUT 3	Switched On	0V = Open, 24V = Switched On
System Board			
A2	DIGITAL INPUT 11	Inch Advance	
A3	DIGITAL INPUT 12	Inch Retard	
A4	DIGITAL INPUT 13	Reset	
5703	P3	Master Line Speed Demand	

The Operator Menu for

The default Operator Menu is shown below.

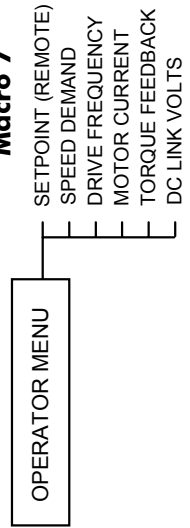

Macro 7

System Board Terminals (option)

Terminal No.	Name	Range	Description
Terminal A 1 2 3 4 5 6			
1	External 0V		User-supplied 0V reference
2	DIGIO1		Configurable digital input/output
3	DIGIO2		Configurable digital input/output
4	DIGIO3		Configurable digital input/output
5	DIGIO4		Configurable digital input/output
6	DIGIO5		Configurable digital input/output
Terminal B 1 2 3 4 5 6 7 8 9			
1	External 24V In	24V dc ($\pm 10\%$) 1A	User-supplied power supply
2	Reference Encoder A		Input
3	Reference Encoder /A		Input
4	Reference Encoder B		Input
5	Reference Encoder /B		Input
6	Reference Encoder Z		Input
7	Reference Encoder /Z		Input
8	Encoder Supply Out	5V, 12V, 18V, 24V	User selectable (max load 500mA)
9	External 0V		User-supplied 0V reference
Terminal C 1 2 3 4 5 6			
1	Slave Encoder A		Input
2	Slave Encoder /A		Input
3	Slave Encoder B		Input
4	Slave Encoder /B		Input
5	Slave Encoder Z		Input
6	Slave Encoder /Z		Input
Terminal D 1 2 3 4 5 6			
1	Repeat Encoder Output A		Output
2	Repeat Encoder Output /A		Output
3	Repeat Encoder Output B		Output
4	Repeat Encoder Output /B		Output
5	Repeat Encoder Output Z		Output
6	Repeat Encoder Output /Z		Output

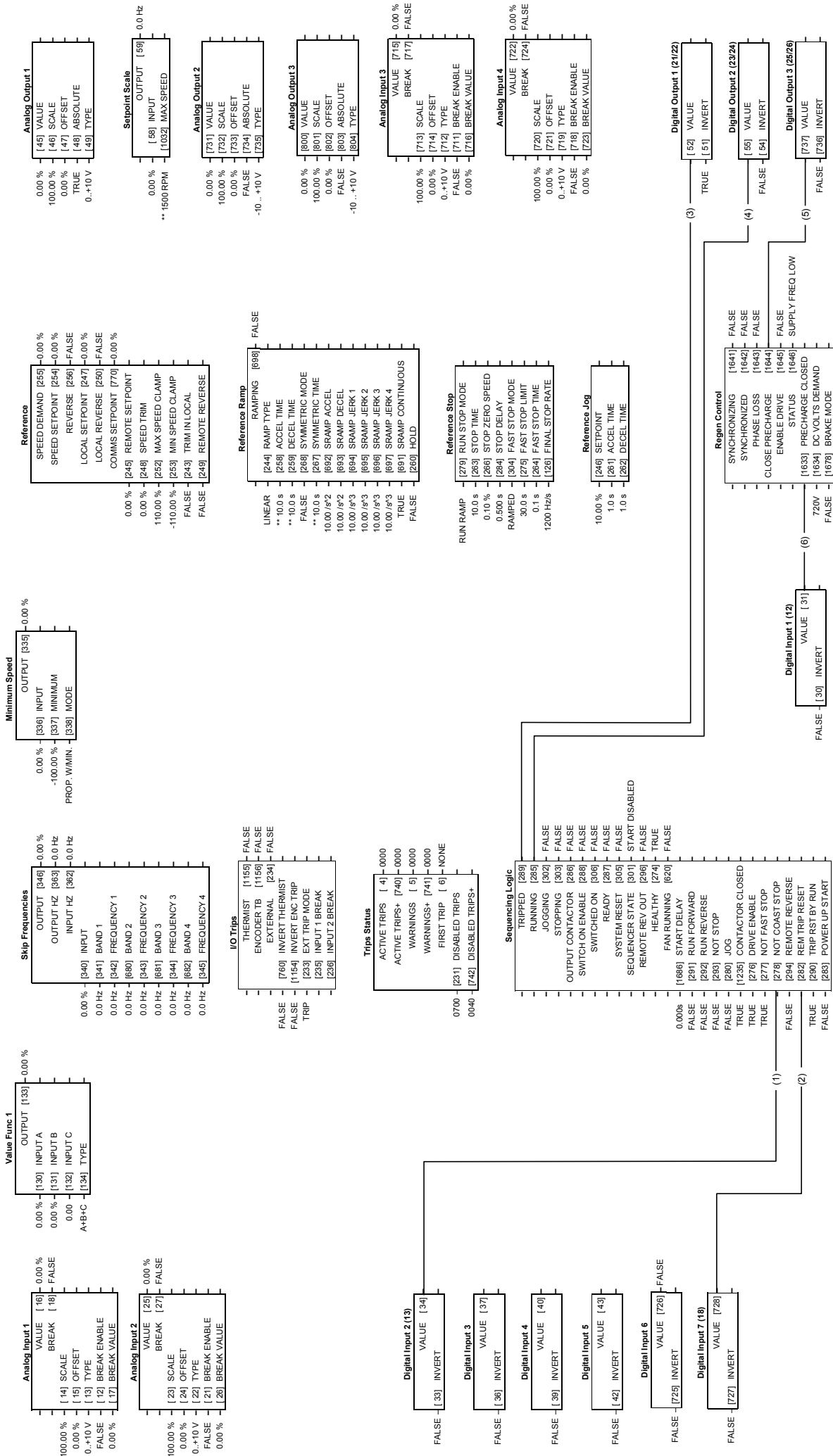

Macro 8: 4-Q Regen

Macro 8: 4-Q Regen

This macro is used for common DC Link schemes. The 4-Q Regen Drive acts as a DC power supply for the common DC Link, capable of drawing and supplying sinusoidal, unity power factor current to the system 3-phase supply. Detailed description of the 4-Q Regen control mode can be found in the Application Note - refer to Chapter ?

Control Wiring I/O			
Terminal	Name	Purpose	Comment
12	DIGITAL INPUT 1	Pre-Charge Closed	24V = External Contactor Closed
13	DIGITAL INPUT 2	Not Coast Stop	0V = Coast Stop
18	DIGITAL INPUT 7	Remote Trip Reset	24V = Reset Trips
19	DIGITAL INPUT 8	External Trip	<i>Non-configurable</i> 0V = Trip (connect to terminal 20)
21, 22	DIGITAL OUTPUT 1	Health	0V = Tripped, i.e. not healthy
23, 24	DIGITAL OUTPUT 2	Running	0V = Stopped, 24V = Running
25, 26	DIGITAL OUTPUT 3	Close Pre-Charge	0V = Pre-Charge Open 24V = Pre-Charge Closed

The Operator Menu for Macro 8

The default Operator Menu is shown below.

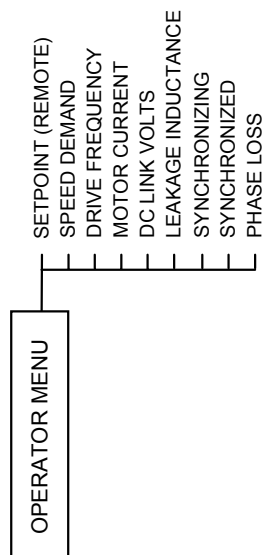

Sequencing and Reference

Autotune	Reference Ramp
ACTIVE [604] FALSE	RAMPING [698] FALSE
[603] ENABLE	[244] RAMP TYPE
	** 10.0 s
	** 100 s
	FALSE
	[248] ACCEL TIME
	** 10.0 s
	FALSE
	[289] SYMMETRIC MODE
	** 10.0 s
	[692] SRAMP ACCEL
	10.00 /s ²
	[693] SRAMP DECEL
	10.00 /s ²
	[694] SRAMP JERK 1
	10.00 /s ³
	[695] SRAMP JERK 2
	10.00 /s ³
	[696] SRAMP JERK 3
	10.00 /s ³
	[697] SRAMP JERK 4
	10.00 /s ³
	[691] SRAMP CONTINUOUS
	TRUE
	[260] HOLD
	FALSE

Auto Restart	Reference Stop
PENDING [608] FALSE	STOP RAMP [279] RUN STOP MODE
RESTARTING [616] FALSE	[279] STOP TIME
ATTEMPTS LEFT [614] 5	0.10 s
TIME LEFT [615] 0.0 s	[296] STOP ZERO SPEED
	0.10 s
[611] ENABLE	[294] STOP DELAY
[612] ATTEMPTS	5.000 s
[610] INITIAL DELAY 1	[304] FAST STOP MODE
10.0 s	[275] FAST STOP LIMIT
[613] ATTEMPT DELAY 1	[264] FAST STOP TIME
0.000	0.1 s
[609] TRIGGERS 1	[126] FINAL STOP RATE
0000	1200 Hz/s
[678] INITIAL DELAY 2	
0.1 s	
[679] ATTEMPT DELAY 2	
0.000	
[677] TRIGGERS 2+	
0000	
[745] TRIGGERS 2+	
0000	

Comms Control	Reference Log
COMMS SEQ [295] FALSE	[246] SETPOINT
COMMS REF [270] FALSE	10.00 %
COMMS STATUS [272] 0	[281] ACCEL TIME
COMMS COMMAND [273] 0	1.0 s
[300] REMOTE COMMS SH	[282] DECEL TIME
FALSE	
TERMINALS/COMMS [307] REMOTE SEQ MODE	
TERMINALS/COMMS [308] REMOTE REF MODE	
0.0 s	
[309] COMMS TIMEOUT	
0.0 s	

Reference	Local Control
SPEED DEMAND [254] 0.00 %	REMOTE SEQ [297] TRUE
REVERSE [256] FALSE	REMOTE REF [257] TRUE
LOCAL SETPOINT [247] 0.00 %	LOCAL/REMOTE [298] SEQ MODES
LOCAL REVERSE [250] FALSE	LOCAL/REMOTE [299] REF MODES
COMMS SETPOINT [710] 0.00 %	REMOTE [296] POWER UP MODE
[245] REMOTE SETPOINT	FALSE [281] SEQ DIRECTION
[248] SPEED TRIM	
[252] MAX SPEED CLAMP	
[253] MIN SPEED CLAMP	
[243] TRIM IN LOCAL	
[249] REMOTE REVERSE	

Sequencing Logic
TRIPPED [289] FALSE
RUNNING [295] FALSE
JOGGING [302] FALSE
STOPPING [303] FALSE
OUTPUT CONTACTOR [286] FALSE
SWITCH ON ENABLE [306] FALSE
SWITCHED ON [305] FALSE
READY [287] FALSE
SYSTEM RESET [309] FALSE
SEQUENCER STATE [301] START DISABLED
REMOTE REV OUT [296] FALSE
HEALTHY [274] TRUE
FAN RUNNING [620] FALSE
[686] START DELAY
[291] RUN FORWARD
[292] RUN REVERSE
[293] NOT STOP
[280] JOG
[1235] CONTACTOR CLOSED
[276] DRIVE ENABLE
[277] NOT FAST STOP
[278] NOT CONSTANT STOP
[294] REMOTE REVERSE
[282] REM TRIP RESET
[290] TRIP RST BY RUN
[283] POWER UP START

Macro Control Blocks

Motor Control

Autotune	Fluxing	Setpoint Scale
ACTIVE [604] FALSE	[104] VF SHAPE	OUTPUT [59] 0.0 Hz
[603] ENABLE	[106] BASE FREQUENCY	[58] INPUT
	** 0.0 Hz	[1032] MAX SPEED
	[107] FIXED BOOST	** 1500 RPM
	** 0.00 %	
	[108] AUTO BOOST	
	0.00 %	
	[1656] ACCELTRN BOOST	
	100.00 %	
	FALSE	
	[1655] ENERGY SAVING	
	10.00 %	
	[1657] USER FREQ 1	
	10.00 s	
	[1658] USER VOLTAGE 1	
	20.00 s	
	[1659] USER FREQ 2	
	20.00 s	
	[1660] USER VOLTAGE 2	
	30.00 s	
	[1661] USER FREQ 3	
	30.00 s	
	[1662] USER VOLTAGE 3	
	40.00 s	
	[1663] USER FREQ 4	
	40.00 s	
	[1664] USER VOLTAGE 4	
	50.00 s	
	[1665] USER FREQ 5	
	50.00 s	
	[1666] USER VOLTAGE 5	
	60.00 s	
	[1667] USER FREQ 6	
	60.00 s	
	[1668] USER VOLTAGE 6	
	70.00 s	
	[1669] USER FREQ 7	
	70.00 s	
	[1670] USER VOLTAGE 7	
	80.00 s	
	[1671] USER FREQ 8	
	80.00 s	
	[1672] USER VOLTAGE 8	
	90.00 s	
	[1673] USER FREQ 9	
	90.00 s	
	[1674] USER VOLTAGE 9	
	100.00 s	
	[1675] USER FREQ 10	
	100.00 s	
	[1676] USER VOLTAGE 10	
	100.00 s	

Current Limit	Dynamic Braking	Energy Motor
[665] CURRENT LIMIT	[80] ENABLE	POWER [604] 0.00 kW
TRUE	[77] BRAKE RESISTANCE	POWER [605] 0.00 HP
[666] REGEN LIM ENABLE	0.1 kW	REACTIVE POWER [606] 0.00 kVA
	[78] BRAKE POWER	ENERGY USEL [607] 0.0 kWh
	[79] ISEC OVER RATING	[603] RESET
	25	FALSE

Motor Data	Pattern Gen	Power Loss Control
[1157] CONTROL MODE	DRIVE FREQUENCY [691] 0.00 Hz	PWR LOSS ACTIVE [1271] FALSE
** 5.50 kW	[98] RANDOM PATTERN	[1266] ENABLE
[1158] POWER	[99] FREQ SELECT	** 447V
** 50.0 Hz	[100] DEFLUX DELAY	[1267] TRIP THRESHOLD
[1159] BASE FREQUENCY	TRUE	20V
** 400.0 V		[1268] CONTROL BAND
[1160] MOTOR VOLTAGE		10.00s
** 400.0 V		[1269] ACCEL TIME
[1161] MOTOR CURRENT		5.00s
** 3.39 A		[1268] DECEL TIME
[1162] MOTOR RPM		[1677] INITIAL STEP
** 1445.0 rpm		[1270] TIME LIMIT
[1163] NAMEPLATE RPM		30.00s
** 4. [84]		
[1164] MOTOR POLES		
** 0.90		
[1165] POWER FACTOR		
** 2.0		
[1166] OVERLOAD		
** 1.3625 Ohm		
[1167] STATOR RES		
** 43.37 mH		
[1168] LEAKAGE INDUCT		
** 173.48 mH		
[1169] MUTUAL INDUCT		
[1170] ROTOR TIME CONST		
276.04 ms		

Fluxing	Flycatching	Regen Control
[104] VF SHAPE	ACTIVE [576] FALSE	SYNCHRONISING [1641] FALSE
[106] BASE FREQUENCY	SETPOINT [281] 0.00 %	PHASE LOSS [1642] FALSE
** 0.0 Hz	[570] ENABLE	PHASE LOSS [1643] FALSE
[107] FIXED BOOST	[571] START MODE	CLOSE PRECHARGE [1644] FALSE
** 0.00 %	ALWAYS	ENABLE DRIVE [1645] FALSE
[108] AUTO BOOST	[572] SEARCH MODE	STATUS [1646] FALSE
0.00 %	** 9.00 %	[1633] PRECHARGE CLOSED
[1656] ACCELTRN BOOST	[573] SEARCH VOLTS	[1634] DC VOLTS DEMAND
100.00 %	[32] SEARCH BOOST	[1678] BRAKE MODE
FALSE	** 40.00 %	
[1655] ENERGY SAVING	[574] SEARCH TIME	
10.00 %	** 10.0	
[1657] USER FREQ 1	[575] MIN SEARCH SPEED	
10.00 s	5.0 Hz	
[1658] USER VOLTAGE 1	[709] REFLUX TIME	
20.00 s	** 3.0	
[1659] USER FREQ 2		
20.00 s		
[1660] USER VOLTAGE 2		
30.00 s		
[1661] USER FREQ 3		
30.00 s		
[1662] USER VOLTAGE 3		
40.00 s		
[1663] USER FREQ 4		
40.00 s		
[1664] USER VOLTAGE 4		
50.00 s		
[1665] USER FREQ 5		
50.00 s		
[1666] USER VOLTAGE 5		
60.00 s		
[1667] USER FREQ 6		
60.00 s		
[1668] USER VOLTAGE 6		
70.00 s		
[1669] USER FREQ 7		
70.00 s		
[1670] USER VOLTAGE 7		
80.00 s		
[1671] USER FREQ 8		
80.00 s		
[1672] USER VOLTAGE 8		
90.00 s		
[1673] USER FREQ 9		
90.00 s		
[1674] USER VOLTAGE 9		
100.00 s		
[1675] USER FREQ 10		
100.00 s		
[1676] USER VOLTAGE 10		
100.00 s		

Feedbacks	Inverse Time
DC LINK VOLTS [75] 0 V	IT LIMITING [1152] FALSE
TERMINAL VOLTS [1020] 0 V	[1148] AIMING POINT
SPEED FEEDBACK [569] 0.00 rpm	[1149] DELAY
SPEED FBK REVS [568] 0.00 revs	105.00 s
ENCODER FBK % [1238] 0.00 %	[1150] DOWN TIME
ENCODER COUNT [1016] 0	[1151] UP TIME
TORQUE FEEDBACK [770] 0.00 %	
FIELD FEEDBACK [773] 0.00 %	
MOTOR CURRENT [666] 0.00 %	
MOTOR CURRENT [671] 0.0 A	
[761] ENCODER SUPPLY	
[686] ENCODER LINES	
** 2048	
[687] ENCODER INVERT	
** FALSE	
[685] ENCODER MODE	
** FALSE	
[150] QUADRATIC TORQUE	

Slip Comp	Speed Log
[82] ENABLE	TOTAL SPD DMD RPM [1203] 0.00 RPM
[85] MOTORING LIMIT	[1206] 0.00 %
[89] REGEN LIMIT	[1207] 0.00 %
** 150.0 rpm	[1208] 0.00 %
** 150.0 rpm	[1209] 0.00 %
	[1210] 0.00 %
	[1211] 0.00 %
	[1212] 0.00 %
	[1213] 0.00 %
	[1214] 0.00 %
	[1215] 0.00 %
	[1216] 0.00 %
	[1217] 0.00 %
	[1218] 0.00 %
	[1219] 0.00 %
	[1220] 0.00 %
	[1221] 0.00 %
	[1222] 0.00 %
	[1223] 0.00 %
	[1224] 0.00 %
	[1225] 0.00 %
	[1226] 0.00 %
	[1227] 0.00 %
	[1228] 0.00 %
	[1229] 0.00 %
	[1230] 0.00 %
	[1231] 0.00 %
	[1232] 0.00 %
	[1233] 0.00 %
	[1234] 0.00 %
	[1235] 0.00 %
	[1236] 0.00 %
	[1237] 0.00 %
	[1238] 0.00 %
	[1239] 0.00 %
	[1240] 0.00 %
	[1241] 0.00 %
	[1242] 0.00 %
	[1243] 0.00 %
	[1244] 0.00 %
	[1245] 0.00 %
	[1246] 0.00 %
	[1247] 0.00 %
	[1248] 0.00 %
	[1249] 0.00 %
	[1250] 0.00 %
	[1251] 0.00 %
	[1252] 0.00 %
	[1253] 0.00 %
	[1254] 0.00 %
	[1255] 0.00 %
	[1256] 0.00 %
	[1257] 0.00 %
	[1258] 0.00 %
	[1259] 0.00 %
	[1260] 0.00 %
	[1261] 0.00 %
	[1262] 0.00 %
	[1263] 0.00 %
	[1264] 0.00 %
	[1265] 0.00 %
	[1266] 0.00 %
	[1267] 0.00 %
	[1268] 0.00 %
	[1269] 0.00 %
	[1270] 0.00 %
	[1271] 0.00 %
	[1272] 0.00 %
	[1273] 0.00 %
	[1274] 0.00 %
	[1275] 0.00 %
	[1276] 0.00 %
	[1277] 0.00 %
	[1278] 0.00 %
	[1279] 0.00 %
	[1280] 0.00 %
	[1281] 0.00 %
	[1282] 0.00 %
	[1283] 0.00 %
	[1284] 0.00 %
	[1285] 0.00 %
	[1286] 0.00 %
	[1287] 0.00 %
	[1288] 0.00 %
	[1289] 0.00 %
	[1290] 0.00 %
	[1291] 0.00 %
	[1292] 0.00 %
	[1293] 0.00 %
	[1294] 0.00 %
	[1295] 0.00 %
	[1296] 0.00 %
	[1297] 0.00 %
	[1298] 0.00 %
	[1299] 0.00 %
	[1300] 0.00 %
	[1301] 0.00 %
	[1302] 0.00 %
	[1303] 0.00 %
	[1304] 0.00 %
	[1305] 0.00 %
	[1306] 0.00 %
	[1307] 0.00 %
	[1308] 0.00 %
	[1309] 0.00 %
	[1310] 0.00 %
	[1311] 0.00 %
	[1312] 0.00 %
	[1313] 0.00 %
	[1314] 0.00 %
	[1315] 0.00 %
	[1316] 0.00 %
	[1317] 0.00 %
	[1318] 0.00 %
	[1319] 0.00 %
	[1320] 0.00 %
	[1321] 0.00 %
	[1322] 0.00 %
	[1323] 0.00 %
	[1324] 0.00 %
	[1325] 0.00 %
	[1326] 0.00 %
	[1327] 0.00 %
	[1328] 0.00 %
	[1329] 0.00 %
	[1330] 0.00 %
	[1331] 0.00 %
	[1332] 0.00 %
	[1333] 0.00 %
	[1334] 0.00 %

Setpoint Functions

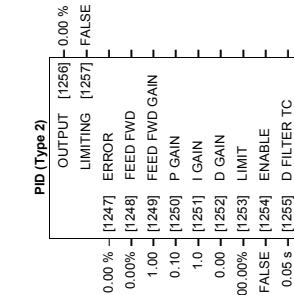
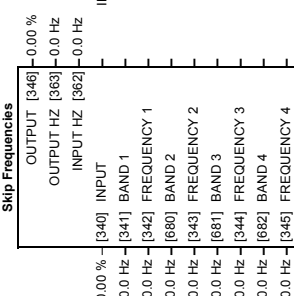
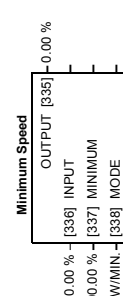
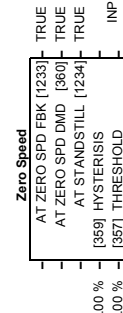
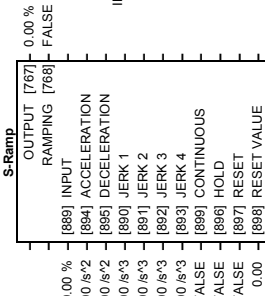
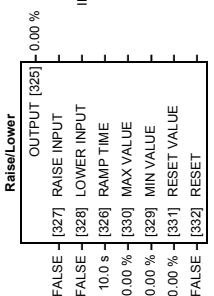
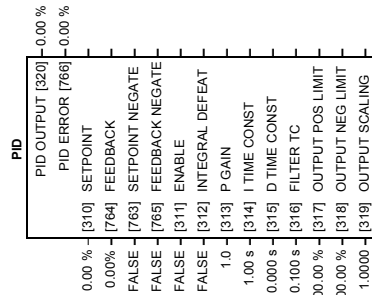
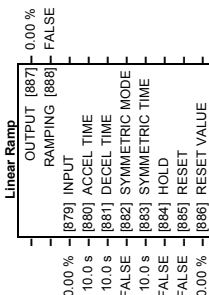
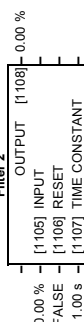
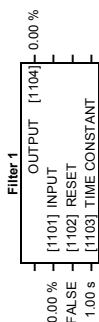

Trips

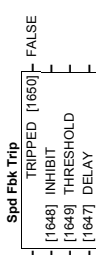
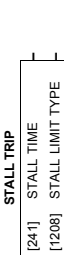
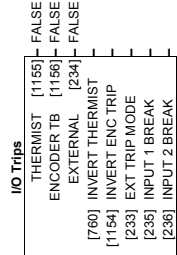
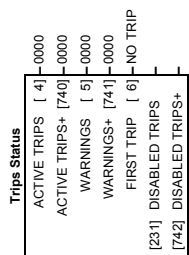
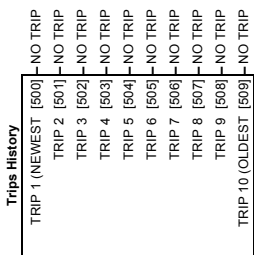

Hoist/Lift

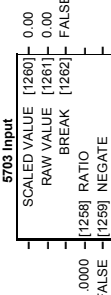
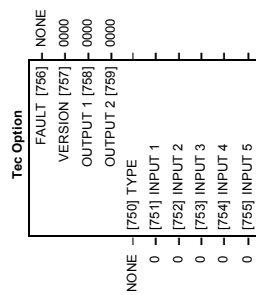
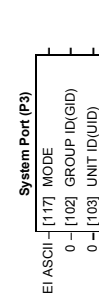
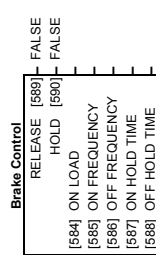

Macro Control Blocks

Some of these blocks may already be in use by the macros

Menus

Operator Menu 1	
NULL	[74] PARAMETER
	[324] NAME
NONE	[1039] SCALING
FALSE	[1040] READ ONLY
FALSE	[1041] IGNORE PASSWORD

Operator Menu 2	
NULL	[371] PARAMETER
	[378] NAME
NONE	[1042] SCALING
FALSE	[1043] READ ONLY
FALSE	[1044] IGNORE PASSWORD

Operator Menu 3	
NULL	[626] PARAMETER
	[1045] NAME
NONE	[1046] SCALING
FALSE	[1047] READ ONLY
FALSE	[1048] IGNORE PASSWORD

Operator Menu 4	
NULL	[627] PARAMETER
	[1049] NAME
NONE	[1050] SCALING
FALSE	[1051] READ ONLY
FALSE	[1052] IGNORE PASSWORD

Operator Menu 5	
NULL	[628] PARAMETER
	[1053] NAME
NONE	[1054] SCALING
FALSE	[1055] READ ONLY
FALSE	[1056] IGNORE PASSWORD

Operator Menu 6	
NULL	[629] PARAMETER
	[1057] NAME
NONE	[1058] SCALING
FALSE	[1059] READ ONLY
FALSE	[1060] IGNORE PASSWORD

Operator Menu 7	
NULL	[630] PARAMETER
	[1061] NAME
NONE	[1062] SCALING
FALSE	[1063] READ ONLY
FALSE	[1064] IGNORE PASSWORD

Operator Menu 8	
NULL	[631] PARAMETER
	[1065] NAME
NONE	[1066] SCALING
FALSE	[1067] READ ONLY
FALSE	[1068] IGNORE PASSWORD

Operator Menu 9	
NULL	[632] PARAMETER
	[1069] NAME
NONE	[1070] SCALING
FALSE	[1071] READ ONLY
FALSE	[1072] IGNORE PASSWORD

Operator Menu 10	
NULL	[633] PARAMETER
	[1073] NAME
NONE	[1074] SCALING
FALSE	[1075] READ ONLY
FALSE	[1076] IGNORE PASSWORD

Operator Menu 11	
NULL	[634] PARAMETER
	[1077] NAME
NONE	[1078] SCALING
FALSE	[1079] READ ONLY
FALSE	[1080] IGNORE PASSWORD

Operator Menu 12	
NULL	[635] PARAMETER
	[1081] NAME
NONE	[1082] SCALING
FALSE	[1083] READ ONLY
FALSE	[1084] IGNORE PASSWORD

Operator Menu 13	
NULL	[636] PARAMETER
	[1085] NAME
NONE	[1086] SCALING
FALSE	[1087] READ ONLY
FALSE	[1088] IGNORE PASSWORD

Operator Menu 14	
NULL	[637] PARAMETER
	[1089] NAME
NONE	[1090] SCALING
FALSE	[1091] READ ONLY
FALSE	[1092] IGNORE PASSWORD

Operator Menu 15	
NULL	[638] PARAMETER
	[1093] NAME
NONE	[1094] SCALING
FALSE	[1095] READ ONLY
FALSE	[1096] IGNORE PASSWORD

Operator Menu 16	
NULL	[639] PARAMETER
	[1097] NAME
NONE	[1098] SCALING
FALSE	[1099] READ ONLY
FALSE	[1100] IGNORE PASSWORD

Macro Control Blocks

Some of these blocks may already be in use by the macros

Menus

Operator Menu 20

NULL	[1755] PARAMETER
	[1756] NAME
NONE	[1757] SCALING
FALSE	[1758] READ ONLY
FALSE	[1759] IGNORE PASSWORD

Operator Menu 19

NULL	[1750] PARAMETER
	[1751] NAME
NONE	[1752] SCALING
FALSE	[1753] READ ONLY
FALSE	[1754] IGNORE PASSWORD

Operator Menu 18

NULL	[1745] PARAMETER
	[1746] NAME
NONE	[1747] SCALING
FALSE	[1748] READ ONLY
FALSE	[1749] IGNORE PASSWORD

Operator Menu 17

NULL	[1740] PARAMETER
	[1741] NAME
NONE	[1742] SCALING
FALSE	[1743] READ ONLY
FALSE	[1744] IGNORE PASSWORD

Operator Menu 24

NULL	[1775] PARAMETER
	[1776] NAME
NONE	[1777] SCALING
FALSE	[1778] READ ONLY
FALSE	[1779] IGNORE PASSWORD

Operator Menu 23

NULL	[1770] PARAMETER
	[1771] NAME
NONE	[1772] SCALING
FALSE	[1773] READ ONLY
FALSE	[1774] IGNORE PASSWORD

Operator Menu 22

NULL	[1765] PARAMETER
	[1766] NAME
NONE	[1767] SCALING
FALSE	[1768] READ ONLY
FALSE	[1769] IGNORE PASSWORD

Operator Menu 21

NULL	[1760] PARAMETER
	[1761] NAME
NONE	[1762] SCALING
FALSE	[1763] READ ONLY
FALSE	[1764] IGNORE PASSWORD

Operator Menu 28

NULL	[1795] PARAMETER
	[1796] NAME
NONE	[1797] SCALING
FALSE	[1798] READ ONLY
FALSE	[1799] IGNORE PASSWORD

Operator Menu 27

NULL	[1790] PARAMETER
	[1791] NAME
NONE	[1792] SCALING
FALSE	[1793] READ ONLY
FALSE	[1794] IGNORE PASSWORD

Operator Menu 26

NULL	[1785] PARAMETER
	[1786] NAME
NONE	[1787] SCALING
FALSE	[1788] READ ONLY
FALSE	[1789] IGNORE PASSWORD

Operator Menu 25

NULL	[1780] PARAMETER
	[1781] NAME
NONE	[1782] SCALING
FALSE	[1783] READ ONLY
FALSE	[1784] IGNORE PASSWORD

Operator Menu 32

NULL	[1815] PARAMETER
	[1816] NAME
NONE	[1817] SCALING
FALSE	[1818] READ ONLY
FALSE	[1819] IGNORE PASSWORD

Operator Menu 31

NULL	[1810] PARAMETER
	[1811] NAME
NONE	[1812] SCALING
FALSE	[1813] READ ONLY
FALSE	[1814] IGNORE PASSWORD

Operator Menu 30

NULL	[1805] PARAMETER
	[1806] NAME
NONE	[1807] SCALING
FALSE	[1808] READ ONLY
FALSE	[1809] IGNORE PASSWORD

Operator Menu 29

NULL	[1800] PARAMETER
	[1801] NAME
NONE	[1802] SCALING
FALSE	[1803] READ ONLY
FALSE	[1804] IGNORE PASSWORD

Display Scale 4

DEFAULT	[860] DECIMAL PLACE
A/B * X + C	[861] FORMULA
1.00	[862] COEFFICIENT A
1.00	[863] COEFFICIENT B
0.00	[864] COEFFICIENT C
0.00	[865] HIGH LIMIT
0.00	[866] LOW LIMIT
	[867] UNITS

Display Scale 3

DEFAULT	[852] DECIMAL PLACE
A/B * X + C	[853] FORMULA
1.00	[854] COEFFICIENT A
1.00	[855] COEFFICIENT B
0.00	[856] COEFFICIENT C
0.00	[857] HIGH LIMIT
0.00	[858] LOW LIMIT
	[859] UNITS

Display Scale 2

DEFAULT	[379] DECIMAL PLACE
A/B * X + C	[676] FORMULA
1.00	[375] COEFFICIENT A
1.00	[673] COEFFICIENT B
0.00	[376] COEFFICIENT C
0.00	[674] HIGH LIMIT
0.00	[675] LOW LIMIT
	[377] UNITS

Display Scale 1

DEFAULT	[334] DECIMAL PLACE
A/B * X + C	[125] FORMULA
1.00	[321] COEFFICIENT A
1.00	[44] COEFFICIENT B
0.00	[322] COEFFICIENT C
0.00	[101] HIGH LIMIT
0.00	[53] LOW LIMIT
	[323] UNITS

Access Control

BASIC	[876] VIEW LEVEL
0000	[8] PASSWORD
NONE	[339] CONFIG NAME
FALSE	[1037] SETPOINT SCALE
0	[1038] NO SETPOINT PWRD
	[93] STARTUP SCREEN

Op Station 2

00F0	[1109] ENABLED KEYS
	[1110] OP VERSION

Op Station 1

00F0	[127] ENABLED KEYS
	[230] OP VERSION

Macro Control Blocks

Some of these blocks may already be in use by the macros

Miscellaneous

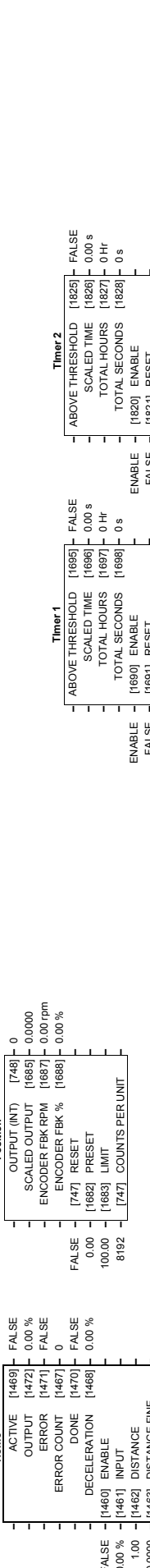
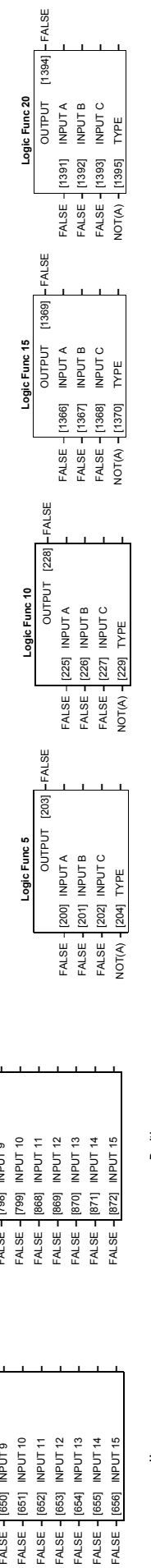
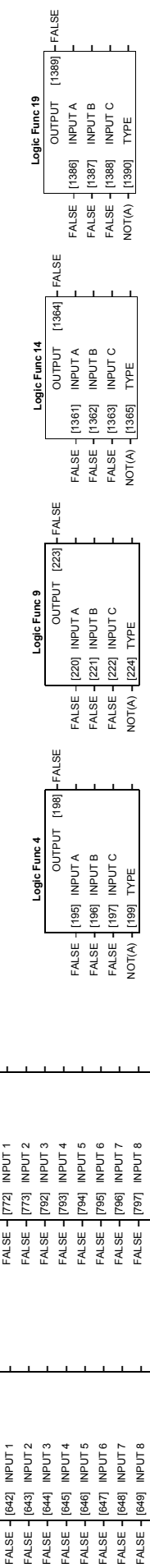
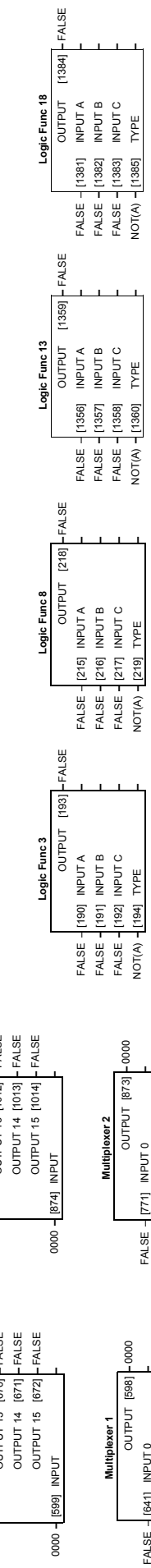
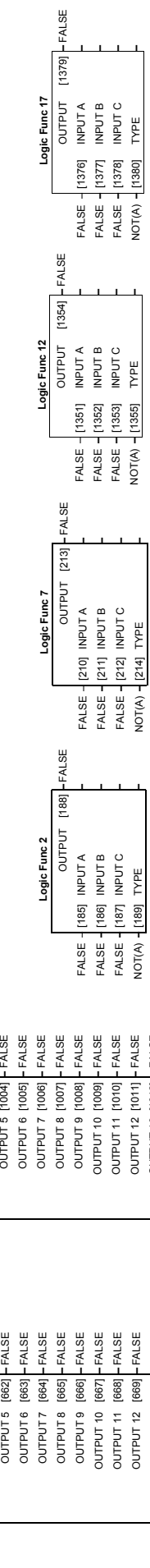
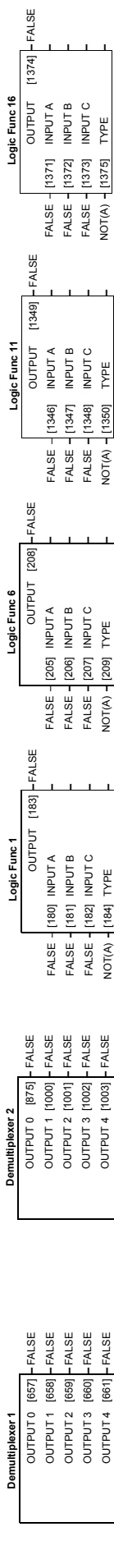

Miscellaneous

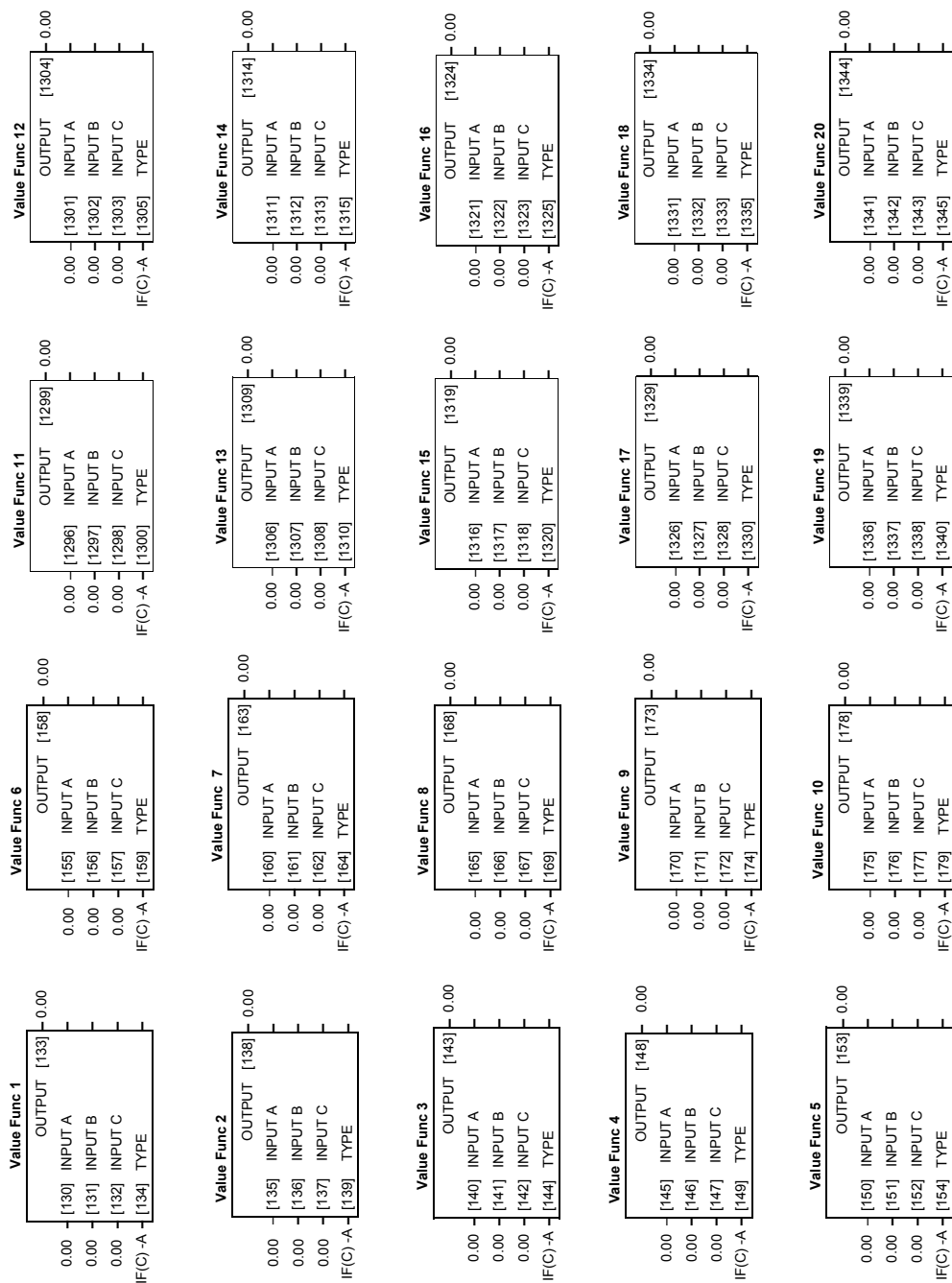

Some of these blocks may already be in use by the macros

690+ Series Frequency Inverter

Inputs and Outputs

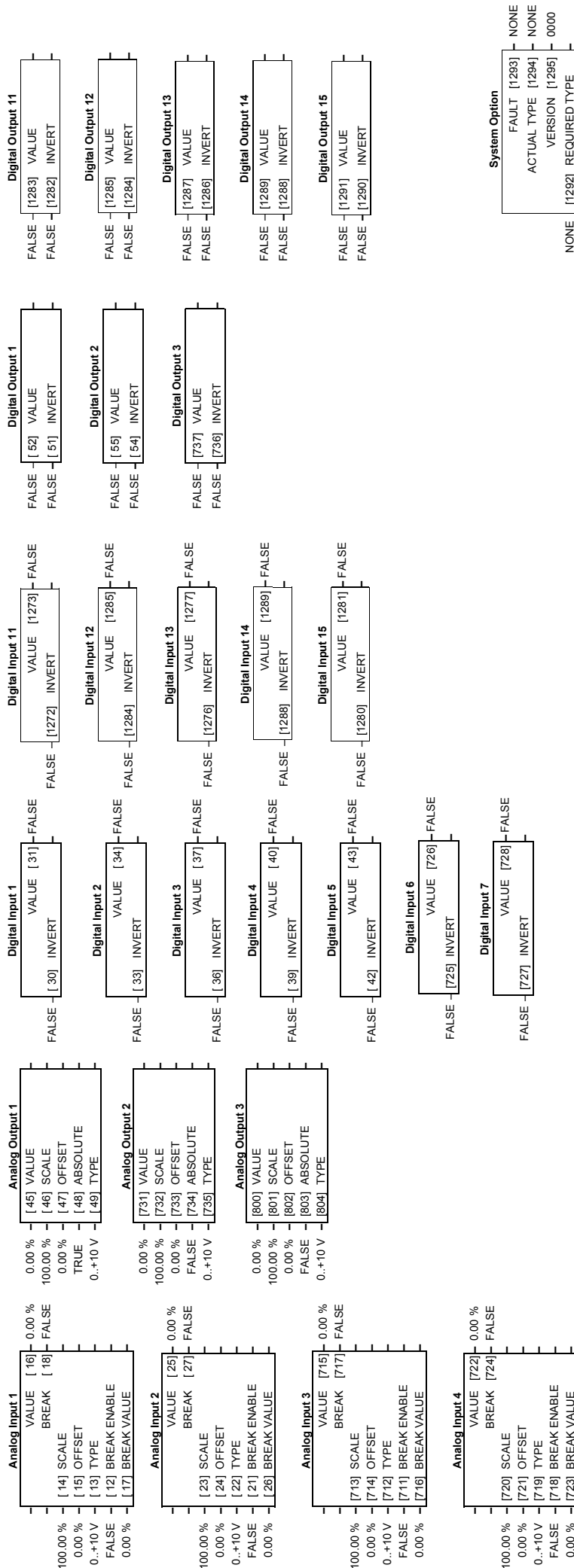

Some of these blocks may already be in use by the macros

ISS.	MODIFICATION	ECN No.	DATE	DRAWN	CHK'D
A	First printed release of HA465038U001	14089	28/06/00	CM	KJ
1	Various small updates to software. First Litho print.	14089	13/9/00	CM	KJ
1	First printed release of HA465038U002. Updated with System Board information and Software Version 2 updates.	14088	19/12/00	CM	KJ
1	First printed release of HA465038U004. Updated with Software Version 4 updates and Frame F information.	16026	6/6/01	CM	KJ
2	Various small updates : 1-38, 1-87, 1-88, 1-102, 2-25, 5-21	16261	18/9/01	CM	KJ
1	First printed release of HA465038U005. Updated with Software Version 5 updates.	17111	14/10/02	CM	DB
2	Updated with SPD FBK TRIP function block. Other small amendments.	17302	13/1/03	CM	DB
FIRST USED ON		MODIFICATION RECORD			
		690+ Series AC Drive			
 EUROTHERM DRIVES		DRAWING NUMBER			SHT. 1
		ZZ465038			OF 1

