

# SYSDRIVE 3G3XV Inverter

## 3G3XV-□□□□□-EV2

### Operation Manual

Revised November 1997

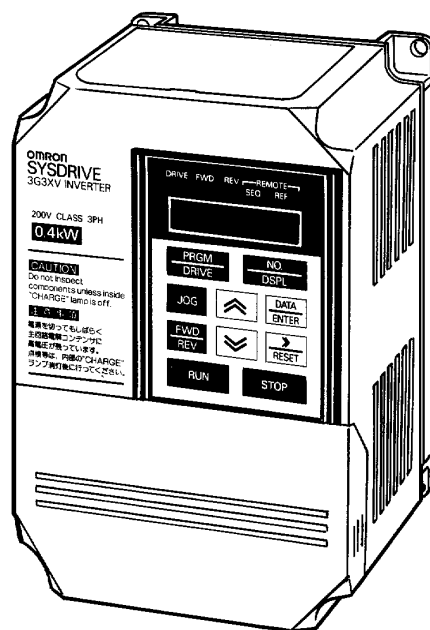



## Notice:

OMRON products are manufactured for use according to proper procedures by a qualified operator and only for the purposes described in this manual.

The following conventions are used to indicate and classify precautions in this manual. Always heed the information provided with them. Failure to heed precautions can result in injury to people or damage to the product.

 **DANGER** Indicates information that, if not heeded, is likely to result in loss of life or serious injury.

 **WARNING** Indicates information that, if not heeded, could possibly result in loss of life or serious injury.

 **Caution** Indicates information that, if not heeded, could result in relatively serious or minor injury, damage to the product, or faulty operation.

## OMRON Product References

All OMRON products are capitalized in this manual. The word “Unit” is also capitalized when it refers to an OMRON product, regardless of whether or not it appears in the proper name of the product.

The abbreviation “Ch,” which appears in some displays and on some OMRON products, often means “word” and is abbreviated “Wd” in documentation in this sense.

The abbreviation “PC” means Programmable Controller and is not used as an abbreviation for anything else.

## Visual Aids

The following headings appear in the left column of the manual to help you locate different types of information.

**Note** Indicates information of particular interest for efficient and convenient operation of the product.

**1, 2, 3...** 1. Indicates lists of one sort or another, such as procedures, checklists, etc.

## © OMRON, 1993

All rights reserved. No part of this publication may be reproduced, stored in a retrieval system, or transmitted, in any form, or by any means, mechanical, electronic, photocopying, recording, or otherwise, without the prior written permission of OMRON.

No patent liability is assumed with respect to the use of the information contained herein. Moreover, because OMRON is constantly striving to improve its high-quality products, the information contained in this manual is subject to change without notice. Every precaution has been taken in the preparation of this manual. Nevertheless, OMRON assumes no responsibility for errors or omissions. Neither is any liability assumed for damages resulting from the use of the information contained in this publication.

# TABLE OF CONTENTS

## SECTION 1

|                                                |          |
|------------------------------------------------|----------|
| <b>SYSDRIVE 3G3XV Inverter Main Unit</b> ..... | <b>1</b> |
| 1-1 Part Names of the 3G3XV .....              | 2        |
| 1-2 Receiving .....                            | 2        |
| 1-3 Installation .....                         | 3        |
| 1-4 Wiring .....                               | 5        |
| 1-5 Operation .....                            | 16       |
| 1-6 Specifications .....                       | 21       |

## SECTION 2

|                                                        |           |
|--------------------------------------------------------|-----------|
| <b>Digital Operator</b> .....                          | <b>27</b> |
| 2-1 Digital Operator Components .....                  | 28        |
| 2-2 Function/Constant Setting .....                    | 29        |
| 2-3 Digital Operator Operation Example .....           | 31        |
| 2-4 Constant Initialization and Write-protection ..... | 33        |
| 2-5 Corrective Function .....                          | 34        |
| 2-6 Monitor .....                                      | 35        |
| 2-7 Function/Constant List .....                       | 37        |
| 2-8 Description of Functions and Constants .....       | 43        |

## SECTION 3

|                                              |           |
|----------------------------------------------|-----------|
| <b>Troubleshooting and Maintenance</b> ..... | <b>65</b> |
| 3-1 Fault Display .....                      | 66        |
| 3-2 Correcting Motor Faults .....            | 69        |
| 3-3 Maintenance .....                        | 70        |
| <b>Revision History</b> .....                | <b>73</b> |

## ***About this Manual:***

This manual provides operating procedures and parameter specifications for the SYSDRIVE 3G3XV All-Digital Low-Noise Inverter.

**Section 1** describes handling, wiring, operation, and specifications of the SYSDRIVE 3G3XV series (hereinafter called 3G3XV).

**Section 2** outlines the digital operator performance, constants, operation, etc.

**Section 3** describes maintenance, periodic inspections, troubleshooting, etc.

Before using the 3G3XV, a thorough understanding of this manual is recommended.

This manual will be of great help for daily maintenance, inspection and troubleshooting.

 **WARNING** Failure to read and understand the information provided in this manual may result in personal injury or death, damage to the product, or product failure. Please read each section in its entirety and be sure you understand the information provided in the section and related sections before attempting any of the procedures or operations given.

# SECTION 1

## SYSDRIVE 3G3XV Inverter Main Unit

This section describes handling, wiring, operation, and specifications of the SYSDRIVE 3G3XV series.

|       |                                  |    |
|-------|----------------------------------|----|
| 1-1   | Part Names of the 3G3XV .....    | 2  |
| 1-2   | Receiving .....                  | 2  |
| 1-3   | Installation .....               | 3  |
| 1-3-1 | Location .....                   | 3  |
| 1-3-2 | Mounting Space .....             | 4  |
| 1-3-3 | Dimensions in Inches (mm) .....  | 4  |
| 1-4   | Wiring .....                     | 5  |
| 1-4-1 | Terminal Blocks .....            | 5  |
| 1-4-2 | Standard Wiring Diagram .....    | 7  |
| 1-4-3 | Main Circuit .....               | 8  |
| 1-4-4 | Control Circuit .....            | 14 |
| 1-5   | Operation .....                  | 16 |
| 1-5-1 | Checking Before Operation .....  | 16 |
| 1-5-2 | Setting Before Operation .....   | 17 |
| 1-5-3 | Test Run Method .....            | 18 |
| 1-6   | Specifications .....             | 21 |
| 1-6-1 | 200-V-class Specifications ..... | 21 |
| 1-6-2 | 400-V-class Specifications ..... | 23 |
| 1-6-3 | Optional Units .....             | 24 |
| 1-6-4 | Peripheral Units .....           | 25 |

## 1-1 Part Names of the 3G3XV

The following diagram shows the main components of the SYS-DRIVE 3G3XV. The terminal block cover has been removed to expose the terminal blocks. Refer to *1-4-1 Terminal Blocks* for details on removing the terminal block cover.

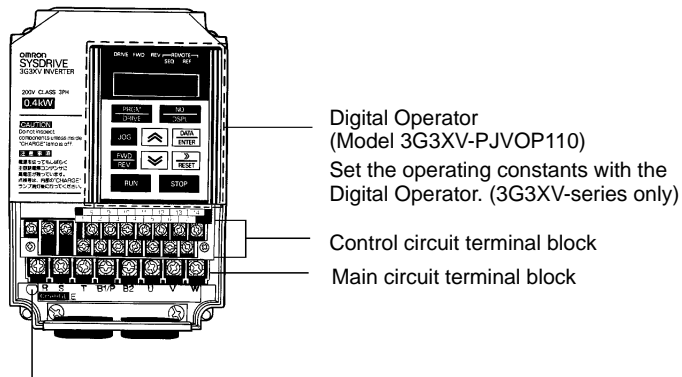

Digital Operator  
(Model 3G3XV-PJVOP110)  
Set the operating constants with the Digital Operator. (3G3XV-series only)

Control circuit terminal block  
Main circuit terminal block

CHARGE indicator  
Do not touch the main circuit terminals when this indicator is lit.

## 1-2 Receiving

This SYSDRIVE 3G3XV has been put through demanding tests at the factory before shipment.

After unpacking, check for the following.

- Verify the part numbers with the purchase order sheet and/or packing slip.
- Transit damage.

If any part of 3G3XV is damaged or lost, immediately notify the shipper.

### Nameplate Data

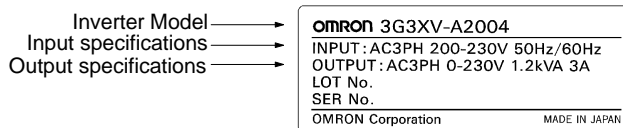

### Inverter Model Numbers

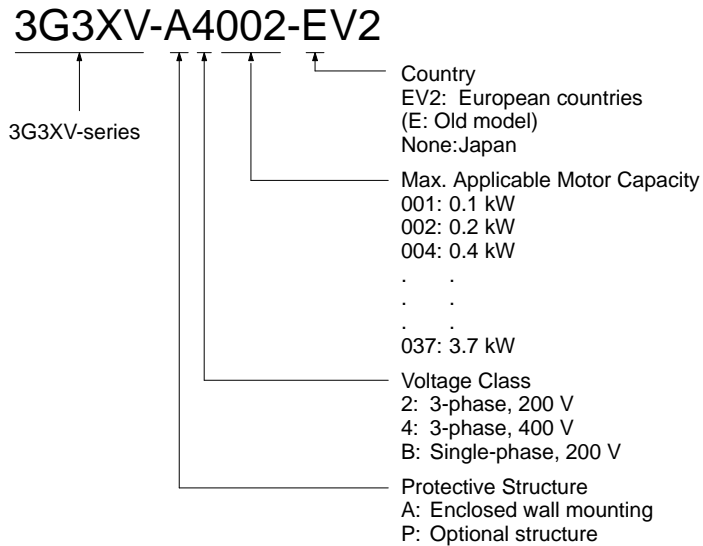

**⚠ WARNING**

- 1, 2, 3...**
1. After turning off the main circuit power supply, do not touch circuit components until the “CHARGE” indicator is extinguished. The capacitors are still charged and can be quite dangerous.
  2. Do not change the wiring while power is applied to the circuit.
  3. Do not check signals during operation.
  4. Be sure to ground 3G3XV using the ground terminal G (E).
  5. Never connect main circuit output terminals, T1 (U), T2 (V), T3 (W), to AC main circuit supply.

**⚠ Caution**

- 1, 2, 3...**
1. All the constants of 3G3XV have been adjusted at the factory. Do not change their settings unnecessarily.
  2. Do not perform withstand voltage test on any part of the 3G3XV Unit. This electronic equipment uses semi-conductors and is vulnerable to high voltage.

## 1-3 Installation

### 1-3-1 Location

Location of the equipment is important to achieve proper performance and normal operating life.

The 3G3XV Units should be installed in areas where the following conditions exist.

- Ambient temperature:
  - 10° to 40°C, 14° to 104°F (with top cover on)
  - 10° to 45°C, 14° to 113°F (with top cover off)
- Protected from rain or moisture.

- Protected from direct sunlight.
- Protected from corrosive gases or liquids.
- Free from airborne dust or metallic particles.
- Free from vibration.
- Free from magnetic noise.

**Caution** To house multiple SYSDRIVE 3G3XVs in a switchgear, install a cooling fan or some other means to cool the air entering the Inverter below 113°F (45°C).

### 1-3-2 Mounting Space

Install the 3G3XV vertically and allow sufficient space for effective cooling as shown in below.

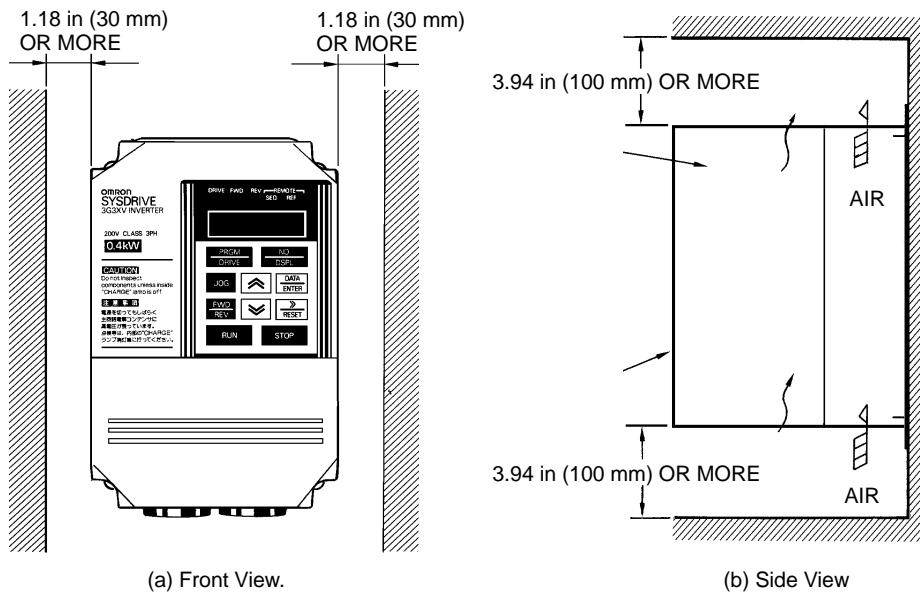

### 1-3-3 Dimensions in Inches (mm)

The Unit dimensions vary from model to model, as shown in the following diagram and table.



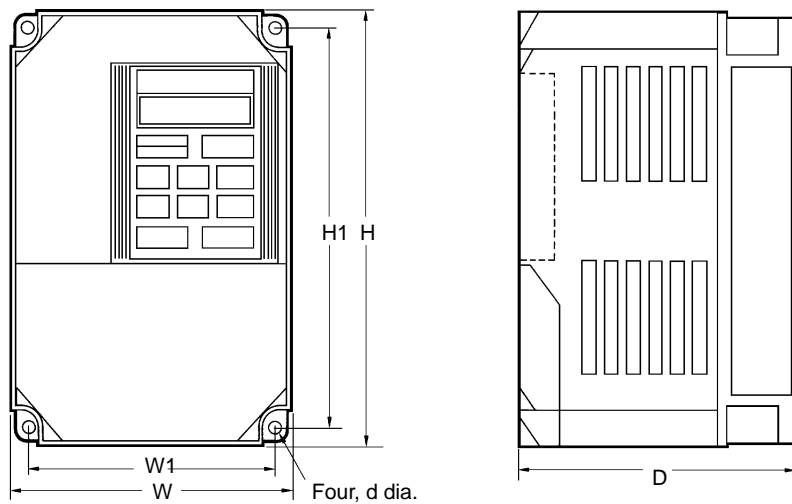

| Voltage | Phase        | Max. Applicable Motor Output HP (kW) | W             | W1            | H             | H1            | D             | d             |
|---------|--------------|--------------------------------------|---------------|---------------|---------------|---------------|---------------|---------------|
| 200 V   | 3-phase      | 0.13 to 0.5 (0.1 to 0.4)             | 4.13<br>(105) | 3.66<br>(93)  | 5.91<br>(150) | 5.43<br>(138) | 3.94<br>(100) | 0.20<br>(5)   |
|         |              | 1/2 (0.75/1.5)                       | 5.51<br>(140) | 5.04<br>(128) | 5.91<br>(150) | 5.43<br>(138) | 5.43<br>(138) | 0.20<br>(5)   |
|         |              | 3/5 (2.2/3.7)                        | 5.51<br>(140) | 4.96<br>(126) | 7.87<br>(200) | 7.32<br>(186) | 6.69<br>(170) | 0.22<br>(5.5) |
|         | Single-phase | 0.13 to 0.5 (0.1 to 0.4)             | 5.51<br>(140) | 5.04<br>(128) | 5.91<br>(150) | 5.43<br>(138) | 5.43<br>(138) | 0.20<br>(5)   |
|         |              | 1/2 (0.75/1.5)                       | 5.51<br>(140) | 4.96<br>(126) | 7.87<br>(200) | 7.32<br>(186) | 6.69<br>(170) | 0.22<br>(5.5) |
|         |              | 3/5 (2.2/3.7)                        | 7.48<br>(190) | 6.89<br>(175) | 7.87<br>(200) | 7.28<br>(185) | 7.48<br>(190) | 0.23<br>(5.8) |
| 400 V   | 3-phase      | 0.25/0.5 (0.2/0.4)                   | 5.51<br>(140) | 4.96<br>(126) | 7.87<br>(200) | 7.32<br>(186) | 4.72<br>(120) | 0.22<br>(5.5) |
|         |              | 1/2 (0.75/1.5)                       | 5.51<br>(140) | 4.96<br>(126) | 7.87<br>(200) | 7.32<br>(186) | 6.69<br>(170) | 0.22<br>(5.5) |
|         |              | 3/5 (2.2/3.7)                        | 7.48<br>(190) | 6.89<br>(175) | 7.87<br>(200) | 7.28<br>(185) | 7.48<br>(190) | 0.23<br>(5.8) |

## 1-4 Wiring

Connect the main circuit and control circuit wiring securely, as described below.

**Note** Use closed-loop connectors sized for the gauge of wire being used. Attach the connectors using a crimping tool recommended by the connector manufacturer.

### 1-4-1 Terminal Blocks

The main circuit and control circuit terminal blocks are at the bottom of the Inverter under a terminal cover.

#### Removing/Attaching the Terminal Cover

To remove the terminal cover, squeeze the sides of the cover (1), and lift up (2) at the same time, as shown in the following diagram. Reverse these steps to attach the cover.

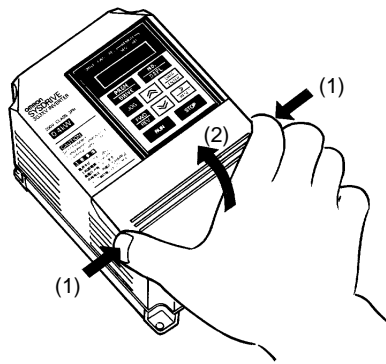

**Terminal Position**

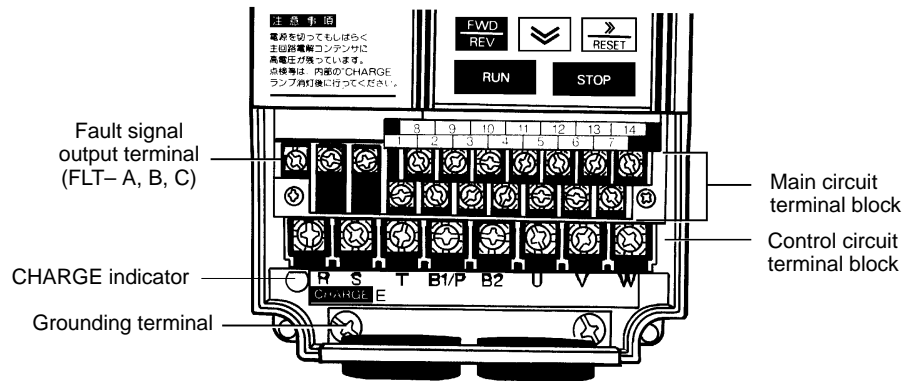

The main circuit and control circuit terminal blocks are shown below. Terminal numbers are usually shown on the terminal number nameplate, but the terminal numbers are printed on the printed board on some Inverters.

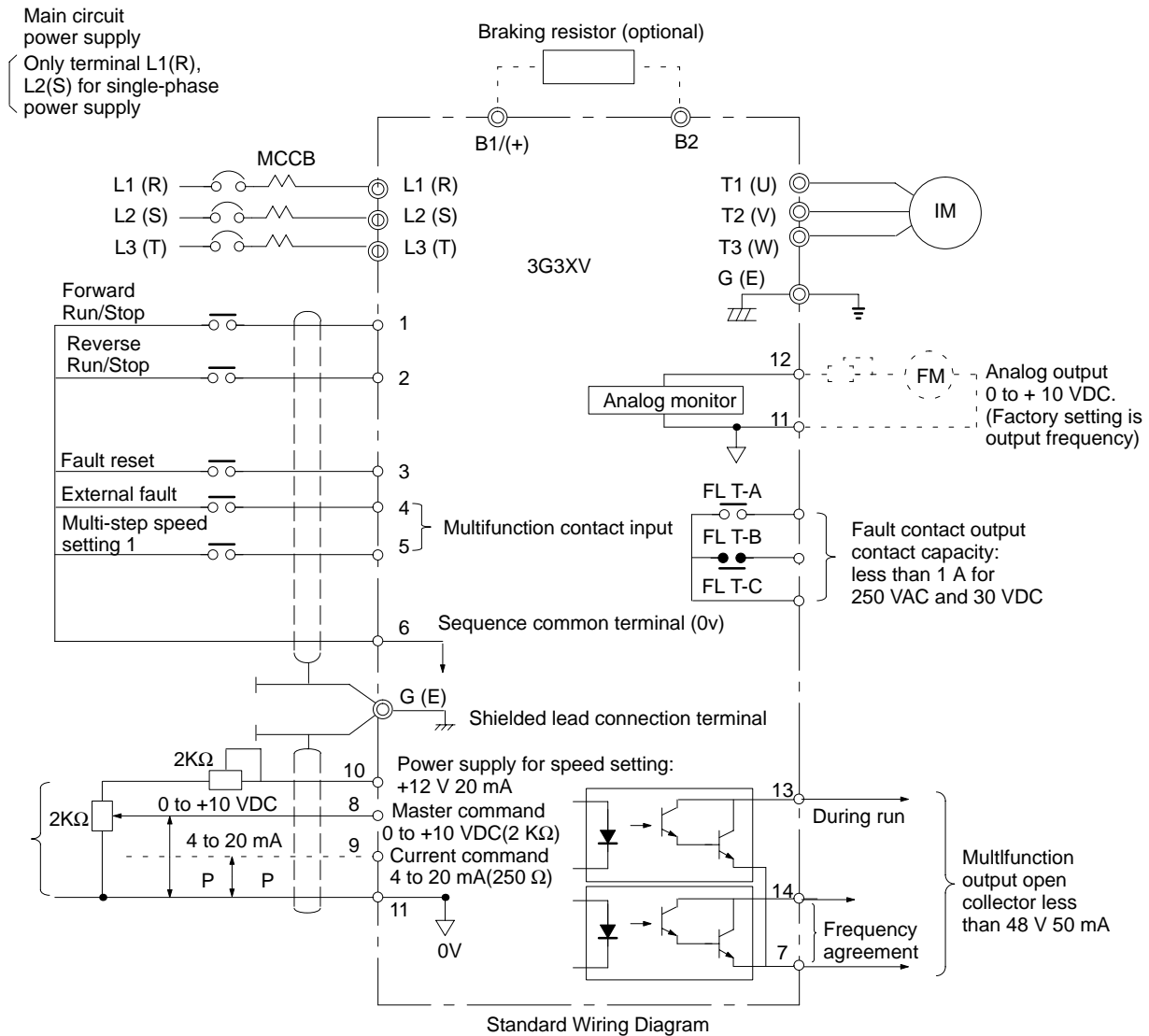

### 1-4-2 Standard Wiring Diagram

Models with Digital Operators can be operated from the Digital Operator only by main circuit wiring. When these models are operated by control circuit terminals, control constant change is required. For details refer to 2-8-2 *Operation Mode Selection*. Models without Digital Operator (with blind cover) are preset in Operation Mode from control circuit terminals at the factory prior to shipping.



- Note**
1.  indicates shielded leads.  indicates twisted-pair shielded leads.
  2. Terminal 10 (12 VDC) has a maximum output current capacity of 20 mA.
  3. Terminal symbols: ⊙ indicates the main circuit, and ○ indicates the control circuit.

- When using the optional braking resistor (3G3IV-PERF150WJ), place a thermal overload relay between the braking resistor and Inverter to prevent the braking resistor from overheating. In addition, use a sequencer to break the power supply side on the thermal overload relay trip contact.

### 1-4-3 Main Circuit

#### Main Circuit Wiring

Connect wiring as shown below.

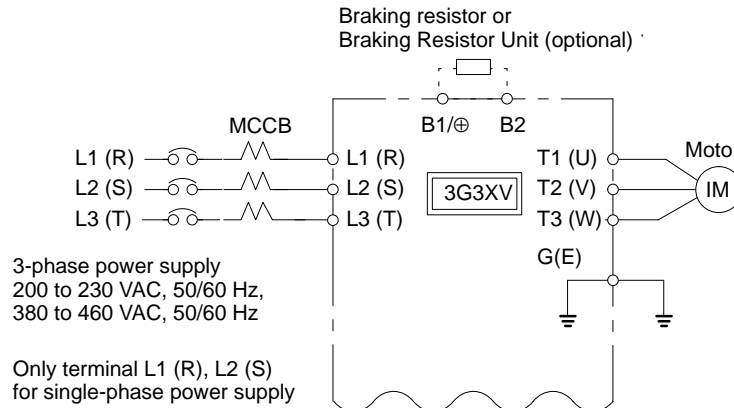

**Note** Circuit terminal block screw size is M4

#### Main Circuit Terminals

##### 3G3XV Main Circuit Terminals

| Terminal           | Description                                                                                                         |
|--------------------|---------------------------------------------------------------------------------------------------------------------|
| L <sub>1</sub> (R) | Main circuit power input<br>“L <sub>1</sub> ” and “L <sub>2</sub> ” are used for single-phase input specifications. |
| L <sub>2</sub> (S) |                                                                                                                     |
| L <sub>3</sub> (T) |                                                                                                                     |
| T <sub>1</sub> (U) | Inverter output                                                                                                     |
| T <sub>2</sub> (V) |                                                                                                                     |
| T <sub>3</sub> (W) |                                                                                                                     |
| B1/⊕               | Braking resistor or Braking Resistor Unit connector (options)                                                       |
| B2                 |                                                                                                                     |
| G (E)              | Grounding (Ground resistance should be 100 ohms or less.)<br><b>Note:</b> Use screw for frame ground.               |

#### Main Circuit Terminal Arrangement

3-phase series (all Models):

|                       |                       |                       |                   |                |                       |                       |                       |
|-----------------------|-----------------------|-----------------------|-------------------|----------------|-----------------------|-----------------------|-----------------------|
| L <sub>1</sub><br>(R) | L <sub>2</sub><br>(S) | L <sub>3</sub><br>(T) | B <sub>1</sub> /⊕ | B <sub>2</sub> | T <sub>1</sub><br>(U) | T <sub>2</sub><br>(V) | T <sub>3</sub><br>(W) |
|-----------------------|-----------------------|-----------------------|-------------------|----------------|-----------------------|-----------------------|-----------------------|

200-V single-phase series, 0.13 to 2 HP (0.1 to 1.5 kW):

|                       |                       |  |                   |                |                       |                       |                       |
|-----------------------|-----------------------|--|-------------------|----------------|-----------------------|-----------------------|-----------------------|
| L <sub>1</sub><br>(R) | L <sub>2</sub><br>(S) |  | B <sub>1</sub> /⊕ | B <sub>2</sub> | T <sub>1</sub><br>(U) | T <sub>2</sub><br>(V) | T <sub>3</sub><br>(W) |
|-----------------------|-----------------------|--|-------------------|----------------|-----------------------|-----------------------|-----------------------|

**Note** The third terminal is blank.

200-V single-phase series, 3/5 HP (2.2/3.7 kW):

|                       |                       |                   |                |                       |                       |                       |
|-----------------------|-----------------------|-------------------|----------------|-----------------------|-----------------------|-----------------------|
| L <sub>1</sub><br>(R) | L <sub>2</sub><br>(S) | B <sub>1</sub> /⊕ | B <sub>2</sub> | T <sub>1</sub><br>(U) | T <sub>2</sub><br>(V) | T <sub>3</sub><br>(W) |
|-----------------------|-----------------------|-------------------|----------------|-----------------------|-----------------------|-----------------------|

### Molded-case Circuit Breaker (MCCB)

Be sure to connect MCCBs between the power supply and 3G3XV input terminals L1 (R), L2 (S), L3 (T). Recommended MCCBs are listed in the tables below.

When a ground fault interrupter is used select the one with no influence for high frequency. When using an ordinary type, the setting current should be 200 mA or over per Unit and operating time, 0.1 sec or over to prevent malfunction.

### Molded-case Circuit Breakers and Magnetic Contactors

200-V-class 3-phase Input Series:

|                              |                          |       |       |       |       |       |       |       |
|------------------------------|--------------------------|-------|-------|-------|-------|-------|-------|-------|
| 3G3XV                        | Model<br>3G3XV-□□□□□-EV2 | A2001 | A2002 | A2004 | A2007 | A2015 | A2022 | A2037 |
|                              | Capacity (kVA)           | 0.3   | 0.6   | 1.1   | 1.9   | 2.5   | 4.2   | 6.7   |
|                              | Rated output current (A) | 0.8   | 1.5   | 3     | 5     | 6.5   | 11    | 17.5  |
| Molded-case Circuit Breakers |                          | 5 A   | 5 A   | 5 A   | 10 A  | 20 A  | 20 A  | 30 A  |

200-V-class Single-phase Input Series:

|                              |                          |       |       |       |       |       |       |       |
|------------------------------|--------------------------|-------|-------|-------|-------|-------|-------|-------|
| 3G3XV                        | Model<br>3G3XV-□□□□□-EV2 | AB001 | AB002 | AB004 | AB007 | AB015 | AB022 | AB037 |
|                              | Capacity (kVA)           | 0.3   | 0.6   | 1.1   | 1.9   | 2.5   | 4.2   | 6.7   |
|                              | Rated output current (A) | 0.8   | 1.5   | 3     | 5     | 6.5   | 11    | 17.5  |
| Molded-case Circuit Breakers |                          | 5 A   | 5 A   | 10 A  | 20 A  | 20 A  | 40 A  | 50 A  |

400-V-class 3-phase Input Series:

|                              |                          |       |       |       |       |       |       |
|------------------------------|--------------------------|-------|-------|-------|-------|-------|-------|
| 3G3XV                        | Model<br>3G3XV-□□□□□-EV2 | A4002 | A4004 | A4007 | A4015 | A4022 | A4037 |
|                              | Capacity (kVA)           | 0.8   | 1.2   | 2.0   | 3.0   | 3.7   | 6.1   |
|                              | Rated output current (A) | 1     | 1.6   | 2.6   | 4     | 4.8   | 8     |
| Molded-case Circuit Breakers |                          | 5 A   | 5 A   | 5 A   | 10 A  | 10 A  | 20 A  |

### Surge Absorber

The surge absorbers should be connected to the coils of relays, magnetic contactors, magnetic valves, or magnetic relays. Select the type from the table below.

### Surge Absorbers

| Coils of magnetic contactor and control relay |                                                       | Surge absorber (see note) |                           |
|-----------------------------------------------|-------------------------------------------------------|---------------------------|---------------------------|
|                                               |                                                       | Model                     | Specifications            |
| 200 to 230 V                                  | Large-size magnetic contactors                        | DCR2-50A22E               | 250 VAC, 0.5 μF + 20 Ω    |
|                                               | Control relay<br>LY-2, -3 (OMRON)<br>MM-2, -4 (OMRON) | DCR2-10A25C               | 250 VAC, 0.1 μF + 100 Ω   |
| 400- to 460-V Units                           |                                                       | DCR2-50D100B              | 1,000 VDC, 0.5 μF + 220 Ω |

**Note** Made by MARCON Electronics. Marketed in Japan.

## **Wiring**

### **Main Circuit Input/Output**

- Phase rotation of input terminals L1 (R), L2 (S), L3 (T) is available in either direction, clockwise and counterclockwise.
- When Inverter output terminals T1 (U), T2 (V), and T3 (W) are connected to motor terminals T1 (U), T2 (V), and T3 (W), respectively, motor rotates counterclockwise, viewed from opposite drive end, upon forward operation command. To reverse the rotation interchange any two of motor leads.
- Never connect AC main circuit power supply to output terminals T1 (U), T2 (V), and T3 (W).
- Care should be taken to prevent contact of wiring leads with the 3G3XV cabinet, or a short-circuit may result.
- Never connect the power factor correction capacitor or noise filter to 3G3XV output.
- Never open or close contactors in the output circuit unless Inverter is properly sized.



#### **Caution**

**The withstand voltage between the motor's phases is insufficient.**

When the motor is connected to the Inverter's output, a surge is generated between the Inverter's switching and the motor's coil. Normally the maximum surge voltage is three times the Inverter's input power supply voltage (i.e., 600 V for 200-V class, and 1,200 V for 400-V class). Be sure to use a motor with a withstand voltage between the motor's phases that is greater than the maximum surge voltage. In particular, when using a 400-V-class Inverter, use a special motor for Inverters.

## Wire Sizes and Types

## 200-V-class 3-phase Input Series:

| Circuit         | Model 3G3XV          | Inverter capacity | Terminal symbol                                          | Terminal screw | Wire size |                 | Wire type                                            |
|-----------------|----------------------|-------------------|----------------------------------------------------------|----------------|-----------|-----------------|------------------------------------------------------|
|                 |                      |                   |                                                          |                | AWG       | mm <sup>2</sup> |                                                      |
| Main circuit    | A2001                | 0.3 kVA           | L1 (R), L2 (S), L3 (T), B1/⊕, B2, T1 (U), T2 (V), T3 (W) | M4             | 14-10     | 2 to 5.5        | Power cable: 600 V vinyl-sheathed lead or equivalent |
|                 |                      |                   | G (E)                                                    |                | 14-10     | 2 to 5.5        |                                                      |
|                 | A2002                | 0.6 kVA           | L1 (R), L2 (S), L3 (T), B1/⊕, B2, T1 (U), T2 (V), T3 (W) | M4             | 14-10     | 2 to 5.5        |                                                      |
|                 |                      |                   | G (E)                                                    |                | 14-10     | 2 to 5.5        |                                                      |
|                 | A2004                | 1.1 kVA           | L1 (R), L2 (S), L3 (T), B1/⊕, B2, T1 (U), T2 (V), T3 (W) | M4             | 14-10     | 2 to 5.5        |                                                      |
|                 |                      |                   | G (E)                                                    |                | 14-10     | 2 to 5.5        |                                                      |
|                 | A2007                | 1.9 kVA           | L1 (R), L2 (S), L3 (T), B1/⊕, B2, T1 (U), T2 (V), T3 (W) | M4             | 14-10     | 2 to 5.5        |                                                      |
|                 |                      |                   | G (E)                                                    |                | 14-10     | 2 to 5.5        |                                                      |
|                 | A2015                | 2.5 kVA           | L1 (R), L2 (S), L3 (T), B1/⊕, B2, T1 (U), T2 (V), T3 (W) | M4             | 12-10     | 3.5 to 5.5      |                                                      |
|                 |                      |                   | G (E)                                                    |                | 14-10     | 2 to 5.5        |                                                      |
|                 | A2022                | 4.2 kVA           | L1 (R), L2 (S), L3 (T), B1/⊕, B2, T1 (U), T2 (V), T3 (W) | M4             | 12-10     | 3.5 to 5.5      |                                                      |
|                 |                      |                   | G (E)                                                    |                | 14-10     | 2 to 5.5        |                                                      |
|                 | A2037                | 6.7 kVA           | L1 (R), L2 (S), L3 (T), B1/⊕, B2, T1 (U), T2 (V), T3 (W) | M4             | 12-10     | 3.5 to 5.5      |                                                      |
|                 |                      |                   | G (E)                                                    |                | 14-10     | 2 to 5.5        |                                                      |
| Control circuit | Common to all Models | —                 | 1 to 14, FLT-A, FLT-B, FLT-C                             | M3.5           | 20-14     | 0.5 to 2        | Shielded lead or equivalent                          |
|                 |                      |                   | G (E)                                                    |                |           |                 |                                                      |

## 200-V-class Single-phase Input Series:

| Circuit      | Model 3G3XV | Inverter capacity | Terminal symbol                                  | Terminal screw | Wire size |                 | Wire type                                            |
|--------------|-------------|-------------------|--------------------------------------------------|----------------|-----------|-----------------|------------------------------------------------------|
|              |             |                   |                                                  |                | AWG       | mm <sup>2</sup> |                                                      |
| Main circuit | AB001       | 0.3 kVA           | L1 (R), L2 (S), B1/⊕, B2, T1 (U), T2 (V), T3 (W) | M4             | 14-10     | 2 to 5.5        | Power cable: 600 V vinyl-sheathed lead or equivalent |
|              |             |                   | G (E)                                            |                | 14-10     | 2 to 5.5        |                                                      |
|              | AB002       | 0.6 kVA           | L1 (R), L2 (S), B1/⊕, B2, T1 (U), T2 (V), T3 (W) | M4             | 14-10     | 2 to 5.5        |                                                      |
|              |             |                   | G (E)                                            |                | 14-10     | 2 to 5.5        |                                                      |
|              | AB004       | 1.1 kVA           | L1 (R), L2 (S), B1/⊕, B2, T1 (U), T2 (V), T3 (W) | M4             | 14-10     | 2 to 5.5        |                                                      |
|              |             |                   | G (E)                                            |                | 14-10     | 2 to 5.5        |                                                      |
|              | AB007       | 1.9 kVA           | L1 (R), L2 (S), B1/⊕, B2, T1 (U), T2 (V), T3 (W) | M4             | 14-10     | 2 to 5.5        |                                                      |
|              |             |                   | G (E)                                            |                | 14-10     | 2 to 5.5        |                                                      |

| Circuit            | Model<br>3G3XV             | Inverter<br>capacity | Terminal symbol                                     | Terminal<br>screw | Wire size |                 | Wire type                                                        |
|--------------------|----------------------------|----------------------|-----------------------------------------------------|-------------------|-----------|-----------------|------------------------------------------------------------------|
|                    |                            |                      |                                                     |                   | AWG       | mm <sup>2</sup> |                                                                  |
| Main<br>circuit    | AB015                      | 2.5 kVA              | L1 (R), L2 (S), B1/⊕, B2, T1<br>(U), T2 (V), T3 (W) | M4                | 14-10     | 2 to 5.5        | Power cable:<br>600 V<br>vinyl-sheathed<br>lead or<br>equivalent |
|                    |                            |                      | G (E)                                               |                   | 14-10     | 2 to 5.5        |                                                                  |
|                    | AB022                      | 4.2 kVA              | L1 (R), L2 (S), B1/⊕, B2, T1<br>(U), T2 (V), T3 (W) | M5                | 12-8      | 3.5 to 8        |                                                                  |
|                    |                            |                      | G (E)                                               |                   | 14-8      | 2 to 8          |                                                                  |
|                    | AB037                      | 6.7 kVA              | L1 (R), L2 (S), B1/⊕, B2, T1<br>(U), T2 (V), T3 (W) | M5                | 10-8      | 5.5 to 8        |                                                                  |
|                    |                            |                      | G (E)                                               |                   | 14-8      | 2 to 8          |                                                                  |
| Control<br>circuit | Common<br>to all<br>Models | —                    | 1 to 14,<br>FLT-A, FLT-B, FLT-C                     | M3.5              | 20-14     | 0.5 to 2        | Shielded lead<br>or equivalent                                   |
|                    |                            |                      | G (E)                                               |                   |           |                 |                                                                  |

## 400-V-class 3-phase Input Series:

| Circuit         | Model<br>3G3XV     | Inverter<br>capacity       | Terminal symbol                                             | Terminal<br>screw               | Wire size |                 | Wire type                                                        |          |                                |
|-----------------|--------------------|----------------------------|-------------------------------------------------------------|---------------------------------|-----------|-----------------|------------------------------------------------------------------|----------|--------------------------------|
|                 |                    |                            |                                                             |                                 | AWG       | mm <sup>2</sup> |                                                                  |          |                                |
| Main<br>circuit | A4002              | 0.8 kVA                    | L1 (R), L2 (S), L3 (T), B1/⊕,<br>B2, T1 (U), T2 (V), T3 (W) | M4                              | 14-10     | 2 to 5.5        | Power cable:<br>600 V<br>vinyl-sheathed<br>lead or<br>equivalent |          |                                |
|                 |                    |                            | G (E)                                                       |                                 | 14-10     | 2 to 5.5        |                                                                  |          |                                |
|                 | A4004              | 1.2 kVA                    | L1 (R), L2 (S), L3 (T), B1/⊕,<br>B2, T1 (U), T2 (V), T3 (W) | M4                              | 14-10     | 2 to 5.5        |                                                                  |          |                                |
|                 |                    |                            | G (E)                                                       |                                 | 14-10     | 2 to 5.5        |                                                                  |          |                                |
|                 | A4007              | 2.0 kVA                    | L1 (R), L2 (S), L3 (T), B1/⊕,<br>B2, T1 (U), T2 (V), T3 (W) | M4                              | 14-10     | 2 to 5.5        |                                                                  |          |                                |
|                 |                    |                            | G (E)                                                       |                                 | 14-10     | 2 to 5.5        |                                                                  |          |                                |
|                 | A4015              | 3.0 kVA                    | L1 (R), L2 (S), L3 (T), B1/⊕,<br>B2, T1 (U), T2 (V), T3 (W) | M4                              | 14-10     | 2 to 5.5        |                                                                  |          |                                |
|                 |                    |                            | G (E)                                                       |                                 | 14-10     | 2 to 5.5        |                                                                  |          |                                |
|                 | A4022              | 3.7 kVA                    | L1 (R), L2 (S), L3 (T), B1/⊕,<br>B2, T1 (U), T2 (V), T3 (W) | M4                              | 14-10     | 2 to 5.5        |                                                                  |          |                                |
|                 |                    |                            | G (E)                                                       |                                 | 14-10     | 2 to 5.5        |                                                                  |          |                                |
|                 | A4037              | 6.1 kVA                    | L1 (R), L2 (S), L3 (T), B1/⊕,<br>B2, T1 (U), T2 (V), T3 (W) | M4                              | 14-10     | 2 to 5.5        |                                                                  |          |                                |
|                 |                    |                            | G (E)                                                       |                                 | 14-10     | 2 to 5.5        |                                                                  |          |                                |
|                 | Control<br>circuit | Common<br>to all<br>Models | —                                                           | 1 to 14,<br>FLT-A, FLT-B, FLT-C | M3.5      | 20-14           |                                                                  | 0.5 to 2 | Shielded lead<br>or equivalent |
|                 |                    |                            |                                                             | G (E)                           |           |                 |                                                                  |          |                                |



**⚠ Caution** Observe the following guidelines when wiring.

- Lead size should be determined considering voltage drop of leads. Select the lead size so that the voltage drop will be within 2% of the normal rated voltage. The voltage drop can be obtained from the lead resistance (R) in  $\Omega/\text{km}$ , wiring distance (D) in meters, and current (I) in A using the following equation:

$$\text{Phase-to-phase voltage drop in volts} = \sqrt{3} \times R \times D \times I \times 10^{-3}$$

- Insertion of AC reactor:

When the power supply capacity exceeds 600 kVA, connect an AC reactor at the Inverter input side for power supply coordination. This reactor is also effective in improving the power factor of the power supply.

- Wiring length between Inverter and motor:

If the total wiring distance between the Inverter and motor is excessively long and the Inverter carrier frequency (main transistor switching frequency) is high, harmonic leakage current from the cable will increase to affect the Inverter Unit or peripheral devices. If the wiring distance between the Inverter and motor is long, reduce the Inverter carrier frequency as shown below. The carrier frequency can be set with constant No. 40. For details, refer to *2-8-18 Carrier Frequency*. The carrier frequency is set to 10 kHz at the factory prior to shipping.

| Wiring distance between Inverter and motor                                 | Up to 30 m         | Up to 50 m         | Up to 100 m       | Over 100 m          |
|----------------------------------------------------------------------------|--------------------|--------------------|-------------------|---------------------|
| Allowable carrier frequency<br>(Corresponding setting for constant no. 40) | 15 kHz max.<br>(6) | 10 kHz max.<br>(4) | 5 kHz max.<br>(2) | 2.5 kHz max.<br>(1) |

## Grounding

Ground the casing of the 3G3XV using ground terminal G (E).

- Ground resistance should be 100  $\Omega$  or less.
- Never ground the 3G3XV in common with welding machines, motors, and other large-current electrical equipment, or ground pole. Run the ground lead in a separate conduit from leads for large-current electrical equipment.
- Use the ground leads which comply with AWG standards and make the length as short as possible.
- Where several 3G3XV Units are used side by side, all the Units should preferably be grounded directly to the ground poles. However, connecting all the ground terminals of 3G3XV in parallel, and grounding only one of 3G3XV to the ground pole is also permissible as shown below. However, do not form a loop with the ground leads.

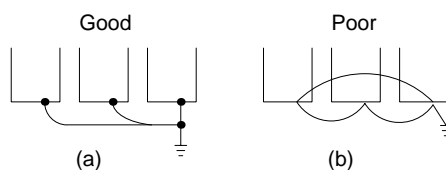



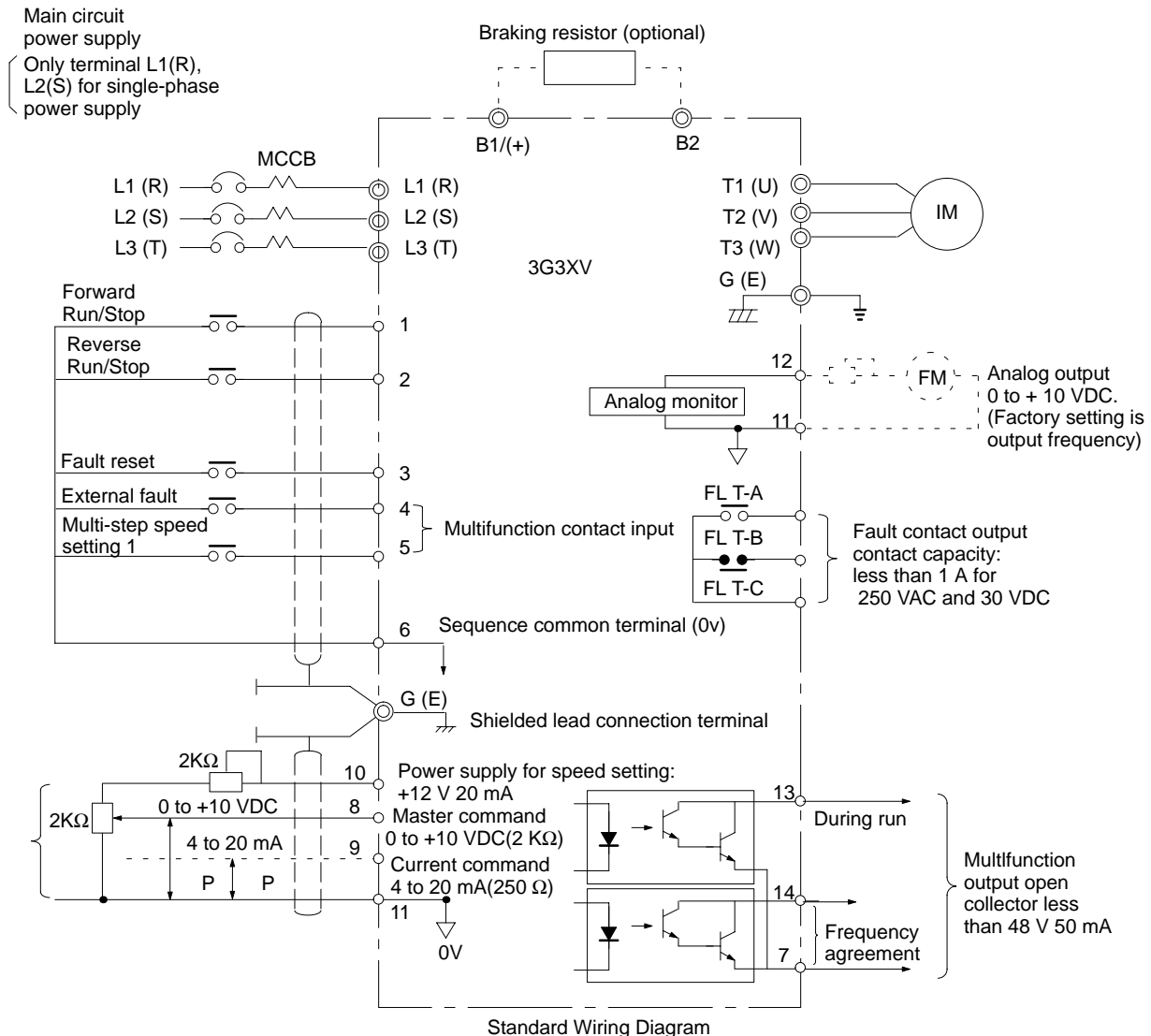

### 1-4-4 Control Circuit

#### Control Circuit Wiring

The control signals are connected by screws. The following figure shows the relationship between I/O signals (factory preset values) and screw terminal numbers. The terminal functions shown in the figure indicate standard setting prior to shipping. Since Operation Mode from the Digital Operator is set for the Model with the Digital Operator, it is necessary to change the control constants when operation is performed from the control circuit terminals. For details, refer to 2-8-2 Operation Mode Selection.



- Note**
1.  indicates shielded leads.  indicates twisted-pair shielded leads.
  2. Terminal symbols:  indicates the main circuit, and  indicates the control circuit.

## Control Circuit (Terminals Factory Preset)

### Control Circuit Terminal Functions

| Classification         | Terminal | Signal name                                 | Function                                              |                                                                           | Signal level                                              |
|------------------------|----------|---------------------------------------------|-------------------------------------------------------|---------------------------------------------------------------------------|-----------------------------------------------------------|
| Sequence Input Signal  | 1        | Forward run/stop signal                     | Forward run when “closed”, stop when “open”.          |                                                                           | Photo-coupler insulation input<br>24 VDC 8 mA             |
|                        | 2        | Reverse run/stop signal                     | Reverse run when “closed”, stop when “open”.          |                                                                           |                                                           |
|                        | 3        | Fault reset signal                          | Reset when “closed”.                                  |                                                                           |                                                           |
|                        | 4        | External fault                              | External fault when “closed”.                         |                                                                           |                                                           |
|                        | 5        | Multi-step speed ref. 1                     | Multi-step speed ref. 1 effective                     | Multifunction contact input: two signals available to select <sup>1</sup> |                                                           |
|                        | 6        | Sequence control input common terminal      |                                                       |                                                                           |                                                           |
| Analog Input Signal    | 10       | Power supply terminal for frequency setting | Speed ref. power supply                               |                                                                           | 12 V (Allowable current 20 mA max.)                       |
|                        | 8        | Frequency ref.                              | 0 to 10 V/Max. output frequency                       |                                                                           | 0 to 10 V (20 kΩ)                                         |
|                        | 9        |                                             | 4 to 20 mA/Max. output frequency                      |                                                                           | 4 to 20 mA (250 Ω)                                        |
|                        | 11       | Common terminal for control circuit         | 0 V                                                   |                                                                           | —                                                         |
| Sequence Output Signal | 13       | During running                              | “L” level at run                                      | Multifunction contact input: two signals available to select <sup>2</sup> | Photo-coupler output<br>48 V, 50 mA max.                  |
|                        | 14       | Frequency agreed signal                     | “L” level at set frequency = output frequency         |                                                                           |                                                           |
|                        | 7        | Photo-coupler output common                 | —                                                     |                                                                           |                                                           |
|                        | FLT-A    | Fault signal contact output                 | “Closed” between A and C at fault                     |                                                                           | Contact capacity<br>250 VAC: 1 A max.<br>30 VDC: 1 A max. |
|                        | FLT-B    |                                             | “Open” between B and C at fault                       |                                                                           |                                                           |
|                        | FLT-C    |                                             | Fault signal contact output common                    |                                                                           |                                                           |
| Analog Output Signal   | 12       | Frequency meter                             | 0 to 10 V/Max. output frequency.                      |                                                                           | 0 to 11 V max.<br>2 mA or less                            |
|                        | 11       | Common                                      | Possible to select current meter output. <sup>3</sup> |                                                                           |                                                           |

**Note** 1. For details refer to 2-8-14 Multifunction Contact Input Function Selection.

2. For details refer to 2-8-15 Multifunction Output Function.

3. For details refer to 2-8-9 Multifunction Analog Output Monitor.

### Control Circuit Terminal Arrangement

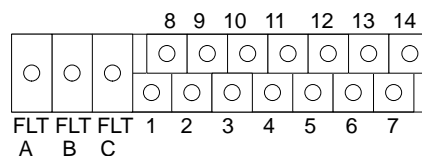

## Precautions for Control Circuit Wiring

Take the following precautions when wiring.

- 1, 2, 3...
1. Separate the control signal line from power lines. Otherwise a malfunction might occur.
  2. For the frequency setting signal (analog), use a shielded lead and be sure that the signal is terminated properly.

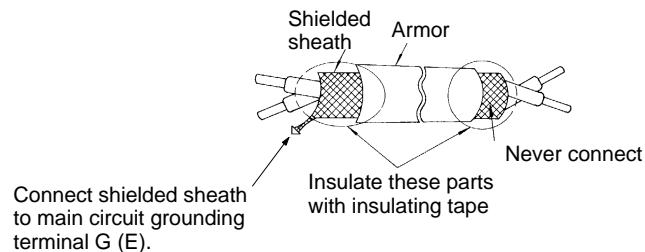

3. The wiring length of the control signal line must be 50 m or less.
4. To drive the contact input signal by transistor, use one having ratings of 50 V 50 mA or more. Circuit leakage current at signal OFF must be 100  $\mu$ A or less.
5. To drive an inductive load (relay coil, etc.) by multifunction photo-coupler output, be sure to insert a free wheel diode.

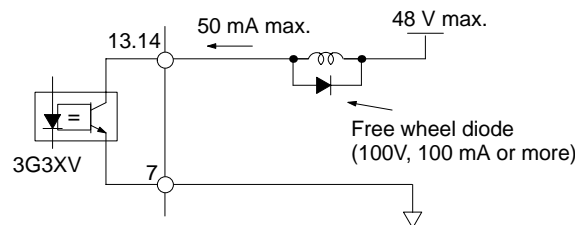

## 1-5 Operation

### 1-5-1 Checking Before Operation

Check the following items after completion of installation and wiring:

- No fault in wiring. Especially, the power supply is connected to the output terminals T1 (U), T2 (V), and T3 (W).
- No short-circuit because of wiring contamination (dust, oil, etc.).
- Screws and terminals are not loosened. Wiring is provided properly.
- Wiring is not grounded.
- Load status is good.

For safe operation, before operation, the motor must be able to operate alone by separating it from the coupling or belt which connects the motor and machine.

When the motor is operated with the machine directly connected, pay close attention.

### 1-5-2 Setting Before Operation

Since the standard Inverter Models are shipped with the default values listed in *2-7 Function/Constant List*, the Digital Operator must be used in order to change the constants from the initial values to values in accordance with the load specifications.

#### Set Value Prior to Shipping

The following describes the functions and initial constant set values which are often used for operation.

Output Frequency and Accel/Decel Time:

The maximum output frequency is set to 60 Hz and accel/decel time to 10 seconds at the factory prior to shipping. To change the values, refer to *2-8-6 Accel/Decel Time and Patterns*.

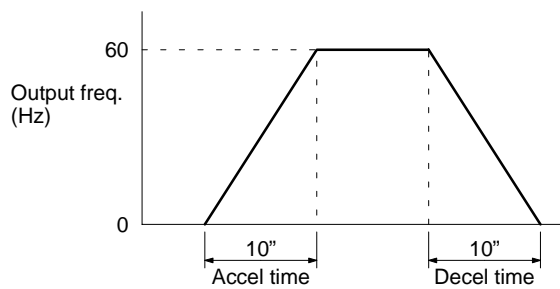

Frequency Setting Signal and Output Frequency:

The figure below shows the Inverter output frequency for control circuit terminal master frequency reference voltage. To change the value, refer to *2-8-7 Output Frequency Control (Gain/Bias)*.

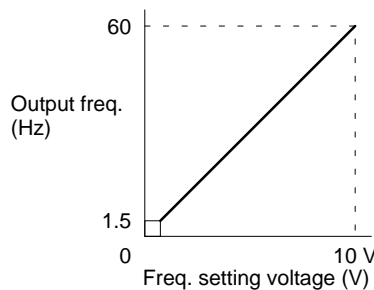

V/f Characteristics:

The figure below shows the output voltage for Inverter output frequency. When its characteristic (max. voltage/frequency) differs from that of the optimum motor, refer to *2-8-3 V/f Characteristic Setting*.

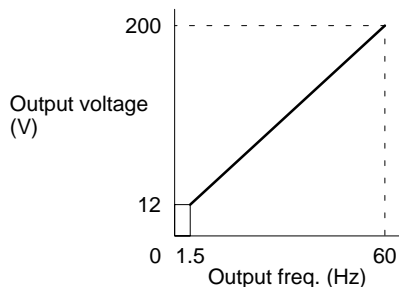

**Motor Rated Current Setting**

Since the Inverter is provided with electronic thermal overload protective function in order to protect the motor from overheating, set the rated current value described on the motor name plate to constant (no. 19). Standard 4-pole motor current value is set as the initial value. For details refer to *2-8-8 Electronic Thermal Overload Function*.

**Note** Provide a thermal relay or thermal protector when more than one motor is operated simultaneously.

**1-5-3 Test Run Method**

The Inverter can be operated using the Digital Operator or control circuit terminal inputs. Models with Digital Operator are set to “OPERATOR MODE BY DIGITAL OPERATOR” prior to shipping.

**Operation Using the Digital Operator**

This is the standard setting of Models with a Digital Operator; in this Mode, the Inverter is operated with the keys of the Digital Operator.

Since this Operation Mode is set at the factory prior to shipping, operation can be performed only by main circuit wiring.

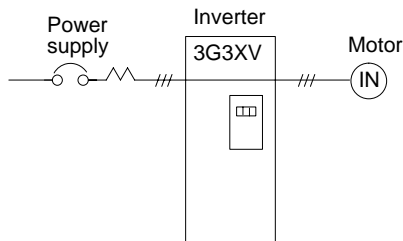

**Operation Procedure**

Follow the procedure below to operate the Inverter using the Digital Operator. Refer to *2-3 Digital Operator Operation Example* for details on Digital Operator operation.

- 1, 2, 3...** 1. Turn the power on.
- 2. Press the DSPL Key on the Digital Operator to select the frequency reference value display (F0000).

3. Set the frequency value using the Up and Down Arrow Keys or the RESET Key.
4. Press the DATA/ENTER Key to enter the frequency value.
5. Press the RUN Key.
6. To stop, press the STOP Key.

### Operation Using Control Circuit Terminal Inputs

In this Mode, the Inverter is operated by a frequency setter and/or operation switches connected to the control circuit terminal. To operate Inverters with Digital Operators in this Mode, the value of constant no. 01 must be reset to 0000.

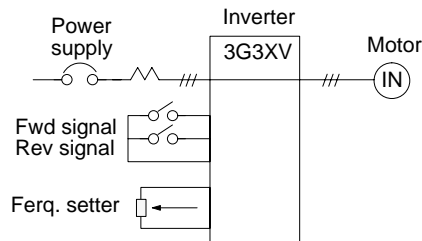

### Operation Procedure

Follow the procedure below to set constant no. 01 to 0000 and enable operation using the control circuit terminal inputs.

- 1, 2, 3...**
1. Turn the power on.
  2. Press the PRGM/DRIVE Key to enter Program Mode.
  3. Set constant no. 01 to 0000 using the Up and Down Arrow Keys or the RESET Key.
  4. Press the DATA/ENTER Key to enter the new value. for constant no.01.
  5. Press the PRGM/DRIVE Key to enter Drive Mode.

Follow the procedure below to operate the Inverter using control circuit terminal inputs.

- 1, 2, 3...**
1. Turn the knob on the frequency setter all the way to the left to set the frequency reference=0.
  2. Turn ON the FWD or REV run signal.
  3. Turn the frequency setter knob slowly to the right to increase the frequency setting to its full value.
  4. To stop, turn the frequency setter knob slowly to the left to decrease the frequency setting to zero and then turn OFF the FWD or REV run signal.

### Check Points

- Motor rotation is smooth.
- Motor rotating direction is proper.
- Motor does not have abnormal vibration or beat.
- Accel/decel is smooth.

**Precautions**

- The motor does not start up if both FWD and REV run signals are turned on simultaneously. If they are turned on simultaneously during run, the motor decelerates to a stop.
- When output frequency reaches 1.5 Hz (set value prior to shipping) at deceleration, the dynamic brake (DB) operates for 0.5 s and metallic noise is generated by the motor. However, this noise is normal.
- If a fault occurs during acceleration or deceleration and the motor coasts to a stop, check the motor stopping position and then the following items:
  - a) Load is not excessively large.
  - b) Accel/decel time is long enough for load.

Resetting must be performed by external signal input (or Digital Operator's RESET Key) or by turning off the power supply.



## 1-6 Specifications

### 1-6-1 200-V-class Specifications

| Inverter Model<br>3G3XV-□□□□□-EV2                    | 3-phase                           | A2001                                                                                                                                                                                                                             | A2002         | A2004        | A2007       | A2015   | A2022   | A2037   |
|------------------------------------------------------|-----------------------------------|-----------------------------------------------------------------------------------------------------------------------------------------------------------------------------------------------------------------------------------|---------------|--------------|-------------|---------|---------|---------|
|                                                      | Single-phase                      | AB001                                                                                                                                                                                                                             | AB002         | AB004        | AB007       | AB015   | AB022   | AB037   |
| Max. applicable motor output Hp (kW)<br>(see note 1) |                                   | 0.13<br>(0.1)                                                                                                                                                                                                                     | 0.25<br>(0.2) | 0.5<br>(0.4) | 1<br>(0.75) | 2 (1.5) | 3 (2.2) | 5 (3.7) |
| Output characteristics                               | Inverter capacity (kVA)           | 0.3                                                                                                                                                                                                                               | 0.6           | 1.1          | 1.9         | 2.5     | 4.2     | 6.7     |
|                                                      | Rated output current (A)          | 0.8                                                                                                                                                                                                                               | 1.5           | 3            | 5           | 6.5     | 11      | 17.5    |
|                                                      | Max. output voltage               | 3-phase, 200 to 230 V (proportional to input voltage)                                                                                                                                                                             |               |              |             |         |         |         |
|                                                      | Max. output frequency             | 400 Hz (available with constant setting)                                                                                                                                                                                          |               |              |             |         |         |         |
| Power supply                                         | Rated input voltage and frequency | 3-phase: 200 to 230 V, 50/60 Hz<br>Single-phase: 200 to 240 V, 50/60 Hz                                                                                                                                                           |               |              |             |         |         |         |
|                                                      | Allowable voltage fluctuation     | ±10%                                                                                                                                                                                                                              |               |              |             |         |         |         |
|                                                      | Allowable frequency fluctuation   | ±5%                                                                                                                                                                                                                               |               |              |             |         |         |         |
| Control characteristics                              | Control method                    | Sine wave PWM                                                                                                                                                                                                                     |               |              |             |         |         |         |
|                                                      | Frequency control range           | 0.1 to 400 Hz                                                                                                                                                                                                                     |               |              |             |         |         |         |
|                                                      | Frequency accuracy                | Digital command: 0.01% +14° to 104°F, -10° to 40°C<br>Analog command: 0.1% 77°±18°F, 25°±10°C                                                                                                                                     |               |              |             |         |         |         |
|                                                      | Frequency resolution              | Digital Operator reference: 0.1 Hz.<br>Analog reference: 0.06 Hz/60 Hz                                                                                                                                                            |               |              |             |         |         |         |
|                                                      | Output frequency resolution       | 0.1 Hz                                                                                                                                                                                                                            |               |              |             |         |         |         |
|                                                      | Overload capacity                 | 150% rated output current for one minute                                                                                                                                                                                          |               |              |             |         |         |         |
|                                                      | Frequency setting signal          | 0 to 10 VDC (20 kΩ), 4-20 mA (250 Ω)                                                                                                                                                                                              |               |              |             |         |         |         |
|                                                      | Accel/decel time                  | 0.1 to 600 sec (accel/decel time setting independently)                                                                                                                                                                           |               |              |             |         |         |         |
|                                                      | Braking torque                    | Approx. 20% (up to 150% possible with optional braking resistor externally mounted)                                                                                                                                               |               |              |             |         |         |         |
|                                                      | V/f characteristic                | Possible to set any program of V/f pattern                                                                                                                                                                                        |               |              |             |         |         |         |
|                                                      | Stall prevention level            | Effective by current limiting at start and during running.                                                                                                                                                                        |               |              |             |         |         |         |
| Protective functions                                 | Instantaneous overcurrent         | Motor coasts to a stop at approx. 200% rated current.                                                                                                                                                                             |               |              |             |         |         |         |
|                                                      | Overload                          | Motor coasts to stop in 60 sec. at 150% rated output current                                                                                                                                                                      |               |              |             |         |         |         |
|                                                      | Ground fault                      | Provided by electronic circuit.                                                                                                                                                                                                   |               |              |             |         |         |         |
|                                                      | Motor overload protection         | Electronic thermal overload relay                                                                                                                                                                                                 |               |              |             |         |         |         |
|                                                      | Overvoltage                       | Motor coasts to stop if main circuit DC voltage exceeds 410 V                                                                                                                                                                     |               |              |             |         |         |         |
|                                                      | Undervoltage                      | Motor coasts to a stop if the main circuit DC voltage of a 3-phase Model drops to 210 V or below and that of a Single-phase Model drops to 170 V or below.                                                                        |               |              |             |         |         |         |
|                                                      | Momentary power loss              | Immediately stops if 15 ms or more momentary power loss. Resumes operating after a power loss period of approximately 2 s if the input is 1.5 kW or more and approximately 1 s if the input is 0.75 kW or less in a certain mode. |               |              |             |         |         |         |
|                                                      | Cooling fin overheat              | Protected by thermoswitch (only for forced cooling method)                                                                                                                                                                        |               |              |             |         |         |         |
|                                                      | Power charge indication           | CHARGE indicator stays ON until main circuit DC voltage drops below 50 V.                                                                                                                                                         |               |              |             |         |         |         |

| Inverter Model<br>3G3XV-□□□□□-EV2 |                                  | 3-phase                                                                                                                                                                                                                                                 | A2001                                                                                                                                                                                                                                | A2002 | A2004          | A2007 | A2015          | A2022 | A2037 |
|-----------------------------------|----------------------------------|---------------------------------------------------------------------------------------------------------------------------------------------------------------------------------------------------------------------------------------------------------|--------------------------------------------------------------------------------------------------------------------------------------------------------------------------------------------------------------------------------------|-------|----------------|-------|----------------|-------|-------|
|                                   |                                  | Single-phase                                                                                                                                                                                                                                            | AB001                                                                                                                                                                                                                                | AB002 | AB004          | AB007 | AB015          | AB022 | AB037 |
| Operation conditions              | Input signals                    | Operation signal                                                                                                                                                                                                                                        | Forward operation/reverse operation by individual command                                                                                                                                                                            |       |                |       |                |       |       |
|                                   |                                  | Reset                                                                                                                                                                                                                                                   | Releases protection while the function is operating.                                                                                                                                                                                 |       |                |       |                |       |       |
|                                   |                                  | Multifunction setting                                                                                                                                                                                                                                   | Possible to set 4 speeds max.                                                                                                                                                                                                        |       |                |       |                |       |       |
|                                   |                                  | Multifunction input selection                                                                                                                                                                                                                           | Multifunction contact input: two of the following signals available to select.<br>Multispeed command, jog operation, accel/decel time select, 3 wire sequence, external coasting stop, speed search, external fault, External fault. |       |                |       |                |       |       |
|                                   | Output signals                   | Operation state (photo-coupler output)                                                                                                                                                                                                                  | Multifunction contact output: two of the following signals available to select.<br>During running output, zero speed, frequency agree, output frequency $\geq$ setting value, during overtorque detection                            |       |                |       |                |       |       |
|                                   |                                  | Fault contact                                                                                                                                                                                                                                           | NO/NC contact output                                                                                                                                                                                                                 |       |                |       |                |       |       |
|                                   | Built-in function                | The following set-up is available: frequency reference bias/gain, upper/lower frequency limit, DC braking stop current at start, s-curve characteristics, torque boost, frequency meter calibrating gain, auto reset/restart operation, frequency jump. |                                                                                                                                                                                                                                      |       |                |       |                |       |       |
| Monitor display function          | Digital Operator                 | Displays setting frequency, output frequency, output current, rotating direction, and the contents at protective function operation.                                                                                                                    |                                                                                                                                                                                                                                      |       |                |       |                |       |       |
|                                   | Analog output monitor            | Analog output (0 to 10 VDC). Possible to select output frequency or output current.                                                                                                                                                                     |                                                                                                                                                                                                                                      |       |                |       |                |       |       |
| Protective configuration          |                                  | Enclosed wall-mounted type NEMA 1<br>(An open chassis type is also available.)                                                                                                                                                                          |                                                                                                                                                                                                                                      |       |                |       |                |       |       |
| Cooling method                    | 3-phase                          | Self-cooling                                                                                                                                                                                                                                            |                                                                                                                                                                                                                                      |       |                |       | Forced cooling |       |       |
|                                   | Single-phase                     | Self-cooling                                                                                                                                                                                                                                            |                                                                                                                                                                                                                                      |       | Forced cooling |       |                |       |       |
| Weight in lb<br>(mass in kg)      | 3-phase                          | 2.4 (1.1)                                                                                                                                                                                                                                               |                                                                                                                                                                                                                                      |       | 4.4 (2)        |       | 6.6 (3)        |       |       |
|                                   | Single-phase                     | 4.4 (2)                                                                                                                                                                                                                                                 |                                                                                                                                                                                                                                      |       | 6.6 (3)        |       | 11.0 (5)       |       |       |
| Environmental Conditions          | Location                         |                                                                                                                                                                                                                                                         | Indoor (protected from corrosive gases and dust)                                                                                                                                                                                     |       |                |       |                |       |       |
|                                   | Ambient temperature              |                                                                                                                                                                                                                                                         | +14° to 104°F (-10° to +40°C) (not frozen)                                                                                                                                                                                           |       |                |       |                |       |       |
|                                   | Storage temperature <sup>2</sup> |                                                                                                                                                                                                                                                         | -4° to 140°F (-20° to +60°C)                                                                                                                                                                                                         |       |                |       |                |       |       |
|                                   | Humidity                         |                                                                                                                                                                                                                                                         | 90% RH (without condensation)                                                                                                                                                                                                        |       |                |       |                |       |       |
| Vibration                         |                                  | Up to 9.8 m/s <sup>2</sup> (1 g) at less than 20 Hz.<br>Up to 2 m/s <sup>2</sup> (0.2 g) at 20 to 50 Hz.                                                                                                                                                |                                                                                                                                                                                                                                      |       |                |       |                |       |       |

- Note**
1. Use a standard 4-pole motor for maximum applicable motor output.
  2. Temperature during shipping (for short period).

### 1-6-2 400-V-class Specifications

| Inverter Model 3G3XV-□□□□□-EV2                    |                                                                           | A4002                                                                                                                                                                                                                             | A4004     | A4007    | A4015   | A4022   | A4037   |
|---------------------------------------------------|---------------------------------------------------------------------------|-----------------------------------------------------------------------------------------------------------------------------------------------------------------------------------------------------------------------------------|-----------|----------|---------|---------|---------|
| Max. applicable motor output <sup>1</sup> Hp (kW) |                                                                           | 0.25 (0.2)                                                                                                                                                                                                                        | 0.5 (0.4) | 1 (0.75) | 2 (1.5) | 3 (2.2) | 5 (3.7) |
| Output characteristics                            | Inverter capacity (kVA)                                                   | 0.8                                                                                                                                                                                                                               | 1.2       | 2.0      | 3.0     | 3.7     | 6.1     |
|                                                   | Rated output current (A)                                                  | 1                                                                                                                                                                                                                                 | 1.6       | 2.6      | 4       | 4.8     | 8       |
|                                                   | Max. output voltage                                                       | 3-phase, 380 to 460 V (proportional to input voltage)                                                                                                                                                                             |           |          |         |         |         |
|                                                   | Max. output frequency                                                     | 400 Hz (available with constant setting)                                                                                                                                                                                          |           |          |         |         |         |
| Power supply                                      | Rated input voltage and frequency                                         | 3-phase: 380 to 460 V, 50/60 Hz                                                                                                                                                                                                   |           |          |         |         |         |
|                                                   | Allowable voltage fluctuation                                             | ±10%                                                                                                                                                                                                                              |           |          |         |         |         |
|                                                   | Allowable frequency fluctuation                                           | ±5%                                                                                                                                                                                                                               |           |          |         |         |         |
| Control characteristics                           | Control method                                                            | Sine wave PWM                                                                                                                                                                                                                     |           |          |         |         |         |
|                                                   | Frequency control range                                                   | 0.1 to 400 Hz                                                                                                                                                                                                                     |           |          |         |         |         |
|                                                   | Frequency accuracy                                                        | Digital command: 0.01% (14° to 104°F, -10° to 40°C)<br>Analog command: 0.1% (77°±50°F, 25°±10°C)                                                                                                                                  |           |          |         |         |         |
|                                                   | Frequency resolution                                                      | Digital Operator reference: 0.1 Hz.<br>Analog reference: 0.06 Hz/60 Hz                                                                                                                                                            |           |          |         |         |         |
|                                                   | Output frequency resolution                                               | 0.1 Hz                                                                                                                                                                                                                            |           |          |         |         |         |
|                                                   | Overload capacity                                                         | 150% rated output current for one minute                                                                                                                                                                                          |           |          |         |         |         |
|                                                   | Frequency setting signal                                                  | 0 to 10 VDC (20 kΩ), 4 to 20 mA (250 Ω)                                                                                                                                                                                           |           |          |         |         |         |
|                                                   | Accel/decel time                                                          | 0.1 to 600 sec (accel/decel time setting independently)                                                                                                                                                                           |           |          |         |         |         |
|                                                   | Braking torque                                                            | Approx. 20% (up to 150% possible with optional braking resistor externally mounted, braking resistor built-in)                                                                                                                    |           |          |         |         |         |
|                                                   | V/f characteristic                                                        | Possible to set any program of V/f pattern                                                                                                                                                                                        |           |          |         |         |         |
|                                                   | Stall prevention level                                                    | Possible to set operating current                                                                                                                                                                                                 |           |          |         |         |         |
| Protective functions                              | Instantaneous overcurrent                                                 | Motor coasts to a stop at approx. 200% rated current.                                                                                                                                                                             |           |          |         |         |         |
|                                                   | Overload                                                                  | Motor coasts to a stop for 1 minute at 150% rated output current                                                                                                                                                                  |           |          |         |         |         |
|                                                   | Ground fault                                                              | Provided by electronic circuit.                                                                                                                                                                                                   |           |          |         |         |         |
|                                                   | Motor overload protection                                                 | Electronic thermal overload relay                                                                                                                                                                                                 |           |          |         |         |         |
|                                                   | Overvoltage                                                               | Motor coasts to stop if main circuit DC voltage exceeds 820 V.                                                                                                                                                                    |           |          |         |         |         |
|                                                   | Undervoltage                                                              | Stops if the main circuit DC voltage is approx. 420 V or less.                                                                                                                                                                    |           |          |         |         |         |
|                                                   | Momentary power loss                                                      | Immediately stops if 15 ms or more momentary power loss. Resumes operating after a power loss period of approximately 2 s if the input is 1.5 kW or more and approximately 1 s if the input is 0.75 kW or less in a certain mode. |           |          |         |         |         |
|                                                   | Cooling fin overheat                                                      | Protected by thermoswitch (only for forced cooling method)                                                                                                                                                                        |           |          |         |         |         |
| Power charge indication                           | CHARGE indicator stays ON until main circuit DC voltage drops below 50 V. |                                                                                                                                                                                                                                   |           |          |         |         |         |

| Inverter Model 3G3XV-□□□□□-EV2 |                                  | A4002                                                                               | A4004                                                                                                                                                                                                                                                   | A4007   | A4015          | A4022    | A4037 |
|--------------------------------|----------------------------------|-------------------------------------------------------------------------------------|---------------------------------------------------------------------------------------------------------------------------------------------------------------------------------------------------------------------------------------------------------|---------|----------------|----------|-------|
| Operation conditions           | Input signals                    | Operation signal                                                                    | Forward operation/reverse operation by individual command                                                                                                                                                                                               |         |                |          |       |
|                                |                                  | Reset                                                                               | Releases protection while the function is operating.                                                                                                                                                                                                    |         |                |          |       |
|                                |                                  | Multifunction input selection                                                       | Multifunction contact input: two of the following signals available to select.<br>External fault multispeed command, jog operation, accel/ decel time select, 3-wire sequence, external coasting stop, speed search command.                            |         |                |          |       |
|                                | Output signals                   | Operation state (photo-coupler output)                                              | Multifunction contact output: two of the following signals available to select.<br>During running output, zero speed, frequency agree, output frequency ≥ setting value, during overtorque detection                                                    |         |                |          |       |
|                                |                                  | Fault contact                                                                       | NO/NC contact output                                                                                                                                                                                                                                    |         |                |          |       |
|                                | Built-in functions               |                                                                                     | The following set-up is available: frequency reference bias/gain, upper/lower frequency limit, DC braking stop current at start, torque boost, frequency meter calibrating gain, frequency jump, S-curve characteristics, auto reset/restart operation. |         |                |          |       |
|                                | Monitor display function         | Digital Operator                                                                    | Displays setting frequency, output frequency, output current, rotating direction, and the contents at protective function operation.                                                                                                                    |         |                |          |       |
| Analog output monitor          |                                  | Analog output (0 to 10 VDC). Possible to select output frequency or output current. |                                                                                                                                                                                                                                                         |         |                |          |       |
| Protective configuration       |                                  | Enclosed wall-mounted type NEMA 1<br>(An open chassis type is also available.)      |                                                                                                                                                                                                                                                         |         |                |          |       |
| Cooling method                 |                                  | Self-cooling                                                                        |                                                                                                                                                                                                                                                         |         | Forced cooling |          |       |
| Weight in lb (kg)              |                                  | 4.4 (2)                                                                             |                                                                                                                                                                                                                                                         | 6.6 (3) |                | 11.0 (5) |       |
| Environmental Conditions       | Location                         |                                                                                     | Indoor (protected from corrosive gases and dust)                                                                                                                                                                                                        |         |                |          |       |
|                                | Ambient temperature              |                                                                                     | +14° to 104°F (−10° to +40°C) (not frozen)                                                                                                                                                                                                              |         |                |          |       |
|                                | Storage temperature <sup>2</sup> |                                                                                     | −4° to 140°F (−20° to +60°C)                                                                                                                                                                                                                            |         |                |          |       |
|                                | Humidity                         |                                                                                     | 90% RH (without condensation)                                                                                                                                                                                                                           |         |                |          |       |
|                                | Vibration                        |                                                                                     | Up to 9.8 m/s <sup>2</sup> (1 g) at less than 20 Hz.<br>Up to 2 m/s <sup>2</sup> (0.2 g) at 20 to 50 Hz.                                                                                                                                                |         |                |          |       |

- Note**
1. Use a standard 4-pole motor for maximum applicable motor output.
  2. Temperature during shipping (for short period).

### 1-6-3 Optional Units

| Name                  | Model (code no.)   | Function                                                                                                     | Installing position  |
|-----------------------|--------------------|--------------------------------------------------------------------------------------------------------------|----------------------|
| Braking Resistor Unit | 3G3IV-PLKEB□□□□    | Shortens the motor deceleration time by causing the regenerative energy to be consumed through the resistor. | Separately installed |
| Braking Resistor      | 3G3IV-PERF150WJ□□□ |                                                                                                              |                      |

**Note** When using the Braking Resistor Unit or Braking Resistor, set the stall prevention during deceleration (rD-20) to “1” (disabled).

**1-6-4 Peripheral Units**

| Name                          | Model (code no.)                 | Function                                                                                                |
|-------------------------------|----------------------------------|---------------------------------------------------------------------------------------------------------|
| Radio noise protective filter | 3G3IV-PHF□□□□□□<br>3G3IV-PLF□□□□ | Use a line filter to reduce radio frequency interference. Always use at the input side of the Inverter. |
| Isolator                      | K3FK                             | Isolates the Inverter input and output signals to reduce induced noise.                                 |

## SECTION 2

# Digital Operator

This section outlines the Digital Operator performance, constants, and operation.

|        |                                                                                            |    |
|--------|--------------------------------------------------------------------------------------------|----|
| 2-1    | Digital Operator Components                                                                | 28 |
| 2-2    | Function/Constant Setting                                                                  | 29 |
| 2-3    | Digital Operator Operation Example                                                         | 31 |
| 2-4    | Constant Initialization and Write-protection                                               | 33 |
| 2-4-1  | Constant Initialization                                                                    | 33 |
| 2-4-2  | Constant Write-protection                                                                  | 33 |
| 2-5    | Corrective Function                                                                        | 34 |
| 2-5-1  | Adjustment of Frequency Setting Value,<br>Output Frequency Bias (No. 23) and Gain (No. 22) | 34 |
| 2-5-2  | Calibration of Frequency Meter                                                             | 35 |
| 2-6    | Monitor                                                                                    | 35 |
| 2-7    | Function/Constant List                                                                     | 37 |
| 2-8    | Description of Functions and Constants                                                     | 43 |
| 2-8-1  | Password Setting                                                                           | 43 |
| 2-8-2  | Operation Mode Selection                                                                   | 44 |
| 2-8-3  | V/f Characteristic Setting                                                                 | 44 |
| 2-8-4  | 4-step Speed Change                                                                        | 46 |
| 2-8-5  | Jog Operation                                                                              | 46 |
| 2-8-6  | Accel/Decel Time and Patterns                                                              | 47 |
| 2-8-7  | Output Frequency Control (Gain/Bias)                                                       | 47 |
| 2-8-8  | Electronic Thermal Overload Function                                                       | 48 |
| 2-8-9  | Multi-function Analog Output Monitor                                                       | 48 |
| 2-8-10 | Output Frequency Limit                                                                     | 49 |
| 2-8-11 | DC Injection Braking                                                                       | 49 |
| 2-8-12 | Motor Stall Prevention Function                                                            | 50 |
| 2-8-13 | Full-range Automatic Torque Boost                                                          | 51 |
| 2-8-14 | Multifunction Contact Input Function Selection                                             | 52 |
| 2-8-15 | Multifunction Output Function                                                              | 54 |
| 2-8-16 | Frequency/Current Meter Calibration                                                        | 54 |
| 2-8-17 | Overtorque Detection Function                                                              | 55 |
| 2-8-18 | Carrier Frequency                                                                          | 56 |
| 2-8-19 | Speed Agreed Signal Output                                                                 | 56 |
| 2-8-20 | S-curve at Accel/Decel Time                                                                | 57 |
| 2-8-21 | Other Functions                                                                            | 58 |
| 2-8-22 | Enable/Disable Setting Constants in DRIVE Mode                                             | 59 |
| 2-8-23 | No. of Auto Reset/Restart Operation (No. 47)                                               | 59 |
| 2-8-24 | Setting Prohibit Frequency Range (No. 50 to No. 53)                                        | 59 |
| 2-8-25 | Speed Search Function                                                                      | 60 |
| 2-8-26 | Accel/Decel Prohibit Function                                                              | 62 |
| 2-8-27 | Slip Compensation Speed Control                                                            | 63 |
| 2-8-28 | Inverter Overload Protection                                                               | 64 |

## 2-1 Digital Operator Components

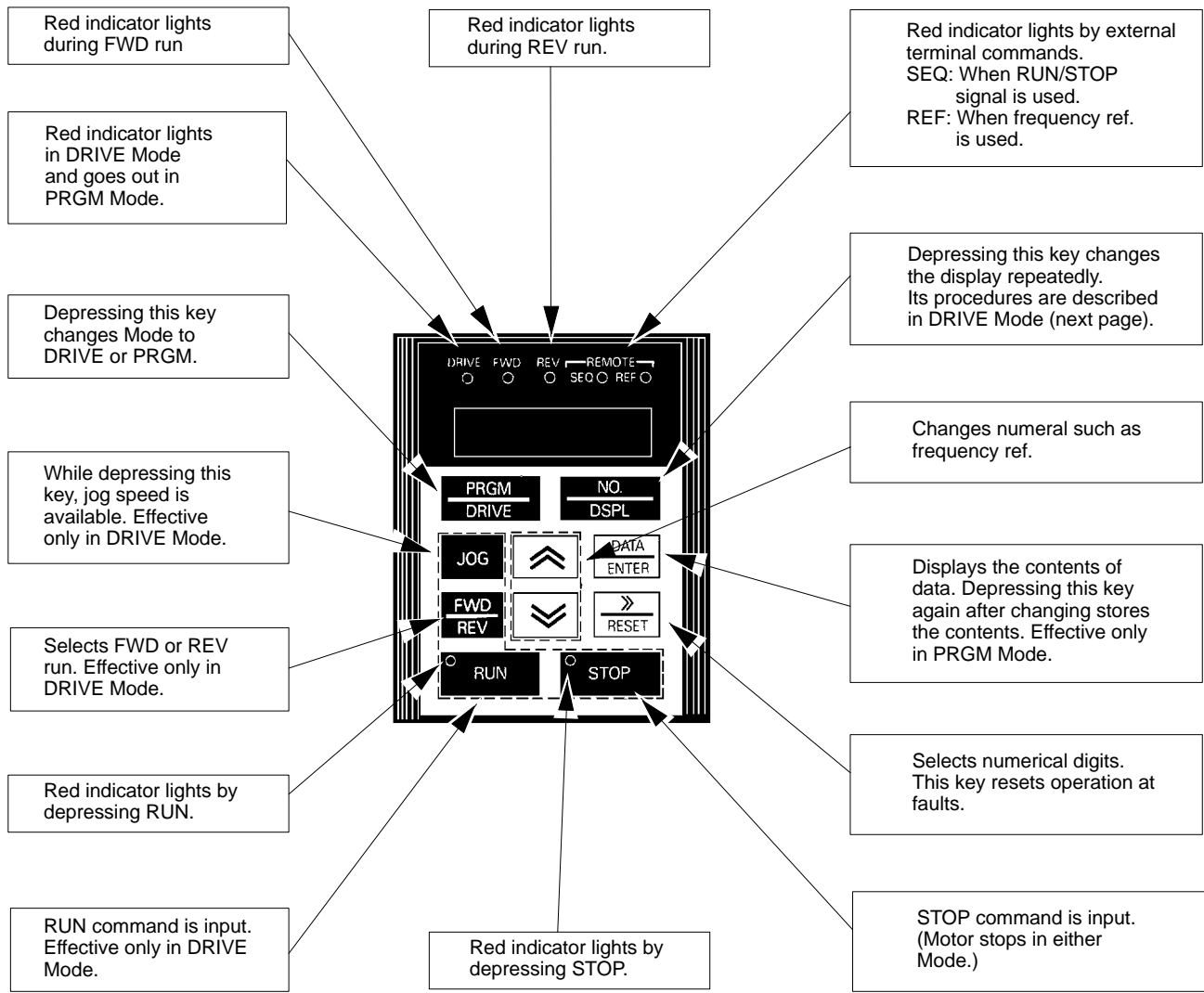

### Indicator Operation

The RUN and STOP indicators are turned on and off in accordance with the following operations:

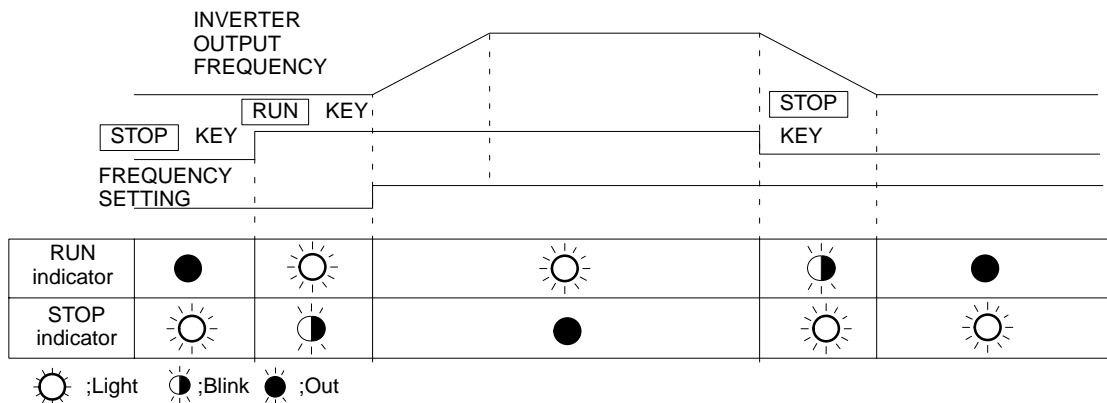

## 2-2 Function/Constant Setting

### DRIVE Mode and PRGM (Program) Mode

Selection of DRIVE Mode or PRGM Mode can be performed by using the 

|       |
|-------|
| PRGM  |
| DRIVE |

 Key when the Inverter is stopped. When function selection or a change of set value is required, switch to the PRGM Mode.

#### DRIVE Mode

- Operation is enabled.
- Operations can be performed with the RUN, STOP, JOG, or FWD/REV Keys.
- Frequency reference, jogging frequency, accel/decel time setting, and frequency reference gain/bias values can be changed during running.

#### PRGM Mode

- Program (function selection, constant setting) can be changed.

#### Display Contents of DRIVE Mode and PRGM Mode

Display contents of the Digital Operator differ according to selected Mode (PRGM/DRIVE).

The constant group to be displayed is changed each time display selection key (the NO/DSPL Key) is pressed.

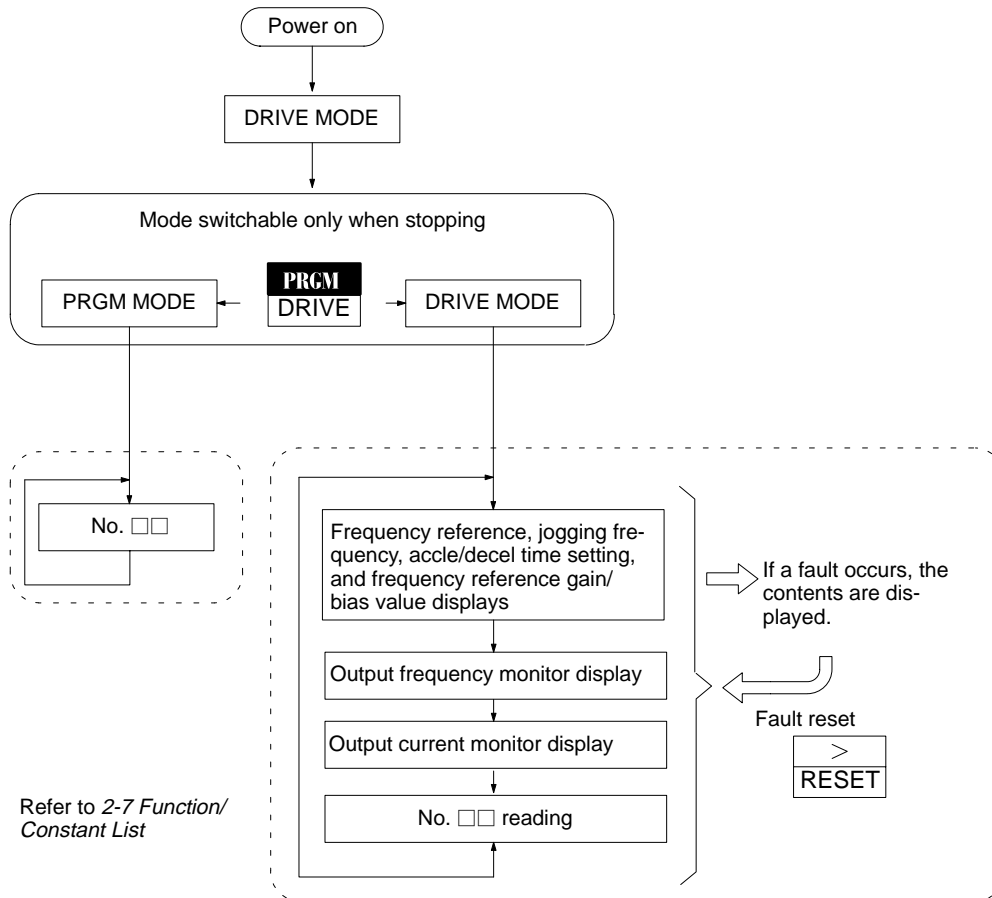



### Reading and Setting Constants

The 3G3XV has various functions for optimum operation. Use it with the set values according to the load conditions or operation conditions of the matching machine. Set values are read or set by the Digital Operator. The value of constant No. 00 determines the groups of functions that can be accessed.

1<sup>st</sup> Function Group:

Set No. 00 = 1 (factory setting) to read/write basic functions used often for operation.

2<sup>nd</sup> and 3<sup>rd</sup> Function Groups:

Set No. 00 = 2 or 3 to read/write constants which must be set in accordance with particular load conditions.

Refer to 2-8 Description of Functions and Constants for details on the constants and their functions.

### Typical Setting

The following shows an example where acceleration time (No. 9) is changed from 10 s to 5 s.

Other constants can be changed in the same operation.

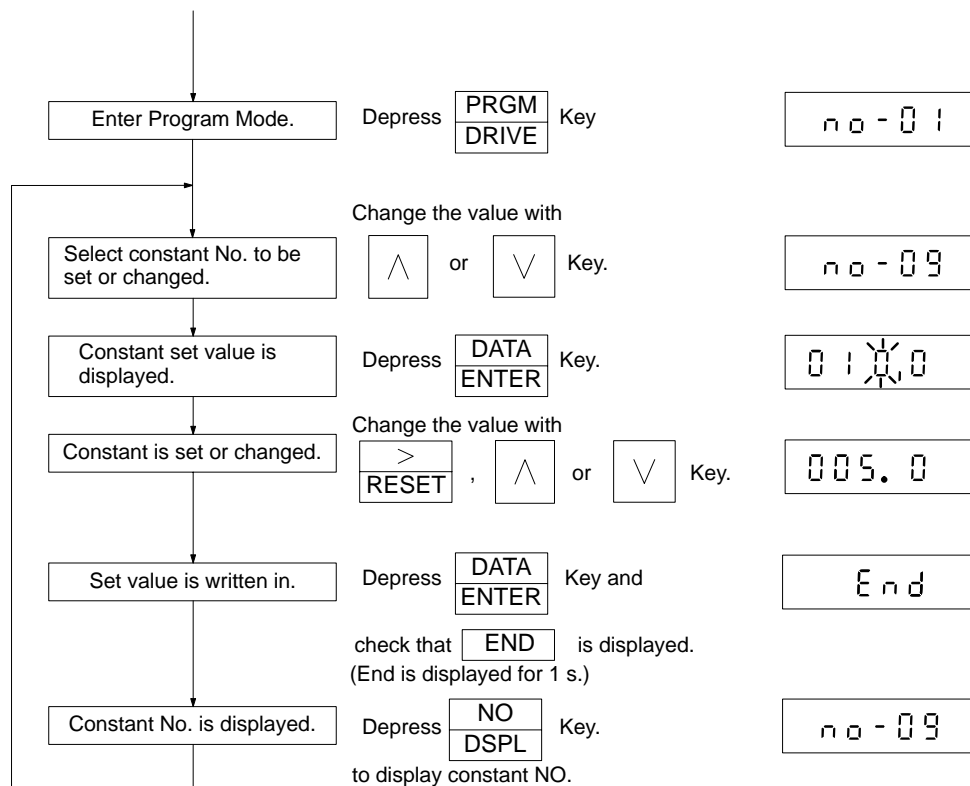

**Note:** Check that **END** is displayed for each constant setting. Constants cannot be changed simultaneously.

**Precautions on Constant Setting**

In the following cases, the set value blinks for 3 s and the data before changing is returned.

- When a value exceeding the setting range is set
- Set values of constants No. 32 and No. 33 are not in descending order.
- If the following conditions are not satisfied in the V/f constant setting:

Maximum frequency (No. 02) ≥ Base frequency (No. 04) > Intermediate frequency (No. 05) ≥ Minimum output frequency (No. 07).

For the following setting, intermediate frequency voltage (No. 6) is disregarded:

Intermediate frequency = Minimum frequency.

For details, refer to 2-8-3 V/f Characteristic Setting.

- If the following condition is not satisfied in the frequency reference constant setting:

Set frequency reference (Nos. 13 to 17) ≤ Maximum frequency (No. 2)

For details, refer to 2-8-3 V/f Characteristic Setting.

- If the following condition is not satisfied in the frequency reference upper/lower limit value setting:

Frequency reference lower limit value (No. 25) ≤ frequency reference upper limit value (No. 24).

## 2-3 Digital Operator Operation Example

The following shows an example of Digital Operator operation.

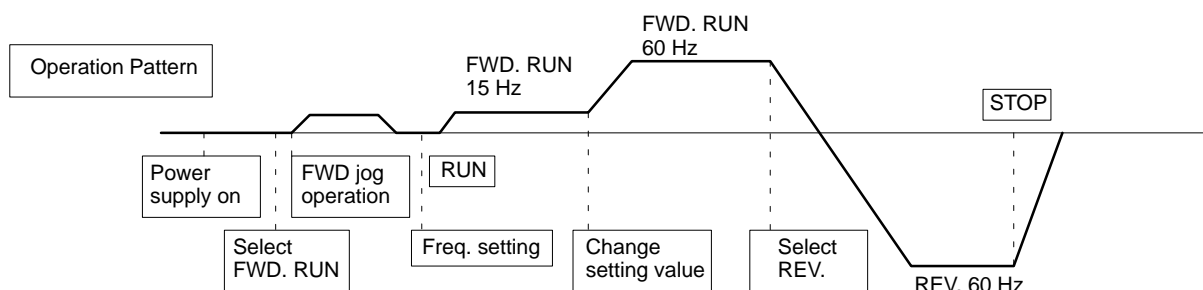

| Operation                                  | [Description]                                                                                                                                                                                     | [Key operation]                                                              | [Digital Operator display]                                          |
|--------------------------------------------|---------------------------------------------------------------------------------------------------------------------------------------------------------------------------------------------------|------------------------------------------------------------------------------|---------------------------------------------------------------------|
| Turn on power supply.                      | Frequency reference value is displayed.                                                                                                                                                           |                                                                              |                                                                     |
| FWD JOG                                    | Select output frequency monitor display. (optional)<br>Select rotating direction. (FWD is default on power on.)<br>Jog operation.                                                                 | NO<br>DSPL<br><br>JOG                                                        | <br>Indicator  lights.<br>                                          |
| FWD run<br>1.5 Hz                          | Frequency reference value display is selected.<br>Change reference value.<br>Set value is written-in. (Stops blinking for 3 s.)<br>Select output frequency monitor display.<br>Running operation. | NO<br>DSPL<br><br>><br>RESET<br>DATA<br>ENTER<br><br>NO<br>DSPL<br><br>• RUN | <br><br><br>(Stops blinking for 3 s.)<br><br><br>Indicator  lights. |
| Change frequency reference value.<br>60 Hz |                                                                                                                                                                                                   | NO<br>DSPL<br><br>><br>RESET<br>DATA<br>ENTER<br><br>NO<br>DSPL              | <br><br><br>                                                        |
| REV run<br>REV 60Hz                        |                                                                                                                                                                                                   | FWD<br>REV                                                                   | Indicator  lights.<br>                                              |
| Stop                                       |                                                                                                                                                                                                   | • STOP                                                                       | <br>Indicator  lights.<br>(  blinks while decelerating)             |

## 2-4 Constant Initialization and Write-protection

### 2-4-1 Constant Initialization

This operation returns the values of all constants to their original factory settings. To initialize constants, write 8 to constant No. 00.

| Description                     | Key Operation                                                                                                                                                       | Digital Operator Display |                                                   |                                                           |       |                                                           |    |
|---------------------------------|---------------------------------------------------------------------------------------------------------------------------------------------------------------------|--------------------------|---------------------------------------------------|-----------------------------------------------------------|-------|-----------------------------------------------------------|----|
| Select PRGM Mode.               | <table border="1"><tr><td>PRGM</td></tr><tr><td>ENTER</td></tr></table>                                                                                             | PRGM                     | ENTER                                             | <table border="1"><tr><td>no-01</td></tr></table>         | no-01 |                                                           |    |
| PRGM                            |                                                                                                                                                                     |                          |                                                   |                                                           |       |                                                           |    |
| ENTER                           |                                                                                                                                                                     |                          |                                                   |                                                           |       |                                                           |    |
| no-01                           |                                                                                                                                                                     |                          |                                                   |                                                           |       |                                                           |    |
| Select constant (No. 00).       | <table border="1"><tr><td>∇</td></tr></table>                                                                                                                       | ∇                        | <table border="1"><tr><td>no-00</td></tr></table> | no-00                                                     |       |                                                           |    |
| ∇                               |                                                                                                                                                                     |                          |                                                   |                                                           |       |                                                           |    |
| no-00                           |                                                                                                                                                                     |                          |                                                   |                                                           |       |                                                           |    |
| Constant (No. 00) is displayed. | <table border="1"><tr><td>DATA</td></tr><tr><td>ENTER</td></tr></table>                                                                                             | DATA                     | ENTER                                             | <table border="1"><tr><td>01</td></tr></table> See note 1 | 01    |                                                           |    |
| DATA                            |                                                                                                                                                                     |                          |                                                   |                                                           |       |                                                           |    |
| ENTER                           |                                                                                                                                                                     |                          |                                                   |                                                           |       |                                                           |    |
| 01                              |                                                                                                                                                                     |                          |                                                   |                                                           |       |                                                           |    |
| Change the set value.           | <table border="1"><tr><td>&gt;</td></tr><tr><td>RESET</td></tr></table> <table border="1"><tr><td>∧</td></tr></table> <table border="1"><tr><td>∇</td></tr></table> | >                        | RESET                                             | ∧                                                         | ∇     | <table border="1"><tr><td>08</td></tr></table> See note 2 | 08 |
|                                 | >                                                                                                                                                                   |                          |                                                   |                                                           |       |                                                           |    |
| RESET                           |                                                                                                                                                                     |                          |                                                   |                                                           |       |                                                           |    |
| ∧                               |                                                                                                                                                                     |                          |                                                   |                                                           |       |                                                           |    |
| ∇                               |                                                                                                                                                                     |                          |                                                   |                                                           |       |                                                           |    |
| 08                              |                                                                                                                                                                     |                          |                                                   |                                                           |       |                                                           |    |
|                                 | <table border="1"><tr><td>DATA</td></tr><tr><td>ENTER</td></tr></table>                                                                                             | DATA                     | ENTER                                             | <table border="1"><tr><td>End</td></tr></table>           | End   |                                                           |    |
| DATA                            |                                                                                                                                                                     |                          |                                                   |                                                           |       |                                                           |    |
| ENTER                           |                                                                                                                                                                     |                          |                                                   |                                                           |       |                                                           |    |
| End                             |                                                                                                                                                                     |                          |                                                   |                                                           |       |                                                           |    |

- Note**
1. Differs according to the setting data before changing.
  2. The display returns to 01 after write-in. This indicates that initialization is executed at writing-in the data.

### 2-4-2 Constant Write-protection

When constant no. 00 is set to 0, the settings in constants no. 01 to 19 can be read, but no constants (except no. 00) can be overwritten. The procedure below sets the value of constant no. 00 to 0.

| Description                     | Key Operation                                                                                                                                                       | Digital Operator Display |                                                   |                                                         |       |                                                |    |
|---------------------------------|---------------------------------------------------------------------------------------------------------------------------------------------------------------------|--------------------------|---------------------------------------------------|---------------------------------------------------------|-------|------------------------------------------------|----|
| Select PRGM Mode.               | <table border="1"><tr><td>PRGM</td></tr><tr><td>ENTER</td></tr></table>                                                                                             | PRGM                     | ENTER                                             | <table border="1"><tr><td>no-01</td></tr></table>       | no-01 |                                                |    |
| PRGM                            |                                                                                                                                                                     |                          |                                                   |                                                         |       |                                                |    |
| ENTER                           |                                                                                                                                                                     |                          |                                                   |                                                         |       |                                                |    |
| no-01                           |                                                                                                                                                                     |                          |                                                   |                                                         |       |                                                |    |
| Select constant (No. 00).       | <table border="1"><tr><td>∇</td></tr></table>                                                                                                                       | ∇                        | <table border="1"><tr><td>no-00</td></tr></table> | no-00                                                   |       |                                                |    |
| ∇                               |                                                                                                                                                                     |                          |                                                   |                                                         |       |                                                |    |
| no-00                           |                                                                                                                                                                     |                          |                                                   |                                                         |       |                                                |    |
| Constant (No. 00) is displayed. | <table border="1"><tr><td>DATA</td></tr><tr><td>ENTER</td></tr></table>                                                                                             | DATA                     | ENTER                                             | <table border="1"><tr><td>01</td></tr></table> See note | 01    |                                                |    |
| DATA                            |                                                                                                                                                                     |                          |                                                   |                                                         |       |                                                |    |
| ENTER                           |                                                                                                                                                                     |                          |                                                   |                                                         |       |                                                |    |
| 01                              |                                                                                                                                                                     |                          |                                                   |                                                         |       |                                                |    |
| Change the set value.           | <table border="1"><tr><td>&gt;</td></tr><tr><td>RESET</td></tr></table> <table border="1"><tr><td>∧</td></tr></table> <table border="1"><tr><td>∇</td></tr></table> | >                        | RESET                                             | ∧                                                       | ∇     | <table border="1"><tr><td>00</td></tr></table> | 00 |
|                                 | >                                                                                                                                                                   |                          |                                                   |                                                         |       |                                                |    |
| RESET                           |                                                                                                                                                                     |                          |                                                   |                                                         |       |                                                |    |
| ∧                               |                                                                                                                                                                     |                          |                                                   |                                                         |       |                                                |    |
| ∇                               |                                                                                                                                                                     |                          |                                                   |                                                         |       |                                                |    |
| 00                              |                                                                                                                                                                     |                          |                                                   |                                                         |       |                                                |    |
|                                 | <table border="1"><tr><td>DATA</td></tr><tr><td>ENTER</td></tr></table>                                                                                             | DATA                     | ENTER                                             | <table border="1"><tr><td>End</td></tr></table>         | End   |                                                |    |
| DATA                            |                                                                                                                                                                     |                          |                                                   |                                                         |       |                                                |    |
| ENTER                           |                                                                                                                                                                     |                          |                                                   |                                                         |       |                                                |    |
| End                             |                                                                                                                                                                     |                          |                                                   |                                                         |       |                                                |    |

- Note** Differs according to setting data before changing.
- The following table shows the levels of access for constant no. 00 values of 0 to 3.

| Constant no. 00 value     | Readable constants | Writeable constants |
|---------------------------|--------------------|---------------------|
| 0 (write-protect setting) | No. 00 to 19       | No. 00 only         |
| 1 (initial setting)       | No. 00 to 19       | No. 00 to 19        |
| 2                         | No. 00 to 29       | No. 00 to 29        |
| 3                         | No. 00 to 59       | No. 00 to 59        |
| 5                         | No. 00 to 69       | No. 00 to 69        |

## 2-5 Corrective Function

### 2-5-1 Adjustment of Frequency Setting Value, Output Frequency Bias (No. 23) and Gain (No. 22)

Any desired value of output frequency for frequency set value (0 to 10 V or 4 to 20 mA) can be set.

#### Example

Adjust so as to obtain 10% speed (6 Hz) at frequency setting voltage 0 V and 100% speed (60 Hz) at 8 V.

| Description                                | Key Operation                                                                                                                                                                                                                | Digital Operator Display                                                              |          |
|--------------------------------------------|------------------------------------------------------------------------------------------------------------------------------------------------------------------------------------------------------------------------------|---------------------------------------------------------------------------------------|----------|
| Select PRGM Mode.                          | <input type="button" value="PRGM"/><br><input type="button" value="ENTER"/>                                                                                                                                                  | <input type="text" value="no-01"/>                                                    | (No. 22) |
| <b>(Bias)</b><br>Select constant (No. 23). | <input type="button" value="^"/>                                                                                                                                                                                             | <input type="text" value="no-23"/>                                                    |          |
| Data (No. 23) are displayed.               | <input type="button" value="DATA"/><br><input type="button" value="ENTER"/>                                                                                                                                                  | <input type="text" value="0.00"/>                                                     |          |
| Change the set value.                      | <input type="button" value="&gt;"/><br><input type="button" value="RESET"/> <input type="button" value="^"/> <input type="button" value="v"/><br><input type="button" value="DATA"/><br><input type="button" value="ENTER"/> | <input type="text" value="0.10"/><br>(10 % = 0.1)<br><input type="text" value="End"/> |          |

| Description                                | Key Operation                                                                                                                                                                                                                | Digital Operator Display                                                          |  |
|--------------------------------------------|------------------------------------------------------------------------------------------------------------------------------------------------------------------------------------------------------------------------------|-----------------------------------------------------------------------------------|--|
| <b>(Gain)</b><br>Select constant (No. 22). | <input type="button" value="NO"/><br><input type="button" value="DSPL"/> <input type="button" value="v"/>                                                                                                                    | <input type="text" value="no-22"/>                                                |  |
| Data (No. 22) are displayed.               | <input type="button" value="DATA"/><br><input type="button" value="ENTER"/>                                                                                                                                                  | <input type="text" value="1.00"/>                                                 |  |
| Change the set value.                      | <input type="button" value="&gt;"/><br><input type="button" value="RESET"/> <input type="button" value="^"/> <input type="button" value="v"/><br><input type="button" value="DATA"/><br><input type="button" value="ENTER"/> | <input type="text" value="1.23"/> (See note.)<br><input type="text" value="End"/> |  |

**Note** 1. The gain can be calculated using the following equations:

$$x = \frac{100 - b}{a} \dots (1) \qquad G = \frac{10x + b}{100} \dots (2)$$

*a*: Setting voltage at 100% frequency  
*b*: Bias level (%)  
*G*: Gain set value

For example, if 100% speed (60 Hz) is obtained at 8 V, *a*=8. If 10% speed (6 Hz) is obtained at a frequency setting voltage of 0 V, *b*=10. In this case, the above equations yield *G*=1.23.

2. No. 22 and No. 23 can also be adjusted in DRIVE Mode.

## 2-5-2 Calibration of Frequency Meter

Calibration of frequency meter or ammeter connected to the Inverter can be performed even without providing a calibration resistor.

### Example

When the frequency meter specifications are 3 V and 1 mA scale, operation is performed at 60 Hz with a frequency setting voltage of 10 V.

| Description               | Key Operation        | Digital Operator Display       |
|---------------------------|----------------------|--------------------------------|
| Select PRGM Mode.         | PRGM<br>ENTER        | no-01                          |
| Select constant (No. 45). | NO<br>DSPL    ^    v | no-45                          |
| Data are displayed.       | DATA<br>ENTER        | 1.00                           |
| Change the set value.     | ><br>RESET    ^    v | 0.30    ... 10 V × 0.3 = 3.0 V |
|                           | DATA<br>ENTER        | End                            |

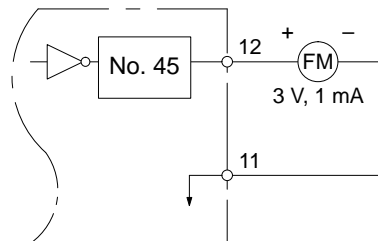

FREQ. meter calibration

## 2-6 Monitor

Frequency reference value, output frequency, output current and fault contents can be monitored.

### Typical Monitor Contents and Display

The monitor item is changed every time when the NO/DSPL Key is pressed.

**Key Operation**

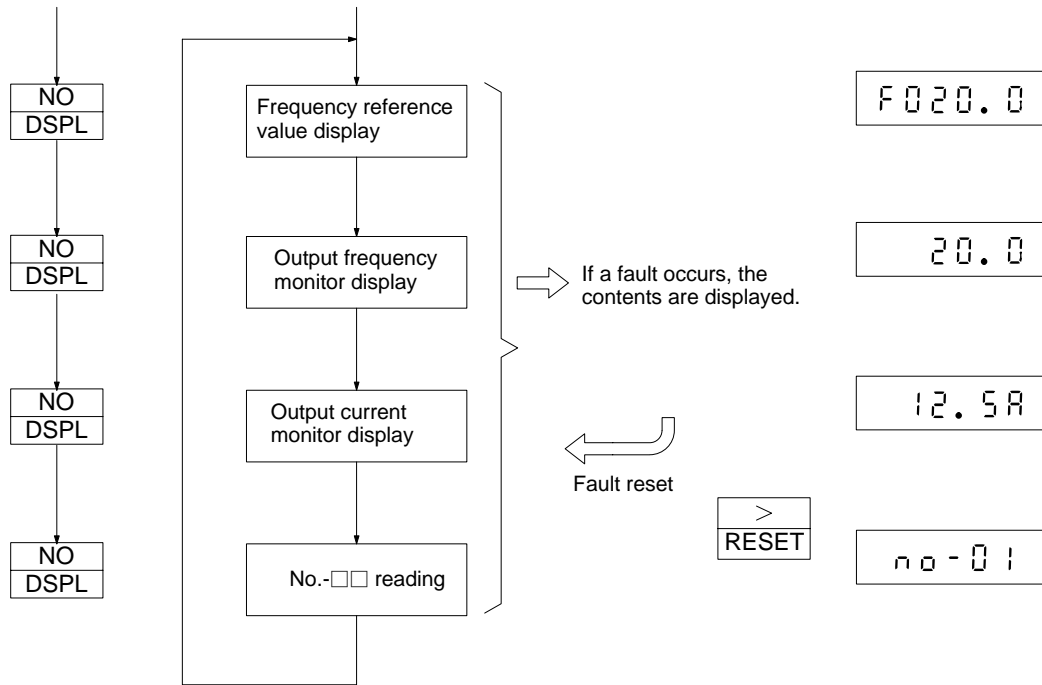

**Monitoring of Fault Contents**

If a fault occurs, the fault contents are displayed with priority over other display items. Press the >/RESET Key or turn on the fault reset signal to reset the fault.

Since the latest fault content data are stored in the Inverter, even if the power supply is turned off, they can be monitored after the power supply is turned on again.

•Checking fault contents

The latest data are stored in the constant No. 48. (except  $U_u$ )

•Clearing fault contents

The fault contents alone can be cleared by setting the value of constant No. 00 to 6. The fault contents will also be cleared when constants are initialized by setting constant No. 00 to 8 or 9. Other constants will also be initialized, so record the constant data before initialization.

•Faults to be stored

OC (overcurrent), OV (overvoltage), OH (cooling fan overheat), OL1 (motor overload), OL2 (Inverter overload), OL3 (overtorque detection), EF4, EF5 (external fault), CPF05 (AD converter fault).

Refer to 3-1 *Fault Display* for details.

## 2-7 Function/Constant List

### First Functions (Constant Nos. 0 to 19)

| Function                   | No. | Name                                       | Description                                                                                                                        | Initial setting                                                | User set values | See page |
|----------------------------|-----|--------------------------------------------|------------------------------------------------------------------------------------------------------------------------------------|----------------------------------------------------------------|-----------------|----------|
| Password setting           | 0   | Password                                   | 0: Password (No. 00) setting/reading and first function (constant Nos. 1 to 19) reading possible                                   | 1                                                              |                 | 44       |
| Constant write-protect     |     |                                            | 1: First function (constant Nos. 0 to 19) setting/reading possible                                                                 |                                                                |                 |          |
| Constant group selection   |     |                                            | 2: First and second function (constant Nos. 0 to 29) setting/reading possible                                                      |                                                                |                 |          |
|                            |     |                                            | 3: First, second and third function (constant Nos. 0 to 59) setting/reading possible                                               |                                                                |                 |          |
| Fault contents clear       |     |                                            | 5: First, second and third function (constant Nos. 0 to 69) setting/reading possible                                               |                                                                |                 |          |
| Constant initialization    |     |                                            | 6: Fault record clear                                                                                                              |                                                                |                 |          |
|                            |     |                                            | 8: Initialize (multifunction terminal: initial value setting)                                                                      |                                                                |                 |          |
|                            |     |                                            | 9: Initialize (3-wire sequence)                                                                                                    |                                                                |                 |          |
| Operation method selection | 1   | Run signal selection 1                     | 1 <sup>st</sup> digit = 0: Main frequency reference-external terminals 8 and 9 inputs<br>1: Main frequency reference-operator Fxxx | 0011<br>↑     ↑<br>4 <sup>th</sup> digit 1 <sup>st</sup> digit |                 | 45       |
| Stopping method selection  |     |                                            | 2 <sup>nd</sup> digit = 0: Run by external terminal run command<br>1: Run by operator run command                                  |                                                                |                 |          |
| V/f pattern setting        |     |                                            | 3 <sup>rd</sup> digit = 0: Deceleration to a stop<br>1: Coasting to a stop                                                         |                                                                |                 |          |
|                            |     | Output voltage limiter selection           | 4 <sup>th</sup> digit = 0: With output voltage limiter<br>1: Without output voltage limiter                                        |                                                                |                 | 47       |
| V/f characteristic setting | 2   | Maximum frequency                          | Setting unit: 0.1 Hz, setting range: 50.0 to 400.0 Hz                                                                              | 60.0 Hz                                                        |                 | 45       |
|                            | 3   | Maximum voltage                            | Setting unit: 0.1 V, setting range: 0.1 to 255.0 V                                                                                 | 200.0 V (Note 1)                                               |                 | 45       |
|                            | 4   | Maximum voltage frequency (base frequency) | Setting unit: 0.1 Hz, setting range: 0.1 to 400.0 Hz                                                                               | 60.0 Hz                                                        |                 | 45       |
|                            | 5   | Intermediate output frequency              | Setting unit: 0.1 Hz, setting range: 0.1 to 400.0 Hz                                                                               | 1.5 Hz                                                         |                 | 45       |
|                            | 6   | Intermediate output frequency voltage      | Setting unit: 0.1 V, setting range: 0.1 to 255.0 V                                                                                 | 12.0 V (Note 1)                                                |                 | 45       |



| Function                                      | No. | Name                             | Description                                                                                                                                                                                                                                                                                                                                                                                                      | Initial setting                                                                          | User set values | See page |
|-----------------------------------------------|-----|----------------------------------|------------------------------------------------------------------------------------------------------------------------------------------------------------------------------------------------------------------------------------------------------------------------------------------------------------------------------------------------------------------------------------------------------------------|------------------------------------------------------------------------------------------|-----------------|----------|
| V/f characteristic setting                    | 7   | Minimum output frequency         | Setting unit: 0.1 Hz, setting range: 0.1 to 10 Hz                                                                                                                                                                                                                                                                                                                                                                | 1.5 Hz                                                                                   |                 | 45       |
|                                               | 8   | Minimum output frequency voltage | Setting unit: 0.1 V, setting range: 0.1 to 50 V                                                                                                                                                                                                                                                                                                                                                                  | 12.0 V (Note 1)                                                                          |                 | 45       |
| First accel/ decel time setting (see note 2)  | 9   | Acceleration time 1              | Setting unit: 0.1 s, setting range: 0.0 to 600.0 s                                                                                                                                                                                                                                                                                                                                                               | 10.0 s                                                                                   |                 | 48       |
|                                               | 10  | Deceleration time 1              | Setting unit: 0.1 s, setting range: 0.0 to 600.0 s                                                                                                                                                                                                                                                                                                                                                               | 10.0 s                                                                                   |                 | 48       |
| Second accel/ decel time setting (see note 2) | 11  | Acceleration time 2              | Setting unit: 0.1 s, setting range: 0.0 to 600.0 s                                                                                                                                                                                                                                                                                                                                                               | 10.0 s                                                                                   |                 | 48       |
|                                               | 12  | Deceleration time 2              | Setting unit: 0.1 s, setting range: 0.0 to 600.0 s                                                                                                                                                                                                                                                                                                                                                               | 10.0 s                                                                                   |                 | 48       |
| Frequency reference (see note 2)              | 13  | Frequency reference 1            | Setting unit: 0.1 Hz, setting range: 0.0 to 400.0 Hz                                                                                                                                                                                                                                                                                                                                                             | 0.0 Hz                                                                                   |                 | 47       |
|                                               | 14  | Frequency reference 2            | Setting unit: 0.1 Hz, setting range: 0.0 to 400.0 Hz                                                                                                                                                                                                                                                                                                                                                             | 0.0 Hz                                                                                   |                 | 47       |
|                                               | 15  | Frequency reference 3            | Setting unit: 0.1 Hz, setting range: 0.0 to 400.0 Hz                                                                                                                                                                                                                                                                                                                                                             | 0.0 Hz                                                                                   |                 | 47       |
|                                               | 16  | Frequency reference 4            | Setting unit: 0.1 Hz, setting range: 0.0 to 400.0 Hz                                                                                                                                                                                                                                                                                                                                                             | 0.0 Hz                                                                                   |                 | 47       |
|                                               | 17  | Jogging frequency reference      | Setting unit: 0.1 Hz, setting range: 0.0 to 400.0 Hz                                                                                                                                                                                                                                                                                                                                                             | 6.0 Hz                                                                                   |                 | 47       |
| Electronic thermal overload motor protection  | 18  | Motor protection selection       | <p>1<sup>st</sup> digit = 0: Electronic thermal overload motor protection provided<br/>1: Electronic thermal overload motor protection not provided</p> <p>2<sup>nd</sup> digit = 0: Electronic thermal overload characteristic is for standard motor<br/>1: Electronic thermal overload characteristic is for constant torque motor</p> <p>3<sup>rd</sup> digit Not used<br/>4<sup>th</sup> digit: Not used</p> | <p>0000</p> <p>↑     ↑</p> <p>   1<sup>st</sup> digit</p> <p>   4<sup>th</sup> digit</p> |                 | 49       |
| Electronic thermal overload reference current | 19  | Motor rated current              | Setting unit: 0.1 A, setting range: 10% to 120% of Inverter rated current                                                                                                                                                                                                                                                                                                                                        | 1.9 A (see note 3)                                                                       |                 | 49       |

- Note**
1. Values for the 400-V Class are twice those for the 200-V Class.
  2. Can be changed even during run.
  3. Initial setting differs according to the Inverter capacity. the values in the above list are provided when Model 3G3XV-A2004

(0.4 kW) and standard motor 200 V 60 Hz. 0.4 kW are combined. Set the values described in the motor nameplate.

## Second Functions (Constant Nos. 20 to 29)

| Function                              | No. | Name                               | Description                                                                                                                                                                                                         | Initial setting                                                  | User set values | See page |     |
|---------------------------------------|-----|------------------------------------|---------------------------------------------------------------------------------------------------------------------------------------------------------------------------------------------------------------------|------------------------------------------------------------------|-----------------|----------|-----|
| REV run prohibit                      | 20  | Run signal selection 2             | 1 <sup>st</sup> digit = 0: REV run enabled<br>= 1: REV run disabled                                                                                                                                                 | 0000<br>↑<br>1 <sup>st</sup> digit<br>↑<br>4 <sup>th</sup> digit |                 | 45       |     |
| Operator stop key precedence          |     |                                    | 2 <sup>nd</sup> digit = 0: STOP Key effective<br>= 1: STOP Key ineffective                                                                                                                                          |                                                                  |                 |          |     |
| —                                     |     |                                    | 3 <sup>rd</sup> digit Not used.                                                                                                                                                                                     |                                                                  |                 |          | --- |
| Stall prevention during deceleration  |     |                                    | 4 <sup>th</sup> digit = 0: Stall prevention during deceleration provided<br>= 1: Stall prevention during deceleration not provided (at braking resistor connected)                                                  |                                                                  |                 |          | 50  |
| —                                     | 21  | Output monitor selection           | 1 <sup>st</sup> digit Not used.                                                                                                                                                                                     | 0000                                                             |                 | 49       |     |
| Analog monitor selection              |     |                                    | 2 <sup>nd</sup> digit = 0: Analog monitor - output frequency<br>= 1: Analog monitor - output current<br>(Analog monitor gain s set by constant No. 45.)                                                             |                                                                  |                 |          |     |
| S-curve at accel/decel time           |     |                                    | S-curve at accel/decel time<br>No S-curve 3rd digit = 0, 4th digit = 0<br>S-curve: 0.2 s 3rd digit = 0, 4th digit = 1<br>S-curve: 0.5 s 3rd digit = 1, 4th digit = 0<br>S-curve: 1.0 s 3rd digit = 1, 4th digit = 1 |                                                                  |                 |          | 58  |
| Output frequency control (see note 2) | 22  | Frequency reference gain           | Setting unit: 0.01, setting range: 0.01 to 2.00                                                                                                                                                                     | 1.00                                                             |                 | 48       |     |
|                                       | 23  | Frequency reference bias           | Setting unit: 0.01, setting range: -1.00 to 1.00                                                                                                                                                                    | 0.00                                                             |                 | 48       |     |
| Frequency limit control               | 24  | Frequency upper limit              | Setting unit: 1%, setting range: 0 to 110%                                                                                                                                                                          | 100%                                                             |                 | 50       |     |
|                                       | 25  | Frequency lower limit              | Setting unit: 1%, setting range: 0 to 110%                                                                                                                                                                          | 0%                                                               |                 |          |     |
| DC injection braking                  | 26  | DC injection braking current       | Setting unit: 1%, setting range: 0 to 100% of Inverter rated current.                                                                                                                                               | 50%                                                              |                 | 50       |     |
|                                       | 27  | DC injection braking time at stop  | Setting unit: 0.1 s, setting range: 0.0 to 25.5 s                                                                                                                                                                   | 0.5 s                                                            |                 |          |     |
|                                       | 28  | DC injection braking time at start | Setting unit: 0.1 s, setting range: 0.0 to 25.5 s                                                                                                                                                                   | 0.0 s                                                            |                 |          |     |
| Torque compensation                   | 29  | Automatic torque boost gain        | Setting unit: 0.1, setting range: 0.0 to 9.9                                                                                                                                                                        | 1.0                                                              |                 | 52       |     |

- Note**
1. When setting the second function, set  $r_{00-0}$  to 2 or 3.
  2. Can be changed even during run.

## Third Functions (Constant Nos. 30 to 49)

| Function                 |                      | No. | Name                                                            | Description                                                                                                                                                                                                                                                                                                                                                                                                                                                                              | Initial setting | User set values | See Page |
|--------------------------|----------------------|-----|-----------------------------------------------------------------|------------------------------------------------------------------------------------------------------------------------------------------------------------------------------------------------------------------------------------------------------------------------------------------------------------------------------------------------------------------------------------------------------------------------------------------------------------------------------------------|-----------------|-----------------|----------|
| Stall Prevention         |                      | 30  | Level of stall preventive operation during acceleration         | Setting unit: 1%, setting range 30% to 200%<br>Note: Stall prevention is not performed during acceleration when 200% is set.                                                                                                                                                                                                                                                                                                                                                             | 170%            |                 | 51       |
|                          |                      | 31  | Level of stall preventive operation during running              | Setting unit: 1%, setting range 30% to 200%<br>Note: Stall prevention is not performed during run when 200% is set.                                                                                                                                                                                                                                                                                                                                                                      | 160%            |                 |          |
| Multi-function selection | Contact input signal | 32  | Multifunction input selection 1 (terminal 4 function selection) | 0: FWD/REV run command (3-WIRE sequence selection)<br>1: External fault (NO contact input)<br>2: External fault (NC contact input)<br>3: Multi-step speed reference 1<br>4: Multi-step speed reference 2<br>5: JOG command<br>6: Accel/decel time select<br>7: External baseblock (NO contact input)<br>8: External baseblock (NC contact input)<br>9: Speed search from max. frequency<br>10: Speed search from set frequency<br>11: Accel/decel prohibit<br>12: Local/Remote operation | 1               |                 | 53       |
|                          |                      | 33  | Multifunction input selection 2 (terminal 5 function selection) | 1: External fault (NO contact input)<br>2: External fault (NC contact input)<br>3: Multi-step speed reference 1<br>4: Multi-step speed reference 2<br>5: JOG command<br>6: Accel/decel time select<br>7: External baseblock (NO contact input)<br>8: External baseblock (NC contact input)<br>9: Speed search from max. frequency<br>10: Speed search from set frequency<br>11: Accel/decel prohibit<br>12: Local/Remote operation<br>14: UP/DOWN command                                | 3               |                 |          |

| Function                         |                             | No.      | Name                                                             | Description                                                                                                                                                                           | Initial setting                                                  | User set values | See Page |
|----------------------------------|-----------------------------|----------|------------------------------------------------------------------|---------------------------------------------------------------------------------------------------------------------------------------------------------------------------------------|------------------------------------------------------------------|-----------------|----------|
| Multi-function selection         | Photo-coupler output signal | 34       | Multifunction input selection 1 (terminal 13 function selection) | 0: Running<br>1: Frequency coincidence<br>2: Zero speed<br>3: Frequency detection (output frequency $\geq$ frequency detection level)<br>4: Overtorque detection<br>5: Operation mode | 0                                                                |                 | 55       |
|                                  |                             | 35       | Multifunction input selection 2 (terminal 14 function selection) | 0: Running<br>1: Frequency coincidence<br>2: Zero speed<br>3: Frequency detection (output frequency $\geq$ frequency detection level)<br>4: Overtorque detection<br>5: Operation mode | 1                                                                |                 |          |
| Desired speed detection          |                             | 36       | Frequency detection level                                        | Setting unit: 0.1 Hz, setting range: 0.0 to 400.0 Hz                                                                                                                                  | 0.0 Hz                                                           |                 | 57       |
| Overtorque detection             |                             | 37       | Overtorque detection function selection                          | 1 <sup>st</sup> digit = 0: Overtorque detection not provided<br>= 1: Overtorque detection provided                                                                                    | 0000<br>↑<br>1 <sup>st</sup> digit<br>↑<br>4 <sup>th</sup> digit |                 | 56       |
|                                  |                             |          |                                                                  | 2 <sup>nd</sup> digit = 0: Detected only during speed coincidence<br>= 1: Detected during running                                                                                     |                                                                  |                 |          |
|                                  |                             |          |                                                                  | 3 <sup>rd</sup> digit = 0: Operation continued after overtorque detection<br>= 1: Output shut-off at overtorque detection                                                             |                                                                  |                 |          |
|                                  |                             |          |                                                                  | 4 <sup>th</sup> digit: Not used                                                                                                                                                       |                                                                  |                 |          |
|                                  |                             | 38       | Overtorque detection level                                       | Setting unit: 1%, setting range: 30% to 200%                                                                                                                                          | 160%                                                             |                 |          |
|                                  |                             | 39       | Overtorque detection time                                        | Setting unit: 0.1 s, setting range: 0.1 to 10.0 s                                                                                                                                     | 0.1 s                                                            |                 |          |
| Carrier frequency adjustment     |                             | 40       | Carrier frequency                                                | Setting unit: 2.5 kHz, setting range: 1 to 6 (2.5 to 15 kHz)                                                                                                                          | 4 (10 kHz)                                                       |                 | 57       |
| —                                |                             | 41 to 44 | Not used.                                                        | Setting disabled.                                                                                                                                                                     | —                                                                | —               | —        |
| Analog monitor scale calibration |                             | 45       | Analog monitor gain                                              | Setting unit: 0.01, setting range: 0.01 to 2.00                                                                                                                                       | 1.00                                                             |                 | 55       |

| Function                     | No. | Name                                                                           | Description                                                                                                                                                                                                                                                                                                                                                                                                                                                            | Initial setting | User set values | See Page |
|------------------------------|-----|--------------------------------------------------------------------------------|------------------------------------------------------------------------------------------------------------------------------------------------------------------------------------------------------------------------------------------------------------------------------------------------------------------------------------------------------------------------------------------------------------------------------------------------------------------------|-----------------|-----------------|----------|
| Function setting             | 46  | Operation selection after momentary power loss                                 | 1 <sup>st</sup> digit = 0: Operation stopped by momentary power loss detection<br>= 1: Operation continues after momentary power loss                                                                                                                                                                                                                                                                                                                                  | 0110            |                 | 59       |
|                              |     | Enable/Disable setting constants 9 to 17, 22, 23, 29, 45, and 57 in DRIVE mode | 2 <sup>nd</sup> digit = 0: Read only<br>= 1: Write possible                                                                                                                                                                                                                                                                                                                                                                                                            |                 |                 | 60       |
|                              |     | Selection level of stall-preventive operation during acceleration              | 3 <sup>rd</sup> digit = 0: Level of stall-preventive operation during acceleration is constant in the motor constant output power area<br>= 1: Level of stall-preventive operation during acceleration is automatically decreased in the motor constant output power area.<br><br><b>Note</b> Motor constant output power area is a frequency area higher than the maximum voltage frequency (base frequency). Set the 3rd digit to "1" when using a high-speed motor. |                 |                 |          |
| Auto reset/restart operation | 47  | No. of auto restart attempts                                                   | Setting unit: 1 time<br>Setting range: 0 to 10 times<br>(Setting to 0 disables fault retry function.)                                                                                                                                                                                                                                                                                                                                                                  | 0               |                 | 60       |
| Fault trace                  | 48  | Fault record                                                                   | The latest fault is number of auto restart attempt: 0 to 10 (setting disabled).                                                                                                                                                                                                                                                                                                                                                                                        |                 | ---             |          |
| Software version             | 49  | PROM No.                                                                       | PROM No. (04100) is displayed (setting disabled).                                                                                                                                                                                                                                                                                                                                                                                                                      |                 | ---             |          |
| Frequency jump control       | 50  | Setting prohibit frequency 1                                                   | Setting unit: 0.1 Hz, setting range: 0.0 to 400.0                                                                                                                                                                                                                                                                                                                                                                                                                      | 0.0 Hz          |                 | 60       |
|                              | 51  | Setting prohibit frequency 2                                                   | Setting unit: 0.1 Hz, setting range: 0.0 to 400.0                                                                                                                                                                                                                                                                                                                                                                                                                      | 0.0 Hz          |                 |          |
|                              | 52  | Setting prohibit frequency 3                                                   | Setting unit: 0.1 Hz, setting range: 0.0 to 400.0                                                                                                                                                                                                                                                                                                                                                                                                                      | 0.0 Hz          |                 |          |
|                              | 53  | Setting prohibit frequency range                                               | Setting unit: 0.1 Hz, setting range: 0.0 to 25.5                                                                                                                                                                                                                                                                                                                                                                                                                       | 1.0 Hz          |                 |          |

| Function                        | No.      | Name                                    | Description                                                                                            | Initial setting | User set values | See Page |
|---------------------------------|----------|-----------------------------------------|--------------------------------------------------------------------------------------------------------|-----------------|-----------------|----------|
| Speed search control            | 54       | Speed search deactivation current level | Setting unit: 1%, setting range: 0 to 200                                                              | 150%            |                 | 61       |
|                                 | 55       | Min. base-block time                    | Setting unit: 0.1 s, setting range: 0.0 to 5.0                                                         | 0.5 s           |                 |          |
|                                 | 56       | V/F during speed search                 | Setting unit: 0.1 s, setting range: 0.0 to 100.0                                                       | 100%            |                 |          |
| Slip compensation speed control | 57       | Slip compensation function              | Setting unit: 0.1%, setting range: 0.0 to 9.9 (100% = Max. Frequency)                                  | 0.0%            |                 | 64       |
|                                 | 58       | Motor no-load current                   | Setting unit: 0%, setting range: 0 to 99 (100% = Motor rated current $n_D-13$ )                        | 30%             |                 |          |
|                                 | 59       | Torque compensation filter time delay   | Setting unit: 0.1%, setting range: 0.1 to 25.5                                                         | 2 s             |                 |          |
| Factory setting                 | 60 to 66 | ---                                     | Do not set.                                                                                            | ---             | ---             | ---      |
| Inverter overload protection    | 67       | OL2 continuous operation selection      | 0: Continuous operation at 103% of rated current.<br>1: Continuous operation at 112% of rated current. | 0001            |                 | 65       |
| Factory setting                 | 68, 69   | ---                                     | Do not set.                                                                                            | ---             | ---             | ---      |

**Note** When setting the third function, set  $n_D-13$  to 3.

## 2-8 Description of Functions and Constants

### 2-8-1 Password Setting

Constant No. 00 is used both to limit read/write access to groups of constants and to clear the fault history or initialize constants. The following tables show the possible values for constant No. 00 and their corresponding functions.

| Constant no. 00 value     | Function                                                            |
|---------------------------|---------------------------------------------------------------------|
| 0 (write-protect setting) | Read access: Nos. 00 to 19 only<br>Write access: No. 00 only        |
| 1 (initial setting)       | Read access: Nos. 00 to 19 only<br>Write access: Nos. 00 to 19 only |
| 2                         | Read access: Nos. 00 to 29 only<br>Write access: Nos. 00 to 29 only |
| 3                         | Read access: Nos. 00 to 59<br>Write access: Nos. 00 to 59           |
| 6                         | Clears the fault history.                                           |

| Constant no. 00 value | Function                                                                                                                                                |
|-----------------------|---------------------------------------------------------------------------------------------------------------------------------------------------------|
| 8                     | Initializes all control constants. Terminal functions are returned to the initial factory settings.                                                     |
| 9                     | Initializes all control constants. Terminal functions are 3-wire sequence. For details, refer to 2-8-14 Multifunction Contact Input Function Selection. |

## 2-8-2 Operation Mode Selection

| Item name                   | Constant to be set | Factory preset |
|-----------------------------|--------------------|----------------|
| Start/stop procedure        | No. 01             | 0011           |
| Reverse rotation prevention | No. 20             | 0000           |

**Start/Stop Procedure** Control input can be selected from the Digital Operator or the terminal strip.

No. 1 = xx 11 (x means 1 or 0.)

0: Frequency command from external terminal  
1: Frequency command from the operator

0: Start/stop control from external terminal  
1: Start/stop control by the operator

**Stop Procedure** Stopping Mode can be selected according to the application

No. 1 = x0xx

0: Ramp to stop  
1: Coasting to a stop

### Reverse Rotation Prevention

Prevents accidental selection of reverse rotation.

No. 20 = xx01

0: Reverse rotation is possible.  
1: Reverse rotation is impossible.

0: STOP Key of Digital Operator effective.  
1: STOP Key of Digital Operator ineffective.

**Note** When controlling from the Digital Operator, the STOP Key is always effective regardless of the 2<sup>nd</sup> digit setting of constant no. 20.

## 2-8-3 V/f Characteristic Setting

| Item name                             | Constant | Factory preset        |
|---------------------------------------|----------|-----------------------|
| Output Voltage Limiter Selection      | No. 01   | 0011                  |
| Max. Output Frequency                 | No. 02   | 60.0 Hz               |
| Max. Voltage                          | No. 03   | 200.0 V (See note 1.) |
| Max. Voltage Output Frequency         | No. 04   | 60.0 Hz               |
| Intermediate Output Frequency         | No. 05   | 1.5 Hz                |
| Intermediate Output Frequency Voltage | No. 06   | 12.0 V (See note 1.)  |
| Min. Output Frequency                 | No. 07   | 1.5 Hz                |
| Min. Output Frequency Voltage         | No. 08   | 12.0 V (See note 1.)  |



In addition, any desired V/f pattern can be set for special specifications.

Any V/f pattern can be set according to the load characteristics. The factory preset value is set to 60 Hz saturation type pattern.

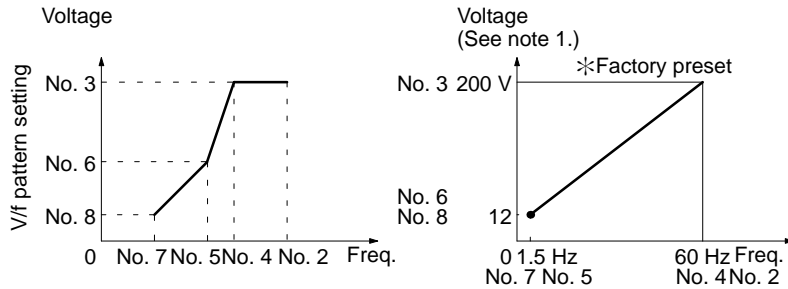

- Note**
1. Values for the 400-V Class are twice those of the 200-V Class.
  2. The output voltage will not exceed the upper limit if the output voltage limiter function is used. To increase the output voltage ignoring the upper limit, do not use the output voltage limiter function. For details refer to *Output Limiter Selection*.
  3. If an excessively large value is set in low-speed area (3 Hz or less), motor overheating or Inverter malfunction may occur.

**Output Limiter Selection** When V/f is set to an excessively large value, an Inverter fault may occur. Therefore, in order to prevent malfunction, an upper limit can be set for the output voltage. However, the setting is not necessary under normal operation.

No. 01 = 0xxx

4<sup>th</sup> digit

0: Desired V/f with output voltage limiter

1: Desired V/f without output voltage limiter

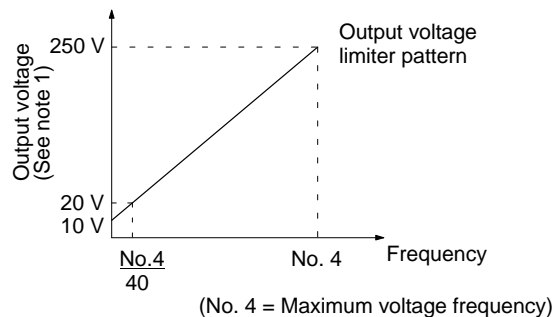

- Note**
1. Output voltages of the 400-V-Class are twice those of the 200-V-Class.
  2. If the 4<sup>th</sup> digit of constant No. 01 is set to 1, V/f Characteristic matching the motor characteristics must be set.

### 2-8-4 4-step Speed Change

| Item name                     | Constant to be set | Factory preset         |
|-------------------------------|--------------------|------------------------|
| Multi-speed frequency command | No. 13 to No. 16   | 0.0 Hz for both        |
| Multi-function command        | No. 32 and No. 33  | No. 32 = 1, No. 33 = 3 |

Up to 4 steps of speeds can be set using signals from external terminals 4 and 5. This eliminates the need for an analog signal thereby enabling operation by simplified external control. See the following example.

Set according to run specifications.

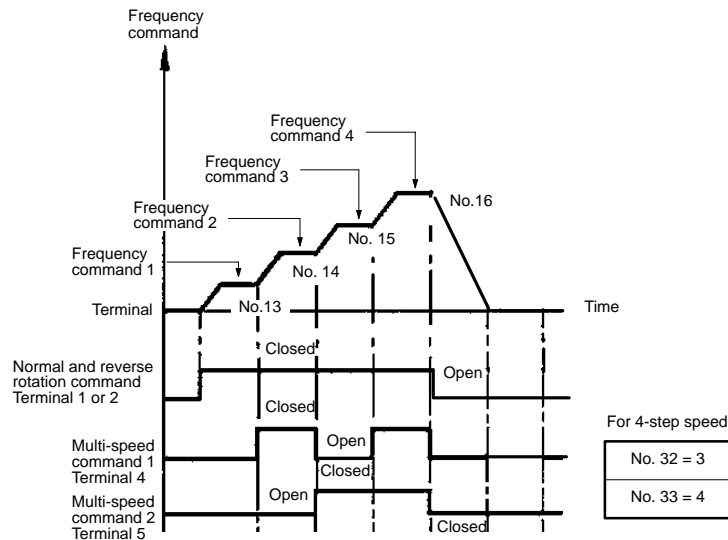

### 2-8-5 Jog Operation

| Item name               | Constant to be set | Factory preset         |
|-------------------------|--------------------|------------------------|
| Jog frequency           | No. 17             | 6.0 Hz                 |
| Jog reference selection | No. 32 or No. 33   | No. 32 = 1, No. 33 = 3 |

The Jog command is input from multifunction contact input terminals 4 and 5. Set the value of constant No. 32 to 5 to specify jog operation for terminal 4, and set the value of constant No. 33 to 5 to specify jog operation for terminal 5.

Select the Jog Mode (connect terminal 4 or 5 to 6) and input the start signal. Jog operation starts.

Depressing the  Key on the Digital Operator performs the same operation.

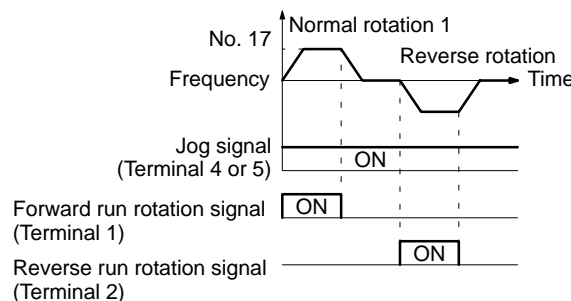

## 2-8-6 Accel/Decel Time and Patterns

| Item name               | Constant to be set | Factory preset         |
|-------------------------|--------------------|------------------------|
| Acceleration time 1     | No. 9              | 10.0 s                 |
| Deceleration time 1     | No. 10             | 10.0 s                 |
| Acceleration time 2     | No. 11             | 10.0 s                 |
| Deceleration time 2     | No. 12             | 10.0 s                 |
| Accel/Decel Time Select | No. 32 or No. 33   | No. 32 = 1, No. 33 = 3 |

Each item can be set from 0.0 sec to 600.0 sec.

The set time indicates the interval required before the maximum output frequency No. 2 is reached.

Time marked with \* can be set for two-step switching using an external contact.

The accel/decel time select command is input from multifunction contact input terminals 4 and 5. Set the value of constant No. 32 to 6 to specify accel/decel time select operation for terminal 4, and set the value of constant No. 33 to 6 to specify accel/decel time select operation for terminal 5.

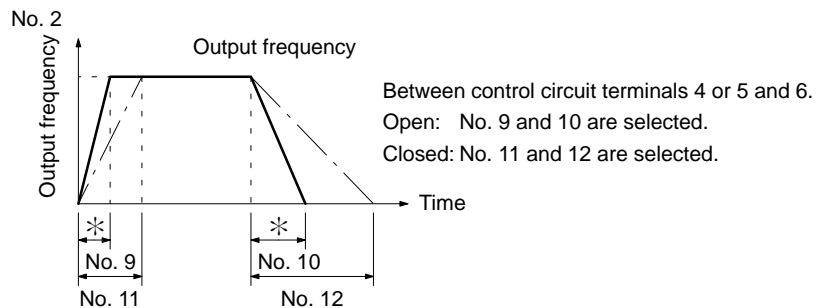

## 2-8-7 Output Frequency Control (Gain/Bias)

| Item name              | Constant to be set | Factory preset |
|------------------------|--------------------|----------------|
| Frequency command gain | No. 22             | 1.0            |
| Frequency command bias | No. 23             | 0.00           |

Output frequency (gain/bias) can be set freely according to frequency setting (0 to 10 V or 4 to 20 mA)

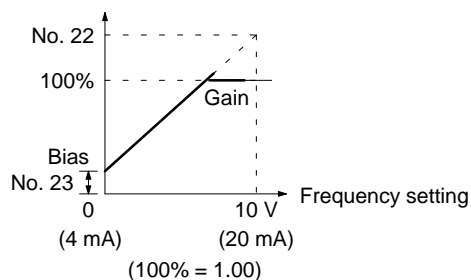

## 2-8-8 Electronic Thermal Overload Function

| Item name           | Constant to be set | Factory preset    |
|---------------------|--------------------|-------------------|
| Motor type          | No. 18             | 0000              |
| Motor rated current | No. 19             | 1.9 A (for A2004) |

Motor output current is monitored by the Inverter's built-in electronic thermal overload function to prevent Inverter exclusive-use motors or standard motors from overloading.

It is not necessary to mount a thermal overload relay externally. However, to connect several motors to one Inverter, a thermal overload relay must be inserted for each motor. It is necessary to reduce carrier frequency according to the wiring distance between the Inverter and motor when thermal overload relays are inserted. For details, refer to the precautions on wiring described in *1-4 Wiring*.

No. 19 = Motor rated current value

Set the motor rated current value according to the value on the motor nameplate.

No. 18 = xx00

└ 1<sup>st</sup> digit

0: Electronic thermal overload function enabled

1: Electronic thermal overload function disabled

└ 2<sup>nd</sup> digit

0: Standard motor

1: Exclusive-use motor

Electronic thermal protection can be disabled by setting "No. 18 = xxx1."

## 2-8-9 Multi-function Analog Output Monitor

| Item name                | Constant to be set | Factory preset |
|--------------------------|--------------------|----------------|
| Output monitor selection | No. 21             | 0000           |

Output frequency or motor current can be monitored. (Standard function)

No. 21 = xx0x

└ 2<sup>nd</sup> digit

0: Output frequency is monitored.

1: Motor current is monitored.

Analog output monitor gain can be set to No. 45.

### 2-8-10 Output Frequency Limit

| Item name                             | Constant to be set | Factory preset |
|---------------------------------------|--------------------|----------------|
| Frequency (speed) command upper limit | No. 24             | 100%           |
| Frequency (speed) command lower limit | No. 25             | 0              |

The upper and lower limits for the output frequency can be clamped. When the lower limit is not 0, acceleration to that lower limit setpoint begins immediately when the start command is input.

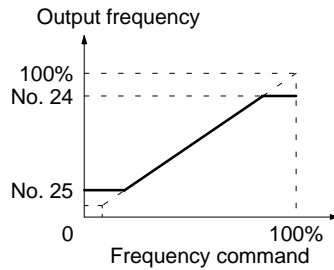

**Note** By setting constant No. 24 to 110%, frequencies up to 1.1 times the value of constant No. 2 can be output. However, 400 Hz is the highest frequency that can be output.

For example, assume constant No. 2 = 60 Hz. A frequency of 66 Hz will be output if constant No. 24 = 1.1.

### 2-8-11 DC Injection Braking

| Item name                    | Constant to be set | Factory preset |
|------------------------------|--------------------|----------------|
| DC injection braking current | No. 26             | 50%            |
| DC injection during stop     | No. 27             | 0.5 s          |
| DC injection at start        | No. 28             | 0.0 s          |

#### DC Injection Braking Current

A 100% setting for the DC injection braking current equals the Inverter’s rated current. The default setting set at the factory prior to shipping is 50%.

#### DC Injection Braking During Stop

Prevents overrun at stop. (Exact position stop)

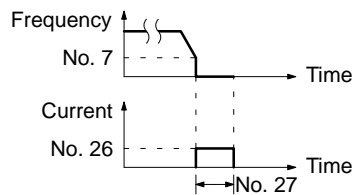

#### Starting DC Injection Braking During Start

Stops a coasting motor without tripping even when the direction of rotation is unknown.

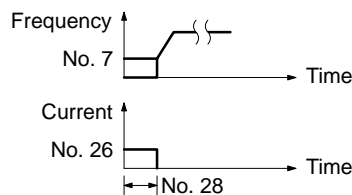

### 2-8-12 Motor Stall Prevention Function

| Item name                                                | Constant to be set | Factory preset |
|----------------------------------------------------------|--------------------|----------------|
| Operation level for stall prevention during acceleration | No. 30             | 170%           |
| Operation level for stall prevention during running      | No. 31             | 160%           |
| Stall prevention during deceleration                     | No. 20             | 0000           |

Automatically adjusts output frequency according to the load so as to continue operation of the machine without stalling the motor.

#### Stall Prevention During Acceleration

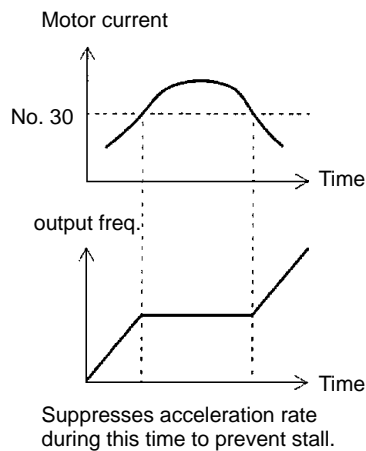

#### Stall Prevention During Running

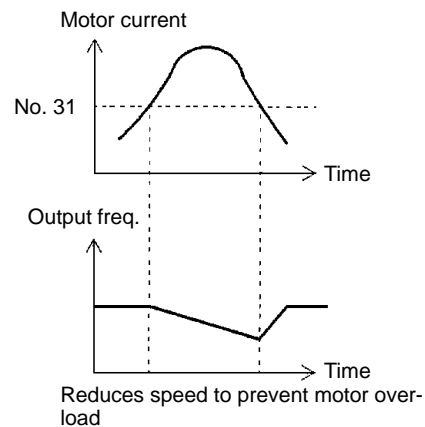

#### Stall Prevention During Deceleration

Set "1" for connecting braking resistor unit.

No. 20 = 0xxx

- 0: Stall prevention during deceleration enabled
- 1: Stall prevention during deceleration disabled

#### Automatic Drop of Stall Prevention Operation Level During Acceleration in Constant Power Output Area

When using a high-speed motor that uses the constant power output area (with frequency of higher than the maximum voltage frequency), the stall prevention operation level must be lowered.

V/F Pattern

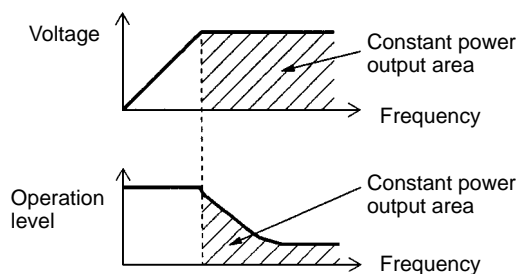

Set the third digit of No. 46 to "1." The Inverter will automatically lower the operating level to ensure stable operation in the constant power output area.

The operation level is lowered according to the following calculation.

$$OP1 = OP2 \times VF / OF$$

OP1: Stall prevention operation level during acceleration in the constant power output area

OP2: Stall prevention operation level during acceleration (No. 30)

VF: Maximum voltage frequency (No. 04)

OF: Output frequency

### 2-8-13 Full-range Automatic Torque Boost

| Item name                | Constant to be set | Factory preset |
|--------------------------|--------------------|----------------|
| Torque compensation gain | No. 29             | 1.0            |

Automatic control of V/f ratio according to the load torque ensures tripless operation and optimum output current. Normally, no adjustment is necessary. Use this function especially when motor capacity is smaller than Inverter capacity and torque is required.

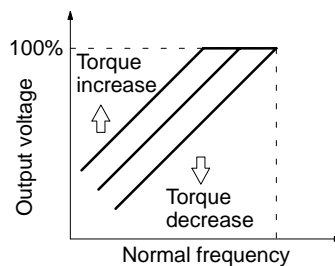

## 2-8-14 Multifunction Contact Input Function Selection

| Item name                            | Constant to be set | Factory preset         |
|--------------------------------------|--------------------|------------------------|
| Multifunction contact input function | No. 32 and No. 33  | No. 32 = 1, No. 33 = 3 |

The function of external output terminals 4 and 5 can be changed if necessary. Set No. 32 and No. 33 in the descending order.

Terminal 4 function: set No. 32.

Terminal 5 function: set No. 33.

| Set value       | Function                                           |
|-----------------|----------------------------------------------------|
| 0 (see note 1)  | FWD/REV run command<br>(3-WIRE sequence selection) |
| 1 (see note 2)  | External fault (NO contact input)                  |
| 2               | External fault (NC contact input)                  |
| 3 (see note 3)  | Multi-step speed reference 1                       |
| 4               | Multi-step speed reference 2                       |
| 5               | JOG command                                        |
| 6               | Accel/Decel time select                            |
| 7               | External baseblock (NO) contact input              |
| 8               | External baseblock (NC) contact input              |
| 9               | Search command from maximum frequency              |
| 10              | Search command from setting frequency              |
| 11              | Accel/Decel prohibit command                       |
| 12              | Local/Remote operation                             |
| 14 (see note 4) | UP/DOWN command                                    |

- Note**
- “0” can be set only to No. 32.
  - Factory preset value for No. 32
  - Factory preset value for No. 33
  - “14” can be set only to No. 33.
  - Contact input capacity is 24 VDC 8 mA or less. Circuit leakage current at signal OFF must be 100  $\mu$ A or less.

Terminal function at 3-WIRE sequence selection:

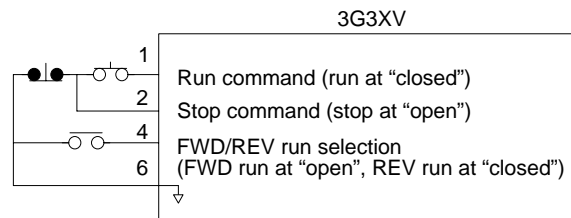

### Local/Remote Operation

No. 1 must first be set to 0000 or 0001. If terminal 4 or 5 is closed, local operation from the Digital Operator is in effect. If terminals 4 and 5 are open, remote operation from the external terminals is in effect. Inverter operation must be stopped before switching from remote to local operation, otherwise the *SErr* is displayed. The Inverter operation, however, is not be affected by the *SErr* message.



**UP/DOWN Command** This command is used to increase or decrease the Inverter's frequency using the sequence input.

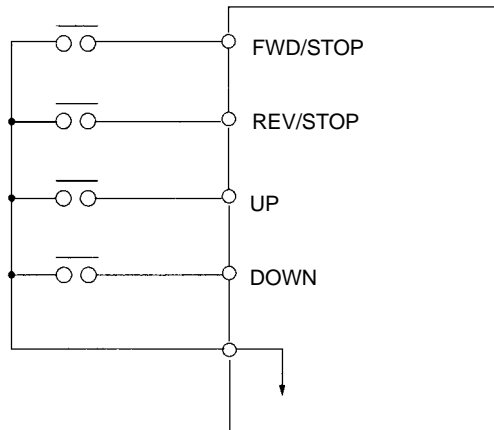

**Note** When No. 33 is set to "14" UP/DOWN command, the UP command will be allocated to terminal 4 and the settings of No. 32 will be ignored.

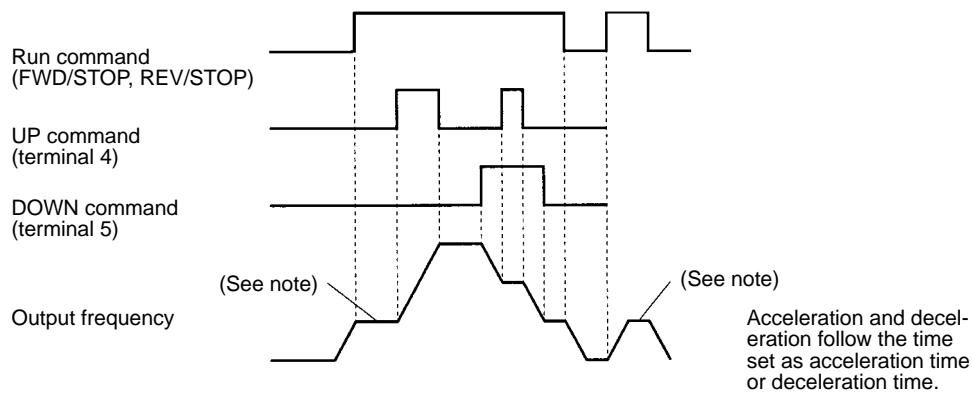

|            |              |              |      |      |
|------------|--------------|--------------|------|------|
| Terminal 4 | ON           | OFF          | OFF  | ON   |
| Terminal 5 | OFF          | ON           | OFF  | ON   |
|            | Acceleration | Deceleration | Hold | Hold |

**Note** Once the Run command is input, rotation starts from either the minimum frequency or the lower frequency limit, whichever is higher.

### 2-8-15 Multifunction Output Function

| Item name                     | Constant to be set | Factory preset         |
|-------------------------------|--------------------|------------------------|
| Multifunction output function | No. 34 and No. 35  | No. 34 = 0, No. 35 = 1 |

Constants No. 34 and No. 35 determine the functions of external output terminals 13 and 14, respectively. (Both of these terminals are used in connection with terminal 7.)

| Set value      | Function                                                                   |
|----------------|----------------------------------------------------------------------------|
| 0 (see note 1) | In operation                                                               |
| 1 (see note 2) | Frequency agreed                                                           |
| 2              | Zero speed                                                                 |
| 3              | Frequency detection<br>(output frequency $\geq$ frequency detection level) |
| 4              | Overtorque detected                                                        |

- Note**
1. Factory preset value for No. 34
  2. Factory preset value for No. 35

### 2-8-16 Frequency/Current Meter Calibration

| Item name               | Constant to be set | Factory preset |
|-------------------------|--------------------|----------------|
| Analog output gain      | No. 45             | 1.00           |
| analog output selection | No. 21             | 0000           |

Frequency/current meter connected to the Inverter can be calibrated without using a resistor for calibration.

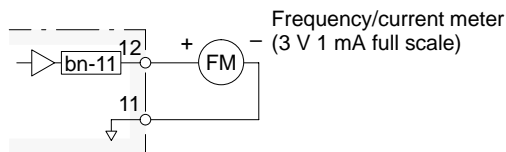

No. 21 = xx0x

- 0: Output frequency meter
- 1: Output current meter

The analog output monitor gain can be set with constant No. 45. The analog output monitor voltage is calculated from the following equations. (G= value set in constant No. 45)

#### Output Frequency Monitor

$$\text{Output voltage (V)} = \text{Output frequency} \times \frac{10 \text{ V}}{\text{Max. output frequency}} \times G$$

#### Output Current Monitor

$$\text{Output voltage (V)} = \text{Output current} \times \frac{10 \text{ V}}{\text{Inverter rated current}} \times G$$

- Note** Since the output current reaches about 200% max. of the Inverter's rated current, output voltage is limited to about 11 V max. when constant No. 45 is set to 1.00 and the Inverter's rated current is exceeded. Set constant No. 45 to approx. 0.5 to maintain linearity.

## 2-8-17 Overtorque Detection Function

| Item name                      | Constant to be set | Factory preset         |
|--------------------------------|--------------------|------------------------|
| Overtorque detection level     | No. 38             | 160%                   |
| Overtorque detection time      | No. 39             | 0.1 s                  |
| Overtorque detection signal    | No. 34 and No. 35  | No. 34 = 0, No. 35 = 1 |
| Overtorque detection selection | No. 37             | 0000                   |

When an excessive load is placed on the machine, the increase in motor current is detected and alarm signal can be output.

If the current exceeds the value set in No. 38 for longer than the time limit set in No. 39, the overtorque detection signal is output to control circuit terminal 13 or 14 until the current falls below the value set in No. 38.

To output the signal to control circuit terminal 13, set constant No. 34 to 4. To output the signal to control circuit terminal 14, set constant No. 35 to 4.

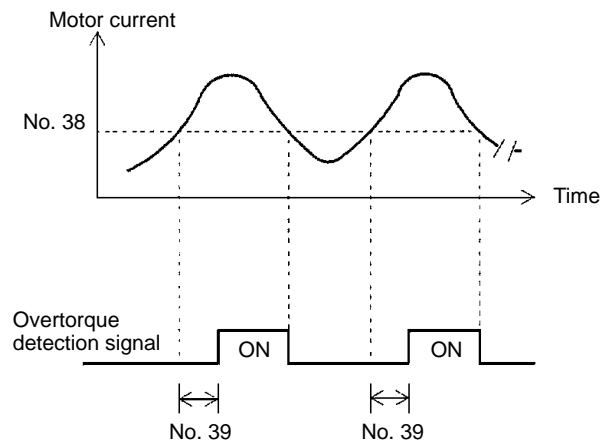

The second digit of No. 37 determines whether overtorque will be detected during acceleration and deceleration, and the third digit determines whether overtorque will be treated as a fault (OL3) or operation will continue after overtorque is detected.

No. 37 = x001

- 1<sup>st</sup> digit
  - 0: Overtorque detection disabled
  - 1: Overtorque detection enabled
- 2<sup>nd</sup> digit
  - 0: Detection only at steady speed
  - 1: Detection during accel/decel also
- 3<sup>rd</sup> digit
  - 0: Operation after overtorque detection
  - 1: Output shut off after overtorque detection

### 2-8-18 Carrier Frequency

| Item name                     | Constant to be set | Factory preset |
|-------------------------------|--------------------|----------------|
| Carrier frequency upper limit | No. 40             | 4              |

Changing the carrier frequency reduces RFI noise and leakage current without increasing motor noise.

$$\text{Carrier frequency (kHz)} = 2.5 \text{ kHz} \times \text{constant No. 40 value}$$

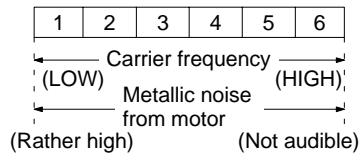
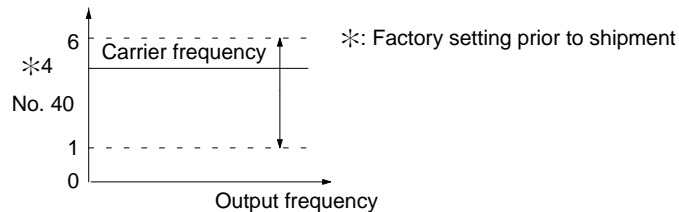

**Note** Reduce continuous output current for changing the frequency to 5 or 6.

| Carrier Frequency Set Value | Maximum Continuous Output Current     |
|-----------------------------|---------------------------------------|
| 1 to 4                      | Up to 100% of Inverter output current |
| 5                           | Up to 90% of Inverter output current  |
| 6                           | Up to 80% of Inverter output current  |

If the wiring distance between the Inverter and motor is long, reduce the carrier frequency. For details, refer to the wiring precautions described in *1-4 Wiring*.

### 2-8-19 Speed Agreed Signal Output

| Item name                             | Constant to be set | Factory preset         |
|---------------------------------------|--------------------|------------------------|
| Frequency detection level             | No. 36             | 0.0 Hz                 |
| Multifunction contact output function | No. 34 and No. 35  | No. 34 = 0, No. 35 = 1 |

This function is used when operation at an arbitrary speed must be indicated. Set the multifunction contact output (No. 34, No. 35) as follows:

**Set Value = 1: Frequency Agreed**

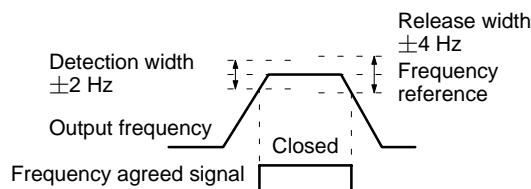

Set Value = 3: Set Value or More

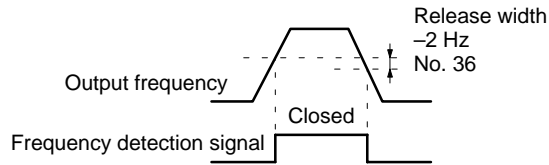

2-8-20 S-curve at Accel/Decel Time

| Item name                   | Constant to be set | Factory preset |
|-----------------------------|--------------------|----------------|
| S-curve at accel/decel time | No. 21             | 0000           |

Digit 3, Digit 4 (S-curve Selection of Soft Starter)

The S-curve characteristics of the soft starter depend on the setting of digits 3 and 4 of No. 21, as follows:

No. 21 = 00xx

4<sup>th</sup> digit | 3<sup>rd</sup> digit

- 0 0: No S-curve characteristic (linear accel.)
- 0 1: The S-curve characteristic is 0.2 s.
- 1 0: The S-curve characteristic is 0.5 s.
- 1 1: The S-curve characteristic is 1 s.

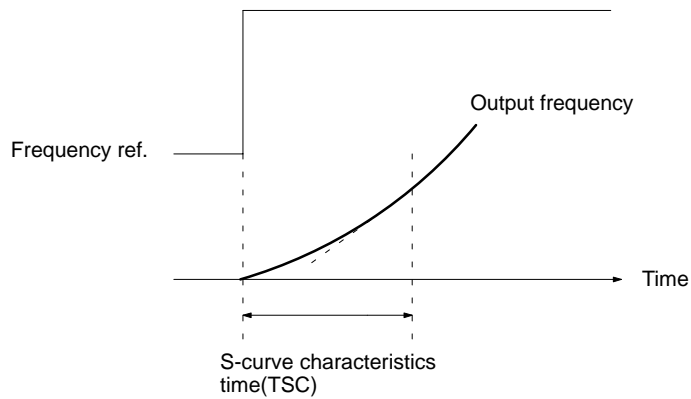

**Note** S-curve characteristics time refers to the time from acceleration rate 0 to the time when a normal acceleration rate determined by a specified acceleration time is obtained.

**Time chart at FWD/REV run change with S-curve characteristics:**

The figure below shows the time chart at FWD/REV run change during deceleration and stop.

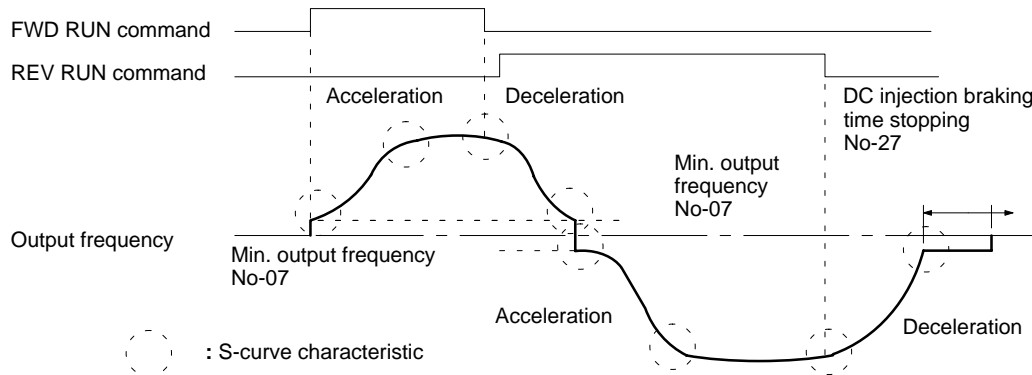

**Note** When digits 3 and 4 are 00, no S-curve characteristics at completion of deceleration.

**Time chart at FWD/REV run change without S-curve characteristics:**

The figure below shows the time chart at FWD/REV run change during deceleration and stop.

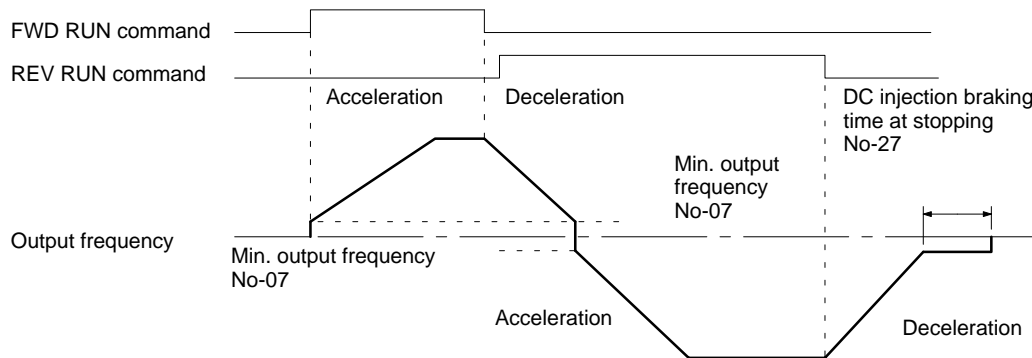

**2-8-21 Other Functions**

| Item name        | Constant to be set | Factory preset |
|------------------|--------------------|----------------|
| Function setting | No. 46             | 0110           |

**Operation Continued at Momentary Stop**

Digit 1 = 0: When momentary stop is detected, power failure (UV fault) occurs and the Inverter output is shut off.

Digit 1 = 1: If momentary stop time is within momentary assurance time (see note), the operation continues after the momentary stop. If the momentary assurance time is exceeded, the Inverter output is shut off.

- Note** 0.75 kW max.: Approximately 1 s.  
1.5 kW max.: Approximately 2 s.

**Enable/Disable Setting Constants in DRIVE Mode** Digit 2 = 0: Constant setting is disabled during running  
Digit 2 = 1: Constant setting is enabled during running (no-09 to no-17, no-22, no-23, no-29, no-45 are enabled)

**Selection Level of Stall Preventive Operation During Acceleration** Digit 3 = 0: Level of stall-preventive operation during acceleration is constant in the motor constant output power area  
Digit 3 = 1: Level of stall-preventive operation during acceleration is automatically decreased in the motor constant output power area.

- Note** Motor constant output power area is a frequency area higher than the maximum voltage frequency (base frequency). Set the 3rd digit to "1" when using a high-speed motor.

### 2-8-22 Enable/Disable Setting Constants in DRIVE Mode

| Item name                                                                      | Constant to be set | Factory preset |
|--------------------------------------------------------------------------------|--------------------|----------------|
| Enable/Disable setting constants 9 to 17, 22, 23, 29, 45, and 57 in DRIVE mode | No. 46             | 0              |

Digit 2 = 0: Read only

Digit 2 = 1: Write possible

### 2-8-23 No. of Auto Reset/Restart Operation (No. 47)

| Item name             | Constant to be set | Factory preset |
|-----------------------|--------------------|----------------|
| Fault retry selection | No. 47             | 00             |

Sets the number of auto reset/restart tries (up to 10). Setting this constant to zero disables the auto reset/restart operation.

Each time a OC, OV, OH, or GF fault occurs, the number of auto reset/restart tries is incremented by one. If this number reaches the value set in No. 47, another auto reset/restart attempt is not made.

The number of auto reset/restart tries is cleared to zero when:

- No fault occurs for 10 minutes.
- A fault reset signal is input from external terminals or Digital Operator.
- Power is turned off.

- Note** GF is for Single-phase Input Models only.

### 2-8-24 Setting Prohibit Frequency Range (No. 50 to No. 53)

| Item name        | Constant to be set | Factory preset |
|------------------|--------------------|----------------|
| Jump Frequency 1 | No. 50             | 0.0 Hz         |
| Jump Frequency 2 | No. 51             | 0.0 Hz         |
| Jump Frequency 3 | No. 52             | 0.0 Hz         |
| Jump width       | No. 53             | 1.0 Hz         |

Set the range of setting prohibit frequency in the units of 0.1 Hz. The range of the setting prohibit frequency is determined as follows, depending on combinations with No. 50 to No. 52.

No. 50 to No. 52 – No. 53 ≤ the range of the setting prohibit frequency ≤ No. 50 to No. 52 + No. 53

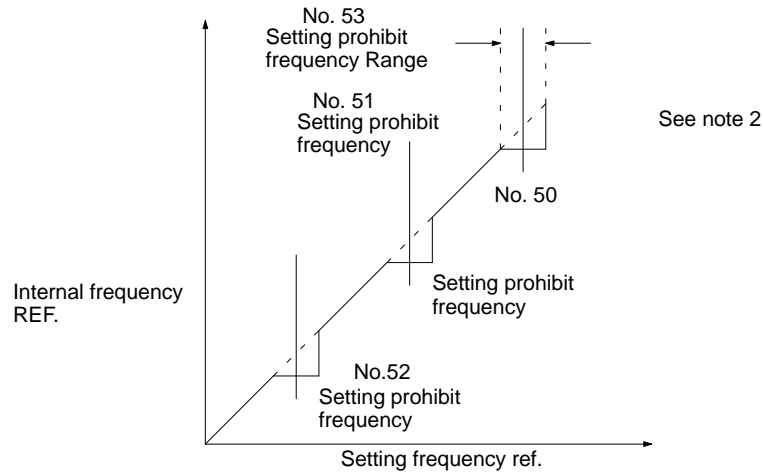

- Note**
1. Constant-speed operation is prohibited in the setting prohibit frequency range. Output frequency does not jump during acceleration or deceleration, which is performed smoothly.,
  2. Set as follows; No. 50 ≥ No. 51 ≥ No. 52

## 2-8-25 Speed Search Function

| Item name                               | Constant to be set | Factory preset |
|-----------------------------------------|--------------------|----------------|
| Multifunction contact input function    | No. 32, 33         | ---            |
| Speed search deactivation current level | No. 54             | 150%           |
| Minimum baseblock time                  | No. 55             | 0.5 s          |
| V/f during speed search                 | No. 56             | 100%           |

### Search Command (Set Value = 9, 10) (No. 32 or No. 33)

When search command is “closed” during baseblock, speed search is started after Inverter output is shut off for the minimum baseblock time.

Search commands with set values of 9 and 10 cannot be set at the same time.

Set value = 9: Speed search starts with the maximum frequency.



Set value = 10: Speed search starts with the frequency reference value when search command is input.

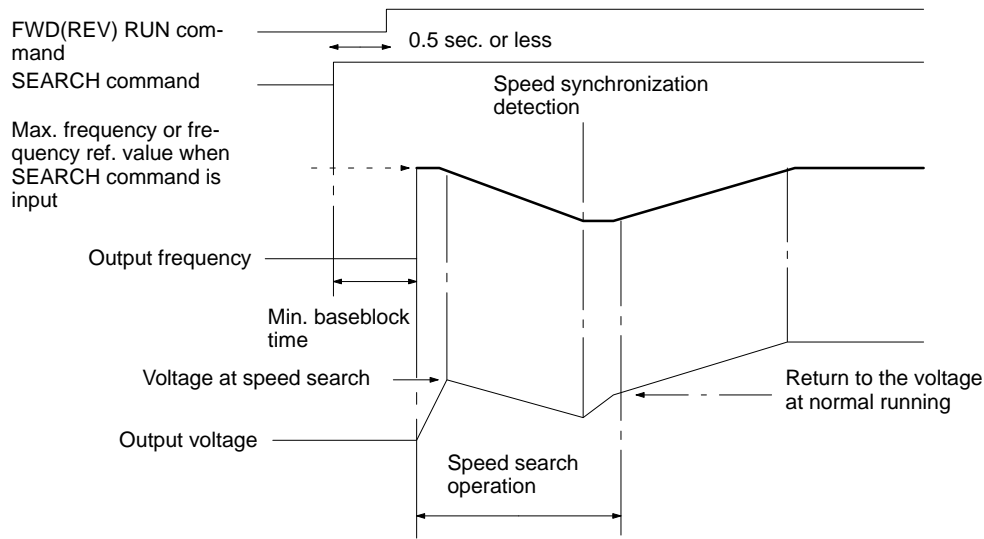

- Note**
1. In Momentary Stop Operation Continuation Mode, speed search operation is performed beginning with current output frequency, regardless of the existence of search command. After completion of speed search, the operation is performed according to the run command.
  2. Determine a sequence so that FWD/REV run command enters at the same time or later than search command.

**Example of Sequence**

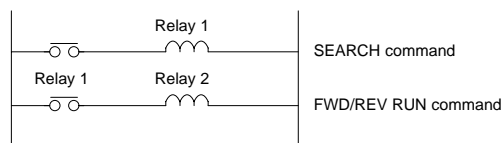

**Speed Search Deactivation Current Level (No. 54)**

When Inverter output current immediately after power recovery is larger than the set value of No. 54, speed search operation is started. When Inverter output current is smaller than the set value of No. 54, the frequency is interpreted as a speed synchronization point and acceleration or deceleration is performed again up to a specified frequency.

**Minimum Baseblock Time (No. 55)**

On detecting momentary power loss, the Inverter shuts off output and maintains the baseblock state for a given time. Set in No. 55 the time when motor residual voltage is expected to be almost zero.

When momentary power loss time is longer than the minimum baseblock time, speed search operation is started immediately after power recovery.

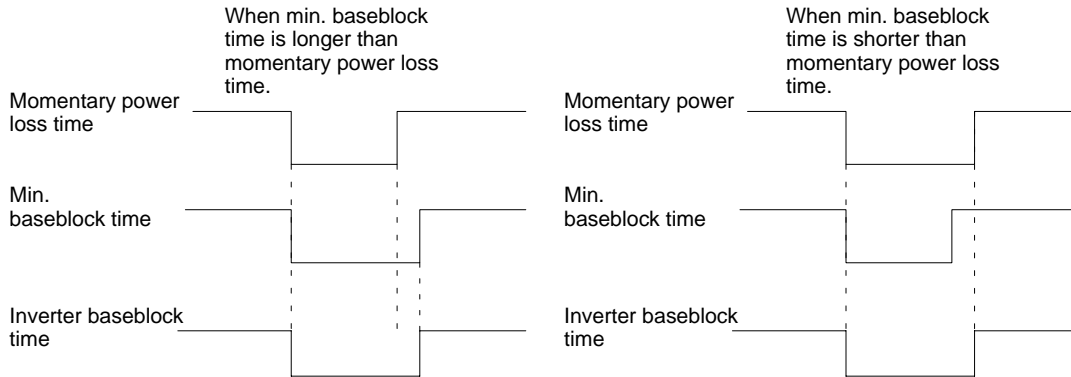

**V/f During Speed Search (No. 56)**

To ensure that a fault such as OC does not occur during speed search operation, V/f must be reduced during speed search operation, as compared with that during normal operation. Set V/f during speed search as follows by the set value of No. 56:

$$V/f \text{ during speed search} = V/f \text{ at normal operation} \times \text{No. 56}$$

**2-8-26 Accel/Decel Prohibit Function**

| Item name                     | Constant to be set | Factory preset         |
|-------------------------------|--------------------|------------------------|
| Accel/Decel Prohibit Function | No. 32 and No. 33  | No. 32 = 1, No. 33 = 3 |

When an accel/decel prohibit command is input during acceleration or deceleration, the output frequency is maintained and acceleration or deceleration is stopped as long as the input is being received.

If a stop command is received while the accel/decel prohibit command is being received, the accel/decel prohibit command will be overridden and operation will be stopped.

The accel/decel prohibit command can be input from multifunction contact input terminals 4 and 5. Set the value of constant No. 32 to 8 to specify an accel/decel prohibit command for terminal 4, and set the value of constant No. 33 to 6 to specify an accel/decel prohibit command for terminal 5.

The following time chart shows the operation of the accel/decel prohibit command:

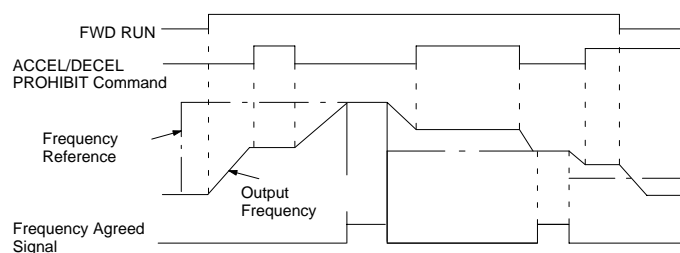

**Note** When the FWD (REV) run command is input in the status where the accel/decel prohibit command is input, the baseblock status is continued and the motor does not operate.

The motor will operate at the frequency set in constant No. 25 (frequency lower limit) when No. 25  $\geq$  No. 07 (minimum output frequency).

## 2-8-27 Slip Compensation Speed Control

| Item name                             | Constant to be set | Factory preset |
|---------------------------------------|--------------------|----------------|
| Slip Compensation Function            | No. 57             | 0%             |
| Motor No-load Current                 | No. 58             | 30%            |
| Torque Compensation Filter Time Delay | No. 59             | ---            |

- The slip compensation function keeps the rotating speed of the motor constant if the load is heavy. Without this function, the motor will slip and the rotating speed of the motor will decrease if the load is heavy.
- If the output current of the Inverter is equal to the electronic thermal reference current (i.e., the rated current of the motor), add the compensation frequency equivalent to the rated slippage value of the motor to the output frequency.
- Refer to the following formulas to obtain the constants to be set in no-57 and no-58.  
no-57 = (Synchronization speed – rated motor revolution)/synchronization speed x 100  
Synchronization speed =  $120/P f$   
P: No. of polls  
f: Rated frequency  
no-58 = (Output current with no load/rated current of the motor) x 100
- The compensation frequency (fc) can be obtained from the following.

If the output frequency is lower than the constant set in no-04 for the maximum voltage frequency, use the following formula to obtain the compensation frequency (fc).

$$fc = \text{no-04} \times \text{no-57} \times [\text{output current} - (\text{no-19} \times \text{no-58}/100)] / [\text{no-19} \times \text{no-58}/100]$$

If the output frequency is equal to or higher than the constant set in no-04 for the maximum voltage frequency, use the following formula to obtain the compensation frequency (fc).

$$fc = \text{output frequency} \times \text{no-57} \times [\text{output current} - (\text{no-19} \times \text{no-58}/100)] / [\text{no-19} - (\text{no-19} \times \text{no-58}/100)]$$

no-04: Maximum voltage frequency (Hz)

no-19: Electronic thermal reference current (A)

- Note** 1. The slip compensation function does not work if the output frequency is lower than the constant set in no-07 for the minimum output frequency.

2. The slip compensation function does not work if the Inverter is in regenerative operation.
  3. The slip compensation function does not work if 0.0 is set for the electronic thermal reference current.
- no-59 = Set to a small value if the response is slow and adjust to a large value if vibration occurs.

## 2-8-28 Inverter Overload Protection

| Item name                | Constant to be set | Factory preset |
|--------------------------|--------------------|----------------|
| OL2 Continuous Operation | No. 67             | 1              |

The Inverter output is shut-off when electronic thermal overload reaches or exceeds the inverse time limit of either 103% or 112% of the Inverter's rated current occurs.

Set value = 0: Continuous operation at 103% of rated current.

Set value = 1: Continuous operation at 112% of rated current.

**Note** When setting to the set value "1" (continuous operation at 112% of rated current), be sure to set the carrier frequency (No. 40, carrier frequency adjustment) to less than 10 kHz (or to the set value of 4 or less).

# SECTION 3

## Troubleshooting and Maintenance

This section describes troubleshooting, inspection, and maintenance procedures.

|       |                                                |    |
|-------|------------------------------------------------|----|
| 3-1   | Fault Display .....                            | 66 |
| 3-1-1 | Protection Functions .....                     | 66 |
| 3-1-2 | Warning and Self-diagnosis Functions .....     | 68 |
| 3-2   | Correcting Motor Faults .....                  | 69 |
| 3-3   | Maintenance .....                              | 70 |
| 3-3-1 | Periodic Inspection .....                      | 70 |
| 3-3-2 | High Voltage Test .....                        | 70 |
| 3-3-3 | Installing/Removing the Digital Operator ..... | 71 |

### 3-1 Fault Display

#### 3-1-1 Protection Functions

| Protection function                    |                          | Explanation                                                                                                                                                                                                                                                                                                                                                                                           | Monitor display                    | Fault contact output |
|----------------------------------------|--------------------------|-------------------------------------------------------------------------------------------------------------------------------------------------------------------------------------------------------------------------------------------------------------------------------------------------------------------------------------------------------------------------------------------------------|------------------------------------|----------------------|
| Low voltage protection                 | Main circuit voltage low | When the Inverter power voltage drops, torque becomes insufficient and motor is overheated. Inverter output is stopped when the main circuit DC voltage becomes lower than the low voltage detection level for 15 ms or longer.<br>Detection level: approximately 210 V or less (200 V, 3-phase)<br>approximately 170 V or less (200 V, single-phase)<br>approximately 420 V or less (400 V, 3-phase) | $UV1$ (UV1)                        | Operation            |
| Overcurrent protection                 |                          | The Inverter output is shut-off when the Inverter output current becomes approx. 200% and above of Inverter rated current.                                                                                                                                                                                                                                                                            | $OC$ (OC)                          | Operation            |
| Ground-fault protection                |                          | The Inverter output is shut-off when a ground-fault occurs at the Inverter output side.                                                                                                                                                                                                                                                                                                               | $GF$ (GF)                          | Operation            |
| Overvoltage protection                 |                          | The Inverter output is shut-off when the main circuit DC voltage becomes excessive because of regeneration energy caused by motor deceleration and negative load.<br>Detection level: approx. 410 V or more (200 V class)<br>approx. 820 V or more (400 V class)                                                                                                                                      | $OV$ (OV)                          | Operation            |
| Fuse blown                             |                          | The Inverter output is shut-off when the main circuit transistor fails.<br>The fuse clears to prevent wiring from being damaged by the short-circuit current.                                                                                                                                                                                                                                         | (Not displayed)                    | Non operation        |
| Cooling fin overheat                   |                          | The Inverter output is shut-off when the ambient temperature rises and the heat sink fin reaches 90°C.<br>Please check for a defective cooling fan or clogged filter.                                                                                                                                                                                                                                 | $OH$ (OH)                          | Operation            |
| Overload protection                    | Motor                    | Inverter output is stopped when motor overload is detected by the electronic thermal overload in the Inverter. Either a Inverter duty constant-torque specialized motor or general-purpose motor can be selected. If more than one motor is drive, overload protection should be disabled. Use a thermal relay or thermal protector for each motor.                                                   | $OL1$ (OL1)                        | Operation            |
|                                        | Inverter                 | The Inverter output is shut-off when electronic thermal overload reaches or exceeds the inverse time limit of 112% of the Inverter's rated current occurs. Maximum rated overload: 150%, 1 min.                                                                                                                                                                                                       | $OL2$ (OL2)                        | Operation            |
|                                        | Over torque detection    | The motor operates according to a preset mode when the Inverter output current exceeds the overtorque detection level. This function is used to protect the machine or to monitor the output torque.                                                                                                                                                                                                  | $OL3$ (OL3)                        | Operation            |
| External fault signal input            |                          | When an external alarm signal is input, the Inverter operates according to a preset stop method (coasting to a stop, or ramp to stop)                                                                                                                                                                                                                                                                 | $EF4$ (EF4)<br>$EF5$ (EF5)         | Operation            |
| Control circuit fault thermistor fault |                          | The Inverter output is shut-off when a transmission error occurs in the control circuit or a component fails.                                                                                                                                                                                                                                                                                         | $CPF00$ to $CPF05^*$<br>(see note) | Operation            |

**Note** \* indicates the content of Digital Operator display

| Protection function                       |                          | Error causes                                                                                                                                                                                                                                                                                         | Action to be taken                                                                                                                                                                                                                                           |
|-------------------------------------------|--------------------------|------------------------------------------------------------------------------------------------------------------------------------------------------------------------------------------------------------------------------------------------------------------------------------------------------|--------------------------------------------------------------------------------------------------------------------------------------------------------------------------------------------------------------------------------------------------------------|
| Low voltage protection                    | Main circuit voltage low | Inverter capacity is too small.<br>Voltage drop due to wiring.<br>A motor of large capacity (11 kW or greater) connected to the same power system has been started.<br>Rapid acceleration with generator power supply<br>Operation sequence when power is off<br>Defective electromagnetic contactor | Check the power capacity and power system.<br>UV display appears when the Inverter power is turned off while operation signal is input.<br>Remove the power after stopping the Inverter.                                                                     |
| Overcurrent protection                    |                          | Extremely rapid accel/decel<br>Motor on/off switching at the Inverter output side<br>Motor of a capacity greater than the Inverter rating has been started.<br>High-speed motor or pulse motor has been started.<br>Inverter output has been short circuited.                                        | Transistor error may occur. Investigate the error cause, correct it, then restart.                                                                                                                                                                           |
| Ground-fault protection                   |                          | Ground-fault at the Inverter output side                                                                                                                                                                                                                                                             |                                                                                                                                                                                                                                                              |
| Overvoltage protection                    |                          | Over voltage<br>Insufficient deceleration time<br>Regenerative load (Motor is turned by the load.)<br>High input voltage compared to motor rated voltage                                                                                                                                             | If braking torque is not proper, extend the decel time or use a braking resistor.                                                                                                                                                                            |
| Fuse blown                                |                          | Repeated overcurrent protection (OC)<br>Repeated overload protection (OL2) power reset<br>Rapid deceleration in excess excitation (improper V/f characteristic setting)                                                                                                                              | Turn off the power supply once and turn it on again.<br>If the fault occurs again after replacement, replace the Inverter.                                                                                                                                   |
| Cooling fin overheat                      |                          | Defective cooling fan<br>Ambient temperature rise<br>Clogged filter                                                                                                                                                                                                                                  | Replace the cooling fan and clean the filter.<br>Ambient temperature: 104°F (40°C) or less [113°F (45°C) or less with top cover off]                                                                                                                         |
| Overload protection                       | Motor                    | Overload, low speed operation or extended acceleration time, improper V/f characteristic setting                                                                                                                                                                                                     | Investigate the cause of overload and review the operation pattern, V/f characteristic, and motor/inverter capacities.<br>(If Inverter is repeatedly reset after an overload occurs, the Inverter may fault. Investigate and correct the cause of overload.) |
|                                           | Inverter                 |                                                                                                                                                                                                                                                                                                      |                                                                                                                                                                                                                                                              |
|                                           | Over torque detection    | Motor current exceeds the preset value because of machine error or overload                                                                                                                                                                                                                          | Check the use of the machine. Correct the overload cause or set a higher detection level which is within the allowable range.                                                                                                                                |
| External fault signal input               |                          | External fault condition occurred.                                                                                                                                                                                                                                                                   | Correct the cause of the fault input.                                                                                                                                                                                                                        |
| Control circuit fault<br>thermistor fault |                          | External noise<br>Excess vibration or shock                                                                                                                                                                                                                                                          | Record all data of CPFD4, then make initialization.<br>Turn off power, then turn on again. If error is persistent, replace the Inverter.                                                                                                                     |

### 3-1-2 Warning and Self-diagnosis Functions

| Protection function                                                                                                                  |                         | Explanation                                                                                                                                                                                                                                                                       | Monitor display          | Fault contact output |
|--------------------------------------------------------------------------------------------------------------------------------------|-------------------------|-----------------------------------------------------------------------------------------------------------------------------------------------------------------------------------------------------------------------------------------------------------------------------------|--------------------------|----------------------|
| Low-voltage protection (main circuit voltage insufficient)                                                                           |                         | Monitor display appears when the main circuit DC voltage drops under the detection level while the Inverter output is off.                                                                                                                                                        | UV (UV)<br>UU (Blink)    | Non operation        |
| Overtorque detection                                                                                                                 |                         | This function is used to protect the machine and to monitor the Inverter's output torque. The Inverter output reacts in a preset manner when the Inverter output current exceeds the over torque detection level. The monitor display blinks when "operation continue" is preset. | OL3 (OL3)<br>oL3 (Blink) | Non operation        |
| Stall prevention (Accel/decel is accomplished with maximum capacity of the Inverter without tripping on overcurrent or overvoltage.) | During acceleration     | Inverter acceleration is stopped when 170% of or more of the Inverter rated current is required by the load. This prevents overload protection (OL2) or overcurrent (OC) from occurring. When current is reduced to less than 170%, acceleration is enabled.                      | ---                      | Non operation        |
|                                                                                                                                      | During normal operation | Output frequency is decreased when 160% of the Inverter rated current or greater is required by the load. This prevents motor and Inverter overload (OL1, OL2). When current is reduced below 160%, Inverter acceleration is then enabled.                                        |                          |                      |
|                                                                                                                                      | During deceleration     | Deceleration is stopped when the DC voltage is caused to rise by motor regenerative energy. This prevents overvoltage trips (OV). When DC voltage decreases, deceleration to the set value then resumes.                                                                          |                          |                      |
| Simultaneous forward and reverse rotation commands                                                                                   |                         | When forward and reverse rotation commands are simultaneously detected for a period of time exceeding 500 ms, the Inverter is stopped according to the preset stop method.                                                                                                        | EF (EF)<br>EF (Blink)    | Non operation        |
| External base block signal input (main circuit transistor instantaneous shut-off)                                                    |                         | When an external base block signal is input, the motor coasts to a stop. When the external base block signal is removed, the Inverter output is immediately turned on at the previously set frequency.                                                                            | BB (BB)<br>bb (Blink)    | Non operation        |



| Protection function                                                                                                                  |                         | Error causes                                                               | Action to be taken                                                                                                                                |
|--------------------------------------------------------------------------------------------------------------------------------------|-------------------------|----------------------------------------------------------------------------|---------------------------------------------------------------------------------------------------------------------------------------------------|
| Low-voltage protection (main circuit voltage insufficient)                                                                           |                         | Input voltage drop                                                         | Check the input power supply voltage using a tester. If the voltage is low, adjust the input voltage.                                             |
| Overtorque detection                                                                                                                 |                         | Motor current exceeded the set value because of machine fault or overload. | Check the driven machine and correct the cause of the fault or set to a higher value.                                                             |
| Stall prevention (Accel/decel is accomplished with maximum capacity of the Inverter without tripping on overcurrent or overvoltage.) | During acceleration     | Insufficient power for accel/decel<br>Overload<br>Phase loss               | Set proper accel/decel time for smooth operation.<br>For stall prevention during normal operation lighten the load or increase Inverter capacity. |
|                                                                                                                                      | During normal operation |                                                                            |                                                                                                                                                   |
|                                                                                                                                      | During deceleration     |                                                                            |                                                                                                                                                   |
| Simultaneous forward and reverse rotation commands                                                                                   |                         | Operation sequence error<br>3-wire/2-wire selection error                  | Recheck the control sequence.<br>Recheck constant settings (No. 32).                                                                              |
| External base block signal input (main circuit transistor instantaneous shut-off)                                                    |                         | ---                                                                        | ---                                                                                                                                               |

### 3-2 Correcting Motor Faults

The following table lists possible causes and corrective actions for faults that might occur.

| Fault                              | Possible Cause                                                                                                                  | Corrective Action                                                                                |
|------------------------------------|---------------------------------------------------------------------------------------------------------------------------------|--------------------------------------------------------------------------------------------------|
| Motor does not rotate.             | Power supply voltage is not supplied to power supply terminals L1 (R), L2 (S), and L3 (T). (The CHARGE indicator should be on.) | Turn on power supply.<br>Turn power supply off and then on again.<br>Check power supply voltage. |
|                                    | Voltage is not being output to output terminals T1 (U), T2 (V), and T3 (W).                                                     | Turn power supply off and then on again.                                                         |
|                                    | Load is too large. (Motor is locked.)                                                                                           | Reduce the load. (Release the lock.)                                                             |
|                                    | A fault is displayed.                                                                                                           | Correct the fault as described in <i>3-1 Fault Display</i> .                                     |
|                                    | FWD or REV run command has not been entered.                                                                                    | Correct the wiring.                                                                              |
|                                    | Frequency setting signal has not been entered.                                                                                  |                                                                                                  |
|                                    | Operation (method selection) Mode setting is incorrect.                                                                         | Use the Digital Operator to check the Operation Method Selection Mode.                           |
| Motor rotating in wrong direction. | Wiring of output terminals T1 (U), T2 (V), and T3 (W) is incorrect.                                                             | Make sure that the terminals' phase order matches the motor terminals'.                          |
|                                    | Wiring of FWD or REV run signals is incorrect.                                                                                  | Correct the wiring.                                                                              |

| Fault                                            | Possible Cause                                                   | Corrective Action                                              |
|--------------------------------------------------|------------------------------------------------------------------|----------------------------------------------------------------|
| Motor rotates, but variable speed does not work. | Wiring of frequency setting circuit is incorrect.                | Correct the wiring.                                            |
|                                                  | Load is too large.                                               | Reduce the load.                                               |
| Motor speed is too high (low)                    | Motor ratings (number of poles, voltage) are incorrect.          | Check motor specifications and nameplate.                      |
|                                                  | Accel/decel ratio by speed converter (gears, etc.) is incorrect. | —                                                              |
|                                                  | Maximum frequency set value is incorrect.                        | Check the maximum frequency set value.                         |
|                                                  | Voltage drops excessively between motor terminals.               | Check the base frequency.                                      |
| Motor speed is unstable                          | Load is too large.                                               | Reduce the load.                                               |
|                                                  | Excessive load variation.                                        | Reduce load variation.<br>Increase Inverter or motor capacity. |

## 3-3 Maintenance

### 3-3-1 Periodic Inspection

The 3G3XV requires a few routine checks to ensure trouble-free operation. Be sure that the 3G3XV is kept clean, cool, and dry, and follow the recommendations given in *1-3-1 Location*.

Before inspecting the Unit, turn off the power and make sure that the CHARGE indicator is off.

| Component                                        | Check For                     | Corrective Action                                                                                                            |
|--------------------------------------------------|-------------------------------|------------------------------------------------------------------------------------------------------------------------------|
| Terminals, Unit mounting bolts, connectors, etc. | Loosened screws or connectors | Tighten                                                                                                                      |
| Cooling fins                                     | Build-up of dust and dirt     | Clean off with dry compressed air at a pressure of 57 to 85 psi (4 to 6 kg·cm <sup>2</sup> ).                                |
| Printed circuit board                            | Accumulation of dust or oil   | Dust and oil can conduct electricity. Clean the board if necessary. Replace Inverter unit if dust and oil cannot be removed. |
| Cooling fan                                      | Abnormal noise or vibration   | Replace cooling fan                                                                                                          |
| Power components                                 | Build-up of dust and dirt     | Clean off with dry compressed air at a pressure of 57 to 85 psi (4 to 6 kg·cm <sup>2</sup> ).                                |
| Smoothing capacitor                              | Discoloration or odor         | Replace capacitor or Inverter.                                                                                               |

### 3-3-2 High Voltage Test

Use an insulation resistance tester (500 V) to conduct an insulation resistance test (high voltage test) on the main control circuit, as described below.

- 1, 2, 3...** 1. Remove the Inverter's main circuit and control circuit terminal wiring and perform the test only between the main circuit terminals and ground G (E), as shown in the following figure.

- The equipment is normal if the insulation resistance tester indicating 1 MΩ or more.

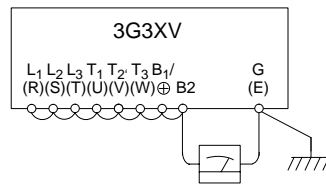

**Caution** Do not conduct a high voltage test on the control circuit terminals.

### 3-3-3 Installing/Removing the Digital Operator

Follow the procedures below to install or remove the Digital Operator. The Digital Operator must not be installed or removed while power is on; be sure to turn off the Inverter's power supply and check that the CHARGE indicator is off.

#### Operator Installation

Insert the Digital Operator directly into the Inverter as shown in the following figure.

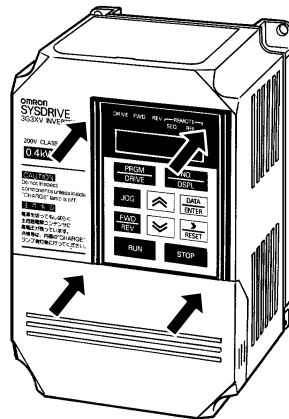

#### Operator Removal

- 1, 2, 3... 1. Remove the terminal cover by simultaneously squeezing the sides (1) and lifting (2), as shown below.

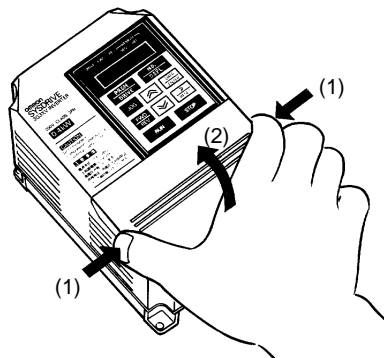

2. Press the lever down (3) and insert a standard screwdriver in slot A, as shown below, then lift the operator up (4) and out of the Inverter.

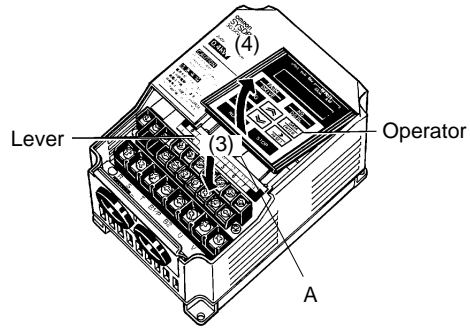

# Revision History

A manual revision code appears as a suffix to the catalog number on the front cover of the manual.

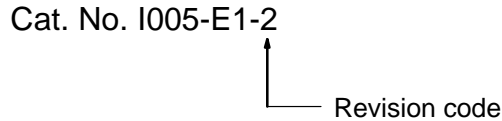

The following table outlines the changes made to the manual during each revision. Page numbers refer to the previous version.

| Revision code | Date          | Revised content                                                                                                                                                                                                                                                                                                                                                                                                                                                                                                                                                                                                                                                                                                                                                                                                                                                                                                                                                                                                                                                                                                                                                                                                                                                                                                                                                                                                                                                                                                                                                                                                                                                                                                                                                                                                                                                                                                                                                                                                                                                                          |
|---------------|---------------|------------------------------------------------------------------------------------------------------------------------------------------------------------------------------------------------------------------------------------------------------------------------------------------------------------------------------------------------------------------------------------------------------------------------------------------------------------------------------------------------------------------------------------------------------------------------------------------------------------------------------------------------------------------------------------------------------------------------------------------------------------------------------------------------------------------------------------------------------------------------------------------------------------------------------------------------------------------------------------------------------------------------------------------------------------------------------------------------------------------------------------------------------------------------------------------------------------------------------------------------------------------------------------------------------------------------------------------------------------------------------------------------------------------------------------------------------------------------------------------------------------------------------------------------------------------------------------------------------------------------------------------------------------------------------------------------------------------------------------------------------------------------------------------------------------------------------------------------------------------------------------------------------------------------------------------------------------------------------------------------------------------------------------------------------------------------------------------|
| 1             | March 1993    | Original production                                                                                                                                                                                                                                                                                                                                                                                                                                                                                                                                                                                                                                                                                                                                                                                                                                                                                                                                                                                                                                                                                                                                                                                                                                                                                                                                                                                                                                                                                                                                                                                                                                                                                                                                                                                                                                                                                                                                                                                                                                                                      |
| 1A            | July 1993     | <p><b>Page 5:</b> Data in the table has been corrected.</p> <p><b>Pages 9, 11, 12:</b> Inverter capacities in the tables have been corrected.</p> <p><b>Pages 21, 23:</b> Output characteristics' inverter capacities in the tables have been corrected.</p> <p><b>Pages 22, 24:</b> Weight data in the tables has been corrected.</p>                                                                                                                                                                                                                                                                                                                                                                                                                                                                                                                                                                                                                                                                                                                                                                                                                                                                                                                                                                                                                                                                                                                                                                                                                                                                                                                                                                                                                                                                                                                                                                                                                                                                                                                                                   |
| 1B            | March 1994    | <p><b>Pages 7, 14:</b> Terminal 8 in the wiring diagram corrected to 0 to +10 VDC (2 K<math>\Omega</math>).</p> <p><b>Page 37:</b> First digit of constant no. 1 corrected to terminals 8 and 9.</p> <p><b>Page 47:</b> Third digit for constant no. 18 corrected to reflect that it is not used.</p> <p><b>Page 57:</b> Set values in the heading for Search Command corrected to "Set Value = 9, 10."</p>                                                                                                                                                                                                                                                                                                                                                                                                                                                                                                                                                                                                                                                                                                                                                                                                                                                                                                                                                                                                                                                                                                                                                                                                                                                                                                                                                                                                                                                                                                                                                                                                                                                                              |
| 1C            | January 1996  | <p><b>Page 3:</b> "Enclosed type" and "open-chassis type" changed to "with top cover on" and "with top cover off," respectively.</p> <p><b>Page 13:</b> "Power supply coordination AC reactor" replaced with "AC reactor." Diagram corrected.</p> <p><b>Page 21:</b> Stall prevention level specification corrected.</p> <p><b>Page 25:</b> Radio noise protective filter function corrected.</p> <p><b>Page 29:</b> Constants that can be changed in DRIVE Mode have been added.</p> <p><b>Page 33:</b> Row where 00 = 5 added.</p> <p><b>Page 34:</b> Note 2 added.</p> <p><b>Page 37:</b> Set value 5 added to No. 0.</p> <p><b>Page 38:</b> References to note 2 added to No. 9 to No. 12.</p> <p><b>Page 39:</b> Setting range of torque compensation increased to 9.0. Note 2 added.</p> <p><b>Page 40:</b> Set values added to No. 32 and No. 33. Initial setting for No. 33 corrected to 3.</p> <p><b>Page 41:</b> 2<sup>nd</sup> digit for constant 46 added. PROM No. added for constant 49.</p> <p><b>Page 42:</b> No. 57 to No. 59 and No. 67 added. Note 1 deleted.</p> <p><b>Page 50:</b> Set values and note 4 added.</p> <p><b>Page 51:</b> <i>Local/Remote Operation</i> and <i>UP/DOWN Command</i> added.</p> <p><b>Page 56:</b> <i>2-8-22 Enable/Disable Setting Constants in DRIVE Mode</i> added.</p> <p><b>Page 59:</b> <i>2-8-26 Slip Compensation Speed Control</i> and <i>2-8-27 Inverter Overload Protection</i> added.</p>                                                                                                                                                                                                                                                                                                                                                                                                                                                                                                                                                                                                                                    |
| 2             | November 1997 | <p>Model number suffix "-E" changed to "EV2" throughout the manual.</p> <p><b>Page 3:</b> "Potentiometers" corrected to "constants" in caution.</p> <p><b>Page 9:</b> Settings when a ground fault interrupter is used have been corrected in <i>Mold-case Circuit Breaker (MCCB)</i>.</p> <p><b>Page 10:</b> Caution on withstand voltage added.</p> <p><b>Page 13:</b> "Acceptable" grounding example removed.</p> <p><b>Page 24:</b> Note added to <i>1-6-3 Optional Units</i>.</p> <p><b>Page 37:</b> Setting range corrected for constant numbers 27 and 28 of "DC injection braking."</p> <p><b>Page 38:</b> "5: Operation mode" added to constant numbers 34 and 35 of "Photocoupler output signal."</p> <p><b>Page 39:</b> 3<sup>rd</sup> digit information and note added to constant number 46. Initial setting corrected.</p> <p><b>Page 40:</b> Descriptions for "Slip compensation speed control" (constant numbers 57 to 59) corrected. Factory settings added (constant numbers 60 to 66, 68, and 69).</p> <p><b>Page 47:</b> Information added to <i>2-8-12 Motor Stall Prevention Function</i>.</p> <p><b>Page 49:</b> Information for <i>UP/DOWN Command</i> changed.</p> <p><b>Page 54:</b> <i>2-8-21 Momentary Power Loss Protection</i> changed to <i>2-8-21 Other Functions</i>.</p> <p><b>Page 56:</b> "Residual voltage" corrected to "motor residual voltage" in <i>Minimum Baseblock Time (No. 55)</i>.</p> <p><b>Page 58:</b> Information in <i>2-8-27 Slip Compensation Speed Control</i> changed and added to. Note added to <i>2-8-28 Inverter Overload Protection</i>.</p> <p><b>Page 61:</b> Information for the low voltage protection, overcurrent protection, and cooling fin overheat protection functions corrected.</p> <p><b>Pages 62, 63:</b> "Simultaneous normal and reverse rotation commands" corrected to "Simultaneous forward and reverse rotation commands."</p> <p><b>Page 63:</b> Information for "Low-voltage protection (main circuit voltage insufficient)" and "Simultaneous forward and reverse rotation commands" corrected.</p> |