

USER'S MANUAL

SYSDRIVE 3G3FV

High-function General-purpose Inverter

OMRON

OMRON Corporation
FA Systems Division H.Q.
66 Matsumoto
Mishima-city, Shizuoka 411-8511
Japan
Tel: (81)559-77-9181/Fax: (81)559-77-9045

Authorized Distributor:

Thank you for choosing this SYSDRIVE 3G3FV-series product. Proper use and handling of the product will ensure proper product performance, will lengthen product life, and may prevent possible accidents.
Please read this manual thoroughly and handle and operate the product with care.

NOTICE

1. This manual describes the functions of the product and relations with other products. You should assume that anything not described in this manual is not possible.
2. Although care has been given in documenting the product, please contact your OMRON representative if you have any suggestions on improving this manual.
3. The product contains potentially dangerous parts under the cover. Do not attempt to open the cover under any circumstances. Doing so may result in injury or death and may damage the product. Never attempt to repair or disassemble the product.
4. We recommend that you add the following precautions to any instruction manuals you prepare for the system into which the product is being installed.
 - Precautions on the dangers of high-voltage equipment.
 - Precautions on touching the terminals of the product even after power has been turned off. (These terminals are live even with the power turned off.)
5. Specifications and functions may be changed without notice in order to improve product performance.

Items to Check when Unpacking

Check the following items when removing the product from the package:

- Has the correct product been delivered (i.e., the correct model number and specifications)? Check the nameplate as shown below.

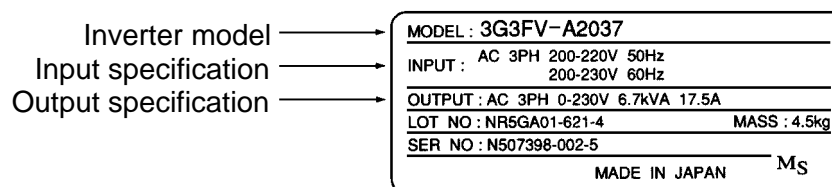

- Has the product been damaged in shipping?
- Are any screws or bolts loose?

OMRON

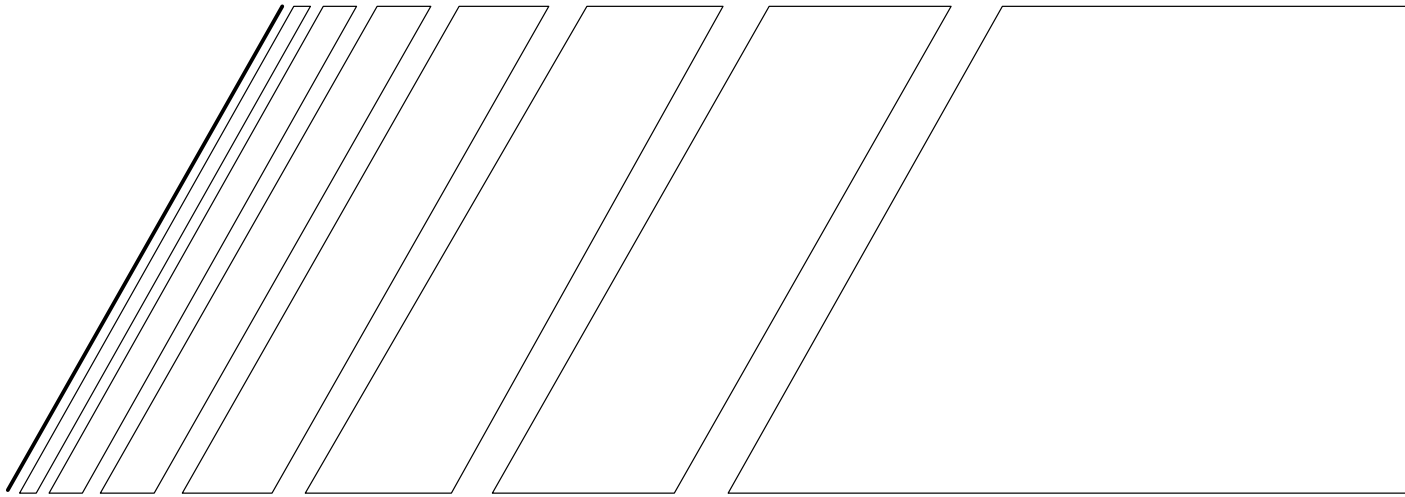

USER'S MANUAL

SYSDRIVE 3G3FV SERIES

High-function General-purpose Inverter

Notice:

OMRON products are manufactured for use according to proper procedures by a qualified operator and only for the purposes described in this manual.

The following conventions are used to indicate and classify precautions in this manual. Always heed the information provided with them. Failure to heed precautions can result in injury to people or damage to property.

 **DANGER** Indicates an imminently hazardous situation which, if not avoided, will result in death or serious injury.

 **WARNING** Indicates a potentially hazardous situation which, if not avoided, could result in death or serious injury.

 **Caution** Indicates a potentially hazardous situation which, if not avoided, may result in minor or moderate injury, or property damage.

OMRON Product References

All OMRON products are capitalized in this manual. The word “Unit” is also capitalized when it refers to an OMRON product, regardless of whether or not it appears in the proper name of the product.

The abbreviation “Ch,” which appears in some displays and on some OMRON products, often means “word” and is abbreviated “Wd” in documentation in this sense.

The abbreviation “PC” means Programmable Controller and is not used as an abbreviation for anything else.

Visual Aids

The following headings appear in the left column of the manual to help you locate different types of information.

Note Indicates information of particular interest for efficient and convenient operation of the product.

© OMRON, 1996

All rights reserved. No part of this publication may be reproduced, stored in a retrieval system, or transmitted, in any form, or by any means, mechanical, electronic, photocopying, recording, or otherwise, without the prior written permission of OMRON.









No patent liability is assumed with respect to the use of the information contained herein. Moreover, because OMRON is constantly striving to improve its high-quality products, the information contained in this manual is subject to change without notice. Every precaution has been taken in the preparation of this manual. Nevertheless, OMRON assumes no responsibility for errors or omissions. Neither is any liability assumed for damages resulting from the use of the information contained in this publication.

General Precautions



Observe the following precautions when using the SYSDRIVE Inverters and peripheral devices.

This manual may include illustrations of the product with protective covers removed in order to describe the components of the product in detail. Make sure that these protective covers are on the product before use.





Consult your OMRON representative when using the product after a long period of storage.

-  **WARNING** Do not touch the inside of the Inverter. Doing so may result in electrical shock.
-  **WARNING** Operation, maintenance, or inspection must be performed after turning OFF the power supply, confirming that the CHARGE indicator (or status indicators) are OFF, and after waiting for the time specified on the front cover. Not doing so may result in electrical shock.
-  **WARNING** Do not damage, pull on, apply stress to, place heavy objects on, or pinch the cables. Doing so may result in electrical shock.
-  **WARNING** Do not touch the rotating parts of the motor under operation. Doing so may result in injury.
-  **WARNING** Do not modify the product. Doing so may result in injury or damage to the product.
-  **Caution** Do not store, install, or operate the product in the following places. Doing so may result in electrical shock, fire or damage to the product.
 - Locations subject to direct sunlight.
 - Locations subject to temperatures or humidity outside the range specified in the specifications.
 - Locations subject to condensation as the result of severe changes in temperature.
 - Locations subject to corrosive or flammable gases.
 - Locations subject to exposure to combustibles.
 - Locations subject to dust (especially iron dust) or salts.
 - Locations subject to exposure to water, oil, or chemicals.
 - Locations subject to shock or vibration.
-  **Caution** Do not touch the Inverter radiator, regenerative resistor, or Servomotor while the power is being supplied or soon after the power is turned OFF. Doing so may result in a skin burn due to the hot surface.
-  **Caution** Do not conduct a dielectric strength test on any part of the Inverter. Doing so may result in damage to the product or malfunction.
-  **Caution** Take appropriate and sufficient countermeasures when installing systems in the following locations. Not doing so may result in equipment damage.
 - Locations subject to static electricity or other forms of noise.
 - Locations subject to strong electromagnetic fields and magnetic fields.
 - Locations subject to possible exposure to radioactivity.
 - Locations close to power supplies.





Transportation Precautions







-  **Caution** Do not hold by front cover or panel , instead, hold by the radiation fin (heat sink) while transporting the product. Doing so may result in injury.
-  **Caution** Do not pull on the cables. Doing so may result in damage to the product or malfunction.
-  **Caution** Use the eye-bolts only for transporting the Inverter. Using them for transporting the machinery may result in injury or malfunction.

Installation Precautions







-  **WARNING** Provide an appropriate stopping device on the machine side to secure safety. (A holding brake is not a stopping device for securing safety.) Not doing so may result in injury.
-  **WARNING** Provide an external emergency stopping device that allows an instantaneous stop of operation and power interruption. Not doing so may result in injury.
-  **Caution** Be sure to install the product in the correct direction and provide specified clearances between the Inverter and control panel or with other devices. Not doing so may result in fire or malfunction.
-  **Caution** Do not allow foreign objects to enter inside the product. Doing so may result in fire or malfunction.
-  **Caution** Do not apply any strong impact. Doing so may result in damage to the product or malfunction.





Wiring Precautions

-  **WARNING** Wiring must be performed only after confirming that the power supply has been turned OFF. Not doing so may result in electrical shock.
-  **WARNING** Wiring must be performed by authorized personnel. Not doing so may result in electrical shock or fire.
-  **WARNING** Be sure to confirm operation only after wiring the emergency stop circuit. Not doing so may result in injury.
-  **WARNING** Always connect the ground terminals to a ground of 100 Ω or less for the 200-V AC class, or 10 Ω or less for the 400-V AC class. Not connecting to a proper ground may result in electrical shock.







-  **Caution** Install external breakers and take other safety measures against short-circuiting in external wiring. Not doing so may result in fire.
-  **Caution** Confirm that the rated input voltage of the Inverter is the same as the AC power supply voltage. An incorrect power supply may result in fire, injury, or malfunction.
-  **Caution** Connect the Braking Resistor and Braking Resistor Unit as specified in the manual. Not doing so may result in fire.
-  **Caution** Be sure to wire correctly and securely. Not doing so may result in injury or damage to the product.
-  **Caution** Be sure to firmly tighten the screws on the terminal block. Not doing so may result in fire, injury, or damage to the product.
-  **Caution** Do not connect an AC power to the U, V, or W output. Doing so may result in damage to the product or malfunction.

Operation and Adjustment Precautions

-  **WARNING** Turn ON the input power supply only after mounting the front cover, terminal covers, bottom cover, Operator, and optional items. Not doing so may result in electrical shock.
-  **WARNING** Do not remove the front cover, terminal covers, bottom cover, Operator, or optional items while the power is being supplied. Doing so may result in electrical shock or damage to the product.
-  **WARNING** Do not operate the Operator or switches with wet hands. Doing so may result in electrical shock.
-  **WARNING** Do not touch the inside of the Inverter. Doing so may result in electrical shock.
-  **WARNING** Do not come close to the machine when using the error retry function because the machine may abruptly start when stopped by an alarm. Doing so may result in injury.
-  **WARNING** Do not come close to the machine immediately after resetting momentary power interruption to avoid an unexpected restart (if operation is set to be continued in the processing selection function after momentary power interruption is reset). Doing so may result in injury.
-  **WARNING** Provide a separate emergency stop switch because the STOP Key on the Operator is valid only when function settings are performed. Not doing so may result in injury.

-  **WARNING** Be sure to confirm that the RUN signal is turned OFF before turning ON the power supply, resetting the alarm, or switching the LOCAL/REMOTE selector. Doing so while the RUN signal is turned ON may result in injury.
-  **Caution** Be sure to confirm permissible ranges of motors and machines before operation because the Inverter speed can be easily changed from low to high. Not doing so may result in damage to the product.
-  **Caution** Provide a separate holding brake when necessary. Not doing so may result in injury.
-  **Caution** Do not perform a signal check during operation. Doing so may result in injury or damage to the product.
-  **Caution** Do not carelessly change settings. Doing so may result in injury or damage to the product.

Maintenance and Inspection Precautions

-  **WARNING** Do not touch the Inverter terminals while the power is being supplied.
-  **WARNING** Maintenance or inspection must be performed only after turning OFF the power supply, confirming that the CHARGE indicator (or status indicators) is turned OFF, and after waiting for the time specified on the front cover. Not doing so may result in electrical shock.
-  **WARNING** Maintenance, inspection, or parts replacement must be performed by authorized personnel. Not doing so may result in electrical shock or injury.
-  **WARNING** Do not attempt to take the Unit apart or repair. Doing either of these may result in electrical shock or injury.
-  **Caution** Carefully handle the Inverter because it uses semiconductor elements. Careless handling may result in malfunction.
-  **Caution** Do not change wiring, disconnect connectors, the Operator, or optional items, or replace fans while power is being supplied. Doing so may result in injury, damage to the product, or malfunction.



Warning Labels

Warning labels are pasted on the product as shown in the following illustration. Be sure to follow the instructions given there.

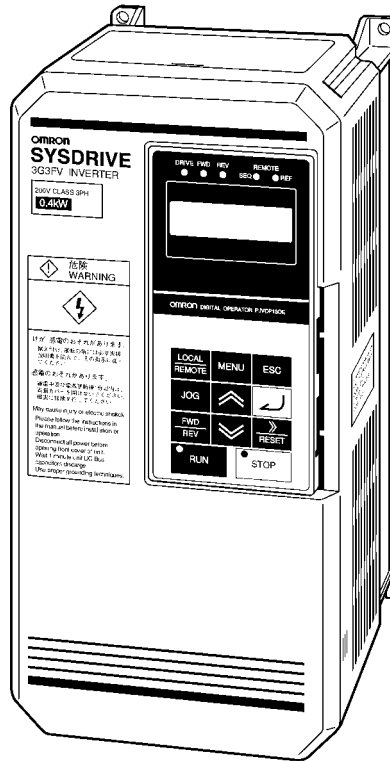
■ Warning Labels



■ Contents of Warning

 危険 WARNING

<p>けが、感電のおそれがあります。</p> <p>据え付け、運転の前には必ず取扱説明書を読んで、その指示に従ってください。</p> <p>感電のおそれがあります。</p> <p>通電中及び電源遮断後1分以内は、表面カバーを開けないでください。確実に接地を行ってください。</p> <p>May cause injury of electric shock. Please follow the instructions in the manual before installation or operation.</p> <p>Disconnect all power before opening front cover of unit. Wait 1 minute until DC Bus capacitors discharge. Use proper grounding techniques.</p>

Maximum Applicable Motor Capacity

004	0.4 kW
007	0.75 kW
015	1.5 kW
022	2.2 kW
037	3.7 kW
055	5.5 kW
075	7.5 kW
110	11 kW
150	15 kW
185	18.5 kW
220	22 kW
300	30 kW
370	37 kW
450	45 kW
550	55 kW
750	75 kW
11K	110 kW
16K	160 kW
18K	185 kW
22K	220 kW
30K	300 kW

Voltage Class

2	Three-phase 200-V AC input (200-V class)
4	Three-phase 400-V AC input (400-V class)

Installation Type

A	Panel-mounting (IP10 min.) or closed wall-mounting models
C	Closed wall-mounting models (IP00 min.)

● Checking for Damage

Check the overall appearance and check for damage or scratches resulting from transportation.

■ Checking the Accessories

Note that this manual is the only accessory provided with the 3G3MV. Set screws and other necessary parts must be provided by the user.

About this Manual

This manual is divided into the chapters described in the following table. Information is organized by application area to enable you to use the manual more efficiently.

Chapter	Contents
Chapter 1 Overview	Describes features and nomenclature. Also describes new functions.
Chapter 2 Installation	Provides information required for system design, such as product dimensions, installation dimensions, peripheral device design information, and peripheral device selection information.
Chapter 3 Preparing for Operation	Describes nomenclature, Digital Operator procedures, such as key operations, for operating and monitoring Inverters, and mode contents and configuration.
Chapter 4 Trial Operation	Describes the method for controlling operation through a Digital Operator to perform trial operation of the system.
Chapter 5 Basic Operation	Describes basic Inverter control functions for users not familiar with Inverters. The functions that must be understood to drive a motor with an Inverter are described. Each of the four control modes of the 3G3FV-series Inverters is described in order alone with the settings required for all modes and individual modes. Refer to the information for all control modes and then to items required for the control mode you will be using.
Chapter 6 Advanced Operation	Describes all of the functions provided by the Inverter. These functions will enable more advanced applications, and includes functions that will improve motor control through the Inverter, such as responsiveness (torque characteristics), increasing speed accuracy, PID control, torque limits, torque controls, overtorque detection, protective functions, and other functions. Each of the four control modes of the 3G3FV-series Inverters is described in order alone with the characteristics of each mode and functions common to all modes. Refer to the information for all control modes and then to items required for the control mode you will be using.
Chapter 7 List of Parameters	Lists basic information on Inverter parameters as a reference for users already familiar with Inverter operation. Parameters are listed in order with the page numbers of further information for easy reference.
Chapter 8 Maintenance Operations	Provides maintenance, inspection, fault analysis, and troubleshooting information required to deal with problems that may occur during operation.
Chapter 9 Specifications	Provides Inverter specifications, as well as the specifications and dimensions of peripheral devices.

How to Change the Digital Operator Display from Japanese to English

If the Digital Operator displays messages in Japanese, change to the English mode using the following steps.

(This manual provides descriptions for the English mode.)

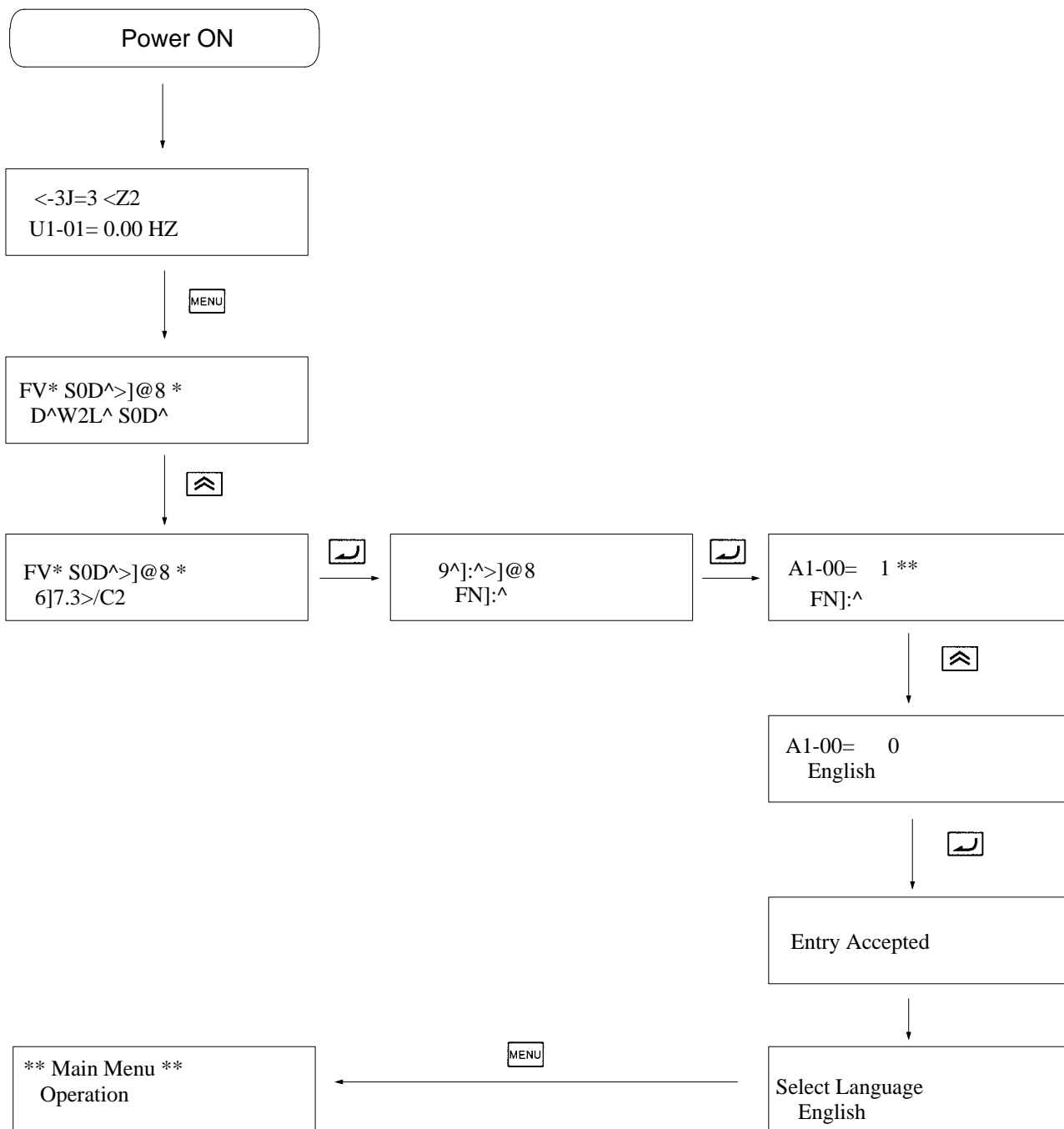

Table of Contents

Chapter 1. Introduction	1-1
1-1 Functions	1-2
1-2 Nomenclature	1-8
1-3 New Functions	1-11
1-3-1 Software Ver. VSG101040	1-11
1-3-2 Software Ver. VSG101043	1-13
1-3-3 Software Ver. VSG101113	1-14
1-3-4 Software Ver. VSG101114	1-17
Chapter 2. Installation	2-1
2-1 Mounting	2-2
2-1-1 Dimensions	2-2
2-1-2 Installation Conditions	2-8
2-2 Wiring	2-11
2-2-1 Removing and Mounting the Front Cover	2-12
2-2-2 Terminals	2-14
2-2-3 Standard Connection Diagram	2-18
2-2-4 Wiring Around the Main Circuit	2-23
2-2-5 Wiring Control Circuit Terminals	2-39
2-2-6 Installing and Wiring PG Speed Control Cards	2-40
Chapter 3. Preparing for Operation	3-1
3-1 Using the Digital Operator	3-2
3-2 Modes	3-3
3-3 Operation Mode	3-10
3-4 Initialize Mode	3-18
3-5 Program Mode	3-25
3-6 Auto-tuning Mode	3-28
3-7 Modified Constants Mode	3-30
3-8 Operation Mode Selection Key and Local/Remote Selection Input	3-31
Chapter 4. Trial Operation	4-1
4-1 Procedure	4-3
4-2 Operation Example	4-5
4-2-1 Power Connection	4-5
4-2-2 Checking the Display Status	4-5
4-2-3 Initializing Parameters	4-6
4-2-4 Setting Input Voltage	4-6
4-2-5 Auto-tuning	4-8
4-2-6 No-load Operation	4-10
4-2-7 Actual Load Operation	4-11
Chapter 5. Basic Operation	5-1
5-1 Common Settings	5-2
5-1-1 Setting the Access Level and Control Mode	5-2
5-1-2 Frequency Reference Settings from Control Circuit Terminals	5-4
5-1-3 Frequency Reference Settings from Digital Operator	5-8
5-1-4 Run Source and Responsiveness Settings	5-10

Table of Contents

5-1-5	Acceleration/Deceleration Time Settings	5-11
5-1-6	Disabling Reverse Operation (b1-04)	5-13
5-1-7	Selecting the Stopping Method (b1-03)	5-13
5-1-8	Multi-function Input Settings (H1-01 through H1-06)	5-15
5-2	Open-loop Vector Control	5-20
5-2-1	Auto-tuning Procedure	5-20
5-2-2	Auto-tuning Faults	5-21
5-3	V/f Control	5-23
5-3-1	Setting the Motor Parameters	5-23
5-3-2	V/f Pattern Selection (E1-03)	5-24
5-4	Flux Vector Control	5-29
5-4-1	PG Speed Control Card Settings	5-29
5-4-2	Setting the Zero-speed Operation Parameters	5-33
5-4-3	Auto-tuning	5-35
5-4-4	Speed Loop (ASR) Structure	5-39
5-4-5	Adjusting Speed Control Loop (ASR) Gain	5-41
5-5	V/f Control with PG	5-44
5-5-1	Setting the Motor Parameters	5-44
5-5-2	V/f Pattern Selection (E1-03)	5-45
5-5-3	PG Speed Control Card Settings	5-46
5-5-4	Speed Loop (ASR) Structure	5-50
5-5-5	Adjusting Speed Control Loop (ASR) Gain	5-51

Chapter 6. Advanced Operation **6-1**

6-1	Open-loop Vector Control	6-2
6-1-1	Summary of Open-loop Vector Control Functions	6-2
6-1-2	Torque Limit Function	6-3
6-1-3	Adjusting Speed Feedback	6-5
6-1-4	Setting Magnetic Flux Characteristics for Open-loop Vector Control	6-6
6-1-5	Operation for Saturated Output Voltage	6-6
6-1-6	Startup Torque Compensation	6-7
6-1-7	Selecting Auto-tuning Carrier Frequency	6-8
6-1-8	Setting/Adjusting Motor Parameters	6-8
6-2	Normal V/f Control	6-12
6-2-1	Summary of V/f Control Functions	6-12
6-2-2	Energy-saving Control Function	6-13
6-2-3	Hunting-prevention Function	6-14
6-2-4	Setting Motor Parameters	6-15
6-3	Flux Vector Control	6-16
6-3-1	Summary of Flux Vector Control Functions	6-16
6-3-2	Droop Control Function	6-17
6-3-3	Zero-servo Function (Position-lock)	6-18
6-3-4	Torque Control	6-20
6-3-5	Speed/Torque Control Switching Function	6-27
6-3-6	Torque Limit Function	6-28
6-3-7	Setting/Adjusting Motor Parameters	6-31
6-3-8	Operation for Saturated Output Voltage	6-34
6-3-9	Selecting Auto-tuning Carrier Frequency	6-35
6-4	V/f Control With PG Feedback	6-36
6-4-1	Summary of V/f Control With PG Feedback Functions	6-36
6-4-2	Energy-saving Control Function	6-37
6-4-3	Hunting-prevention Function	6-38

Table of Contents

6-4-4	Setting Motor Parameters	6-39
6-5	Common Functions	6-40
6-5-1	Summary of Common Control Functions	6-40
6-5-2	Application Parameters (b)	6-41
6-5-3	Tuning Parameters (C)	6-58
6-5-4	Reference Parameters (d)	6-64
6-5-5	Motor Parameters (E)	6-66
6-5-6	Option Parameters (F)	6-70
6-5-7	External Terminal Functions: H	6-76
6-5-8	Protective Functions: L	6-97
6-5-9	Operator Parameters: o	6-110

Chapter 7. Parameter Lists **7-1**

7-1	Initialize Mode Parameters	7-3
7-2	Program Mode Parameter List	7-5
7-2-1	Application Group: b	7-5
7-2-2	Tuning Parameters	7-13
7-2-3	Reference Parameters List	7-21
7-2-4	Motor Constant Parameter Lists	7-24
7-2-5	Options Parameter Lists	7-29
7-2-6	Terminal Parameter Lists	7-36
7-2-7	Protection Parameter Lists	7-44
7-2-8	Operator Parameter Lists	7-51

Chapter 8. Maintenance Operations **8-1**

8-1	Protective and Diagnostic Functions	8-2
8-1-1	Fault Detection	8-2
8-1-2	Minor Fault Detection	8-8
8-1-3	Operation Errors	8-12
8-2	Troubleshooting	8-14
8-3	Maintenance and Inspection	8-22

Chapter 9. Specifications **9-1**

9-1	Inverter Specifications	9-2
9-2	Option Specifications	9-7

Chapter 10. Appendix **10-1**

10-1	Notes on Using the Inverter for a Motor	10-2
------	---	------

Revision History **R-1**

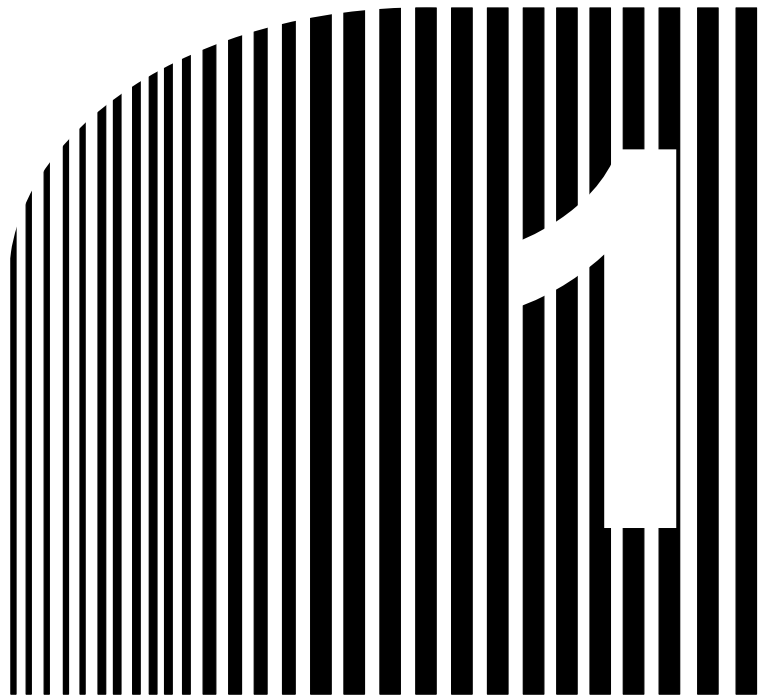

Chapter 1

• Introduction •

- 1-1 Function
- 1-2 Nomenclature
- 1-3 New Functions

1-1 Functions

The general-purpose SYSDRIVE 3G3FV Inverter provides full current vector control based on advanced control logic. An auto-tuning function allows for easy vector control. The Digital Operator's display area features a 2-line by 16-character liquid crystal display. Parameters can be displayed in up to seven languages, including Japanese. The parameter settings and monitor items can be understood at a glance, providing an interactive feel during operation.

■ SYSDRIVE 3G3FV Inverter Models

- The following 200- and 400-V class 3G3FV Inverter models are available.
- A total of 21 types of Inverters are available for maximum applicable motor capacities of 0.4 to 300 kW.

Voltage class	Protective structure	Maximum applied motor capacity	Model
200-V class (3-phase)	NEMA1 type	0.4 kW	3G3FV-A2004
		0.75 kW	3G3FV-A2007
		1.5 kW	3G3FV-A2015
		2.2 kW	3G3FV-A2022
		3.7 kW	3G3FV-A2037
		5.5 kW	3G3FV-A2055
		7.5 kW	3G3FV-A2075
		11 kW	3G3FV-A2110
		15 kW	3G3FV-A2150
	Open chassis type	18.5 kW	3G3FV-B2185
		22 kW	3G3FV-B2220
		30 kW	3G3FV-B2300
		37 kW	3G3FV-B2370
		45 kW	3G3FV-B2450
		55 kW	3G3FV-B2550
400-V class (3-phase)	NEMA1 type	0.4 kW	3G3FV-A4004
		0.75 kW	3G3FV-A4007
		1.5 kW	3G3FV-A4015
		2.2 kW	3G3FV-A4022
		3.7 kW	3G3FV-A4037
		5.5 kW	3G3FV-A4055
		7.5 kW	3G3FV-A4075
		11 kW	3G3FV-A4110
		15 kW	3G3FV-A4150
	Open chassis type	18.5 kW	3G3FV-B4185
		22 kW	3G3FV-B4220
		30 kW	3G3FV-B4300
		37 kW	3G3FV-B4370
		45 kW	3G3FV-B4450
		55 kW	3G3FV-B4550
		75 kW	3G3FV-B4750-E
		110 kW	3G3FV-B411K-E
		160 kW	3G3FV-B416K-E
185 kW	3G3FV-B418K-E		
220 kW	3G3FV-B422K-E		
300 kW	3G3FV-B430K-E		

■ Selection of Modes for Vector Control and V/f Control

- The 3G3FV has the following four control modes.
 - Open-loop vector control (without PG*) [Factory default]
 - Flux vector control (with PG)
 - V/f control (without PG)
 - V/f control (with PG)
- *PG stands for “pulse generator” (encoder).
- Vector control is a method for removing interferences with magnetic flux and torque, and controlling torque according to references. Current vector control independently controls magnetic flux current and torque current by simultaneously controlling the motor’s primary current and its phases. This allows smooth rotation and high torque, along with accurate speed and torque control, at very low speeds.
- Vector control can be replaced from the conventional V/f control system. If the motor parameter required for vector control is unknown, it can be set automatically with the auto-tuning function.
- The respective control modes are effective for the following applications:
 - Open-loop vector control (without PG): General variable speed drive
 - Flux vector control (with PG): Simple servo-drive, high-precision speed control, torque control
 - V/f control (without PG): Conventional Inverter control mode. Used for multiple drives.
 - V/f control (with PG): Simple speed feedback control
- The control characteristics for each mode are shown in the following table.

	Vector control		V/f control	
	Without PG	With PG	Without PG	With PG
Speed control range	1:100	1:1,000	1:40	1:40
Speed control precision	±0.2%	±0.02%	±2 to 3%	±0.03%
Starting torque	150% at 1 Hz	150% at 0 Hz	150% at 3 Hz	

■ Auto-tuning Function

- This function is valid with vector control.
- The motor parameters are set automatically just by entering the motor’s rating plate value. This feature allows flux vector control to operate accurately with virtually any normal AC induction motor regardless of the supplier.

■ Torque Control

- This function is valid with flux vector control (with PG).
- Torque is controlled by taking multi-function analog input signals as torque references.
- Switching is possible between torque control and speed control.

■ V/f Pattern Settings

- This function is valid for V/f control.
- Select a V/f pattern according to the application from among the 15 preset V/f patterns.

- Custom V/f pattern can be set.

■ Frequency References

- The following five types of frequency references can be used to control the output frequency of the Inverter.
 - Numeric input from the Digital Operator
 - Voltage input within a range from 0 to 10 V
 - Voltage input within a range from 0 to ± 10 V (With minus voltage, rotation is in the opposite direction of the run command.)
 - Current input within a range from 4 to 20 mA
 - Input by Optional Card

The Inverter can be set to use any of the above types by designating it with parameters.

- A maximum of eight frequency references can be registered in the Inverter. Including inching, this enables multi-step speed operation with up to nine speed steps via remote multi-step reference inputs.

■ PID Control

- The Inverter has a PID control function, enabling easy follow-up control.
- Follow-up control is a control method in which the Inverter varies the output frequency to match the feedback value from the sensor with the set target value.
- Follow-up control can be applied to a variety of control operations, depending on the contents detected by the sensor.
- PID control is available for the following applications.
 - Speed control: With a speed sensor, such as a tacho-generator, the Inverter regulates the rotation speed of the motor regardless of the load of the motor or synchronizes the rotation speed of the motor with that of another motor.
 - Pressure control: With a pressure sensor, the Inverter performs constant pressure control.
 - Flow-rate control: By sensing the flow rate of a fluid, the Inverter performs precise flow-rate control.
 - Temperature control: With a temperature sensor, the Inverter performs temperature control by fan speed.

■ Zero-servo Control

- This function is valid with vector control (with PG).
- Even at a motor speed of zero (0 Hz), a torque of 150% of the motor's rated torque can be generated and the average servomotor holding power (stopping power) can be obtained.

■ Speed Control By Feedback

- This function is valid with PG.
- An optional PG Speed Control Card can be used to enable feedback control for speeds, thereby improving speed control accuracy.

■ Dwell Function

- By holding the output frequency for a constant time during acceleration and deceleration, acceleration and deceleration can be performed without stepping out even when driving a motor with a large start-up load.

■ Low Noise (0.4- to 160-kW Models)

- The output transistor of the Inverter is an IGBT (insulated gate bipolar transistor). Using a sine-wave PWM method with a high-frequency carrier, the motor does not generate metallic noise.

■ Monitor Function

- The following items can be monitored with the Digital Operator.
 - Frequency reference, output frequency, output current, motor speed, output voltage reference, main-circuit DC voltage, output power, torque reference, status of input terminals, status of output terminals, operating status, total operating time, software number, speed deviation value, PID feedback value, fault status, fault history, etc.
- All types of data can be monitored even with multi-function analog output.

■ Seven-language Digital Operator (from Software Ver. VSG101113)

- Application as a global inverter is enabled by displays in Japanese, English, French, German, Italian, Spanish, or Portuguese.
- The Digital Operator area utilizes a 16-character x 2-line liquid crystal display. Parameter setting items and monitor display can be easily read in any of seven languages to operate the Inverter in a conversational style.

■ Harmonic Countermeasures (0.4- to 160-kW Models)

- DC reactors (optional) can be connected to 0.4- to 15-kW models.
- Models of 18.5 to 160 kW have a built-in DC reactor.

■ Parameter Hierarchy and Three Types of Access Levels

- The 3G3FV has a number of parameters for carrying out the various functions. These parameters are classified into hierarchical levels to make them easier to use. The levels are as follows, from top to bottom: Mode — Group — Function — Parameter.

Level name	Contents
Mode	Classified according to operation Operation mode: For operating the Inverter. (All kinds of monitoring are possible.) Initialize mode: For selecting the language displayed at the Digital Operator, setting access levels, and initializing. Program mode: For setting parameters for operation. Auto-tuning mode: For automatic calculation or setting motor parameters. (Only under the vector control mode.) Modified constants mode: For setting or referencing parameters changes after shipping.
Group	Classified by application.
Function	Classified by function.
Parameter	Individual parameter settings.

- The 3G3FV allows the following three kinds of access levels to be set in order to further simplify parameter setting. (An access level is a range of parameters that can be set or referenced.)
 - Quick-start: Sets/reads parameters required for trial operation. [Factory setting]
 - Basic: Sets/reads parameters that are commonly used.
 - Advanced: Sets/reads all the parameters that can be used.
- In general, press the Enter Key to move from an upper to a lower level. This varies somewhat, however, according to the access level, as shown in the following diagram. For the Quick-start access level, which has few parameters that can be set, pressing the Enter Key jumps directly to the Parameter level; whereas for the Advanced access level, which has many, pressing the Enter Key first leads to the Group level.

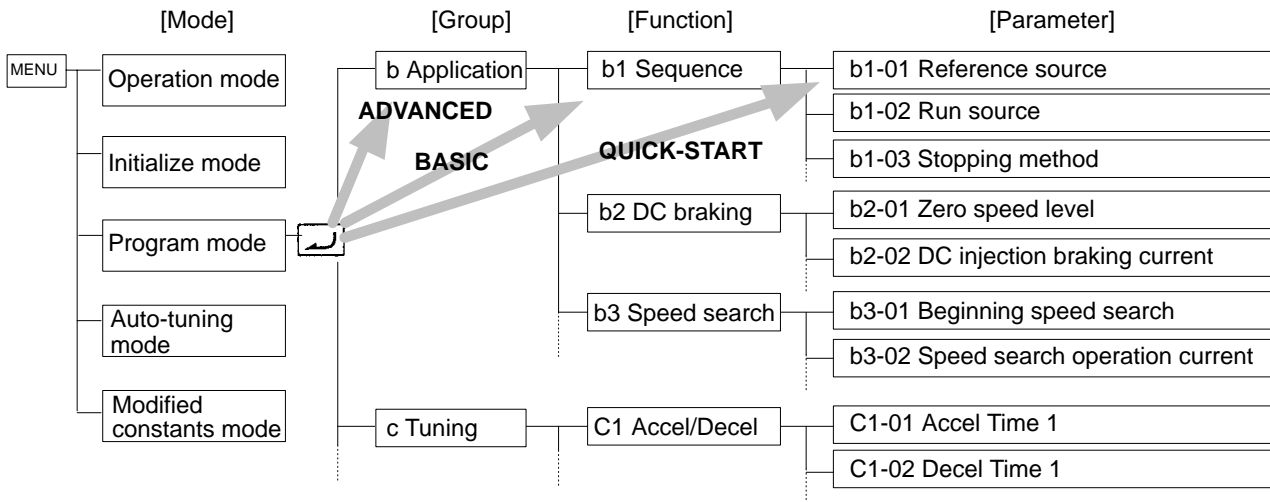

1-2 Nomenclature

■ Panel

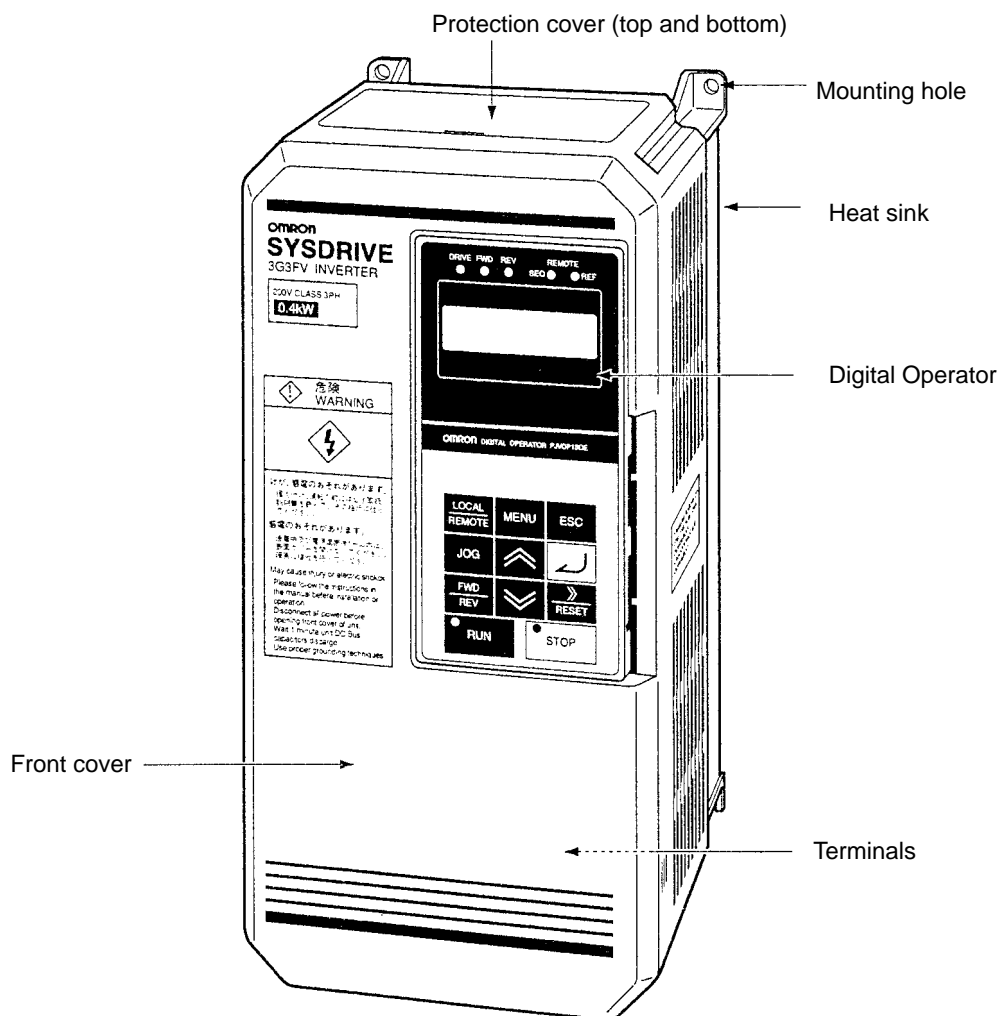

• Terminals (with Front Cover Removed)

Example: 200-V Class Inverter with 0.4-kW Output

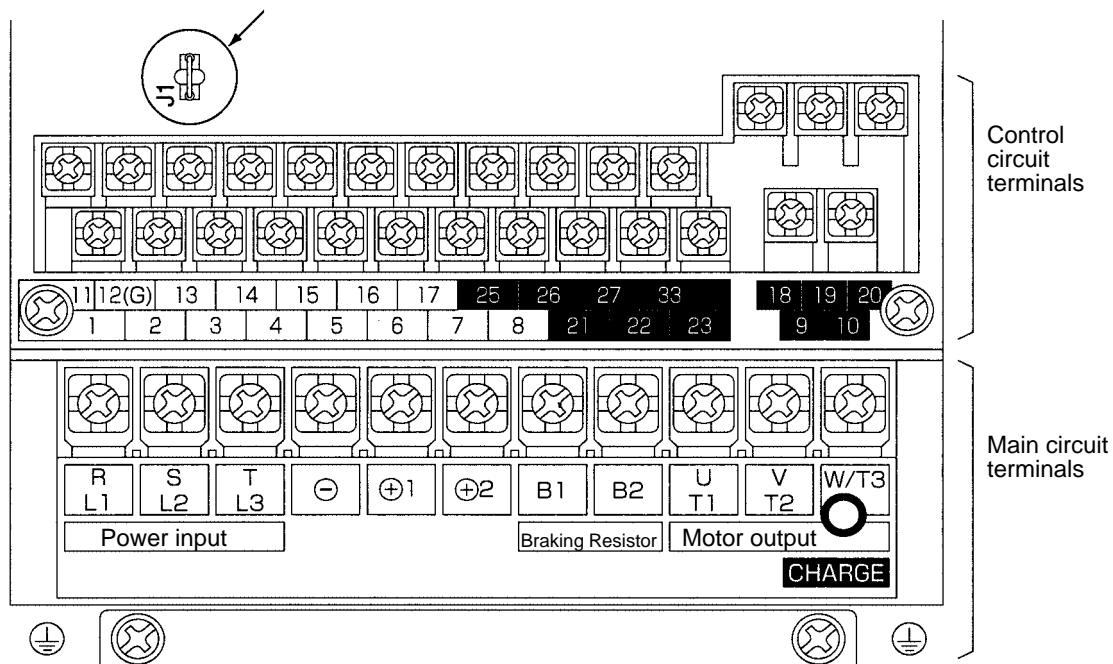

■ Digital Operator

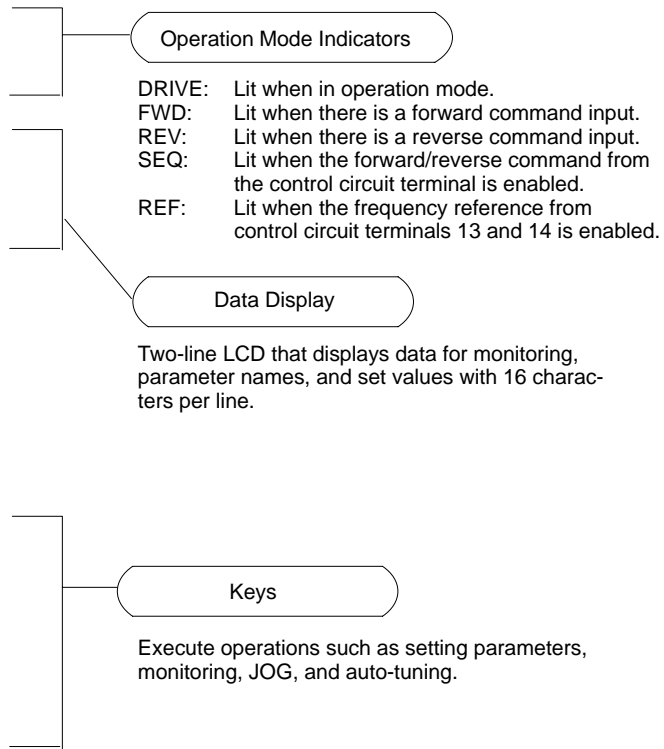
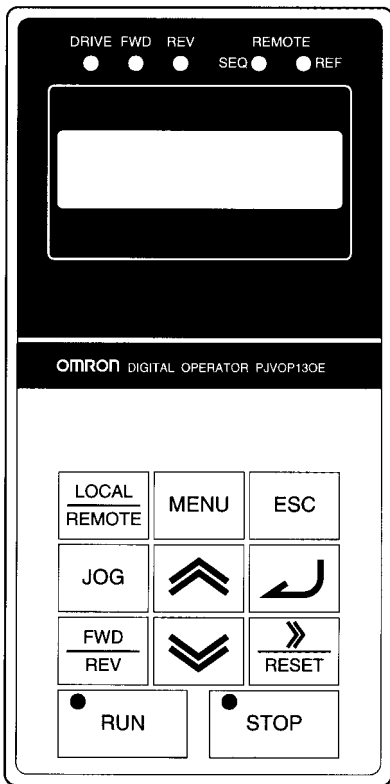

Key	Name	Function
	Operation Mode Selection Key	Switches between Operator and parameter setting (run command and frequency reference). This key can be enabled or disabled with a parameter setting (o2-02).
	Menu Key	Displays each mode.
	Escape Key	Returns to the status before the Enter Key is pressed.
	Jog Key	Enables JOG operation when the 3G3FV is in operation with the Digital Operator.
	Forward/Reverse Rotation Selection Key	Selects the rotation direction of the motor when the 3G3FV is in operation with the Digital Operator.
	Reset/Digit Selection Key	Selects digits for parameter settings. Also acts as the reset key when an fault has occurred. (see note)
	Increment Key	Selects modes, groups, functions, parameter names, and set values. This key increases numbers when pressed.
	Decrement Key	Selects modes, groups, functions, parameter names, and set values. This key decreases numbers when pressed.
	Enter Key	Enters modes, functions, parameters, and set values after they are set.
	Run Key	Starts the 3G3FV running when the 3G3FV is in operation with the Digital Operator.
	Stop Key	Stops the 3G3FV running. This key can be enabled or disabled with a parameter setting (o2-02) in operation with the control circuit terminal.

Note For safety reasons, the reset operation will not function when a forward or reverse run command is being input. Use the reset after turning OFF the run command.

1-3 New Functions

The following software versions have been implemented for the 3G3FV Series to add and upgrade functions.

August 1996: Software Ver. VSG101032 (S1032)

April 1997: Software Ver. VSG101040 (S1040)

Sept. 1998: Software Ver. VSG101043 (S1043)

Sept. 1999: Software Ver. VSG101113 (S1113)

Sept. 2000: Software Ver. VSG101114 (S1114)

The software version can be confirmed using the 5-digit number display for the FLASH ID for U1-14.

This section describes the new functions and improvements for each software version. Refer to *Chapter 5 Basic Operation* and *Chapter 6 Advance Operation*.

1-3-1 Software Ver. VSG101040

■ CompoBus/D (DeviceNet) Communications Card

The CompoBus/D Communications Card can be used to connect the Inverter to a DeviceNet network. The following function additions and improvements were made to support this new functionality.

● CompoBus/D Addition to the Frequency Reference Selection (Parameter b1-01)

A function was added to Frequency Reference Selection so that the Inverter frequency reference can be input via DeviceNet communications.

● CompoBus/D Addition to the Run Source Selection (Parameter b1-02)

A function was added to Run Source Selection so that the Inverter run command can be input via DeviceNet communications.

● Communications External Fault Input (Parameters F9-01 to F9-03)

A function was added to support an external fault input from DeviceNet communications to stop the Inverter when an error occurs. Sequence settings and operation designation for errors for the communications external fault input have been added.

■ Two-motor Switching Control

A function was added to enable switching control between two motors using one Inverter. The following function additions were made to support this new functionality.

● Control Mode Setting Second Motor (Parameter E3-01)

A control mode setting was added so that the second motor can be set to a different mode.

Note The control mode setting was limited to 0 (V/f control without PG) or 2 (open-loop vector control), but was changed in system version VSG101043 to support all control modes 0 to 3.

● V/f Pattern Settings for Second Motor (Parameters E4-01 to E4-06)

V/f pattern settings were added so that the second motor can be set to a different pattern.

- **Parameter Settings for Second Motor (Parameters E5-01 to E5-06)**

Parameter settings were added so that different parameters can be set for the second motor.

- **Inverter Output Noise Reduction**

The noise output by 400-V class Inverters was reduced to reduce the affect on peripheral devices and conform to EN standards. The following function improvements were added to support noise reduction.

- **Default Setting Change for Carrier Frequency (Parameters C6-10 to C6-03)**

The default carrier frequency setting for 400-V class Inverters was changed for the reduction of output noise.

- **Inverter Overload Function Change (OL2 Detection)**

The Inverter overload detection function was changed because the Inverter's rated output current would be reduced if it was set higher than the carrier frequency.

Note If an Inverter overload is detected before a motor overload (OL1), lower the Inverter's carrier frequency setting.

- **Operation Selection after Switching to Remote Mode (Parameter b1-07)**

Operation can be switched between Digital Operator and the frequency reference (b1-01) and between Digital Operator and the run command (b1-01) by setting the local/remote selection using the Digital Operator's operation mode selection key or multi-function inputs (H1-01 to H1-06). The new function can be used to enable or disable run commands when switching between the two forms of operation.

Note If the run command is enabled when switching operation, the Inverter can start operation immediately after switching operation. You must take appropriate safety measures when using this function.

- **PG Disconnection Detection (PGO) Detection Time Setting (Parameter F1-14)**

A setting for PG disconnection (PGO) was added so that the detection time can be adjusted.

- **New Functions for Multi-function Inputs 1 to 6 (H1-01 to H1-06)**

The following functions were added to the multi-function inputs.

- Sample/hold function for the analog frequency reference (setting: 1E)
- PID control integral reset (setting: 30)

- **Constant Output Area Settings for Flux Vector Control (E1-11 to E1-13)**

Settings were added to enable controlling V/f characteristics to compensate voltage increases caused by motor impedance when special motors, such as constant power-output motors and machine tool shaft motors, are used in the constant output area.

- **Vector Control Adjustment Settings (C3-05, C5-08, C8-09, C8-30)**

Adjustment functions were added for vector control.

1-3-2 Software Ver. VSG101043

■ CompoBus/D Communications Improved

The following functions were added for DeviceNet communications using a CompoBus/D Communications Card.

● Network Reference/Network Control Support (CompoBus/D Communications Remote I/O)

A function was added to switch between inputting the Inverter frequency reference and a run command using CompoBus/D communications from remote I/O. The Network Reference Bit can be turned ON and OFF to switch between the method set for the frequency reference selection (b1-01) and a frequency reference from communications. In the same way, the Network Control Bit can be turned ON and OFF to switch between the method set for the run source selection (b1-02) and a run command from communications.

● Selection of Operation for Communications Errors (Parameter F9-06)

A setting was added to select the operation of the Inverter when a communications error is detected. The selection can be made according to the application, e.g., a deceleration stop, free-run stop, continuing operation, etc.

● Torque Limit/Torque Reference Operation Selection via Communications (Parameter F9-05)

A function was added to set the torque limit and torque reference (for torque control) from communications. This enables controlling torque operation from communications when the vector with PG control mode is used.

Note The CompoBus/D Communications Card does not support the torque limit/torque reference function. Leave this function disabled.

■ V/f Control with PG and Flux Vector Control for Two-motor Switching Control (Parameter E3-01)

Settings were added for V/f Control with PG and Flux Vector Control to the control modes for the second motor, enabling feedback control of 2 motors with 1 Inverter.

Note 1. Wiring for the pulse generator or encoder must be switched between the two motors.

Note 2. Use a pulse generator with the same specifications for both motors. (There is only one group of parameters for the pulse generator.)

■ Motor Parameter Autotuning (Parameter C8-30)

An autotuning function was added to autotune the motor parameters for special motors.

■ Ground Fault Protection Operation Selection (Parameter: L8-10)

A setting was added to enable and disable ground fault protection so that it can be disabled when required by the application.

■ Improved English Messages

The English messages displayed on the Digital Operator when the language is set to English (A1-00 = 0) have been improved.

1-3-3 Software Ver. VSG101113

■ Messages in 7 Languages

Application as a global inverter is enabled by displays in Japanese, English, French, German, Italian, Spanish, or Portuguese.

■ Low-speed Rotation Inconsistencies Greatly Reduced

Improvements in the current detector for vector control and in the responsiveness of current control have greatly reduced torque ripple. This greatly reduces the low-speed inconsistencies for the 3G3FV Series.

■ Better Motor Speed Control Accuracy (Parameter C3-06)

Previously the motor speed control accuracy for vector control was greatly reduced when the limit of Inverter's voltage output was approached (a voltage greater than that of the input power supply cannot be output). If the new output voltage control method is used, the output voltage will be controlled so that the limit will not be reached, thus maintaining speed accuracy. The linear characteristic of torque control has also been improved.

Note The current may increase by about 10% when this function is used. Be sure to select an Inverter with ample output current capacity.

■ Improved Motor Parameter Autotuning

A new method has been added for autotuning to produce greater accuracy.

■ Improved PID Control

Additions have been made to PID control to increase the range of possible applications.

● PID Control Reverse Characteristics (Parameter b5-09)

Previously, only positive characteristic PID control, in which the feedback value increases when the Inverter's output frequency increases, was possible. In addition to this, reverse characteristic PID control is now possible, in which the feedback value decreases when the Inverter's output frequency increases.

● Frequency Reference + PID Control (Parameters b5-01 and b5-10)

A control method using the frequency reference and PID control has been added between the previous frequency reference or PID control. This is ideal for applications in which the target speed is set, but fine adjustments need to be made with PID control (such as tension control).

● Reverse Motor Control for PID Control (Parameter b5-11)

Motor rotation in only one direction was possible for previous PID control, but a reverse control setting has been added to produce rotation in the reverse direction when the PID control result is negative.

- **Feedback Loss Detection for PID Control (Parameters b5-12 to b5-14)**

A function has been added to detect the loss of the feedback signal (e.g., as a result of line disconnection) and specify the operation when an error is detected.

- **PID Control Target Value Added to Multi-function Inputs (Parameters H3-05 and H3-09)**

A function was added so that both the analog frequency reference and the PID control target value can be input as analog signals for frequency reference + PID control.

- **PID Integral Hold Added to Multi-function Inputs (Parameters H1-01 to H1-06)**

A function was added to hold the the calculated integral value for PID control.

- **Jump Frequencies Added to PID Control (Parameters d3-01 to d3-04)**

The setting disabled frequencies (jump frequencies) have been enabled for PID control. This function can be used to avoid frequency ranges that cause machine vibration during PID control.

- **Motor Startup Responsiveness Improved**

Compensation functions have been added to ensure faster motor startup.

- **Startup Torque Compensation Function for Open-loop Vector Control (Parameters C4-03 to C4-05)**

A startup torque compensation function has been added to ensure faster startup for open-loop vector control. If this function is used, high torque can be output immediately after startup to enable better control of lifting and lowering operations for large machines with high friction or cranes.

Note This function cannot be used during regenerative condition or when using a second motor.

- **Magnetic Flex Compensation (Parameter b2-08)**

Large-capacity motors have large electrical constants, and time is required to develop magnetic flux in the motor after power has been turned ON. To improve this situation, a magnetic flux compensation function has been added to the startup DC braking function, enabling magnetic flux to be built up in the motor during DC braking.

- **Braking Function with Stall Prevention during Deceleration (Parameter L3-04)**

Even if regenerative energy is handled using a Braking Resistor or Braking Resistor Unit, overvoltages (OV) can be detected during rapid deceleration. A stall prevention function for deceleration has been added to the braking function (regeneration processing) to limit voltages when main circuit overvoltages are likely to be detected, thus enabling faster braking without overvoltage detection.

- **Inverter Overload (OL2) Protection Selection for Low-speed Operation (Parameters L8-17 and L8-19)**

An Inverter overload protection operation selection has been added to protect from overcurrent damage at low speeds. This function allows the best protection to be selected according to the application.

■ Protection Setting for Motors for Vector Control (Parameter E1-02)

A special protection setting has been provided for vector-control motors, which have high resistance to overloads even at low speeds.

■ Bias Function for Analog Monitor Cards (Parameters F4-05 and F4-06)

A bias function has been added to the analog output from Analog Monitor Cards to enable adjusting the offset voltage.

■ NC Contact Emergency Stop Function for Multi-function Inputs (Parameters d3-01 to d3-04)

An NC contact emergency stop function has been added to the previous NO function.

■ Bias Function for Reverse Motor Control for Multi-function Inputs (Parameters H3-05 and H3-09)

A function has been added for reverse motor operation by establishing a frequency bias 2 (setting: D) for the multi-function inputs that causes reverse operation when the sum of the bias values is negative.

■ Run Command Selection Outside of Drive Mode (Parameter b1-08)

A function has been added to enable or disable run command inputs in mode other than Drive Mode, e.g., Program Mode or Initialize Mode.

Note If this function is used, a run command can be input and Inverter operation started even when adjusting parameters in Program Mode. Proper safety measures must be taken to prevent dangerous situations.

■ Motor Core Loss Adjustment for Torque Compensation (Parameter E2-10)

A motor core loss setting has been added to enable fine adjustment of torque compensation (totally automatic torque boost) in V/f control without PG and V/f control with PG control modes.

■ Changes in Default Settings and Setting Ranges

The defaults and setting ranges for the following parameters have been changed for applications.

● Cumulative Operation Time Display Change (Parameter o2-07)

Previously 0 was display when the default value was set for the cumulative operation time, but this has been changed to display the current cumulative operation time as the default.

● New Parameter Setting Ranges

Parameter number	Parameter name	Applicable Inverters	Previous setting range	New setting range
E2-06	Motor leakage inductance	All Inverters	0% to 30%	0% to 40%
E5-06	Motor 2 leakage inductance	All Inverters	0% to 30%	0% to 40%
L2-03	Minimum baseblock time	All Inverters	0.0 to 5.0 s	0.1 to 5.0 s
L8-02	Inverter overheat detection pre-alarm level	All Inverters	50 to 110°C	50 to 130°C

● New Parameter Default Setting

Parameter number	Parameter name	Applicable Inverters	Previous setting range	New setting range
L2-04	Voltage restart time	Inverters of 55 kW or larger	0.6 s	1.0 s

1-3-4 Software Ver. VSG101114**■ PG Speed Deviation Detection Function Upgrade (F1-04)**

This function has been changed so that the conditions can be selected for speed deviation (DEV) detection. Either of the following two conditions can be selected by means of an F1-04 parameter setting.

- Detect only when the frequency reference matches the output frequency (within the range set in L4-02).
- Detect only when the frequency reference matches the PG feedback speed (within the range set in L4-02).

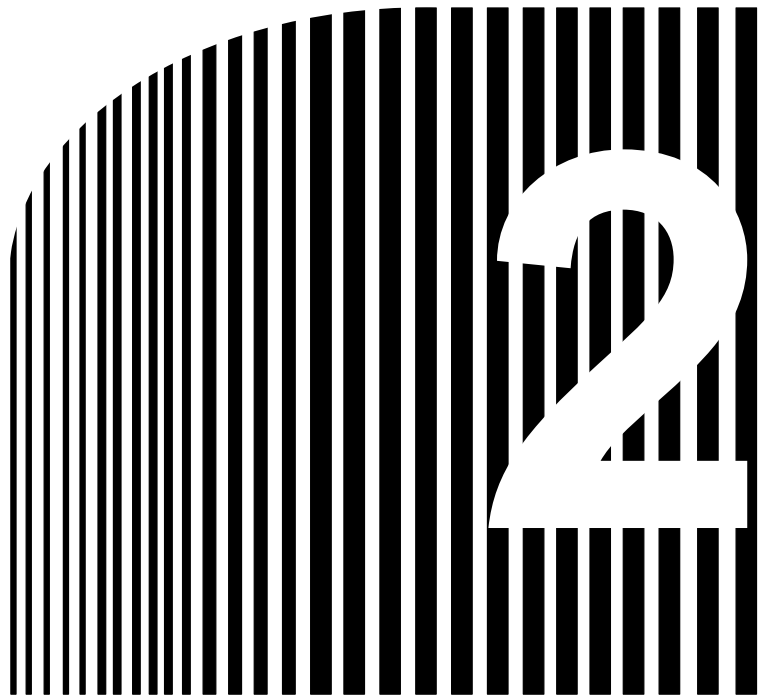

Chapter 2

• Installation •

2-1 Mounting

2-2 Wiring

2-1 Mounting

2-1-1 Dimensions

- 3G3FV-A2004/-A2007/-A2015/-A2022/-A2037
3G3FV-A4004/-A4007/-A4015/-A4022/-A4037

- External Dimensions

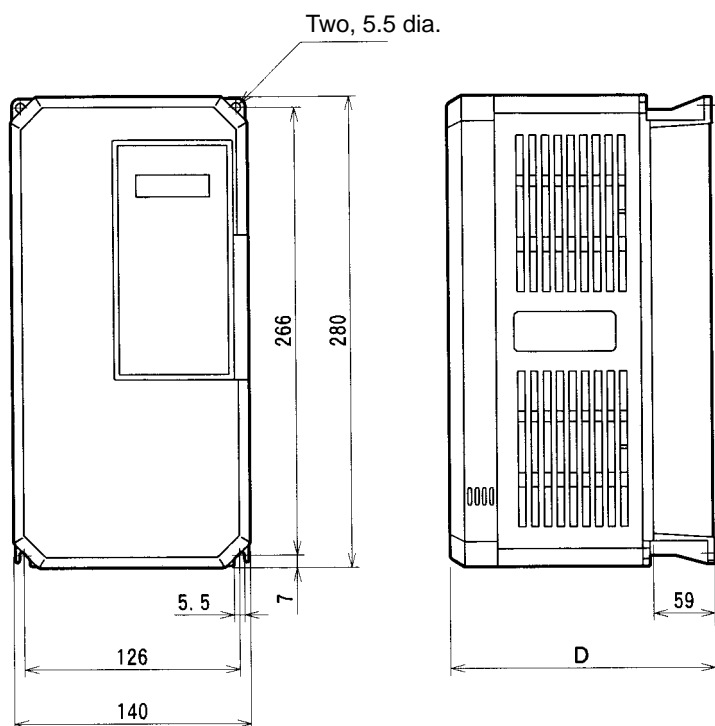

- Mounting Dimensions

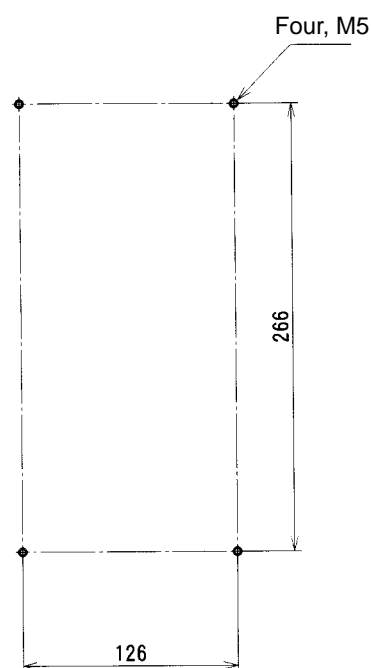

Voltage class	Model 3G3FV-	Dimensions (mm)
		D
200-V	A2004/A2007/A2015	160
	A2022/A2037	180
400-V	A4004/A4007	160
	A4015/A4022/A4037	180

■ 3G3FV-A2055/-A2075/-A4055/-A4075

● External Dimensions

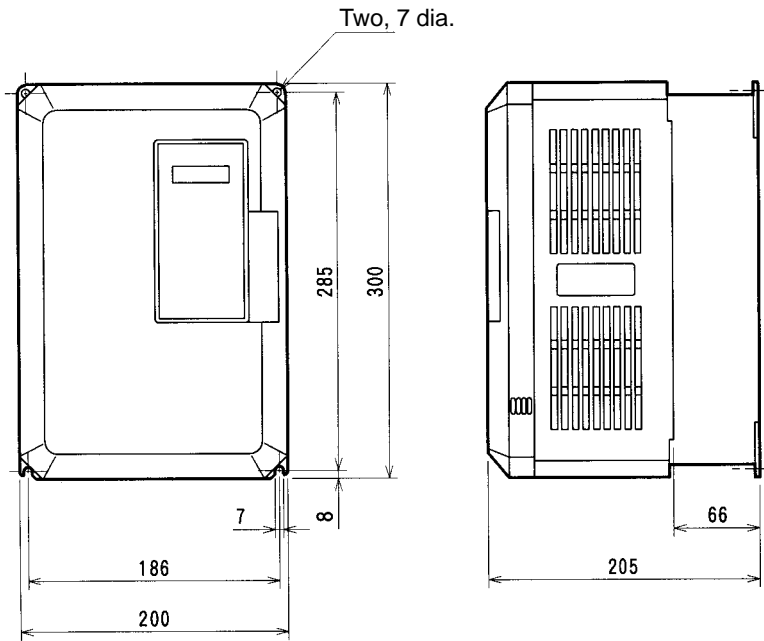

● Mounting Dimensions

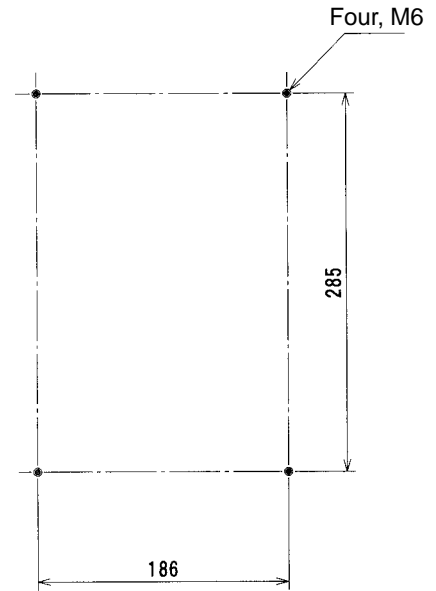

■ 3G3FV-A2110/-A2150/-A4110/-A4150

● External Dimensions

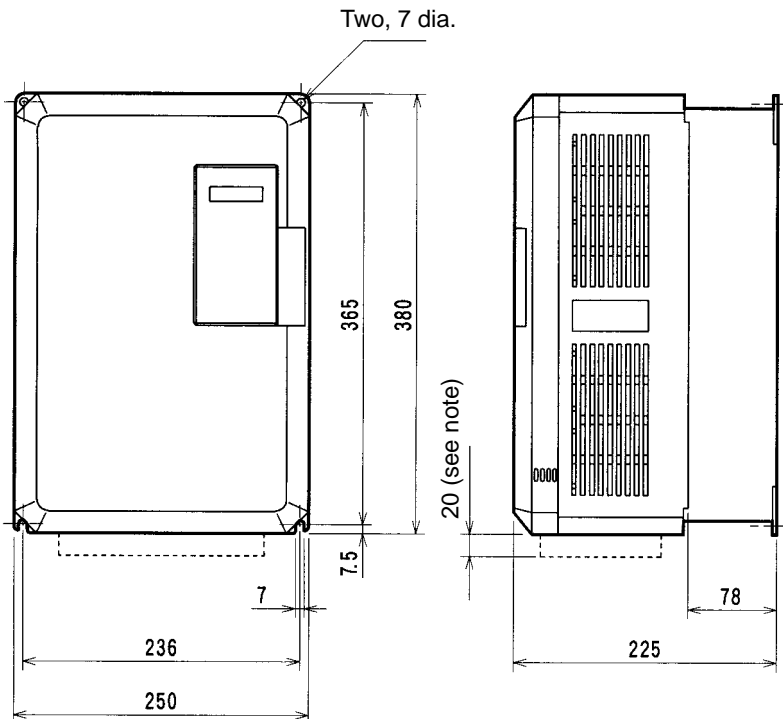

● Mounting Dimensions

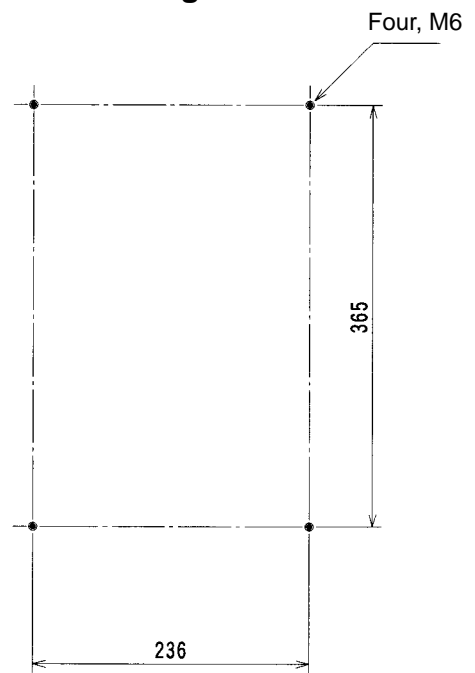

Note *The dashed lines apply only to the A2150.

■ 3G3FV-B2185/-B2220/-B4185/-B4220/-B4300/-B4450

● External Dimensions

● Mounting Dimensions

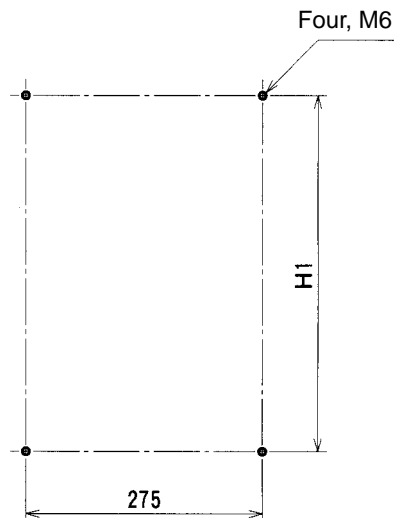
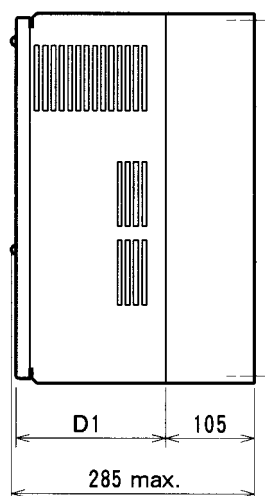
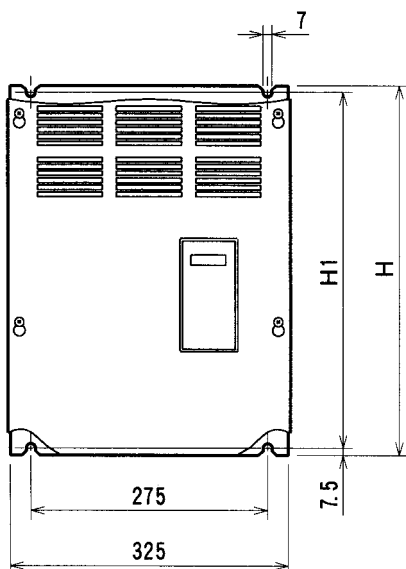

Voltage class	Model 3G3FV-	Dimensions (mm)		
		H	H1	D1
200-V	B2185/B2220	450	435	174.5
400-V	B4185/B4220	450	435	174.5
	B4300/B4370/B4450	625	610	175

■ 3G3FV-B2300/-B2370/-B2450/-B2550/-B4550/-B4750-E

● External Dimensions

● Mounting Dimensions

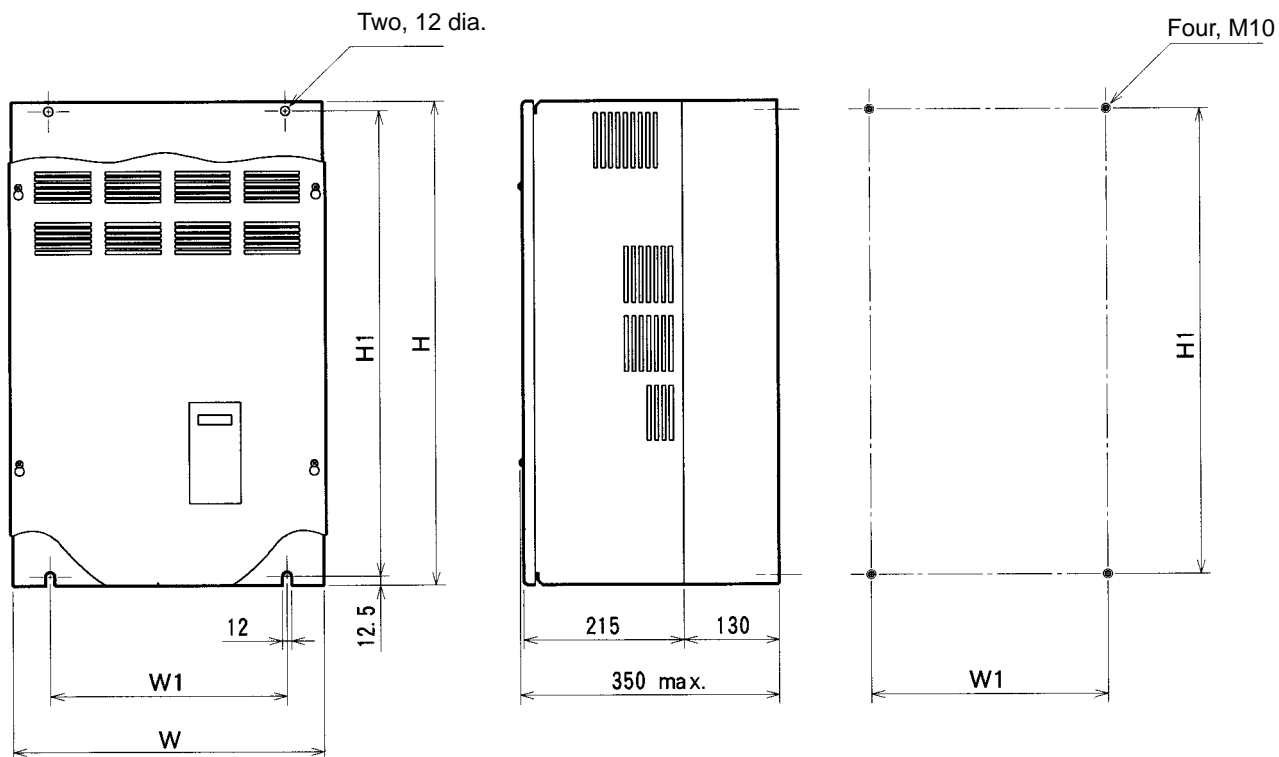

Voltage class	Model 3G3FV-	Dimensions (mm)			
		W	H	W1	H1
200-V	B2300/B2370	425	675	320	650
	B2450/B2550	475	800	370	775
400-V	B4550/B4750-E	455	820	350	795

■ 3G3FV-B2750-E/-B411K-E/-B416K-E

● External Dimensions

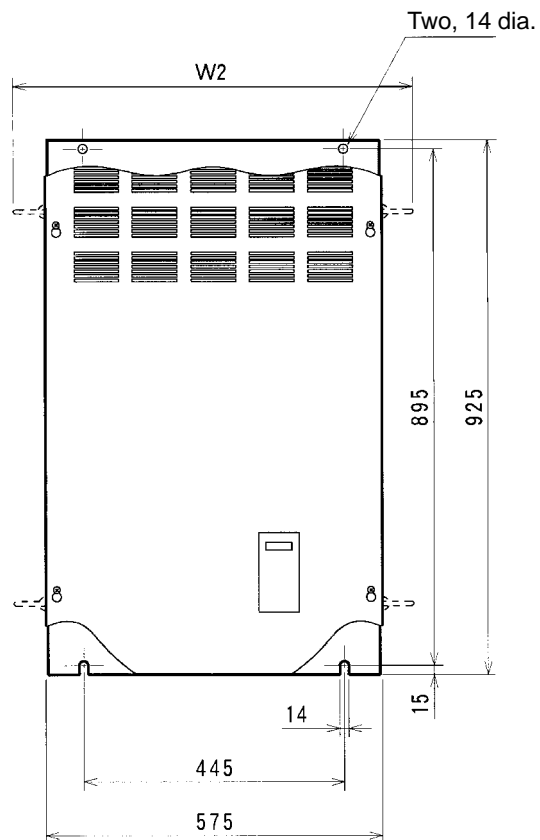

● Mounting Dimensions

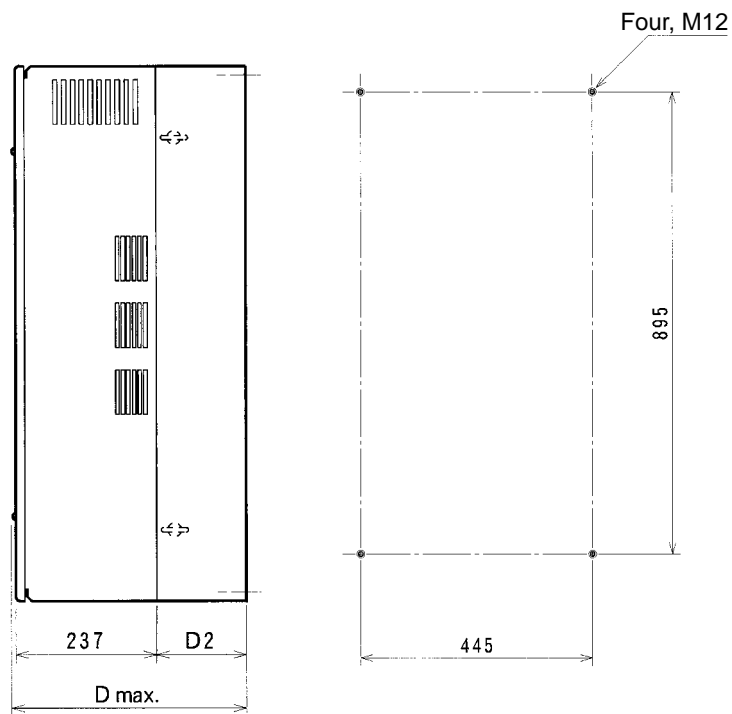

Voltage class	Model 3G3FV-	Dimensions (mm)		
		D	D2	W2
200-V	B2750-E	400 max.	158	695
400-V	B411K-E	375 max.	130	695
	B416K-E	400 max.	158	695

■ 3G3FV-B418K-E/-B422K-E

● External Dimensions

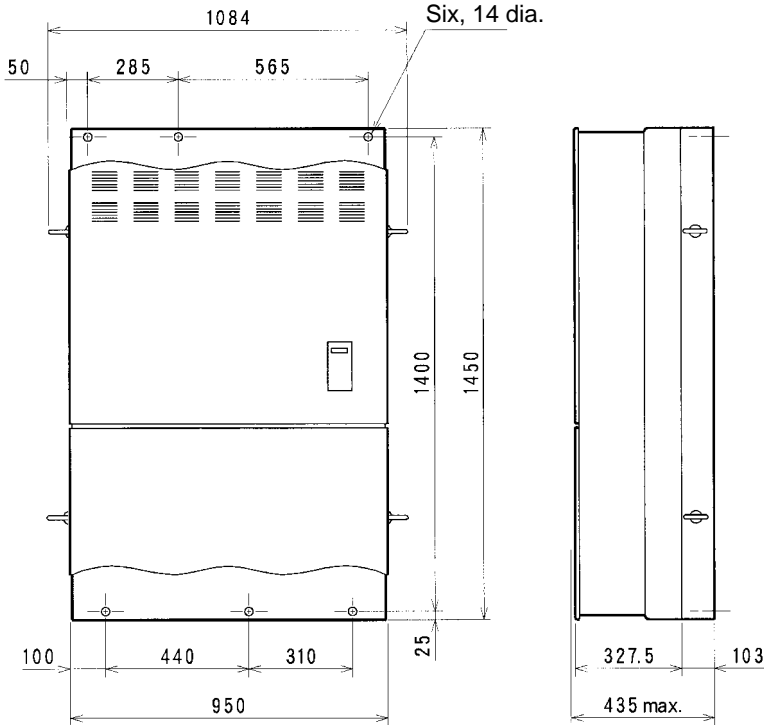

● Mounting Dimensions

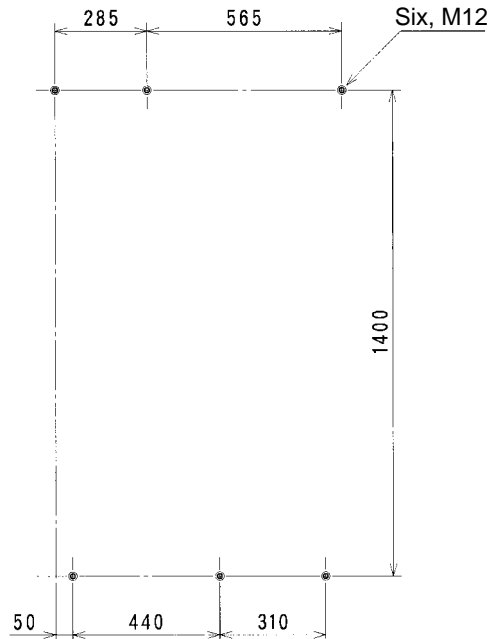

■ 3G3FV-B430K-E

● External Dimensions

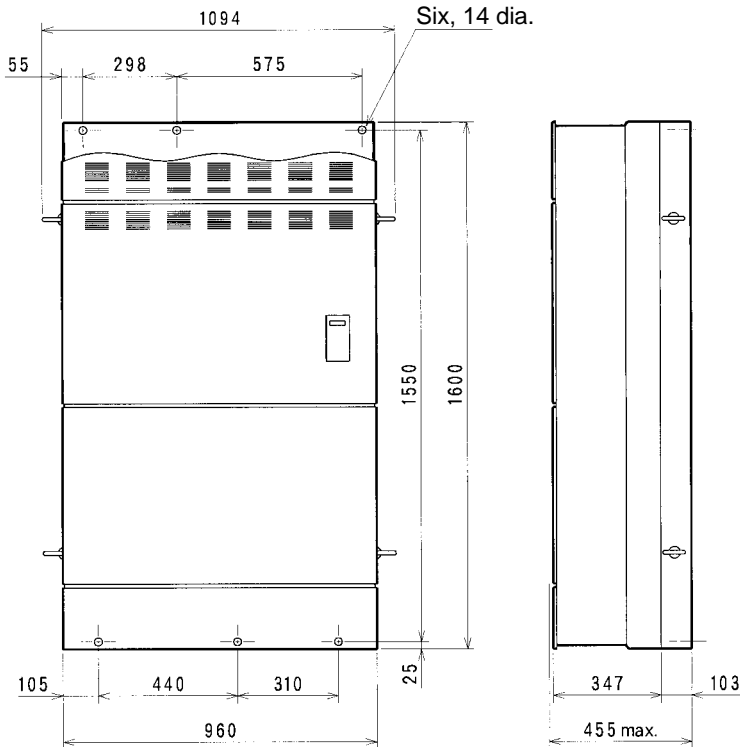

● Mounting Dimensions

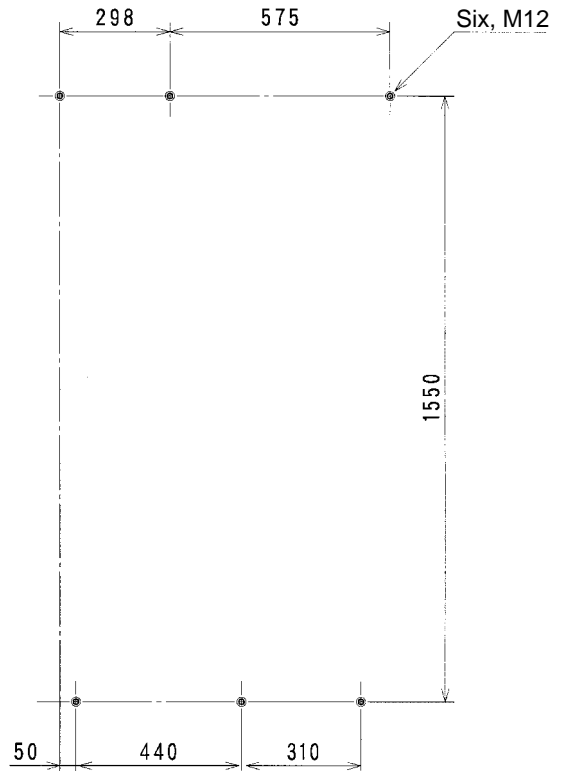

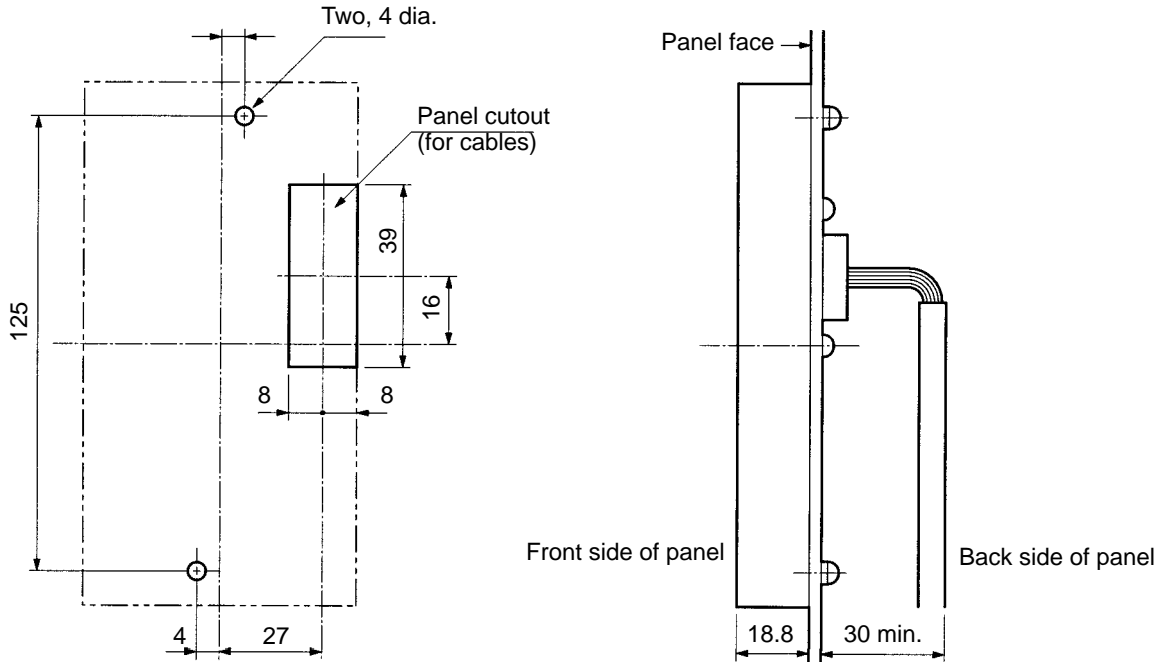

2-1-2 Installation Conditions

■ Cautions and Warnings

- ! WARNING** Provide an appropriate stopping device on the machine side to secure safety. (A holding brake is not a stopping device for securing safety.) Not doing so may result in injury.
- ! WARNING** Provide an external emergency stopping device that allows an instantaneous stop of operation and power interruption. Not doing so may result in injury.
- ! Caution** Be sure to install the product in the correct direction and provide specified clearances between the Inverter and control panel or with other devices. Not doing so may result in fire or malfunction.
- ! Caution** Do not allow foreign objects to enter inside the product. Doing so may result in fire or malfunction.
- ! Caution** Do not apply any strong impact. Doing so may result in damage to the product or malfunction.

■ Direction and Dimensions

- Install the Inverter on a vertical surface so that the characters on the nameplate are oriented upward.
- When installing the Inverter, always provide the following installation space to allow normal heat dissipation from the Inverter.

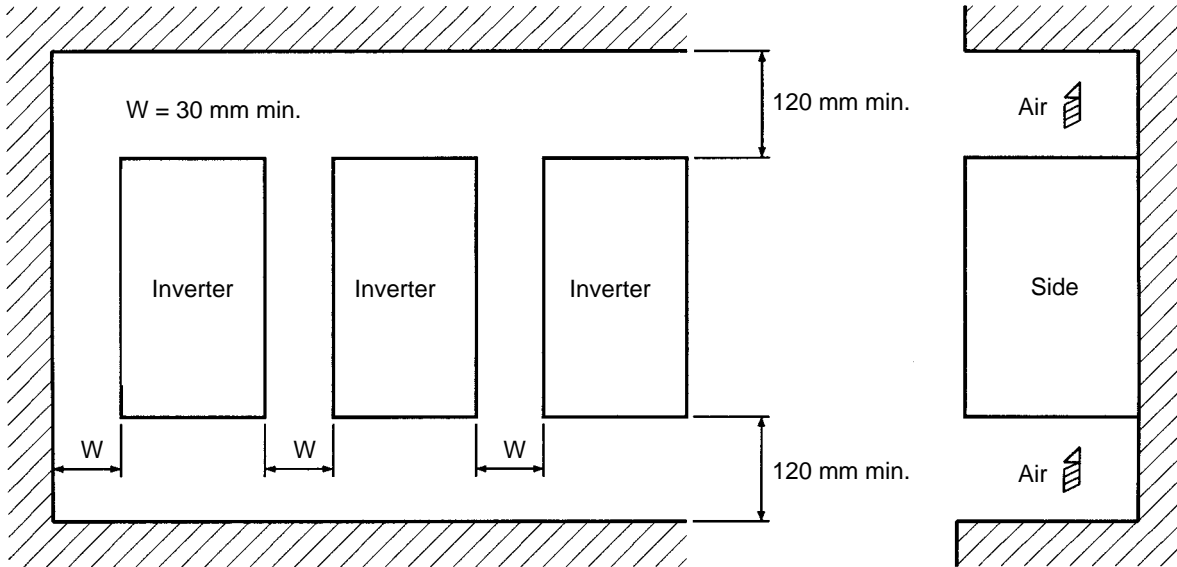

■ Installation Site

- Install the Inverter under the following conditions.

NEMA1 Type

Ambient temperature for operation: -10 to 40°C
 Humidity: 90% RH or less (no condensation)

Open Chassis Type

Ambient temperature for operation: -10 to 45°C
 Humidity: 90% RH or less (no condensation)

Note A protection cover is attached to the top and bottom of the Inverter. Be sure to remove the protection covers before installing the 200- or 400-V Class Inverter that has an output of 15 kW or less to a panel.

- Install the Inverter in a clean location free from oil mist and dust. Alternatively, install it in a totally enclosed panel that is completely shielded from floating dust.
- When installing or operating the Inverter, always take special care so that metal powder, oil, water, or other foreign matter does not get into the Inverter.
- Do not install the Inverter on inflammable material such as wood.

■ Ambient Temperature Control











- To enhance operation reliability, the Inverter should be installed in an environment free from extreme temperature rises.
- If the Inverter is installed in an enclosed environment such as a box, use a cooling fan or air conditioner to maintain the internal air temperature below 45°C.

■ Protecting Inverter from Foreign Matter During Installation

- Place a cover over the Inverter during installation to shield it from metal power produced by drilling.
- Upon completion of installation, always remove the cover from the Inverter. Otherwise, ventilation will be affected, causing the Inverter to overheat.

2-2 Wiring

■ Cautions and Warnings

-  **WARNING** Wiring must be performed only after confirming that the power supply has been turned OFF. Not doing so may result in electrical shock.
-  **WARNING** Wiring must be performed by authorized personnel. Not doing so may result in electrical shock or fire.
-  **WARNING** Be sure to confirm operation only after wiring the emergency stop circuit. Not doing so may result in injury.
-  **WARNING** Always connect the ground terminals to a ground of 100 Ω or less for the 200-V AC class, or 10 Ω or less for the 400-V AC class. Not connecting to a proper ground may result in electrical shock.
-  **Caution** Install external breakers and take other safety measures against short-circuiting in external wiring. Not doing so may result in fire.
-  **Caution** Confirm that the rated input voltage of the Inverter is the same as the AC power supply voltage. An incorrect power supply may result in fire, injury, or malfunction.
-  **Caution** Connect the Braking Resistor and Braking Resistor Unit as specified in the manual. Not doing so may result in fire.
-  **Caution** Be sure to wire correctly and securely. Not doing so may result in injury or damage to the product.
-  **Caution** Be sure to firmly tighten the screws on the terminal block. Not doing so may result in fire, injury, or damage to the product.
-  **Caution** Do not connect an AC power to the U, V, or W output. Doing so may result in damage to the product or malfunction.

2-2-1 Removing and Mounting the Front Cover

Remove the front cover to wire the terminals. Remove the Digital Operator from the front cover before removing the front cover. For models of 15 kW or less (both 200-V and 400-V class), do not remove or mount the front cover without first removing the Digital Operator; otherwise the Digital Operator may malfunction due to imperfect contact.

■ Removing the Cover (Models of 15 kW or Less)

• Removing the Digital Operator

Press the lever on the side of the Digital Operator in the arrow ① direction to unlock the Digital Operator and lift the Digital Operator in the arrow ② direction to remove the Digital Operator as shown in the following illustration.

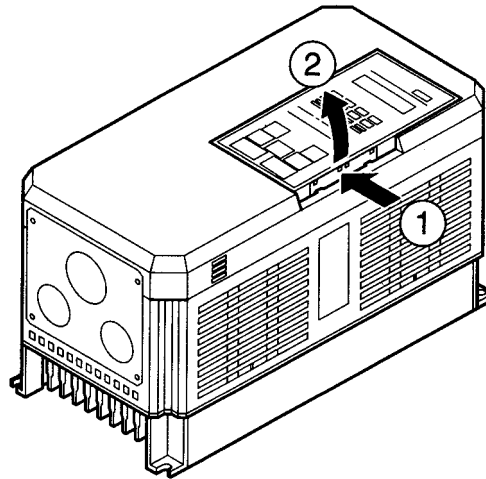

• Removing the Front Cover

Press the left and right sides of the front cover in the arrow ① directions and lift the bottom of the cover in the arrow ② direction to remove the front cover as shown in the following illustration.

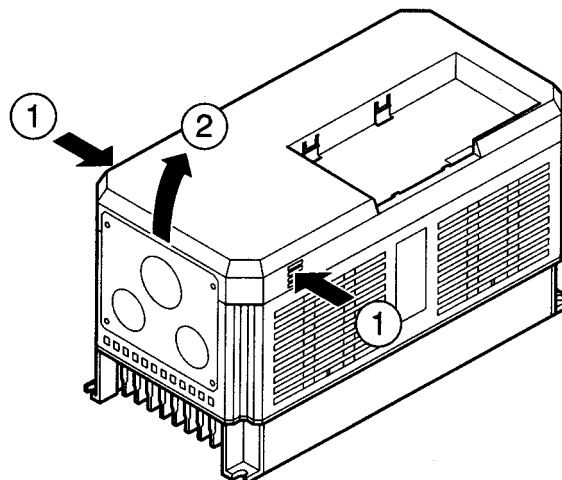

• **Mounting the Front Cover**

Mount the front cover to the Inverter by taking in reverse order to the steps to remove the front cover after wiring the terminals.

Do not mount the front cover with the Digital Operator attached to the front cover, otherwise Digital Operator may malfunction due to imperfect contact.

Insert the tab of the upper part of the front cover into the groove of the Inverter and press the lower part of the front cover onto the Inverter until the front cover snaps shut.

■ **Mounting the Digital Operator**

- Hook the Digital Operator on clicks A of the front cover in the arrow ① direction as shown in the following illustration.
- Press the Digital Operator in the arrow ② direction until it snaps shut with clicks B.

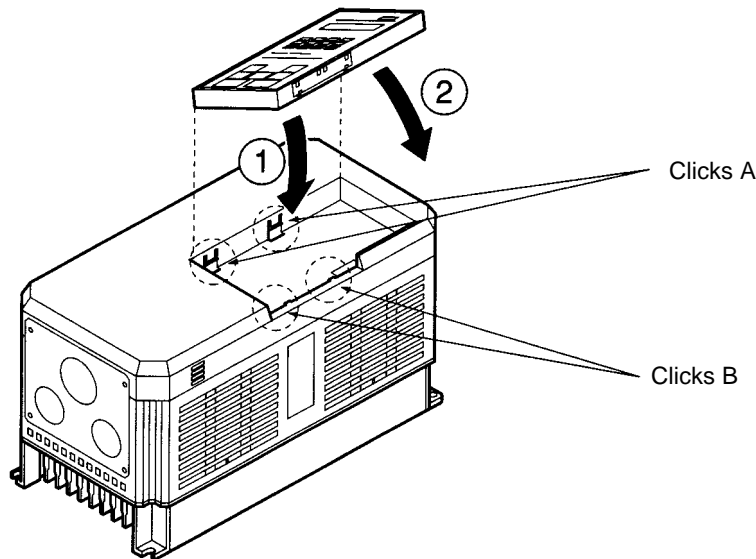

Note Do not remove or attach the Digital Operator or mount or remove the front cover using methods other than those mentioned above, otherwise the Inverter may malfunction due to imperfect contact or break.

■ **Removing the Front Cover of Inverters with 18.5-kW Output or More**

- The front cover can be removed without removing the Digital Operator from the Inverter provided that the Inverter model is one with an output of 18.5 kW or more.
- Loosen the four screws of the front cover and move the front cover slightly upwards to remove the front cover.

2-2-2 Terminals

■ Terminal Block Configuration (200-V Class with 0.4-kW Output)

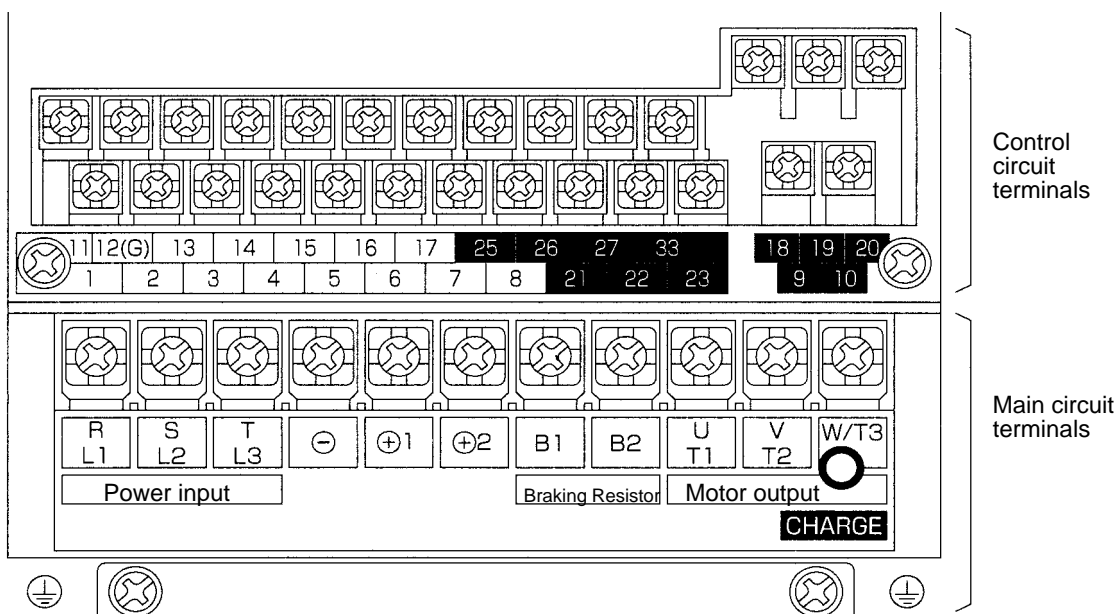

■ Main Circuit Terminals

● 200-V Class

Model 3G3FV-	A2004 to A2075	A2110 to A2150	B2185 to B2220	B2300 to B2750-E
Maximum applied motor capacity	0.4 to 7.5 kW	11 to 15 kW	18.5 to 22 kW	30 to 75 kW
L1 (R)	Power supply input terminals, 3-phase, 200 to 230 VAC, 50/60 Hz			
L2 (S)				
L3 (T)				
T1 (U)	Motor output terminals, 3-phase, 200 to 230 VAC (correspond to input voltage)			
T2 (V)				
T3 (W)				
B1	Braking Resistor Unit connection terminals	---		
B2				
(+) 1	DC reactor connection terminal (+) 1-(+) 2	DC reactor connection terminal (+) 1-(+) 2	DC power supply input terminal (+) 1-(-) 1	---
(+) 2				
(-) 1	DC power supply input terminal (+) 1-(-) 1	DC power supply input terminal (+) 1-(-) 1	Braking Unit connection terminal (+) 3-(-) 3	Braking Unit connection terminal (+) 3-(-) 3 See note 1
(+) 3				
s	---		Cooling fan power supply input terminal	See note 2
r				
s200	---			
s400	---			
(⏚)	Ground the terminal at a resistance of less than 100 Ω.			

Note 1. Don't connect a DC power supply. Otherwise, equipment trouble may occur.

Note 2. These are the cooling fan power supply and control circuit power supply input terminals.

● 400-V Class

Model 3G3FV-	A4004 to A4150	B4185 to B4450	B4550 to B416K-E	B418K-E to B430K-E
Maximum applied motor capacity	0.4 to 15 kW	18.5 to 45 kW	55 to 160 kW	185 to 300 kW
L1 (R)	Power supply input terminals, 3-phase, 380 to 460 VAC, 50/60 Hz			
L2 (S)				
L3 (T)				
T1 (U)	Motor output terminals, 3-phase, 380 to 460 VAC (correspond to input voltage)			
T2 (V)				
T3 (W)				
B1	Braking Resistor Unit connection terminals	---		
B2				
⊕ 1	DC reactor connection terminal (⊕ 1-⊕ 2)	DC power supply input terminal (⊕ 1-⊖)	---	DC power supply input terminal (⊕ 1-⊖)
⊕ 2				
⊖	DC power supply input terminal (⊕ 1-⊖)	Braking Unit connection terminal (⊕ 3-⊖)	Braking Unit connection terminal (⊕ 3-⊖) See note 1	Braking Unit connection terminal (⊕ 3-⊖) See note 1
⊕ 3				
s	---	Cooling fan power supply input terminal	---	---
r			See notes 2, 3	See notes 2, 3
s200		---	---	
s400		---	---	
⊕	Ground the terminal at a resistance of less than 10 Ω.			

Note 1. Don't connect a DC power supply. Otherwise, equipment trouble may occur.

Note 2. These are the cooling fan power supply and control circuit power supply input terminals.

Note 3. When 200-V is used, input 200 to 230 VAC from r – s200. When 400-V is used, input 380 to 460 VAC from r – s400.

■ Control Circuit Terminals for All 3G3FV Models

Symbol	Name	Function	Signal level
Input	1	Forward/Stop	Photocoupler 24 VDC, 8 mA
	2	Reverse/Stop	
	3	Multi-function contact input 1	
	4	Multi-function contact input 2	
	5	Multi-function contact input 3	
	6	Multi-function contact input 4	
	7	Multi-function contact input 5	
	8	Multi-function contact input 6	
	11	Sequence input common	

Symbol	Name	Function	Signal level	
Input	15	Frequency reference power supply (15 VDC)	15-VDC power supply for frequency reference.	15 VDC (±10%), 20 mA max.
	33	Frequency reference power supply (-15 VDC)	-15-VDC power supply for frequency reference.	-15 VDC (±10%), 20 mA max.
	13	Frequency reference input (voltage)	Frequency reference voltage input terminal Either 0 to +10 V or 0 to ±10 V can be selected as the parameter (H3-01).	0 to 10 VDC (Input impedance: 20 kΩ) 0 to ±10 V (Input impedance: 20 kΩ)
	14	Frequency reference input (current)	Current input terminal for frequency reference.	4 to 20 mA (Input impedance: 250 kΩ)
	16	Multi-function analog input	Set by parameter H3-05.	0 to 10 VDC (Input impedance: 20 kΩ) 0 to ±10 V (Input impedance: 20 kΩ)
	17	Frequency reference input common	Common for analog input signal.	---
	12	Shielded wire connection ground	Shielded terminal for sequence input, frequency reference input.	---
Output	9	Multi-function contact output	Set by parameter H2-01 (during running).	Contact output (SPST-NO) 30 VDC, 1 A max. 250 VAC, 1 A max.
	10	Multi-function contact output common		
	25	Multi-function output 1	Set by parameter H2-02 (zero speed detection).	Open collector output 48 V, 50 mA max.
	26	Multi-function output 2	Set by parameter H2-03 (agree output reference detection).	
	27	Multi-function output 1 and 2 common	Common for terminals, 25, 26.	
	18	Fault output (NO condition)	When fault occurs: Terminals 18 to 20: Closed Terminals 19 to 20: Open	Contact output (SPDT) 30 VDC, 1 A max. 250 VAC, 1 A max.
	19	Fault output (NC condition)		
	20	Fault output common		
Output	21	Multi-function analog output 1	Set by parameter H4-01. (Output frequency: 0 to ±10 V/±100% frequency)	0 to ±10 VDC (±5%), 0 to 10 VDC (±5%), 2 mA max.
	23	Multi-function analog output 2	Set by parameter H4-01. (Output current: 5 V/Inverter rated current)	
	22	Multi-function analog output common	Common for analog output.	

Note The settings shown in parentheses in the “Function” column for multi-function inputs 1 to 6, multi-function contact outputs, and multi-function outputs 1 and 2 indicate default settings.

2-2-3 Standard Connection Diagram

■ Main Circuit Terminal Connections

● 3G3FV-A2004 to A2075, A4004 to A4150

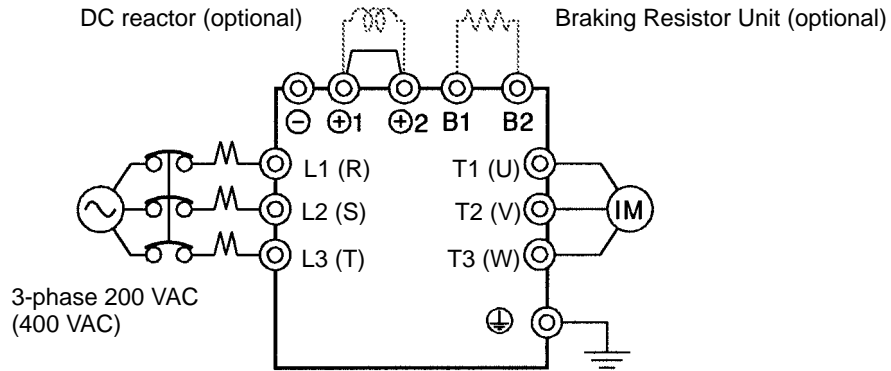

Note: Be sure to remove the short bar before connecting a DC reactor.

● 3G3FV-A2110 to A2150

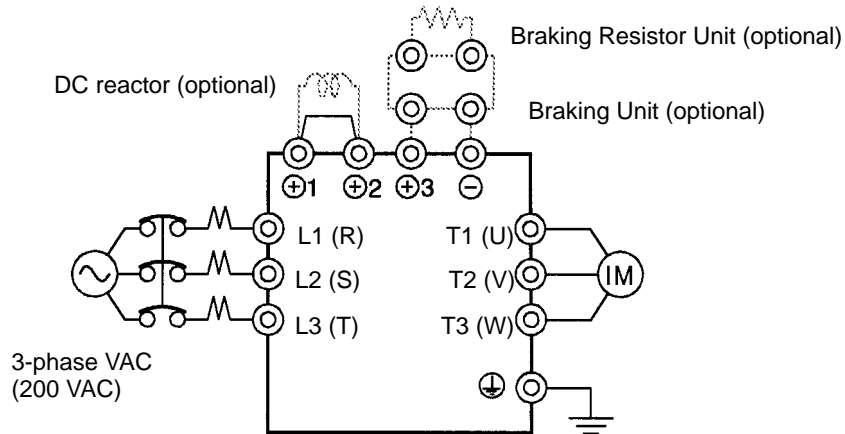

Note: Be sure to remove the short bar before connecting a DC reactor.

● 3G3FV-B2185 to B2220, B4185 to B4450

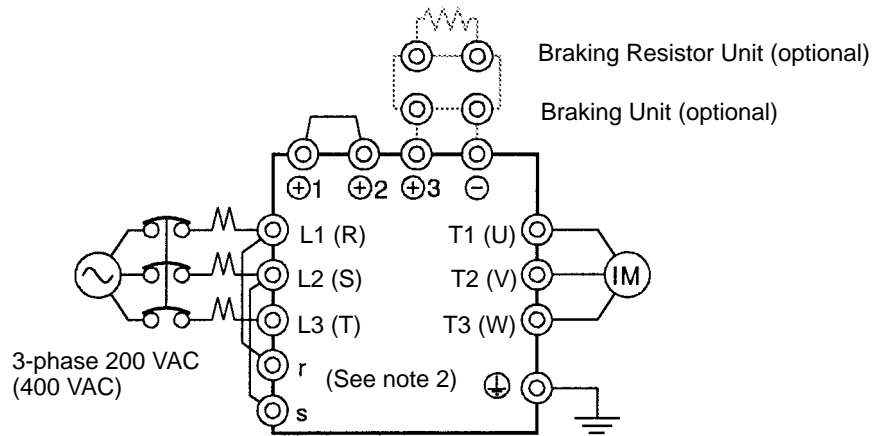

Note: The DC reactor is built in.

● 3G3FV-B2300 to B2550

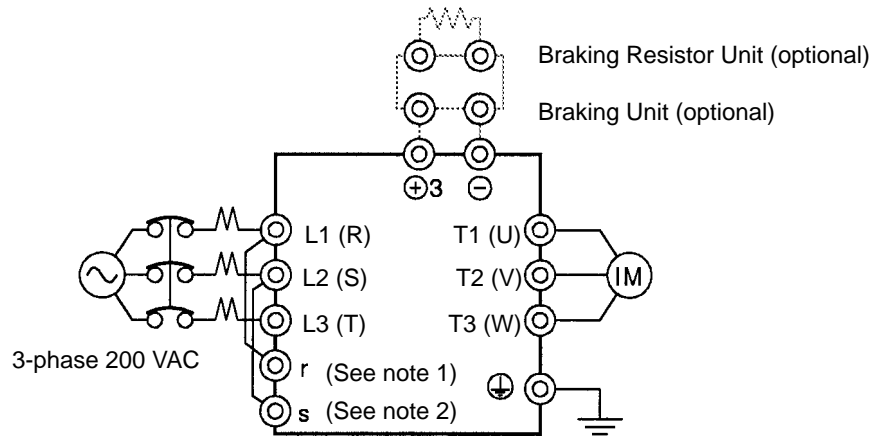

Note: The DC reactor is built in.

Note 1. For 200-V class, 30 to 75 kW (B2300 to B2750-E) and 400-V class, 55 to 300 kW (B4550 to B430K), input the control circuit power supply from r-s. (For others, create the control power supply internally from the main circuit DC power supply.)

Note 2. The r-L1 (R) and s-L2 (S) terminals are short-circuited for shipping.

● 3G3FV-B2750-E

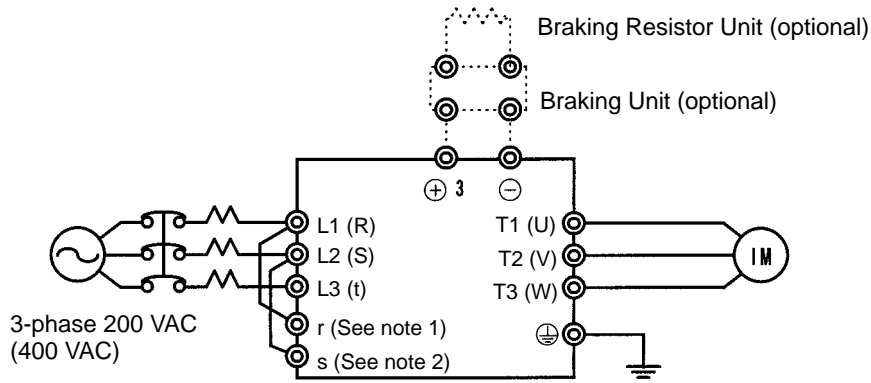

Note: The DC reactor is built in.

Note 1. For 200-V class, 30 to 75 kW (B2300 to B2750-E) and 400-V class, 55 to 300 kW (B4550-E to B430K-E), input the control circuit power supply from r–s. (For others, create the control power supply internally from the main circuit DC power supply.)

Note 2. The r–L1 (R) and s–L2 (S) terminals are short-circuited for shipping.

● 3G3FV-B4550 to B416K-E

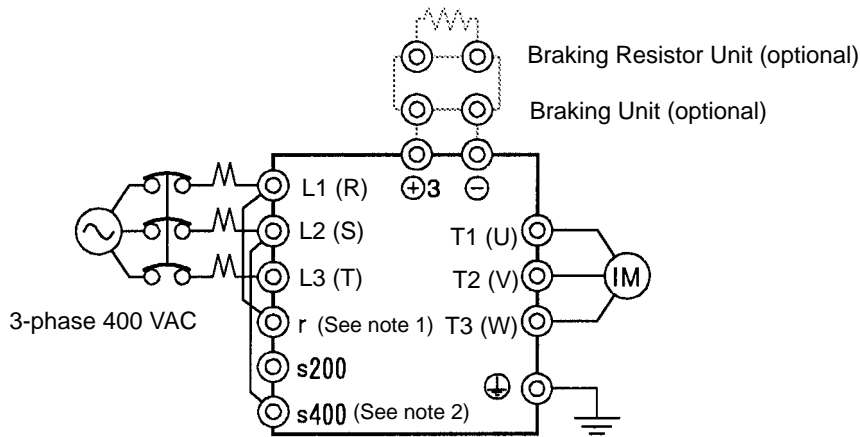

Note: The DC reactor is built in.

Note 1. For 200-V class, 30 to 75 kW (B2300 to B2750-E) and 400-V class, 55 to 300 kW (B4550-E to B430K-E), input the control circuit power supply from r–s. (For others, create the control power supply internally from the main circuit DC power supply.)

Note 2. The r–L1 (R) and s (s400)–L2 (S) terminals are short-circuited for shipping.

● 3G3FV-B418K-E to B430K-E

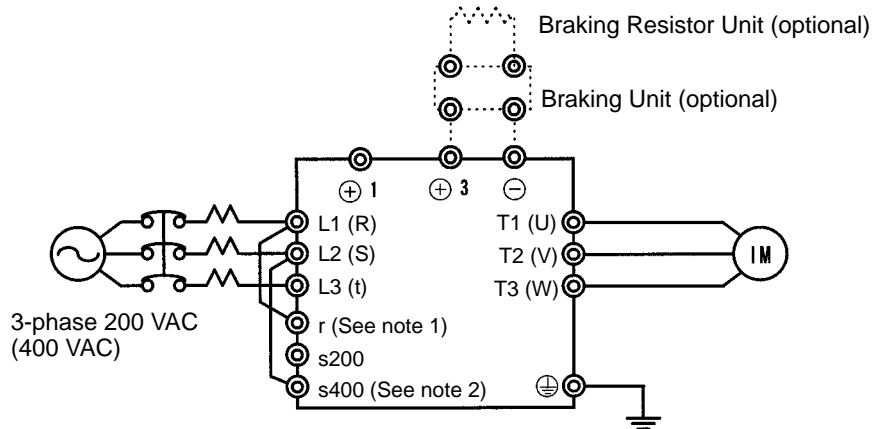

Note: Models of 185 to 300 kW can not use the DC reactor.

Note 1. For 200-V class, 30 to 75 kW (B2300 to B2750-E) and 400-V class, 55 to 300 kW (B4550-E to B430K-E), input the control circuit power supply from r–s. (For others, create the control power supply internally from the main circuit DC power supply.)

Note 2. The r–L1 (R) and s (s400)–L2 (S) terminals are short-circuited for shipping.

■ Control Circuit Terminal Connections (All Models)

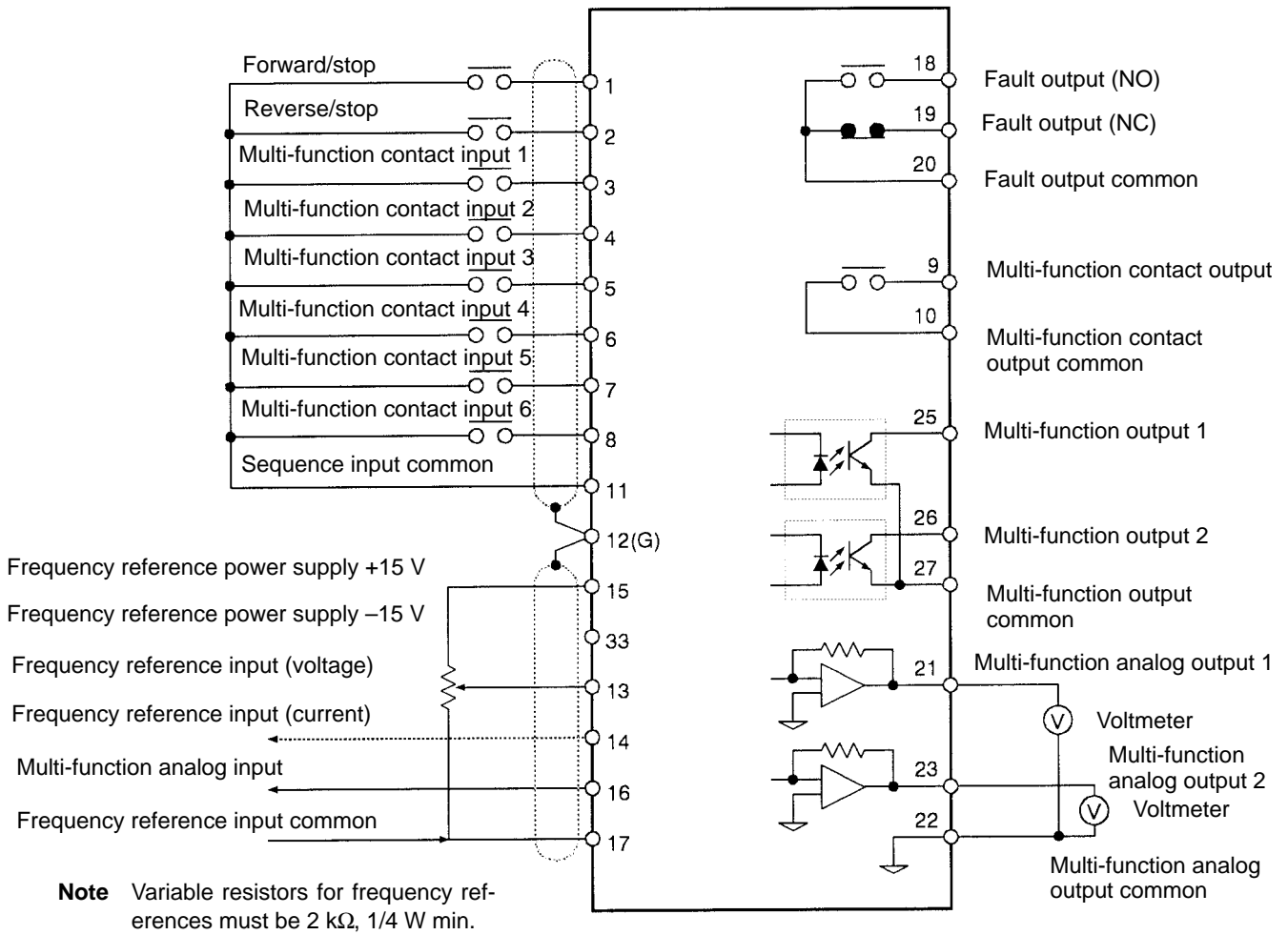

Wiring Example

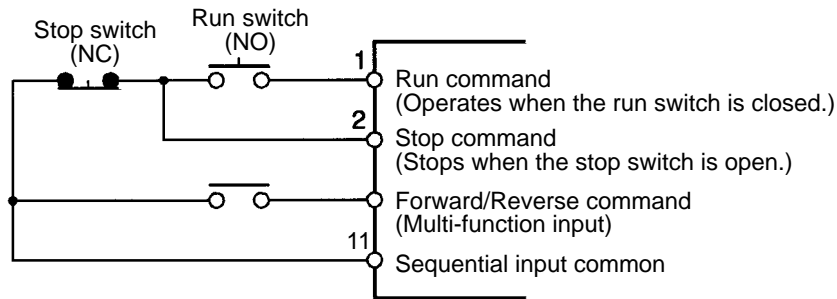

Note Wiring methods for 3G3FV--CUE (-CE) Inverters are sometimes different. Always check wiring methods in the *Installation Manual* (I530 and I520).

2-2-4 Wiring Around the Main Circuit















System reliability and noise resistance are affected by the wiring method used. Therefore, always follow the instructions given below when connecting the Inverter to peripheral devices and other parts.

■ Wire Size and Round Solderless Terminal

For the main circuit and ground, always use 600-V polyvinyl chloride (PVC) cables.













If the cable is long and may cause voltage drops, increase the wire size according to the cable length.









● Wire Sizes

Voltage class	Model	Terminal	Terminal screw	Wire thickness (mm ²)
200-V Class	3G3FV-A2004	L1, L2, L3, (-), (+)1, (+)2, B1, B2, T1, T2, T3	M4	2 to 5.5
				
	3G3FV-A2007	L1, L2, L3, (-), (+)1, (+)2, B1, B2, T1, T2, T3	M4	2 to 5.5
				
	3G3FV-A2015	L1, L2, L3, (-), (+)1, (+)2, B1, B2, T1, T2, T3	M4	2 to 5.5
				3.5 to 5.5
	3G3FV-A2022	L1, L2, L3, (-), (+)1, (+)2, B1, B2, T1, T2, T3	M4	3.5 to 5.5
				
	3G3FV-A2037	L1, L2, L3, (-), (+)1, (+)2, B1, B2, T1, T2, T3	M4	5.5
				
	3G3FV-A2055	L1, L2, L3, (-), (+)1, (+)2, B1, B2, T1, T2, T3	M5	8
				5.5 to 8
	3G3FV-A2075	L1, L2, L3, (-), (+)1, (+)2, B1, B2, T1, T2, T3	M5	8
				5.5 to 8
	3G3FV-A2110	L1, L2, L3, (-), (+)1, (+)2, (+)3, T1, T2, T3	M6	22
				8
	3G3FV-A2150	L1, L2, L3, (-), (+)1, (+)2, (+)3, T1, T2, T3	M8	30
			M6	8
	3G3FV-B2185	L1, L2, L3, (-), (+)1, (+)2, (+)3, T1, T2, T3	M8	30
				14
		r, s	M4	0.5 to 5.5
	3G3FV-B2220	L1, L2, L3, (-), (+)1, (+)2, (+)3, T1, T2, T3	M8	38
				14
		r, s	M4	0.5 to 5.5
	3G3FV-B2300	L1, L2, L3, (-), (+)3, T1, T2, T3	M10	100
			M8	22
		r, s	M4	0.5 to 5.5
	3G3FV-B2370	L1, L2, L3, (-), (+)3, T1, T2, T3	M10	60 x 2P
			M8	22
		r, s	M4	0.5 to 5.5
3G3FV-B2450	L1, L2, L3, (-), (+)3, T1, T2, T3	M10	60 x 2P	
		M8	22	
	r, s	M4	0.5 to 5.5	
3G3FV-B2550	L1, L2, L3, (-), (+)3, T1, T2, T3	M10	60 x 2P	
		M8	30	
	r, s	M4	0.5 to 5.5	

Voltage class	Model	Terminal	Terminal screw	Wire thickness (mm ²)
200-V Class	3G3FV-B2750-E	L1, L2, L3, (-), (+)3, T1, T2, T3	M12	100 x 2P
			M8	50
		r, s	M4	0.5 to 5.5

Note The wire thickness is set for copper wires at 75°C.

Voltage class	Model	Terminal	Terminal screw	Wire thickness (mm ²)
400-V Class	3G3FV-A4004	L1, L2, L3, (-), (+)1, (+)2, B1, B2, T1, T2, T3	M4	2 to 5.5
				
	3G3FV-A4007	L1, L2, L3, (-), (+)1, (+)2, B1, B2, T1, T2, T3	M4	2 to 5.5
				
	3G3FV-A4015	L1, L2, L3, (-), (+)1, (+)2, B1, B2, T1, T2, T3	M4	2 to 5.5
				
	3G3FV-A4022	L1, L2, L3, (-), (+)1, (+)2, B1, B2, T1, T2, T3	M4	2 to 5.5
				
	3G3FV-A4037	L1, L2, L3, (-), (+)1, (+)2, B1, B2, T1, T2, T3	M4	2 to 5.5
				3.5 to 5.5
	3G3FV-A4055	L1, L2, L3, (-), (+)1, (+)2, B1, B2, T1, T2, T3	M4	3.5 to 5.5
				
	3G3FV-A4075	L1, L2, L3, (-), (+)1, (+)2, B1, B2, T1, T2, T3	M5	5.5
				
	3G3FV-A4110	L1, L2, L3, (-), (+)1, (+)2, B1, B2, T1, T2, T3	M5	8 to 14
			M6	8
	3G3FV-A4150	L1, L2, L3, (-), (+)1, (+)2, B1, B2, T1, T2, T3	M5	8 to 14
			M6	8
	3G3FV-B4185	L1, L2, L3, (-), (+)1, (+)2, (+)3, T1, T2, T3	M6	14
			M8	8
		r, s	M4	0.5 to 5.5
	3G3FV-B4220	L1, L2, L3, (-), (+)1, (+)2, (+)3, T1, T2, T3	M6	22
			M8	8
		r, s	M4	0.5 to 5.5
3G3FV-B4300	L1, L2, L3, (-), (+)1, (+)2, (+)3, T1, T2, T3	M8	22	
			8	
	r, s	M4	0.5 to 5.5	
3G3FV-B4370	L1, L2, L3, (-), (+)1, (+)2, (+)3, T1, T2, T3	M8	30	
			14	
	r, s	M4	0.5 to 5.5	

Voltage class	Model	Terminal	Terminal screw	Wire thickness (mm ²)
400-V Class	3G3FV-B4450	L1, L2, L3, (-), (+)1, (+)2, (+)3, T1, T2, T3	M8	50
				14
		r, s	M4	0.5 to 5.5
	3G3FV-B4550	L1, L2, L3, (-), (+)3, T1, T2, T3	M10	100
			M8	22
		r, s200, s400	M4	0.5 to 5.5
	3G3FV-B4750-E	L1, L2, L3, (-), (+)3, T1, T2, T3	M10	60 x 2P
			M8	22
		r, s200, s400	M4	0.5 to 5.5
	3G3FV-B411K-E	L1, L2, L3, (-), (+)3, T1, T2, T3	M10	60 x 2P
			M8	30
		r, s200, s400	M4	0.5 to 5.5
	3G3FV-B416K-E	L1, L2, L3, (-), (+)3, T1, T2, T3	M12	100 x 2P
			M8	50
		r, s200, s400	M4	0.5 to 5.5
	3G3FV-B418K-E	L1, L2, L3, (-), (+)1, (+)3, T1, T2, T3	M16	325 x 2P
			M8	50
		r, s200, s400	M4	0.5 to 5.5
3G3FV-B422K-E	L1, L2, L3, (-), (+)1, (+)3, T1, T2, T3	M16	325 x 2P	
		M8	60	
	r, s200, s400	M4	0.5 to 5.5	
3G3FV-B430K-E	L1, L2, L3, (-), (+)1, (+)3, T1, T2, T3	M16	325 x 2P	
		M8	60	
	r, s200, s400	M4	0.5 to 5.5	

Note The wire thickness is set for copper wires at 75°C.

● Round Solderless Terminals and Tightening Torque

Wire thickness (mm ²)	Terminal screw	Size	Tightening torque (N•m)
0.5	M4	1.25-4	1.2
0.75	M4	1.25-4	1.2
1.25	M4	1.25-4	1.2
2	M4	2-4	1.2
	M5	2-5	2.0
	M6	2-6	2.5
	M8	2-8	6.0
3.5/5.5	M4	5.5-4	1.2
	M5	5.5-5	2.0
	M6	5.5-6	2.5
	M8	5.5-8	6.0
8	M5	8-5	2.0
	M6	8-6	2.5
	M8	8-8	6.0
14	M6	14-6	2.5
	M8	14-8	6.0
22	M6	22-6	2.5
	M8	22-8	6.0
30/38	M8	38-8	6.0
50/60	M8	60-8	6.0
	M10	60-10	10.0
80	M10	80-10	10.0
100		100-10	10.0
100	M12	100-12	14.0
150		150-12	14.0
200		200-12	14.0
325	M12 x 2	325-12	14.0
	M16	325-16	25.0

Note Determining Wire Size

Determine the wire size for the main circuit so that line voltage drop is within 2% of the rated voltage.

Line voltage drop is calculated as follows:

$$\text{Line voltage drop (V)} = \sqrt{3} \times \text{wire resistance } (\Omega/\text{km}) \times \text{wire length (m)} \times \text{current (A)} \times 10^{-3}$$

■ Wiring on the Input Side of the Main Circuit

● Installing a Molded-case Circuit Breaker

Always connect the power input terminals (R/L1, S/L2, and T/L3) and power supply via a molded case circuit breaker (MCCB) suitable to the Inverter.

- Install one wiring circuit breaker per Inverter.
- Choose an MCCB with a capacity of 1.5 to 2 times the Inverter’s rated current.
- For the MCCB’s time characteristics, be sure to consider the Inverter’s overload protection (one minute at 150% of the rated output current).
- If the MCCB is to be used in common among multiple Inverters, or other devices, set up a sequence such that the power supply will be turned OFF by a fault output, as shown in the following diagram.

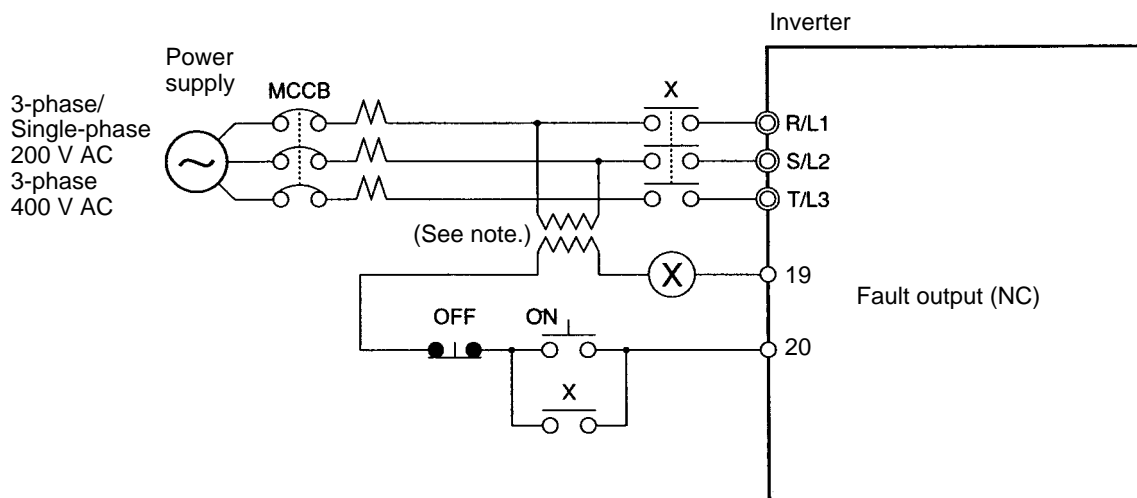

Note Use a 400/200 V transformer for a 400-V model.

● Installing a Ground Fault Interrupter

Inverter outputs use high-speed switching, so high-frequency leakage current is generated.

In general, a leakage current of approximately 100 mA will occur for each Inverter (when the power cable is 1 m) and approximately 5 mA for each additional meter of power cable.

Therefore, at the power supply input area, use a special-purpose breaker for Inverters, which detects only the leakage current in the frequency range that is hazardous to humans and excludes high-frequency leakage current.

- For the special-purpose breaker for Inverters, choose a ground fault interrupter with a sensitivity amperage of at least 10 mA per Inverter.
- When using a general leakage breaker, choose a ground fault interrupter with a sensitivity amperage of 200 mA or more per Inverter and with an operating time of 0.1 s or more.

● Installing a Magnetic Contactor

If the power supply of the main circuit is to be shut off because of the sequence, a magnetic contactor can be used instead of a molded-case circuit breaker.

When a magnetic contactor is installed on the primary side of the main circuit to stop a load forcibly, however, the regenerative braking does not work and the load coasts to a stop.

- A load can be started and stopped by opening and closing the magnetic contactor on the primary side. Frequently opening and closing the magnetic contactor, however, may cause the Inverter to break down. To maintain the service life of the Inverter's internal relays and electrolytic capacitors, it is recommended that this operation be performed no more than once every 30 minutes.
- When the Inverter is operated with the Digital Operator, automatic operation cannot be performed after recovery from a power interruption.
- When using the Braking Resistor Unit, be sure to arrange a sequence in which the thermal relay of the Unit turns the magnetic contactor OFF.

● Connecting Input Power Supply to the Terminal Block

Input power supply can be connected to any terminal on the terminal block because the phase sequence of input power supply is irrelevant to the phase sequence (R/L1, S/L2, and T/L3).

● Installing an AC Reactor

If the Inverter is connected to a large-capacity power transformer (660 kW or more) or the phase advance capacitor is switched, an excessive peak current may flow through the input power circuit, causing the converter unit to break down.

To prevent this, install an optional AC reactor on the input side of the Inverter.

This also improves the power factor on the power supply side.

● Installing a Surge Absorber

Always use a surge absorber or diode for the inductive loads near the Inverter. These inductive loads include magnetic contactors, electromagnetic relays, solenoid valves, solenoid, and magnetic brakes.

● **Installing a Noise Filter on the Power Supply Side**

The Inverter’s outputs utilize high-speed switching, so noise may be transmitted from the Inverter to the power line and adversely affect other devices in the vicinity. It is recommended that a Noise Filter be installed at the Power Supply to minimize this noise transmission. Conversely, noise can also be reduced from the power line to the Inverter.

Wiring Example 1

Input Noise Filters

Simple Input Noise Filter: 3G3EV-PLNFD□

Input Noise Filter: 3G3IV-PFN□

EMC-conforming Input Noise Filter: 3G3FV-PFS□

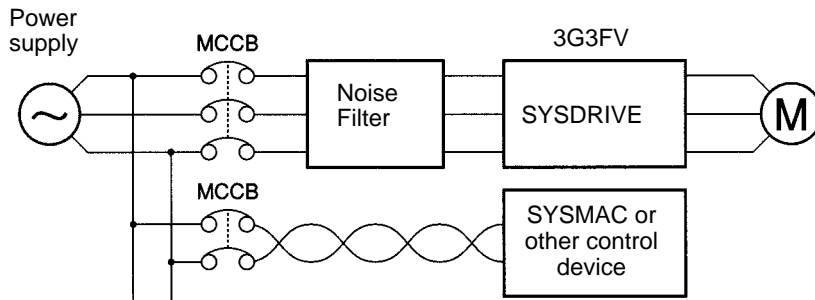

Note Use a noise filter designed for Inverters. A general-purpose noise filter will be less effective and may not reduce noise.

● **Calculating the Inverter Input Power Supply Capacity**

The following formula can generally be used to calculate the input power supply capacity for the Inverter. Always select an Inverter with more than sufficient capacity.

Input power supply capacity [kVA] =

$$\text{Motor output [kW]} / (\text{Motor efficiency} \times \text{Inverter efficiency} \times \text{Inverter input power factor})$$

Normal motor efficiency = 0.8, Normal inverter efficiency = 0.9, Inverter input power factor = 0.65 to 0.9

Note The Inverter’s input power factor will vary with the impedance of the power supply facilities. Use 0.9 when using an AC reactor and 0.65 when not using an AC reactor.

For the input current, divide the input power supply capacity by the input voltage. Assuming the Inverter’s resistance to overloads to be 150%, the calculated value can be multiplied by 1.5.

Example for 3-phase 200 V: $1.5 \times \text{input power supply capacity} / (\sqrt{3} \times 200 \text{ V})$

Example for single-phase 200 V: $1.5 \times \text{input power supply capacity} / 200 \text{ V}$

■ **Wiring on the Output Side of Main Circuit**

● **Connecting the Terminal Block to the Load**

Connect output terminals T1 (U), T2 (V), and T3 (W) to motor lead wires T1 (U), T2 (V), and T3 (W), respectively. Check that the motor rotates forward with the forward command. Switch over any two of the output terminals to each other and reconnect if the motor rotates in reverse with the forward command.

● **Never Connect a Power Supply to Output Terminals**

Never connect a power supply to output terminals T1 (U), T2 (V), and T3 (W). If voltage is applied to the output terminals, the internal circuit of the Inverter will be damaged.

● **Never Short or Ground Output Terminals**

If the output terminals are touched with bare hands or the output wires come into contact with the Inverter casing, an electric shock or grounding will occur. This is extremely hazardous. Also, be careful not to short the output wires.

● **Do Not Use a Phase Advancing Capacitor or Noise Filter**

Never to connect a phase advance capacitor or LC/RC noise filter to the output circuit. Doing so may result in damage to the Inverter or cause other parts to burn.

● **Do Not Use an Electromagnetic Switch or Magnetic Contactor**

Do not connect an electromagnetic switch or magnetic contactor to the output circuit. If a load is connected to the Inverter during running, an inrush current will actuate the overcurrent protective circuit in the Inverter.

● **Installing a Thermal Relay**

This Inverter has an electronic thermal protection function to protect the motor from overheating. If, however, more than one motor is operated with one Inverter or multi-polar motor is used, always install a thermal relay (THR) between the Inverter and the motor and set n033 to 0 (no thermal protection). In this case, program the sequence so that the magnetic contactor on the input side of the main circuit is turned off by the contact of the thermal relay.

● **Installing a Noise Filter on Output Side**

Connect a noise filter to the output side of the Inverter to reduce radio noise and induction noise.

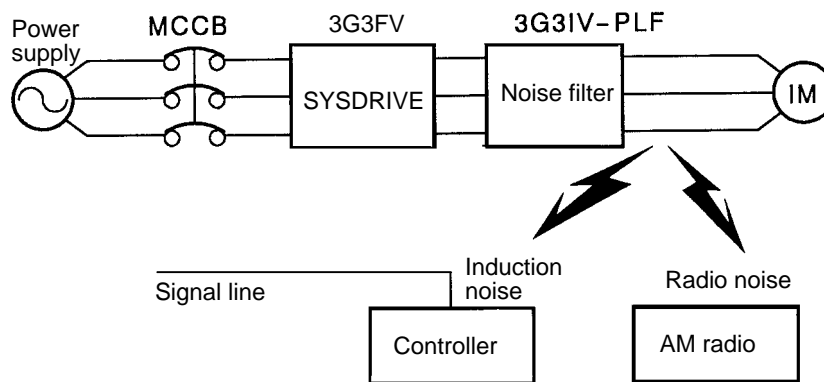

Induction Noise: Electromagnetic induction generates noise on the signal line, causing the controller to malfunction.

Radio Noise: Electromagnetic waves from the Inverter and cables cause the broadcasting radio receiver to make noise.

● Countermeasures Against Induction Noise

As described previously, a noise filter can be used to prevent induction noise from being generated on the output side. Alternatively, cables can be routed through a grounded metal pipe to prevent induction noise. Keeping the metal pipe at least 30 cm away from the signal line considerably reduces induction noise.

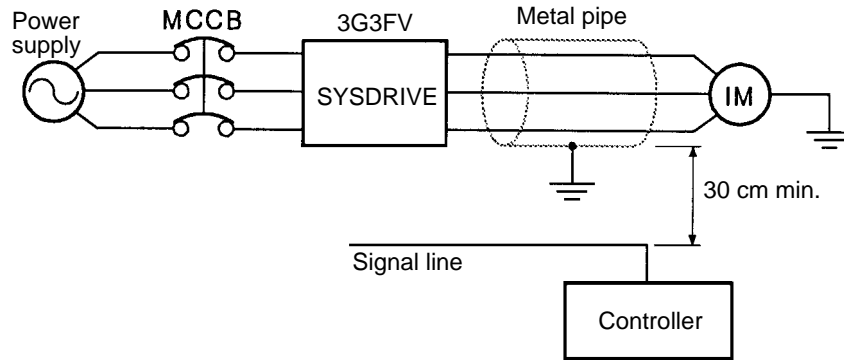

● Countermeasures Against Radio Interference

Radio noise is generated from the Inverter as well as the input and output lines. To reduce radio noise, install noise filters on both input and output sides, and also install the Inverter in a totally enclosed steel box. The cable between the Inverter and the motor should be as short as possible.

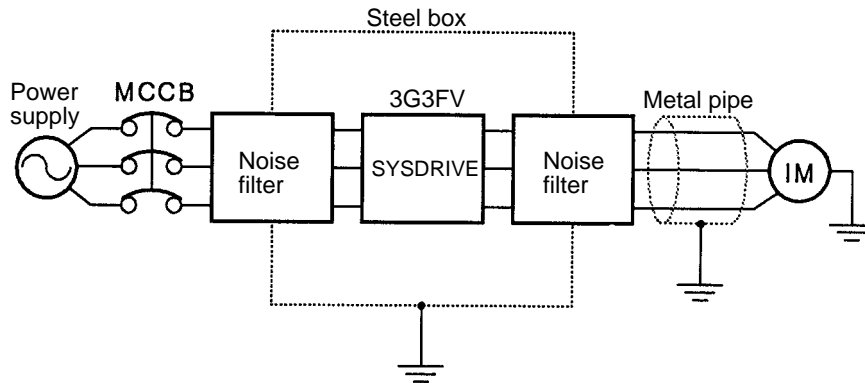

● Cable Length between Inverter and Motor

As the cable length between the Inverter and the motor is increased, the floating capacity between the Inverter outputs and the ground is increased proportionally. The increase in floating capacity at the Inverter outputs causes the high-frequency leakage current to increase, and this may adversely affect peripheral devices and the current detector in the Inverter’s output section. To prevent this from occurring, use a cable of no more than 100 meters between the Inverter and the motor. If the cable must be longer than 100 meters, take measures to reduce the floating capacity by not wiring in metallic ducts, by using a separate cable for each phase, and so on.

Also adjust the carrier frequency according to the cable length between the Inverter and the motor, as shown in the table below.

Cable length	50 m max.	100 m max.	More than 100 m
Carrier frequency	15 kHz max.	10 kHz max.	5 kHz max.
(Set value: C06-01)	(15.0)	(10.0)	(5.0)
(Set value: C06-02)	(15.0)	(10.0)	(5.0)
(Set value: C06-02)	(0)	(0)	(0)

Note The carrier frequency setting range varies depending on the Inverter capacity.

200-V class, 18.5 kW max.; 400-V class, 30 kW max.: 0.4 to 15.0 kHz

200-V class, 22 to 75 kW; 400-V class, 37 to 160 kW: 0.4 to 10.0 kHz

400-V class, 185 to 300 kW: 0.4 to 2.5 kHz

● **Single-phase Motors Cannot Be Used**

The Inverter is not suited for the variable speed control of single-phase motors.

Single-phase motors are either capacitor start motors or split-phase start motors. (The method for determining rotation direction at startup is different.) If a capacitor start motor is used, the capacitor may be damaged by a sudden electric discharge caused by Inverter output. If a split-phase start motor is used, the starting coil may burn because the centrifugal switch does not operate.

■ **Ground Wiring**

● Always use the ground terminal of the 200-V Inverter with a ground resistance of less than 100 Ω and that of the 400-V Inverter with a ground resistance of less than 10 Ω.

● Do not share the ground wire with other devices such as welding machines or power tools.

● Always use a ground wire that complies with technical standards on electrical equipment and minimize the length of the ground wire.

Leakage current flows through the Inverter. Therefore, if the distance between the ground electrode and the ground terminal is too long, potential on the ground terminal of the Inverter will become unstable.

● When using more than one Inverter, be careful not to loop the ground wire.

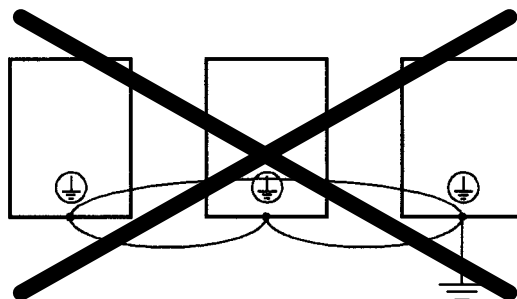
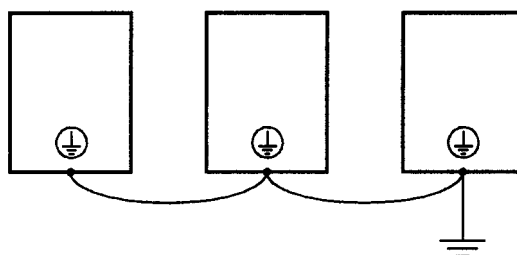
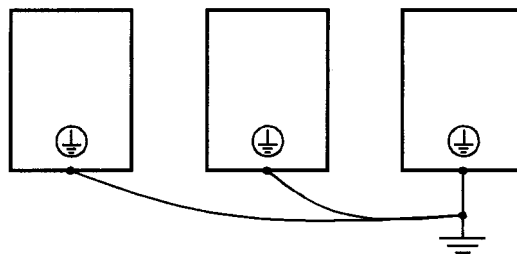

■ Countermeasures against Harmonics

With the continuing development of electronics, the generation of harmonics from industrial machines has been causing problems recently. Refer to the following for the definition of harmonics (i.e., harmonic currents with voltages) and countermeasures against the generation of harmonics from the Inverter.

● Harmonics (Harmonic Currents with Voltages)

● Definition

Harmonics consist of electric power produced from AC power and alternating at frequencies that are integral multiples of the frequency of the AC power.

The following are the harmonic frequencies of a 60- or 50-Hz commercial power supply.

Second harmonic: 120 (100) Hz

Third harmonic: 180 (150) Hz

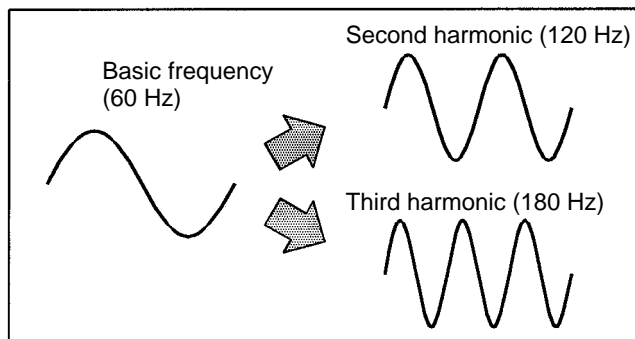

● Problems Caused by Harmonics Generation

The waveform of the commercial power supply will be distorted if the commercial power supply contains excessive harmonics.

Machines with such a commercial power supply will malfunction or generate excessive heat.

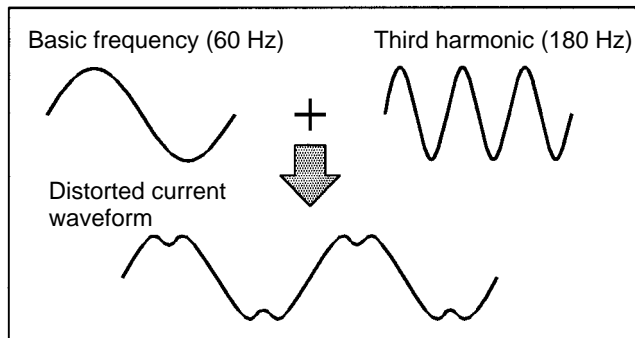

● Causes of Harmonics Generation

● Usually, electric machines have built-in circuitry that converts commercial AC power supply into DC power. Such AC power, however, contains harmonics due to the difference in current flow between AC and DC.

● Obtaining DC from AC using Rectifiers and Capacitors

DC voltage is obtained by converting AC voltage into a pulsating one-side voltage with rectifiers and smoothing the pulsating one-side voltage with capacitors. Such AC current, however, contains harmonics.

• **Inverter**

The Inverter as well as normal electric machines has an input current containing harmonics because the Inverter converts AC into DC.

The output current of the Inverter is comparatively high. Therefore, the ratio of harmonics in the output current of the Inverter is higher than that of any other electric machine.

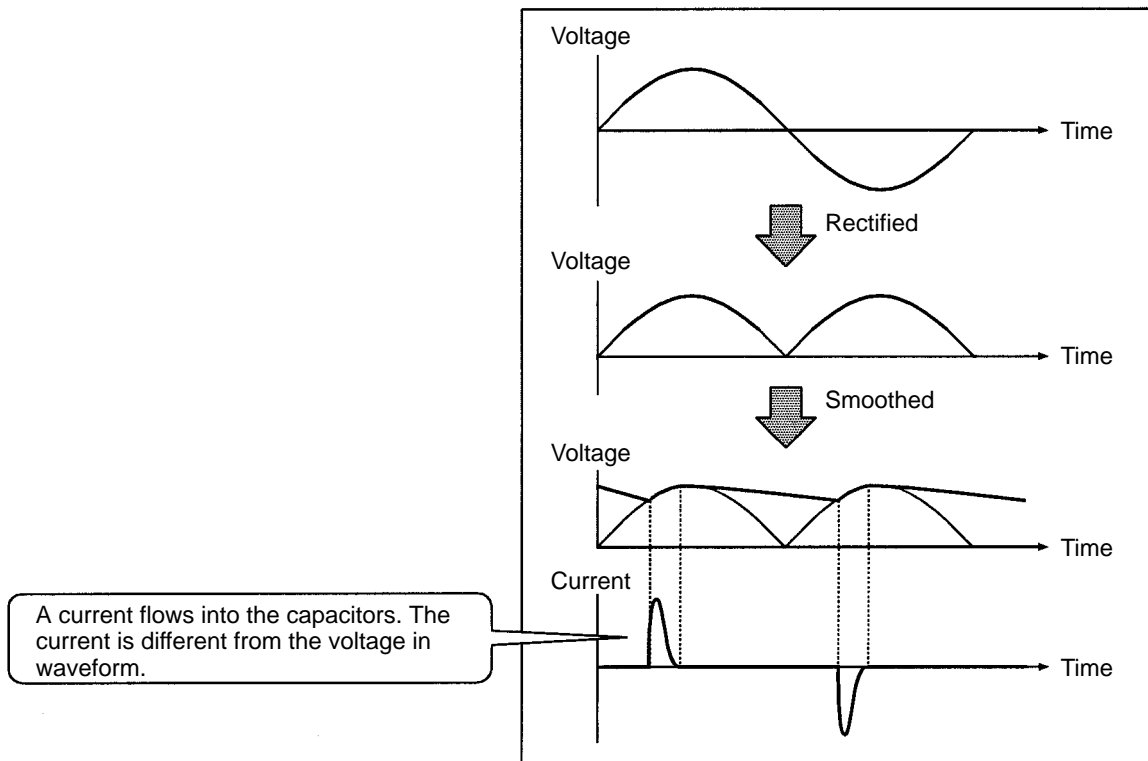

• **Countermeasures with Reactors against Harmonics Generation**

• **DC/AC Reactors**

The DC reactor and AC reactor suppress harmonics and currents that change suddenly and greatly. The DC reactor suppresses harmonics better than the AC reactor. The DC reactor used with the AC reactor suppresses harmonics more effectively.

The input power factor of the Inverter is improved by suppressing the harmonics in the input current of the Inverter.

Note 18.5- to 160-kW Inverters have a built-in DC reactor.

185- to 300-kW Inverters cannot use a DC reactor.

• **Connection**

Connect the DC reactor to the internal DC power supply of the Inverter after shutting off the power supply to the Inverter and making sure that the charge indicator of the Inverter turns off.

! WARNING Do not touch the internal circuitry of the Inverter in operation, otherwise an electric shock or a burn injury may occur.

• **Wiring Method**
With DC Reactor

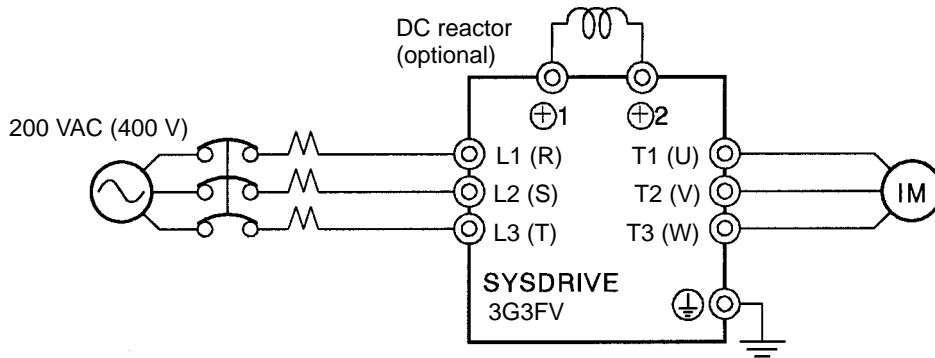

Note Be sure to remove the short bar on terminals +1 and +2 before connecting the DC reactor.

With DC and AC Reactors

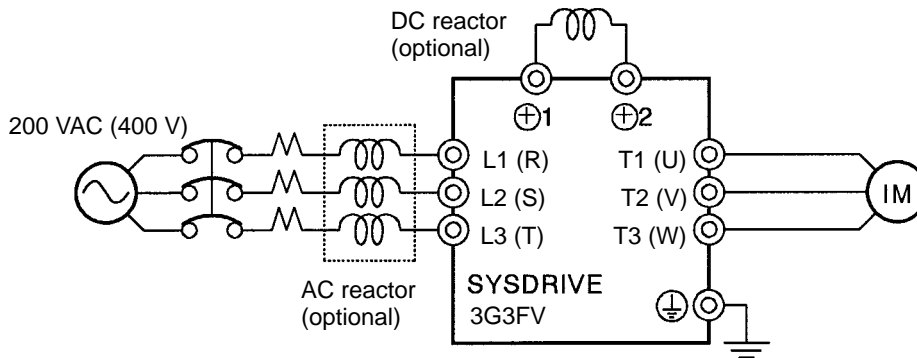

Note Be sure to remove the short bar on terminals +1 and +2 before connecting the DC reactor.

• **Reactor Effects**

Harmonics are effectively suppressed when the DC reactor is used with the AC reactor as shown in the following table.

Harmonic suppression method	Harmonic generation rate (%)							
	5th harmonic	7th harmonic	11th harmonic	13th harmonic	17th harmonic	19th harmonic	23th harmonic	25th harmonic
No reactor	65	41	8.5	7.7	4.3	3.1	2.6	1.8
AC reactor	38	14.5	7.4	3.4	3.2	1.9	1.7	1.3
DC reactor	30	13	8.4	5	4.7	3.2	3.0	2.2
DC and AC reactors	28	9.1	7.2	4.1	3.2	2.4	1.6	1.4

■ **Connecting the Braking Resistor**

- Connect the braking resistor as shown in the following diagram.
- When using a Braking Resistor Unit, set L8-01 to “1” (i.e., overheating protection of the braking resistor) and set L3-04 to “0” (i.e., no decelerating stall prevention) or “2” (i.e., braking with stall prevention).

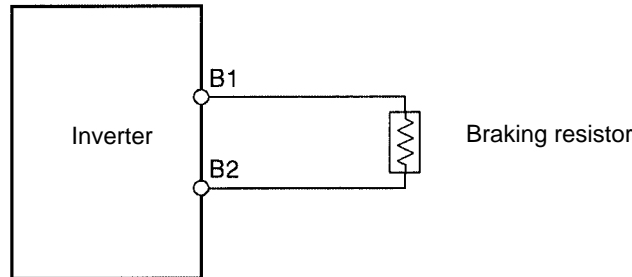

⚠ Caution The braking resistor’s connection terminals are B1 and B2. Do not connect any other terminals. Connecting any terminals other than B1 or B2 can cause the resistor to overheat, resulting in damage to the equipment.

■ **Connecting the Braking Resistor Unit and Braking Unit**

- Connect the Braking Resistor Unit and Braking Unit to the Inverter as shown in the following diagrams.
- Set L8-01 to “0” (i.e., no overheating protection of the braking resistor) and L3-04 to “0” (i.e., no decelerating stall prevention) or “2” (i.e., braking with stall prevention) before using the Inverter with the Braking Resistor Unit connected.

Note 1. Set L8-01 to “1” before operating the Inverter with the braking resistor without thermal relay trip contacts.

Note 2. The Braking Resistor Unit cannot be used and the deceleration time cannot be shortened by the Inverter if L3-04 is set to “1” (i.e., decelerating stall prevention).

- To prevent the Unit from overheating, make a power supply sequence as shown below or connect the thermal relay trip output of the Unit to the external fault input terminal of the Inverter to interrupt the running of the Inverter.

● **200-V Class with 0.4- to 7.5-kW Output and 400-V Class with 0.4- to 15-kW Output**

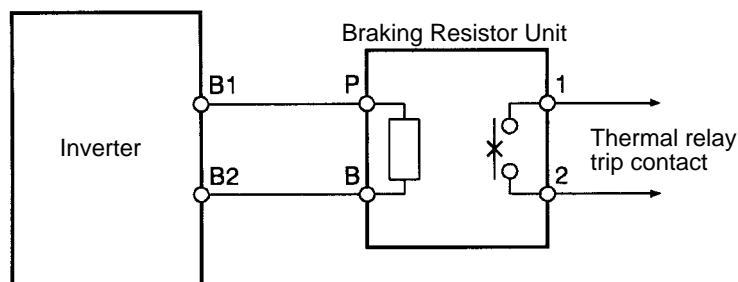

• 200-V Class with 11-kW-or-more Output and 400-V Class with 18.5-or-more Output

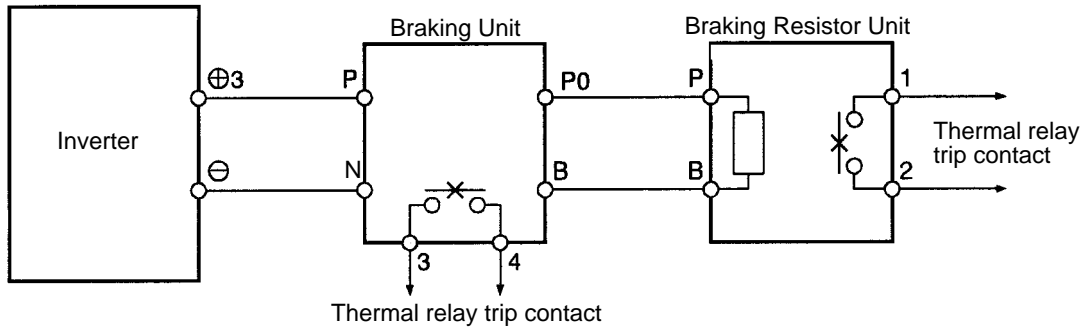

• Connecting Braking Units in Parallel

When connecting two or more Braking Units in parallel, use the wiring and connectors shown in the following diagram. There are connectors for selecting whether each Braking Unit is to be a Master or Slave. Select "Master" for the first Braking Unit only; select "Slave" for all other Braking Units (i.e., from the second Unit onwards).

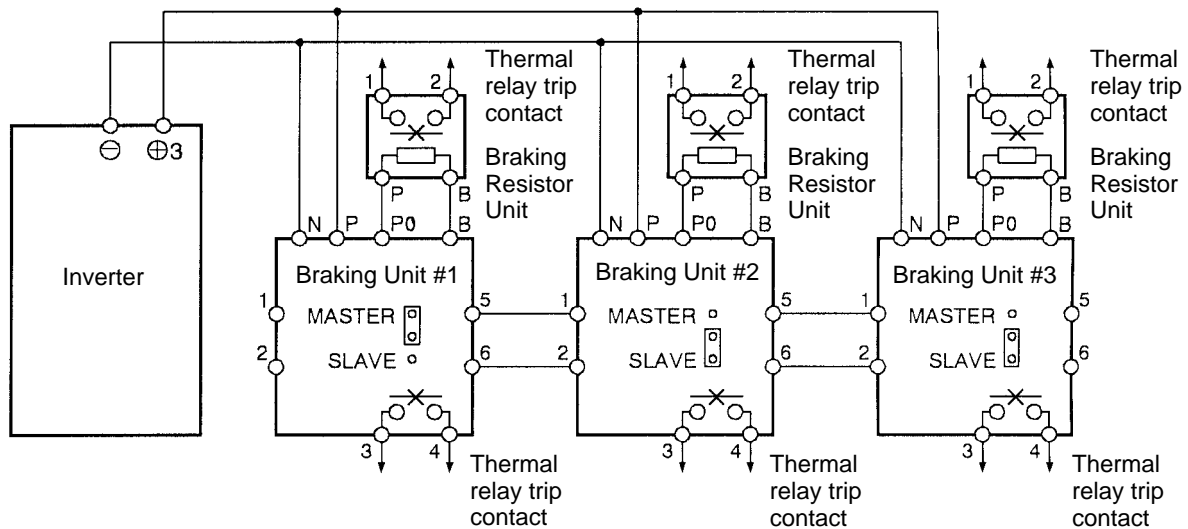

● Power Supply Sequence

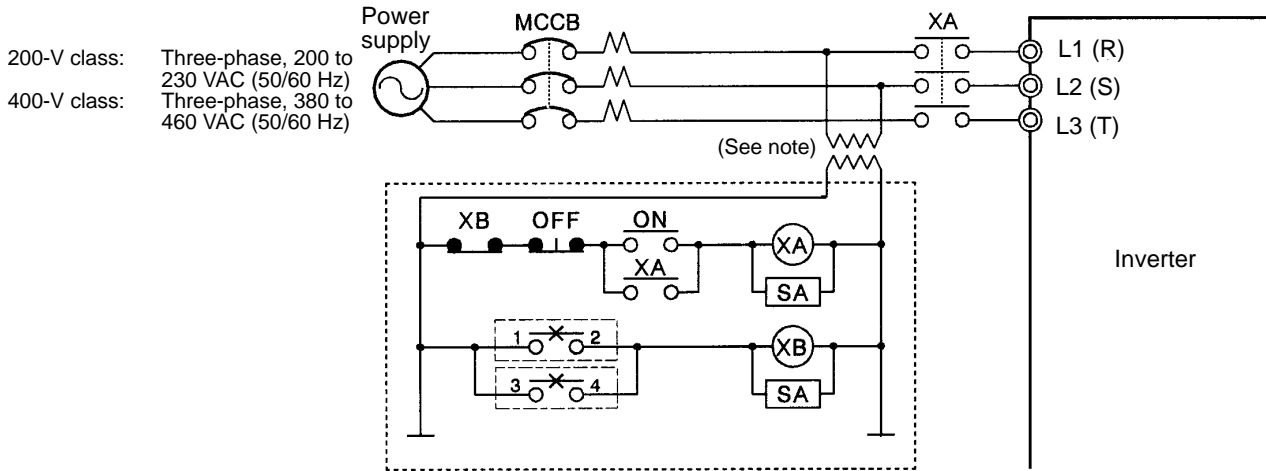

Note Use a transformer with 200- and 400-V outputs for the power supply of the 400-V Inverter.

2-2-5 Wiring Control Circuit Terminals

A control signal line must be 50 m maximum and separated from power lines. The frequency reference must be input to the Inverter through twisted-pair wires.

■ Wire Size and Round Solderless Terminals

Use thick wires to prevent voltage drops if the wires are long.

● Wires for All Inverter Models

Terminal	Terminal screw	Wire thickness (mm ²)	Type
1 to 11, 13 to 33	M3.5	Stranded wire: 0.5 to 1.25 Single wire: 0.5 to 1.25	Shielded, twisted-pair wire
12 (G)	M3.5	0.5 to 2	Shielded, polyethylene-covered, vinyl sheath cable

● Round Solderless Terminals for Ground Terminal

Wire thickness (mm ²)	Terminal screw	Size	Screw torque (N • m)
0.5	M3.5	1.25 to 3.5	0.8
0.75		1.25 to 3.5	
1.25		1.25 to 3.5	
2		2 to 3.5	

■ Considerations When Wiring Control Circuit Terminals

- Wire control signal lines separately from the main circuit lines and other power lines.
- Wire control circuit terminals 9, 10, 18, 19, and 20 (contact outputs) separately from terminals 1 to 8, 21, 22, 23, 25, 26, 27, 33, and 11 to 17.
- Connect shielded wire to terminal 12(G).
- Insulate the shielded areas with tape to prevent contact with other signal lines and equipment.

2-2-6 Installing and Wiring PG Speed Control Cards

PG Speed Control Cards are used for executing speed control using a pulse generator (PG). There are four types of PG speed control, as shown below. Select the type that fits the application and control method.

- 3G3FV-PPGA2: A-phase (single) pulse input for open collector output, special-purpose V/f control
- 3G3FV-PPGB2: A/B-phase pulse input for open collector output, special-purpose vector control
- 3G3FV-PPGD2: A-phase (single) pulse input, line driver input, special-purpose V/f control
- 3G3FV-PPGX2: A/B/Z-phase pulse input, line driver input, special-purpose vector control

■ Installing a PG Speed Control Card

1. Turn off the main-circuit power supply, and leave it off for at least one minute before removing the front cover of the Inverter (or at least three minutes for Inverters of 30 kW or more). Check to be sure that the CHARGE light is OFF.
2. Insert the spacer (which is provided) into the spacer hole in the Inverter's mounting base. For Inverters of 3.7 kW or less, there are two adjacent holes. Insert the spacer into the 7CN hole. The spacer cannot be easily removed if inserted into the wrong hole. Be very careful to insert the spacer into the correct hole, and in the proper direction.
3. Referring to the enlarged illustration in the following diagram, align the PG Speed Control Card with the catch position as shown by (1) and (2) and fit it precisely to the Option-A connector. Then pass the spacer through the spacer hole at the Card. (Refer to illustration A.) Check to be sure that it is precisely aligned with the 4CN position, and snap it into the proper position.

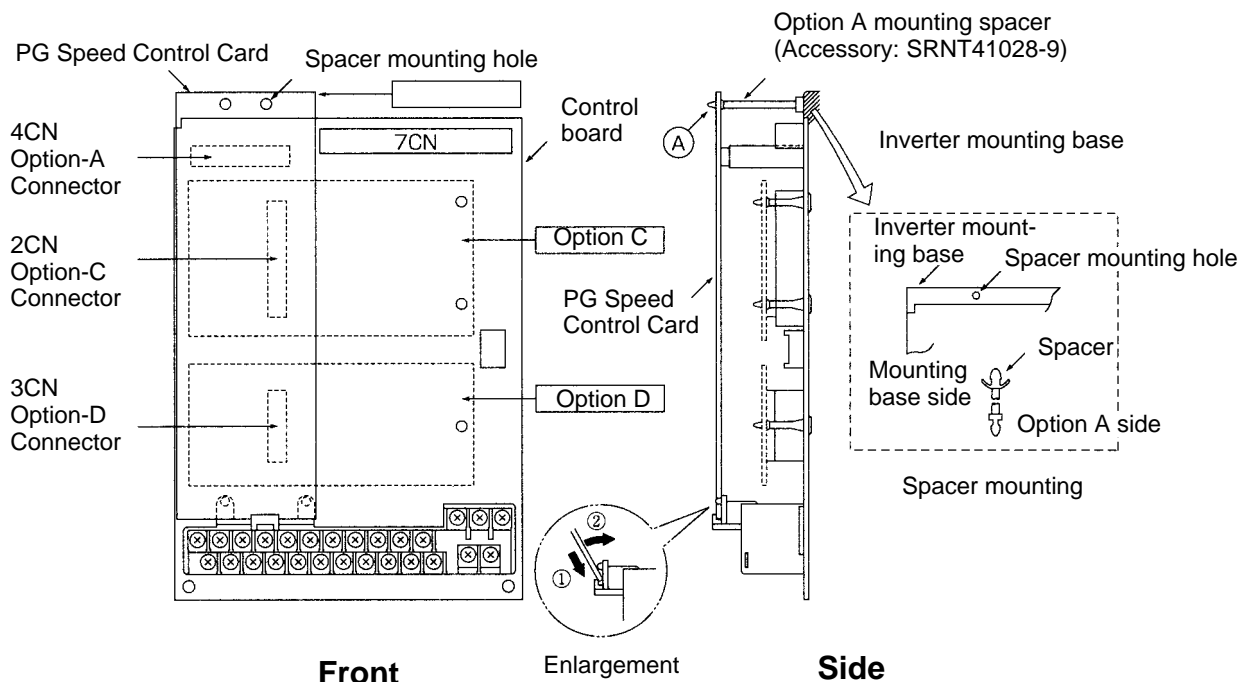

■ PG Speed Control Card Terminal Blocks

● 3G3FV-PPGA2 (For V/f With PG Feedback Mode Only)

Terminal	No.	Contents	Specifications
TA1	1	Power supply for pulse generator	12 VDC ($\pm 5\%$), 200 mA max.
	2		0 VDC (GND for power supply)
	3	+12-V/open collector switching terminal	Terminal for switching between 12-V voltage input and open collector input. For open collector input, short across 3 and 4.
	4		
	5	Pulse input terminal	H: +4 to 12 V; L: +1 V max. (Maximum response frequency: 30 kHz)
	6		Pulse input common
	7	Pulse motor output terminal	12 VDC ($\pm 10\%$), 20 mA max.
	8		Pulse monitor output common
TA2	(E)	Shielded-wire connection terminal	---

● 3G3FV-PPGB2 (For Flux Vector Control Mode Only)

Terminal	No.	Contents	Specifications
TA1	1	Power supply for pulse generator	12 VDC ($\pm 5\%$), 200 mA max.
	2		0 VDC (GND for power supply)
	3	A-phase pulse input terminal	H: +8 to 12 V; L: +1 V max. (Maximum response frequency: 30 kHz)
	4		Pulse input common
	5	B-phase pulse input terminal	H: +8 to 12 V; L: +1 V max. (Maximum response frequency: 30 kHz)
	6		Pulse input common
TA2	1	A-phase monitor output terminal	Open collector output, 24 VDC, 30 mA max.
	2		A-phase monitor output common
	3	B-phase monitor output terminal	Open collector output, 24 VDC, 30 mA max.
	4		B-phase monitor output common
TA3	(E)	Shielded-wire connection terminal	---

● 3G3FV-PPGD2 (For V/f With PG Feedback Mode Only)

Terminal	No.	Contents	Specifications
TA1	1	Power supply for pulse generator	12 VDC ($\pm 5\%$), 200 mA max. (see note)
	2		0 VDC (GND for power supply)
	3		5 VDC ($\pm 5\%$), 200 mA max. (see note)
	4	Pulse input + terminal	Line driver input (RS-422 level input) Maximum response frequency: 300 kHz
	5	Pulse input – terminal	
	6	Common terminal	---
	7	Pulse monitor output + terminal	Line driver output (RS-422 level output)
	8	Pulse monitor output – terminal	
TA2	(E)	Shielded-wire connection terminal	---

Note 5 VDC and 12 VDC cannot be used at the same time.

● 3G3FV-PPGX2 (For Flux Vector Control Mode Only)

Terminal	No.	Contents	Specifications
TA1	1	Power supply for pulse generator	12 VDC ($\pm 5\%$), 200 mA max. (see note)
	2		0 VDC (GND for power supply)
	3		5 VDC ($\pm 5\%$), 200 mA max. (see note)
	4	A-phase + input terminal	Line driver input (RS-422 level input) Maximum response frequency: 300 kHz
	5	A-phase – input terminal	
	6	B-phase + input terminal	
	7	B-phase – input terminal	
	8	Z-phase + input terminal	
	9	Z-phase – input terminal	
	10	Common terminal	
TA2	1	A-phase + output terminal	Line driver output (RS-422 level output)
	2	A-phase – output terminal	
	3	B-phase + output terminal	
	4	B-phase – output terminal	
	5	Z-phase + output terminal	
	6	Z-phase – output terminal	
	7	Control circuit common	Control circuit GND
TA3	(E)		---

Note 5 VDC and 12 VDC cannot be used at the same time.

■ Wiring a PG Speed Control Card

● 3G3FV-PPGA2 (For V/f With PG Feedback Mode Only)

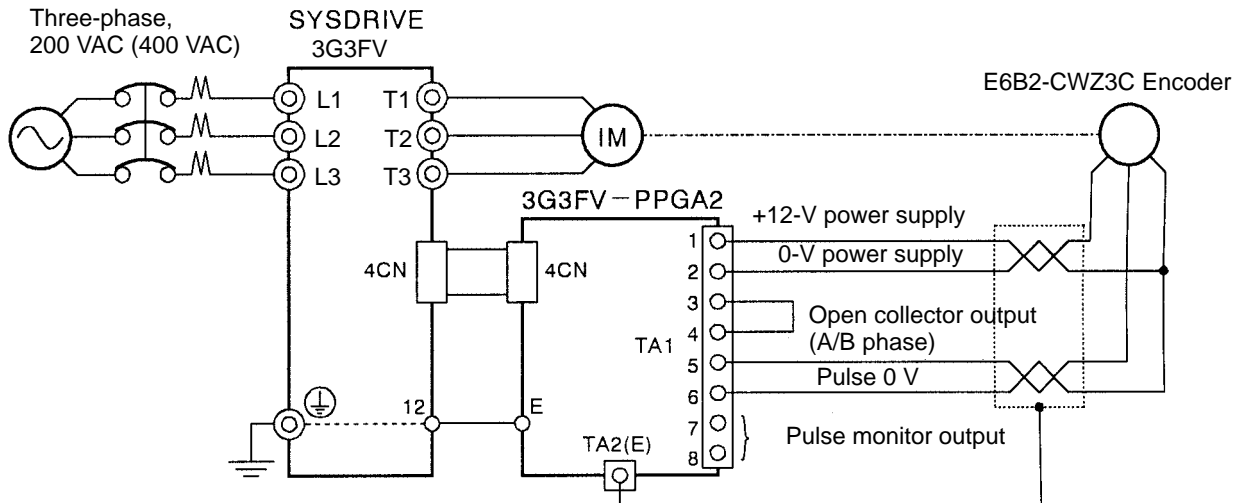
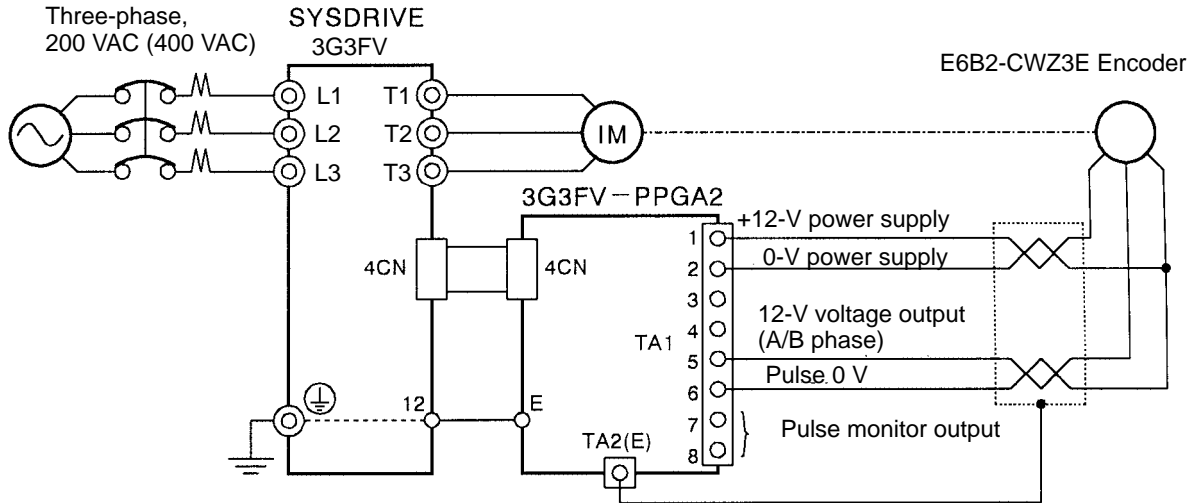

- Note 1.** Twisted-pair shielded wire must be used for signal lines.
- Note 2.** Do not use the pulse generator's power supply for anything other than the pulse generator (encoder). Using it for another purpose can cause malfunctions due to noise.
- Note 3.** The length of the pulse generator's wiring must not be more than 30 meters.

I/O Circuit Configuration

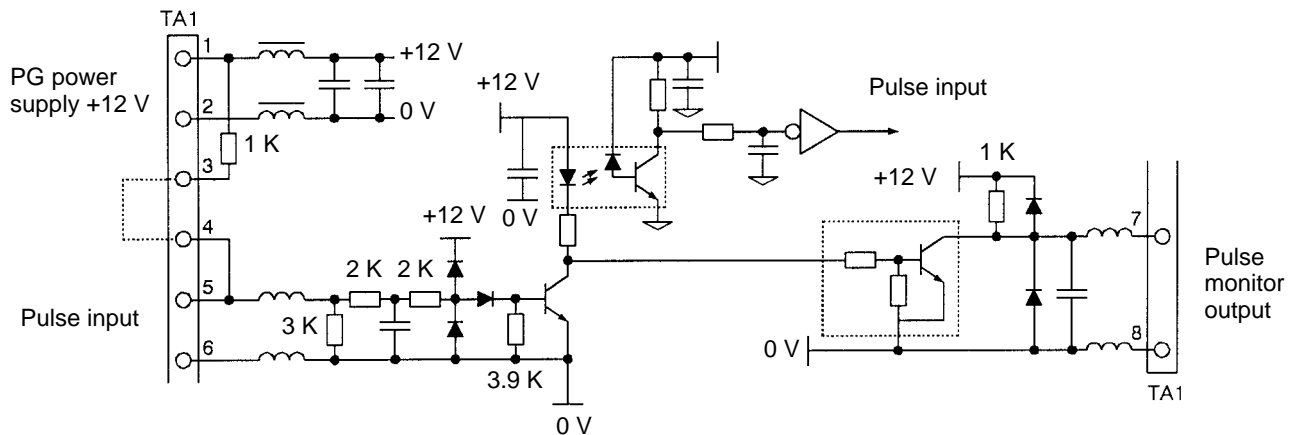

Note When connecting to a voltage-output-type PG (encoder), select a PG with an output impedance of no more than 3 kΩ.

● 3G3FV-PPGB2 (For Flux Vector Control Mode Only)

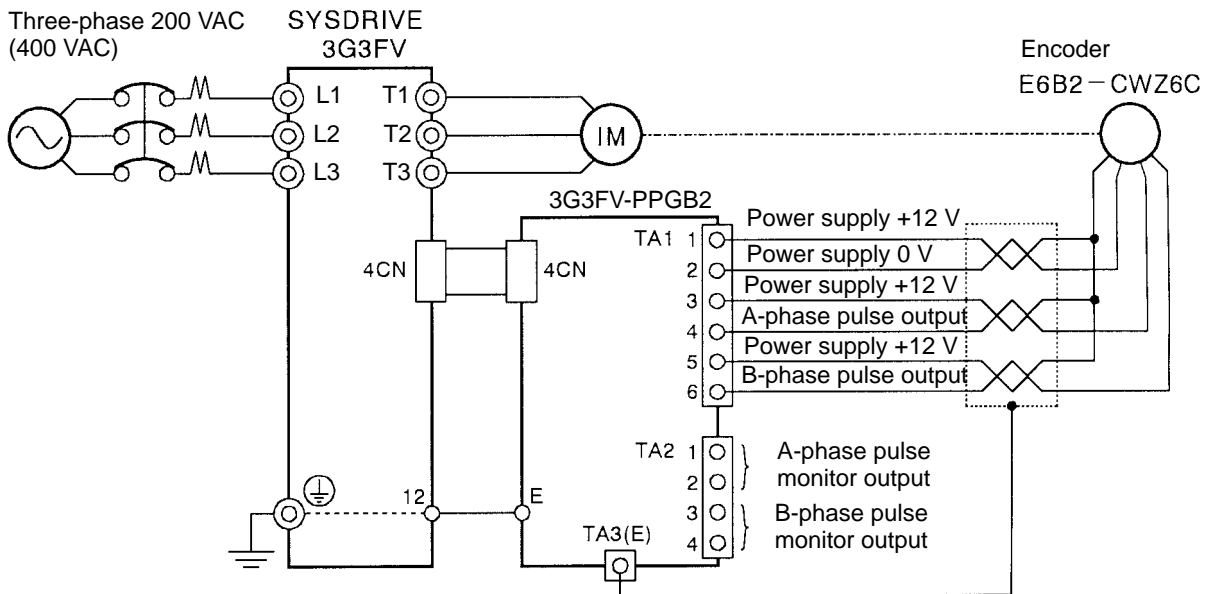

Note 1. Twisted-pair shielded wire must be used for signal lines.

Note 2. Do not use the pulse generator's power supply for anything other than the pulse generator (encoder). Using it for another purpose can cause malfunctions due to noise.

Note 3. The length of the pulse generator's wiring must not be more than 30 meters.

I/O Circuit Configuration

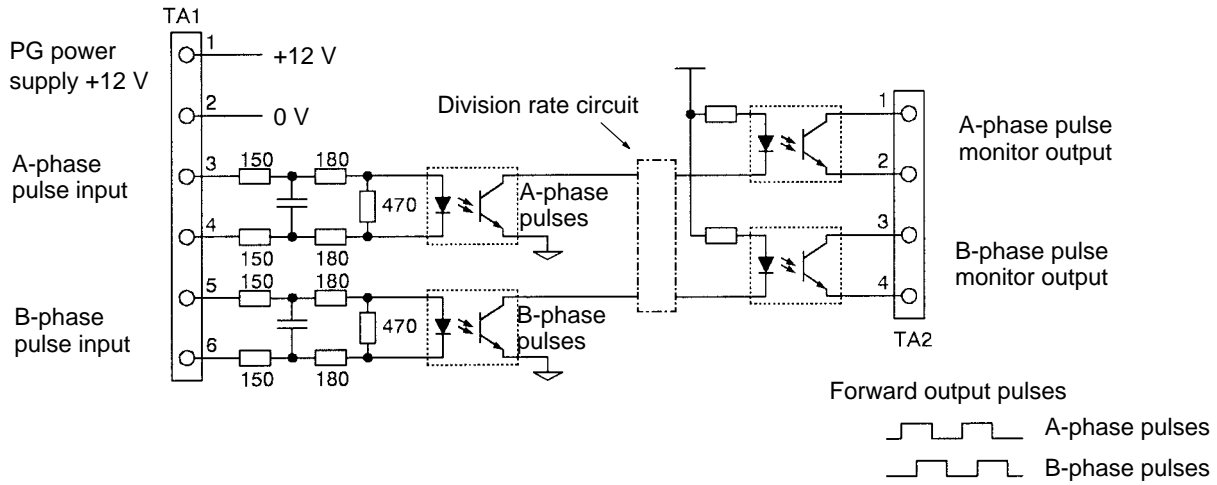

Note When connecting to a voltage-output-type PG (encoder), select a PG that has an output impedance with a current of at least 12 mA to the input circuit photocoupler (diode). The E6B2-CWZ3E cannot be used.

● 3G3FV-PPGD2 (For V/f With PG Feedback Mode Only)

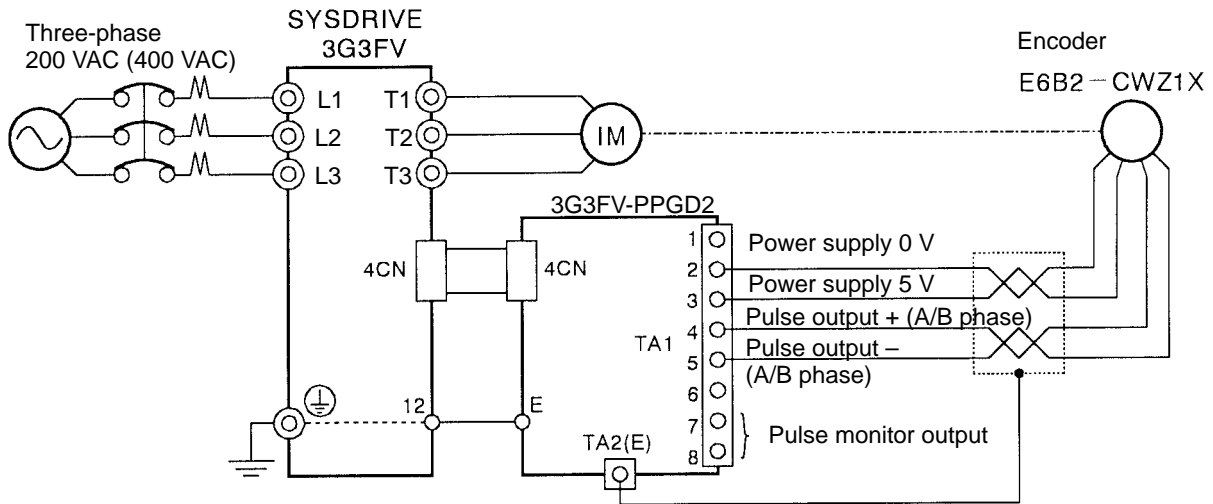

Note 1. Twisted-pair shielded wire must be used for signal lines.

Note 2. Do not use the pulse generator's power supply for anything other than the pulse generator (encoder). Using it for another purpose can cause malfunctions due to noise.

Note 3. The length of the pulse generator's wiring must not be more than 50 meters.

● 3G3FV-PPGX2 (For Flux Vector Control Mode Only)

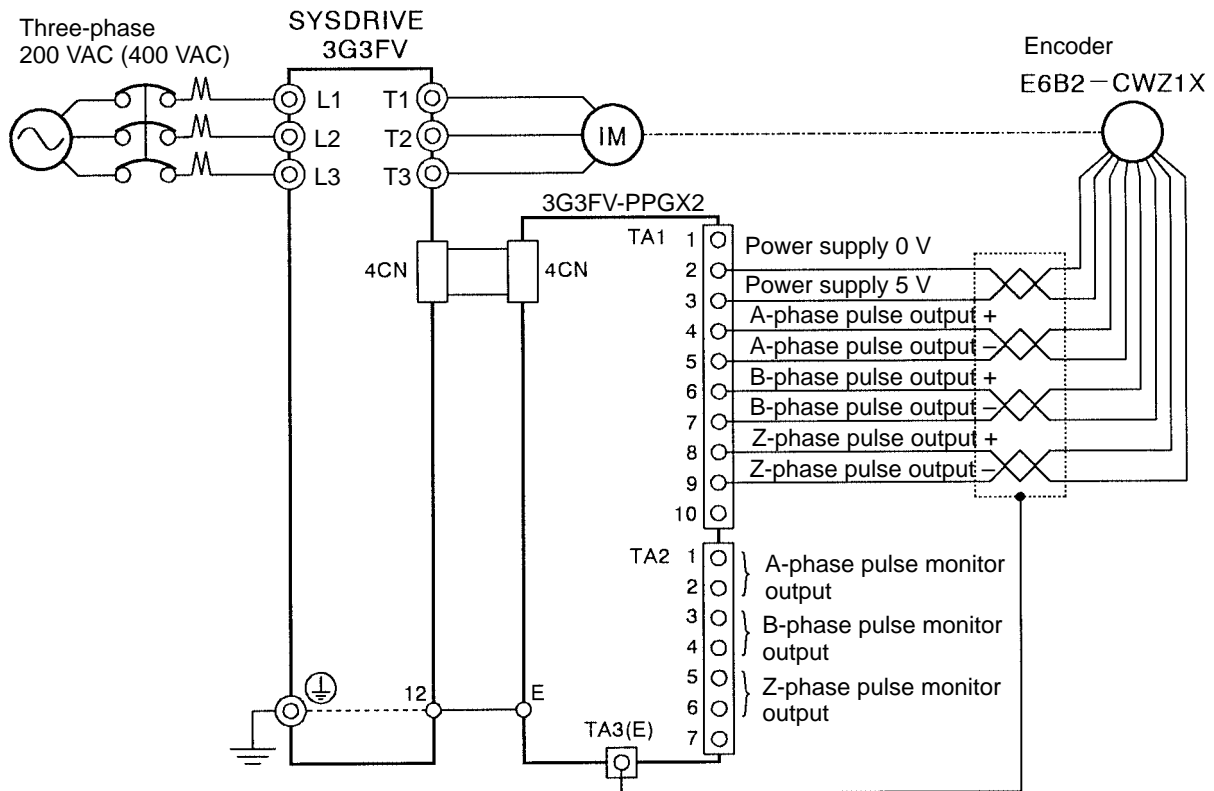

Note 1. Shielded, twisted-pair wire must be used for signal lines.

Note 2. Do not use the pulse generator's power supply for anything other than the pulse generator (encoder). Using it for another purpose can cause malfunctions due to noise.

Note 3. The length of the pulse generator's wiring must not be more than 50 meters.

■ Wiring PG Speed Control Card Terminal Blocks

Use no more than 30 meters of wiring for PG (encoder) signal lines and no more than 50 meters for 3G3FV-PPGD2 and 3G3FV-PPGX2, and keep them separate from power lines. Use shielded, twisted-pair wire for pulse input and pulse output monitor wire, and connect the shield to the shielded wire connection terminal.

● Wires for All Inverter Models

Terminal	Terminal screw	Wire thickness (mm ²)	Type
Pulse generator power supply	---	Stranded wire: 0.5 to 1.25	Shielded, twisted-pair wire Shielded, polyethylene-covered, vinyl sheath cable
Pulse input terminal	---	Single wire: 0.5 to 1.25	
Pulse monitor output terminal	---	---	
Shielded wire connection terminal	M3.5	0.5 to 2	

● **Solderless Terminals for Control Circuit Terminals**

The use of solderless terminals for the control circuit terminals is recommended because solderless terminals are easy to connect securely.

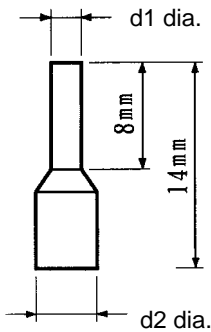

Wire thickness	Model	d1	d2	Manufacturer
0.5 mm ²	A1 0.5-8WH	1.00	2.60	Phoenix Contact
0.75 mm ²	A1 0.75-8GY	1.20	2.80	
1 mm ²	A1 1-8RD	1.40	3.00	
1.5 mm ²	A1 1.5-8BK	1.70	3.50	

Note Do not solder wires with the control circuit terminals if wires are used instead of solderless terminals. Wires may not contact well with the control circuit terminals or the wires may be disconnected from the control circuit terminals due to vibration if the wires are soldered.

● **Round Solderless Terminal Sizes and Screw Torque**

Wire thickness (mm ²)	Terminal screw	Size	Screw torque (N • m)
0.5	M3.5	1.25 to 3.5	0.8
0.75		1.25 to 3.5	
1.25		1.25 to 3.5	
2		2 to 3.5	

■ **Wiring Control Circuit Terminals**

● **Wiring Method**

1. Loosen the terminal screws with a thin-slotted screwdriver.
2. Insert the wires from underneath the terminal block.
3. Tighten the terminal screws firmly.

Note 1. Always separate the control signal line from the main circuit cables and other power cables.

Note 2. Do not solder the wires to the control circuit terminals. The wires may not contact well with the control circuit terminals if the wires are soldered.

Note 3. The end of each wire connected to the control circuit terminals must be stripped for approximately 7 mm.

Note 4. Use a shielded wire for the ground terminal.

Note 5. Insulate the shield with tape so that the shield will not touch any signal line or device.

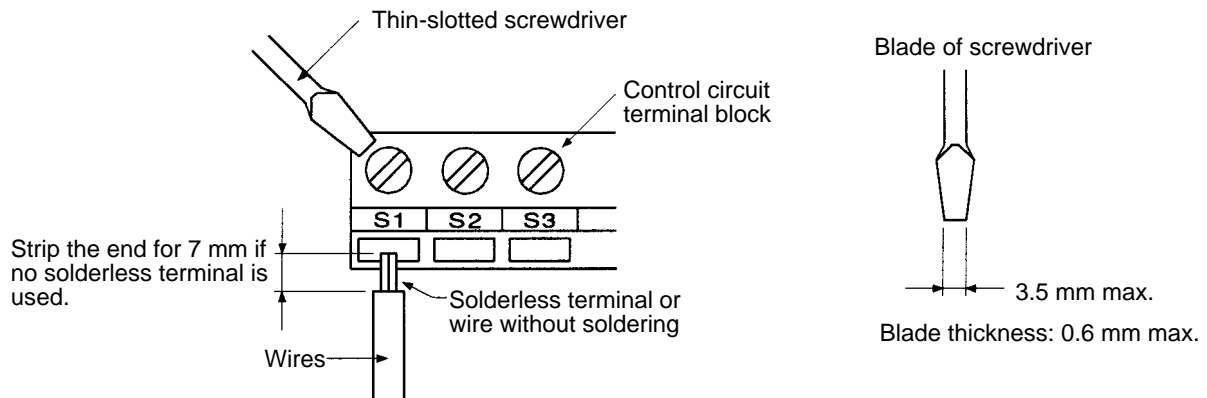

Note 6. Tighten the screws to a tightening torque of 0.5 to 0.6 N·m. The terminal block may be damaged if the tightening torque is too strong, and malfunctions and short-circuits may result if the tightening torque is too weak.

■ Selecting the Number of PG (Encoder) Pulses

● 3G3FV-PPGA2/-PPGB2

- The maximum response frequency is 30 kHz.
- Taking into consideration the encoder pulse deviation (phase difference: $90 \pm 45^\circ$) and the waveform when the cable is long, select a smaller number of pulses than the ones shown in the following table.

Motor's maximum speed (r/min)	1,800	1,500	900
Number of encoder pulses (p/r)	500	600	1,000
Maximum encoder frequency (kHz)	15	15	15

● 3G3FV-PPGD2/-PPGX2

- The maximum response frequency is 300 kHz.
- When the encoder pulse deviation (phase difference: $90 \pm 45^\circ$) is taken into consideration, the number of encoder pulses can be calculated by means of the following formula:

$$\text{Number of encoder pulses [p/r]} \cong \frac{60 \times \text{maximum response frequency (300,000 Hz)}}{2 \times \text{motor's maximum rotation speed (r/min)}}$$

- If the motor's maximum speed is less than 4,000 r/min, an encoder of 1,000 to 2,000 p/r is recommended. Even if an encoder with higher than required resolution is selected, it will not improve the speed control range or precision.

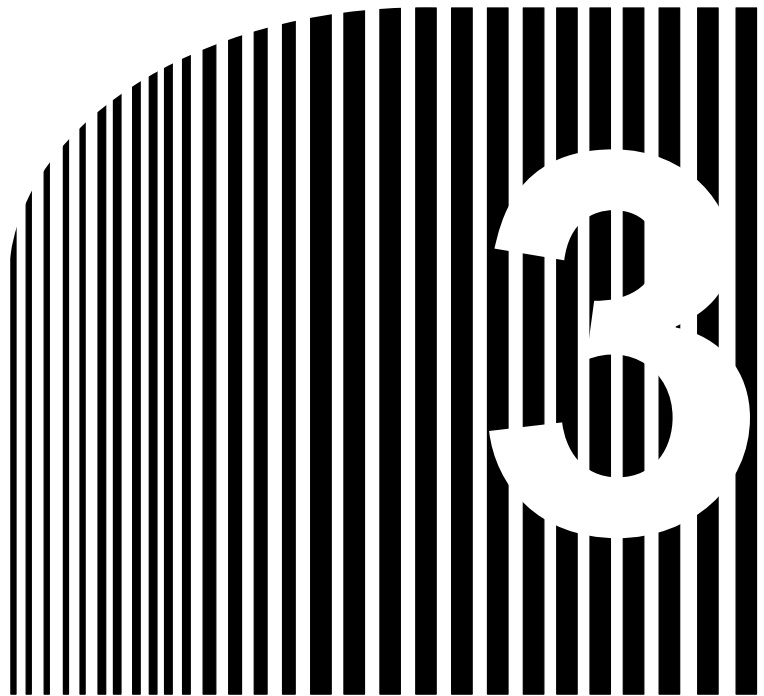

Chapter 3

• Preparing for Operation •

- 3-1 Using the Digital Operator
- 3-2 Modes
- 3-3 Operation Mode
- 3-4 Initialize Mode
- 3-5 Program Mode
- 3-6 Auto-tuning Mode
- 3-7 Modified Constants Mode
- 3-8 Operation Mode Selection Key and
Local/Remote Selection Input

3-1 Using the Digital Operator

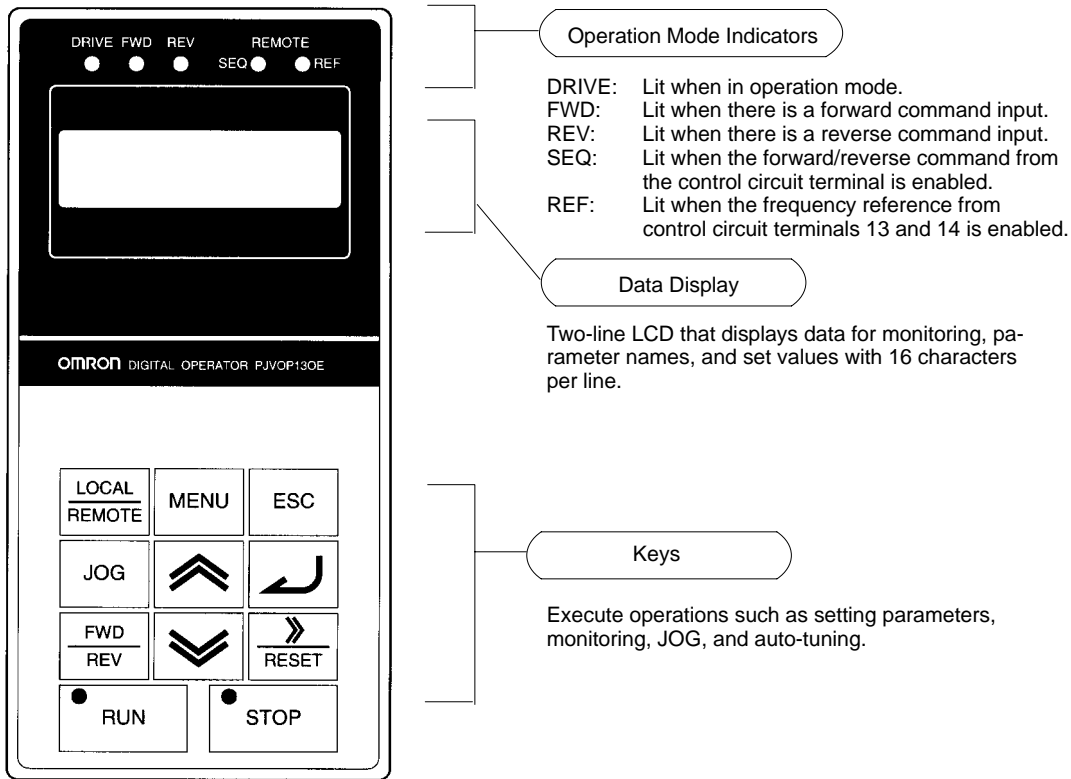

Key	Name	Function
	Operation Mode Selection Key	Switches between Operator and parameter setting (run command and frequency reference). This key can be enabled or disabled with a parameter setting (o2-02).
	Menu Key	Displays each mode.
	Escape Key	Returns to the status before the Enter Key is pressed.
	Jog Key	Enables JOG operation when the 3G3FV is in operation with the Digital Operator.
	Forward/Reverse Rotation Selection Key	Selects the rotation direction of the motor when the 3G3FV is in operation with the Digital Operator.
	Reset/Digit Selection Key	Selects digits for parameter settings. Also acts as the reset key when an fault has occurred. (See note.)
	Increment Key	Selects modes, groups, functions, parameter names, and set values. This key increases numbers when pressed.
	Decrement Key	Selects modes, groups, functions, parameter names, and set values. This key decreases numbers when pressed.
	Enter Key	Enters modes, functions, constants, and set values after they are set.
	Run Key	Starts the 3G3FV running when the 3G3FV is in operation with the Digital Operator.
	Stop Key	Stops the 3G3FV running. This key can be enabled or disabled with a parameter setting (o2-02) in operation with the control circuit terminal.

Note For safety reasons, the Reset Key cannot be used when a run command (forward/reverse) is being input. Turn OFF the run command before attempting to reset.

3-2 Modes

This section describes the 3G3FV's various parameter setting and monitoring modes.

■ Inverter Modes

- The SYSDRIVE 3G3FV Inverter's parameters and monitoring functions have been organized in groups, so it is easier to make settings and read data. These function groups are known as modes.
- The 3G3FV is equipped with 5 modes, as shown in the following table.

Mode	Primary function(s)
Operation mode	The Inverter can be run in this mode. Use this mode when monitoring values such as frequency references or output current, displaying fault information, or displaying the fault history.
Initialize mode	Use this mode when selecting the language displayed on the Digital Operator, selecting the access level for setting/reading parameters, selecting the control mode, or initializing the parameters.
Program mode	Use this mode when setting/reading the parameters required for operation. The program-mode functions are subdivided into the following groups: Application: Operation mode selection, DC control, speed search, etc. Tuning: Acceleration/deceleration times, S-curve characteristics, carrier frequencies, etc. Reference: Settings related to frequency control Motor: V/f characteristics and motor parameters Option: Settings for Optional Cards Terminal: Settings for sequential I/O and analog I/O Protection: Settings for the motor and inverter protection functions Operator: Selects the Digital Operator's display and key functions
Auto-tuning mode	(Usable only with the vector control mode) Use this mode when running a motor with unknown motor parameters in the vector control mode. The motor parameters are calculated and set automatically.
Modified constants mode	Use this mode to set/read parameters that have been changed from their factory-set values.

■ Switching Modes

- Once the Unit has been put into operation mode by pressing the Menu Key, the Increment and Decrement Keys can be pressed to switch to other modes.
- Press the Enter Key to set/read the parameters in each mode.

- Press the Escape Key to return to the mode display from the parameter display.

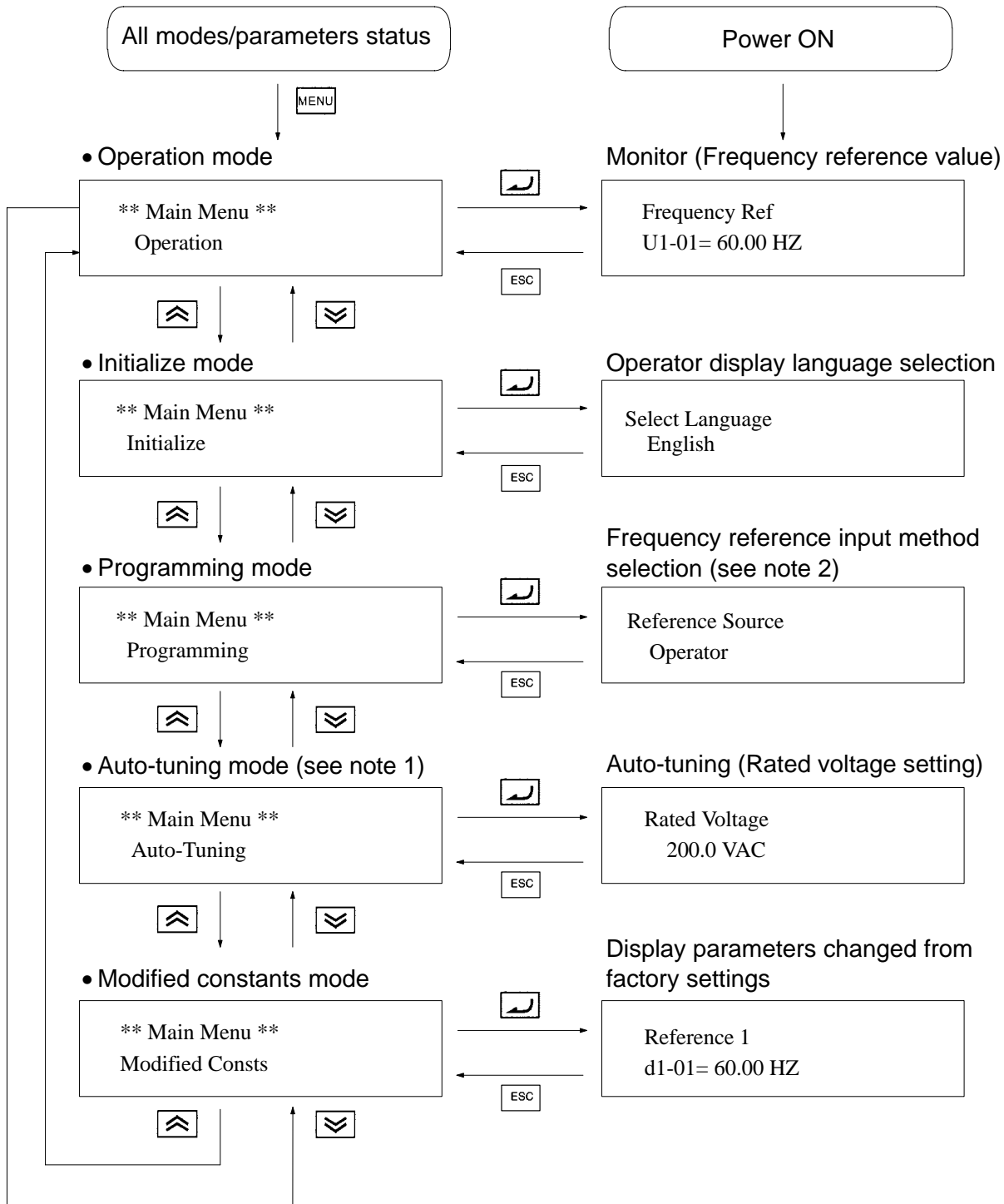

Note 1. Auto-tuning mode will be displayed only when vector control mode has been selected. (The factory setting is for open-loop vector control.)

Note 2. The actual display depends on the parameter access level setting (A1-01).







■ **Parameter Access Level**

The SYSDRIVE 3G3FV's has three access levels which divide the various parameters based on their usage, as shown below. The access level restricts which parameters can be set or displayed.

Level	Function
Quick-start	Allows setting/reading of parameters required for test runs. (factory-set)
Basic	Allows setting/reading of general-purpose parameters.
Advanced	Allows setting/reading of all parameters.

Set the access level in initialize mode with parameter A1-01.

● **Changing the Access Level from Quick-start to Basic**

Key sequence	Display	Explanation
	** Main Menu ** Operation	Displays operation mode.
	** Main Menu ** Initialize	Displays initialize mode.
	Select Language English	Puts the Unit in initialize mode.
	Access Level Quick Start	Switches to the access level parameter.
	A1-01= 2 *** Quick Start	Displays the access level parameter setting.
	A1-01= 3 Basic Level	Changes the access level setting to "BASIC."
	Entry Accepted	Writes the new parameter setting.
	Access Level Basic Level	Returns to the access level parameter display.

The following diagram shows this procedure in flowchart format.

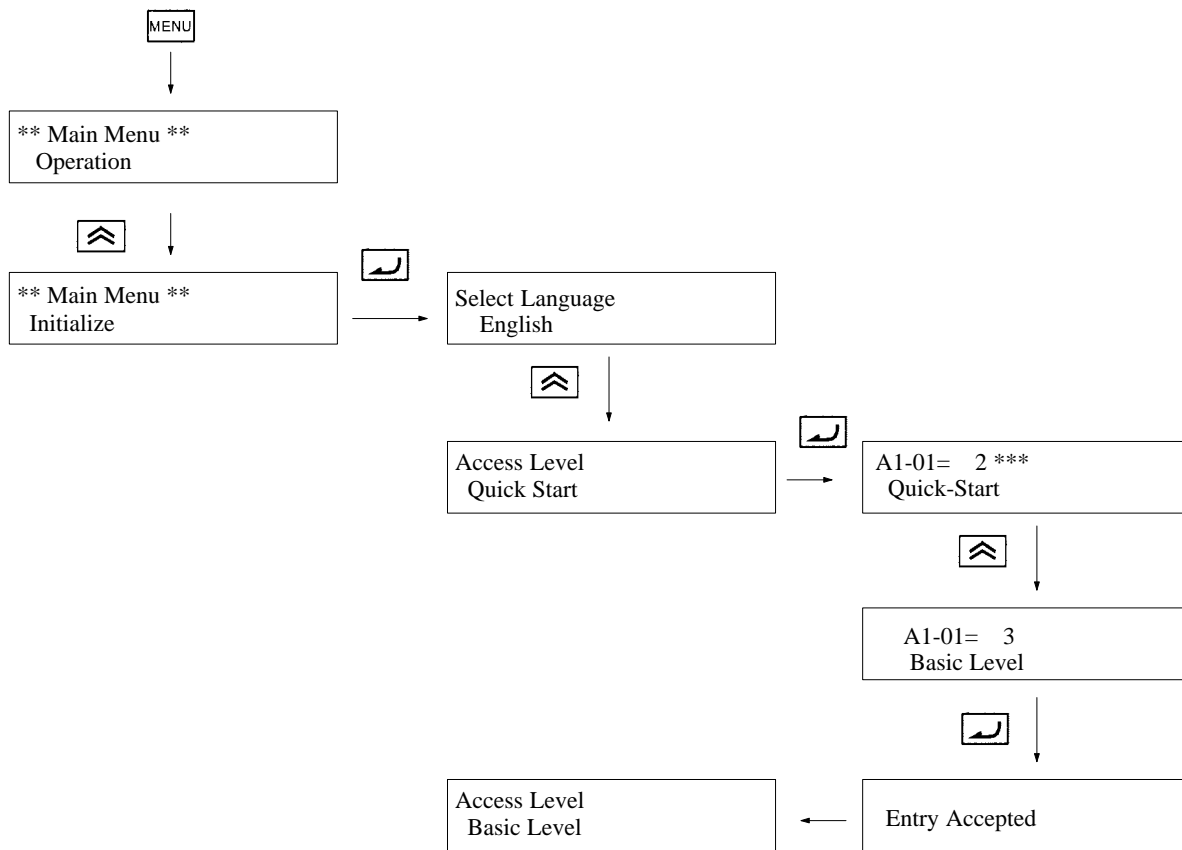

■ Setting Parameters in Each Access Level

- The displays in program mode differ for each access level. (There is no difference in other modes.)
- This section provides the procedure to change the acceleration time to 20 s in each access level. The acceleration time (C1-01) is a parameter in program mode.
- If the new parameter setting is not written to the Unit (by pressing the Enter Key) within one minute after starting the procedure, the display will automatically revert to the original parameter setting. In this case, the procedure must be started again.

● Parameter Setting Levels (Partial)

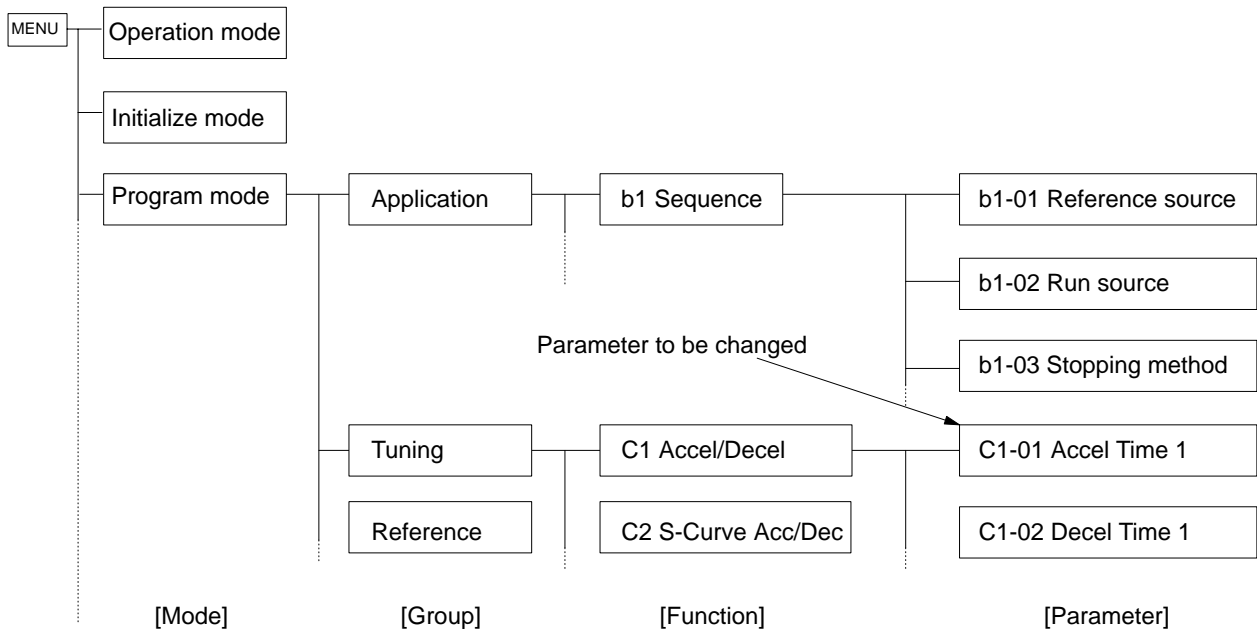











● Setting the Parameter in the Quick-start Access Level

The parameter level will be displayed when the Enter Key is pressed at the program mode display.

Key sequence	Display	Explanation
	** Main Menu ** Operation	Displays operation mode.
2 times	** Main Menu ** Programming	Displays program mode.
	Reference Source Terminals	Puts the Unit in program mode. Displays the b1-01 Reference source selection.
	Run Source Terminals	Displays the b1-02 Run source selection.
	Stopping Method Ramp to Stop	Displays the b1-03 Stopping method selection.
	Accel Time 1 c1-01= 10.0 Sec	Displays C1-01 Acceleration time 1.
	Accel Time 1 0010.0 Sec	Selects the parameter so that the leading 0 flashes. (The digit that can be changed flashes.)
2 times	Accel Time 1 0010.0 Sec	Moves the cursor so that the "1" digit flashes.
	Accel Time 1 0020.0 Sec	Changes the 1 to a 2.
	Entry Accepted	Writes the new setting.
---	Accel Time 1 c1-01= 20.0 Sec	Returns to the C1-01 Acceleration time 1 display.
	** Main Menu ** Programming	Returns to the program mode display.











● **Setting the Parameter in the Basic Access Level**

The function level will be displayed when the Enter Key is pressed at the program mode display.

Key sequence	Display	Explanation
 MENU	** Main Menu ** Operation	Displays operation mode.
 2 times	** Main Menu ** Programming	Displays program mode.
	Function b1 Sequence	Puts the Unit in program mode. Displays the b1 Sequence function selection.
	Function b2 DC Braking	Displays the b2 DC Braking function selection.
	Function C1 Accel/Decel	Displays the C1 Accel/Decel function selection.
	Accel Time 1 c1-01= 10.0 Sec	Displays C1-01 Acceleration time 1.
	Accel Time 1 0010.0 Sec	Selects the parameter so that the leading 0 flashes. (The digit that can be changed flashes.)
 2 times	Accel Time 1 0010.0 Sec	Moves the cursor so that the "1" digit flashes.
	Accel Time 1 0020.0 Sec	Changes the 1 to a 2.
	Entry Accepted	Writes the new setting.
---	Accel Time 1 c1-01= 20.0 Sec	Returns to the C1-01 Acceleration time 1 display.
 ESC	Function C1 Accel/Decel	Returns to the program mode display.

● **Setting the Parameter in the Advanced Access Level**

The group level will be displayed when the Enter Key is pressed at the program mode display.

Key sequence	Display	Explanation
 MENU	** Main Menu ** Operation	Displays operation mode.
 2 times	** Main Menu ** Programming	Displays program mode.
	Group b Application	Puts the Unit in program mode. Displays the Group b Application group selection.
	Group C Tuning	Displays the Group C Tuning group selection.
	Function C1 Accel/Decel	Displays the C1 Accel/Decel function selection.
	Accel Time 1 c1-01= 10.0 Sec	Displays C1-01 Acceleration time 1.
	Accel Time 1 0010.0 Sec	Selects the parameter so that the leading 0 flashes. (The digit that can be changed flashes.)
 2 times	Accel Time 1 0010.0 Sec	Moves the cursor so that the "1" digit flashes.
	Accel Time 1 0020.0 Sec	Changes the 1 to a 2.
	Entry Accepted	Writes the new setting.
---	Accel Time 1 c1-01= 20.0 Sec	Returns to the C1-01 Acceleration time 1 display.
 ESC	Function C1 Accel/Decel	Returns to the C1 Accel/Decel function selection.

3-3 Operation Mode

Operation mode is the mode in which the Inverter can run. When running the Inverter, press the Enter Key from the operation mode display to bring up the monitor display. Run commands can't be received from any other display. Once the Unit is running, it can be switched to other modes.

Many parameters can't be changed when the Inverter is running. Refer to *Chapter 7 Parameter Lists* for details.

Bring up monitor displays such as the frequency reference, output frequency, output current, and output voltage as well as fault information and the fault history in operation mode.

■ Operations in Operation Mode

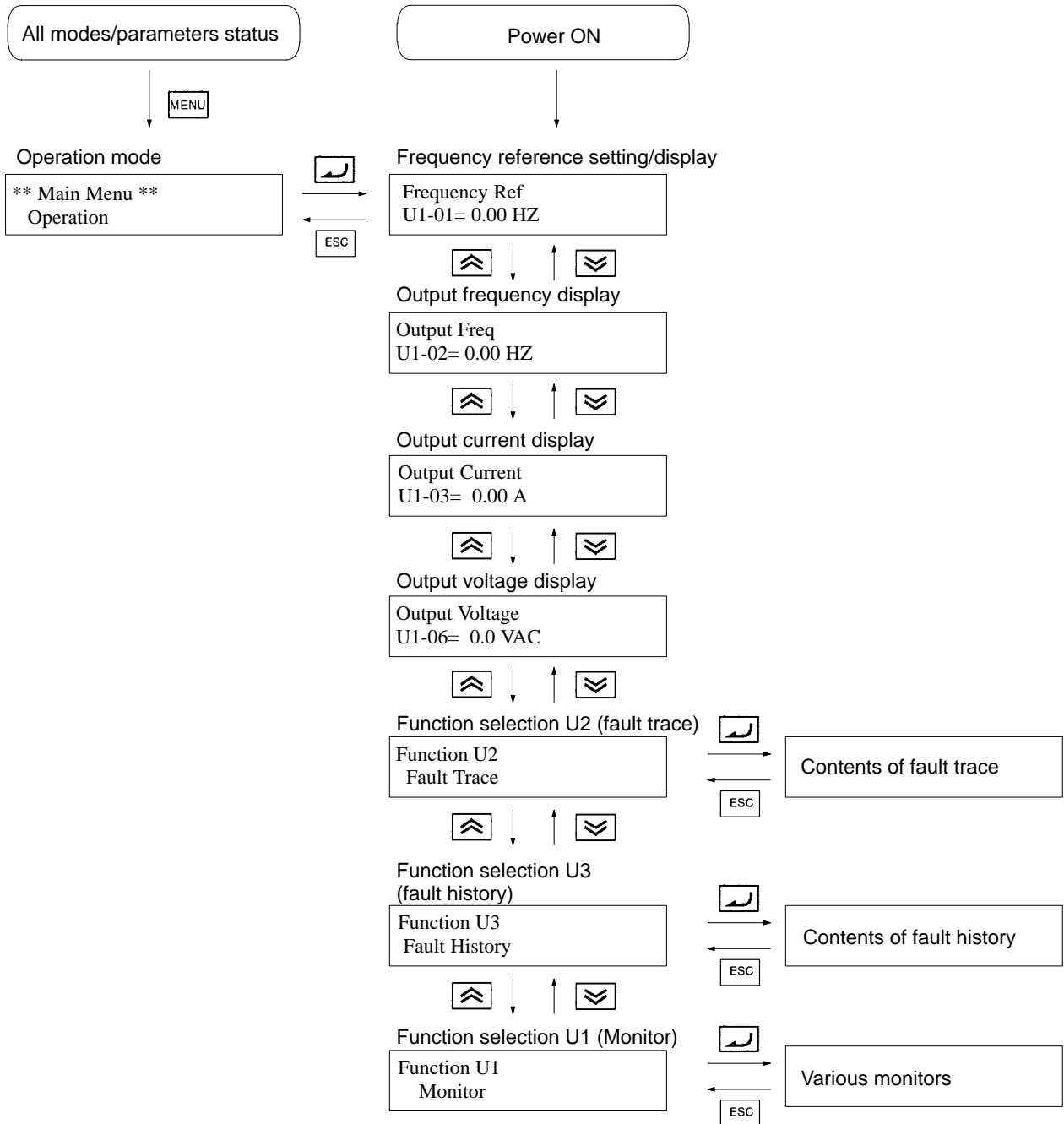

■ Conditions for Monitoring

The following tables show the items that can be monitored in operation mode. The table's "Valid access levels" column indicates whether an item can be monitored in a particular access level and control mode. The codes in this column have the following meanings.

Q: These items can be monitored in all access levels. (Quick-start, Basic, and Advanced)

B: These items can be monitored in the Basic and Advanced access levels.

A: These items can be monitored in the Advanced access level only.

X: These items cannot be monitored in the control mode shown.

The output signal levels for multi-function analog outputs shown in the table are for a gain of 100.0 and a bias of 0.00.

Status Monitor

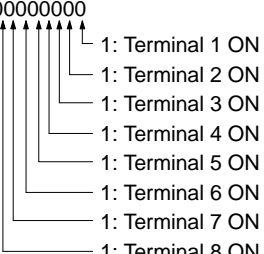
Item	Display	Function	Output signal levels for multi-function analog outputs	Min. Units	Valid access levels			
					V/f	V/f w/PG	Open Vector	Flux Vector
U1-01	Frequency Ref	Monitors/sets the frequency reference value. The display units can be set with parameter o1-01.	10 V: Max. frequency (0 to ±10 V possible)	0.01 Hz	Q	Q	Q	Q
U1-02	Output Freq	Monitors the output frequency. The display units can be set with parameter o1-01.	10 V: Max. frequency (0 to ±10 V possible)	0.01 Hz	Q	Q	Q	Q
U1-03	Output Current	Monitors the output current.	10 V: Rated current (0 to +10 V output)	0.1 A	Q	Q	Q	Q
U1-04	Control Method	Shows which control mode is set.	Can't be output.	---	Q	Q	Q	Q
U1-05	Motor Speed	Monitors the motor speed.	10 V: Max. frequency (0 to ±10 V possible)	0.01 Hz	X	Q	Q	Q
U1-06	Output Voltage	Monitors the Inverter's internal output voltage reference value.	10 V: 200 (400) VAC (0 to +10 V output)	0.1 V	Q	Q	Q	Q
U1-07	DC Bus Voltage	Monitors the DC voltage of the Inverter's internal main circuit.	10 V: 400 (800) VDC (0 to +10 V output)	1 V	Q	Q	Q	Q
U1-08	Output kWatts	Monitors the output power. (This is an internally detected value.)	10 V: Max. motor capacity (0 to ±10 V possible)	0.1 kW	Q	Q	Q	Q
U1-09	Torque Reference	Monitors the internal torque reference value when vector control is used.	10 V: Rated torque (0 to ±10 V possible)	0.1%	X	X	Q	Q
U1-10	Input Term Sts (Input terminal status)	Shows the ON/OFF status of inputs. U1-10=00000000  <ul style="list-style-type: none"> 1: Terminal 1 ON 1: Terminal 2 ON 1: Terminal 3 ON 1: Terminal 4 ON 1: Terminal 5 ON 1: Terminal 6 ON 1: Terminal 7 ON 1: Terminal 8 ON 	Can't be output.	---	Q	Q	Q	Q

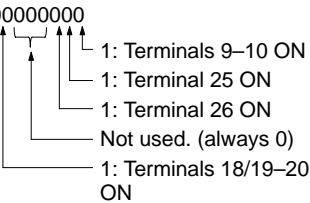
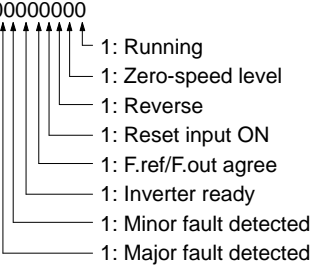
Item	Display	Function	Output signal levels for multi-function analog outputs	Min. Units	Valid access levels			
					V/f	V/f w/PG	Open Vector	Flux Vector
U1-11	Output Term Sts (Output terminal status)	Shows the ON/OFF status of outputs. U1-11=00000000 	Can't be output.	---	Q	Q	Q	Q
U1-12	Int Ctl Sts 1 (Internal control status)	Shows the Inverter's operating status. U1-12=00000000 	Can't be output.	---	Q	Q	Q	Q
U1-13	Elapsed Time	Monitors the Inverter's elapsed operating time. The initial value and running/power-on time selection can be set with parameters o2-07 and o2-08.	Can't be output.	1 hr	Q	Q	Q	Q
U1-14	FLASH ID	Manufacturer's ID number	Can't be output.	---	Q	Q	Q	Q
U1-15	Term 13 Level (Terminal 13 input voltage level)	Monitors the input voltage of the frequency reference (voltage). An input of 10 V corresponds to 100%.	10 V: 100% (10 V) (0 to ±10 V possible)	0.1%	B	B	B	B
U1-16	Term 14 Level (Terminal 14 input current level)	Monitors the input current of the frequency reference (current). An input of 20 mA corresponds to 100%.	10 V: 100% (20 mA) (0 to +10 V output)	0.1%	B	B	B	B
U1-17	Term 16 Level (Terminal 16 input voltage level)	Monitors the input voltage of the multi-function analog input. An input of 10 V corresponds to 100%.	10 V: 100% (10 V) (0 to ±10 V possible)	0.1%	B	B	B	B
U1-18	Mot SEC Current	Monitors the calculated value of the motor's secondary current (Iq). The motor's rated current corresponds to 100%.	10 V: Rated current (0 to +10 V output)	0.1%	B	B	B	B
U1-19	Mot EXC Current	Monitors the calculated value of the motor's excitation current (Id). The motor's rated current corresponds to 100%.	10 V: Rated current (0 to +10 V output)	0.1%	X	X	B	B
U1-20	SFS Output	Monitors the output frequency after a soft start. The display shows the frequency without the correction from compensation functions such as slip compensation.	10 V: Max. frequency (0 to ±10 V possible)	0.01 Hz	A	A	A	A
U1-21	ASR Input	Monitors the input to the speed control loop. The max. frequency corresponds to 100%.	10 V: Max. frequency (0 to ±10 V possible)	0.01 %	X	A	X	A
U1-22	ASR Output	Monitors the output from the speed control loop. The motor's rated current corresponds to 100%.	10 V: Rated current (0 to ±10 V possible)	0.01 %	X	A	X	A
U1-23	Speed Deviation	Monitors the speed deviation within the speed control loop. The max. frequency corresponds to 100%.	10 V: Max. frequency (0 to ±10 V possible)	0.01 %	X	A	X	A
U1-24	PID Feedback	Monitors the feedback value when PID control is used. The input for the max. frequency corresponds to 100%.	10 V: Max. frequency (0 to ±10 V possible)	0.01 %	A	A	A	A

Item	Display	Function	Output signal levels for multi-function analog outputs	Min. Units	Valid access levels			
					V/f	V/f w/PG	Open Vector	Flux Vector
U1-25	DI-16 Reference	Monitors the reference value from a 3G3FV-PDI16H2 Digital Command Card. The value will be displayed in binary or BCD depending on parameter F3-01.	Can't be output.	---	A	A	A	A
U1-26	Voltage Ref (Vq)	Monitors the Inverter's internal voltage reference value for the motor's secondary current control.	10 V: 200 (400) VAC (0 to ±10 V possible)	0.1 V	X	X	A	A
U1-27	Voltage Ref (Vd)	Monitors the Inverter's internal voltage reference value for the motor's excitation current control.	10 V: 200 (400) VAC (0 to ±10 V possible)	0.1 V	X	X	A	A
U1-28	CPU ID	Manufacturer's CPU software ID number	Can't be output.	0.1 V	A	A	A	A
U1-32	ACR(q) Output	Monitor's the current control output value for the motor's secondary current.	10 V: 100%	0.1%	X	X	A	A
U1-33	ACR(d) Output	Monitor's the current control output value for the motor's excitation current.	10 V: 100%	0.1%	X	X	A	A
U1-34	OPE Detected	Displays the first constant number for which an OPE error was detected.	Can't be output.	---	A	A	A	A
U1-35	Zero Servo Pulse	Multiplies the number of PG pulses by four to display the movement width at the zero servo stop point.	Can't be output.	1	X	X	X	A
U1-36	PID Input	PID reference + PID reference bias – PID feedback value The max. frequency corresponds to 100%.	10 V: Max. frequency	0.01 %	A	A	A	A
U1-37	PID Output	PID control output The max. frequency corresponds to 100%.	10 V: Max. frequency	0.01 %	A	A	A	A
U1-38	PID Setpoint	PID reference + PID reference bias The max. frequency corresponds to 100%.	10 V: Max. frequency	0.01 %	A	A	A	A

Fault Trace

Item	Display	Function	Output signal levels for multi-function analog outputs	Min. Units	Valid access levels			
					V/f	V/f w/PG	Open Vec-tor	Flux Vec-tor
U2-01	Current Fault	Information on the current fault	Can't be output.	---	Q	Q	Q	Q
U2-02	Last Fault	Information on the last fault		---	Q	Q	Q	Q
U2-03	Frequency Ref	Frequency reference value when the "last fault" occurred.		0.01 Hz	Q	Q	Q	Q
U2-04	Output Freq	Output frequency when the "last fault" occurred.		0.01 Hz	Q	Q	Q	Q
U2-05	Output Current	Output current when the "last fault" occurred.		0.1 A	Q	Q	Q	Q
U2-06	Motor Speed	Motor speed when the "last fault" occurred.		0.01 Hz	X	Q	Q	Q
U2-07	Output Voltage	Output voltage when the "last fault" occurred.		0.1 V	Q	Q	Q	Q
U2-08	DC Bus Voltage	The main circuit DC voltage when the "last fault" occurred.		1 V	Q	Q	Q	Q
U2-09	Output kWatts	Output power when the "last fault" occurred.		0.1 kW	Q	Q	Q	Q
U2-10	Torque Reference	Torque reference when the "last fault" occurred. (The rated torque = 100%.)		0.1%	X	X	Q	Q
U2-11	Input Term Sts	Input terminal status when the "last fault" occurred. (Same format as U1-10.)		---	Q	Q	Q	Q
U2-12	Output Term Sts	Output terminal status when the "last fault" occurred. (Same format as U1-11.)		---	Q	Q	Q	Q
U2-13	Inverter status	Inverter operating status when the "last fault" occurred. (Same format as U1-12.)		---	Q	Q	Q	Q
U2-14	Elapsed time	Elapsed operating or power-on time when the "last fault" occurred.		1 hr	Q	Q	Q	Q

Fault History

Item	Display	Function	Output signal levels for multi-function analog outputs	Min. Units	Valid access levels			
					V/f	V/f w/PG	Open Vec-tor	Flux Vec-tor
U3-01	Last Fault	Information on the last fault.	Can't be output.	---	Q	Q	Q	Q
U3-02	Fault Message 2	Information on the 2 nd to last fault.		---	Q	Q	Q	Q
U3-03	Fault Message 3	Information on the 3 rd to last fault.		---	Q	Q	Q	Q
U3-04	Fault Message 4	Information on the 4 th to last fault.		---	Q	Q	Q	Q
U3-05	Elapsed Time 1	Elapsed running or power-on time when the last fault occurred.		1 hr	Q	Q	Q	Q
U3-06	Elapsed Time 2	Elapsed running or power-on time when the 2 nd to last fault occurred.		1 hr	Q	Q	Q	Q
U3-07	Elapsed Time 3	Elapsed running or power-on time when the 3 rd to last fault occurred.		1 hr	Q	Q	Q	Q
U3-08	Elapsed Time 4	Elapsed running or power-on time when the 4 th to last fault occurred.		1 hr	Q	Q	Q	Q

■ Monitoring at Startup









- In operation mode, the frequency reference, output frequency, output current, and output voltage can be monitored immediately if the default settings are being used. One of these four values, the output voltage, can be changed to a different value. When a value other than the output voltage is to be monitored, set that value’s number in parameter o1-01 (user monitor selection).
- When the power is turned on, the frequency reference will appear in the Unit’s data display if the default settings are being used. Any one of the four values monitored at startup (frequency reference, output frequency, output current, or the value set in parameter o1-01) can be selected to appear when the power is turned on. The value that appears at startup is determined by parameter o1-02 (Power-On Monitor).
- Parameters o1-01 and o1-02 can be changed in the Basic or Advanced access levels. These parameters can be changed during operation.

User Monitor Selection (Parameter o1-01)

Use parameter o1-01 to select the values that will be monitored at startup.
 Use the last two digits from the “U1 Monitor” list (U1-□□) to select a value. For example, the torque reference is U1-09, so input 9 to select the torque reference.

Parameter number	Display name	Setting range	Units	Default setting	Valid access levels			
					V/f Control	V/f with PG	Open Loop Vector	Flux Vector
o1-01	User Monitor Sel	4 to 28	---	6	Basic or Advanced			

The following example shows how to change parameter o1-01 so that the output power is monitored at startup instead of the output voltage.

Key sequence	Display	Explanation
	** Main Menu ** Operation	Displays operation mode.
	** Main Menu ** Programming	Displays program mode.
	Function b1 Sequence	Puts the Unit in program mode.
 2 times	Function o1 Monitor Select	Displays function selection o1.
	User Monitor Sel Output Voltage	Puts the Unit in function selection o1. (Monitor Select)
	o1-01= 6 *** Output Voltage	Displays the parameter setting for o1-01.
 2 times	o1-01= 8 *** Output kWatts	Sets the parameter to output power.
	Entry Accepted	Writes the new setting.
	User Monitor Sel Output kWatts	Returns to the Monitor Select display.







Note In this example, the setting is changed in the Basic access level.

Power-On Monitor (Parameter o1-02)

Use parameter o1-02 to indicate which value will be displayed when the Unit is started.
 A setting of 1 indicates the frequency reference, 2 indicates the output frequency, 3 indicates the output current, and 4 indicates the value set in parameter o1-01.

Parameter number	Display name	Setting range	Units	Default setting	Valid access levels			
					V/f Control	V/f with PG	Open Loop Vector	Flux Vector
o1-02	Power-On Monitor	1 to 4	---	1	Basic or Advanced			

The following example shows how to change parameter o1-02 so that the output current is displayed at startup. (The procedure continues from the end of the previous example.)

Key sequence	Display	Explanation
	User Monitor Sel Output kWatts	Monitor Select display (See the previous example.)
	Power-On Monitor Frequency Ref	Displays the Power-On Monitor display.
	o1-02= 1 *** Frequency Ref	Displays the parameter setting for o1-02.
 2 times	O1-02= 3 Output Current	Sets the parameter to output current.
	Entry Accepted	Writes the new setting.
	Power-On Monitor Output Current	Returns to the Power-On Monitor display.
	Function o1 Monitor Select	Returns to the function selection o1 display.
	** Main Menu ** Programming	Returns to the program mode display.

Note In this example, the setting is changed in the Basic access level.

3-4 Initialize Mode

The initialize mode is used to select the language displayed by the Unit, the access level, and the control mode; it is also used to initialize the Unit's parameters.

■ Selecting the Display Language







Use parameter A1-00 to select the language displayed by the Unit. Messages can be displayed in 0: English, 1: Japanese, 2: German, 3: French, 4: Italian, 5: Spanish, or 6: Portuguese. This parameter is not initialized by the initialize operation and it can be changed during operation.

Note The language that is set will be indicated on the display.

Parameter number	Display name	Setting range	Units	Default setting	Valid access levels			
					V/f Control	V/f with PG	Open Loop Vector	Flux Vector
A1-00	Select Language	0 to 6	---	0	Quick-start, Basic, or Advanced			

Example

The following example shows how to change parameter A1-00 so that Japanese is displayed instead of English.

Key sequence	Display	Explanation
	** Main Menu ** Operation	Displays operation mode.
	** Main Menu ** Initialize	Displays initialize mode.
	Select Language English	Puts the Unit in initialize mode. (Select Language display)
	A1-00= 0 English	Displays the parameter setting for A1-00.
	A1-00= 1 *** FN]:^	Sets the display language to Japanese.
	<^.3=3 67:P6]	Writes the new setting.
	9^]:^ >]@8 FN]:^	Returns to the Select Language display.

■ Setting the Access Level

Use parameter A1-01 to select the parameter access level. This level determines which parameters can be displayed and changed. (The parameters which can be displayed and changed also depend upon the control mode being used.) This parameter can be changed during operation.

Parameter number	Display name	Setting range	Units	Default setting	Valid access levels			
					V/f Control	V/f with PG	Open Loop Vector	Flux Vector
A1-01	Access Level	0 to 4	---	2	Quick-start, Basic, or Advanced			

Access Level Settings

Setting	Name	Function
0	Operation Only	This setting allows operation mode and initialize mode to be displayed or changed. Use this setting to prevent parameter settings from being changed.
1	User Level	This setting allows only the user-selected parameters (up to 32) to be displayed or changed. Select the desired parameters as "User Parameters" in parameters A2-01 through A2-32.
2	Quick-start	This setting allows the parameters required to start the Inverter (about 25) to be displayed or changed.
3	Basic	This setting allows the commonly used parameters to be displayed or changed.
4	Advanced	This setting allows all parameters to be displayed or changed.

■ **Setting the Control Mode**

Use parameter A1-02 to select one of the four control modes. This parameter is not initialized by the initialize operation and it cannot be changed during operation.

Parameter number	Display name	Setting range	Units	Default setting	Valid access levels			
					V/f Control	V/f with PG	Open Loop Vector	Flux Vector
A1-02	Control Method	0 to 3	---	2	Quick-start, Basic, or Advanced			

Control Mode Settings

Setting	Name	Function
0	V/f Control	V/f control without pulse generator (normal V/f control)
1	V/f w/PG Fdbk	V/f control with pulse generator (V/f control using a PG Speed Control Card)
2	Open Loop Vector	Vector control without pulse generator (Vector control using the Inverter's internal speed information)
3	Flux Vector	Vector control with pulse generator (Vector control using a PG Speed Control Card)

Control Mode Characteristics

Characteristic	V/f Control	V/f w/PG Fdbk	Open Loop Vector	Flux Vector
Basic control method	Voltage/frequency control (open loop)	Voltage/frequency control with speed compensation	Current vector control without PG	Current vector control with PG
Speed detector	Not required	Required (pulse generator)	Not required	Required (pulse generator)
Optional Speed Detectors	Not required	3G3FV-PPGA2 or 3G3FV-PPGD2	Not required	3G3FV-PPGB2 or 3G3FV-PPGX2
Speed control range	1:40	1:40	1:100	1:1,000
Starting torque	150%/3 Hz	150%/3 Hz	150%/1 Hz	150%/0 Hz
Speed control precision	±2 to 3%	±0.03%	±0.2%	±0.02%
Torque limit	Not possible	Not possible	Possible	Possible
Torque control	Not possible	Not possible	Not possible	Possible
Example applications	<ul style="list-style-type: none"> Multiple motors 	<ul style="list-style-type: none"> Simple speed feedback control 	<ul style="list-style-type: none"> Variable speed drive applications 	<ul style="list-style-type: none"> Simple servo drives Precision speed control Torque control

Example

The following example shows how to change parameter A1-02 to select Flux Vector control (vector control with pulse generator).

Key sequence	Display	Explanation
	** Main Menu ** Operation	Displays operation mode.
	** Main Menu ** Initialize	Displays initialize mode.
	Select Language English	Puts the Unit in initialize mode. (Select Language display)
2 times	Control Method Open Loop Vector	Displays the Control Method display.
	A1-02= 2 Open Loop Vector	Displays the parameter setting for A1-02.
	A1=02 3 Flux Vector	Changes the setting to Flux Vector.
	Entry Accepted	Writes the new setting.
	Control Method Flux Vector	Returns to the Control Method display.

■ Initializing the Parameters

Use parameter A1-03 to initialize the parameters. This parameter cannot be changed during operation.

Parameter number	Display name	Setting range	Units	Default setting	Valid access levels			
					V/f Control	V/f with PG	Open Loop Vector	Flux Vector
A1-03	Init Parameters	0, 1110, 2220, or 3330	---	0	Quick-start, Basic, or Advanced			

Initialize Parameters Settings

Setting	Function
0	Returns to the Initialize display without initializing any parameters.
1110	Initializes the parameters to the user settings. This function initializes the parameters to values that have been recorded as user settings. To record the user settings, change the parameters to the desired values and then set parameter o2-03 (User Defaults) to 1. (The 1110 function is disabled when parameter o2-03 is 0.)
2220	2-wire sequential initialization (Initializes the parameters to the factory settings.)
3330	3-wire sequential initialization

● Example of Wiring for 2-wire Sequential Operation

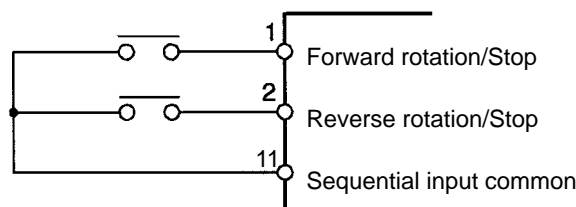

● Example of Wiring for 3-wire Sequential Operation

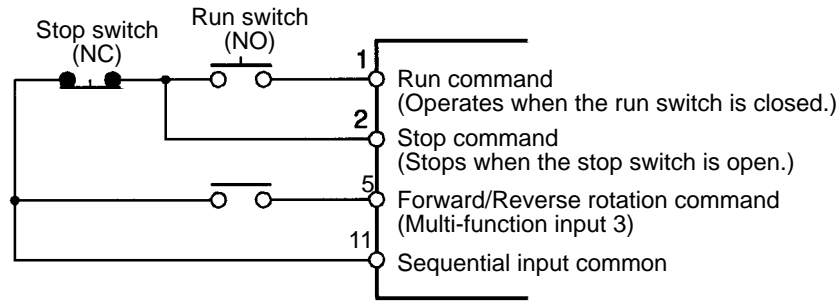

Note 1. The default settings of the multi-function inputs are different from the default settings of the 2-wire sequence.

Note 2. When setting a 3-wire sequence, the operation can be started and stopped with an automatically resetting pushbutton switch.

Initialization Example

The following example shows how to initialize parameters with the 2-wire sequence (factory settings).

Key sequence	Display	Explanation
	** Main Menu ** Operation	Displays operation mode.
	** Main Menu ** Initialize	Displays initialize mode.
	Select Language English	Puts the Unit in initialize mode. (Select Language display)
3 times	Init Parameters No Initialize	Displays the Initialize display.
	A1-03= 0 *** No Initialize	Displays the parameter setting for A1-03.
	A1-03= 2220 2-wire Initial	Changes the setting to 2-wire Initialization.
	Entry Accepted	Writes the new setting.
	Init Parameters No Initialize	Returns to the Initialize display.

■ Write-protect Passwords

Use parameters A1-04 and A1-05 to write-protect the initialize-mode parameters. Parameters A1-01 through A1-03 and A2-01 through A2-32 can be displayed but not changed if the contents of A1-04 and A1-05 don't match. These parameters cannot be changed during operation.

To write-protect the initialize-mode parameters, set the password in A1-05 after inputting the desired values in A1-01 through A1-03 and A2-01 through A2-32. Parameter A1-05 can be displayed by displaying A1-04 and pressing the Menu Key while pressing the Reset Key. (A1-05 can't be displayed with the usual key sequences.)











It will be possible to change the initialize-mode parameters again when the password is written to A1-04.

Parameter number	Display name	Setting range	Units	Default setting	Valid access levels			
					V/f Control	V/f with PG	Open Loop Vector	Flux Vector
A1-04	Enter Password	0000 to 9999	---	0	Quick-start, Basic, or Advanced			

Parameter number	Display name	Setting range	Units	Default setting	Valid access levels			
					V/f Control	V/f with PG	Open Loop Vector	Flux Vector
A1-05	Select Password	0000 to 9999	---	0	Quick-start, Basic, or Advanced			

Password Setting Example

The following example shows how to set the password to “1000.”

Key sequence	Display	Explanation
	** Main Menu ** Operation	Displays operation mode.
	** Main Menu ** Initialize	Displays initialize mode.
	Select Language English	Puts the Unit in initialize mode. (Select Language display)
 4 times	Enter Password A1-04= 0	Displays the Enter Password display.
 + 	Select Password A1-05= 0	Press and hold the Reset Key and then press the Menu Key to display A1-05.
	Select Password 0000	Selects the parameter so that the leading 0 flashes. (The digit that can be changed flashes.)
	Select Password 1000	Changes the password to 1000.
	Entry Accepted	Writes the new setting.
	Select Password A1-05= 1000	Returns to the Select Password display (A1-05).
	Enter Password A1-04= 0	Returns to the Enter Password display (A1-04).

■ User Parameters

Parameters A2-01 through A2-32 specify the parameters that can be displayed and changed when the access level parameter (A1-01) is set to 1. Parameters A2-01 through A2-32 can be changed only in the Advanced access level and cannot be changed during operation.

















Parameter numbers	Display name	Setting range	Units	Default setting	Valid access levels			
					V/f Control	V/f with PG	Open Loop Vector	Flux Vector
A2-01 to A2-32	User parameter 1 to User parameter 32	b1-01 to o2-08	---	---	Advanced			

The following restrictions apply to setting/displaying parameters when the access level is set to the user level.

Mode	Accessible parameters
Operation	The Quick-start level parameters can be displayed.
Initialize	The Quick-start level parameters can be set or displayed.
Program	Only the parameters specified in A2-01 through A2-32 can be set or displayed.
Auto-tuning	The parameters cannot be displayed.
Modified constants	The parameters cannot be displayed.

Setting Example

The following example shows how to specify parameter C1-01 (Acceleration time 1) in user parameter A2-01 and set the access level to the user level.

Key sequence	Display	Explanation
	** Main Menu ** Operation	Displays operation mode.
	** Main Menu ** Initialize	Displays initialize mode.
	Select Language English	Puts the Unit in initialize mode. (Select Language display)
	Function A2 User Parameters	Displays the User Parameters display.
	User Param 1 A2-01= ----	Displays the parameter setting for A2-01.
	User Param 1 ----	Selects the parameter so that the leading digit flashes. (The digit that can be changed flashes.)
 2 times	User Param 1 C1-01	Sets the first digit to "C." (At this point the other digits will be displayed.)
 2 times	User Param 1 C1-01	Moves the cursor to the third digit.
 7 times	User Param 1 C1-08	Sets the last digits to "08."
	Entry Accepted	Writes the new setting.
	User Param 1 A2-01= C1-08	Returns to the parameter setting for A2-01.
	Function A2 User Parameters	Returns to the User Parameters display.
 2 times	Access Level Advanced Level	Displays the Access Level display.
	A1-01= 4 ADVANCED	Displays the parameter setting for A1-01.
 2 times	A1-01= 1 User Level	Changes the setting to "User Level."
	Entry Accepted	Writes the new setting.
	Access Level User Level	Returns to the Access Level display.
	** Main Menu ** Initialize	Returns to the initialize mode display.

Note The access level can be set to “User Level” after at least one parameter has been specified in A2-01 through A2-32. The “User Level” selection won’t appear as an option for parameter A1-01 unless a parameter has been specified in A2-01 through A2-32.

■ Initialize Mode Parameter Levels (Reference)

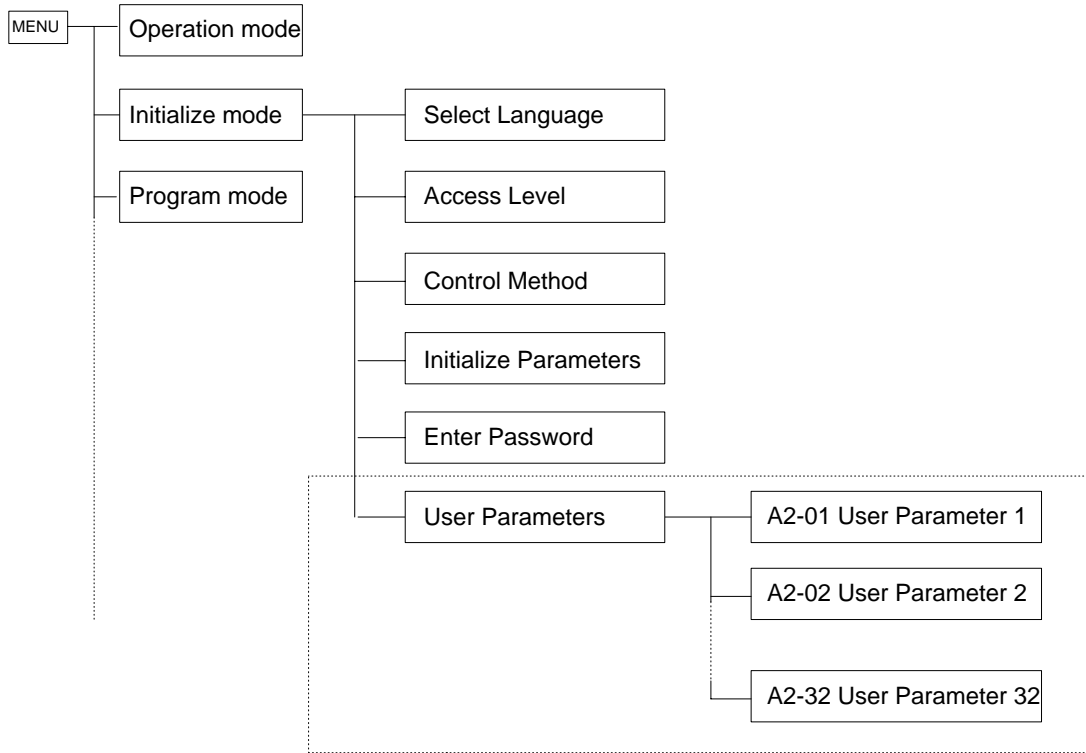

↑
These parameters can be displayed and changed only in the Advanced access level.

3-5 Program Mode

The Inverter parameters can be set in program mode. The parameters which can be displayed and changed depend on the access level and control mode that are being used. Refer to the following table to determine if a parameter can be changed.

■ Parameter Groups

An “OK” in the control mode column indicates that the parameter can be changed in that control mode.

Group	Function		Comments	Control mode			
				V/f	V/f w/PG	Open-loop Vector	Flux Vector
Application	b1	Sequence	Settings such as the reference input method	OK	OK	OK	OK
	b2	DC Braking	DC braking function settings	OK	OK	OK	OK
	b3	Speed Search	Speed search function settings	OK	OK	OK	OK
	b4	Delay Timers	Timer function settings	OK	OK	OK	OK
	b5	PID Control	PID control settings	OK	OK	OK	OK
	b6	Reference Hold	Accel/deceleration time dwell function settings	OK	OK	OK	OK
	b7	Droop Control	Droop control (speed drop) settings	---	---	---	OK
	b8	Energy Saving	Terminal input energy-saving control settings	OK	OK	---	---
	b9	Zero Servo	Stop in the position loop	---	---	---	OK
Tuning	C1	Accel/Decel	Acceleration/deceleration time settings	OK	OK	OK	OK
	C2	S-Curve Acc/Dec	S-curve characteristics for accel/decel times	OK	OK	OK	OK
	C3	Motor-Slip Comp	Slip compensation function settings	OK	OK	OK	OK
	C4	Torque Comp	Torque compensation function settings	OK	OK	OK	---
	C5	ASR Tuning	Speed control loop parameter settings	---	OK	---	OK
	C6	Carrier Freq	Carrier frequency settings	OK	OK	OK	OK
	C7	Hunting Prev	Hunting prevention function for V/f control	OK	OK	---	---
	C8	Factory Tuning	Adjustment for open-loop vector control	---	---	OK	---
Reference	d1	Preset Reference	Operator frequency reference settings	OK	OK	OK	OK
	d2	Reference Limits	Frequency upper and lower limit settings	OK	OK	OK	OK
	d3	Jump Frequencies	Prohibited frequency settings	OK	OK	OK	OK
	d4	Sequence	Hold for analog frequency reference	OK	OK	OK	OK
	d5	Torque Control	Parameter settings for torque control	---	---	---	OK
Motor	E1	V/f Pattern	Sets the motor's V/f characteristics.	OK	OK	OK	OK
	E2	Motor Setup	Sets the motor parameters.	OK	OK	OK	OK
	E3	Control Method 2	Sets the control method of motor 2.	OK	OK	OK	OK
	E4	V/f Pattern 2	Sets the V/f pattern of motor 2.	OK	OK	OK	OK
	E5	Motor Setup 2	Motor setup for motor 2.	OK	OK	OK	OK
Options	F1	PG Option Setup	Parameter settings for a PG Card	---	OK	---	OK
	F2	AI-14 Setup	Parameter settings for an Analog Reference Card	OK	OK	OK	OK
	F3	DI-08, 16 Setup	Parameter settings for a Digital Reference Card	OK	OK	OK	OK
	F4	AO-08, 12 Setup	Parameter settings for an Analog Monitor Card	OK	OK	OK	OK
	F5	Not used (DO-02)	Not Used. (Do not change these settings.)	---	---	---	---
	F6	Not used (DO-08)					
	F7	PO-36F Setup	Parameter settings for a Pulse Monitor Card.	OK	OK	OK	OK
	F8	SI-F/G Setup	SYSMAC BUS Interface card setup.	OK	OK	OK	OK
	F9	CP-916 Setup	CompoBus/D (DeviceNet) communications card setup.	OK	OK	OK	OK

Group	Function		Comments	Control mode			
				V/f	V/f w/PG	Open-loop Vector	Flux Vector
Terminal	H1	Digital Inputs	Function selection for multi-function inputs	OK	OK	OK	OK
	H2	Digital Outputs	Function selection for multi-function outputs	OK	OK	OK	OK
	H3	Analog Inputs	Function selection for analog inputs	OK	OK	OK	OK
	H4	Analog Outputs	Function selection for analog outputs	OK	OK	OK	OK
	H5	Serial Com Setup	Not Used. (Do not change these settings.)	---	---	---	---
Protection	L1	Motor Overload	Overload protection settings and selection	OK	OK	OK	OK
	L2	PwrLoss Ridethru	Selects the power-loss processing method.	OK	OK	OK	OK
	L3	Stall Prevention	Stall prevention settings and selection	OK	OK	OK	OK
	L4	Ref Detection	Frequency detection settings and selection	OK	OK	OK	OK
	L5	Fault Restart	Fault restart function settings	OK	OK	OK	OK
	L6	Torque Detection	Overtorque detection settings and selection	OK	OK	OK	OK
	L7	Torque Limit	Torque limit settings (vector control only)	---	---	OK	OK
	L8	Hdwe Protection	Overheating and phase loss protection settings	OK	OK	OK	OK
Operator	o1	Monitor Select	Selects the display and setting methods.	OK	OK	OK	OK
	o2	Key Selections	Key function selection and other parameters	OK	OK	OK	OK

■ Setting Parameters in Program Mode

The parameters that can be displayed and changed will vary depending on the access level that has been set.

In the Quick-start level, the first parameter (b1-01) will be displayed when the Enter Key is pressed at the program mode display. In the Basic level, the first function (b1) will be displayed when the Enter Key is pressed at the program mode display. In the Advanced level, the first group (b) will be displayed when the Enter Key is pressed at the program mode display.

For setting examples, refer to *Setting Parameters in Each Access Level* on page 3-6.

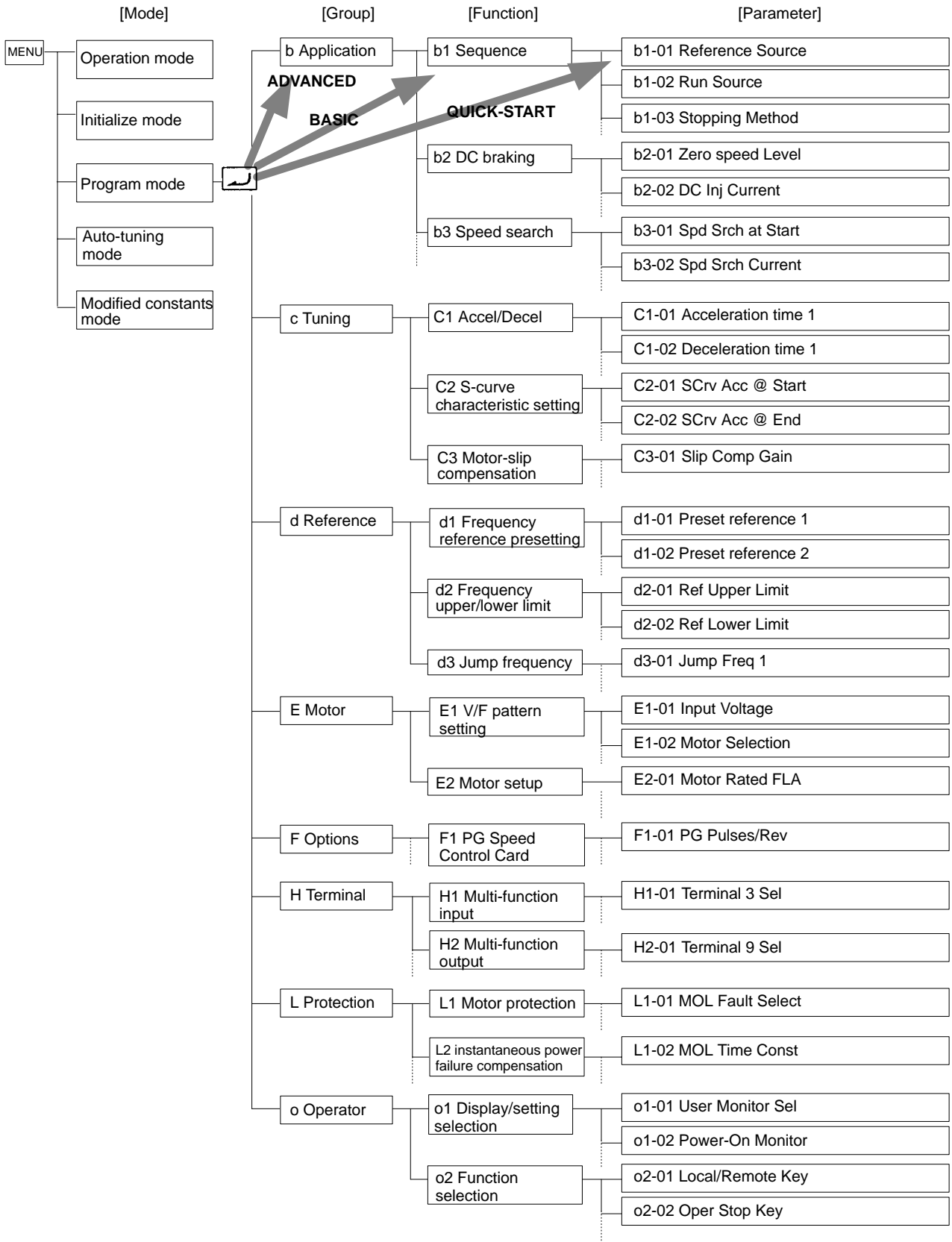

Note The above parameter levels are simplified levels used mainly in programming operation.

3-6 Auto-tuning Mode

The auto-tuning function automatically tunes and sets the required motor parameters when operating in the open-loop or flux vector control modes.

When the rated voltage, rated current, rated frequency, rated rotational frequency, and number of poles listed on the motor's nameplate have been input and the Run Key is pressed, the motor parameters calculated from these values are written to E1-01 through E2-08 automatically.

The auto-tuning mode won't be displayed if V/f control has been selected.

■ Precautions for Auto-tuning Operation



















Caution

Do not connect a load to the motor when performing auto-tuning. Doing so may result in personal injury or equipment damage.

- The Inverter's auto-tuning function automatically determines the motor parameters while a servo system's auto-tuning function determines the size of a load, so these auto-tuning functions are fundamentally different.
- If a load is connected when auto-tuning is performed, not only will incorrect motor parameters be recorded, but the motor may operate erratically resulting in dangerous conditions such as loads falling from vertical axis motors. Never perform auto-tuning with a load connected to the motor.

■ Auto-tuning Operation Example

Key sequence	Display	Explanation
	** Main Menu ** Operation	Displays operation mode.
 3 times	** Main Menu ** Auto-Tuning	Displays auto-tuning mode.
	Rated Voltage 200.0 VAC	Displays the rated voltage.
	Rated Voltage 200.0 VAC	When changing the rated voltage, press the Enter Key again to enter input mode. (The digits will flash.)
  	Rated Voltage 200.0 VAC	Use the Reset, Up Arrow and Down Arrow Keys to change the rated voltage setting.
	Entry Accepted	Writes the new setting.
	Rated Voltage 200.0 VAC	Returns to the rated voltage display.
	Rated Current 1.90 A	Displays the rated current. Follow the procedure used to change for the rated voltage when changing this setting.
	Rated Frequency 60.0 Hz	Displays the rated frequency. Follow the procedure used to change for the rated voltage when changing this setting.
	Rated Speed 1750 RPM	Displays the rated speed. Follow the procedure used to change for the rated voltage when changing this setting.
	Number of Poles 4	Displays the number of poles. Follow the procedure used to change for the rated voltage when changing this setting.
	Select Motor 1/2 1	Displays the motor selection. (Selection of motor 1 parameter or motor 2 parameter)
	Tuning Ready ? Press RUN key	Displays a confirmation prompt for the start of the auto-tuning function. (The lower line will flash.)
	Tune Proceeding <input type="checkbox"/> HZ <input type="checkbox"/> A	Starts the auto-tuning function. (The upper line will flash.)
	Tune Successful	Indicates the completion of auto-tuning.
	** Main Menu ** Operation	Returns to the operation mode display.









3-7 Modified Constants Mode

The modified constants mode is used to display or change parameters that have been changed from their factory-preset values.

When any parameters have been changed in program mode (b1-01 through o2-08), pressing the Enter Key in modified constants mode will cause these parameters to be displayed. (The initialize-mode parameters won't be displayed.)

■ Modified Constants Mode Operations

- In the following example, parameters C1-01 (acceleration time 1) and d1-01 (preset reference 1) have been changed from their factory settings.
- The settings for these two parameters are displayed and the setting for d1-01 is changed from "60.00 Hz" to "30.00 Hz."

Key sequence	Display	Explanation
	** Main Menu ** Operation	Displays operation mode.
	** Main Menu ** Modified Consts	Displays modified constants mode.
	Accel Time 1 c1-01= 20.0 Sec	Displays acceleration time 1 (C1-01).
	Frequency Ref 1 d1-01= 60.00 Hz	Displays frequency reference 1 (d1-01).
	Frequency Ref 1 060.00 Hz	Pressing Enter allows the setting to be changed. (The leading digit will flash.)
 	Frequency Ref 1 030.00 Hz	Changes the setting to "30.00 Hz."
	Entry Accepted	Writes the new setting.
	Frequency Ref 1 d1-01= 30.00 Hz	Returns to the frequency reference 1 display.
	** Main Menu ** Modified Consts	Returns to the modified constants mode display.

3-8 Operation Mode Selection Key and Local/Remote Selection Input

The operation mode of the Inverter can be changed using the Operation Mode Selection Key on the Digital Operator. Using this key, it is possible to switch between the two operation modes shown below. The same kind of switching is also possible with control circuit terminals set using the multi-function input parameters 1 to 6 (set value: 2 (local/remote selection input)).

Operation mode	Description	Contents
Remote	Inverter operates according to control signals from a higher level control system.	Operation will be determined by the following settings. Frequency reference selection: b1-01 Run source selection: b1-02
Local	Inverter operates alone in order to check operation directly related to the Inverter.	Run commands: RUN/STOP Key on Digital Operator. Frequency reference: Value set with the Digital Operator. Note Operates as if b1-01 and b1-02 were set to "0."

- Note 1.** The operation mode will always be Remote Mode when power is supplied. Therefore, to start operation immediately after power is supplied, set b1-01 and b1-02 to the required settings in advance.
- Note 2.** If b1-01 and b1-02 are set to 0, there is no difference in the two modes.
- Note 3.** Frequencies set from the Digital Operator using the speed setting will be entered in frequency reference parameters 1 to 8 (d1-01 to d1-08) or the inching frequency reference parameter (d1-09) regardless of whether the mode is Remote Mode or Local Mode.
- Note 4.** Multi-function inputs 1 to 6 will be enabled regardless of whether the mode is Remote Mode or Local Mode. The following settings, however, will be disabled in Local Mode:
Stop command (3-wire sequence selection); Set value: 0
- Note 5.** For safety reasons, run signals input while changing from Local Mode to Remote Mode are usually ignored. Input the run signal again after the mode has changed. It is possible, however, to stop such run signals being ignored by setting the Local/Remote Key selection parameter (b1-07) to 1. If this setting is made, when the mode changes from Local Mode to Remote Mode, the Inverter will start running immediately. Take steps to ensure the safety of the system for such operation.

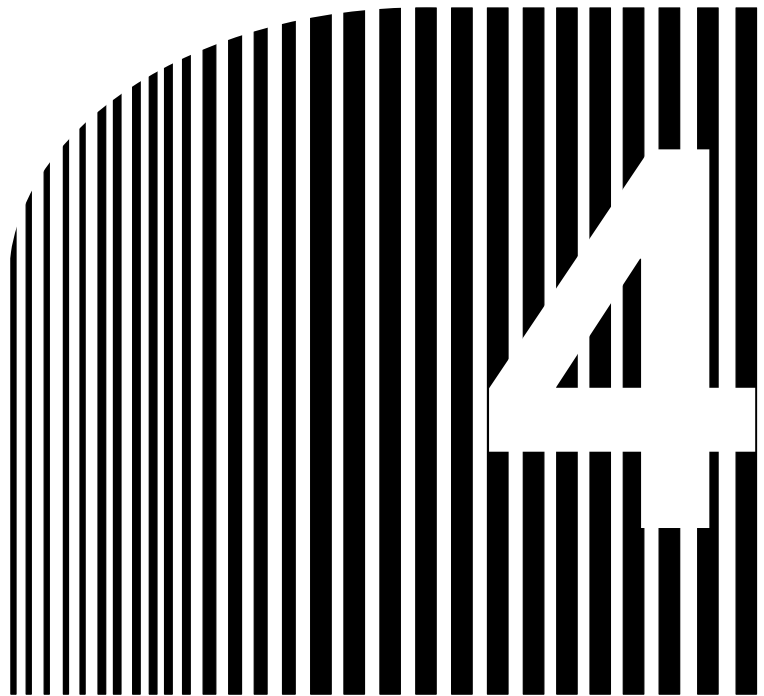













Chapter 4

• Trial Operation •

- 4-1 Procedure
- 4-2 Operation Example

■ Cautions and Warnings

-  **WARNING** Turn ON the input power supply only after mounting the front cover, terminal covers, bottom cover, Operator, and optional items. Not doing so may result in electrical shock.
-  **WARNING** Do not remove the front cover, terminal covers, bottom cover, Operator, or optional items while the power is being supplied. Not doing so may result in electrical shock or damage to the product.
-  **WARNING** Do not operate the Operator or switches with wet hands. Doing so may result in electrical shock.
-  **WARNING** Do not touch the inside of the Inverter. Doing so may result in electrical shock.
-  **WARNING** Do not come close to the machine when using the error retry function because the machine may abruptly start when stopped by an alarm. Doing so may result in injury.
-  **WARNING** Do not come close to the machine immediately after resetting momentary power interruption to avoid an unexpected restart (if operation is set to be continued in the processing selection function after momentary power interruption is reset). Doing so may result in injury.
-  **WARNING** Provide a separate emergency stop switch because the STOP Key on the Operator is valid only when function settings are performed. Not doing so may result in injury.
-  **WARNING** Be sure confirm that the RUN signal is turned OFF before turning ON the power supply, resetting the alarm, or switching the LOCAL/REMOTE selector. Doing so while the RUN signal is turned ON may result in injury.
-  **Caution** Be sure to confirm permissible ranges of motors and machines before operation because the Inverter speed can be easily changed from low to high. Not doing so may result in damage to the product.
-  **Caution** Provide a separate holding brake when necessary. Not doing so may result in injury.
-  **Caution** Do not perform a signal check during operation. Doing so may result in injury or damage to the product.
-  **Caution** Do not carelessly change settings. Doing so may result in injury or damage to the product.

4-1 Procedure

1. Installation and Mounting

Install the Inverter according to the installation conditions. Refer to page 2-2. Ensure that the installation conditions are met.

2. Wiring and Connection

Connect to the power supply and peripheral devices. Refer to page 2-11. Select peripheral devices which meet the specifications and wire correctly.

3. Power Connection

Carrying out the following pre-connection checks before turning on the power supply:

- Always ensure that a power supply of the correct voltage is used and that the power input terminal (L1, L2, L3) is wired correctly.
 - 200-V class: 3-phase 200 to 230 VDC, 50/60 Hz
 - 400-V class: 3-phase 380 to 460 VDC, 50/60 Hz
- Make sure that the Motor output terminal (T1, T2, T3) and the Motor are connected correctly.
- Ensure that the control circuit terminals and the control device are wired correctly. Make sure that all control terminals are turned OFF.
- When using a PG Speed Control Card, ensure that it is wired correctly.
- Set the motor to no-load status, (not connected to the mechanical system).
- Having conducted the above checks, connect the power supply.

4. Check the Display Status

Check to be sure that there are no faults in the Inverter.

- If the display at the time the power is connected is normal, it will read as follows:
 - Data Display: Frequency Ref
- When an fault has occurred, the details of the fault will be displayed. In that case, refer to *Section 8 Maintenance Operations*.

5. Initializing Parameters

Initialize the parameters.

6. Setting the Input Voltage

Set the Inverter input voltage (E1-01) to the correct voltage. (At the same time, set the short pin for the 400-V class models of 18.5 KW or larger.)

7. Auto-tuning

Execute auto-tuning in the open-loop vector control mode.

- When auto-tuning is executed, motor parameters are set automatically.
- When this is not possible using auto-tuning, switch to V/f control mode and set the V/f pattern.

8. No-load Operation

Start the no-load motor using the Digital Operator.

- Set the frequency reference using the Digital Operator and start the motor using key sequences.

9. Actual Load Operation

Connect the mechanical system and operate using the Digital Operator.

- When there are no difficulties using the no-load operation, connect the mechanical system to the motor and operate using the Digital Operator.

10. Operation

Basic Operation: Operation based on the basic settings required to start and stop the Inverter. Refer to page 5-2.

Applied Operation: Operation which uses PID control or other functions. Refer to page 6-1.

- For operation within standard parameters select “Basic Operation.”
- To use the various applied functions such as, direct current control braking, speed search, timer, S-curve acceleration/deceleration, slip correction, torque compensation, drip control, position lock, and torque control, select “Applied Operation” in combination with “Basic Operation.”

4-2 Operation Example

4-2-1 Power Connection

■ Checkpoints before Connecting the Power Supply

- Check that the power supply is of the correct voltage.
 - 200-V class: 3-phase 200 to 230 VDC, 50/60 Hz
 - 400-V class: 3-phase 380 to 460 VDC, 50/60 Hz
- Make sure that the Motor output terminal (T1, T2, T3) and the Motor are connected correctly.
- Ensure that the control circuit terminal and the control device are wired correctly. Set all control circuit terminals to OFF.
- When using a PG Speed Control Card, ensure that it is wired correctly.
- Set the motor to no-load status, (not connected to the mechanical system).

■ Connecting the Power Supply

- Having conducted the above checks, connect the power supply.

4-2-2 Checking the Display Status

- If the display at the time the power is connected is normal, it will read as follows:

Normal Frequency Ref
 U1-01= 0.00 HZ

The frequency reference monitor is displayed in the data display section.









- When an fault has occurred, the details of the fault will be displayed. In that case, refer to *Section 8 Maintenance Operations*.

Fault UV
 Under Voltage

The display will differ depending on the type of fault.

4-2-3 Initializing Parameters

- Initialize the parameters using the following procedure. (Returns to default settings).
- To initialize the parameters, set “2220” in A1-03 (Initialize).
- After initialization the access level is set to Quick-start (A1-01). The following table shows the setting method for Quick-start.

Key sequence	Display	Explanation
	Frequency Ref U1-01= 0.00 Hz	Frequency reference display.
	** Main Menu ** Operation	Displays operation mode.
	** Main Menu ** Initialize	Displays initialize mode.
	Select Language English	Puts the Unit in initialize mode.
 3 times	Initialize Select	Displays the Initialize display.
	A1-03= 0 *** Select	Displays the parameter setting for A1-03.
	A1-03= 2220 2-wire Initial	Changes the setting to 2-wire Initialization.
	Entry Accepted	Writes the set values. “Entry Accepted” is displayed for approximately 0.5 seconds.
	Initialize Select	Returns to the Initialize display.
	** Main Menu ** Initialize	Returns to the initialize mode display.









4-2-4 Setting Input Voltage

- Set the input voltage of the Inverter (E1-01) according to the current voltage. This parameter cannot be changed during operation.

Parameter number	Display name	Setting range	Units	Default setting	Valid access levels			
					V/f Control	V/f with PG	Open Loop Vector	Flux Vector
E1-01	Input Voltage	155 to 255 (310 to 510)	VAC	200 (400)	Quick-start, Basic, or Advanced			

Note The setting range, or the default settings and in indicated in parentheses and indicate values for the 400-V class.

- The following is a setting example for a 200-V class Inverter with an input voltage of 230 V.

Key sequence	Display	Explanation
	** Main Menu ** Operation	Displays initialize mode.
	** Main Menu ** Programming	Displays program mode.
	Frequency Ref Terminal	Puts the Unit in program mode.
 10 times	Input Voltage E1-01= 200 VAC	Displays the input voltage setting display.
	Input Voltage 200 VAC	Press to change data. (The leading digit will flash).
	Input Voltage 200 VAC	Causes the + to flash.
 3 times	Input Voltage 230 VAC	Set to "3"
	Entry Accepted	The set values are overwritten. "Entry Accepted" is displayed for approximately 0.5 seconds.
	Input Voltage E1-01= 230 VAC	Returns to the input voltage display. Check that the data has been updated.
	** Main Menu ** Programming	Returns to the program mode display.

■ Setting the Power Supply Voltage Short Pin (400-V Class Inverter of 18.5 kW or More)

Set the power supply voltage short pin when setting the parameter (E1-01). Insert the short pin into the voltage connector nearest to the actual power supply voltage.

It is factory-set to the 440-V connector when shipped.

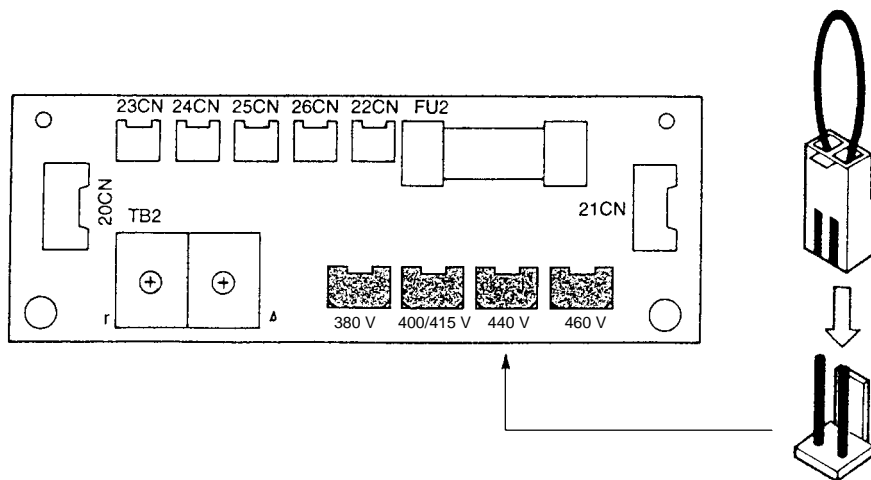

Note 1. The above figure is the 400-V class Inverter (18.5 to 45 kW).

Note 2. Be sure to turn off the power supply switch and wait for at least one minute (three minutes for models larger than 30 kW) before removing the front panel and setting the pin.

4-2-5 Auto-tuning

■ Auto-tuning Operation

- Execute auto-tuning and the motor parameters are set automatically.

Key sequence	Display	Explanation
	** Main Menu ** Programming	Displays program mode
	** Main Menu ** Auto-Tuning	Displays auto-tuning mode.
	Rated Voltage 200.0 VAC	Displays the rated voltage. (see note)
	Rated Current 1.90A	Displays the rated current. (see note)
	Rated Frequency 60.0 HZ	Displays the rated frequency. (see note)
	Rated Speed 1750 RPM	Displays the rated speed. (see note)
	Number of Poles 4	Displays the number of poles. (see note)
	Select Motor 1/2 1	Displays the motor selection. (Selections other than "1" can't be made.)
	Tuning Ready ? Press RUN key	Displays a confirmation prompt for the start of the auto-tuning function. (The lower line will flash.)
	Tune Proceeding <input type="checkbox"/> HZ <input type="checkbox"/> A	Starts the auto-tuning function. (The upper line will flash.)
	Tune Successful	Indicates the completion of auto-tuning.
	** Main Menu ** Operation	Returns to the operation mode display.



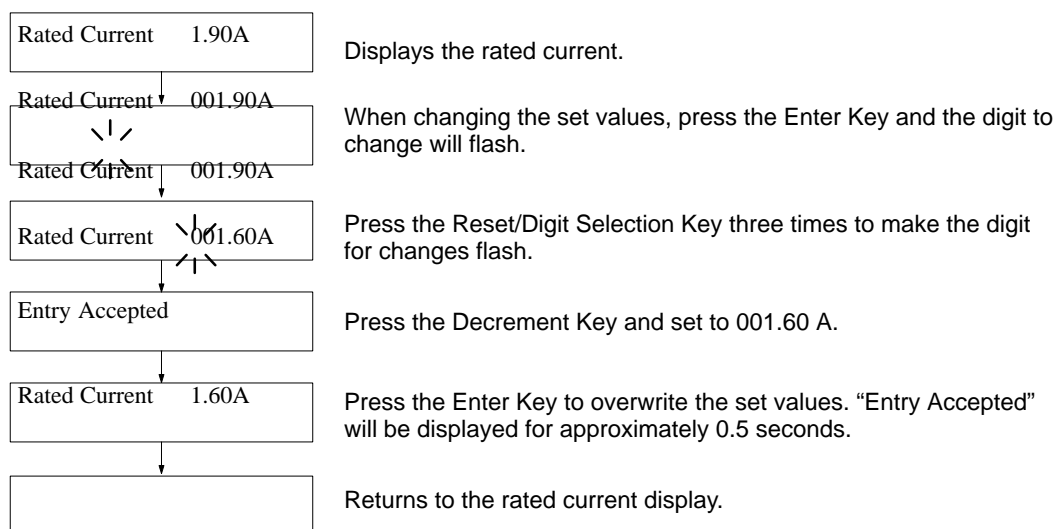





Note When the values displayed and the motor parameters differ, set each value separately. The setting method is as follows. (An operation example for changing the motor parameters current to 1.60 A.



- When auto-tuning has been executed correctly, the parameters (E1-01 to E2-08) will be automatically overwritten.

■ Setting the V/f Pattern

- When auto-tuning has not been executed correctly (i.e., when “Tune Aborted” is displayed), switch the control mode to “V/f control” and set the V/f pattern.
- Procedure for changing the control mode.

Key sequence	Display	Explanation
	** Main Menu ** Operation	Displays operation mode.
	** Main Menu ** Initialize	Displays initialize mode.
	Select Language English	Puts the Unit in initialize mode. (Select Language display)
 2 times	Control Method Open Loop Vector	Press the Up Arrow Key and the control mode select is displayed.
	A1-02= 2 Open Loop Vector	Control mode select (A1-02) is displayed.
 2 times	A1-02= 0 V/f Control	Selects open-loop vector control.
	Entry Accepted	The set values are overwritten.
	Control Method V/f Control	Returns to the control mode select display.
	** Main Menu ** Operation	Returns to the operation mode display.

- Set the control mode to “V/f control,” and then set the following three items. These parameters cannot be changed during operation.

Parameter number	Display name	Setting range	Units	Default setting	Valid access levels			
					V/f Control	V/f with PG	Open Loop Vector	Flux Vector
E1-05	Max Voltage	0.0 to 255.0 (0.0 to 510.0)	VAC	200.0 (400.0)	Quick-start, Basic, or Advanced			

Parameter number	Display name	Setting range	Units	Default setting	Valid access levels			
					V/f Control	V/f with PG	Open Loop Vector	Flux Vector
E1-06	Base Frequency	0.0 to 400.0	Hz	60.0	Quick-start, Basic, or Advanced			

Parameter number	Display name	Setting range	Units	Default setting	Valid access levels			
					V/f Control	V/f with PG	Open Loop Vector	Flux Vector
E2-01	Motor Rated FLA	10 to 200% (See note 1)	A	See note 2	Quick-start, Basic, or Advanced			

Note 1. Inverter rated current ratio.

Note 2. The default setting for rated current differs according to the type of Inverter.







- Check the values on the motor nameplate and set each of the parameters.

E1-05 Maximum voltage (VMAX): Sets the motor rated voltage.

E1-06 Base frequency (FA): Sets the motor rated frequency.

E2-01 Motor rated FLA: Sets the motor rated current.

- The setting procedure for these three parameters is as follows.

Key sequence	Display	Explanation
	** Main Menu ** Operation	Displays operation mode.
 2 times	** Main Menu ** Programming	Displays program mode.
	Reference Source Terminal	Puts the Unit in program mode.
 14 times	Max Voltage E1-05= 200.0 V	Press the Up Arrow Key to display the maximum voltage. (see note)
	Base Frequency E1-06= 60.0 HZ	Displays the maximum voltage frequency. (see note)
 5 times	Motor Rated FLA E2-01= 1.90 A	Press the Up Arrow Key to display the rated current. (see note)
	** Main Menu ** Operation	Returns to the operation mode display.







Note When there are discrepancies between the displayed values and the rated values, set each value separately.

4-2-6 No-load Operation

- Operate the Digital Operator in with the motor in the no-load state (not connected to the mechanical system).

■ Setting the Frequency Reference

- Set the frequency reference on the frequency reference monitor in the operation mode.
- The following is an operation example with the frequency reference set to 10 Hz.

Key sequence	Display	Explanation
	** Main Menu ** Operation	Displays operation mode.
	Frequency Ref U1-01= 0.00 HZ	Puts the Unit in operation mode and displays the frequency reference.
	Frequency Ref U1-01= 6.00 HZ	Switches operation to the Digital Operator. (SEQ, REF and LED indicators turn OFF.)
	Frequency Ref 006.00 HZ	Sets the frequency reference.
 2 times	Frequency Ref 006.00 HZ	The first position flashes.
 4 times	Frequency Ref 010.00 HZ	Set to 010.00 Hz.
	Entry Accepted	The set values are overwritten.
	Frequency Ref 010.00 HZ	Returns to the frequency reference display.

■ Operation Using the Digital Operator

- Press the Run Key. The motor will start to rotate. (forward rotation)
- Press the Forward/Reverse Key. The motor will rotate in the reverse direction.

- Press the Stop Key. The motor will stop. (The operation LED indicator will keep flashing until the motor stops.)
- The frequency reference can be changed, even during operation. When this is done, the frequency reference is changed as soon as the Enter Key is pressed to input the set values.
- If the Jog Key is pressed when the Unit is stopped, it will rotate by the jog frequency (default setting: 6.0 Hz) only while the Key is being pressed.

■ **Checking the Operating Status**

- After changing the frequency reference or the rotation direction, check that there is no vibration or abnormal sound from the motor.
- Check that no faults have occurred in the Inverter during operation.

4-2-7 Actual Load Operation

- After checking the operation with the motor in no-load status, connect the mechanical system and operate with an actual load.

■ **Connecting the System**

- After confirming that the motor has stopped completely, connect the mechanical system.
- Be sure to tighten all the screws when fixing the motor axis in the mechanical system.

■ **Operation using the Digital Operator**

- In case a fault occurs during operation, make sure the Stop Key on the Digital Operator is easily accessible.
- Use the Digital Operator in the same way as no-load operation.
- First set the frequency reference to a low speed of one tenth the normal operating speed.

■ **Checking Operating Status**

- Having checked that the operating direction is correct and that the machine is operating smoothly at slow speed, increase the frequency reference.
- After changing the frequency reference or the rotation direction, check that there is no vibration or abnormal sound from the motor. Check the monitor display to ensure that the U1-03 (output current) is not becoming excessive.

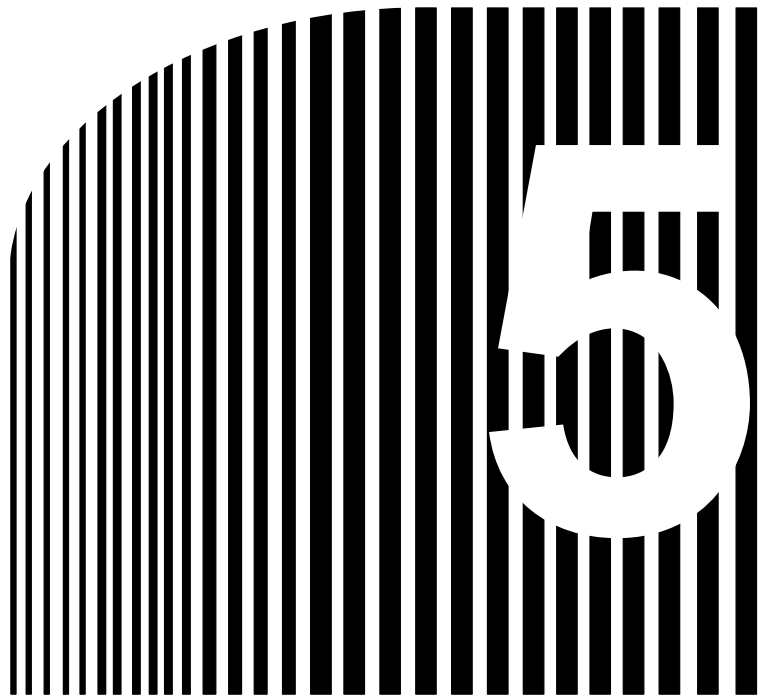

Chapter 5

• Basic Operation •

- 5-1 Common Settings
- 5-2 Open-loop Vector Control
- 5-3 V/f Control
- 5-4 Flux Vector Control
- 5-5 V/f Control with PG

This section explains the basic settings required to operate and stop the Inverter. The parameter settings described here will be sufficient for simple Inverter operations. After the basic settings common to all of the control modes are introduced, the basic settings specific to each control mode will be explained. Read the common settings first and then skip to the explanation for the control mode that will be used. Even when your application requires special functions such as torque control or PID control, make these basic settings first and then skip to the explanations of those special functions. (Refer to *Chapter 6 Advanced Operation*.)

5-1 Common Settings

5-1-1 Setting the Access Level and Control Mode

■ Setting the Access Level (A1-01)

Parameter A1-01 is used to select the parameter access level. This level determines which parameters can be displayed and changed. This parameter can be changed during operation.

Parameter number	Display name	Setting range	Units	Default setting	Valid access levels			
					V/f Control	V/f with PG	Open Loop Vector	Flux Vector
A1-01	Access Level	0 to 4	---	2	Quick-start, Basic, or Advanced			

Access Level Settings



The control mode setting also affects which parameters can be displayed and changed.





Setting	Name	Function
0	Operation Only	This setting allows the operation mode and initialize mode to be displayed or changed. Use this setting to prevent parameter settings from being changed.
1	User Level	This setting allows only the user-selected parameters (up to 32) to be displayed or changed. Select the desired parameters as "User Parameters" in parameters A2-01 through A2-32.
2	Quick-start	This setting allows the parameters required to start the Inverter (about 25) to be displayed or changed.
3	Basic	This setting allows the commonly used parameters to be displayed or changed.
4	Advanced	This setting allows all parameters to be displayed or changed.

Note The parameters required for basic operation can be displayed and changed in the Basic level, but this section also describes parameters that can be set only in the Advanced level, so set the access level to Advanced.

Example

The following example shows how to change parameter A1-01 from Quick-start to Advanced.

Key sequence	Display	Explanation
	** Main Menu ** Operation	Displays operation mode.
	** Main Menu ** Initialize	Displays initialize mode.

Key sequence	Display	Explanation
	Select Language English	Puts the Unit in initialize mode. (Select Language display)
	Access Level Quick Start	Displays the Access Level (A1-01).
	A1-01= 2 *** Quick-Start	Displays the parameter setting for A1-01.
 2 times	A1-01= 4 Advanced	Changes the setting to Advanced.
	Entry Accepted	Writes the new setting.
	Access Level Advanced Level	Returns to the Access Level display.

■ **Setting the Control Mode (A1-02)**

Parameter A1-02 is used to select one of the four control modes. This parameter is not initialized by the initialize operation and it cannot be changed during operation.

Parameter number	Display name	Setting range	Units	Default setting	Valid access levels			
					V/f Control	V/f with PG	Open Loop Vector	Flux Vector
A1-02	Control Method	0 to 3	---	2	Quick-start, Basic, or Advanced			

Control Mode Settings

Setting	Name	Function
0	V/f Control	V/f control without pulse generator (normal V/f control)
1	V/f w/PG Fdbk	V/f control with pulse generator (V/f control using a PG Speed Control Card)
2	Open Loop Vector	Vector control without pulse generator (Vector control using the Inverter's internal speed information)
3	Flux Vector	Vector control with pulse generator (Vector control using a PG Speed Control Card)

Control Mode Characteristics

Characteristic	V/f Control	V/f w/PG Fdbk	Open Loop Vector	Flux Vector
Basic control method	Voltage/frequency control (open loop)	Voltage/frequency control with speed compensation	Current vector control without PG	Current vector control with PG
Speed detector	Not required	Required (pulse generator)	Not required	Required (pulse generator)
Optional Speed Detectors	Not required	3G3FV-PPGA2 or 3G3FV-PPGD2	Not required	3G3FV-PPGB2 or 3G3FV-PPGX2
Speed control range	1:40	1:40	1:100	1:1,000
Starting torque	150%/3 Hz	150%/3 Hz	150%/1 Hz	150%/0 Hz
Speed control precision	±2 to 3%	±0.03%	±0.2%	±0.02%
Torque limit	Not possible	Not possible	Possible	Possible
Torque control	Not possible	Not possible	Not possible	Possible
Example applications	<ul style="list-style-type: none"> • Multiple motors 	<ul style="list-style-type: none"> • Simple speed feedback control 	<ul style="list-style-type: none"> • Variable speed drive applications 	<ul style="list-style-type: none"> • Simple servo drives • Precision speed control • Torque control

Note Vector control has a greater starting torque and more precise speed control than V/f control, so use of vector control is recommended whenever possible. Use V/f control in the following types of applications:

- When several motors are being operated
- When special motors such as submersible motors or spindle motors are being used (Situations in which auto-tuning cannot be used.)
- When operation is being coordinated with an older inverter control system

5-1-2 Frequency Reference Settings from Control Circuit Terminals

These settings are required when inputting analog voltage or current signals from the control circuit terminals.

■ Frequency Reference Selection (b1-01)

Parameter b1-01 is used to select the reference source; it cannot be changed during operation.

Parameter number	Display name	Setting range	Units	Default setting	Valid access levels			
					V/f Control	V/f with PG	Open Loop Vector	Flux Vector
b1-01	Reference Source	0 to 4	---	1	Quick-start, Basic, or Advanced			

Reference Source Settings

Setting	Name	Reference source
0	Operator	Digital Operator
1	Terminals	Control circuit terminals (analog inputs)
2	Serial Com	Not used. (Do not set.)
3	Option PCB	Optional Card (CompoBus/D Communications Card, SYSMAC BUS I/F Card, Analog Command Card, or Digital Command Card)
4	EWS	Not used. (Do not set.)

Note 1. The frequency reference is input from the control circuit terminals (external terminals), so set b1-01 to 1.

Note 2. The source specified for the frequency reference is used as frequency reference 1 in multi-stage control. If the frequency reference source is set to a control terminal, the frequency reference analog input from the control terminal will take priority and the frequency for d1-01 will be ignored. (The frequency for d1-01 will be used, however, if operation is switched to local mode using the operation mode selection key.)

Note 3. Regardless of the frequency source, the values set for frequency reference parameters 2 to 8 (d1-02 to d1-08) and the inching frequency reference parameter (d1-09) will be enabled.

■ Frequency Reference: Terminal 13 Voltage Input (H3-01)

The frequency reference (voltage) is valid when parameter b1-01 has been set to 1. Parameter H3-01 is used to set the voltage range for the frequency reference (voltage) signal. This parameter cannot be changed during operation.

Parameter number	Display name	Setting range	Units	Default setting	Valid access levels			
					V/f Control	V/f with PG	Open Loop Vector	Flux Vector
H3-01	Term 13 Signal	0 or 1	---	0	Basic or Advanced			

Terminal 13 Signal Level Settings

Setting	Name	Function
0	0 to 10 VDC	0 to 10 VDC input
1	-10 to 10 VDC	-10 to 10 VDC input (A negative voltage is a command for rotation in the opposite direction.)

■ Frequency Reference: Terminal 14 Current Input (H3-08 and H3-09)

Terminal 14 must be set to “frequency reference” with parameter H3-09 in order to use terminal 14 as the frequency reference terminal; the “frequency reference” setting is 1F. Neither H3-08 nor H3-09 can be changed during operation.

Parameter number	Display name	Setting range	Units	Default setting	Valid access levels			
					V/f Control	V/f with PG	Open Loop Vector	Flux Vector
H3-09	Terminal 14 Sel	1 to 1F	---	1F	Advanced			

After setting parameter H3-09, set terminal 14’s signal level with H3-08. The frequency reference (current) is valid when parameter b1-01 has been set to 1.

Parameter number	Display name	Setting range	Units	Default setting	Valid access levels			
					V/f Control	V/f with PG	Open Loop Vector	Flux Vector
H3-08	Term 14 Signal	0 to 2	---	2	Advanced			

Terminal 14 Signal Level Settings

Setting	Name	Function
0	0 to 10 VDC	0 to 10 VDC input
1	-10 to 10 VDC	-10 to 10 VDC input (A negative voltage is a command for rotation in the opposite direction.)
2	4 to 20 mA	4 to 20 mA input

Note When the terminal is being used as a voltage input terminal (setting 0 or 1), jumper J1 must be disconnected on the control board. (See the following diagram.) The terminal's input resistor will be destroyed if the terminal is used for a voltage input with jumper J1 connected.

- When frequency references are being input simultaneously from both the voltage terminal 13 and the current terminal 14, the final reference value will be the sum of the two references that are input.
- To switch the frequency reference input between the voltage terminal 13 and the current terminal 14, set a value of 1F in any one of the multi-function inputs (H1-01 through H1-06). The voltage terminal 13 will be used when this multi-function input is OFF and the current terminal 14 will be used when this multi-function input is ON.
- The following diagram shows the location of jumper J1 on a 200-V Class, 0.4-kW Unit.

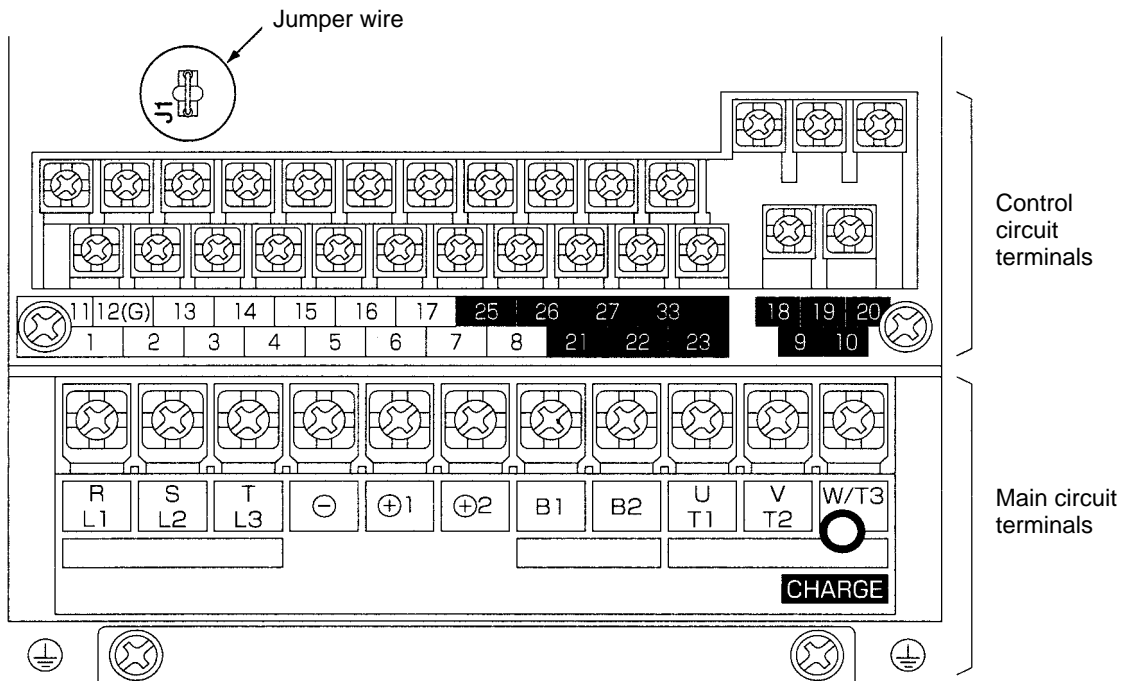

■ Frequency Reference: Terminal 16 Voltage Input (H3-04 and H3-05)

This function is useful when switching between two analog inputs. When using this multi-function input (terminal 16) as the frequency reference terminal, first set the multi-function analog input's function to "Auxiliary Reference" by setting parameter H3-05 to "0." (Neither H3-04 nor H3-05 can be changed during operation.)

Parameter number	Display name	Setting range	Units	Default setting	Valid access levels			
					V/f Control	V/f with PG	Open Loop Vector	Flux Vector
H3-05	Terminal 16 Sel	0 to 1F	---	1F	Basic or Advanced			

After setting H3-05 to “0,” set any one of the multi-function inputs (H1-01 through H1-06) to a value of 3 (Multi-step Reference 1). When a multi-function analog input has been set to “Auxiliary Reference,” it is treated as “frequency reference 2” during multi-step operation, so it can’t be used unless Multi-step Reference 1 has been set.

Set terminal 16’s signal level with H3-04.

Parameter number	Display name	Setting range	Units	Default setting	Valid access levels			
					V/f Control	V/f with PG	Open Loop Vector	Flux Vector
H3-04	Term 16 Signal	0 or 1	---	0	Basic or Advanced			

Terminal 16 Signal Level Settings

Setting	Name	Function
0	0 to 10 VDC	0 to 10 VDC input
1	-10 to 10 VDC	-10 to 10 VDC input (A negative voltage is a command for rotation in the opposite direction.)

■ Adjusting the Analog Inputs

There are three parameters used to adjust the analog inputs: the gain and bias (set separately for each input) and the filter time constant (a single value for all of the inputs).

The gain and bias can be adjusted separately for each analog input (terminals 13, 14, and 16).

- Gain: Set the frequency corresponding to a 10 V (20 mA) input as a percentage of the maximum. (The maximum frequency set in E1-04 is 100%.)
- Bias: Set the frequency corresponding to a 0 V (4 mA) input as a percentage of the maximum. (The maximum frequency set in E1-04 is 100%.)

Set terminal 13’s gain and bias with H3-02 and H3-03. (Both settings can be changed during operation.)

Parameter number	Display name	Setting range	Units	Default setting	Valid access levels			
					V/f Control	V/f with PG	Open Loop Vector	Flux Vector
H3-02	Terminal 13 Gain	0.0 to 1,000.0	%	100.0	Basic or Advanced			
H3-03	Terminal 13 Bias	-100.0 to 100.0	%	0.0	Basic or Advanced			

Set terminal 14’s gain and bias with H3-10 and H3-11. (Both settings can be changed during operation.)

Parameter number	Display name	Setting range	Units	Default setting	Valid access levels			
					V/f Control	V/f with PG	Open Loop Vector	Flux Vector
H3-10	Terminal 14 Gain	0.0 to 1,000.0	%	100.0	Advanced			
H3-11	Terminal 14 Bias	-100.0 to 100.0	%	0.0	Advanced			

Set terminal 16's gain and bias with H3-06 and H3-07. (Both settings can be changed during operation.)

Parameter number	Display name	Setting range	Units	Default setting	Valid access levels			
					V/f Control	V/f with PG	Open Loop Vector	Flux Vector
H3-06	Terminal 16 Gain	0.0 to 1,000.0	%	100.0	Basic or Advanced			
H3-07	Terminal 16 Bias	-100.0 to 100.0	%	0.0	Basic or Advanced			

Gain and Bias Chart

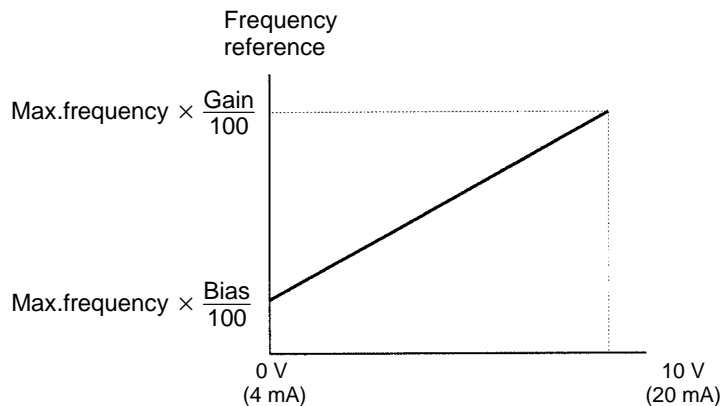

Note Use the current values shown in parentheses when current input has been selected.

The first-order lag's digital filter can be set for all three analog inputs (frequency reference (voltage), frequency reference (current), and multi-function analog input) with parameter H3-12. This setting is effective when there are sudden changes or noise in the analog input signal. Responsiveness decreases as the setting increases.

The filter time constant cannot be changed during operation.

Parameter number	Display name	Setting range	Units	Default setting	Valid access levels			
					V/f Control	V/f with PG	Open Loop Vector	Flux Vector
H3-12	Filter Avg Time	0.00 to 2.00	s	0.00	Advanced			

5-1-3 Frequency Reference Settings from Digital Operator

■ **Selecting the Frequency Reference Source (b1-01)**

Parameter b1-01 is used to select the reference source; it cannot be changed during operation.

Parameter number	Display name	Setting range	Units	Default setting	Valid access levels			
					V/f Control	V/f with PG	Open Loop Vector	Flux Vector
b1-01	Reference Source	0 to 4	---	1	Quick-start, Basic, or Advanced			

Reference Source Settings

Setting	Name	Reference source
0	Operator	Digital Operator
1	Terminals	Control circuit terminals (analog inputs)
2	Serial Com	Not used. (Do not set.)
3	Option PCB	Optional Card (CompoBus/D Communications Card, SYSMAC BUS I/F Card, Analog Command Card, or Digital Command Card)
4	EWS	Not used. (Do not set.)

Note 1. The frequency reference is input from the Digital Operator, so set b1-01 to 0.

Note 2. The source specified for the frequency reference is used as one of the frequency references in multistage control. If the frequency reference source is set to the Digital Operator, the frequency reference for d1-01 will be used and analog frequency reference (voltage/current) input from the control terminal will be ignored. (The frequency for d1-01 will also be used if operation is switched to local mode using the operation mode selection key.)

Note 3. Regardless of the frequency source, the values set for frequency reference parameters 2 to 8 (d1-02 to d1-08) and the inching frequency reference parameter (d1-09) will be enabled.

■ Setting the Frequency Reference Units (o1-03)

Parameter o1-03 is used to set the units for setting and displaying the frequency reference; it cannot be changed during operation.

Parameter number	Display name	Setting range	Units	Default setting	Valid access levels			
					V/f Control	V/f with PG	Open Loop Vector	Flux Vector
o1-03	Display Scaling	0 to 39,999	---	0	Basic or Advanced			

Display Unit Settings

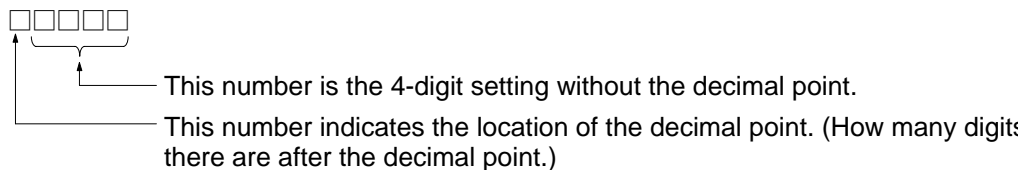
Setting	Function
0	0.01 Hz units
1	0.01 % units (The maximum frequency is 100%.)
2 to 39	r/min units (Set the number of poles)
40 to 39,999	<p>Sets a particular value for the maximum frequency.</p>  <p>For example, set o1-03 to “12000” when you want to display “200.0” for the maximum frequency.</p>

Note When the 40 to 39,999 range is used, any scale can be set for the reference frequency. For example, the frequency reference can be set or displayed in units such as mm/s or m/min to coincide with a machine’s linear operating speed.

■ Presetting Frequency Reference Values (d1-01 through d1-09)

Parameters d1-01 through d1-08 contain preset reference values 1 through 8. The setting range for all of the values is 0 to the max. frequency. These 8 parameters can be changed during operation.

Parameter number	Display name	Setting range	Units	Default setting	Valid access levels			
					V/f Control	V/f with PG	Open Loop Vector	Flux Vector
d1-01	Reference 1	0 to max.	o1-03	6.00 Hz	Quick-start, Basic, or Advanced			
d1-02	Reference 2	0 to max.	o1-03	0.00 Hz	Quick-start, Basic, or Advanced			
d1-03	Reference 3	0 to max.	o1-03	0.00 Hz	Quick-start, Basic, or Advanced			
d1-04	Reference 4	0 to max.	o1-03	0.00 Hz	Quick-start, Basic, or Advanced			
d1-05	Reference 5	0 to max.	o1-03	0.00 Hz	Basic or Advanced			
d1-06	Reference 6	0 to max.	o1-03	0.00 Hz	Basic or Advanced			
d1-07	Reference 7	0 to max.	o1-03	0.00 Hz	Basic or Advanced			
d1-08	Reference 8	0 to max.	o1-03	0.00 Hz	Basic or Advanced			

Note 1. The units for these values are set in o1-03.

Note 2. The frequency reference's initial value and set value will change when o1-03 is changed. For example, if preset reference 1 is set to 6.00 Hz and o1-03 is changed to 1 (0.01% units), the setting for preset reference 1 will become 10.00%.

Note 3. When using preset references 2 through 8, be sure to set Multi-Step Reference 1, 2, and 3 in the multi-function inputs (H1-01 through H1-06) as required.

When using the Jog function, set the jog frequency reference in parameter d1-09. The setting range for this value is 0 to the max. frequency. This parameter can be changed during operation.

Parameter number	Display name	Setting range	Units	Default setting	Valid access levels			
					V/f Control	V/f with PG	Open Loop Vector	Flux Vector
d1-09	Jog Reference	0 to max.	o1-03	6.00 Hz	Quick-start, Basic, or Advanced			

Note 1. When performing the Jog operation from an external terminal, set the multi-function inputs (H1-01 through H1-06) to "Jog Frequency Reference," "Forward Jog," or "Reverse Jog" as required.

Note 2. The multi-function input setting is unnecessary when performing the Jog operation from the Operator.

5-1-4 Run Source and Responsiveness Settings

■ Selecting the Run Source (b1-02)

Parameter b1-02 is used to select the source of the run command; it cannot be changed during operation. When a control circuit terminal (external terminal) is set, the Unit operates with 2-wire forward/stop and reverse/stop control. (When the Unit has been initialized for a 3-wire control or a multi-function input is set to "0" (3-wire control), the Unit operates with 3-wire run, stop and forward/reverse control.)

Parameter number	Display name	Setting range	Units	Default setting	Valid access levels			
					V/f Control	V/f with PG	Open Loop Vector	Flux Vector
b1-02	Run Source	0 to 4	---	1	Quick-start, Basic, or Advanced			

Run Source Settings

Setting	Name	Run source
0	Operator	Digital Operator
1	Terminals	Control circuit terminals (external terminals)
2	Serial Com	Not used. (Do not set.)
3	Option PCB	Optional Card (CompoBus/D Communications Card or SYSMAC BUS I/F Card)
4	EWS	Not used. (Do not set.)

■ Setting Control Input Responsiveness (b1-06)

Parameter b1-06 is used to set the responsiveness of the control inputs (forward/reverse and multi-function inputs); it cannot be changed during operation.

Parameter number	Display name	Setting range	Units	Default setting	Valid access levels			
					V/f Control	V/f with PG	Open Loop Vector	Flux Vector
b1-06	Cntl Input Scans	0 or 1	---	1	Advanced			

Settings

Setting	Name	Function
0	2mS – 2 Scans	Two scans every 2 ms (Use when connecting transistor outputs.)
1	5mS – 2 Scans	Two scans every 5 ms (Use when connecting contact outputs or switches.)

Note Set the responsiveness to match the type of control inputs being used. Use a setting of “1” if there is even one contact input.

5-1-5 Acceleration/Deceleration Time Settings

■ Acceleration/Deceleration Time Units (C1-10)

Parameter C1-10 is used to set the units for the acceleration and deceleration time settings in C1-01 through C1-08. Setting C1-10 to “0” allows the acceleration and deceleration times to be set very precisely, but reduces the maximum time setting from 6000.0 s to 600.00 s.

This parameter cannot be changed during operation.

Parameter number	Display name	Setting range	Units	Default setting	Valid access levels			
					V/f Control	V/f with PG	Open Loop Vector	Flux Vector
C1-10	Acc/Dec Units	0 or 1	---	1	Advanced			

Settings

Setting	Name	Function
0	0.01 Seconds	Sets the acceleration/deceleration time units to 0.01 seconds.
1	0.1 Seconds	Sets the acceleration/deceleration time units to 0.1 seconds.

■ Acceleration/Deceleration Time Settings (C1-01 through C1-08)

Parameters C1-01 through C1-08 set the acceleration and deceleration times individually.

The acceleration time is the time required to go from 0% to 100% of the maximum frequency and the deceleration time is the time required to go from 100% to 0% of the maximum frequency.

Four acceleration times and four deceleration times can be set. When using acceleration/deceleration times 2 through 4, set “Multi-Accel/Decel 1” or “Multi-Accel/Decel 2” in the multi-function inputs (H1-01 through H1-06).

Parameter number	Display name	Setting range (See note 1.)	Units	Default setting	Valid access levels			
					V/f Control	V/f with PG	Open Loop Vector	Flux Vector
C1-01	Acceleration time 1	0.0 to 6000.0	s	10.0	Quick-start, Basic, or Advanced			
C1-02	Deceleration time 1	0.0 to 6000.0	s	10.0	Quick-start, Basic, or Advanced			
C1-03	Acceleration time 2	0.0 to 6000.0	s	10.0	Basic or Advanced			
C1-04	Deceleration time 2	0.0 to 6000.0	s	10.0	Basic or Advanced			
C1-05	Acceleration time 3	0.0 to 6000.0	s	10.0	Advanced			
C1-06	Deceleration time 3	0.0 to 6000.0	s	10.0	Advanced			
C1-07	Acceleration time 4	0.0 to 6000.0	s	10.0	Advanced			
C1-08	Deceleration time 4	0.0 to 6000.0	s	10.0	Advanced			

Note 1. The setting range for the acceleration/deceleration times depends upon the setting in C1-10 (Acc/Dec Units). The table shows the setting range when the factory setting is used for C1-10. If C1-10 is set to “0,” the setting range will be 0.00 to 600.00 s.

Note 2. Parameters C1-01 through C1-04 can be changed during operation, but C1-05 through C1-08 cannot.

■ Emergency Stop Time Setting (C1-09)

Parameter C1-09 sets the deceleration time that will be used when an emergency stop signal is input or a fault is detected; it can be changed during operation. The deceleration time is the time required to go from 100% to 0% of the maximum frequency.

When using an emergency stop input, set a multi-function input (H1-01 through H1-06) to “Fast-Stop.” The emergency stop time is effective for the following faults. Set a stopping method for each.

- Inverter overheating (OH) pre-alarm: Set in L8-03.
- Pulse generator faults: Set in F1-02 through F1-04.

Parameter number	Display name	Setting range (See note.)	Units	Default setting	Valid access levels			
					V/f Control	V/f with PG	Open Loop Vector	Flux Vector
C1-09	Fast Stop Time	0.0 to 6000.0	s	10.0	Basic or Advanced			

Note The setting range for the emergency stop deceleration time depends upon the setting in C1-10 (Acc/Dec Units). The table shows the setting range when the factory setting is used for C1-10. If C1-10 is set to “0,” the setting range will be 0.00 to 600.00 s.

■ Acceleration/Deceleration Time Switching Frequency (C1-11)

When the acceleration/deceleration time switching frequency is set in C1-11, the acceleration and deceleration times will be changed automatically as the frequency passes the set level. This parameter cannot be changed during operation.

The “Multi-Accel/Decel 1” and “Multi-Accel/Decel 2” inputs will have priority when “Multi-Accel/Decel 1” and “Multi-Accel/Decel 2” have been set in the multi-function inputs (H1-01 through H1-06).

Parameter number	Display name	Setting range (See note.)	Units	Default setting	Valid access levels			
					V/f Control	V/f with PG	Open Loop Vector	Flux Vector
C1-11	Acc/Dec SW Freq	0.0 to 400.0	Hz	0.0	Advanced			

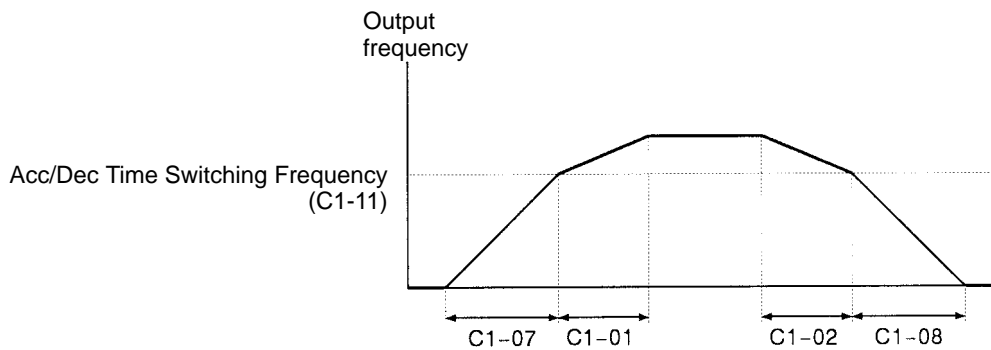

Acceleration/Deceleration Time 1 (C1-01 and C1-02) are used when the output frequency \geq C1-11
 Acceleration/Deceleration Time 4 (C1-07 and C1-08) are used when the output frequency $<$ C1-11

5-1-6 Disabling Reverse Operation (b1-04)

Parameter b1-04 is used to enable and disable reverse command inputs. This parameter can be set to “1” to disable reverse operation when necessary. This parameter cannot be changed during operation.

Parameter number	Display name	Setting range	Units	Default setting	Valid access levels			
					V/f Control	V/f with PG	Open Loop Vector	Flux Vector
b1-04	Reverse Oper	0 or 1	---	0	Basic or Advanced			

Settings

Setting	Name	Function
0	Reverse Enabled	Allows reverse operation.
1	Reverse Disabled	Prohibits reverse operation.

5-1-7 Selecting the Stopping Method (b1-03)

Parameter b1-03 sets the stopping method used when a stop command is input. This parameter cannot be changed during operation.

Parameter number	Display name	Setting range	Units	Default setting	Valid access levels			
					V/f Control	V/f with PG	Open Loop Vector	Flux Vector
b1-03	Stopping Method	0 to 3	---	0	Quick-start, Basic, or Advanced			

Settings

Only settings 0 and 1 can be used with Flux Vector control.

Setting	Name	Function
0	Ramp to Stop	Deceleration stop
1	Coast to Stop	Free-run stop
2	DC Injection to Stop	DC braking stop: Stops faster than free-run, without regenerative operation.
3	Coast w/Timer	Free-run stop with timer: Run commands are ignored during deceleration time.

The following diagrams show the operation of each stopping method. The “deceleration time” in the diagrams refers to the selected deceleration time. (Deceleration times 1 through 4 are set with C1-02, C1-04, C1-06, and C1-08.)

• Deceleration Stop (b1-03 = 0)

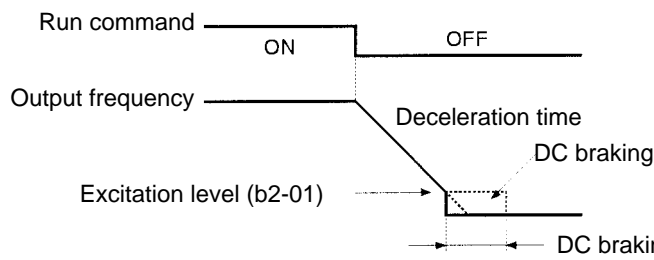

- Note** 1. Decelerates to a stop at a rate set with the selected deceleration time.
- Note** 2. If the run command turns back ON during deceleration, deceleration will be stopped as soon as the run command turns ON and the motor will be accelerated at the specified frequency.

• Free-run Stop (b1-03 = 1)

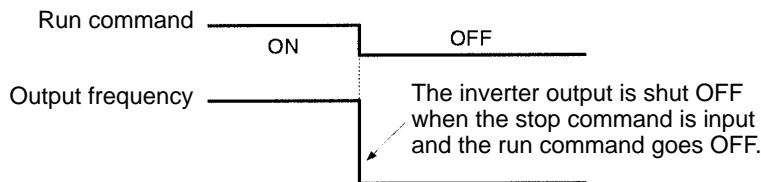

- Note** 1. After the stop command is input, run commands are ignored until the minimum base-block time (L2-03) has elapsed.
- Note** 2. Do not input the run command again until the motor has slowed down sufficiently. If the run command turns ON, the motor will rapidly decelerate to a low frequency, and a main circuit overvoltage (OV) or overcurrent (OC) will be detected. If necessary, use a timed free-run stop and set the deceleration time to a value large enough to ensure sufficient deceleration (restarting is not possible during the deceleration time). Use one of the multi-function inputs 1 to 6 (H1-01 to H1-06) for a speed search, find the speed during the free-run stop, and ensure that acceleration is smooth.

• DC Braking Stop (b1-03 = 2)
(DC Injection)

Note: After the stop command is input and the minimum baseblock time (L2-03) has elapsed, DC braking is applied and the motor stopped. The DC braking time depends upon the output frequency when the stop command is input and the “DC braking time at stop” setting in b2-04, as shown in the graph below.

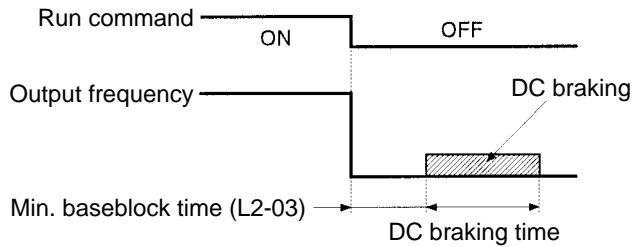

Note: Lengthen the min. baseblock time (L2-03) when an overcurrent (OC) occurs during stopping. When the power to an induction motor is turned off, the counter-electromotive force generated by the residual magnetic field in the motor can cause an overcurrent to be detected when DC braking is applied.

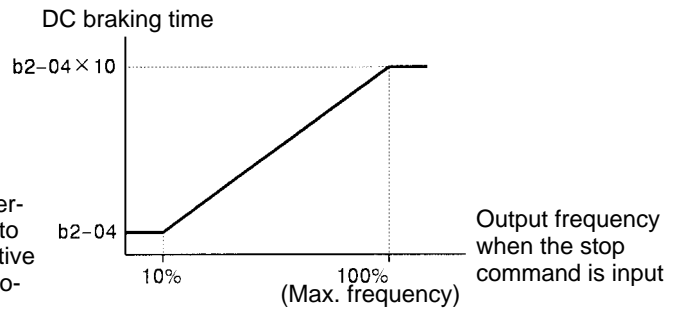

• Free-run Stop with Timer (b1-03 = 3)

Note: After the stop command is input, run commands are ignored until the time t_0 has elapsed. The time t_0 depends upon the output frequency when the stop command is input and the deceleration time.

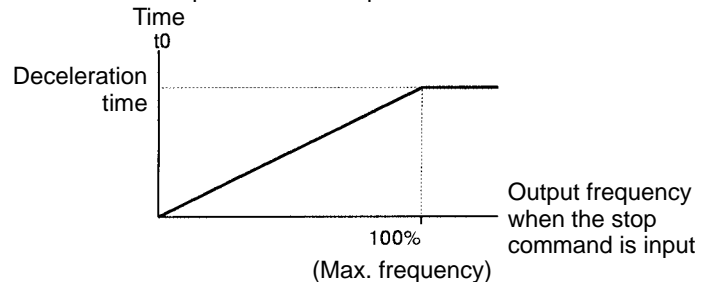
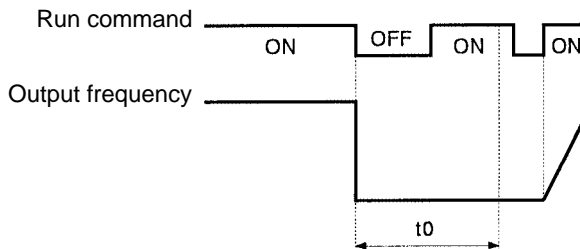

5-1-8 Multi-function Input Settings (H1-01 through H1-06)

Parameters H1-01 through H1-06 set the multi-function inputs in accordance with the application. These 6 parameters cannot be changed during operation.

Parameter number	Display name	Setting range	Units	Default setting (See note.)	Valid access levels			
					V/f Control	V/f with PG	Open Loop Vector	Flux Vector
H1-01	Terminal 3 Sel	0 to 77	---	24	Basic or Advanced			
H1-02	Terminal 4 Sel	0 to 77	---	14	Basic or Advanced			
H1-03	Terminal 5 Sel	0 to 77	---	3 (0)	Basic or Advanced			
H1-04	Terminal 6 Sel	0 to 77	---	4 (3)	Basic or Advanced			
H1-05	Terminal 7 Sel	0 to 77	---	6 (4)	Basic or Advanced			
H1-06	Terminal 8 Sel	0 to 77	---	8 (6)	Basic or Advanced			

Note The default settings in parentheses are the default values when the Unit is initialized for 3-wire sequence control with A1-03.

The parameter settings which are used most often are explained below. Refer to *Chapter 6 Advanced Operation* or the parameter tables for details on the other settings.

- Setting “0”: 3-wire Control (forward/reverse command)
- Setting “3” to “6”: Multi-step References 1 through 3 and Jog Reference
- Setting “7” and “1A”: Multi-Accel/Decel Time Selector 1 and 2
- Setting “15”, “17”: Fast-Stop (emergency stop)
- Setting “12” and “13”: Forward and Reverse Jog Commands
- Setting “1F”: Terminal 13/14 Switch

● **Setting “0”: 3-wire Control (Forward/Reverse Command)**

When a value of “0” is set for any one of the multi-function inputs (H1-01 through H1-06), 3-wire control is established and the multi-function input terminal for which “0” was set becomes the forward/reverse command terminal. When the Unit is initialized for 3-wire sequence control with A1-03 (a setting of 3330), multi-function input 3 (terminal 5) becomes the input terminal for the forward/reverse command.

Wiring Example

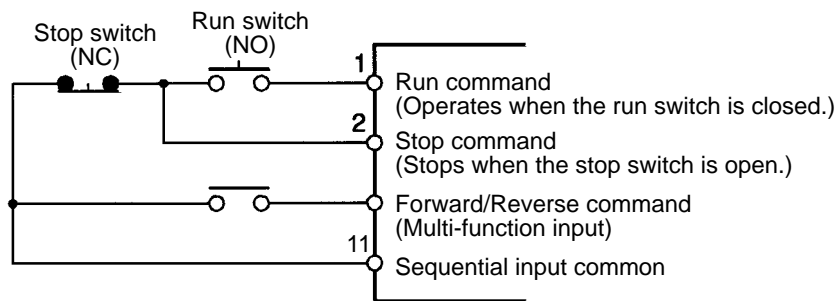

Timing Chart

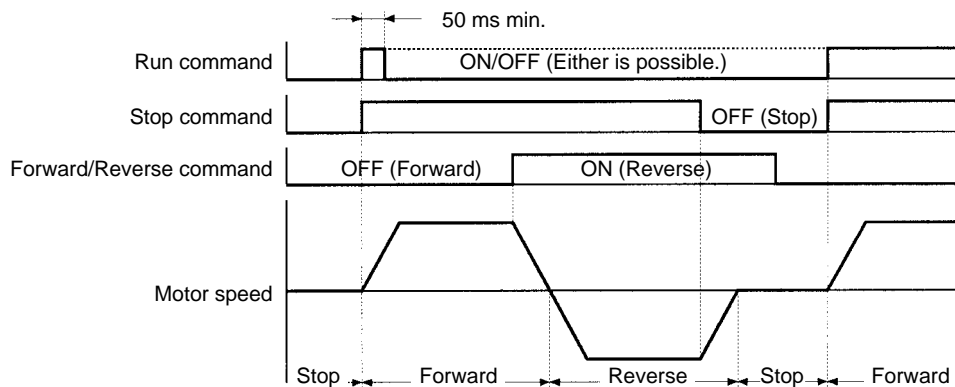

● **Setting “3” to “6”: Multi-step References 1 through 3 and Jog Reference**

Eight frequency references and one jog reference can be used in the 3G3FV. Set “Multi-step Reference 1, 2, and 3” and “Jog Frequency Reference” in multi-function inputs, and change the status of these inputs to switch between these 9 frequency references.

Setting	Function
3	Multi-step Reference 1 (Also used for main-speed/auxiliary-speed switching when “Auxiliary Reference” is set in multi-function analog input H3-05.)
4	Multi-step Reference 2
5	Multi-step Reference 3
6	Jog frequency reference (This setting has higher priority than the multi-step references.)

The following table shows which frequency is selected by each possible combination of multi-step and jog reference settings.

Multi-step Reference			Jog Reference	Selected frequency
1	2	3		
OFF	OFF	OFF	OFF	Reference 1: d1-01 (main-speed frequency, see note 1)
ON	OFF	OFF	OFF	Reference 2: d1-02 (auxiliary-speed frequency, see note 2)
OFF	ON	OFF	OFF	Reference 3: d1-03
ON	ON	OFF	OFF	Reference 4: d1-04
OFF	OFF	ON	OFF	Reference 5: d1-05
ON	OFF	ON	OFF	Reference 6: d1-06
OFF	ON	ON	OFF	Reference 7: d1-07
ON	ON	ON	OFF	Reference 8: d1-08
---	---	---	ON	Jog reference: d1-09

Note 1. Reference 1 is selected when b1-01 is set to “0” (Operator) and the analog input (terminal 13 or 14) is selected when b1-01 is set to “1” (Terminals).

Note 2. The analog input from terminal 16 is selected when H3-05 is set to “0” (Auxiliary Reference) and reference 2 is selected for any other H3-05 setting.

Timing Chart

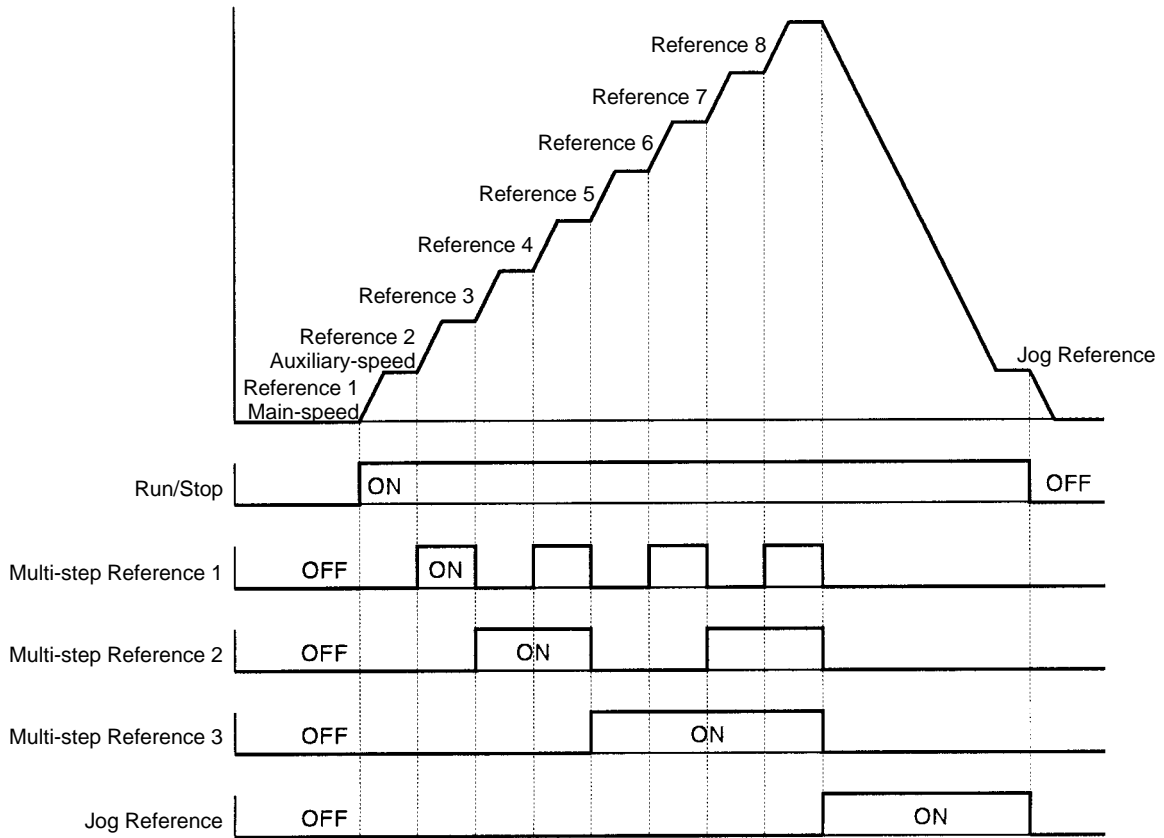

Note The jog reference setting has priority over the multi-step reference settings.

● **Setting “7” and “1A”: Multi-Accel/Decel Time Selector 1 and 2**

Four acceleration times and four deceleration times can be set in the 3G3FV. Set “Multi-Accel/Decel 1 and 2” in multi-function inputs and change the status of these inputs to switch between these acceleration and deceleration times.

Setting	Function
7	Multi-Accel/Decel 1 (multi-accel/decel time selector 1)
1A	Multi-Accel/Decel 2 (multi-accel/decel time selector 2)

The following table shows which acceleration and deceleration times are selected by each possible combination of acceleration/deceleration time selectors 1 and 2.

Multi-accel/decel time selector		Acceleration time	Deceleration time
1	2		
OFF or not set	OFF or not set	Acceleration time 1 (C1-01)	Deceleration time 1 (C1-02)
ON	OFF or not set	Acceleration time 2 (C1-03)	Deceleration time 2 (C1-04)
OFF or not set	ON	Acceleration time 3 (C1-05)	Deceleration time 3 (C1-06)
ON	ON	Acceleration time 4 (C1-07)	Deceleration time 4 (C1-08)

Note The acceleration and deceleration times can be changed while the Inverter is operating.

● Setting “15”, “17”: Fast-Stop (Emergency Stop)

When the multi-function input that is set to “Fast-Stop” is turned ON (or OFF for an N.C. contact), the motor will decelerate to a stop at the rate set with the deceleration time in C1-09 (fast-stop time). To clear the emergency stop, turn the run command OFF, turn the fast-stop input OFF (or ON for an N.C. contact), and then turn the run command ON again.

● Setting “12” and “13”: Forward and Reverse Jog Commands

The jog function can operate in forward or reverse. The forward jog and reverse jog commands have priority over other frequency reference commands.

Setting	Function
12	Forward Jog command: Runs forward at the jog reference frequency (d1-09).
13	Reverse Jog command: Runs in reverse at the jog reference frequency (d1-09).

The inverter will stop operation with the stopping method is set in b1-03 if the forward jog and reverse jog commands are both on for more than 500 ms. Turn ON either the forward jog command or the reverse jog command, not both.

These jog commands can operate the Inverter independently. It isn't necessary for a forward/reverse command to be input.

● Setting “1F”: Terminal 13/14 Switch

When this function is set in a multi-function input, that input terminal can be used to switch between terminal 13 and terminal 14.

OFF	The analog input from terminal 13 is used as the main-speed frequency reference.
ON	The analog input from terminal 14 is used as the main-speed frequency reference.

When terminal 14 is used as the frequency reference, set “1F” (frequency reference) in parameter H3-09; this parameter is the function selector for frequency reference (current) terminal 14. A setting fault (OPE03) will occur if this function is selected without setting “1F” in H3-09.

When H3-09 is set to “1F” (frequency reference) but none of the multi-function inputs is set to “1F” (terminal 13/14 switch), the sum of the inputs from terminals 13 and 14 will be used as the main-speed frequency reference.

5-2 Open-loop Vector Control

Open-loop vector control is vector control without pulse generator input. Auto-tuning is the only setting for basic operation with open-loop vector control.

When the voltage limit restricted by the input power supply is reached near the rated motor speed, vector control cannot be established and speed accuracy will be reduced. To operate with the greatest speed precision near the rated speed, either select a motor with a rated voltage that is at least 20 V below the Inverter's input power supply voltage (40 V below for a 400-V class Inverter) and use a special vector control motor is possible, or set an output voltage restriction in parameter C3-06 (see 6-1-5 *Operation for Output Voltage Saturation* for details). (If an output voltage restriction is set in C3-06, the Inverter's output current will be reduced by about 10%, so be sure to use an Inverter with sufficient capacity.)

5-2-1 Auto-tuning Procedure

■ Inverter Input Voltage Setting (E1-01)

Set the Inverter's input voltage (E1-01) to match the power supply voltage; it cannot be changed during operation. This setting is used as the reference value for functions such as the protection functions.

Parameter number	Display name	Setting range	Units	Default setting	Valid access levels			
					V/f Control	V/f with PG	Open Loop Vector	Flux Vector
E1-01	Input Voltage	155 to 255 (310 to 510)	VAC	200 (400)	Quick-start, Basic, or Advanced			

Note The voltage settings shown in parentheses are the values for the 400-V class.

■ Motor Selection (E1-02)

Set the motor selection (E1-02) to the type of motor to be used. This setting is used as a basis for motor protection

Parameter number	Display name	Setting range	Units	Default setting	Valid access levels			
					V/f Control	V/f with PG	Open Loop Vector	Flux Vector
E1-02	Motor Selection	0 to 2	---	0	Quick-start			

● Setting

Setting	Function
0	Standard fan-cooled motor (general-purpose motor)
1	Standard blower motor (inverter-exclusive motor)
2	Special motor (special vector control motor)

■ Precautions Before Auto-tuning

 **Caution** Do not connect a load to the motor when performing auto-tuning. Doing so may result in personal injury or equipment damage.

- The Inverter's auto-tuning function automatically determines the motor parameters while a servo system's auto-tuning function determines the size of a load, so these auto-tuning functions are fundamentally different.
- If a load is connected when auto-tuning is performed, not only will incorrect motor parameters be recorded, but the motor may operate erratically resulting in dangerous conditions such as loads falling from vertical axis motors. Never perform auto-tuning with a load connected to the motor.

■ Required Parameter Settings

Enter auto-tuning mode and make the following parameter settings:

Rated Voltage:	Set the rated voltage (VAC) shown on the motor's nameplate.
Rated Current:	Set the rated current (A) shown on the motor's nameplate.
Rated Frequency:	Set the rated frequency (Hz) shown on the motor's nameplate.
Rated Speed:	Set the rated speed (r/min) shown on the motor's nameplate.
Number of poles:	Set the number of poles.
Motor Selection:	Select motor 1. For two-motor switching control, select motor 1 or motor 2.

The following message will appear when the parameters have been set:

Tuning Ready ?
Press RUN key

At this point, it is still possible to change the parameter settings by pressing the Increment and Decrement Keys to display the desired parameter.

Press the Menu Key to cancel auto-tuning. (The operation mode display will appear.)

■ Performing Auto-tuning

Auto-tuning will start if the Run Key is pressed when the "Tuning Ready?" message is being displayed. The motor will operate during auto-tuning, so be sure that it is safe for the motor to operate before pressing the Run Key.

The following message will be displayed when the Run Key is pressed:

Tune Proceeding
HZ A

Auto-tuning takes up to 1.5 minutes. The message "Tune Successful" will be displayed when auto-tuning is completed. If auto-tuning has been completed successfully, press the Menu Key and proceed to the next operation. If a fault occurred during auto-tuning, refer to *5-2-2 Auto-tuning Faults* for details on correcting the cause of the fault and perform auto-tuning again.

Note To cancel auto-tuning after it has been started, press the Stop Key to stop the operation and then press the Menu Key to return to Drive Mode.

5-2-2 Auto-tuning Faults

One of the fault messages in the following table will be displayed if a fault occurs during auto-tuning. In this case, determine the cause of the fault, correct it, and perform auto-tuning again.

The fault display can be cleared by pressing the Menu Key. The motor parameters will revert to their default settings if a fault occurs. Set these parameters again when auto-tuning.

Fault display	Probable cause and remedy
Data Invalid (Motor setting data fault)	There was a fault in the data set during auto-tuning. <ul style="list-style-type: none"> • There was a fault in the relationship between the rated frequency, rated speed, and number of poles. → Change the settings to conform to the following formula: $\text{Rated speed} < 120 \times \text{Motor frequency} / \text{Number of poles}$
ALARM: Over Load (Excessive load during auto-tuning)	The effective load factor exceeded 20% during auto-tuning. <ul style="list-style-type: none"> • A load is connected to the motor axis. → Remove the load. • There was a setting fault during auto-tuning. → Check the rated current setting. Change if necessary. • There is a motor bearing problem. → Turn the Inverter off and rotate the motor by hand. Replace the motor if it doesn't turn smoothly.
Motor speed (Motor speed fault)	The torque reference value exceeded 100% during auto-tuning. <ul style="list-style-type: none"> • There is a broken/disconnected motor power wire. → Check and replace wiring components if necessary. • A load is connected to the motor axis. → Remove the load.
Accelerate (Motor acceleration fault)	The motor doesn't accelerate within the prescribed time. <ul style="list-style-type: none"> • The torque limit function is operating. → Initialize the torque limit parameters (L7-01 to L7-04). • The acceleration time is too short. → Increase acceleration time 1 (C1-01). • A load is connected to the motor axis. → Remove the load.
Rated Slip (Rated slip fault)	The rated slip setting can't be tuned within the prescribed time. <ul style="list-style-type: none"> • A load is connected to the motor axis. → Remove the load.
Saturation-1 (Core-saturation coefficient 1 fault)	The core-saturation coefficients can't be tuned within the prescribed time. <ul style="list-style-type: none"> • The rated current setting isn't correct. → Check and change the setting if necessary. • There is a broken/disconnected motor power wire. → Check and replace wiring components if necessary.
Saturation-2 (Core-saturation coefficient 2 fault)	
Resistance (Motor wire resistance fault)	The motor terminal resistance or no-load current setting can't be tuned within the prescribed time. <ul style="list-style-type: none"> • The rated current setting isn't correct. → Check and change the setting if necessary. • There is a broken/disconnected motor power wire. → Check and replace wiring components if necessary.
No-load Current (Motor no-load current fault)	
Minor Fault (Minor fault)	• A minor fault has occurred in the Inverter (warning or alarm detected). → Refer to <i>Chapter 8 Maintenance Operations</i> for appropriate actions.
V/f Over Setting (V/f setting too high)	• The torque reference exceeded 100% and the non-load current exceeded 70% of the rated motor current during auto-tuning. → The settings are incorrect for the rated voltage or rated frequency. Correct the settings. → The motor is connected to a load. Disconnect the load.

5-3 V/f Control

With V/f control, the user must set the Inverter's input voltage, motor selection, rated current, and V/f pattern.

5-3-1 Setting the Motor Parameters

■ Inverter Input Voltage Setting (E1-01)

Set the Inverter's input voltage (E1-01) to match the power supply voltage; it cannot be changed during operation. This setting is used as the reference value for functions such as the protection functions.

Parameter number	Display name	Setting range	Units	Default setting	Valid access levels			
					V/f Control	V/f with PG	Open Loop Vector	Flux Vector
E1-01	Input Voltage	155 to 255 (310 to 510)	VAC	200 (400)	Quick-start, Basic, or Advanced			

Note The voltage settings shown in parentheses are the values for the 400-V class.

■ Motor Selection and Rated Current Setting (E1-02 and E2-01)

Set the type of motor being used with the motor selection parameter (E1-02). This setting is a reference for the protection functions. This parameter cannot be changed during operation.

Parameter number	Display name	Setting range	Units	Default setting	Valid access levels			
					V/f Control	V/f with PG	Open Loop Vector	Flux Vector
E1-02	Motor Selection	0 to 2	---	0	Quick-start, Basic, or Advanced			

E1-02 Settings

Setting	Function
0	Standard fan-cooled motor (general-purpose motor)
1	Standard blower-cooled motor (inverter-exclusive motor)
2	Special motor (special vector control motor)

Set parameter (E2-01) to rated current (A) shown on the motor's nameplate. This parameter cannot be changed during operation.

Parameter number	Display name	Setting range ¹	Units	Default setting ²	Valid access levels			
					V/f Control	V/f with PG	Open Loop Vector	Flux Vector
E2-01	Motor Rated FLA	10 to 200%	A	(Note 2)	Quick-start, Basic, or Advanced			

Note 1. The setting range is 10 to 200% of the Inverter's rated output current.

Note 2. The default setting depends upon the type of Inverter.

5-3-2 V/f Pattern Selection (E1-03)

Set the V/f pattern with parameter E1-03. This parameter cannot be changed during operation.

Parameter number	Display name	Setting range	Units	Default setting	Valid access levels			
					V/f Control	V/f with PG	Open Loop Vector	Flux Vector
E1-03	V/f Selection	0 to F	---	F	Quick-start, Basic, or Advanced		Not applicable.	

The V/f pattern settings can be divided into two categories: the 15 preset patterns (settings 0 through E) and custom user-set patterns (setting F). The factory default setting for E1-03 is “F” (user-defined V/f pattern), but the contents of this setting are actually the same as setting “1.”

■ Selecting a Preset V/f Pattern (Settings “0” through “E”)

Refer to the following table when selecting one of the 15 preset patterns.

Characteristics	Applications	Setting	Specifications
General-purpose	These patterns are for general-purpose applications. Use these patterns when there is a roughly proportional relationship between the rotational speed and load, such as in straight-line conveyors.	0	50 Hz
		1	60 Hz
		2	60 Hz, Voltage saturation at 50 Hz
		3	72 Hz, Voltage saturation at 60 Hz
Variable torque	Use these patterns when there is a quadratic or cubic relationship between the rotational speed and load, such as in fans or pumps.	4	50 Hz, cubic
		5	50 Hz, quadratic
		6	60 Hz, cubic
		7	60 Hz, quadratic
High starting torque	(Normally it isn't necessary to use these patterns because starting torque is ensured by automatic torque boost functions.)	8	50 Hz, low starting torque
		9	50 Hz, high starting torque
		A	60 Hz, low starting torque
		b	60 Hz, high starting torque
High-speed operation	These patterns are for applications that must rotate at frequencies greater than 60 Hz. A fixed voltage is applied at frequencies greater than 60 Hz.	C	90 Hz, Voltage saturation at 60 Hz
		d	120 Hz, Voltage saturation at 60 Hz
		E	180 Hz, Voltage saturation at 60 Hz

Note 1. Select a high starting torque V/f pattern only in the following cases:

- The wiring distance between the Inverter and motor is relatively large (greater than 150 m).
- A large torque is required at startup (such as heavy axis loads).
- An AC or DC reactor is connected to the Inverter's input or output.

Note 2. The parameter settings for E1-04 through E1-10 will be changed automatically when one of these patterns is selected. There are three possible settings for these parameters depending on the Inverter's capacity: a 0.4 to 1.5 kW V/f pattern, a 2.2 to 45 kW V/f pattern, and a 55 kW V/f pattern.

Note 3. The characteristics for these patterns are shown in the diagrams on the following pages. The voltages in these graphs are for 200-V class Inverters. Double the voltage for 400-V class Inverters.

V/f Patterns: 0.4 to 1.5 kW

• General-purpose Characteristics (Settings 0 to 3)

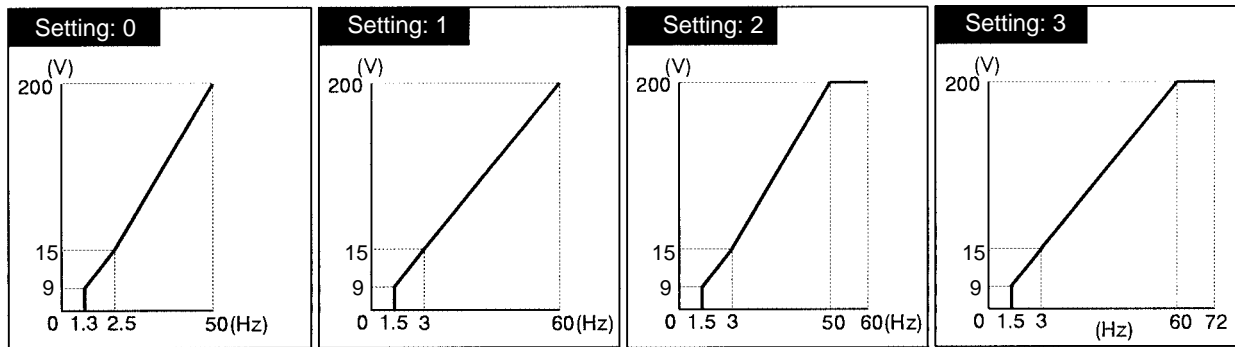

• Variable Torque Characteristics (Settings 4 to 7)

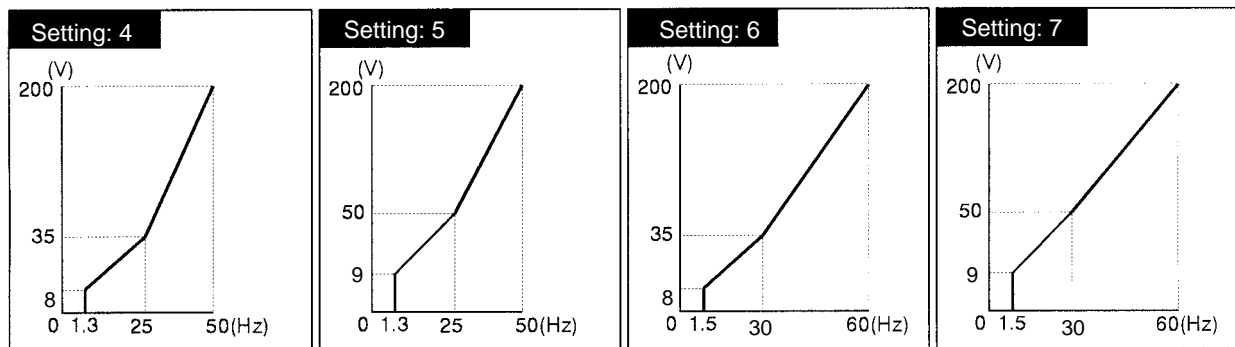

• High Starting Torque Characteristics (Settings 8 to b)

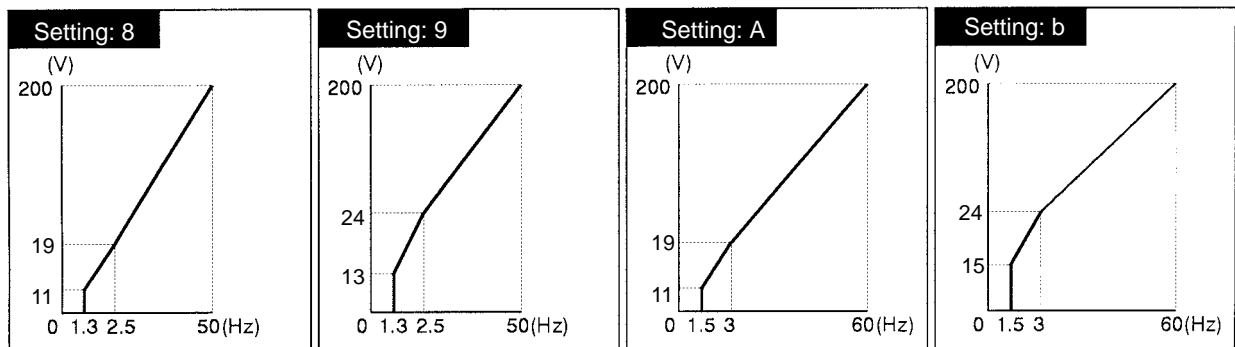

• High-speed Operation (Settings C to E)

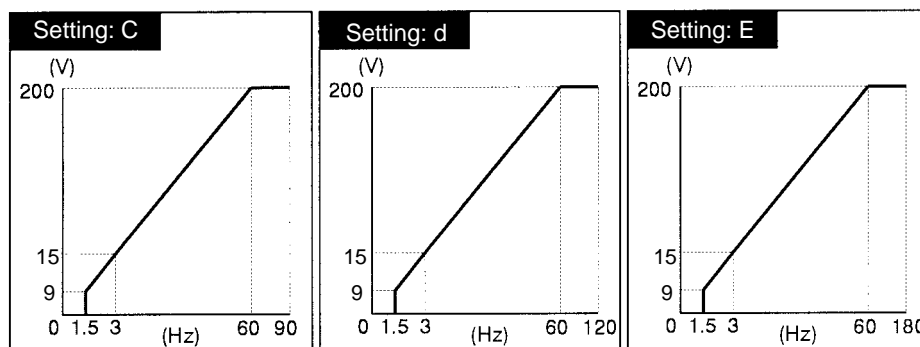

Note The voltages above are for 200-V class Inverters. Double the voltages for 400-V class Inverters.

V/f Patterns: 2.2 to 45 kW

• General-purpose Characteristics (Settings 0 to 3)

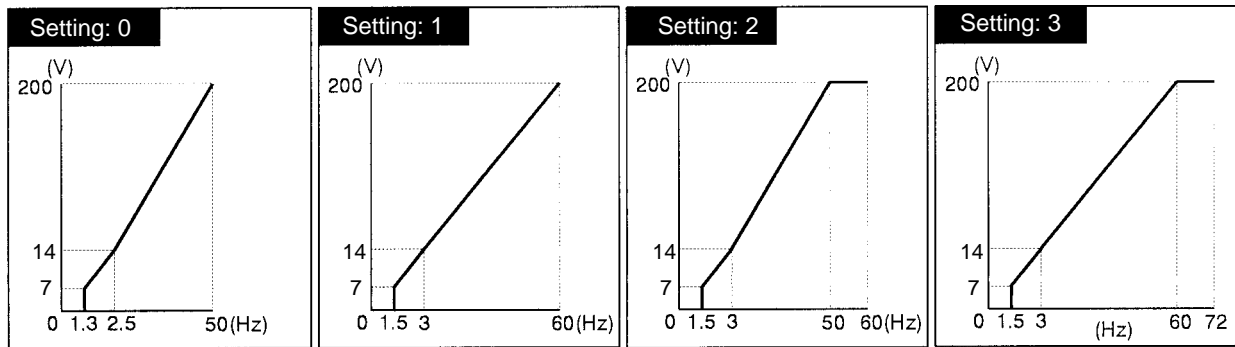

• Variable Torque Characteristics (Settings 4 to 7)

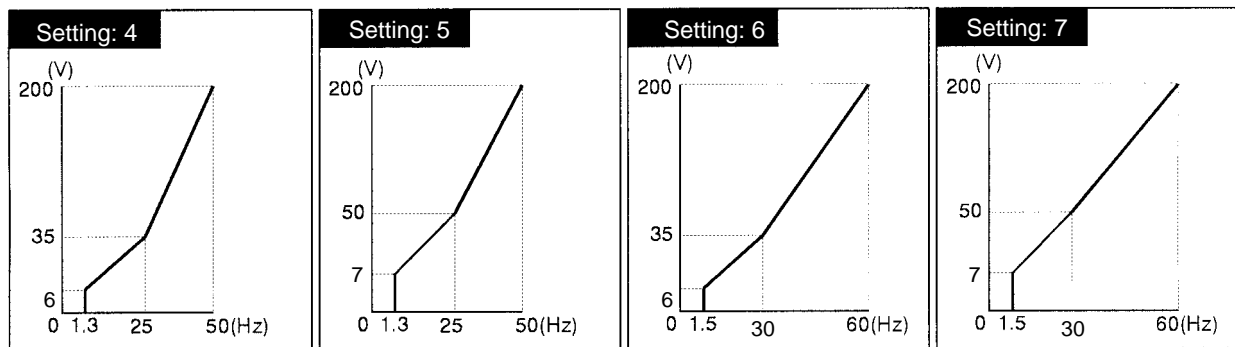

• High Starting Torque Characteristics (Settings 8 to b)

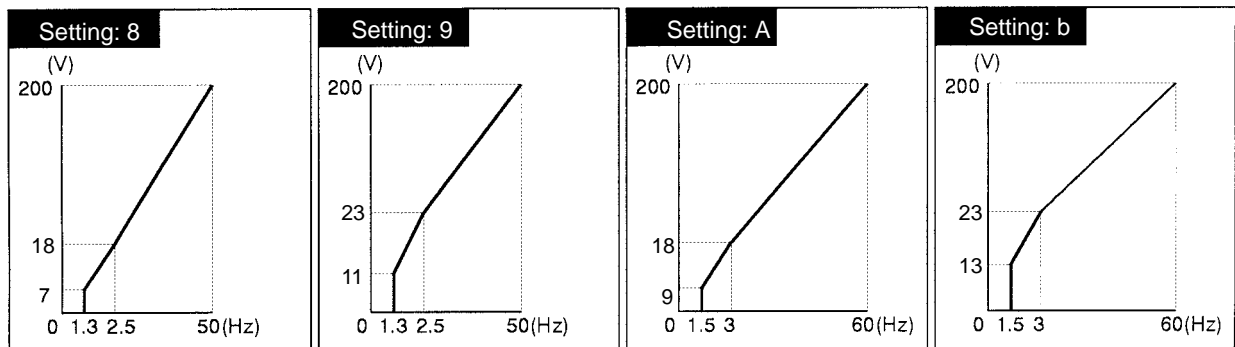

• High-speed Operation (Settings C to E)

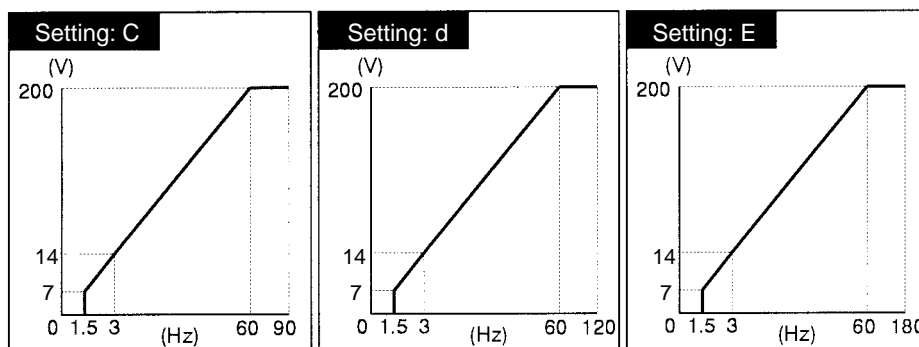

Note The voltages above are for 200-V class Inverters. Double the voltages for 400-V class Inverters.

V/f Patterns: 55 to 300 kW

• General-purpose Characteristics (Settings 0 to 3)

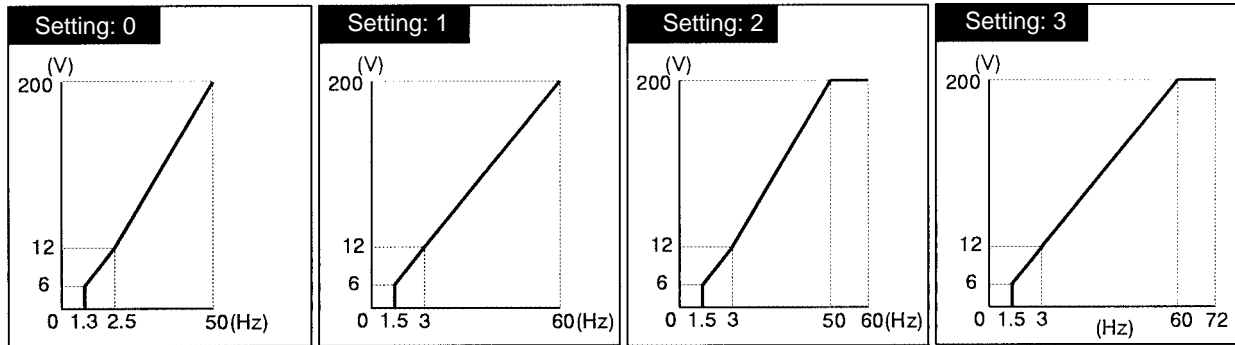

• Variable Torque Characteristics (Settings 4 to 7)

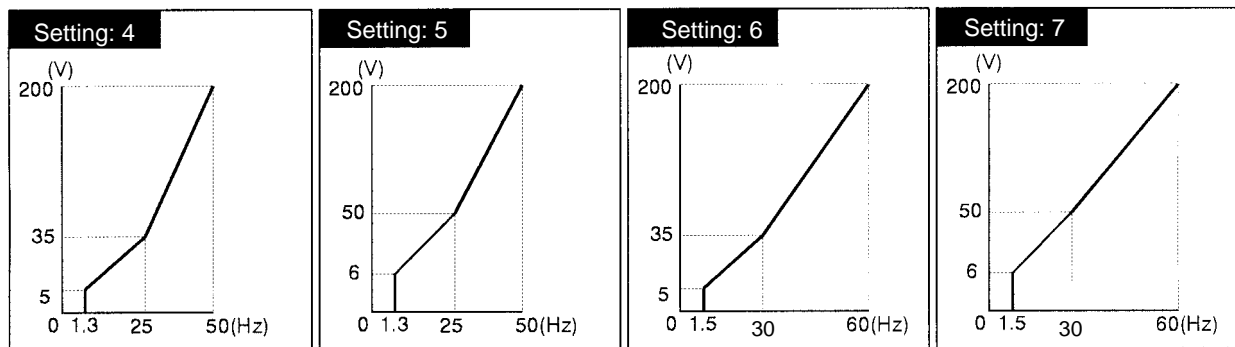

• High Starting Torque Characteristics (Settings 8 to b)

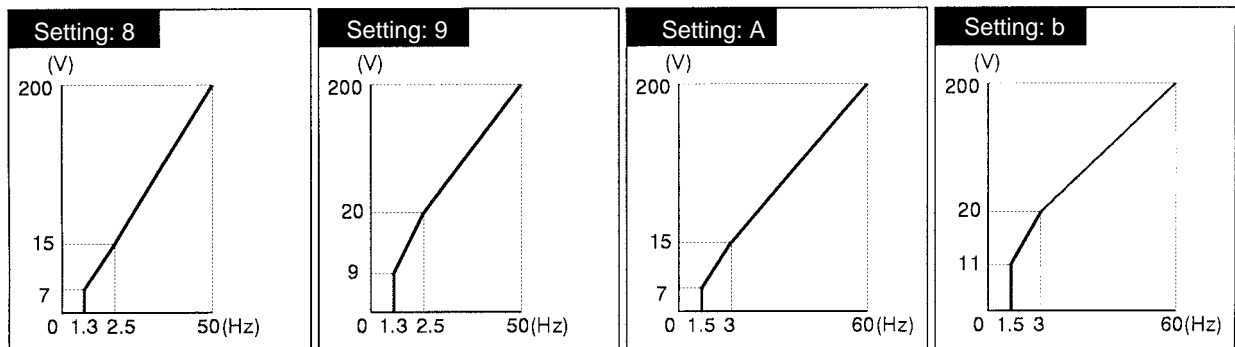

• High-speed Operation (Settings C to E)

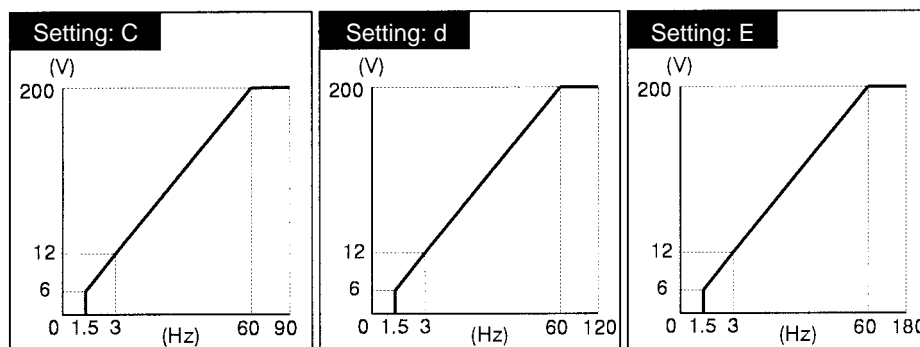

Note The voltages above are for 200-V class Inverters. Double the voltages for 400-V class Inverters.

■ **Setting a User-defined V/f Pattern (Setting “F”)**

Parameters E1-04 through E1-10 can be set by the user when E1-03 has been set to “F.” These parameters are read-only when E1-03 isn’t set to “F.” Parameters E1-04 through E1-10 cannot be changed during operation.

When making the V/f characteristics a straight line, set the same value in E1-07 (middle output frequency) and E1-09 (minimum output frequency). In this case, parameter E1-08 (middle output voltage) will be ignored.

Parameter number	Display name	Setting range	Units	Default setting	Valid access levels*1			
					V/f Control	V/f with PG	Open Loop Vector	Flux Vector
E1-04	Max Frequency	40.0 to 400.0	Hz	60.0	Q	Q	Q	Q
E1-05	Max Voltage	0.0 to 255.0*2	VAC	200.0*2	Q	Q	Q	Q
E1-06	Base Frequency	0.0 to 400.0	Hz	60.0	Q	Q	Q	Q
E1-07	Mid Frequency A	0.0 to 400.0	Hz	3.0	Q	Q	A	---
E1-08	Mid Voltage A	0.0 to 255.0*2	VAC	15.0*2,3	Q	Q	A	---
E1-09	Min Frequency	0.0 to 400.0	Hz	1.5	Q	Q	Q	A
E1-10	Min Voltage	0.0 to 255.0*2	VAC	9.0*2,3	Q	Q	A	---

Note 1. Q: Quick-start, Basic, or Advanced
 A: Advanced only
 ---: Not applicable.

Note 2. These voltages are for the 200-V class; Double the voltage for 400-V class Inverters.

Note 3. The default setting depends on the Inverter’s capacity. The default settings shown in the table are for 200-V class, 0.4 to 1.5 kW Inverters. Refer to the graphs for “Setting: 1” on pages 5-26 and 5-27 for the default settings in 2.2 to 45 kW and 55 to 300 kW Inverters.

Note 4. The default settings for E1-07 through E1-10 depend on the control mode. The default settings shown in the table are for V/f control.

Note 5. The four frequency settings must satisfy the following formula:
 $E1-04 (F_{MAX}) \geq E1-06 (F_A) > E1-07 (F_B) \geq E1-09 (F_{MIN})$
 For flux vector control, make the settings as follows:
 $E1-04 (F_{MAX}) \geq E1-06 (F_A) > E1-09 (F_{MIN})$

User-defined V/f Pattern

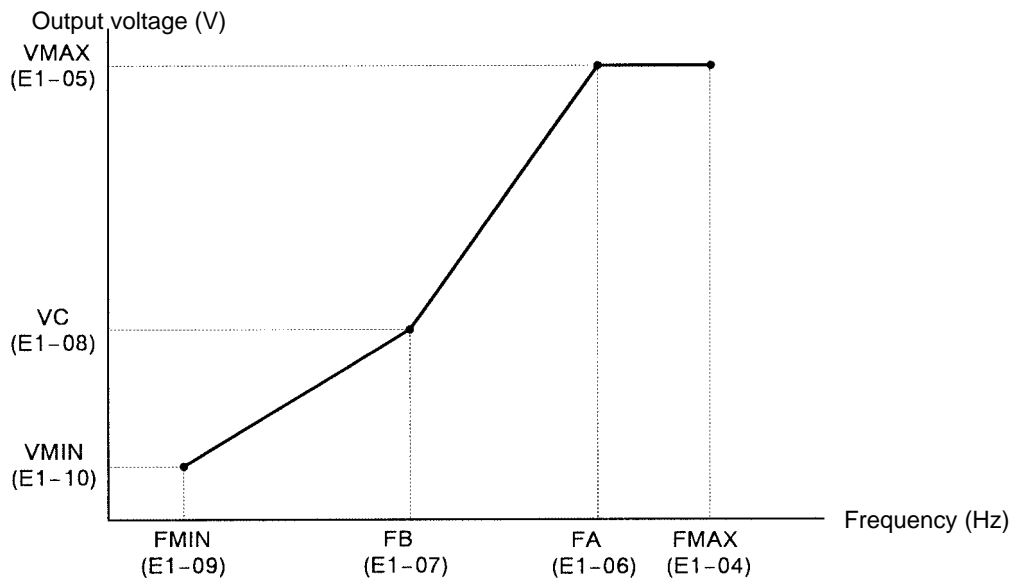

5-4 Flux Vector Control

With flux vector control (vector control with PG), make the settings for the PG Speed Control Card, select the zero-speed operation method, set the various auto-tuning parameters, and then adjust the gain of the speed control loop.

To ensure high-precision torque/speed control, use a motor specifically designed for vector control with an integrated PG. Always use an Inverter with twice the motor's capacity when a large load (50% or more of the rated current) is applied while in zero-speed, such as with a vertical-axis load.

When setting up a separate PG (encoder), connect it directly to the motor axis. If the PG is connected to the motor via gearing or belts, responses can be delayed by backlash or torsion; the delayed responses can generate vibration and make control impossible.

5-4-1 PG Speed Control Card Settings

■ Available PG Speed Control Cards

There are 4 types of PG Speed Control Cards, but only 2 types can be used with vector control.

3G3FV-PPGB2: Phase-A/Phase-B pulse inputs, inputs for open collector

3G3FV-PPGX2: Phase-A/Phase-B/Phase-Z pulse inputs, line driver inputs

Select the Card according to the application and install it in the Inverter as described in 2-2-6 *Installing and Wiring PG Speed Control Cards*.

■ Setting the PG Pulse Number (F1-01)

Set the PG (pulse generator or encoder) pulse number in pulses/revolution. Set the number of phase A or phase B pulses in one motor revolution. This parameter cannot be changed during operation.

Parameter number	Display name	Setting range	Units	Default setting	Valid access levels*			
					V/f Control	V/f with PG	Open Loop Vector	Flux Vector
F1-01	PG Pulses/Rev	0 to 60,000	p/r	1,000	---	Q	---	Q

Note Q: Quick-start, Basic, or Advanced

---: Not applicable.

■ Setting the PG Rotation Direction (F1-05)

This parameter is used to coordinate the PG's rotation direction with the motor's rotation direction; it cannot be changed during operation.

Generally, phase A leads when the PG rotates in the clockwise direction (looking from the input axis). When a forward command is input to the inverter, the motor rotates in the counterclockwise direction (looking from the output axis). (These directions may be reversed in PG-integrated motors or other motors.)

Set whether phase A or phase B leads when the motor operates in the forward direction.

Parameter number	Display name	Setting range	Units	Default setting	Valid access levels*			
					V/f Control	V/f with PG	Open Loop Vector	Flux Vector
F1-05	PG Rotation Sel	0 or 1	---	0	---	B	---	B

Note B: Basic or Advanced
 ---: Not applicable.

PG Rotation Settings

Setting	Function
0	Phase A leads with forward command. (Phase B leads with reverse command.)
1	Phase B leads with forward command. (Phase A leads with reverse command.)

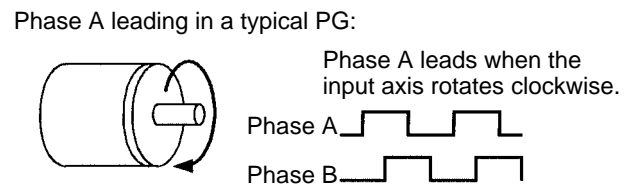
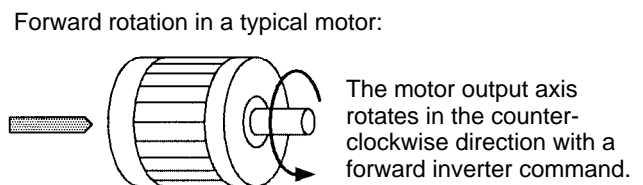
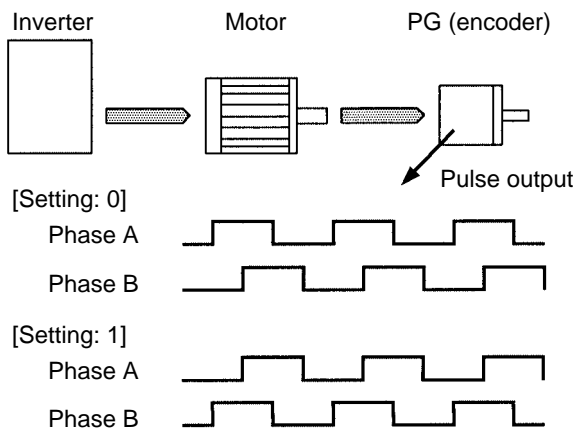

■ **Setting the PG Pulse Output Monitor Division Ratio (F1-06)**

This parameter is effective only when a 3G3FV-PPB2 is used; it sets the division ratio used when the pulse monitor output is connected to a pulse input device. This parameter cannot be changed during operation.

Parameter number	Display name	Setting range	Units	Default setting	Valid access levels*			
					V/f Control	V/f with PG	Open Loop Vector	Flux Vector
F1-06	PG Output Ratio	001 to 032, 101 to 132	---	1	---	B	---	B

Note B: Basic or Advanced
 ---: Not applicable.

The first digit in the setting (0 or 1) is n and the second two digits (01 to 32) are m. The division ratio is calculated from n and m with the following equation:

F1 - 06 = $\begin{matrix} \square & \square \\ | & | \\ \square & \square \\ | & | \\ m & n \end{matrix}$

$$\text{Division ratio} = \frac{(1 + n)}{m}$$

The possible division ratio settings: $1/32 \leq F1-06 \leq 1$

■ Setting and Adjusting the Fault Detection Functions

● PG Disconnection Stopping Method (F1-02)

This parameter sets the stopping method that is used when the signal from the PG is lost.

Parameter number	Display name	Setting range	Units	Default setting	Valid access levels*			
					V/f Control	V/f with PG	Open Loop Vector	Flux Vector
F1-02	PG Fdbk Loss Sel	0 to 3	---	1	---	B	---	B

Note B: Basic or Advanced
---: Not applicable.

Settings

Setting	Name	Function
0	Ramp to Stop	Deceleration stop using deceleration time 1 (C1-02).
1	Coast to Stop	Free-run stop
2	Fast Stop	Emergency stop using the fast-stop time (C1-09).
3	Alarm Only	Continue operation (This setting can't be made with flux vector control.)

● PG Disconnection Detection Time (F1-14)

A PG disconnection will be detected if a disconnection status lasts for the following time or longer.

Note The motor speed will not be controlled while the PG is disconnected. Set this time as short as possible in any application where safety cannot be ensured.

Parameter number	Display name	Setting range	Units	Default setting	Valid access levels*			
					V/f Control	V/f with PG	Open Loop Vector	Flux Vector
F1-14	PGO Detect Time	0.0 to 10.0	Sec	2.0	X	A	X	A

● Overspeed Settings (F1-03, F1-08, and F1-09)

Overspeed refers to an excessive motor speed. These parameters set the conditions for an overspeed fault and the stopping method that is used when an overspeed fault occurs; they cannot be changed during operation.

Parameter F1-03 sets the stopping method that is used when an overspeed fault occurs.

Parameter number	Display name	Setting range	Units	Default setting	Valid access levels*			
					V/f Control	V/f with PG	Open Loop Vector	Flux Vector
F1-03	PG Overspeed Sel	0 to 3	---	1	---	B	---	B

Note B: Basic or Advanced
---: Not applicable.

Settings

Setting	Name	Function
0	Ramp to Stop	Deceleration stop using deceleration time 1 (C1-02).
1	Coast to Stop	Free-run stop
2	Fast Stop	Emergency stop using the fast-stop time (C1-09).
3	Alarm Only	Continue operation (This setting can't be made with flux vector control.)

Parameter F1-08 sets the overspeed detection level as a percentage of the maximum output frequency. Parameter F1-09 sets the length of time that the motor speed must exceed the overspeed detection level in order to generate an overspeed fault.

Parameter number	Display name	Setting range	Units	Default setting	Valid access levels*			
					V/f Control	V/f with PG	Open Loop Vector	Flux Vector
F1-08	PG Overspd Level	0 to 120	%	115	---	A	---	A
F1-09	PG Overspd Time	0.0 to 2.0	s	0.0	---	A	---	A

Note A: Advanced

---: Not applicable.

● **PG Speed Deviation Settings (F1-04, F1-10, and F1-11)**

PG speed deviation refers to the difference between the actual motor speed and the reference command speed. These parameters set the conditions for a PG speed deviation fault and the stopping method that is used when a PG speed deviation fault occurs; they cannot be changed during operation.

Parameter F1-04 sets the conditions for detecting a PG speed deviation fault and the stopping method to be used when a fault is detected.

Parameter number	Display name	Setting range	Units	Default setting	Valid access levels*			
					V/f Control	V/f with PG	Open Loop Vector	Flux Vector
F1-04	PG Deviation Sel	0 to 7	---	3	---	B	---	B

Note B: Basic or Advanced

---: Not applicable.

Settings

Setting	Stopping method	Function
0	Ramp to Stop (C1-02)/Fault	Detect when deviation occurs with the frequency reference matching (within the L4-02 detection range) the output frequency.
1	Coast to Stop/Fault	Detect when deviation occurs with the frequency reference matching (within the L4-02 detection range) the output frequency.
2	Fast Stop (C1-09)/Fault	Detect when deviation occurs with the frequency reference matching (within the L4-02 detection range) the output frequency.
3	Continue/Alarm Only	Detect when deviation occurs with the frequency reference matching (within the L4-02 detection range) the output frequency.
4	Ramp to Stop (C1-02)/Fault	Detect when deviation occurs with the frequency reference matching (within the L4-02 detection range) the motor speed (PG feedback).
5	Coast Stop/Fault	Detect when deviation occurs with the frequency reference matching (within the L4-02 detection range) the motor speed (PG feedback).
6	Fast Stop (C1-09)/Fault	Detect when deviation occurs with the frequency reference matching (within the L4-02 detection range) the motor speed (PG feedback).
7	Continue/Alarm Only	Detect when deviation occurs with the frequency reference matching (within the L4-02 detection range) the motor speed (PG feedback).

Note 1. In order to detect faulty contacts, and so on, inserted at the Inverter output side, select detection when the frequency reference matches the output frequency.

Note 2. The detection conditions vary as shown below depending on the software version. In Ver. VSG101114 and later versions, both functions are provided.

VSG101043 and earlier software: Set values 0 to 3.

VSG101113 software: Set values 4 to 7.

Parameter F1-10 sets the PG speed deviation detection level as a percentage of the maximum output frequency. Parameter F1-11 sets the length of time that the difference between the motor speed and reference speed must exceed the PG speed deviation detection level in order to generate a PG speed deviation fault (DEV).

Parameter number	Display name	Setting range	Units	Default setting	Valid access levels*			
					V/f Control	V/f with PG	Open Loop Vector	Flux Vector
F1-10	PG Deviate Level	0 to 50	%	10	---	A	---	A
F1-11	PG Deviate Time	0.0 to 10.0	s	0.5	---	A	---	A

Note A: Advanced

---: Not applicable.

5-4-2 Setting the Zero-speed Operation Parameters

With flux vector control, operation is possible even when the frequency reference is zero (below the minimum output frequency). Parameter E1-09 sets the minimum output frequency and B1-05 sets the operation method around this minimum frequency. These parameters cannot be changed during operation.

■ Selecting the Stopping Method (b1-03)

Parameter b1-03 sets the stopping method used when a stop command is input.

Parameter number	Display name	Setting range	Units	Default setting	Valid access levels			
					V/f Control	V/f with PG	Open Loop Vector	Flux Vector
b1-03	Stopping Method	0 to 3	---	0	Quick-start, Basic, or Advanced			

Settings

Setting	Name	Function
0	Ramp to Stop	Deceleration stop
1	Coast to Stop	Free-run stop
2	DC Injection to Stop	DC braking stop (This setting can't be made with flux vector control.)
3	Coast w/Timer	Free-run stop with timer (This setting can't be made with flux vector control.)

■ Setting the Zero-speed Operation Method (b1-05)

Parameter b1-05 sets the operation method used when the frequency reference is below the minimum output frequency set in E1-09.

Parameter number	Display name	Setting range	Units	Default setting	Valid access levels			
					V/f Control	V/f with PG	Open Loop Vector	Flux Vector
b1-05	Zero Speed Oper	0 to 3	---	0	Not applicable.			Advanced

Settings

Setting	Name	Function
0	RUN at Frequency Ref	Operate according to the frequency reference. (E1-09 is invalid.)
1	STOP	Interrupt the output. (Coast when the frequency reference is below E1-09.)
2	RUN at Min Frequency	Operate at E1-09 frequency. (Output the frequency set in E1-09.)
3	RUN at Zero RPM	Zero-speed operation (Zero reference value when the frequency reference is below E1-09.)

Parameter E1-09 sets the minimum output frequency. Set this minimum level to satisfy the requirements of the application.

Parameter number	Display name	Setting range	Units	Default setting	Valid access levels			
					V/f Control	V/f with PG	Open Loop Vector	Flux Vector
E1-09	Min Frequency	0.0 to 400.0	---	0.0	Quick-start, Basic, or Advanced			Advanced

■ Initial Excitation Function Settings (b2-01, b2-03, and b2-04)

With flux vector control, the DC braking (injection) function is replaced by the initial excitation function. The initial excitation function stops a motor that is rotating because of inertia. These parameters cannot be changed during operation.

Parameter number	Name (not displayed)	Setting range	Units	Default setting	Valid access levels			
					V/f Control	V/f with PG	Open Loop Vector	Flux Vector
b2-01	Excitation level	0.0 to 10.0	Hz	0.0	Basic or Advanced			
b2-03	Initial excitation time when starting	0.00 to 10.00	s	0.00	Basic or Advanced			
b2-04	Initial excitation time when stopping	0.00 to 10.00	s	0.50	Basic or Advanced			

The timing of the initial excitation function depends on the zero-speed operation method selected with b1-05, as shown in the following diagrams.

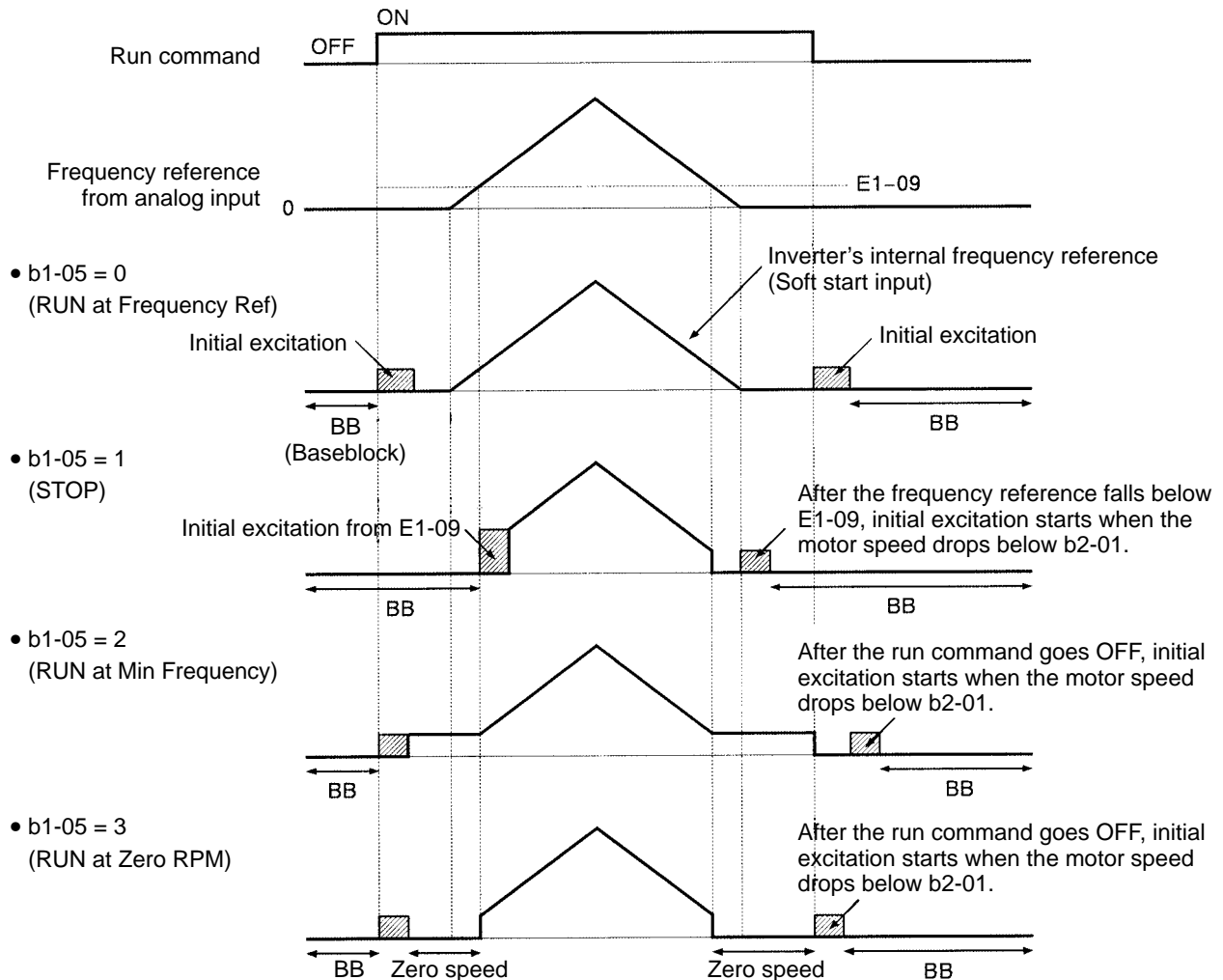

Note 1. Initial excitation is started from b2-01 (excitation level) when decelerating. A setting of b2-01 < E1-09 is valid only with flux vector control.

Note 2. The current level for the initial excitation function is set in E2-03 (no-load current). The DC braking (injection) current (b2-02) isn't used with flux vector control and can't be set.

5-4-3 Auto-tuning

■ Inverter Input Voltage Setting (E1-01)

Set the Inverter's input voltage (E1-01) to match the power supply voltage; it cannot be changed during operation. This setting is used as the reference value for functions such as the protection functions.

Parameter number	Display name	Setting range	Units	Default setting	Valid access levels			
					V/f Control	V/f with PG	Open Loop Vector	Flux Vector
E1-01	Input Voltage	155 to 255 (310 to 510)	VAC	200 (400)	Quick-start, Basic, or Advanced			

Note The voltage settings shown in parentheses are the values for the 400-V class.

■ **Motor Selection Setting (E1-02)**

Set the motor selection (E1-02) to the type of motor to be used. This setting is used as a basis for motor protection

Parameter number	Display name	Setting range	Units	Default setting	Valid access levels			
					V/f Control	V/f with PG	Open Loop Vector	Flux Vector
E1-02	Motor Selection	0 to 2	---	0	Quick-start			

● **Setting**

Setting	Function
0	Standard fan-cooled motor (general-purpose motor)
1	Standard blower motor (inverter-exclusive motor)
2	Special motor (special vector control motor)

■ **Precautions Before Auto-tuning**

 **Caution** Do not connect a load to the motor when performing auto-tuning. Doing so may result in personal injury or equipment damage.

- The Inverter’s auto-tuning function automatically determines the motor parameters while a servo system’s auto-tuning function determines the size of a load, so these auto-tuning functions are fundamentally different.
- If a load is connected when auto-tuning is performed, not only will incorrect motor parameters be recorded, but the motor may operate erratically resulting in dangerous conditions such as loads falling from vertical axis motors. Never perform auto-tuning with a load connected to the motor.

■ **Required Parameter Settings**

Enter auto-tuning mode and make the following parameter settings:

- Rated Voltage: Set the rated voltage (VAC) shown on the motor’s nameplate.
- Rated Current: Set the rated current (A) shown on the motor’s nameplate.
- Rated Frequency: Set the rated frequency (Hz) shown on the motor’s nameplate.
- Rated Speed: Set the rated speed (r/min) shown on the motor’s nameplate.
- Number of poles: Set the number of poles.
- Motor Selection: Select motor 1.
For two-motor switching control, select motor 1 or motor 2.
- PG Pulses/Rev: Set the number of A-phase or B-phase pulses per revolution.

The following message will appear when the parameters have been set:

Tuning Ready ?
Press RUN key

At this point, it is still possible to change the parameter settings by pressing the Increment and Decrement Keys to display the desired parameter.

Press the Menu Key to cancel auto-tuning. (The operation mode display will appear.)

■ Performing Auto-tuning

Auto-tuning will start if the Run Key is pressed when the “Tuning Ready?” message is being displayed. The motor will operate during auto-tuning, so be sure that it is safe for the motor to operate before pressing the Run Key.

The following message will be displayed when the Run Key is pressed:

Tune Proceeding
 HZ A

Auto-tuning takes up to 1.5 minutes. The message “Tune Successful” will be displayed when auto-tuning is completed. If auto-tuning has been completed successfully, press the Menu Key and proceed to the next operation.

Note To cancel auto-tuning after it has been started, press the Stop Key to stop the operation and then press the Menu Key to return to Drive Mode.

■ Auto-tuning Faults

One of the fault messages in the following table will be displayed if a fault occurs during auto-tuning. In this case, determine the cause of the fault, correct it, and perform auto-tuning again.

The fault display can be cleared by pressing the Menu Key. The motor parameters will revert to their default settings if a fault occurs. Set these parameters again when auto-tuning.

Fault display	Probable cause and remedy
Data Invalid (Motor setting data fault)	There was a fault in the data set during auto-tuning. <ul style="list-style-type: none"> • There was a fault in the relationship between the rated frequency, rated speed, and number of poles. → Change the settings to conform to the following formula: Rated speed < 120 × Motor frequency/Number of poles
ALARM: Over Load (Excessive load during auto-tuning)	The effective load factor exceeded 20% during auto-tuning. <ul style="list-style-type: none"> • A load is connected to the motor axis. → Remove the load. • There was a setting fault during auto-tuning. → Check the rated current setting. Change if necessary. • The PG pulse number setting is incorrect. → Check the setting and change if necessary. • There is a motor bearing problem. → Turn the Inverter off and rotate the motor by hand. Replace the motor if it doesn't turn smoothly.
Motor speed (Motor speed fault)	The torque reference value exceeded 100% during auto-tuning. <ul style="list-style-type: none"> • There is a broken/disconnected motor power wire. → Check and replace wiring components if necessary. • The PG pulse number setting is incorrect. → Check the setting and change if necessary. • The acceleration time is too short. → Increase acceleration time 1 (C1-01). • A load is connected to the motor axis. → Remove the load.

Fault display	Probable cause and remedy
Accelerate (Motor acceleration fault)	The motor doesn't accelerate within the prescribed time. <ul style="list-style-type: none"> • The torque limit function is operating. → Initialize the torque limit parameters (H7-01 to H7-04). • The acceleration time is too short. → Increase acceleration time 1 (C1-01). • A load is connected to the motor axis. → Remove the load.
Rated Slip (Rated slip fault)	The rated slip setting can't be tuned within the prescribed time. <ul style="list-style-type: none"> • A load is connected to the motor axis. → Remove the load.
Saturation-1 (Core-saturation coefficient 1 fault)	The core-saturation coefficients can't be tuned within the prescribed time. <ul style="list-style-type: none"> • The rated current setting isn't correct. → Check and change the setting if necessary.
Saturation-2 (Core-saturation coefficient 2 fault)	<ul style="list-style-type: none"> • There is a broken/disconnected motor power wire. → Check and replace wiring components if necessary.
Resistance (Motor wire resistance fault)	The motor terminal resistance or no-load current setting can't be tuned within the prescribed time. <ul style="list-style-type: none"> • The rated current setting isn't correct. → Check and change the setting if necessary.
No-load Current (Motor no-load current fault)	<ul style="list-style-type: none"> • There is a broken/disconnected motor power wire. → Check and replace wiring components if necessary.
PGO, PG Open (Broken PG cable detection)	Pulses aren't being input from the PG even though a rotation output is being sent to the motor. <ul style="list-style-type: none"> • The cable to the PG is broken/disconnected. → Check the wiring and correct any problems. • The PG's power supply is broken/disconnected. → Check the power supply voltage and correct if necessary.
PG Direction (Motor direction error)	<ul style="list-style-type: none"> • The motor direction and PG direction are different. → Motor power lines are wrong. Connect in following order: U, V, W. → Encoder wiring is wrong. Wire phase A, phase B, and + correctly. → F1-05 is set incorrectly. Set so that the directions agree.
Minor Fault (Minor fault)	<ul style="list-style-type: none"> • A minor fault has occurred in the Inverter (warning or alarm detected). → Refer to <i>Chapter 8 Maintenance Operations</i> for appropriate actions.
V/f Over Setting (V/f setting too high)	<ul style="list-style-type: none"> • The torque reference exceeded 100% and the non-load current exceeded 70% of the rated motor current during auto-tuning. → The settings are incorrect for the rated voltage or rated frequency. Correct the settings. → The motor is connected to a load. Disconnect the load.

5-4-4 Speed Loop (ASR) Structure

The following block diagram shows the structure of the speed loop.

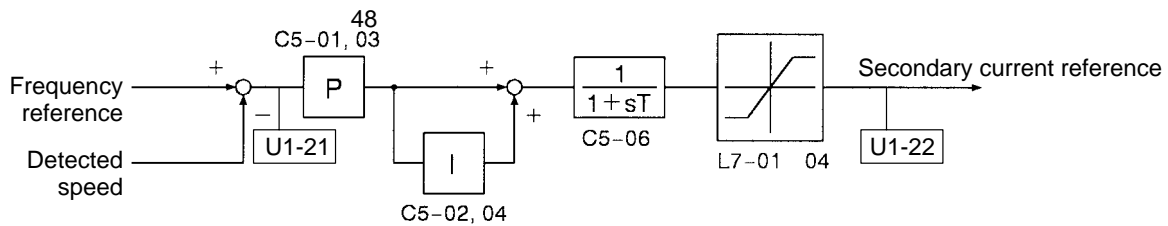

Note In vector flux control, the ASR’s P gain is the maximum frequency standard.

■ Regular Gain Settings (C5-01 and C5-02)

Parameter C5-01 sets the proportional gain of the speed loop (ASR), and C5-02 sets the integral time. Both of these parameters can be changed during operation.

Parameter number	Display name	Setting range	Units	Default setting	Valid access levels*			
					V/f Control	V/f with PG	Open Loop Vector	Flux Vector
C5-01	ASR P Gain 1	0.00 to 300.00	Factor	20.00	---	B	---	B
C5-02	ASR I Time 1	0.000 to 10.000	s	0.500	---	B	---	B

Note B: Basic or Advanced
 ---: Not applicable.

■ Low-speed Gain Settings (C5-03, C5-04, and C5-07)

Use these parameters to use different proportional gain and integral time settings for low-speed operation. Parameter C5-03 sets the proportional gain of the speed loop (ASR), and C5-04 sets the integral time. Both of these parameters can be changed during operation.

Parameter number	Display name	Setting range	Units	Default setting	Valid access levels*			
					V/f Control	V/f with PG	Open Loop Vector	Flux Vector
C5-03	ASR P Gain 2	0.00 to 300.00	Factor	20.00	---	B	---	B
C5-04	ASR I Time 2	0.000 to 10.000	s	0.500	---	B	---	B

Note B: Basic or Advanced
 ---: Not applicable.

Parameter C5-07 is the “ASR Gain Switching Frequency Level.” ASR P Gain 1 and ASR I Time 1 are used when the frequency is above this level. Below this level, the proportional gain and integral time approach ASR P Gain 2 and ASR I Time 2 as the frequency approaches zero. This parameter cannot be changed during operation.

Parameter number	Display name	Setting range	Units	Default setting	Valid access levels*			
					V/f Control	V/f with PG	Open Loop Vector	Flux Vector
C5-07	ASR Gain SW Freq	0.0 to 400.0	Hz	0.0	Not applicable.			

Note A: Advanced

The following graph shows how the proportional gain and integral time approach ASR P Gain 2 and ASR I Time 2 linearly as the frequency approaches zero.

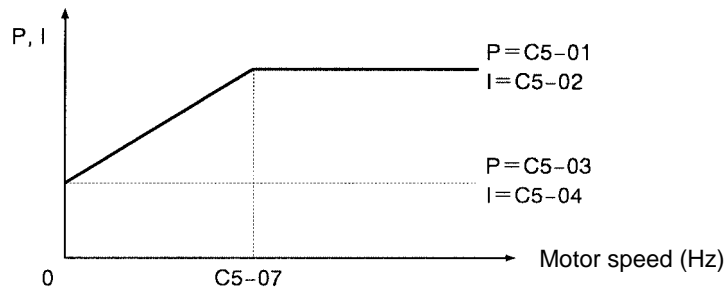

Note If C5-07 is set to 0.0, ASR P Gain 1 and ASR I Time 1 are used for the proportional gain and integral time at all frequencies.

■ **Multi-function Input Settings (H1-01 through H1-06)**

● **ASR Integral Reset (Setting E)**

When one of the multi-function inputs is set to “E,” the input can be used to switch the speed control loop between P control and PI control. P control (integral reset) is used when the multi-function input is ON.

● **ASR Proportional Gain Switch (Setting 77)**

When one of the multi-function inputs is set to “77,” the input can be used to switch between proportional gain 1 and proportional gain 2. Proportional gain 2 (C5-03) is used when the multi-function input is ON. This input has higher priority than the ASR switching frequency set in C5-07.

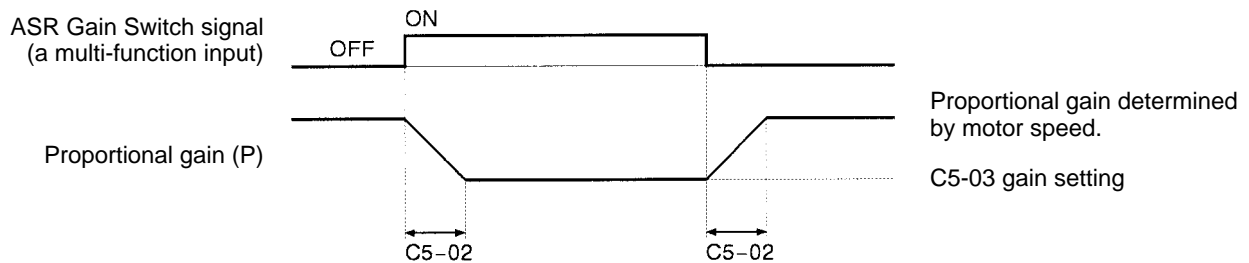

Note The gain is changed linearly in integral time 1 (C5-02). The integral time setting isn’t switched.

■ Adjusting Speed Loop (ASR) Responsiveness (C5-06) and Integral Limit (C5-08)

Normally it isn't necessary to make this adjustment, but parameter C5-06 can be used when adjusting the gain doesn't remove motor vibration, or adjusting the gain removes vibration but results in poor responsiveness. A high C5-06 setting lowers the responsiveness of the speed control loop, but makes it difficult for vibration to develop. This parameter cannot be changed during operation.

Parameter number	Display name	Setting range	Units	Default setting	Valid access levels*			
					V/f Control	V/f with PG	Open Loop Vector	Flux Vector
C5-06	ASR Delay Time	0.000 to 0.500	s	0.004	Not applicable.			

Note A: Advanced

Parameter number	Display name	Setting range	Units	Default setting	Valid access levels*			
					V/f Control	V/f with PG	Open Loop Vector	Flux Vector
C5-08	ASR 1 Limit	0 to 400	---	400	X	X	X	A

The setting of C5-08 does not normally need to be changed. It is used to set an upper limit for the integral used in speed control. Set a smaller value if rapid changes in the load can damage the load or cause the motor to become disengaged due to Inverter responsiveness. If the setting is too small, however, it may become impossible to perform speed control.

5-4-5 Adjusting Speed Control Loop (ASR) Gain

■ Gain Adjustment Procedure

Use the following procedure to adjust the gain with the mechanical system and actual load connected.

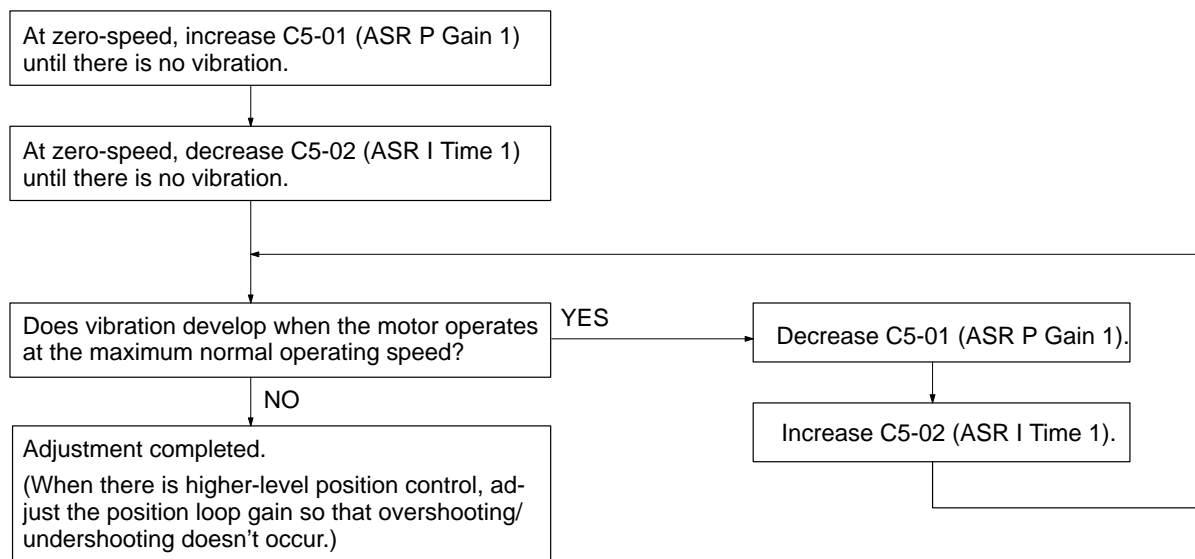

■ Fine Adjustments

When you want even finer gain adjustment, adjust the gain while observing the speed waveform. Parameter settings like those shown in the following table will be necessary to observe the speed waveform.

Parameter	Setting	Explanation
H4-01 Analog output selection (terminal 21)	21	Settings that allow multi-function analog output 1 to be used to monitor the ASR input.
H4-02 Analog output gain (terminal 21)	1.00	
H4-03 Analog output bias (terminal 21)	0.0	
H4-04 Analog output selection (terminal 23)	5	Settings that allow multi-function analog output 2 to be used to monitor the motor speed.
H4-05 Analog output gain (terminal 23)	1.00	
H4-06 Analog output bias (terminal 23)	0.0	
H4-07 Analog output level selection	1	This setting allows a 0 to ± 10 V signal range to be monitored.

The multi-function analog outputs have the following functions with these parameter settings. Terminal 22 is the multi-function analog output common. (There are separate commons, terminals 27 and 37, for the 3G3FV-□-CUE/CE.)

Multi-function analog output 1 (terminal 21): Outputs the Inverter's ASR input (0 to ± 10 V).

Multi-function analog output 2 (terminal 23): Outputs the actual motor speed (0 to ± 10 V).

We recommend monitoring both the ASR input and the motor speed in order to observe a response delay or deviation from the reference value, as shown in the following diagram.

Example Waveforms

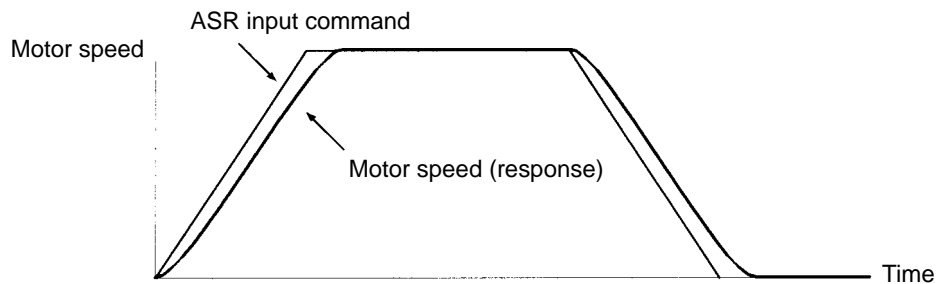

● Adjusting ASR Proportional Gain 1 (C5-01)

This gain setting adjusts the responsiveness of the speed control loop. The responsiveness is increased when this setting is increased. Usually this setting is higher for larger loads. Vibration will occur if this setting is increased too much.

The following diagram shows changes that occur in the response when the ASR proportional gain is changed.

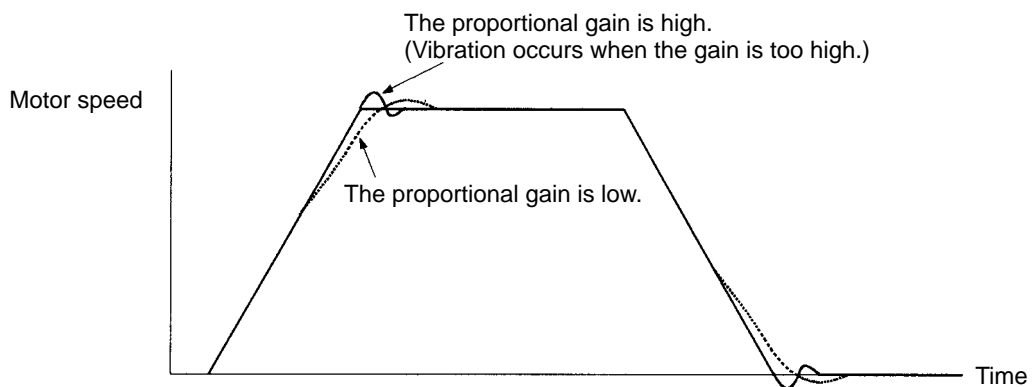

● Adjusting ASR Integral Time 1 (C5-02)

This parameter sets the speed control loop's integral time. Lengthening the integral time lowers the responsiveness, and weakens the resistance to external influences. Vibration will occur if this setting is too short.

The following diagram shows changes that occur in the response when the ASR integral time is changed.

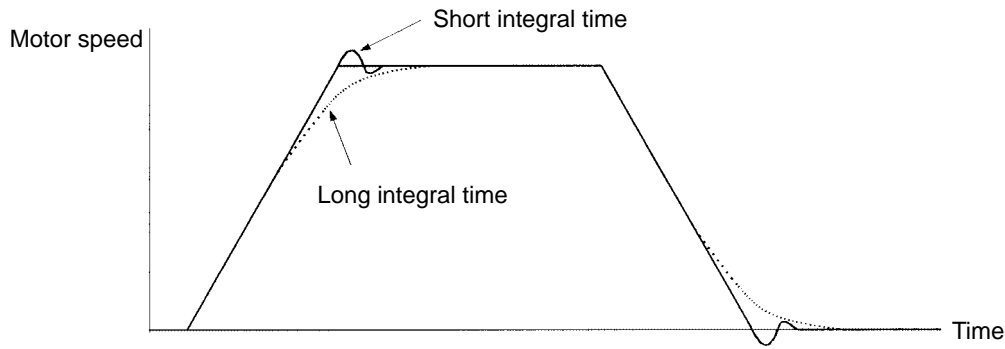

■ Different Gain Settings for Low-speed/High-speed

Switch between low-speed and high-speed gain when vibration occurs because of resonance with the mechanical system at low speed or high speed.

● Setting the Gain Switching Frequency (C5-07)

Set the switching frequency to about 80% of the motor's operating frequency or the frequency at which vibration occurs.

● Low-speed Gain Adjustments (C5-03 and C5-04)

- Connect the actual load and adjust these parameters at zero-speed.
- Increase ASR proportional gain 2 (C5-03) until there is no vibration.
- Decrease ASR integral time 2 (C5-04) until there is no vibration.

● High-speed Gain Adjustments (C5-01 and C5-02)

- Adjust these parameters at normal operating speed.
- Increase ASR proportional gain 1 (C5-01) until there is no vibration.
- Decrease ASR integral time 1 (C5-02) until there is no vibration.
- Refer to *Fine Adjustments* on page 5-41 for details on making fine adjustments of high-speed operation.

5-5 V/f Control with PG

With V/f control with PG, the user must set the motor parameters, V/f pattern, PG Control Card settings, and then adjust the speed control loop's gain.

5-5-1 Setting the Motor Parameters

■ Inverter Input Voltage Setting (E1-01)

Set the Inverter's input voltage (E1-01) to match the power supply voltage; it cannot be changed during operation. This setting is used as the reference value for functions such as the protection functions.

Parameter number	Display name	Setting range	Units	Default setting	Valid access levels			
					V/f Control	V/f with PG	Open Loop Vector	Flux Vector
E1-01	Input Voltage	155 to 255 (310 to 510)	VAC	200 (400)	Quick-start, Basic, or Advanced			

Note The voltage settings shown in parentheses are the values for the 400-V class.

■ Motor Selection and Rated Current Setting (E1-02 and E2-01)

Set the type of motor being used with the motor selection parameter (E1-02). This setting is a reference for the protection functions. This parameter cannot be changed during operation.

Parameter number	Display name	Setting range	Units	Default setting	Valid access levels			
					V/f Control	V/f with PG	Open Loop Vector	Flux Vector
E1-02	Motor Selection	0 to 2	---	0	Quick-start, Basic, or Advanced			

E1-02 Settings

Setting	Function
0	Standard fan-cooled motor (general-purpose motor)
1	Standard blower-cooled motor (inverter-exclusive motor)
2	Special motor (special vector control motor)

Set parameter (E2-01) to rated current (A) shown on the motor's nameplate. This parameter cannot be changed during operation.

Parameter number	Display name	Setting range ¹	Units	Default setting ²	Valid access levels			
					V/f Control	V/f with PG	Open Loop Vector	Flux Vector
E2-01	Motor Rated FLA	10 to 200%	A	(Note 2)	Quick-start, Basic, or Advanced			

Note 1. The setting range is 10 to 200% of the Inverter's rated output current.

Note 2. The default setting depends upon the type of Inverter.

Set parameter (E2-04) to the number of poles shown on the motor’s nameplate. This parameter cannot be changed during operation.

Parameter number	Display name	Setting range ¹	Units	Default setting ²	Valid access levels			
					V/f Control	V/f with PG	Open Loop Vector	Flux Vector
E2-04	Number of Poles	2 to 48	---	4	---	Quick-start	---	Quick-start

5-5-2 V/f Pattern Selection (E1-03)

Set the V/f pattern with parameter E1-03. This parameter cannot be changed during operation.

Parameter number	Display name	Setting range	Units	Default setting	Valid access levels			
					V/f Control	V/f with PG	Open Loop Vector	Flux Vector
E1-03	V/f Selection	0 to F	---	F	Quick-start, Basic, or Advanced		Not applicable.	

The V/f pattern settings can be divided into two categories: the 15 preset patterns (settings 0 through E) and custom user-set patterns (setting F). The factory default setting for E1-03 is “F” (user-defined V/f pattern), but the contents of this setting are actually the same as setting “1.”

■ Selecting a Preset V/f Pattern (Settings “0” through “E”)

Refer to the following table when selecting one of the 15 preset patterns.

Characteristics	Applications	Setting	Specifications
General-purpose	These patterns are for general-purpose applications. Use these patterns when there is a roughly proportional relationship between the rotational speed and load, such as in straight-line conveyors.	0	50 Hz
		1	60 Hz
		2	60 Hz, Voltage saturation at 50 Hz
		3	72 Hz, Voltage saturation at 60 Hz
Variable torque	Use these patterns when there is a quadratic or cubic relationship between the rotational speed and load, such as in fans or pumps.	4	50 Hz, cubic
		5	50 Hz, quadratic
		6	60 Hz, cubic
		7	60 Hz, quadratic
High starting torque	(Normally it isn’t necessary to use these patterns because starting torque is ensured by automatic torque boost functions.)	8	50 Hz, low starting torque
		9	50 Hz, high starting torque
		A	60 Hz, low starting torque
		b	60 Hz, high starting torque
High-speed operations	These patterns are for applications that must rotate at frequencies greater than 60 Hz. A fixed voltage is applied at frequencies greater than 60 Hz.	C	90 Hz, Voltage saturation at 60 Hz
		d	120 Hz, Voltage saturation at 60 Hz
		E	180 Hz, Voltage saturation at 60 Hz

Note 1. Select a high starting torque V/f pattern only in the following cases:

- The wiring distance between the Inverter and motor is relatively large (greater than 150 m).
- A large torque is required at startup (such as heavy axis loads).
- An AC or DC reactor is connected to the Inverter’s input or output.

Note 2. The parameter settings for E1-04 through E1-10 will be changed automatically when one of these patterns is selected. There are three possible settings for these parameters depending on the Inverter’s capacity: a 0.4 to 1.5 kW V/f pattern, a 2.2 to 45 kW V/f pattern, and a 55 to 300 kW V/f pattern.

Note 3. The characteristics for these patterns are shown in the diagrams on pages 5-25 through 5-27.

■ **Setting a User-defined V/f Pattern (Setting “F”)**

Parameters E1-04 through E1-10 can be set by the user when E1-03 has been set to “F.” Refer to page 5-28 for details on setting these parameters.

5-5-3 PG Speed Control Card Settings

■ **Available PG Speed Control Cards**

There are 4 types of PG Speed Control Cards, but only 2 types can be used with V/f control.

3G3FV-PPGA2: Phase-A (single) pulse input, input for open collector

3G3FV-PPGD2: Phase-A (single) pulse input, line driver inputs

Select the Card according to the application and install it in the Inverter as described in 2-2-6 *Installing and Wiring PG Speed Control Cards*.

■ **Setting the PG Pulse Number (F1-01)**

Set the PG (pulse generator or encoder) pulse number in pulses/revolution. Set the number of phase A or phase B pulses in one motor revolution. This parameter cannot be changed during operation.

Parameter number	Display name	Setting range	Units	Default setting	Valid access levels*			
					V/f Control	V/f with PG	Open Loop Vector	Flux Vector
F1-01	PG Pulses/Rev	0 to 60,000	p/r	1,000	---	Q	---	Q

Note Q: Quick-start, Basic, or Advanced
 ---: Not applicable.

■ **Setting the Number of PG Gear Teeth (F1-12 and F1-13)**

When “V/f control with PG feedback” is used, the motor can be operated even if there are gears between the motor and PG because the responsiveness is lower than it is with vector control.

Set the number of teeth on the gears if there are gears between the motor and PG. The motor’s speed will be calculated within the Inverter using the following equation:

$$\text{Motor speed (r/min)} = \frac{\text{Number of pulses input from the PG} \times 60}{\text{Number of PG pulses (F1-01)}} \times \frac{\text{Number of gear teeth 2 (F1-13)}}{\text{Number of gear teeth 1 (F1-12)}}$$

Parameter number	Display name	Setting range	Units	Default setting	Valid access levels ¹			
					V/f Control	V/f with PG	Open Loop Vector	Flux Vector
F1-12	PG # Gear Teeth1	0 to 1,000	---	0	---	A	---	---
F1-13	PG # Gear Teeth2	0 to 1,000	---	0	---	A	---	---

Note 1. A: Advanced
 ---: Not applicable.

Note 2. These parameters cannot be changed during operation.

Note 3. A gear ratio of 1 (F1-12 = F1-13 = 1) will be used if either of these parameters is set to 0.

■ Selecting Integral Operation During Acceleration/Deceleration (F1-07)

When “V/f control with PG feedback” is used, integral control during acceleration and deceleration can be enabled or disabled with F1-07. This parameter cannot be changed during operation.

Set F1-07 to “1” (integral control enabled) if you want to keep the motor speed as close to the frequency reference as possible during acceleration and deceleration. Set F1-07 to “0” (integral control disabled) if you want to prevent the occurrence overshooting/undershooting.

Parameter number	Display name	Setting range	Units	Default setting	Valid access levels ¹			
					V/f Control	V/f with PG	Open Loop Vector	Flux Vector
F1-07	PG Ramp PI/I Sel	0 or 1	---	0	---	B	---	---

Note A: Basic or Advanced
 ---: Not applicable.

Settings

Setting	Function
0	Disabled (The integral function isn't used while accelerating or decelerating; it is used at constant speeds.)
1	Enabled (The integral function is used at all times.)

■ Setting and Adjusting the Fault Detection Functions

● PG Disconnection Stopping Method (F1-02)

This parameter sets the stopping method that is used when the signal from the PG is lost.

Parameter number	Display name	Setting range	Units	Default setting	Valid access levels*			
					V/f Control	V/f with PG	Open Loop Vector	Flux Vector
F1-02	PG Fdbk Loss Sel	0 to 3	---	1	---	B	---	B

Note B: Basic or Advanced
 ---: Not applicable.

Settings

Setting	Name	Function
0	Ramp to Stop	Deceleration stop using deceleration time 1 (C1-02).
1	Coast to Stop	Free-run stop
2	Fast Stop	Emergency stop using the fast-stop time (C1-09).
3	Alarm Only	Continue operation (Display “PGO” and continue operation with V/f control.)

● PG Disconnection Detection Time (F1-14)

A PG disconnection will be detected if a disconnection status lasts for the following time or longer.

Note The motor speed will not be controlled while the PG is disconnected. Set this time as short as possible in any application where safety cannot be ensured.

Parameter number	Display name	Setting range	Units	Default setting	Valid access levels*			
					V/f Control	V/f with PG	Open Loop Vector	Flux Vector
F1-14	PGO Detect Time	0.0 to 10.0	Sec	2.0	X	A	X	A

● **Overspeed Settings (F1-03, F1-08, and F1-09)**

Overspeed refers to an excessive motor speed. These parameters set the conditions for an overspeed fault and the stopping method that is used when an overspeed fault occurs; they cannot be changed during operation.

Parameter F1-03 sets the stopping method that is used when an overspeed fault occurs.

Parameter number	Display name	Setting range	Units	Default setting	Valid access levels*			
					V/f Control	V/f with PG	Open Loop Vector	Flux Vector
F1-03	PG Overspeed Sel	0 to 3	---	1	---	B	---	B

Note B: Basic or Advanced
 ---: Not applicable.

Settings

Setting	Name	Function
0	Ramp to Stop	Deceleration stop using deceleration time 1 (C1-02).
1	Coast to Stop	Free-run stop
2	Fast Stop	Emergency stop using the fast-stop time (C1-09).
3	Alarm Only	Continue operation (Display “OS” and continue control.)

Parameter F1-08 sets the overspeed detection level as a percentage of the maximum output frequency. Parameter F1-09 sets the length of time that the motor speed must exceed the overspeed detection level in order to generate an overspeed fault.

Parameter number	Display name	Setting range	Units	Default setting	Valid access levels*			
					V/f Control	V/f with PG	Open Loop Vector	Flux Vector
F1-08	PG Overspd Level	0 to 120	%	115	---	A	---	A
F1-09	PG Overspd Time	0.0 to 2.0	s	0.0	---	A	---	A

Note A: Advanced
 ---: Not applicable.

● **PG Speed Deviation Settings (F1-04, F1-10, and F1-11)**

PG speed deviation refers to the difference between the actual motor speed and the reference command speed. These parameters set the conditions for a PG speed deviation fault and the stopping method that is used when a PG speed deviation fault occurs; they cannot be changed during operation.

Parameter F1-04 sets the conditions for detecting a PG speed deviation fault and the stopping method to be used when a fault is detected.

Parameter number	Display name	Setting range	Units	Default setting	Valid access levels*			
					V/f Control	V/f with PG	Open Loop Vector	Flux Vector
F1-04	PG Deviation Sel	0 to 7	---	3	---	B	---	B

Note B: Basic or Advanced
 ---: Not applicable.

Settings

Setting	Stopping method	Function
0	Ramp to Stop (C1-02)/Fault	Detect when deviation occurs with the frequency reference matching (within the L4-02 detection range) the output frequency.
1	Coast to Stop/Fault	Detect when deviation occurs with the frequency reference matching (within the L4-02 detection range) the output frequency.
2	Fast Stop (C1-09)/Fault	Detect when deviation occurs with the frequency reference matching (within the L4-02 detection range) the output frequency.
3	Continue/Alarm Only	Detect when deviation occurs with the frequency reference matching (within the L4-02 detection range) the output frequency.
4	Ramp to Stop (C1-02)/Fault	Detect when deviation occurs with the frequency reference matching (within the L4-02 detection range) the motor speed (PG feedback).
5	Coast Stop/Fault	Detect when deviation occurs with the frequency reference matching (within the L4-02 detection range) the motor speed (PG feedback).
6	Fast Stop (C1-09)/Fault	Detect when deviation occurs with the frequency reference matching (within the L4-02 detection range) the motor speed (PG feedback).
7	Continue/Alarm Only	Detect when deviation occurs with the frequency reference matching (within the L4-02 detection range) the motor speed (PG feedback).

Note 1. In order to detect faulty contacts, and so on, inserted at the Inverter output side, select detection when the frequency reference matches the output frequency.

Note 2. The detection conditions vary as shown below depending on the software version. In Ver. VSG101114 and later versions, both functions are provided.
 VSG101043 and earlier software: Set values 0 to 3.
 VSG101113 software: Set values 4 to 7.

Parameter F1-10 sets the PG speed deviation detection level as a percentage of the maximum output frequency. Parameter F1-11 sets the length of time that the difference between the motor speed and reference speed must exceed the PG speed deviation detection level in order to generate a PG speed deviation fault (DEV).

Parameter number	Display name	Setting range	Units	Default setting	Valid access levels*			
					V/f Control	V/f with PG	Open Loop Vector	Flux Vector
F1-10	PG Deviate Level	0 to 50	%	10	---	A	---	A
F1-11	PG Deviate Time	0.0 to 10.0	s	0.5	---	A	---	A

Note A: Advanced
 ---: Not applicable.

5-5-4 Speed Loop (ASR) Structure

The following block diagram shows the structure of the speed loop.

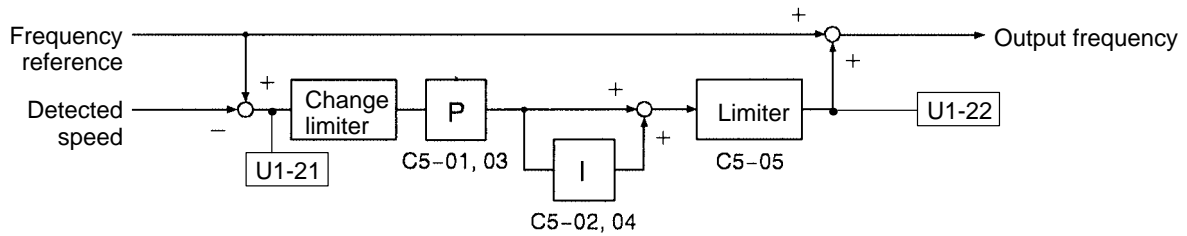

Gain Settings

When using “V/f control with PG feedback,” set the gain at the minimum frequency and maximum frequency.

Max. Frequency Gain Settings (C5-01 and C5-02)

Set ASR proportional gain 1 (C5-01) and ASR integral time 1 (C5-02) at the maximum frequency.

Parameter number	Display name	Setting range	Units	Default setting	Valid access levels*			
					V/f Control	V/f with PG	Open Loop Vector	Flux Vector
C5-01	ASR P Gain 1	0.00 to 300.00	Factor	0.20	---	B	---	B
C5-02	ASR I Time 1	0.000 to 10.000	s	0.200	---	B	---	B

Note B: Basic or Advanced
 ---: Not applicable.

Min. Frequency Gain Settings (C5-03 and C5-04)

Set ASR proportional gain 2 (C5-03) and ASR integral time 2 (C5-04) at the minimum frequency.

Parameter number	Display name	Setting range	Units	Default setting	Valid access levels*			
					V/f Control	V/f with PG	Open Loop Vector	Flux Vector
C5-03	ASR P Gain 2	0.00 to 300.00	Factor	0.02	---	B	---	B
C5-04	ASR I Time 2	0.000 to 10.000	s	0.050	---	B	---	B

Note B: Basic or Advanced
 ---: Not applicable.

The following graph shows how the proportional gain and integral time are calculated from parameters C5-01 through C5-04.

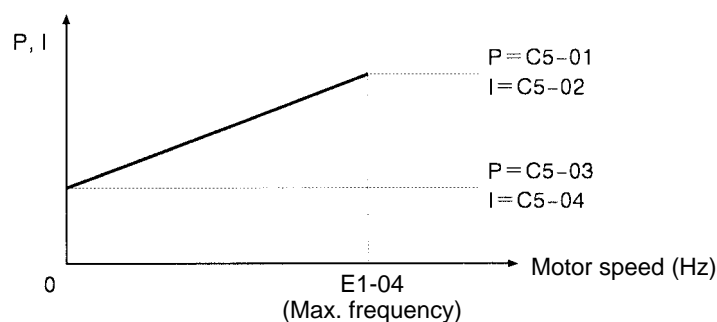

■ **Multi-function Input Settings (H1-01 through H1-06)**

● **V/f Mode Select (Setting D)**

When one of the multi-function inputs is set to “D,” the input can be used to enable and disable the speed control loop. The speed control loop is disabled (normal V/f control) when the multi-function input is ON.

● **ASR Integral Reset (Setting E)**

When one of the multi-function inputs is set to “E,” the input can be used to switch the speed control loop between P control and PI control. P control (integral reset) is used when the multi-function input is ON.

5-5-5 Adjusting Speed Control Loop (ASR) Gain

■ **Gain Adjustment Procedure**

Use the following procedure to adjust the gain with the mechanical system and actual load connected.

● **Gain Adjustments at Minimum Frequency**

1. Operate the motor at the minimum frequency.
2. Increase C5-03 (ASR proportional gain 2) to a level where there is no vibration.
3. Decrease C5-04 (ASR integral time 2) to a level where there is no vibration.
4. Monitor the Inverter’s output current and verify that it is less than 50% of the Inverter’s rated current. If the output current exceeds 50% of the Inverter’s rated current, decrease C5-03 and increase C5-04.

● **Gain Adjustments at Maximum Frequency**

1. Operate the motor at the maximum frequency.
2. Increase C5-01 (ASR proportional gain 1) to a level where there is no vibration.
3. Decrease C5-02 (ASR integral time 1) to a level where there is no vibration.

● **Gain Adjustments for Integral Control during Acceleration/Deceleration**

Enable integral operation during acceleration and deceleration (with F1-07) when you want the motor’s speed to closely follow the frequency reference during acceleration and deceleration. Integral operation causes the speed to reach the target speed as fast as possible, but may result in overshooting or undershooting.

1. Set F1-07 to “1” to enable integral operation at all times.
2. Make the parameter settings shown below in order to observe the speed waveform while making fine adjustments to the gain.

Parameter	Setting	Explanation
H4-01 Analog output selection (terminal 21)	21	Settings that allow multi-function analog output 1 to be used to monitor the ASR input.
H4-02 Analog output gain (terminal 21)	1.00	
H4-03 Analog output bias (terminal 21)	0.0	
H4-04 Analog output selection (terminal 23)	5	Settings that allow multi-function analog output 2 to be used to monitor the motor speed.
H4-05 Analog output gain (terminal 23)	1.00	
H4-06 Analog output bias (terminal 23)	0.0	
H4-07 Analog output level selection	1	This setting allows a 0 to ±10 V signal range to be monitored.

The multi-function analog outputs have the following functions with these parameter settings. Terminal 22 is the multi-function analog output common. (There are separate commons, terminals 27 and 37, for the 3G3FV-□-CUE/CE.)

Multi-function analog output 1 (terminal 21): Outputs the Inverter's ASR input (0 to ±10 V).

Multi-function analog output 2 (terminal 23): Outputs the actual motor speed (0 to ±10 V).

We recommend monitoring both the ASR input and the motor speed in order to observe a response delay or deviation from the reference value, as shown in the following diagram.

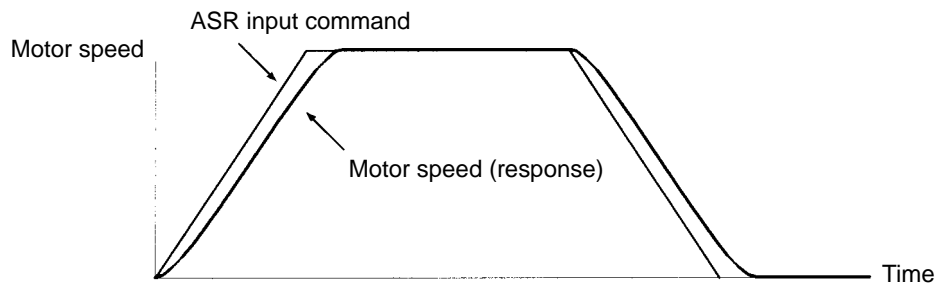

3. Give acceleration/deceleration commands and adjust the gain while observing the waveform.

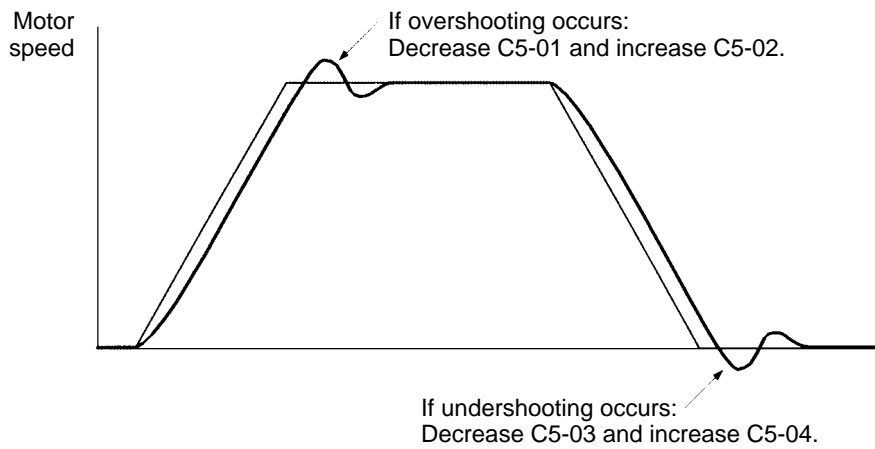

4. If the overshooting or undershooting can't be eliminated by adjusting the gain, decrease the ASR limit (C5-05) to lower the frequency reference compensation limit. Since C5-05 can't be changed during operation, stop the Inverter's operation and then decrease the ASR limit by 0.5 (%). Perform step 3 again after the setting has been changed.

The ASR limit is the frequency limit for compensation by speed control loop. Set this frequency limit as a percentage of the maximum output frequency. If the frequency limit is lowered too much, the motor speed might not reach the target speed. Verify that the target speed is reached during normal operation.

Parameter number	Display name	Setting range	Units	Default setting	Valid access levels*			
					V/f Control	V/f with PG	Open Loop Vector	Flux Vector
C5-05	ASR Limit	0.0 to 20.0	%	5.0	---	A	---	---

Note A: Advanced
 ---: Not applicable.

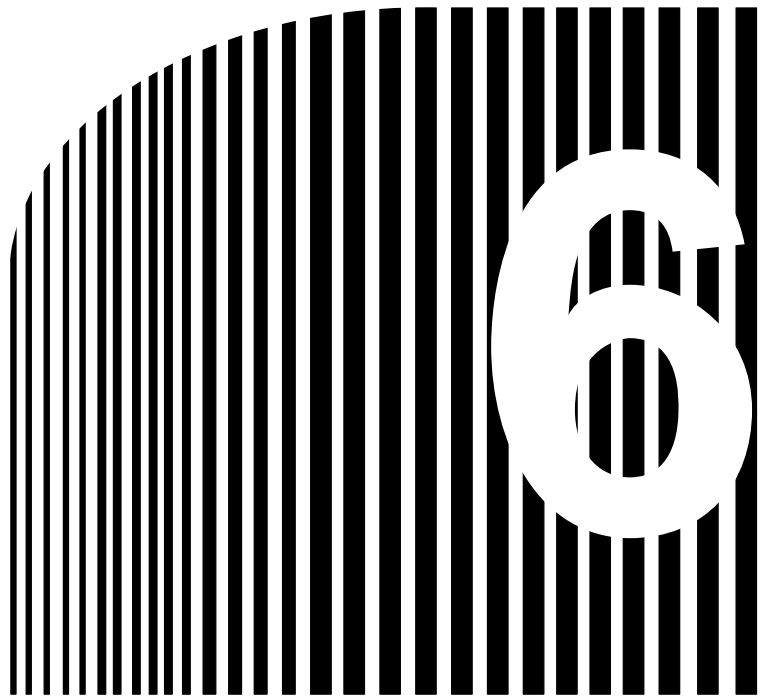

Chapter 6

• Advanced Operation •

- 6-1 Open-loop Vector Control
- 6-2 Normal V/f Control
- 6-3 Flux Vector Control
- 6-4 V/f Control With PG Feedback
- 6-5 Common Functions

6-1 Open-loop Vector Control

This section summarizes the functions that can be used with open-loop vector control (vector control without PG feedback) and then provides detailed explanations of the functions that are specific to open-loop vector control.

6-1-1 Summary of Open-loop Vector Control Functions

An “OK” in the control mode column indicates that the parameter can be changed in that control mode. The functions specific to open-loop vector control are marked with a “★” and described in more detail later in this section.

Group	Function		Comments	Control mode			
				V/f	V/f w/PG	Open-loop Vector	Flux Vector
Application	b1	Sequence	Settings such as the reference input method	OK	OK	OK	OK
	b2	DC Braking	DC braking function settings	OK	OK	OK	OK
	b3	Speed Search	Speed search function settings	OK	OK	OK	OK
	b4	Delay Timers	Timer function settings	OK	OK	OK	OK
	b5	PID Control	PID control settings	OK	OK	OK	OK
	b6	Reference Hold	Accel/deceleration time dwell function settings	OK	OK	OK	OK
	b7	---	Not used. (Can't be set.)	---	---	---	OK
	b8	Energy Saving	Not used. (Can't be set.)	OK	OK	---	---
	b9	Zero Servo	Not used. (Can't be set.)	---	---	---	OK
Tuning	C1	Accel/Decel	Acceleration/deceleration time settings	OK	OK	OK	OK
	C2	S-Curve Acc/Dec	S-curve characteristics for accel/decel times	OK	OK	OK	OK
	C3	Motor-Slip Comp	★ Slip compensation function settings	OK	OK	OK	OK
	C4	Torque Comp	★ Torque compensation function settings	OK	OK	OK	---
	C5	ASR Tuning	Not used. (Can't be set.)	---	OK	---	OK
	C6	Carrier Freq	Carrier frequency settings	OK	OK	OK	OK
	C7	Hunting Prev	Not used. (Can't be set.)	OK	OK	---	---
	C8	Factory Tuning	★ Adjustment for open-loop vector control	---	---	OK	---
Reference	d1	Preset Reference	Frequency reference settings (when using Operator)	OK	OK	OK	OK
	d2	Reference Limits	Frequency upper and lower limit settings	OK	OK	OK	OK
	d3	Jump Frequencies	Prohibited frequency settings	OK	OK	OK	OK
	d4	Sequence	Up/Down, Accel/Decel stop hold frequency setting	OK	OK	OK	OK
	d5	Torque Control	Not used. (Can't be set.)	---	---	---	OK
Motor	E1	V/f Pattern	★ Motor parameters (Motor parameters are set by the auto-tuning function.)	OK	OK	OK	OK
	E2	Motor Setup		OK	OK	OK	OK
	E3	Control Method 2	Control mode settings for second motor	OK	OK	OK	OK
	E4	V/f Pattern 2	Parameters for second motor	OK	OK	OK	OK
	E5	Motor Setup 2		OK	OK	OK	OK
Options	F1	PG Option Setup	Not used. (Can't be set.)	---	OK	---	OK
	F2	AI-14 Setup	Parameter settings for an Analog Command Card	OK	OK	OK	OK
	F3	DI-08, 16 Setup	Parameter settings for a Digital Command Card	OK	OK	OK	OK
	F4	AO-08, 12 Setup	Parameter settings for an Analog Monitor Card	OK	OK	OK	OK
	F5	DO-02 Setup	Not Used. (Do not change these settings.)	---	---	---	---
	F6	DO-08 Setup					
	F7	PO-36F Setup	Parameter settings for a Pulse Monitor Card	OK	OK	OK	OK
	F8	SI-F/G Setup	Parameter settings for a SYSMAC BUS Interface Card.	OK	OK	OK	OK
	F9	CP-916 Setup	Parameter settings for a CompoBus/D Communications Card	OK	OK	OK	OK

Group	Function		Comments	Control mode			
				V/f	V/f w/PG	Open-loop Vector	Flux Vector
Terminal	H1	Digital Inputs	Function selection for multi-function inputs	OK	OK	OK	OK
	H2	Digital Outputs	Function selection for multi-function outputs	OK	OK	OK	OK
	H3	Analog Inputs	Adjustment/function selection for external analog inputs	OK	OK	OK	OK
	H4	Analog Outputs	Adjustment/function selection for multi-function analog outputs	OK	OK	OK	OK
	H5	Serial Com Setup	Not Used. (Do not change this setting.)	---	---	---	---
Protection	L1	Motor Overload	Sets electrical/thermal functions that protect the motor.	OK	OK	OK	OK
	L2	PwrLoss Ridethru	Selects the power-loss processing method.	OK	OK	OK	OK
	L3	Stall Prevention	Accel/Decel stall prevention settings and selection	OK	OK	OK	OK
	L4	Ref Detection	Frequency detection settings and selection	OK	OK	OK	OK
	L5	Fault Restart	Fault restart function settings	OK	OK	OK	OK
	L6	Torque Detection	Sets overtorque detection functions 1 and 2 (by torque)	OK	OK	OK	OK
	L7	Torque Limit	★ Torque limit settings	---	---	OK	OK
	L8	Hdwe Protection	Hardware overheating and phase loss protection settings	OK	OK	OK	OK
Operator	o1	Monitor Select	Selects the Operator's display and setting methods.	OK	OK	OK	OK
	o2	Key Selections	Operator's key function selection and other parameters	OK	OK	OK	OK

6-1-2 Torque Limit Function

With open-loop vector control, the torque limit can be applied at an arbitrary value because the torque output by the motor is calculated internally.

The torque limit function is useful when the load cannot sustain a torque above a certain level or regenerative torque above a certain level. The two ways to apply a torque limit are listed below. (The lower torque limit will be used if both of these methods are set.)

- 1) Setting a torque limit with the parameters
- 2) Limiting torque with the analog inputs

The precision of the torque limit is $\pm 5\%$ for output frequencies above 10 Hz, but the precision is lower for output frequencies below 10 Hz. Use flux vector control if you want to apply a torque limit at low-speed (below 10 Hz).

■ Setting a Torque Limit with Parameters

Torque limits can be set separately for the 4 ways that torque can be applied: forward torque, reverse torque, forward regenerative torque, and reverse forward regenerative torque. These parameters cannot be changed during operation.

Parameter number	Display name	Setting range	Units	Default setting	Valid access levels			
					V/f Control	V/f with PG	Open Loop Vector	Flux Vector
L7-01	Torque Limit Fwd	0 to 300	%	200	Not applicable		Basic or Advanced	
L7-02	Torque Limit Rev							
L7-03	Torque Limit Fwd Rgn							
L7-04	Torque Limit Rev Rgn							

The following diagram shows the relationship between each parameter and the output torque.

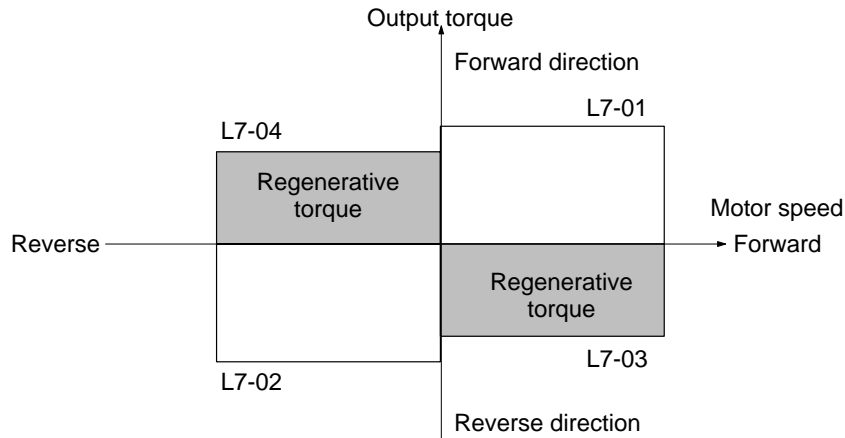

Note When the torque limit function is engaged the torque control has priority and motor speed control and compensation will be ignored, so the acceleration/deceleration times might be lengthened and motor speed might be reduced.

■ Limiting Torque with Analog Inputs

The following two analog inputs that can be used to limit torque.

- Multi-function analog input terminal 16
- Frequency reference (current) terminal 14

Use either or both of these inputs as needed with parameters H3-05 and H3-09. These parameters cannot be changed during operation.

Parameter number	Display name	Setting range	Units	Default setting	Valid access levels			
					V/f Control	V/f with PG	Open Loop Vector	Flux Vector
H3-05	Terminal 16 Sel	0 to 1F	---	1F	Basic or Advanced			
H3-09	Terminal 14 Sel	1 to 1F	---	1F	Advanced			

Settings

The following table shows only those settings related to the torque limit function.

Setting	Name
10	Forward Torque Limit
11	Reverse Torque Limit
12	Regenerative Torque Limit
15	Speed Limit (Limits torque in both the forward and reverse directions.)

Set the analog input terminal’s signal level, gain, and bias to match the actual input signal. The factory default settings for the input terminal’s signal level are as follows:

- Terminal 16: 0 to 10 V (A 10-V input limits the torque to 100% of the motor’s rated torque.)
- Terminal 14: 4 to 20 mA (A 20-mA input limits the torque to 100% of the motor’s rated torque.)

The following diagram shows the relationship between the output torque and each torque limit.

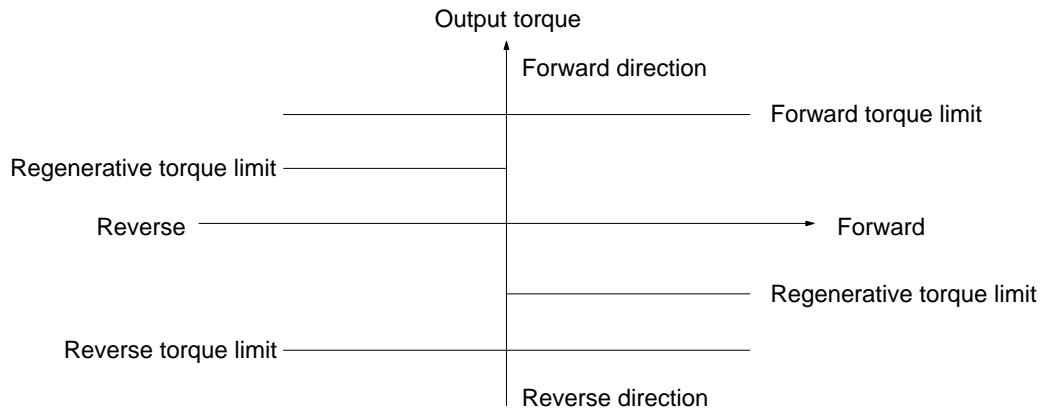

- Note 1.** When the forward torque limit has been set, the analog input signal acts as the limit value for torque generated in the forward direction. The torque limit input is effective when torque is generated in the forward direction even if the motor is operating in reverse (regenerative torque).
- Note 2.** The torque limit is 100% of the motor’s rated torque when the analog input is at its maximum value (10 V or 20 mA). To increase the torque limit above 100%, set the input terminal’s gain above 100%. For example, a gain of 150.0% would result in a torque limit of 150% of the motor’s rated torque with a 10-V or 20-mA analog input.

6-1-3 Adjusting Speed Feedback

With open-loop vector control, internal Inverter data is used to calculate the feedback value. The gain of this automatic frequency regulator (AFR) operation can be fine-tuned according to motor response. (Normally it isn’t necessary to change the default setting.)

Parameter number	Display name	Setting range	Units	Default setting	Valid access levels			
					V/f Control	V/f with PG	Open Loop Vector	Flux Vector
C8-08	AFR Gain	0.00 to 10.00	Factor	1.00	---	---	Advanced	---

Parameter number	Display name	Setting range	Units	Default setting	Valid access levels			
					V/f Control	V/f with PG	Open Loop Vector	Flux Vector
C8-09	AFR Time	0 to 2000	ms	50	---	---	Advanced	---

- Note 1.** The default settings do not normally need to be changed.
- Note 2.** Fine-tune the gain or time constant if the rotation of the motor is unstable, causing hunting to occur, or the torque and speed responsiveness of the motor is low.
- Set parameter C8-09 to a larger value if hunting occurs. Set the parameter C8-08 to a smaller value if hunting cannot be suppressed with the parameter C8-09.
 - Set parameter C8-09 to a smaller value within a range where no hunting occurs if the torque and speed responsiveness of the motor are low. To increase the gain, set parameter C8-08 to a larger value within a range where no hunting occurs.

6-1-4 Setting Magnetic Flux Characteristics for Open-loop Vector Control

Set the following parameter to select the method for V/f calculation to determine the magnetic flux characteristics. The default setting does not normally need to be changed. Set the parameter if stable slip compensation is required in the constant output area where the operating frequency is as high as or higher than the rated frequency.

Parameter number	Display name	Setting range	Units	Default setting	Valid access levels			
					V/f Control	V/f with PG	Open Loop Vector	Flux Vector
C3-05	Flux Select	0, 1	---	0	---		Advanced	---

Settings

Setting	Description
0	The calculation of magnetic flux in open-loop vector control is based on the output frequency after slip compensation.
1	The calculation of magnetic flux in open-loop vector control is based on the output frequency with the V/f characteristic (i.e., the value without slip compensation).

Note Set the parameter to 1 if the speed of the motor is unstable in the constant output area.

6-1-5 Operation for Saturated Output Voltage

Previously, the accuracy of motor speed for vector control was greatly reduced when the limit of the Inverter’s voltage output was approached (a voltage greater than that of the input power supply cannot be output).

Set the following parameter to control the output voltage so that the limit will not be reached, thus maintaining speed accuracy.

Parameter number	Display name	Setting range	Units	Default setting	Valid access levels			
					V/f Control	V/f with PG	Open Loop Vector	Flux Vector
C3-06	Output V limit	0, 1	---	0	---		Advanced	---

Settings

Setting	Description
0	Disabled. (There is no limit of output voltage saturation. Slip compensation is disabled when the output voltage saturates.)
1	Enabled. (Output voltage saturation is suppressed to maintain speed control.)

Note 1. Set the parameter to 1 if accuracy of speed is required within the rated rpm range. This will cause an increase of approximately 10% in the output current. Therefore, be sure that Inverter has more than sufficient output current.

Note 2. If the Inverter’s input voltage is extremely lower than the rated motor voltage, the accuracy of the speed of the motor may not be maintained even with the output voltage suppressed.

6-1-6 Startup Torque Compensation

With open-loop vector control, a starting-torque compensation can be input to decrease the torque reference's rise time at startup.

This function is effective for equipment in which a starting torque is required, such as machinery with a high friction load or cranes. Unlike flux vector control, the compensation is input only at startup.

Starting-torque Compensation Function Settings

Parameter number	Display name	Setting range	Units	Default setting	Valid access levels			
					V/f Control	V/f with PG	Open Loop Vector	Flux Vector
C4-03	F TorqCmp@start	0.0 to 200.0	0.1%	0.0	---		Advanced	---
C4-04	R TorqCmp@start	-200.0 to 0.0	0.1%	0.0	---		Advanced	---
C4-05	TorqCmp Delay T	0 to 200	1 ms	10	---		Advanced	---

These parameters cannot be changed during operation.

Timing Chart

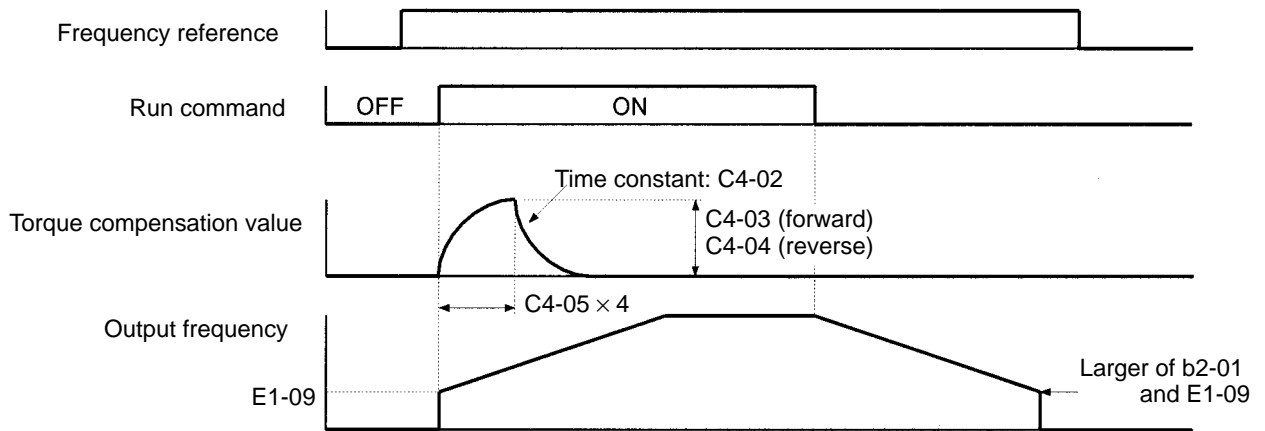

Note The Inverter's torque reference value is at its lower limit with the torque compensation value shown above.

- When using this compensation function, set the starting-torque compensation value to the friction load in regular machinery or the lifting/lowering load for machinery such as cranes.
 - Friction loads:
Set the friction load in both C4-03 and C4-04.
 - Lifting/lowering load:
Set the electrically driven (winding) load only. (When the lifting machinery is equipped with a counterweight, a shock may be generated if there is a regenerative load so do not use this function.)
- It is only possible to set the electrically driven compensation in both forward and reverse. (The regenerative setting cannot be made.)
- The starting-torque compensation is not applied when switching between forward and reverse or after a speed search.
- The starting-torque compensation is usually not applied when using a second motor.

- When a shock is generated at startup, increase the setting for the starting-torque compensation time constant (C4-05). Use either the DC injection braking at startup (b2-03) or the “DC braking reference” multi-function input (set value: 60) to raise the motor’s magnetic flux in advance before startup. (The magnetic flux from the DC injection braking at startup (b2-03) can also be brought up quickly. Refer to *Setting DC Injection Braking (b2)* on page 6-42 for details.)

6-1-7 Selecting Auto-tuning Carrier Frequency

The auto-tuning carrier frequency is by default set to a value higher than that used for conventional models to improve the accuracy of auto-tuning. The default setting does not normally need to be changed.

Parameter number	Display name	Setting range	Units	Default setting	Valid access levels			
					V/f Control	V/f with PG	Open Loop Vector	Flux Vector
C8-30	Carrier in tune	0 to 2	---	2	---	---	Advanced	---

Settings

Setting	Description
0	The auto-tuning carrier frequency is set to 2 kHz.
1	The auto-tuning carrier frequency is set according to the set value of parameter C6-01.
2	The auto-tuning carrier frequency is set to 5 kHz.

Note The default setting does not normally need to be changed. Adjust the parameter with the parameter C6-01 set to 0 or 1 if auto tuning cannot be executed.

6-1-8 Setting/Adjusting Motor Parameters

■ Adjusting the V/f Pattern

Normally it isn’t necessary to adjust the V/f pattern with open-loop vector control. Adjust the V/f pattern when you want to change the maximum frequency setting or decrease the Inverter’s output voltage or when stalls are occurring during no-load operation. It is possible to make user-defined V/f pattern settings (E1-04 through E1-10) in open-loop vector control mode. (The preset V/f patterns cannot be selected.)

Parameter number	Display name	Setting range	Units	Default setting	Valid access levels*1			
					V/f Control	V/f with PG	Open Loop Vector	Flux Vector
E1-04	Max Frequency	40.0 to 400.0	Hz	60.0	Q	Q	Q	Q
E1-05	Max Voltage	0.0 to 255.0*2	VAC	200.0*2	Q	Q	Q	Q
E1-06	Base Frequency	0.0 to 400.0	Hz	60.0	Q	Q	Q	Q
E1-07	Mid Frequency A	0.0 to 400.0	Hz	3.0*2	Q	Q	A	---
E1-08	Mid Voltage A	0.0 to 255.0*2	VAC	11.0*2,3	Q	Q	A	---
E1-09	Min Frequency	0.0 to 400.0	Hz	0.5	Q	Q	Q	A
E1-10	Min Voltage	0.0 to 255.0*2	VAC	2.0*2,3	Q	Q	A	---

Note 1. Q: Quick Start, Basic, or Advanced
 A: Advanced only
 ---: Not applicable.

- Note 2.** These voltages are for the 200-V class; Double the voltage for 400-V class Inverters.
- Note 3.** The default setting depends on the Inverter’s capacity. The default settings shown in the table are for 200-V class, 0.4 to 1.5 kW Inverters.
- Note 4.** The default settings for E1-07 through E1-10 depend on the control mode. The default settings shown in the table are for open-loop vector control.
- Note 5.** The four frequency settings must satisfy the following formula:

$$E1-04 (F_{MAX}) \geq E1-06 (F_A) > E1-07 (F_B) \geq E1-09 (F_{MIN})$$
 For flux vector control, make the settings as follows:

$$E1-04 (F_{MAX}) \geq E1-06 (F_A) > E1-09 (F_{MIN})$$
- Note 6.** When making the V/f characteristics a straight line, set the same value in E1-07 (middle output frequency) and E1-09 (minimum output frequency). In this case, parameter E1-08 (middle output voltage) will be ignored.

User-defined V/f Pattern

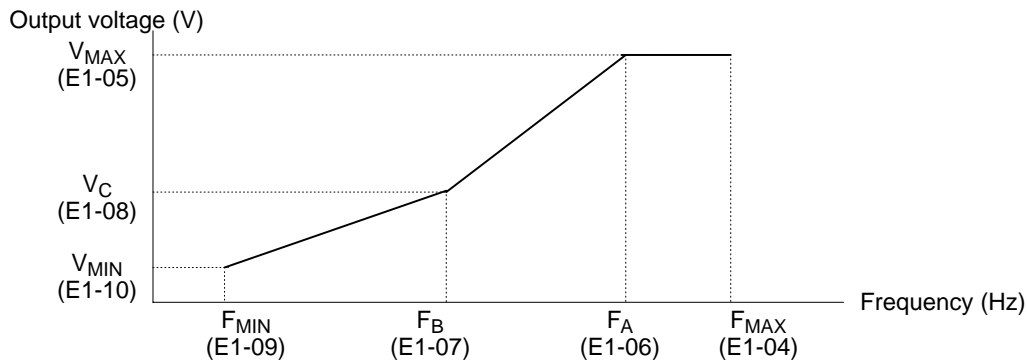

● **Adjusting Output Voltage**

Adjust the output voltage when you want to output more torque at low speed, such as in an elevator, or when torque isn’t really necessary and you want to reduce the output voltage to save energy.

- When generating more torque, gradually increase the voltage but do not exceed 100% of the Inverter’s rated output current.
- When saving energy, decrease the voltage but do not cause stalling.

● **Setting the Maximum Frequency**

The maximum frequency can be set from 50.0 to 400.0 Hz. Set this parameter in accordance with the motor’s maximum rotational speed.

■ **Setting Motor Parameters**

The motor parameters (function E2) will all be set automatically when auto-tuning is performed, so it normally isn’t necessary to set them manually. Set these parameters manually if auto-tuning can’t be completed properly. These parameters cannot be changed during operation.

Set the rated current (A) shown on the motor’s nameplate.

Parameter number	Display name	Setting range	Units	Default setting*	Valid access levels			
					V/f Control	V/f with PG	Open Loop Vector	Flux Vector
E2-01	Motor Rated FLA	0.32 to 6.40	A	1.90	Quick Start, Basic, or Advanced			

Note The setting range is 10% to 200% of the Inverter’s rated output current. The default setting depends upon the type of Inverter. (The table shows the default setting for 200-V class, 0.4-kW Inverters.)

Calculate the rated slip (E2-02) from the value shown on the motor’s nameplate with the following equation and set this value.

$$\text{Rated slip} = \text{rated frequency (Hz)} - \text{rated speed (r/min)} \times \text{number of poles}/120$$

Set the no-load current (E2-03) at the rated voltage and rated frequency. Normally this value isn’t shown on the motor’s nameplate, so it might be necessary to contact the motor manufacturer.

Parameter number	Display name	Setting range	Units	Default setting*	Valid access levels			
					V/f Control	V/f with PG	Open Loop Vector	Flux Vector
E2-02	Motor Rated Slip	0.00 to 20.00	Hz	2.90	Advanced		Quick Start, Basic, or Advanced	
E2-03	No-Load Current	0.00 to 2.90 (see note 2)	A	1.20				

Note 1. The default setting depends upon the type of Inverter. (The table shows the default settings for 200-V class, 0.4-kW Inverters.)

Note 2. The setting range is between 0.00 and 0.1 less than the Inverter’s rated current.

Set the motor’s terminal resistance between U and V, V and W, or W and U.

Usually the nameplate of the motor does not provide the motor’s terminal resistance. Contact the motor manufacturer for a test report on the motor’s terminal resistance to set the following values.

- Type E insulation: Motor’s terminal resistance (Ω) at 75°C x 0.92
- Type B insulation: Motor’s terminal resistance (Ω) at 75°C x 0.92
- Type F insulation: Motor’s terminal resistance (Ω) at 115°C x 0.87

Parameter number	Display name	Setting range	Units	Default setting	Valid access levels			
					V/f Control	V/f with PG	Open Loop Vector	Flux Vector
E2-05	Term Resistance	0.000 to 65.000	Ω	9.842	Advanced			

Note The default setting depends upon the type of Inverter.

(The table shows the default settings for 200-V class, 0.4-kW Inverters.)

Set the voltage drop (caused by the motor’s leakage inductance) as a percentage of the motor’s rated voltage in parameter E2-06. Normally this value is not shown on the motor’s nameplate, so it might be necessary to contact the motor manufacturer. It is also acceptable to set the loss (caused by the motor’s leakage inductance) as a percentage.

Parameter number	Display name	Setting range	Units	Default setting	Valid access levels			
					V/f Control	V/f with PG	Open Loop Vector	Flux Vector
E2-06	Leak Inductance	0.0 to 40.0	%	18.2	Not applicable.		Advanced	

Note The default setting depends upon the type of Inverter.

(The table shows the default settings for 200-V class, 0.4-kW Inverters.)

The default setting does not normally need to be changed because the Inverter in operation adjusts the leak inductance automatically. Set the parameter if a high-speed motor or any other motor with low inductance is used.

Parameters E2-07 and E2-08 are used in a frequency range even higher than the motor’s rated frequency. It isn’t necessary to set these parameters when operating below the motor’s rated frequency. Set the following values:

Motor core-saturation coefficient 1: Core-saturation coefficient when magnetic flux is 50%.

Motor core-saturation coefficient 2: Core-saturation coefficient when magnetic flux is 75%.

Normally these values aren't shown on the motor's nameplate, so it might be necessary to contact the motor manufacturer.

Parameter number	Display name	Setting range	Units	Default setting	Valid access levels			
					V/f Control	V/f with PG	Open Loop Vector	Flux Vector
E2-07	Saturation Comp 1	0.0 to 0.50	---	0.50	Not applicable.		Advanced	
E2-08	Saturation Comp 2	0.00 to 0.75	---	0.75				

Note It is possible to operate the motor with the default settings, but motor efficiency may decrease.

6-2 Normal V/f Control

This section summarizes the functions that can be used with normal V/f control (V/f control without PG feedback) and then provides detailed explanations of the functions that are specific to normal V/f control.

6-2-1 Summary of V/f Control Functions

An “OK” in the control mode column indicates that the parameter can be changed in that control mode. The functions specific to normal V/f control are marked with a “★” and described in more detail later in this section.

Group	Function		Comments	Control mode			
				V/f	V/f w/PG	Open-loop Vector	Flux Vector
Application	b1	Sequence	Settings such as the reference input method	OK	OK	OK	OK
	b2	DC Braking	DC braking function settings	OK	OK	OK	OK
	b3	Speed Search	Speed search function settings	OK	OK	OK	OK
	b4	Delay Timers	Timer function settings	OK	OK	OK	OK
	b5	PID Control	PID control settings	OK	OK	OK	OK
	b6	Reference Hold	Accel/deceleration time dwell function settings	OK	OK	OK	OK
	b7	---	Not used. (Can't be set.)	---	---	---	OK
	b8	Energy Saving	★ Multi-function input: Energy-saving control settings	OK	OK	---	---
	b9	Zero Servo	Not used. (Can't be set.)	---	---	---	OK
Tuning	C1	Accel/Decel	Acceleration/deceleration time settings	OK	OK	OK	OK
	C2	S-Curve Acc/Dec	S-curve characteristics for accel/decel times	OK	OK	OK	OK
	C3	Motor-Slip Comp	Slip compensation function settings	OK	OK	OK	OK
	C4	Torque Comp	Torque compensation function settings	OK	OK	OK	---
	C5	ASR Tuning	Not used. (Can't be set.)	---	OK	---	OK
	C6	Carrier Freq	Carrier frequency settings	OK	OK	OK	OK
	C7	Hunting Prev	★ Hunting prevention function settings	OK	OK	---	---
	C8	Factory Tuning	Not used. (Can't be set.)	---	---	OK	---
Reference	d1	Preset Reference	Frequency reference settings (when using Operator)	OK	OK	OK	OK
	d2	Reference Limits	Frequency upper and lower limit settings	OK	OK	OK	OK
	d3	Jump Frequencies	Prohibited frequency settings	OK	OK	OK	OK
	d4	Sequence	Up/Down, Accel/Decel stop hold frequency setting	OK	OK	OK	OK
	d5	Torque Control	Not used. (Can't be set.)	---	---	---	OK
Motor	E1	V/f Pattern	★ Motor parameters (Motor parameters set manually.)	OK	OK	OK	OK
	E2	Motor Setup		OK	OK	OK	OK
	E3	Control Method 2	Control mode settings for second motor	OK	OK	OK	OK
	E4	V/f Pattern 2	Parameter settings for second motor	OK	OK	OK	OK
	E5	Motor Setup 2		OK	OK	OK	OK
Options	F1	PG Option Setup	Not used. (Can't be set.)	---	OK	---	OK
	F2	AI-14 Setup	Parameter settings for an Analog Command Card	OK	OK	OK	OK
	F3	DI-08, 16 Setup	Parameter settings for a Digital Command Card	OK	OK	OK	OK
	F4	AO-08, 12 Setup	Parameter settings for an Analog Monitor Card	OK	OK	OK	OK
	F5	DO-02 Setup	Not Used. (Do not change these settings.)	---	---	---	---
	F6	DO-08 Setup					
	F7	PO-36F Setup	Parameter settings for a Pulse Monitor Card	OK	OK	OK	OK
	F8	SI-F/G Setup	Parameter settings for a SYSMAC BUS Interface Card.	OK	OK	OK	OK
	F9	CP-916 Setup	Parameter settings for a CompoBus/D Communications Card.	OK	OK	OK	OK

Group	Function		Comments	Control mode			
				V/f	V/f w/PG	Open-loop Vector	Flux Vector
Terminal	H1	Digital Inputs	Function selection for multi-function inputs	OK	OK	OK	OK
	H2	Digital Outputs	Function selection for multi-function outputs	OK	OK	OK	OK
	H3	Analog Inputs	Adjustment/function selection for external analog inputs	OK	OK	OK	OK
	H4	Analog Outputs	Adjustment/function selection for multi-function analog outputs	OK	OK	OK	OK
	H5	Serial Com Setup	Not Used. (Do not change this setting.)	---	---	---	---
Protection	L1	Motor Overload	Sets electrical/thermal functions that protect the motor.	OK	OK	OK	OK
	L2	PwrLoss Ridethru	Selects the power-loss processing method.	OK	OK	OK	OK
	L3	Stall Prevention	Accel/Decel/Run stall prevention settings and selection	OK	OK	OK	OK
	L4	Ref Detection	Frequency detection settings and selection	OK	OK	OK	OK
	L5	Fault Restart	Fault restart function settings	OK	OK	OK	OK
	L6	Torque Detection	Sets overtorque detection functions 1 and 2 (by current)	OK	OK	OK	OK
	L7	Torque Limit	Not used. (Can't be set.)	---	---	OK	OK
	L8	Hdwe Protection	Hardware overheating and phase loss protection settings	OK	OK	OK	OK
Operator	o1	Monitor Select	Selects the Operator's display and setting methods.	OK	OK	OK	OK
	o2	Key Selections	Operator's key function selection and other parameters	OK	OK	OK	OK

6-2-2 Energy-saving Control Function

The energy-saving control function is enabled when the energy-saving command (setting 63) has been set in a multi-function input (H1-01 through H1-06). Inputting the energy-saving command while there is a light load causes the Inverter's output voltage to be reduced and saves energy. Turn OFF the energy-saving command when a normal load is added.

Parameter b8-01 determines the Inverter's output voltage when the energy-saving command is input. Set this value as a percentage of the V/f pattern's voltage. Parameter L2-04 (the voltage recovery time) determines the rate at which the output voltage is changed when the energy-saving command is turned ON or OFF.

Parameter b8-02 determines the lower limit frequency for the energy-saving function. The energy-saving command is enabled only when the frequency reference is above this lower-limit and the motor speed is within the "speed agree" range.

Parameters b8-01 and b8-02 cannot be changed during operation.

Parameter number	Display name	Setting range	Units	Default setting	Valid access levels			
					V/f Control	V/f with PG	Open Loop Vector	Flux Vector
b8-01	Energy Save Gain	0 to 100	%	80	Advanced		Not applicable.	
b8-02	Energy Save Freq	0.0 to 400.0	Hz	0.0				

Timing Chart

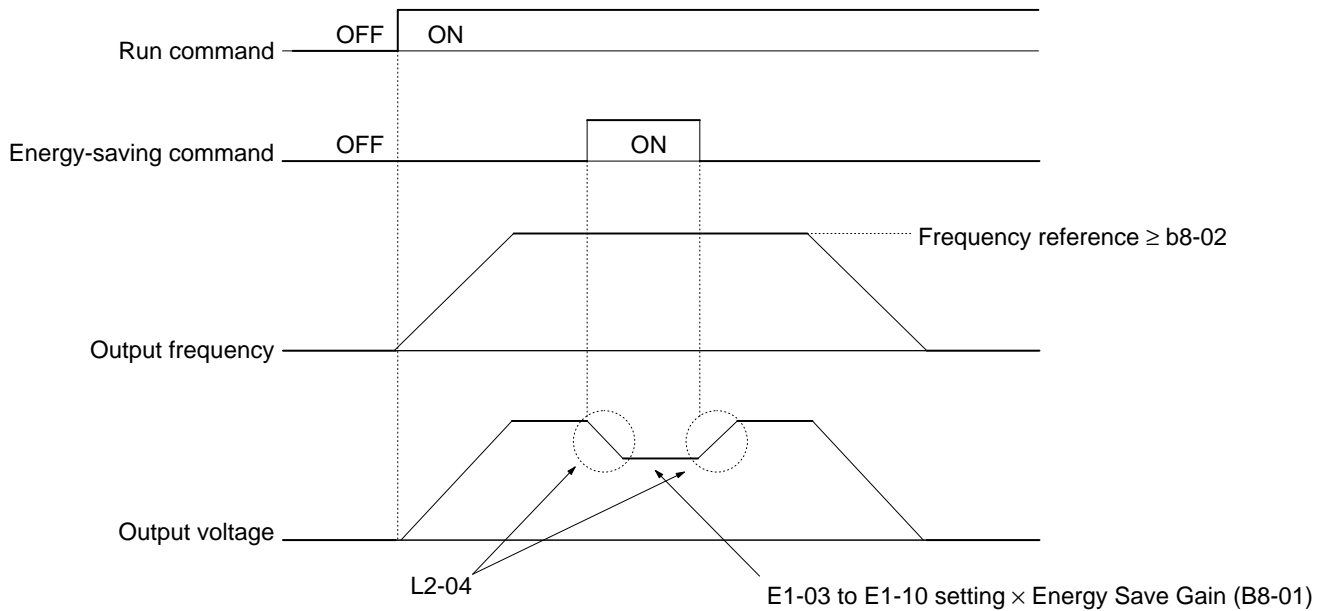

6-2-3 Hunting-prevention Function

The hunting-prevention function suppresses hunting when the motor is operating with a light load. This function is valid with V/f control and V/f with PG control. Parameters C7-01 and C7-02 cannot be changed during operation.

Parameter number	Display name	Setting range	Units	Default setting	Valid access levels			
					V/f Control	V/f with PG	Open Loop Vector	Flux Vector
C7-01	Hung Prev Select	0, 1	---	1	Advanced		Not applicable.	

C7-01 Settings

Setting	Function
0	Disables the hunting-prevention function.
1	Enables the hunting-prevention function.

Parameter number	Display name	Setting range	Units	Default setting	Valid access levels			
					V/f Control	V/f with PG	Open Loop Vector	Flux Vector
C7-02	Hung Prev Gain	0.00 to 2.50	Factor	1.00	Advanced		Not applicable.	

Normally it isn't necessary to change these parameters. Adjust these parameters as follows if hunting occurs with a light load.

- Increase the setting in C7-02 if vibration occurs when operating with a light load. (If the setting is increased too much, the current can fall to the point where stalling occurs.)
- Decrease the setting in C7-02 if stalling occurs.
- Disable the hunting-prevention function (C7-01 = 0) if high responsiveness is more important than suppressing vibration.

6-2-4 Setting Motor Parameters

The motor parameters other than the V/f pattern parameters are described below:

Calculate the rated slip (E2-02) from the value shown on the motor’s nameplate with the following equation and set this value.

$$\text{Rated slip} = \text{rated frequency (Hz)} - \text{rated speed (r/min)} \times \text{number of poles}/120$$

Set the no-load current (E2-03) at the rated voltage and rated frequency. Normally this value isn’t shown on the motor’s nameplate, so it might be necessary to contact the motor manufacturer.

Parameter number	Display name	Setting range	Units	Default setting*	Valid access levels			
					V/f Control	V/f with PG	Open Loop Vector	Flux Vector
E2-02	Motor Rated Slip	0.00 to 20.00	Hz	2.90	Advanced		Quick Start, Basic, or Advanced	
E2-03	No-Load Current	0.00 to 2.90 (see note 2)	A	1.20				

Note 1. The default setting depends upon the type of Inverter.
(The table shows the default settings for 200-V class, 0.4-kW Inverters.)

Note 2. The setting range is between 0.00 and 0.1 less than the Inverter’s rated current.

Note 3. These settings are used as reference values for the motor slip compensation function.

Set the motor’s terminal resistance (phase to phase) in parameter E2-05. Normally this value isn’t shown on the motor’s nameplate, so it might be necessary to contact the motor manufacturer.

Parameter number	Display name	Setting range	Units	Default setting	Valid access levels			
					V/f Control	V/f with PG	Open Loop Vector	Flux Vector
E2-05	Term Resistance	0.000 to 65.000	Ω	9.842	Advanced			

Note 1. The default setting depends upon the type of Inverter.
(The table shows the default settings for 200-V class, 0.4-kW Inverters.)

Note 2. This setting is used as a reference value for the torque compensation function.

Parameter number	Display name	Setting range	Units	Default setting*	Valid access levels			
					V/f Control	V/f with PG	Open Loop Vector	Flux Vector
E2-10	Tcomp Iron Loss	0 to 65535	W	14	Advanced		---	

Note 1. The default setting varies with the Inverter’s capacity. The above setting applies to 200-V class, 0.4-kW Inverters.

Note 2. Set the motor iron core loss in 1-W increments. The default setting does not normally need to be changed.

Note 3. The set value is used as the reference value for the torque compensation function.

6-3 Flux Vector Control

This section summarizes the functions that can be used with flux vector control (vector control with PG feedback) and then provides detailed explanations of the functions that are specific to flux vector control.

6-3-1 Summary of Flux Vector Control Functions

An “OK” in the control mode column indicates that the parameter can be changed in that control mode. The functions specific to normal V/f control are marked with a “★” and described in more detail later in this section.

Group	Function		Comments	Control mode			
				V/f	V/f w/PG	Open-loop Vector	Flux Vector
Application	b1	Sequence	Settings such as the reference input method	OK	OK	OK	OK
	b2	DC Braking	DC braking function settings	OK	OK	OK	OK
	b3	Speed Search	Speed search function settings	OK	OK	OK	OK
	b4	Delay Timers	Timer function settings	OK	OK	OK	OK
	b5	PID Control	PID control settings	OK	OK	OK	OK
	b6	Reference Hold	Accel/deceleration time dwell function settings	OK	OK	OK	OK
	b7	Droop Control	★ Droop Control function settings	---	---	---	OK
	b8	Energy Saving	Not used. (Can't be set.)	OK	OK	---	---
	b9	Zero Servo	★ Zero-servo function settings	---	---	---	OK
Tuning	C1	Accel/Decel	Acceleration/deceleration time settings	OK	OK	OK	OK
	C2	S-Curve Acc/Dec	S-curve characteristics for accel/decel times	OK	OK	OK	OK
	C3	Motor-Slip Comp	★ Motor temperature compensation function adjustment	OK	OK	OK	OK
	C4	Torque Comp	Not used. (Can't be set.)	OK	OK	OK	---
	C5	ASR Tuning	Speed control loop adjustment	---	OK	---	OK
	C6	Carrier Freq	Carrier frequency settings	OK	OK	OK	OK
	C7	Hunting Prev	Not used. (Can't be set.)	OK	OK	---	---
	C8	Factory Tuning	Not used. (Can't be set.)	---	---	OK	---
Reference	d1	Preset Reference	Frequency reference settings (when using Operator)	OK	OK	OK	OK
	d2	Reference Limits	Frequency upper and lower limit settings	OK	OK	OK	OK
	d3	Jump Frequencies	Prohibited frequency settings	OK	OK	OK	OK
	d4	Sequence	Up/Down, Accel/Decel stop hold frequency setting	OK	OK	OK	OK
	d5	Torque Control	★ Torque control settings and adjustment	---	---	---	OK
Motor	E1	V/f Pattern	★ Motor parameters (Motor parameters set automatically with auto-tuning.)	OK	OK	OK	OK
	E2	Motor Setup		OK	OK	OK	OK
	E3	Control Method 2	Control mode settings for second motor	OK	OK	OK	OK
	E4	V/f Pattern 2	Parameter settings for second motor	OK	OK	OK	OK
	E5	Motor Setup 2		OK	OK	OK	OK
Options	F1	PG Option Setup	Parameter settings for a PG Speed Control Card	---	OK	---	OK
	F2	AI-14 Setup	Parameter settings for an Analog Command Card	OK	OK	OK	OK
	F3	DI-08, 16 Setup	Parameter settings for a Digital Command Card	OK	OK	OK	OK
	F4	AO-08, 12 Setup	Parameter settings for an Analog Monitor Card	OK	OK	OK	OK
	F5	DO-02 Setup	Not Used. (Do not change these settings.)	---	---	---	---
	F6	DO-08 Setup					
	F7	PO-36F Setup	Parameter settings for a Pulse Monitor Card	OK	OK	OK	OK
	F8	SI-F/G Setup	Parameter settings for a SYSMAC BUS Interface Card.	OK	OK	OK	OK
	F9	CP-916 Setup	Parameter settings for a CompoBus/D Communications Card.	OK	OK	OK	OK

Group	Function		Comments	Control mode			
				V/f	V/f w/PG	Open-loop Vector	Flux Vector
Terminal	H1	Digital Inputs	Function selection for multi-function inputs	OK	OK	OK	OK
	H2	Digital Outputs	Function selection for multi-function outputs	OK	OK	OK	OK
	H3	Analog Inputs	Adjustment/function selection for external analog inputs	OK	OK	OK	OK
	H4	Analog Outputs	Adjustment/function selection for multi-function analog outputs	OK	OK	OK	OK
	H5	Serial Com Setup	Not Used. (Do not change this setting.)		---	---	---
Protection	L1	Motor Overload	Sets electrical/thermal functions that protect the motor.	OK	OK	OK	OK
	L2	PwrLoss Ridethru	Selects the power-loss processing method.	OK	OK	OK	OK
	L3	Stall Prevention	Accel/Decel stall prevention settings and selection	OK	OK	OK	OK
	L4	Ref Detection	Frequency detection settings and selection	OK	OK	OK	OK
	L5	Fault Restart	Fault restart function settings	OK	OK	OK	OK
	L6	Torque Detection	Sets overtorque detection functions 1 and 2 (by current)	OK	OK	OK	OK
	L7	Torque Limit	★ Torque limit function settings	---	---	OK	OK
	L8	Hdwe Protection	Hardware overheating and phase loss protection settings	OK	OK	OK	OK
Operator	o1	Monitor Select	Selects the Operator's display and setting methods.	OK	OK	OK	OK
	o2	Key Selections	Operator's key function selection and other parameters	OK	OK	OK	OK

6-3-2 Droop Control Function

Droop control is a function that allows the user to set the amount of motor slip. When a single load is operated with two motors (such as in a crane conveyor), a high-resistance motor (a motor in which the secondary winding's resistance is increased resulting in an increased amount of slip) is normally used to adjust the load balance, as shown in the following diagram.

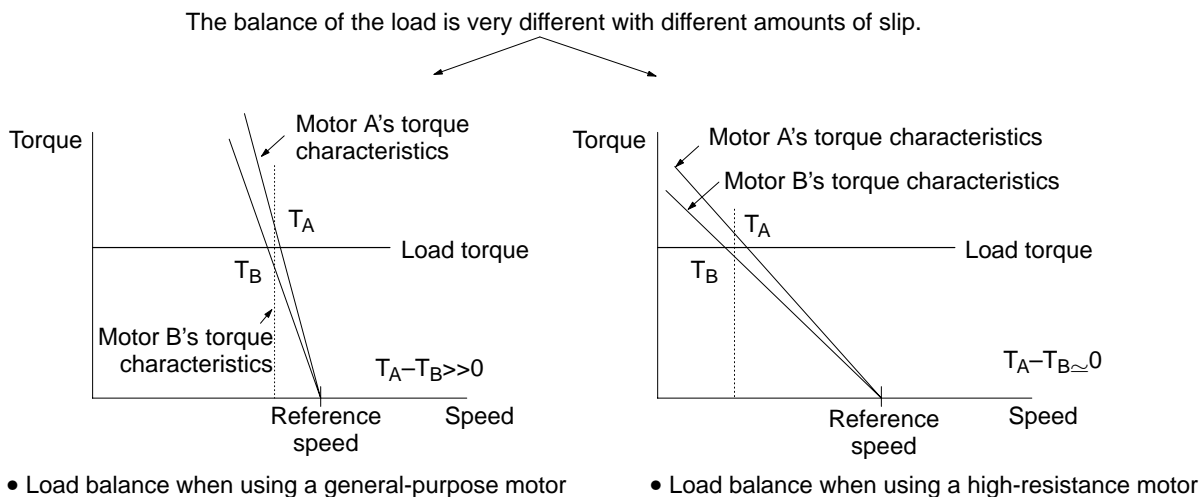

If droop control is used, a high-resistance motor's characteristics can be set for a general-purpose motor. Also, it is easy to make adjustments while watching the load balance because the amount of slip can be set arbitrarily.

Set the amount of slip in parameter b7-01 as the percentage of slip when the maximum frequency is input and the rated torque is generated. Droop control is disabled if b7-01 is set to 0.0.

Parameter b7-02 is used to adjust the responsiveness of droop control. Increase this setting if vibration or hunting occur.

Parameter number	Display name	Setting range	Units	Default setting	Valid access levels			
					V/f Control	V/f with PG	Open Loop Vector	Flux Vector
b7-01	Droop gain	0.0 to 100.0	%	0.0	Not applicable.			
b7-02	Droop delay time	0.03 to 2.00	s	0.05				

Note These parameters can be changed during operation.

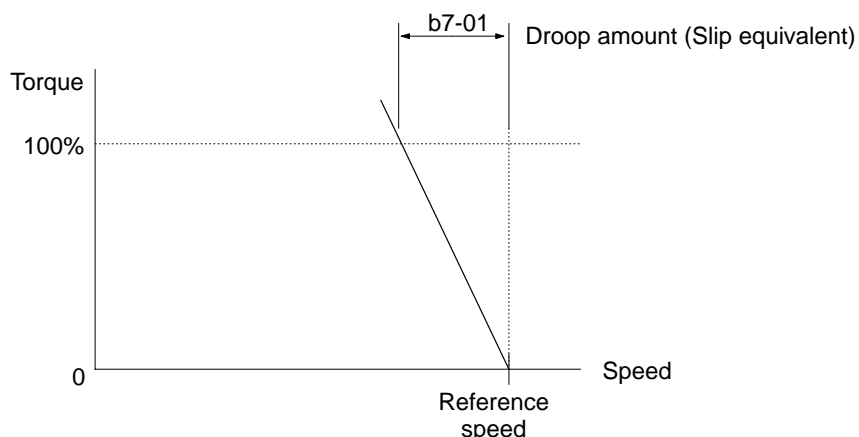

6-3-3 Zero-servo Function (Position-lock)

The zero-servo function is enabled when one of the multi-function inputs (H1-01 through H1-06) is set to 72 (Zero Servo Command). If the zero-servo command is ON when the frequency (speed) reference

falls below the excitation level (b2-01), a position control loop is formed and the motor is stopped. (The motor will not rotate even if there is an offset in the analog reference input.)

Parameter number	Display name	Setting range	Units	Default setting	Valid access levels			
					V/f Control	V/f with PG	Open Loop Vector	Flux Vector
b9-01	Zero Servo Gain	0 to 100	---	5	Not applicable			
b9-02	Zero Servo Count	0 to 16383	Pulses	10				

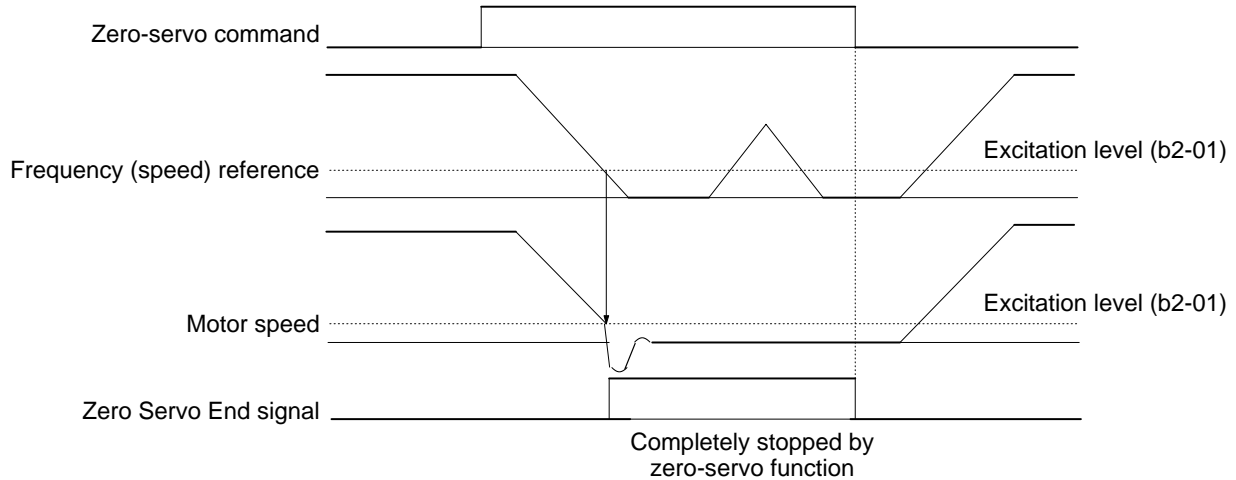

- Assign the zero-servo command (setting 72) to one of the multi-function inputs (H1-01 through H1-06).
- The zero-servo status is entered when the frequency (speed) reference falls below the zero-speed level (b2-01).
- Be sure to leave the run command input ON. If the run command is turned OFF, the output will be interrupted and the zero-servo function will become ineffective.
- Adjust the holding strength of the zero-servo position lock with parameter b9-01 (Zero Servo Gain). Increasing this setting increases the holding strength, although vibration will occur if the setting is too high. (Adjust the holding strength after adjusting the speed control (ASR) gain.)
- To output the zero-servo status externally, assign the Zero Servo End signal (setting 33) to one of the multi-function outputs (H2-01 through H2-03). The Zero Servo Count setting in b9-02 is enabled when one of the multi-function outputs has been set to 33.
- The “Zero Servo Count” specifies the allowed offset from the starting position, and the Zero Servo End signal remains ON as long as the position is within this range (starting position \pm Zero Servo Count).
- Set the Zero Servo Count to four times the number of pulses from the PG (pulse generator or encoder), as shown in the following diagram. For example, when a 1,000 p/r encoder is being used, the number of pulses would be 4,000 p/r after multiplying by four.
- The Zero Servo End signal will go OFF when the zero-servo command is turned OFF.
- These parameters cannot be changed during operation.

Note When using the zero-servo function for an extended period of time, limit the load to a maximum of 50% of the Inverter’s rated output current. If a high holding strength is required of the zero-servo

position lock for a long time, select an Inverter with a capacity one rank higher than the capacity of the motor.

Factor of 4: By counting the rising and falling edges of phase A and phase B, this method has four times the resolution of the PG.

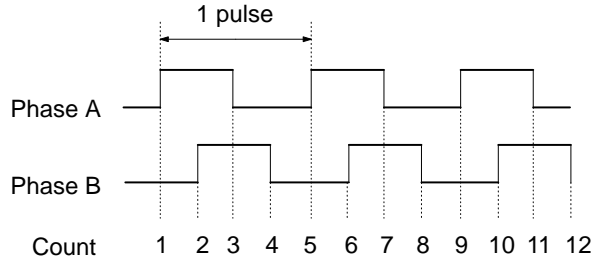

6-3-4 Torque Control

■ Torque Control Function Settings

With flux vector control, the motor’s output torque can be controlled by a torque reference from an analog input. Set parameter d5-01 to “1” to select torque control. This parameter cannot be changed during operation.

Parameter number	Display name	Setting range	Units	Default setting	Valid access levels			
					V/f Control	V/f with PG	Open Loop Vector	Flux Vector
d5-01	Torq Control Sel	0 or 1	---	0	Not applicable.			Advanced

Settings

Setting	Function
0	Speed control (controlled by C5-01 through C5-07)
1	Torque control

The following block diagram shows the operation of torque control.

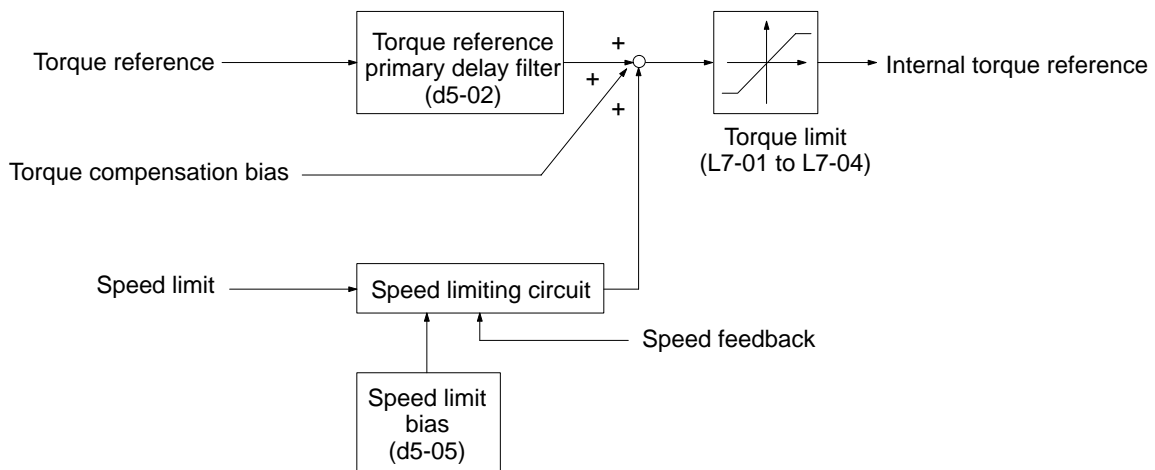

■ Torque Reference Settings

- Set multi-function analog input (terminal 16) or frequency reference current input (terminal 14) to torque reference. The torque reference value cannot be set with the Digital Operator.

Parameter number	Display name	Setting range	Units	Default setting	Valid access levels			
					V/f Control	V/f with PG	Open Loop Vector	Flux Vector
H3-05	Terminal 16 Sel	0 to 1F	---	1F	Basic or Advanced			
H3-09	Terminal 14 Sel	1 to 1F	---	1F	Advanced			

Note Set either one of these parameters to torque reference (setting 13). (These parameters cannot be changed during operation.)

- Next, set the signal level for the analog input terminal that was set to torque reference. These parameters cannot be changed during operation.

Parameter number	Display name	Setting range	Units	Default setting	Valid access levels			
					V/f Control	V/f with PG	Open Loop Vector	Flux Vector
H3-04	Term 16 Signal	0 or 1	---	0	Basic or Advanced			
H3-08	Term 14 Signal	0 to 2	---	2	Advanced			

Signal Level Settings

Setting	Function
0	0- to +10-V input (When H3-08 is being set, be sure to disconnect jumper wire J1.)
1	0- to ±10-V input (When H3-08 is being set, be sure to disconnect jumper wire J1.)
2	4- to 20-mA input (H3-08 only)

Note 1. Set the proper signal level for the torque reference that you want to input.

Note 2. The direction of the torque that is output is determined by the sign (polarity) of the signal that was input. It is not determined by the direction of the run command (forward/reverse).
 +Voltage (or current): Forward torque reference (generally counter-clockwise; axis side)
 -Voltage: Reverse torque reference (generally clockwise; axis side)
 Since the polarity of the voltage input determines the direction, only forward torque references can be input when the “0 to +10 V” or “4 to 20 mA” signal level has been selected. If you want to input reverse torque references, be sure to select the “0 to ±10 V” signal level.

Note 3. When supplying a voltage input to the frequency reference current input (terminal 14), be sure to disconnect jumper wire J1 on the control board. If the jumper wire isn’t disconnected, the input resistor will be destroyed.

200-V Class, 0.4-kW Inverter Example

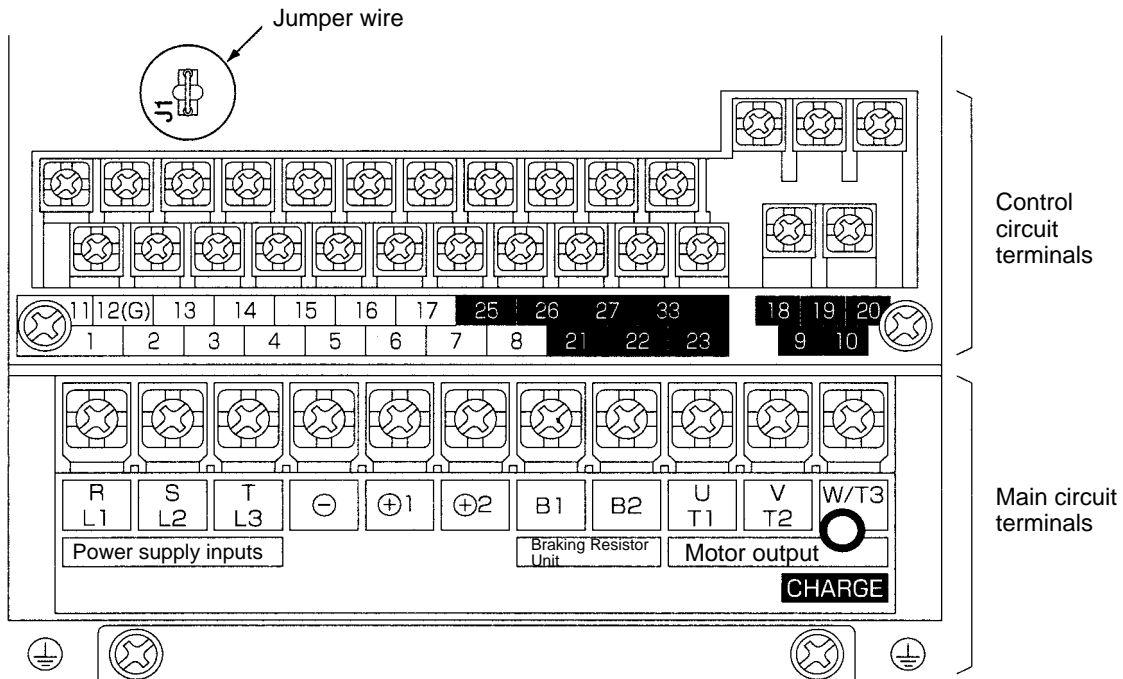

■ Speed Limit Function Settings

- This setting selects the speed limit function used when torque control is performed. With torque control, the motor sometimes rotates at high speed with no load or a light load. The speed limit function keeps the motor speed from exceeding the specified limit in these cases.
- If the speed limit is exceeded during torque control operation, a suppressing torque (proportional to the divergence from the speed limit) is added to the torque reference. (The suppressing torque is applied opposite to the motor rotation.)
- There are two ways to set the motor speed limit: a parameter setting or an analog input value.

● Speed Limit Selection

Parameter number	Display name	Setting range	Units	Default setting	Valid access levels			
					V/f Control	V/f with PG	Open Loop Vector	Flux Vector
d5-03	Speed Limit Sel	1 or 2	---	1	Not applicable.			Advanced

Note This parameter cannot be changed during operation.

Settings

Setting	Function
1	The speed limit is set from one of the analog frequency reference terminals (13 or 14).
2	The speed limit is set to the value in parameter d5-04.

● Speed Limit Selection Settings

- Limit with Analog Input (d5-03 = 1)

- The speed limit value is set by the input voltage to frequency reference (voltage) terminal 13.
- When frequency reference (current) terminal 14 has been set to frequency reference by setting parameter H3-09 to 1F, this terminal is also used as an input terminal for the speed limit. In this case, the actual speed limit value is the sum of the voltage input value at terminal 13 and the current input value at terminal 14.
- The polarity of the speed limit signal and the direction of the run command determine the direction in which the speed is limited, as shown in the following table.

Signal polarity	Run command	Speed limit direction
+Voltage input	Forward rotation	Speed is limited in the forward direction.
	Reverse rotation	Speed is limited in the reverse direction.
-Voltage input	Forward rotation	Speed is limited in the reverse direction.
	Reverse rotation	Speed is limited in the forward direction.

- The speed limit value is zero for rotation opposite to the speed limit direction. For example, when a +voltage is being input and the forward rotation command is ON, the effective range of the torque control is from zero to the speed limit value in the forward direction (when parameter d5-05, the speed limit bias, is set to 0).

Parameter number	Display name	Setting range	Units	Default setting	Valid access levels			
					V/f Control	V/f with PG	Open Loop Vector	Flux Vector
H3-01	Term 13 Signal	0 or 1	---	0	Basic or Advanced			

Note Set the signal level to match the speed limit voltage being input. (This parameter cannot be changed during operation.)

- Limit with Parameter Setting (d5-03 = 2)

Parameter number	Display name	Setting range	Units	Default setting	Valid access levels			
					V/f Control	V/f with PG	Open Loop Vector	Flux Vector
d5-04	Speed Lmt Value	-120 to +120	%	0	Not applicable.			Advanced

Note This parameter cannot be changed during operation.

- Set the speed limit as a percentage of the maximum frequency. (The max. frequency is 100%.)
- The sign of the parameter setting and the direction of the run command determine the direction in which the speed is limited, as shown in the following table.

Sign of d5-04	Run command	Speed limit direction
Setting +	Forward rotation	Speed is limited in the forward direction.
	Reverse rotation	Speed is limited in the reverse direction.
Setting -	Forward rotation	Speed is limited in the reverse direction.
	Reverse rotation	Speed is limited in the forward direction.

- The speed limit value is zero for rotation opposite to the speed limit direction. For example, when a positive value is set in d5-04 and the forward rotation command is ON, the effective range of the torque control is from zero to the speed limit value in the forward direction (when parameter d5-05, the speed limit bias, is set to 0).

• Speed Limit Bias Setting

Parameter number	Display name	Setting range	Units	Default setting	Valid access levels			
					V/f Control	V/f with PG	Open Loop Vector	Flux Vector
d5-05	Speed Lmt Bias	0 to 120	%	10	Not applicable.			Advanced

Note This parameter cannot be changed during operation.

- Set the speed limit bias as a percentage of the maximum frequency. (The max. frequency is 100%.)
- The speed limit bias can be used to add margins to the speed limit.
- When the speed limit bias is used, it is possible to set the same speed limit value in both the forward and reverse directions. For example, the following settings establish speed limits of 50% of the maximum frequency in both the forward and reverse directions.
 - Speed limit setting: Zero (with d5-04 as the speed limit: d5-03 = 2, d5-04 = 0)
 - Speed limit bias setting: 50% (d5-05 = 50)
- When a forward speed limit and a speed limit bias have been set, the speed range of the torque control is from the “–speed limit bias setting” to the “speed limit setting + speed limit bias setting.” In effect, the speed limit range is extended by the speed limit bias in both the forward and reverse directions.

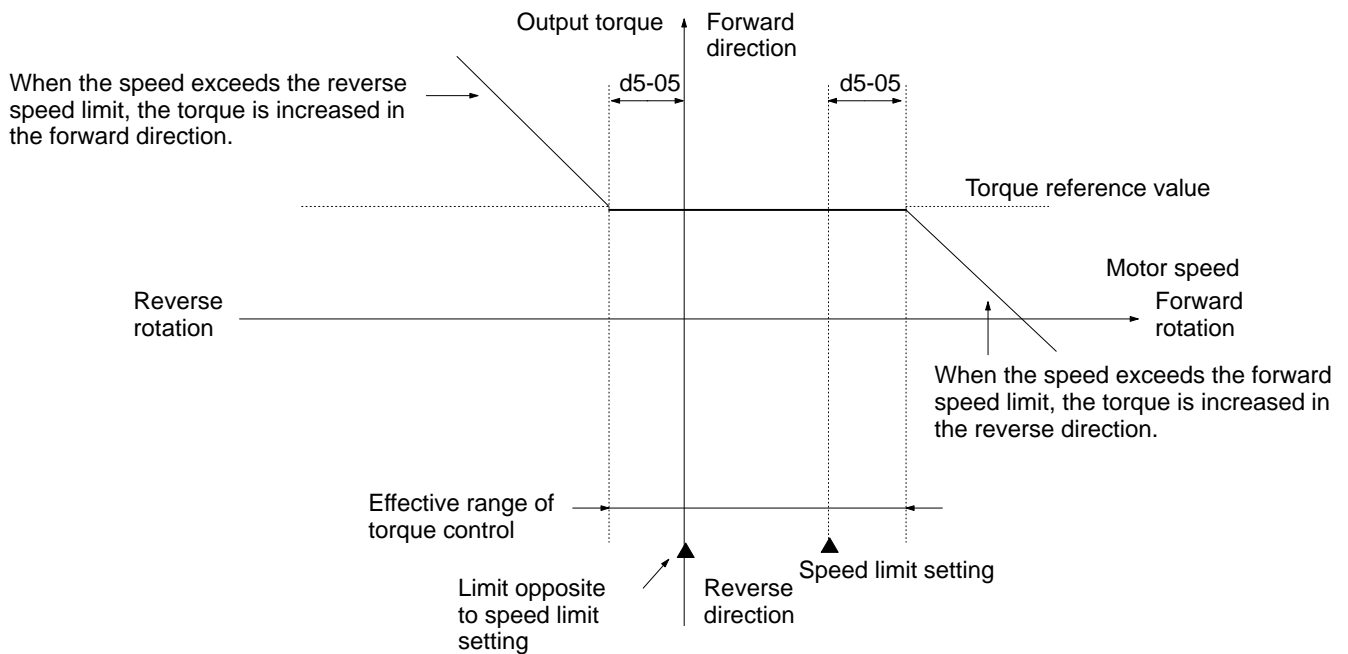

■ Torque Reference Adjustment

- **Primary Delay Time Constant for Torque Reference Filter**
- The time constant of the primary filter in the torque reference section can be adjusted.

- This parameter is used to eliminate noise in the torque reference signal and adjust the responsiveness to the host controller. This parameter cannot be changed during operation.

Parameter number	Display name	Setting range	Units	Default setting	Valid access levels			
					V/f Control	V/f with PG	Open Loop Vector	Flux Vector
d5-02	Torq Ref Filter	0 to 1000	ms	0	Not applicable.			

Note 1. Set the torque reference filter’s primary delay time constant in ms units.

Note 2. Increase the time constant setting if vibration occurs during torque control operation.

• Setting the Torque Compensation Bias

- Set multi-function analog input (terminal 16) or frequency reference current input (terminal 14) to torque compensation (setting 14).
- When the amount of torque loss at the load is input to one of these terminals, it is added to the torque reference to compensate for the loss.

Parameter number	Display name	Setting range	Units	Default setting	Valid access levels			
					V/f Control	V/f with PG	Open Loop Vector	Flux Vector
H3-05	Terminal 16 Sel	0 to 1F	---	1F	Basic or Advanced			
H3-09	Terminal 14 Sel	1 to 1F	---	1F	Advanced			

Note 1. Set torque compensation (setting 14) in the input terminal that wasn’t set to torque reference (setting 13).

Note 2. These parameters cannot be changed during operation.

- Set the signal level for the terminal. These parameters cannot be changed during operation.

Parameter number	Display name	Setting range	Units	Default setting	Valid access levels			
					V/f Control	V/f with PG	Open Loop Vector	Flux Vector
H3-04	Term 16 Signal	0 or 1	---	0	Basic or Advanced			
H3-08	Term 14 Signal	0 to 2	---	2	Advanced			

Signal Level Settings

Setting	Function
0	0 to +10 V input (When H3-08 is being set, be sure to disconnect jumper wire J1.)
1	0 to ±10 V input (When H3-08 is being set, be sure to disconnect jumper wire J1.)
2	4 to 20 mA input (H3-08 only)

Note 1. Set the proper signal level for the torque compensation bias that you want to input.

Note 2. The direction of the torque compensation bias is determined by the sign (polarity) of the signal that is input. It is not determined by the direction of the run command (forward/reverse).

+Voltage (or current): Forward torque compensation

(generally counter-clockwise; axis side)

–Voltage: Reverse torque compensation (generally clockwise; axis side)

Since the polarity of the voltage input determines the direction, only forward torque compensation can be input when the “0 to +10 V” or “4 to 20 mA” signal level has been selected. If you want to input reverse torque compensation, be sure to select the “0 to ±10 V” signal level.

Note 3. When supplying a voltage input to the frequency reference current input (terminal 14), be sure to disconnect jumper wire J1 on the control board. If the jumper wire isn't disconnected, the input resistor will be destroyed. Refer to page 6-22 for a diagram of the control board.

● **Adjusting the Gain/Bias of the Analog Inputs**

● Adjust the gain and bias for the frequency reference (voltage), frequency reference (current), and multi-function analog inputs according to the input specifications for each input. The following parameters can be changed during operation.

Parameter number	Display name	Setting range	Units	Default setting	Valid access levels			
					V/f Control	V/f with PG	Open Loop Vector	Flux Vector
H3-02	Terminal 13 Gain	0.0 to 1,000.0	%	100.0	Basic or Advanced			
H3-03	Terminal 13 Bias	-100.0 to 100.0	%	0.0	Basic or Advanced			
H3-06	Terminal 16 Gain	0.0 to 1,000.0	%	100.0	Basic or Advanced			
H3-07	Terminal 16 Bias	-100.0 to 100.0	%	0.0	Basic or Advanced			
H3-10	Terminal 14 Gain	0.0 to 1,000.0	%	100.0	Advanced			
H3-11	Terminal 14 Bias	-100.0 to 100.0	%	0.0	Advanced			

Note 1. Adjust the gain so that the maximum signal level corresponds to the maximum frequency or the motor's rated torque, as follows.

- When the input terminal is used for frequency reference:
A 10-V (20 mA) input indicates a frequency reference that is 100% of the max. frequency.
- When the input terminal is used for torque reference:
A 10-V (20 mA) input indicates a torque reference that is 100% of the motor's rated torque.
- When the input terminal is used for torque compensation:
A 10-V (20 mA) input indicates a torque compensation that is 100% of the motor's rated torque.

Note 2. Adjust the bias so that the minimum signal level corresponds to the maximum frequency or the motor's rated torque, as follows.

- When the input terminal is used for frequency reference:
A 0-V (4 mA) input indicates a frequency reference that is 100% of the max. frequency.
- When the input terminal is used for torque reference:
A 0-V (4 mA) input indicates a torque reference that is 100% of the motor's rated torque.

- When the input terminal is used for torque compensation:
A 0-V (4 mA) input indicates a torque compensation that is 100% of the motor’s rated torque.

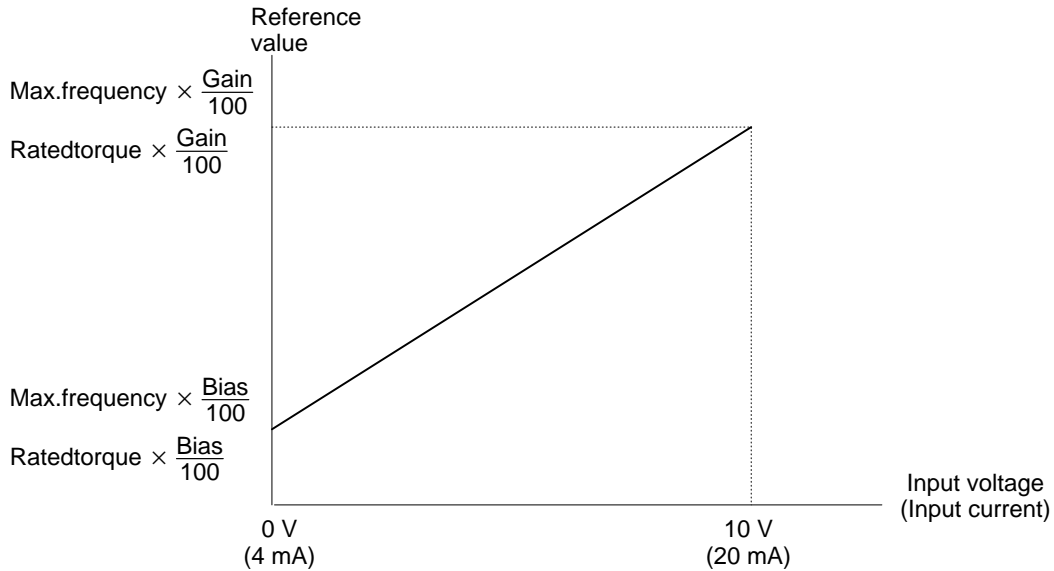

Note Use the current values shown in parentheses when current input has been selected.

6-3-5 Speed/Torque Control Switching Function

It is possible to switch between speed control and torque control when one of the multi-function inputs (H1-01 through H1-06) is set to 71 (Speed/Torque Control Change). Speed control is performed when the input is OFF and torque control is performed when the input is ON.

■ Torque Control Function Settings

Parameter number	Display name	Setting range	Units	Default setting	Valid access levels			
					V/f Control	V/f with PG	Open Loop Vector	Flux Vector
d5-01	Torq Control Sel	0 or 1	---	0	Not applicable.			Advanced

Note This parameter cannot be changed during operation.

Settings

Setting	Function
0	Speed control (controlled by C5-01 through C5-07)
1	Torque control

Note Set parameter d5-01 to 0 (speed control) when using the speed/torque control switching function.

■ Setting the Speed/Torque Control Switching Timer

This setting specifies the delay (0 to 1,000 ms) between a change in the multi-function input (ON → OFF or OFF → ON) and the corresponding change in the control mode. The timer setting is effective only when 71 (Speed/Torque Control Change) has been set in one of the multi-function inputs (H1-01 through H1-06).

During the timer delay, the value of the 3 analog inputs will retain the values they had when the ON/OFF status of speed/torque control switching signal was changed. Use this delay to make any preparations for the change in the control mode.

Parameter number	Display name	Setting range	Units	Default setting	Valid access levels			
					V/f Control	V/f with PG	Open Loop Vector	Flux Vector
d5-06	Ref Hold Time	0 to 1000	ms	0	Not applicable.			Advanced

■ Frequency Reference and Speed Limit

The frequency reference (during speed control) is set with b1-01 (Reference Source).
 The speed limit (during torque control) is set with d5-03 (Speed Limit Selection).
 It is possible to assign the frequency reference and speed limit functions to the same analog input terminal (13 or 14).

■ Torque Reference and Torque Limit

If the torque reference has been assigned to a multi-function analog input or the frequency reference (current) terminal, the input's function changes when the control mode is switched between torque control and speed control.

- During speed control: The analog input terminal is used as the torque limit input.
- During torque control: The analog input terminal is used as the torque reference input.

Either the absolute value of the torque limit input or the torque limit parameter setting (L7-01 through L7-04), whichever is smaller, will be used for the torque limit.

■ Stopping Method

When the run command is turned OFF during speed control, the motor is decelerated to a stop.
 When the run command is turned OFF during torque control, the control mode is automatically switched to speed control and the motor is decelerated to a stop.

6-3-6 Torque Limit Function

With flux vector control, the torque limit can be applied at an arbitrary value because the torque output by the motor is calculated internally.

The torque limit function is useful when the load cannot sustain a torque above a certain level or regenerative torque above a certain level. The two ways to apply a torque limit are listed below. (The lower torque limit will be used if both of these methods are set.)

- 1) Setting a torque limit with the parameters
- 2) Limiting torque with the analog inputs

The precision of the torque limit is $\pm 5\%$ at all frequencies.

■ **Setting a Torque Limit with Parameters**

Torque limits can be set separately for the 4 ways that torque can be applied: forward torque, reverse torque, forward regenerative torque, and reverse forward regenerative torque. These parameters cannot be changed during operation.

Parameter number	Display name	Setting range	Units	Default setting	Valid access levels			
					V/f Control	V/f with PG	Open Loop Vector	Flux Vector
L7-01	Torque Limit Fwd	0 to 300	%	200	Not applicable		Basic or Advanced	
L7-02	Torque Limit Rev							
L7-03	Torque Limit Fwd Rgn							
L7-04	Torque Limit Rev Rgn							

The following diagram shows the relationship between each parameter and the output torque.

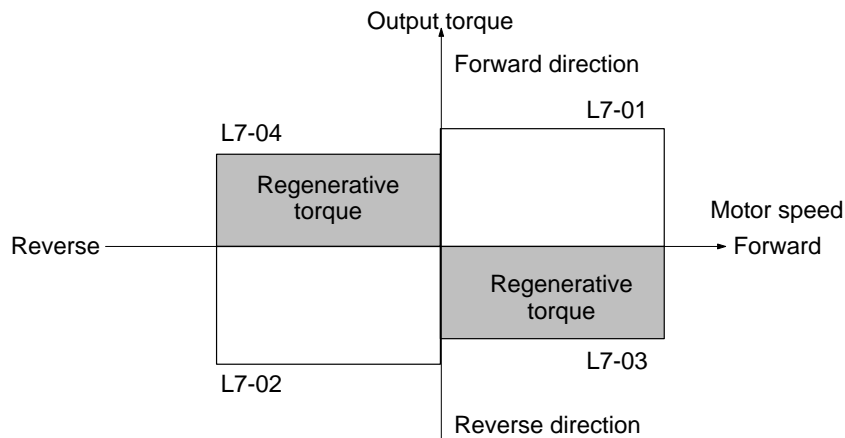

Note When the torque limit function is engaged the torque control has priority and motor speed control and compensation will be ignored, so the acceleration/deceleration times might be lengthened and motor speed might be reduced.

■ **Limiting Torque with Analog Inputs**

The following two analog inputs that can be used to limit torque.

- Multi-function analog input terminal 16
- Frequency reference (current) terminal 14

Use either or both of these inputs as needed with parameters H3-05 and H3-09. These parameters cannot be changed during operation.

Parameter number	Display name	Setting range	Units	Default setting	Valid access levels			
					V/f Control	V/f with PG	Open Loop Vector	Flux Vector
H3-05	Terminal 16 Sel	0 to 1F	---	1F	Basic or Advanced			
H3-09	Terminal 14 Sel	1 to 1F	---	1F	Advanced			

Settings

The following table shows only those settings related to the torque limit function.

Setting	Name
10	Forward Torque Limit
11	Reverse Torque Limit
12	Regenerative Torque Limit
13	Torque reference (The input limits torque in both the forward and reverse directions during speed control.)
15	Speed Limit (Limits torque in both the forward and reverse directions.)

Set the analog input terminal's signal level, gain, and bias to match the actual input signal. The factory default settings for the input terminal's signal level are as follows:

- Terminal 16: 0 to +10 V (A 10-V input limits the torque to 100% of the motor's rated torque.)
- Terminal 14: 4 to 20 mA (A 20-mA input limits the torque to 100% of the motor's rated torque.)

The following diagram shows the relationship between the output torque and each torque limit.

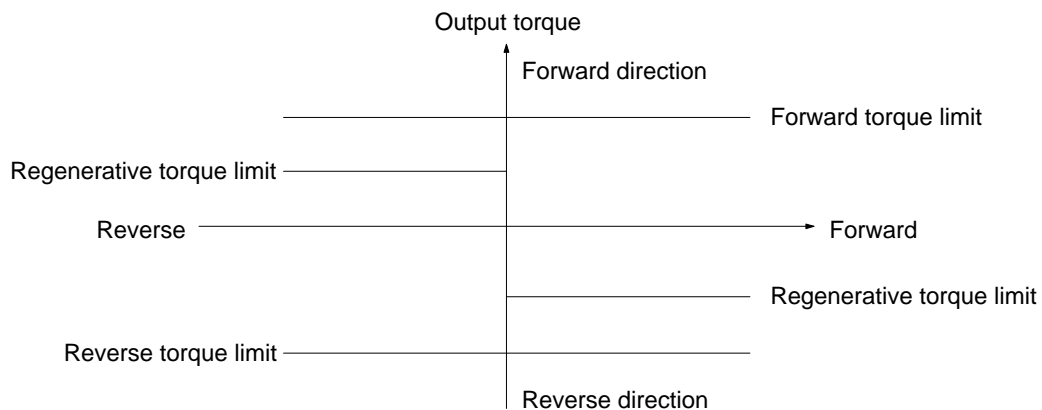

Note 1. When the forward torque limit has been set, the analog input signal acts as the limit value for torque generated in the forward direction. The torque limit input is effective when torque is generated in the forward direction even if the motor is operating in reverse (regenerative torque).

Note 2. The torque limit is 100% of the motor's rated torque when the analog input is at its maximum value (10 V or 20 mA). To increase the torque limit above 100%, set the input terminal's gain above 100%. For example, a gain of 150.0% would result in a torque limit of 150% of the motor's rated torque with a 10-V or 20-mA analog input.

6-3-7 Setting/Adjusting Motor Parameters

■ Adjusting the V/f Pattern

Normally it isn't necessary to adjust the V/f pattern with flux vector control. Adjust the V/f pattern when you want to change the maximum frequency, maximum voltage, base frequency, or minimum output frequency settings.

Parameter number	Display name	Setting range	Units	Default setting	Valid access levels*1			
					V/f Control	V/f with PG	Open Loop Vector	Flux Vector
E1-04	Max Frequency	40.0 to 400.0	Hz	60.0	Q	Q	Q	Q
E1-05	Max Voltage	0.0 to 255.0*2	VAC	200.0*2	Q	Q	Q	Q
E1-06	Base Frequency	0.0 to 400.0	Hz	60.0	Q	Q	Q	Q
E1-09	Min Frequency	0.0 to 400.0	Hz	0.0	Q	Q	Q	A

Note 1. Q: Quick Start, Basic, or Advanced
A: Advanced only

Note 2. These voltages are for the 200-V class; Double the voltage for 400-V class Inverters.

Note 3. The default setting for E1-09 depends on the control mode. The default settings shown in the table are for flux vector control.

Note 4. The three frequency settings must satisfy the following formula:
 $E1-04 (F_{MAX}) \geq E1-06 (F_A) > E1-09 (F_{MIN})$

V/f Pattern

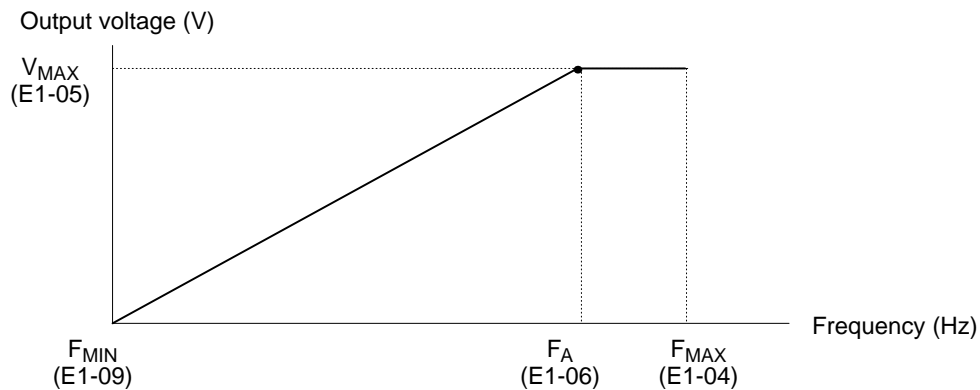

● Units for V/f Pattern Settings

The units used for V/f pattern frequency settings can be changed when flux vector control has been selected. This parameter cannot be changed during operation.

Parameter number	Display name	Setting range	Units	Default setting	Valid access levels*			
					V/f Control	V/f with PG	Open Loop Vector	Flux Vector
o1-04	Display Units	0 or 1	---	0	Not applicable.			

Note B: Basic or Advanced

Display Unit Settings

Setting	Function
0	Units: Hz
1	Units: r/min

Note 1. The setting units for parameters E1-04, E1-06, and E1-09 can be changed.

Note 2. This function is specific to flux vector control.

■ **Setting Motor Parameters**

The motor parameters (function E2) will all be set automatically when auto-tuning is performed, so it normally isn't necessary to set them manually. Set these parameters manually if auto-tuning can't be completed properly. These parameters cannot be changed during operation.

Set the rated current (A) shown on the motor's nameplate.

Parameter number	Display name	Setting range	Units	Default setting*	Valid access levels			
					V/f Control	V/f with PG	Open Loop Vector	Flux Vector
E2-01	Motor Rated FLA	0.32 to 6.40	A	1.90	Quick Start, Basic, or Advanced			

Note The setting range is 10% to 200% of the Inverter's rated output current. The default setting depends upon the type of Inverter. (The table shows the default setting for 200-V class, 0.4-kW Inverters.)

Calculate the rated slip (E2-02) from the value shown on the motor's nameplate with the following equation and set this value.

$$\text{Rated slip} = \text{rated frequency (Hz)} - \text{rated speed (r/min)} \times \text{number of poles}/120$$

Set the no-load current (E2-03) at the rated voltage and rated frequency. Normally this value isn't shown on the motor's nameplate, so it might be necessary to contact the motor manufacturer.

Parameter number	Display name	Setting range	Units	Default setting*	Valid access levels			
					V/f Control	V/f with PG	Open Loop Vector	Flux Vector
E2-02	Motor Rated Slip	0.00 to 20.00	Hz	2.90	Advanced		Quick Start, Basic, or Advanced	
E2-03	No-Load Current	0.00 to 2.90 (see note 2)	A	1.20				

Note 1. The default setting depends upon the type of Inverter. (The table shows the default settings for 200-V class, 0.4-kW Inverters.)

Note 2. The setting range is between 0.00 and 0.1 less than the Inverter's rated current.

Set the number of poles (E2-04) shown on the motor's nameplate.

Parameter number	Display name	Setting range	Units	Default setting	Valid access levels*			
					V/f Control	V/f with PG	Open Loop Vector	Flux Vector
E2-04	Number of Poles	2 to 48	---	4	---	Q	---	Q

Note Q: Quick Start, Basic, or Advanced
 ---: Not applicable.

Set the motor's terminal resistance between U and V, V and W, or W and U.

Usually the nameplate of the motor does not provide the motor's terminal resistance. Contact the motor manufacturer for a test report on the motor's terminal resistance to set the following values.

- Type E insulation: Motor's terminal resistance (Ω) at 75°C x 0.92
- Type B insulation: Motor's terminal resistance (Ω) at 75°C x 0.92

- Type F insulation: Motor's terminal resistance (Ω) at 115°C x 0.87

Parameter number	Display name	Setting range	Units	Default setting	Valid access levels			
					V/f Control	V/f with PG	Open Loop Vector	Flux Vector
E2-05	Term Resistance	0.000 to 65.000	Ω	9.842	Advanced			

Note The default setting depends upon the type of Inverter.
 (The table shows the default settings for 200-V class, 0.4-kW Inverters.)

Set the voltage drop (caused by the motor's leakage inductance) as a percentage of the motor's rated voltage in parameter E2-06. Normally this value is not shown on the motor's nameplate, so it might be necessary to contact the motor manufacturer. It is also acceptable to set the loss (caused by the motor's leakage inductance) as a percentage.

Parameter number	Display name	Setting range	Units	Default setting	Valid access levels			
					V/f Control	V/f with PG	Open Loop Vector	Flux Vector
E2-06	Leak Inductance	0.0 to 30.0	%	18.2	Not applicable.		Advanced	

Note 1. The default setting depends upon the type of Inverter.
 (The table shows the default settings for 200-V class, 0.4-kW Inverters.)

Note 2. The default setting does not normally need to be changed because the Inverter in operation adjusts the leak inductance automatically. Set the parameter if a high-speed motor or any other motor with low inductance is used.

Parameters E2-07 and E2-08 are used in a frequency range even higher than the motor's rated frequency. It isn't necessary to set these parameters when operating below the motor's rated frequency. Set the following values:

- Motor core-saturation coefficient 1: Core-saturation coefficient when magnetic flux is 50%.
- Motor core-saturation coefficient 2: Core-saturation coefficient when magnetic flux is 75%.

Normally these values aren't shown on the motor's nameplate, so it might be necessary to contact the motor manufacturer.

Parameter number	Display name	Setting range	Units	Default setting	Valid access levels			
					V/f Control	V/f with PG	Open Loop Vector	Flux Vector
E2-07	Saturation Comp 1	0.0 to 0.50	---	0.50	Not applicable.		Advanced	
E2-08	Saturation Comp 2	0.00 to 0.75	---	0.75				

Note It is possible to operate the motor with the default settings, but motor efficiency may decrease.

Parameter E2-09 is used to compensate for torque lost mechanically in the motor. Normally it isn't necessary to change this setting, but it can be adjusted when there is a large torque loss to the motor's bearings or to a fan or pump connected to the motor. This parameter cannot be changed during operation.

Set the mechanical loss as a percentage of the motor's rated output power (W).

Parameter number	Display name	Setting range	Units	Default setting	Valid access levels			
					V/f Control	V/f with PG	Open Loop Vector	Flux Vector
E2-09	Mechanical Loss	0.0 to 10.0	%	0.0	Not applicable.			Advanced

■ **Setting the Slip Compensation Gain**

With flux vector control, parameter C3-01 sets the motor’s temperature compensation gain. Adjust this setting when a torque limit or torque control is being used and the output torque varies with the ambient temperature. (There is no change to the compensation during speed control operation.)

Normally it isn’t necessary to change this setting. If the motor’s internal parameters change at higher temperatures and the amount of slip increases, this parameter can be set to adjust the amount of slip according to an internally calculated temperature rise. This parameter cannot be changed during operation.

Parameter number	Display name	Setting range	Units	Default setting	Valid access levels*			
					V/f Control	V/f with PG	Open Loop Vector	Flux Vector
C3-01	Slip Come Gain	0.0 to 2.5	Factor	1.0	B	---	B	

Note 1. B: Basic or Advanced
 ---: Not applicable.

Note 2. Adjust the setting if the output torque varies with the ambient temperature when a torque control or torque limit is being used. The compensation amount increases as the set value is increased. This adjustment is not required during speed control operation.

6-3-8 Operation for Saturated Output Voltage

Previously, the accuracy of motor speed for vector control was greatly reduced when the limit of the Inverter’s voltage output was approached (a voltage greater than that of the input power supply cannot be output).

Set the following parameter to control the output voltage so that the limit will not be reached, thus maintaining speed accuracy.

Parameter number	Display name	Setting range	Units	Default setting	Valid access levels			
					V/f Control	V/f with PG	Open Loop Vector	Flux Vector
C3-06	Output V limit	0, 1	---	0	Not applicable.		Advanced	

Settings

Setting	Description
0	Disabled (There is no limit of output voltage saturation. Slip compensation is disabled when the output voltage saturates.)
1	Enabled (Output voltage saturation is suppressed to keep the speed constantly.)

Note 1. Set the parameter to 1 if the accuracy of speed is required within the rated rpm range. This will cause an increase of approximately 10% in the output current. Therefore, be sure that the Inverter has more and sufficient output current.

Note 2. If the Inverter’s input voltage is extremely lower than the rated motor voltage, the accuracy of the speed of the motor may not be maintained even with the output voltage suppressed.

6-3-9 Selecting Auto-tuning Carrier Frequency

The auto-tuning carrier frequency is by default set to a value higher than that used for conventional models to improve the accuracy of auto-tuning. The default setting does not normally need to be changed.

Parameter number	Display name	Setting range	Units	Default setting	Valid access levels			
					V/f Control	V/f with PG	Open Loop Vector	Flux Vector
C8-30	Carrier in tune	0 to 2	---	2	Not applicable.		Advanced	

Settings

Setting	Description
0	The auto-tuning carrier frequency is set to 2 kHz.
1	The auto-tuning carrier frequency is set according to the set value in parameter C6-01.
2	The auto-tuning carrier frequency is set to 5 kHz.

Note The default setting does not normally need to be changed. Adjust the parameter with the parameter C6-01 set to 0 or 1 if auto-tuning cannot be executed.

6-4 V/f Control With PG Feedback

This section summarizes the functions that can be used with V/f control with PG feedback, and provides detailed explanations of the functions that are specific to V/f control with PG feedback.

6-4-1 Summary of V/f Control With PG Feedback Functions

An “OK” in the control mode column indicates that the parameter can be changed in that control mode. The functions specific to V/f control with PG feedback are marked with a “★” and described in more detail later in this section.

Group	Function			Control mode			
				V/f	V/f w/PG	Open-loop Vector	Flux Vector
Application	b1	Sequence	Settings such as the reference input method	OK	OK	OK	OK
	b2	DC Braking	DC braking function settings	OK	OK	OK	OK
	b3	Speed Search	Speed search function settings	OK	OK	OK	OK
	b4	Delay Timers	Timer function settings	OK	OK	OK	OK
	b5	PID Control	PID control settings	OK	OK	OK	OK
	b6	Reference Hold	Accel/deceleration time dwell function settings	OK	OK	OK	OK
	b7	Droop Control	Not used. (Can't be set.)	---	---	---	OK
	b8	Energy Saving	★ Multi-function input: Sets energy-saving control by energy saving reference.	OK	OK	---	---
	b9	Zero Servo	Not used. (Can't be set.)	---	---	---	OK
Tuning	C1	Accel/Decel	Acceleration/deceleration time settings	OK	OK	OK	OK
	C2	S-Curve Acc/Dec	S-curve characteristics for accel/decel times	OK	OK	OK	OK
	C3	Motor-Slip Comp	Slip compensation function settings	OK	OK	OK	OK
	C4	Torque Comp	Torque compensation function settings	OK	OK	OK	---
	C5	ASR Tuning	Speed control adjustment	---	OK	---	OK
	C6	Carrier Freq	Carrier frequency settings	OK	OK	OK	OK
	C7	Hunting Prev	★ Hunting prevention settings	OK	OK	---	---
	C8	Factory Tuning	Not used. (Can't be set.)	---	---	OK	---
Reference	d1	Preset Reference	Frequency reference settings (when using Operator)	OK	OK	OK	OK
	d2	Reference Limits	Frequency upper and lower limit settings	OK	OK	OK	OK
	d3	Jump Frequencies	Prohibited frequency settings	OK	OK	OK	OK
	d4	Sequence	Up/Down, Accel/Decel stop hold frequency setting	OK	OK	OK	OK
	d5	Torque Control	Not used. (Can't be set.)	---	---	---	OK
Motor	E1	V/f Pattern	★ Motor parameters (Motor parameters are set manually.)	OK	OK	OK	OK
	E2	Motor Setup		OK	OK	OK	OK
	E3	Control Method 2	Control mode settings for second motor	OK	OK	OK	OK
	E4	V/f Pattern 2	Parameter settings for second motor	OK	OK	OK	OK
	E5	Motor Setup 2		OK	OK	OK	OK

Group	Function		Control mode				
			V/f	V/f w/PG	Open-loop Vector	Flux Vector	
Options	F1	PG Option Setup	Parameter settings for a PG Speed Control Card	---	OK	---	OK
	F2	AI-14 Setup	Parameter settings for an Analog Command Card	OK	OK	OK	OK
	F3	DI-08, 16 Setup	Parameter settings for a Digital Command Card	OK	OK	OK	OK
	F4	AO-08, 12 Setup	Parameter settings for an Analog Monitor Card	OK	OK	OK	OK
	F5	Not used	(Do not change these settings.)	---	---	---	---
	F6	Not used					
	F7	PO-36F Setup	Parameter settings for a Pulse Monitor Card	OK	OK	OK	OK
	F8	SI-F/G Setup	Parameter settings for a SYSMAC BUS Interface Card.	OK	OK	OK	OK
	F9	CP-916 Setup	Parameter settings for a CompoBus/D Communications Card.	OK	OK	OK	OK
Terminal	H1	Digital Inputs	Function selection for multi-function inputs	OK	OK	OK	OK
	H2	Digital Outputs	Function selection for multi-function outputs	OK	OK	OK	OK
	H3	Analog Inputs	Adjustment/function selection for external analog inputs	OK	OK	OK	OK
	H4	Analog Outputs	Adjustment/function selection for multi-function analog outputs	OK	OK	OK	OK
	H5	Not used	(Do not change these settings.)	---	---	---	---
Protection	L1	Motor Overload	Sets electrical/thermal functions that protect the motor.	OK	OK	OK	OK
	L2	PwrLoss Ridethru	Selects the power-loss processing method.	OK	OK	OK	OK
	L3	Stall Prevention	Accel/Decel stall prevention settings and selection	OK	OK	OK	OK
	L4	Ref Detection	Frequency detection settings and selection	OK	OK	OK	OK
	L5	Fault Restart	Fault restart function settings	OK	OK	OK	OK
	L6	Torque Detection	Sets overtorque detection functions 1 and 2	OK	OK	OK	OK
	L7	Torque Limit	Not used. (Can't be set.)	---	---	OK	OK
	L8	Hdwe Protection	Hardware overheating and phase loss protection settings	OK	OK	OK	OK
Operator	o1	Monitor Select	Selects the Operator's display and setting methods.	OK	OK	OK	OK
	o2	Key Selections	Operator's key function selection and other parameters	OK	OK	OK	OK

6-4-2 Energy-saving Control Function

The energy-saving control function is enabled when the energy-saving command (setting 63) has been set in a multi-function input (H1-01 through H1-06). Inputting the energy-saving command while there is a light load causes the Inverter's output voltage to be reduced and saves energy. Turn OFF the energy-saving command when a normal load is added.

Parameter b8-01 determines the Inverter's output voltage when the energy-saving command is input. Set this value as a percentage of the V/f pattern's voltage. Parameter L2-04 (the voltage recovery time) determines the rate at which the output voltage is changed when the energy-saving command is turned ON or OFF.

Parameter b8-02 determines the lower limit frequency for the energy-saving function. The energy-saving command is enabled only when the frequency reference is above this lower limit and the motor speed is within the "speed agree" range.

Parameters b8-01 and b8-02 cannot be changed during operation.

Parameter number	Display name	Setting range	Units	Default setting	Valid access levels			
					V/f Control	V/f with PG	Open Loop Vector	Flux Vector
b8-01	Energy Save Gain	0 to 100	%	80	Advanced		Not applicable.	
b8-02	Energy Save Freq	0.0 to 400.0	Hz	0.0				

Timing Chart

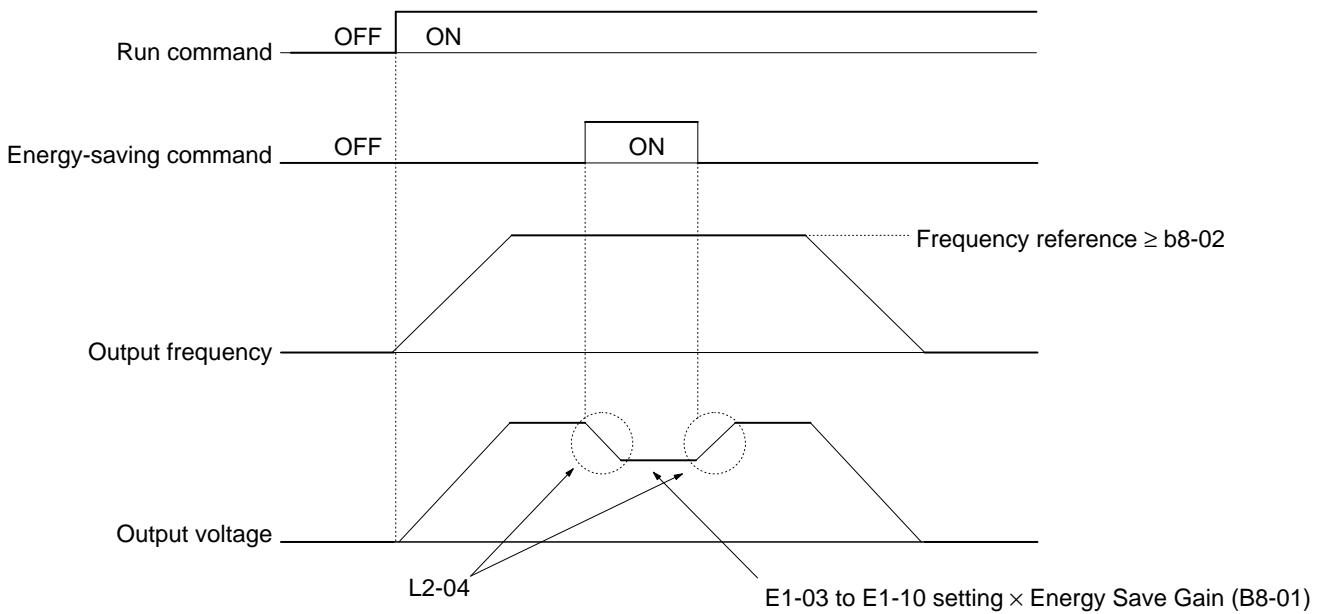

6-4-3 Hunting-prevention Function

The hunting-prevention function suppresses hunting when the motor is operating with a light load. This function is valid with V/f control and V/f with PG control. Parameters C7-01 and C7-02 cannot be changed during operation.

Parameter number	Display name	Setting range	Units	Default setting	Valid access levels			
					V/f Control	V/f with PG	Open Loop Vector	Flux Vector
C7-01	Hunt Prev Select	0, 1	---	1	Advanced		Not applicable.	

Setting	Function
0	Disables the hunting-prevention function.
1	Enables the hunting-prevention function.

Parameter number	Display name	Setting range	Units	Default setting	Valid access levels			
					V/f Control	V/f with PG	Open Loop Vector	Flux Vector
C7-02	Hunt Prev Gain	0.0 to 2.50	Multi-ples	1.00	Advanced		Not applicable.	

Normally it isn't necessary to change these parameters. Adjust these parameters as follows if hunting occurs with a light load.

- Increase the setting in C7-02 if vibration occurs when operating with a light load.
(If the setting is increased too much, the current can fall to the point where stalling occurs.)
- Decrease the setting in C7-02 if stalling occurs.
- Disable the hunting-prevention function (C7-01 = 0) if high responsiveness is more important than suppressing vibration.

6-4-4 Setting Motor Parameters

The motor parameters other than the V/f pattern parameters are described below:

Calculate the rated slip (E2-02) from the value shown on the motor’s nameplate with the following equation and set this value.

$$\text{Rated slip} = \text{rated frequency (Hz)} - \text{rated speed (r/min)} \times \text{number of poles}/120$$

Set the no-load current (E2-03) at the rated voltage and rated frequency. Normally this value isn’t shown on the motor’s nameplate, so it might be necessary to contact the motor manufacturer.

Parameter number	Display name	Setting range	Units	Default setting*	Valid access levels			
					V/f Control	V/f with PG	Open Loop Vector	Flux Vector
E2-02	Motor Rated Slip	0.00 to 20.00	Hz	2.90	Advanced		Quick Start, Basic, or Advanced	
E2-03	No-Load Current	0.00 to 2.90 (see note 2)	A	1.20				

Note 1. The default setting depends upon the type of Inverter.
(The table shows the default settings for 200-V class, 0.4-kW Inverters.)

Note 2. The setting range is between 0.00 and 0.1 less than the Inverter’s rated current.

Note 3. These settings are used as reference values for the motor slip compensation function.

Set the motor’s terminal resistance (phase to phase) in parameter E2-05. Normally this value isn’t shown on the motor’s nameplate, so it might be necessary to contact the motor manufacturer.

Parameter number	Display name	Setting range	Units	Default setting	Valid access levels			
					V/f Control	V/f with PG	Open Loop Vector	Flux Vector
E2-05	Term Resistance	0.000 to 65.000	Ω	9.842	Advanced			

Note 1. The default setting depends upon the type of Inverter.
(The table shows the default settings for 200-V class, 0.4-kW Inverters.)

Note 2. This setting is used as a reference value for the torque compensation function.

Parameter number	Display name	Setting range	Units	Default setting*	Valid access levels			
					V/f Control	V/f with PG	Open Loop Vector	Flux Vector
E2-10	Tcomp Iron Loss	0 to 65535	W	14	Advanced		Not applicable.	

Note 1. The default setting varies with the Inverter’s capacity. The above setting applies to 200-V class, 0.4-kW Inverters.

Note 2. Set the iron core loss in 1-W increments. The default setting does not normally need to be changed.

Note 3. The set value is used as the reference value for the torque compensation function.

6-5 Common Functions

This section summarizes the functions that can be used in common among the various modes, and provides detailed explanations of their operations.

6-5-1 Summary of Common Control Functions

An “OK” in the control mode column indicates that the parameter can be changed in that control mode. The functions that can be used in common are marked with a “★” and described in more detail later in this section.

Group	Function		Comments	Control mode			
				V/f	V/f w/PG	Open-loop Vector	Flux Vector
Application	b1	Sequence	★ Settings such as the reference input method	OK	OK	OK	OK
	b2	DC Braking	★ DC braking function settings	OK	OK	OK	OK
	b3	Speed Search	★ Speed search function settings	OK	OK	OK	OK
	b4	Delay Timers	★ Timer function settings	OK	OK	OK	OK
	b5	PID Control	★ PID control settings	OK	OK	OK	OK
	b6	Reference Hold	★ Accel/deceleration time dwell function settings	OK	OK	OK	OK
	b7	Droop Control	Droop control settings	---	---	---	OK
	b8	Energy Saving	Multi-function input: Sets energy-saving control by energy saving reference.	OK	OK	---	---
	b9	Zero Servo	Zero servo settings	---	---	---	OK
Tuning	C1	Accel/Decel	Acceleration/deceleration time settings	OK	OK	OK	OK
	C2	S-Curve Acc/Dec	★ S-curve characteristics for accel/decel times	OK	OK	OK	OK
	C3	Motor-Slip Comp	★ Slip compensation function settings	OK	OK	OK	OK
	C4	Torque Comp	★ Torque compensation function settings	OK	OK	OK	---
	C5	ASR Tuning	Speed control tuning	---	OK	---	OK
	C6	Carrier Freq	★ Carrier frequency settings	OK	OK	OK	OK
	C7	Hunting Prev	Hunting prevention settings	OK	OK	---	---
	C8	Factory Tuning	Adjustment for open-loop vector control	---	---	OK	---
Reference	d1	Preset Reference	Frequency reference settings (when using Operator)	OK	OK	OK	OK
	d2	Reference Limits	★ Frequency upper and lower limit settings	OK	OK	OK	OK
	d3	Jump Frequencies	★ Prohibited frequency settings	OK	OK	OK	OK
	d4	Sequence	★ Up/Down, Accel/Decel stop hold frequency setting	OK	OK	OK	OK
	d5	Torque Control	Torque control settings and tuning	---	---	---	OK
Motor	E1	V/f Pattern	★ Motor settings	OK	OK	OK	OK
	E2	Motor Setup		OK	OK	OK	OK
	E3	Control Method 2	★ Control mode settings for second motor	OK	OK	OK	OK
	E4	V/f Pattern 2	★ Parameter settings for second motor	OK	OK	OK	OK
	E5	Motor Setup 2		OK	OK	OK	OK
Options	F1	PG Option Setup	Parameter settings for a PG Speed Control Card	---	OK	---	OK
	F2	AI-14 Setup	★ Parameter settings for an Analog Command Card	OK	OK	OK	OK
	F3	DI-08, 16 Setup	★ Parameter settings for a Digital Command Card	OK	OK	OK	OK
	F4	AO-08, 12 Setup	★ Parameter settings for an Analog Monitor Card	OK	OK	OK	OK
	F5	DO-02 Setup	Not Used. (Do not change these settings.)	---	---	---	---
	F6	DO-08 Setup					
	F7	PO-36F Setup	★ Parameter settings for a Pulse Monitor Card	OK	OK	OK	OK
	F8	SI-F/G Setup	★ Parameter settings for a SYSMAC BUS Interface Card.	OK	OK	OK	OK
	F9	CP-916 Setup	★ Parameter settings for a CompoBus/D Communications Card.	OK	OK	OK	OK

Group	Function		Comments	Control mode				
				V/f	V/f w/PG	Open-loop Vector	Flux Vector	
Terminal	H1	Digital Inputs	★ Function selection for multi-function inputs	OK	OK	OK	OK	
	H2	Digital Outputs	★ Function selection for multi-function outputs	OK	OK	OK	OK	
	H3	Analog Inputs	★ Adjustment/function selection for external analog inputs	OK	OK	OK	OK	
	H4	Analog Outputs	★ Adjustment/function selection for multi-function analog outputs	OK	OK	OK	OK	
	H5	Serial Com Setup	Not Used. (Do not change this setting.)		---	---	---	---
Protection	L1	Motor Overload	★ Sets electrical/thermal functions that protect the motor.	OK	OK	OK	OK	
	L2	PwrLoss Ridethru	★ Selects the power-loss processing method.	OK	OK	OK	OK	
	L3	Stall Prevention	★ Accel/Decel stall prevention settings and selection	OK	OK	OK	OK	
	L4	Ref Detection	★ Frequency detection settings and selection	OK	OK	OK	OK	
	L5	Fault Restart	★ Fault restart function settings	OK	OK	OK	OK	
	L6	Torque Detection	★ Sets overtorque detection functions 1 and 2	OK	OK	OK	OK	
	L7	Torque Limit	Torque limit settings		---	---	OK	OK
	L8	Hdwe Protection	★ Hardware overheating and phase loss protection settings		OK	OK	OK	OK
Operator	o1	Monitor Select	★ Selects the Operator's display and setting methods.	OK	OK	OK	OK	
	o2	Key Selections	★ Operator's key function selection and other parameters	OK	OK	OK	OK	

6-5-2 Application Parameters (b)

■ Setting Operation Source Selection (b1)

- The input methods of parameters or frequency references and the operation methods of the run command can be set in the Inverter in operation mode. In addition, the following advanced functions are available.
- The run command already set in the Inverter can be disabled or enabled when switching the Inverter to local mode from remote mode.
- The run command already set in the Inverter in any mode other than drive mode can be disabled or enabled.
- Set the parameter according to the application.

Parameter number	Display name	Setting range	Units	Default setting	Valid access levels			
					V/f Control	V/f with PG	Open Loop Vector	Flux Vector
b1-07	LOC/REM RUN Sel	0, 1	---	0	Advanced			

Explanation of Settings

Setting	Description
0	The run command already set is disabled (when the Inverter is switched to local mode from remote mode. The Inverter will start operating with the run command input again.)
1	The run command already set is enabled (and the Inverter will start operating according to the present run command when the Inverter is switched to local mode from remote mode).

Note If parameter b1-07 (LOC/REM RUN Sel) is set to 1, the run command will not be ignored. In this case, an Inverter may start operating immediately when switched to remote mode from local mode. Take necessary measures for safety.

Parameter number	Display name	Setting range	Units	Default setting	Valid access levels			
					V/f Control	V/f with PG	Open Loop Vector	Flux Vector
b1-08	RUN CMD at PRG	0, 1	---	0	Advanced			

Explanation of Settings

Setting	Description
0	The run command in any mode other than drive mode is disabled. (The Inverter will start operating with the run command input again in drive mode.)
1	A run command is enabled. (The Inverter will start operating according to the present run command in drive mode or any other mode.) Note The run command is disabled if the Digital Operator is specified with parameter b1-02 set to 0.

Note If the parameter b1-08 is set to 1, the Inverter will start operating regardless of whether parameters are adjusted in program mode or not. Take necessary safety measures to prevent accidents.

■ **Setting DC Injection Braking (b2-01 to 04)**

The DC injection braking function decelerates by applying a DC magnetic field to the motor.

DC injection braking time at start:

This is effective for temporarily stopping and then restarting, without regenerative processing, a motor coasting by inertia.

DC injection braking time at stop:

When there is a large load, this is used to prevent coasting by inertia when the motor is not completely stopped by normal deceleration. The stopping time can be shortened by lengthening the DC injection braking time or increasing the DC injection braking current.

Parameter number	Display name	Setting range	Units	Default setting	Valid access levels			
					V/f Control	V/f with PG	Open Loop Vector	Flux Vector
b2-01	DC Inj Start Freq	0.0 to 10.0	Hz	0.5	Basic or Advanced			
b2-02	DC Inj Current	0 to 100	%	50	Basic or Advanced			---
b2-03	DC Inj Time@Start	0.0 to 10.00	Sec	0.00	Basic or Advanced			
b2-04	DC Inj Time@Stop	0.0 to 10.00	Sec	0.50	Basic or Advanced			

These parameters cannot be changed during operation.

- For the excitation level (b2-01), set the frequency for beginning DC injection braking at the time of deceleration. If the excitation level is lower than the minimum output frequency (E1-09), the DC injection braking will begin from the minimum output frequency.

Note 1. In flux vector control mode, DC injection braking becomes the initial excitation starting frequency at the time of deceleration. In that case, braking starts from the excitation level regardless of the minimum output frequency setting.

Note 2. The excitation level is also used as the operating frequency for the zero servo function (for flux vector control only).

- For the DC injection braking current (b2-02), set the value for the current that is output at the time of DC injection braking. DC injection braking current is set as a percentage of Inverter rated output current, with the Inverter rated output current taken as 100%. If the DC injection braking time (parameters b2-03 and b2-04) is longer than one second, set the DC injection braking current to 50% or less.
- For the DC injection braking time at start (b2-03), set the DC injection braking operating time for when the motor is started.
- For the DC injection braking time at stop (b2-04), set the DC injection braking operating time for when the motor is stopped.

DC Injection (Initial Excitation) Timing Chart

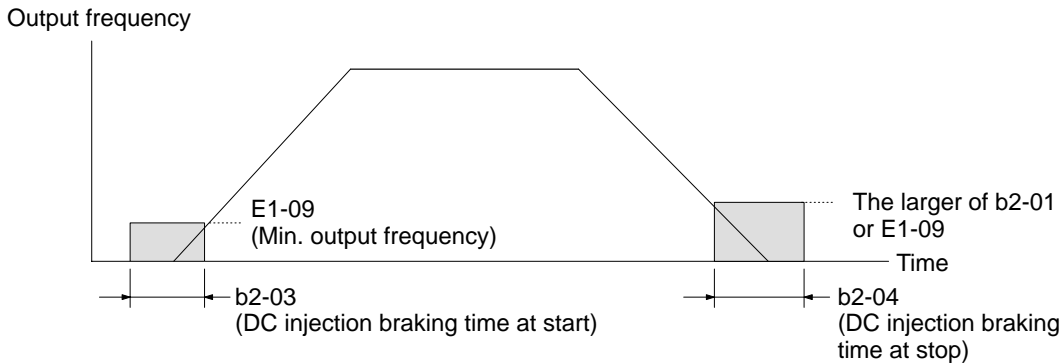

■ Setting Magnetic Field Compensation (b2-08)

When using the “DC injection braking at startup” (initial excitation) function to bring up the motor’s magnetic flux before running machinery that requires high starting torque, it may take some time for the magnetic flux to rise sufficiently. This depends upon the motor’s electrical time constant, and is especially true with high-capacity motors.

This function can be used to apply a stronger magnetic flux current when the “DC injection braking at startup” (initial excitation) function starts, so that the magnetic field in the motor rises faster and more reliably.

Parameter number	Display name	Setting range	Units	Default setting	Valid access levels			
					V/f Control	V/f with PG	Open Loop Vector	Flux Vector
b2-08	Field Comp@start	0 to 500	1%	0	Not applicable.		Advanced	

This parameter cannot be changed during operation.

Note When b2-08 is 100%, it indicates the motor’s no-load current value (motor magnetic flux current).

Timing Chart

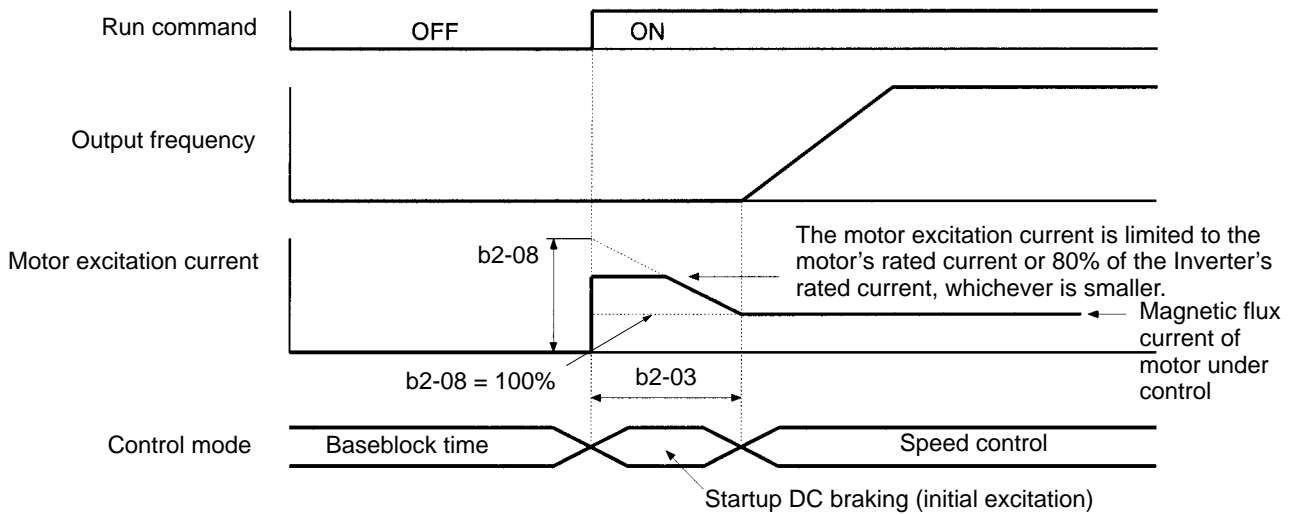

- The magnetic flux in the motor can be brought up faster by setting b2-08 greater than 100% so that a larger current flows when the “DC injection braking at startup” (initial excitation) function starts. The magnetic flux will rise approximately twice as fast when b2-08 is set to 200%.
- The magnetic flux in the motor will rise more slowly when b2-08 is set below 100%. (In general do not set b2-08 below 100%, although operation with b2-08 = 0% is the same as b2-08 = 100% and the magnetic flux is raised by the set DC injection braking current (b2-02).)
- The sound generated from the motor during startup DC injection braking may increase as the magnetic compensation value in b2-08 is increased.
- If the delay before the start of control due to the DC injection braking (initial excitation) time at start setting in b2-03 is too long, do not use this compensation function. Use the DC injection braking multi-function input (set value: 60) instead and raise the motor magnetic flux in advance while the motor is stopped.

■ Setting Speed Search (b3)

The speed search function finds the speed of a coasting motor and starts up smoothly from that speed. It is effective in situations such as switching from a commercial power supply.

The speed search function applies a lower voltage than normal, and finds the speed at the current flowing at that time. The speed search is determined to be completed when the frequency is lowered from the maximum frequency (or a set frequency) and the current that is output falls below a fixed value. When the speed search is completed, the speed is accelerated to the frequency reference according to the acceleration time that has been set. For V/f with PG or flux vector control, detection occurs at the motor speed with PG feedback.

Parameter number	Display name	Setting range	Units	Default setting	Valid access levels			
					V/f Control	V/f with PG	Open Loop Vector	Flux Vector
b3-01	Spd Srch at Start	0, 1	---	0 (See note.)	Advanced			

This parameter cannot be changed during operation.

Note When the control mode is switched, the factory default setting changes as follows:

V/f control: 0; V/f with PG: 1; open-loop vector 0; flux vector: 1

Explanation of Settings

Set value	Contents
0	Speed search disabled: Motor starts from minimum output frequency.
1	Speed search enabled: Speed search is performed from maximum output frequency and motor is started. (In control modes with PG, i.e., V/f with PG and flux vector, motor starts from the motor speed.)

Set “1” to use the speed search function. To use speed search freely in control modes without PG, i.e., V/f control and open-loop vector control, set the multi-function contact input selection (H1-01 to H1-06) to 61 or 62 (external search command).

Parameter number	Display name	Setting range	Units	Default setting	Valid access levels			
					V/f Control	V/f with PG	Open Loop Vector	Flux Vector
b3-02	Spd Srch Current	0 to 200	%	100	Advanced	---	Advanced	---
b3-03	Spd Srch Dec Time	0.1 to 10.0	Sec	2.0	Advanced	---	Advanced	---
L2-03	PwrL Baseblock t	0.0 to 0.5	Sec	0.5 (see note)	Basic or Advanced			

These parameters cannot be changed during operation.

Note The factory-set default varies depending on the Inverter capacity. The values shown in the table are for 200-V class, 0.4-kW.

- For the speed search operating current (b3-02), set the operating current for the speed search. If restarting is not possible with the set value, then lower the set value. Set the speed search operating current as a percentage of the Inverter’s rated output current, with the Inverter’s rated output current taken as 100%.
- For the speed search deceleration time (b3-03), set the output frequency deceleration time for while the speed search is being performed.
- When the speed search and DC injection braking are set, set the minimum baseblock time (L2-03). For the minimum baseblock time, set the time to wait for the motor’s residual voltage to dissipate. If an overcurrent is detected when starting a speed search or DC injection braking, raise the set value to prevent a fault from occurring.

Speed Search Timing Chart

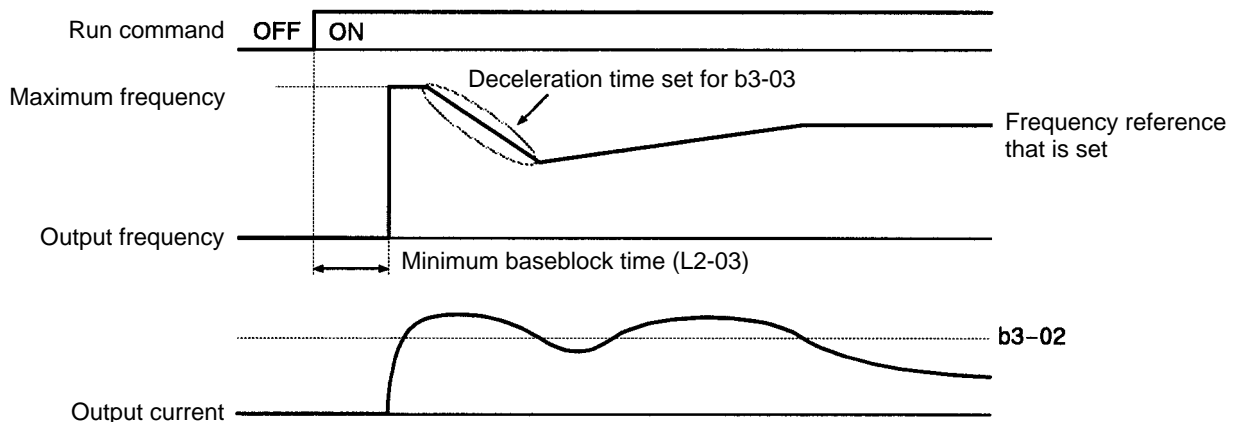

■ **Setting the Timer Function (b4)**

The timer function is enabled when the timer function input (set value: 18) and the timer function output (set value: 12) are set for the multi-function input and multi-function output respectively. These inputs and outputs serve as general-purpose I/O. Chattering of sensors, switches, and so on, can be prevented by setting a delay time.

Parameter number	Display name	Setting range	Units	Default setting	Valid access levels			
					V/f Control	V/f with PG	Open Loop Vector	Flux Vector
b4-01	Delay-ON Timer	0.0 to 300.0	Sec	0.0	Advanced			
b4-02	Delay-OFF Timer	0.0 to 300.0	Sec	0.0	Advanced			

These parameters cannot be changed during operation.

- When the timer function input ON time is longer than the value set for b4-01 (timer function ON-delay time), the timer function output turns ON.
- When the timer function input OFF time is longer than the value set for b4-02 (timer function OFF-delay time), the timer function output turns OFF.

Operation Example

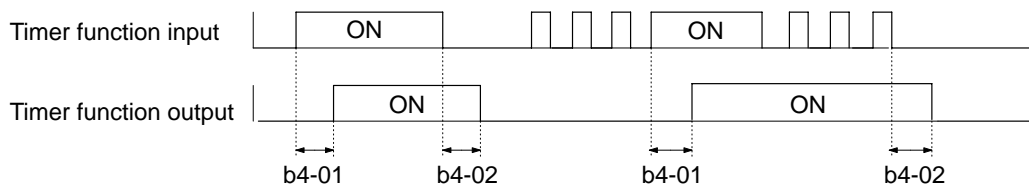

■ **Setting PID Control (b5)**

The PID control function is a control system that matches a feedback value (i.e., a detected value) to the set target value. Combining proportional (P), integral (I), and derivative (D) control makes control possible even for a mechanical system with dead time. The PID control provided by the SYSDRIVE 3G3FV Inverter is not suited for control that requires a responsiveness of 50 ms or less.

This section explains the PID control applications and operations, along with the parameter settings and tuning procedure.

● **PID Control Applications**

The following table shows examples of PID control applications using the Inverter.

Application	Control contents	Sensors used (example)
Speed control	Speeds are matched to target values as speed information in a mechanical system. Speed information for another mechanical system is input as target values, and synchronized control is executed by feeding back actual speeds.	Tacho-generator
Pressure control	Pressure information is returned as feedback for stable pressure control.	Pressure sensor
Flow control	Flow information is returned as feedback for accurate flow control.	Flow sensor
Temperature control	Temperature information is returned as feedback to control temperature by turning a fan.	Thermocouple Thermistor

● **PID Control Operations**

In order to distinguish the separate PID control operations (i.e., proportional, integral, and derivative), the following diagram shows the changes in the control input (i.e., the output frequency) when the deviation between the target value and the feedback is held constant.

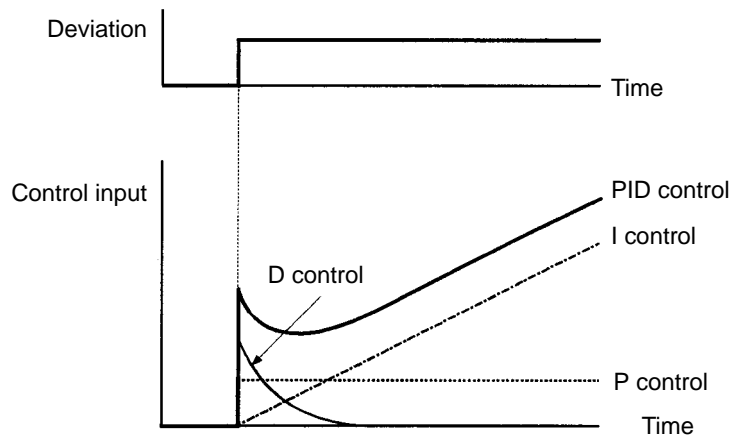

● **P Control**

A control input proportional to the deviation is output. The deviation cannot be zeroed by P control alone.

● **I Control**

A control input which is an integral of the deviation is output. This is effective for matching the feedback to the target value. Sudden changes, however, cannot be followed.

● **D Control**

A control input which is an integral of the deviation is output. Quick response to sudden changes is possible.

● **PID Control**

Optimum control is achieved by combining the best features of P, I, and D control.

● **Types of PID Control**

Two types of PID control are possible with the 3G3FV: measured-value derivative PID control and basic PID control. The type that is normally used is measured-value derivative PID control.

• Measured-value Derivative PID Control

With measured-value derivative PID control, the feedback value is differentiated for PID control. Response is possible with respect to changes both in target values and the control object.

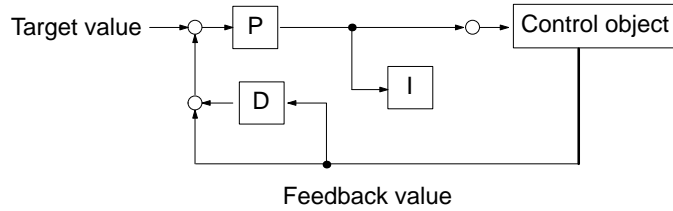

• Basic PID Control

This is the basic form of PID control. When the D control response is adjusted to follow changes in the control object, overshooting and undershooting can occur with changes in the target value.

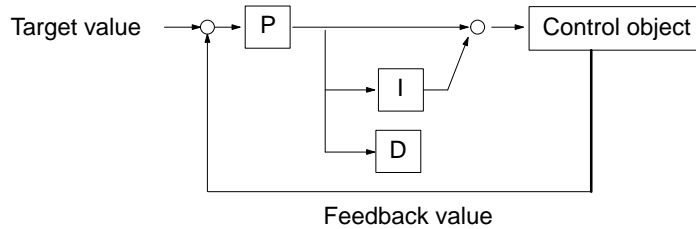

• Inverter's PID Control Function

The following illustration is a block diagram of the Inverter's internal PID control.

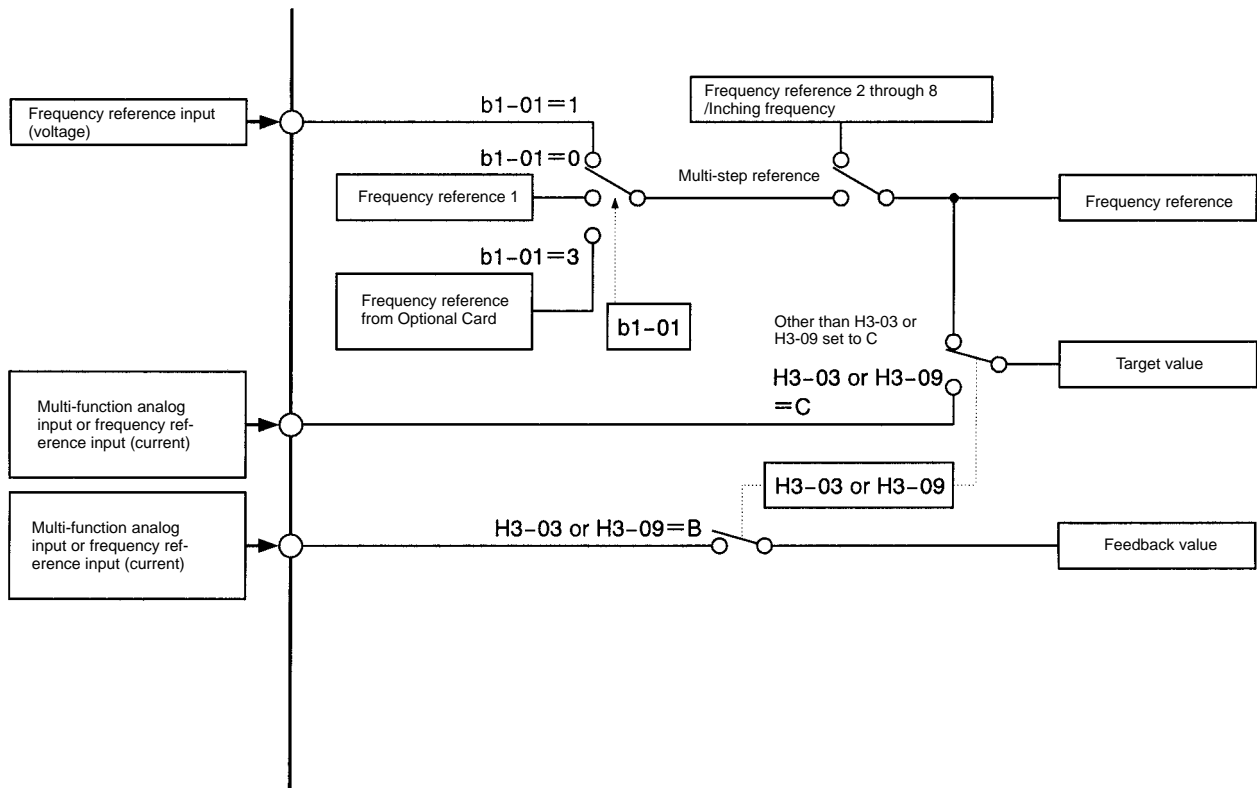

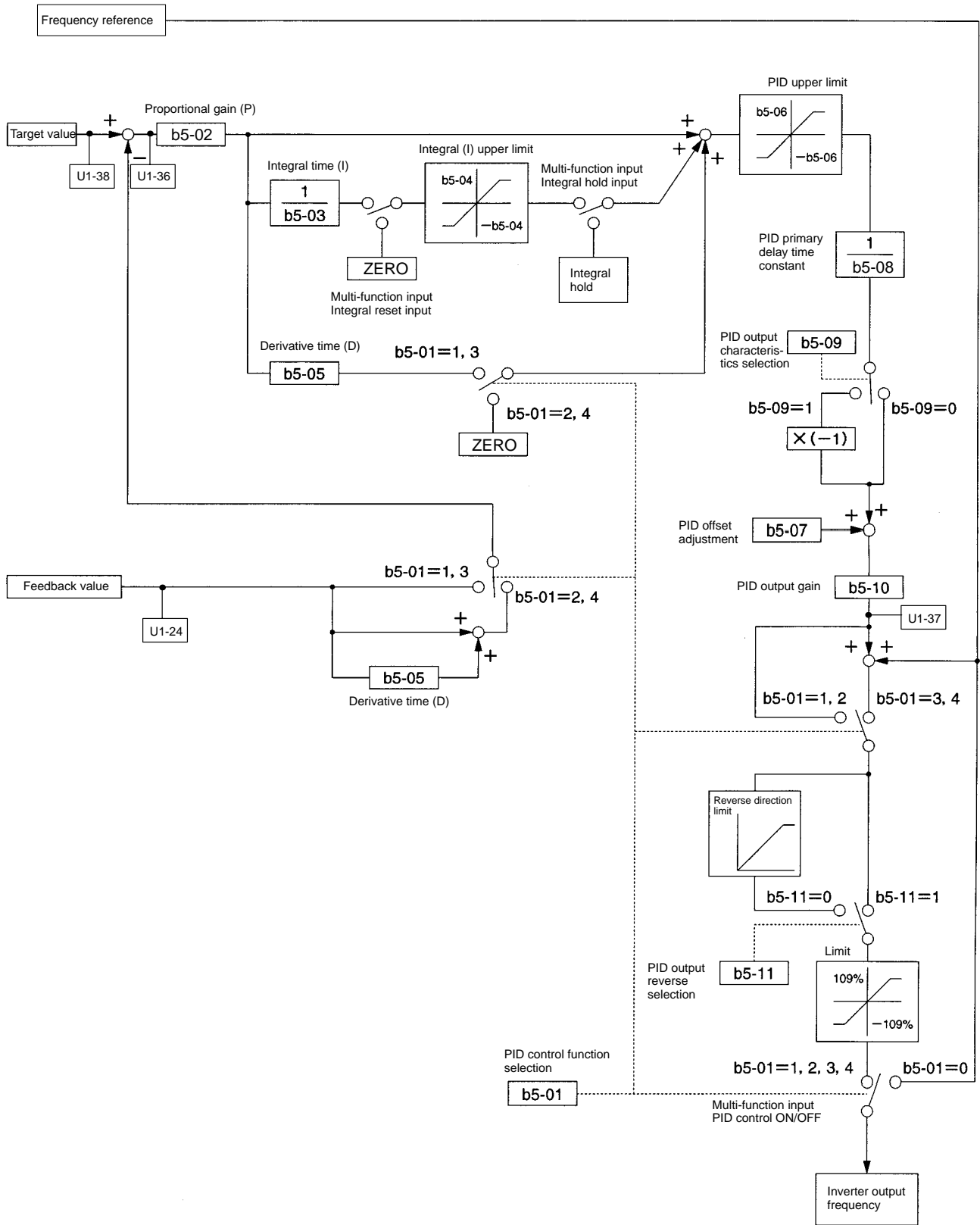

● PID Control Settings

Parameter number	Display name	Setting range	Units	Default setting	Valid access levels			
					V/f Control	V/f with PG	Open Loop Vector	Flux Vector
b5-01	PID Mode	0 to 4	---	0	Advanced			

This parameter cannot be changed during operation.

Set value	Contents
0	PID disabled
1	PID enabled (Deviation signal is put through derivative control.)
2	PID enabled (Feedback signal is put through derivative control.)
3	PID enabled. (Frequency reference and PID control/deviation signal are put through derivative control.)
4	PID enabled. (Frequency reference and PID control/feedback signal are put through derivative control.)

Note 1. To enable PID control, set 1 through 4. (Normally 2 or 4 is used for measured-value derivative PID control.)

Note 2. If the target speed of the application (e.g., tension control) is rather clear and PID control is required for fine tuning, set 3 or 4 for frequency reference and PID control.

Setting Target Values for PID Control

The following guidelines can be used to select target values for PID Control.

c	Contents
Frequency reference input, voltage: Terminal 13	The frequency source selected for parameter b1-01 is used as the target value. Note 1. If the PID control target value is not set for a multi-function analog input or frequency reference (current) selection (H3-05, H3-09), then the setting of b1-01 is used automatically. Note 2. Frequency references 2 to 8 and the inching reference are enabled regardless of the setting of b1-01. Note 3. Operation will be clearer if o1-03 is set to 1 (% unit) when setting from a Digital Operator.
Setting via Digital Operator	
Option frequency reference	
Multi-function analog input: Terminal 16	Set C for the function selection of multi-function analog input terminal 16 (H3-05) to select the PID target value.
Frequency reference, current: Terminal 14	Set C for the function selection of frequency reference (current) terminal 14 (H3-09) to select the PID target value.

Note When using different input signals for frequency reference and PID control, set the PID target value to either a multi-function analog input or the frequency reference (current).

Setting Feedback Values for PID Control

The following guidelines can be used to select feedback values for PID Control.

c	Contents
Multi-function analog input: Terminal 16	Set B for the function selection of multi-function analog input terminal 16 (H3-05) to select the PID feedback value.
Frequency reference, current: Terminal 14	Set B for the function selection of frequency reference (current) terminal 14 (H3-09) to select the PID feedback value.

Note 1. Use the gain and bias settings for the analog inputs to adjust the feedback value.

Note 2. PID control feedback cannot be set for more than one analog input.

Note 3. Use different settings for the PID target value and the PID feedback value.

Adjust the responsiveness of the PID control by means of the proportional gain (P), integral time (I), and derivative time (D).

Parameter number	Display name	Setting range	Units	Default setting	Valid access levels			
					V/f Control	V/f with PG	Open Loop Vector	Flux Vector
b5-02	PID Gain	0.00 to 25.00	Multi-ple	1.00	Advanced			
b5-03	PID I Time	0.0 to 360.0	Sec	1.0	Advanced			
b5-05	PID D Time	0.0 to 10.00	Sec	0.00	Advanced			

These parameters can be changed during operation.

Explanation of Set Values

- Optimize the responsiveness by adjusting it while operating an actual load (mechanical system). (Refer to *Adjusting PID Control* on page 6-55.)
- Any control (P, I, or D) that is set to zero (0.0, 0.00) will not operate.

Parameter number	Display name	Setting range	Units	Default setting	Valid access levels			
					V/f Control	V/f with PG	Open Loop Vector	Flux Vector
b5-04	PID I Limit	0.0 to 100.0	%	100.0	Advanced			

This parameter can be changed during operation.

Explanation of Set Values

- This parameter prevents the calculated value of the integral control in the PID control from exceeding the fixed amount.
- Parameter b5-04 is preset at the factory to the optimum value for most applications, so there is normally no need to change the setting.
- Reduce the set value if there is a risk of load damage, or of the motor going out of step, by the Inverter's response when the load suddenly changes. If the set value is reduced too much, the target value and the feedback value will not match.
- Set this parameter as a percentage of the maximum frequency, with the maximum frequency taken as 100%.

Parameter number	Display name	Setting range	Units	Default setting	Valid access levels			
					V/f Control	V/f with PG	Open Loop Vector	Flux Vector
b5-06	PID Limit	0.0 to 100.0	%	100.0	Advanced			

This parameter can be changed during operation.

Explanation of Set Values

- Parameter b5-06 prevents the frequency reference after PID control from exceeding the fixed amount.
- Set this parameter as a percentage of the maximum frequency, with the maximum frequency taken as 100%.

Parameter number	Display name	Setting range	Units	Default setting	Valid access levels			
					V/f Control	V/f with PG	Open Loop Vector	Flux Vector
b5-07	PID Offset	-100.0 to 100.0	%	0.0	Advanced			

This parameter can be changed during operation.

Explanation of Set Values

- Parameter b5-07 adjusts the PID control offset.
- If both the target value and the feedback value are set to zero, adjust the Inverter’s output frequency to zero.

Parameter number	Display name	Setting range	Units	Default setting	Valid access levels			
					V/f Control	V/f with PG	Open Loop Vector	Flux Vector
b5-08	PID Delay Time	0.00 to 10.00	Sec	0.00	Advanced			

This parameter can be changed during operation.

Explanation of Set Values

- Parameter b5-08 is the low-pass filter setting for PID control outputs.
- Parameter b5-08 is preset at the factory to the optimum value for most applications, so there is normally no need to change the setting.
- If the viscous friction of the mechanical system is high, or if the rigidity is low, causing the mechanical system to vibrate, increase the set value so that it is higher than the vibration frequency period. This will decrease the responsiveness, but it will prevent the vibration.

• Jump Frequency Function

While the Inverter is in PID control, a frequency band can be avoided by setting parameters d3-01 through d3-04 to the desired frequencies. Use this function to prevent vibration of the mechanical system.

Note The frequency band to be set should be as narrow as possible, otherwise PID control will not function properly and the mechanical system may vibrate.

• PID Control Reverse Characteristics

Use the following parameter to set or adjust PID control characteristics.

Parameter number	Display name	Setting range	Units	Default setting	Valid access levels			
					V/f Control	V/f with PG	Open Loop Vector	Flux Vector
b5-09	Output Level Set	0, 1	---	0	Advanced			

Explanation of Settings

Set value	Contents
0	Positive PID output.
1	Negative PID output. (-1 is added to the operation result of PID control.)

- Positive or reverse characteristic PID control is possible.
- Set the characteristic according to the relationship between the Inverter’s output frequency and the feedback value.

Positive characteristic: The feedback value increases when the Inverter’s output frequency increases.

Negative characteristic: The feedback value increases when the Inverter’s output frequency decreases.

Parameter number	Display name	Setting range	Units	Default setting	Valid access levels			
					V/f Control	V/f with PG	Open Loop Vector	Flux Vector
b5-10	Output Gain	0.0 to 25.0	Times	1.0	Advanced			

Explanation of Settings

- Use this parameter to set the multiplication ratio of the Inverter’s final output under PID control.
- The entire PID control amount can be adjusted. For frequency reference + PID control, the adjustment of PID control of the frequency reference can be made.

Parameter number	Display name	Setting range	Units	Default setting	Valid access levels			
					V/f Control	V/f with PG	Open Loop Vector	Flux Vector
b5-11	Output Rev Set	0, 1	---	0	Advanced			

Explanation of Settings

Set value	Contents
0	Reverse rotation disabled. (If the final output is negative, the output will be limited to 0 and the motor will not rotate in the reverse direction.)
1	Reverse rotation enabled. (If the final output is negative, the motor will rotate according to the output value.)

- Set this parameter to enable or disable the motor to rotate in the reverse direction if the Inverter’s final output under PID control is negative.
The reverse direction means the direction opposite to the direction specified by the run command input. Therefore, if a run command is input for reverse rotation, the motor will rotate in the forward direction. If a run command is input for forward rotation input, the motor will rotate in the opposite.
- The parameter is by default set to 0 in consideration of safety. Set this parameter according to the application.

Note 1. If the parameter is set to 1, the motor will rotate in the reverse rotation when run command for forward rotation is input. Take necessary safety measure for the prevention of accidents.

Note 2. If parameter b1-04 (Disabling Reverse Operation) is set to 1, the motor will not rotate in the reverse direction even with the parameter b5-11 set to 1.

• Feedback Loss Detection for PID Control

This function is used to detect the loss of the feedback signal (e.g., as a result of line disconnection or short-circuiting) when the feedback voltage drops suddenly.

Parameter number	Display name	Setting range	Units	Default setting	Valid access levels			
					V/f Control	V/f with PG	Open Loop Vector	Flux Vector
b5-12	Fb los Det Sel	0 to 2	---	0	Advanced			

Explanation of Settings

Set value	Contents
0	Feedback loss detection disabled.
1	Feedback loss detection enabled. (The Inverter will continue operating with a warning output turned ON.)
2	Feedback loss detection enabled. (The Inverter's protective function shuts off the output.)

- Set this parameter to disable or enable the feedback loss detection function and to specify the operation of the Inverter after the loss of the feedback signal is detected.
- Feedback loss will be detected if the Inverter receives feedback values lower than the feedback loss detection level set with b5-13 for the time set with b5-14.
- The loss of the feedback can be checked with the following output.
 - If 1 (warning) is set: Multi-function contact output or multi-function 1/2 output will turn ON as an alarm (setting: 10).
 - If 2 (protective function) is set: The fault contact output will turn ON.

Parameter number	Display name	Setting range	Units	Default setting	Valid access levels			
					V/f Control	V/f with PG	Open Loop Vector	Flux Vector
b5-13	Bb loss Det Lvl	0 to 100	%	0	Advanced			

Parameter number	Display name	Setting range	Units	Default setting	Valid access levels			
					V/f Control	V/f with PG	Open Loop Vector	Flux Vector
b5-14	Fb los Det Time	0.0 to 25.5	Sec	1.0	Advanced			

- These parameters are used to set reference values for detecting the loss of the feedback signal for PID control.
- Set parameter b5-13 to the detection level in 1% increments based on the feedback value corresponding to the maximum frequency as 100%.
- Set parameter b5-14 to the detection time in 1-s increments so that the loss of the feedback signal will be detected when the time set elapses.

• PID Control Switching Function of Multi-function Input

By setting multi-function inputs 1 through 6 (the parameters H1-01 through H1-06) to the following functions, PID control characteristics can be selected.

- PID control ON/OFF (setting: 19)
 - ON: PID control disabled (The Inverter is in normal control.)
 - PID or normal control function can be selected in advance.
- PID control integral value reset (setting: 30)
 - ON: The integral value is reset.
 - The PID integral value will be reset to zero and the integral function disabled. This can be used to handle the friction of the mechanism when stopped or to reduce gain.
- PID control integral value hold (setting: 31)
 - ON: The integral value is retained.
 - The integral value in PID control can be fixed with the parameter set. This can be used to handle the friction of the mechanism when stopped or to reduce gain or fluctuations.

- **Adjusting PID Control**
- **Step Response**

This section explains how to adjust PID control parameters while observing the step response of the control object.

1. Measuring the Step Response Waveform

Use the following procedure to measure the step response waveform.

- a) Connect a load under the same conditions as for normal operation.
- b) Set parameter b5-01 to "0" (PID control disabled).
- c) Set the Inverter's acceleration time as low as possible, and input the step frequency reference.
- d) Measure the response waveform of the feedback (i.e., the detection value).

Note Conduct the measurement so as to know the timing with the step input.

2. Calculating the PID Parameters

- Draw a tangential line at the steepest point of the gradient of the step response waveform measured in procedure 1.

- **Measuring R**

Measure the inclination of the tangential line, with the target value as "1."

- **Measuring L**

Measure the time (unit: seconds) until the tangential line from the beginning of the step input joins the time axis.

- **Measuring T**

Measure the time (unit: seconds) from the point where the tangential line joins the time axis to the point where it meets the target value.

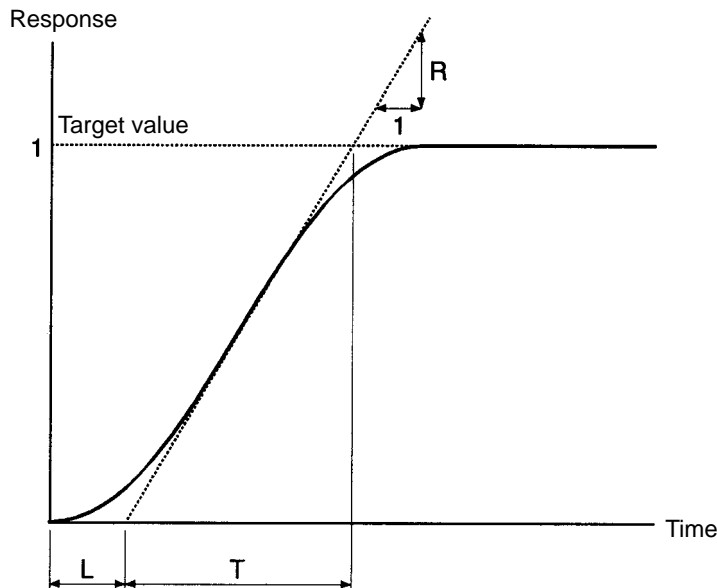

• **Calculating the PID Parameters**

The PID parameters can be calculated from the R, L, and T values measured above, as shown in the following table.

	Proportional gain (P) (b5-02)	Integral time (I) (b5-03)	Derivative time (D) (b5-05)
P control	0.3/RL	---	---
PI control	0.35/RL	1.2T	---
PID control	0.6/RL	T	0.5L

First set the PID control parameters by this method, and then make fine adjustments.

If the viscous friction of the mechanical system is high, or if the rigidity is low, these set values may not be optimum.

• **Making Manual Adjustments**

Use the following procedure to make adjustments while using PID control and observing the response waveform.

1. Set parameter b5-01 to "1" to "4" (PID control enabled).
2. Increase the proportional gain P (b5-02) in the non-vibration range.
3. Decrease the integral time I (b5-03) in the non-vibration range.
4. Decrease the derivative time I (b5-05) in the non-vibration range.

• **Making Fine Adjustments**

First set the individual PID control parameters, and then make fine adjustments.

• **Reducing Overshooting**

If overshooting occurs, shorten the derivative time (D) and lengthen the integral time (I).

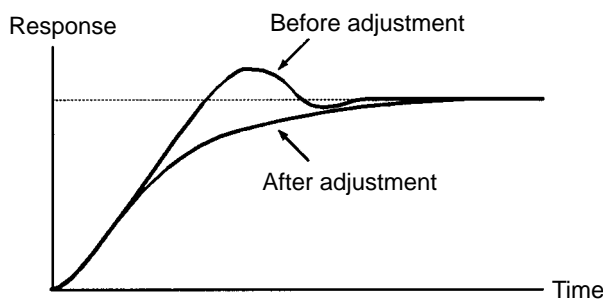

• **Rapidly Stabilizing Control Status**

To rapidly stabilize the control conditions even when overshooting occurs, shorten the integral time (I) and lengthen the derivative time (D).

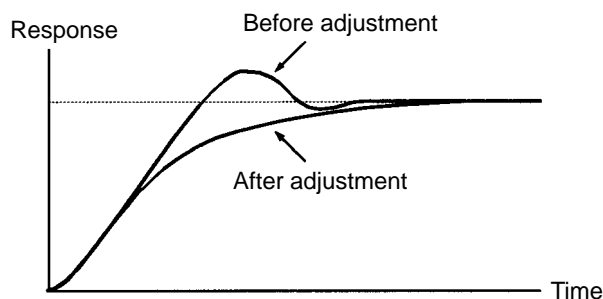

• Reducing Long-cycle Vibration

If vibration occurs with a longer cycle than the integral time (I) set value, it means that integral operation is strong. The vibration will be reduced as the integral time (I) is lengthened.

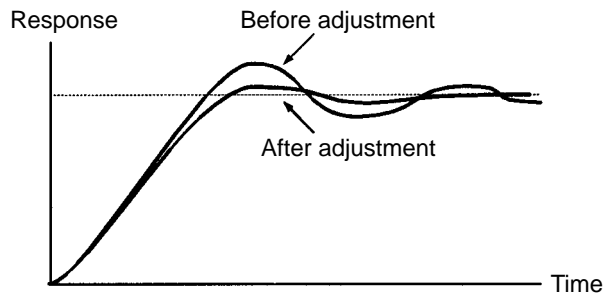

• Reducing Short-cycle Vibration

If the vibration cycle is short and vibration occurs with a cycle approximately the same as the derivative time (D) set value, it means that the derivative operation is strong. The vibration will be reduced as the derivative time (D) is shortened.

If vibration cannot be reduced even by setting the derivative time (D) to “0.00” (no derivative control), then either lower the proportional gain (P) or raise the PID’s primary delay time constant.

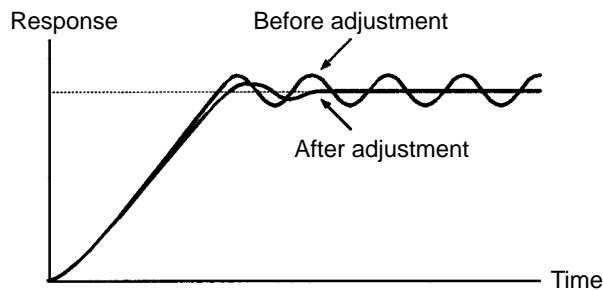

■ Setting the Reference Hold Function (b6)

The reference hold or dwell function is used to temporarily hold the output frequency when starting or stopping a motor with a heavy load. This helps to prevent stalling.

Parameter number	Display name	Setting range	Units	Default setting	Valid access levels			
					V/f Control	V/f with PG	Open Loop Vector	Flux Vector
b6-01	Dwell Ref @Start	0.0 to 400.0	Hz	0.0	Advanced			
b6-02	Dwell Time@Start	0.0 to 10.0	Sec	0.0	Advanced			
b6-03	Dwell Ref @Stop	0.0 to 400.0	Hz	0.0	Advanced			
b6-04	Dwell Time @Stop	0.0 to 10.0	Sec	0.0	Advanced			

These parameters cannot be changed during operation.

The relation between these parameters is shown in the following diagram.

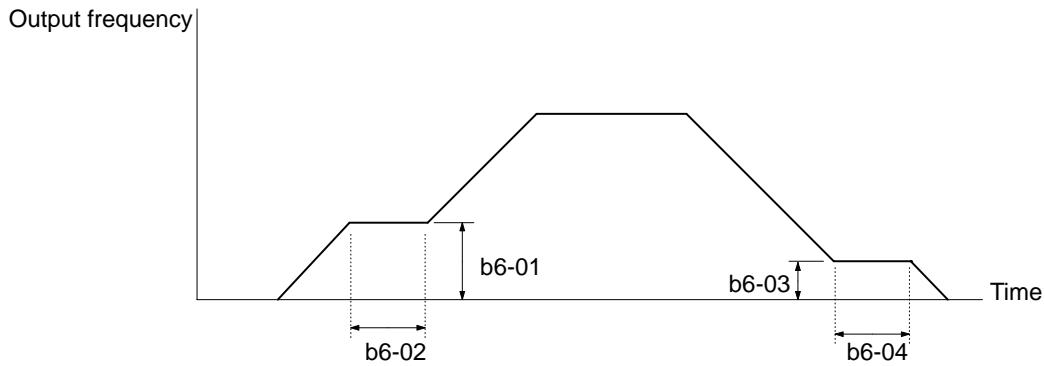

6-5-3 Tuning Parameters (C)

■ Setting the S-curve Characteristic Function (C2)

- Using the S-curve characteristic function for acceleration and deceleration can reduce shock to the machinery when stopping and starting.
- With the SYSDRIVE 3G3FV, S-curve characteristic times can be set respectively for beginning acceleration, ending acceleration, beginning deceleration, and ending deceleration.

Parameter number	Display name	Setting range	Units	Default setting	Valid access levels			
					V/f Control	V/f with PG	Open Loop Vector	Flux Vector
C2-01	SCrv Acc @ Start	0.00 to 2.50	Sec	0.20	Advanced			
C2-02	SCrv Acc @ End	0.00 to 2.50	Sec	0.20	Advanced			
C2-03	SCrv Dec @ Start	0.00 to 2.50	Sec	0.20	Advanced			
C2-04	SCrv Dec @ End	0.00 to 2.50	Sec	0.20	Advanced			

These parameters cannot be changed during operation.

- The relation between these parameters is shown in the following diagram.

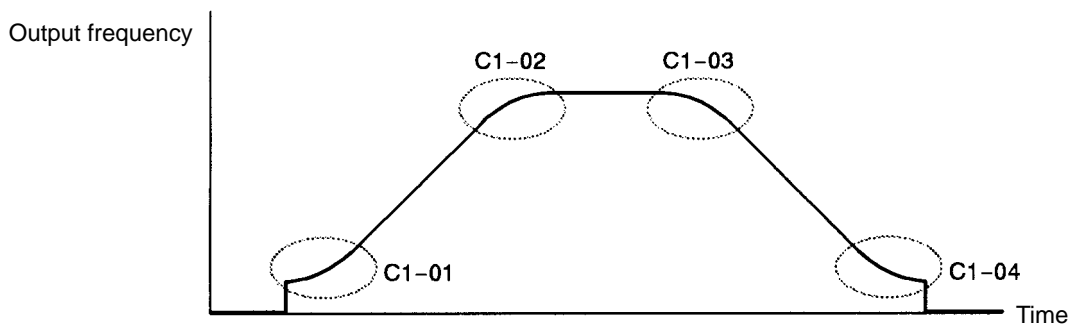

Note When the S-curve characteristic time is set, the acceleration and deceleration times will be lengthened as follows:

$$\text{Acceleration time} = \text{Selected acceleration time} + (\text{S-curve at beginning of acceleration} + \text{S-curve at end of acceleration}) / 2$$

$$\text{Deceleration time} = \text{Selected deceleration time} + (\text{S-curve at beginning of deceleration} + \text{S-curve at end of deceleration}) / 2$$

■ **Setting Motor Slip Compensation (C3)**

- The motor slip compensation function calculates the motor torque according to the output current, and sets gain to compensate for output frequency.
- This function is used to improve speed accuracy when operating with a load. It is mainly effective with V/f control (without PG).

Parameter number	Display name	Setting range	Units	Default setting	Valid access levels			
					V/f Control	V/f with PG	Open Loop Vector	Flux Vector
C3-01	Slip Come Gain	0.0 to 2.5	Multi-ple	1.0 (See note.)	Basic or Adv.	---	Basic or Advanced	

This parameter can be changed during operation.

Note When the control mode is switched, the factory default setting changes as follows:

V/f control: 0.0; V/f with PG: 1.0; open-loop vector 0; flux vector: 1.0

When “1.0” is set, this function compensates for the rated slip that has been set, by the rated torque output.

With flux vector control, this becomes the gain to compensate for slip caused by motor temperature variation. (Refer to page 6-34.)

• **Motor Slip Compensation Gain Adjustment Procedure**

1. Correctly set the motor rated slip (parameter E2-02) and the motor no-load current (parameter E2-03). The motor rated slip can be calculated by means of the following equation, using the numbers that are shown on the motor’s nameplate.

$$\text{Motor rated slip} = \text{Motor rated frequency (Hz)} - \text{rated speed (r/min)} \times \text{motor (No. of poles)} / 120$$

(With vector control, the motor rated slip is automatically set by auto-tuning.)

2. Set the slip compensation gain (parameter C3-01 to “1.0.” (If it is set to “0.0,” slip compensation will be disabled.)
3. Operate with a load, measure the speed, and adjust the slip compensation gain (in increments of 0.1). If the speed is lower than the target value, increase the slip compensation gain. If the speed is higher than the target value, decrease the slip compensation gain.

Parameter number	Display name	Setting range	Units	Default setting	Valid access levels			
					V/f Control	V/f with PG	Open Loop Vector	Flux Vector
C3-02	Slip Come Time	0 to 10000	ms	200 (See note.)	Adv.	---	Advanced	---

This parameter cannot be changed during operation.

Note When the control mode is switched, the values change as follows:

V/f control: 2,000; open-loop vector: 200

Adjust the slip compensation primary delay time if the motor slip compensation responsiveness is low, or if the speeds are unstable. (This does not normally need to be set.) If responsiveness is low, lower the set value. If speeds are unstable, raise the set value.

Parameter number	Display name	Setting range	Units	Default setting	Valid access levels			
					V/f Control	V/f with PG	Open Loop Vector	Flux Vector
C3-03	Slip Come Limit	0 to 250	%	200	Adv.	---	Advanced	---

This parameter cannot be changed during operation.

Parameter C3-03 sets the slip compensation limit as a percentage of motor rated slip (E2-02), with the motor rated slip taken as 100%.

If the speed is lower than the target value and does not change even when the slip compensation gain is adjusted, it is possible that the slip compensation limit has been reached. Raise the limit and then check again. Make sure, however, that the value of the sum of the command frequency and the slip compensation limit does not exceed the speed capacity of the machinery.

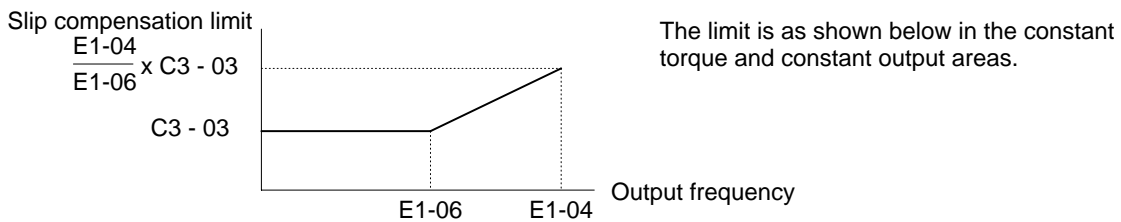

The limit is as shown below in the constant torque and constant output areas.

E1-06: Maximum voltage frequency

E1-04: Maximum output frequency

Parameter number	Display name	Setting range	Units	Default setting	Valid access levels			
					V/f Control	V/f with PG	Open Loop Vector	Flux Vector
C3-04	Slip Come Regen	0, 1	---	0	Advanced			---

This parameter cannot be changed during operation.

Explanation of Set Value

Set value	Contents
0	Slip compensation disabled during regeneration
1	Slip compensation enabled during regeneration

Parameter C3-04 enables or disables slip compensation during regeneration. The amount of regeneration is momentarily increased when this function is used, so some control option (e.g., control resistor, Control Resistor Unit, Braking Unit) may be required.

■ Setting the Torque Compensation Function (C4)

The torque compensation function detects increases in the motor load, and increases the output torque to compensate.

Parameter number	Display name	Setting range	Units	Default setting	Valid access levels			
					V/f Control	V/f with PG	Open Loop Vector	Flux Vector
C4-01	Torq Comp Gain	0.00 to 2.50	Multiple	1.00	Advanced			---

This parameter can be changed during operation, but normally no adjustments are required. Make adjustments in the following cases:

- If the wiring distance between the Inverter and the motor is long, raise the set value.
- If the motor capacity is less than the Inverter capacity (the maximum application motor capacity), raise the set value.
- If the motor generates excessive vibration, lower the set value.

Set the torque compensation gain so that the output current at low-speed rotation does not exceed 50% of the Inverter’s rated output current. If the setting exceeds 100% of the Inverter’s rated output current, the Inverter may be damaged.

Parameter number	Display name	Setting range	Units	Default setting	Valid access levels			
					V/f Control	V/f with PG	Open Loop Vector	Flux Vector
C4-02	Torq Comp Time	0 to 10000	ms	(See note.)	Advanced			

This parameter cannot be changed during operation.

Note When the control mode is switched, the factory default setting changes as follows:
 V/f control: 200; V/f with PG: 200; open-loop vector 20

The torque compensation time constant does not normally need to be adjusted, but make adjustments in the following cases:

- If the motor generates excessive vibration, raise the set value.
- If motor responsiveness is low, lower the set value.

■ Setting the Carrier Frequency (C6)

The carrier frequency characteristics differ according to the control mode.

- V/f control and V/f with PG control: Carrier frequency variable setting possible.
- Open-loop vector control and flux vector control: Constant frequency (The carrier frequency upper limit only is set.)

The carrier frequency does not normally need to be adjusted, but make adjustments in the following cases:

- If the wiring distance between the Inverter and the motor is long, lower the carrier frequency. The standards are 15 mHz or less for a wiring distance of 50 meters or less; 10 mHz or less for 100 meters or less; and 5 mHz or less for over 100 meters.
- If there are great irregularities in speed or torque, lower the carrier frequency.

Setting the Carrier Frequency and Inverter Overload “OL2”

For a 400-V Inverter, if the carrier frequency is set to a value higher than the default setting, the Inverter overload detection value will decrease in consideration of an increase in the heat that will be generated by the change in the carrier frequency. Since the detection value is set to decrease by approximately 15% for an increase of 2 kHz, carefully set the frequency so that the rated motor current can be output.

Parameter number	Display name	Setting range	Units	Default setting	Valid access levels			
					V/f Control	V/f with PG	Open Loop Vector	Flux Vector
C6-01	Carrier Freq Max	0.4 to 15.0 (See note.)	kHz	(See note.)	Basic or Advanced			
C6-02	Carrier Freq Min	0.4 to 15.0 (See note.)	kHz	(See note.)	Advanced		---	
C6-03	Carrier Freq Gain	0 to 99	Multiple	0	Advanced		---	

These parameters cannot be changed during operation.

Note The setting range and the factory default setting vary according to the Inverter capacity. The table shows a value of 200-V class, 0.4 kW.

In the vector control modes, the carrier frequency is determined by the carrier frequency upper limit (parameter C6-01).

In the V/f control modes (both with and without PG), the carrier frequency can be changed in response to the output frequency by setting the carrier frequency lower limit (parameter C6-02) and the carrier frequency proportional gain (parameter C6-03).

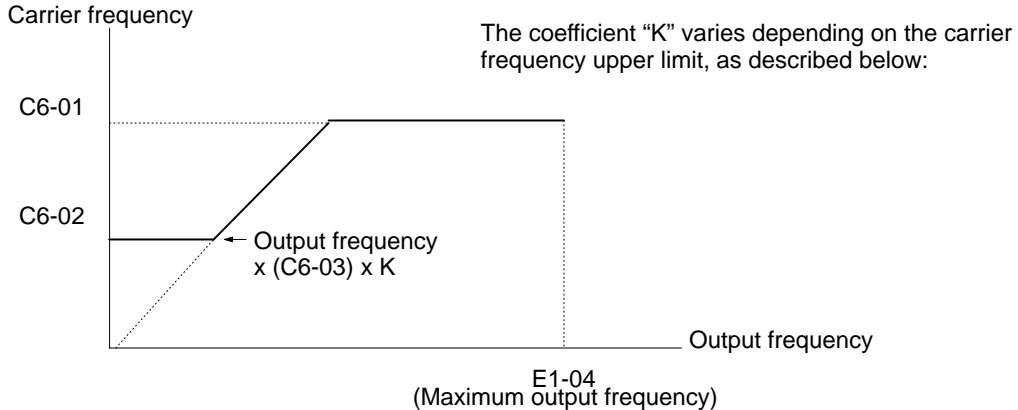

To make the carrier frequency constant, either set the same value for parameters C6-01 and C6-02 or set the carrier frequency proportional gain (parameter C6-03) to "0" (i.e., fix at upper limit value).

The following settings will generate a parameter setting fault (OPE11):

- Carrier frequency upper limit (C6-01) > 5.0 kHz and carrier frequency lower limit (c6-02) ≤ 5.0 kHz
- Carrier frequency proportional gain (C6-03) > 6 and (C6-01) < C6-02)

If the lower limit is set higher than the upper limit, the lower limit will be ignored and carrier frequency will be fixed at the upper limit.

Note For a 400-V Inverter, if the carrier frequency is set to a value higher than the default setting, the Inverter's rated output current will decrease. If the Inverter's overload is detected earlier than the motor overload fault (OL2), set the carrier frequency to a lower value.

400-V class Inverter capacity	3G3FV-A□-E(-A□) English model (Japanese model)			3G3FV-A□-CU/3G3FV-A□-CE EN-approved model		
	Default setting	Reduction in rating at 10 kHz	Reduction in rating at 15 kHz	Default setting	Reduction in rating at 10 kHz	Reduction in rating at 15 kHz
0.4 to 5.5 kW	15.0 kHz	100%	100%	15.0 kHz	100%	95%
7.5 kW	12.5 kHz	100%	90%	12.5 kHz	100%	80%
11 kW	12.5 kHz	100%	90%	15.0 kHz	100%	95%
15/18.5 kW	12.5 kHz	100%	90%	10.0 kHz	100%	80%
22 kW	10.0 kHz	100%	80%	8.0 kHz	85%	50%
30 kW	10.0 kHz	100%	80%	8.0 kHz	85%	50%
37 kW	10.0 kHz	100%	---	6.0 kHz	70%	---
45 kW	7.0 kHz	85%	---	6.0 kHz	70%	---
55 to 160 kW	6.0 kHz	70%	---	6.0 kHz	70%	---
185 to 300 kW	2.5 kHz	---	---	---	---	---

6-5-4 Reference Parameters (d)

■ Setting the Frequency Reference Function (d2)

The frequency reference function sets the output frequency upper and lower limits.

When the frequency reference is zero and a run command is input, the motor operates at the frequency reference lower limit (d2-02). The motor will not operate, however, if the lower limit is set lower than the minimum output frequency (E1-09).

Parameter number	Display name	Setting range	Units	Default setting	Valid access levels			
					V/f Control	V/f with PG	Open Loop Vector	Flux Vector
d2-01	Ref Upper Limit	0.0 to 110.0	%	100.0	Basic or Advanced			
d2-02	Ref Lower Limit	0.0 to 109.0	%	0.0	Basic or Advanced			

These parameters cannot be changed during operation.

Note The frequency reference upper and lower limits are set as a percentage of the maximum output frequency (E1-04), in increments of 1%.

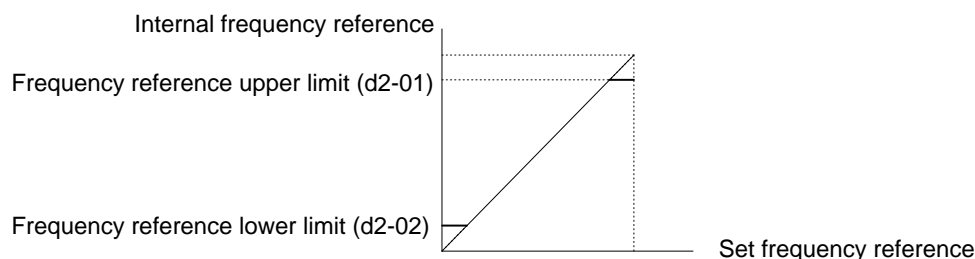

■ Setting Prohibiting Frequency (Jump Frequencies) (d3)

This function allows the prohibition or “jumping” of certain frequencies within the Inverter’s output frequency range so that the motor can operate without resonant vibrations caused by some machine systems. It is also used for deadband control.

Parameter number	Display name	Setting range	Units	Default setting	Valid access levels			
					V/f Control	V/f with PG	Open Loop Vector	Flux Vector
d3-01	Jump Freq 1	0.0 to 400.0	Hz	0.0	Basic or Advanced			
d3-02	Jump Freq 2	0.0 to 400.0	Hz	0.0	Basic or Advanced			
d3-03	Jump Freq 3	0.0 to 400.0	Hz	0.0	Basic or Advanced			
d3-04	Jump Bandwidth	0.0 to 20.0	Hz	1.0	Basic or Advanced			

These parameters cannot be changed during operation.

To disable this function, set the jump frequency references (d3-01 to d3-03) to 0.0 Hz.

For d3-01 to d3-03, set the center values of the frequencies to be jumped.

For d3-04, set the jump frequency bandwidth. The jump frequency \pm the jump bandwidth becomes the jump frequency range.

Operation is prohibited within the jump frequency range, but changes during acceleration and deceleration are smooth with no jumps.

Be sure to set the jump frequency so that $d3-03 \leq d3-02 \leq d3-01$.

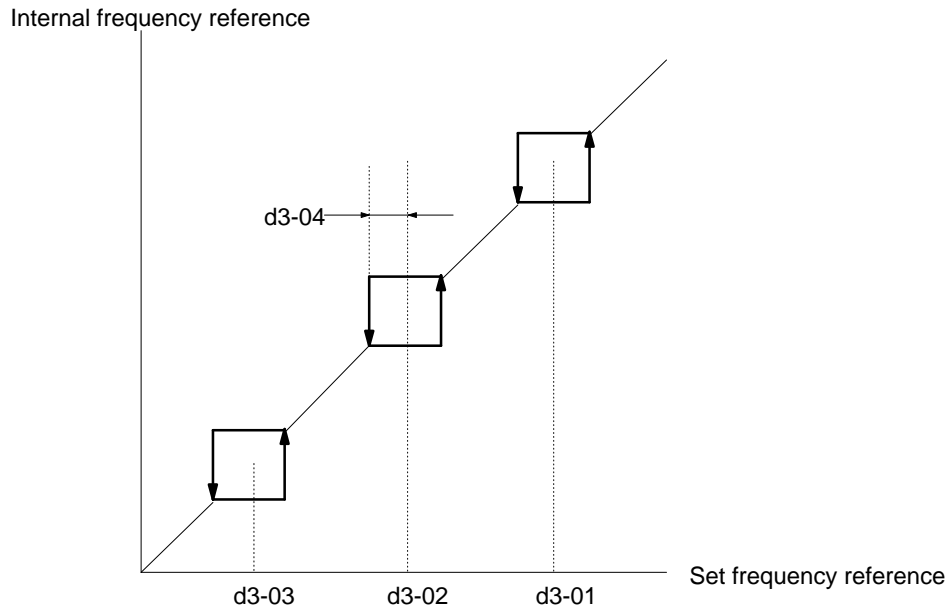

■ Hold Reference Memory Selection (d4-01)

Parameter d4-01 selects whether the held frequency during motor operated potentiometer (MOP) simulation operation is stored when operation is stopped. MOP operation is enabled by making either of the following settings for the multi-function inputs (H1-01 to H1-06).

Accel/decel ramp hold (set value: A)

UP command (set value: 10)/DOWN command (set value: 11) {MOP increase/decrease}

When hold status is established by these external signals, specify whether or not the output frequency is to be retained.

When this function is enabled, operation is re-started after power-up using the frequency reference value that was retained.

Parameter number	Display name	Setting range	Units	Default setting	Valid access levels			
					V/f Control	V/f with PG	Open Loop Vector	Flux Vector
d4-01	MOP Ref Memory	0, 1	---	0	Advanced			

This parameter cannot be changed during operation.

Explanation of Settings

Setting	Description
0	Disabled. Held frequency during MOP operation is not retained. If a stop command is given, or if power is removed, the frequency reference is reset to 0Hz. Restart after operation stoppage or power-up begins at zero.
1	Enabled. Held frequency during MOP operation is retained. If a stop command is given, or if power is removed, operation resumes at the held frequency reference when the run command is restored.

For information regarding the accel/decel stop (HOLD) command and the UP and DOWN commands, refer to 6-5-7 External Terminal Function (H).

■ **Trim Control Level (d4-02)**

This function sets the motor operated “trim” control level as a percentage of maximum output frequency in units of 1%. When trim control increase and decrease are selected as multi-function contact input functions (setting: H1__ = “1C” and “1D” respectively), the trim control level is added to or subtracted from the analog frequency reference, when each respective contact closes.

Parameter number	Display name	Setting range	Units	Default setting	Valid access levels			
					V/f Control	V/f with PG	Open Loop Vector	Flux Vector
d4-02	Trim Control Lvl	0 to 100	%	25	Advanced			

This parameter cannot be changed during operation.

If the minus speed command is ON and the result of the subtraction is beyond zero, the output frequency will become zero.

For information regarding the plus and minus speed commands, refer to the explanations of the multi-function inputs (H1) in 6-5-7 *External Terminal Function (H)*.

6-5-5 Motor Parameters (E)

■ **Intermediate Output Frequency 2 and Intermediate Output Frequency Voltage 2**

For vector control of a special motor, such as a constant power-output motor or machine tool shaft motor, the motor may not fully operate in the constant output area (i.e., in frequency range as high as or higher than the rated frequency).

If the high-performance control of the motor is required in the constant output area, V/f characteristics to compensate for voltage increases caused by the motor inductance must be set.

These parameter settings are not required for normal motor control.

Parameter number	Display name	Setting range	Units	Default setting	Valid access levels			
					V/f Control	V/f with PG	Open Loop Vector	Flux Vector
E1-11	Mid Frequency B	0.0 to 400.0	Times	0.0	Advanced			

Parameter number	Display name	Setting range	Units	Default setting	Valid access levels			
					V/f Control	V/f with PG	Open Loop Vector	Flux Vector
E1-12	Mid Voltage B	0.0 to 255.0 (see note)	Times	0.0	Advanced			

Parameter number	Display name	Setting range	Units	Default setting	Valid access levels			
					V/f Control	V/f with PG	Open Loop Vector	Flux Vector
E1-13	Base Voltage	0.0 to 255.0 (see note)	Times	0.0	Advanced		Quick startup	

Note The above upper limit values are for 200-V class Inverters. Double the values for 400-V class Inverters.

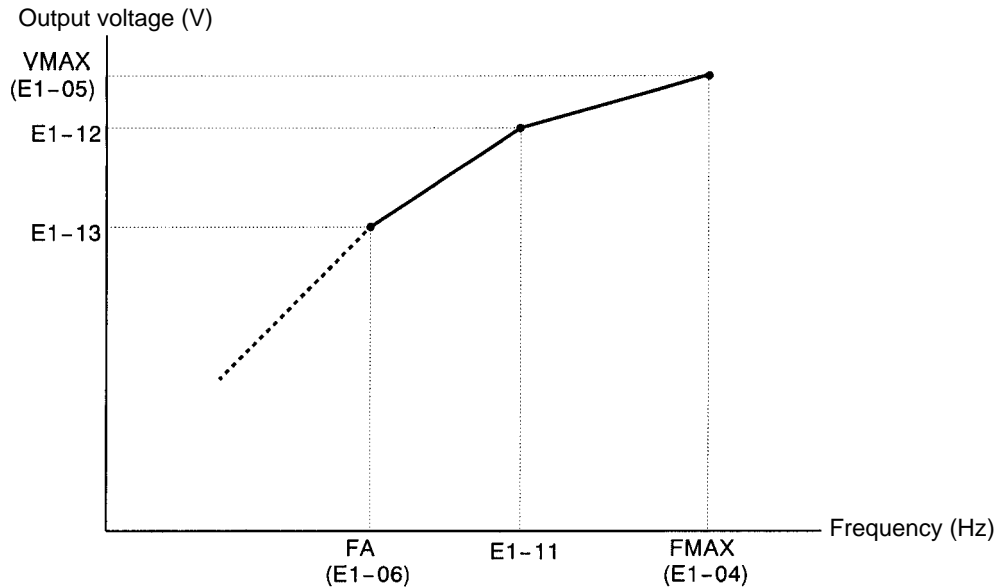

Note 1. Set so that the following condition will be satisfied.
 $E1-06 \leq E1-11 \leq E1-04$

Note 2. The function is disabled if the parameters E-11 and E1-12 are both set to 0.0.

Note 3. If auto-tuning is executed, the parameters E1-05 and E1-13 will be set to the set voltage.

■ Two-motor Switching Control Function

This function enables switching control between two motors using one Inverter. The following function additions were made to support this new functionality.

● Setting Control Mode and Motor Parameters for Second Motor

Set the following parameter for the second motor. The settings of parameters E1 and E2 are used for the first motor.

If the motor is operated in flux or open-loop vector control mode, set the motor selection for auto-tuning to 2.

Parameter number	Display name	Setting range	Units	Default setting	Valid access levels			
					V/f Control	V/f with PG	Open Loop Vector	Flux Vector
E3-01	Control Method	0 to 3	---	2	Advanced			

Explanation of Settings

Setting	Description
0	Normal V/f control
1	V/f control with PG
2	Open-loop vector control
3	Flux vector control

Set the control mode for the second motor. The set value will not be set to the default value when the Inverter is initialized.

Parameter number	Display name	Setting range	Units	Default setting	Valid access levels				
					V/f Control	V/f with PG	Open Loop Vector	Flux Vector	
E4-01	Max. Frequency	40.0 to 400.0	Hz	60.0	Advanced				
E4-02	Max. Voltage	0.0 to 255.0 (see note 2)	V	200.0 (see note 2)	Advanced				
E4-03	Base Frequency	0.0 to 400.0	Hz	60.0	Advanced				
E4-04	Mid Frequency	0.0 to 400.0	Hz	3.0 (see note 3)	Advanced				Not applicable.
E4-05	Mid Voltage	0.0 to 255.0 (see note 2)	V	11.0 (see notes 2, 3)	Advanced				Not applicable.
E4-06	Min Frequency	0.0 to 400.0	Hz	0.5 (see note 3)	Advanced				
E4-07	Min Voltage	0.0 to 255.0 (see note 2)	V	2.0 (see notes 2, 3)	Advanced				Not applicable.
E5-01	Motor Rated FLA	0.32 to 6.40 (see note 4)	A	1.9 (see note 3)	Advanced				

Parameter number	Display name	Setting range	Units	Default setting	Valid access levels			
					V/f Control	V/f with PG	Open Loop Vector	Flux Vector
E5-02	Motor Rated Slip	0.00 to 20.00	Hz	2.90 (see note 3)	Advanced			

Parameter number	Display name	Setting range	Units	Default setting	Valid access levels			
					V/f Control	V/f with PG	Open Loop Vector	Flux Vector
E5-03	No-Load Current	0.00 to 2.90 (see note 5)	A	1.20 (see note 3)	Advanced			

Parameter number	Display name	Setting range	Units	Default setting	Valid access levels			
					V/f Control	V/f with PG	Open Loop Vector	Flux Vector
E5-04	Number of Poles	2 to 48	---	4	Not applicable.	Advanced	Not applicable.	Advanced

Parameter number	Display name	Setting range	Units	Default setting	Valid access levels			
					V/f Control	V/f with PG	Open Loop Vector	Flux Vector
E5-05	Term Resistance	0.000 to 65.000	Ω	9.842 (see note 3)	Advanced			

Parameter number	Display name	Setting range	Units	Default setting	Valid access levels			
					V/f Control	V/f with PG	Open Loop Vector	Flux Vector
E5-06	Leak Inductance	0.0 to 40.0	%	18.2 (see note 3)	Not applicable.		Advanced	

The above parameters are used to set the V/f characteristics and constants of the second motor. Set them like the parameters E2-01 through E2-06 and E1-04 through E1-10.

- Note 1.** If the first motor and second motor are different to each other in maximum frequency setting, the higher set value of them will be the set range of the frequency reference.
- Note 2.** The upper limit values and default settings are for 200-V class Inverter models. Double the values for 400-V class Inverters.
- Note 3.** The default settings vary with the Inverter's capacity or a change in the control mode. The values for 200-V class, 0.4-kW Inverters are shown.
- Note 4.** The setting range is between 10% and 200% of the Inverter's rated current. The value for 200-V class, 0.4-kW Inverters is shown.
- Note 5.** The setting range is between 0.00 and 0.1 less than the Inverter's rated current. The value for 200-V class, 0.4-kw Inverters is shown.

● **Switching Control for Two Motors**

Set a multi-function input 1 to 6 (the parameters H1-01 to H1-06) to 16 for motor switching. When the motor switching input turns ON, the constants of the second motor will be selected. Switch the following

external wires to the second motor when the constants are selected. By setting the multi-function contact output or the multi-function output 1 or 2 to 1C for motor selection, the status of the switching of the motor can be checked. The output will turn ON when the second motor is selected.

- Power wires U, V, and W
- PG signal line (if PG is selected)
- Peripheral circuits (e.g., a motor brake and a thermo switch for excessive heating detection)

Note 1. Two-motor switching control is not possible while the Inverter is in operation. If an attempted is made to switch the motor while the Inverter is in operation, the message “Motor Running” will flash.

Note 2. Switch the motor while the motor is not rotating. Do not attempt to switch the motor while it is coasting to a stop, otherwise a main circuit overvoltage (OV) or overcurrent (OC) fault will result.

Note 3. Other than the motor constants, the same parameters are used by the first and second motors. When connecting a PG, check that the two motors have the same number of PG pulses. The default settings of some constants vary with the motor control mode. In that case, when the second motor is selected, the constants will be set to default values.

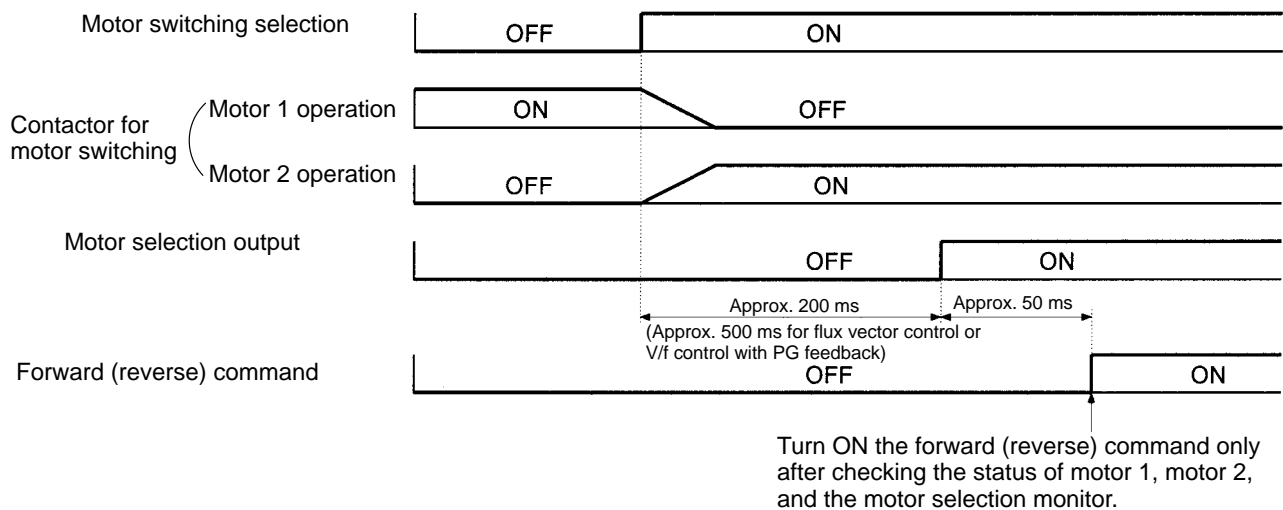

6-5-6 Option Parameters (F)

■ Installing Optional Cards

A maximum of three Optional Cards can be installed in the SYSDRIVE 3G3FV. The installation location of each is determined by the type of Card. Be sure to install the Cards in their correct locations.

● Installation Procedure

1. Turn off the Inverter’s main-circuit power supply. Wait at least one minute (or at least three minutes for models of 30 kW or more), and then remove the Inverter’s front cover. Check to be sure that the CHARGE light is turned OFF.
2. Check the Optional Card’s installation location (A, C, or D).

Type of card	Model	Specifications	Location
Analog Reference Card	3G3IV-PAI14U	14-bit analog, 2 inputs (voltage/current)	C
	3G3IV-PAI14B	14-bits analog, 3 inputs	C
Digital Reference Card	3G3IV-PDI08	8-bit digital input (BCD/binary)	C
	3G3IV-PDI16H2	16-bit digital input (BCD/binary)	C
PG Speed Control Card	3G3FV-PPGA2	Open-collector-compatible, single input	A
	3G3FV-PPGB2	Open-collector-compatible, A/B-phase input	A
	3G3FV-PPGD2	Line-driver-compatible, single input	A
	3G3FV-PPGX2	Line-driver-compatible, A/B-phase input	A
Analog Monitor Card	3G3IV-PAO08	8-bit analog output, 2 channels	D
	3G3IV-PAO12	12-bit analog output, 2 channels	D
Pulse Monitor Card	3G3IV-PPO36F	Pulse frequency output	D

3. Insert the accessory spacer into the spacer mounting hole in the Inverter’s mounting base.
4. Align the Optional Card connector with the connector position on the control board, and then pass the spacer through the spacer mounting hole on the card. Press firmly until the spacer snaps into place.
5. Connect the Optional Card’s FG connection line to the Inverter’s FG terminal (terminal 12).

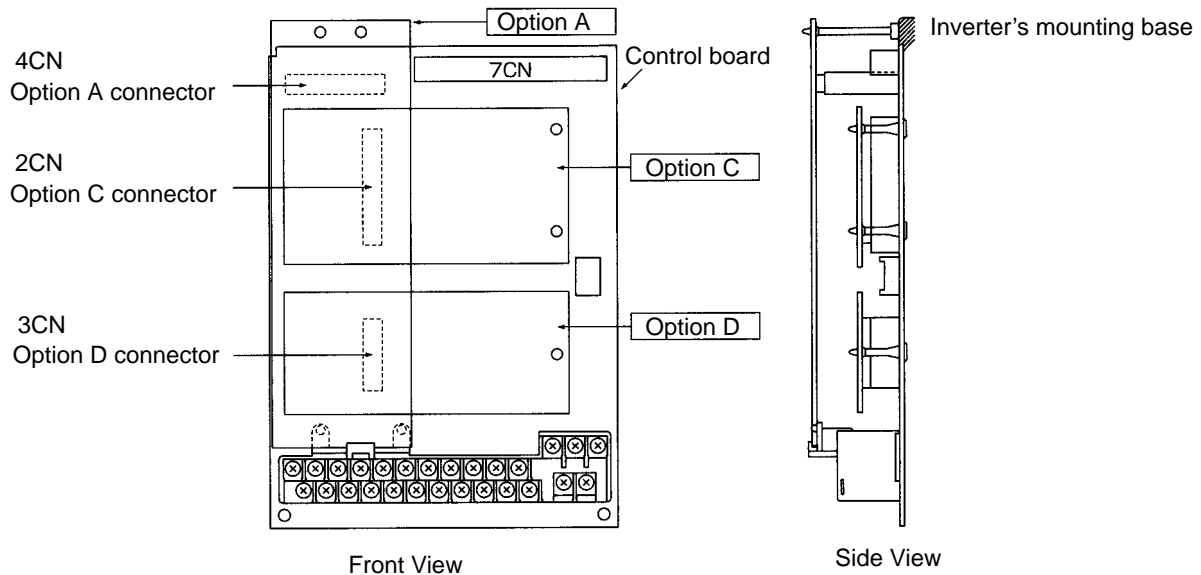

■ Setting a Analog Reference Card (F2)

When using a 3G3IV-PAI14B/PA114U Analog Reference Card, set parameter b1-01 (reference selection) to “3” (option).

When using a 3G3IV-PAI14B, set the function for channels 1 to 3 with parameter F2-01. (There are no parameters to set for 3G3IV-PAI14U.)

Parameter number	Display name	Setting range	Units	Default setting	Valid access levels			
					V/f Control	V/f with PG	Open Loop Vector	Flux Vector
F2-01	AI-14 Input Sel	0, 1	---	0	Basic or Advanced			

This parameter cannot be changed during operation.

Explanation of Settings

Setting	Description
0	3-channel individual input (CH1: terminal 13; CH2: terminal 14; CH3: terminal 16;
1	3-channel additional input (Sum of CH1 to CH3 is used as the frequency reference value.)

Parameter b1-01 (reference selection) must be set to “1” (external terminal), except for when 3-channel input (setting: 0) is set.

When using a 3G3IV-PAI14B, the multi-function input “Option/Inverter selection” function (setting: 2) cannot be used.

■ **Setting a Digital Reference Card (F3)**

When using a 3G3IV-PDI08/PD116H2 Digital Reference Card, set parameter b1-01 (reference selection) to “3” (option) and set the input method with parameter F3-01.

Parameter number	Display name	Setting range	Units	Default setting	Valid access levels			
					V/f Control	V/f with PG	Open Loop Vector	Flux Vector
F3-01	DI Input	0 to 7	---	0	Basic or Advanced			

This parameter cannot be changed during operation.

Explanation of Settings

Setting	Description
0	BCD 1% unit
1	BCD 0.1% unit
2	BCD 0.01% unit
3	BCD 1 Hz unit
4	BCD 0.1 Hz unit
5	BCD 0.01 Hz unit
6	BCD special setting (5-digit input) (Only when 3G3FV-PDI16H2 is used.)
7	Binary input (Set value is displayed in decimal notation.)

- When binary input is used (setting: 7), this becomes the maximum frequency (100% speed) reference when all bits are set to “1.”

3G3IV-PD108: Maximum frequency reference when FFH (255) is set.

3G3IV-PD116H2: Maximum frequency reference when FFFH (4095) is set with 12 bits selected. Maximum frequency reference when 7530H (30000) is set with 16 bits selected.

- Setting 6, BCD special setting (5-digit input), is valid only when the 3G3IV-PD116H2 is used.

If the parameter o1-03 (Display Scaling) is set to 2 or a larger value, normal BCD setting will be valid and the setting unit in the parameter o1-03 will be valid.

Setting: 1 to 5	Sign	8 x 10 ³	4 x 10 ³	2 x 10 ³	1 x 10 ³	to ...	8 x 10 ⁰	4 x 10 ⁰	2 x 10 ⁰	1 x 10 ⁰	
Setting: 6		2 x 10 ⁴	1 x 10 ⁴	8 x 10 ³	4 x 10 ³	2 x 10 ³	to ...	1 x 10 ¹	8 x 10 ⁰	4 x 10 ⁰	2 x 10 ⁰

The sign bit is used as a data bit, so only positive (plus) data can be set.

The second digit below the decimal point is set by bits 8x10⁰, 4x10⁰, and 2x10⁰, so the settings are made in units of 0.02 Hz. (If these three bits are “111,” “110,” and “101,” they will be recognized as “9.”)

■ Setting an Analog Monitor Card (F4)

When using a 3G3IV-PAO08/PAO12 Analog Monitor Card, set the monitor items and gain with the following parameters. Parameters F4-02, F4-04, F4-05, and F4-06 can be changed during operation, while F4-01 and F4-03 cannot.

Parameter number	Display name	Setting range	Units	Default setting	Valid access levels			
					V/f Control	V/f with PG	Open Loop Vector	Flux Vector
F4-01	AO Ch1 Select	0 to 38	---	2	Basic or Advanced			
F4-02	AO Ch1 Gain	0.00 to 2.50	Multiple	1.00	Basic or Advanced			
F4-03	AO Ch2 Select	0 to 38	---	3	Basic or Advanced			
F4-04	AO Ch2 Gain	0.00 to 2.50	Multiple	0.50	Basic or Advanced			
F4-05	AO Ch1 Bias	-10.0 to 10.0	%	0.0	Basic or Advanced			
F4-06	AO Ch2 Bias	-10.0 to 10.0	%	0.0	Basic or Advanced			

Set parameters F4-01 and F4-03 (AO Ch1 Select and AO Ch2 Select) to the right side of the of “U1” parameters in the table on page 3-12 of this manual. The setting range is between 1 and 38, but the following numbers cannot be set: 4, 10, 11, 13, 14, 25, 28, 29, 30, 31, 34, 35.

Set the parameters F4-05 and F4-06 (AO Ch1 Bias and AO Ch2 Bias) to a bias that moves the output characteristics up and down in parallel in 1% increments based on 10 V as 100%.

When the 3G3IV-PAO12 is used, outputs of 0 to ± 10 V are possible. For that, set parameter H4-07 (multi-function analog output signal level selection) to “1” (0 to ± 10 -V outputs). There are some monitor items, however, that can only use outputs of 0 to +10 V even if parameter H4-07 is set to “1.”

When the 3G3IV-PAO08 is used, only outputs of 0 to +10 V are possible regardless of the parameter H4-07 setting.

■ Setting a Pulse Monitor Card (F7)

When using a 3G3IV-PPO36F Pulse Monitor Card, set the number of output pulses with parameter F7-01.

Parameter number	Display name	Setting range	Units	Default setting	Valid access levels			
					V/f Control	V/f with PG	Open Loop Vector	Flux Vector
F7-01	PO-36F Selection	0 to 4	---	1	Basic or Advanced			

Explanation of Settings

Setting	Description
0	1F
1	6F
2	10F
3	12F
4	36F

Note “F” indicates the output frequency (Hz). For example, if “0” (1F) is set, when the output frequency is 60 Hz there will be an output of 60 pulses per minute. (Duty 50%)

■ **Setting a Wired SYSMAC BUS Interface Card (F8)**

When using a 3G3IV-PSIG Wired SYSMAC BUS Interface Card, set the following parameter in order to specify the operation of the Inverter for communications failures.

Parameter number	Display name	Setting range	Units	Default setting	Valid access levels			
					V/f Control	V/f with PG	Open Loop Vector	Flux Vector
F8-01	E-15 Det Sel	0 to 3	---	1	Basic or Advanced			

Set the parameter according to the application.

Setting	Description	Inverter's status	Fault output
0	Deceleration 2: Decelerates to a stop with C1-02 set.	Fault	ON
1	Coast to a stop.	Fault	ON
2	Emergency stop time: Decelerates to a stop according to the C1-09 setting.	Fault	ON
3	Continuous operation. (See note.)	Alarm	OFF

Note If the parameter is set to 3, the Inverter will operate without references from the host controller. Take necessary measures, such as emergency stop measures, to ensure safety.

■ **Setting a CompoBus/D Communications Card (F9)**

When using a 3G3FV-PDRT1-SIN CompoBus/D Communications Card, make the communications settings with the following parameters.

● **Setting Communications External Fault Input**

Set the following three parameters to specify the detection method of communications external fault input.

Parameter number	Display name	Setting range	Units	Default setting	Valid access levels			
					V/f Control	V/f with PG	Open Loop Vector	Flux Vector
F9-01	EF0 Selection	0, 1	---	0	Basic or Advanced			

Explanation of Settings

Setting	Description
0	Normally open contact. (A communications external fault is input with the bit turns ON.)
1	Normally close contact. (A communications external fault is input with the bit turns OFF.)

Parameter number	Display name	Setting range	Units	Default setting	Valid access levels			
					V/f Control	V/f with PG	Open Loop Vector	Flux Vector
F9-02	EF0 Detection	0, 1	---	0	Basic or Advanced			

Explanation of Settings

Setting	Description
0	Always detects communications external faults
1	Detects communications external faults during operation.

Parameter number	Display name	Setting range	Units	Default setting	V/f Control	V/f with PG	Open Loop Vector	Flux Vector

Explanation of Settings

Setting	Description	Inverter's status	Fault output
0	Deceleration 2: Decelerates to a stop with C1-02 set.	Fault	ON
1	Coast to a stop.	Fault	ON
2	Emergency stop time: Decelerates to a stop according to the C1-09 setting.	Fault	ON
3	Continuous operation. (See note.)	Alarm	OFF

• Torque Limit/Torque Reference Operation Selection via Communications

Parameter number	Display name	Setting range	Units	Default setting	Valid access levels			
					V/f Control	V/f with PG	Open Loop Vector	Flux Vector
F9-05	Torq Ref/Lmt Sel	0, 1	---	1	Not applicable.			
								Basic or Advanced

Explanation of Settings

Setting	Description
0	The communications torque reference/torque limit reference is disabled.
1	The communications torque reference/torque limit reference is enabled.

Note Set the parameter to 1 because the CompoBus/D Communications Card does not support torque references or torque limit references.

• Selection of Operation for Communications Failures

Parameter number	Display name	Setting range	Units	Default setting	Valid access levels			
					V/f Control	V/f with PG	Open Loop Vector	Flux Vector
F9-06	BUS Fault Sel	0 to 3	---	1	Basic or Advanced			

Set the parameter according to the application.

Setting	Description	Inverter's status	Fault output
0	Deceleration 2: Decelerates to a stop with C1-02 set.	Fault	ON
1	Coast to a stop.	Fault	ON
2	Emergency stop time: Decelerates to a stop according to the C1-09 setting.	Fault	ON
3	Continuous operation. (See note.)	Alarm	OFF

Note If the parameter is set to 3, the Inverter will operate without references from the host controller. Take necessary measures, such as emergency stop measures, to ensure safety.

6-5-7 External Terminal Functions: H

■ Multi-function Input Settings (H1)

Setting	Function	Control mode			
		V/f	V/f w/PG	Open-loop Vector	Flux Vector
0	3-Wire Control (with a forward/reverse rotation input)	OK	OK	OK	OK
1	Local/Remote Selection (operation signal selection)	OK	OK	OK	OK
2	Option/Inverter Selection (ON: Optional Card)	OK	OK	OK	OK
3	Multi-Step Reference 1 Switches between main speed and auxiliary speed when parameter H3-05 is set to 0 (auxiliary frequency reference).	OK	OK	OK	OK
4	Multi-Step Reference 2	OK	OK	OK	OK
5	Multi-Step Reference 3	OK	OK	OK	OK
6	Jog Frequency Reference (higher priority than multi-step)	OK	OK	OK	OK
7	Multi-Accel/Decel 1 (accel/decel time selector 1)	OK	OK	OK	OK
8	External Baseblock N.O. (normally open contact)	OK	OK	OK	OK
9	External Baseblock N.C. (normally closed contact)	OK	OK	OK	OK
A	Accel/Decel Ramp Hold (Pauses acceleration/deceleration.)	OK	OK	OK	OK
B	OH2 Alarm Signal (Inverter overheating warning)	OK	OK	OK	OK
C	Terminal 16 Enable (Enables the multi-function analog input.)	OK	OK	OK	OK
D	ASR Selection (Disables PG feedback and switches to normal V/f control.)	---	OK	---	---
E	ASR Integral Reset (Disables integral control.)	---	OK	---	OK
F	Not used. (Do not input this setting.)	---	---	---	---
10	UP command (Always used with the DOWN command.)	OK	OK	OK	OK
11	DOWN command (Always used with the UP command.)	OK	OK	OK	OK
12	Forward Jog command (Forward jog at the speed in d1-09.)	OK	OK	OK	OK
13	Reverse Jog command (Reverse jog at the speed in d1-09.)	OK	OK	OK	OK
14	Fault Reset (Faults are reset when input goes OFF → ON.)	OK	OK	OK	OK
15	Fast-Stop (Emergency stop using the deceleration time in C1-09.)	OK	OK	OK	OK
16	Motor 2 Selection Selection of motor 1 or motor 2 for two-motor switching (ON: Motor 2 selected)	OK	OK	OK	OK
17	Fast-stop N.C. (OFF: Decelerates to a stop when the emergency stop time set with C1-09 elapses.)	OK	OK	OK	OK
18	Timer Function Input (Used with the b4 ON/OFF delay timers and timer output.)	OK	OK	OK	OK
19	PID Disable (Disables PID control.)	OK	OK	OK	OK
1A	Multi-Accel/Decel 2 (accel/decel time selector 2)	OK	OK	OK	OK
1B	Program Lockout (Parameters write-protected when OFF.)	OK	OK	OK	OK
1C	Trim Control Increase (Adds the d4-02 trim control level to the analog frequency reference.)	OK	OK	OK	OK
1D	Trim Control Decrease (Subtracts the d4-02 trim control level from the analog frequency reference.)	OK	OK	OK	OK
1E	Ref Sample Hold (ON: Retains the analog value.)	OK	OK	OK	OK

Setting	Function	Control mode			
		V/f	V/f w/PG	Open-loop Vector	Flux Vector
1F	Terminal 13/14 Switch (Selects terminal 14 when ON.)	OK	OK	OK	OK
20 to 2F	External Fault (Any combination of the following can be set as needed.) Input: Normally open or normally closed Detection mode: Always or During operation only Stopping method: Decel, Coast, Emergency, or Continue	OK	OK	OK	OK
30	PID Integral Reset (ON: Resets the integral value with I control disabled.)	OK	OK	OK	OK
31	PID Integral Hold (ON: Retains the integral value.)	OK	OK	OK	OK
60	DC Injection Activate (Performs DC braking when ON.)	OK	OK	OK	OK
61	External search 1 (Speed search from max. frequency)	OK	---	OK	---
62	External search 2 (Speed search from frequency reference)	OK	---	OK	---
63	Energy-saving operation (according to b8-01 and b8-02)	OK	OK	---	---
64 to 66	Not used. (Do not input this setting.)	---	---	---	---
71	Speed Torque Control Change (Torque Control when ON.)	---	---	---	OK
72	Zero-servo Command (Zero Servo operation when ON.)	---	---	---	OK
77	ASR Gain Switch ON: Use proportional gain in C5-03. OFF: Calculate gain from C5-01, C5-03, and C5-07.	---	---	---	OK

● Parameter Settings

The following table shows the setting information for multi-function inputs 1 through 6. These parameters cannot be changed during operation.

Parameter number	Display name	Setting range	Units	Default setting*1	Valid access levels			
					V/f Control	V/f with PG	Open Loop Vector	Flux Vector
H1-01	Terminal 3 Sel	0 to 77	---	24	Basic or Advanced			
H1-02	Terminal 4 Sel	0 to 77	---	14	Basic or Advanced			
H1-03	Terminal 5 Sel	0 to 77	---	3 (0)	Basic or Advanced			
H1-04	Terminal 6 Sel	0 to 77	---	4 (3)	Basic or Advanced			
H1-05	Terminal 7 Sel	0 to 77	---	6 (4)	Basic or Advanced			
H1-06	Terminal 8 Sel	0 to 77	---	8 (6)	Basic or Advanced			

Note 1. The default settings in parentheses are the default settings when the Unit is initialized for 3-wire control.

Note 2. The following table shows the settings and page references for some common functions.

Function(s)	Setting(s)	Page
3-Wire Control (with forward/reverse rotation input)	0	5-16
Multi-step References 1 through 3 and Jog Reference	3 through 6	5-17
Multi-Accel/Decel 1 and 2 (acceleration/deceleration time selectors 1 and 2)	7 and 1A	5-18
Fast-Stop (Emergency stop)	15 and 17	5-19
Forward and Reverse Jog commands	12 and 13	5-19
Terminal 13/14 Switch	1F	5-19
Timer Function Input	18	6-46
Energy-saving operation	63	6-13, 6-37
Two-motor switching control	16	6-67
PID control integral reset	30	6-54
PID control integral hold	31	6-54

● **Local/Remote Selection (Setting: 1)**

OFF	Operate with the frequency reference and run command specified in b1-01 (the frequency reference source selector) and b1-02 (the run command source selector).
ON	Operate with the frequency reference and run command set at the Digital Operator.

- With this setting, the multi-function input selects the input method for the frequency reference and run command.
- The input method can be switched only when the Inverter is stopped.
- The Digital Operator's LOCAL/REMOTE Key is disabled when this function has been set in a multi-function input.

Note 1. There is no difference between two modes if the parameters b1-01 and b1-02 are both set to 0.

Note 2. The above values are set through the Digital Operator and the frequencies are stored in frequency references 1 through 8 (d1-01 through d1-08) or the inching frequency reference (d1-09) in remote or local mode.

Note 3. Multi-function inputs 1 through 6 are enabled in remote or local mode. The stop command is, however, disabled in local mode only if the 3-wire sequential set value is 0.

Note 4. If the run command is input when switching the Inverter to remote mode from local mode, the run input will be ignored to ensure safety. Turn the run command OFF once. Then turn the run command ON again in remote mode. If the parameter b1-07 (LOC/REM RUN Sel) is set to 1, the run command will not be ignored. In this case, the Inverter may operate immediately when switched to remote mode from local mode. Take necessary measures for safety.

● **Option/Inverter Selection (Setting: 2)**

OFF	The Inverter's frequency reference is enabled.
ON	The Optional Card's frequency reference is enabled.

- With this setting, the multi-function input enables the frequency reference input from the Inverter itself or the one from Optional Card.
- The frequency reference input can be switched only when the Inverter is stopped.
- Be sure that b1-01 (the frequency reference source selector) has been set to 0 (Operator) or 1 (external terminal). Only the frequency reference from the Optional Card will be enabled if b1-01 is set to 3 (Option PCB).

- Setting 2 can't be selected if the 3G3IV-PAI14B is being used and parameter F2-01 (AI-14 Input Selector) is set to 0.

● **External Baseblock N.O. (Setting: 8)**

OFF	Normal operation
ON	Baseblock

● **External Baseblock N.C. (Setting: 9)**

OFF	Baseblock
ON	Normal operation

- With either of these settings, the multi-function input controls baseblock operation.
- Baseblock is an interruption of the Inverter output. The motor coasts while the baseblock command is being input.
- The output frequency is retained internally, so the speed search will start from the same frequency and the motor will be started up when the baseblock command is cleared. To cancel the retained frequency, turn OFF the run command once. Then the retained frequency will be set to 0.
- After a baseblock command is cleared, the voltage will be restored in the voltage recovery time set in L2-04.

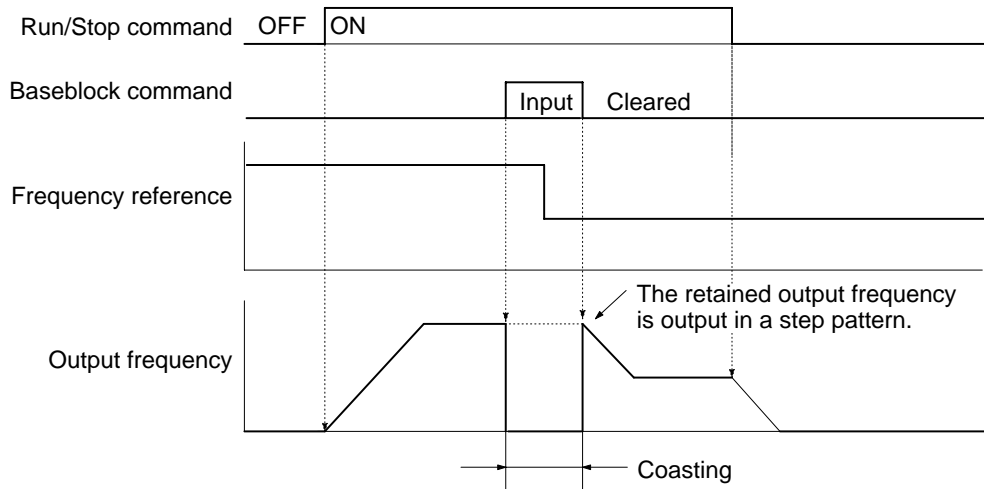

● **Acceleration/Deceleration Ramp Hold (Setting: A)**

OFF	Normal operation or restart acceleration/deceleration.
ON	Pause acceleration/deceleration and maintain the present frequency.

- With this setting, the multi-function input pauses acceleration or deceleration and maintains (holds) the output frequency.
- Acceleration/deceleration is restarted when the acceleration/deceleration ramp hold input is turned OFF.
- The motor will be stopped if a stop command is input while the acceleration/deceleration ramp hold input is ON.

- When parameter d4-01 (the frequency reference hold function selector) is set to 1, the held frequency will be stored in memory. This stored frequency will be retained even after a power interruption and the motor will be restarted at this frequency when a run command is input again.

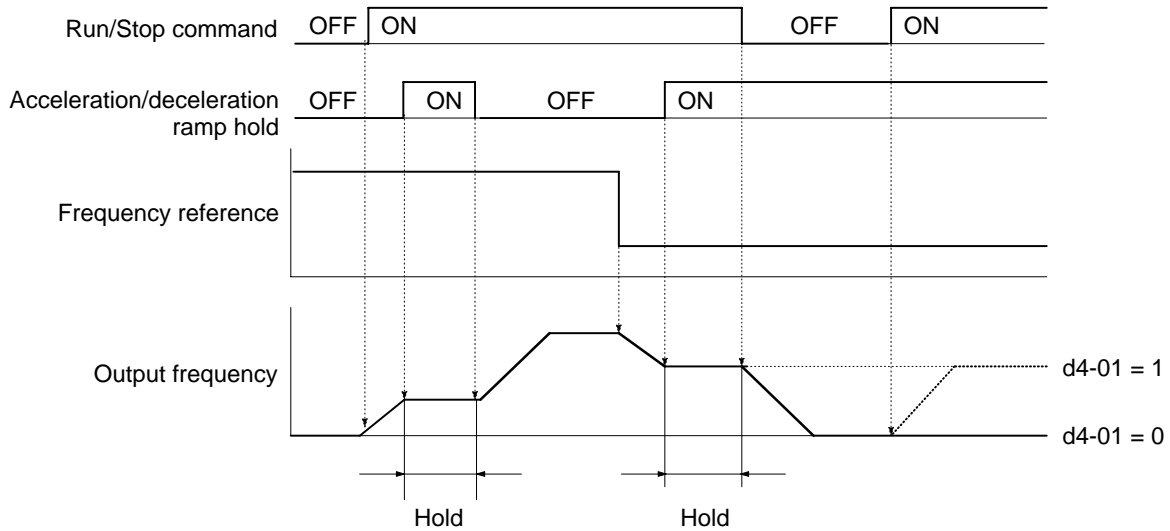

- Note 1.** When d4-01 is set to 1, the held output frequency will be retained. To operate at this frequency even after the Inverter is stopped, input the run command with the acceleration/deceleration ramp hold input ON.
- Note 2.** When d4-01 is set to 0, the output frequency will be held at zero if the run command is input with the acceleration/deceleration ramp hold input ON.
- Note 3.** Select and set one of the following functions for multi-function input. Do not set more than one of them, otherwise a setting error (OPE3) will result.
- Acceleration/Deceleration Ramp Hold (Setting: A)
 - UP and DOWN Commands (Settings: 10 and 11)
 - Trim Control Increase and Decrease (Settings: 1C and 1D)
 - Analog Frequency Reference Sample/Hold (Setting: 1E)

• OH2 Alarm Signal (Setting: B)

OFF	Normal operation
ON	Normal operation (The warning message “OH2” will be displayed on the Digital Operator.)

- With this setting, a temperature sensor can be connected to the multi-function input to display a warning message when the temperature rises too high.
- The message “OH2” will be displayed on the Digital Operator while the multi-function input is ON and the display will revert to its previous status when the input is turned OFF. (It isn’t necessary to reset the alarm.)
- The Inverter will continue operation without detecting a fault.

• Terminal 16 Enable (Setting: C)

OFF	Disables the multi-function analog input (terminal 16).
ON	Enables the multi-function analog input (terminal 16).

- With this setting, the multi-function input can be used to enable or disable the multi-function analog input.
- Turning the input OFF has the same effect as setting H3-05 (the multi-function analog input selector for terminal 16) to 1F.

● **ASR Selection (Setting: D)**

OFF	V/f control with PG feedback (speed control with speed feedback)
ON	Normal V/f control with PG feedback (Disables speed feedback control.)

- With this setting, the multi-function input can be used to switch “V/f control with PG feedback” to “Normal V/f control.”
- It is possible to switch between these control modes during operation.

● **ASR Integral Reset (Setting: E)**

OFF	Operates with PI-control speed control loop.
ON	Operates with P-control speed control loop. (The speed control’s integral values are reset by the integral time constant.)

- This function is valid only in “V/f control with PG feedback” mode when parameter F1-07 is set to 0. (Setting F1-07 to 0 disables ASR integral operation during acceleration/deceleration.)
- It is possible to switch between these speed control modes during operation.

● **UP and DOWN Commands (Settings: 10 and 11)**

UP command	DOWN command	Operation
ON	OFF	Acceleration
OFF	ON	Deceleration
ON	ON	Hold
OFF	OFF	Hold

- With these settings, the multi-function inputs can be used to control the Inverter’s output frequency.
- When using this function, be sure to set both the UP command (setting 10) and the DOWN command (setting 11) in 2 multi-function inputs.
(An OPE03 option fault will occur if only one of these commands is set.)
- Be sure to set parameter b1-02 (the run command source selector) to 1 (external terminal). The up/down function won’t operate with any other b1-02 setting.
- The frequency up/down commands operate according to the normal acceleration/deceleration times in C1-01 through C1-08.
- The upper and lower limits for the output frequency with the up/down commands are determined by the following settings:

$$\text{Upper limit} = \text{Maximum frequency (E1-04)} \times \frac{\text{Reference upper limit (d2-01)}}{100}$$

$$\text{Lower limit} = \text{Maximum frequency (E1-04)} \times \frac{\text{Reference lower limit (d2-02)}}{100}$$

When frequency reference (voltage) terminal 13 or frequency reference (current) terminal 14 is being used as a frequency reference input, the greatest frequency value becomes the lower limit.

- When the up/down function is being used, the output frequency will be accelerated to the lower limit if a run command is input.
- When the up/down function and jog frequency reference are both assigned to multi-function inputs, an ON jog frequency reference input has the highest priority.
- Multi-step References 1 through 8 are all disabled when the up/down function has been set.
- The output frequency held by the up/down function will be stored in memory if d4-01 (the frequency reference hold function selector) is set to 1.
This output frequency will be retained even after a power interruption, and operation will be re-started at this frequency the next time that a run command is input. The stored output frequency will be cleared from memory if the UP or DOWN command is turned ON while the run command is OFF.

Note Select and set one of the following functions for multi-function input. Do not set more than one of them, otherwise a setting error (OPE3) will result.

- Acceleration/Deceleration Ramp Hold (Setting: A)
- UP and DOWN Commands (Settings: 10 and 11)
- Trim Control Increase and Decrease (Settings: 1C and 1D)
- Analog Frequency Reference Sample/Hold (Setting: 1E)
- The operation of the up/down function is shown in the following timing chart.

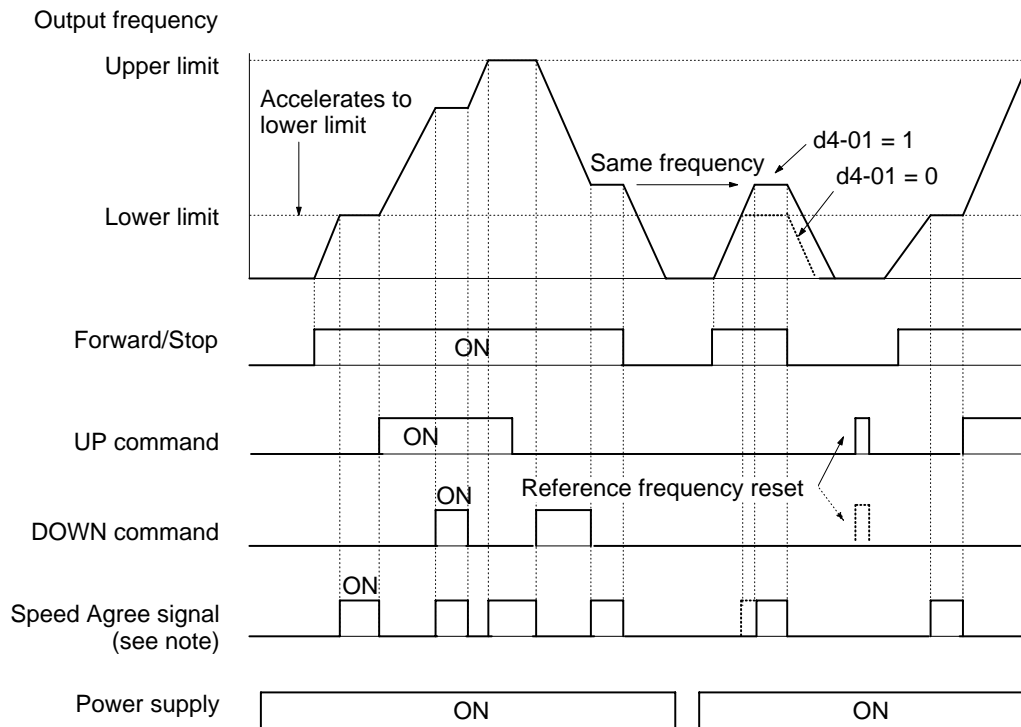

Note The Speed Agree signal remains ON while the run command is ON and the motor is not accelerating or decelerating.

• **Fault Reset (Setting: 14)**

OFF	Normal operation
ON	Resets faults when input goes from OFF to ON. (Normal operation when no fault has occurred.)

- With this setting, the multi-function input resets faults that have occurred.
- When a fault has occurred, be sure to find out what kind of fault occurred, take steps to correct the cause of the fault, and restart the Inverter. It is possible to damage the Inverter by repeatedly resetting a fault without correcting the cause.
- To resume operation after a fault has occurred, turn the run command OFF, turn the fault reset input from ON to OFF, and then turn the run command ON again. A fault cannot be reset while the run command is ON.
- If a fault hasn't occurred, turning the fault reset ON and OFF will have no effect on operation.

● **PID Disable (Setting: 19)**

OFF	Enables PID control.
ON	Disables PID control. (Normal Inverter control)

- With this setting, the multi-function input switches between PID control and normal Inverter control.
- This function can be used to perform trial operation or jog operation with normal inverter control (open-loop control) and then switch to PID control (closed-loop control using feedback) after adjusting the system. The PID disable function can also be used to switch to open-loop control when there is a problem with the feedback value.

● **Program Lockout (Setting: 1B)**

OFF	Write-protects all parameters except for frequency monitor.
ON	Allows parameters specified in Initialize mode to be changed.

- With this setting, the multi-function input can be used to write-protect the Operator's parameters.
- When the input is OFF, the Operation mode's frequency can be monitored and the frequency can be changed but other changes are prohibited.

● **Trim Control Increase and Decrease (Settings: 1C and 1D)**

Trim Control Increase	Trim Control Decrease	Output frequency
ON	OFF	Reference frequency + trim control level (d4-02)
OFF	ON	Reference frequency – trim control level (d4-02)
ON	ON	Reference frequency
OFF	OFF	Reference frequency

- The trim control increase function adds the level in d4-02 to the analog frequency reference and the trim control decrease function subtracts the level in d4-02 to the analog frequency reference.
- These functions are effective when the frequency reference is input from an analog input.
- These functions can be used independently or together.
- The analog frequency reference won't be changed when both the trim control increase and decrease inputs are ON.
- The output frequency is limited to zero when the trim control decrease input is ON and the result of the subtraction is less than zero.

Note Select and set one of the following functions for multi-function input. Do not set more than one of them, otherwise a setting error (OPE3) will result.

- Acceleration/Deceleration Ramp Hold (Setting: A)
- UP and DOWN Commands (Settings: 10 and 11)
- Trim Control Increase and Decrease (Settings: 1C and 1D)
- Analog Frequency Reference Sample/Hold (Setting: 1E)

• Analog Frequency Reference Sample/Hold (Setting: 1E)

This function retains the analog input in the Inverter.

- If the analog frequency reference sample/hold input is ON for 100 ms continuously, the analog value that is input 100 ms after the analog frequency reference sample/hold input turns ON will be sampled and retained.
- The retained analog value will be kept on hold until the next sampling period.
- All the following analog inputs are applicable.
 - Frequency reference input (voltage): Pin 13
 - Frequency reference input (current): Pin 14
 - Multi-function analog input: Pin 16
 - Analog Input Cards: 3G3IV-PAI14U/3G3IV-PAI14B

Note Select and set one of the following functions for multi-function input. Do not set more than one of them, otherwise a setting error (OPE3) will result.

- Acceleration/Deceleration Ramp Hold (Setting: A)
- UP and DOWN Commands (Settings: 10 and 11)
- Trim Control Increase and Decrease (Settings: 1C and 1D)
- Analog Frequency Reference Sample/Hold (Setting: 1E)

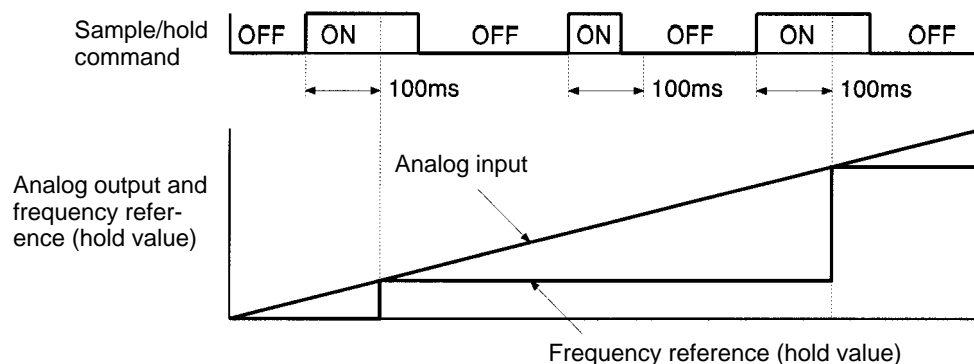

● **External Faults (Settings: 20 through 2F)**

- With this setting, the multi-function input can be used to stop the Inverter or output an alarm when a malfunction or fault occurs in a peripheral device.
- There are 16 external fault inputs available with all 16 combinations of the following variables. Select the setting with the desired combination.

Input level: Normally open or normally closed
 Detection method: Always or During operation only
 Operation selection: Decelerate to stop, Coast to stop, Emergency stop, or Continue operation

Setting	Input level		Detection method		Operation selection			
	N.O.	N.C.	Always	During operation	Decelerate to stop (Fault)	Coast to stop (Fault)	Emergency stop (Fault)	Continue operation (Alarm)
20	Yes	---	Yes	---	Yes	---	---	---
21	---	Yes	Yes	---	Yes	---	---	---
22	Yes	---	---	Yes	Yes	---	---	---
23	---	Yes	---	Yes	Yes	---	---	---
24	Yes	---	Yes	---	---	Yes	---	---
25	---	Yes	Yes	---	---	Yes	---	---
26	Yes	---	---	Yes	---	Yes	---	---
27	---	Yes	---	Yes	---	Yes	---	---
28	Yes	---	Yes	---	---	---	Yes	---
29	---	Yes	Yes	---	---	---	Yes	---
2A	Yes	---	---	Yes	---	---	Yes	---
2B	---	Yes	---	Yes	---	---	Yes	---
2C	Yes	---	Yes	---	---	---	---	Yes
2D	---	Yes	Yes	---	---	---	---	Yes
2E	Yes	---	---	Yes	---	---	---	Yes
2F	---	Yes	---	Yes	---	---	---	Yes

Note 1. For the input level, select whether you want a fault to be detected when the input signal is ON (normally open input) or OFF (normally closed input).

Note 2. For the detection method, select whether you want faults to be detected any time that the Inverter is on or only during operation.

Note 3. For the operation selection, select the processing method that you want to be performed when a fault has been detected.

Decelerate to stop: A fault is output and the output stopped in the selected deceleration time.

Coast to stop: A fault is output and the Inverter output is cut off.

Emergency stop: A fault is output and the output stopped in the fast-stop time (C1-09).

Continue operation: An alarm is output and operation continues.

When an alarm is going to be output externally, be sure to set one of the multi-function outputs (H2) to alarm (Minor Fault, setting 10).

- An external fault setting cannot be set in more than one multi-function input.

- Unlike other parameter settings, the external fault settings have an input procedure, as shown in the following diagrams.

1. When setting an external fault function, press the Enter Key when “External Fault” is displayed to bring up the “Input Level” display.

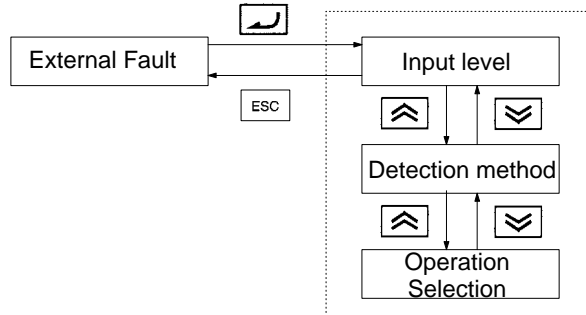

2. Press the Increment Key to switch displays as follows:
 “Detection Method” → “Operation Selection” → “Input Method”
3. Press the Enter Key at the desired parameter to select that parameter. At this point, the Increment and Decrement Keys can be pressed to scroll through the available settings for the selected parameter. Press the Enter Key to select the displayed parameter setting.
 (Press the Escape Key to cancel the operation without changing the parameter setting.)

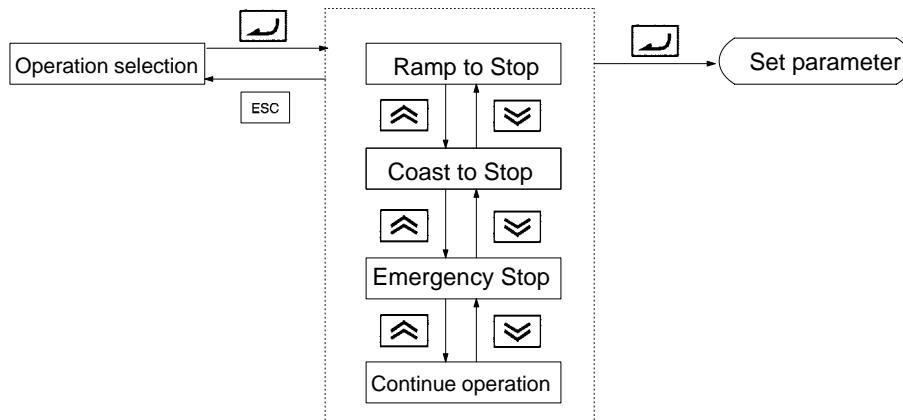
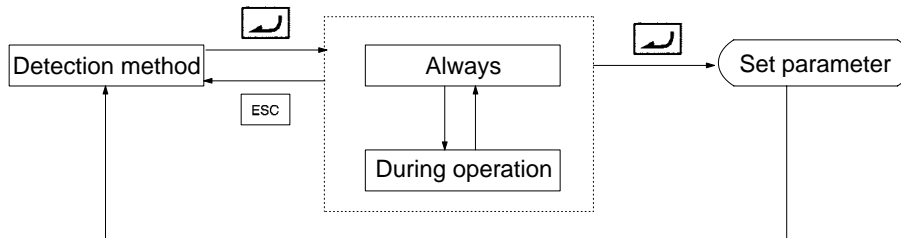
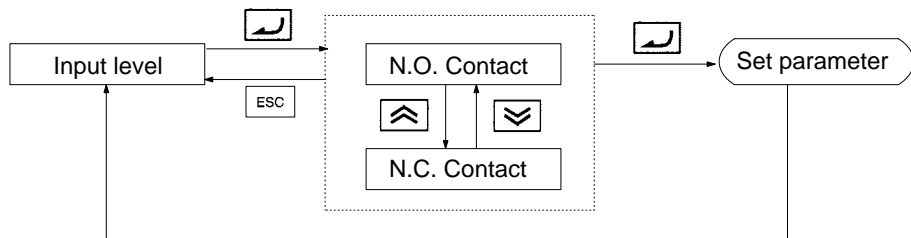

● **DC Injection Activate (Setting: 60)**

OFF	Normal operation
ON	Applies DC braking if the Inverter is stopped. (Applies initial excitation when flux vector control is being used.)

- DC braking is used to prevent the motor from rotating due to inertia or external forces when the Inverter is stopped.
- DC braking is performed if the DC braking input is ON while the Inverter is stopped.
- If a run command or jog command (jog frequency reference, forward jog, or reverse jog) is input, the DC braking will be cleared and motor operation will be started.

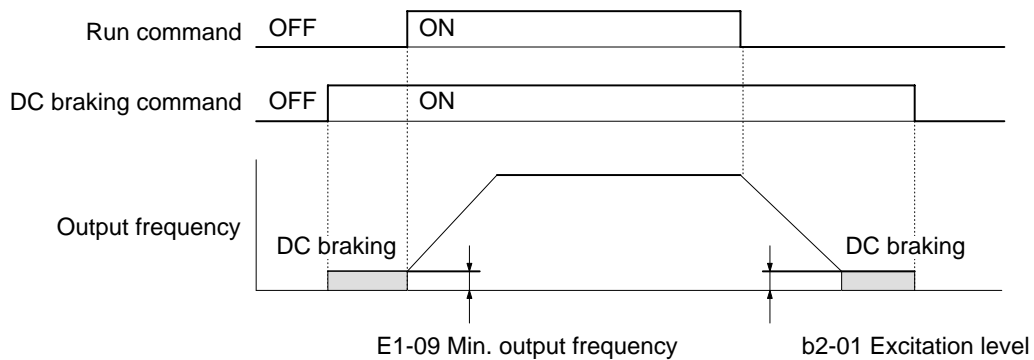

● **External Search 1 (Settings: 61)**

OFF	Normal operation
ON	Starts a speed search from the maximum frequency.

● **External Search 2 (Settings: 62)**

OFF	Normal operation
ON	Starts a speed search from the set frequency (the present reference frequency).

The speed search function applies a lower voltage than normal, and finds the speed at the current flowing at that time. The speed search is determined to be completed when the frequency is lowered from the maximum frequency (or a set frequency) and the current that is output falls below a fixed value. When the speed search is completed, the speed is accelerated to the frequency reference according to the acceleration time that has been set. For V/f with PG or flux vector control, detection occurs at the motor speed with PG feedback, so there is no need to set this function.

- The speed search function can be used to operate the motor without tripping when switching operation from a commercial power supply and the Inverter or starting a coasting motor.
- The speed search will begin after the minimum baseblock time has elapsed when the run command is input after the external search command has been turned ON.
- Either one of the external search functions can be set, but not both.

Timing Chart

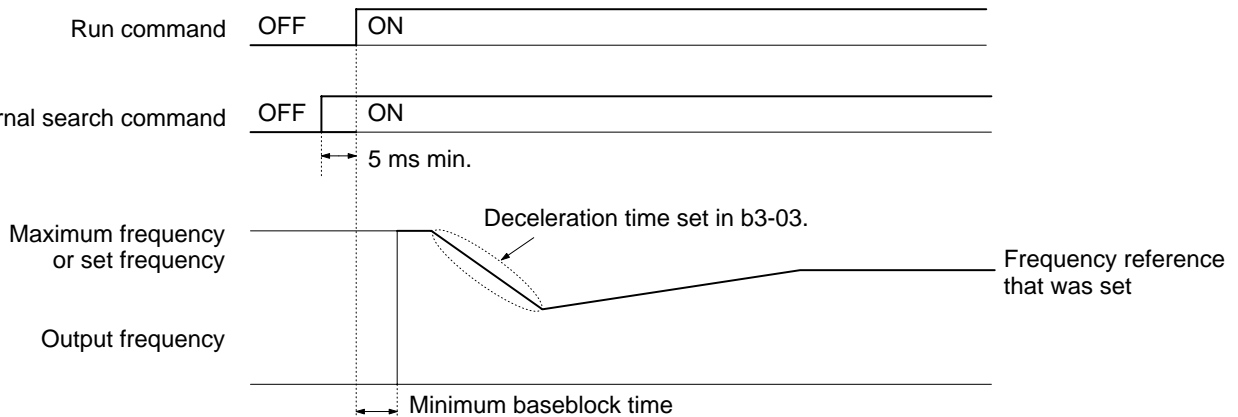

• **Speed Torque Control Change (Setting: 71)**

OFF	Speed control
ON	Torque control

- With this setting, the multi-function input can be used to switch between speed and torque control.

Note Refer to 6-3-5 *Speed/Torque Control Switching Function* for more details.

• **Zero-servo Command (Setting: 72)**

OFF	Normal operation
ON	Locks position when the frequency (speed) reference falls below the zero-speed level in b2-01.

- With this setting, the multi-function input controls the zero servo function (B9-01 and b9-02).
- When the zero-servo command is ON, a position control loop is formed and the motor is completely stopped when the frequency (speed) reference falls below the excitation level set in b2-01.

Note Refer to 6-3-3 *Zero-servo Function (Position-lock)* for more details.

• **ASR Gain Switch (Setting: 77)**

OFF	The gain is set according to the values in C5-01, C5-03, and C5-07.
ON	The gain is set to the value in C5-03 (ASR proportional gain 2).

- With this setting, the multi-function input switches the proportional gain used in speed control (ASR). (The integral time is not changed.)

Note Refer to 5-4-4 *Speed Loop (ASR) Structure* for more details on parameters C5-01, C5-03, and C5-07.

■ Multi-function Output Settings (H2)

Setting	Function	Control mode			
		V/f	V/f w/PG	Open-loop Vector	Flux Vector
0	During RUN 1	OK	OK	OK	OK
1	Zero-speed	OK	OK	OK	OK
2	Fref/Fout Agree 1 (Detection width in L4-02)	OK	OK	OK	OK
3	Fref/Set Agree 1 (Detection width in L4-02)	OK	OK	OK	OK
4	Frequency Detection 1 ($-L4-01 \geq$ output frequency $\geq +L4-01$)	OK	OK	OK	OK
5	Frequency Detection 2 ($ \text{Output frequency} \geq L4-01$)	OK	OK	OK	OK
6	Inverter Ready (Initialization completed, no faults)	OK	OK	OK	OK
7	DC Bus Undervoltage (Main circuit voltage too low)	OK	OK	OK	OK
8	Baseblock 1	OK	OK	OK	OK
9	Option Reference (ON: Frequency reference from Operator)	OK	OK	OK	OK
A	Remote Operation (ON: Run command from Operator)	OK	OK	OK	OK
B	Torque Detection 1 (N.O.)	OK	OK	OK	OK
C	Loss of Reference (Valid when L4-05 is set to 1.)	OK	OK	OK	OK
D	DB overheat (DC braking resistor overheating or faulty)	OK	OK	OK	OK
E	Fault (A fault other than CPF00 or CPF01 occurred.)	OK	OK	OK	OK
10	Minor Fault (Alarm display)	OK	OK	OK	OK
11	Reset Command Active (Fault reset command in progress)	OK	OK	OK	OK
12	Timer Output	OK	OK	OK	OK
13	Fref/Fout Agree 2 (Detection width in L4-04)	OK	OK	OK	OK
14	Fref/Set Agree 2 (Detection width in L4-04)	OK	OK	OK	OK
15	Frequency Detection 3 (Output frequency $\leq -L4-03$)	OK	OK	OK	OK
16	Frequency Detection 4 (Output frequency $\geq -L4-03$)	OK	OK	OK	OK
17	Torque Detection 1 (N.C.)	OK	OK	OK	OK
18	Torque Detection 2 (N.O.)	OK	OK	OK	OK
19	Torque Detection 2 (N.C.)	OK	OK	OK	OK
1A	Reverse Direction (Operating in reverse direction.)	OK	OK	OK	OK
1B	Baseblock 2	OK	OK	OK	OK
1C	Motor 2 Selected (ON: Motor 2 selected)	OK	OK	OK	OK
1D	Regenerating	---	---	---	OK
1E	Restart Enabled (Enabled during restart by Auto Restart operation) (ON: During restart)	OK	OK	OK	OK
1F	Overload (OL1) (ON when 90% or more than detection level)	OK	OK	OK	OK
20	OH Prealarm (ON when temperature exceeds L8-02 setting)	OK	OK	OK	OK
30	Current/Torque Limit	---	---	OK	OK
31	Speed Limit	---	---	---	OK
33	Zero Servo End (Zero servo function completed)	---	---	---	OK
37	During RUN 2 (ON when outputting a frequency. OFF for baseblock, DC braking, initial excitation, or stopped operation.)	OK	OK	OK	OK

● **Parameter Settings**

The following table shows the setting information for the multi-function outputs. These parameters cannot be changed during operation.

Parameter number	Display name	Setting range	Units	Default setting*1	Valid access levels			
					V/f Control	V/f with PG	Open Loop Vector	Flux Vector
H2-01	Terminal 9 Sel	0 to 37	---	0	Basic or Advanced			
H2-02	Terminal 25 Sel	0 to 37	---	1	Basic or Advanced			
H2-03	Terminal 26 Sel	0 to 37	---	2	Basic or Advanced			

Note 1. The following table shows the settings and page references for functions that are described in more detail in this chapter.

Function	Setting	Page
Fref/Fout Agree 1	2	6-103
Fref/Set Agree 1	3	6-103
Frequency Detection 1	4	6-103
Frequency Detection 2	5	6-103
Torque Detection 1 (N.O.)	B	6-107
Loss of Reference	C	6-103
Timer Output	12	6-46
Fref/Fout Agree 2	13	6-103
Fref/Set Agree 2	14	6-103
Frequency Detection 3	15	6-103
Frequency Detection 4	16	6-103
Torque Detection 1 (N.C.)	17	6-107
Torque Detection 2 (N.O.)	18	6-107
Torque Detection 2 (N.C.)	19	6-107
Motor Selection	1C	6-70

Note 2. The following table shows the settings for simple functions that aren't explained in detail.

Function	Setting
Inverter Ready	6
DC Bus Undervoltage	7
Baseblock 1	8
Option Reference	9
Remote Operation	A
DB overheat	D
Fault	E
Minor Fault	10
Reset Command Active	11
Reverse Direction	1A
Baseblock 2	1B
Motor 2 Selected	1D
Regenerating	1E
Current/Torque Limit	30
Speed Limit	31

● Inverter Operating 1 (“During RUN 1,” Setting: 0)

OFF	The run command is OFF and there is not output voltage.
ON	The run command is ON and voltage is being output.

● Inverter Operating 2 (“During RUN 2,” Setting: 37)

OFF	The Inverter is not outputting a frequency. (Baseblock, DC braking, initial excitation, or stopped)
ON	The Inverter is outputting a frequency.

- These outputs can be used to indicate the Inverter’s operating status.

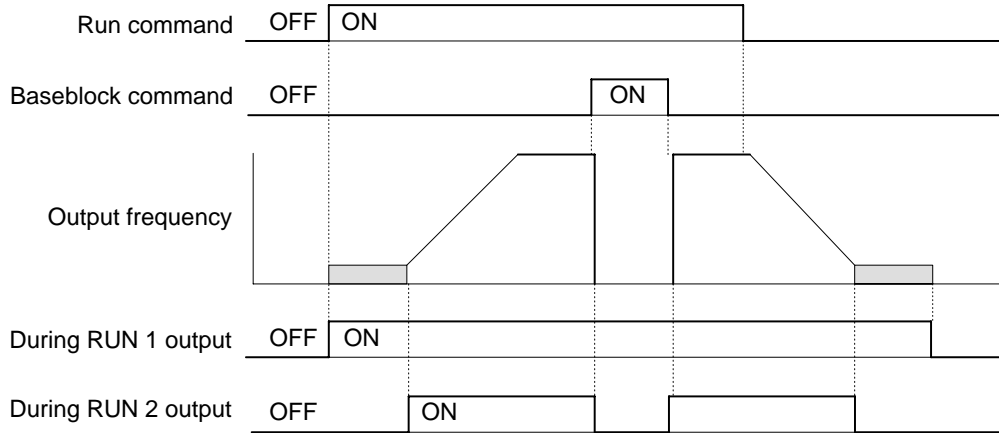

● Excitation (Setting: 1)

OFF	The output frequency is greater than the minimum output frequency (E1-09). (With flux vector control, the output frequency is greater than the excitation level (b2-01).)
ON	The output frequency is less than the minimum output frequency (E1-09). (With flux vector control, the output frequency is less than the excitation level (b2-01).)

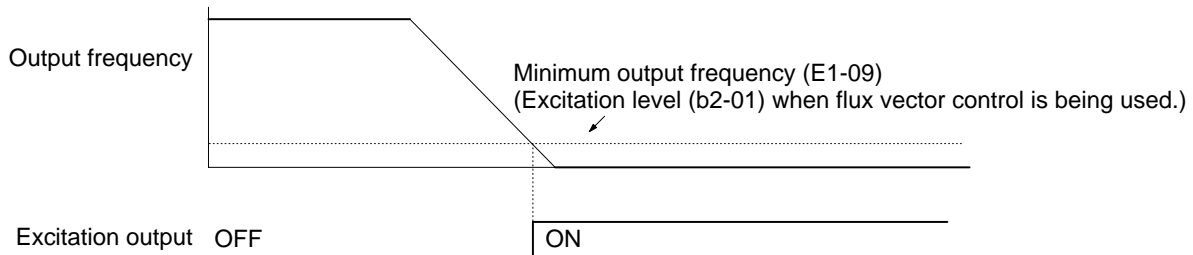

● Overload OL1 (Setting: 1F)

OFF	The motor protection function’s electronic thermal value is less than 90% of the detection level.
ON	The motor protection function’s electronic thermal value is greater than 90% of the detection level.

- This output function is valid when the motor overload protection function is enabled (L1-01 =1).
- This output can be used to warn of overheating before the protection function itself operates.

● OH Prealarm (Setting: 20)

OFF	The cooling fin temperature is less than the “OH Pre-Alarm Level” set in L8-02.
ON	The cooling fin temperature exceeds the “OH Pre-Alarm Level” set in L8-02.

- This output function indicates that the temperature of the cooling fins reaches the temperature set in L8-02 (the Inverter overheating alarm detection level).

● Zero-servo End (Setting: 33)

OFF	The zero-servo command isn't being input or zero-servo position control hasn't been completed.
ON	The position has been brought within the zero servo completion width (b9-02) after the zero servo command was input.

- This output function indicates that zero-servo position control has been completed.
- The output is turned ON after the zero servo command is input and the difference between the zero-servo operation starting position and the current position is within the zero servo completion width (b9-02).

■ Multi-function Analog Input/Frequency Reference (Current) (H3-05/H3-09)

● Parameter Settings

Parameter number	Display name	Setting range	Units	Default setting	Valid access levels			
					V/f Control	V/f with PG	Open Loop Vector	Flux Vector
H3-05	Terminal 16 Sel	0 to 1F	---	1F	Basic or Advanced			
H3-09	Terminal 14 Sel	1 to 1F	---	1F	Advanced			

Note These parameters cannot be changed during operation.

Setting	Function	Equivalent of 100% Input (10 V or 20 mA)	Control mode			
			V/f	V/f w/PG	Open-loop Vector	Flux Vector
0	Auxiliary reference (H3-05)	Maximum frequency	OK	OK	OK	OK
1	Frequency Gain	Frequency ref. of terminal 13	OK	OK	OK	OK
2	Frequency Bias	Maximum frequency (added to H3-03)	OK	OK	OK	OK
4	Voltage Bias	Rated voltage (E1-05)	OK	OK	OK	OK
5	Accel/Decel Change	Accel/Decel times (C1-□□)	OK	OK	OK	---
6	DC Brake Current	Inverter's rated output current	OK	OK	OK	OK
7	Overtorque Level	Rated torque or Inverter's rated output (Setting in L6-05 is ignored.)	OK	OK	---	---
8	Stall Prevention Level	Inverter's rated output current	OK	OK	OK	OK
9	Reference Lower Limit	Maximum frequency	OK	OK	OK	OK
A	Jump Frequency	Maximum frequency	OK	OK	OK	OK
B	PID Feedback	Maximum frequency	OK	OK	OK	OK
C	PID target value	Maximum frequency	OK	OK	OK	OK
D	Frequency bias 2	Maximum frequency (added to H3-03 set value)	OK	OK	OK	OK
10	Forward Torque Limit	Rated torque	---	---	OK	OK
11	Reverse Torque Limit	Rated torque	---	---	OK	OK
12	Regenerative Torque Limit	Rated torque	---	---	OK	OK
13	Torque reference	Rated torque	---	---	---	OK
14	Torque Compensation Bias	Rated torque	---	---	---	OK
15	Speed Limit	Rated torque	---	---	OK	OK

Setting	Function	Equivalent of 100% Input (10 V or 20 mA)	Control mode			
			V/f	V/f w/PG	Open-loop Vector	Flux Vector
1F	Disable analog input (H3-05)	---	OK	OK	OK	OK
	Frequency Reference (H3-09)	Maximum frequency				

Note 1. The analog inputs' signal level, gain, and bias are set with the following parameters. Terminal 16 is the multi-function analog input and terminal 14 is the frequency reference (current) input.

- Terminal 16 signal level selector . . . H3-04 (0 to +10 V or 0 to ±10 V)
- Terminal 16 input gain H3-06
- Terminal 16 input bias H3-07
- Terminal 14 signal level selector . . . H3-08 (0 to +10 V, 0 to ±10 V, or 4 to 20 mA)
- Terminal 14 input gain H3-10
- Terminal 14 input bias H3-11

Note 2. When a voltage input is being input to terminal 14, be sure to disconnect jumper wire J1 on the control board. The input resistance will be destroyed if a voltage input is used without disconnecting the jumper wire.

Note 3. Set the time constant with the following parameter when adding a primary delay filter to an analog input:

- Analog input filter time constant . . . H3-12
- This filter time constant applies to all three of the analog inputs.

Note 4. The frequency bias setting (setting: 2) is different from the frequency bias 2 setting (setting: D) in the operation of the Inverter if the calculation results in a negative value. The frequency bias will be limited to 0 and frequency bias 2 will rotate the motor in the reverse direction.

Note 5. The frequency bias and frequency bias 2 cannot be set together for two analog inputs. A setting error (OPE07) will result if an attempt is made to set them.

• Analog Input Characteristics with Gain = 100.0% and Bias = 0.0%

- Auxiliary Frequency Reference (Setting: 0)
- Frequency Bias (Setting: 2)
- Frequency Bias 2 (Setting: D)
- PID Feedback (Setting: B)
- Frequency Reference (H3-09, Setting: 1F)

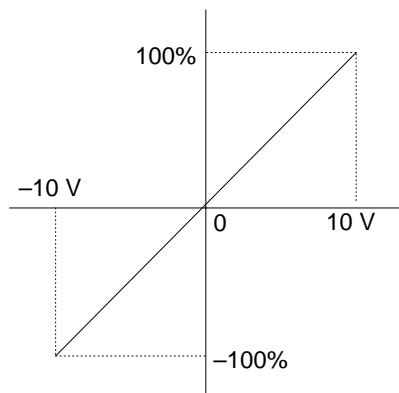

- Frequency Gain (Setting: 1)
 Output Voltage Bias (Setting: 4)
 DC Braking Current (Setting: 6)
 Overtorque Detection Level (Setting: 7)

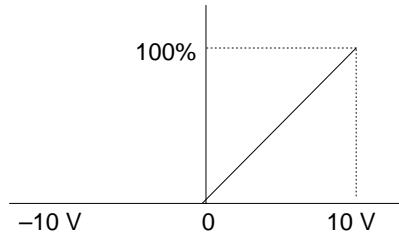

Note 1. If 1 is set, the final gain will be equal to the result of multiplication by the set value of H3-02.

Note 2. The setting 7 is only valid for overtorque detection 1.

- Acceleration/Deceleration Time Gain (Setting: 5)

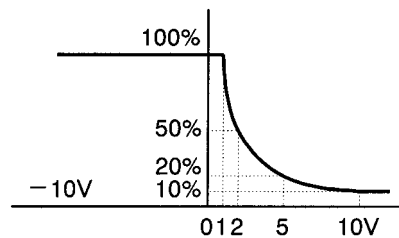

Note The acceleration/deceleration time gain for 1 to 10 V is $10 \text{ V}/\text{input voltage (V)} \times 10\%$

- Stall Prevention Level (Setting: 8)

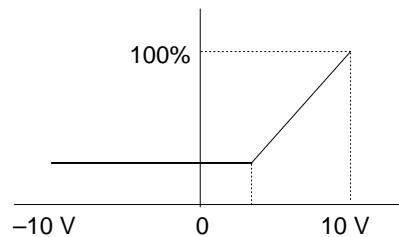

- Output Frequency Lower Limit (Setting: 9)
 Jump Frequency (Setting: A)

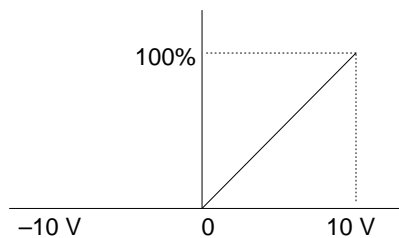

- Torque Reference (Setting: 13)
Torque Compensation Bias (Setting: 14)

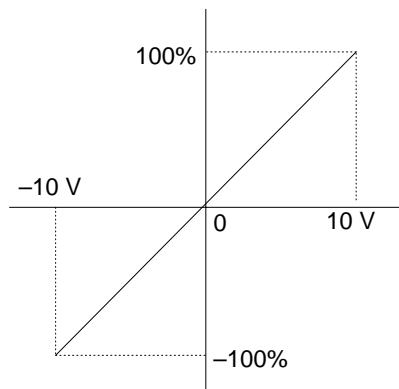

- Forward Torque Limit (Setting: 10)
Reverse Torque Limit (Setting: 11)
Regenerative Torque Limit (Setting: 12)

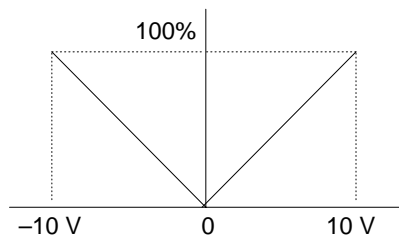

- Forward/Reverse Torque (Speed) Limit (Setting: 15)

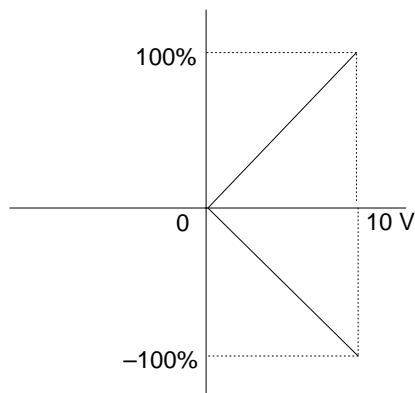

■ Multi-function Analog Output Settings (H4)

• Function Selection Parameters

Parameter number	Display name	Setting range ^{1,2}	Units	Default setting	Valid access levels			
					V/f Control	V/f with PG	Open Loop Vector	Flux Vector
H4-01	Terminal 21 Sel	1 to 38	---	2	Basic or Advanced			
H4-04	Terminal 23 Sel	1 to 38	---	3	Basic or Advanced			

Note These parameters cannot be changed during operation.

- The multi-function outputs can be set to monitor any of the U1 Inverter status items by setting the last two digits of the parameter number (U1-□□). Refer to page 3-12 for a table listing all of these U1 settings.
- The Inverter’s status monitor item U1 can be output as multi-function analog output. Set the parameters H4-01 and H4-03 (AO Ch1 Select and AO Ch2 Select) to the right side of the of “U1” constants in the table on page 3-12 of this manual. The setting range is between 1 and 38, but the following numbers cannot be set: 4, 10, 11, 13, 14, 25, 28, 29, 30, 31, 34, 35.

• **Adjusting the Monitor Output**

Parameter number	Display name	Setting range	Units	Default setting	Valid access levels			
					V/f Control	V/f with PG	Open Loop Vector	Flux Vector
H4-02	Terminal 21 Gain	0.00 to 2.50	Factor	1.00	Basic or Advanced			
H4-03	Terminal 21 Bias	-10.0 to 10.0	%	0.0	Basic or Advanced			
H4-05	Terminal 23 Gain	0.00 to 2.50	Factor	0.50	Basic or Advanced			
H4-06	Terminal 23 Bias	-10.0 to 10.0	%	0.0	Basic or Advanced			

Note These parameters can be changed during operation.

- For the output gain, set what multiple of 10 V will correspond to a 100% output of the monitored item.
- For the output bias, set the amount that the output characteristic will be shifted vertically. Set this amount as a percentage, with 10 V corresponding to 100%.

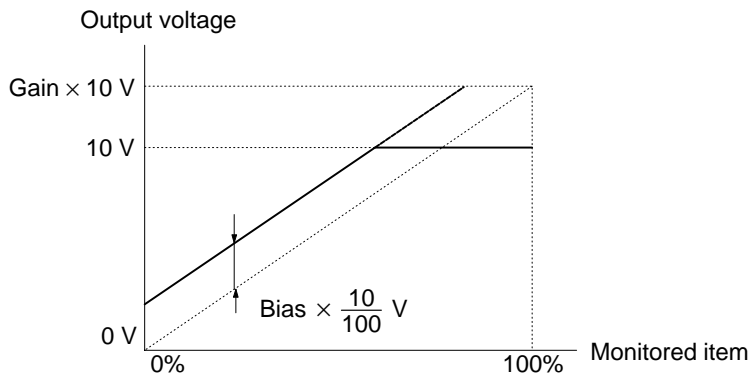

• **Multi-function Analog Output Signal Level**

Parameter number	Display name	Setting range	Units	Default setting	Valid access levels			
					V/f Control	V/f with PG	Open Loop Vector	Flux Vector
H4-07	AO Level Select	0 or 1	---	0	Basic or Advanced			

Note This parameter cannot be changed during operation.

Setting	Function
0	0 to +10 V (Absolute value output)
1	0 to ±10 V

- This signal level setting applies to analog outputs 1 and 2 (terminals 21 and 23).
- When the 0- to ±10-V signal level is used to output speed values (frequency reference, output frequency, or motor speed), positive voltage indicates Inverter output in the forward direction and negative voltage indicates Inverter output in the reverse direction. (Assuming a bias setting of 0.0.)

- There are some monitor items that are limited to the 0 to +10 V signal range even when the 0- to ±10-V signal level has been selected. Refer to the table of status monitor items in page 3-12 for details.

6-5-8 Protective Functions: L

■ Motor Protection Settings (L1)

Parameter number	Display name	Setting range	Units	Default setting	Valid access levels			
					V/f Control	V/f with PG	Open Loop Vector	Flux Vector
L1-01	MOL Fault Select	0 or 1	---	1	Basic or Advanced			

Note This parameter cannot be changed during operation.

Setting	Function
0	Disabled.
1	Enabled.

- This setting enables or disables the motor overload protection function.
- The rated current setting (E2-01) is used as a basis for overload detection.
- Disable the motor protection function (setting 0) when two or more motors are connected to a single Inverter. Use another method to provide overload protection separately to each motor, such as connecting a thermal relay to the power line of each motor.
- The motor protection function may not protect a motor when the power supply is turned on and off frequently, because the thermal value is reset each time that the power is turned off.
- If the Overload OL1 alarm (1F) is set in one of the multi-function outputs (H2-01 through H2-03), the output will be turned ON when the electronic thermal value reaches 90% of the overload detection level.

Parameter number	Display name	Setting range	Units	Default setting	Valid access levels			
					V/f Control	V/f with PG	Open Loop Vector	Flux Vector
L1-02	MOL Time Const	0.1 to 5.0	Minutes	1.0	Basic or Advanced			

Note This parameter cannot be changed during operation.

- Normally it isn't necessary to change this setting. (The default setting is a 150%, 1 minute endurance.)
- This setting specifies the electronic thermal detection time.
- Set the protection time for a 150% load imposed after hot-starting and continuously operating the Inverter with a rated current. Set the protection time at rated speed if a general-purpose motor is used. The rated current of the general-purpose motor will decrease if the frequency drops. Therefore, the Inverter will automatically shorten the detection time at low frequency.
- When the motor's overload endurance level is known, set the hot-start overload resistance level for the motor, but be sure to allow some margin for safety.
- Decrease this setting when you want to detect an overload more quickly.

Electronic Thermal Time Characteristics

In this example, L1-02 is set to 1 minute, the motor is operating at 60 Hz, and general-purpose motor characteristics are used.

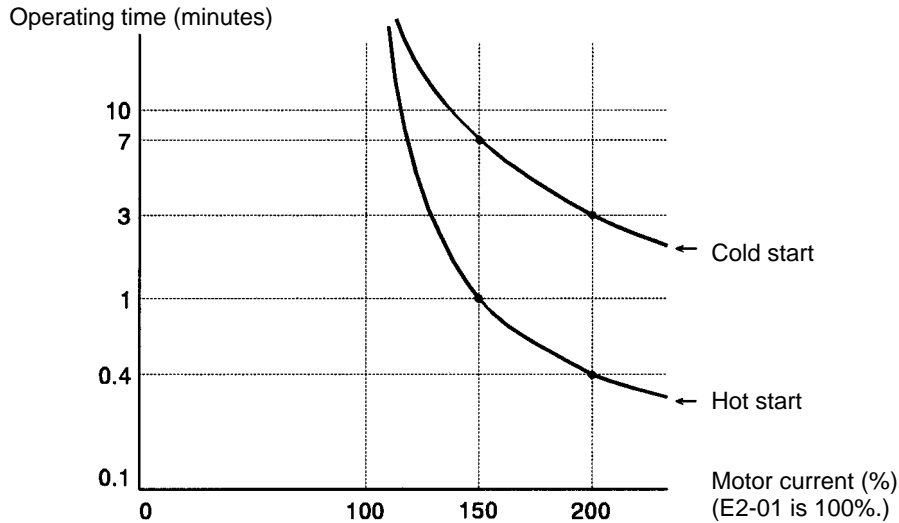

■ Momentary Power Loss Settings (L2)

Parameter number	Display name	Setting range	Units	Default setting	Valid access levels			
					V/f Control	V/f with PG	Open Loop Vector	Flux Vector
L2-01	PwrL Selection	0 to 2	---	0	Basic or Advanced			

Note This parameter cannot be changed during operation.

Setting	Function
0	Disabled. (An under-voltage fault is detected when there is a momentary power loss.)
1	Enabled. (Restarts if power is restored within the L2-02 time. An under-voltage fault is detected for a longer power loss.)
2	Enabled during CPU operation. (Restarts if power is restored while the CPU is operating. An under-voltage fault is not detected.)

- This parameter specifies the processing that is performed when a momentary power loss occurs.
- When power-loss ridethrough is enabled (setting 1 or 2), operation will be restarted after a speed search if the power is restored within the allowed time interval.
- When power-loss ridethrough is disabled (setting 0), an under-voltage fault will be detected if power is interrupted for more than 15 ms.

Parameter number	Display name	Setting range	Units	Default setting*2	Valid access levels			
					V/f Control	V/f with PG	Open Loop Vector	Flux Vector
L2-02	PwrL Ridethru t	0.0 to 2.0	s	0.5	Basic or Advanced			

Note 1. This parameter cannot be changed during operation.

Note 2. The default setting depends on the Inverter’s capacity. The default setting shown in the table is for a 200-V class, 0.4-kW Inverter.

- This setting is valid only when parameter L2-01 is set to 1.

- Set the power-loss ridethrough time in seconds.

Parameter number	Display name	Setting range	Units	Default setting*2	Valid access levels			
					V/f Control	V/f with PG	Open Loop Vector	Flux Vector
L2-03	PwrL Baseblock t	0.1 to 5.0	s	0.3	Basic or Advanced			

Note 1. This parameter cannot be changed during operation.

Note 2. The default setting varies with the Inverter’s capacity. The setting for 200-V class, 0.4-kW Inverters is shown.

- This setting is used with the speed search and DC braking functions.
- Set the time required for the leakage voltage to dissipate. Increase the setting if an overcurrent (OC) occurs when the speed search or DC braking function starts.
- This setting is valid for speed searches performed after a momentary power loss and regular speed searches.

Parameter number	Display name	Setting range	Units	Default setting	Valid access levels			
					V/f Control	V/f with PG	Open Loop Vector	Flux Vector
L2-04	PwrL V/F Ramp t	0.1 to 5.0	s	0.3	Advanced			

Note This parameter cannot be changed during operation.

- Set the time allowed for the normal voltage to be restored after completion of the speed search.
- For a 200-V class Inverter, this is the time in seconds for voltage to be restored from 0 VAC to 200 VAC. For a 400-V class Inverter, this is the time in seconds for voltage to be restored from 0 VAC to 400 VAC.
- This setting is valid for speed searches after a momentary power loss, regular speed searches, the voltage changes with energy-saving control, and the voltage changes with baseblock clearing.

Parameter number	Display name	Setting range	Units	Default setting	Valid access levels			
					V/f Control	V/f with PG	Open Loop Vector	Flux Vector
L2-05	PUV Det Level	150 to 210 (300 to 420)	V	190 (380)	Advanced			

Note 1. This parameter cannot be changed during operation.

Note 2. The values in parentheses are for 400-V class Inverters.

- Normally it isn’t necessary to change this setting.
- Use this parameter when you want to add an AC reactor and lower the main circuit under-voltage detection level. Be sure to set a main circuit DC voltage value (V) that will detect a main circuit under-voltage.

■ Stall Prevention Function Settings (L3)

A stall occurs if the rotor cannot keep up with the rotating magnetic field on the motor stator side when a large load is applied to the motor or a sudden acceleration/deceleration is performed.

In the 3G3FV, stall prevention functions can be set independently for accelerating, running, and decelerating. (Some functions are restricted depending on the control mode.)

Parameter number	Display name	Setting range	Units	Default setting	Valid access levels*2			
					V/f Control	V/f with PG	Open Loop Vector	Flux Vector
L3-01	StallP Accel Sel	0 to 2	---	1	Basic or Advanced			N.A.

Note 1. This parameter cannot be changed during operation.

Note 2. N.A. = Not applicable.

Setting	Function
0	Disabled. (Accelerate according to the settings. Stalls may occur with large loads.)
1	Enabled. (Stop acceleration if L3-02 setting is exceeded. Accelerate again when current recovers.)
2	Intelligent. (Adjust acceleration so that the L3-02 isn't exceeded by much. Ignore the acceleration time setting.)

- When setting 1 (enabled) is selected, acceleration is stopped if the motor current exceeds the acceleration stall prevention level. Acceleration is started again when the current falls below this level.
- When setting 2 (intelligent) is selected, acceleration is performed using the the acceleration stall prevention level as a basis. In this case, the acceleration time is ignored.

Parameter number	Display name	Setting range	Units	Default setting	Valid access levels*2			
					V/f Control	V/f with PG	Open Loop Vector	Flux Vector
L3-02	StallP Accel Lvl	0 to 200	%	150	Basic or Advanced			N.A.

Note 1. This parameter cannot be changed during operation.

Note 2. N.A. = Not applicable.

- This setting is valid when L3-01 is set to 1 or 2.
- There is normally no need to change this setting.
- Decrease this setting when the motor's capacity is small compared to the Inverter's capacity or stalling occurs when the motor is operated with the default setting. The standard target setting is 2 to 3 times the motor's rated current. (Set this current value as a percentage of the Inverter's rated current, i.e., 100% corresponds to the Inverter's rated current.)

Acceleration Stall Prevention Example: L3-01 = 1

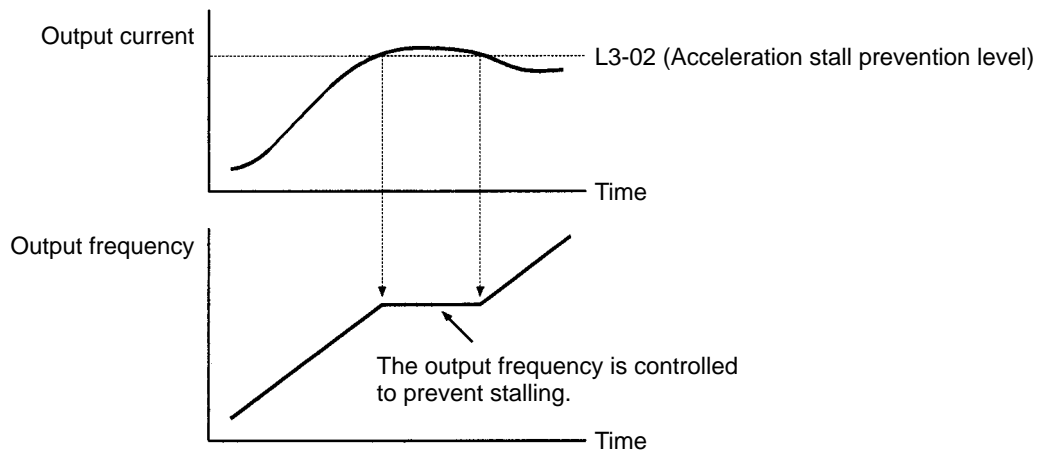

Parameter number	Display name	Setting range	Units	Default setting*2	Valid access levels*3			
					V/f Control	V/f with PG	Open Loop Vector	Flux Vector
L3-03	StallP CHP Lvl	0 to 100	%	50	Advanced			N.A.

Note 1. This parameter cannot be changed during operation.

Note 2. N.A. = Not applicable.

- There is normally no need to change this setting.
- Set this parameter when a high-speed motor is being used in the high-speed range (the high frequency range above the base frequency).
The standard target setting is the motor’s rated current. (Set this current value as a percentage of the Inverter’s rated current, i.e., 100% corresponds to the Inverter’s rated current.)

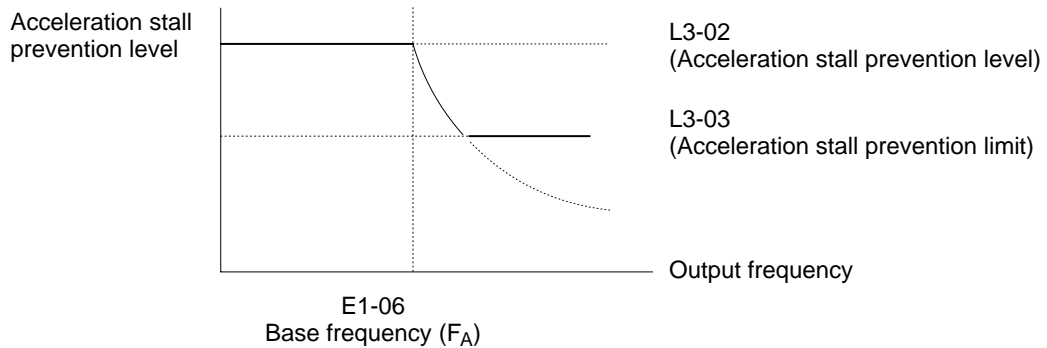

- When the motor is used in the high-speed range, the acceleration stall prevention level is automatically lowered to provide smoother acceleration. The acceleration stall prevention limit (L3-03) limits how much the acceleration stall prevention level is lowered so that it isn’t lowered any more than necessary.

Parameter number	Display name	Setting range	Units	Default setting	Valid access levels			
					V/f Control	V/f with PG	Open Loop Vector	Flux Vector
L3-04	StallIP Decel Sel	0 to 3	---	1	Basic or Advanced			

Note This parameter cannot be changed during operation.

Setting	Function
0	Disabled. (Decelerate according to the settings. Main circuit over-voltage may occur if the deceleration time is too short.)
1	Enabled. (Stops deceleration if the main circuit voltage exceeds the over-voltage level. Decelerate again when voltage recovers.)
2	Intelligent. (Decelerate as fast as possible judging from the main circuit voltage. Ignore the deceleration time setting.)
3	Enabled. (Stall preventive function using a Braking Resistor or Braking Resistor Unit.)

- If the parameter is set to 1, the deceleration time will be automatically prolonged without using the braking function (i.e., without using a Braking Resistor or Braking Resistor Unit and Braking Unit) so that the main circuit overvoltage (OV) will not result.
- Set the parameter to 0 or 3 when using the braking function (i.e., using a Braking Resistor or Braking Resistor Unit and Braking Unit), otherwise the braking function cannot be used and the deceleration time will not be shortened. If 3 is set, part of deceleration time will be automatically prolonged to prevent main circuit overvoltage (OV) with the braking function (a Braking Resistor or Braking Resistor Unit and Braking Unit) used. As a result, the possible set time will be shorter than that possible with the parameter set to 0, and the deceleration time will be shortened as well. Set the parameter to 0, however, if it is desired to decelerate the motor in the set deceleration time.

- When this parameter is set to 3, in contrast to a setting of 0, the deceleration time is automatically prolonged with main axis overvoltage (OV) easily detected. Therefore the actual deceleration time becomes longer than the deceleration time that has been set. This can be adjusted, however, by setting a shorter deceleration time than for the 0 setting, so that the actual deceleration time will also be shorter.

Note The parameter cannot be set to 3 in flux vector control.

Deceleration Stall Prevention Example: L3-04 = 1

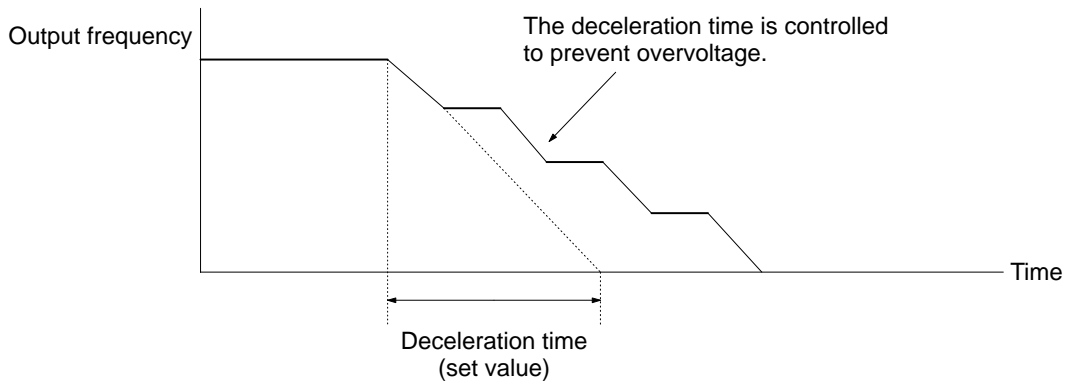

Parameter number	Display name	Setting range	Units	Default setting	Valid access levels			
					V/f Control	V/f with PG	Open Loop Vector	Flux Vector
L3-05	StallP Run Sel	0 to 2	---	1	Basic or Advanced		Not applicable.	

Note This parameter cannot be changed during operation.

Setting	Function
0	Disabled. (Run according to the settings. Stalls may occur with large loads.)
1	Enabled – deceleration time 1. (Use deceleration time in C1-02 for stall prevention function.)
2	Enabled – deceleration time 2. (Use deceleration time in C1-04 for stall prevention function.)

- When setting 1 or 2 (enabled) is selected, deceleration is started if the run stall prevention level's current continues for more than 100 ms. The motor is accelerated back to the reference frequency again when the current falls below this level.

Parameter number	Display name	Setting range	Units	Default setting	Valid access levels			
					V/f Control	V/f with PG	Open Loop Vector	Flux Vector
L3-06	StallP Run Level	30 to 200	%	160	Basic or Advanced		Not applicable.	

Note This parameter cannot be changed during operation.

- This setting is valid when L3-05 is set to 1 or 2.
- Normally it isn't necessary to change this setting.
- Decrease this setting when the motor's capacity is small compared to the Inverter's capacity or stalling occurs when the motor is operated with the default setting. The standard target setting is 2 to 3 times the motor's rated current. (Set this current value as a percentage of the Inverter's rated current, i.e., 100% corresponds to the Inverter's rated current.)

Run Stall Prevention Example: L3-05 = 1 or 2

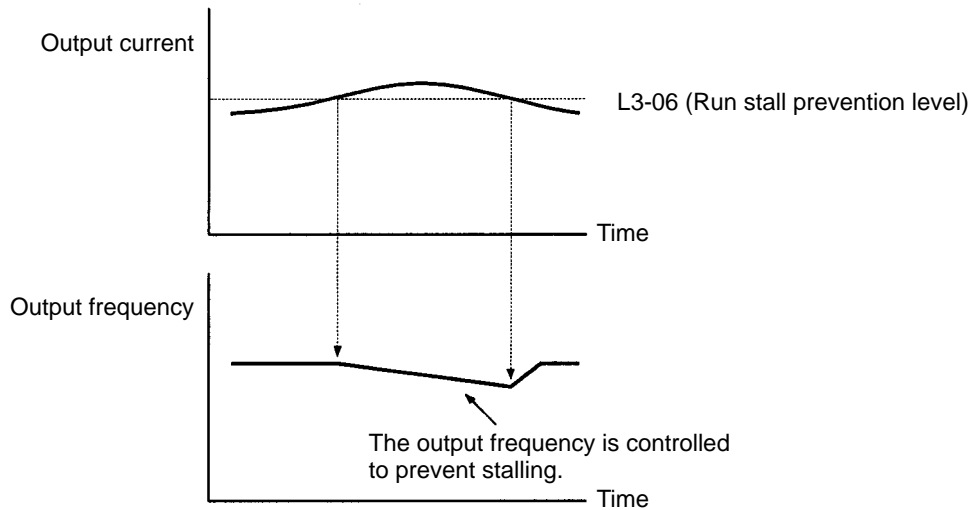

■ Frequency Detection Settings (L4)

Parameter number	Display name	Setting range	Units	Default setting	Valid access levels			
					V/f Control	V/f with PG	Open Loop Vector	Flux Vector
L4-01	Spd Agree Level	0.0 to 400.0	Hz	0.0	Basic or Advanced			
L4-02	Spd Agree Width	0.0 to 20.0	Hz	2.0	Basic or Advanced			
L4-03	Spd Agree Lvl+–	–400.0 to +400.0	Hz	0.0	Advanced			
L4-04	Spd Agree Wdth+–	0.0 to 20.0	Hz	2.0	Advanced			

Note These parameters cannot be changed during operation.

- Set these parameters when outputting one of the frequency agree or frequency detection signals from a multi-function output (settings 2, 3, 4, 5, 13, 14, 15, or 16). The following table shows the relationship between these parameters and the output signals.

Parameter	Related output settings	Parameter function
Speed Agree Level (Absolute value)	Fref/Set Agree 1 (setting 3) Frequency Detection 1 (setting 4) Frequency Detection 2 (setting 5)	Set the speed that you want to detect in Hz. The set speed is an absolute value, so the speed is detected in forward or reverse.
Speed Agree Width (Absolute value)	Fref/Fout Agree 1 (setting 2) Fref/Set Agree 1 (setting 3) Frequency Detection 1 (setting 4) Frequency Detection 2 (setting 5)	Set the speed detection range in Hz.
Speed Agree Level +/- (Signed value)	Fref/Set Agree 2 (setting 14) Frequency Detection 3 (setting 15) Frequency Detection 4 (setting 16)	Set the speed that you want to detect in Hz. Set positive values for forward, negative values for reverse.
Speed Agree Width +/- (Signed value)	Fref/Fout Agree 2 (setting 13) Fref/Set Agree 2 (setting 14) Frequency Detection 3 (setting 15) Frequency Detection 4 (setting 16)	Set the speed detection range in Hz.

- Set the corresponding setting in the multi-function output (H2-01, H2-02, or H2-03) to output the desired Fref/Fout Agree signal, Fref/Set Agree signal, or Frequency Detection signal. There is a timing chart showing the operation of these signals on the following page.

Parameter number	Display name	Setting range	Units	Default setting	Valid access levels			
					V/f Control	V/f with PG	Open Loop Vector	Flux Vector
L4-05	Ref Loss Sel	0 or 1	---	0	Advanced			

Note This parameter cannot be changed during operation.

Setting	Function
0	Stop. (Operate according to the frequency reference value.)
1	Continue operation at 80% speed. (Continue operation with a speed that is 80% of the value when the frequency reference was lost.)

- The frequency reference is considered lost when the frequency reference voltage drops by 90% for more than 400 ms.

● Frequency Detection Operation

Related parameter	L4-01: Speed Agree Level L4-02: Speed Agree Width	L4-03: Speed Agree Level +/- L4-04: Speed Agree Width +/-
Fref/Fout Agree	<p>Fref/Fout Agree 1</p> <p>(Multi-function output setting = 2)</p>	<p>Fref/Fout Agree 2</p> <p>(Multi-function output setting = 13)</p>
	Fref/Set Agree	<p>Fref/Set Agree 1</p> <p>(Multi-function output setting = 3)</p>
Frequency Detection	<p>Frequency Detection 1</p> <p>(Multi-function output setting = 4)</p>	<p>Frequency Detection 3</p> <p>(Multi-function output setting = 15)</p>
	<p>Frequency Detection 2</p> <p>(Multi-function output setting = 5)</p>	<p>Frequency Detection 4</p> <p>(Multi-function output setting = 16)</p>

■ Fault Restart Settings (L5)

Parameter number	Display name	Setting range	Units	Default setting	Valid access levels			
					V/f Control	V/f with PG	Open Loop Vector	Flux Vector
L5-01	Num of Restarts	0 to 10	---	0	Basic or Advanced			

Note This parameter cannot be changed during operation.

! Caution The Inverter might be damaged when using the fault restart function. Understanding that the Inverter might be damaged, be sure to take the following precautions:
 Always set up a no-fuse breaker (NFB).
 Set up a sequence that will stop peripheral equipment when an Inverter fault occurs.

- The fault restart function automatically restarts the Inverter even when an internal fault occurs during Inverter operation.
- Use this function only when continuing operation is more important than damaging the Inverter.
- The fault restart function is effective with the following faults. With other faults, the protective operations will engage immediately without attempting to restart operation.

- OC (Over-current)
- GF (Ground fault)
- PUF (Fuse blown)
- OV (Main circuit over-voltage)
- UV1 (Main circuit under-voltage)
- PF (Main circuit voltage fault)
- LF (Output open-phase)
- RF (Braking resistor overheated)
- RR (Braking transistor failure)
- OL1 (Motor overload)
- OL2 (Inverter overload)
- OL3 (Overtorque)
- OL4 (Overtorque)

- The fault restart count is cleared when operation is normal for 10 minutes after a fault restart is performed or the power is turned off and then on again.
- When one of the multi-function outputs (H2-01, H2-02, or H2-03) is set to 1E (Restart Enabled), the output will be ON while the fault restart function is in progress.

Parameter number	Display name	Setting range	Units	Default setting	Valid access levels			
					V/f Control	V/f with PG	Open Loop Vector	Flux Vector
L5-02	Restart Sel	0 or 1	---	0	Basic or Advanced			

Note This parameter cannot be changed during operation.

Setting	Function
0	Do not output fault restart. (The fault contact does not operate.)
1	Output fault restart. (The fault contact operates.)

■ **Overtorque Detection Settings (L6)**

Parameter number	Display name	Setting range	Units	Default setting	Valid access levels			
					V/f Control	V/f with PG	Open Loop Vector	Flux Vector
L6-01	Torq Det 1 Sel	0 to 4	---	0	Basic or Advanced			
L6-02	Torq Det 1 Lvl	0 to 300	%	150	Basic or Advanced			
L6-03	Torq Det 1 Time	0.0 to 10.0	s	0.1	Basic or Advanced			
L6-04	Torq Det 2 Sel	0 to 4	---	0	Advanced			
L6-05	Torq Det 2 Lvl	0 to 300	%	150	Advanced			
L6-06	Torq Det 2 Time	0.0 to 10.0	s	0.1	Advanced			

Note These parameters cannot be changed during operation.

- The overtorque detection function detects an excessive mechanical load from an increase in the output current (or output torque).
- The settings in the torque detection selection parameters (L6-01 and L6-04) determine whether overtorque conditions will be detected and what kind of processing will be performed if a overtorque condition is detected.

L6-01/L6-04 Settings

Setting	Function
0	No overtorque detection
1	Detect only during speed agreement. Continue operation even after detection. (Minor fault)
2	Detect overtorque at any time. Continue operation even after detection. (Minor fault)
3	Detect only during speed agreement. Stop output after detection. (Fault)
4	Detect overtorque at any time. Stop output after detection. (Fault)

- When overtorque detection is enabled, be sure to set the overtorque detection level (L6-02 or L6-05) and the overtorque detection time (L6-02 or L6-05). An overtorque condition is detected when the current exceeds the overtorque detection level for longer than the overtorque detection time.
- The overtorque detection level settings depend on the control mode:
 - Open-loop or flux vector control: Set as a percentage of the motor’s rated torque.
 - Normal V/f or V/f with PG control: Set as a percentage of the Inverter’s rated output current.
- Any of the following functions can be set in a multi-function output (H2-01, H2-02, or H2-03) to indicate the fact that an overtorque condition has been detected.
 - Setting B: Overtorque detection 1 (N.O.)
 - Setting 17: Overtorque detection 1 (N.C.)
 - Setting 18: Overtorque detection 2 (N.O.)
 - Setting 19: Overtorque detection 2 (N.C.)

Overtorque Detection Timing Chart

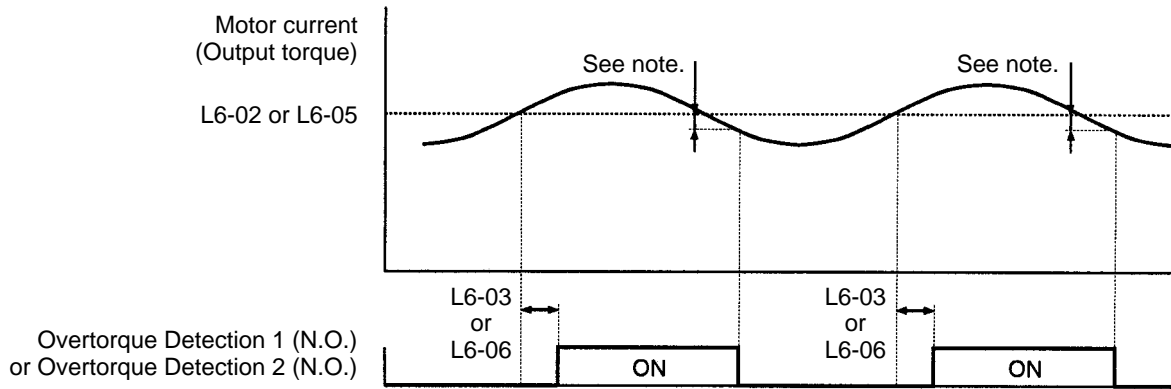

Note The overtorque detection is cleared when the current drops about 5% of the Inverter’s rated current (or the motor’s rated torque).

■ Hardware Protection Settings (L8)

Parameter number	Display name	Setting range	Units	Default setting	Valid access levels			
					V/f Control	V/f with PG	Open Loop Vector	Flux Vector
L8-01	DB Resistor Prot	0 or 1	---	0	Basic or Advanced			

Note This parameter cannot be changed during operation.

Setting	Function
0	Disabled. (Select 0 when a braking resistor isn’t being used or a Braking Resistor Unit is being used.)
1	Enabled. (Protects the braking resistor from overheating.)

Parameter number	Display name	Setting range	Units	Default setting	Valid access levels			
					V/f Control	V/f with PG	Open Loop Vector	Flux Vector
L8-02	OH Pre-Alarm Lvl	50 to 130	°C	100	Advanced			
L8-03	OH Pre-Alarm Sel	0 to 3	---	3	Advanced			

Note These parameters cannot be changed during operation.

- Parameter L8-02 specifies the detection temperature in °C for the Inverter overheat (OH) pre-alarm function. An overheat pre-alarm occurs when the temperature of the cooling fins reaches this level.
- Parameter L8-03 specifies the processing that will be performed when an overheat pre-alarm occurs.

Setting	Name	Function
0	Ramp to Stop	Decelerates to a stop in the deceleration time set in C1-09. (Fault)
1	Coast to Stop	Coasts to a stop. (Fault)
2	Fast-Stop	Emergency stop in the fast-stop time set in C1-09. (Fault)
3	Alarm Only	Continues operation. (Monitor display only.) (Minor fault)

Parameter number	Display name	Setting range	Units	Default setting	Valid access levels			
					V/f Control	V/f with PG	Open Loop Vector	Flux Vector
L8-05	Ph Loss In Sel	0 or 1	---	0	Advanced			

Note This parameter cannot be changed during operation.

- This function detects changes in the main circuit's DC voltage which indicate a power supply phase loss, large imbalance in the power supply voltage, or deterioration of the main circuit condenser.

Setting	Function
0	Disabled.
1	Enabled. (Detects input power supply phase loss, 3-phase imbalance, or deterioration of the main circuit condenser.)

Parameter number	Display name	Setting range	Units	Default setting	Valid access levels			
					V/f Control	V/f with PG	Open Loop Vector	Flux Vector
L8-07	Ph Loss Out Sel	0 or 1	---	0	Advanced			

Note This parameter cannot be changed during operation.

- This function detects an Inverter output phase loss.

Setting	Function
0	Disabled.
1	Enabled. (Detects an output phase loss at under 5% of the Inverter's rated output current.)

- False phase loss detections may occur when the motor's capacity is small compared to the capacity of the Inverter. In this case, disable the detection function by setting L8-07 to 0.

Parameter number	Display name	Setting range	Units	Default setting	Valid access levels			
					V/f Control	V/f with PG	Open Loop Vector	Flux Vector
L8-10	Ground Fault Sel	0 or 1	---	1	Advanced			

Settings

Setting	Function
0	Disabled. (No ground fault is protected.)
1	Enabled. (The ground fault is protected.)

- The ground fault protective function can be enabled or disabled with the parameter.
- The default setting does not normally need to be changed. Set the parameter to 0 if the output power cable is as long as or longer than 100 m or the stray capacitance of the output cable is excessively high and the ground fault protective function operates by mistake.

Parameter number	Display name	Setting range	Units	Default setting	Valid access levels			
					V/f Control	V/f with PG	Open Loop Vector	Flux Vector
L8-17	L-Spd IGBD PrIcl	0 to 3	---	1	Advanced			Not applicable.

Parameter number	Display name	Setting range	Units	Default setting	Valid access levels			
					V/f Control	V/f with PG	Open Loop Vector	Flux Vector
L8-19	OL2 Chara@L-Spd	0 or 1	---	0	Advanced			

- The inverter overload (OL2) characteristics can be set according to the application.
- Set parameter L8-17 to 0 and parameter L8-10 to 1 if the motor has metal friction noise (or to increase the carrier frequency).

- If the output torque at low speed is a problem (i.e., a heavy load is connected at low speed), set the parameter L8-18 to 1 and the parameter L8-19 to 0.

Note 1. Do not set both parameters (L8-17 and L8-19) to 0, otherwise the Inverter may be damaged. In that case, use a higher rank Inverter with parameter L8-17 set to 0 and parameter L8-19 set to 1.

Note 2. Use a higher rank Inverter or set parameter C6-01 (Carrier Freq Max) to 2 kHz if a high load is continuously connected at low speed in flux vector control mode.

Settings for L8-17

Setting	Function
0	Disabled. (The carrier frequency is not reduced at low speed.)
1	Enabled. (The carrier frequency is reduced at low speed.)
2	For factory adjustment. (Do not use.)
3	

Settings for L8-19

Setting	Function
0	Disabled. (The OL2 detection level is not reduced at low speed.)
1	Enabled (The OL2 detection level is reduced at low speed.)

6-5-9 Operator Parameters: o

■ Operator Display Selection (o1)

Parameter number	Display name	Setting range	Units	Default setting	Valid access levels			
					V/f Control	V/f with PG	Open Loop Vector	Flux Vector
o1-01	User Monitor Sel	4 to 38	---	6	Basic or Advanced			

Note This parameter can be changed during operation.

- In operation mode, the frequency reference, output frequency, output current, and output voltage can be monitored immediately if the default settings are being used. One of these four values, the output voltage, can be changed to a different value. When you want to monitor a value other than the output voltage, set that value’s number in parameter o1-01.
- Use the last two digits from the “U1 Monitor” list (U1-□□) to select a value. Refer to page 3-12 for a table listing all of these U1 settings.

Parameter number	Display name	Setting range	Units	Default setting	Valid access levels			
					V/f Control	V/f with PG	Open Loop Vector	Flux Vector
o1-02	Power-On Monitor	1 to 4	---	1	Basic or Advanced			

Note This parameter can be changed during operation.

- When the power is turned on, the frequency reference will appear in the Unit's data display if the default settings are being used. Any one of the four values monitored at startup (frequency reference, output frequency, output current, or the value set in parameter o1-01) can be selected to appear when the power is turned on. The value that appears automatically at startup is determined by parameter o1-02 (Power-On Monitor).

Setting	Name	Function
1	Frequency reference	The frequency reference is displayed at start-up.
2	Output Frequency	The output frequency is displayed at start-up.
3	Output Current	The output current is displayed at start-up.
4	User Monitor	The value set in parameter o1-01 is displayed at start-up.

■ Key Function Settings/Other Settings (o2)

Parameter number	Display name	Setting range	Units	Default setting	Valid access levels			
					V/f Control	V/f with PG	Open Loop Vector	Flux Vector
o2-01	Local/Remote Key	0, 1	---	1	Basic or Advanced			

- This parameter enables or disables the LOCAL/REMOTE Key (the Operation Mode Selector Key) on the Digital Operator; it cannot be changed during operation.

Setting	Function
0	Disabled.
1	Enabled. (Pressing the LOCAL/REMOTE Key switches control of operation between the Operator and the sources specified in parameters b1-01 and b1-02.)

Parameter number	Display name	Setting range	Units	Default setting	Valid access levels			
					V/f Control	V/f with PG	Open Loop Vector	Flux Vector
o2-02	Oper Stop Key	0, 1	---	1	Basic or Advanced			

- This parameter enables or disables the STOP on the Digital Operator; it cannot be changed during operation.

Setting	Function
0	Disabled. (The STOP Key is disabled when the run command is input from an external terminal.)
1	Enabled. (The STOP Key is enabled at all times during operation.)

Parameter number	Display name	Setting range	Units	Default setting	Valid access levels			
					V/f Control	V/f with PG	Open Loop Vector	Flux Vector
o2-03	User Defaults	0, 1, or 2	---	0	Basic or Advanced			

- This parameter is used to record or clear the user defaults; it cannot be changed during operation. Once the user defaults have been recorded, parameter A1-03 can be used to initialize the Inverter's parameters to these defaults.
- If the message "MAX Param Change" is displayed, the memory capacity is full. Reduce the number of parameters that changed their default settings and register them again.

Note After the parameter o2-03 is set, the Digital Operator's display will return to 0 when parameter registration processing is completed.

Setting	Function
0	No change. (Retain current settings.)
1	Record user defaults. (Record the current parameter settings as user defaults.)
2	Clear user defaults. (Clear the recorded user defaults.)

Parameter number	Display name	Setting range	Units	Default setting	Valid access levels			
					V/f Control	V/f with PG	Open Loop Vector	Flux Vector
o2-04	Inverter Model #	0 to FF	---	0	Basic or Advanced			

- Do not change this parameter setting; it is used by the manufacturer to identify the Inverter model.
- The setting range and default setting depend on the Inverter capacity. The settings shown in the table are for a 200-V class, 0.4 kW Inverter.

Parameter number	Display name	Setting range	Units	Default setting	Valid access levels			
					V/f Control	V/f with PG	Open Loop Vector	Flux Vector
o2-05	Operator M.O.P.	0, 1	---	0	Advanced			

- This parameter determines whether it is necessary to press the Enter Key when changing the frequency reference with the Digital Operator's frequency reference monitor; it cannot be changed during operation.
- When o2-05 is set to 1 (Enter Key input not required.), the frequency reference changes simultaneously with the Digital Operator's value.

Setting	Function
0	Enter Key input required.
1	Enter Key input not required.

Parameter number	Display name	Setting range	Units	Default setting	Valid access levels			
					V/f Control	V/f with PG	Open Loop Vector	Flux Vector
o2-06	Oper Detection	0 or 1	---	0	Advanced			

- This parameter specifies whether to stop operation when the Digital Operator is disconnected; it cannot be changed during operation.

Setting	Function
0	Disable Operator detection. (Continue operation when the Digital Operator is disconnected.)
1	Enable Operator detection. (Detect an OPR fault when the Digital Operator is disconnected, stop the Inverter output, and operate the fault contact.)

Parameter number	Display name	Setting range	Units	Default setting	Valid access levels			
					V/f Control	V/f with PG	Open Loop Vector	Flux Vector
o2-07	Elapsed Time Set	0 to 65535	h	0	Advanced			
o2-08	Elapsed Time Run	0 or 1	---	0	Advanced			

Note These parameters cannot be changed during operation

- Set the initial elapsed time in parameter o2-07. The elapsed operating time will start from this value.

Note When parameter o2-07 is set to the initial elapsed time, the accumulated operating time will be the same as the value set in the parameter U1-13.

- Parameter o2-08 determines whether the elapsed operating time is the time that the Inverter is on or the time that the Inverter is running.

Setting	Function
0	Inverter power-on time. (Counts the elapsed time from start-up until power is turned off.)
1	Inverter running time. (Counts the elapsed time that there is an Inverter output.)

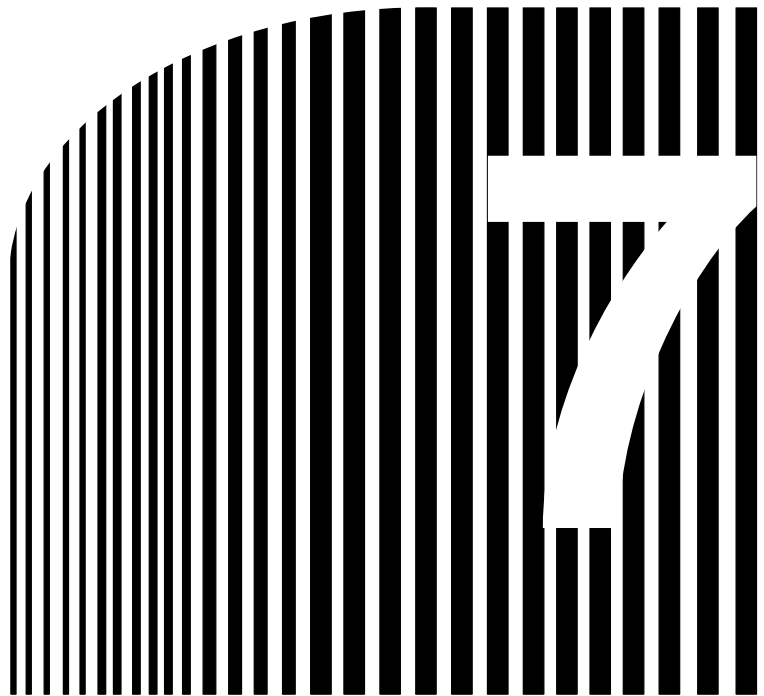

Chapter 7

• Parameter Lists •

- 7-1 Initialize Mode Parameters
- 7-2 Program Mode Parameter List

This sections lists all parameters that can be used in the Program and Initialize modes.

■ Using the Lists

Parameter No.	Name	Description	Setting range	Default setting	Changes during operation	Control mode				Page
	Display name					V/f control	V/f with PG	Open loop vector	Flux vector	
A1-00	Display Language	Used to select the language displayed on the Digital Operator 0: English 1: Japanese 2: German 3: French 4: Italian 5: Spanish 6: Portuguese Note: This parameter is not initialized by the initialize operation.	0 to 6	1	OK	Q	Q	Q	Q	3-18
	Select Language									

- Parameter No.** The parameter number.
- Name** The parameter name.
- Display name** The parameter name displayed on the Digital Operator.
- Description** Details of the parameter function or setting value.
- Setting range** The parameter setting range.
- Default setting** The default setting value (each control mode has its own default setting. Therefore the default setting changes when the control mode is changed.)
- Changes during operation** Indicates whether or not the parameter can be changed while in the Inverter is in operation.
OK: Changes possible during operation.
NO: Changes not possible during operation.
- Control mode** Indicates which control modes and which access levels can be set and referenced.
Q: Items which can be set and referenced on all access levels; QUICK-START, BASIC, and ADVANCED.
B: Items which can be set and referenced in BASIC and ADVANCED.
A: Items which can be set and referenced in ADVANCED only.
X: Items which cannot be set or referenced in that control mode.
- Page** Reference page for more detailed information on the parameter.

7-1 Initialize Mode Parameters

Parameter No.	Name	Description	Setting range	Default setting	Change during operation	Control mode				Page
	Display name					V/f control	V/f with PG	Open loop vector	Flux vector	
A1-00	Display Language	Used to select the language displayed on the Digital Operator 0: English 1: Japanese 2: German 3: French 4: Italian 5: Spanish 6: Portuguese Note: This parameter is not initialized by the initialize operation.	0 to 6	1	OK	Q	Q	Q	Q	3-18
	Select Language									
A1-01	Access Level	Used to set the parameter access level (set/read.) 0: Monitoring only (Displays only Operation mode and Initialize mode) 1: Used to select user parameter (Parameters A2-01 to A2-32 only can be set/read.) 2: QUICK-START 3: BASIC 4: ADVANCED	0 to 4	2	OK	Q	Q	Q	Q	3-18
	Access Level									
A1-02	Select Control Method	Used to select the control method for the Inverter 0: V/f control 1: V/f with PG 2: Open loop vector 3: Flux vector Note: This parameter is not initialized by the initialize operation.	0 to 3	2	NO	Q	Q	Q	Q	3-19
	Control Method									
A1-03	Initialize	Used to initialize the parameters using the specified method. 0: No initializing 1110: Initializes using the User parameters 2220: Initializes using a two-wire sequence. 3330: Initializes using a three-wire sequence.	0 to 3330	0	NO	Q	Q	Q	Q	3-20
	Init Parameters									
A1-04	Password	When a password has been set in A1-05 this function write protects the password input section of the Operation mode parameter. Note: If the password is changed, parameters A1-01 to A1-03 and A2-01 to A2-32 can no longer be changed. (Program mode parameters can be changed.)	0 to 9999	0	NO	Q	Q	Q	Q	3-22
	Enter Password									

Parameter No.	Name	Description	Setting range	Default setting	Change during operation	Control mode				Page
	Display name					V/f control	V/f with PG	Open loop vector	Flux vector	
A1-05	Setting the Password	Used to set a four digit number as the password. Note: This parameter is not usually displayed. When the password (A1-04) is displayed, hold down the Reset/Select Key and press the Menu Key and the password will be displayed.	0 to 9999	0	NO	Q	Q	Q	Q	3-22
	Select Password									
A2-01 to A2-32	Setting the User Parameter	Used to set the parameter numbers that can be set/read. Maximum 32. Note It is most effective to set the user setting parameter to 1 in access level A1-01. If set in the Program mode only, parameters set in access levels A2-01 to A2-32 may be set/read.	b1-01 to o2-08	---	NO	A	A	A	A	3-22
	User Param 1 to 32									

7-2 Program Mode Parameter List

7-2-1 Application Group: b

■ Operation Sequence Selection: b1

Parameter No.	Name	Description	Setting range	Default setting	Changes during operation	Control mode				Page
	Display name					V/f control	V/f with PG	Open loop vector	Flux vector	
b1-01	Frequency Reference Selection	Used to set the input method for the reference frequency. 0: Digital Operator 1: Control circuit terminals (analog inputs). 2: Not used. (Do not set this value.) 3: Optional Card 4: Not used. (Do not set this value.)	0 to 4	1	NO	Q	Q	Q	Q	5-4, 5-8
	Reference Source									
b1-02	Run Source Selection	Used to set the source of the run command. 0: Digital Operator 1: Control circuit terminals (sequence inputs). 2: Not used. (Do not set this value.) 3: Optional Card 4: Not used. (Do not set this value.)	0 to 4	1	NO	Q	Q	Q	Q	5-10
	Run Source									
b1-03	Stopping Method Selection	Used to set the stopping method used when a stop command is input. 0: Ramp to stop 1: Coast to stop. 2: DC braking stop: (Stops faster than coast to stop, without regenerative operation.) 3: Coast to stop with timer: Run commands are ignored during deceleration. Note: Only settings 0 and 1 can be used with flux vector control.	0 to 3	0	NO	Q	Q	Q	Q	5-13
	Stopping Method									
b1-04	Disabling Reverse Operation	0: Reverse enabled 1: Reverse disabled	0, 1	0	NO	B	B	B	B	5-13
	Reverse Oper									

Parameter No.	Name	Description	Setting range	Default setting	Changes during operation	Control mode				Page
	Display name					V/f control	V/f with PG	Open loop vector	Flux vector	
b1-05	Operation Selection for Minimum Frequency (E1-09 or less)	Used to set the method of operation when the frequency reference input is less than the minimum frequency (E1-09). 0: Run at frequency reference (E1-09 not effective). 1: STOP (Frequencies below E1-09 in the coast to stop state.) 2: Run at min. frequency. (E1-09) 3: Run at zero speed (Frequencies below E1-09 are zero) Note: This function is only available in with flux vector control.	0 to 3	0	NO	X	X	X	A	5-33
	Zero-Speed Oper									
b1-06	Setting Control Input Responsiveness	Used to set the responsiveness of the control inputs (forward/reverse and multi-function inputs.) 0: Two scans every 2 ms (Use when connecting transistor outputs.) 1: Two scans every 5 ms (Use when connecting contact outputs or switches.)	0, 1	1	NO	A	A	A	A	5-11
	Cntl Input Scans									
b1-07	Operation Selection After Switching to Remote Mode	Used to set the Operation mode by switching to the Remote mode using the Local/Remote Key. 0: Run signals that are input during mode switching are ignored. (Input Run signals after switching the mode.) 1: Run signals become effective immediately after switching to the Remote mode.	0, 1	0	NO	A	A	A	A	---
	LOC/REM RUN Sel									
b1-08	Operation for run commands in modes other than drive mode	Used to set the operation when a run command is input in a mode other than drive mode. 0: Run command ineffective (Ignore run command. Switch to drive mode and input the run command again in order to run.) 1: Run command effective (Run according to run command.) Note: Safety precautions are required when using the "1" setting. Note: The "1" setting is not valid if b1-02 = 0.	0, 1	0	NO	A	A	A	A	6-41
	RUN CMD at PRG									

■ DC Braking: b2

Parameter No.	Name	Description	Setting range	Default setting	Changes during operation	Control mode				Page
	Display name					V/f control	V/f with PG	Open loop vector	Flux vector	
b2-01	Excitation level (DC injection starting frequency)	Used to set the frequency which starts DC injection braking (the initial excitation for flux vector control) in units of 0.1 Hz when deceleration to stop is selected. Note: When b2-01 is less than E1-09, E1-09 becomes the DC starting frequency. Only with flux vector control is b2-01 used.	0.0 to 10.0	0.5	NO	B	B	B	B	6-42, 5-34
	DCInj Start Freq									
b2-02	DC injection braking current	Sets the DC injection braking current as a percentage of the Inverter rated current. Note: The initial excitation current for flux vector control depends on the E2-03 setting.	0 to 100	50	NO	B	B	B	X	6-42
	DCInj Current									
b2-03	DC injection braking time at start.	Used to set the time to perform DC injection braking (initial excitation for flux vector control) at start in units of 1 second. Note: Used to stop the load rotating and restart it. When the set value is 0, DC injection braking at start is not performed.	0.00 to 10.00	0.00	NO	B	B	B	B	6-42, 5-34
	DCInj Time@ Start									
b2-04	DC injection braking time at stop.	Used to set the time to perform DC injection braking (initial excitation for flux vector control) at stop in units of 1 second. Note: Used to prevent coasting after the stop command is input. When the set value is 0.00, DC injection braking at stop is not performed.	0.00 to 10.00	0.50	NO	B	B	B	B	6-42, 5-34
	DOInj Time@Stop									
b2-08	Magnetic flux compensation value	Sets the magnetic flux compensation value during DC injection braking as a percentage of the no-load current. Note: Used to reduce the starting time in motors with high electrical time constants, such as high-capacity motors.	0 to 500	0	NO	X	X	A	A	6-43
	Field Comp@start									

■ Speed Search: b3

Parameter No.	Name	Description	Setting range	Default setting	Changes during operation	Control mode				Page
	Display name					V/f control	V/f with PG	Open loop vector	Flux vector	
b3-01	Speed search selection at start	Sets the speed search function to start when the run command is input. 0: Disabled (Starts from the minimum output frequency.) 1: Enabled (Speed search is started from the maximum frequency. In a control mode with PG, the motor starts at the frequency of motor rotation when the run command is input.)	0, 1	0 (See note.)	NO	A	A	A	A	6-44
	Spd Srch at Start									
b3-02	Speed search operation current	Sets the speed search operation current as a percentage of the Inverter rated current. Note: Not usually necessary to set. When restarting is not possible with the set value, reduce the value.	0 to 200	100	NO	A	X	A	X	6-45
	Spd Srch Current									
b3-03	Speed search deceleration time	Sets the output frequency deceleration time during speed search in 1-second units. Note: Set the time for deceleration from the maximum frequency to 0 Hz.	0.1 to 10.0	2.0	NO	A	X	A	X	6-45
	Spd Srch Dec Time									

Note When the control mode is changed, the Inverter reverts to default settings. (The open loop vector control default settings are given above.)

■ Timer Function: b4

Parameter No.	Name	Description	Setting range	Default setting	Changes during operation	Control mode				Page
	Display name					V/f control	V/f with PG	Open loop vector	Flux vector	
b4-01	Timer function ON-delay time	Sets the timer function output ON-delay time (dead band) for the timer function input, in 1-second units. Note: Enabled when the timer function is set for multi-function inputs and outputs.	0.0 to 300.0	0.0	NO	A	A	A	A	6-46
	Delay-ON Timer									
b4-02	Timer function OFF-delay time	Sets the timer function output OFF-delay time (dead band) for the timer function input, in 1-second units. Note: Enabled when the timer function is set for multi-function inputs and outputs.	0.0 to 300.0	0.0	NO	A	A	A	A	6-46
	Delay-OFF Timer									

■ PID Control: b5

Parameter No.	Name	Description	Setting range	Default setting	Changes during operation	Control mode				Page
	Display name					V/f control	V/f with PG	Open loop vector	Flux vector	
b5-01	PID control selection	0: Disabled 1: Enabled (Deviation is D-controlled.) 2: Enabled (Feedback value is D-controlled.) 3: Enabled (Frequency reference + PID control/ deviation is D-controlled.) 4: Enabled (Frequency reference + PID control/ feedback value is D-controlled.)	0 to 4	0	NO	A	A	A	A	6-50
	PID Mode									
b5-02	Proportional gain (P)	Sets P-control proportional gain as a percentage. Note: P-control is not performed when the setting is 0.00.	0.00 to 25.00	1.00	OK	A	A	A	A	6-51
	PID Gain									
b5-03	Integral time (I)	Sets I-control integral time in 1-second units. Note: I-control is not performed when the setting is 0.0.	0.0 to 360.0	1.0	OK	A	A	A	A	6-51
	PID I Time									
b5-04	Integral limit (I)	Sets the I-control limit as a percentage of the maximum frequency.	0.0 to 100.0	100.0	OK	A	A	A	A	6-51
	PID I Limit									
b5-05	Differential time (D)	Sets D-control differential time in 1-second units. Note: D-control is not performed when the setting is 0.00.	0.00 to 10.00	0.00	OK	A	A	A	A	6-51
	PID D Time									
b5-06	PID limit	Sets the limit after PID-control as a percentage of the maximum frequency.	0.0 to 100.0	100.0	OK	A	A	A	A	6-51
	PID Limit									
b5-07	PID offset adjustment	Sets the offset after PID-control as a percentage of the maximum frequency.	-100.0 to 100.0	0.0	OK	A	A	A	A	6-52
	PID Offset									
b5-08	PID primary delay time constant	Sets the time constant for low pass filter for PID-control outputs in 1-second units. Note: Not usually necessary to set.	0.00 to 10.00	0.00	OK	A	A	A	A	6-52
	PID Delay Time									
b5-09	PID output characteristics selection	Selects whether the PID output is reflected in positive or negative characteristics. 0: Positive characteristics (Increased output frequency increases feedback value) 1: Negative characteristics (Increased output frequency decreases feedback value)	0, 1	0	NO	A	A	A	A	6-52
	Output Level Sel									
b5-10	PID output gain	Sets the multiplier for the final calculation result of PID control (PID control value). Note: Normally it is not necessary to change the factory settings. Adjust the level of PID influence when using "Frequency reference + PID control."	0.0 to 25.0	1.0	NO	A	A	A	A	6-53
	Output Gain									

Parameter No.	Name	Description	Setting range	Default setting	Changes during operation	Control mode				Page
	Display name					V/f control	V/f with PG	Open loop vector	Flux vector	
b5-11	PID output reverse selection	Selects operation when the final calculation result of PID control is a negative value. 0: Disable reverse. (If the result is negative, the zero limit is imposed and there is no rotation in reverse.) 1: Enable reverse. (If the result is negative, rotation in reverse occurs in accordance with the result.) Note: The zero limit is imposed if reverse operation is disabled in b1-04.	0, 1	0	NO	A	A	A	A	6-53
	Output Rev Sel									
b5-12	Feedback loss detection selection	Selects the method used to detect that feedback has been lost during PID control. 0: Disable feedback loss detection. 1: Enable feedback loss detection. (Continue operation: Alarm) 2: Enable feedback loss detection. (Stop output: Protective operation)	0 to 2	0	NO	A	A	A	A	6-53
	Fb los Det Sel									
b5-13	Feedback loss detection level	Sets the detection level used when feedback loss detection has been enabled. Set as a percentage of the feedback value that is produced at the maximum frequency.	0 to 100	0	NO	A	A	A	A	6-54
	Fb los Det Lvl									
b5-14	Feedback loss detection time	Sets the detection time used when feedback loss detection has been enabled. Note: Feedback loss is detected if the feedback value is below the level set in b5-13 for longer than the detection time set here.	0.0 to 25.5	1.0	NO	A	A	A	A	6-54
	Fb los Det Time									

■ Reference Hold: b6

Parameter No.	Name	Description	Setting range	Default setting	Changes during operation	Control mode				Page	
	Display name					V/f control	V/f with PG	Open loop vector	Flux vector		
b6-01	Dwell frequency at start	Note: The dwell function is used to stop/start the output frequency temporarily when driving a motor with a heavy load. 	0.0 to 400.0	0.0	NO	A	A	A	A	6-57	
	Display name: Dwell Ref @Start										
b6-02	Dwell time at start		0.0 to 10.0	0.0	NO	A	A	A	A	A	6-57
	Display name: Dwell Time @Start										
b6-03	Dwell frequency at stop	0.0 to 400.0	0.0	NO	A	A	A	A	A	6-57	
	Display name: Dwell Ref @Stop										
b6-04	Dwell time at stop	0.0 to 10.0	0.0	NO	A	A	A	A	A	6-57	
	Display name: Dwell Time @Stop										

■ Droop Control: b7

Parameter No.	Name	Description	Setting range	Default setting	Changes during operation	Control mode				Page
	Display name					V/f control	V/f with PG	Open loop vector	Flux vector	
b7-01	Droop control gain	Sets the slip as a percentage of maximum frequency when the maximum frequency is specified and the rated torque occurs. Note: Droop-control is not performed when the setting is 0.0.	0.0 to 100.0	0.0	OK	X	X	X	A	6-18
	Display name: Droop gain									
b7-02	Droop control delay time	Droop control responsiveness parameter Note: When hunting or vibration occurs, increase the value.	0.03 to 2.00	0.05	OK	X	X	X	A	6-18
	Display name: Droop delay time									

■ Energy Saving: b8

Parameter No.	Name	Description	Setting range	Default setting	Changes during operation	Control mode				Page
	Display name					V/f control	V/f with PG	Open loop vector	Flux vector	
b8-01	Energy-saving gain	Sets the Inverter output voltage when the energy-saving command is input. Note: Enabled when the “energy-save mode” command is set for multi-function input. Set as a percentage of the V/f pattern voltage.	0 to 100	80	NO	A	A	X	X	6-13, 6-38
	Energy Save Gain									
b8-02	Energy-saving frequency	Sets the energy-saving effective range minimum frequency in Hz. Note: The energy-saving function is only enabled when the frequency is greater than the energy-saving frequency and the speeds are consistent.	0.0 to 400.0	0.0	NO	A	A	X	X	6-13, 6-38
	Energy Save Freq									

■ Zero Servo: b9

Parameter No.	Name	Description	Setting range	Default setting	Changes during operation	Control mode				Page
	Display name					V/f control	V/f with PG	Open loop vector	Flux vector	
b9-01	Zero-servo gain	Used to adjust the strength of the zero-servo lock. Note: Enabled when the “zero-servo command” is set for the multi-function input. When the zero-servo command has been input and the frequency reference drops below excitation level (b2-01), a position control loop is created and the motor stops. Increasing the zero-servo gain in turn increases the strength of the lock. Increasing it by too much will cause vibration.	0 to 100	5	NO	X	X	X	A	6-19
	Zero Servo Gain									
b9-02	Zero-servo completion width	Sets the output width of the P-lock completion signal. Note: Enabled when the “zero-servo completion (end)” is set for multi-function output. The zero-servo completion signal is ON when the current position is within the range (the zero-servo position ± zero-servo completion width.) Set the allowable position displacement from the zero-servo position to 4 times the pulse rate of the PG (pulse generator, encoder) in use.	0 to 16383	10	NO	X	X	X	A	6-19
	Zero Servo Count									

7-2-2 Tuning Parameters

■ Acceleration/Deceleration: C1

Parameter No.	Name	Description	Setting range	Default setting	Changes during operation	Control mode				Page								
	Display name					V/f control	V/f with PG	Open loop vector	Flux vector									
C1-01	Acceleration time 1	Sets the acceleration time to accelerate from 0 to the maximum frequency, in 1-second units.	0.0 to 6000.0 (See note.)	10.0	OK	Q	Q	Q	Q	5-12, 5-18								
	Acceleration Time 1																	
C1-02	Deceleration time 1	Sets the deceleration time to decelerate from the maximum frequency to 0, in 1-second units.			0.0 to 6000.0 (See note.)	10.0	OK	Q	Q	Q	Q	5-12, 5-18						
	Deceleration Time 1																	
C1-03	Acceleration time 2	The acceleration time when the multi-function input "multi-accel/decel time 1" is set to ON.					0.0 to 6000.0 (See note.)	10.0	OK	B	B	B	B	5-12, 5-18				
	Acceleration Time 2																	
C1-04	Deceleration time 2	The deceleration time when the multi-function input "multi-accel/decel time 1" is set to ON.							0.0 to 6000.0 (See note.)	10.0	OK	B	B	B	B	5-12, 5-18		
	Deceleration Time 2																	
C1-05	Acceleration time 3	The acceleration time when the multi-function input "multi-accel/decel time 2" is set to ON.									0.0 to 6000.0 (See note.)	10.0	NO	A	A	A	A	5-12, 5-18
	Acceleration Time 3																	
C1-06	Deceleration time 3	The deceleration time when the multi-function input "multi-accel/decel time 2" is set to ON.	0.0 to 6000.0 (See note.)	10.0									NO	A	A	A	A	5-12, 5-18
	Deceleration Time 3																	
C1-07	Acceleration time 4	The acceleration time when the multi-function input "multi-accel/decel time 1" and "multi-accel/decel time 2" are set to ON.			0.0 to 6000.0 (See note.)	10.0							NO	A	A	A	A	5-12, 5-18
	Acceleration Time 4																	
C1-08	Deceleration time 4	The deceleration time when the multi-function input "multi-accel/decel time 1" and "multi-accel/decel time 2" are set to ON.					0.0 to 6000.0 (See note.)	10.0					NO	A	A	A	A	5-12, 5-18
	Deceleration Time 4																	
C1-09	Emergency stop time	The deceleration time when the multi-function input "Emergency (fast) stop" is set to ON. Note: This function can be used as a stop method when a fault has been detected.							0.0 to 6000.0 (See note.)	10.0			NO	B	B	B	B	5-12, 5-18
	Fast Stop Time																	
C1-10	Acceleration/deceleration time units	0: 0.01-second units 1: 0.1-second units									0, 1	1	NO	A	A	A	A	5-11, 5-18
	Acc/Dec Units																	

Parameter No.	Name	Description	Setting range	Default setting	Changes during operation	Control mode				Page
	Display name					V/f control	V/f with PG	Open loop vector	Flux vector	
C1-11	Acceleration/deceleration switching frequency	Sets the frequency for automatic acceleration/deceleration switching. Below set frequency: Accel/decel time 4, above set frequency: Accel/decel time 1 Note: The multi-function input "multi-accel/decel time 1" or "multi-accel/decel time 2" take priority.	0.0 to 400.0	0.0	NO	A	A	A	A	5-13
	Acc/Dec SW Freq									

Note The setting range for acceleration/deceleration times will differ according to the setting for C1-10 (the unit for acceleration/deceleration time.) When C1-10 is set to 0, the setting range for acceleration/deceleration times becomes 0.00 to 600.00 seconds.

■ S-curve Acceleration/Deceleration: C2

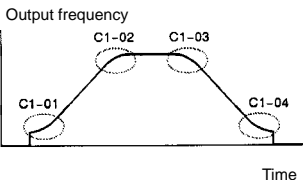
Parameter No.	Name	Description	Setting range	Default setting	Changes during operation	Control mode				Page
	Display name					V/f control	V/f with PG	Open loop vector	Flux vector	
C2-01	S-curve characteristic time at acceleration start.	All sections of the S-curve characteristic time are set in seconds units. Note: When the S-curve characteristic time is set, the accel/decel times will increase by only half of the S-curve characteristic times at start and end.	0.00 to 2.50	0.20	NO	A	A	A	A	6-58
	SCrv Acc @ Start									
C2-02	S-curve characteristic time at acceleration end.		0.00 to 2.50	0.20	NO	A	A	A	A	6-58
	SCrv Acc @ End									
C2-03	S-curve characteristic time at deceleration start.	 <p>The diagram shows a trapezoidal S-curve for output frequency over time. The curve starts at a low frequency, rises to a peak, and then falls back to a low frequency. Four points are marked: C1-01 at the start of the rise, C1-02 at the start of the peak, C1-03 at the end of the peak, and C1-04 at the end of the fall.</p>	0.00 to 2.50	0.20	NO	A	A	A	6-58	
	SCrv Dec @ Start									
C2-04	S-curve characteristic time at deceleration end.		0.00 to 2.50	0.00	NO	A	A	A	A	6-58
	SCrv Dec @ End									

■ Motor-Slip Compensation: C3

Parameter No.	Name	Description	Setting range	Default setting	Changes during operation	Control mode				Page
	Display name					V/f control	V/f with PG	Open loop vector	Flux vector	
C3-01	Slip compensation gain.	Used to improve speed accuracy when operating with a load. Note: Usually setting is not necessary. When actual speed is low, increase the set value. When actual speed is high, decrease the set value. In flux vector control mode this function becomes gain to compensate for slip caused by temperature variation.	0.0 to 2.5	1.0 (See note.)	OK	B	X	B	B	6-59, 6-34
	Slip Comp Gain									
C3-02	Slip compensation primary delay time.	Slip compensation primary delay time is set in ms units. Note: Usually setting is not necessary. Adjust when slip compensation responsiveness is low, or speed is not stabilized. When responsiveness is low, decrease the set value. When speed is not stabilized, increase the set value.	0 to 10000	200 (See note.)	NO	A	X	A	X	6-59
	Slip Comp Time									
C3-03	Slip compensation limit.	Sets the slip compensation limit as a percentage of motor rated slip.	0 to 250	200	NO	A	X	A	X	6-60
	Slip Comp Limit									
C3-04	Slip compensation during regeneration.	0: Disabled. 1: Enabled. Note: When the slip compensation during regeneration function has been activated, as regeneration capacity increases momentarily, it may be necessary to use a braking option (braking resistor, Braking Resistor Unit or Braking Unit.)	0, 1	0	NO	A	A	A	X	6-60
	Slip Comp Regen									
C3-05	Flux Calculation Method	Used to set the flux calculation method. Normally, this setting is not required. 0: Flux is calculated based on the output frequency after frequencies using slip compensation, etc. 1: Flux is calculated based on the output frequency before correcting frequencies using slip compensation, etc. Note: Set to "1" when motor rotation becomes unstable due to interference using slip compensation.	0, 1	0	NO	X	X	A	X	6-6
	Flux Select									

Parameter No.	Name	Description	Setting range	Default setting	Changes during operation	Control mode				Page
	Display name					V/f control	V/f with PG	Open loop vector	Flux vector	
C3-06	Selects output voltage limit operation	<p>Selects the output voltage limit function so that the voltage calculation in open-loop vector control does not become saturated.</p> <p>0: Disabled. (Output voltage saturation is not limited. Slip compensation is disabled.)</p> <p>1: Enabled. (Output voltage saturation is suppressed. Speed accuracy is not reduced.)</p>	0, 1	0	NO	X	X	A	A	6-6
	Output V limit	<p>Note: Be sure that there is sufficient output current capacity in the inverter because the output current is about 10% higher when this function is enabled.</p> <p>Note: The speed accuracy may be reduced when the input voltage is very low.</p>								

Note When the control mode is changed, the Inverter reverts to default settings. (The open loop vector control default settings are given above.)

■ Torque Compensation: C4

Parameter No.	Name	Description	Setting range	Default setting	Changes during operation	Control mode				Page
	Display name					V/f control	V/f with PG	Open loop vector	Flux vector	
C4-01	Torque compensation gain.	<p>Sets torque compensation gain as a ratio.</p> <p>Note: Usually setting is not necessary. Adjust in the following circumstances: When the cable is long; increase the set value. When the motor capacity is smaller than the capacity of the Inverter (Max. applicable motor capacity), increase the set values. When the motor is vibrating, decrease the set values.</p> <p>When adjusting the gain, be sure that the output current at low speeds does not exceed 100% of the Inverter's rated output current.</p> <p>Note: Do not change the torque compensation gain when using open-loop vector control.</p>	0.00 to 2.50	1.00	OK	B	B	B	X	6-60
	Torq Comp Gain									

Parameter No.	Name	Description	Setting range	Default setting	Changes during operation	Control mode				Page
	Display name					V/f control	V/f with PG	Open loop vector	Flux vector	
C4-02	Torque compensation delay time.	The torque compensation delay time is set in ms units. Note: Usually setting is not necessary. Adjust in the following circumstances: When the motor is vibrating, increase the set values. When the responsiveness of the motor is low, decrease the set values.	0 to 10000	20 (See note.)	NO	A	A	A	X	6-61
	Torq Comp Time									
C4-03	Starting torque value (forward)	When using open-loop vector control, these parameters set the motor's forward and reverse starting-torque compensation values as a percentage of the motor's rated torque. Note: Effective for reducing the starting time with friction loads or lifting machinery. Note: Not effective when starting motor 2 if using a regenerative starting system.	0.0 to 200.0	0.0	NO	X	X	A	X	6-7
	F TorqCmp @start									
C4-04	Starting torque value (reverse)	Note: Effective for reducing the starting time with friction loads or lifting machinery. Note: Not effective when starting motor 2 if using a regenerative starting system.	-200.0 to 0.0	0.0	NO	X	X	A	X	6-7
	R TorqCmp @start									
C4-05	Starting torque time constant	Sets the rise time constant (ms) for the starting torque value. Note: The starting torque time constant is disabled if set between 0 and 4 ms.	0 to 200	10	NO	X	X	A	X	6-7
	TorqCmp Delay T									

Note When the control mode is changed, the Inverter reverts to default settings. (The open loop vector control default settings are given above.)

■ Speed Control (ASR): C5

Parameter No.	Name Display name	Description	Setting range	Default setting	Changes during operation	Control mode				Page
						V/f control	V/f with PG	Open loop vector	Flux vector	
C5-01	ASR Proportional (P) gain 1	Sets the proportional gain of the speed loop (ASR.)	0.00 to 300.00	20.0 (See note.)	OK	X	B	X	B	5-39, 5-50
	ASR P Gain 1									
C5-02	ASR Integral (I) time 1	Sets the integral time of the speed loop (ASR) in 1-second units.	0.000 to 10.000	0.500 (See note.)	OK	X	B	X	B	5-39, 5-50
	ASR I Gain 1									
C5-03	ASR Proportional Gain (P) 2	Usually setting is not necessary. Note: Set to change the rotational speed gain.	0.00 to 300.00	20.0 (See note.)	OK	X	B	X	B	5-39, 5-50
	ASR P Gain 2									
C5-04	ASR Integral (I) time 2		0.000 to 10.000	0.500 (See note.)	OK	X	B	X	B	5-39, 5-50
	ASR I Time 2									
C5-05	ASR Limit	Sets the upper limit for the compensation frequency for the speed loop (ASR) to a percentage of the maximum frequency.	0.0 to 20.0	5.0	NO	X	A	X	X	5-52
	ASR Limit									
C5-06	ASR Primary delay time	Sets the filter time constant; the time from the speed loop to the torque reference output, in units of 1-second. Note: Usually setting is not necessary.	0.000 to 0.500	0.004	NO	X	X	X	A	5-41
	ASR Delay Time									
C5-07	ASR Switching frequency	Sets the frequency for switching between Proportion Gain 1, 2 and Integral Time 1, 2 in Hz units. Note: The multi-function input "ASR Gain SW" takes priority.	0.0 to 400.0	0.0	NO	X	X	X	A	5-39
	ASR Gain SW Freq									
C5-08	ASR Integral (I) Limit	Used to set the limit to the integral of the speed loop (ASR). Normally, this setting is not required. Note: Set to a small value to prevent any radical load change. Set to 100% of the maximum output frequency.	0 to 400	400	NO	X	X	X	A	5-41
	ASR I Limit									

Note When the control mode is changed, the Inverter reverts to default settings. (The open loop vector control default settings are given above.)

■ Carrier Frequency: C6

Parameter No.	Name	Description	Setting range	Default setting	Changes during operation	Control mode				Page
	Display name					V/f control	V/f with PG	Open loop vector	Flux vector	
C6-01	Carrier frequency upper limit.	Sets the carrier frequency upper limit and lower limit in kHz units. (See note 2) The carrier frequency proportional gain is set as follows:	2.0 to 15.0 (see note 1)	15.0 (see note 1)	NO	B	B	B	B	6-62
	Carrier Freq Max									
C6-02	Carrier frequency lower limit.	Note: In vector control mode, the upper limit of the carrier frequency is fixed at C6-01 Carrier frequency	0.4 to 15.0 (see note 1)	15.0 (see note 1)	NO	A	A	X	X	6-62
	Carrier Freq Min									
C6-03	Carrier frequency proportional gain.	<p>Output frequency × (C6-03) × K</p>	0 to 99	0	NO	A	A	X	X	6-62
	Carrier Freq Gain									

Note 1. The setting range and the default of the Inverter will differ depending on its capacity and control mode. (The value for the 200-V class 0.4 kW Inverter in open loop vector control mode is given above.)

Note 2. For a 400-V Inverter, if the carrier frequency is set to a value higher than the default setting, the Inverter overload “OL2” detection value will decrease.

■ Hunting Prevention: C7

Parameter No.	Name	Description	Setting range	Default setting	Changes during operation	Control mode				Page
	Display name					V/f control	V/f with PG	Open loop vector	Flux vector	
C7-01	Hunting prevention selection	0: Disabled 1: Enabled Note: The hunting prevention function is used to stop a motor under a light load from hunting. This function is exclusively for the V/f control mode. When greater responsiveness than vibration control is required, set hunting prevention to “disabled.”	0, 1	1	NO	A	A	X	X	6-14, 6-38
	Hunt Prev Select									
C7-02	Hunting prevention gain	Sets the ratio for hunting prevention gain. Note: Usually setting is not necessary. Adjust in the following circumstances: When vibration occurs due to a light load, increase the set values. When the motor is stalled, decrease the set values. If the set values become too large, the motor may stall as a result of non-controlled current.	0.00 to 2.50	1.00	NO	A	A	X	X	6-14, 6-38
	Hunt Prev Gain									

■ Factory Tuning: C8

Parameter No.	Name	Description	Setting range	Default setting	Changes during operation	Control mode				Page
	Display name					V/f control	V/f with PG	Open loop vector	Flux vector	
C8-08	Speed feedback detection control (AFR) gain	Sets the gain and time constant of the internal speed feedback detection control circuit. Normally it is not necessary to set these parameters. Adjust in the following circumstances: <ul style="list-style-type: none"> Hunting occurs: Increase C8-09. If that does not correct the problem, reduce C8-08. Poor responsiveness: Reduce C8-09 as long as hunting does not occur. Increase the gain in C8-08 as long as hunting does not occur. Note Unit for C8-09: ms	0.00 to 10.00	1.00	NO	X	X	A	X	6-5
	AFR Gain									
C8-09	Speed feedback detection control (AFR) time constant	Sets the carrier frequency during Auto-tuning. Normally it is not necessary to set this parameter. Adjust if auto-tuning is not functioning. <ul style="list-style-type: none"> 0: Sets the carrier frequency to 2 kHz. 1: Sets the carrier frequency to the value in C6-01. 2: Sets the carrier frequency to 5 kHz. 	0 to 2000	50	NO	X	X	A	X	6-5
	AFR Time									
C8-30	Carrier Frequency Selection During Auto-tuning	Sets the carrier frequency during Auto-tuning. Normally it is not necessary to set this parameter. Adjust if auto-tuning is not functioning. <ul style="list-style-type: none"> 0: Sets the carrier frequency to 2 kHz. 1: Sets the carrier frequency to the value in C6-01. 2: Sets the carrier frequency to 5 kHz. 	0 to 2	2	NO	X	X	A	A	6-8
	Carrier in tune									

7-2-3 Reference Parameters List

■ Preset Reference: d1

Parameter No.	Name	Description	Setting range	Default setting	Changes during operation	Control mode				Page
	Display name					V/f control	V/f with PG	Open loop vector	Flux vector	
d1-01	Frequency reference 1	Sets the frequency reference in the units used in o1-03 (frequency reference display/set units.) The default setting unit for o1-03 is Hz.	0 to max. frequency.	6.00	OK	Q	Q	Q	Q	5-10
	Preset Reference 1									
d1-02	Frequency reference 2	The frequency reference when the multi-function input "multi-step speed reference 1" is ON.		0.00	OK	Q	Q	Q	Q	5-10
	Preset Reference 2									
d1-03	Frequency reference 3	The frequency reference when the multi-function input "multi-step speed reference 2" is ON.		0.00	OK	Q	Q	Q	Q	5-10
	Preset Reference 3									
d1-04	Frequency reference 4	The frequency reference when the multi-function input "multi-step speed reference 1, 2" is ON.		0.00	OK	Q	Q	Q	Q	5-10
	Preset Reference 4									
d1-05	Frequency reference 5	The frequency reference when the multi-function input "multi-step speed reference 3" is ON.		0.00	OK	B	B	B	B	5-10
	Preset Reference 5									
d1-06	Frequency reference 6	The frequency reference when the multi-function input "multi-step speed reference 1, 3" is ON.	0.00	OK	B	B	B	B	5-10	
	Preset Reference 6									
d1-07	Frequency reference 7	The frequency reference when the multi-function input "multi-step speed reference 2, 3" is ON.	0.00	OK	B	B	B	B	5-10	
	Preset Reference 7									
d1-08	Frequency reference 8	The frequency reference when the multi-function input "multi-step speed reference 1, 2, 3" is ON.	0.00	OK	B	B	B	B	5-10	
	Preset Reference 8									
d1-09	Jog frequency reference	The reference frequency when the multi-function inputs, "Jog reference frequency selection," "FJOG command," and "RJOG command" are ON.	6.00	OK	Q	Q	Q	Q	5-10	
	Jog Reference									

■ Reference Limits: d2

Parameter No.	Name	Description	Setting range	Default setting	Changes during operation	Control mode				Page
	Display name					V/f control	V/f with PG	Open loop vector	Flux vector	
d2-01	Reference frequency upper limit	Sets the output frequency upper limit as a percentage of the maximum frequency.	0.0 to 110.0	100.0	NO	B	B	B	B	6-64
	Ref Upper Limit									
d2-02	Reference frequency lower limit	Sets the output frequency lower limit as a percentage of the maximum frequency.	0.0 to 109.0	0.0	NO	B	B	B	B	6-64
	Ref Lower Limit									

■ Jump Frequencies: d3

Parameter No.	Name	Description	Setting range	Default setting	Changes during operation	Control mode				Page
	Display name					V/f control	V/f with PG	Open loop vector	Flux vector	
d3-01	Jump frequency 1	Sets the center value of the jump frequency in Hz. Note: This function is disabled by setting the jump frequency to 0 Hz. Always ensure that the following applies: $d3-01 \geq d3-02 \geq d3-03$ Operation in the jump frequency range is prohibited but during acceleration and deceleration, speed changes smoothly without jump.	0.0 to 400.0	0.0	NO	B	B	B	B	6-64
	Jump Freq 1									
d3-02	Jump frequency 2		0.0	NO	B	B	B	B	B	6-64
	Jump Freq 2									
d3-03	Jump frequency 3		0.0	NO	B	B	B	B	B	6-64
	Jump Freq 3									
d3-04	Jump frequency width	Sets the jump frequency bandwidth in Hz. Note: The jump frequency will be the jump frequency \pm d3-04.	0.0 to 20.0	1.0	NO	B	B	B	B	6-64
	Jump Bandwidth									

■ Sequence for Reference: d4

Parameter No.	Name	Description	Setting range	Default setting	Changes during operation	Control mode				Page
	Display name					V/f control	V/f with PG	Open loop vector	Flux vector	
d4-01	Reference frequency hold function selection	Sets whether or not frequencies on hold will be recorded. 0: Disabled (when operation is stopped or the power is turned on again starts at 0.) 1: Enabled (when operation is stopped or the power is turned on again starts at the previous hold frequency.) Note: This function is available when the multi-function inputs "accel/decel Ramp Hold" or "UP/DOWN" commands (MOP increase/decrease) are set.	0, 1	0	NO	A	A	A	A	6-65
	MOP Ref Memory									
d4-02	Trim control level	Sets the increase/decrease frequency for analog frequency references as a percentage of the maximum frequency. Note: This function is available when the multi-function inputs "Trim Ctl Increase" or "Trim Ctl Decrease" is set.	0 to 100	25	NO	A	A	A	A	6-66
	Trim Control Lvl									

■ Torque Control: d5

Parameter No.	Name	Description	Setting range	Default setting	Changes during operation	Control mode				Page
	Display name					V/f control	V/f with PG	Open loop vector	Flux vector	
d5-01	Torque control selection	0: Speed control (C5-01 to C5-07) 1: Torque control Note: This function is only available in flux vector control mode. To use the function for switching between speed and torque control, set to 0 and set the multi-function input to "speed/torque control change."	0, 1	0	NO	X	X	X	A	6-20, 6-27
	Torq Control Sel									
d5-02	Torque reference delay time	Sets the torque reference delay time in ms units. Note: This function can be used to adjust the noise of the torque control signal or the responsiveness with the host controller. When vibration occurs during torque control, increase the set value.	0 to 1000	0	NO	X	X	X	A	6-25
	Torq Ref Filter									

Parameter No.	Name	Description	Setting range	Default setting	Changes during operation	Control mode				Page
	Display name					V/f control	V/f with PG	Open loop vector	Flux vector	
d5-03	Speed limit selection	Sets the speed limit command method for the torque control mode. 1: The analog input limit from an analog frequency reference terminal (terminals 13 and 14.) 2: Limited to d5-04 parameter setting values.	1, 2	1	NO	X	X	X	A	6-22
	Speed Limit Sel									
d5-04	Speed limit	Sets the speed limit during torque control as a percentage of the maximum frequency. Note: This function is enabled when d5-03 is set to 2. Directions are as follows. +: operation command direction -: operation command opposite direction	-120 to +120	0	NO	X	X	X	A	6-23
	Speed Lmt Value									
d5-05	Speed limit bias	Sets the speed limit bias as a percentage of the maximum frequency. Note: Bias is given to the specified speed limit. It can be used to adjust the margin for the speed limit.	0 to 120	10	NO	X	X	X	A	6-24
	Speed Lmt Bias									
d5-06	Speed/torque control switching timer.	Sets the delay time from inputting the multi-function input "speed/torque control change" (from ON to OFF or OFF to ON) until the control is actually changed, in ms units. Note: This function is enabled when the multi-function input "speed/torque control change" is set. In the speed/torque control switching timer, the three analog inputs hold the values of when the "speed/torque control change" changes. Always be sure to allow time for this process to finish completely.	0 to 1000	0	NO	X	X	X	A	6-28
	Ref Hold Time									

7-2-4 Motor Constant Parameter Lists

■ V/f Pattern: E1

Parameter No.	Name	Description	Setting range	Default setting	Changes during operation	Control mode				Page
	Display name					V/f control	V/f with PG	Open loop vector	Flux vector	
E1-01	Input voltage setting	Sets the Inverter input voltage in units of 1 V. Note: This setting is used as the reference value for functions such as the protection functions.	155 to 255 (see note 1)	200 (see note 1)	NO	Q	Q	Q	Q	5-20, 5-23, 5-35, 5-44
	Input Voltage									

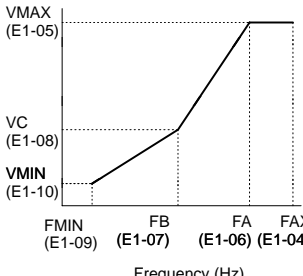
Parameter No.	Name Display name	Description	Setting range	Default setting	Changes during operation	Control mode				Page		
						V/f control	V/f with PG	Open loop vector	Flux vector			
E1-02	Motor selection	0: Standard fan-cooled motor (general-purpose motor) 1: Special motor (Inverter-only motor) 2: Special motor (Vector control-only motor) Note: This setting is used as the reference value for functions such as the protection functions.	0 to 2	0	NO	Q	Q	Q	Q	5-23, 5-44		
	Motor Selection											
E1-03	V/f pattern selection	0 to E: Select from the 15 preset patterns. F: Custom user-set patterns (Applicable for settings E1-04 to E1-10.)	0 to F	F	NO	Q	Q	X	X	5-24		
	V/F Selection											
E1-04	Maximum frequency (FMAX)	Output voltage (V)  <p>VC (E1-08) VMAX (E1-05) VMIN (E1-10) FMIN (E1-09) FB (E1-07) FA (E1-06) FAX (E1-04) Frequency (Hz)</p>	40.0 to 400.0	60.0	NO	Q	Q	Q	Q	5-28		
	Max Frequency											
E1-05	Maximum voltage (VMAX)		VC (E1-08) VMIN (E1-10)	0.0 to 255.0 (see note 1)	200.0 (see note 1)	NO	Q	Q	Q	Q	5-28	
	Max Voltage											
E1-06	Maximum voltage frequency (FA)		Note: To set V/f characteristics in a straight line, set the same values for E1-07 and E1-09. In this case, the setting for E1-08 will be ignored. Always ensure that the four frequencies are set in the following manner: E1-04 (FMAX) ≥ E1-06 (FA) > E1-07 (FB) ≥ E1-09 (FMIN)	0.0 to 400.0	60.0	NO	Q	Q	Q	Q	5-28	
	Base Frequency											
E1-07	Intermediate frequency (FB)			Note: For flux vector control, make the settings as follows: E1-04 (FMAX) ≥ E1-06 (FA) > E1-09 (FMIN)	0.0 to 400.0	3.0 (see note 2)	NO	Q	Q	A	X	5-28
	Mid Frequency A											
E1-08	Intermediate voltage (VC)			Note: For flux vector control, make the settings as follows: E1-04 (FMAX) ≥ E1-06 (FA) > E1-09 (FMIN)	0.0 to 255.0 (see note 1)	11.0 (see note 1, 2)	NO	Q	Q	A	X	5-28
	Mid Voltage A											
E1-09	Minimum frequency (FMIN)	Note: For flux vector control, make the settings as follows: E1-04 (FMAX) ≥ E1-06 (FA) > E1-09 (FMIN)		0.0 to 400.0	0.5 (see note 2)	NO	Q	Q	Q	A	5-28	
	Min Frequency											
E1-10	Minimum voltage (VMIN)	Note: For flux vector control, make the settings as follows: E1-04 (FMAX) ≥ E1-06 (FA) > E1-09 (FMIN)		0.0 to 255.0 (see note 1)	2.0 (see note 1, 2)	NO	Q	Q	A	X	5-28	
	Min Voltage											

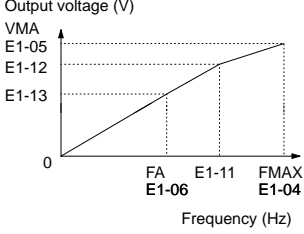
Parameter No.	Name	Description	Setting range	Default setting	Changes during operation	Control mode				Page
	Display name					V/f control	V/f with PG	Open loop vector	Flux vector	
E1-11	Mid. Output Frequency B	Used to set the middle frequency and voltage in the constant output area. Normally, this setting is not required. Note: When using a high-speed motor, set the characteristics of the constant output area.	0.0 to 400.0	0.0	NO	A	A	A	A	---
	Mid frequency B									
E1-12	Mid. Output Voltage B	Output voltage (V) VMA E1-05 E1-12 E1-13  0 FA E1-11 FMAX E1-06 E1-04 Frequency (Hz)	0.0 to 255.0 (See note 1.)	0.0	NO	A	A	A	A	---
	Mid voltage B									
E1-13	Base Voltage	Note: Set as follows: E1-06<E1-11<E1-04. Note: This parameter becomes disabled if E1-11 and E1-12 are set to "0."	0.0 to 255.0 (See note 1.)	0.0	NO	A	A	Q	Q	---
	Base voltage									

Note 1. These are values for a 200-V class Inverter. Double these values for a 400-V class Inverter.

Note 2. When the control mode is changed, the Inverter reverts to default settings. (The open loop vector control default settings are given above.)

■ Motor Setup: E2

Parameter No.	Name	Description	Setting range	Default setting	Changes during operation	Control mode				Page
	Display name					V/f control	V/f with PG	Open loop vector	Flux vector	
E2-01	Motor rated current	Sets the motor rated current in 1-A units. Note: These set values will become the reference values for motor protection, torque limits and torque control. These values will automatically be set if they were set during auto-tuning.	0.32 to 6.40 (See note 2.)	1.90 (See note 1.)	NO	Q	Q	Q	Q	5-23, 5-44, 6-9, 6-32
	Motor Rated FLA									
E2-02	Motor rated slip	Sets the motor rated slip in Hz units. Note: These set values will become the reference values for slip compensation. These values will be automatically set if auto-tuning is started.	0.00 to 20.00	2.90 (See note 1.)	NO	A	A	Q	Q	6-10, 6-15, 6-32
	Motor Rated Slip									
E2-03	Motor no-load current	Sets the motor no-load current in 1-A units. Note: These values will be automatically set if auto-tuning is started.	0.00 to 2.9 (See note 3.)	1.20 (See note 1.)	NO	A	A	Q	Q	6-10, 6-15, 6-32
	No-Load Current									

Parameter No.	Name	Description	Setting range	Default setting	Changes during operation	Control mode				Page
	Display name					V/f control	V/f with PG	Open loop vector	Flux vector	
E2-04	Number of motor poles	Sets the number of motor poles. Note: These values will automatically be set if they were set during auto-tuning.	2 to 48	4	NO	X	Q	X	Q	5-45, 6-32
	Number of Poles									
E2-05	Motor phase-to-phase resistance	Sets the motor phase-to-phase resistance in Ω units. Note: These values will be automatically set if auto-tuning is started.	0.000 to 65.000	9.842 (See note 1.)	NO	A	A	A	A	6-10, 6-15, 6-33
	Term Resistance									
E2-06	Motor leakage inductance	Sets the voltage drop due to motor leakage inductance as a percentage of the motor rated voltage. Note: These values will be automatically set if auto-tuning is started.	0.0 to 40.0	18.2 (See note 1.)	NO	X	X	A	A	6-10, 6-33
	Leak Inductance									
E2-07	Motor iron-core saturation coefficient 1	Sets the motor iron-core saturation coefficient at 50% of magnetic flux. Note: These values will be automatically set if auto-tuning is started.	0.00 to 0.50	0.50	NO	X	X	A	A	6-11, 6-33
	Saturation Comp1									
E2-08	Motor iron-core saturation coefficient 2	Sets the motor iron-core saturation coefficient at 75% of magnetic flux. Note: These values will be automatically set if auto-tuning is started.	0.00 to 0.75	0.75	NO	X	X	A	A	6-11, 6-33
	Saturation Comp2									
E2-09	Mechanical loss	Sets motor mechanical loss as a percentage of motor rated output (W). Note: Usually setting is not necessary. Adjust in the following circumstances: When torque loss is large due to motor bearing. When the torque loss in the pump or fan is large. The set mechanical loss will compensate for torque.	0.0 to 10.0	0.0	NO	X	X	X	A	6-33
	Mechanical Loss									
E2-10	Torque compensation for motor loss	Sets the motor's copper loss in watts (W).	0 to 65535	14 (see note 1)	NO	A	A	X	X	6-15
	Tcomp Iron Loss									

Note 1. The default setting depends upon the type of Inverter. The values for a 200-V class 0.4 kW Inverter are given above.

Note 2. The setting range is 10 to 200% of the Inverter's rated output current. The values for a 200-V class 0.4 kW Inverter are given above.

Note 3. The setting range is between 0.00 and [Inverter's rated current – 0.1].

■ Motor 2 Setup: E3 to E5 (Reference pages: 6-67 to 6-69)

Parameter No.	Name	Description	Setting range	Default setting	Changes during operation	Control mode			
	Display name					V/f control	V/f with PG	Open loop vector	Flux vector
E3-01	Select control method of motor 2	0: Normal V/f Control 1: V/f Control With PG Feedback 2: Open-loop Vector Control 3: Flux Vector Control	0 to 3	2	NO	A	A	A	A
	Control Method								
E4-01	Motor 2 maximum frequency	Sets the motor constants of motor 2, when used for two-motor switching Note 1: Enabled when the motor 2 selection function is set for multi-function input. Note 2: Set like E1-04 to E2-06. Note 3: Changes motors after Inverter and motor stop. Note 4: Waits to change motor for 20 to 50 ms after Inverter input. Note 5: Cannot use motor 1 parameters and motor 2 parameters at same time. Note 6: Motor selection signal will be enabled when the motor 2 selected function is set for multi-function output. Note 7: If the control method for motor 1 is different from that for motor 2, all other parameters of motor 2 will be set to default settings.	40.0 to 400.0	60.0	NO	A	A	A	A
	Max Frequency								
E4-02	Motor 2 maximum voltage (VMAX)		0.0 to 255.0 (see note 1)	200 (see note 1)	NO	A	A	A	A
	Max Voltage								
E4-03	Motor 2 maximum voltage frequency		0.0 to 400.0	60.0	NO	A	A	A	A
	Base Frequency								
E4-04	Motor 2 intermediate frequency		0.0 to 400.0	3.0 (see note 2)	NO	A	A	A	X
	Mid Frequency								
E4-05	Motor 2 intermediate voltage		0.0 to 255.0 (see note 1)	11.0 (see notes 1, 2)	NO	A	A	A	X
	Mid Voltage								
E4-06	Motor 2 minimum frequency		0.0 to 400.0	0.5 (see note 2)	NO	A	A	A	A
	Min Frequency								
E4-07	Motor 2 minimum voltage		0.0 to 255.0	2.0 (see notes 1, 2)	NO	A	A	A	X
	Min Voltage								
E5-01	Motor 2 rated current		0.32 to 6.40 (see note 4)	1.90 (see note 3)	NO	A	A	A	A
	Motor Rated FLA								
E5-02	Motor 2 rated slip		0.00 to 20.00	2.90 (see note 3)	NO	A	A	A	A
	Motor Rated Slip								

Parameter No.	Name	Description	Setting range	Default setting	Changes during operation	Control mode			
	Display name					V/f control	V/f with PG	Open loop vector	Flux vector
E5-03	Motor 2 no-load current	Sets the motor constants of motor 2, when used for two-motor switching Note 1: Enabled when the motor 2 selection function is set for multi-function input.	0.00 to 2.90 (see note 5)	1.20 (see note 3)	NO	A	A	A	A
	No-Load Current								
E5-04	Motor 2 number of motor poles	Note 2: Set like E1-04 to E2-06. Note 3: Changes motors after Inverter and motor stop.	2 to 48	4	NO	A	A	A	A
	Number of Poles	Note 4: Waits to change motor for 20 to 50 ms after Inverter input.							
E5-05	Motor 2 phase-to-phase resistance	Note 5: Cannot use motor 1 parameters and motor 2 parameters at same time. Note 6: Motor selection signal will be enabled when the motor 2 selected function is set for multi-function output.	0.000 to 65.000	9.842 (see note 3)	NO	A	A	A	A
	Term Resistance								
E5-06	Motor 2 leakage inductance	Note 7: If the control method for motor 1 is different from that for motor 2, all other parameters of motor 2 will be set to default settings.	0.0 to 40.0	18.2 (see note 3)	NO	A	A	A	A
	Leak Inductance								

Note 1. These voltages are for the 200-V class; Double the voltage for 400-V class Inverters.

Note 2. The default values are restored if the control mode is changed. The defaults for open-loop control are shown.

Note 3. The default setting depends on the Inverter's capacity. The default settings shown in the table are for 200-V class, 0.4 to 1.5 kW Inverters.

Note 4. The setting range is 10% to 200% of the Inverter's rated output current. (The default settings shown in the table are for 200-V class, 0.4-kW Inverters.)

Note 5. The setting range is between 0.00 and 0.1 less than the motor's rated current. (The default settings shown in the table are for 200-V class, 0.4-kW Inverters.)

7-2-5 Options Parameter Lists

■ PG Option Setup: F1

Parameter No.	Name	Description	Setting range	Default setting	Changes during operation	Control mode				Page
	Display name					V/f control	V/f with PG	Open loop vector	Flux vector	
F1-01	Number of PG pulses	Sets the number of PG (pulse generator or encoder) pulses. Note: Sets the number of pulses per motor revolution.	0 to 60000	1000	NO	X	Q	X	Q	5-29, 5-46
	PG Pulses/Rev									

Parameter No.	Name	Description	Setting range	Default setting	Changes during operation	Control mode				Page
	Display name					V/f control	V/f with PG	Open loop vector	Flux vector	
F1-07	Selecting integral control during accel/decel.	Sets integral control during acceleration/deceleration to either enabled or disabled. 0: Disabled (The integral function isn't used while accelerating or decelerating; it is used at constant speeds.) 1: Enabled (The integral function is used at all times.)	0, 1	0	NO	X	B	X	X	5-47
	PG Ramp PI/I Sel									
F1-08	Overspeed (OS) detection level.	Sets the overspeed detection method. Frequencies above that set for F1-08 (set as a percentage of the maximum frequency), which continue to exceed this frequency for the detection time (F1-09), are detected as overspeed faults.	0 to 120	115	NO	X	A	X	A	5-32, 5-48
	PG Overspd Level									
F1-09	Overspeed (OS) detection time		0.0 to 2.0	0.0 (See note.)	NO	X	A	X	A	5-32, 5-48
	PG Overspd Time									
F1-10	PG speed deviation detection level (DEV)	Sets the speed deviation detection method. Any speed deviation above the F1-10 set level (set as a percentage of the maximum frequency), which continues for the deviation detection time (F1-11) is detected as a speed deviation. Note: Speed deviation is the difference between actual motor speed and the reference command speed.	0 to 50	10	NO	X	A	X	A	5-33, 5-49
	PG Deviate Level									
F1-11	PG speed deviation detection time (DEV)		0.0 to 10.0	0.5	NO	X	A	X	A	5-33, 5-49
	PG Deviate Time									
F1-12	Number of PG gear teeth 1	Sets the number of teeth on the gears if there are gears between the PG and the motor. Motor speed (r/min) = [No. of pulses input from PG x 60/No. of PG pulses (F1-01)] x [(F1-13)/(F1-12)]	0 to 1000	0	NO	X	A	X	X	5-46
	PG # Gear Teeth1									
F1-13	Number of PG gear teeth 2	Note: A gear ratio of 1 will be used if either of these parameters is set to 0.		0	NO	X	A	X	X	5-46
	PG # Gear Teeth2									
F1-14	PG Disconnection Detection Time	Used to set the PG disconnection detection time. PGO will be detected if the detection time continues beyond the set time.	0 to 10.0	2.0	NO	X	A	X	A	---
	PG0 Time									

Note The setting range will change when the control mode is changed. (The setting range for Open loop vector control is given above.)

■ Other Options Setup: F2 to F9

Parameter No.	Name	Description	Setting range	Default setting	Changes during operation	Control mode				Page
	Display name					V/f control	V/f with PG	Open loop vector	Flux vector	
F2-01	Analog Reference Card selection	Sets the functions for channels 1 to 3 which are effective when the 3G3IV-PAI14B Analog Reference Card is used. 0: 3-channel individual (Channel 1: terminal 13, Channel 2: terminal 14, Channel 3: terminal 16) 1: 3-channel addition (Addition values are the frequency reference) Note: When set to 0, select 1 for b1-01. In this case the multi-function input "Option/Inverter selection" cannot be used.	0, 1	0	NO	B	B	B	B	6-71
	AI-14 Input Sel									
F3-01	Digital Reference Card input selection	Sets the Digital Reference Card input method. 0: BCD 1% unit 1: BCD 0.1% unit 2: BCD 0.01% unit 3: BCD 1 Hz unit 4: BCD 0.1 Hz unit 5: BCD 0.01 Hz unit 6: BCD special setting (5-digit input) 7: Binary input Note: Setting "6" is effective only when the 3G3FV-PDI16H2 is used, but the input will be BCD and the units will be set in o1-03 if 01-03 has been set to "2" or higher. Note: When F3-01 is set to "7", input the following values as the max. frequency. 3G3IV-PD108: FF hex (255 decimal) 3G3FV-PD116H2: FFF hex (4,095 decimal) for 12 bits or 7530 hex (30,000 decimal) for 16 bits	0 to 7	0	NO	B	B	B	B	6-72
	DI Input									

Parameter No.	Name Display name	Description	Setting range	Default setting	Changes during operation	Control mode				Page
						V/f control	V/f with PG	Open loop vector	Flux vector	
F4-01	Channel 1 output monitor selection	Effective when an Analog Monitor Card is used. Monitor selection: Set the number of the monitor item to be output. (U1-□□) Gain: Set the multiple of 10 V for outputting monitor items. Note: 4, 10, 11, 12, 13, 14, 25, 28 cannot be set. 29 to 31 are not used. When the 3G3IV-PAO12 is used outputs of ± 10 V are possible. In this case, set H4-07 (select multi-function analog output signal level) to 1. When the 3G3IV-PAO08 is used, only outputs of 0 to 10 V are possible.	1 to 38	2	NO	B	B	B	B	6-73
	AO Ch1 Select									
F4-02	Channel 1 gain		0.00 to 2.50	1.00	OK	B	B	B	B	6-73
	AO Ch1 Gain									
F4-03	Channel 2 output monitor selection	Effective when an Analog Monitor Card is used. Monitor selection: Set the number of the monitor item to be output. (U1-□□) Gain: Set the multiple of 10 V for outputting monitor items. Note: 4, 10, 11, 12, 13, 14, 25, 28 cannot be set. 29 to 31 are not used. When the 3G3IV-PAO12 is used outputs of ± 10 V are possible. In this case, set H4-07 (select multi-function analog output signal level) to 1. When the 3G3IV-PAO08 is used, only outputs of 0 to 10 V are possible.	1 to 38	3	NO	B	B	B	B	6-73
	AO Ch2 Select									
F4-04	Channel 2 gain		0.00 to 2.50	0.50	OK	B	B	B	B	6-73
	AO Ch2 Gain									
F4-05	Channel 1 output monitor bias	Sets the bias value of channel 1 on the Analog Monitor Card. Set as a percentage with 10 V equivalent to 100%.	-10.0 to 10.0	0.0	OK	B	B	B	B	6-73
	AO Ch1 Bias									
F4-06	Channel 2 output monitor bias	Sets the bias value of channel 2 on the Analog Monitor Card. Set as a percentage with 10 V equivalent to 100%.	-10.0 to 10.0	0.0	OK	B	B	B	B	6-73
	AO Ch2 Bias									
F5-01	Channel 1 output selection	Selects the function to be set for channel 1 when a Contact Output Card is used. The same functions can be set as for multi-function outputs H2-01 to H2-03.	0 to 37	0	NO	B	B	B	B	---
	D0-02 Ch1 Select									
F5-02	Channel 2 output selection	Selects the function to be set for channel 1 when a Contact Output Card is used. The same functions can be set as for multi-function outputs H2-01 to H2-03.	0 to 37	1	NO	B	B	B	B	---
	D0-02 Ch2 Select									
F6-01	Digital output selection	Selects the digital output method for when a Digital Output Card is used. 0: 8 channels individually 1: Code output (binary code)	0, 1	0	NO	B	B	B	B	---
	D0-08 Selection									
F7-01	Output pulse multiple selection	Effective when a Pulse Monitor Card is used. Sets the number of output pulses. 0: 1F, 1: 6F, 2: 10F, 3: 12F, 4: 36F Note: F= the output frequency displayed in Hz. Example: When 0 (1F) is set, and the output frequency is 60 Hz, 60 pulses per second are output. (50% duty)	0 to 4	1	NO	B	B	B	B	6-73
	PO-36F Selection									

Parameter No.	Name	Description	Setting range	Default setting	Changes during operation	Control mode				Page
	Display name					V/f control	V/f with PG	Open loop vector	Flux vector	
F8-01	E-15 operation selection	<p>Selects inverter operation to perform when a communications error occurs at the SYSMAC BUS (Wired) I/F Card.</p> <p>0: Decelerate to stop. 1: Coast to stop. 2: Emergency stop. 3: Continue operation.</p>	0 to 3	1	NO	B	B	B	B	6-74
	E-15 Det Sel									
F9-01	Communications external fault input: input type	<p>Selects the type of input used for the communications external fault input from communications (CompoBus/D Communications Card.)</p> <p>0: Normally open input 1: Normally closed input</p>	0, 1	0	NO	B	B	B	B	6-74
	EFO Selection									
F9-02	Communications external fault input: detection method	<p>Selects the detection method for used for the communications external fault input from communications (CompoBus/D Communications Card.)</p> <p>0: Always detect. 1: Detect during operation.</p>	0, 1	0	NO	B	B	B	B	6-74
	EFO Detection									
F9-03	Communications external fault input: Operation	<p>Selects the inverter operation to perform when there is an communications external fault input from communications (CompoBus/D Communications Card.)</p> <p>0: Decelerate to stop in the time set in C1-02. (Protective operation) 1: Coast to stop. (Protective operation) 2: Emergency stop in the time set in C1-09. (Protective operation) 3: Continue operation. (Alarm)</p>	0 to 3	1	NO	B	B	B	B	6-74
	EFO Fault Action									
F9-04	Not used.	---	0 to 60000	0	NO	B	B	B	B	---
	Trace Sample Tim									
F9-05	Torque reference/ torque limit selection from communications	<p>This setting enables or disables torque reference and torque limit values input from communications (CompoBus/D Communications Card.)</p> <p>Note: Always set to "disable" when using a CompoBus/D Communications Card.</p> <p>0: Disable torque reference/ torque limit from communications. 1: Enable torque reference/ torque limit from communications.</p>	0, 1	1	NO	X	X	X	B	6-75
	TorqueRef/ Lmt Sel									

Parameter No.	Name	Description	Setting range	Default setting	Changes during operation	Control mode				Page
	Display name					V/f control	V/f with PG	Open loop vector	Flux vector	
F9-06	Operation after communications error	Selects the inverter operation to perform when a communications (CompoBus/D Communications Card) error occurs. 0: Decelerate to stop in the time set in C1-02. (Protective operation) 1: Coast to stop. (Protective operation) 2: Emergency stop in the time set in C1-09. (Protective operation) 3: Continue operation. (Alarm)	0 to 3	1	NO	B	B	B	B	6-75
	BUS Fault Sel									

7-2-6 Terminal Parameter Lists

■ Digital Inputs: H1

Parameter No.	Name	Description	Setting range	Default setting	Changes during operation	Control mode				Page
	Display name					V/f control	V/f with PG	Open loop vector	Flux vector	
H1-01	Multi-function input 1: Terminal 3 selection	Terminal 3 Sel	0 to 77	24	NO	B	B	B	B	6-77
H1-02	Multi-function input 2: Terminal 4 selection	Terminal 4 Sel	0 to 77	14	NO	B	B	B	B	6-77
H1-03	Multi-function input 3: Terminal 5 selection	Terminal 5 Sel	0 to 77	3 (0) (See note.)	NO	B	B	B	B	6-77
H1-04	Multi-function input 4: Terminal 6 selection	Terminal 6 Sel	0 to 77	4 (3) (See note.)	NO	B	B	B	B	6-77
H1-05	Multi-function input 5: Terminal 7 selection	Terminal 7 Sel	0 to 77	6 (4) (See note.)	NO	B	B	B	B	6-77
H1-06	Multi-function input 6: Terminal 8 selection	Terminal 8 Sel	0 to 77	8 (6) (See note.)	NO	B	B	B	B	6-77

Note The values in parentheses indicate initial values when initialized in 3-wire sequence.

● Digital Input Functions List

Setting value	Function	Control mode				Page
		V/f	V/f w/PG	Open loop Vector	Flux vector	
0	3-wire control (Forward/Reverse command)	OK	OK	OK	OK	5-16
1	Local/Remote selection (ON: Operating, OFF: Setting parameters)	OK	OK	OK	OK	6-78

Setting value	Function	Control mode				Page
		V/f	V/f w/PG	Open loop Vector	Flux vector	
2	Option/Inverter selection (ON: Option)	OK	OK	OK	OK	6-78
3	Multi-step speed reference 1 When H3-05 is set to "0," this function is combined with "Main/auxiliary speed switch."	OK	OK	OK	OK	5-17
4	Multi-step speed reference 2	OK	OK	OK	OK	5-17
5	Multi-step speed reference 3	OK	OK	OK	OK	5-17
6	Jog frequency reference (has priority over multi-step speed)	OK	OK	OK	OK	5-17
7	Multi-accel/decel time 1	OK	OK	OK	OK	5-18
8	Baseblock NO (contact a: Base block ON)	OK	OK	OK	OK	6-79
9	Baseblock NC (contact b: Base block OFF)	OK	OK	OK	OK	6-79
A	Accel/decel ramp hold (ON: Accel/decel stopped, frequency on hold)	OK	OK	OK	OK	6-79
B	OH2 alarm signal input (ON: OH2 will be displayed)	OK	OK	OK	OK	6-80
C	Multi-function analog input selection (ON: Enable)	OK	OK	OK	OK	6-80
D	V/f mode selection (ON: Speed feedback control disabled, (normal V/f control))	---	OK	---	---	6-81
E	Speed control integral reset (ON: Integral control disabled)	---	OK	---	OK	6-81
F	Not used: Do not set	---	---	---	---	---
10	UP command "MOP Increase" (Always set with the DOWN command)	OK	OK	OK	OK	6-81
11	DOWN command "MOP Decrease" (Always set with the UP command)	OK	OK	OK	OK	6-81
12	FJOG command (ON: Forward rotation for jog frequency d1-09)	OK	OK	OK	OK	5-19
13	RJOG command (ON: Reverse rotation for jog frequency d1-09)	OK	OK	OK	OK	5-19
14	Fault reset (Reset when turned ON)	OK	OK	OK	OK	6-82
15	Emergency stop "Fast-stop" (Normally open condition, When ON: Decelerate to a stop in the emergency stop time set in c1-09)	OK	OK	OK	OK	5-19
16	Motor 2 selection: Selection of motor 1 or motor 2 for two-motor switching control (ON: Motor 2 selected)	OK	OK	OK	OK	---
17	Emergency stop N.C. (ON: Decelerate to a stop in the emergency stop time set in c1-09)	OK	OK	OK	OK	5-19
18	Timer function input (Functions are set with b4-01, b4-02 and the timer function is set at the same time)	OK	OK	OK	OK	6-46
19	PID control ON/OFF (ON: PID control disabled)	OK	OK	OK	OK	6-83
1A	Multi-accel/decel time 2	OK	OK	OK	OK	5-18
1B	Parameter write access (ON: Parameters can be overwritten; OFF: All parameters other than frequency monitor are write protected.)	OK	OK	OK	OK	6-83
1C	Trim control increase (ON: d4-02 frequencies are added to analog frequency references.)	OK	OK	OK	OK	6-83

Setting value	Function	Control mode				Page
		V/f	V/f w/PG	Open loop Vector	Flux vector	
1D	Trim control decrease (ON: d4-02 frequencies are subtracted from analog frequency references.)	OK	OK	OK	OK	6-83
1E	Sample/hold analog frequency reference (ON: Hold analog value)	OK	OK	OK	OK	6-84
1F	Frequency reference terminal 13/14 selection (ON: select terminal 14) Valid only when H3-09 is set to "1F".	OK	OK	OK	OK	5-19
20 to 2F	External fault (Desired settings possible) Input mode: contact a/contact b, Detection mode: Normal/during operation Stopping method: Ramp to stop, coast to stop, fast stop or continue operation.	OK	OK	OK	OK	6-85
30	Reset PID control integration (ON: resets the PID control integration value)	OK	OK	OK	OK	6-54
31	Hold PID control integration (ON: maintains the PID control integration value)	OK	OK	OK	OK	6-54
60	DC injection braking command (ON: DC operation)	OK	OK	OK	OK	6-87
61	External speed search command 1: Maximum frequency (ON: speed search)	OK	---	OK	---	6-87
62	External speed search command 2: Set frequency (ON: speed search)	OK	---	OK	---	6-87
63	Energy save mode (ON: Energy-saving control set for b8-01, b8-02)	OK	OK	---	---	6-13
64	External speed search command	OK	OK	OK	OK	---
65	KEB (deceleration operation for momentary power interruption) command (NC contact)	OK	OK	OK	OK	---
66	KEB (deceleration operation for momentary power interruption) command (NO contact)	OK	OK	OK	OK	---
71	Speed/torque control change (ON: Torque control)	---	---	---	OK	6-88
72	Zero-servo command (ON: Zero-servo lock)	---	---	---	OK	6-88
77	Speed control (ASR) proportional gain switch (ON: C5-03)	---	---	---	OK	6-88

■ Digital Outputs: H2

Parameter No.	Name	Description	Setting range	Default setting	Changes during operation	Control mode				Page
	Display name					V/f control	V/f with PG	Open loop vector	Flux vector	
H2-01	Multi-function contact output: terminal 9 to 10.	Terminal 9 to 10 Sel	0 to 37	0	NO	B	B	B	B	6-90
H2-02	Multi-function output 1: terminal 25.	Terminal 25 Sel	0 to 37	1	NO	B	B	B	B	6-90
H2-03	Multi-function output 2: terminal 26.	Terminal 26 Sel	0 to 37	2	NO	B	B	B	B	6-90

• Digital Outputs List

Setting value		Control mode				Page
		V/f	V/f w/PG	Open loop Vector	Flux vector	
0	During run 1	OK	OK	OK	OK	6-91
1	Excitation	OK	OK	OK	OK	6-91
2	Frequency (ref/out) agree 1: detection width L4-02	OK	OK	OK	OK	6-103
3	Desired frequency (ref/setting) agree 1 (ON: Output frequency = \pm L4-01, detection width L4-02)	OK	OK	OK	OK	6-103
4	Frequency detection 1 (ON: $+L4-01 \geq$ output frequency $\geq -L4-01$, detection width L4-02)	OK	OK	OK	OK	6-103
5	Frequency detection 2 (ON: Output frequency $\geq +L4-01$ or output frequency $\leq -L4-01$, detection width L4-02)	OK	OK	OK	OK	6-103
6	Inverter operation ready READY: After initialization, no faults	OK	OK	OK	OK	---
7	During DC bus low voltage (UV) detection	OK	OK	OK	OK	---
8	During baseblock 1 (ON: during baseblock)	OK	OK	OK	OK	---
9	Operation reference (ON: Operator)	OK	OK	OK	OK	---
A	Run command remote operation (ON: Operator)	OK	OK	OK	OK	---
B	Overtorque detection 1 NO (contact a: ON, overtorque detection)	OK	OK	OK	OK	6-107
C	Loss of frequency reference (Effective when operation selection is "1" for L4-05 frequency reference missing)	OK	OK	OK	OK	6-104
D	DB overheat (ON: Resistance overheat or braking Tr fault)	OK	OK	OK	OK	---
E	Fault (ON: Faults other than CPF00, CPF01 have occurred.)	OK	OK	OK	OK	8-1
F	Not used. Do not set.	---	---	---	---	---
10	Minor fault (ON:Report displayed)	OK	OK	OK	OK	8-8
11	Fault reset command active	OK	OK	OK	OK	---
12	Timer output	OK	OK	OK	OK	6-46
13	Frequency (ref/out) agree 2 (Detection width: L4-04)	OK	OK	OK	OK	6-103
14	Desired frequency (ref/setting) agree 2 (ON: Output frequency = L4-03, detection width L4-04)	OK	OK	OK	OK	6-103
15	Frequency detection 3 (ON: output frequency $\leq -L4-03$, detection width L4-04)	OK	OK	OK	OK	6-103
16	Frequency detection 4 (ON: output frequency $\geq -L4-03$, detection width L4-04)	OK	OK	OK	OK	6-103
17	Overtorque detection 1 NC (Contact b: OFF, torque detection)	OK	OK	OK	OK	6-107
18	Overtorque detection 2 NO (Contact a: ON, torque detection)	OK	OK	OK	OK	6-107
19	Overtorque detection 2 NC (Contact b: OFF, torque detection)	OK	OK	OK	OK	6-107
1A	During reverse run (ON: during reverse run)	OK	OK	OK	OK	---

Setting value		Control mode				Page
		V/f	V/f w/PG	Open loop Vector	Flux vector	
1B	During baseblock 2 (OFF: During base block)	OK	OK	OK	OK	---
1C	Motor 2 selected (ON: motor 2 selected)	OK	OK	OK	OK	---
1D	Regenerating (ON: Regenerating)	---	---	---	OK	---
1E	Restart enabled (ON: Restart enabled)	OK	OK	OK	OK	6-106
1F	Motor overload (OL1) pre-alarm (ON: 90% or more of the detection level)	OK	OK	OK	OK	6-91
20	Inverter overheat (OH) pre-alarm (ON: Temperature is above L8-02)	OK	OK	OK	OK	6-91
30	During torque limit (current limit) (ON: During torque limit)	---	---	OK	OK	---
31	During speed limit. (ON: During speed limit)	---	---	---	OK	---
33	Zero-servo end (ON: Zero-servo)	---	---	---	OK	6-92
37	During run 2 (ON: Frequency output, OFF: Base block, DC braking, initialization, operation stop.	OK	OK	OK	OK	6-91

■ Analog Inputs: H3

Parameter No.	Name Display name	Description	Setting range	Default setting	Changes during operation	Control mode				Page
						V/f control	V/f with PG	Open loop vector	Flux vector	
H3-01	Signal selection: terminal 13 (Voltage)	0: 0 to +10 V 1: 0 to ±10 V	0, 1	0	NO	B	B	B	B	5-5
	Term 13 Signal									
H3-02	Gain: terminal 13	Sets the frequency when 10 V is input, as a percentage of the maximum frequency.	0.0 to 1000.0	100.0	OK	B	B	B	B	5-7
	Terminal 13 Gain									
H3-03	Bias: terminal 13	Sets the frequency when 0 V is input, as a percentage of the maximum frequency.	-100.0 to +100.0	0.0	OK	B	B	B	B	5-7
	Terminal 13 Bias									
H3-04	Multi-function analog input signal selection: terminal 16	0: 0 to +10 V 1: 0 to ±10 V	0, 1	0	NO	B	B	B	B	5-7
	Term 16 Signal									
H3-05	Selection: Terminal 16	Select from the functions listed on the following table. Refer to page 6-92.	0 to 1F	1F	NO	B	B	B	B	5-7, 6-92
	Terminal 16 Sel									
H3-06	Gain: terminal 16	Sets the input gain (level) when terminal 16 is 10 V. The contents in the following table are taken as 100%.	0.0 to 1000.0	100.0	OK	B	B	B	B	5-8
	Terminal 16 Gain									
H3-07	Bias: terminal 16	Sets the input gain (level) when terminal 16 is 0 V. The contents in the following table are taken as 100%.	-100.0 to +100.0	0.0	OK	B	B	B	B	5-8
	Terminal 16 Bias									

Parameter No.	Name	Description	Setting range	Default setting	Changes during operation	Control mode				Page
	Display name					V/f control	V/f with PG	Open loop vector	Flux vector	
H3-08	Signal selection: terminal 14	0: 0 to +10 V (Always cut jumper wire J1) 1: 0 to ±10 V (Always cut jumper wire J1) 2: 4 to 20 mA	0 to 2	2	NO	A	A	A	A	5-6
	Term 14 Signal									
H3-09	Selection: Terminal 14	Set as for H3-05. Note: Cannot be set to 0. The 1F function will become "frequency reference."	1 to 1F	1F	NO	A	A	A	A	5-5, 6-92
	Terminal 14 Sel									
H3-10	Gain: Terminal 14	Sets the input gain (level) when terminal 14 is 10 V (20 mA). The contents in the following table are taken as 100%.	0.0 to 1000.0	100.0	OK	A	A	A	A	5-7
	Terminal 14 Gain									
H3-11	Bias: Terminal 14	Sets the input gain (level) when terminal 14 is 0 V (4 mA). The contents in the following table are taken as 100%.	-100.0 to +100.0	0.0	OK	A	A	A	A	5-7
	Terminal 14 Bias									
H3-12	Analog input filter time constant	Sets terminals 13, 14, 16 to primary delay filter time constant, in seconds units. Note: Effective for noise control etc.	0.00 to 2.00	0.00	NO	A	A	A	A	5-8
	Filter Avg Time									

● Description of Multi-function Analog Input: Terminal 16

Function		Contents	Control mode			
0	Auxiliary frequency reference	Maximum frequency	OK	OK	OK	OK
1	Frequency gain	Frequency reference command value (voltage.)	OK	OK	OK	OK
2	Frequency bias	Maximum frequency (H0-03 +)	OK	OK	OK	OK
4	Voltage bias	Motor rated voltage (E1-05)	OK	OK	---	---
5	Accel/decel change	Set acceleration and deceleration times (C1-01 to C1-08)	OK	OK	OK	OK
6	DC injection braking current	Inverter rated output current	OK	OK	OK	---
7	Overtorque detection level	Motor rated torque	OK	OK	OK	OK
8	Stall prevention level during run	Inverter rated output current	OK	OK	---	---
9	Frequency reference lower limit level	Maximum frequency	OK	OK	OK	OK
A	Jump frequency	Maximum frequency	OK	OK	OK	OK
B	PID feedback	Maximum frequency	OK	OK	OK	OK
C	PID target value	Maximum frequency	OK	OK	OK	OK
D	Frequency bias 2 (rotates in reverse with negative values)	Maximum frequency (H0-03 +)	OK	OK	OK	OK
10	Forward side torque limit	Rated torque	---	---	OK	OK
11	Reverse side torque limit	Rated torque	---	---	OK	OK
12	Regeneration side torque limit	Rated torque	---	---	OK	OK
13	Torque reference/torque limit at speed control	Rated torque	---	---	---	OK
14	Torque compensation (bias)	Rated torque	---	---	---	OK
15	Forward/reverse side torque limit	Rated torque	---	---	OK	OK
1F	Not used (terminal 14: frequency reference)	---	OK	OK	OK	OK

■ Analog Outputs: H4

Parameter No.	Name	Description	Setting range	Default setting	Changes during operation	Control mode				Page
	Display name					V/f control	V/f with PG	Open loop vector	Flux vector	
H4-01	Multi-function analog output 1 selection: terminal 21	Sets the number of the monitor item to be output (U1-□□) from terminal 21. Note: Settings 4, 10, 11, 12, 13, 14, 25, 28, 34, and 35 cannot be set and 29 to 31 are not used.	1 to 38	2	NO	B	B	B	B	6-95
	Terminal 21 Sel									
H4-02	Gain terminal 21	Sets the multi-function analog output 1 voltage level gain. Sets whether the monitor item output will be output in multiples of 10 V.	0.00 to 2.50	1.00	OK	B	B	B	B	6-96
	Terminal 21 Gain									
H4-03	Bias terminal 21	Sets the multi-function analog output 1 voltage level bias. Sets output characteristic up/down parallel movement as a percentage of 10 V.	-10.0 to +10.0	0.0	OK	B	B	B	B	6-96
	Terminal 21 Bias									
H4-04	Multi-function analog output 2 selection: terminal 23	Sets the number of the monitor item to be output (U1-□□) from terminal 23. Note: Settings 4, 10, 11, 12, 13, 14, 25, 28, 34, and 35 cannot be set and 29 to 31 are not used.	1 to 38	3	NO	B	B	B	B	6-95
	Terminal 23 Sel									
H4-05	Gain terminal 23	Sets the multi-function analog output 2 voltage level gain. Sets whether the monitor item output will be output in multiples of 10 V.	0.00 to 2.50	0.50	OK	B	B	B	B	6-96
	Terminal 23 Gain									
H4-06	Bias terminal 23	Sets the multi-function analog output 2 voltage level bias. Sets output characteristic up/down parallel movement as a percentage of 10 V.	-10.0 to +10.0	0.0	OK	B	B	B	B	6-96
	Terminal 23 Bias									
H4-07	Analog output signal level selection	Sets the signal output level for multi-function outputs 1 and 2 (terminals 21, 23.) 0: 0 to +10 V output 1: 0 to ±10 V output Note: The optional Analog Monitor Card may also be used with this setting.	0, 1	0	NO	B	B	B	B	6-96
	AO Level Select									

■ Serial Communications Setup: H5

Parameter No.	Name	Description	Setting range	Default setting	Changes during operation	Control mode				Page
	Display name					V/f control	V/f with PG	Open loop vector	Flux vector	
H5-01	Slave Address	Sets the Slave address for RS-422/485 communications. 00: Communications function disabled.	00 to 20	1F	NO	A	A	A	A	---
	Serial Comm Adr									
H5-02	Baud rate selection	Selects the baud rate for RS-422/485 communications. 0: 1,200 bps 1: 2,400 bps 2: 4,800 bps 3: 9,600 bps 4: 19,200 bps	0 to 4	3	NO	A	A	A	A	---
	Serial Baud Rate									
H5-03	Parity selection	Selects the parity check function for RS-422/485 communications. 0: No parity 1: Odd parity 2: Even parity	0 to 2	0	NO	A	A	A	A	---
	Serial Com Sel									
H5-04	Operation for communication timeover	Selects the method of operation for when it is detected that the communications time has elapsed in RS-422/485 communications. 0: Deceleration stop (C1-02)/Fault 1: Free-run stop/Fault 2: Fast stop (C1-09)/Fault 3: Continue/Alarm	0 to 3	3	NO	A	A	A	A	---
	Serial Fault Sel									
H5-05	Communications timeover detection selection	Enables or disables the communications timeover function in RS-422/485 communications. 0: Disable 1: Enable	0, 1	1	NO	A	A	A	A	---
	Serial Flt Dtct									

7-2-7 Protection Parameter Lists

■ Motor Overload: L1

Parameter No.	Name	Description	Setting range	Default setting	Changes during operation	Control mode				Page
	Display name					V/f control	V/f with PG	Open loop vector	Flux vector	
L1-01	Motor protection selection	Sets whether the motor overload function is enabled or disabled at electric thermal overload relay. 0: Disabled 1: Enabled Note: In some applications when the Inverter power supply is turned off, the thermal value is reset, so even if this parameter is set to 1, (Enabled), protection may not be effective. When several motors are connected to one Inverter, set to 0 (Disabled) and ensure that each motor is installed with a protection device.	0, 1	1	NO	B	B	B	B	6-97
	MOL Fault Select									
L1-02	Motor protection time constant	Sets the electric thermal detection time in units of seconds. Note: Usually setting is not necessary. The default setting is 150% overload for one minute. When the motor's overload resistance is known, set at the overload resistance when the motor is hot started. (Always leave a margin for error.)	0.1 to 5.0	1.0	NO	B	B	B	B	6-97
	MOL Time Const									

■ Power Loss Ridethrough: L2

Parameter No.	Name	Description	Setting range	Default setting	Changes during operation	Control mode				Page
	Display name					V/f control	V/f with PG	Open loop vector	Flux vector	
L2-01	Momentary power loss selection	0: Disabled (Undervoltage fault detection) 1: Enabled (Restarted when the power returns within the time for L2-02. When L2-02 is exceeded, undervoltage fault detection.) 2: Enabled while CPU is operating. (Restarts when power returns during control operations. Does not detect undervoltage fault.)	0 to 2	0	NO	B	B	B	B	6-98
	PwrL Selection									
L2-02	Momentary power loss ridethru	Sets the recovery time, when momentary power loss selection (L2-01) is set to 1, in units of one second.	0.0 to 2.0	0.7 (See note 1.)	NO	B	B	B	B	6-98
	PwrL Ridethru t									

Parameter No.	Name	Description	Setting range	Default setting	Changes during operation	Control mode				Page
	Display name					V/f control	V/f with PG	Open loop vector	Flux vector	
L2-03	Minimum baseblock time (BB)	Sets the Inverter's minimum baseblock time in units of one second, when the Inverter is restarted after power loss ridethrough. Note: Sets the time for the motor's residual voltage to dissipate. When an overcurrent occurs when starting a speed search or DC injection braking, increase the set values.	0.1 to 5.0	0.5 (See note 1.)	NO	B	B	B	B	6-99
	PwrL Baseblock t									
L2-04	Voltage restart time	Sets the time required to return to normal voltage at the completion of a speed search, in units of one second. Note: Set the time required for a 200-V class Inverter to recover from 0 V to 200 VAC. (For the 400-V class Inverter, the time from 0 V to 400 VAC.)	0.0 to 5.0	0.3	NO	A	A	A	A	6-99
	PwrL V/F Ramp t									
L2-05	Under voltage detection level (UV)	Sets the main circuit under voltage (UV) detection level (main circuit DC voltage) in V units. Note: Usually setting is not necessary. Insert a AC reactor and use this function to lower the main circuit under voltage detection level.	150 to 210 (See note 2.)	190 (See note 2.)	NO	A	A	A	A	6-99
	PUV Det Level									
L2-06	KEB deceleration rate	By decelerating simultaneously with a momentary power interruption, this function produces regenerative energy and utilizes this energy to counter the power interruption. Select the deceleration rate to be applied after the KEB command (set value: 65 or 66) set for multi-function inputs is input. Set as a percentage the deceleration frequency rate for when the time set in L2-02 has elapsed after KEB command input. If 80% is set, deceleration will be performed taking the time set in L2-02, up to 80% of the output frequency when KEB is input. If L2-06 is set to 0.0, C1-09 will automatically decelerate to the base so that the undervoltage (UV) of the main circuit will not be detected.	0.0 to 100.0	0.1	NO	A	A	A	A	---
	KEB Frequency									

Note 1. The default setting depends upon the type of Inverter. The values for a 200-V class 0.4-kW Inverter are given above.

Note 2. These are values for a 200-V class Inverter. Values for the 400-V class Inverter are double.

■ Stall Prevention: L3

Parameter No.	Name	Description	Setting range	Default setting	Changes during operation	Control mode				Page
	Display name					V/f control	V/f with PG	Open loop vector	Flux vector	
L3-01	Stall prevention during acceleration	0: Disabled (Acceleration as set. With a large load, the motor may stall.) 1: Enabled (Acceleration stopped when L3-02 level is exceeded. Acceleration starts again when the current is returned.) 2: Intelligent acceleration mode (Using the L3-02 level as a basis, acceleration is automatically adjusted. Set acceleration time is disregarded.)	0 to 2	1	NO	B	B	B	X	6-100
	StallP Accel Sel									
L3-02	Stall prevention level during acceleration	Effective when L3-01 is set to 1 or 2. Set as a percentage of Inverter rated output current. Note: Usually setting is not necessary. The default setting reduces the set values when the motor stalls.	0 to 200	150	NO	B	B	B	X	6-100
	StallP Accel Lvl									
L3-03	Stall prevention level during acceleration	Sets the lower limit for stall prevention during acceleration, as a percentage of the Inverter rated output current, when operation is in the frequency range above the maximum voltage frequency (E1-06.) Note: Usually setting is not necessary.	0 to 100	50	NO	A	A	A	X	6-100
	StallP CHP Lvl									
L3-04	Stall prevention during deceleration	0: Disabled (Deceleration as set. If deceleration time is too short, a main circuit overvoltage may result.) 1: Enabled (Deceleration is stopped when the main circuit voltage exceeds the overvoltage level. Deceleration restarts when voltage is returned.) 2: Intelligent deceleration mode (Deceleration rate is automatically adjusted so that in Inverter can decelerate in the shortest possible time. Set deceleration time is disregarded.) 3: Enabled (Stall prevention using a braking resistance device or Braking Resistor Unit) Note: When a braking option (braking resistance device, Braking Resistor Unit, or Braking Unit) is used, always set to 0 or 3.	0 to 3	1	NO	B	B	B	B	6-101
	StallP Decel Sel									

Parameter No.	Name	Description	Setting range	Default setting	Changes during operation	Control mode				Page
	Display name					V/f control	V/f with PG	Open loop vector	Flux vector	
L3-05	Stall prevention during run	0: Disabled (Runs as set. With a large load, the motor may stall.) 1: Enabled: Deceleration time 1 (the deceleration time for the stall prevention function is C1-02.) 2: Enabled: Deceleration time 2 (the deceleration time for the stall prevention function is C1-04.)	0 to 2	1	NO	B	B	X	X	6-102
	StallP Run Sel									
L3-06	Stall prevention level during run	Effective when L3-04 is 1 or 2. Set as a percentage of the Inverter rated output current. Note: Usually setting is not necessary. The default setting reduces the set values when the motor stalls.	30 to 200	160	NO	B	B	X	X	6-102
	StallP Run Level									

Note When the control mode is changed, the Inverter returns to default settings. (The open loop vector control default settings are given above.)

■ Reference Detection: L4

Parameter No.	Name	Description	Setting range	Default setting	Changes during operation	Control mode				Page
	Display name					V/f control	V/f with PG	Open loop vector	Flux vector	
L4-01	Frequency detection level	Effective when "Desired frequency (ref/setting) agree 1," "Frequency detection 1," "Frequency detection 2," are set for multi-function output. Frequencies to be detected are set in Hz units.	0.0 to 400.0	0.0	NO	B	B	B	B	6-103
	Spd Agree Level									
L4-02	Frequency detection width	Effective when "Frequency (ref/out) agree 1," "Desired frequency (ref/setting) agree 1," "Frequency detection 1," "Frequency detection 2" are set for multi-function output. Sets the frequency detection width in Hz units.	0.0 to 20.0	2.0	NO	B	B	B	B	6-103
	Spd Agree Width									
L4-03	Frequency detection level (+/-)	Effective when "Desired frequency (ref/setting) agree 2," "Frequency detection 3," "Frequency detection 4," are set for multi-function output. Frequencies to be detected are set in Hz units.	-400.0 to +400.0	0.0	NO	A	A	A	A	6-103
	Spd Agree Lvl+-									
L4-04	Frequency detection width (+/-)	Effective when "Frequency (ref/out) agree 2," "Desired frequency (ref/setting) agree 1," "Frequency detection 3," "Frequency detection 4" are set for multi-function output. Sets the frequency detection width in Hz units.	0.0 to 20.0	2.0	NO	A	A	A	A	6-103
	Spd Agree Wdth+-									

Parameter No.	Name	Description	Setting range	Default setting	Changes during operation	Control mode				Page
	Display name					V/f control	V/f with PG	Open loop vector	Flux vector	
L4-05	Operation when frequency reference is lost	0: Stop (Operation follows the frequency reference.) 1: Operation at 80% speed continues. (At 80% of speed before the frequency reference was lost)	0, 1	0	NO	A	A	A	A	6-104
	Ref Loss Sel	Note: Frequency reference is lost: Frequency reference dropped over 90% in 400 ms.								

■ Fault Restart: L5

Parameter No.	Name	Description	Setting range	Default setting	Changes during operation	Control mode				Page
	Display name					V/f control	V/f with PG	Open loop vector	Flux vector	
L5-01	Number of auto restart attempts	Sets the number of auto restart attempts. Automatically restarts after a fault and conducts a speed search from the run frequency.	0 to 10	0	NO	B	B	B	B	6-106
	Num of Restarts									
L5-02	Auto restart operation selection	Sets whether a fault contact output is activated during fault restart. 0: Not output (Fault contact is not activated.) 1: Output (Fault contact is activated.)	0, 1	0	NO	B	B	B	B	6-106
	Restart Sel									

■ Torque Detection: L6

Parameter No.	Name	Description	Setting range	Default setting	Changes during operation	Control mode				Page
	Display name					V/f control	V/f with PG	Open loop vector	Flux vector	
L6-01	Torque detection selection 1	0: Overtorque detection disabled. 1: Detection during speed agree only/Operation continues after detection (Minor fault) 2: Detection during run/Operation continues after detection (Minor fault) 3: Detection during speed agree only/Inverter output is shut off after detection (Fault) 4: Detection during run/Inverter output is shut off after detection (Fault)	0 to 4	0	NO	B	B	B	B	6-107
	Torq Det 1 Sel									
L6-02	Torque detection level1	Vector control: Motor rated torque is set as 100%. V/f control: Inverter rated output current is set as 100%.	0 to 300	150	NO	B	B	B	B	6-107
	Torq Det 1 Lvl									

Parameter No.	Name	Description	Setting range	Default setting	Changes during operation	Control mode				Page
	Display name					V/f control	V/f with PG	Open loop vector	Flux vector	
L6-03	Torque detection time 1	Sets the torque detection time in 1-second units.	0.0 to 10.0	0.1	NO	B	B	B	B	6-107
	Torq Det 1 Time									
L6-04	Torque detection selection 2	Setting procedure is the same as for "Torque detection selection 1" (L6-01 to L6-03.) The following outputs are possible:	0 to 4	0	NO	A	A	A	A	6-107
	Torq Det 2 Sel									
L6-05	Torque detection level 2	Torque detection selection 1: Multi-function output "Torque detection selection 1" NO/NC Torque detection selection 2: Multi-function output "Torque detection selection 2" NO/NC	0 to 300	150	NO	A	A	A	A	6-107
	Torq Det 2 Lvl									
L6-06	Torque detection time 2		0.0 to 10.0	0.1	NO	A	A	A	A	6-107
	Torq Det 2 Time									

■ Torque Limit: L7

Parameter No.	Name	Description	Setting range	Default setting	Changes during operation	Control mode				Page
	Display name					V/f control	V/f with PG	Open loop vector	Flux vector	
L7-01	Forward torque limit	<p>Reverse Output torque Forward side</p> <p>Reverse L7-04 L7-01 Motor speed Forward</p> <p>Reverse side L7-02 L7-03 Reverse side</p>	0 to 300	200	NO	X	X	B	B	6-3, 6-29
	Torq Limit Fwd									
L7-02	Reverse torque limit		0 to 300	200	NO	X	X	B	B	6-3, 6-29
	Torq Limit Rev									
L7-03	Forward regenerative torque limit	0 to 300	200	NO	X	X	B	B	6-3, 6-29	
	Torq Lmt Fwd Rgn									
L7-04	Reverse regenerative torque limit	0 to 300	200	NO	X	X	B	B	6-3, 6-29	
	Torq Lmt Rev Rgn									

■ Hardware Protection: L8

Parameter No.	Name	Description	Setting range	Default setting	Changes during operation	Control mode				Page
	Display name					V/f control	V/f with PG	Open loop vector	Flux vector	
L8-01	DB resistor protection	0: Disabled (Braking resistor is not used or the Braking Resistor Unit is used) 1: Enabled (Protects the braking resistor from overheating)	0, 1	0	NO	B	B	B	B	6-108
	DB Resistor Prot									

Parameter No.	Name	Description	Setting range	Default setting	Changes during operation	Control mode				Page
	Display name					V/f control	V/f with PG	Open loop vector	Flux vector	
L8-02	Inverter overheat detection pre-alarm level	Sets the detection temperature for the Inverter overheat detection pre-alarm in °C. Note: The pre-alarm detects when the cooling fin temperature reaches the set value.	50 to 130	95	NO	A	A	A	A	6-108
	OH Pre-Alarm Lvl									
L8-03	Operation after Inverter overheat pre-alarm	Sets the operation for when the Inverter overheat pre-alarm goes ON. 0: Ramp to stop in deceleration time C1-02. 1: Coast to stop 2: Fast stop in fast-stop time C1-09. 3: Continue operation (Monitor display only.) Note: A fault will be given in setting 0 to 2 and a minor fault will be given in setting 3.	0 to 3	3	NO	A	A	A	A	6-108
	OH Pre-Alarm Sel									
L8-05	Input open-phase protection selection	0: Disabled 1: Enabled (Detects if input current open-phase, power supply voltage imbalance or main circuit electrostatic capacitor deterioration occurs.)	0, 1	0	NO	A	A	A	A	6-108
	Ph Loss In Sel									
L8-07	Output open-phase protection selection	0: Disabled 1: Enabled (Output open phase detected at less than 5% of Inverter's rated current.) Note: Output open phase may be detected inadvertently when applied motor capacity is small for Inverter capacity. In this case, set to 0 (Disabled.)	0, 1	0	NO	A	A	A	A	6-109
	Ph Loss Out Sel									
L8-10	Ground fault protection selection	0: Disable ground fault protection. 1: Enable ground fault protection.	0, 1	1	NO	A	A	A	A	6-109
	Ground Fault Sel									

Parameter No.	Name	Description	Setting range	Default setting	Changes during operation	Control mode				Page
	Display name					V/f control	V/f with PG	Open loop vector	Flux vector	
L8-17	Carrier frequency reduction at low speed	L8-17 settings: Enable or disable the low-speed carrier frequency reduction function. 0: Disable (Don't reduce carrier frequency at low speed.) 1: Enable (Reduce carrier frequency at low speed.) 2,3: Reserved for factory adjustments. L8-19 settings: 0: Disable (Don't reduce the OL2 detection level at low speed.) 1: Enable (Reduce the OL2 detection level at low speed.) Note: Set these parameters in one of the following combinations:	0 to 3	1	NO	A	A	A	X	6-109
	L-Spd GBT Prtct									
L8-19	Inverter overload characteristics at low speed	<ul style="list-style-type: none"> To reduce motor noise at low speeds, set L8-17 to "0" and L8-19 to "1". When high torque is required at low speeds, set L8-17 to "1" and L8-19 to "0". Note: Do not set both L8-17 and L8-19 to "0". Doing so may damage the inverter. Use a larger inverter if high torque is required and you want to set a higher carrier frequency. Note: If flux vector control is being used and a large load is being applied continuously at low speed, either use a larger inverter or set the carrier frequency to 2 kHz in C6-01.	0, 1	0	NO	A	A	A	A	6-109
	OL2 Chara @L-Spd									

7-2-8 Operator Parameter Lists

■ Monitor Select: o1

Parameter No.	Name	Description	Setting range	Default setting	Changes during operation	Control mode				Page
	Display name					V/f control	V/f with PG	Open loop vector	Flux vector	
o1-01	Monitor selection	Set the number of the monitor item to be displayed in the earliest 4 monitor items. (U1-□□) Note: The output monitor voltage (default setting) can be changed.	4 to 38	6	OK	B	B	B	B	6-110
	User Monitor Sel									

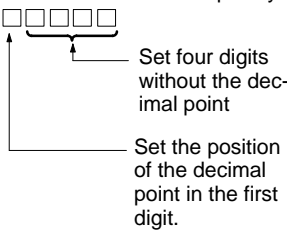
Parameter No.	Name	Description	Setting range	Default setting	Changes during operation	Control mode				Page
	Display name					V/f control	V/f with PG	Open loop vector	Flux vector	
o1-02	Monitor selection after power-on	Sets the monitor item to be displayed when the power is turned on. 1: Frequency reference 2: Output frequency 3: Output current 4: The monitor item set for o1-01	1 to 4	1	OK	B	B	B	B	6-110
	Power-On Monitor									
o1-03	Frequency reference setting and display units	Sets the units that will be set and displayed for the frequency reference and frequency monitor. 0: 0.01-Hz units 1: 0.01% units (Maximum frequency is 100%) 2 to 39: r/min units (Sets the motor poles. Cannot be set in Flex Vector Control.) 40 to 39999: User desired display Set the desired values for setting and display for the max. frequency.  Example: When the max. frequency value is 200.0, set 12000	0 to 39999	0	NO	B	B	B	B	5-9
	Display Scaling									
o1-04	V/f pattern setting units	Set the V/f pattern setting units. (E1-04, 06, 09 set units) 0: Hz units 1: r/min units Note: Effective only in the flux control vector mode.	0, 1	0	NO	X	X	X	B	6-31
	Display Units									
o1-05	Not used	Do not set.	---	0	---	---	---	---	---	---
	Address Display									

■ Key Selections: o2

Parameter No.	Name	Description	Setting range	Default setting	Changes during operation	Control mode				Page
	Display name					V/f control	V/f with PG	Open loop vector	Flux vector	
o2-01	Local/Remote Key	Sets the Digital Operator Local/Remote Key enabled/disabled. 0: Disabled 1: Enabled (Switches between the Digital Operator and the parameter settings.)	0, 1	1	NO	B	B	B	B	6-111
	Local/Remote Key									

Parameter No.	Name	Description	Setting range	Default setting	Changes during operation	Control mode				Page
	Display name					V/f control	V/f with PG	Open loop vector	Flux vector	
o2-02	Stop Key	Sets the Stop Key in the run mode. 0: Disabled (When the run command is issued from and external terminal, the Stop Key is disabled.) 1: Enabled (Effective even during run.)	0, 1	1	NO	B	B	B	B	6-111
	Oper Stop Key									
o2-03	User parameter initial values	Clears or stores user initial values. 0: Stores/not set 1: Begins storing (Records the set parameters as user initial values.) 2: All clear (Clears all recorded user initial values) Note: When the set parameters are recorded as user initial values, 1110 will be displayed in the Initialize mode (A1-03.)	0 to 2	0	NO	B	B	B	B	6-111
	User Defaults									
o2-04	Inverter capacity selection	Do not set Note: This parameter is set by the manufacturer	0 to FF (See note.)	0 (See note.)	NO	B	B	B	B	6-112
	Inverter Model #									
o2-05	Frequency reference setting method	When the frequency reference is set on the Digital Operator's frequency reference monitor, sets whether the Enter Key is necessary. 0: Enter Key needed 1: Enter Key not needed Note: When set to 1, the Inverter accepts the frequency reference without Enter Key operation.	0, 1	0	NO	A	A	A	A	6-112
	Operator M.O.P.									
o2-06	Operation selection when Digital Operator is disconnected	Sets the operation when the Digital Operator is disconnected. 0: Disabled (Operation continues even if the Digital Operator is disconnected.) 1: Enabled (OPR is detected at Digital Operator disconnection. Inverter output is cut off, and fault contact is operated.)	0, 1	0	NO	A	A	A	A	6-112
	Oper Detection									
o2-07	Cumulative operation time setting	Sets the cumulative operation time in hour units. Note: Operation time is calculated from the set values.	0 to 65535	0	NO	A	A	A	A	6-112
	Elapsed Time Set									
o2-08	Cumulative operation time selection	0: Cumulative time when the Inverter power is on. (All time while the Inverter power is on is accumulated.) 1: Cumulative Inverter run time. (Only Inverter output time is accumulated.)	0, 1	0	NO	A	A	A	A	6-112
	Elapsed Time Run									

Parameter No.	Name	Description	Setting range	Default setting	Changes during operation	Control mode				Page
	Display name					V/f control	V/f with PG	Open loop vector	Flux vector	
o2-09	Factory use	Do not set.	---	0	---	---	---	---	---	---
	Init mode sel									

Note The default setting depends upon the type of Inverter. The values for a 200-V class 0.4 kW Inverter are given above.

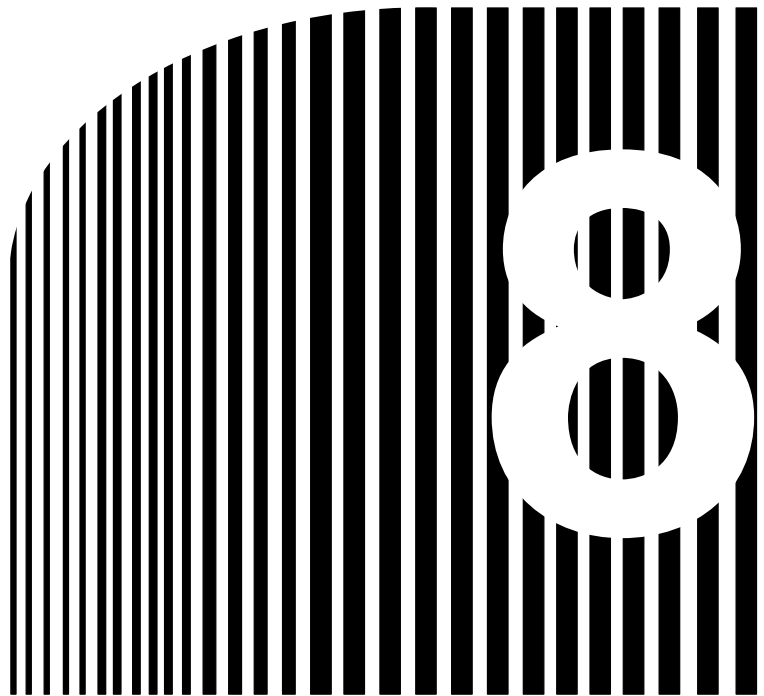

Chapter 8

• **Maintenance Operations**

- 8-1 Protective and Diagnostic Functions
- 8-2 Troubleshooting
- 8-3 Maintenance and Inspection

8-1 Protective and Diagnostic Functions

8-1-1 Fault Detection

When the Inverter detects a fault, the fault code is displayed on the Digital Operator, the fault contact output operates, and the Inverter output is shut OFF causing the motor to coast to a stop. (The stopping method can be selected for some faults, and the selected stopping method will be used with these faults.)

Before restarting, reset the error using one of the following procedures. If the run command is ON, the reset will be ignored. Turn OFF the run command before resetting.

- Turn ON the fault reset signal.
(A multi-function input (H1-01 to H1-06) must be set to 14 (Fault Reset).)
- Press the RESET Key on the Digital Operator.
- Turn the main circuit power supply off and then on again.

■ Fault Displays and Processing

Fault Display	Meaning	Probable causes and remedies
OC Overcurrent	The Inverter output current exceeded the overcurrent detection level.	<ul style="list-style-type: none"> • A short-circuit or ground fault occurred at the Inverter output. (A short or ground fault can be caused by motor burn damage, worn insulation, or a damaged cable.) • The load is too large or the acceleration/deceleration time is too short. • A special-purpose motor or motor with a capacity too large for the Inverter is being used. • A magnetic switch was switched at the Inverter's output. <p>→ Reset the fault after correcting its cause.</p>
GF Ground Fault	The ground fault current at the Inverter's output exceeded approximately 80% of the Inverter's rated output current.	<ul style="list-style-type: none"> • A ground fault occurred at the Inverter output. (A ground fault can be caused by motor burn damage, worn insulation, or a damaged cable.) <p>→ Reset the fault after correcting its cause.</p>
PUF DC Bus Fuse Open	The fuse in the main circuit is blown.	<ul style="list-style-type: none"> • The output transistor has failed because of a short-circuit or ground fault at the Inverter output. Check whether there is a short-circuit between the following terminals. A short-circuit will damage the output transistor: B1(+3) ↔ T1(U), T2(V), T3(W) (-) ↔ T1(U), T2(V), T3(W) <p>→ Replace the Inverter after correcting the cause.</p>

Fault Display	Meaning	Probable causes and remedies
SC Short Circuit	The Inverter output or load was short-circuited.	<ul style="list-style-type: none"> • A short-circuit or ground fault occurred at the Inverter output. (A short or ground fault can be caused by motor burn damage, worn insulation, or a damaged cable.) → Reset the fault after correcting its cause.
OV Overvoltage	The main circuit DC voltage exceeded the overvoltage detection level. 200-V class: Approx. 400 V 400-V class: Approx. 800 V	<ul style="list-style-type: none"> • The deceleration time is too short and the regenerative energy from the motor is too large. → Increase the deceleration time or connect a braking resistor (or Braking Resistor Unit). • A surge is generated when the phase-advancer condenser switches. → Add an AC reactor to the power supply input. • The power supply voltage is too high. → Decrease the voltage so it's within specifications.
UV1 DC Bus Undervolt	The main circuit DC voltage is below the undervoltage detection level (L2-05). 200-V class: Approx. 190 V 400-V class: Approx. 380 V	<ul style="list-style-type: none"> • A phase loss occurred with the input power supply. • A momentary power interruption occurred. • The wiring terminals for the input power supply are loose. • The voltage fluctuations in the input power supply are too large. → Reset the fault after correcting its cause.
UV2 CTL PS Undervolt	The control power supply voltage dropped.	<ul style="list-style-type: none"> → Try turning the power supply off and on. → Replace the Inverter if the fault continues to occur.
UV3 MC Answerback	A failure occurred in the inrush prevention circuit.	<ul style="list-style-type: none"> → Try turning the power supply off and on. → Replace the Inverter if the fault continues to occur.
PF Input Pha Loss	The main circuit DC voltage oscillates unusually (not when regenerating). This fault is detected when L8-05 is set to "Enabled."	<ul style="list-style-type: none"> • A phase loss occurred in the input power supply. • A momentary power interruption occurred. • The wiring terminals for the input power supply are loose. • The voltage fluctuations in the input power supply are too large. • The voltage balance between phases is bad. → Reset the fault after correcting its cause. • The main circuit smoothing condenser has exceeded its life expectancy. → Replace the electrolytic condenser. (Contact your OMRON representative.)

Fault Display	Meaning	Probable causes and remedies
<p>LF Output Pha Loss</p>	<p>A phase loss occurred at the Inverter's output. This fault is detected when L8-07 is set to "Enabled."</p>	<ul style="list-style-type: none"> • There is a broken wire in the output cable. • There is a broken wire in the motor's winding. • The output terminals are loose. → Reset the fault after correcting its cause. • The motor being used has a capacity less than 10% of the Inverter's maximum motor capacity. → Check the motor and Inverter capacity.
<p>OH Heatsink Over tmp</p>	<p>The temperature of the Inverter's cooling fins exceeded the setting in L8-02 or 105°C.</p>	<ul style="list-style-type: none"> • The ambient temperature is too high. → Install a cooling unit. • There is a heat source nearby. → Remove the heat source. • The Inverter's cooling fan has stopped. → Replace the cooling fan. (Contact your OMRON representative.) • High carrier frequency. (400V-class models) → Decrease the C6-01 setting.
<p>RH Dyn Brk Resistor</p>	<p>The braking resistor is overheated and the protection function set with L8-01 has operated.</p>	<ul style="list-style-type: none"> • The deceleration time is too short and the regenerative energy from the motor is too large. → Lighten the load, increase the deceleration time, or reduce the motor speed. → Change to a Braking Resistor Unit.
<p>RR Dyn Brk Transistr</p>	<p>The braking transistor is not operating properly.</p>	<ul style="list-style-type: none"> → Try turning the power supply off and on. → Replace the Inverter if the fault continues to occur.
<p>OL1 Motor Overloaded</p>	<p>The motor overload protection function has operated based on the internal electronic thermal value.</p>	<ul style="list-style-type: none"> • The load is too large. The acceleration time, deceleration time, and cycle time are too short. → Check the size of the load and the length of the acceleration, deceleration, and cycle times. • The V/f characteristics voltage is too high. → Check the V/f characteristics. • The motor's rated current setting (E2-01) is incorrect. → Check the motor's rated current setting (E2-01).
<p>OL2 Inv Overloaded</p>	<p>The Inverter overload protection function has operated based on the internal electronic thermal value.</p>	<ul style="list-style-type: none"> • The load is too large. The acceleration time, deceleration time and cycle time are too short. → Check the size of the load and the length of the acceleration, deceleration, and cycle times. • The V/f characteristics voltage is too high. → Check the V/f characteristics. • The Inverter's capacity is too low. → Replace the Inverter with one that has a larger capacity. • High carrier frequency. → Decrease the C6-01 setting.

Fault Display	Meaning	Probable causes and remedies
OL3 Overtorque Det 1	There has been a current greater than the setting in L6-02 for longer than the setting in L6-03.	<ul style="list-style-type: none"> → Make sure that the settings in L6-02 and L6-03 are appropriate. → Check the mechanical system and correct the cause of the overtorque.
OL4 Overtorque Det 2	There has been a current greater than the setting in L6-05 for longer than the setting in L6-06.	<ul style="list-style-type: none"> → Make sure that the current setting in L6-05 and time setting in L6-06 are appropriate. → Check the mechanical system and correct the cause of the overtorque.
OS Over speed	The speed has been greater than the setting in F1-08 for longer than the setting in F1-09.	<ul style="list-style-type: none"> • Overshooting/Undershooting are occurring. <ul style="list-style-type: none"> → Adjust the gain again. • The reference speed is too high. <ul style="list-style-type: none"> → Check the reference circuit and reference gain. • The settings in F1-08 and F1-09 aren't appropriate. <ul style="list-style-type: none"> → Check the settings in F1-08 and F1-09.
PGO PG open	The PG is disconnected. The Inverter is outputting a frequency, but PG pulses aren't being input.	<ul style="list-style-type: none"> • There is a break in the PG wiring. <ul style="list-style-type: none"> → Fix the broken/disconnected wiring. • The PG is wired incorrectly. <ul style="list-style-type: none"> → Fix the wiring. • Power isn't being supplied to the PG. <ul style="list-style-type: none"> → Supply power to the PG properly. • The torque limit is set to 0 through CompoBus/D communications. (Applies only to flux vector control.) <ul style="list-style-type: none"> → Set F9-05 to 0 (torque limit disabled).
DEV Speed Deviation	The speed deviation has been greater than the setting in F1-10 for longer than the setting in F1-11.	<ul style="list-style-type: none"> • The load is too large. <ul style="list-style-type: none"> → Lighten the load. • The acceleration time and deceleration time are too short. <ul style="list-style-type: none"> → Lengthen the acceleration time and deceleration time. • The load is locked. <ul style="list-style-type: none"> → Check the mechanical system. • The settings in F1-10 and F1-11 aren't appropriate. <ul style="list-style-type: none"> → Check the settings in F1-10 and F1-11. • The torque limit is set to 0 through CompoBus/D communications. (Applies only to flux vector control.) <ul style="list-style-type: none"> → Set F9-05 to 0 (torque limit disabled).

Fault Display	Meaning	Probable causes and remedies
OPR Oper Disconnect	Faulty Digital Operator connection. The Digital Operator connection was broken during Inverter operation. Detected when the parameter is set as follows: 02-06=1.	<ul style="list-style-type: none"> • Wiring cable is broken. • The Digital Operator or Inverter contacts are faulty. → After disconnecting the connectors and then connecting them again or cleaning the connectors, restart the power supply. • Parameter was set incorrectly. → Set 02-06 to 0. • If the problem persists, replace the cables or Inverter.
EFO Opt External Flt	External fault (Communications/option)	<ul style="list-style-type: none"> • An external fault was input from an Optional Communications Card. → Reset the external fault from the Optional Communications Card. → Remove the cause of the external fault input.
EF3 External Fault 3	External fault (Input terminal 3)	<ul style="list-style-type: none"> • An external fault was input from a multi-function input. → Reset external fault inputs to the multi-function inputs. → Remove the cause of the external fault.
EF4	External fault (Input terminal 4)	
EF5	External fault (Input terminal 5)	
EF6	External fault (Input terminal 6)	
EF7	External fault (Input terminal 7)	
EF8	External fault (Input terminal 8)	
E-15 SI-F/G Com Err	SYSMAC BUS communications error. An error occurred in the SYSMAC BUS communications line, disrupting communications.	<ul style="list-style-type: none"> • The communications line was broken, short-circuited, or wired in reverse. → Check the communications line and correct the trouble. • Hardware on the Master end is faulty. → Check the Master and take necessary measures. • Communications data was damaged due to noise. → Use twisted-pair cables for communications lines and ground all the shields on the Master end. • The Optional Card was damaged. → If wiring is correct and if the problem persists, replace the Optional Card.

Fault Display	Meaning	Probable causes and remedies
<p>BUS Option Com Err</p>	<p>CompoBus/D communications error. Communications error occurred in the CompoBus/D Communications Card.</p>	<ul style="list-style-type: none"> • Communications cable was broken, short-circuited, or wired incorrectly. → Check wiring of communications cables and correct the fault. • Hardware on the Master end is faulty. → Check the Master and take necessary measures. • Data was damaged due to noise. → Change to special communications cables or shielded cables and ground the shields on the Master end or power supply end. → Separate communications cables from other lines and install a noise filter on the power supply. • The Optional Card was damaged. → If wiring is correct and if the problem persists, replace the Optional Card.
<p>CPF00 COM-ERR (OP&INV)</p>	<p>Communications with the Operator were not established within 5 seconds after the power was turned on.</p>	<ul style="list-style-type: none"> • The Digital Operator's connector isn't connected properly. → Disconnect the Digital Operator and then connect it again. • The Inverter CPU's peripheral element is faulty. → Replace the Inverter.
<p>CPF01 COM-ERR (OP&INV)</p>	<p>After communications were established, there was a transmission error with the Digital Operator for more than 2 seconds.</p>	<ul style="list-style-type: none"> • The Digital Operator isn't connected properly. → Disconnect the Digital Operator and then connect it again. • The Inverter CPU's peripheral element is faulty. → Replace the Inverter.
<p>CPF02 BB Circuit Err</p>	<p>Baseblock circuit error</p>	<ul style="list-style-type: none"> → Try turning the power supply off and on again. • The control circuit is damaged. → Replace the Inverter.
<p>CPF03 EEPROM Error</p>	<p>EEPROM error</p>	<ul style="list-style-type: none"> → Try turning the power supply off and on again. • The control circuit is damaged. → Replace the Inverter.
<p>CPF04 Internal A/D Err</p>	<p>CPU internal A/D converter error</p>	<ul style="list-style-type: none"> → Try turning the power supply off and on again. • The control circuit is damaged. → Replace the Inverter.
<p>CPF05 External A/D Err</p>	<p>CPU external A/D converter error</p>	<ul style="list-style-type: none"> → Try turning the power supply off and on again. • The control circuit is damaged. → Replace the Inverter.

Fault Display	Meaning	Probable causes and remedies
CPF06 Option Error	Optional Card connection error	<ul style="list-style-type: none"> The Optional Card isn't connected properly. → Turn off the power and insert the Card again. The Inverter or Optional Card is faulty. → Replace the faulty component.
CPF20 Option A/D Error	Optional Card A/D converter error	<ul style="list-style-type: none"> The Optional Card isn't connected properly. → Turn off the power and insert the Card again. The Optional Card's A/D converter is faulty. → Replace the Optional Card.
CPF21 Option CPU down	Optional Communications Card diagnosis error	<ul style="list-style-type: none"> The Optional Communications Card isn't connected properly. → Turn off the power and insert the Card again. The Optional Communications Card is faulty. → Replace the Optional Communications Card.
CPF22 Option Type Err	Optional Communications card Type error	
CPF23 Option DPRAM Err	Optional Communications Card mutual diagnosis error	

8-1-2 Minor Fault Detection

Minor faults are a type of Inverter protection function that do not operate the fault contact output and are automatically returned to their original status once the cause of the minor fault has been removed. The Digital Operator display flashes and the minor fault is output from the multi-function outputs (H2-01 to H2-03). Take appropriate measures according to the table below.

■ Minor Fault Displays and Processing

Minor fault display	Meaning	Probable causes and remedies
EF (flashing) External Fault	Both the forward and reverse commands have been ON for more than 0.5 s.	<p>→ Check the sequence of the forward and reverse commands.</p> <p>* Since the rotational direction is unknown, the motor will be decelerated to a stop when this minor fault occurs.</p>
UV (flashing) DC Bus Undervolt	The main circuit DC voltage is below the undervoltage detection level (L2-05). 200-V class: Approx. 190 V 400-V class: Approx. 380 V	<ul style="list-style-type: none"> A phase loss occurred with the input power supply. A momentary power interruption occurred. The wiring terminals for the input power supply are loose. The voltage fluctuations in the input power supply are too large. <p>→ Reset the fault after correcting its cause.</p>
OV (flashing) Overvoltage	The main circuit DC voltage exceeded the overvoltage detection level. 200-V class: Approx. 400 V 400-V class: Approx. 800 V	<ul style="list-style-type: none"> The power supply voltage is too high. <p>→ Decrease the voltage so it's within specifications.</p>

Minor fault display	Meaning	Probable causes and remedies
OH (flashing) Heatsink Over tmp	The temperature of the Inverter's cooling fins exceeded the setting in L8-02.	<ul style="list-style-type: none"> • The ambient temperature is too high. → Install a cooling unit. • There is a heat source nearby. → Remove the heat source. • The Inverter's cooling fan has stopped. → Replace the cooling fan. (Contact your OMRON representative.) • High carrier frequency. (400V-class models) → Decrease the C6-01 setting.
OH2 (flashing) Over Heat 2	An OH2 alarm signal (Inverter overheating alarm signal) was input from a multi-function input.	<ul style="list-style-type: none"> • Clear the multi-function input's overheating alarm input.
OL3 (flashing) Overtorque Det 1	There has been a current greater than the setting in L6-02 for longer than the setting in L6-03.	<ul style="list-style-type: none"> → Make sure that the settings in L6-02 and L6-03 are appropriate. → Check the mechanical system and correct the cause of the overtorque.
OL4 (flashing) Overtorque Det 2	There has been a current greater than the setting in L6-05 for longer than the setting in L6-06.	<ul style="list-style-type: none"> → Make sure that the current setting in L6-05 and time setting in L6-06 are appropriate. → Check the mechanical system and correct the cause of the overtorque.
OS (flashing) Over speed	The speed has been greater than the setting in F1-08 for longer than the setting in F1-09.	<ul style="list-style-type: none"> • Overshooting/undershooting are occurring. → Adjust the gain again. • The reference speed is too high. → Check the reference circuit and reference gain. • The settings in F1-08 and F1-09 aren't appropriate. → Check the settings in F1-08 and F1-09.
PGO (flashing) PG open	The PG is disconnected. The Inverter is outputting a frequency, but PG pulses aren't being input.	<ul style="list-style-type: none"> • There is a break in the PG wiring. → Fix the broken/disconnected wiring. • The PG is wired incorrectly. → Fix the wiring. • Power isn't being supplied to the PG. → Supply power to the PG properly. • The torque limit is set to 0 through CompoBus/D communications. (Applies only to flux vector control.) → Set F9-05 to 0 (torque limit disabled).

Minor fault display	Meaning	Probable causes and remedies
DEV (flashing) Speed Deviation	The speed deviation has been greater than the setting in F1-10 for longer than the setting in F1-11.	<ul style="list-style-type: none"> • The load is too large. → Lighten the load. • The acceleration time and deceleration time are too short. → Lengthen the acceleration time and deceleration time. • The load is locked. → Check the mechanical system. • The settings in F1-10 and F1-11 aren't appropriate. → Check the settings in F1-10 and F1-11. • The torque limit is set to 0 through CompoBus/D communications. (Applies only to flux vector control.) → Set F9-05 to 0 (torque limit disabled).
EFO Opt External Flt	External fault (Communications/option)	<ul style="list-style-type: none"> • An external fault was input from an Optional Communications Card. → Reset the external fault from the Optional Communications Card. → Remove the cause of the external fault input.
EF3 (flashing) External Fault 3	External fault (Input terminal 3)	<ul style="list-style-type: none"> • An external fault was input from a multi-function input. → Reset external fault inputs to the multi-function inputs. → Remove the cause of the external fault.
EF4 (flashing)	External fault (Input terminal 4)	
EF5 (flashing)	External fault (Input terminal 5)	
EF6 (flashing)	External fault (Input terminal 6)	
EF7 (flashing)	External fault (Input terminal 7)	
EF8 (flashing)	External fault (Input terminal 8)	
CALL SI-F/G ComCall	SYSMAC BUS CALL error Only 00 was received since communications were established.	<p>Only 00 was transmitted since communications were established and the host was ready.</p> <p>Note The Inverter waits for the host to be ready. Clear this standby state by sending data.</p> <p>→ Correct the program so that data other than 00 is sent first after communications are established.</p>

Minor fault display	Meaning	Probable causes and remedies
<p>E-15 SI-F/G Com Err</p>	<p>SYSMAC BUS communications error. An error occurred in the SYSMAC BUS communications line, disrupting communications.</p>	<ul style="list-style-type: none"> • The communications line was broken, short-circuited, or wired in reverse. → Check the communications line and correct the trouble. • Hardware on the Master end is faulty. → Check the Master and take necessary measures. • Communications data was damaged due to noise. → Use twisted-pair cables for communications lines and ground all the shields on the Master end. • The Optional Card was damaged. → If wiring is correct and if the problem persists, replace the Optional Card.
<p>BUS Option Com Err</p>	<p>CompoBus/D communications error. Communications error occurred in the CompoBus/D Communications Card.</p>	<ul style="list-style-type: none"> • Communications cable was broken, short-circuited, or wired incorrectly. → Check wiring of communications cables and correct the fault. • Hardware on the Master end is faulty. → Check the Master and take necessary measures. • Data was damaged due to noise. → Change to special communications cables or shielded cables and ground the shields on the Master end or power supply end. → Separate communications cables from other lines and install a noise filter on the power supply. • The Optional Card was damaged. → If wiring is correct and if the problem persists, replace the Optional Card.

8-1-3 Operation Errors

After the parameters have been set, an operation error will occur if there is an invalid setting or a contradiction between two parameter settings.

It won't be possible to start the Inverter until the parameters have been set correctly. (The minor fault output and fault contact output will not operate, either.)

When an operation error has occurred, refer to the following table to identify and correct the cause of the errors.

■ Operation Error Displays and Incorrect Settings

Display	Meaning	Incorrect settings
OPE01 kVA Selection	Incorrect Inverter capacity setting	<ul style="list-style-type: none"> The Inverter capacity setting doesn't match the Unit. (Contact your OMRON representative.)
OPE02 Limit	Parameter setting range error	<ul style="list-style-type: none"> The parameter setting is outside of the valid setting range.
OPE03 Terminal	Multi-function input selection error	<ul style="list-style-type: none"> One of the following errors has been made in the multi-function input (H1-01 to H1-06) settings: <ul style="list-style-type: none"> The same setting has been selected for two or more multi-function inputs. An UP or DOWN command was selected independently. (They must be used together.) More than two out of the following four items are set. UP/DOWN commands, Hold Accel/Decel, +Speed/-Speed commands, and Sample/Hold for analog frequency reference. Speed Search 1 (61) and Speed Search 2 (62) were selected at the same time. External Baseblock N.O. (8) and External Baseblock N.C. (9) were selected at the same time. The UP/DOWN commands (10 and 11) were selected while PID control (b5-01) was enabled. The Terminal 13/14 Switch (1F) was selected, but the terminal 14 function selector (H3-09) wasn't set to frequency reference (1F). The +Speed and -Speed commands are not set at the same time. The NO and NC contacts of an emergency stop input are set at the same time.
OPE05 Sequence Select	Optional Card selection error	<ul style="list-style-type: none"> The Optional Card was selected as the frequency reference source by setting b1-01 to 3, but an Optional Card isn't connected.
OPE06 PG Opt Missing	Control mode selection error	<ul style="list-style-type: none"> V/f control with PG feedback was selected by setting A1-02 to 1, but a PG Speed Control Card isn't connected. Flux vector control was selected by setting A1-02 to 3, but a PG Speed Control Card isn't connected.

Display	Meaning	Incorrect settings
OPE07 Analog Selection	Multi-function analog input selection error	<ul style="list-style-type: none"> • The same setting (other than 1F) has been selected for H3-05 and H3-09. • A 3G3IV-PA114B Analog Reference Card is being used and F2-01 is set to 0, but a multi-function input (H1-01 to H1-06) has been set to Option/Inverter Selection (2). • Frequency Bias and Frequency Bias 2 are set at the same time.
OPE08 Function Setting	Function setting error	Functions that cannot be controlled by the current control mode are set. (For example, the torque reference was set in V/f control.)
OPE10 V/f Ptrn Setting	V/f data setting error	<ul style="list-style-type: none"> • Parameters E1-04, E1-06, E1-07, and E1-09 do not satisfy the following conditions: <ul style="list-style-type: none"> • $E1-04 (F_{MAX}) \geq E1-06 (F_A) > E1-07 (F_B) \geq E1-09 (F_{MIN})$
OPE11 CarrFrg / On-Delay	Parameter setting error	<ul style="list-style-type: none"> • One of the following parameter setting errors exists. <ul style="list-style-type: none"> • The carrier frequency upper limit (C6-01) > 5 KHz and the carrier frequency lower limit (C6-02) ≤ 5 KHz. • The carrier frequency gain (C6-03) > 6 and (C6-01) < (C6-02).
ERR (flashing) EEPROM R/W Err	A verification error occurred when writing EEPROM.	<ul style="list-style-type: none"> → Try turning the power supply off and on again. → Try setting the parameters again.

8-2 Troubleshooting

Due to parameter setting errors, faulty wiring, and so on, the Inverter and motor may not operate as expected when the system is started up. If that should occur, use this section as a reference and apply the appropriate measures. If the contents of the fault are displayed, refer to *8-1 Protective and Diagnostic Functions*.

■ If Parameter Constants Cannot Be Set.

- **The display does not change when the Increment and Decrement Keys are pressed.**

- **Passwords do not match.**

If the parameter A1-04 (Password 1) and A1-05 (Password 2) numbers are different, the constants for the initialize mode cannot be changed. Reset the password. If you cannot remember the password, display A1-05 (select password) by pressing the Reset/Select Key and the Menu Key simultaneously while in the A1-04 display. Then reset the password. (Input the reset password in parameter A1-04.)

- **Constant write-in prohibition is input.**

This occurs when “program lockout” (set value: 1B) is set for a multi-function input. If the program lock-out input is OFF, the constants cannot be changed. Turn it ON and then set the constants.

- **The Inverter is operating (drive mode).**

There are some constants that cannot be set during operation. Turn the Inverter off and then make the settings.

- **OPE01 through OPE11 is displayed.**

This is a parameter setting error. The set value for the parameter constant is wrong. Refer to *8-1-3 Operation Errors* and correct the setting.

- **CPF00 or CPF01 is displayed.**

This is a Digital Operator transmission fault. The connection between the Digital Operator and the Inverter may be faulty. Remove the Digital Operator and then re-install it.

■ If the Motor Does Not Operate

- **The motor does not operate when the Run Key on the Digital Operator is pressed.**

- **The operation method setting is wrong.**

If parameter b1-02 (run source) is set to “1” (control circuit terminal), the motor will not operate when the Run Key is pressed. Either press the Local/Remote Key* to switch to Digital Operator operation or set parameter b1-02 to “0” (Digital Operator).

* The Local/Remote Key is enabled (set value: 1) or disabled (set value: 2) by means of parameter o2-01. It is enabled when the drive mode is entered.

- **The Inverter is not in operation mode.**

If the Inverter is not in drive mode, it will remain in ready status and will not start. Press the Menu Key to display the operation mode, and enter the drive mode by pressing the Enter Key.
- **The frequency reference is too low.**

If the frequency reference is set below the frequency set in E1-09 (minimum output frequency), the Inverter will not operate. Raise the frequency reference to at least the minimum output frequency.
- **There is a multi-function analog input setting error.**

If multi-function analog inputs H3-05 and H3-09 are set to “1” (frequency gain), and if no voltage (current) is input, then the frequency reference will be zero. Check to be sure that the set value and analog input value are correct.
- **Frequency reference 2 is specified with multi-step speed operation, and auxiliary frequency reference is not input.**

If multi-function analog input H3-05 is set to “0” (auxiliary frequency reference), and if multi-step speed reference is used, the auxiliary frequency reference will be treated as frequency reference 2. Check to be sure that the set value and analog input value (terminal 16) are correct.

- **The motor does not operate when an external operation signal is input.**
- **The operation method selection is wrong.**

If parameter b1-02 (run source) is set to “0” (Digital Operator), the motor will not operate when an external operation signal is input. Set b1-02 to “1” (control circuit terminal) and try again. Similarly, the motor will also not operate if the Local/Remote Key has been pressed to switch to Digital Operator operation. In that case press the Local/Remote Key* again to return to the original setting.

 - * The Local/Remote Key is enabled (set value: 1) or disabled (set value: 2) by means of parameter o2-01. It is enabled when drive mode is entered.
- **A 3-wire sequence is in effect.**

The input method for a 3-wire sequence is different than when operating by forward/stop and reverse/stop (2-wire sequence). When 3-wire sequence is set, the motor will not operate even when an input terminal suitable for forward/stop and reverse/stop is turned ON. When using a 3-wire sequence, refer to the timing chart on page 5-16 and input the proper signals. When using a 2-wire sequence, set multi-function inputs H1-01 through H1-06 to a value other than 0.
- **The Inverter is not in operation mode.**

If the Inverter is not in operation mode, it will remain in ready status and will not start. Press the Menu Key to display the drive mode, and enter the drive mode by pressing the Enter Key.
- **The frequency reference is too low.**

If the frequency reference is set below the frequency set in E1-09 (minimum output frequency), the Inverter will not operate. Raise the frequency reference to at least the minimum output frequency.
- **There is a multi-function analog input setting error.**

If multi-function analog inputs H3-05 and H3-09 are set to “1” (frequency gain), and if no voltage (current) is input, then the frequency reference will be zero. Check to be sure that the set value and analog input value are correct.
- **Frequency reference 2 is specified with multi-step speed operation and auxiliary frequency reference is not input.**

If multi-function analog input H3-05 is set to “0” (auxiliary frequency reference) and if multi-step speed reference is used, the auxiliary frequency reference will be treated as frequency reference 2. Check to be sure that the set value and analog input value (terminal 16) are correct.

- **The motor stops during acceleration or when a load is connected.**

The load may be too big. The 3G3FV has a stall prevention function and an automatic torque boost function, but the motor responsiveness limit may be exceeded if acceleration is too rapid or if the load is too big. Lengthen the acceleration time or reduce the load. Also consider increasing the motor capacity.

- **The motor only rotates in one direction.**

“Reverse run prohibited” is selected. If b1-04 (prohibition of reverse operation) is set to “1” (reverse run prohibited), the Inverter will not receive reverse run commands. To use both forward and reverse operation, set b1-04 to “0.”

- **If the Direction of the Motor’s Rotation is Reversed**

The motor’s output wiring is faulty. When the Inverter’s T1(U), T2(V), and T3(W) are properly connected to the motor’s T1(U), T2(V), and T3(W), the motor operates in a forward direction when a forward command is executed. The forward direction depends on the maker and the motor type, so be sure to check the specifications. Switching two wires among the T1(U), T2(V), and T3(W) will reverse the direction of rotation.

- **If the Motor Does Not Put Out Torque or If Acceleration is Slow**

- **The torque limit has been reached.**

When a torque limit has been set in parameters L7-01 to L7-04, no torque will be output beyond that limit. This can cause the torque to be insufficient, or the acceleration time to be too long. Check to be sure that the value set for the torque limit is suitable. If the torque limit has been set by multi-function analog inputs H3-05 and H3-09 (set value: 10 to 13), check to be sure that the analog input value is suitable.

- **The stall prevention level during acceleration is too low.**

If the value set for L3-02 (stall prevention level during acceleration) is too low, the acceleration time will be too long. Check to be sure that the set value is suitable.

- **The stall prevention level during running is too low.**

If the value set for L3-06 (stall prevention level during running) is too low, the speed will drop before outputting torque. Check to be sure that the set value is suitable.

- **If the Motor Does Not Operate According to Reference**

- **The motor runs faster than reference.**

- **The frequency reference bias setting is wrong.**

The frequency reference bias set in parameter H3-03 is added to the frequency reference. Check to be sure that the set value is suitable.

- **Frequency bias is set for multi-function analog inputs.**

When “2” (frequency bias) is set for multi-function analog inputs H3-05 and H3-09, a frequency corresponding to the input voltage (current) is added to the frequency reference. Check to be sure that the set value and analog input value are suitable.

- **A signal is being input to the frequency reference (current) terminal 14.**

When “1F” (frequency reference) is set for parameter H3-09 (multi-function analog input terminal 14), a frequency corresponding to the terminal 14 input input voltage (current) is added to the frequency reference. Check to be sure that the set value and analog input value are suitable.

- **The motor does not rotate according to reference.**

Torque control mode is selected. When parameter d5-01 (torque control selection) is set to “1” (torque control), speed control cannot be executed. (Speed limits can be set.) To switch torque control and speed control, set parameter d5-01 to “0” (speed control) and set one of the parameters from H1-01 through H1-06 (multi-function inputs) to “71” (speed/torque control change).

- **If the Slip Compensation Function Has Low Speed Precision**

The slip compensation limit has been reached. With the slip compensation function, compensation cannot be carried out beyond the slip compensation limit set in parameter C3-03. Check to be sure that the set value is suitable.

- **If There is Low Speed Precision at High-speed Rotation in Open-loop Control Mode**

The motor’s rated voltage is high. The Inverter’s maximum output voltage is determined by its input voltage. (For example, if 200 VAC is input, then the maximum output voltage will be 200 VAC.) If, as a result of vector control, the output voltage reference value exceeds the Inverter output voltage maximum value, the speed precision will decrease. Either use a motor with a low rated voltage (i.e., a special motor for use with vector control) or change to flux vector control.

- **If Motor Deceleration is Slow**

- **The deceleration time is long even when control resistance is connected.**

- “Stall prevention during deceleration enabled” is set. When control resistance is connected, set parameter L3-04 (stall prevention selection during deceleration) to “0” (disabled). When this parameter is set to “1” (enabled, the factory-set default), control resistance is not used.

- **The deceleration time setting is too long.**

Check the deceleration time setting (parameters C1-02, C1-04, C1-06, and C1-08).

- **Motor torque is insufficient.**

If the parameter constants are correct and there is no overvoltage fault, then the motor’s power is limited. Consider increasing the motor capacity.

- **The torque limit has been reached.**

When a torque limit has been set in parameters L7-01 to L7-04, no torque will be output beyond that limit. This can cause the deceleration time to be too long. Check to be sure that the value set for the torque limit is suitable. If the torque limit has been set by multi-function analog inputs H3-05 and H3-09 (set value: 10 to 13), check to be sure that the analog input value is suitable.

■ If the Vertical-axis Load Drops When Brake is Applied

• The sequence is incorrect.

The Inverter goes into DC braking status for 0.5 seconds after deceleration is completed. (This is the factory-set default.) To make sure that the brake holds, use the frequency detection function and apply the brake only when the detected frequency drops to 3 to 5 Hz or lower. Also at startup, use the frequency detection function, and release the brake only when the detected frequency is 3 to 5 Hz or higher.

• The DC braking is insufficient.

If the DC braking power is insufficient, adjust parameter b2-02 (DC injection braking current).

• An inappropriate brake is being used.

The holding brake is designed only for holding, not for braking. If the holding brake is used for braking, the brake pad will wear out much faster than designed. Use an appropriate brake for braking.

■ If the Motor Burns Out

• The load is too big.

If the motor's load is too big and the motor is used with the effective torque exceeding the motor's rated torque, the motor will burn out. Also, if the motor's inscription states that the motor is rated for eight hours, for example, the motor's rated torque and capacity may be limited to eight hours of use. If that 8-hour rated torque is used for normal operation it may cause the motor to burn out. Reduce the load amount by either lightening the load or lengthening the acceleration/deceleration time. Also consider increasing the motor capacity.

• The ambient temperature is too high.

The motor's rating is determined within a particular ambient operating temperature range. The motor will burn out if it is run continuously at the rated torque in an environment in which the maximum ambient operating temperature is exceeded. Lower the motor's ambient temperature to within the acceptable ambient operating temperature range.

• The withstand voltage between the motor's phases is insufficient.

When the motor is connected to the Inverter's output, a surge is generated between the Inverter's switching and the motor's coil. Normally the maximum surge voltage is three times the Inverter's input power supply voltage (i.e., 600 V for 200-V class, and 1,200 V for 400-V class). Be sure to use a motor with a withstand voltage between the motor's phases that is greater than the maximum surge voltage. In particular, when using a 400-V-class Inverter, use a special motor for Inverters.

■ If There is Noise When the Inverter is Started or From an AM Radio

If noise is generated by Inverter switching, implement the following measures:

- Lower the Inverter's carrier frequency (parameter C6-01). This will help to some extent by reducing the amount of internal switching.
- Install a 3G3EV-PLNF or 3G3IV-PFN Input Noise Filter at the Inverter's power supply input area.
- Install a 3G3IV-PLF Output Noise Filter at the Inverter's power supply output area.
- Use metal tubing. Electric waves can be shielded by metal, so encase the Inverter with metal (steel).

■ If the Leakage Breaker Operates When the Inverter is Run

The Inverter performs internal switching, so there is a certain amount of leakage current. This may cause the leakage breaker to operate and cut off the power supply. Change to a leakage breaker with a

high leakage detection level (i.e., a sensitivity current of 200 mA or greater per Unit, with an operating time of 0.1 s or more), or one that incorporates high frequency measures (i.e., one designed for use with Inverters).

It will also help to some extent to lower the Inverter's carrier frequency (parameter C6-01). In addition, remember that the leakage current increases as the cable is lengthened. (In general, approximately 5 mA of leakage current occurs for each meter of cable.)

■ If There is Mechanical Vibration

● The machinery is making unusual sounds.

- There may be resonance between the mechanical system's characteristic frequency and the carrier frequency. If the motor is running with no problems and the machinery is vibrating with a high-pitched whine, it may indicate that this is occurring. To prevent this type of resonance, adjust the carrier frequency with parameters C6-01 to C6-03.
- There may be resonance between a machine's characteristic frequency and the output frequency of the Inverter. To prevent this from occurring, either use the jump frequency functions in parameters d3-01 to d3-04 or install rubber padding on the motor base to reduce vibration.

● Vibration and hunting are occurring with open-loop vector control.

The gain adjustment may be insufficient. Reset the gain to a more effective level by adjusting parameters C4-02 (torque compensation time constant), C8-08 (AFR gain), and C3-02 (slip compensation primary delay time) in order. Lower the gain setting and raise the primary delay time setting.

● Vibration and hunting are occurring with V/f control.

The gain adjustment may be insufficient. Reset the gain to a more effective level by adjusting parameters C4-02 (torque compensation time constant), C7-02 (hunting prevention gain), and C3-02 (slip compensation primary delay time) in order. Lower the gain setting and raise the primary delay time setting.

● Vibration and hunting are occurring with flux vector control.

The gain adjustment may be insufficient. Adjust the various types of speed control loop (ASR) gain. (For details, refer to *Chapter 5 Basic Operation* of this manual.) If the mechanical system's resonance point coincides with the Inverter's operating frequency and the vibration cannot be eliminated in this way, increase the ASR primary delay time (parameter C5-06) and then try adjusting the gain again.

● Vibration and hunting are occurring with V/f w/PG control.

The gain adjustment may be insufficient. Adjust the various types of speed control loop (ASR) gain. (For details, refer to *Chapter 5 Basic Operation* of this manual.) If the vibration cannot be eliminated in this way, set the hunting prevention selection (parameter C7-01) to "0" (disabled) and then try adjusting the gain again.

● Vibration and hunting are occurring with PID control.

Check the vibration cycle and individually adjust the P, I, and D. (Refer to page 6-55.)

■ If the Motor Rotates Even When Inverter Output is Stopped

The DC braking is not operating properly. If the motor continues operating at low speed, without completely stopping, and after a deceleration stop has been executed, it means that the DC braking is not decelerating enough. Adjust the DC braking as follows:

- Increase the parameter b2-02 (DC injection braking current) setting.
- Increase the parameter b2-04 (DC injection braking time at stop) setting.

■ If 0 V is Detected When the Fan is Started, or Fan Stalls

DC braking is insufficient at startup. Generation of 0 V and stalling can occur if the fan is turning when it is started. This can be prevented by slowing fan rotation by DC braking before starting the fan. Increase the parameter b2-03 (DC injection braking time at start) setting.

■ If Output Frequency Does Not Rise to Frequency Reference

● The frequency reference is within the jump frequency range.

When the jump frequency function is used, the output frequency does not change within the jump frequency range. Check to be sure that the jump frequency (parameters d3-01 to d3-03) and jump frequency width (parameter d3-04) settings are suitable.

● The frequency reference upper limit has been reached.

The output frequency upper limit is determined by the following formula:

$$\text{Maximum output frequency (E1-04)} \times \text{Frequency reference upper limit (d2-01)} / 100$$

Check to be sure that the parameter E1-04 and d2-01 settings are suitable.

■ Inverter Overload “OL2” is Detected

For a 400-V Inverter, if the carrier frequency “C6-01” is set to a value higher than the default setting, the Inverter overload “OL2” detection value will decrease in consideration of an increase in the heat that will be generated by the change in the carrier frequency. Since the detection value is set to decrease by approximately 15% for every increase of 2 kHz from the default setting, the Inverter overload “OL2” may be detected prior to the motor overload “OL1” depending on the set value. Set the carrier frequency to a lower level.

■ If Inverter Does Not Operate Due to an EF Error (Forward and Reverse Commands Input)

● The sequence is faulty.

The EF error will be detected if the forward command and reverse command are input at the same time for over 0.5 seconds. Check and correct the sequence.

● Stray current causes malfunction.





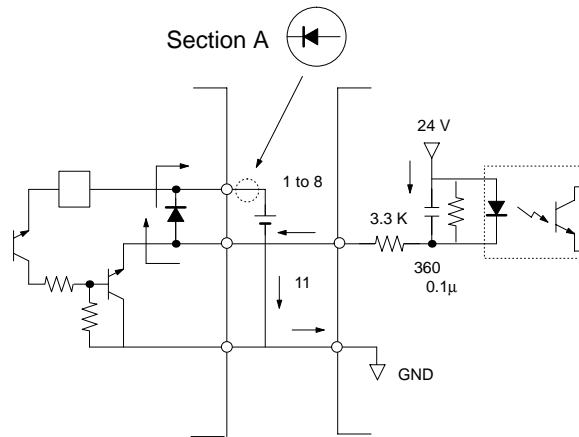

The Inverter input may always remain ON due to stray current from the control section. As shown in the following illustration, a current may flow in the direction shown by an arrow to turn ON the Inverter input

when the power output from the control section is below 24 VDC or when the power is turned OFF. If this occurs, insert a diode as indicated by section A below.



8-3 Maintenance and Inspection

■ Cautions and Warnings

-  **WARNING** Do not touch the Inverter terminals while the power is being supplied.
-  **WARNING** Maintenance or inspection must be performed only after turning OFF the power supply, confirming that the CHARGE indicator (or status indicators) is turned OFF, and after waiting for the time specified on the front cover. Not doing so may result in electrical shock.
-  **WARNING** Maintenance, inspection, or parts replacement must be performed by authorized personnel. Not doing so may result in electrical shock or injury.
-  **WARNING** Do not attempt to take the Unit apart or repair. Doing either of these may result in electrical shock or injury.
-  **Caution** Carefully handle the Inverter because it uses semiconductor elements. Careless handling may result in malfunction.
-  **Caution** Do not change wiring, disconnect connectors, the Operator, or optional items, or replace fans while power is being supplied. Doing so may result in injury, damage to the product, or malfunction.

● Daily Inspection

Check the following items with the system in operation.

- The motor should not be vibrating or making unusual noises.
- There should be no abnormal heat generation.
- The ambient temperature should not be too high.
- The output current value shown on the monitor display should not be higher than normal.
- The cooling fan on the bottom of the Inverter should be operating normally.

● Periodic Inspection

Check the following items during periodic maintenance. Before beginning inspection, be sure to turn off the power supply. Confirm that the LED indicators on the front panel have all turned OFF, and then wait until at least one minute (or at least three minutes for 30 kW or more) has elapsed before beginning the inspection. Be sure not to touch terminals right after the power has been turned off. Doing so can result in electric shock.

- Terminal screws should not be loose.
- There should be no conductive dust or oil mist on the terminal block or inside the Inverter.
- The Inverter's mounting screws should not be loose.

- No dirt or dust should be accumulating on the heating fan unit.
- No dust should be accumulating on the vents.
- There should be no abnormalities in the outward appearance.
- The control panel cooling fan should be operating normally. (Check to be sure that there are no unusual noises or vibration and that the accumulated operating time has not exceeded the specifications.)

● Periodic Maintenance of Parts

The Inverter is configured of many parts, and these parts must be operating properly in order to make full use of the Inverter's functions.

Among the electronic components, there are some that require maintenance depending on their usage conditions. In order to keep the Inverter operating normally over a long period of time, it is necessary to perform period inspections and replace parts according to their service life.

Periodic inspection standards vary depending the Inverter's installation environment and usage conditions.

The Inverter's maintenance periods are noted below. Keep them as reference.

- Cooling fan: 2 to 3 years
- Electrolytic capacitor: 5 years
- Fuses: 10 years

The usage conditions are as follows:

- Ambient temperature 40°C
- Load factor: 80%
- Operating time: 8 hours per day
- Installation: According to instructions in manual.

If the maintenance period is extended, it is recommended that the ambient temperature be lowered and that the power-on time be reduced as much as possible.

Note For details regarding maintenance, consult your OMRON sales representative.

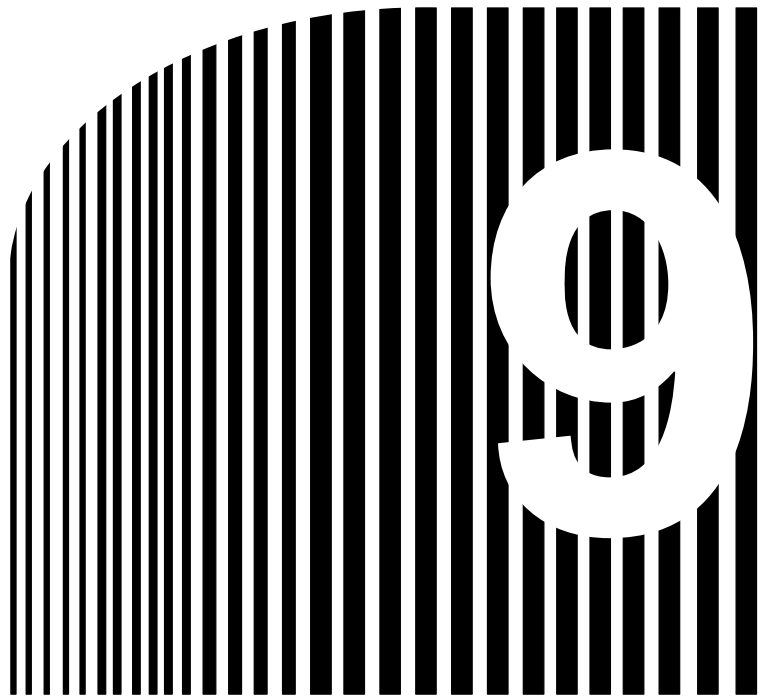

Chapter 9

• Specifications •

- 9-1 Inverter Specifications
- 9-2 Option Specifications

9-1 Inverter Specifications

General Specifications for 200-V Inverters

Model number 3G3FV-	A2004	A2007	A2015	A2022	A2037	A2055	A2075	A2110	A2150	B2185	B2220	B2300	B2370	B2450	B2550	B2750 -E
Max. applica- ble motor ca- pacity (kW)	0.4	0.75	1.5	2.2	3.7	5.5	7.5	11	15	18.5	22	30	37	45	55	75
Output characteristics																
Rated output capacity (kVA)	1.2	2.3	3.0	4.2	6.7	9.5	13	19	24	30	37	50	61	70	85	110
Rated output current (A)	3.2	6.0	8.0	11	17.5	25	33	49	64	80	96	130	160	183	224	300
Max. output voltage (V)	3-phase, 200 to 230 VAC (Corresponds to input voltage.)															
Max. output frequency (Hz)	400 Hz (Set by parameter.)															
Power supply characteristics																
Rated volt- age (V) Rated fre- quency (Hz)	3-phase, 200 to 230 VAC, 50/60 Hz															
Allowable voltage fluc- tuation	-15% to 10%															
Allowable frequency fluctuation	±5%															
Power con- sumption (kW)	0.07	0.09	0.12	0.14	0.22	0.30	0.35	0.59	0.73	0.89	1.2	1.4	1.8	2.1	2.7	3.3
Approximate weight (kg)	3.0	3.0	3.0	4.5	4.5	5.5	6.0	11	11	28	28	61	62	80	80	135

Control Characteristics

Model number 3G3FV-	A2004	A2007	A2015	A2022	A2037	A2055	A2075	A2110	A2150	B2185	B2220	B2300	B2370	B2450	B2550	B2750 -E
Power supply harmonic countermeasures	DC reactor (option) connection possible.									DC reactor built in						
Control method	Sine wave PWM (high-carrier frequency control)															
Carrier frequency	0.4 to 15 kHz (2.0 to 15 kHz in vector control)										0.4 to 10 kHz (2.0 to 10 kHz in vector control)					
Speed control range	1:100 (1:1000 with PG)															
Speed control precision	$\pm 0.2\%$ ($\pm 0.02\%$ with PG)															
Speed control response	5 Hz (30 Hz with PG)															
Torque characteristics	150% at 1 Hz (150% at 0 rpm with PG). A torque limit function is incorporated.															
Torque control precision	$\pm 5\%$ (with PG)															
Torque control response	40 Hz (with PG)															
Frequency control range	0.1 to 400 Hz															
Frequency precision (temperature characteristics)	Digital references: $\pm 0.01\%$ (-10 to 40°C) Analog references: $\pm 0.1\%$ ($25 \pm 10^\circ\text{C}$)															
Frequency setting resolution	Digital references: 0.01 Hz (Less than 100 Hz), 0.1 Hz (100 Hz or higher) Analog references: 0.03 Hz/60 Hz (11 bits + sign)															
Output frequency resolution	0.001 Hz															
Overload capacity	150% of rated current for one minute															
Frequency setting signal	0 to ± 10 VDC (20 k Ω), 0 to 10 VDC (20 k Ω) voltage input or 4 to 20 mA (250 Ω) current input															
Acceleration/Deceleration time	0.01 to 6000.0 s (4 selectable combinations of independent acceleration and deceleration settings)															
Braking torque	Approximately 20% (Increment possible with an external braking resistor.)															
Voltage/frequency characteristics	Select vector control, one from 15 types of fixed V/f patterns, or set a user V/f pattern.															

Protective Functions

Model number 3G3FV-	A2004	A2007	A2015	A2022	A2037	A2055	A2075	A2110	A2150	B2185	B2220	B2300	B2370	B2450	B2550	B2750 -E
Motor protection	Protection by electronic thermal.															
Instantaneous overcurrent protection	Stops at approx. 200% of rated output current.															
Overload protection	Stops in one minute at approx. 150% of rated output current.															
Overvoltage protection	Stops when main-circuit DC voltage is approx. 410 V.															
Undervoltage protection	Stops when main-circuit DC voltage is approx. 190 V.															
Momentary power interruption compensation (selection)	Stops for 15 ms or more. By selecting the momentary power interruption mode, operation can be continued if power is restored within 2 s.															
Cooling fin overheating	Protection by thermistor.															

Model number 3G3FV-	A2004	A2007	A2015	A2022	A2037	A2055	A2075	A2110	A2150	B2185	B2220	B2300	B2370	B2450	B2550	B2750 -E
Grounding protection	Protection by electronic circuits.															
Charge indicator (internal LED)	Lit when the main circuit DC voltage is approx. 50 V or more.															

Environment

Model number 3G3FV-	A2004	A2007	A2015	A2022	A2037	A2055	A2075	A2110	A2150	B2185	B2220	B2300	B2370	B2450	B2550	B2750 -E
Location	Indoors (no corrosive gas, oil spray, metallic dust, etc.)															
Ambient operating temperature	-10 to 45°C (NEMA1 type: -10 to 40°C)										-10° to 45°C (Open chassis type)					
Ambient operating humidity	90% RH max. (with no condensation)															
Storage temperature	-20 to 60°C															
Altitude	1,000 m max.															
Insulation resistance	5 MΩ min. (Do not carry out the insulation resistance test or withstand voltage test.)															
Vibration withstand	Vibration frequency less than 20 Hz, 9.8 m/s ² {1G} max.; 20 to 50 Hz, 2 m/s ² {0.2G} max															
Protective structure	Both enclosed NEMA1 type and open chassis type: IP00										Open chassis type: IP00					

General Specifications for 400-V Inverters

Model number 3G3FV-	A4004	A4007	A4015	A4022	A4037	A4055	A4075	A4110	A4150	B4185	B4220	B4300	B4370	B4450	B4550	B4750 -E	B411K -E	B416K -E	B418K -E	B422K -E	B430K -E
Max. applicable motor capacity (kW)	0.4	0.75	1.5	2.2	3.7	5.5	7.5	11	15	18.5	22	30	37	45	55	75	110	160	185	220	300
Output characteristics																					
Rated output capacity (kVA)	1.4	2.6	3.7	4.7	6.1	11	14	21	26	31	37	50	61	73	98	130	170	230	260	340	460
Rated output current (A)	1.8	3.4	4.8	6.2	8.0	14	18	27	34	41	48	65	80	96	128	165	224	302	340	450	605
Max. output voltage (V)	3-phase, 380 to 460 VAC (Corresponds to input voltage.)																				
Max. output frequency (Hz)	400 Hz (Set by parameter.)																				
Power supply characteristics																					
Rated voltage (V) Rated frequency (Hz)	3-phase, 380 to 460 VAC, 50/60 Hz																				
Allowable voltage fluctuation	-15% to 10%																				
Allowable frequency fluctuation	±5%																				
Power consumption (kW)	0.06	0.09	0.11	0.13	0.15	0.22	0.36	0.46	0.57	0.66	0.88	1.1	1.3	1.4	1.9	2.4	3.1	4.2	5.0	6.9	9.8
Approximate weight (kg)	3.0	3.0	4.0	4.5	4.5	6.0	6.0	11	11	27	27	44	44	44	79	80	135	145	360	360	420

Control Characteristics

Model number 3G3FV-	A4004	A4007	A4015	A4022	A4037	A4055	A4075	A4110	A4150	B4185	B4220	B4300	B4370	B4450	B4550	B4750 -E	B411K -E	B416K -E	B418K -E	B422K -E	B430K -E
Power supply harmonic countermeasures	DC reactor (option) connection possible.									DC reactor built in									No item		
Control method	Sine wave PWM (high-carrier frequency control)																				
Carrier frequency	0.4 to 15 kHz (2.0 to 15 kHz in vector control)												0.4 to 10 kHz (2.0 to 10 kHz in vector control)						0.4 to 2.5 kHz (2.0 to 2.5 kHz in vector control)		
Speed control range	1:100 (1:1000 with PG)																				
Speed control precision	±0.2% (±0.02% with PG)																				
Speed control response	5 Hz (30 Hz with PG)																				
Torque characteristics	150% at 1 Hz (150% at 0 rpm with PG). A torque limit function is incorporated.																				
Torque control precision	±5% (with PG)																				
Torque control response	40 Hz (with PG)																				
Frequency control range	0.1 to 400 Hz																				
Frequency precision (temperature characteristics)	Digital references: ±0.01% (-10 to 40°C) Analog references: ±0.1% (25±10°C)																				
Frequency setting resolution	Digital references: 0.01 Hz (Less than 100 Hz), 0.1 Hz (100 Hz or higher) Analog references: 0.03 Hz/60 Hz (11 bits + sign)																				
Output frequency resolution	0.001 Hz																				
Overload capacity	150% of rated current for one minute																				
Frequency setting signal	0 to ±10 VDC (20 kΩ), 0 to 10 VDC (20 kΩ) voltage input or 4 to 20 mA (250 Ω) current input																				
Acceleration/Deceleration time	0.01 to 6000.0 s (4 selectable combinations of independent acceleration and deceleration settings)																				
Braking torque	Approximately 20% (Increment possible with an external braking resistor.)																				
Voltage/frequency characteristics	Select vector control, one from 15 types of fixed V/f patterns, or set a user V/f pattern.																				

Protective Functions

Model number 3G3FV-	A4004	A4007	A4015	A4022	A4037	A4055	A4075	A4110	A4150	B4185	B4220	B4300	B4370	B4450	B4550	B4750 -E	B411K -E	B416K -E	B418K -E	B422K -E	B430K -E
Motor protection	Protection by electronic thermal.																				
Instantaneous overcurrent protection	Stops at approx. 200% of rated output current.																				
Overload protection	Stops in one minute at approx. 150% of rated output current.																				
Overvoltage protection	Stops when main-circuit DC voltage is approx. 820 V.																				
Undervoltage protection	Stops when main-circuit DC voltage is approx. 380 V.																				
Momentary power interruption compensation (selection)	Stops for 15 ms or more. By selecting the momentary power interruption mode, operation can be continued if power is restored within 2 s.																				
Cooling fin overheating	Protection by thermistor.																				
Grounding protection	Protection by electronic circuits.																				
Charge indicator (internal LED)	Lit when the main circuit DC voltage is approx. 50 V or more.																				





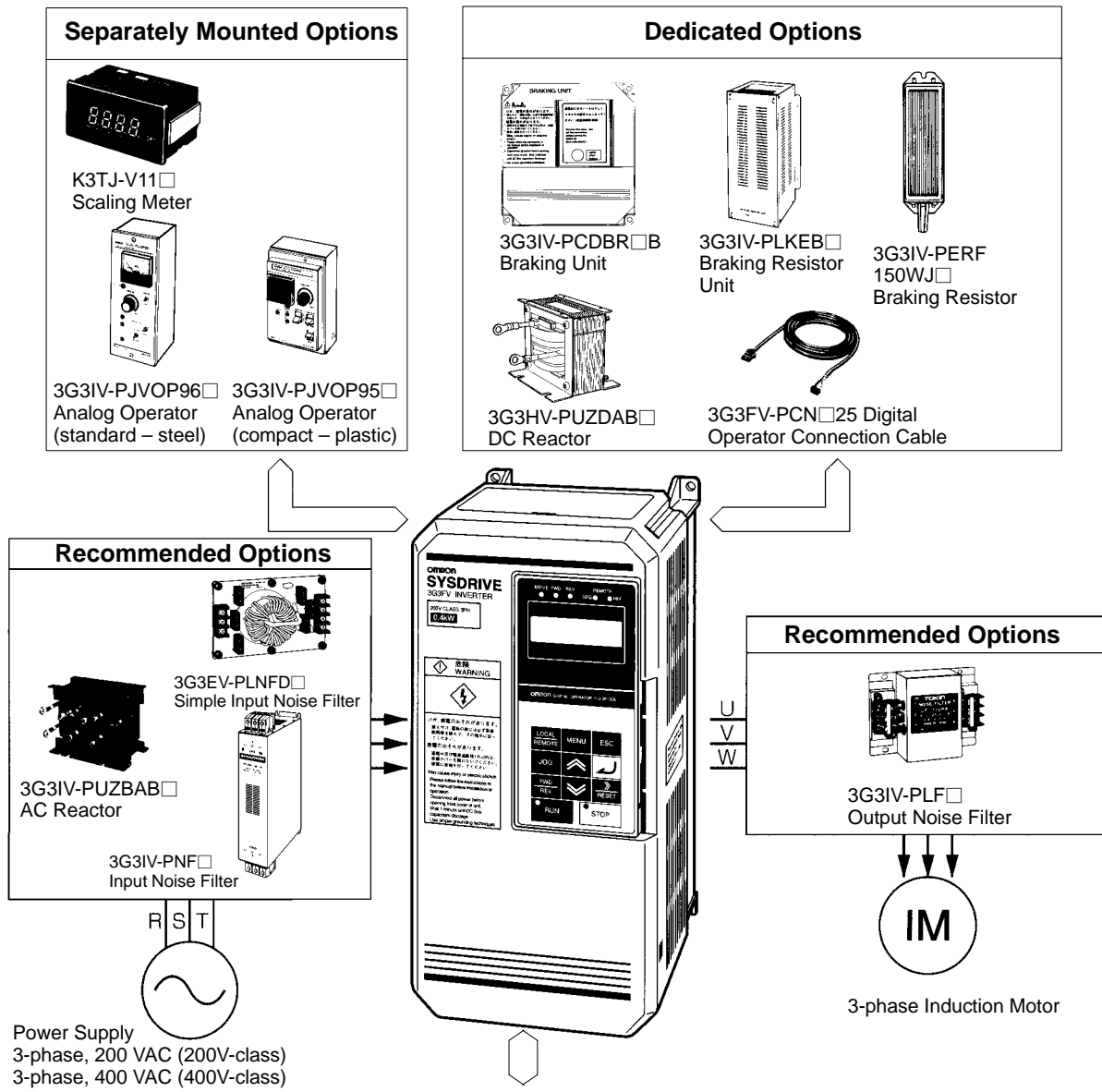

Environment

Model number 3G3FV-	A4004	A4007	A4015	A4022	A4037	A4055	A4075	A4110	A4150	B4185	B4220	B4300	B4370	B4450	B4550	B4750 -E	B411K -E	B416K -E	B418K -E	B422K -E	B430K -E
Location	Indoors (no corrosive gas, oil spray, metallic dust, etc.)																				
Ambient operating temperature	-10 to 45°C (NEMA1 type: -10 to 40°C)										-10° to 45°C (Open chassis type)										
Ambient operating humidity	90% RH max. (with no condensation)																				
Storage temperature	-20 to 60°C																				
Altitude	1,000 m max.																				
Insulation resistance	5 MΩ min. (Do not carry out the insulation resistance test or withstand voltage test.)																				
Vibration withstand	Vibration frequency less than 20 Hz, 9.8 m/s ² {1G} max.; 20 to 50 Hz, 2 m/s ² {0.2G} max																				
Protective structure	Both enclosed NEMA1 type and open chassis type: IP00										Open chassis type: IP00										

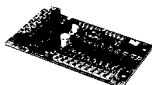
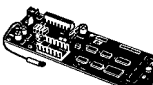
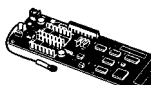
9-2 Option Specifications

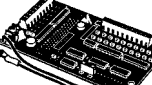
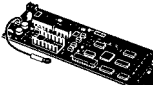
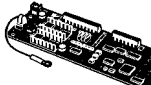

Optional Cards

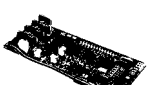
 3G3IV-PAI14U Analog Reference Card	 3G3IV-PDI08 Digital Reference Card	 3G3FV-PPGA2 PG Speed Control Card	 3G3FV-PPGD2 PG Speed Control Card	 3G3VF-PDRT1-SIN CompoBus/D Commu- nications Card	 3G3IV-PAO08 Analog Monitor Card	 3G3IV-PPO36F Pulse Monitor Card
 3G3IV-PAI14B Analog Reference Card	 3G3FV-PDI16H2 Digital Reference Card	 3G3FV-PPGB2 PG Speed Control Card	 3G3FV-PPGX2 PG Speed Control Card	 3G3IV-PSIG SYSMAC Bus (Wire) I/F Card	 3G3IV-PAO12 Analog Monitor Card	

■ Separately Mounted Options

Name	Model	Descriptions
Scaling Meter	K3TJ-V11□	Connects to the multi-functional analog output of the Inverter. It displays the rotational speed of a machine or the line speed.
Analog Operator (steel: standard type)	3G3IV-PJVOP96□	Allows frequency reference settings and ON/OFF operation control to be performed by analog references from a remote location (50 m max.). Frequency counter specifications: 75 Hz, 150 Hz, 220 Hz
Analog Operator (plastic: compact type)	3G3IV-PJVOP95□	Allows frequency reference settings and ON/OFF operation control to be performed by analog references from a remote location (50 m max.). Frequency counter specifications: 60/120 Hz, 90/180Hz

■ Dedicated Options

Name	Model	Descriptions
Braking Unit	3G3IV-PCDBR□B	Used in combination with a Braking Resistor Unit for reducing motor's deceleration time. Not necessary for 200V-class models of 7.5 kW max. or 400V-class models of 15 kW max.
Braking Resistor Unit	3G3IV-PLKEB□	Consumes the regenerative energy of the motor and reduces the deceleration time of the motor.
Braking Resistor	3G3IV-PERF 150WJ□01	Used for 200-V class of 3.7 kW max. and 400-V class of 2.2 kW max. Consumes the regenerative energy of the motor and reduces the deceleration time of the motor.
DC Reactor	3G3HV-PUZDAB□	Suppresses the harmonic currents of the 3G3FV and improves the power factor of the 3G3FV. Models of 18.5 kW or more have a built-in DC Reactor.
Digital Operator Connection Cable	3G3FV-PCN125 (1 m) 3G3FV-PCN325 (3 m)	A dedicated cable for the 3G3FV Series. Used to connect the 3G3FV and Digital Operator when they are separated.

■ **Optional Cards**

Name	Model	Descriptions
Analog Reference Card	3G3IV-PAI14U	The 3G3FV incorporates analog input terminals for frequency references with a resolution of 1/2,048. This card increases the resolution to 1/16,384.
	3G3IV-PAI14B	Allows -10- to 10-VDC frequency reference inputs with a resolution of 1/8,192 + sign. Forward and reverse rotation is selected with the polarity of the input voltage.
Digital Reference Card	3G3IV-PDI08	Used to set frequency references in 2-digit BCD or 8-bit binary.
	3G3FV-PDI16H2	Used to set frequency references with 16 or 12 bits (switchable). A parameter setting can be used to select BCD or binary data. The card incorporates a 24-VDC battery (8 mA max.).
Analog Monitor Card	3G3IV-PAO08	Makes it possible to use the analog output of the terminals as control signals. The card, which has two-point, 0 to 10 V analog output, is used to monitor the output frequency, output current, output voltage reference, or DC voltage of the 3G3FV. The 3G3IV-PAO08 has an output resolution of 1/256 (output voltage of 0 to 10 V) and the 3G3IV-PAO12 has an output resolution of 1/2,048 (output voltage of 0 to ±10 V).
	3G3IV-PAO12	
Pulse Monitor Card	3G3IV-PPO36F	Used to output pulse-train signals according to the output frequency of the 3G3FV. The pulse-train signals can be input to another device such as a frequency meter or counter.
PG Speed Control Card	3G3FV-PPGA2	Used for V/f control using the PG at a maximum response frequency of 30 kHz for phase-A (single) pulse input for open-collector output. Pulse monitor output is incorporated.
	3G3FV-PPGB2	Used for vector control using the PG at a maximum response frequency of 30 kHz for phase-A/phase-B inputs for open-collector output. Pulse monitor output is incorporated.
	3G3FV-PPGD2	Used for V/f control using the PG at a maximum response frequency of 300 kHz for phase-A (single) pulse input and RS-422 line driver input. Pulse monitor output is incorporated.
	3G3FV-PPGX2	Used for vector control using the PG at a maximum response frequency of 300 kHz for phase-A/phase-B/phase-Z pulse inputs and RS-422 line driver input. Pulse monitor output is incorporated.
Wired SYSMAC BUS Interface Card	3G3IV-PSIG	Used to operate via Wired SYSMAC BUS Interface Card communications.
CompoBus/D (DeviceNet) Communications Card	3G3FV-PDRT1-SIN	Used to operate via DeviceNet communications.

Note 1. Use the Digital Reference Card when setting frequencies digitally from a PC's Output Unit or thumbwheel switches.

Note 2. Use the PG Speed Control Card for speed control with the Pulse Generator (PG).

■ **Recommended Options**

Name	Model	Descriptions
AC Reactor	3G3IV-PUZBAB□	Used if the harmonic currents of the 3G3FV must be suppressed or the capacity of the power supply connected to the 3G3FV is much larger than the capacity of the 3G3FV. The AC Reactor improves the power factor of the 3G3FV.
Input Noise Filter	3G3EV-PLNFD□ 3G3IV-PFN□	Used to eliminate noise coming into the inverter from the power supply line and to reduce noise flowing from the inverter into the power supply line. Connect to the power supply input side.
Output Noise Filter	3G3IV-PLF□	Used to suppress noise that is generated by the inverter from affecting the power supply side. Connect to the motor output side.

■ Separately Mounted Options

● Scaling Meter

K3TJ-V11



By connecting to the Inverter's multi-function analog output (analog monitor), it is possible to display the number of rotations, line speed, and so on.

● Standard Models

Model	Control power supply	Display
K3TJ-V111R	100 to 200 VAC	Red LED indicator
K3TJ-V111G		Green LED indicator
K3TJ-V116R	24 VDC with insulation (See note.)	Red LED indicator
K3TJ-V116G		Green LED indicator

Note The power supply circuit and input circuit are insulated.

● Standard Specifications

Sampling time	0.5 s
Display refresh period	0.5 s
Process value averaging method	Simple average or movement average
Number of process value averaging operations	1, 2, 4, or 8 times
Max. displayed digits	4 digits (−1,999 to +9,999)
Display	7-segment red or green LED with character height of 14.2 mm
Decimal display	Selected by the Up and Down Keys and parameter selector
Scaling function	Shift/Scaling adjustment is possible with the Up and Down Keys and parameter selector
Scaling range	−1,999 to +9,999
Zero-limit range	0 to 99 digits
Overflow display	Flashes
Zero-suppress function	Yes
External control	Process value hold (by short-circuiting the rear terminals)
Enclosure rating (conforming to IEC standards)	Front panel: IP51 (see note) Case: IP20 Terminals: IP00
Memory protection	Non-volatile memory (no backup battery required)

Note IP51 ensured when the optional K32-L49SC Water-resistive Soft Front Cover is used and IP50 when it is not.

● **Wiring Example**

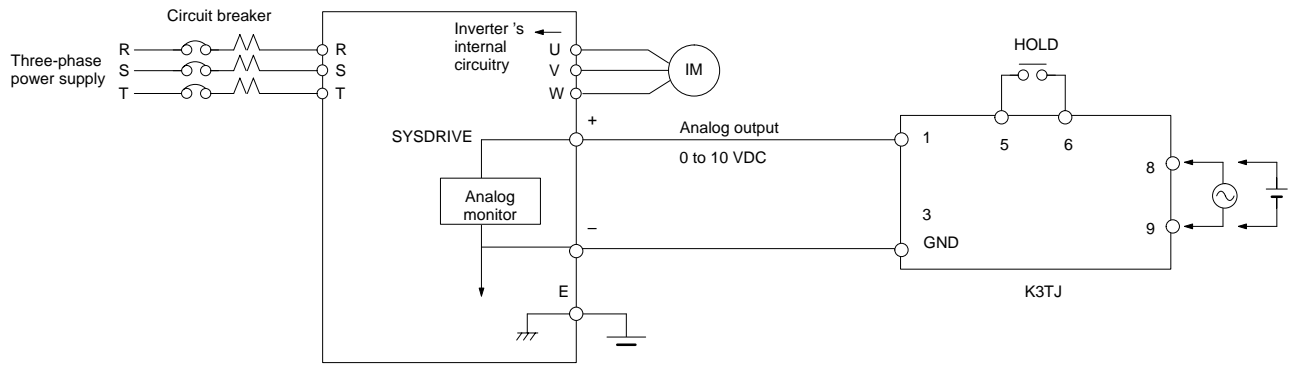

● **External Dimensions**

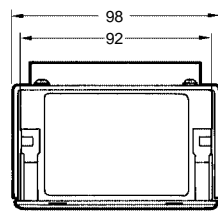

Panel Cutouts (Recommended)

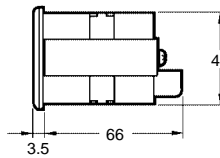
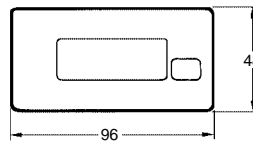
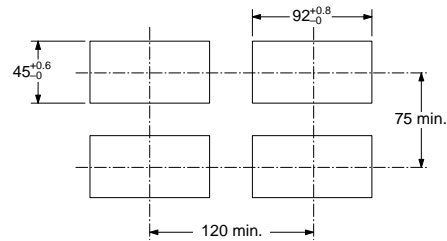

LED Display Character Size

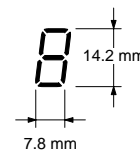

Weight: 200 g

● **Analog Operators**

3G3IV-PJVOP96□ Analog Operator (Standard Steel-plate Type)

The 3G3IV-PJVOP96□ Analog Operator is a control panel that allows frequency and run/stop operation by analog references from a distance (50 m). Frequency scale: 75 Hz, 150 Hz, 220 Hz.

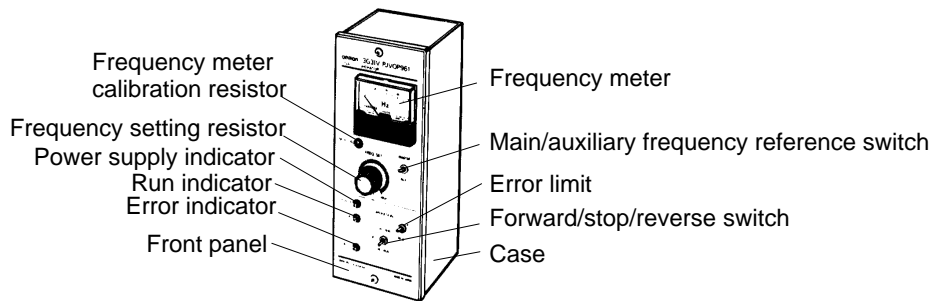

● **Standard Models**

Model	Frequency meter specifications
3G3IV-PJVOP961	DCF-6A 3 V 1 mA 75 Hz
3G3IV-PJVOP962	DCF-6A 3 V 1 mA 150 Hz
3G3IV-PJVOP963	DCF-6A 3 V 1 mA 220 Hz

● External Dimensions (mm)

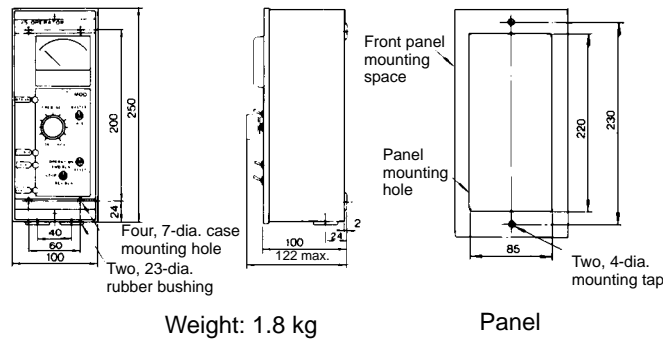

3G3IV-PJVOP95□ Analog Operator (Compact Plastic Type)

The 3G3IV-PJVOP95□ Analog Operator is a control panel that allows frequency and run/stop operation by analog references from a distance (50 m). Frequency scale: 60/120 Hz, 90/180 Hz.

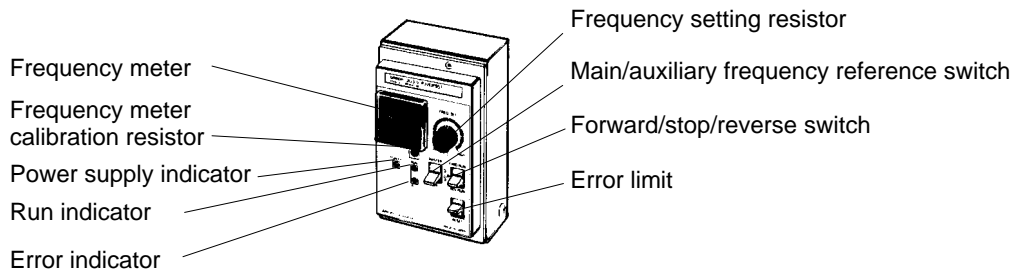

● Standard Models

Model	Frequency meter specifications
3G3IV-PJVOP951	TRM-45 3 V 1 mA 60/120 Hz
3G3IV-PJVOP952	TRM-45 3 V 1 mA 90/180 Hz

● External Dimensions (mm)

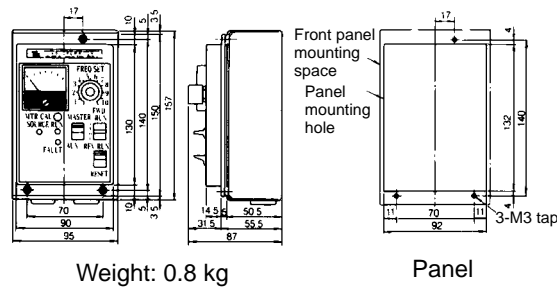

■ Dedicated Options

● Braking Unit

3G3IV-PCDBR□B

The 3G3IV-PCDBR□B is used in combination with a Braking Resistor Unit to shorten the motor's deceleration time. It is not serviceable at 200-V-class, 5 kW, or 400-V-class, 15 kW, or less.



● Standard Models

Inverter		Braking Unit	
Voltage class	Max. applicable motor capacity (kW)	Model	Number used
200-V class	11	3G3IV-PCDBR2015B	1
	15	3G3IV-PCDBR2015B	1
	18.5	3G3IV-PCDBR2022B	1
	22	3G3IV-PCDBR2022B	1
	30	3G3IV-PCDBR2015B	2
	37	3G3IV-PCDBR2015B	2
	45	3G3IV-PCDBR2022B	2
	55	3G3IV-PCDBR2022B	2
	75	3G3IV-PCDBR2022B	3
400-V class	18.5	3G3IV-PCDBR4030B	1
	22	3G3IV-PCDBR4030B	1
	30	3G3IV-PCDBR4030B	1
	37	3G3IV-PCDBR4045B	1
	45	3G3IV-PCDBR4045B	1
	55	3G3IV-PCDBR4030B	2
	75	3G3IV-PCDBR4045B	2
	110	3G3IV-PCDBR4030B	3
	160	3G3IV-PCDBR4045B	4
	185	3G3IV-PCDBR4045B	4
	220	3G3IV-PCDBR4045B	5
	300	3G3IV-PCDBR4045B	6

● Braking Unit Dimensions (mm)

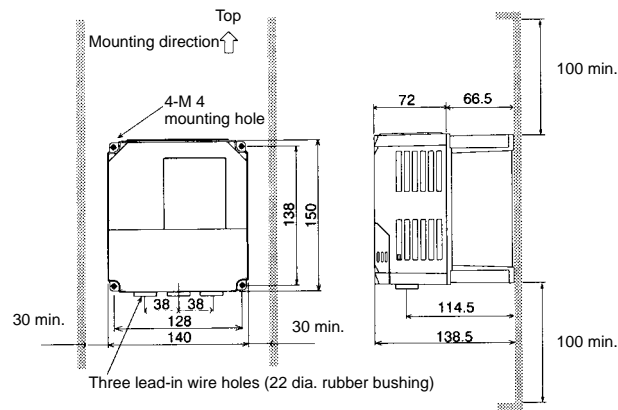

● Braking Resistor Unit (Yaskawa Electric)

3G3IV-PLKEB□

The 3G3IV-PLKEB□ shortens deceleration time by consuming the motor's regenerative energy by means of a resistor. (Usage rate: 10% ED)

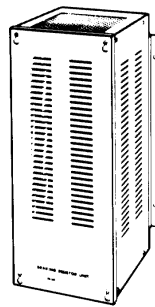

Note The “usage rate: 10% ED” means that 10% of the operating time in one cycle can be used for braking (deceleration).

• Standard Models

Inverter		3G3IV- PLKEB□	Resistor specifications (For one Unit)	Number of Units (See note.)		Approx. braking torque (10% ED)	Minimum connection resistance (Ω)
Voltage class	Maximum applicable motor capacity (kW)			Used	Connectible		
				200-V class	0.4		
	0.75	20P7	70 W 200 Ω	1	4	125%	48
	1.5	21P5	260 W 100 Ω	1	5	125%	16
	2.2	22P2	260 W 70 Ω	1	7	120%	9.6
	3.7	23P7	390 W 40 Ω	1	4	125%	9.6
	5.5	25P5	520 W 30 Ω	1	3	115%	9.6
	7.5	27P5	780 W 20 Ω	1	2	125%	9.6
	11	2011	2400 W 13.6 Ω	1	1	125%	9.6
	15	2015	3000 W 10 Ω	1	1	125%	9.6
	18.5	2018	4800 W 8 Ω	1	1	125%	6.4
	22	2022	4800 W 6.8 Ω	1	1	125%	6.4
	30	2015	3000 W 10 Ω	2	1	125%	9.6
	37	2015	3000 W 10 Ω	2	1	100%	9.6
	45	2022	4800 W 6.8 Ω	2	1	120%	6.4
	55	2022	4800 W 6.8 Ω	2	1	100%	6.4
	75	2022	4800 W 6.8 Ω	3	1	110%	6.4
400-V class	0.4	40P7	70 W 750 Ω	1	11	230%	64
	0.75	40P7	70 W 750 Ω	1	11	130%	64
	1.5	41P5	260 W 400 Ω	1	6	125%	64
	2.2	42P2	260 W 250 Ω	1	7	135%	32
	3.7	43P7	390 W 150 Ω	1	4	135%	32
	5.5	45P5	520 W 100 Ω	1	3	135%	32
	7.5	47P5	780 W 75 Ω	1	2	130%	32
	11	4011	1040 W 50 Ω	1	2	135%	20
	15	4015	1560 W 40 Ω	1	2	125%	20
	18.5	4018	4800 W 32 Ω	1	1	125%	19.2
	22	4022	4800 W 27.2 Ω	1	1	125%	19.2
	30	4030	6000 W 20 Ω	1	1	125%	19.2
	37	4037	9600 W 16 Ω	1	1	125%	12.8
	45	4045	9600 W 13.6 Ω	1	1	125%	12.8
	55	4030	6000 W 20 Ω	2	1	135%	19.2
	75	4045	9600 W 13.6 Ω	2	1	145%	12.8
	110	4030	6000 W 20 Ω	3	1	100%	19.2
	160	4045	9600 W 13.6 Ω	4	1	140%	12.8
	185	4045	9600 W 13.6 Ω	4	1	120%	12.8
	220	4045	9600 W 13.6 Ω	5	1	125%	12.8
	300	4045	9600 W 13.6 Ω	6	1	110%	12.8

Note 1. The *Connectable* column indicates the maximum number of Braking Resistor Units that can be connected to a single Inverter or Braking Unit.

Note 2. Do not use a resistor with a resistance of less than the minimum connection resistance shown above. Otherwise, the Inverter or Braking Unit will be damaged.

• Braking Resistor Unit Dimensions (mm)

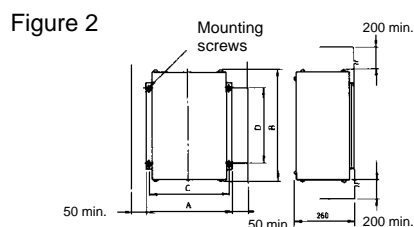
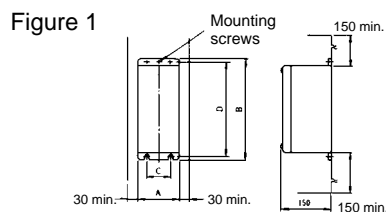

• 200-V Class

3G3IV-PLKEB□	Figure	Dimensions (mm)					Screws	Weight (kg)
		A	B	C	D			
20P7	1	105	275	50	260	M5 x 3	3.0	
21P5	1	130	350	75	335	M5 x 4	4.5	
22P2	1	130	350	75	335	M5 x 4	4.5	
23P7	1	130	350	75	335	M5 x 4	5.0	
25P5	1	250	350	200	335	M6 x 4	7.5	
27P5	1	250	350	200	335	M6 x 4	8.5	
2011	2	266	543	246	340	M8 x 4	10	
2015	2	356	543	336	340	M8 x 4	15	
2018	2	446	543	426	340	M8 x 4	19	
2022	2	446	543	426	340	M8 x 4	19	

• 400-V Class

3G3IV-PLKEB□	Figure	Dimensions (mm)					Screws	Weight
		A	B	C	D			
40P7	1	105	275	50	260	M5 x 3	3.0	
41P5	1	130	350	75	335	M5 x 4	4.5	
42P2	1	130	350	75	335	M5 x 4	4.5	
43P7	1	130	350	75	335	M5 x 4	5.0	
45P5	1	250	350	200	335	M6 x 4	7.5	
47P5	1	250	350	200	335	M6 x 4	8.5	
4011	2	350	412	330	325	M6 x 4	16	
4015	2	350	412	330	325	M6 x 4	18	
4018	2	446	543	426	340	M8 x 4	19	
4022	2	446	543	426	340	M8 x 4	19	
4030	2	356	956	336	740	M8 x 4	25	
4037	2	446	956	426	740	M8 x 4	33	
4045	2	446	956	426	740	M8 x 4	33	

● Braking Resistor (Yaskawa Electric)

3G3IV-PERF150WJ □

The 3G3IV-PERF150WJ □ shortens deceleration time by consuming the motor's regenerative energy by means of a resistor. (Usage rate: 3% ED)



Note The “usage rate: 3% ED” means that 3% of the operation time in one cycle can be used for braking (deceleration).

● Standard Models

Inverter		Braking Resistor			Approx. braking torque (3% ED)
Voltage class	Maximum applicable motor capacity (kW)	3G3IV-PERF150WJ □	Resistor specifications	Number used	
200-V class	0.4	201	150 W 200 Ω	1	220%
	0.75	201	150 W 200 Ω	1	125%
	1.5	101	150 W 100 Ω	1	125%
	2.2	700	150 W 70 Ω	1	120%
	3.7	620	150 W 62 Ω	1	100%
400-V class	0.4	751	150 W 750 Ω	1	230%
	0.75	751	150 W 750 Ω	1	130%
	1.5	401	150 W 400 Ω	1	125%
	2.2	301	150 W 300 Ω	1	115%
	3.7	201	150 W 200 Ω	1	110% (See note.)

Note Usage rate: 2%.

● External Dimensions (mm)

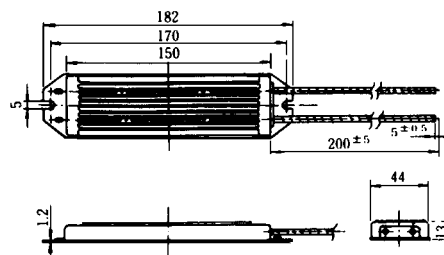

● Digital Operator Connecting Cable

3G3FV-PCN□25

This is a special cable for the 3G3FV Series. It is used for connecting the Inverter to the Digital Operator. The cable length can be either 1 or 3 meters.

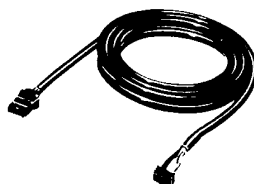

● Standard Models

3G3FV-PCN125	Cable length: 1 meter
3G3FV-PCN325	Cable length: 3 meters

● DC Reactor (Yaskawa Electric)

3G3HV-PUZDAB□A□MH

This DC Reactor is used for controlling harmonic current generated by the Inverter. It is more effective than an AC reactor, and can be used in conjunction. It is intended for use with Inverters of 15 kW or less. (It is built into Inverters of 18.5 kW and over.)

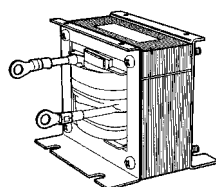

● Standard Models

Inverter		DC Reactor				
Voltage class	Maximum applicable motor capacity (kW)	3G3IV-PUZDAB□	Rated voltage (V)	Rated current (A)	Inductance (mH)	Loss (W)
200-V class	0.4/0.75	5.4A8MH	800 VDC	5.4	8	8
	1.5 to 3.7	18A3MH		18	3	18
	5.5/7.5	36A1MH		36	1	22
	11/15	72A0.5MH		72	0.5	29
400-V class	0.4/0.75	3.2A28MH	800 VDC	3.2	28	9
	1.5/2.2	5.7A11MH		5.7	11	11
	3.7	12A6.3MH		12	6.3	16
	5.5/7.5	23A3.6MH		23	3.6	27
	11/15	33A1.9MH		33	1.9	26

● External Dimensions (mm)

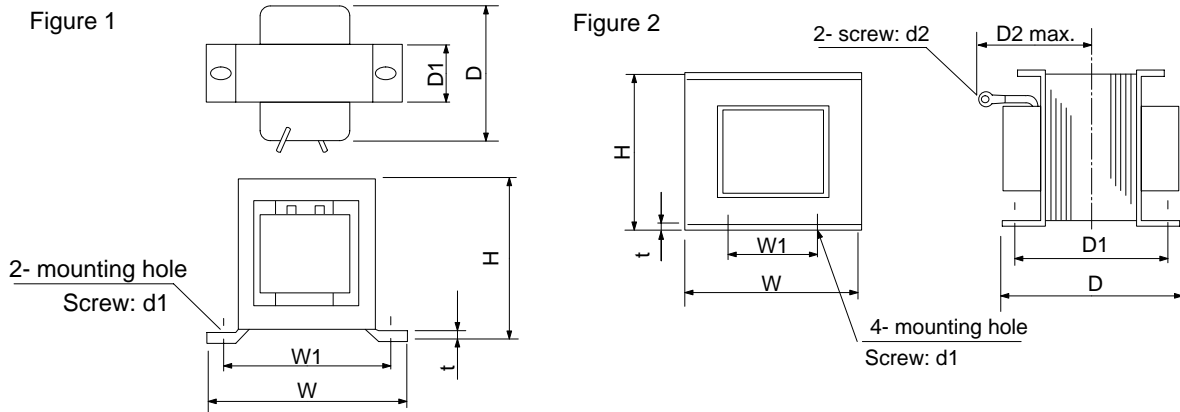

3G3HV-PUZDAB□	Figure	Dimensions (mm)									Weight (kg)
		H	W	W1	D	D1	D2	t	d1	d2	
5.4A8MH	1	53	85	74	60	32	---	0.8	M4	---	0.8
18A3MH	2	76	86	60	72	55	80	1.2	M4	M5	2.0
36A1MH	2	93	105	64	92	80	90	1.6	M6	M6	3.2
72A0.5MH	2	93	105	64	112	100	105	1.6	M6	M8	4.9
3.2A28MH	1	53	85	74	60	32	---	0.8	M4	---	0.8
5.7A11MH	1	60	90	80	60	32	---	0.8	M4	---	1.0
12A6.3MH	2	76	86	60	72	55	80	1.2	M4	M5	2.0
23A3.6MH	2	93	105	64	92	80	90	1.6	M6	M5	3.2
33A1.9MH	2	93	105	64	102	90	95	1.6	M6	M6	4.0

■ Separately Mounted Options

● AC Reactor (Yaskawa Electric)

3G3IV-PUZBAB□A□MH

Connect this AC Reactor for controlling harmonic current generated by the Inverter, or when the power supply capacity is extremely large compared with that of the Inverter. It is also effective for improving the power factor. Select an AC Reactor from the following tables according to the motor capacity.

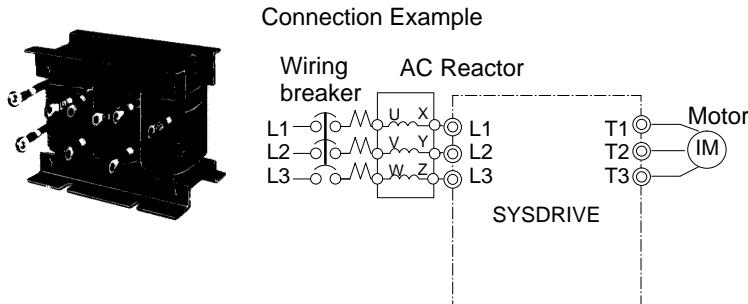

Applicable Range

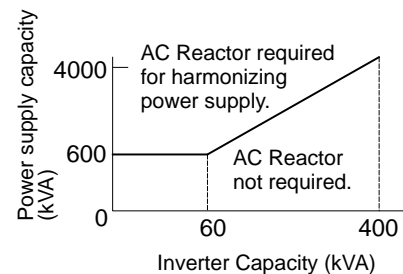

● Standard Specifications and Dimensions (mm)

● 200-V Class

Maximum applicable motor capacity (kW)	3G3IV-PUZBAB□	Current (A)	Inductance (mH)	Loss (W)	Weight (kg)	Figure
0.4	2.5A4.2MH	2.5	4.2	15	2.5	1
0.75	5A2.1MH	5	2.1	15	2.5	
1.5	10A1.1MH	10	1.1	25	3	
2.2	15A0.71MH	15	0.71	30	3	
3.7	20A0.53MH	20	0.53	35	3	2
5.5	30A0.35MH	30	0.35	45	3	
7.5	40A0.265MH	40	0.265	50	4	
11	60A0.18MH	60	0.18	65	6	
15	80A0.13MH	80	0.13	75	8	
18.5	90A0.12MH	90	0.12	90	8	
22	120A0.09MH	120	0.09	90	8	
30	160A0.07MH	160	0.07	100	12	
37	200A0.05MH	200	0.05	110	15	
45	240A0.044MH	240	0.044	125	23	
55	280A0.038MH	280	0.038	130	23	

Dimensions (mm)											
A	B	B1	C	D	E	F	H	J	K	L	M
120	71	---	120	40	50	105	20	M6	10.5	7	M4
120	71	---	120	40	50	105	20	M6	10.5	7	M4
130	88	---	130	50	65	130	22	M6	11.5	7	M4
130	88	---	130	50	65	130	22	M6	11.5	7	M4
130	88	114	105	50	65	130	22	M6	11.5	7	M5
130	88	119	105	50	70	130	22	M6	9	7	M5
130	98	139	105	50	75	130	22	M6	11.5	7	M6
160	105	147.5	130	75	85	160	25	M6	10	7	M6
180	100	155	150	75	80	180	25	M6	10	7	M8
180	100	150	150	75	80	180	25	M6	10	7	M8
180	100	155	150	75	80	180	25	M6	10	7	M10
210	100	170	175	75	80	205	25	M6	10	7	M10
210	115	182.5	175	75	95	205	25	M6	10	7	M10
240	126	218	215±5	150	110	240	25	M6	8	7	M10
240	126	218	215±5	150	110	240	25	M8	8	10	M12

• 400-V Class

Maximum applicable motor capacity (kW)	3G3IV-PUZBAB□	Current (A)	Inductance (mH)	Loss (W)	Weight (kg)	Figure
0.4	1.3A18.0MH	1.3	18.0	15	2.5	1
0.75	2.5A8.4MH	2.5	8.4	15	2.5	
1.5	5A4.2MH	5	4.2	25	3	
2.2	7.5A3.6MH	7.5	3.6	35	3	
3.7	10A2.2MH	10	2.2	43	3	
5.5	15A1.42MH	15	1.42	50	4	
7.5	20A1.06MH	20	1.06	50	5	2
11	30A0.7MH	30	0.7	65	6	
15	40A0.53MH	40	0.53	90	8	
18.5	50A0.42MH	50	0.42	90	8	
22	60A0.36MH	60	0.36	90	8.5	
30	80A0.26MH	80	0.26	95	12	
37	90A0.24MH	90	0.24	110	15	
45	120A0.18MH	120	0.18	130	23	
55	150A0.15MH	150	0.15	150	23	

Dimensions (mm)											
A	B	B1	C	D	E	F	H	J	K	L	M
120	71	---	120	40	50	105	20	M6	10.5	7	M4
120	71	---	120	40	50	105	20	M6	10.5	7	M4
130	88	---	130	50	70	130	22	M6	9	7	M4
130	88	---	130	50	70	130	22	M6	9	7	M4
130	88	---	130	50	65	130	22	M6	11.5	7	M4
130	98	---	130	50	75	130	22	M6	11.5	7	M4
160	90	115	130	75	70	160	25	M6	10	7	M5
160	105	132.5	130	75	85	160	25	M6	10	7	M5
180	100	140	150	75	80	180	25	M6	10	7	M6
180	100	145	150	75	80	180	25	M6	10	7	M6
180	100	150	150	75	75	180	25	M6	10	7	M6
210	100	150	175	75	80	205	25	M6	10	7	M8
210	115	177.5	175	75	95	205	25	M6	10	7	M8
240	126	193	205±5	150	110	240	25	M8	8	10	M10
240	126	198	205±5	150	110	240	25	M8	8	10	M10

Figure 1

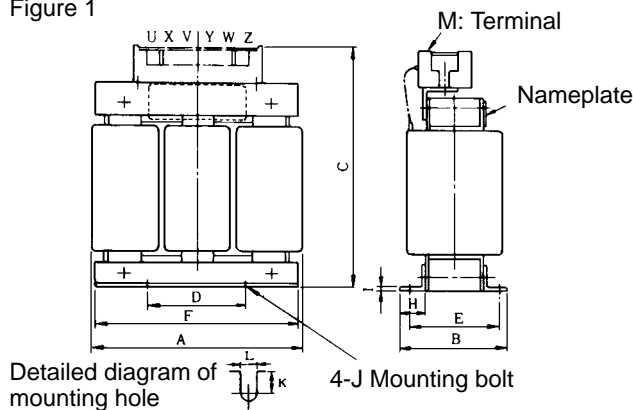
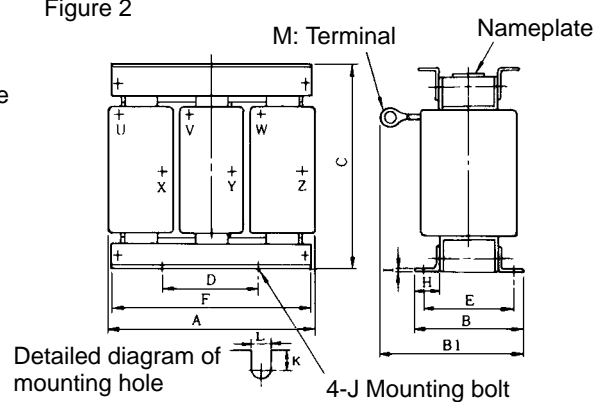
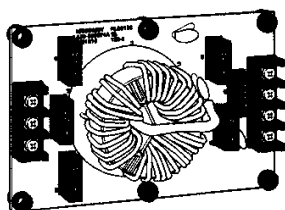

Figure 2



• Simple Input Noise Filter and Input Noise Filter
 3G3EV-PLNFD□ (Yaskawa Electric)/3G3IV-PFN□ (Schaffner)



Simple Input Noise Filter



Input Noise Filter

The Simple Input Noise Filter is connected to the power input side to eliminate the noise in the power line connected to the Inverter and suppress noise leaking from the Inverter to the power line.

Applicable Models

200-V class			400-V class		
Maximum motor capacity (kW)	New model	Rated current (A)	Maximum motor capacity (kW)	New model	Rated current (A)
0.1 to 0.75	3G3EV-PLNFD2103DY	10	0.2 to 0.75	3G3EV-PLNFD4053DY	5
1.5	3G3EV-PLNFD2153DY	15	1.5/2.2	3G3EV-PLNFD4103DY	10
2.2	3G3EV-PLNFD2203DY	20	3.7	3G3EV-PLNFD4153DY	15
3.7	3G3EV-PLNFD2303DY	30	5.5	3G3EV-PLNFD4203DY	20
5.5	3G3IV-PFN258L4207	42	7.5	3G3EV-PLNFD4303DY	30
7.5	3G3IV-PFN258L5507	55	11	3G3IV-PFN258L4207	42
11	3G3IV-PFN258L7534	75	15/18.5	3G3IV-PFN258L5507	55
15	3G3IV-PFN258L10035	100	22	3G3IV-PFN258L7534	75
18.5/22	3G3IV-PFN258L13035	130	30	3G3IV-PFN258L10035	100
30	3G3IV-PFN258L18007	180	37/45	3G3IV-PFN258L13035	130
37/45	3G3IV-PFN359P25099	250	55	3G3IV-PFN258L18007	180
55	3G3IV-PFN359P30099	300	75/110	3G3IV-PFN359P30099	300
75	3G3IV-PFN359P25099 x 2P	500	160/185	3G3IV-PFN359P25099 x 2P	500
			220	3G3IV-PFN359P30099 x 2P	600
			300	3G3IV-PFN359P30099 x 2P	900

Connection Example

3-phase input

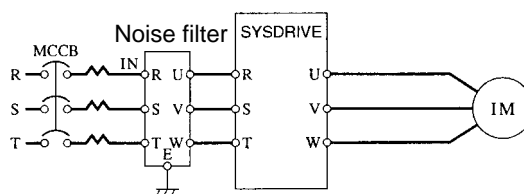

Dimensions

Dimensions 1 (Three-phase Input)

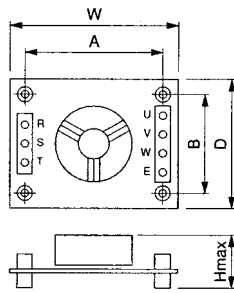

Dimensions 2 (Three-phase Input)

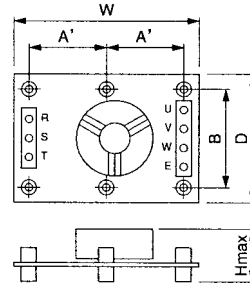

Model 3G3EV-	Figure (above)	Dimension (mm)						Mounting screw
		W	D	H max.	A	A'	B	
PLNFD2103DY	1	120	80	55	108	---	68	M4 × 4, 20 mm
PLNFD2153DY		120	80	55	108	---	68	M4 × 4, 20 mm
PLNFD2203DY		170	90	70	158	---	78	M4 × 4, 20 mm
PLNFD2303DY	2	170	110	70	---	79	98	M4 × 6, 20 mm
PLNFD4053DY		170	130	75	---	79	118	M4 × 6, 30 mm
PLNFD4103DY		170	130	95	---	79	118	M4 × 6, 30 mm
PLNFD4153DY		170	130	95	---	79	118	M4 × 6, 30 mm
PLNFD4203DY		200	145	100	---	94	133	M4 × 6, 30 mm
PLNFD4303DY		200	145	100	---	94	133	M4 × 6, 30 mm

External Figure 1

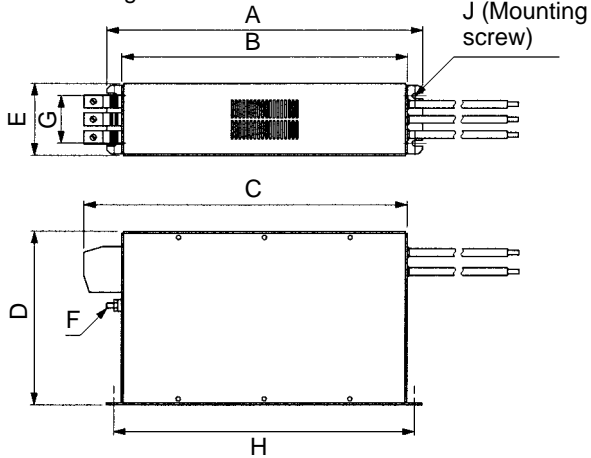

External Figure 2

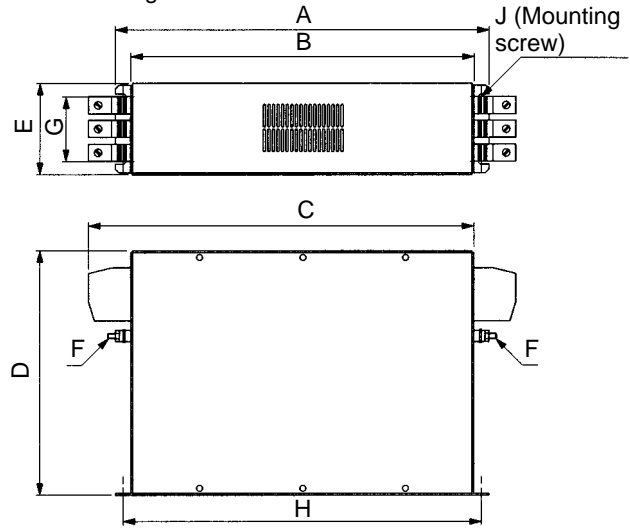

External Figure 3

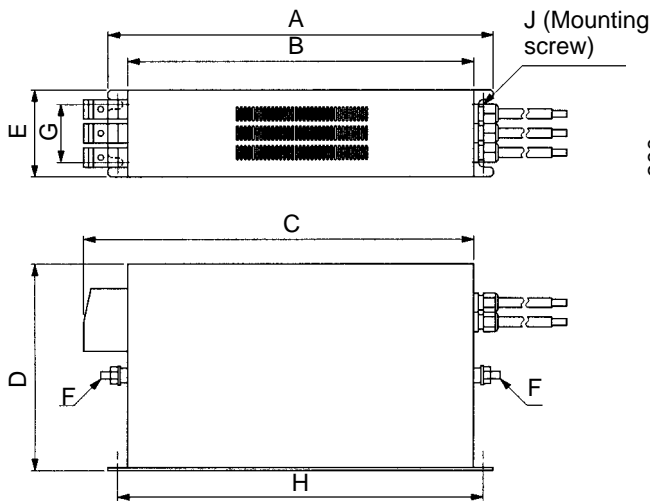

External Figure 4

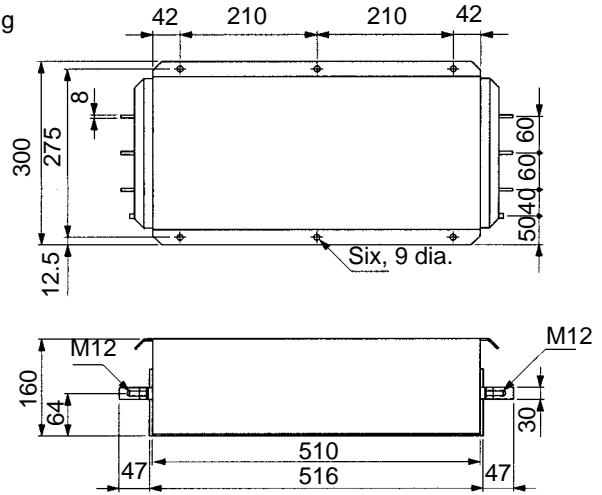

Model 3G3IV-	Figure (above)	Dimensions (mm)									Weight (kg)
		A	B	C	D	E	F	G	H	J	
PFN258L4207	1	329	300	325	185	70	M6	45	314	4-M5	2.8
PFN258L5507		329	300	353	185	80	M6	55	314	4-M5	3.1
PFN258L7534	2	329	300	377	220	80	M6	55	314	4-M5	4
PFN258L10035		379	350	436	220	90	M10	65	364	4-M5	5.5
PFN258L13035		439	400	486	240	110	M10	80	414	4-M5	7.5
PFN258L18007	3	438	400	480	240	110	M10	80	413	4-M5	11
PFN359P25099	4	---	---	---	---	---	---	---	---	---	16
PFN359P30099		---	---	---	---	---	---	---	---	---	16

● 3G3IV-PLF□ Output Noise Filter (Tokin Corp.)

Connect the 3G3IV-PLF□ Output Noise Filter to the motor output side of the Inverter to prevent the noise generated by the Inverter from flowing to the motor.

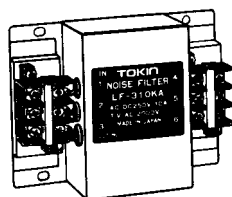

Standard Specifications and External Dimensions

	Maximum motor capacity (kW)	Inverter capacity (kVA)	Output Noise Filter	
			Model 3G3IV-	Rated current (A)
200-V class	3.7	6.7	PLF320KA	20
	5.5	9.5	PLF350KA	50
	7.5	13	PLF350KA	50
	11	19	PLF350KA x 2P	100
	15	24	PLF350KA x 2P	100
	18.5	30	PLF350KA x 2P	100
	22	37	PLF350KA x 3P	150
	30	50	PLF350KA x 3P	150
	37	61	PLF3110KB x 2P	220
	45	70	PLF3110KB x 2P	220
	55	85	PLF3110KB x 3P	330
75	110	PLF3110KB x 4P	440	
400-V class	3.7	6.1	PLF310KB	10
	5.5	11	PLF320KB	20
	7.5	14	PLF320KB	20
	11	21	PLF335KB	35
	15	26	PLF335KB	35
	18.5	31	PLF345KB	45
	22	37	PLF375KB	75
	30	50	PLF375KB	75
	37	61	PLF3110KB	110
	45	73	PLF3110KB	110
	55	98	PLF375KB x 2P	150
	75	130	PLF3110KB x 2P	220
	110	170	PLF3110KB x 3P	330
	160	230	PLF3110KB x 4P	440
	185	260	PLF3110KB x 4P	440
220	340	PLF3110KB x 5P	550	
300	460	PLF3110KB x 6P	660	

External Dimensions

Model 3G3IV-	Terminals	Dimensions								Weight (kg)
		A	B	C	D	E	F	G	H	
PLF320KA	TE-K5.5 M4	140	100	100	90	70	45	7 x 4.5 dia.	4.5 dia.	0.6
PLF350KA	TE-K22 M6	260	180	180	160	120	65	7 x 4.5 dia.	4.5 dia.	2.0
PLF310KA	TE-K5.5 M4	140	100	100	90	70	45	7 x 4.5 dia.	4.5 dia.	0.5
PLF320KB	TE-K5.5 M4	140	100	100	90	70	45	7 x 4.5 dia.	4.5 dia.	0.6
PLF335KB	TE-K5.5 M4	140	100	100	90	70	45	7 x 4.5 dia.	4.5 dia.	0.8
PLF345KB	TE-K22 M6	260	180	180	160	120	65	7 x 4.5 dia.	4.5 dia.	2.0
PLF375KB	TE-K22 M6	540	320	480	300	340	240	9 x 6.5 dia.	6.5 dia.	12.0
PLF3110KB	TE-K60 M8	540	340	480	300	340	240	9 x 6.5 dia.	6.5 dia.	19.5

Appearance

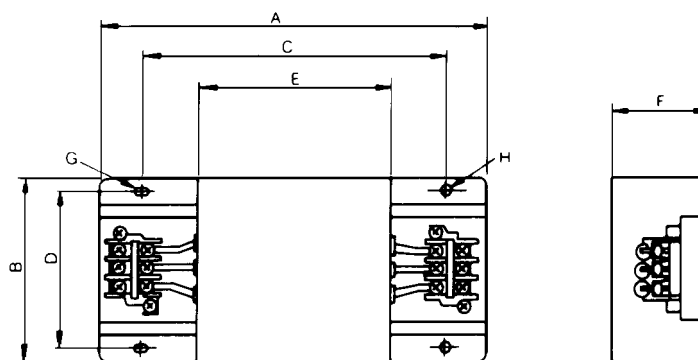

● Output Noise Filter (Tokin Corp.)

3G3IV-PLF□

This Noise Filter controls the noise generated by the Inverter from disseminating to the power supply side. Connect it to the motor output.

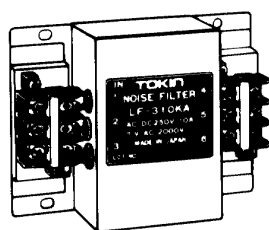

● Standard Models

Maximum applicable motor capacity (kW)	200-V class			400-V class		
	Inverter capacity (kVA)	Output Noise Filter		Inverter capacity (kVA)	Output Noise Filter	
		Model (3G3IV-)	Rated current (A)		Model (3G3IV-)	Rated current (A)
0.4	1.2	PLF310KA	10	1.4	PLF310KB	10
0.75	2.3	PLF310KA	10	2.6	PLF310KB	10
1.5	3.0	PLF310KA	10	3.7	PLF310KB	10
2.2	4.2	PLF310KA	10	4.7	PLF310KB	10
3.7	6.7	PLF320KA	20	6.1	PLF310KB	10
5.5	9.5	PLF350KA	50	11	PLF320KB	20
7.5	13	PLF350KA	50	14	PLF320KB	20
11	19	PLF350KA x 2P	100	21	PLF335KB	35
15	24	PLF350KA x 2P	100	26	PLF335KB	35
18.5	30	PLF350KA x 2P	100	31	PLF345KB	45
22	37	PLF350KA x 3P	150	40	PLF375KB	75
30	50	PLF350KA x 3P	150	50	PLF375KB	75
37	61	PLF3110KB x 2P	220	61	PLF3110KB	110
45	70	PLF3110KB x 2P	220	73	PLF3110KB	110
55	85	PLF3110KB x 3P	330	98	PLF375KB x 2P	150
75	110	PLF3110KB x 4P	440	130	PLF3110KB x 2P	220
110	---	---	---	170	PLF3110KB x 3P	330
160	---	---	---	230	PLF3110KB x 4P	440
185	---	---	---	260	PLF3110KB x 4P	440
220	---	---	---	340	PLF3110KB x 5P	550
300	---	---	---	460	PLF3110KB x 6P	660

● External Dimensions (mm)

Model (3G3IV-)	Terminal	A	B	C	D	E	F	G	H	Weight (kg)
PLF310KA	TE-K5.5 M4	140	100	100	90	70	45	7 x 4.5 dia.	4.5 dia.	0.5
PLF320KA	TE-K5.5 M4	140	100	100	90	70	45	7 x 4.5 dia.	4.5 dia.	0.6
PLF350KA	TE-K22 M6	260	180	180	160	120	65	7 x 4.5 dia.	4.5 dia.	2.0
PLF310KB	TE-K5.5 M4	140	100	100	90	70	45	7 x 4.5 dia.	4.5 dia.	0.5
PLF320KB	TE-K5.5 M4	140	100	100	90	70	45	7 x 4.5 dia.	4.5 dia.	0.6
PLF335KB	TE-K5.5 M4	140	100	100	90	70	45	7 x 4.5 dia.	4.5 dia.	0.8
PLF345KB	TE-K22 M6	260	180	180	160	120	65	7 x 4.5 dia.	4.5 dia.	2.0
PLF375KB	TE-K22 M6	540	320	480	300	340	240	9 x 6.5 dia.	6.5 dia.	12.0
PLF3110KB	TE-K60 M8	540	340	480	300	340	240	9 x 6.5 dia.	6.5 dia.	19.5

Dimensions

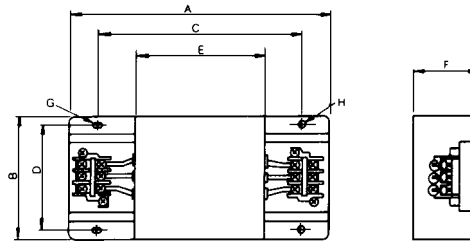

● Noise Filter Connection Example

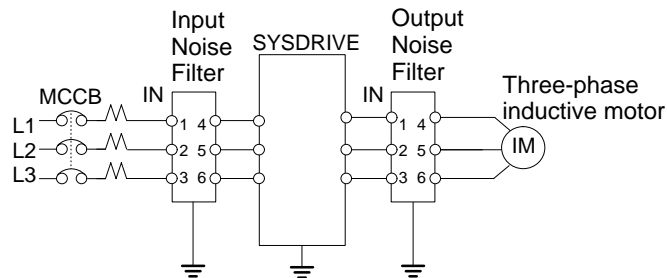

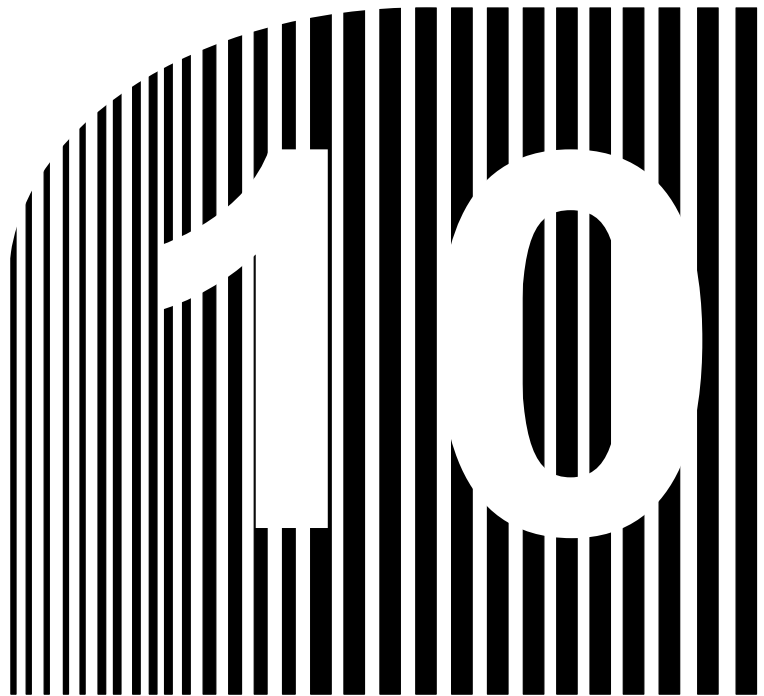

Chapter 10

• Appendix •

10-1 Notes on Using the Inverter for a Motor

10-1 Notes on Using the Inverter for a Motor

■ Using the Inverter for an Existing Standard Motor

When a standard motor is operated with the Inverter, power loss is slightly higher than when operated with a commercial power supply.

In addition, cooling effects also diminish in the low-speed range, resulting in an increase in the motor temperature. Therefore, the motor torque should be reduced in the low speed range.

The following graph shows the allowable load characteristics of a standard motor.

If 100% torque is continuously required in the low-speed range, use a special motor for use with inverters.

Allowable Load Characteristics of Standard Motor

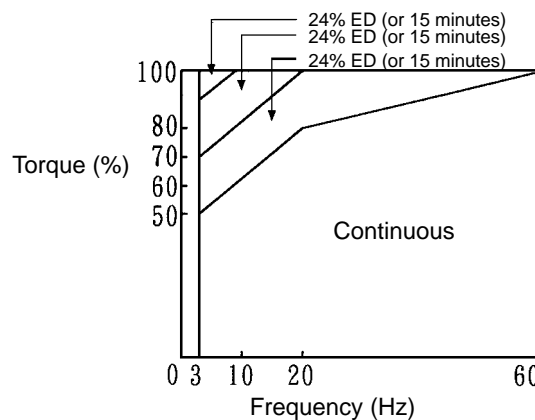

● High-speed Operation

When using the motor at a high speed (60 Hz or more), problems may arise in dynamic balance and bearing durability.

● Torque Characteristics

The motor may require more acceleration torque when the motor is operated with the Inverter than when operated with a commercial power supply. Check the load torque characteristics of the machine to be used with the motor to set a proper V/f pattern

● Vibration

The 3G3FV Series uses a high carrier PWM to reduce motor vibration. When the motor is operated with the Inverter, motor vibration is almost the same as when operated with a commercial power supply. Motor vibration may, however, become greater in the following cases.

● Resonance with the natural frequency of the mechanical system

Take special care when a machine that has been operated at a constant speed is to be operated in variable speed mode.

If resonance occurs, install vibration-proof rubber on the motor base or use the frequency jump function to skip any frequency resonating the machine.

● Imbalanced rotor

Take special care when the motor is operated at a higher speed (60 Hz or more).

10-2

- **Noise**

Noise is almost the same as when the motor is operated with a commercial power supply. Motor noise, however, becomes louder when the motor is operated at a speed higher than the rated speed (60 Hz).

- **Using the Inverter for Special Motors**

- **Pole-changing Motor**

The rated input current of pole-changing motors differs from that of standard motors. Select, therefore, an appropriate Inverter according to the maximum input current of the motor to be used.

Before changing the number of poles, always make sure that the motor has stopped. Otherwise, the overvoltage protective or overcurrent protective mechanism will be actuated, resulting in an error.

- **Submersible Motor**

The rated input current of submersible motors is higher than that of standard motors. Therefore, always select an Inverter by checking its rated output current.

When the distance between the motor and Inverter is long, use a cable thick enough to connect the motor and Inverter to prevent motor torque reduction.

- **Explosion-proof Motor**

When an explosion-proof motor or increased safety-type motor is to be used, it must be subject to an explosion-proof test in conjunction with the Inverter. This is also applicable when an existing explosion-proof motor is to be operated with the Inverter.

Since the Inverter itself is, however, not explosion-proof, always install it in a safe place.

- **Gearmotor**

The speed range for continuous operation differs according to the lubrication method and motor manufacturer. In particular, continuous operation of an oil-lubricated motor in the low speed range may result in burning. If the motor is to be operated at a speed higher than 60 Hz, consult with the manufacturer.

- **Synchronous Motor**

A synchronous motor is not suitable for Inverter control.

If a group of synchronous motors is individually turned ON and OFF, synchronism may be lost.

- **Single-phase Motor**

Do not use an Inverter for a single-phase motor. The motor should be replaced with a 3-phase motor.

- **Power Transmission Mechanism (Speed Reducers, Belts, and Chains)**

If an oil-lubricated gearbox or speed reducer is used in the power transmission mechanism, oil lubrication will be affected when the motor operates only in the low speed range. The power transmission mechanism will make noise and experience problems with service life and durability if the motor is operated at a speed higher than 60 Hz.

■ Motor Burnout Due to Insufficient Dielectric Strength of Each Phase of the Motor

Surge occurs among the phases of the motor when the output voltage is switched. If the dielectric strength of each phase of the motor is insufficient, the motor may burn out. The dielectric strength of each phase of the motor must be higher than the maximum surge voltage. Normally, the maximum surge voltage is approximately three times the power voltage imposed on the Inverter.

Be sure to connect a dedicated motor to the 400-V Inverter. A standard motor may burn out if it is connected to the Inverter due to the insufficient dielectric strength of each phase of the standard motor.

Revision History

A manual revision code appears as a suffix to the catalog number on the front cover of the manual.

Cat. No. I516-E1-04

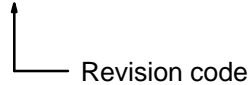

The following table outlines the changes made to the manual during each revision. Page numbers refer to the previous version.

Revision code	Date	Revised content
1	September 1996	Original production
2	April 1997	<p>The following constant numbers were added to Section 7: b1-07, C3-05, C5-08, C8-30, E1-11, E1-12, E1-13, F1-14, F8-01, H5-05</p> <p>Page 1-2: Inverter model list updated. "3-phase" added.</p> <p>Page 1-5: Low noise and harmonic countermeasure information clarified.</p> <p>Page 2-5: Dimensions added for the new models.</p> <p>Pages 2-12 and 2-13: Terminals and connections changed for the 200-V Class and 400-V Class tables. Notes added. New models reflected.</p> <p>Pages 2-16, 2-17, 2-19, and 2-20: New models added.</p> <p>Page 2-21: New wire sizes and tightening torque added.</p> <p>Page 2-23: New models reflected in the information for wiring the power terminal of the Inverter.</p> <p>Pages 2-26 and 2-29: Note added.</p> <p>Page 2-31: New models reflected in the bottom output diagram.</p> <p>Page 3-29: Motor selection explanation corrected.</p> <p>Pages 5-19 and 5-34: Motor selection information corrected.</p> <p>Page 5-26: New models reflected in the V/f patterns.</p> <p>Page 5-27: Note 2 reference removed from E1-07 in the table. New models reflected in Note 3.</p> <p>Page 5-42: New models reflected in Note 2.</p> <p>Page 6-50: <i>Setting the Carrier Frequency and Inverter Overload "OL2"</i> information added.</p> <p>Pages 6-50 and 6-51: Note references added to the carrier frequency table. Following note rewritten.</p> <p>Page 6-58: Setting 16 (Motor 2 Selection) added to the table.</p> <p>Page 6-70: Settings 1C to 1E corrected and added to.</p> <p>Page 6-79: Inverter model corrected for each Note 2.</p> <p>Page 7-16: Note references added to the carrier frequency table. Following notes rewritten.</p> <p>Page 7-24: <i>Motor 2 Setup: E3 to E5</i> list added.</p> <p>Pages 7-26 and 7-27: F9 constant numbers added.</p> <p>Pages 7-29 and 7-31: Setting values 16 and 1C (motor 2 selection and motor 2 selected) added.</p> <p>Pages 8-4 and 8-7: High carrier frequency information added to OH and OL2 fault displays and OH minor fault display.</p> <p>Page 8-17: Inverter overload information added.</p> <p>Pages 9-2 to 9-4: Specifications completely updated.</p> <p>Page 9-11: "Control Unit" corrected to "Braking Unit."</p> <p>Pages 9-11 and 9-13: New models added.</p> <p>Pages 9-21 and 9-23: Noise Filter models added.</p> <p>Page 10-5: New models added.</p>

Revision History

Revision code	Date	Revised content
3	June 2000	<p>Addition of 3G3FV-□-CUE, changes accompanying 3G3FV software changes, changes to some display messages, and other changes and improvements. Specific changes are as follows:</p> <p>Front matter: Added General Precautions, Warning Label information, and About this Manual. Model numbers changed in Checking before Unpacking. Changes to information on changing Digital Operator language.</p> <p>Pages 1-2, 1-6, and 3-13: Changes to information on changing Digital Operator language.</p> <p>Page 1-5: Changed second item in <i>Frequency References</i>.</p> <p>Pages 1-10, 2-10, 2-46, 3-2, 5-13, 5-20, 5-34, 6-16, 6-51, 6-59, 6-50, 6-62 to 6-65, 6-71, 6-74, 6-92, and 9-17: Added notes.</p> <p>Page 1-11: Added section on new functions.</p> <p>Pages 2-4, 2-6, 4-2, and 8-13: Changed warnings.</p> <p>Page 2-10: Added to Multi-function analog input signal level.</p> <p>Page 2-21: Added information on frequency reference variable resistor and added graphic and note to bottom of page.</p> <p>Pages 2-26 to 2-28: Replaced <i>Wiring on Input Side of Main Circuit</i> and added information on calculating inverter input power supply capacity.</p> <p>Page 2-30: Added information on inverter-motor cable length.</p> <p>Page 2-35: Added setting for L3-04.</p> <p>Page 3-14: Added U1-32 to U1-38.</p> <p>Pages 3-25, 6-2, 6-9, 6-13, 6-31, and 6-35: Added E2 to E5 and F7 to F9.</p> <p>Page 3-30: Added section 3-8.</p> <p>Pages 5-4 to 5-5, 5-8, and 5-10: Changed setting range to 0 to 4 and added descriptions and notes.</p> <p>Pages 5-9: Added information to "2 to 39" setting and deleted "This setting can't be used with flux vector control."</p> <p>Pages 5-15 and 5-18: Added setting "17."</p> <p>Page 5-19: Added section section 5-2.</p> <p>Pages 5-22 and 5-28: Added "PG Direction," "Minor Fault," and "V/f over Setting" to table.</p> <p>Pages 5-22 and 5-41: Added setting "2."</p> <p>Page 5-24: Corrected voltage for setting of 7 to "9 V."</p> <p>Pages 5-27, 6-6, and 6-27: Changed setting range for E1-04.</p> <p>Page 5-28: Added information to introduction.</p> <p>Pages 5-30 and 5-44: Added F1-14.</p> <p>Pages 5-33 to 5-34: Added E1-02</p> <p>Page 5-38: Added C5-08.</p> <p>Pages 5-39 and 5-48: Added information on 3G3FV-□-CUE/CE.</p> <p>Page 6-5: Added sections 6-1-3 to 6-1-7.</p> <p>Page 6-6: Added section on startup torque compensation.</p> <p>Pages 6-7 and 6-50: Changed percentage to 100%.</p> <p>Pages 6-7, 6-12, 6-28, and 6-34: Changed setting range for E2-03 and added note.</p> <p>Pages 6-8 and 6-29: Changed descriptions of E2-05 and E2-06.</p> <p>Pages 6-12 and 6-34: Added E2-10.</p> <p>Page 6-14: Made corrections to b7-01 and b7-02.</p> <p>Page 6-30: Added sections 6-3-8 and 6-3-9.</p> <p>Page 6-36: Added section <i>Setting Operation Source Selection (b1)</i>.</p> <p>Page 6-37: Added b2-08.</p> <p>Page 6-38: Changed factory settings for b3-02 and b3-03.</p> <p>Pages 6-41 to 6-43: Added PID control functions.</p> <p>Page 6-45: Changed end of setting range for b5-01 to "4."</p> <p>Page 6-54: Added information for settings for second motor.</p> <p>Page 6-56: Changed information for binary input setting.</p> <p>Page 6-56: Made changes to analog monitor card settings.</p> <p>Page 6-57: Added F8 and F9.</p> <p>Page 6-58: Added settings 15, 16, 17, 1E, 30, and 31.</p> <p>Page 6-60: Added information on external baseblock.</p> <p>Page 6-65: Add setting 1E.</p> <p>Page 6-73: Added C and D.</p> <p>Pages 6-74 and 6-75: Corrected analog input characteristics.</p> <p>Pages 6-76, 6-79, and 6-90: Corrected information on setting ranges.</p> <p>Page 7-77: Added information after second bullet.</p> <p>Page 6-81: Changed factory setting for L3-03 and deleted note.</p> <p>Page 6-82: Added setting 3.</p> <p>Page 6-89: Changed setting range of L8-02.</p> <p>Page 6-90: Changed "10%" to "5%" and added information.</p> <p>Page 6-92: Added sentence and note to o2-03.</p> <p>Pages 7-2 to 7-48: Added/corrected parameters.</p> <p>Page 8-2: Added to introduction.</p> <p>Pages 8-5 and 8-5: Added/changed PGO, DEV, OPR, EFO, EF8, E-15, BUS, CPF21, CPF22, and CPF23.</p> <p>Page 8-8: Added/changed PGO, DEV, EFO, ERR, CALL, E-15, and BUS.</p> <p>Pages 8-9 and 8-10-: Added/changed OPE03, OPE07, OPE08, and ERR.</p> <p>Page 8-15: Information added on vertical axes.</p> <p>Page 8-17: Information added EF.</p> <p>Pages 9-7 and 9-9: Diagrams changed and cards added.</p> <p>Pages 9-13 and 9-14: Diagrams changed and model numbers changed.</p> <p>Pages 9-14 and 9-15: Note added and minimum connection resistances added to table.</p> <p>Page 9-18: Losses added to table.</p> <p>Page 9-20: "1120" changed to "120" and "182.8" changed to "182.5."</p> <p>Pages 9-22 to 9-25: Models changed.</p> <p>Page 10-5: Model numbers deleted.</p>
04	October 2001	<p>Page 1-4: Changed "Starting drive" to "Starting torque."</p> <p>Page 1-11: Updated software version information.</p> <p>Page 1-16: Added information on PG speed deviation detection in software version VSG101114.</p> <p>Page 5-22: Changed parameter numbers from "H7" to "L7."</p> <p>Page 5-28: Added information on flux vector control.</p> <p>Page 5-32: Changed information on PG speed deviation settings.</p> <p>Page 5-38: Changed speed loop diagram.</p> <p>Page 5-48: Changed information on PG speed deviation settings. Changed speed loop diagram.</p> <p>Page 6-9: Added information on flux vector control.</p> <p>Page 6-19: Changed diagram. Changed "servo-lock" to "zero-servo."</p> <p>Page 6-44: Added information on speed search function.</p> <p>Page 6-49: Changed diagram.</p> <p>Page 6-87: Added information on external search.</p> <p>Page 6-101: Added information on stall prevention function settings.</p> <p>Page 7-20: Added note to table.</p> <p>Page 7-25: Added note to table.</p> <p>Page 7-33: Changed information in table.</p> <p>Page 7-37: Changed information in table.</p> <p>Page 7-43: Changed information in serial communications setup table.</p> <p>Page 7-44: Changed information in table.</p> <p>Page 8-18: Added and changed information on Input Noise Filters.</p>