

NT631/631C

Programmable Terminal

OPERATION MANUAL



OMRON

NT631/631C

Programmable Terminal

Operation Manual

Produced March 1999

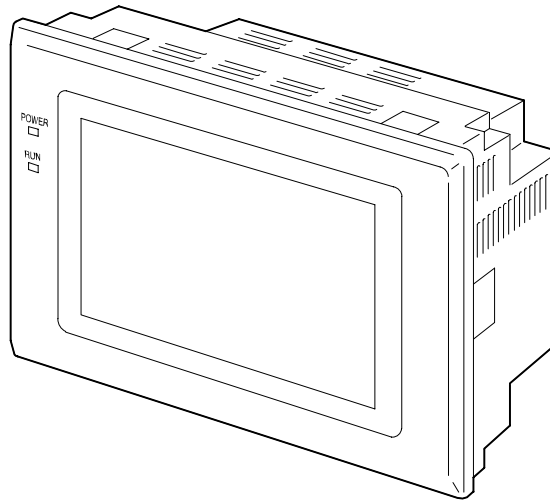

OMRON Product References

All OMRON products are capitalized in this manual. The word "Unit" is also capitalized when it refers to an OMRON product, regardless of whether or not it appears in the proper name of the product.

The abbreviation "Ch," which appears in some displays and on some OMRON products, often means "word" and is abbreviated "Wd" in documentation in this sense.

The abbreviation "PC" means Programmable Controller and is not used as an abbreviation for anything else.

The abbreviation "Host" means a controller such as an FA computer which controls a PT (programmable terminal).

Visual Aids

The following headings appear in the left column of the manual to help you locate different types of information.

- | | |
|-------------------|---|
| Note | Indicates information of particular interest for efficient and convenient operation of the product. |
| 1, 2, 3... | 1. Indicates lists of one sort or another, such as procedures, checklists, etc. |

? OMRON, 1999

All rights reserved. No part of this publication may be reproduced, stored in a retrieval system, or transmitted, in any form, or by any means, mechanical, electronic, photocopying, recording, or otherwise, without the prior written permission of OMRON.

No patent liability is assumed with respect to the use of the information contained herein. Moreover, because OMRON is constantly striving to improve its high-quality products, the information contained in this manual is subject to change without notice. Every precaution has been taken in the preparation of this manual. Nevertheless, OMRON assumes no responsibility for errors or omissions. Neither is any liability assumed for damages resulting from the use of the information contained in this publication.

TABLE OF CONTENTS

PRECAUTIONS	xiii
1 Intended Audience	xiv
2 General Precautions	xiv
3 Safety Precautions	xiv
SECTION 1	
General	1
1-1 Role and Operation of the NT631/NT631C	2
1-2 Functions of the NT631/NT631C	4
1-3 Communication with the Host	15
1-4 Communication by Using Memory Link	24
1-5 System Configuration	26
1-6 Before Operating	28
SECTION 2	
Preparing for Connection	31
2-1 Method for Connection to the Host	32
2-2 Preparations at the NT631/NT631C	35
SECTION 3	
Hardware Settings and Connections	37
3-1 Installation	38
3-2 Connecting to the Support Tool	41
3-3 Connecting a Printer	42
3-4 Connecting a Bar Code Reader	43
3-5 Using a Memory Unit (NT631/NT631C with V1)	46
3-6 Using a Memory Unit (NT631/NT631C without V1)	56
SECTION 4	
Connecting to the Host from the RS-232C Port	63
4-1 Connecting to the RS-232C Port at the Host	64
SECTION 5	
Connecting to the Host from the RS-422A/485 Port	93
5-1 Connecting to the Host's RS-232C Port	94
5-2 Connecting to the Host's RS-422A/485 Port	111
SECTION 6	
System Menu Operation	145
6-1 System Menu Operation Flow	148
6-2 Starting the NT631/NT631C	149
6-3 Operation Modes and the System Menu	150
6-4 Memory Initialization	155
6-5 Operations in the System Installer Mode	163
6-6 Transmitting the Screen Data	168
6-7 Setting the Conditions for Communications with the Host by Using the Memory Switches ..	171
6-8 Starting Operation	183
6-9 Various System Settings	185
6-10 Setting the Bar Code Reader Input Function	204
6-11 System Maintenance	207
6-12 Programming Console Function	236

SECTION 7

NT631/NT631C Functions 243

7-1	NT631/NT631C Screen	246
7-2	Areas for Control/Notification	259
7-3	Memory Tables	277
7-4	Fixed Displays	294
7-5	Image and Library Data	312
7-6	Lamps	319
7-7	Touch Switches	327
7-8	Numeral Display	347
7-9	Character String Display	355
7-10	Graphs	361
7-11	Alarm List, Alarm History	394
7-12	Inputting Numeric Values	405
7-13	Inputting Character Strings	421
7-14	Window Function	426
7-15	Special Functions	434
7-16	PT Configuration Settings	450

SECTION 8

How to Use the PT 453

8-1	Screen Creation Procedure	454
8-2	Buzzer, Backlight, and Display Control	456
8-3	Screen Display and Notification	467
8-4	Display and Control of Windows	476
8-5	Changing Numeral and Character String Display	486
8-6	Display of Graphs	502
8-7	Input of Numeric Values and Character Strings	503
8-8	Using the Alarm List/History Function	523
8-9	Using the Display History Function	528
8-10	Display and Setting of Calendar Clock	531
8-11	Printing Data and Checking the Printer Status	539
8-12	Enabling/Disabling PT Operations	543

SECTION 9

Using Memory Link 545

9-1	Operation of the Memory Link	546
9-2	Outline of Communications	549
9-3	Commands/Responses	553

SECTION 10

Function Applications 585

10-1	Examples of Actual Applications of Direct Access	586
10-2	Examples of Actual Applications of Memory Link	600

SECTION 11

Troubleshooting and Maintenance 605

11-1	Troubleshooting	606
11-2	Responding to Displayed Error Messages	609
11-3	Maintenance of the NT631/NT631C	616
11-4	Inspection and Cleaning	624

APPENDICES	627
A. Specifications	628
B. Dimensions	640
C. Using an RS-232C/RS-422A Convertor Unit	643
D. Transporting and Storing the NT631/NT631C	649
E. Making the Cable	650
F. Making the Cable for Connecting a PC	653
G. Making the Cable for Connection to a Bar Code Reader	654
H. Making the Cable for Connection to a Printer	655
I. Compatibility with Screen Data of Other PT Models	656
J. Model List	664
K. Option List	670
L. PC Memory Map	673
M. Keycode Tables	675
INDEX	677

About this Manual:

This manual describes the basic functions and operation procedures of the NT-series programmable terminal NT631/631C, its operations when connected to a PC or a Host, and includes the sections described below.

Please read this manual carefully and be sure you understand the information provided before attempting to install and operate the NT-series programmable terminal NT631/631C.

Section 1 describes the functions and configuration of the NT631/NT631C.

Section 2 gives basic information on the method for connecting to the host and communication methods, and describes the names and functions of the parts of the NT631/NT631C.

Section 3 describes how to make the settings at the NT631/NT631C, and how to connect it to peripheral devices.

Section 4 describes the method for connection to the host, communication method, compatible PC models, etc., when using the RS-232C port at the NT631/NT631C for the connection.

Section 5 describes the method for connection to the host, communication method, compatible PC models, etc., when using the RS-422A/485 port at the NT631/NT631C for the connection.

Section 6 describes how to use the system menu, which allows various settings and checks to be performed using the touch panel of the NT631/NT631C.

Section 7 describes the functions of the NT631/NT631C, focusing on the functions of the display elements that can be registered for the screens.

Section 8 describes the operations and procedures actually employed when using the NT631/NT631C, including those for functions that can be executed by combining screen elements, and control from the host.

Section 9 describes how to use the the NT631/NT631C, when using memory link

Section 10 gives suggestions to enable you to use the NT631/NT631C to its full potential.

Section 11 describes the corrective action to take when the system does not function normally, and the procedures for daily maintenance of the NT631/NT631C.

APPENDIX describes the specifications and method for making connector cables, and includes a list of related parts and a PC area map.

Related Manuals and Their Contents:

The related manuals are listed below.

The □ symbol at the end of the manual number is the revision history number.

[Operating the programmable terminal and communicating with the host]

- NT631/631C Programmable Terminal Operation Manual (V044-E1-□)
..... This manual

This operation manual is the manual for the NT631/631C itself.

This operation manual describes the functions and handling of both the programmable terminal body and the host interface function.

[Creating and transferring screen data]

- NT-series Support Tool Operation Manual (V053-E1-□)

The screens displayed on the NT631/631C are created with the support tool and transferred to the NT631/631C. This manual describes how to create and transfer screen data.

Note that in this manual, the NT-series Support Tool for Windows 95/98 is referred to as the “Support Tool”.

PRECAUTIONS

This section provides general precautions for using the Programmable Terminal.

The information contained in this section is important for the safe and reliable application of the Programmable Terminal. You must read this section and understand the information contained before attempting to set up or operate a Programmable Terminal.

1	Intended Audience	xiv
2	General Precautions	xiv
3	Safety Precautions	xiv

1 Intended Audience

This manual is intended for the following personnel, who must also have knowledge of electrical systems (an electrical engineer or the equivalent).

- Personnel in charge of introducing FA systems into production facilities.
- Personnel in charge of designing FA systems.
- Personnel in charge of installing and connecting FA systems.
- Personnel in charge of managing FA systems and facilities.

2 General Precautions

The user must operate the product according to the performance specifications described in the operation manuals.

Before using the product under conditions which are not described in the manual or applying the product to nuclear control systems, railroad systems, aviation systems, vehicles, combustion systems, medical equipment, amusement machines, safety equipment, and other systems, machines and equipment that may have a serious influence on lives and property if used improperly, consult your OMRON representative.

Make sure that the ratings and performance characteristics of the product are sufficient for the systems, machines, and equipment, and be sure to provide the systems, machines, and equipment with double safety mechanisms.

This manual provides information for using the Programmable Terminal. Be sure to read this manual before attempting to use the software and keep this manual close at hand for reference during operation.

 **WARNING** It is extremely important that Programmable Terminals and related devices be used for the specified purpose and under the specified conditions, especially in applications that can directly or indirectly affect human life. You must consult with your OMRON representative before applying Programmable Terminals to the above-mentioned applications.

 **WARNING** Do not use input functions such as PT touch switches for applications where danger to human life or serious damage is possible, or for emergency switch applications.

3 Safety Precautions

Read these safety precautions carefully and make sure you understand them before using the Programmable Terminal so that you can use it safely and correctly.

Safety Conventions and their Meanings

This operation manual uses the following conventions and symbols to indicate cautions, warnings, and dangers in order to ensure safe use of the NT631/631C. The cautions, warnings, and dangers shown here contain important information related to safety. This instructions in these cautions, warnings, and dangers must be observed.

The conventions used and their meanings are presented below.

 **WARNING** Indicates information that, if not heeded, could possibly result in loss of life or serious injury.

 **CAUTION** Indicates information that, if not heeded, could result in relatively serious or minor injury, damage to the product, or faulty operation.

Precautions

 **WARNING**

Do not attempt to take the unit apart and do not touch any internal parts while the power is being supplied. Doing either of these may result in electrical shock.



 **WARNING**

Switch OFF the NT631C power before replacing the backlight. Otherwise you could sustain an electric shock.



SECTION 1

General

This section provides fundamental information about the functions and features of the NT631/NT631C, types of connection, communication methods, etc. This information will enable you to understand the applications of the NT631/NT631C.

1-1	Role and Operation of the NT631/NT631C	2
1-1-1	Operation of an NT631/NT631C at an FA Production Site	2
1-1-2	Operations of the NT631/NT631C	3
1-2	Functions of the NT631/NT631C	4
1-2-1	Features	4
1-2-2	Comparison between NT631 and NT631C	6
1-2-3	Supplemental functions to V1	6
1-2-4	Comparison between NT620S/NT620C/NT625C and NT631/NT631C	7
1-2-5	Principal Functions of NT631/NT631C	8
1-2-6	Displays	10
1-3	Communication with the Host	15
1-3-1	Direct Connection Function	15
1-3-2	Host link	16
1-3-3	NT Link	16
1-3-4	Functions of the Allocated Bits and Words	18
1-3-5	Connecting to other model PCs	23
1-4	Communication by Using Memory Link	24
1-4-1	Memory Link	24
1-4-2	Comparison between Direct Connection and Memory Link	25
1-5	System Configuration	26
1-5-1	Peripheral Devices That Can Be Connected	26
1-5-2	Connecting to the Host	27
1-6	Before Operating	28

1-1 Role and Operation of the NT631/NT631C

The NT631/NT631C is a sophisticated display unit (programmable terminal) which automatically displays information and can also be used for operations when necessary. The following gives a general description of the role and operation of the NT631/NT631C for those using a programmable terminal (PT) for the first time.

1-1-1 Operation of an NT631/NT631C at an FA Production Site

Production Line Status Monitoring

The NT631/NT631C displays real-time information about the system and equipment operating status, etc. Its power of expression is enhanced by graphs and other visuals, making the displays easy to understand.

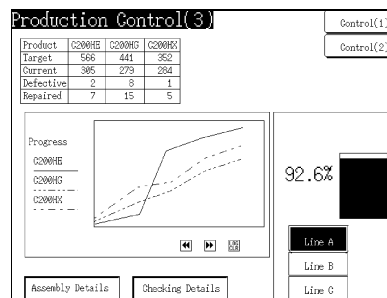

Directions to Workers on the Shop Floor

The NT631/NT631C warns of system or equipment failures and prompts the appropriate remedial action.

Alarm

Assembly line B

Positioning pin

is defective. Line stopped.

Check the following.

1. Defective pin L3
2. Position of dog M2
3. Mounting of photosensor P5

Panel Switch Functions

Setting touch switches on the NT631/NT631C allows workers to use the NT631/NT631C as an operating panel; the results of the operations are transmitted to the host.

Electroplating control			
Transport	Electr. head	Wash. head	Corr. prv. head
<div style="display: flex; flex-direction: column; align-items: center;"> <div style="display: flex; gap: 10px;"> ↑ Clamp </div> <div style="display: flex; gap: 10px;"> ← → </div> <div style="display: flex; flex-direction: column; align-items: center;"> ↓ Unclamp </div> </div>	<div style="display: flex; flex-direction: column; align-items: center;"> UP DOWN </div>	<div style="display: flex; flex-direction: column; align-items: center;"> UP DOWN </div>	<div style="display: flex; flex-direction: column; align-items: center;"> UP DOWN </div>
<div style="display: flex; gap: 10px;"> Int. stop Adv. </div>	<div style="display: flex; flex-direction: column; align-items: center;"> Rev. Electro-lyte </div>	<div style="display: flex; flex-direction: column; align-items: center;"> Wash </div>	<div style="display: flex; flex-direction: column; align-items: center;"> Corr. prv. fluid </div>

1-1-2 Operations of the NT631/NT631C

Displays Screens

The information to be displayed (screen data) can be created on a computer using the Support Tool and stored in the NT631/NT631C. The screen data can be displayed on the NT631/NT631C in response to instructions from the host or touch switch operation.

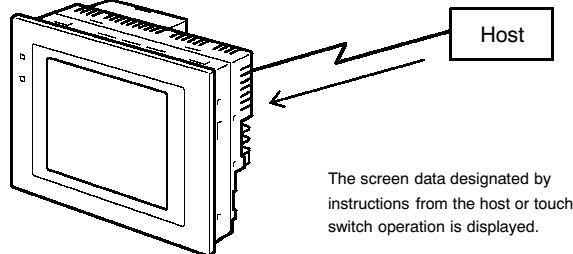

Receives Data from a Host

The NT631/NT631C can be connected to the host by a host link or NT link and receive necessary data from the host.

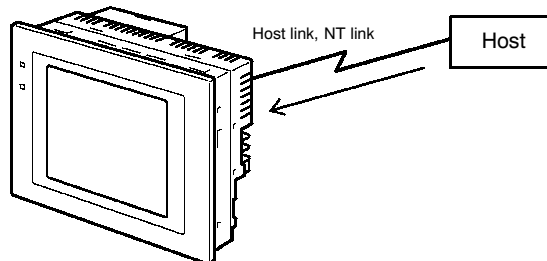

Sends Data to a Host

Data input using the touch panel (switch ON/OFF statuses, numeric values, character strings) can be transmitted to the host.

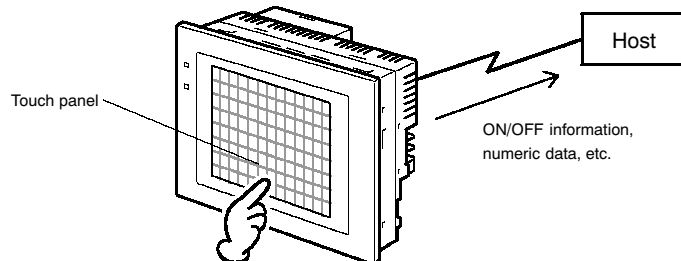

Screen Data

The screen data to be displayed on the NT631/NT631C can be created on a personal computer using the Support Tool. Connect the NT631/NT631C to the personal computer with an RS-232C cable and transmit the screen data to the NT631/NT631C.

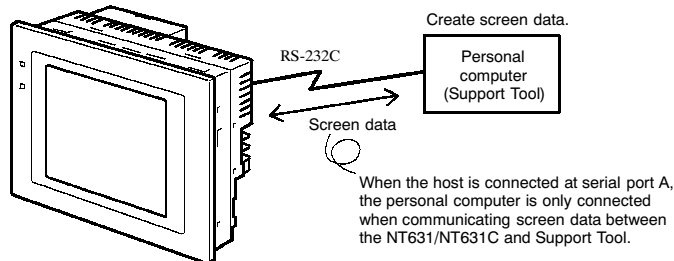

1-2 Functions of the NT631/NT631C

The NT631/NT631C has the following features.

1-2-1 Features

Slim Body

- High-performance in a low-profile body (50 mm or less in the panel*).
 - The communication cable connectors are housed in the unit so that they do not protrude from the unit.
- * When mounted in a panel of the recommended thickness (page 38).

Construction Best Suited to the FA Environment

- The panel is provided with a high-contrast monochrome EL display for NT631-ST211□-EV1, an STN color LCD display with backlight for NT631C-ST141□-EV1, and a TFT color LCD high definition display for NT631C-ST151□-EV1.
 - The backlight unit and battery can be replaced at the operation site.
 - Waterproofed equivalent to the NEMA4 standard and to IP65F*.
- * The panel may not be usable in environments where it is exposed to oil for long periods.

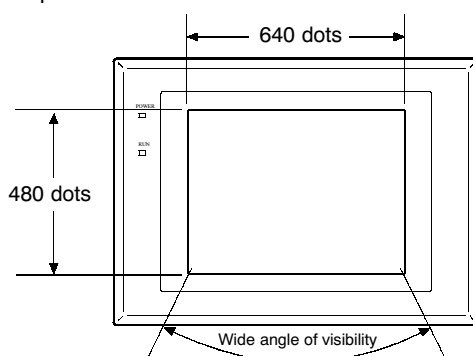

Touch Switch Operation

- Contrast and brightness are adjustable by touch switch operations (for NT631C-ST141□-EV1 only).

Compatibility with Other PTs

- There is upward compatibility between the NT631/NT631C and the following models for screen data and user programs: NT11S, NT20S, NT30, NT30C, NT31, NT31 NT600S, NT610G, NT610C, NT620S, NT620C, NT625C. (After being read to the Support Tool, screens must be modified in accordance with the screen size. Depending on the function used, partial modification of programs may also be necessary. For details, refer to APPENDIX I “Compatibility with Screen Data of Other PT Models” (page 657) and the Support Tool manual.)
- The dimensions of the panel cut-out to accommodate the NT631/NT631C are the same as for the NT625C.

Two Ports Featured as Standard: Port A for Common Use by Support Tool/Host and Port B for Exclusive Use by the Host

- Communication with the host is possible via another port while connected to the Support Tool.
- Reading bar code data from a bar code reader is possible via another port while communicating with the host.

Rapid System Program & Screen Data Changes Possible Using a Memory Unit.

- Installing a memory unit (type NT-MF261) on the rear of the NT631/NT631C makes it easy to write screen data into the NT631/NT631C on site. This enables a rapid response to setup changes.
- NT631/NT631C can store a system program into a memory unit. This enables the system to handle more flexible setups.

Screen Data Check Function • Screen data can be checked simply by operations at the NT631/NT631C system menu, without connecting up to the Support Tool.

Large Increase in Maximum Number of Registered Elements

- The number of elements that can be registered on one screen has been considerably increased, making it possible to create more expressive screens. For details, refer to "Display Restrictions" (page 634).

Binary Data can be Read to/Written from the Host

- It is now possible to write binary data stored in words at the host directly to the NT631/NT631C. This makes data conversion by a program at the host unnecessary, reducing the load on the host.

Character Display Using High Definition Fonts

- Any quadrupled characters are displayed with a 32 dot high-definition font.

Simple Version Upgrades • By using the system installer supplied with the Support Tool (Type NT-ZJ3MX1/ZJCMX1-EV3), the system program at the NT631/NT631C can be changed easily from a personal computer.

Complies with International Standards

- The NT631/NT631C meets UL/CSA standards and EC directives.

1-2-2 Comparison between NT631 and NT631C

Two NT631 models — the NT631, which is capable of versatile graphic displays (EL display, yellow), and the NT631C, which is also capable of color display — are available. The differences between the NT631 and NT631C are tabled below:

Function	NT631-ST211□-EV1	NT631C-ST141□-EV1	NT631C-ST151□-EV1
Type	NT631-ST211-EV1 (Beige) NT631-ST211B-EV1 (Black)	NT631C-ST141-EV1 (Beige) NT631C-ST141B-EV1 (Black)	NT631C-ST151-EV1 (Beige) NT631C-ST151B-EV1 (Black)
Display panel	Monochrome EL display	STN color LCD display (with white backlight)	TFT color LCD display (with white backlight)

Beige and black are the front panel colors of each NT631/NT631C types.

1-2-3 Supplemental functions to V1

The V1 version of NT631/NT631C is supplemented and enhanced by the following functions.

Supporting memory link

By using the RS-232C/422A interface, V1 has become capable of supporting a "memory link" that carries out a quasi-direct connection. Now NT631/NT631C can be controlled from a personal computer or an FA computer.

Supporting a variety of vendors

V1 has become capable of supporting the Mitsubishi A series sequencer (computer link) and FX series sequencer (programmable controller). Sequencers built by different manufactures will be able to control NT631/NT631C if their specific system programs are installed.

System transfer by memory unit

V1 has become capable of storing the NT631/NT631C system program into the memory unit (Type NT-MF261) installed on the rear of NT631/NT631C. The installation of the memory unit is all that is needed to enable the easy system program change at the operation site.

Enhancing Window functions

V1 has become capable of laying out more parts on windows. Also, it can display a maximum of three windows simultaneously.

A window control area (9CH) has been added to the direct connection area. This has enabled a control of the windows display from the host side as well as the moving of windows.

Adding an analogue meter

"An analogue meter", a graph having the shape of a meter, has become available. Quarter, half, and full circle shapes are available to display numeric values on this graph.

Equipped with high-Definition fonts

Any quadrupled characters are automatically displayed with more sophisticated fonts. (Standard size characters by a 16 by 32 dot font.)

Equipped with a high intensity TFT (NT631C-ST151□-V1 only)

The intensity of the NT631C TFT type (NT631C-ST151□-V1) has been enhanced, resulting in a brighter and more legible display.

1-2-4 Comparison between NT620S/NT620C/NT625C and NT631/NT631C

Item	NT620S/NT620C/NT624C	NT631/NT631C
Support Tool used	NT-ZJ3MX1/ZJCMX1-EV3 or NT-ZA3AT-EV2	NT-ZJ3MX1/ZJCMX-EV3
DIP switches	On rear of unit	None (software settings)
Use of memory unit	Not possible	Possible
RS-232C interface	Connector (9-pin) also used as port for screen data transfer.	- Serial port A connector (also used for screen data transfer, 9-pin) - Serial port B connector (for host communications only, 9-pin)
RS-422A/485 interface	NT620S/NT620C: None NT625C: Terminal block (DIP-switch selectable between RS232C and RS-422A/485)	Terminal block (serial port B; memory-switch selectable between RS232C and RS-422A/485)
Replacement backlight	NT620C-CFL01 (NT620C) NT610C-CFL02 (NT625C)	NT631C-CFL01 (for ST151) NT631C-CFL02 (for ST141)
NT631/NT631C system program data	NT620-ZS3AT-EV1/EMV1 (including system installer)	The system installer and system program data are supplied with the Support Tool.
LCD contrast adjustment	By a control on the rear of the unit	By touch panel operation (Possible in the NT631-ST141□-V1 only.)
Backlight brightness adjustment	Not possible	By touch panel operation (Possible in the NT631-ST141□-V1 only.)
Number of user-registered screens	Maximum of 2000	Maximum of 3999
Screen data capacity*1 (User program memory)	512 KB	1 MB
Screen data capacity*	NT620S: 512 KB NT620C/NT625C: 1 MB	1 MB
Numeral string data	Maximum of 1000	Maximum of 2000
Character string data	Maximum of 1000	Maximum of 2000
Bit data	256	Maximum of 1000
Image data	Maximum of 224	Maximum of 4095
Library data	Maximum of 896	Maximum of 12288
Method for storing numeric values (numeral memory data and PT status control area)	Fixed as BCD (binary coded decimal)	Selectable from BCD (binary coded decimal) or binary
PT status control area size	4 words	5 words (partial change of contents)
PT status notify area size	3 words	2 words (partial change of contents)
Window control area size	None	9 CH*2
Registering continuous screen	Possible	Not possible (Use a screen switchover as a substitute.)

*1 : This is the capacity of the flash memory that stores screen data.

*2 : This is available only on V1 of NT631/NT631C.

For differences in programming, refer to APPENDIX I “Compatibility with Screen Data of Other PT Models” on page 30.

1-2-5 Principal Functions of NT631/NT631C

The following are the principal functions of the NT631/NT631C.

Functions relating to data display

Character display
 Characters of various sizes can be displayed. Characters can be flashed and displayed in reverse video. High grade fonts are available for the characters with their size enlarged.

Graphic display
 Polylines, rectangles, polygons, circles, circular arcs, and sector shapes can be displayed. They can also be tiled with various patterns, flashed, or displayed in reverse video.

Memory data display
 The contents of character string memory tables and numeral memory tables can be displayed. The contents of memory tables can be changed from the host.

Graph display
 Not only bar graphs but also broken line graphs, trend graphs, and analogue meter graphs can be displayed using numeral memory tables

Lamp display
 Lamps can be turned on and flashed under the control of the host. It is also possible to display different graphics in the "on" and "off" states.

Alarm list/history display
 Warning messages are automatically displayed in a list in response to the state of a host bit. The time and the number of times of the messages appeared can also be displayed.

Functions relating to data output

Buzzer
 A built-in buzzer can be sounded.

Screen printing
 A hard copy of the currently displayed screen can be printed at the printer connected to the NT631/NT631C.

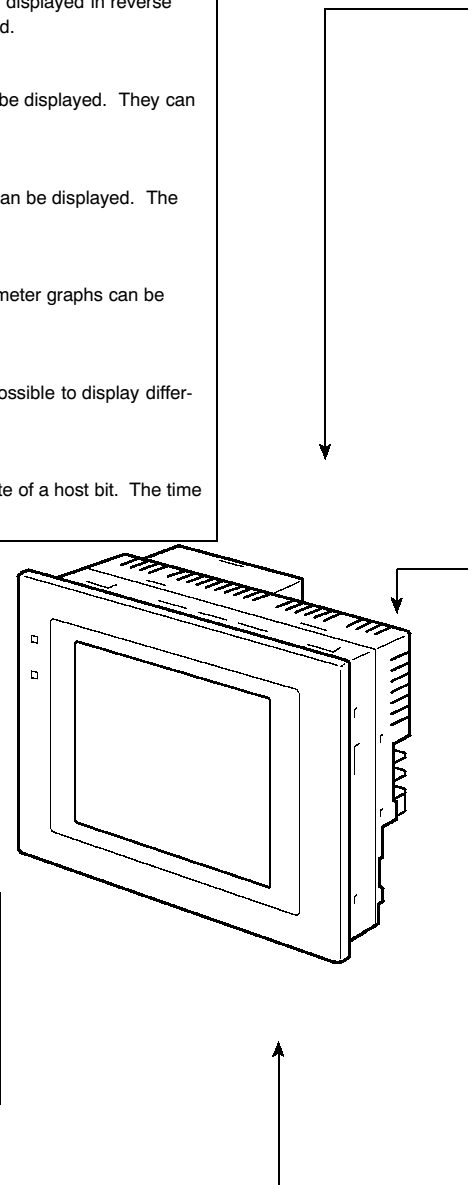

Functions relating to data input

Input by touch switches

Data can be input by simply touching touch switches displayed on the screen.

The possible functions of touch switches include sending data to the host and changing the screen display.

Pop-up window function

A window overlaying the currently displayed screen can be alternately opened and closed by pressing a touch switch.

In addition to fixed character and graphic displays, control keys and character keys created as touch switches can also be set inside the window. A maximum of three windows can be displayed simultaneously. Since the window need only be opened when input is required, the screen can be used efficiently.

Numeral/character string setting function

Numeric keys and character keys can be assigned to touch switches so that numeric values and character strings can be input at the operation site.

The input data is written to numeral/character string memory tables and also sent to the host. It is also possible to disable input by control from the host.

Input from a bar code reader

Data read with a bar code reader can be input to a character string input field.

Functions relating to communication

Communications with the host

The NT631/NT631C can communicate with the host by four methods: host link, NT link (1:1), and NT link (1:N) and Memory link. Data can be read from the host, and data input by means of touch switches and numeral/character string settings can be sent to the host. It is also possible to connect with other model PCs.

Functions relating to the system

System menu

System settings and maintenance can be performed by selecting from system menus displayed on the screen.

Creation of screen data

Screen data created using the Support Tool at a personal computer can be transferred and stored in the built-in screen data memory.

Resume function

The status and memory table contents of the NT631/NT631C immediately before its operation is stopped can be stored while operation is stopped, or while the power is off, and then displayed on the screen again when operation is restarted.

Screen saver function

This function serves to extend the service life of the backlight and EL and prevent the formation of an afterimage on the screen.

Clock function

The time can be displayed in accordance with the internal clock data.

Programming console function

When the NT631/NT631C is connected to a C series CPM1, CQM1, or C200HX/HG/HE-(Z)E programmable controller in an NT link (1:1) connection, and also is connected to CS1 series CS1G/CS1H in an NT link (1:N) connection, operations equivalent to those of a programming console (C200H-PR027-E) are possible.

System program install function

The system program of the NT631/NT631C can be changed by using the system installer supplied with the Support Tool (NT-ZJ3AT1/ZJCAT-EV2). It can also be installed by using a memory unit (NT-MF261).

Screen display history function/alarm history function

The screen display history function records the time at which specific screens are displayed and the number of times they are displayed. The alarm history function records the time at which specific bits at the host are turned ON and the number of times they are turned ON.

Trend graph logging function and background function

Changes in the contents of numeral memory tables displayed in trend graphs can be recorded (logging function). Also, the record can be maintained even when the trend graph is not displayed (background function).

1-2-6 Displays

The NT631/NT631C can display various kinds of elements such as characters, numeric values, graphs, lamps, and touch switches, on a screen. The screen data displayed by the NT631/NT631C are created by using the Support Tool at a personal computer.

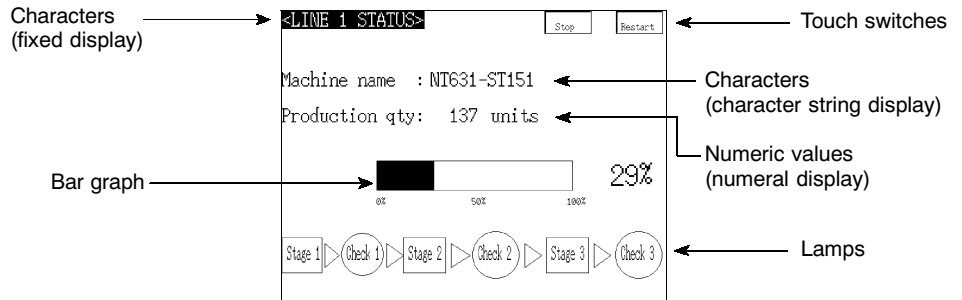

- Fixed displays

Characters and various graphics (circles, circular arcs, sectors, polylines, polygons and rectangles) whose display does not have to be changed, and mark data, image data, and library data that has already been registered, can be written directly onto the screen.

Circle

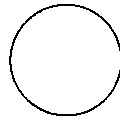

Arc



Sector

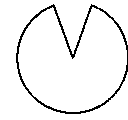

Polyline

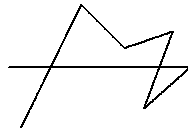

Polygon



Rectangle



* A continuous straight line with up to 256 points can be drawn.

* A polygon with up to 255 vertices can be drawn.

“Marks” are graphics comprising 16 by 16 dots that can be used as characters. They can be used as custom characters within character strings.

“Image data” are graphics comprising any required area of dots. They are registered in advance and as many as required can be displayed at any position on the screen.

Windows bit map (BMP) data can be used for images.

There is a two-color mode, in which the display color and background color of the image are specified when it is registered in a screen, and an eight-color mode in which colors are assigned to the image in advance.

Since image data is composed of dots, it requires a large data size but offers great powers of expression.

“Library data” are combinations of fixed display graphics registered as a single graphic. They are registered in advance and as many as required can be displayed at any position on the screen.

Since it is generated by combining graphics, library data has a small data size.

Mark Image data Library data



• Lamps

These are graphics whose display status changes in accordance with the states of bits at the host. Squares, circles, sectors and polygons can be used for lamps (normal (standard) lamps). In accordance with the status of the host bit, they can be lit (displayed in reverse video) or flashed (repeated alternation between normal and reverse video display states).

Lamps can also display different image/library data for the ON and OFF states of the host bit (such lamps are called “image/library lamps”).

- Normal (standard) lamps

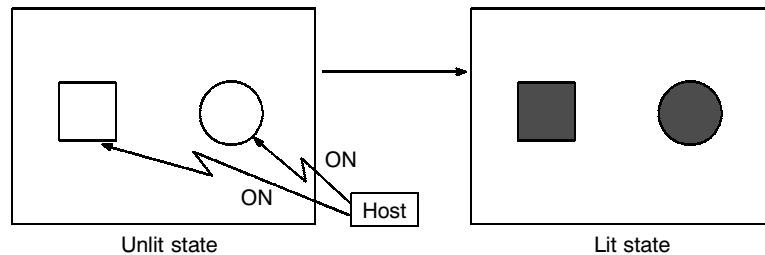

- Image/library lamps

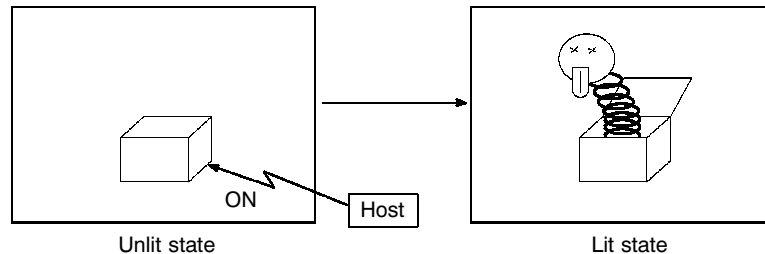

• Touch switches

These switches can be set at any location on the screen. Pressing a touch switch on the screen where a touch switch has been set can have the following effects:

- Notification to a host bit (input notification function)
- Changing the displayed screen (screen switching function)
- Input of a numeric value or character string (input key function)
- Copying of a numeric value or character string (copy key function)
- Shifting to another numeric value or character string input field (cursor moving key function)
- Obtaining a hard copy of the screen (screen print function)
- Opening / Closing a window
- Moving a window

Touch switches can be made to light or flash in accordance with the status of a host bit in the same way as lamps.

The following 8 types of display graphic can be used for touch switches:

Standard, shadow, 3-dimension, no display frame, rectangle, circle, polygon, sector

When rectangle, circle, polygon, or sector is selected as the shape, the area within which pressing of the touch switch is sensed (the "touch switch area") can be set independently of the position where the display graphic is set.

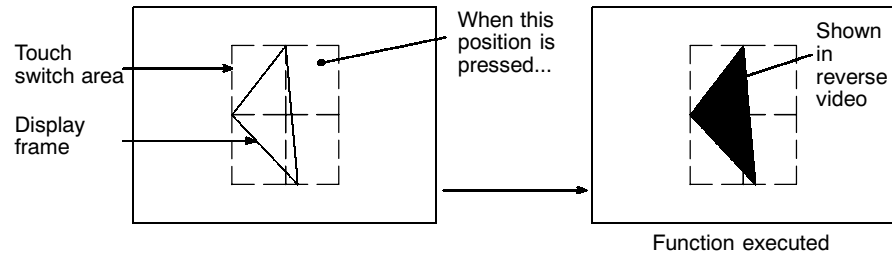

- Numeral display

Numeric values stored in the numeral memory tables are displayed. The displayed numerals can be changed by changing the data stored in the numeral memory tables.

Hexadecimal values can also be displayed.

When decimal values are displayed, the number of digits for the integral part and fractional part of displayed values can be specified in advance.

- String display

Character strings stored in the character string memory tables are displayed. The displayed character strings can be changed by changing the data stored in the character string memory tables.

- Numeral input

Numeric values can be input at the PT by using touch switches. The input numeric values can also be stored in a numeral memory table and notified to the host.

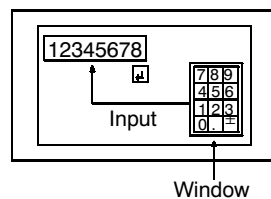

- String input

Character strings can be input at the PT by using touch switches, bar code readers, etc. The input character strings can also be stored in a character string memory table and notified to the host.

Character string setting input field

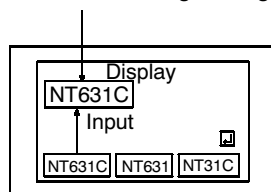

- Thumbwheel switches

Numeric values can be input by incrementing or decrementing each digit with the corresponding touch switch (+, -). The input numeric values can also be stored in a numeral memory table and notified to the host.

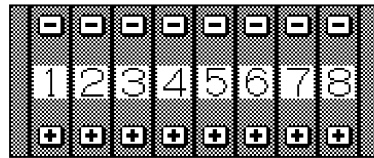

- Graphs

These are graphics whose display changes in accordance with the numeric values stored in numeral memory tables. There are the following four types.

Bar graphs:

Bar graphs display the present value in a numeral memory table converted to a percentage within the range -100% to +100% of a preset value.



Analogue meter:

Analogue meters display, using a quarter, half, or full circle shape, the present value in a numeral memory table converted to a percentage within the range -100% to +100% of the preset value. Users can choose from moving pointer type and filling area type displays. Users can also add graduation to the graph.



Broken line graphs:

Broken line graphs display, in an easy-to-read form, a sequence of numeral memory table values converted to a percentage within the range -100% to +100% of a preset value.

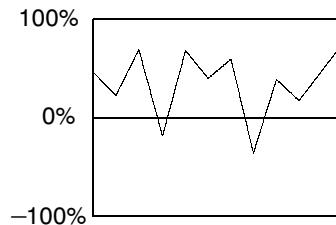

Example showing a series of 11 numeral memory table values (with a check mark set for "Display Sign")

Trend graphs

Trend graphs display chronological changes in the value in a numeral memory table, converting the value to a percentage within the range -100% to +100% of a preset value. The trend graph shifts position with the passage of time.

Past data can also be recorded, and the numeral memory table can be read (sampled) even while the trend graph is not being displayed.

The user can choose to stop sampling, restart sampling, or display past data, by pressing touch switches.

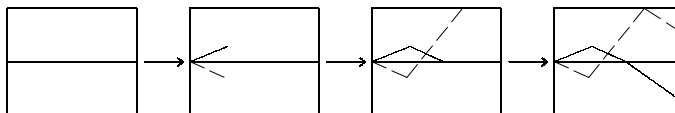

• Alarm list/history

The alarm list/history function displays messages in list form, or graphics (image/library data), in accordance with changes in bit memory table statuses.

For the alarm list, a series of bit memory tables are monitored, and messages (contents of character string memory tables) set for bit memory tables that come ON are displayed.

For the alarm history, bit memory tables for which the history property is set are continually monitored, and the time when they come ON and number of times they come ON are recorded and displayed together with the message (character string) set for the bit memory table.

The NT631/NT631C allows selection of the display order as “newest record first” or “oldest record first” by memory switch setting.

The alarm list function is used to determine which bits are ON at the present time. The alarm history function is used to determine the times at which alarms occurred in the past and how many times alarms have occurred.

- Alarm list

Message (character string table No. 32)
set for bit memory table No. 14

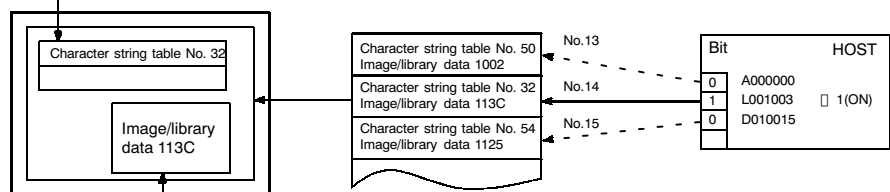

When the message displayed is pressed, the image/library data (113C) set for bit memory table No. 14 is displayed.

- Alarm history

Message (character string table No. 13)
set for bit memory table No. 24

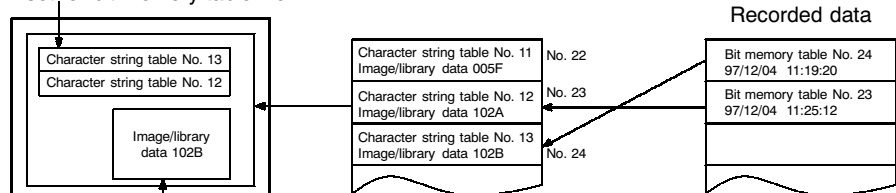

When the upper message displayed is pressed, the image/library data (102B) set for bit memory table No. 13 is displayed.

1-3 Communication with the Host

The NT631/NT631C is connected to the host by one of the following four communication methods.

- Host link method:
- NT link (1:1) method
- NT link (1:N) method
- Memory link method

In all of these communication methods that can be used with NT631/NT631C, data communication with host is by "direct connection" (Memory link is, however, a quasi-direct connection).

In the following, the host link and NT link that carry out the "direct connection" will be discussed. Memory link will be explained in section "1-4 Communication by memory link".

1-3-1 Direct Connection Function

With the NT631/NT631C, the bits and words referring to data required for display, and those for storing input data, can be allocated to any part of the PC memory area.

The NT631/NT631C can directly write to and read from such allocated bits and words to change the display status of the elements on the PT screen, control the PT operating status, and notify statuses to the host.

This function, which directly reads and writes the statuses of words and bits without using a PC program is called the "direct connection" function.

The words and bits allocated for direct connection are called the "allocated words" and "allocated bits".

The direct connection function allows the data to be displayed at the NT631/NT631C to be read from the memory area in the PC and written to memory tables in the NT631/NT631C. Also, the data input at the NT631/NT631C can be written to the memory area in the PC. The NT631/NT631C screen can be changed in accordance with statuses in the PC memory area, and the NT631/NT631C's status data can be written to the PC's memory area.

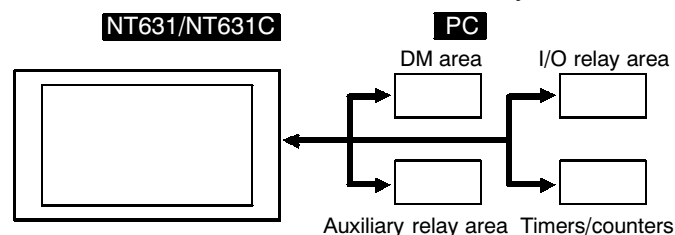

Features of the Direct Connection Function

The direct connection function has the following features.

- The bits and words referring to operating status and work instruction information and those for storing input data can be freely allocated to almost any area of the PC memory.
- Since the NT631/NT631C can directly refer to PC bit and word data without using the program at the PC, it can be connected to the PC without changing the PC program which controls the currently running production line.
- The area to control and notify the NT631/NT631C statuses, including display screens, display/no display status, and buzzer output, can be freely allocated to any part of the PC data area. This means that the PC status can be read and controlled just by reading this area at the PC side, without preparing a special communication program.

The direct connection function allows the NT631/NT631C to directly read and write almost all bits and words in the PC and to automatically change the NT631/NT631C screen display. This function can reduce the load on the PC so that its program development efficiency is improved.

1-3-2 Host link

The host is connected to a PT in a 1:1 connection, and the words and bits of the host are read and displayed by host link communication. This method can be used for connection to the majority of PC types.

1-3-3 NT Link

NT link is a method for high-speed communication with a PC using the direct connection function. The PCs that can be connected with the NT link are as follows.

- When using the built-in host link function of a CPU unit or SRM1
CPM1, CQM1, C200HS, C200HX/HG/HE(-ZE), CS1G/CS1H, CVM1/CV-series PC (-EV1 or later version), SRM1
- When using a communication board
C200HX/HG/HE(-ZE)

Besides the 1:1 NT link method, in which one PC is connected to one PT, the NT631/NT631C can also use the 1:N connection NT link method, which allows a maximum of eight PTs to be connected to one PC port.

PCs that can be connected with the 1:N connection NT link method are as follows.

C200HX/HG/HE (-Z), CS1G/CS1H

In the following sections, the term “NT link” is used to refer to the NT link communication method in general, the term “NT link (1:1)” is used to refer specifically to NT links with a 1:1 connection, and the term “NT link (1:N)” is used to refer specifically to NT links with a 1:N connection.

Features of the NT Link

The NT link has the following features.

- High-speed communications with specific types of PCs can be executed.
- Writing in units of bits to the PC memory area is possible.

This enables the other bits of words to which a touch switch has been allocated to be allocated for other purposes (e.g. a lamp).

However, since data is written to the DM area in word units, the other bits of words allocated to touch switches in this area cannot be used for other purposes.

- The NT link can be used even when the PC is in the RUN mode. (When the host link method is used, the NT631/NT631C switches to the monitor mode when the PC is in the RUN mode.)
- In the case of PTs that support the host link (1:N) method (NT20S, NT31, NT31C, NT600S, NT620S, NT620C, NT625C, NT631, NT631C) up to 8 PTs can be connected to one port of the PC and used at the same time.
- When using C200HX/HG/HE-(Z)E, by installing a communication board in the option slot of the CPU, up to three NT link (1:N) systems (i.e., 24 PTs) can be connected. For details on the communication board, refer to the SYSMAC Communication Board User's Manual (W304-E1-□).
- When using CS1G/H, by installing a communication board in the INNER board slot of the CPU or installing a serial communication unit in the base unit, multiple NT link (1:N) systems can be connected. For details on the communication board/communication unit, refer to the CS1 series Serial Communication Board/Unit User's manual (W336-E1-□).
- If the PC used supports the programmable console function, the NT631/NT631C can be used as a programmable console.

The NT link is compatible with the host link. The NT631/NT631C screen data and PC programs used with the host link direct connection method can be used with the NT link method as they are.

1-3-4 Functions of the Allocated Bits and Words

Elements displayed on the NT631/NT631C and the NT631/NT631C status can be allocated to the bits and words of the PC when using the direct connection function. By changing the contents of the bits and words, the NT631/NT631C can be controlled by the PC. It is also possible to send data to the PC by pressing touch switches at the NT631/NT631C.

- Controlling the NT631/NT631C with a PC

The following NT631/NT631C functions can be controlled by a PC.

- Screens:

Display of designated screens, confirmation of screen numbers, etc.

- Memory tables:

Writing to a memory table, copying from a memory table to another memory table, etc.

- Lamps and touch switches:

Display instructions, confirmation of display status, etc.

- System control:

Buzzer ON/OFF, display/no display status, screen printing, and other NT631/NT631C statuses

- Notifying from the NT631/NT631C to a PC

Data in the NT631/NT631C is sent to a PC when, for example, a touch switch is pressed. The following 4 types of data are sent to a PC.

- NT631/NT631C status, screen number of currently displayed screen

- Touch switch statuses

- Numeric values and character string input with the numeral/character string setting function using touch switches or a bar code reader.

- Changes in memory tables after copying between memory tables, etc.

Functions of Display Elements

- Lamps (page 320)

Allocation destination: Bit

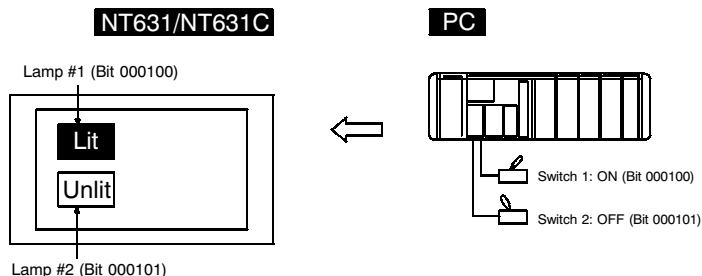

The PC's bit status is displayed by the "lamp" at the NT631/NT631C.

Normal (standard) lamps come on (flash) when the PC's bit status (lamp bit) is ON (1), and go off when it is OFF (0).

With image/library lamps, the displayed image or library data can be switched in accordance with the ON (1)/OFF (0) status of PC bits (lamp bits).

- Touch switches (page 328)

Allocation destination: Bit

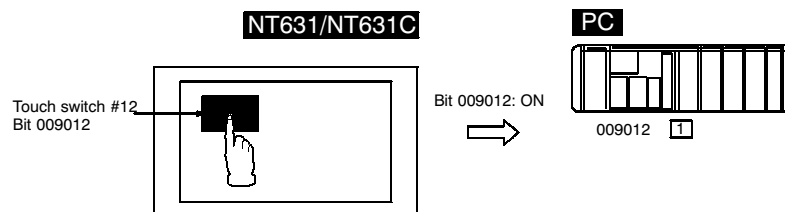

The lamp comes on (flashes) when the PC's bit (lamp bit) is ON (1) and goes OFF when it is OFF (0). When the touch switch is pressed, the PC's notification bit comes ON (1) or goes OFF (0).

- Numeral display (numeral memory tables) (page 348)

Allocation destination: Word

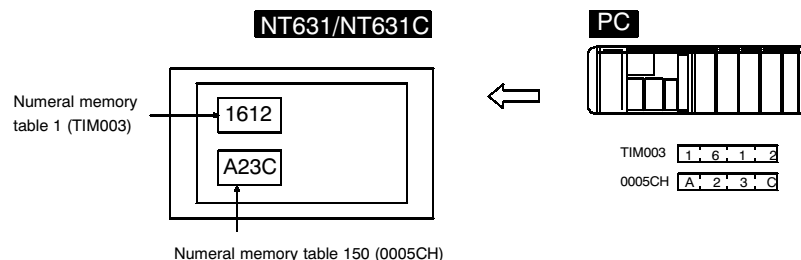

Allocate numeral memory tables to required words in the PC. If the word contents change when the corresponding numeral memory table is displayed on the screen, the value on the screen will also change. The words can also be monitored easily.

Reading and writing are executed so that the contents of allocated words are always the same as those of the numeral memory tables.

- Character string display (character string memory tables) (page 356)

Allocation destination: Word

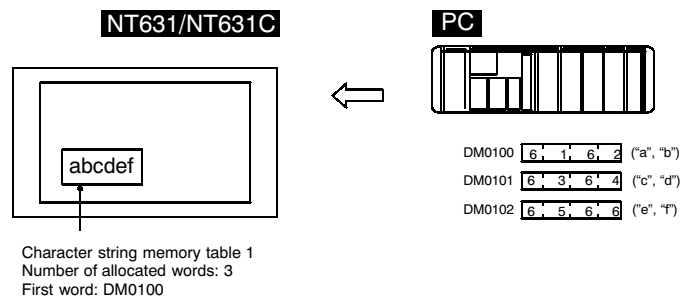

Allocate character string memory tables to arbitrary words in the PC. If the word contents change when the corresponding character string memory table is displayed on the screen, the character string on the screen will also change. Any messages can be displayed easily.

Reading and writing are executed so that the contents of allocated words are always the same as those of the character string memory tables.

- Alarm list (bit memory table) (page 395)

Allocation destination: Bit

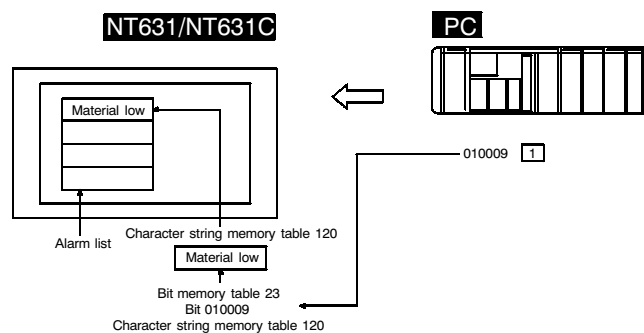

When the PC bit comes ON (1), the contents of the character string memory tables registered for the bit memory tables are displayed in the alarm list. When the bit returns to the OFF (0) status, the character string memory table display is automatically cleared.

- Alarm history (bit memory table) (page 395)

Allocation destination: Bit

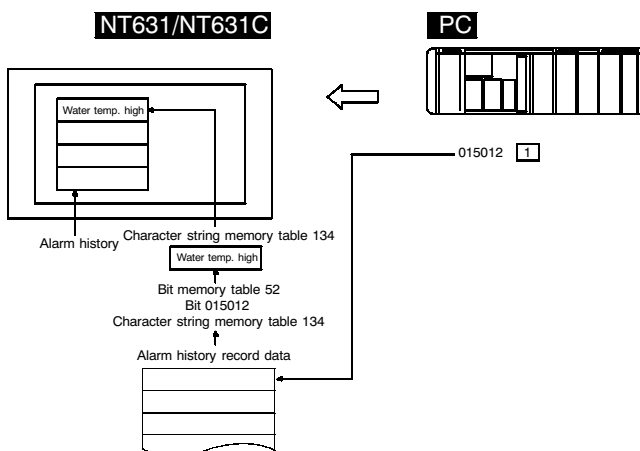

The PC bit allocated to bit memory table for which the history property has been set is continually monitored: when the bit comes ON (1), the time and the number of times, and the contents of the character string memory table registered for the bit memory table, are recorded in the alarm history record data.

This record data can be displayed as the alarm history.

Functions of the PT Status Control Area (PC to NT631/NT631C)

The “PT status control area” is used to control the NT631/NT631C status. When data is written to this area in the PC, the NT631/NT631C reads the contents and operates according to the contents.

[Example of PT status control area application]

When data is written to the PT status control area, the NT631/NT631C operates as shown below (page 260).

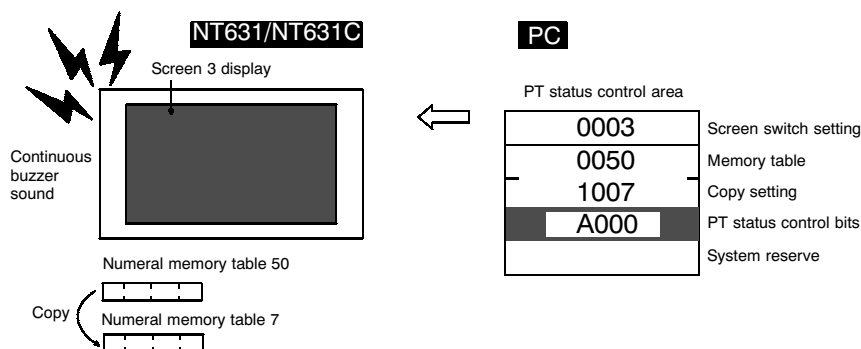

Functions of the PT Status Notify Area (NT631/NT631C to PC)

The "PT status notify area" is used to notify the changes in the NT631/NT631C status.

When the NT631/NT631C status changes, the change is written to this area in the PC. By reading the data from this area, the NT631/NT631C status can be checked.

[Example of PT status notify area application]

When the NT631/NT631C status changes, the change is notified to the PT status notify area as shown below (page 269).

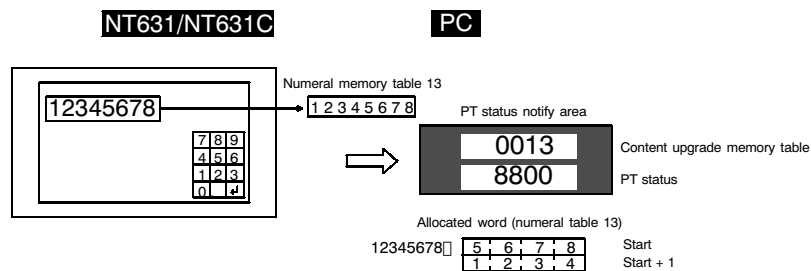

Functions of the Window Control Area (PC to and from PT)

The "window control area" is used to notify and control the window status. The window control area has areas that correspond to three windows. Each area stores the screen number, and the X and Y coordinates of the lower left corner of the window that is being displayed.

When data is written to this area in the PC, the NT631/NT631C reads the contents and executes tasks such as switching the windows to be displayed or moving the position of the windows according to the contents (page 7 to 170).

When the window display status changes, the change is written to this area in the PC. By reading the data from this area, the window display status can be checked (refer to page 7 to 170).

If the window functions are not used, it is not necessary to allocate a window control area to the host.

[Example of window control area application]

When data is written to the window control area, the NT631/NT631C operates as shown below.

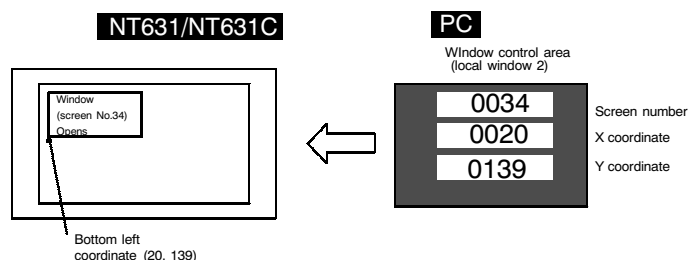

When the window display status changes, the change is notified to the window control area as shown below (Window's Opening/Closing status is notified to the PT status notify area as well).

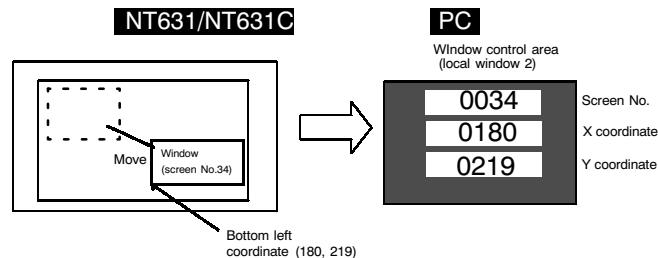

1-3-5 Connecting to other model PCs

Installing a system program for multi-venders by using a specific system installer enables the NT631/NT631C to be connected to the PCs of other models in direct connection.

This system installer is supplied with the Support Tool (NT-ZJ3MX1-EV3/NT-ZJCMX1-EV3).

Compatible PC

The NT631/NT631C can be connected to the following model PCs.

- Mitsubishi A series programmable controller (computer link module)
- Mitsubishi FX series programmable controller

For details on the procedure for connecting to other model PCs, refer to the PC Connection Manual.

1-4 Communication by Using Memory Link

In this section, a communication method other than the direct connection, called the memory link, is discussed.

1-4-1 Memory Link

Memory link is a method to send and receive data between a personal computer or a FA computer and the NT631/NT631C by using RS-232C/422A communication.

In memory link, there is an area called "PT Memory", as shown below, inside the NT631/NT631C, and this area is treated as a virtual area on the PC. This allows PT memory and the display elements of the NT631/NT631C to make a quasi-direct connection. By sending a command for the memory link, the host can make the NT631/NT631C execute processes through PT memory. Frequently used commands are kept handy for read and write tasks of the numeral memory table, character-string memory table, and bit memory table.

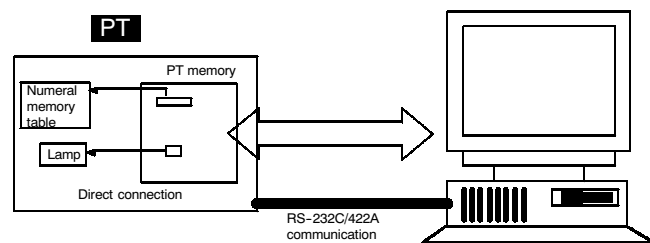

In the memory link method, the only difference is that the NT631/NT631C finds its communication target inside instead of outside. In the memory link method, therefore, change of the target is all that is needed to be capable of using the exact screen data that is acquired by the direct connection.

When compared to the direct connection of the host link or NT link methods, the memory link method has some restrictions regarding the use of some functions, as described below.

- It cannot use the programmable controller functions.
- The following stroblings of PT status notify bits does not turn on (page 7 to 27).
 - Screen switching strobing
 - Numerals input strobing
 - Character-string input strobing
- The usable area for allocation is the memory link area only.

1-4-2 Comparison between Direct Connection and Memory Link

The major differences between the direct connection and the memory link are as follows:

- a) In the memory link method, the communication with the host should be carried out by using commands. Compared to the ordinal direct connection, which can be used requiring almost no programs, the memory link method requires a program that is necessary for interchange of commands.
This, however, gives advantages to the memory link method by using a large variety of functions available in the direct connections from major models such as a personal computer and a FA computer equipped with RS-232C/RS-422A communication means, allowing the PT to be suited for larger usage.
- b) Actual PCs have many kinds of areas, where as PT memory is a single area with only one kind. When creating screen data by using the memory link methods, it is always necessary to allocate display parts on the memory link area.

For communication between the host and the PT by the memory link method, refer to "Section 9 Using Memory Link", and for how to use screen and display elements, refer to "Section 8 How to Use the PT".

1-5 System Configuration

This section shows the configuration of a system that uses an NT631/NT631C. For details on product models, refer to APPENDIX J "Model List" (page 665).

1-5-1 Peripheral Devices That Can Be Connected

The following peripheral devices can be connected to an NT631/NT631C.

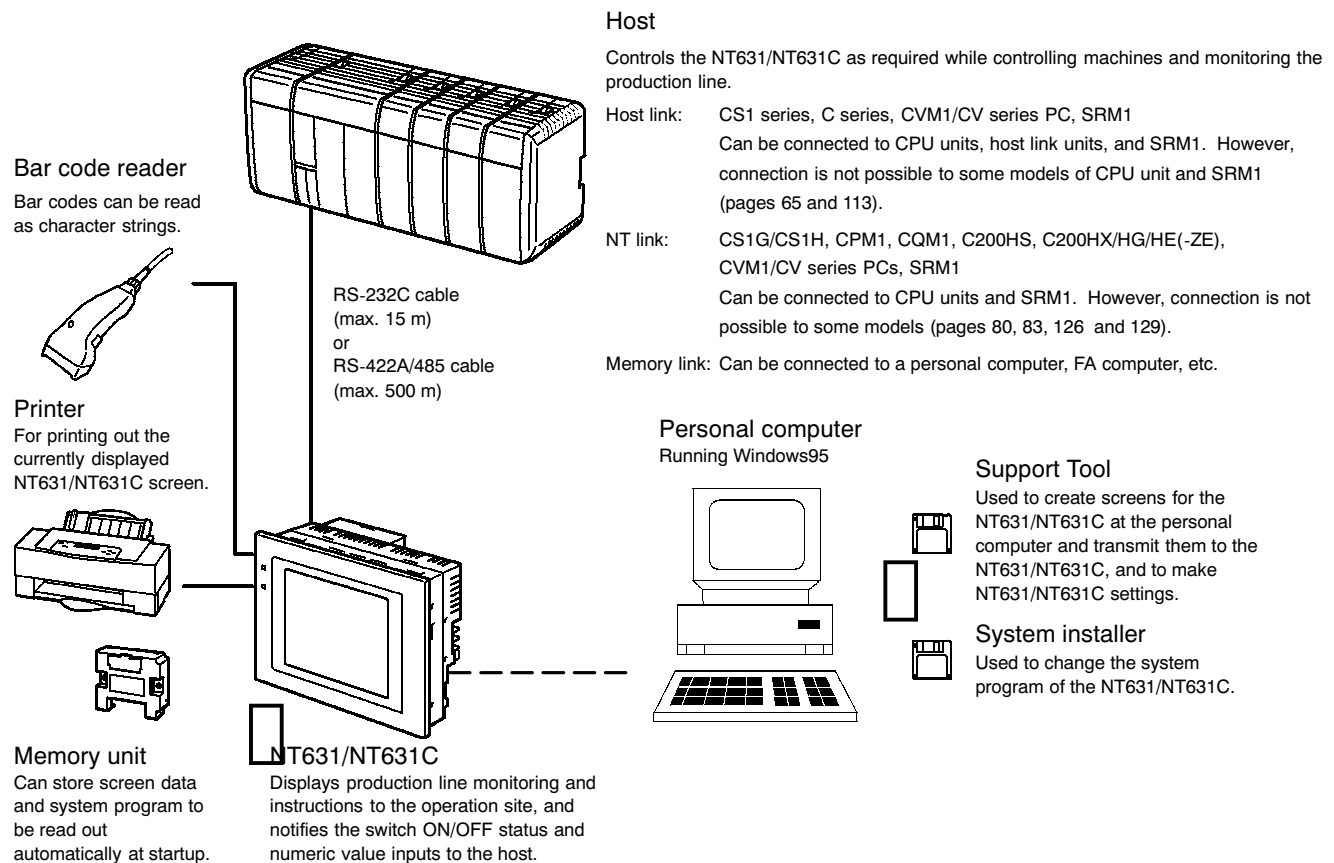

- Bar code reader (page 43)
- Recommended printers (page 42)
 - ESC/P 24-pin printer (EPSON)
 - HP, PCL 5 printer (HP)

Apart from the above, it is also possible to use printers that can emulate PC-PR201H, and printers that comply with one of the following EPSON control standards: ESC/P 24-J83C (color), or ESC/P 24-J82 (monochrome). If using an HP printer, make sure that it conforms to the PCL 5 standard.

- Memory unit (page 46)
 - NT-MF261 (made by OMRON)
- Support Tool (page 41)
 - NT-series Support Tool Ver. 3.0 for Windows 95/98 (Made by OMRON)
 - NT-ZJ3MX1-EV3 (FD version)
 - NT-ZJCMX1-EV3 (CD-ROM version)

- System installer (page 41)
 - System installer (made by OMRON)

The system installer is supplied as a standard accessory with the Support Tool (NT-ZJ3MX1/ZJCMX1-EV3).

Reference	The following optional devices are available. All of them can be used either with NT631 or NT631C.	
	Replacement backlight	NT631C-CFL01 (for NT631C-ST151□) NT631C-CFL02 (for NT631C-ST141□)
	Reflection-suppressing protective sheet (5 pcs/set)	NT610C-KBA04
	Chemical-resistant cover	NT625-KBA01
	Replacement battery	3G2A9-BAT08

1-5-2 Connecting to the Host

The NT631/NT631C has the following two communication ports. The serial port B is equipped with an RS-232C connector and an RS-422A/485 terminal block (selectable by memory switch).

- Serial port A:
 - D-SUB 9-pin connector
 - For RS-232C use only (The Support Tool and bar code readers can be connected here.)
- Serial port B:
 - D-SUB 9-pin connector for RS-232C use only (The Support Tool and bar code readers can be connected here) or Terminal block for RS-422A/485 use only.

The host can be connected at either of these two ports.

The connection methods for each communication method at the PT and host sides are indicated below. Make the settings in accordance with the communication method that can be used with the PC to be connected and the conditions at the operation site.

Reference	When using an RS-232C/422A convertor unit (NT-AL001) with the host link or NT link (1:1) communication method, RS-485 cannot be used. The connection must be made with RS-232C or RS-422A.
------------------	--

1-6 Before Operating

Follow the procedure given below to start the system of the NT631/NT631C.

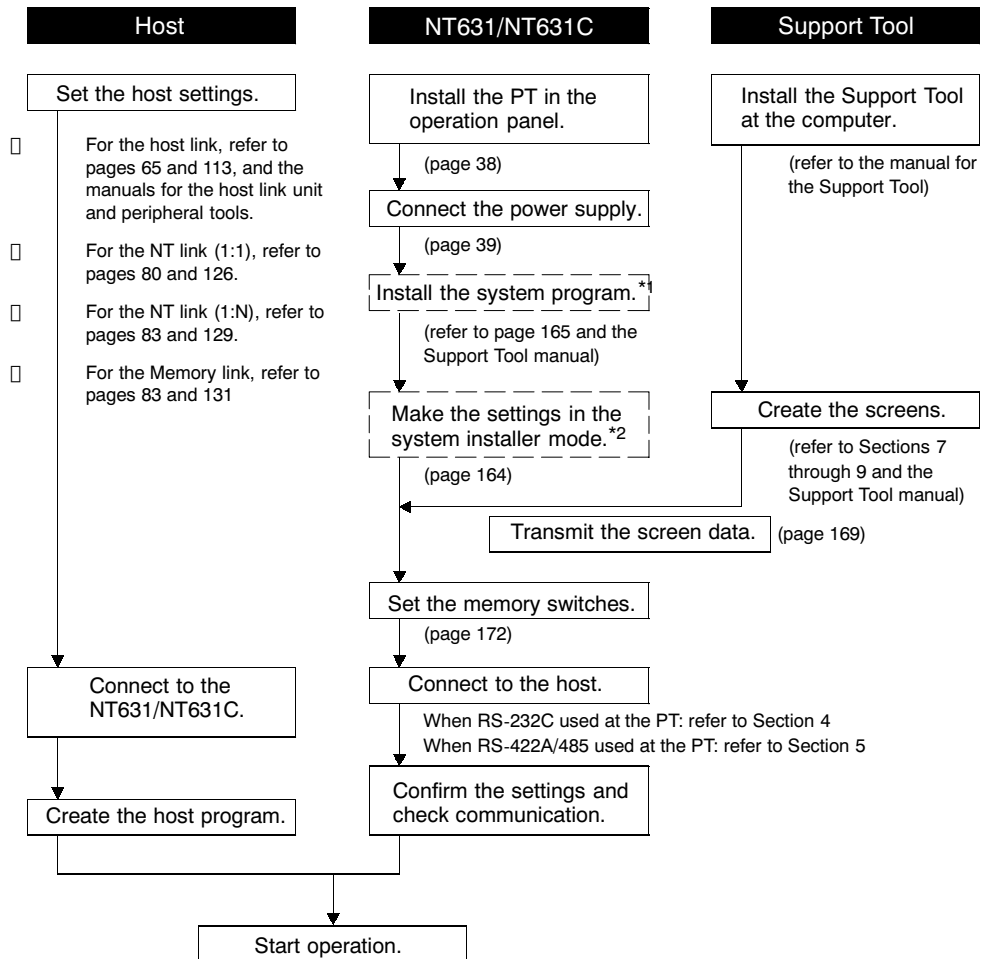

*1 System program installation is only done in special circumstances, for example when changing the system program, or to recover the original status of the installed program. This operation is not normally necessary. When using other PC models (sequencers), however, it is necessary to install specific system programs.

*2 Display of the system menu, and all change operations, can be inhibited. This enables you to prevent the accidental deletion or alteration of screens and settings.

Reference

- For the system program, use the NT631/NT631C system program supplied as an accessory with the NT series Support Tool (NT-ZJ3MX1/ZJCMX1-EV3).
- For the Support Tool, use NT-series Support Tool for Windows 95/98 (Ver. 3.0.).

Refer to the following manuals for the equipment and software.

Equipment or Software	Manual Title	Manual Number
System installer	NT-series Support Tool for Windows95/98	V053-E1-□
Support Tool	NT-series Support Tool for Windows95/98	V053-E1-□
PC	SYSMAC CPM1 User's Manual	W262-E1-□
	SYSMAC CPM1A User's Manual	W317-E1-□
	SYSMAC C200H User's Manual (for CPU01/03/11) (Programming)	W130-E1-□
	SYSMAC C200H User's Manual (for CPU21/23/31) (Programming)	W217-E1-□
	SYSMAC C200HS Setup Manual	W236-E1-□
	SYSMAC C200HS Programming Manual	W235-E1-□
	SYSMAC C200HX/HG/HE Setup Manual	W302-E1-□
	SYSMAC C200HX/HG/HE Programming Manual	W303-E1-□
	SYSMAC C1000H/C2000H User's Manual (Programming)	W140-E1-□
	SYSMAC CQM1 Reference Manual	W228-E1-□
	SYSMAC CVM1/CV500/CV1000/CV2000 User's Manual (Ladder) (If using a CVM1-series PC, refer to the SYSMAC CV500/CV1000/CV2000 User's Manual).	W202-E1-□
	CS1 series CS1G/H-CPU □□-E Programmable Controllers Operation Manual	W339-E1-□
CS1 series Serial Communicaton Boards/Units Operation Manual	W336-E1-□	
CompoBus master control unit	SRM1 User's Manual	W318-E1-□
Peripheral tools	SYSMAC Support Software Operation Manual: C-series PCs	W248-E1-□
	SYSMAC Support Software Operation Manual: CVM1 PCs	W249-E1-□
	SYSMAC CPT Operation Manual	W332-E1-□ W333-E1-□
	CX-Programmer Operation Manual	-
Host link unit/ Communication Board	SYSMAC C series Host Link Unit User's Manual	W143-E1-□
	SYSMAC CVM1/CV Series Host Link User's Manual	W205-E1-□
	SYSMAC C200HW-COM01 C200HW-COM02-V1 to C200HW-COM06-EV1 Communications Boards Operation Manual	W304-E1-□

SECTION 2

Preparing for Connection

This section describes the connection methods that are possible with the NT631/NT631C, and the functions of the parts of NT631/NT631C, as the required knowledge before connecting to the host and to the peripheral devices.

2-1	Method for Connection to the Host	32
2-1-1	Connection Method and Communication Method	32
2-2	Preparations at the NT631/NT631C	35
2-2-1	Names and Functions of Parts	35

2-1 Method for Connection to the Host

This section describes the methods for connection to the host used with the NT631/NT631C, and the relationship between the connection method and the communication method.

2-1-1 Connection Method and Communication Method

- NT631/NT631C communication ports and communication methods

The NT631/NT631C has two communication ports. Their uses are indicated in the table below.

Communication Port		Usable Communication Methods	Communication Type
Serial port A		Host link NT link (1:1) NT link (1:N) Memory link (Support Tool connection) (bar code reader input function)	RS-232C
Serial port B	Connector	Host link NT link (1:1) NT link (1:N) Memory link	RS-232C (select between connector and terminal block)
	Terminal block	Host link NT link (1:1) NT link (1:N)	RS-422A/485 (select between connector and terminal block)

- Communication methods that can be used with the host

The following communication methods can be used with the hosts that can be connected to the NT631/NT631C.

- RS-232C
- RS-422A
- RS-485

The communication types that are actually supported differ depending on the host unit. For details, refer to Section 4 "Connecting to the Host from the RS-232C Port" and Section 5 "Connecting to the Host from the RS-422A/485 Port".

- Converting the communication type with an RS-232C/RS-422A convertor unit

The following communication type conversions are possible by using an RS-232C/RS-422A convertor unit (NT-AL001, made by OMRON).

- RS-232C ⇔ RS-422A
- RS-232C ⇔ RS-485

- Combinations of communication method and connection method

The connection methods that can be used depending on the communication method used and the communication type for communication between the NT631/NT631C and the host are indicated in the table below.

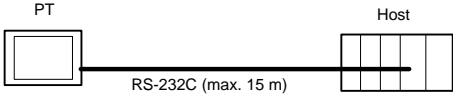
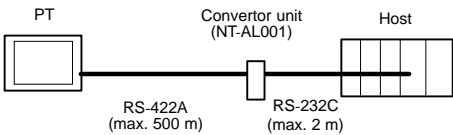
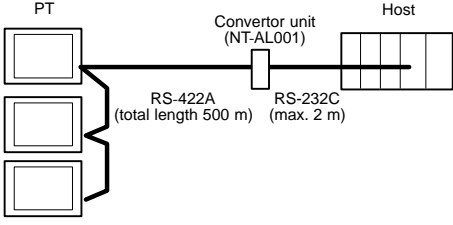
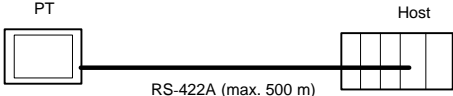
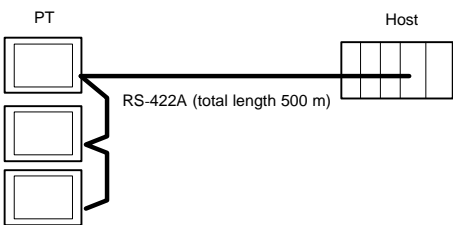
Communication Type at PT	Communication Type at Host	Usable Connection Method	Usable Communication Method				Details
			Host link	NT Link (1:1)	NT Link (1:N)	Memory link	
RS-232C	RS-232C	Direct 1:1 connection 	○	○	○	○	88
RS-422A	RS-232C	1:1 connection via a convertor unit 	○	○	○	○	98
		1:N connection via a convertor unit 	×	×	○	×	103
	RS-422A	Direct 1:1 connection 	○	○	○	○	132
		1:N connection 	×	×	○	×	138

○: Connection possible ×: Connection not possible

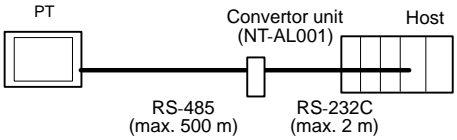
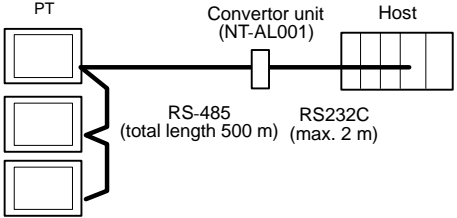
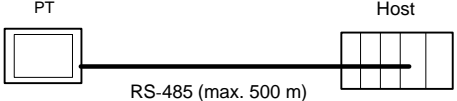
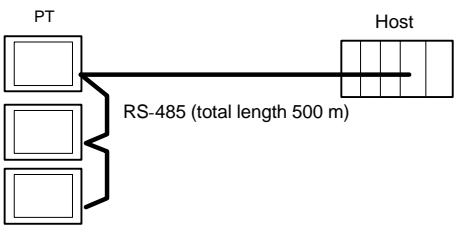
Communication Type at PT	Communication Type at Host	Usable Connection Method	Usable Communication Method				Details
			Host link	NT Link (1:1)	NT Link (1:N)	Memory link	
RS-485	RS-232C	1:1 connection via a convertor unit 	×	×	○	×	98
		1:N connection via a convertor unit 	×	×	○	×	103
	RS-485	Direct 1:1 connection 	×	×	○	×	137
		1:N connection 	×	×	○	×	141

○: Connection possible ×: Connection not possible

- The RS-232C/RS-422A convertor unit (NT-AL001) requires +5 V, 150 mA at pin 6 of the RS-232C connector. Check the signals of the RS-232C connector at the host.
- +5 V is not output from serial port B of the NT631/NT631C. When connecting an NT-AL001 at serial port B, a separate power supply is required for the NT-AL001.
- The cable of an NT-AL001 cannot be connected or disconnected while the power is ON. Always connect or disconnect the cable while the power supply from the RS-232C cable is OFF (while the host power supply is OFF).
- NT link (1:N) connection is possible even when RS-232C is used at the NT631/NT631C side for communication with the host, but in this case one NT-AL001 unit is required for each NT631/NT631C. In this case, it is convenient to use serial port A of the NT631/NT631C. +5 V is not output from serial port B.

2-2 Preparations at the NT631/NT631C

Before starting operation, the names and functions of the parts of the NT631/NT631C are described here as a confirmation. A method of hardware settings is also described.

2-2-1 Names and Functions of Parts

Front View

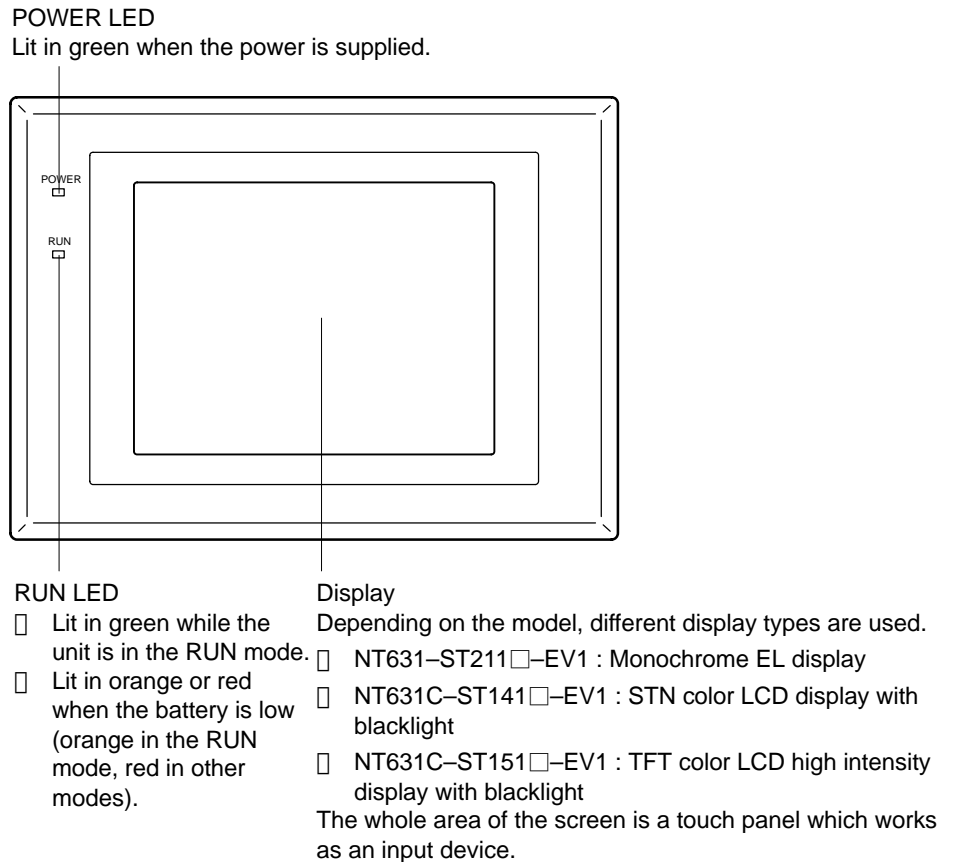

Reference The NT631/NT631C comes in two body colors.

NT631 (EL)	NT631C (STN)	NT631C (TFT)	Body Color
NT631-ST211-EV1	NT631C-ST141-EV1	NT631C-ST151-EV1	Beige
NT631-ST211B-EV1	NT631C-ST141B-EV1	NT631C-ST151B-EV1	Black

Rear View Notice

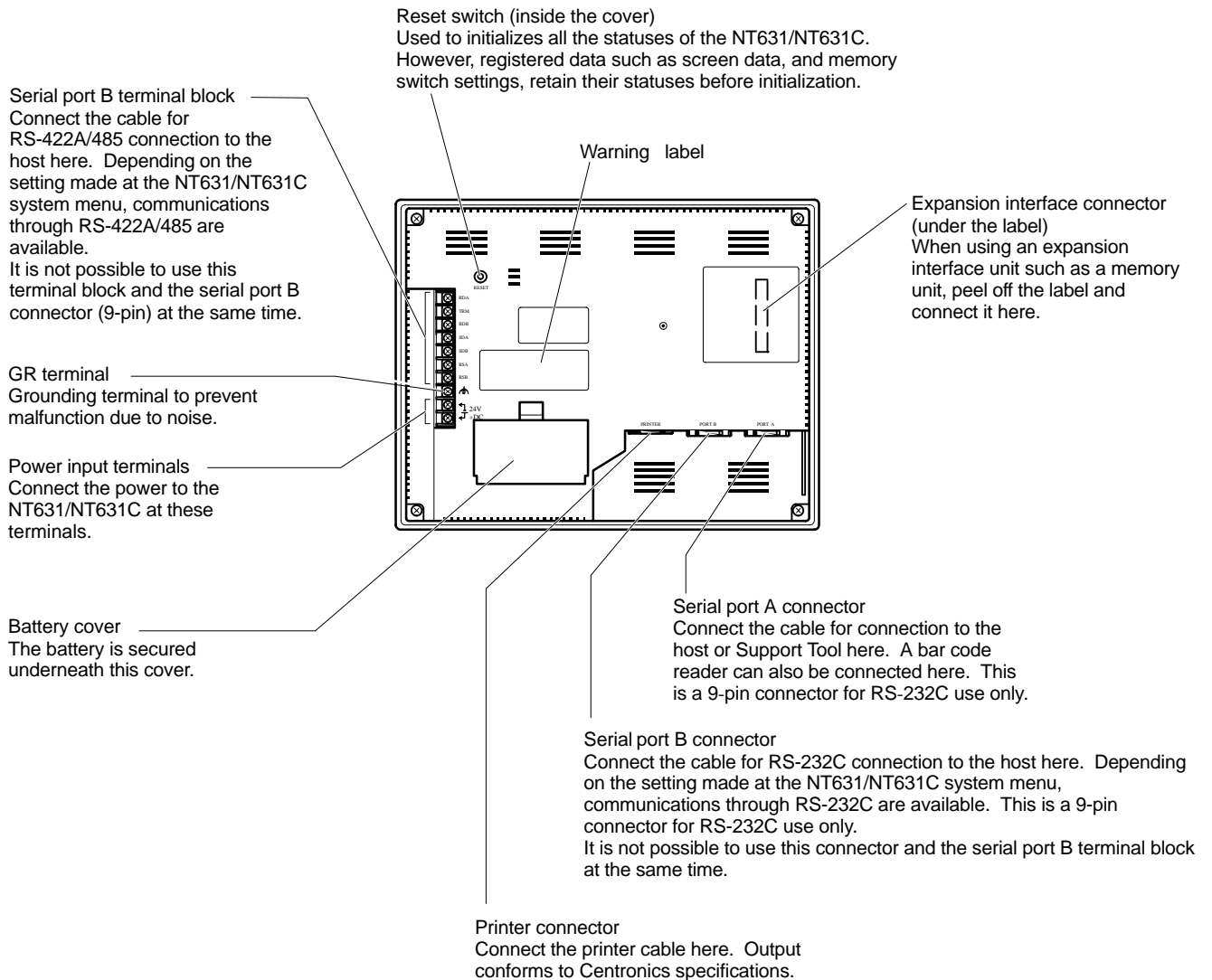

Notice

Confirm system safety before turning the power ON/OFF or resetting.

SECTION 3

Hardware Settings and Connections

This section describes the settings of the NT631/NT631C and methods for connection to peripheral devices.

For details on the method for connection to the host, refer Section 4 “Connecting to the Host from the RS-232C Port” or Section 5 “Connecting to the Host from the RS-422A/485 Port”.

3-1	Installation	38
3-1-1	Installation Environment	38
3-1-2	Installation in the Operation Panel	38
3-1-3	Power Supply Connection	39
3-1-4	Grounding	40
3-2	Connecting to the Support Tool	41
3-3	Connecting a Printer	42
3-3-1	Connection Method	42
3-4	Connecting a Bar Code Reader	43
3-4-1	Connection Method	43
3-4-2	Setting a Bar Code Reader	44
3-4-3	Data Format	45
3-5	Using a Memory Unit (NT631/NT631C with V1)	46
3-5-1	Installation Method	47
3-5-2	Method of Use	48
3-6	Using a Memory Unit (NT631/NT631C without V1)	56
3-6-1	Installation Method	57
3-6-2	Method of Use	57

Notice

On unpacking the NT631/NT631C and peripheral devices, check their external appearance and confirm that there is no damage. Also confirm that there is no abnormal noise on shaking the unit lightly.

3-1 Installation

Install the NT631/NT631C in the operation panel and connect the power to the NT631/NT631C as described below.

3-1-1 Installation Environment

Observe the following points when installing the PT in an operation panel.

Notice

- Do not install the unit at sites subject to the following conditions.
 - Severe temperature variations
 - Temperatures or humidities outside the ranges stated in the specifications
 - High humidity, condensation
 - Splashing chemical agents
 - Severe oil splashing
 - Corrosive or flammable gases
 - Strong vibrations or shocks
 - Direct exposure to wind and rain (outdoor sites)
 - Strong ultra-violet irradiation
- Take adequate measures to ensure shielding if the unit is used at a location subject to any of the following conditions.
 - Static electricity, or noise from other equipment
 - Strong electromagnetic fields
 - Nearby power cables
 - Potential exposure to radioactivity

3-1-2 Installation in the Operation Panel

The NT631/NT631C is mounted in an operation panel by embedding it in the panel.

Use the panel fittings and tool (Philips screwdriver) included in the product package and follow the procedure below.

- (1) Open a hole of the dimensions shown below in the panel and install the NT631/NT631C from the front side of the panel.

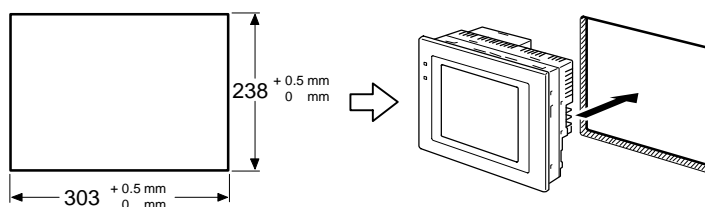

- (2) Attach the panel fittings at the following positions shown below, from the rear of the NT631/NT631C.

Fit the hook of the fitting in the square hole in the body and tighten the screw with the Philips head screwdriver while lightly pulling the fitting.

Fittings at the two (*) positions are not necessary if you do not need it dust proof and waterproof.

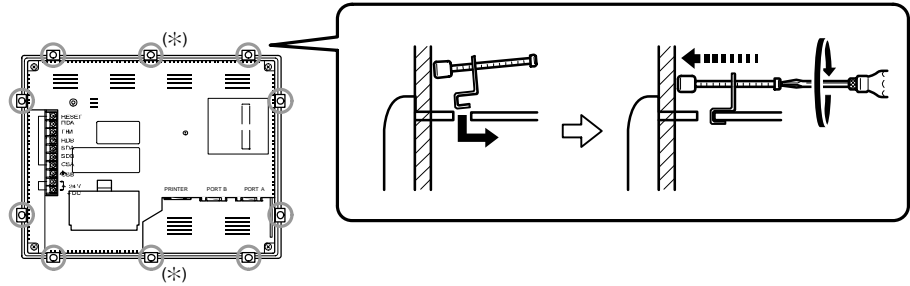

Notice

- During work at the panel, take care to ensure that no metal scraps enter the unit.
- The thickness of applicable operation panel is 1.6 mm to 4.8 mm. All fittings must be tightened uniformly to a torque of 0.5 to 0.6 N·m in order to ensure water- and dust-resistance. Front sheet of NT631/NT631C may be warped if the tightening is too strong or not uniformity. The panel must not be soiled or warped, and must be able to support an installation that will remain secure and strong.

3-1-3 Power Supply Connection

Connect a 24 VDC power supply to the power input terminals.

Notice

- Depending on how the power is switched ON/OFF, the entire system may stop. Follow the correct procedure when switching the power ON/OFF.
- Carefully check the wiring before switching ON the power.
- Do not connect AC power to the DC terminals.
- Use DC power supplies with low voltage fluctuation.
- Do not perform a dielectric strength test.
- If complying with EC directives (low voltage directives), the following points must be noted (compliance with EC directives):
 1. Use a power supply with reinforced insulation.
 2. When installing NT631-ST211(B)-EV1 on the ultimate system, the rear of the NT631 must be placed within an enclosure to restrict the operators' use only to the front panel.
- When using NT631-ST211(B)-EV1, warm-up time of the power supply must be 200 ms or less. If longer than this, NT631 may not boot up.

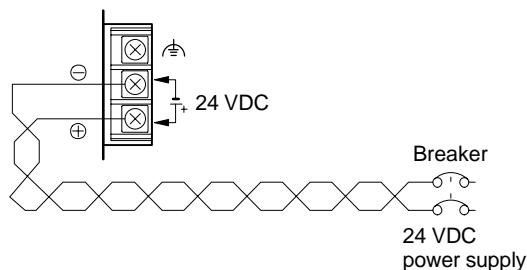

• Power supply

The applicable power supply specifications are as follows.

Item	Value
Power supply	24 VDC
Allowable power supply voltage fluctuation range	20.4 VDC to 26.4 VDC (24 VDC -15%, +10%)
Power supply voltage capacity	NT631-ST211 (B)-V1: 30 W or more (Power supply warm-up time within 200 ms.) NT631C-ST141 (B) /ST151 (B)-V1 : 18 W or more

• Parts used for connection

Notice

For the connection to the power supply terminal block, twisted wires of 2 mm² or greater cross sectional area and M3.5 size crimp terminals must be used.

Tighten the screws on the terminal block to a torque of 0.8 N·m.

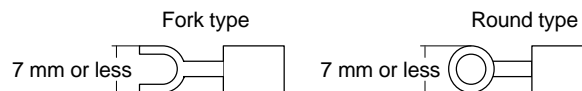

- Recommended terminals

Maker	Type (fork type)	Type (round type)	Applicable Wire (stranded wire)
Japan Solderless Terminal MFG	2-YS3A	2-3.5	2.0 to 2.63 mm ²
Fuji Terminal	2-YAS3.5	V2-S3.5	
Nichifu Terminal	2Y-3.5	2-3.5	

3-1-4 Grounding

The NT631/NT631C has a functional ground terminal (⏏).

Carry out wiring under the following conditions.

- (1) In cases where the distance between the NT631/NT631C is small and it is assumed that there is no potential difference between grounds, ground as shown in Fig. (a) below.
- (2) In cases where there is a potential difference between the grounds of the NT631/NT631C and the host, ground as shown in Fig. (b). If there is some distance between the NT631/NT631C and host and grounding at a single point is difficult, do not connect the functional ground terminal (⏏) of the NT631/NT631C.
- (3) If the NT631/NT631C is installed in the same panel as equipment that generates noise, such as a motor or inverter, do not ground the functional ground terminal (⏏) of the NT631/NT631C.

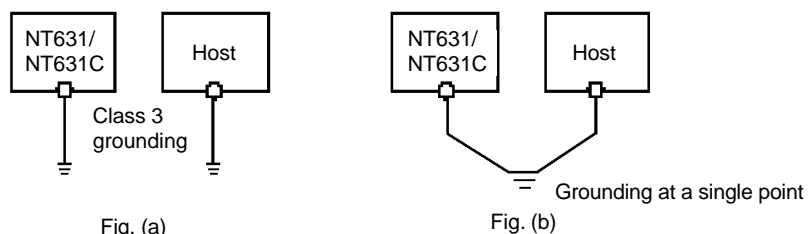

Notice

Carry out grounding correctly in order to prevent misoperation due to noise.

3-2 Connecting to the Support Tool

In order to install the system program in the NT631/NT631C, or to transmit screen data created with the Support Tool to the NT631/NT631C, the NT631/NT631C must be connected to a personal computer with an RS-232C cable.

The NT631/NT631C connects the RS-232C cable from a personal computer at serial port A. When the host is connected at serial port B, the connection with the host can be maintained as it is while the NT631/NT631C is connected to the RS-232C cable from a personal computer.

However, when a bar code reader is being used, it must be disconnected, so that the RS-232C cable can be connected, since they both use serial port A.

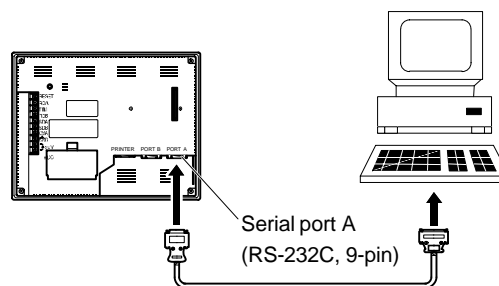

- Communication conditions

The communication conditions are automatically set when the system installer and Support Tool are started.

- Recommended connector cable

Use the cable indicated below.

- CV500-CN228 (length: 2 m), made by OMRON
(D-SUB 9-pin, male ↔ D-SUB 25-pin, male)
- XW2Z-S001 (conversion cable), made by OMRON
(D-SUB 25-pin, female ↔ half pitch 14-pin, male)
- XW2Z-S002 (length: 2 m), made by OMRON
(D-SUB 9-pin, male ↔ D-SUB 9-pin, female)

For details on making a connector cable, refer to APPENDIX F "Making the Cable for Connecting a PC" (page 654).

3-3 Connecting a Printer

Connecting a printer to the NT631/NT631C enables printing of hard copies of the currently displayed screen (printing of screen images), and, by system menu operations, printing of the screen display history and alarm history.

The following types of data can be printed, depending on the printer connected to the NT631/NT631C. For details, refer to the pages cited.

- Hard copies of the screen (8-11-1 "Printing the Screen" in 8-11 "Printing Data and Checking the Printer Status", page 541)
- Screen display history record data (page 215)
- Alarm history record data (page 217)

3-3-1 Connection Method

Connect the printer to the NT631/NT631C with a Centronics cable, as shown below. The length of the cable should not exceed 1.5 m.

Reference If the connector cable is connected or disconnected while the power to the printer is on, the NT631/NT631C may malfunction. Always turn off the power to the printer before connecting or disconnecting the cable.

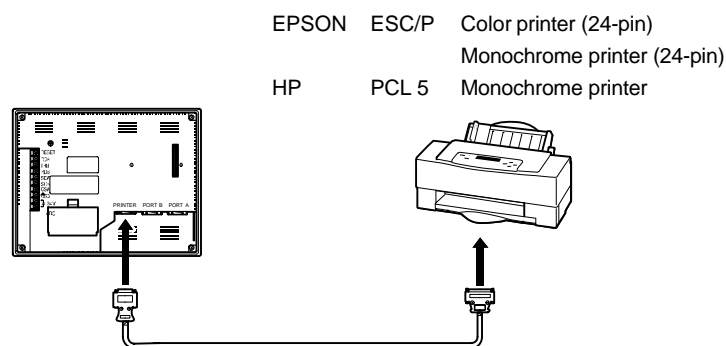

- Recommended connector cable

The following connection cables are recommended.

- NT-CNT121 (1.5 m, 20-pin to 36-pin), made by OMRON

- Recommended printers

- EPSON ESC/P Printer (24-pin), Color or Monochrome
- HP PCL 5 Printer, Monochrome

Apart from above, it is also possible to use printers that can emulate PC-PR201H (conform to PC-PR201PL control standards), and printers that comply with one of the following Epson control standards.

- ESC/P 24-J83C (color), ESC/P 24-J82 (monochrome)

If using an HP printer, make sure that it conforms to the "PCL 5" control standard.

When using a monochrome printer with an NT631C, set "Tone" with the NT631C memory switches (page 192).

3-4 Connecting a Bar Code Reader

Connecting a bar code reader to the NT631/NT631C enables bar code data to read as character strings into character string input fields, and set in character string memory tables.

In order to use a bar code reader, the "Comm. A Method" memory switch must be set to "Bar-Code Reader".

For details on the method for inputting character strings with a bar code reader, refer to 8-7-2 "Inputting Character Strings" in 8-7 "Input of Numeric Values and Character Strings" in the programming manual (page 520).

Notice

Make sure that the power supply to the bar code reader and the power supply to the PT are both OFF before connecting or disconnecting the cable.

3-4-1 Connection Method

Connect the bar code reader to serial port A of the NT631/NT631C, as shown in the figure below.

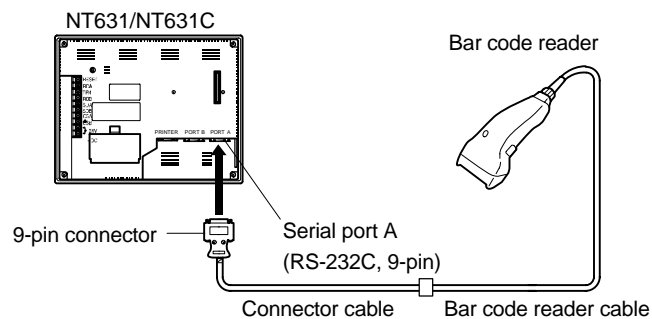

Bar code reader must match the communication setting (3-4-2 "Setting a Bar Code Reader", page 44) and data format (3-4-3 "Data Format", page 45) in order to connect to the NT631/NT631C. Please confirm the specification of the bar code reader before using.

For details on making a connector cable, refer to APPENDIX G "Making the Cable for Connection to a Bar Code Reader" (page 655).

Reference

The bar code reader must be connected to serial port A. This means that it cannot be connected at the same time as the Support Tool. Note also that when a bar code reader is used, the host must be connected at serial port B.

3-4-2 Setting a Bar Code Reader

After connecting a bar code reader, set the communication conditions and other settings for it by selection from the system menu.

Settings at the NT631/NT631C

At the NT631/NT631C, set the communication conditions for communication with the bar code reader by using the memory switches, selecting from the options indicated in the table below.

For more detailed information on the actual system menu operations, refer to 6-10 "Setting the Bar Code Reader Input Function" (page 205).

Item	Possible Settings	Default Setting
Data bits	7 or 8 bits	7 bits
Stop bit(s)	1 or 2 bits	2 bits
Parity	None, odd, even	Even
Communications speed	4800, 9600, 19200 bps	9600 bps
Input Method	Manual, Auto	Manual

Settings at the Bar Code Reader

Make the settings shown in the table below at the bar code reader. Make sure that the communications speed, parity, stop bit, and data bit settings match the communication settings made at the NT631/NT631C. For details on the setting method, refer to the instruction manual for the bar code reader used.

Item	Possible Settings
Communications speed	4800, 9600, 19200 bps
Parity	EVEN, ODD, NONE
Stop bits	1 or 2 bits
Data bits	7 or 8 bits
Preamble	STX
Postamble	ETX
RS/CS control	Available
Communication protocol	No-protocol mode
Transmission of number of bar code label digits	Transmission prohibited
Transmission of ID characters	Transmission prohibited
Bar code types	Multi-reading (all types can be read)
Trigger switch setting	Automatic reading mode

- About RS/CS control

During bar code reading, the NT631/NT631C performs RS/CS control. When the "Input Method" setting of the NT631/NT631C is set to "Auto", the RS signal is turned OFF, prohibiting the next input, until the read data has been notified to the host.

Because of this, when the "Auto" setting is made, the next input is not possible until the data has been notified to the host.

However, when the setting is "Auto" and the RS/CS signals of the cable are shorted, RS/CS control is ineffective. Consequently, data input from the bar code reader to the NT631/NT631C is updated regardless of whether or not the data is notified to the host.

For details, refer to the instruction manual for the bar code reader used.

3-4-3 Data Format

The data format for communication when using the bar code input function of the NT631/NT631C is shown below.

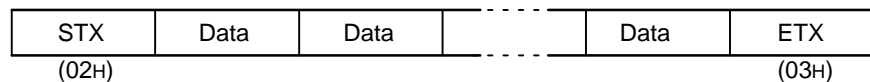

The characters which are effective as data are hexadecimal codes from 20 to 7FH, and the maximum data length is 40 bytes.

Data which does not follow the data format described above is invalidated and discarded.

3-5 Using a Memory Unit (NT631/NT631C with V1)

This section discusses the using of a memory unit when the system program for NT631/NT631C with V1 is installed to the NT631/NT631C (NT631-ST211□-EV1/NT631C-ST141□-EV1/NT631C-ST151□-EV1) with V1.

Reference Depending on the PT model and the system program which is installed, the function and using method of memory unit varies as follows.

PT Model	System Program	Function of Memory Unit
Without "V1"	Without "V1"	Conventional memory unit function. (Refer to 56.) (System programs can not be transmitted using memory unit.)
	With "V1"	
With "V1"	Without V1	New memory unit function. (System programs can be transmitted using memory unit.)
	With V1	

By installing a memory unit (NT-MF261) on the NT631/NT631C, the screen data in the NT631/NT631C can be recorded (backed up) in the memory unit.

In addition, the screen data in the memory unit can be automatically read into the NT631/NT631C when it starts up. This means that system program and screen data can be changed easily at the operation site without connecting to the Support Tool.

The data in the memory unit is retained without backup by a battery or other means.

In systems where there are frequent setup changes, by preparing a number of memory units in advance and recording screen data in them in accordance with the control performed in each case, the NT631/NT631C screen data can be changed simply by installing the memory unit, without connecting to the Support Tool.

In addition, even if NT631/NT631C is replaced, the previous status can be maintained simply by installing the memory unit that retains the system program and screen data of the previous NT631/NT631C.

By using the following combinations, data can be stored (backed up) to a memory unit.

- Screen data for two PTs.
- System program for two PTs.
- System program and screen data for one PT.

One memory unit can store the screen data for two PTs.

Notice

- Make sure that the power supply to the PT is OFF before connecting or disconnecting a memory unit.
After mounting a memory unit, be sure to tighten its two screws.
- During data transmission, do not turn off the power supply to the NT631/NT631C or reset it.
- Do not touch the PCB (printed circuit board) with bare hands.

- Reference**
- When a memory unit is mounted, the NT631/NT631C cannot be set to the operating status. On completion of data transmission with a memory unit, always disconnect the memory unit from the NT631/NT631C before starting NT631/NT631C operation.
 - Memory units (NT-MF261) can be used in common for the following PT models: NT31, NT31C, NT631, and NT631C (with and without V1). One memory unit can store screen data for up to two PTs of different models. However, since the data compatibility is not complete between NT31/NT31C and NT631/NT631C, an error may occur if an attempt is made to read NT631C data with an NT31C. (The data must be converted using the Support Tool.)
Note also that although there is data compatibility between the NT31 and NT31C, and between the NT631 and NT631C, the display may not be correct since these models have different numbers of colors.
 - One memory unit can store a system program for up to two PTs of different models. In order to transmit a system program from the memory unit to the NT631/NT631C, the system program must be compatible to the target PT model.
 - The statuses of memory switch settings and system settings can be recorded to the memory unit besides screen data. When the data in the memory unit is written into the NT631/NT631C, make sure that these settings can be adapted to the NT631/NT631C used before transmission.

3-5-1 Installation Method

Install the memory unit (NT-MF261) at the expansion interface connector at the rear of the NT631/NT631C as shown in the figure below (the expansion interface connector is located underneath the "note" label.).

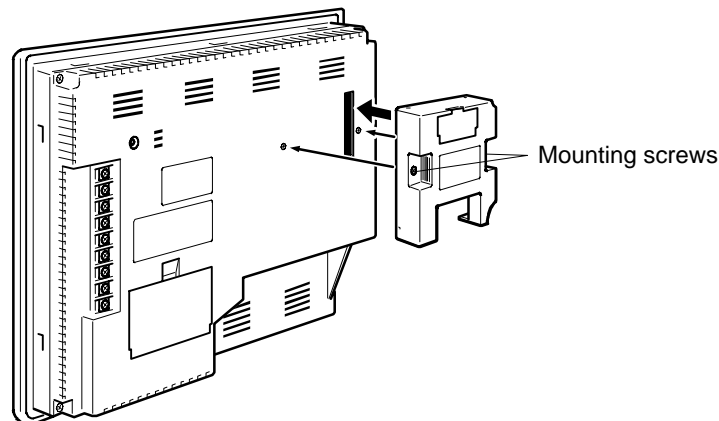

3-5-2 Method of Use

As shown in the figure below, a memory unit has two sets of four DIP switches, and the operation is determined by the DIP switches that are set at startup.



Notice

- Always confirm that the power to the NT631/NT631C is off before setting the DIP switches.
- Do not touch the PCB (printed circuit board) directly with bare hands.

DIP Switch Functions

The functions of the DIP switches on the memory unit are indicated in the table below.

• SW1

Switch	Function	
SW1-1	Automatic transmission (writing from the memory unit to the PT)	OFF: Not executed ON : Executed
SW1-2	Automatic transmission (writing from the PT to the memory unit)	OFF: Not executed ON : Executed
SW1-3	Manual transmission (Direction of transmission and bank used selected at the PT touch panel)	OFF: Not executed ON : Executed
SW1-4	Data type to transfer	OFF: Screen data ON : System program

• SW2

Switch	Function	
SW2-1	Disable/enable writing to PT	OFF: Disable ON : Enable
SW2-2	Disable/enable writing to the memory unit	OFF: Disable ON : Enable
SW2-3	Area (bank) selection of automatic transmission. *	OFF: Bank 0 ON : Bank 1
SW2-4	System/Screen simultaneous transmission	OFF: Disable ON : Enable

* The memory unit stores system program or screen data for one PT in each of areas (bank 0, bank 1). (The total data storage is for two PTs.) SW2-3 sets which of these two banks is used for automatic transmission.

Reference

- The DIP switch function of the memory unit is supplemented to NT631/NT631C With V1.

- Reference**
- In the following cases, a mode setting error occurs.
 - More than one of the SW1 switches are set to "ON".
 - None of the SW1 switches are set to "ON".
 - In the following case, a protect setting error occurs.
 - Transmitting to the write destination has been disabled by the setting for SW2-1 or SW2-2.
 - In the following cases, a data transmission error occurs.
 - An attempt is made to transmit data other than the system program to PT system program area.
 - An attempt is made to transmit the system program to PT screen data area.
 - For details on mode setting errors and protect setting errors, refer to "Errors When Using a Memory Unit" (page 54).

Writing Screen Data to a Memory Unit Using Automatic Transmission (PT to Memory Unit)

In this mode, system program or the screen data in the NT631/NT631C is forcibly written to the memory unit irrespective of the setting status of the NT631/NT631C.

This mode is convenient if the touch panel is broken and touch switch operation is not possible, or if someone unfamiliar with touch switch operation at the operation site is using the system.

- Reference**
- When screen data is written to the memory unit, the data that has been stored in the specified area up until that point is lost (if the data is written into only one Bank, the other Bank will not be affected).

- Method of execution

Use the following procedure to write the screen data in the NT631/NT631C to the memory unit by automatic transmission.

- (1) Check that the power supply to the NT631/NT631C is OFF, then set the DIP switches of the memory unit as follows after installing memory unit to NT631/NT631C.

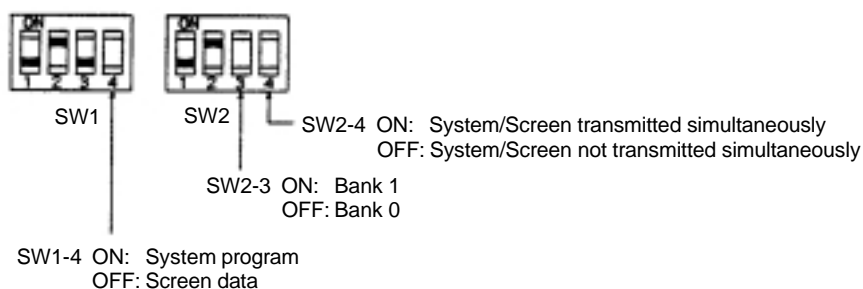

It is not strictly necessary to set SW2-1 to "OFF" (to disable writing to the PT), but it is recommended to do so to avoid loss of data in the event of misoperation.

- Reference**
- Setting SW2-4 to ON (System/Screen transmitted simultaneously) disables the setting of SW1-4.
 - Setting SW2-4 to ON (System/Screen transmitted simultaneously) disables the setting of SW2-3, writes the system program into bank 0, and the screen data into bank 1 at all times.

- (2) Switch the NT631/NT631C power ON.

The screen data is automatically written into the memory unit. The screen data in the NT631/NT631C is preserved.

The messages “Preparing”, “Transmitting”, “Verifying”, and “Finished” are displayed on the screen in accordance with the progress of data writing.

At the same time, the progress of the data writing status is displayed by the means of the number of bytes and blocks (1 bank = 16 block = 1024k byte).

RUN LED operates as follows according to the processing status.

Preparing	: flashes at intervals of 1 second
Transmitting	: flashes at intervals of 0.5 second
Verifying	: flashes at intervals of 0.5 second
Finished	: lights up

- (3) Switch the NT631/NT631C power OFF, remove the memory unit.

To operate NT631/NT631C continuously, switch the NT631/NT631C power back ON.

Writing Screen Data to the PT Using Automatic Transmission (Memory Unit to PT)

In this mode, the system program or screen data in the memory unit is forcibly written to NT631/NT631C irrespective of the setting status of the NT631/NT631C.

Since data transmission by this method is faster than when the Support Tool or system installer is used, it can save a lot of time. When transmitting the same system program or screen data to multiple NT631/NT631C, this mode becomes convenient.

Reference

When data is written to the NT631/NT631C, the data that has been stored up until that point is lost. When the system program is changed, the operation of NT631/NT631C also changes.

• Method of execution

Use the following procedure to write the screen data in the memory unit to the NT631/NT631C by automatic transmission.

- (1) Check that the NT631/NT631C power is OFF, then set the DIP switches on the memory unit as follows after installing memory unit to NT631/NT631C.

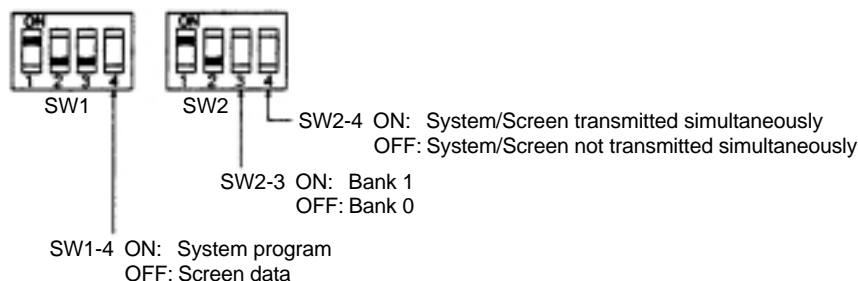

It is not strictly necessary to set SW2-2 to “OFF” (to disable writing to the memory unit), but it is recommended to do so to avoid loss of data in the event of misoperation.

- Reference**
- Setting SW2-4 to ON (System/Screen transmitted simultaneously) disables the setting of SW1-4.
 - Setting SW2-4 to ON (System/Screen transmitted simultaneously) disables the setting of SW2-3. In this case, the data transmission becomes possible only if the data inside memory unit is in either of following combinations.
 - Bank 0: system program, Bank 1: other than system program
 - Bank 0: other than system program, Bank 1: system programIf the combination is not as listed above, a data transmitting error occurs.
 - When writing the system program into the NT631/NT631C, the type of system program inside memory unit and the type of PT unit must be corresponding.
-

(2) Switch the NT631/NT631C power ON.

The screen data is automatically written into the PT.

The messages "Preparing", "Transmitting", "Verifying" and "Finished" are displayed on the screen in accordance with the progress of data writing.

At the same time, the progress of data writing status is displayed by the means of the number of bytes and blocks (1 bank = 16 block = 1024k byte).

The RUN LED operates as follows according to the processing status.

Preparing	: flashes at intervals of 1 second
Transmitting	: flashes at intervals of 0.5 second
Verifying	: flashes at intervals of 0.5 second
Finished	: lights up

(3) Switch the NT631/NT631C power OFF, remove the memory unit.

To operate NT631/NT631C continuously, switch the NT631/NT631C power back ON.

Reading and Writing Data by Manual Transmission

In this method, the direction of transmission and area of the memory unit used are set by touch switch operations at the NT631/NT631C. Transmission can be executed while checking the settings.

Reference When data is written to the NT631/NT631C or memory unit, the data that has been stored up until that point is lost.

- Method of execution

Use the following procedure to write screen data using manual transmission.

- (1) Check that the NT631/NT631C power is OFF, then set the DIP switches on the memory unit as follows.

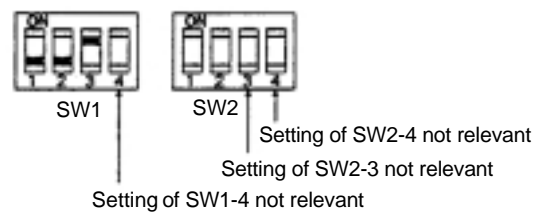

In order to avoid loss of data in the event of misoperation, it is advisable to set SW2-1 and SW2-2 so as to disable writing to the unit from which the data is to be read.

- (2) Switch the NT631/NT631C power ON.

Display language select screen appears.



- (3) Press the “Japanese” or “English” touch switches to select the display language.

The following descriptions are for when “English” is selected. The screen shown below is displayed.



“Current PT Screen Data”–system

The first line : “Compatible PT type” for the system program inside PT.

The second line : “System program name” and “Version” for the system program inside PT.

(The second line may not be displayed in the kind of system program.)

“Current PT Screen Data”–screen

The comment for the screen data in the NT631/NT631C is displayed here.

“Current Memory Unit Screen Data”

- In the case of system program:

The first line : “Compatible PT type” for the system program inside the memory unit.

The second line : “System program name” and “Version” for the system program inside the memory unit.

(The second line may not be displayed in the system program for some models.)

- In the case of screen data:

The comment for the screen data in the NT631/NT631C is displayed here.

The available “transmitting” destinations are altered depending on the settings of the origin of “transmitting” as described in the table below.

Source	Destination
[PT]screen	
[PT]system	
[PT]system/screen	[Memory unit] Bank 0/1 (fixed)
[Memory unit] Bank 0	<ul style="list-style-type: none"> • If system program is selected [PT]system (fixed)
[Memory unit] Bank 1	<ul style="list-style-type: none"> • If screen data is selected [PT]screen (fixed)
[Memory unit] Bank 0/1	[PT]system/screen (fixed)

Reference

- When transmitting the system program and screen data simultaneously from the PT to the memory unit, the setting of banks is “Bank 0: system program, Bank 1: screen data”, and when transmitting them from the memory unit to the PT, either of the following combinations must be used.
 - Bank 0: system program, Bank 1: other than system program
 - Bank 0: other than system program, Bank 1: system program
- When writing the system program into the NT631/NT631C, the type of system program inside memory unit and the type of PT unit must be corresponding.

- (4) Press "Execute".

The data is transmitted.

The messages "Preparing", "Transmitting", "Verifying", and "Finished" are displayed in accordance with the progress of data transmission. At the same time, the progress of data transmitting status is displayed by the means of the number of bytes and blocks (1 bank = 16 block = 1024k byte).

When the data transmission is operated manually, "RUN LED" remains OFF.

- (5) Switch the NT631/NT631C power OFF, remove the memory unit, then switch the NT631/NT631C power back ON.

Errors When Using a Memory Unit

If an error occurs when using the memory unit, the NT631/NT631C operates as follows.

- The details of the error and remedial action are displayed on the screen.

Each screen has touch switches to change the display language from one to the other. When the manual data transmission is operating, the content of error and remedial action are shown with selected language. When the automatic transmission is operating, it is displayed in Japanese.

- The continuous buzzer sounds.
- The RUN LED flashes.

If a protect setting error occurs when executing manual transmission, it is possible to return to the memory unit manual transmission screen by pressing the OK touch switch, but in the case of other errors, the status described above remains in effect until the NT631/NT631C power is turned OFF or reset.

When an error occurs, take remedial action by referring to the table below.

Error	Probable Cause	Remedial Action
Mode setting error	DIP switches SW1-1 to SW1-3 are all OFF, or more than one is ON.	Turn the NT631/NT631C power OFF, set the memory unit DIP switches correctly, then turn the NT631/NT631C power back ON.
Protect setting error (automatic transmission)	Writing to the data write destination has been prohibited by the setting of SW2-1 or SW2-2.	Turn the NT631/NT631C power OFF, set the memory unit DIP switches correctly, then turn the NT631/NT631C power back ON.
Protect setting error (manual transmission)	Writing to the data write destination has been prohibited by the setting of SW2-1 or SW2-2.	Perform either of the following procedures. <ul style="list-style-type: none"> • Press the OK touch switch to return to the memory unit manual transmission screen, make the correct settings, then try again. • Turn the NT631/NT631C power OFF, correct the DIP switches settings of the memory unit, then turn the power back ON.
Flash memory error	An error occurred during initialization of the NT631/NT631C or memory unit flash memory, or during write processing.	Turn the NT631/NT631C power OFF, then back ON. If the error recurs, the flash memory at the write destination may be faulty. In this case, replace the unit.
Verify error	An error occurred during verification processing at the flash memory of the NT631/NT631C or the memory unit.	Turn the NT631/NT631C power OFF, then back ON. If the error recurs, the flash memory at the write destination may be faulty. In this case, replace the unit.
Transmitting data error (The automatic transmission only)	An attempt is made to transmit data other than a system program or the system program of a different PC model into the NT631/NT631C as the system program. An attempt is made to write a system program into the NT631/NT631C as screen data.	Perform either of the following procedures. <ul style="list-style-type: none"> • Turn the NT631/NT631C power OFF, correct the DIP switch settings of the memory unit, and then turn the power back ON. • Turn the NT631/NT631C power OFF, set the DIP switch settings to the manual transmission, and then check the data inside the memory unit.

3-6 Using a Memory Unit (NT631/NT631C without V1)

This section discusses the using of a memory unit when the system program for NT631/NT631C with V1 is installed to the NT631/NT631C (NT631-ST211□-E/NT631-ST141□-E/NT631C-ST151□-E) without V1.

Reference In this case, the function and use of the memory unit are the same as ones for the NT631/NT631C without V1. (The system program transmission by using a memory unit cannot be processed.)

By installing a memory unit (NT-MF261) on the NT631/NT631C, the screen data in the NT631/NT631C can be recorded (backed up) in the memory unit.

In addition, the screen data in the memory unit can be automatically read into the NT631/NT631C when it starts up. This means that screen data can be changed easily at the operation site without connecting to the Support Tool.

The data in the memory unit is retained without backup by a battery or other means.

In systems where there are frequent setup changes, by preparing a number of memory units in advance and recording screen data in them in accordance with the control performed in each case, the NT631/NT631C screen data can be changed simply by changing the memory unit, without connecting to the Support Tool.

One memory unit can store the screen data for two PTs.

Notice

- Make sure that the power supply to the PT is OFF before connecting or disconnecting a memory unit. After mounting a memory unit, be sure to tighten its two screws.
- During data transmission, do not turn off the power supply to the NT631/NT631C or reset it.
- Do not touch the PCB (printed circuit board) with bare hands.

Reference

- When a memory unit is mounted, the NT631/NT631C cannot be set to the operating status. On completion of data transmission with a memory unit, always disconnect the memory unit from the NT631/NT631C before starting NT631/NT631C operation.

- Memory units (NT-MF261) can be used in common for the following PT models: NT31, NT31C, NT631, NT631C (with and without V1). One memory unit can store screen data for up to two PTs of different models. However, since the data compatibility is not complete between NT31/NT31C and NT631/NT631C, the data of NT631 cannot be used in NT31C without putting it through a conversion (the data must be converted using the Support Tool).

Note also that although there is data compatibility between the NT31 and NT31C, and between the NT631 and NT631C, the display may not be correct since these models have different numbers of colors.

The screen data for the NT631/NT631C with V1 cannot be used if a system program is for the NT631/NT631C without V1.

- The statuses of memory switch settings and system settings can be recorded to the memory unit besides screen data. When the data in the memory unit is written into the NT631/NT631C, make sure that these settings can be adapted to the NT631/NT631C used before transmission.

3-6-1 Installation Method

Install the memory unit (NT-MF261) at the expansion interface connector at the rear of the NT631/NT631C as shown in the figure below. (The expansion interface connector is located underneath the “note” label.)

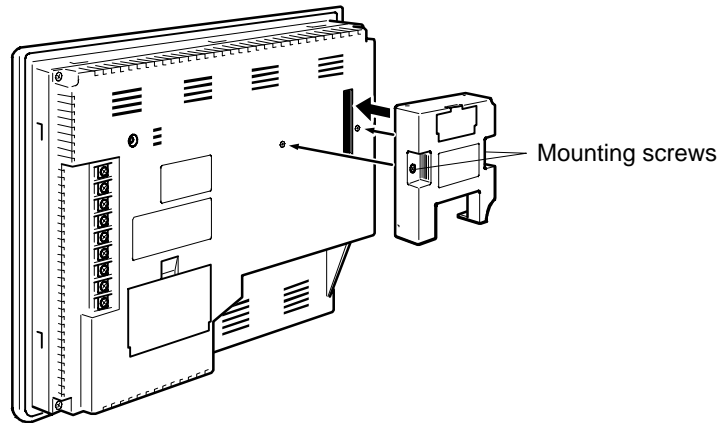

3-6-2 Method of Use

As shown in the figure below, a memory unit has two sets of four DIP switches, and the operation is determined by the DIP switches that are set at startup.



Notice

- Always confirm that the power to the NT631/NT631C is off before setting the DIP switches.
- Do not touch the PCB (printed circuit board) directly with bare hands.

DIP Switch Functions

The functions of the DIP switches on the memory unit are indicated in the table below.

- SW1

Switch	Function	
SW1-1	Automatic transmission (writing from the memory unit to the PT)	OFF: Not executed ON : Executed
SW1-2	Automatic transmission (writing from the PT to the memory unit)	OFF: Not executed ON : Executed
SW1-3	Manual transmission (Direction of transmission and bank used selected at the PT touch panel)	OFF: Not executed ON : Executed
SW1-4	Reserved for system use (must be set to “OFF”)	

- SW2

Switch	Function	
SW2-1	Disable/enable writing to PT	OFF: Disable
		ON : Enable
SW2-2	Disable/enable writing to the memory unit	OFF: Disable
		ON : Enable
SW2-3	Area (bank) selection of automatic transmission.	OFF: Bank 0
		ON : Bank 1
SW2-4	Reserved for system use (must be set to "OFF")	

* The memory unit stores screen data for one PT in each area (bank 0, bank 1). (The total data storage is for two PTs.) SW2-3 sets which of these two banks is used for automatic transmission.

- Reference**
- In the following cases, a mode setting error occurs.
 - More than one of the SW1 switches are set to "ON".
 - None of the SW1 switches are set to "ON".
 - In the following case, a protect setting error occurs.
 - Writing to the write destination has been disabled by the setting for SW2-1 or SW2-2.
 - For details on mode setting errors and protect setting errors, refer to "Errors When Using a Memory Unit" (page 3 to 25).

Writing Screen Data to a Memory Unit Using Automatic Transmission (PT to Memory Unit)

In this mode, the screen data in the NT631/NT631C is forcibly written to the memory unit irrespective of the setting status of the NT631/NT631C.

This mode is convenient if the touch panel is broken and touch switch operation is not possible, or if someone unfamiliar with touch switch operation at the operation site is using the system.

- Reference**
- When screen data is written to the memory unit, the data that has been stored in the specified area up until that point is lost (there is no effect on the other area).

- Method of execution

Use the following procedure to write the screen data in the NT631/NT631C to the memory unit by automatic transmission.

- (1) Check that the power supply to the NT631/NT631C is OFF, then set the DIP switches of the memory unit as follows after installing the memory unit in NT631/NT631C.

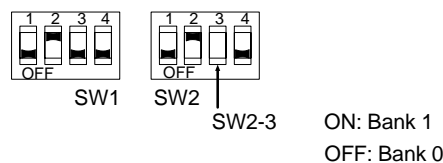

It is not strictly necessary to set SW 2-1 to "OFF" (to disable writing to the memory unit), but it is recommended to do so to avoid loss of data in the event of misoperation.

- (2) Switch the NT631/NT631C power ON.

The screen data is automatically written into the memory unit. The screen data in the NT631/NT631C is preserved.

The messages "Preparing", "Transmitting", "Verifying", and "Finished" are displayed on the screen in accordance with the progress of data writing.

When messages "Preparing", "Transmitting", and "Verifying" are displayed, the RUN LED flashes, and when the message "Finished" is displayed, the RUN LED lights.

- (3) Switch the NT631/NT631C power OFF, remove the memory unit. To operate NT631/NT631C continuously, switch the NT631/NT631C power back ON.

Writing Screen Data to the PT Using Automatic Transmission (Memory Unit to PT)

In this mode, screen data is forcibly written from the memory unit to the NT631/NT631C irrespective of the setting status of the NT631/NT631C.

Since data transmission by this method is faster than when the Support Tool is used, it can save a lot of time. When transmitting the same system program or screen data to multiple NT631/NT631C, this mode becomes convenient.

Reference When data is written to the NT631/NT631C, the data that has been stored up until that point is lost.

- Method of execution

Use the following procedure to write the screen data in the memory unit to the NT631/NT631C by automatic transmission.

- (1) Check that the NT631/NT631C power is OFF, then set the DIP switches on the memory unit as follows after installing the memory unit in NT631/NT631C.

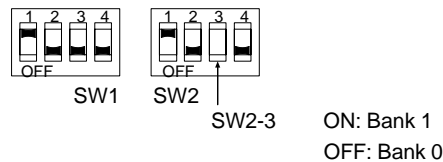

It is not strictly necessary to set SW2-2 to "OFF" (to disable writing to the memory unit), but it is recommended to do so to avoid loss of data in the event of misoperation.

- (2) Switch the NT631/NT631C power ON.

The screen data is automatically written into the PT.

The messages "Preparing", "Transmitting", "Verifying" and "Finished" are displayed on the screen in accordance with the progress of data writing.

When messages "Preparing", "Transmitting", and "Verifying" are displayed, the RUN LED flashes, and when the message "Finished" is displayed, the RUN LED lights.

- (3) Switch the NT631/NT631C power OFF, and remove the memory unit. To operate NT631/NT631C continuously, switch the NT631/NT631C power back ON.

Reading and Writing Data by Manual Transmission

In this method, the direction of transmission and area of the memory unit used are set by touch switch operations at the NT631/NT631C. Transmission can be executed while checking the settings.

Reference When data is written to the NT631/NT631C or memory unit, the data that has been stored up until that point is lost.

- Method of execution

Use the following procedure to read and write screen data using manual transmission.

- (1) Check that the NT631/NT631C power is OFF, then set the DIP switches on the memory unit as follows.

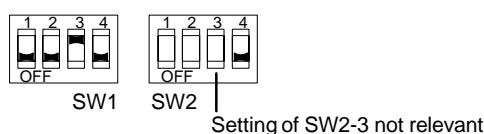

In order to avoid loss of data in the event of misoperation, it is advisable to set SW2-1 and SW2-2 so as to disable writing to the unit from which the data is to be read.

- (2) Switch the NT631/NT631C power ON.

The screen shown below is displayed.

(Example)

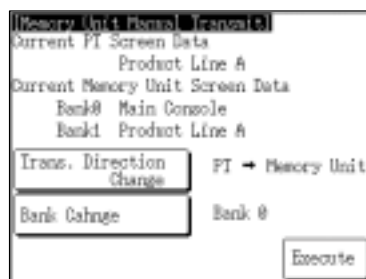

“Current PT Screen Data”

The comment for the screen data in the NT631/NT631C is displayed here.

“Current Memory Unit Screen Data”

The comments for the screen data in each area are displayed here.

Pressing the “Trans. Direction Change” and “Bank Change” touch switches changes the selections for the direction of transmission and the area of the memory unit used.

- (3) Press “Execute”.

The data is transmitted.

The messages “Preparing”, “Transmitting”, “Verifying”, and “Finished” are displayed in accordance with the progress of data transmission.

- (4) Switch the NT631/NT631C power OFF, remove the memory unit, then switch the NT631/NT631C power back ON.

Errors When Using a Memory Unit

If an error occurs when using the memory unit, the NT631/NT631C operates as follows.

- The details of the error and remedial action are displayed on the screen.
- The continuous buzzer sounds.
- The RUN LED flashes.

If a protect setting error occurs when executing manual transmission, it is possible to return to the memory unit manual transmission screen by pressing the OK touch switch, but in the case of other errors, the status described above remains in effect until the NT631/NT631C power is turned OFF or reset.

When an error occurs, take remedial action by referring to the table below.

Error	Probable Cause	Remedial Action
Mode setting error	DIP switches SW1-1 to SW1-3 are all OFF, or more than one is ON.	Turn the NT631/NT631C power OFF, set the memory unit DIP switches correctly, then turn the NT631/NT631C power back ON.
Protect setting error (automatic transmission)	Writing to the data write destination has been prohibited by the setting of SW2-1 or SW2-2.	Turn the NT631/NT631C power OFF, set the memory unit DIP switches correctly, then turn the NT631/NT631C power back ON.
Protect setting error (manual transmission)	Writing to the data write destination has been prohibited by the setting of SW2-1 or SW2-2.	Perform either of the following procedures. <ul style="list-style-type: none"> • Press the OK touch switch to return to the memory unit manual transmission screen, make the correct settings, then try again. • Turn the NT631/NT631C power OFF, correct the DIP switches settings of the memory unit, then turn the power back ON.
Flash memory error	An error occurred during initialization of the NT631/NT631C or memory unit flash memory, or during write processing.	Turn the NT631/NT631C power OFF, then back ON. If the error recurs, the flash memory at the write destination may be faulty. In this case, replace the unit.
Verify error	An error occurred during verification processing at the flash memory of the NT631/NT631C or the memory unit.	Turn the NT631/NT631C power OFF, then back ON. If the error recurs, the flash memory at the write destination may be faulty. In this case, replace the unit.

SECTION 4

Connecting to the Host from the RS-232C Port

This section describes the method for connecting to the host using the RS-232C port of the NT631/NT631C.

4-1	Connecting to the RS-232C Port at the Host	64
4-1-1	Host Types and Settings	65
4-1-2	Connecting Directly between RS-232C Ports	87

4-1 Connecting to the RS-232C Port at the Host

The method for connecting between the RS-232C port of the PT and the RS-232C port of the host is as follows.

The following discussion is focused on the connection method to OMRON PCs (By using the memory link method, a connection can be made to any arbitrary RS-232 unit). When making a connection to a host other than OMRON PCs, refer to the "PC Connection" (V042-E1-[2](#))

- Direct connection between the RS-232C ports using an RS-232C cable (page 126)

This is the easiest connection method. Depending on the host to which the connection is to be made, it may be possible to use OMRON cables with connectors.

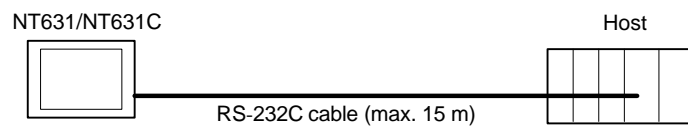

Reference The CS1 series CPU cannot be connected with the 1:1 connection NT link method. Use the 1:N connection NT link method instead to make the 1:1 connection. For details, refer to "NT link (1:N) method" (page 80).

4-1-1 Host Types and Settings

The types of host that can be connected to a PT by using the RS-232C ports of both units, and the settings to be made at the host, are described here.

When Using the Host Link Method

- Compatible host units

Some models and series of OMRON PCs have the host link function built in.

- In the CS1 series, the host link method can be used by installing a serial communication board. In addition, some C200HX/HG/HE (-Z) have an integral CPU that can be connected in the host link method by installing a communication board.

Check the model and series of the PC, the type of installed serial communication board, the serial communication unit, and the host link unit at the connection end before making a connection.

The host units that can be connected to the NT631/NT631C by the host link method using the RS-232C ports of both units are indicated in the table below.

PLC Series	Units with Built-in Host Link Function	CPUs Connectable with Host Link Units or Expansion Communication Board	Host Link Unit/Communication Board	Connectable to
CS1 Series	CS1G-CPU42/43/44/45-E CS1H-CPU63/64/65/66/67-E	CS1G-CPU42/43/44/45-E CS1H-CPU63/64/65/66/67-E	CS1W-SCB41-E	CS1G CS1H

C Series		C200H-CPU01/02/03/11/ 21/22/23/31-E C1000H-CPU01-EV1 C2000H-CPU01-EV1	C120-LK201-EV1	C200H C1000H C2000H
		C200H-CPU01/2/03/11/ 21/22/23/31-E C200HS-CPU01/03/21/23/ 31/33-E C200HE-CPU11/32/42-E C200HE-CPU11/32/42-ZE C200HG-CPU33/43/53/63-E C200HG-CPU33/43/53/63-ZE C200HX-CPU34/44/54/64-E C200HX-CPU34/44/54/64/ 65/85-ZE	C200H-LK201-EV1	C200H C200HS C200HE C200HE-Z C200HG C200HG-Z C200HX C200HX-Z
	C200HS-CPU21/23/31/33			C200HS
	C200HE-CPU42 C20HE-CPU42-Z	C200HE-CPU32/42-E C200HE-CPU32/42-ZE	C200HW-COM02/04/ 05/06-EV1	C200HE C200HE-Z
	C200HG-CPU43/63 C200HG-CPU43/63-Z	C200HG-CPU33/43/53/63-E C200HG-CPU33/43/53/63-ZE		C200HG C200HG-Z
	C200HX-CPU44/64 C200HX-CPU44/64/65/85-Z	C200HX-CPU34/44/54/64-E C200HX-CPU34/44/54/64/ 65/85-ZE		C200HX C200HX-Z
		C1000H-CPU01-EV1 C2000H-CPU01-EV1	C500-LK201-EV1	C1000H C2000H
		C1000H-CPU01-EV1 C1000HF-CPUA1-EV1 C2000H-CPU01-EV1	C500-LK203	C1000H (F) C2000H
	CPM1-10/20/30CDR- ☒ +CPM1-CIF01			CPM1
	CPM1A-10/20/30/40CD ☒ ☒ +CPM1-CIF01			
	CQM1-CPU21 CQM1-CPU41/42/43/44-V1			CQM1

PLC Series	Units with Built-in Host Link Function	CPUs Connectable with Host Link Units or Expansion Communication Board	Host Link Unit/Communication Board	Connectable to
CV Series (*1)	CV500-CPU01-EV1	CV500-CPU01-EV1	CV500-LK201	CV500
	CV1000-CPU01-EV1	CV1000-CPU01-EV1		CV1000
	CV2000-CPU01-EV1	CV2000-CPU01-EV1		CV2000
CVM1 Series (*1)	CVM1-CPU01-EV2	CVM1-CPU01-EV2	CV500-LK201	CVM1
	CVM1-CPU11-EV2	CVM1-CPU11-EV2		
	CVM1-CPU21-EV2	CVM1-CPU21-EV2		
CompoBus/S master control unit	SRM1-C02-V1			SRM1

*1 CPUs of CVM1/CV-series PCs without the suffix "-EV□" cannot be connected.

- Settings at the host

When using the host link method, the settings shown below must be made at the host (depending on the unit, some of these settings may not be necessary, or settings not shown here may be necessary).

Item	Switch Setting
I/O port	RS-232C
Communications speed	Set the same speed as for the NT631/NT631C. (*1)
Transfer code	ASCII, 7 data bits, 2 stop bits
Parity	Even
1-to-1/1-to-N	1-to-N(*2)
Instruction level	Level 1, 2, 3
Unit #	00

*1 Set the host link communications speed at 9600 bps or 19200 bps with the memory switch at the NT631/NT631C. For details, refer to "Setting the Host Link Method" (page 174).

*2 The 1-to-N setting enables BCC (Block Check Character). It is not actually possible to connect more than one NT631/NT631C in a single host link.

The setting methods for each type of unit are described in the following.

- Connecting to a C series host link unit

C200H/C200HS/C200HE/HG/HX (-ZE) backplate mounted type:
C200H-LK201-V1

[Setting the front switches]

Set each switch with a flat blade screwdriver so that the values or symbols in the setting value window agree with the following.

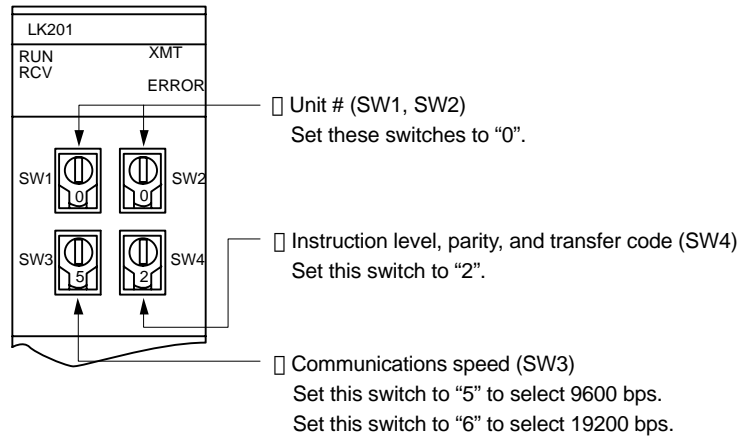

[Setting the rear switches]

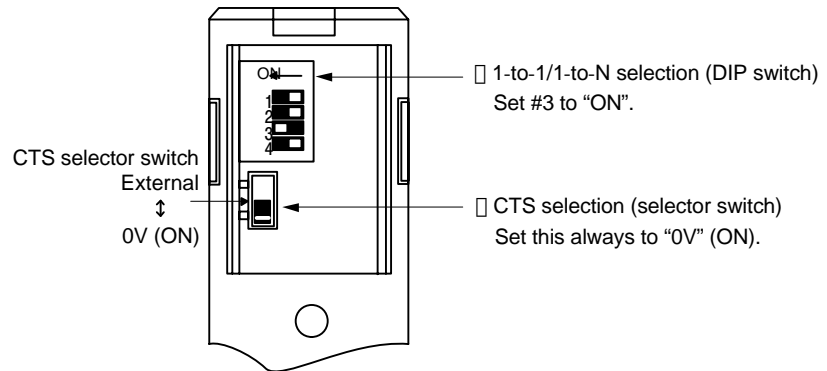

C1000H(F)/C2000H backplate mounted type: 3G2A5-LK201-EV1

[Setting the front switches]

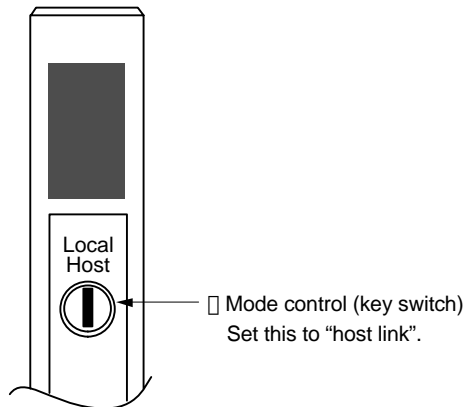

[Setting the rear switches]

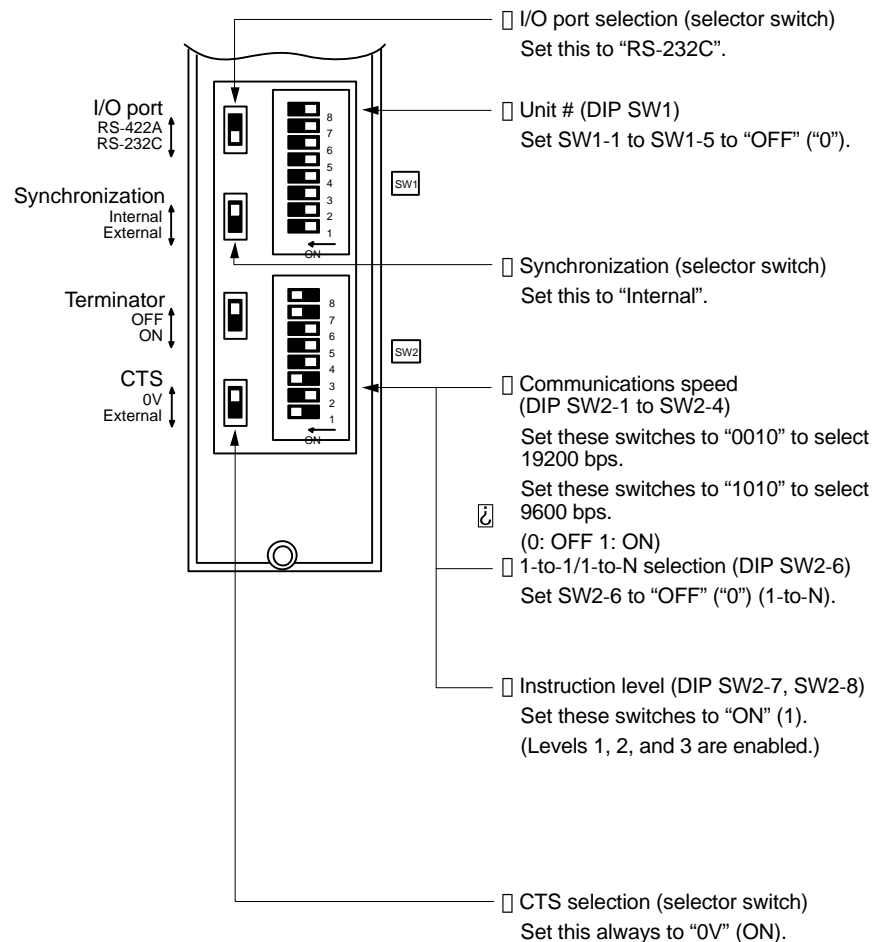

C1000H/C2000H backplate mounted type: C500-LK203

[Setting the rear switches]

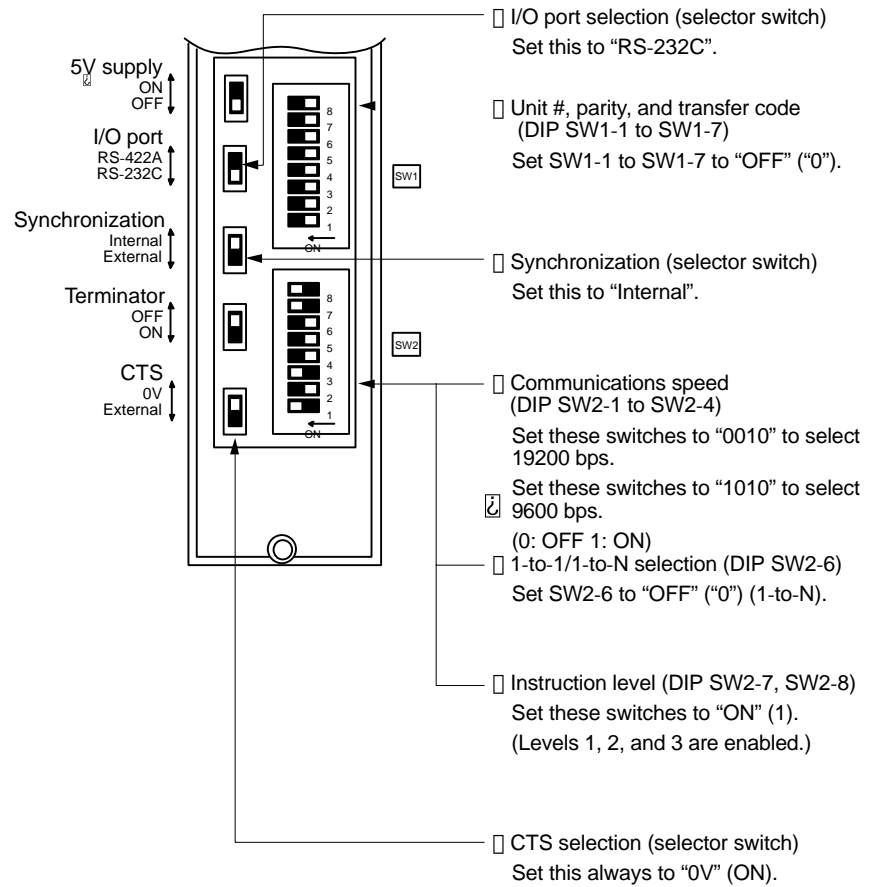

C200H/C1000H/C2000H CPU mounting type: 3G2A6-LK201-EV1

[Setting the rear switches]

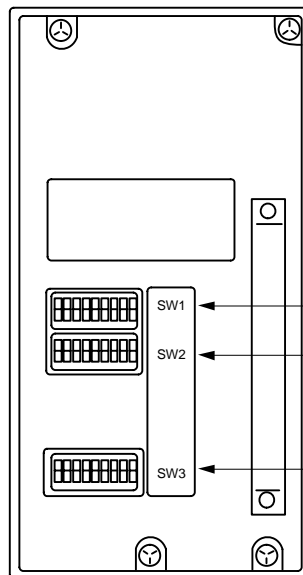

- Unit #, parity, and transfer code (DIP SW1-1 to SW1-5)
Set SW1-1 to SW1-5 to "OFF" (0).
* Parity is fixed at Even Parity. Transfer code is fixed at ASCII 7 data bits and 2 stop bits.
- Communications speed (DIP SW2-1 to SW2-4)
Set these switches to "0010" to select 19200 bps.
Set these switches to "1010" to select 9600 bps.
(0: OFF 1: ON)
- 1-to-1/1-to-N selection (DIP SW2-6)
Set SW2-6 to "OFF" ("0") (1-to-N).
- Instruction level (DIP SW2-7, SW2-8)
Set these switches to "ON" (1).
(Levels 1, 2, and 3 are enabled.)
- CTS selection (DIP SW3-1 and SW3-2)
Set SW3-1 to "ON" (1), and SW3-2 to "OFF" (0).
(Set this always to "0V".)
- Synchronization (DIP SW3-3 to SW3-6)
Set SW3-3, SW3-5, and SW3-6 to "ON" (1), and SW3-4 to "OFF" (0). (Set these to "Internal".)

- Connecting to a CVM1/CV series host link unit

CVM1/CV series backplane mounted type: CV500-LK201

A CVM1/CV series host link unit (CV500-LK201) has two connectors (communication ports 1 and 2). Either of these ports can be used for connection to an NT631/NT631C by the RS-232C method. However, since the connectors at these ports are of different types, a cable that matches the connector must be prepared.

- Communication port 1

Communication port 1 is a 25-pin connector for RS-232C use only.

- Communication port 2

Communication port 2 is a 9-pin connector which allows selection of the RS-232C or RS-422A method. When this port is used with the RS-232C method, the I/O port selector switch on the front of the unit must be set to "RS-232C" (the upper position).

[CPU bus unit settings]

When connecting to a CVM1/CV series host link unit, set the following communication conditions for the CPU bus unit settings.

Item	Setting at Host
Communications speed	Set the same speed as set at the NT631/NT631C(*1)
Transfer code	ASCII, 7 data bits, 2 stop bits
Parity	Even
1-to-1, 1-to-N	1-to-N(*2)
Instruction level	Level 1, 2, 3

*1 Set the host link communications speed at 9600 bps or 19200 bps with the memory switch at the NT631/NT631C. For details, refer to "Setting the Host Link Method" (page174).

*2 The 1-to-N setting enables BCC (Block Check Character). It is not actually possible to connect more than one NT631/NT631C in a single host link.

Set the CPU bus unit settings directly from a peripheral tool (e.g. SYSMAC support software).

For details on the CPU bus unit settings, refer to the SYSMAC CVM1/CV series Host Link Unit User's Manual (W205-E1-□).

[Setting the front switches]

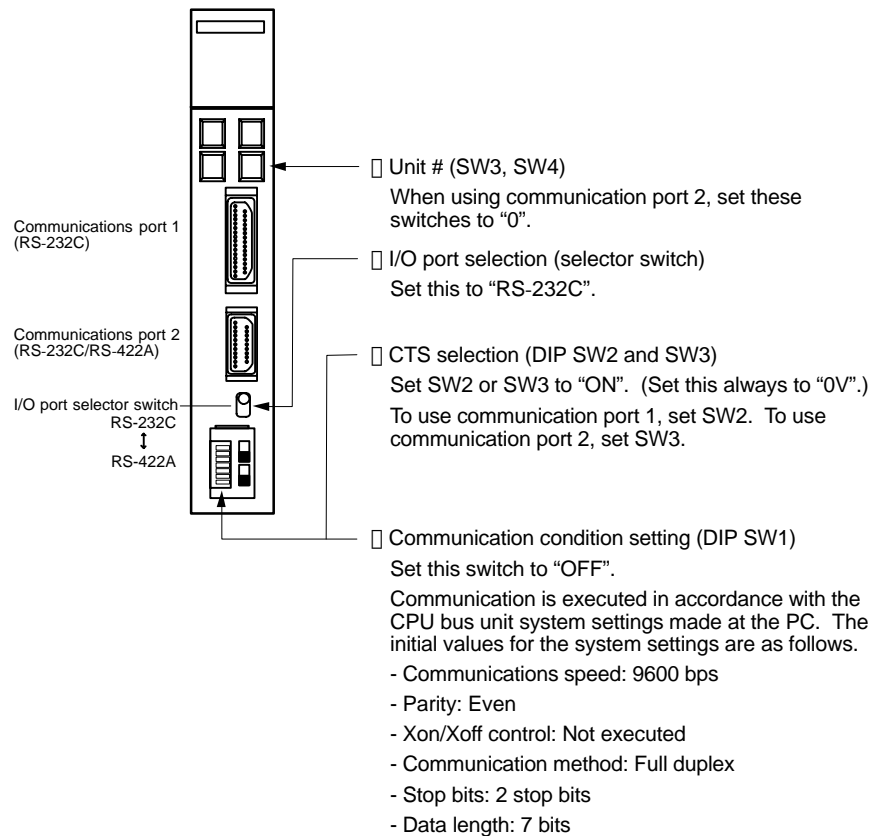

- Connecting to a CS1 series serial communication unit

CS1 series backplate mounted type: CS1W-SCU21-E

[Setting the front switches]

Set the unit number of the serial communication unit by using the rotary switch located on the front panel. Set each switch with a flat blade screwdriver so that the values or symbols in the setting value window agree with the following.

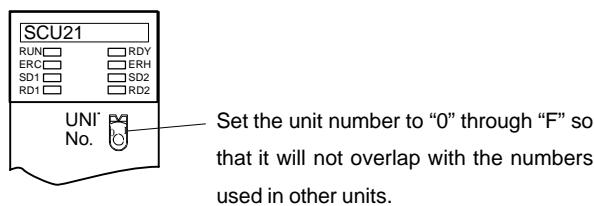

[Allocation DM area settings for CPU]

Settings are written from the peripheral tool (a programming console or CX-Programmer) directly into the allocation DM area (system setting area) of the CPU. After the settings are written, they become effective by turning the power ON, restarting the unit, restarting the communication port, or execution of the STUP command.

In the following, the channel numbers of the allocation DM area and the settings are shown.

$$m = \text{DM30000} + 100$$

Allocation DM area H)		Writing Value	Settings
Port 1	Port 2		
m	m+10	8000	host link mode, 2 stop bits, even parity, data length 7 bits
m+1	m+11	0000	Communication speed 9600 bps.
		0007	Communication speed 19200 bps.
m+2	m+12	0000	Transmit delay time 0 ms.
m+3	m+13	0000	No CTS control Unit No.0 for host link

- Connecting to a CPU

C-series CVM1/CV-series (-EV□)

· CV500-CPU01-EV1/CV1000-CPU01-EV1/CV2000-CPU01-EV1

· CVM1-CPU01-EV2/CVM1-CPU11-EV2/CVM1-CPU21-EV2

- PC system settings

When connecting to a CVM1/CV series CPU, set the following communication conditions for the "PC system settings".

Item	Setting at Host
Communications speed	Set the same speed as set at the NT631/NT631C(*1)
Stop bit	2 stop bits
Parity	Even
Data length	ASCII 7 bits
Unit #	00

*1 Set the host link communications speed at 9600 bps or 19200 bps with the memory switch at the NT631/NT631C. For details, refer to "Setting the Host Link Method" (page 174).

Either set PC system settings directly from a peripheral tool (e.g. SYSMAC support software), or transmit the PC system settings made at a peripheral tool to the CPU.

For details on the PC system settings, refer to the SYSMAC CVM1/CV500/1000/2000 User's Manual (Ladder) (W202-E1-□).

[Setting the front switches]

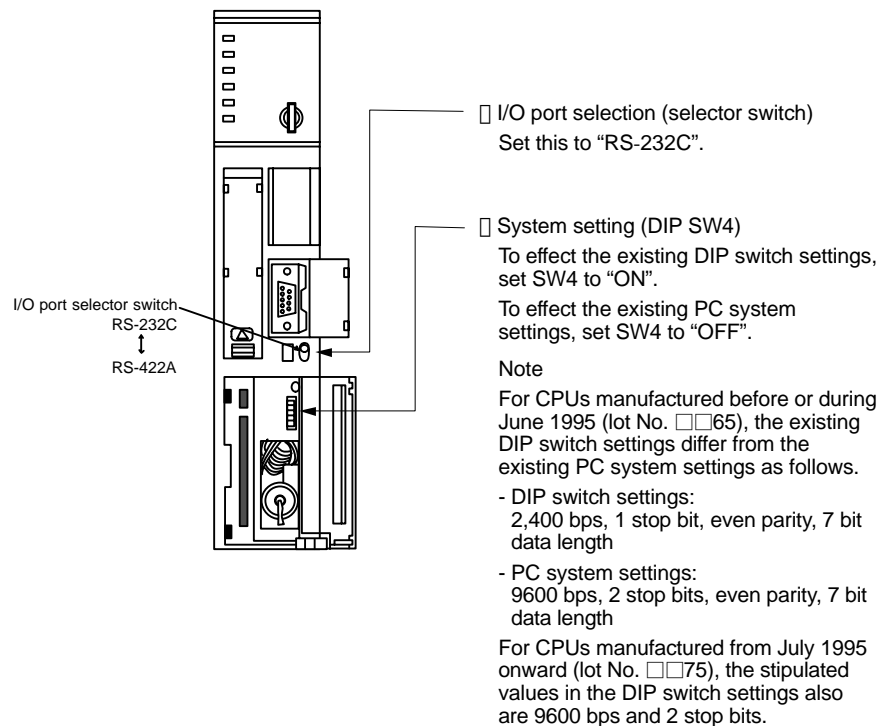

C-series C200HS, C200HX/HG/HE (-ZE), CPM1, CQM1 CPUs, SRM1

Connect to the built-in RS-232C port of the CPU, or the RS-232C port (port A, B) of the communication board. Note that the connection to a CPM1 must be made via an RS-232C adapter (CPM1-CIF01).

Reference Connection to the peripheral port of the CPU is not possible.

- PC system setting area settings

When connecting to a C200HS, C200HX/HG/HE (-ZE), CPM1, or CQM1 CPU, or SRM1, set the following communication conditions for the PC system setting area.

Item	Setting at Host
Communication mode	Host link mode
Communications speed	Set the same speed as set at the NT631/NT631C(*1)
Stop bit	2 stop bits
Parity	Even
Data length	ASCII 7 bits
Unit #	00

*1 Set the host link communications speed at 9600 bps or 19200 bps with the memory switch at the NT631/NT631C. For details, refer to "Settings the Host Link Method" (page174).

Set the PC system setting area settings directly from a peripheral tool (e.g. SYSMAC support software).

For details on operations relating to the PC system setting area, refer to the manual for the PC which is used.

The PC system setting area word numbers and settings to be made depending on the unit and port to which the connection is made are shown below.

When using the built-in RS-232C port of C200HX/HG/HE (-ZE), CQM1, SRM1

Word #	Writing Value	Settings
DM6645	0001	Host link mode, no CTS control Communication conditions set by the contents of DM
DM6646	0303	Data length 7 bits, 2 stop bits, even parity, communications speed: 9600 bps
	0304	Data length 7 bits, 2 stop bits, even parity, communications speed: 19200 bps
DM6648	0000	Unit # 00

When using port A of the communication board of C200HX/HG/HE (-ZE)

Word #	Writing Value	Settings
DM6555	0001	Host link mode, no CTS control Communication conditions set by the contents of DM
DM6556	0303	Data length 7 bits, 2 stop bits, even parity, communications speed: 9600 bps
	0304	Data length 7 bits, 2 stop bits, even parity, communications speed: 19200 bps
DM6558	0000	Unit # 00

When using port B of the communication board of C200HX/HG/HE (-ZE)

Word #	Writing Value	Settings
DM6550	0001	Host link mode, no CTS control Communication conditions set by the contents of DM
DM6551	0303	Data length 7 bits, 2 stop bits, even parity, communications speed: 9600 bps
	0304	Data length 7 bits, 2 stop bits, even parity, communications speed: 19200 bps
DM6553	0000	Unit # 00

When using a CPM1

Word #	Writing Value	Settings
DM6650	0001	Host link mode Communication conditions set by the contents of DM
DM6651	0303	Data length 7 bits, 2 stop bits, even parity, communications speed: 9600 bps
	0304	Data length 7 bits, 2 stop bits, even parity, communications speed: 19200 bps
DM6653	0000	Unit # 00

[Setting the DIP switches on the front of a C200HX/HG/HE (-ZE)]

When using a C200HX/HG/HE (-ZE) or CQM1, the DIP switches on the front panel must be set as shown below in order to make the settings in the PC system setting area (data memory) effective.

C200HX/HG/HE(-ZE)

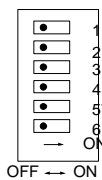

CQM1

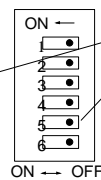

RS-232C port communication condition setting
Set DIP SW5 to "OFF" to make the settings made in PC system setting effective.

[Setting the switches on a CPM1 RS-232C adapter]

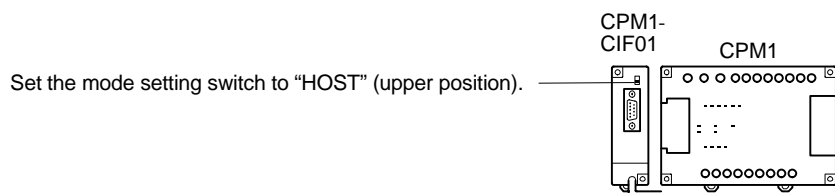

CS1 series CPU type : CS1G/H-CPU

Connect to the built-in RS-232C port of the CPU, or the RS-232C port of the communication board. Note that the connection to a peripheral port must be made via an RS-232C adapter (CS1W-CN118) specially designed for connecting to a peripheral port.

- PC system settings

When connecting to a CS1 series CPU, set the following communication conditions for the PC system setting area. Since the settings shown below are the PC default settings for the CPU, no change to the PC system setting is necessary as long as the communication speed is maintained at 9600 bps.

Item	Setting at Host
Communication speed	Set the same speed as set at the NT631/NT631C(*1)
Stop bits	2 stop bits
Parity	Even
Data length	ASCII 7 bits
Unit No. for the host link	00

*1: Set the host link communications speed at 9600 bps or 19200 bps with the memory switch at the NT631/NT631C. For details, refer to "Settings the Host Link Method" (page 174).

When the communication speed is set to 19200 bps., the PC system settings of the CPU need to be changed.

Either set the PC system settings directly from a peripheral tool (programming console), or transmit the PC system settings made at a peripheral tool (CX-Programmer) to the CPU.

For details on PC system settings, refer to the "SYSMAC CS1 Series Operation Manual" (W339-E1-)

When using the built-in RS-232C port of CS1G/H

Word #	Writing Value	Settings
160	8000	Host link mode, data length 7 bits, 2 stop bits, even parity
161	0000	Communication speed: 9600 bps.
	0007	Communication speed: 19200 bps.
163	0000	Unit #00

When using the peripheral port of CS1G/H

Word #	Writing Value	Settings
144	8000	Host link mode, data length 7 bits, 2 stop bits, even parity
145	0000	Communication speed: 9600 bps.
	0007	Communication speed: 19200 bps.
147	0000	Unit #00

[Setting the front switches]

Set the CPU DIP switches to 4 or 5 in accordance with the port NT631/NT631C is connected to.

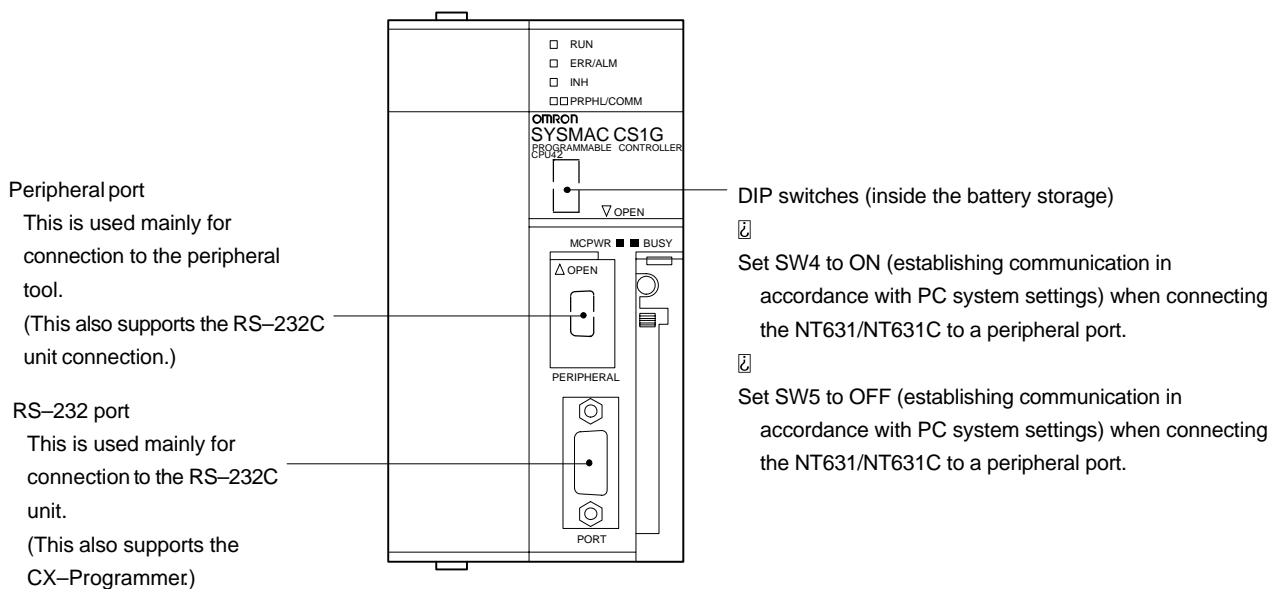

- Connecting to CS1 series serial communication board

INNER board with RS-232C port equipped for CS1 series CPU type : CS1W-SCB41/21

[Allocation DM area settings for CPU]

Settings are written from the peripheral tool (a programming console or CX-Programmer) directly into the allocation DM area (system setting area) of the CPU. After the settings are written, they become effective by turning the power ON, restarting the unit, restarting the communication port, or execution of the STUP command.

In the following, the channel numbers of the allocation DM area and the settings are shown.

Allocation DM area		Writing Value	Settings
☑	H)		
Port 1	Port 2		
DM32000	DM32010	8000	Host link mode, 2 stop bits, even parity, data length 7 bits
DM32001	DM32011	0000	Communication speed 9600 bps.
		0007	Communication speed 19200 bps.
DM32002	DM32012	0000	Transmit delay time 0 ms.
DM32003	DM32013	0000	No CTS control Unit No.0 for host link

When Using the NT Link (1:1) Method

- Compatible host units

Some models and series of OMRON PCs have the NT link (1:1) function built in. There are also some C200HX/HG/HE(-ZE) CPUs that can be connected by the NT link (1:1) method by installing a communication board.

Check the model and series of the PC against the type of CPU before making the connections.

The host units that can be connected to the NT631/NT631C by the NT link (1:1) method using the RS-232C ports of both units are indicated in the table below.

PC Series	CPUs with Built-in NT Link Function	CPUs Connectable with Expansion Communication Board ^(*1)	Connectable to
C series	C200HS-CPU21-E, -EC C200HS-CPU23-E C200HS-CPU31-E C200HS-CPU33-E		C200HS
	C200HE-CPU42-(Z)E	C200HE-CPU32-(Z)E C200HE-CPU42-(Z)E	C200HE (-ZE)
	C200HG-CPU43-(Z)E C200HG-CPU63-(Z)E	C200HG-CPU33-(Z)E C200HG-CPU43-(Z)E C200HG-CPU53-(Z)E C200HG-CPU63-(Z)E	C200HG (-ZE)
	C200HX-CPU44-(Z)E C200HX-CPU64-(Z)E X200HX-CPU65-ZE C200HX-CPU85-ZE	C200HX-CPU34-(Z)E C200HX-CPU44-(Z)E C200HX-CPU54-(Z)E C200HX-CPU64-(Z)E C200HX-CPU65-ZE C200HX-CPU85-ZE	C200HX (-ZE)
	CPM1-10CDR-□ ^(*2) CPM1-20CDR-□ ^(*2) CPM1-30CDR-□ ^(*2) CPM1A-10CD-□-□ ^(*2) CPM1A-20CD-□-□ ^(*2) CPM1A-30CD-□-□ ^(*2) CPM1A-40CD-□-□ ^(*2)		CPM1
	CQM1-CPU41-EV1 CQM1-CPU42-EV1 CQM1-CPU43-EV1 CQM1-CPU44-EV1 CQM1-CPU45-EV1		CQM1
CV series ^(*3)	CV500-CPU01-EV1		CV500
	CV1000-CPU01-EV1		CV1000
	CV2000-CPU01-EV1		CV2000
CVM1 series ^(*3)	CVM1-CPU01-EV2 CVM1-CPU11-EV2 CVM1-CPU21-EV2		CVM1
	CompoBus/S master control unit	SRM1-C02-V1	SRM1

*1 One of the following communication boards is required:
C200HW-COM02/COM04/COM05/COM06-EV1.

*2 A CPM1-CIF01 adapter is required.

*3 CPUs of CVM1/CV series PCs without the suffix “-EV□” cannot be connected.

Reference

CS1 series CPU cannot be connected with the 1:1 connection NT link method. Use the 1:N connection NT link method instead to make the 1:1 connection. For details, refer to “NT link (1:N) method” (page 83).

- Settings at the host

The setting methods for each unit are as follows.

- Connecting to a C-series C200HS, C200HX/HG/HE(-ZE), CPM1, CQM1, SRM1

[PC system setting area settings]

Write the “PC system setting area” (data memory) settings directly from a peripheral tool (e.g. SYSMAC support software) in accordance with the host model and port.

Host Model	Word #	Writing Value	Setting
RS-232C port of C200HS, C200HX/HG/HE(-ZE), CQM1, SRM1	DM6645	4000	Use NT link (1:1)
Port A of C200HX/HG/HE(-ZE) (*1)	DM6555		
Port B of C200HX/HG/HE(-ZE) (*1)	DM6550		
CPM1	DM6650		

*1 RS-232C port of the communication board

For details on operations relating to the “PC system setting area”, refer to the manual for the PC which is used.

[Setting the DIP switches on the front of a C200HX/HG/HE(-ZE)]

When using a C200HX/HG/HE(-ZE) or CQM1, the DIP switches on the front panel must be set as shown below in order to make the settings in the “PC system setting area” (data memory) effective.

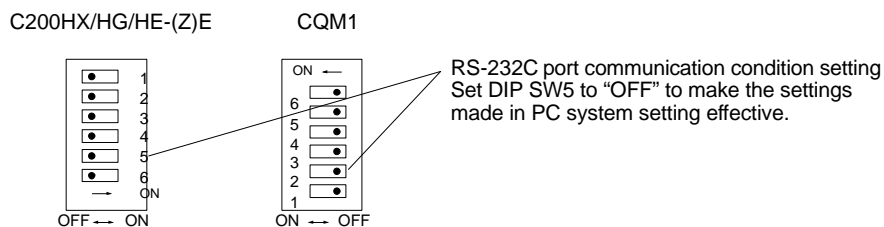

[Setting the switches on a CPM1 RS-232C adapter]

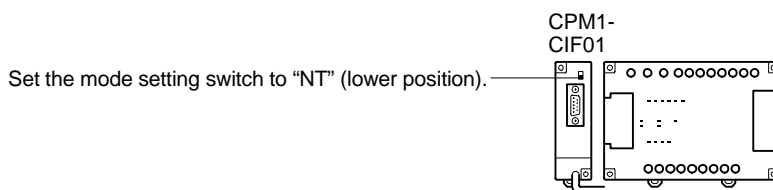

- Connecting to CVM1/CV series (-EV□)

Set the DIP switches on the front panel as follows.

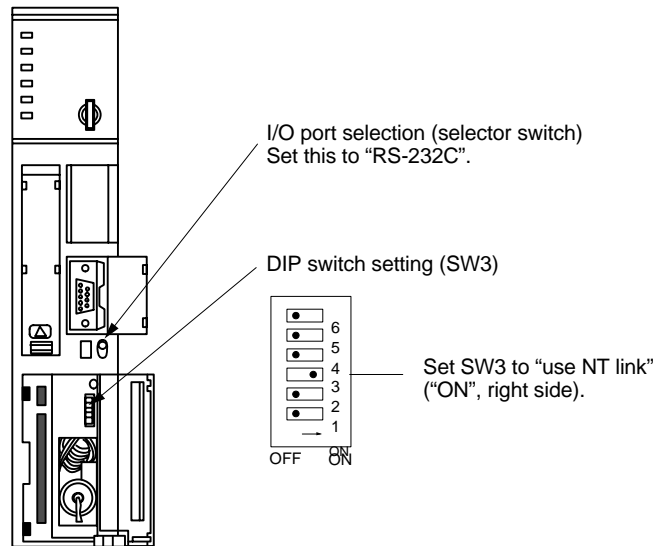

When using the CVM1/CV series, "CPU execution processing (execution control 2)" in the PC system settings must be set to "Simultaneous processing".

When Using the NT Link (1:N) Method

- Compatible host units

The OMRON PCs that can be connected using the NT link (1:N) method are CS1 series CS1G/H and C series C200HX/HG/HE (-Z) only.

Check the model and series of the PC against the type of CPU or communications board before making the connections.

The host units that can be connected to the NT631/NT631C by the NT link (1:N) method using the RS-232C ports of both units are indicated in the table below.

PC Series	CPUs with Built-in NT Link Function	CPUs Connectable with Expansion Communication Board(*1)	Connectable to
CS1 series	CS1G-CPU42/43/44/45-E CS1H-CPU63/64/65/ 66/67-E	CS1G-CPU42/43/44/ 45-E CS1H-CPU63/64/65/ 66/67-E	CS1G CS1H
C series	C200HE-CPU42-(Z)E	C200HE-CPU32-(Z)E(*2) C200HE-CPU42-(Z)E(*2)	C200HE (-ZE)
	C200HG-CPU43-(Z)E C200HG-CPU63-(Z)E	C200HG-CPU33-(Z)E(*2) C200HG-CPU43-(Z)E(*2) C200HG-CPU53-(Z)E(*2) C200HG-CPU63-(Z)E(*2)	C200HG (-ZE)
	C200HX-CPU44-(Z)E C200HX-CPU64-(Z)E C200HX-CPU65-ZE C200HX-CPU85-ZE	C200HX-CPU34-(Z)E(*2) C200HX-CPU44-(Z)E(*2) C200HX-CPU54-(Z)E(*2) C200HX-CPU64-(Z)E(*2) C200HX-CPU65-ZE(*2) C200HX-CPU85-ZE(*2)	C200HX (-ZE)

*1 One of these serial communication boards, CS1W-SCB21-E or CS1W-SCB41-E, is required.

*2 One of the following communication boards is required:
C200HW-COM02/COM04/COM05/COM06 (-EV1)

- Settings at the host

<C-series C200HX/HG/HE (-ZE)>

[PC system setting area settings]

Write the communication conditions directly to the "PC system setting area" (data memory) using a peripheral tool (e.g. SYSMAC support software).

For details on setting the "PC system setting area settings", refer to the "SYSMAC C200HX/HG/HE (-ZE) Programming Manual" (W303-E1-□).

Make the settings in the words shown below according to the port used.

Connection to	Word #	Writing Value	Setting
C200HX/HG/HE (-ZE) Built-in RS-232C port	DM6645	5□00	Use NT link (1:N) □ = highest unit number of the connected PTs (1 to 7) (*1)
Communication board Port A	DM6555		
Communication board Port B	DM6550		

*1 When using C200HE (-ZE), the range for PT unit numbers is 1 to 3.

CS1 series CPU type : CS1G/H-CPU

- PC system settings

When connecting to a CS1 series CPU, set the following communication conditions for the PC system setting area, in accordance with the communication port to be used.

When using the built-in RS-232C port of CS1G/H

Word #	Writing Value	Settings
160	8200	NT link (1:N) mode
166	000 ☑	☑ = The largest model number of the connected PT (0 - 7)

When using the peripheral port of CS1G/H

Word #	Writing Value	Settings
144	8200	NT link (1:N) mode
146	000 ☑	☑ = The largest model number of the connected PT (0 - 7)

When connecting PT with its model number 0, 2-5 to the built-in RS-232C port, for example, set the value 8200 Hex to 160 CH, and 0005 Hex to 166CH.

Either set PC system settings directly from a peripheral tool (programming console), or transmit the PC system settings made at a peripheral tool (CX-Programmer) to the CPU.

For details on PC system settings, refer to the "SYSMAC CS1 Series Operation Manual" (W339-E1).

[Setting the front switches]

Set the CPU DIP switch to 4 or 5 in accordance with the port NT631/NT631C is connected to.

Peripheral port
This is used mainly for connection to the peripheral tool.
(This also supports the RS-232C unit connection.)

RS-232 port
This is used mainly for connection to the RS-232C unit.
(This also supports the CX-Programmer.)

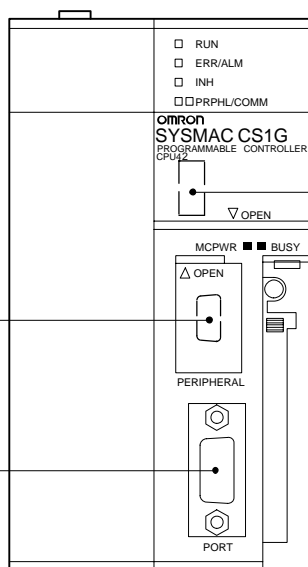

DIP switches (inside the battery storage)

☑ Set SW4 to ON (establishing communication in accordance with PC system settings) when connecting the NT631/NT631C to a peripheral port.

☑ Set SW5 to OFF (establishing communication in accordance with PC system settings) when connecting the NT631/NT631C to a peripheral port.

- Connecting to the CS1 series serial communication board

INNER board with RS-232C port equipped for CS1 series CPU type :
CS1W-SCB41/21-E

[CPU allocation DM area settings]

Setting is written from the peripheral tool (a programming console or CX-Programmer) directly into the allocation DM area (system setting area) of the CPU. After the setting is written, it becomes effective by turning the power ON, restarting the unit, restarting the communication port, or execution of the STUP command. In the following, the channel numbers of the allocation DM area and settings are shown.

Allocation DM area H)		Writing Value	Settings
Port 1	Port 2		
DM32000	DM32010	8200	NT link (1:N) mode
DM32006	DM32016	000	model number of the connected PT (0 – 7)

When connecting the PT with its model number 3–6 to port 1, for example, set the value 8200 Hex to DM32000CH, and 0006 Hex to DM32006CH.

- Connecting to CS1 series serial communication unit

A CS1 series backplane mounted type : CS1W-SCU21-E

[Setting the front switches]

Set the unit number of the serial communication unit by using the rotary switch located on the front panel. Set each switch with a flat blade screwdriver so that the values or symbols in the setting value window agree with the following.

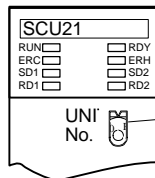

Set the unit number to "0" through "F" so that it will not overlap with the numbers used in other units.

[Allocation DM area settings for CPU]

Setting is written from the peripheral tool (a programming console or CX-Programmer) directly into the allocation DM area (system setting area) of the CPU. After the setting is written, it becomes effective by turning the power ON, restarting the unit, restarting the communication port, or execution of the STUP command. In the following, the channel numbers of the allocation DM area and settings are shown.

$$m = DM30000 + 100 * \text{unit number (CH)}$$

Allocation DM area H)		Writing Value	Settings
Port 1	Port 2		
m	m+10	8200	NT link (1:N) mode
m+6	m+16	000	model number of the connected PT (0 – 7)

When Using the Memory Link Method

In the memory link method, the connection can be made to a personal computer with RS-232 and an FA computer, etc.

When connecting to the host in the memory link method, it is necessary to create a program for the memory link at the host side.

The following are the communication conditions that can be used in the memory link method. For the host (a personal computer, an FA computer, etc.), its setting should be compatible to one of the communication conditions listed in the following table. Set the same communication conditions at the NT631/NT631C by the memory switch. (page 179).

Item	Settings at the host
Input/Output port	RS-232C
Communication speed	1200, 2400, 4800, 9600, 19200, 38400 bps.
Data bits length	7 bits, 8 bits
Stop bits length	1 bits, 2 bits
Parity	None, even, odd
Flow control	None, RS/CS, XON/XOFF

4-1-2 Connecting Directly between RS-232C Ports

The method for connection between the RS-232C ports of the NT631/NT631C and the host is described here.

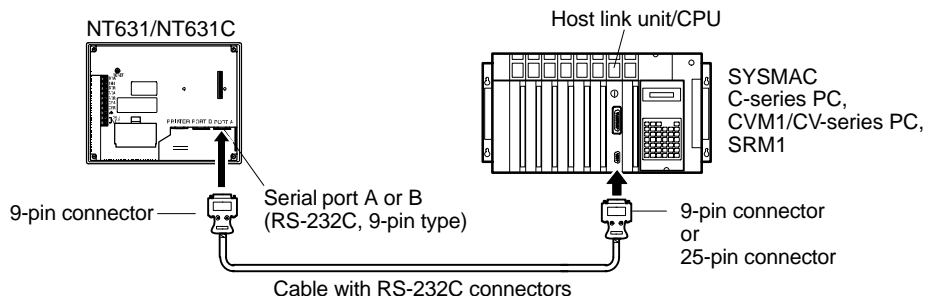

- Recommended connector cable

When making the connector cable, as far as possible use the recommended connectors, connector hoods, and cables indicated in the table below. Some units come supplied with one connector and one connector hood.

Check the required components and prepare them in advance.

Name	Model	Remarks	Delivered with
Connector	XM2A-0901	9-pin Made by OMRON	CS1-series CS1G/CS1H C-series CQM1, C200HS, C200HX/HG/HE (-ZE), CVM1/CV-series CPUs CV500-LK201
	XM24-2501	25-pin Made by OMRON	C500-LK203 CV500-LK201 C200H-LK201-EV1
	DB-25P	25-pin Made by JAE	3G2A5-LK201-EV1 3G2A6-LK201-EV1
Connector hood	XM2S-0911	9-pin Made by OMRON	C-series CQM1, C200HS, C200HX/HG/HE- (ZE), CVM1/CV-series CPUs CV500-LK201
	XM2S-0913	9-pin Made by OMRON	
	XM2S-0911-E	9-pin Made by OMRON	CS1-series CS1G/CS1H
	XM2S-2511	25-pin Made by OMRON	C500-LK203 CV500-LK201 C200H-LK201-EV1
	DB-C2-J9	25-pin Made by JAE	3G2A5-LK201-EV1 3G2A6-LK201-EV1
Cable	AWG28 × 5P IFVV-SB	Multi-core shielded cable Made by Fujikura, Ltd.	
	CO-MA-VV-SB 5P × 28AWG	Multi-core shielded cable Made by Hitachi Cable, Ltd.	

Notice

After connecting a communication cable, always secure it with the screws.

- OMRON cables with connectors

When a connection is made at serial port A in other than the memory link method, OMRON cables with connectors shown below are available.

Model	Cable Length	Connector Specification
XW2Z-200S	2 m	9-pin ↔ 25 pin
XW2Z-500S	5 m	
XW2Z-200T	2 m	9-pin ↔ 9-pin
XW2Z-500T	5 m	

When a connection is made to a personal computer at serial port A in the memory link method, OMRON cable with connectors shown below are available.

Model	Cable Length	Connector Specification
CV500-CN228	2 m	9-pin ↔ 25 pin
XW2Z-S002	2 m	9-pin ↔ 9 pin

Notice

The cable's tensile load is 30 N. Do not subject it to loads greater than this.

Wiring for a Host Link Unit (25-pin) Connection

Applicable units : C200H-LK201-EV1
 3G2A5-LK201-EV1
 C500-LK203
 3G2A6-LK201-EV1
 CV500-LK201 (communication port 1)

Cables with connectors that can be used at serial port A:
 XW2Z-200S (9-pin ↔ 25-pin, 2 m)
 XW2Z-500S (9-pin ↔ 25-pin, 5 m)

CVM1/CV-series host link units (CV500-LK201) have two types of connector; a 25-pin connector (communication port 1), and a 9-pin connector (communication port 2). When using communication port 2, refer to "Wiring for Other Connections (other than the memory link method)" (page91).

Wiring for Other Connections

Applicable units :

CV500-LK201 (communication port 2)	
CPM1-10CDR-□	CPM1-20CDR-□
CPM1-30CDR-□	
CPM1A-10CD□-□	CPM1A-20CD□-□
CPM1A-30CD□-□	CPM1A-40CD□-□
CQM1-CPU21-E	
CQM1-CPU41-EV1	CQM1-CPU42-EV1
CQM1-CPU43-EV1	CQM1-CPU44-EV1
CQM1-CPU45-EV1	
CS1G-CPU42-E	CS1G-CPU43-E
CS1G-CPU44-E	CS1G-CPU45-E
CS1H-CPU63-E	CS1H-CPU64-E
CS1H-CPU65-E	CS1H-CPU66-E
	CS1H-CUP67-E
C200HS-CPU21-E, -EC	C200HS-CPU23-E
C200HS-CPU31-E	C200HS-CPU33-E
C200HE-CPU32-(Z)E	C200HE-CPU42-(Z)E
C200HG-CPU33-(Z)E	C200HG-CPU43-(Z)E
C200HG-CPU53-(Z)E	C200HG-CPU63-(Z)E
C200HX-CPU34-(Z)E	C200HX-CPU44-(Z)E
C200HX-CPU54-(Z)E	C200HX-CPU64-(Z)E
C200HX-CPU65-ZE	C200HX-CPU85-ZE
CV500-CPU01-EV1	CV1000-CPU01-EV1
CV2000-CPU01-EV1	
CVM1-CPU01-EV2	CVM1-CPU11-EV2
CVM1-CPU21-EV2	
SRM1-C02-V1	

Cables with connectors that can be used at serial port A:

XW2Z-200T (9-pin ⇔ 9-pin, 2 m)

XW2Z-500T (9-pin ⇔ 9-pin, 5 m)

CPUs of CVM1/CV-series PCs without the suffix “-EV□” cannot be connected by any connection method.

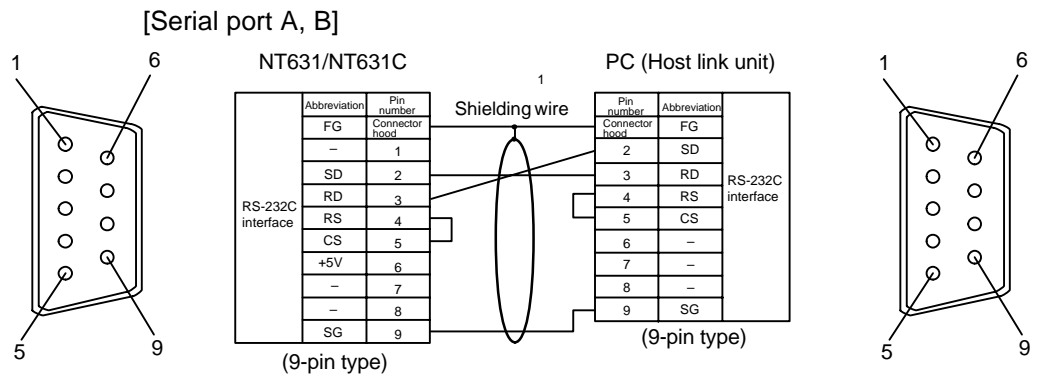

Wiring for a Memory Link connection

Cables with connectors that can be used:

CV500–CN228 (9–pin⇔25–pin, 2 m)

XW2Z–S002 (9–pin⇔9–pin, 2 m)

[Serial port A, B]

Prepare the adapter cable while referring to the following diagram.

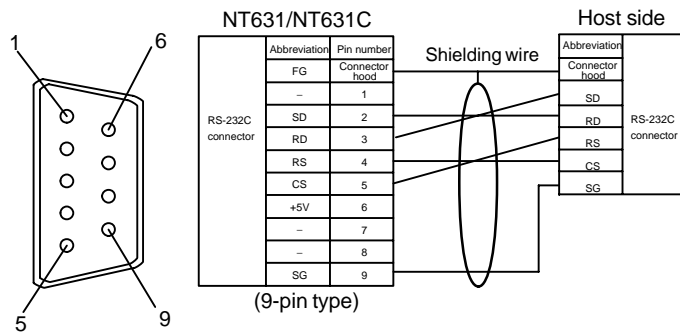

SECTION 5

Connecting to the Host from the RS-422A/485 Port

This section describes the method for connecting to the host using the RS-422A/485 port of the NT631/NT631C.

5-1	Connecting to the Host's RS-232C Port	94
5-1-1	The type of host and settings	95
5-1-2	1:1 Connection between RS-422A/485 at the NT631/NT631C and RS-232C at the Host	97
5-1-3	1:N Connection between RS-422A/485 at the NT631/NT631C and RS-232C at the Host	102
5-1-4	Recommended Connectors, Cables, and Crimp Terminals	108
5-1-5	Setting the Terminal Resistance for RS-422A/485 Communications	110
5-2	Connecting to the Host's RS-422A/485 Port	111
5-2-1	Host Types and Settings	112
5-2-2	Direct Connection between RS-422A Ports at Both Units	131
5-2-3	Direct Connection between RS-485 Ports at Both Units	136
5-2-4	1:N Connection among RS-422A Ports	137
5-2-5	1:N Connection among RS-485 Ports	140
5-2-6	Recommended Connectors, Cables and Crimp Terminals	143
5-2-7	Setting the Terminal Resistance for RS-422A/485 Communications	144

5-1 Connecting to the Host's RS-232C Port

The methods for connecting the RS-422A/485 port of the NT631/NT631C and the RS-232C port of the host are described here. There are the following methods.

The following discussion is focused on the connection method to OMRON PCs (By using the memory link method, a connection can be made to any arbitrary RS-232C unit). When making a connection to a host other than OMRON PCs, refer to the "PC Connection" (V042-E1-□).

- Method in which the RS-422A port of the NT631/NT631C and the RS-232C port of the host are connected in a 1:1 connection via an RS-232C/RS-422A convertor unit (page 98).

When this method is used, the cable length can be extended up to 500 m.

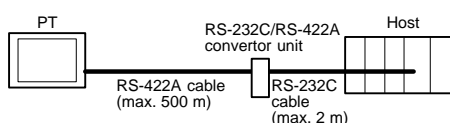

- Method in which the RS-485 port of the NT631/NT631C and the RS-232C port of the host are connected in a 1:1 connection via an RS-232C/RS-422A convertor unit (page 98).

When this method is used, the cable length can be extended up to 500 m. This connection method can be used only with the NT link (1:N) method of type RS-485.

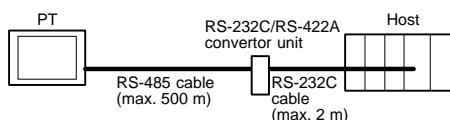

- Method in which the RS-422A ports of multiple NT631/NT631Cs and the RS-232C port of the host are connected in a 1:N connection via an RS-232C/RS-422A convertor unit (page 103).

This connection method is used with the RS-422A type NT link (1:N) method.

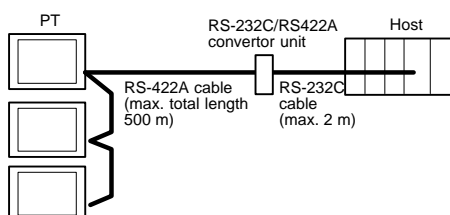

- Method in which the RS-485 ports of multiple NT631/NT631Cs and the RS-232C port of the host are connected in a 1:N connection via an RS-232C/RS-422A convertor unit (page 103).

This connection method is used with the RS-485 type NT link (1:N) method.

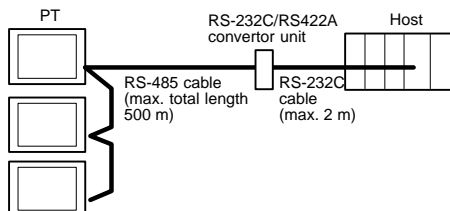

Notice

One end of the wire must always be connected to the host (PC), and there must be no branching. Branching will cause problems such as transmission delays and communication failures.

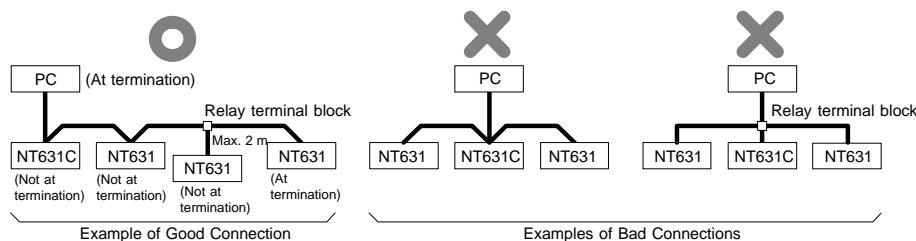

Reference

CS1 series CPUs cannot be connected with the 1:1 connection NT link method. Use the 1:N connection NT link method instead to make the 1:1 connection. For details, refer to "NT link (1:N) method" (page 83).

5-1-1 The type of host and settings

The using condition is the same as the connecting PT side RS-232C and the host side RS-232C.

For the available type and settings of the host, refer to the pages listed below.

For the host link method, refer to "Host Link Method" (page 65).

For the NT link (1:1) method, refer to "NT Link (1:1) method" (page 80).

For the NT link (1:N) method, refer to "NT Link (1:N) method" (page 83).

For the memory link method, refer to "Memory Link Method" (page 87).

Settings at the RS-232C/RS-422A Convertor Unit (NT-AL001)

When making a connection between RS-232C and RS-422A/485 ports using an RS-232C/RS-422A convertor unit, set the DIP switches on the NT-AL001 as follows.

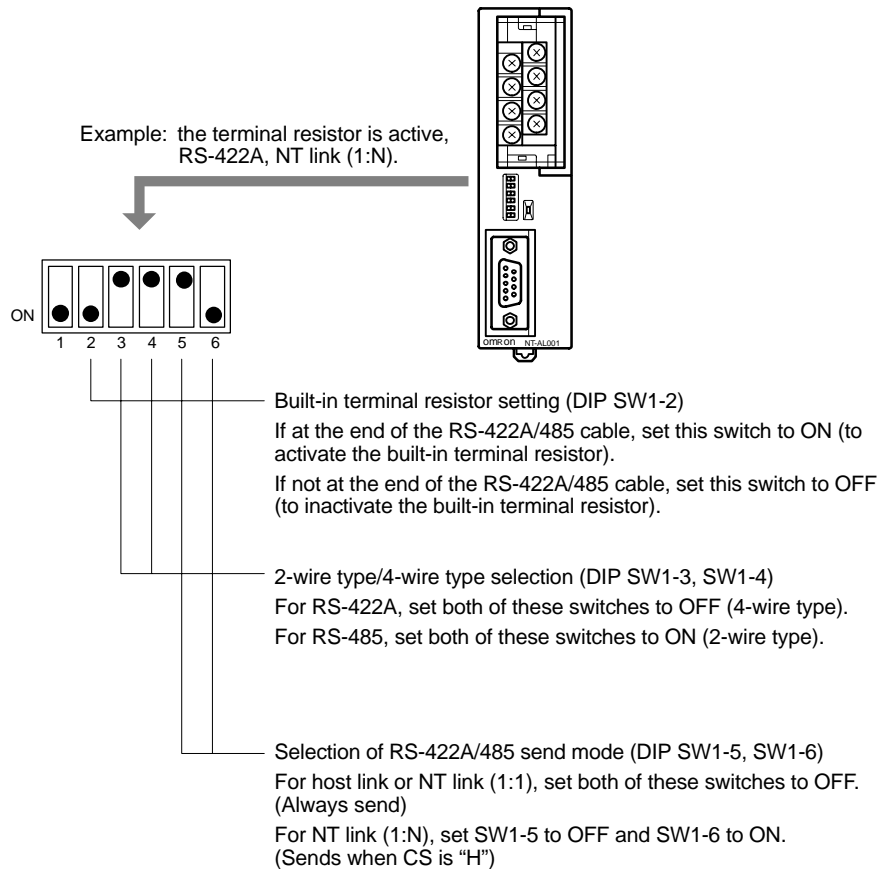

Notice Read the manual supplied with the NT-AL001 carefully before using the unit.

5-1-2 1:1 Connection between RS-422A/485 at the NT631/NT631C and RS-232C at the Host

The connection method in which the RS-422A/485 port of an NT631/NT631C and the RS-232C port of a host are connected via a converter unit is described here.

An RS-232C/RS-422A converter unit (NT-AL001) is used to convert between the RS-232C and RS-422A communication methods.

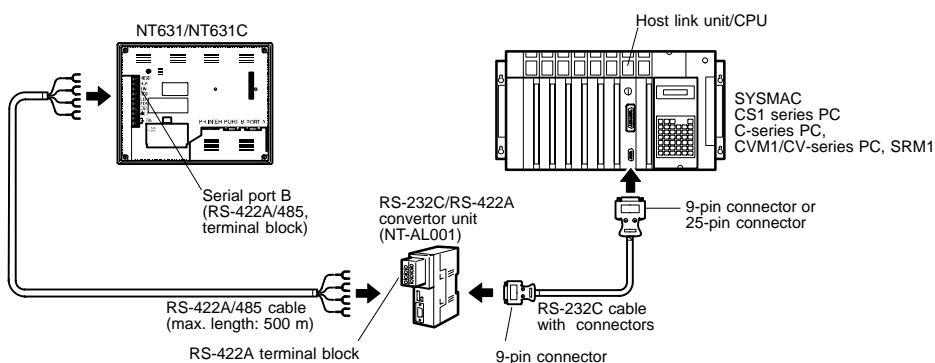

Reference When using RS-485 as a port for the NT631/NT631C, only NT link (1:N) method can be used.

Connecting an NT631/NT631C and NT-AL001 (RS-422A)

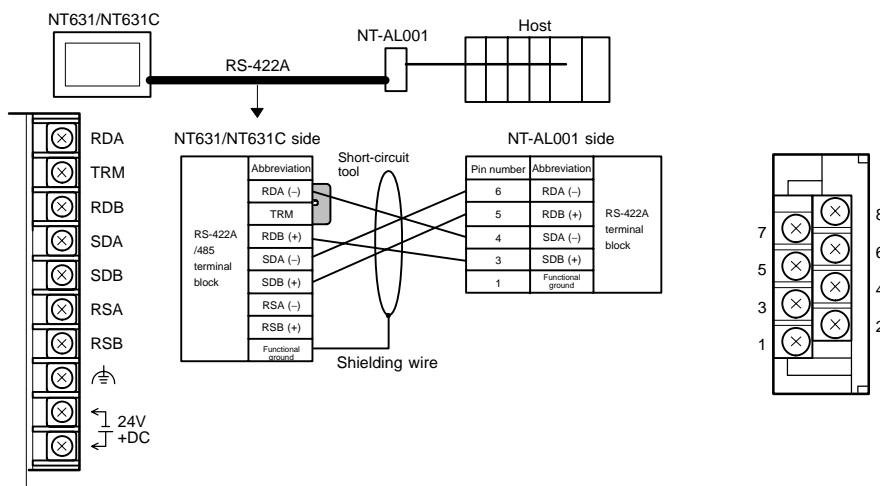

In order to avoid an FG ground loop, do not make the connection between the functional ground of the NT-AL001 and the shielding.

Connecting an NT631/NT631C and NT-AL001 (RS-485)

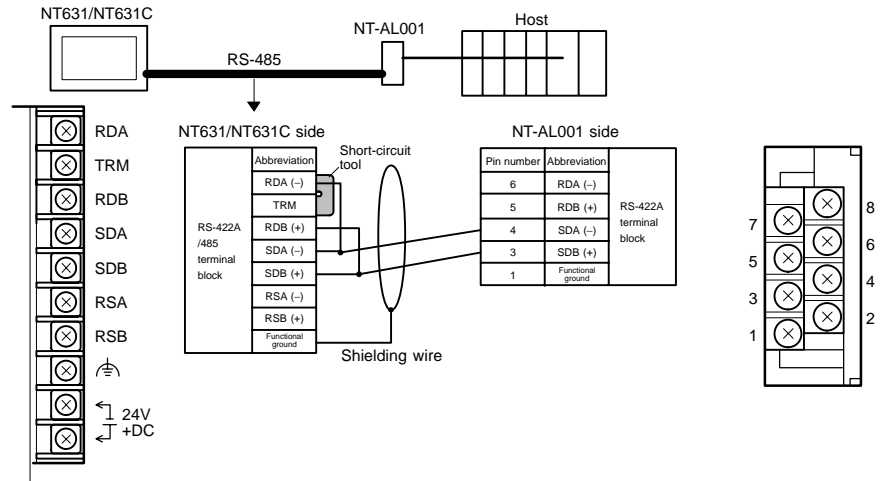

Reference When using RS-485 as a port for the NT631/NT631C, only NT link (1:N) method can be used.

Connecting an NT-AL001 and Host

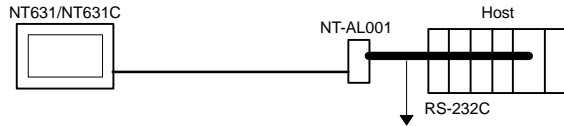

- Wiring when connecting a host link unit (25-pin)

Applicable units:

- C200H-LK201-V1
- 3G2A5-LK201-EV1
- C500-LK203
- 3G2A6-LK201-EV1
- CV500-LK201 (communication port 1)

Cables with connectors that can be used:

- XW2Z-200S (9-pin ⇔ 25-pin, 2 m)
- XW2Z-500S (9-pin ⇔ 25-pin, 5 m)

CVM1/CV-series host link unit (CV500-LK201) has two types of connector: a 25-pin connector (communication port 1), and a 9-pin connector (communication port 2). When using the communication port, refer to "Wiring for Connections other than Memory Link" (page 101).

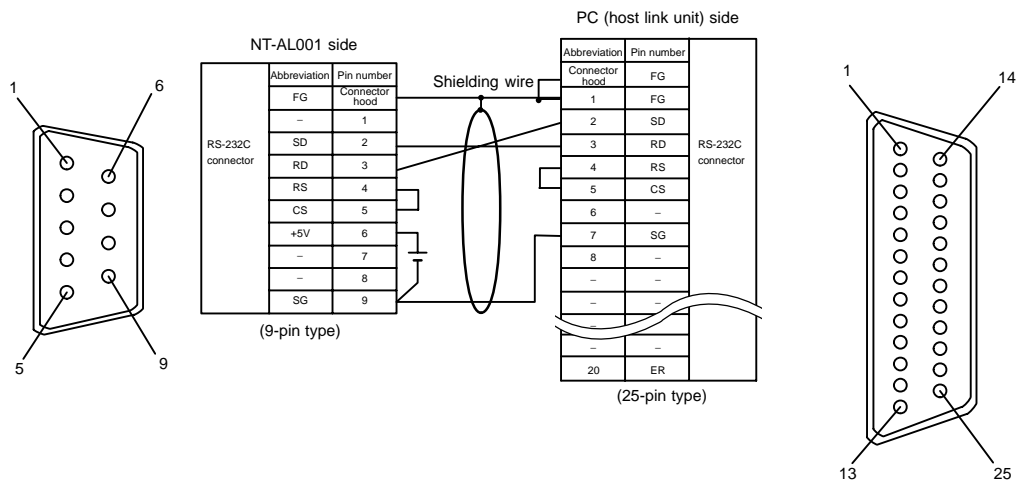

- Wiring for Connections other than Memory Link

Applicable units:

CV500-LK201 (communication port 2)	
CPM1-10CDR-□	CPM1-20CDR-□
CPM1-30CDR-□	
CPM1A-10CD□-□	CPM1A-20CD□-□
CPM1A-30CD□-□	CPM1A-40CD□-□
CQM1-CPU21-E	
CQM1-CPU41-EV1	CQM1-CPU42-EV1
CQM1-CPU43-EV1	CQM1-CPU44-EV1
CQM1-CPU45-EV1	
CS1G-CPU42-E	CS1G-CPU43-E
CS1G-CPU44-E	CS1G-CPU45-E
CS1H-CPU63-E	CS1H-CPU64-E
CS1H-CPU65-E	CS1H-CPU66-E
	CS1H-CPU67-E
C200HS-CPU21-E	C200HS-CPU23-E
C200HS-CPU31-E	C200HS-CPU33-E
C200HE-CPU32-E	C200HE-CPU42-E
C200HG-CPU33-E	C200HG-CPU43-E
C200HG-CPU53-E	C200HG-CPU63-E
C200HX-CPU34-E	C200HX-CPU44-E
C200HX-CPU54-E	C200HX-CPU64-E
C200HE-CPU32-ZE	C200HE-CPU42-ZE
C200HG-CPU33-ZE	C200HG-CPU43-ZE
C200HG-CPU53-ZE	C200HG-CPU63-ZE
C200HX-CPU34-ZE	C200HX-CPU44-ZE
C200HX-CPU54-ZE	C200HX-CPU64-ZE
C200HX-CPU65-ZE	C200HX-CPU85-ZE
CV500-CPU01-EV1	CV1000-CPU01-EV1
CV2000-CPU01-EV1	
CVM1-CPU01-EV2	CVM1-CPU11-EV2
CVM1-CPU21-EV2	
SRM1-C02-V1	

CVM1/CV-series CPUs whose model names do not have the suffix “-EV□” cannot be connected by any connection method.

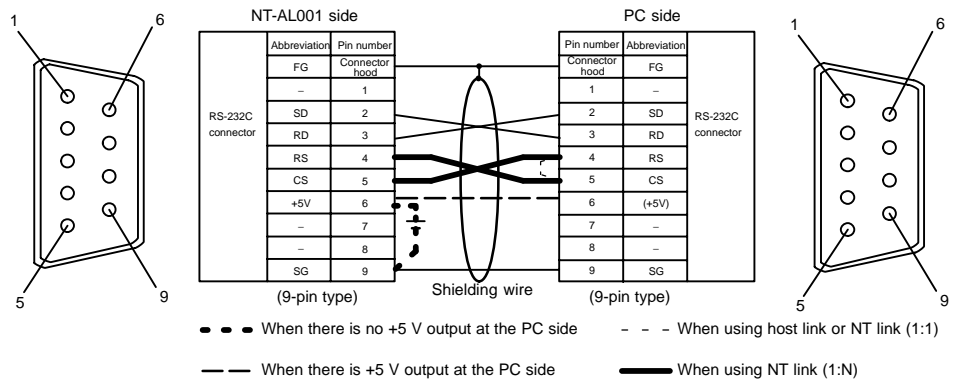

- When using the host link or NT link (1:1) method, short the RS and CS terminals at the PC side with each other (leave the RS and CS terminals at the NT-AL001 side open).
- When using the NT link (1:N), cross-connect the RS and CS terminals at the NT-AL001 and PC sides.

If there is +5 V output at the PC side, no external power supply is required for the NT-AL001.

• Wiring for a Memory Link connection

Prepare the adapter cable while referring to the diagram shown below.

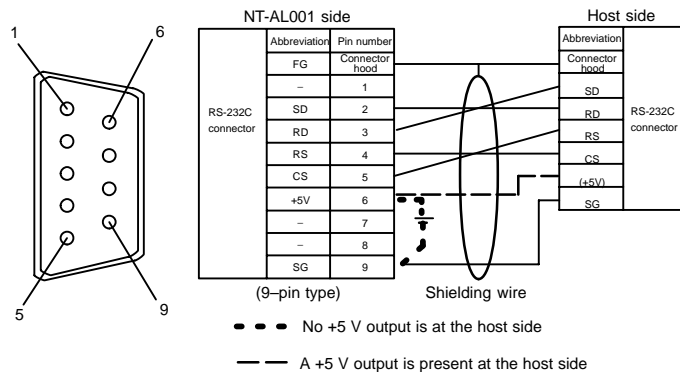

Since it is necessary to input a voltage of +5 V to the number 6 pin of NT-AL001, supplying a voltage of 5 V from the host or an external voltage supply for NT-AL001 is required.

5-1-3 1:N Connection between RS-422A/485 at the NT631/NT631C and RS-232C at the Host

The connection method in which the RS-422A/485 ports of multiple NT631/NT631Cs are connected to the RS-232C port of one host in a 1:N connection is described here.

An RS-232C/RS-422A converter unit (NT-AL001) is used to convert between the RS-232C and RS-422A/485 communication methods.

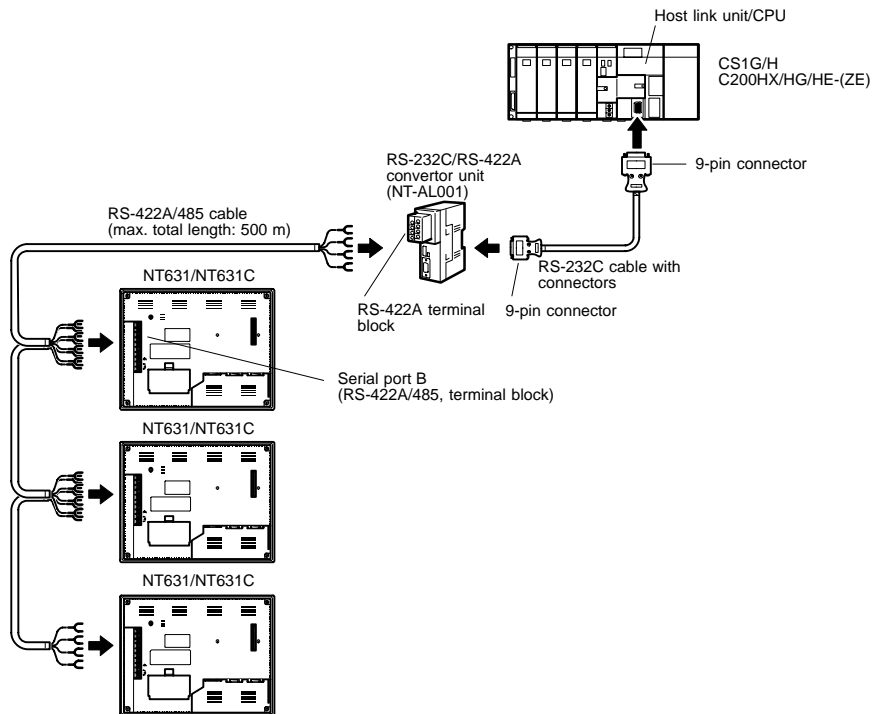

Connecting an NT631/NT631C and NT-AL001 (RS-422A)

The relay terminal board is not included in the figure below. Insert a relay terminal board so as to achieve the wiring configuration indicated below.

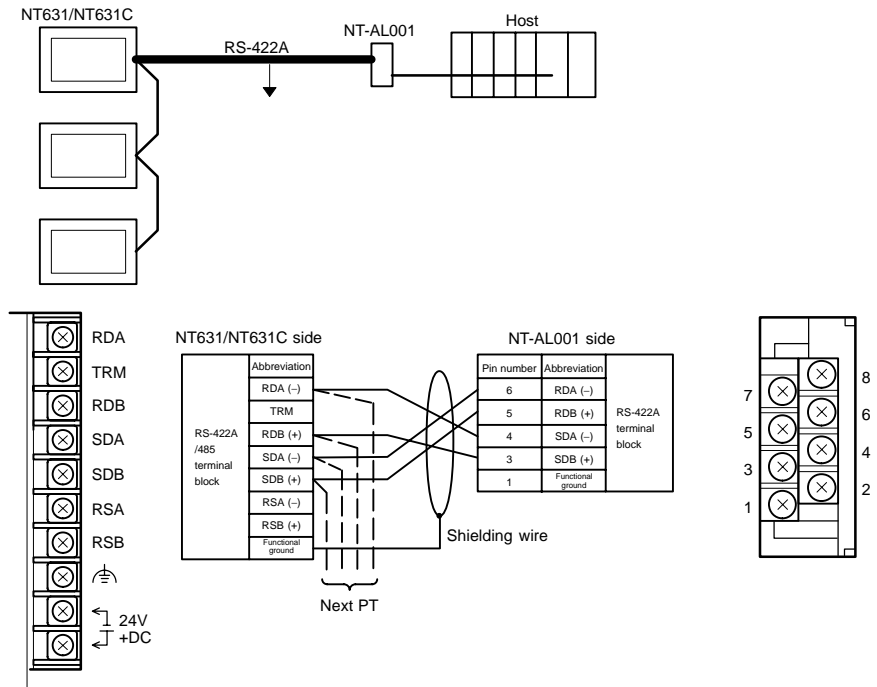

In order to avoid an FG ground loop, do not make the connections between the functional ground of the NT-AL001 and the shielding.

Connecting an NT631/NT631C and NT-AL001 (RS-485)

The relay terminal board is not included in the figure below. Insert a relay terminal board so as to achieve the wiring configuration indicated below.

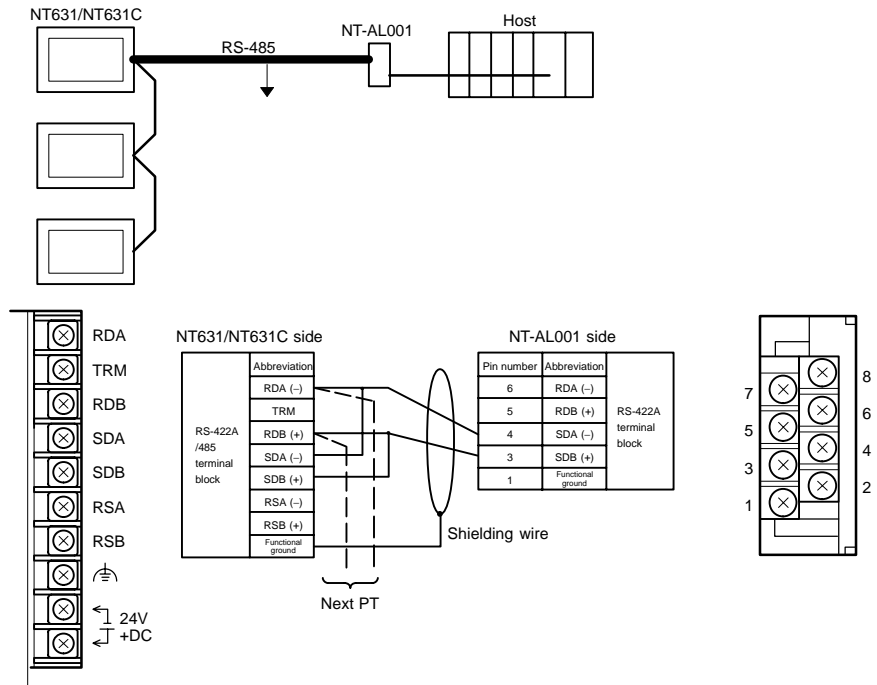

In order to avoid an FG ground loop, do not make the connections between the functional ground of the NT-AL001 and the shielding.

Connection between NT631/NT631C Units (RS-422A)

The relay terminal board is not included in the figure below. Insert a relay terminal board so as to achieve the wiring configuration indicated below.

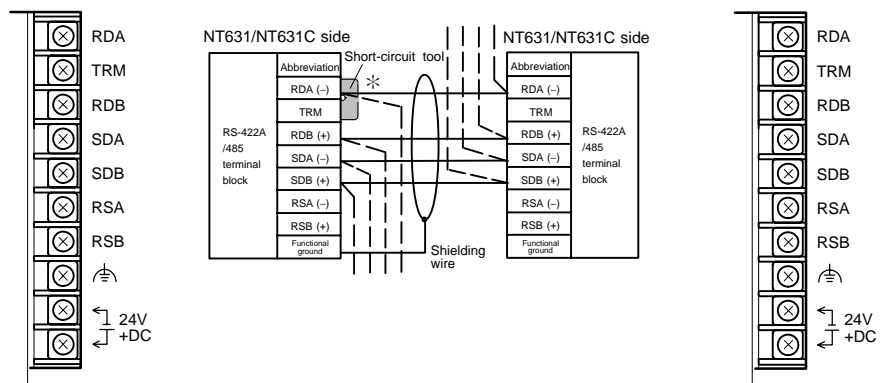
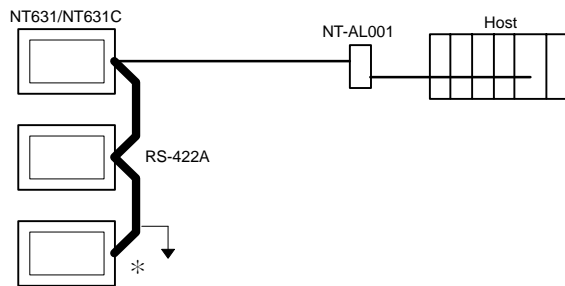

* Short TRM and RDA terminals of the NT631/NT631C at the end of the RS-422A cable (* marked in the above figure) using the short-circuit tool supplied with the NT631/NT631C.

In order to avoid an FG ground loop, make the connection between the connector hood and the shielding at one side only.

Connection between NT631/NT631C Units (RS-485)

The relay terminal board is not included in the figure below. Insert a relay terminal board so as to achieve the wiring configuration indicated below.

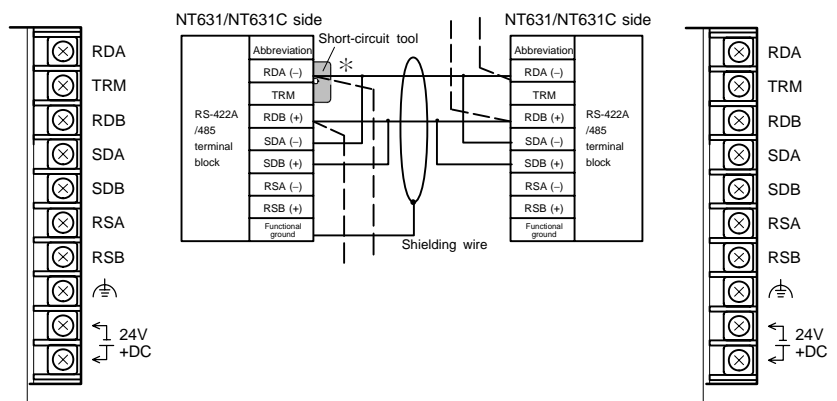
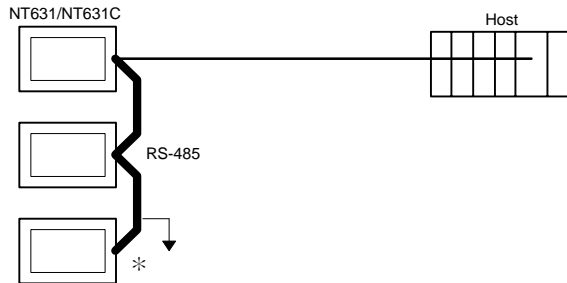

* Short TRM and RDA terminals of the NT631/NT631C at the end of the RS-485 cable (* marked in the above figure) using the short-circuit tool supplied with the NT631/NT631C.

In order to avoid an FG ground loop, make the connection between the connector hood and the shielding at the one side only.

Connecting an NT-AL001 and Host

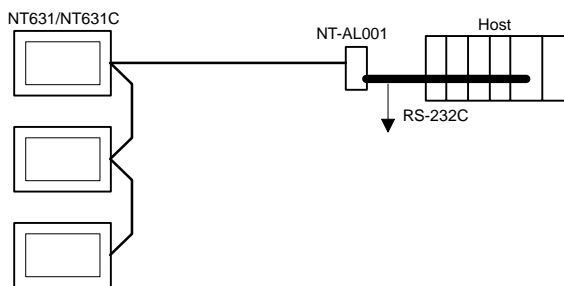

- Wiring when connecting a CS1 series CS1G/H serial communication board, C series C200HX/HG/HE (-Z) communication board.

Applicable units:

CS1G-CPU42-E	CS1G-CPU43-E
CS1G-CPU44-E	CS1G-CPU45-E
CS1H-CPU63-E	CS1H-CPU64-E
CS1H-CPU65-E	CS1H-CPU66-E
	CS1H-CPU67-E
C200HE-CPU32-(Z)E	C200HE-CPU42-(Z)E
C200HG-CPU33-(Z)E	C200HG-CPU43-(Z)E
C200HG-CPU53-(Z)E	C200HG-CPU63-(Z)E
C200HX-CPU34-(Z)E	C200HX-CPU44-(Z)E
C200HX-CPU54-(Z)E	C200HX-CPU64-(Z)E
C200HX-CPU65-ZE	C200HX-CPU85-ZE

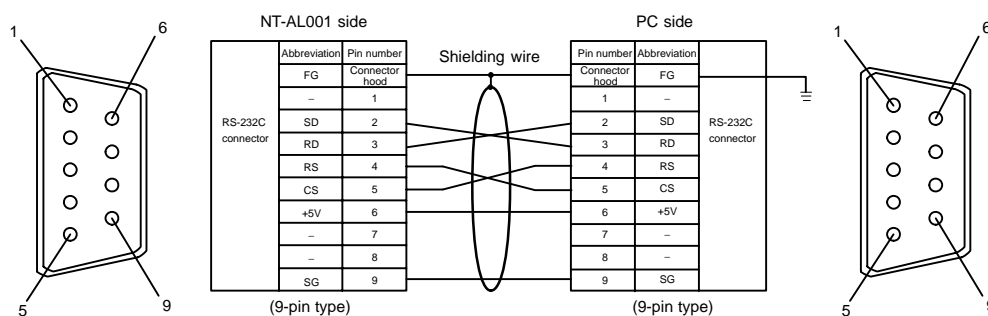

Since the C200HX/HG/HE(-ZE) has a +5 V output, no external power supply is required CS1G/H and for the NT-AL001.

5-1-4 Recommended Connectors, Cables, and Crimp Terminals

- Connectors and cables recommended for RS-232C

When making an RS-232C connecting cable, as far as possible use the recommended parts indicated in the table below. Some units come supplied with one connector and connector hood.

Check the required parts and prepare them in advance.

Name	Model	Remarks	Delivered with
Connector	XM2A-0901	9-pin type Made by OMRON	CS1-series CS1G/H C-series CQM1, C200HS, C200HX/HG/HE(-ZE) CVM1/CV-series CPUs CV500-LK201
	XM2A-2501	25-pin type Made by OMRON	C500-LK203 3G2A5-LK201-EV1 C200H-LK201-V1
	DB-25P	25-pin type Made by JAE	3G2A5-LK201-EV1 3G2A6-LK201-EV1
Connector hood	XM2S-0911	9-pin type Made by OMRON	C-series CQM1, C200HS, C200HX/HG/HE(-ZE) CVM1/CV-series CPUs CV500-LK201
	XM2S-0913	Made by OMRON 9-pin	
	XM2S-0911-E	Made by OMRON 9-pin	CS1 series CS1G/CS1H
	XM2S-2511	25-pin type Made by OMRON	C500-LK203 3G2A5-LK201-EV1 C200H-LK201-V1
	DB-C2-J9	25-pin type Made by JAE	3G2A5-LK201-EV1 3G2A6-LK201-EV1
Cable	AWG28 × 5P IFVV-SB	Multi-core shielded cable Made by Fujikura, Ltd.	
	CO-MA-VV-SB 5P × 28AWG	Multi-core shielded cable Made by Hitachi, Ltd.	

- Cables with connectors made by OMRON

When connecting an NT-AL001 and a PC, use the OMRON cables with connectors indicated in the table below.

Model	Cable Length	Connector Specification
XW2Z-200S	2 m	9-pin ⇔ 25-pin Host link, NT link (1:1)
XW2Z-500S	5 m	
XW2Z-200T	2 m	9-pin ⇔ 9-pin Host link, NT link (1:1)
XW2Z-500T	5 m	

Notice

- The maximum tensile load of the recommended cable is 30 N. Do not exceed this load.
- After connecting a connecting cable, always tighten the connector screws.

- Recommended connectors, cables and crimp terminals for RS-422A/485

When making an RS-422A/485 connecting cable, as far as possible use the recommended parts indicated in the table below. Some units come supplied with one connector and connector hood.

Check the required parts and prepare them in advance.

Name	Model	Maker	Remarks
Connector	XM2A-2501	25-pin type Made by OMRON	Delivered with the following units: C500-LK203
	DB-25P F-N	25-pin type Made by JAE	Delivered with the following units: 3G2A6-LK201-EV1 3G2A5-LK201-EV1
Connector hood	XM2S-2511	25-pin type Made by OMRON	Delivered with the following units: C500-LK203
	DB-C2-J9	25-pin type Made by JAE	Delivered with the following units: 3G2A6-LK201-EV1 3G2A5-LK201-EV1
Cable	TKVVBS4P-03	Tachii Electric Wire Co., Ltd.	
Crimp terminals	1.25-N3A (fork type)	Japan Solderless Terminal MFG	Recommended cable size: AWG22 to 18 (0.3 to 0.75 mm ²)
	Y1.25-3.5L (fork type)	Morex Inc.	

The terminal screws of the NT631/NT631C are M3.5 specification. When wiring, use crimp terminals for M3.5 use. Tighten terminal screws with a tightening torque of 0.8 N□m.

Notice

Always use crimp terminals for wiring.

- Examples of applicable terminals

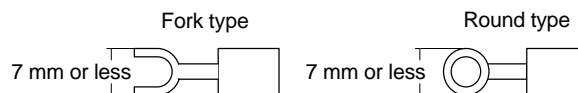

5-1-5 Setting the Terminal Resistance for RS-422A/485 Communications

The serial port B connector of the NT631/NT631C has a terminal resistance setting terminal (TRM).

In RS-422A/485 communications, a terminal resistor must be set at the device at the end of the communication cable, but not at any other device.

The NT631/NT631C has a built-in terminal resistor, and whether or not the terminal resistance is applied is set by shorting or opening the terminal resistance setting terminals (TRM). The terminal resistance is 120 Ω.

When carrying out RS-422A/485 communications using serial port B, short between TRM and RDA terminals at the NT631/NT631C at the end of the RS-422A/485 cable. Leave these terminals open at NT631/NT631C units other than the one at the end of the cable.

When not using RS-422A/485 communications, the terminal resistance setting is ineffective.

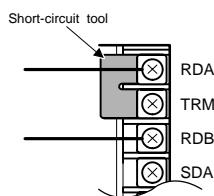

TRM-RDA terminals	Function
Shorted	Terminal resistance is applied. Short only at the NT631/NT631C connected to the end of an RS-422A/485 cable.
Open	Terminal resistance is not applied. Leave the terminals open when connecting an NT631/NT631C anywhere other than at the end of the RS-422A/485 cable.

Notice Before connecting or disconnecting cables between devices, make sure that the power supply to all of the connected devices (NT631/NT631C, PC, etc.) is OFF.

Reference - The internal circuit of the NT631/NT631C is shown below.

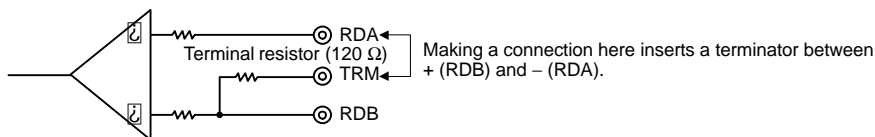

- For details on setting the terminal resistance of NT-AL001, refer to "Settings at the RS-232C/RS-422A Convertor Unit (NT-AL001)" (page 97).

5-2 Connecting to the Host's RS-422A/485 Port

The methods for connecting the RS-422A/485 port of the NT631/NT631C and the RS-422A/485 port of the host are described here. There are the following methods.

The following discussion is focused on the connection method to OMRON PCs (By using the memory link method, a connection can be made to any arbitrary RS-422 unit). When making a connection to a host other than OMRON PCs, refer to the "PC Connection" (V042-E1-□).

- Method in which the RS-422A ports of the NT631/NT631C and host are connected directly by an RS-422A cable (page 132).

When this method is used, the cable length can be extended up to 500 m.

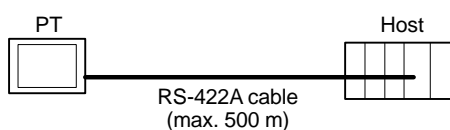

- Method in which the RS-485 ports of the NT631/NT631C and host are connected by an RS-485 cable (page 137).

When this method is used, the cable length can be extended up to 500 m.

This connection method can be used only with the NT link (1:N) method of type RS-485.

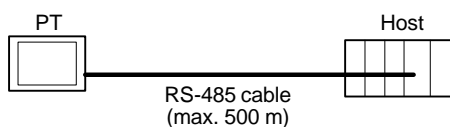

- Method in which the RS-422A ports of multiple NT631/NT631Cs and the RS-422A port of the host are connected in a 1:N connection (page 138).

This connection method is used with the RS-422A type NT link (1:N) method.

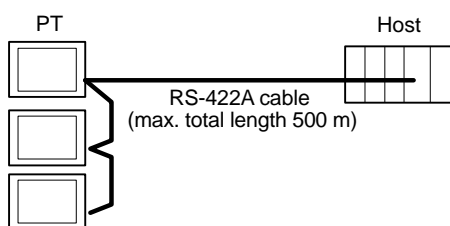

- Method in which the RS-485 ports of multiple NT631/NT631Cs and the RS-485 port of the host are connected in a 1:N connection (page 141).

This connection method is used with the with the RS-485 type NT link (1:N) method.

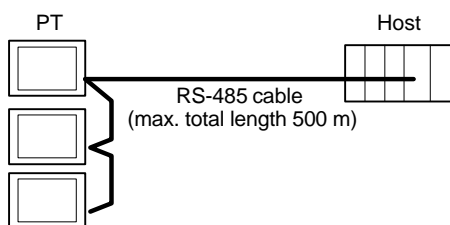

Notice One end of the wire must always be connected to the host (PC), and there must be no branching. Branching will cause problems such as transmission delays and communication failures.

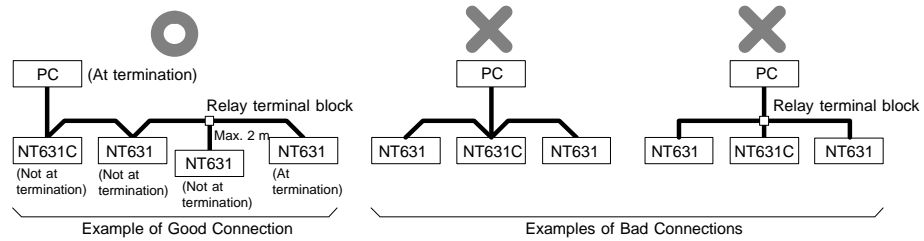

Reference CS1 series CPUs cannot be connected with the 1:1 connection NT link method. Use the 1:N connection NT link method instead to make the 1:1 connection. For details, refer to “Using the NT link (1:N) Method” (page 126)

5-2-1 Host Types and Settings

The types of host that have an RS-422A port and can be connected to the RS-422A/485 port of the NT631/NT631C, and the settings to be made at the host, are described here.

When Using the Host Link Method

- **Compatible host units**
 Some models and series of OMRON PCs have the RS-422A/485 type host link function built in. In a CS1 series, the host link method can be used by installing a serial communication board. In addition, some C200HX/HG/HE (-Z) devices have an integral CPU that can be connected in the host link method by installing a communication board.
 Check the model and series of the PC, the type of the installed serial communication board, the serial communication unit, and host link unit at the connection end before making a connection.
 The host units featuring the RS-422A/485 type host link function and can be connected to the RS-422A/485 port of the NT631/NT631C are indicated in the table below.

PC Series	Units with Built-in Host Link Function		CPUs Connectable with Host Link Units or Expansion Communication Board	Connectable to
	Host Link Unit / Communication Board	CPU		
CS1 series	CS1W-SCB41-E		CS1G-CPU42/43/44/45-E CS1H-CPU63/64/65/66/67-E	CS1G CS1H
C series	3G2A6-LK202-EV1		C200H-CPU01/03/11/21/23/31-E C1000H-CPU01-EV1 C2000H-CPU01-EV1	C200H C1000H C2000H
	C200H-LK202-V1		C200H-CPU01/03/11/21/23/31 C200HS-CPU01/03/21/23/31/33-E C200HS-CPU01/21-EC C200HE-CPU11/32/42-E C200HE-CPU11/32/42-ZE C200HG-CPU33/43/53/63-E C200HG-CPU33/43/53/63-ZE C200HX-CPU34/44/54/64-E C200HX-CPU34/44/54/64/65/85-ZE	C200H C200HS C200HE C200HE-ZE C200HG C200HG-ZE C200HX C200HX-ZE
	C200HW-COM03/06-EV1		C200HE-CPU32/42-E C200HE-CPU32/42-ZE	C200HE C200HE-ZE
			C200HG-CPU33/43/53/63-E C200HG-CPU33/43/53/63-ZE	C200HG C200HG-ZE
			C200HX-CPU34/44/54/64-E C200HX-CPU34/44/54/64/65/85-ZE	C200HX C200HX-ZE
	3G2A5-LK201-EV1		C1000H-CPU01-EV1 C2000H-CPU01-EV1	C1000H C2000H
	C500-LK203		C1000H-CPU01-EV1 C2000H-CPU01-EV1	C1000H C2000H
		CPM1-10/20/30CDR-□ +CPM1-CIF11 CPM1A-10/20/30/40CD□-□ +CPM1-CIF11	CPM1	
CV series (*1)	CV500-LK201	CV500-CPU01-EV1	CV500-CPU01-EV1	CV500
		CV1000-CPU01-EV1	CV1000-CPU01-EV1	CV1000
		CV2000-CPU01-EV1	CV2000-CPU01-EV1	CV2000
CVM1 series (*1)	CV500-LK201	CVM1-CPU01-EV2 CVM1-CPU11-EV2 CVM1-CPU21-EV2	CVM1-CPU01-EV2 CVM1-CPU11-EV2 CVM1-CPU21-EV2	CVM1
SRM1		SRM1-C02-V1+CPM1-CIF11		SRM1

*1 CPUs of CVM1/CV-series PCs without the suffix "-EV□" cannot be connected.

The host link method cannot be used when an NT631/NT631C is connected using RS-485. To use the host link method, connect by RS-422A.

- Settings at the host

When using the RS-422A type host link method, the settings shown below must be made at the host (depending on the unit, some of these settings may not be necessary, or settings not shown here may be necessary).

Item	Setting at Host
I/O port	RS-422A
Communications speed	Set the same speed as for the NT631/NT631C. (*1)
Transfer code	ASCII, 7 data bits, 2 stop bits
Parity	Even
1-to-1/1-to-N	1-to-N(*2)
Instruction level	Level 1, 2, 3
Unit #	00

*1 Set the host link communications speed at 9600 bps or 19200 bps with the "Comm. Speed" memory switch at the NT631/NT631C. For details, refer to "Setting the Host Link Method" (page 173).

*2 The 1-to-N setting enables BCC (Block Check Character). It is not actually possible to connect more than one NT631/NT631C in a single host link.

The setting methods for each type of unit are described in the following.

- Connecting to a C series host link unit

C200H/C200HS/C200HE(-ZE)/C200HG(-ZE)/C200HX(-ZE) backplate mounting type: C200H-LK201-V1

[Setting the front switches]

Set each switch with a flat blade screwdriver so that the values or symbols in the setting value window agree with the following:

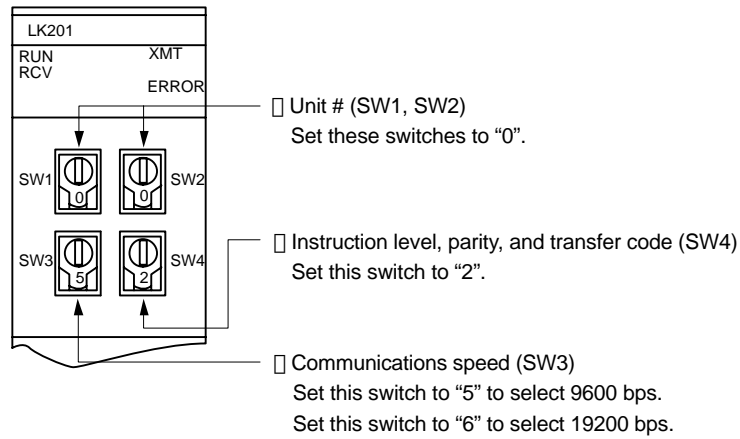

[Setting the rear switches]

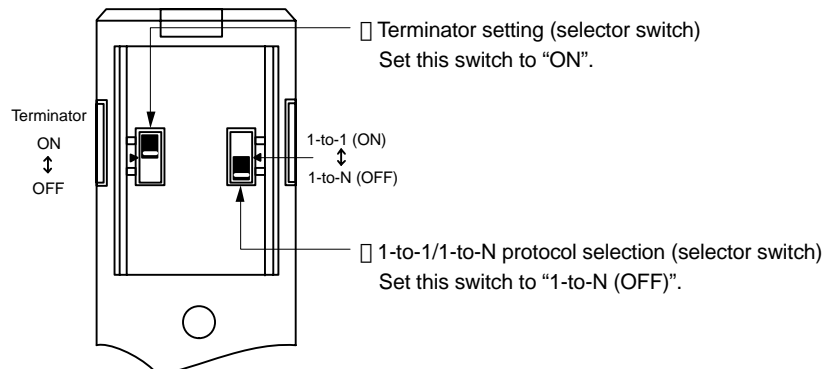

C1000H/C2000H rack-mounting type: 3G2A5-LK201-EV1

[Setting the front switches]

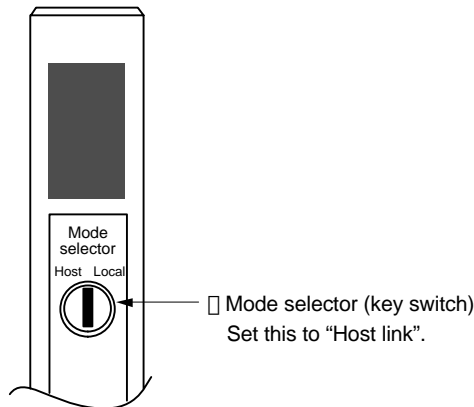

[Setting the rear switches]

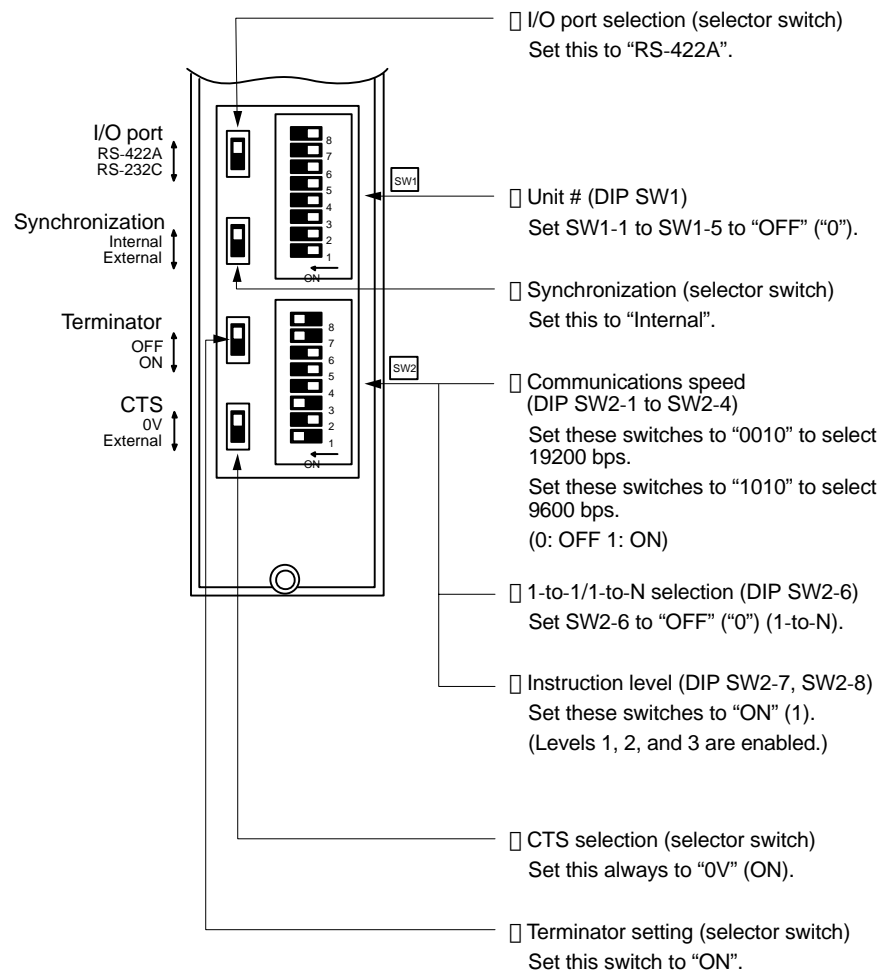

C1000H/C2000H rack-mounting type: C500-LK203

[Setting the rear switches]

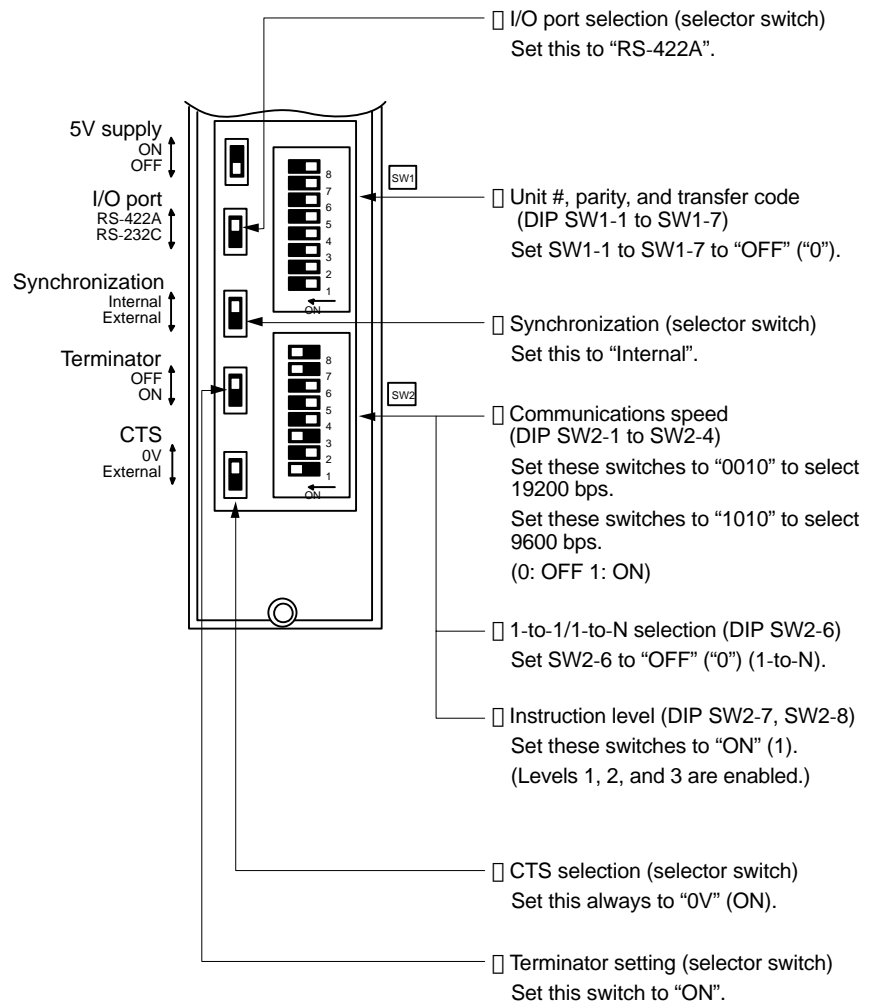

C200H/C1000H/C2000H CPU mounting type: 3G2A6-LK202-EV1

[Setting the rear switches]

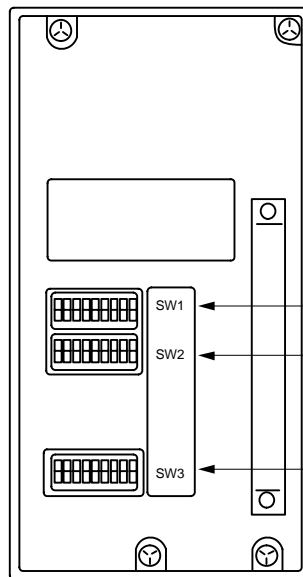

- Unit #, parity, and transfer code (DIP SW1-1 to SW1-5)
Set SW1-1 to SW1-5 to "OFF" (0).
* Parity is fixed at Even Parity. Transfer code is fixed at ASCII 7 data bits and 2 stop bits.
- Communications speed (DIP SW2-1 to SW2-4)
Set these switches to "0010" to select 19200 bps.
Set these switches to "1010" to select 9600 bps.
(0: OFF 1: ON)
- 1-to-1/1-to-N selection (DIP SW2-6)
Set SW2-6 to "OFF" ("0") (1-to-N).
- Instruction level (DIP SW2-7, SW2-8)
Set these switches to "ON" (1).
(Levels 1, 2, and 3 are enabled.)
- Terminator setting (DIP SW3-1 to SW3-6)
Set SW3-1, SW3-3, and SW3-5 to "ON" (1).
Set SW3-2, SW3-4, and SW3-6 to "OFF" (0).
(Set terminator "ON".)

- Connecting to a CVM1/CV series host link unit

CVM1/CV series rack-mounting type: CV500-LK201

A CVM1/CV series host link unit (CV500-LK201) has two connectors (communication ports 1 and 2). To use the RS-422A type host link method, set communication port 2 to "RS-422A".

Communication port 2 is a 9-pin connector which allows selection of the RS-232C or RS-422A method. When this port is used with the RS-422A method, the I/O port selector switch on the front of the unit must be set to "RS-422A" (the lower position).

[CPU bus unit settings]

When connecting to a CVM1/CV series host link unit, set the following communication conditions for the CPU bus unit settings.

Item	Setting at Host
Communications speed	Set the same speed as for the NT631/NT631C. (*1)
Transfer code	ASCII, 7 data bits, 2 stop bits
Parity	Even
1-to-1/1-to-N	1-to-N(*2)
Instruction level	Level 1, 2, 3

*1 Set the host link communications speed at 9600 bps or 19200 bps with the "Comm. Speed" memory switch at the NT631/NT631C. For details, refer to "Setting the Host Link Method" (page 173).

*2 The 1-to-N setting enables BCC (Block Check Character). It is not actually possible to connect more than one NT631/NT631C in a single host link.

Set the CPU bus unit settings directly from a peripheral tool (e.g. SYSMAC support software).

For details on the CPU bus unit settings, refer to the SYSMAC CVM1/CV series Host Link Unit User's Manual (W205).

[Setting the front switches]

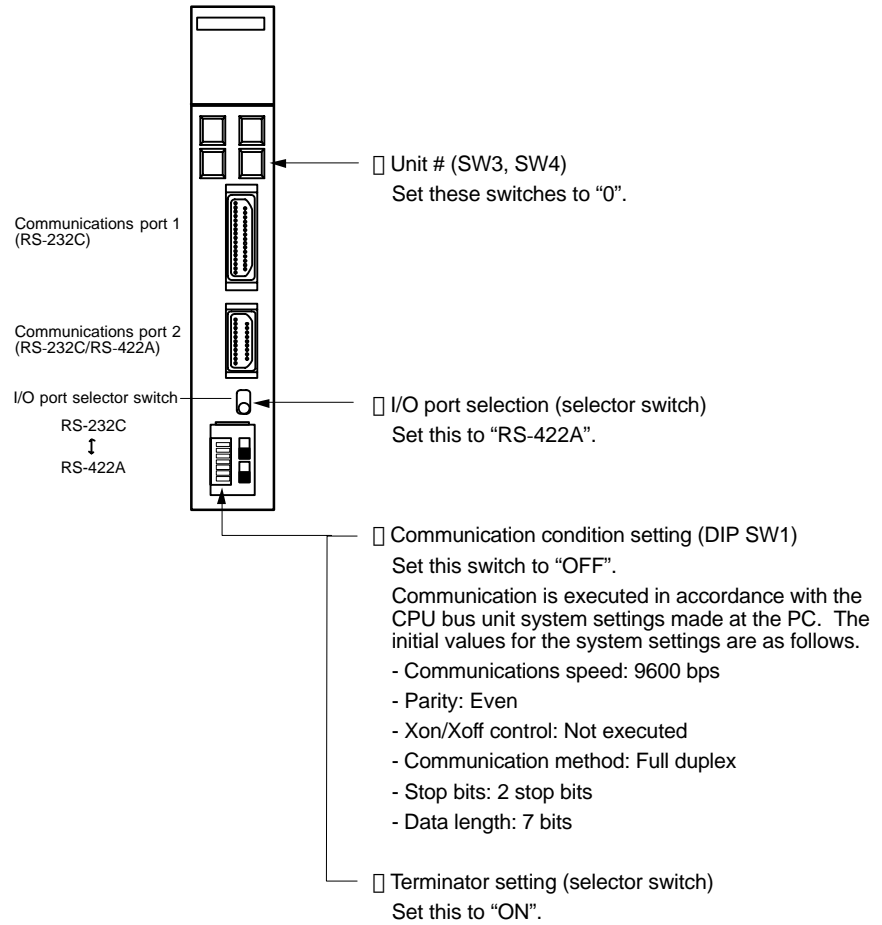

- Connecting to a CPU

CVM1/CV-series (-EV□) CPUs

□ CV500-CPU01-EV1/CV1000-CPU01-EV1/CV2000-CPU01-EV1

□ CVM1-CPU01-EV2/CVM1-CPU11-EV2/CVM1-CPU21-EV2

[PC system settings]

When connecting to a CVM1/CV series CPU, set the following communication conditions for the "PC system settings".

Item	Setting at Host
Communications speed	Set the same speed as for the NT631/NT631C. (*1)
Stop bit	2 stop bits
Parity	Even
Data length	ASCII 7 bits
Unit #	00

*1 Set the host link communications speed at 9600 bps or 19200 bps with the "Comm. Speed" memory switch at the NT631/NT631C. For details, refer to "Setting the Host Link Method" (page 173).

Either set PC system settings directly from a peripheral tool (e.g. SYSMAC support software), or transmit the PC system settings made at a peripheral tool to the CPU.

For details on the PC system settings, refer to the SYSMAC CVM1/CV500/1000/2000 User's Manual (Ladder) (W202).

[Setting the front switches]

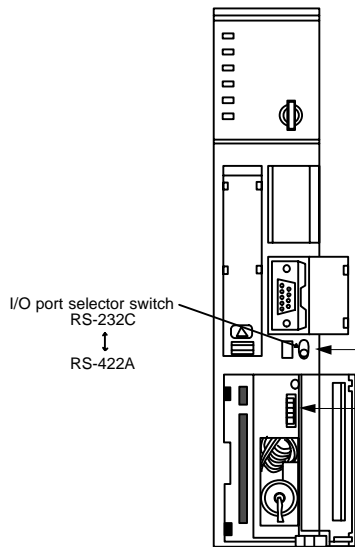

- Host link communication method selection (selector switch)
Set this to "RS-422A".
- Communication type setting (DIP SW3)
Set SW3 to "OFF".
(for "host link" communication)
- Host link default value settings (DIP SW4)
To effect the existing DIP switch settings, set SW4 to "ON".
To effect the values set in the PC system settings, set SW4 to "OFF".
- Note
For CPUs manufactured before or during June 1995 (lot No. □□65), the existing DIP switch settings differ from the PC system setting default values as follows.
 - Existing DIP switch settings:
2400 bps, 1 stop bit, even parity, 7 bit data length
 - PC system setting default values:
9600 bps, 2 stop bits, even parity, 7 bit data length
 For CPUs manufactured from July 1995 onward (lot No. □□75), the stipulated values in the DIP switch settings also are 9600 bps and 2 stop bits.
- Terminator setting (DIP SW6)
Set this switch to "ON".
(Set terminator "ON".)

C-series C200HX/HG/HE(-ZE), CPM1 CPUs, SRM1

Connect to the RS-422A/485 port (port A) of the communication board. Note that the connection to a CPM1 or/and SRM1 must be made via an RS-422A adapter (CPM1-CIF11).

Reference There are no communication boards for which port B is the RS-422A port.

[PC system setting area settings]

When connecting to a C200HX/HG/HE(-ZE) or CPM1 CPUs or SRM1, set the following communication conditions for the PC system setting area.

Item	Setting at Host
I/O port	RS-422A
Communication mode	Host link mode
Communications speed	Set the same speed as for the NT631/NT631C. (*1)
Stop bit	2 stop bits
Parity	Even
Data length	ASCII 7 bits
Unit #	00

*1 Set the host link communications speed at 9600 bps or 19200 bps with the "Comm. Speed" at the NT631/NT631C. For details, refer to "Setting the Host Link Method" (page 173).

Set the PC system setting area settings directly from a peripheral tool (e.g. SYS-MAC support software).

For details on operations relating to the PC system setting area, refer to the manual for the PC which is used.

The PC system setting area word numbers and settings to be made depending on the unit to which the connection is made are shown below.

When using port A of the communication board of C200HX/HG/HE(-ZE)

Word #	Writing Value	Settings
DM6555	0001	Host link mode, no CTS control Communication conditions set by the contents of DM
DM6556	0303	Data length 7 bits, 2 stop bits, even parity, communications speed: 9600 bps
	0304	Data length 7 bits, 2 stop bits, even parity, communications speed: 19200 bps
DM6558	0000	Unit # 00

When using a CPM1, SRM1

Word #	Writing Value	Settings
DM6650	0001	Host link mode, no CTS control Communication conditions set by the contents of DM
DM6651	0303	Data length 7 bits, 2 stop bits, even parity, communications speed: 9600 bps
	0304	Data length 7 bits, 2 stop bits, even parity, communications speed: 19200 bps
DM6653	0000	Unit # 00

[Setting the DIP switches on the front of a C200HX/HG/HE(-ZE)]

When using a C200HX/HG/HE(-ZE) , the DIP switches on the front panel must be set as shown below in order to make the settings in the PC system setting area (data memory) effective.

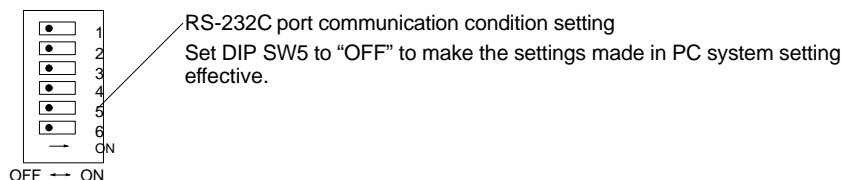

[Setting switches on a C200HX/HG/HE(-ZE) communication board]

Set the switches on a C200HX/HG/HE(-ZE) communication board as follows.

Switch 1: Set to [4] (4-wire type, for RS-422A)

Switch 2 : Set to "ON" for terminator ON (termination resistance applied)

[Setting the switches on a CPM1 RS-422A adapter]

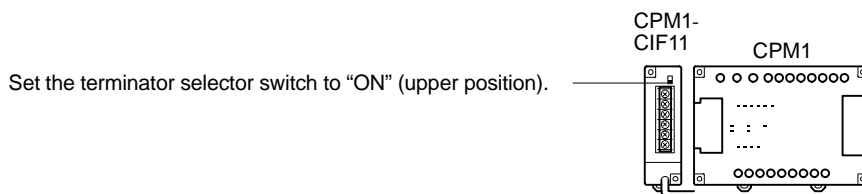

- Connecting to a CS1 series serial communication board

INNER board with RS-422A/485 port equipped for CS1 series CPU Type :

CS1W-SCB41-E (The port 2 is RS-422A/485 port.)

[Allocation DM area settings for CPU]

Settings are written from the peripheral tool (a programming console or CX-Programmer) directly into the allocation DM area (system setting area) of the CPU. After the settings are written, they become effective by turning the power ON, restarting the unit, restarting the communication port, or executing the STUP command.

In the following, the channel numbers of the allocation DM area and the settings are shown.

Allocation DM area (CH)	Writing Value	Settings
Port 2		
DM32010	8000	Host link mode, 2 stop bits, data length 7 bits, even parity,
DM32011	0000	Communication speed 9600 bps.
	0007	Communication speed 19200 bps.
DM32012	0000	Transmit delay time 0 ms.
DM32013	0000	No CTS control Unit No.0 for host link

When Using the NT Link (1:1) Method

- Compatible host units

Some models and series of OMRON PCs have the RS-422A type NT link (1:1) function built in. There are also some C200HX/HG/HE(-ZE) CPUs that can be connected by the RS-422A type NT link (1:1) method by installing a communication board.

Check the model and series of the PC against the type of CPU before making the connections.

The host units that can be connected to the RS-422A port of the NT631/NT631C by the RS-422A type NT link (1:1) method are indicated in the table below.

PC Series	CPUs with Built-in RS-422A type NT Link (1:1) Function	Model Name	
C series	C200HE-CPU32-(Z)E ^(*1) C200HE-CPU42-(Z)E ^(*1)	C200HE (-ZE)	
	C200HG-CPU33-(Z)E ^(*1) C200HG-CPU43-(Z)E ^(*1) C200HG-CPU53-(Z)E ^(*1) C200HG-CPU63-(Z)E ^(*1)	C200HG (-ZE)	
	C200HX-CPU34-(Z)E ^(*1) C200HX-CPU44-(Z)E ^(*1) C200HX-CPU54-(Z)E ^(*1) C200HX-CPU64-(Z)E ^(*1) C200HX-CPU65-ZE ^(*1) C200HX-CPU85-ZE ^(*1)	C200HX (-ZE)	
	CV500-CPU01-EV1	CV500	
	CV1000-CPU01-EV1	CV1000	
	CV2000-CPU01-EV1	CV2000	
	CVM1 series ^(*2)	CVM1-CPU01-EV2	CVM1
		CVM1-CPU11-EV2	
		CVM1-CPU21-EV2	

*1 One of the following communication boards is required:
C200HW-COM03-EV1 or C200HW-COM06-EV1.

*2 CPUs of CVM1/CV series PCs without the suffix "-EV□" cannot be connected.

The NT link (1:1) method cannot be used using RS-485. To use the NT link (1:1) method, connect by RS-422A.

NT link connection using RS-422A is not possible with CPM1.

- Settings at the host

The setting methods for each type of unit are described in the following.

- Connecting to a CVM1/CV-series (-EV□) CPUs

- CV500-CPU01-EV1/CV1000-CPU01-EV1/CV2000-CPU01-EV1

- CVM1-CPU01-EV2/CVM1-CPU11-EV2/CVM1-CPU21-EV2

[PC system settings]

When connecting to the CVM1/CV series CPU by the NT link (1:1) method, no particular settings are required at the PC system settings.

[Setting the front switches]

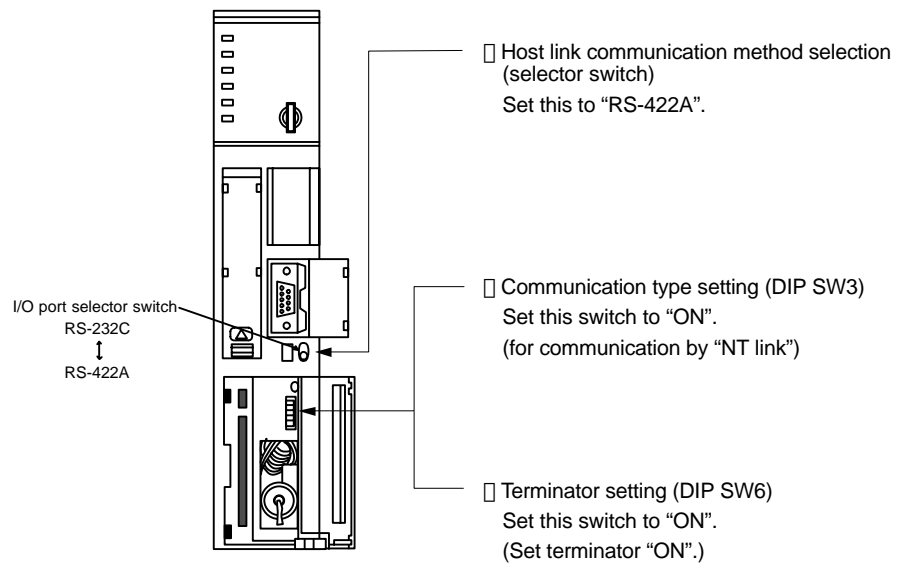

- Connecting to a C-series C200HX/HG/HE(-ZE)

[PC system setting area settings]

Write the PC system setting area (data memory) settings directly from a peripheral tool (e.g. SYSMAC support software) in accordance with the host model.

Host Model	Word #	Writing Value	Setting
Port A of C200HX/HG/HE(-ZE)*1	DM6555	4000	Use NT link (1:1)

*1 RS-422A port of the communication board

For details on operations relating to the PC system setting area, refer to the manual for the PC you are using.

[Setting the DIP switches on a C200HX/HG/HE(-ZE) communication board]

Set the switches on a C200HX/HG/HE(-ZE) communication board as follows.

Switch 1: Set to [4] (4-wire type, for RS-422A)

Switch 2 : Set to "ON" for terminator ON (termination resistance applied)

When Using the NT Link (1:N) Method

- Compatible host units

The OMRON PCs that can be connected using the RS-422A/485 type NT link (1:N) method are C-series C200HX/HG/HE-ZE models only. A communication board must be installed to make the connection.

Check the model and series of the PC against the type of CPU or communications board before making the connections.

The host units that can be connected to the RS-232C port of the NT631/NT631C by the RS-422A type NT link (1:N) function via a convertor are indicated in the table below.

PC Series	CPUs with Built-in RS-422A type NT Link (1:1) Function	CPU that becomes connectable by installing a communication board	Model Name
CS1 series		CS1G-CPU42/43/44/45-E ^(*1) CS1H-CPU63/64/65/66/67-E ^(*1)	CS1G CS1H
C series		C200HE-CPU32 (-Z) ^(*2) C200HE-CPU42 (-Z) ^(*2)	C200HE (-Z)
	C200HE-CPU32-(Z)E ^(*1) C200HE-CPU42-(Z)E ^(*1)	C200HE-CPU32-(Z)E ^(*1) C200HE-CPU42-(Z)E ^(*1)	C200HE (-ZE)
	C200HG-CPU33-(Z)E ^(*1) C200HG-CPU43-(Z)E ^(*1) C200HG-CPU53-(Z)E ^(*1) C200HG-CPU63-(Z)E ^(*1)	C200HG-CPU33-(Z)E ^(*1) C200HG-CPU43-(Z)E ^(*1) C200HG-CPU53-(Z)E ^(*1) C200HG-CPU63-(Z)E ^(*1)	C200HG (-ZE)
	C200HX-CPU34-(Z)E ^(*1) C200HX-CPU44-(Z)E ^(*1) C200HX-CPU54-(Z)E ^(*1) C200HX-CPU64-(Z)E ^(*1) C200HX-CPU65-ZE ^(*1) C200HX-CPU85-ZE ^(*1)	C200HX-CPU34-(Z)E ^(*1) C200HX-CPU44-(Z)E ^(*1) C200HX-CPU54-(Z)E ^(*1) C200HX-CPU64-(Z)E ^(*1) C200HX-CPU65-ZE ^(*1) C200HX-CPU85-ZE ^(*1)	C200HX (-ZE)

*1 The serial CS1W-SCB41-E communication board is required.

*2 A C200HW-COM03-V1 or C200-COM06-V1 communication board is required.

- Settings at the host

- C-series C200HX/HG/HE(-ZE)

[PC system setting area settings]

Write the communication conditions directly into the PC system setting area (data memory) using a peripheral tool (e.g. SYSMAC support software).

For details on setting the PC system setting area settings, refer to the SYSMAC C200HX/HG/HE(-ZE) Operation Manual (W303/W322).

Make the setting indicated in the word shown below.

Connection to	Word #	Writing Value	Setting
Communication board Port A	DM6555	5□00	Use NT link (1:N) □ = highest unit number of the connected PTs (1 to 7)*

* When using C200HE(-ZE), the range for PT unit numbers is 1 to 3.

Reference There are no communication boards for which port B is the RS-422A/485 port.

[Setting the DIP switches on a C200HX/HG/HE(-ZE) communication board]
Set the switches on a C200HX/HG/HE(-ZE) communication board as follows.

Switch 1: Set to [4] (4-wire type, for RS-422A), or
Set to [2] (2-wire type, for RS-485)

Switch 2 : Set to "ON" for terminator ON (termination resistance applied)

- Connecting to CS1 series serial communication board

INNER board with RS-422A/485 port equipped for CS1 series CPU type :

CS1W-SCB41-E (The port 2 is RS-422A/485 port.)

[Setting the front switches]

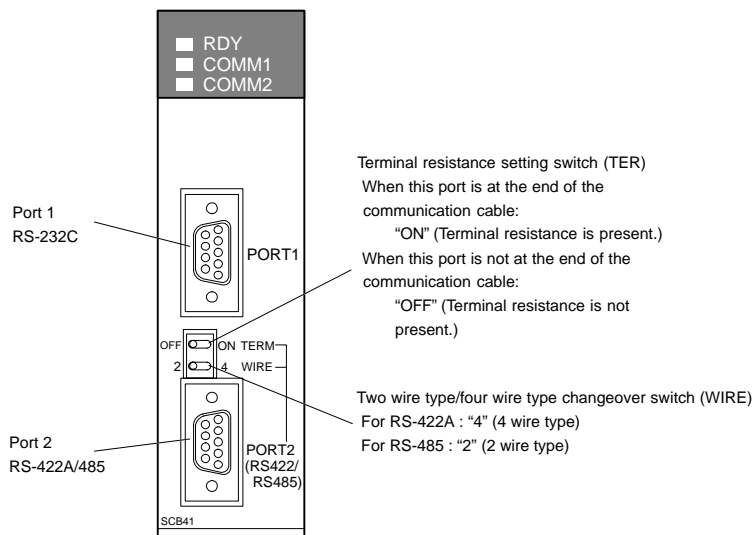

[Allocation DM area settings for CPU]

Settings are written from the peripheral tool (a programming console or CX-Programmer) directly into the allocation DM area (system setting area) of the CPU. After settings are written, they become effective by turning the power ON, restarting the unit, restarting the communication port, or executing the STUP command.

In the following, the channel numbers of the allocation DM area and settings are shown.

Allocation DM area (CH)	Writing Value	Settings
Port 2		
DM32010	8200	NT link (1:N) mode
DM32016	000□	□ = The largest model number of the connected PT (0 – 7)

When connecting the PT with its model number from 3 to 6 to port 2 in the NT link (1:N), for example, set a value of 8200 Hex for D32010CH, and 0006 Hex for D32016CH.

When using the Memory Link Method

With the memory link method, the connection can be made to a personal computer and an FA computer with RS-422A.

When connecting to the host with the memory link method, it is necessary to create a program for the memory link at the host side.

The following are the communication conditions that can be used with the memory link method. For the host (a personal computer, an FA computer, etc.), its setting should be compatible to one of the communication conditions listed in the following table. Set the same communication conditions at the NT631/NT631C by the memory switch. (page 179).

Item	Setting at Host
Input/Output board	RS-422A
Communication speed	1200, 2400, 4800, 9600, 19200, 38400 bps.
Data bits length	7 bits, 8 bits
Stop bits length	1 bit, 2 bits
Parity	None, even, odd
Flow control	None, XON/XOFF

5-2-2 Direct Connection between RS-422A Ports at Both Units

The connection method in which the RS-422A ports of an NT631/NT631C and a host are connected is described here.

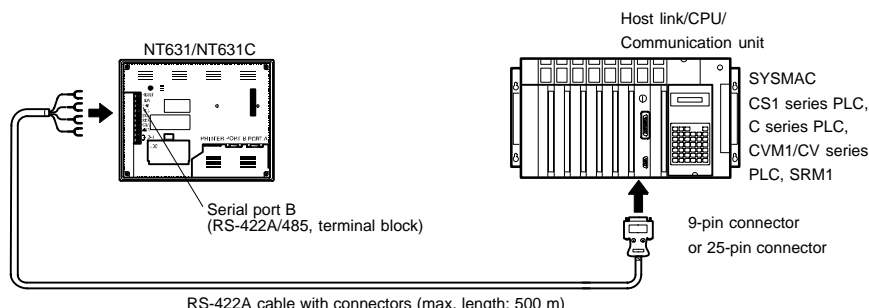

Connecting an NT631/NT631C and Host (RS-422A)

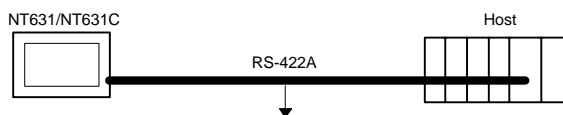

- Wiring when connecting a C-series host link unit or CPM1 (host link)

Applicable units:

- C200H-LK202-V1
- 3G2A5-LK201-EV1
- C500-LK203
- 3G2A6-LK202-EV1

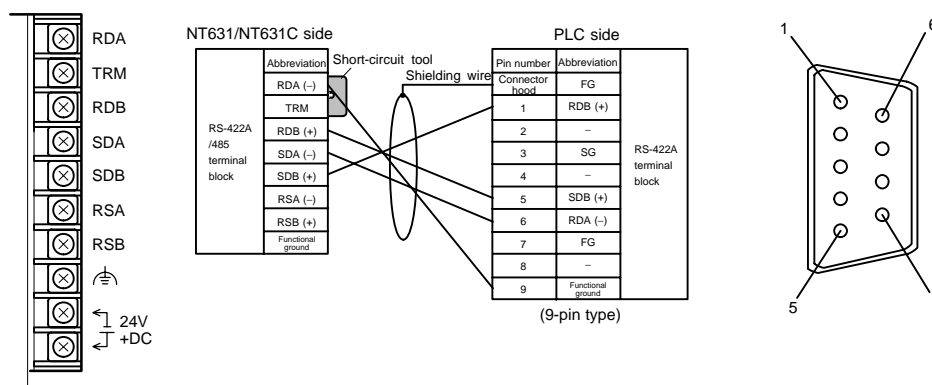

In order to avoid an FG ground loop, do not connect the functional ground of the NT631/NT631C to the shielding of the RS-422A cable.

- Wiring when connecting CPM1, SRM1

Applicable units:

- | | |
|---------------|---------------|
| CPM1-10CDR-□ | CPM1-20CDR-□ |
| CPM1-30CDR-□ | |
| CPM1A-10CD□-□ | CPM1A-20CD□-□ |
| CPM1A-30CD□-□ | CPM1A-40CD□-□ |
| SRM1-C02-V1 | |

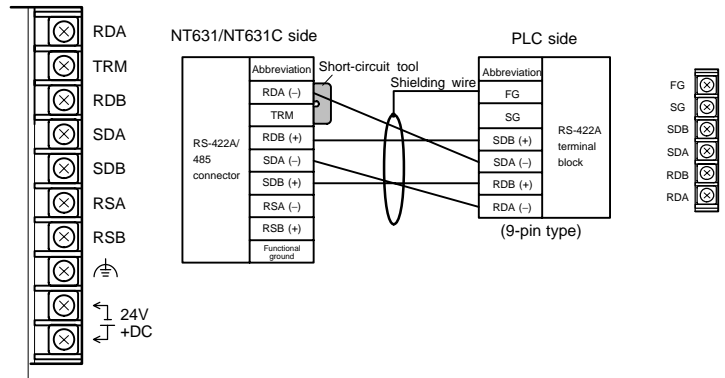

In order to avoid an FG ground loop, do not connect the functional ground of the NT631/NT631C to the shielding of the RS-422A cable.

- Wiring when connecting a CS1-series CS1G/H serial communication board, C series C200HX/HG/HE (-ZE) communication board, or CVM1/CV-series host link unit

Applicable units:

- | | |
|------------------------------------|-------------------|
| CS1G-CPU42-E | CS1G-CPU43-E |
| CS1G-CPU44-E | CS1G-CPU45-E |
| CS1H-CPU63-E | CS1H-CPU64-E |
| CS1H-CPU65-E | CS1H-CPU66-E |
| | CS1H-CPU67-E |
| C200HE-CPU32-(Z)E | C200HE-CPU42-(Z)E |
| C200HG-CPU33-(Z)E | C200HG-CPU43-(Z)E |
| C200HG-CPU53-(Z)E | C200HG-CPU63-(Z)E |
| C200HX-CPU34-(Z)E | C200HX-CPU44-(Z)E |
| C200HX-CPU54-(Z)E | C200HX-CPU64-(Z)E |
| C200HX-CPU65-ZE | C200HX-CPU85-ZE |
| CV500-LK201 (communication port 2) | |

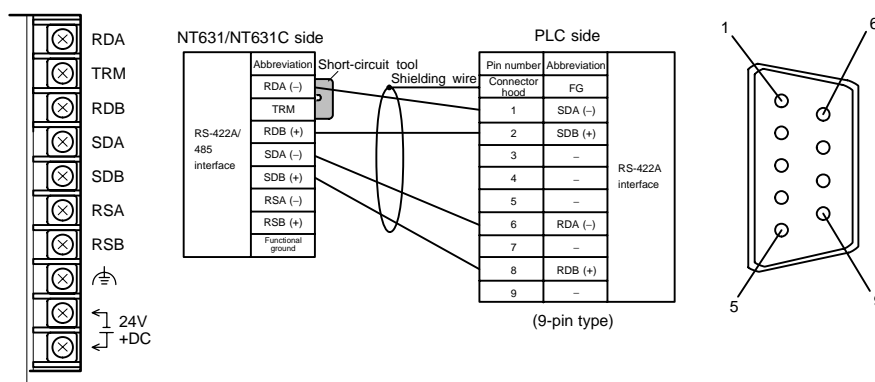

In order to avoid an FG ground loop, do not connect the functional ground of the NT631/NT631C to the shielding of the RS-422A cable.

- Wiring when connecting a CVM1/CV-series CPU

Applicable units:

CV500-CPU01-EV1	CV1000-CPU01-EV1
CV2000-CPU01-EV1	
CVM1-CPU01-EV□	CVM1-CPU11-EV□
CVM1-CPU21-EV□	

CVM1/CV-series CPUs whose model names do not have the suffix “-EV□” cannot be connected by any connection method.

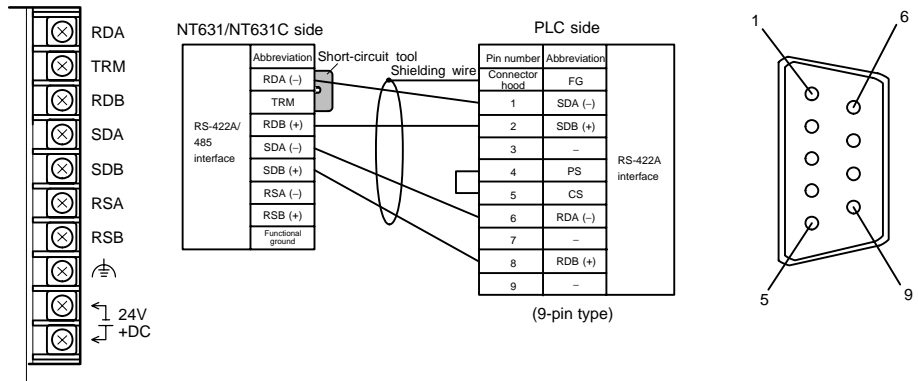

In order to avoid an FG ground loop, do not connect the functional ground of the NT631/NT631C to the shielding of the RS-422A cable.

- Wiring for a Memory Link connection

Prepare the adapter cable while referring to the following diagram.

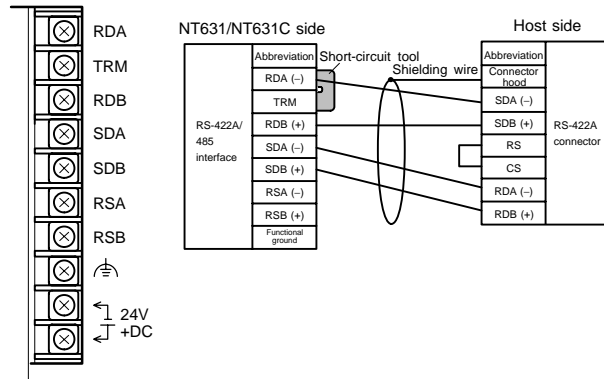

In order to avoid an FG ground loop, do not connect the functional ground of the NT631/NT631C to the shielding of the RS-422A cable.

5-2-3 Direct Connection between RS-485 Ports at Both Units

The connection method in which the RS-485 ports of an NT631/NT631C and a host are connected is described here.

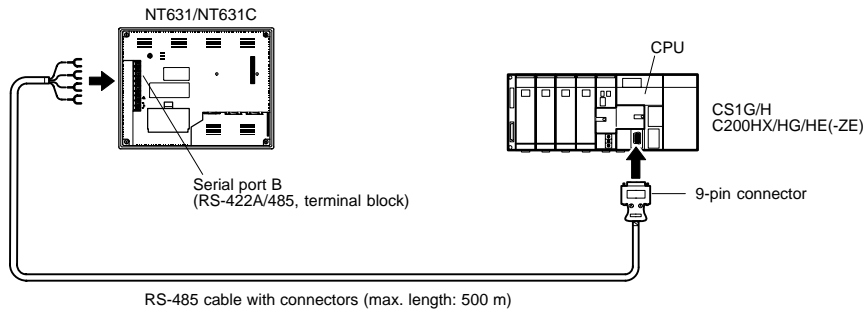

Reference When RS-485 is used at the PT side, only the NT link (1:N) method can be used.

Connecting an NT631/NT631C and Host

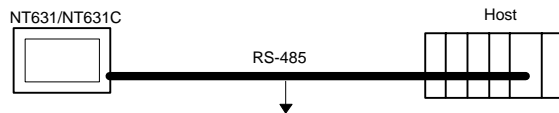

- Wiring when connecting a CS1-series CS1G/H serial communication board and C series C200HX/HG/HE (-ZE) communication board

Applicable units:

CS1G-CPU42-E	CS1G-CPU43-E
CS1G-CPU44-E	CS1G-CPU45-E
CS1H-CPU63-E	CS1H-CPU64-E
CS1H-CPU65-E	CS1H-CPU66-E
	CS1H-CPU67-E
C200HE-CPU32-(Z)E	C200HE-CPU42-(Z)E
C200HG-CPU33-(Z)E	C200HG-CPU43-(Z)E
C200HG-CPU53-(Z)E	C200HG-CPU63-(Z)E
C200HX-CPU34-(Z)E	C200HX-CPU44-(Z)E
C200HX-CPU54-(Z)E	C200HX-CPU64-(Z)E
C200HX-CPU65-ZE	C200HX-CPU85-ZE

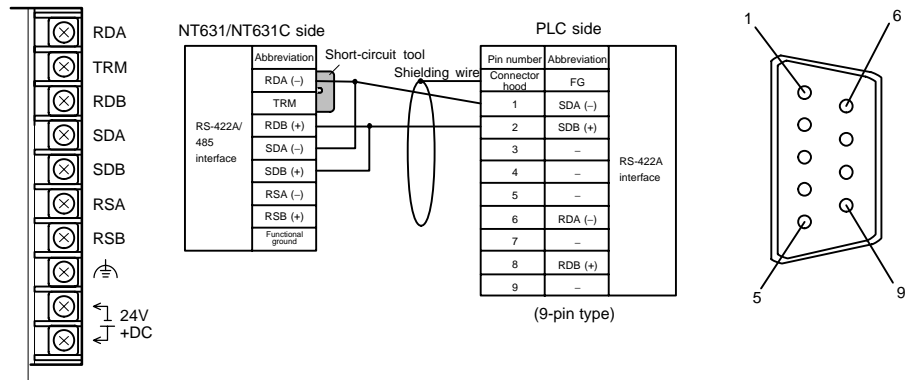

In order to avoid an FG ground loop, do not connect the functional ground of the NT631/NT631C to the shielding of the RS-422A cable.

5-2-4 1:N Connection among RS-422A Ports

The connection method in which the RS-422A ports of multiple NT631/NT631Cs and one host are connected in a 1:N connection is described here.

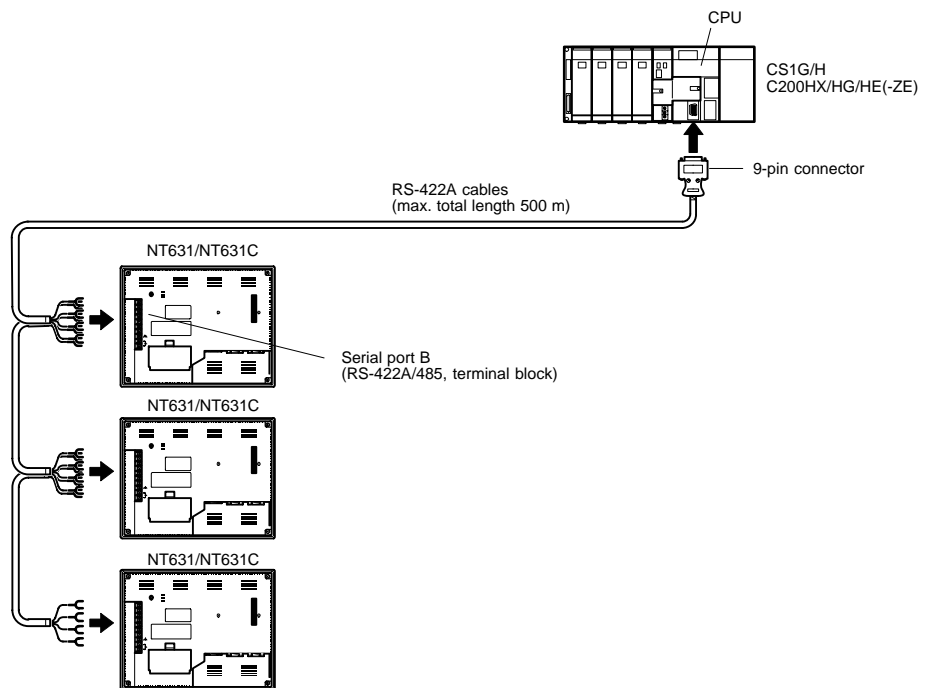

Reference Communication using the RS-422A type NT link (1:N) method is possible when a serial communication board is installed at CS1 series CS1G/H, and when a communication board is installed at the C200HX/HG/HE (-ZE).

Connecting between NT631/NT631C Units

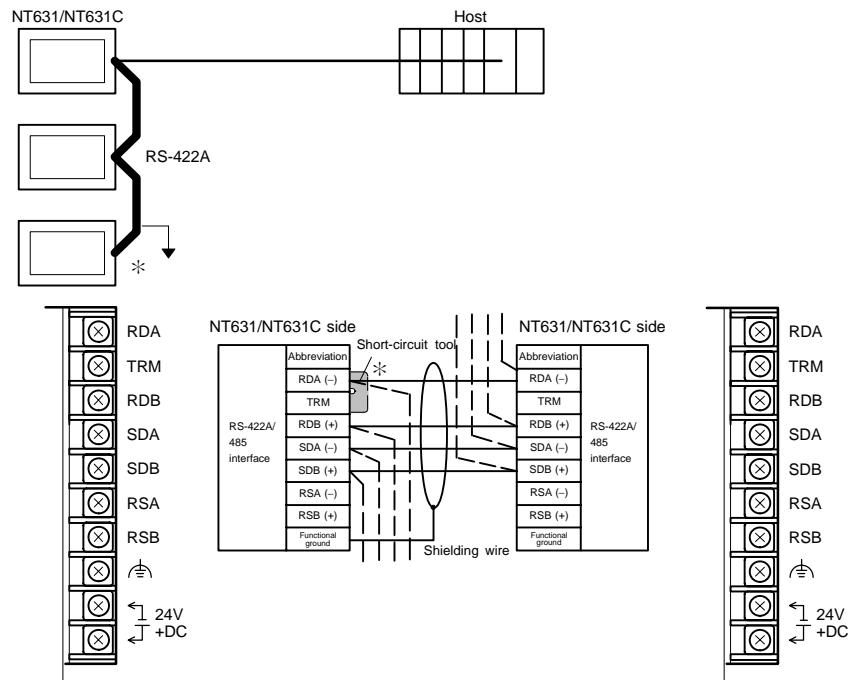

* Short TRM and RDA terminals of the NT631/NT631C at the end of the RS-422A cable (* marked in the above figure) using the short-circuit tool supplied with the NT631/NT631C.

In order to avoid an FG ground loop, connect the functional ground of only one of the NT631/NT631C units to the shielding of the RS-422A cable.

Connecting an NT631/NT631C and a Host

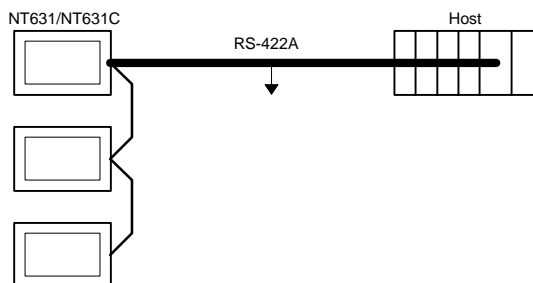

- Wiring when connecting a CS1-series CS1G/H serial communication board and C series C200HX/HG/HE (-ZE) communication board

Applicable units:

CS1G-CPU42-E	CS1G-CPU43-E
CS1G-CPU44-E	CS1G-CPU45-E
CS1H-CPU63-E	CS1H-CPU64-E
CS1H-CPU65-E	CS1H-CPU66-E
	CS1H-CPU67-E
C200HE-CPU32-(Z)E	C200HE-CPU42-(Z)E
C200HG-CPU33-(Z)E	C200HG-CPU43-(Z)E
C200HG-CPU53-(Z)E	C200HG-CPU63-(Z)E
C200HX-CPU34-(Z)E	C200HX-CPU44-(Z)E
C200HX-CPU54-(Z)E	C200HX-CPU64-(Z)E
C200HX-CPU65-ZE	C200HX-CPU85-ZE

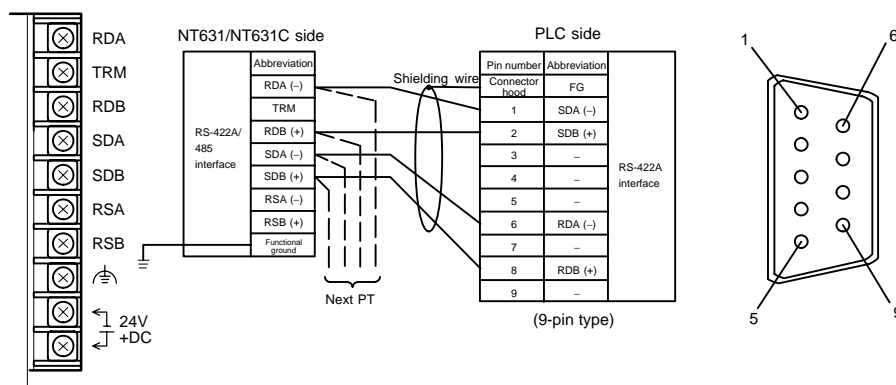

In order to avoid an FG ground loop, do not connect the functional ground of the NT631/NT631C to the shielding of the RS-422A cable.

5-2-5 1:N Connection among RS-485 Ports

The connection method in which the RS-485 ports of multiple NT631/NT631Cs and one host are connected in a 1:N connection is described here.

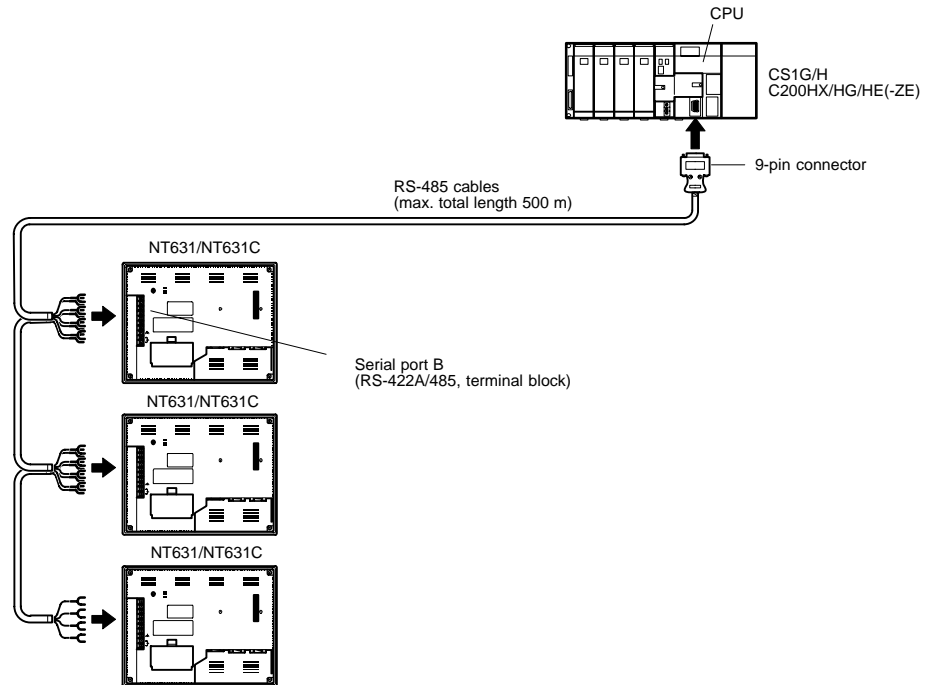

Reference Communication using the RS-422A type NT link (1:N) method is possible when a serial communication board is installed at CS1 series CS1G/H, and when a communication board is installed at the C200HX/HG/HE (-ZE).

Connecting between NT631/NT631C Units

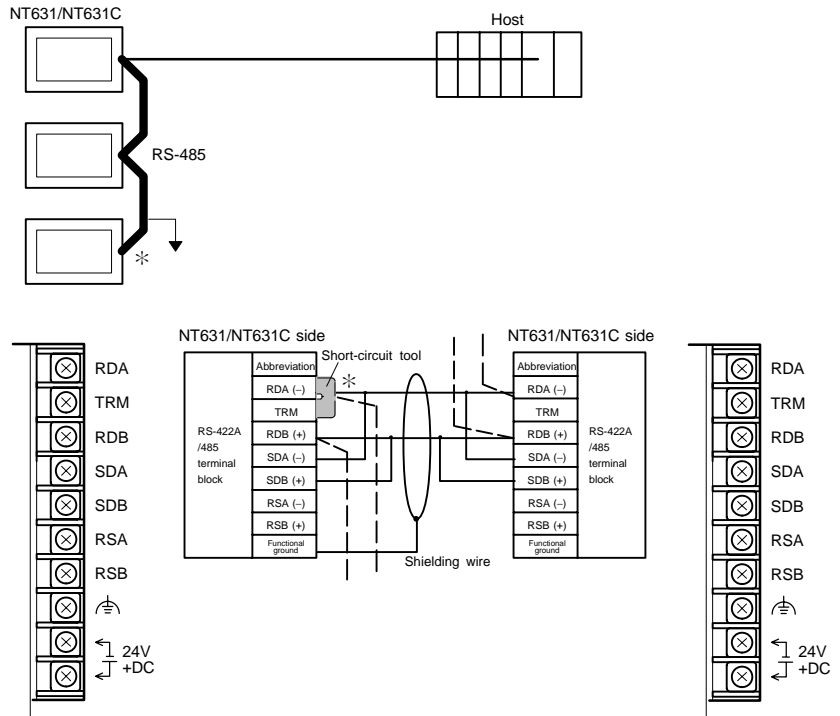

* Short TRM and RDA terminals of the NT631/NT631C at the end of the RS-485 cable (* marked in the above figure) using the short-circuit tool supplied with the NT631/NT631C.

In order to avoid an FG ground loop, do not connect the functional ground of the NT631/NT631C to the shielding of the RS-422A cable.

Connecting an NT631/NT631C and a Host

The relay terminal block is not included in this figure. Insert the relay terminal block so as to achieve the wiring configuration shown below.

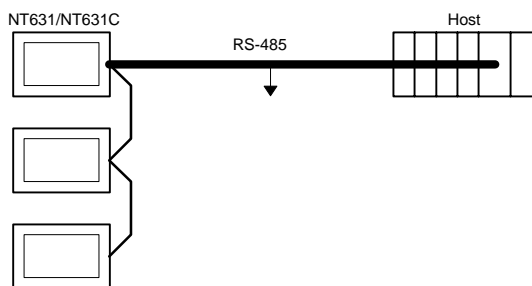

- Wiring when connecting a CS1-series CS1G/H serial communication board and C series C200HX/HG/HE (-ZE) communication board

Applicable units:

- | | |
|-------------------|-------------------|
| CS1G-CPU42-E | CS1G-CPU43-E |
| CS1G-CPU44-E | CS1G-CPU45-E |
| CS1H-CPU63-E | CS1H-CPU64-E |
| CS1H-CPU65-E | CS1H-CPU66-E |
| | CS1H-CPU67-E |
| C200HE-CPU32-(Z)E | C200HE-CPU42-(Z)E |
| C200HG-CPU33-(Z)E | C200HG-CPU43-(Z)E |
| C200HG-CPU53-(Z)E | C200HG-CPU63-(Z)E |
| C200HX-CPU34-(Z)E | C200HX-CPU44-(Z)E |
| C200HX-CPU54-(Z)E | C200HX-CPU64-(Z)E |
| C200HX-CPU65-ZE | C200HX-CPU85-ZE |

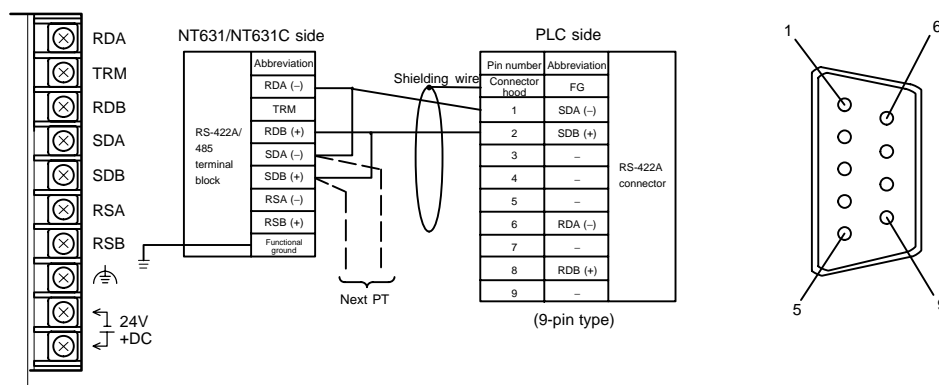

In order to avoid an FG ground loop, do not connect the functional ground of the NT631/NT631C to the shielding of the RS-485A cable.

5-2-6 Recommended Connectors, Cables and Crimp Terminals

- Connectors and cables recommended for RS-422A/485

When making an RS-422A/485 connecting cable, as far as possible use the recommended parts indicated in the table below. When using the memory link method, however, use a connector that matches with the RS-422A port at the CPU (CP) side. Some units come supplied with one connector and connector hood.

Check the required parts and prepare them in advance.

Name	Model	Maker	Remarks
Connector	XM2A-0901	9-pin type Made by OMRON	Delivered with the following units: CS1 series CS1G/H C series C200HS C200HX/HG/HE (-ZE) Delivered with the following units: CVM1/CV series CPU unit CV500-LK201
Connector hood	XM2S-0911	9-pin type Made by OMRON	Delivered with the following units: C series C200HS C200HX/HG/HE (-ZE) Delivered with the following units: CVM1/CV series CPU unit CV500-LK201
	XM2S-0911-E	9-pin type Made by OMRON	Delivered with the following units: CS1 series CS1G/H
Cable	TKVVBS4P-03	Tachii Electric Wire Co., Ltd.	
Crimp terminals	1.25-N3A (fork type) *1	Japan Solderless Terminal MFG	Recommended cable size: AWG22 to 18 (0.3 to 0.75 mm ²)
	Y1.25-3.5L (fork type) *1	Morex Inc.	

*1 Crimp terminals of common use for M3 and M3.5

The terminal screws of the NT631/NT631C are M3.5 specification. When wiring, use crimp terminals for M3.5 use. Tighten terminal screws with a tightening torque of 0.8 N□

The terminal screws of the RS-422A adaptor (CPM1-CIF11) are M3 specification. When wiring, use crimp terminals for M3 use. Tighten terminal screws with a tightening torque of 0.5 N□m.

Notice

- Make sure to tighten screws at the connectors after cable connection.
- Always use crimp terminals for wiring at terminal blocks.

- Examples of applicable terminals

For M3.5

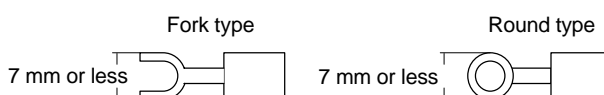

For M3

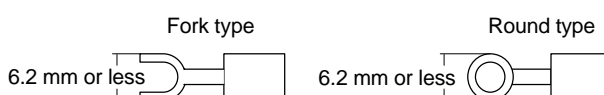

5-2-7 Setting the Terminal Resistance for RS-422A/485 Communications

The serial port B connector of the NT631/NT631C has a terminal resistance setting terminal (TRM).

In RS-422A/485 communications, a terminal resistor must be set at the device at the end of the communication cable, but not at any other device.

The NT631/NT631C has a built-in terminal resistor, and whether or not the terminal resistance is applied is set by shorting or opening the terminal resistance setting terminals (TRM). The terminal resistance is 120 Ω.

When carrying out RS-422A/485 communications using serial port B, short between terminals at the NT631/NT631C at the end of the RS-422A/485 cable. Leave these terminals open at NT631/NT631C units other than the one at the end of the cable.

When not using RS-422A/485 communications, the terminal resistance setting is ineffective.

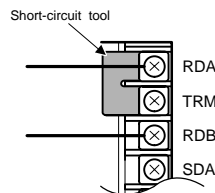

TRM-RDA terminals	Function
Shorted	Terminal resistance is applied. Short only at the NT631/NT631C connected to the end of an RS-422A/485 cable.
Open	Terminal resistance is not applied. Leave the terminals open when connecting an NT631/NT631C anywhere other than at the end of the RS-422A/485 cable.

Notice Before connecting or disconnecting cables between devices, make sure that the power supply to all of the connected devices (NT631/NT631C, PC, etc.) is OFF.

Reference - The internal circuit of the NT631/NT631C is shown below.

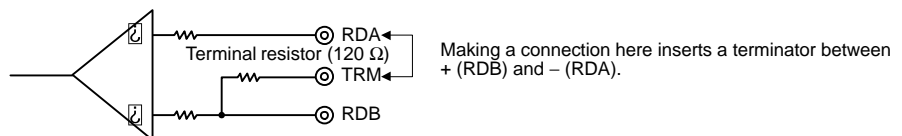

- For details on setting the terminal resistance of the host unit, refer to "Setting methods" for each type of the communication.

SECTION 6

System Menu Operation

This section describes the operation of the System Menu, focusing on the procedure to start up the NT631/NT631C.

Functions which are convenient when using the NT631/NT631C and those that are useful for system maintenance are also explained here.

6-1	System Menu Operation Flow	148
6-2	Starting the NT631/NT631C	149
	6-2-1 Operation at Startup	149
6-3	Operation Modes and the System Menu	150
	6-3-1 Relationships among Modes	150
	6-3-2 Menu Tree	152
	6-3-3 Operations with the System Menu	153
6-4	Memory Initialization	155
	6-4-1 Clearing Screen Data	155
	6-4-2 Initializing Display History Record Data	157
	6-4-3 Initializing Alarm History Record Data	158
	6-4-4 Initializing the Memory Tables	160
	6-4-5 Initializing the Memory Switches	161
6-5	Operations in the System Installer Mode	163
	6-5-1 Setting the Display Language in the System Installer Mode	163
	6-5-2 Clearing/Installing the System Program	164
	6-5-3 Changing the System Settings	165
	6-5-4 Clearing Screen Data	167
6-6	Transmitting the Screen Data	168
6-7	Setting the Conditions for Communications with the Host by Using the Memory Switches ..	171
	6-7-1 About Communication Conditions	172
	6-7-2 Setting the Host Link Method	173
	6-7-3 Setting the NT Link (1:1) Method	175
	6-7-4 Setting the NT Link (1:N) Method	176
	6-7-5 Setting the Memory Link Method	178
	6-7-6 Setting the Communication Type for Serial Port B	181
6-8	Starting Operation	183
6-9	Various System Settings	185
	6-9-1 Memory Switch Setting Screens	185
	6-9-2 Setting the "Start-up Wait Time"	186
	6-9-3 Setting the "Key Press Sound"	187
	6-9-4 Setting the "Buzzer Sound"	188
	6-9-5 Setting the "Printer Controller"	190
	6-9-6 Setting the "Print Method" (NT631C Only)	191
	6-9-7 Setting "Screen Saver Movement"	193
	6-9-8 Setting the Screen Saver Start-up Time	195
	6-9-9 Setting the History Display Method	196
	6-9-10 Setting the Resume Function	198
	6-9-11 Setting the Automatic Reset Function	199
	6-9-12 Setting the Time-out Interval	201
	6-9-13 Setting the Retry Count	202
6-10	Setting the Bar Code Reader Input Function	204

6-11	System Maintenance	207
	6-11-1 I/O Settings	207
	6-11-2 Displaying/Setting the Calendar and Clock	210
	6-11-3 Checking the PT Setting Status	212
	6-11-4 Displaying and Printing the Display History Record	214
	6-11-5 Displaying and Printing the Alarm History Record	216
	6-11-6 Checking Screen Data	218
	6-11-7 Device Check	221
	6-11-8 Checking Interfaces	230
6-12	Programming Console Function	236
	6-12-1 Usable Systems	237
	6-12-2 Connection Method	238
	6-12-3 Method of Use	238

6-1 System Menu Operation Flow

Follow the procedure below when using the NT631/NT631C for the first time or changing the system program.

[Create the Screen Data]



Create the data to be displayed on the NT631/NT631C by using the Support Tool.
For details on creating screen data, refer to the NT-series Support Tool Ver. 3.0 for Windows95 Operation Manual (V053-E1-□).

[Start Up the NT631/NT631C (Display the System Menu)] (page 150)



Turn ON the power to the NT631/NT631C.

If no screen data has been registered, an error message is displayed. In this case, press the "OK" touch switch on the error message screen to display the System Menu.

If screen data has been registered and the RUN mode is established, perform the appropriate operations on the touch panel to display the System Menu.

[Initialize the Memory] (page 156)



If necessary, initialize the memory of the NT631/NT631C by operation from the System Menu.

[Transmit the Screen Data] (page 169)



Connect the Support Tool to the NT631/NT631C and transmit the screen data from the Support Tool to the NT631/NT631C.

For details on connecting the Support Tool, refer to 3-2 "Connecting to the Support Tool" (page 41).

[Set the Memory Switches] (pages 172, 186)



Select the System Menu and set the operations of the NT631/NT631C — for example the conditions for communication with the host — using the memory switches.

[Start Operation] (page 184)



Connect the NT631/NT631C to the host and start operation.

[System Maintenance] (page 208)

If an error occurs during operation, check the I/Os, settings, etc., by referring to this guide.

6-2 Starting the NT631/NT631C

After checking that the hardware has been connected correctly, switch on the power to the NT631/NT631C to start it up.

This section describes the operation of the NT631/NT631C when it is started up.

6-2-1 Operation at Startup

The NT631/NT631C operates as follows when the power is switched ON, or when it is reset.

[Initial Processing]

Self diagnosis — including a check on the internal memory of the NT631/NT631C and a system program check — and the internal processing required for startup, are performed.



If an error occurs during initial processing, an error screen is displayed.

If there is an error in the system program, the system program must be re-installed. For details on the installation procedure, refer to 6-5 “Operations in the System Installer Mode” (page 164).

[Memory Unit Check and Processing]

Check if a memory unit is installed. If a memory unit is installed, processing (screen data and system program reading/writing) is executed in accordance with its DIP switch settings (page 46).



If there is an error in the screen data, an error screen is displayed. Pressing the “OK” touch switch on the error screen will return the display to that immediately before the error occurred. It is also possible to display the System Menu from the error screen by pressing two of the four corners of the touch panel simultaneously. If there is an error in the system program, the main menu of the system installer mode is displayed. If this is the case, reinstall the proper system program.

Initialize the memory or change the settings as required.

[Start of Communication with the Host]

Communication with the host starts in accordance with the communication method set in the system memory of the NT631/NT631C. During the interval until communication is established, the “system initialization screen” (screen No. 9000) is displayed.



For details, refer to “6-8 Starting Operation” (page 184).

If the “system initialization screen” remains on, display the System Menu by pressing two of the four corners of the touch panel simultaneously, and check the settings for the communication conditions for communication with the host.

[Operation Start]

The RUN mode is established, and operation starts in accordance with the screen data in the NT631/NT631C.

When changing the settings or checking the statuses, perform the appropriate operation by displaying the System Menu. For details on displaying the System Menu, refer to 6-3-3 “Operations with the System Menu” (page 154).

6-3 Operation Modes and the System Menu

The NT631/NT631C operates in four modes: the “RUN”, “Transmit”, “Maintenance”, and “Expansion” modes. These modes are selected from the System Menu.

In addition, the NT631/NT631C also features the “System Installer” mode which is used specifically for installing the system program.

The System Installer mode is selected by operation at the panel when the NT631/NT631C power is switched ON.

6-3-1 Relationships among Modes

The relationships among the System Menu, each of the operation modes, and the System Installer mode, are indicated in the figure below.

For details on system menu operation, refer to 6-3-3 “Operations with the System Menu” (page 154).

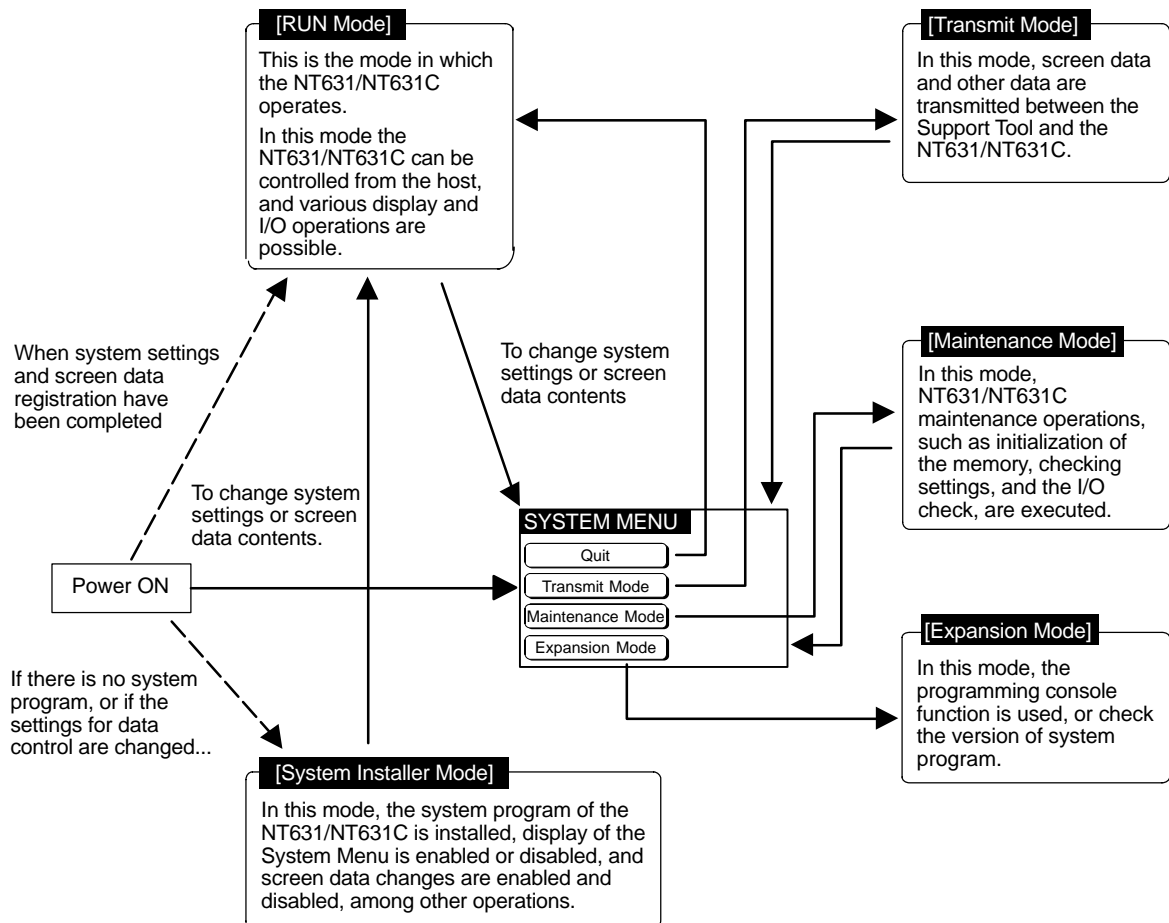

Items in the System Menu

The items displayed in the system menu and their functions are as follows.

Menu Item	Function
Quit	Clear the System Menu screen and return to the RUN mode screen.
Transmit Mode	Display the Transmit Mode screen to allow transmission for screen data between the Support Tool and the NT631/NT631C. For details on transmission of screen data, refer to 6-6 "Transmitting the Screen Data" (page 169).
Maintenance Mode	Display the Maintenance Mode menu to allow system maintenance of the NT631/NT631C, and various NT631/NT631C settings.
Expansion Mode	Display the Expansion Mode menu to allow selection of the expansion functions embedded in the NT631/NT631C. Among the expansion functions of the NT631/NT631C is the Programming console function, which allows the NT631/NT631C to be used as the programming console for a CS1 series CS1G/CS1H C-series CPM1, CQM1, C200HX/HG/HE, or SRM1, and the version display function which displays the version of system program. For details on the programming console function, refer to 6-12 "Programming Console Function" (page 237).

Functions of the System Installer Mode

The following functions can be executed in the System Installer mode.

- Setting the display language
- Clearing and installing system programs
- Disabling/enabling display of the System Menu.
- Disabling/enabling writing to the screen data memory
- Clearing screen data

For details on these functions, refer to 6-5 "Operations in the System Installer Mode" (page 164).

6-3-2 Menu Tree

The System Menu allows the various functions of the NT631/NT631C to be executed by using touch switches displayed on the touch panel. The menu tree, starting from the System Menu, is shown below.

For details on System Menu operations, refer to 6-3-3 "Operations with the System Menu" (page 154).

The menu tree may differ according to the system program installed in the NT631/NT631C. The menu tree for the system program that is installed in the NT631/NT631C on shipment is shown below.

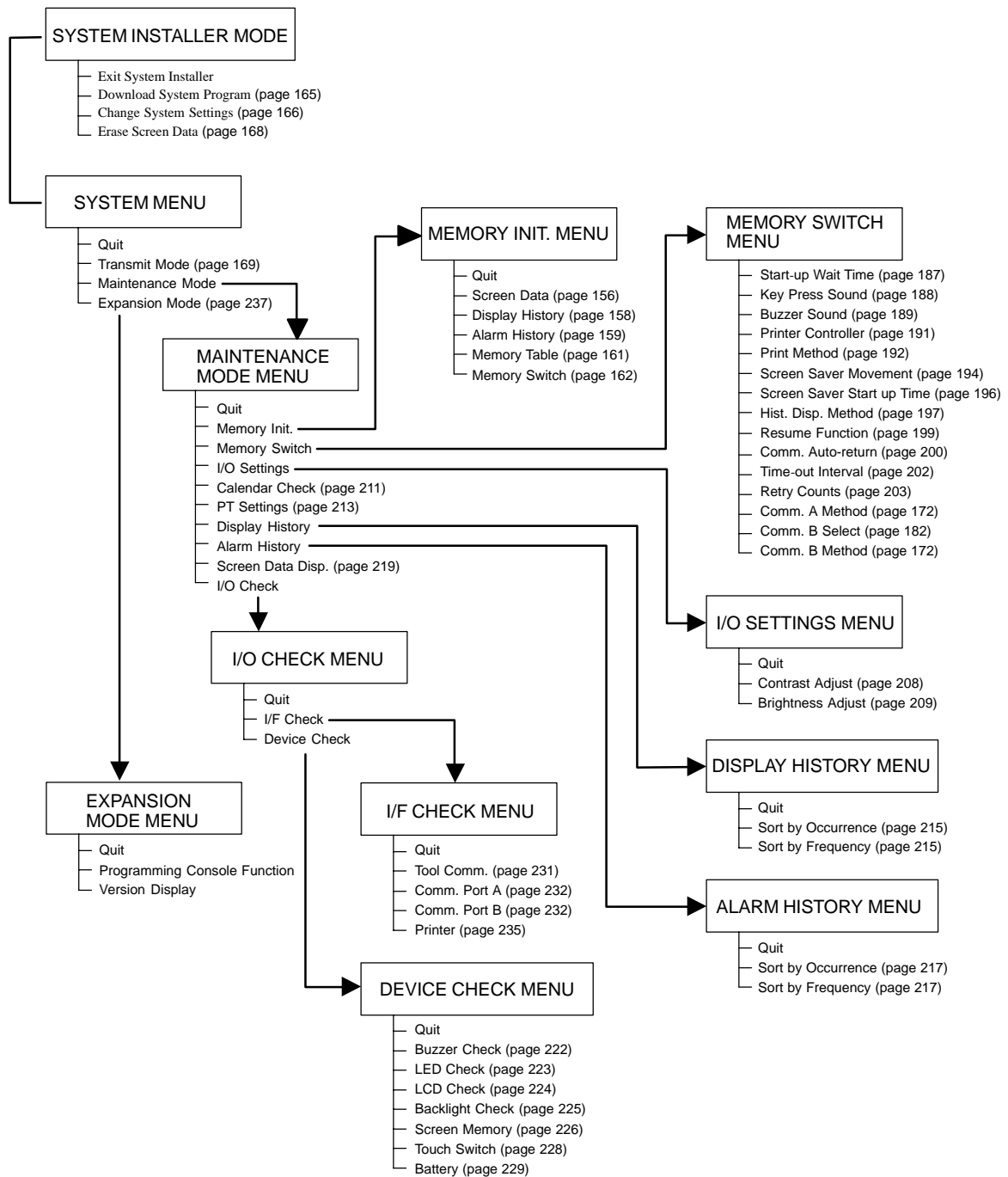

6-3-3 Operations with the System Menu

This section describes how to use the menus, including how to call the System Menu, how to call the System Installer mode, and how to select menu items.

Calling the System Menu

The System Menu can be displayed by either of the following two methods.

- Touching the corners of the touch panel
- Pressing a touch switch that displays the System Menu

- Reference**
- If display of the System Menu is disabled by the setting made in the System Installer mode, the System Menu cannot be displayed (this does not apply if an error has occurred).
 - At the same as the System Menu is displayed, the operation of the NT631/NT631C stops and the RUN LED goes OFF.

- Touching the corners of the touch panel

When two of the four corners of the touch panel (see the figure below) are touched simultaneously, the System Menu is displayed.

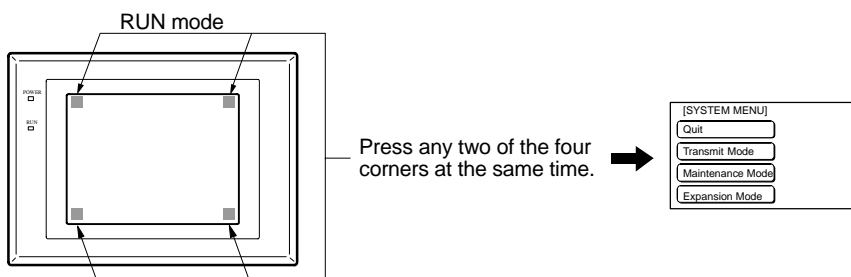

Note that the touch switches used to call the System Menu are not displayed at corners on the screen. If a touch switch displayed in a corner is pressed first, the touch switch will function and the System Menu will not be displayed. Especially, when the touch switch has switch screen function, as a result of screen switch over, it means the corner is not pressed even if it is kept pressing. To successfully call the System Menu, first press a corner where no touch switch is displayed, and then press any other corner regardless of the presence of a touch switch.

- Reference**
- With the NT631/NT631C, the System Menu can be displayed even if the screen has touch switches registered at all four corners.

- Pressing a touch switch that displays the System Menu

There is a “control key” that has the function of displaying the System Menu.

By registering the touch switch for System Menu display ([MENU]) on a screen when creating it, the System Menu can be displayed just by pressing this switch.

Calling the System Installer Mode

If the NT631/NT631C has no system program installed, or if the system program is destroyed, the System Installer mode is automatically established when the power is switched ON.

To establish the System Installer mode in order to install a system program or make settings for data management, either turn the power ON, or reset the NT631/NT631C, while pressing the touch switch at the top left corner of the touch panel (size: 7.2 mm × 7.2 mm).

Switch the power to the NT631/NT631C ON while pressing this touch switch.

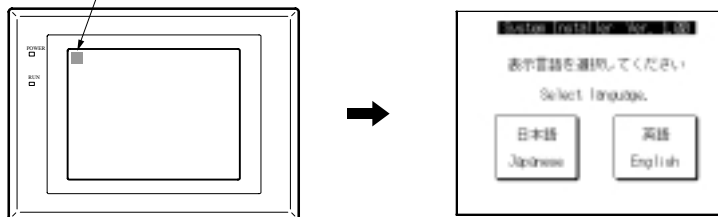

Selecting Menu Items

The menu items in the System Menu are displayed on the NT631/NT631C screen as touch switches. Menu items can be selected simply by pressing them.

Example: Displaying the MAINTENANCE MODE MENU screen by pressing “Maintenance Mode” in the System Menu.

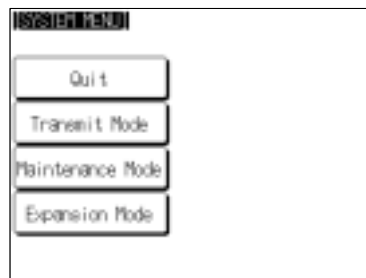

Press “Maintenance Mode”.

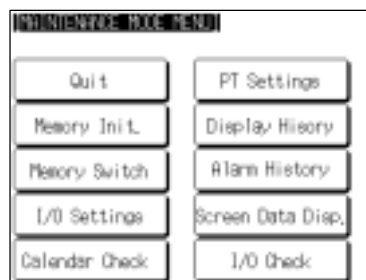

Switching from the System Menu to the RUN Mode

Return to the RUN mode by selecting “Quit” in the System Menu and other menus.

Reference Unlike previous PT models, the NT631/NT631C does not return to the RUN mode automatically if no operations are performed.

6-4 Memory Initialization

The NT631/NT631C has the following initialization functions. Use them as necessary.

- Clearing screen data Page 156
- Initializing memory tables Page 161
- Initializing memory switches Page 162
- Initializing display history record data Page 158
- Initializing alarm history record data Page 159

Reference If writing to the screen data memory has been disabled by the “System Setting” setting in the System Installer mode, memory initialization is not possible.

6-4-1 Clearing Screen Data

Use this function if the screen data has been corrupted and the NT631/NT631C cannot be started up correctly.

It clears (initializes) only the screen data: the memory switch settings and display history/alarm history record data are retained.

Reference

- When this function is used, all of the screen data contents registered in the NT631/NT631C up to that point are cleared. Check that the created screens are backed up at the Support Tool before using it.
- The screen data can be cleared in the System Installer mode too (page 165).
- The following types of data can be initialized individually.
 - Contents of numeral/character string memory tables (page 159)
 - Memory switch settings (page 161)
 - Display history record data (page 158)
 - Alarm history record data (page 159)

Clear the screen data by following the menu operation from the System Menu shown below.

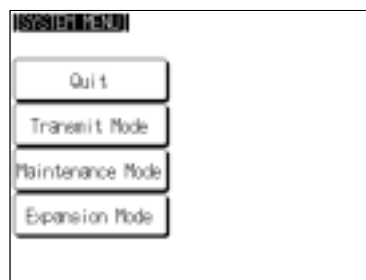

Select “Maintenance Mode”.



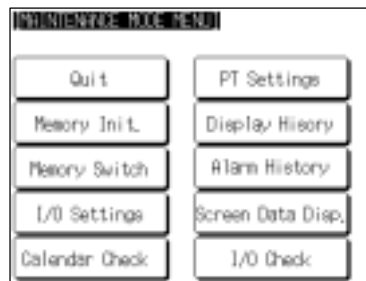

Select "Memory Init.".

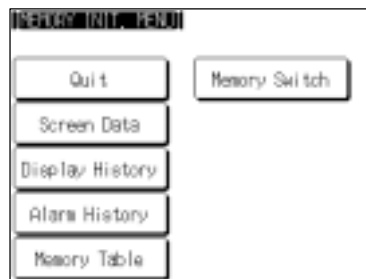

Select "Screen Data".



Select "Yes".

The screen data is cleared. During clearance, the message "Erasing Now..." is displayed.

- If "No" is selected, the NT631/NT631C returns to the "MEMORY INIT. MENU" screen without clearing the screen data.

On completion of screen data clearance, the NT631/NT631C returns to the "MEMORY INIT. MENU" screen.

After the screen data has been cleared, if an attempt is made to set the NT631/NT631C to the RUN mode before screen data has been transmitted from the Support Tool or memory unit, an error message will be displayed and the RUN mode will not be established.

6-4-2 Initializing Display History Record Data

The display history record function keeps a record of the order of display of the screens displayed during operation, and the number of times each screen is displayed. These records are kept only for screens for which the "History" attribute has been set.

The maximum number of records is 1024 for "sort by occurrence" (order of display occurrence) and 255 for "sort by frequency" (order of the number of times each screen has been displayed).

Use the display history record initialization function to clear the history record data to 0, for example when the screen data has been changed, etc. Also, if "Alarm (Use Ring Buffer)" under "History Setting" of "System" in "PT Configuration" (Tools) has not been checked, no more records will be stored after the maximum number of records has been kept, and therefore the records must be periodically initialized. If "Alarm (Use Ring Buffer)" is checked, when the maximum number of records is reached the oldest record is deleted and the newest data is recorded.

Reference

The NT631/NT631C also allows the display history record data to be initialized by controlling the PT status control area from the host. For details, refer to "Display history initialization (bit 11)" (page 267).

Initialize the display history record data by following the menu operation from the System Menu shown below.

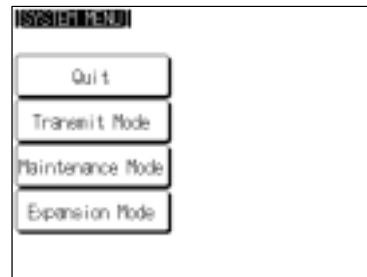

Select "Maintenance Mode".

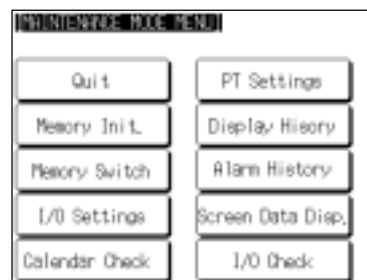

Select "Memory Init.".



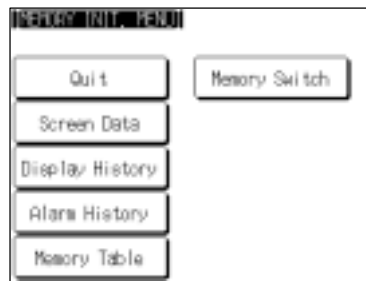

Select "Display History".



Select "Yes".

The display history record data is initialized. During initialization, the message "Initializing" is displayed.

- If "No" is selected, the NT631/NT631C returns to the "MEMORY INIT. MENU" screen without initializing the display history record data.

On completion of display history record data initialization, the message "Finished" is displayed and the NT631/NT631C returns to the "MEMORY INIT. MENU" screen.

6-4-3 Initializing Alarm History Record Data

The alarm history record function continually checks the status of host bits that have been designated in advance with a bit memory table, and records the time when any of the bits is set to 1 (comes "ON"), and the number of times that each bit comes ON.

The maximum number of records is 256 for "sort by occurrence" (order of error occurrence) and 255 for "sort by frequency" (order of the number of times each error has occurred).

Use the alarm history record initialization function to reset the alarm history record data to 0, for example when the screen data has been changed, etc. Also, if "Screen (Use Ring Buffer)" under "History Setting" in the "PT Environment Settings" – "System Settings" has not been checked, no more records will be stored after the maximum number of records has been kept, and therefore the records must be periodically initialized. If "Screen (Use Ring Buffer)" is checked, when the maximum number of records is reached the oldest record is deleted and the newest data is recorded.

Reference

The NT631/NT631C also allows the alarm history record data to be initialized by controlling the PT status control area from the host. For details, refer to "Alarm history initialization (bit 1)" (page 269).

Initialize the alarm history record data by following the menu operation from the System Menu shown below.

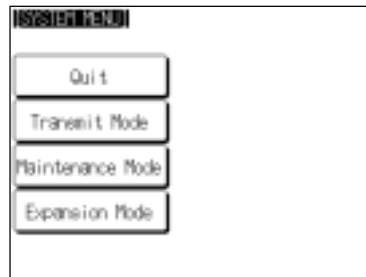

Select "Maintenance Mode".

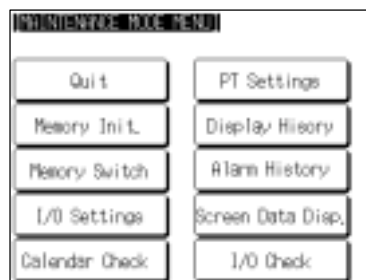

Select "Memory Init.".

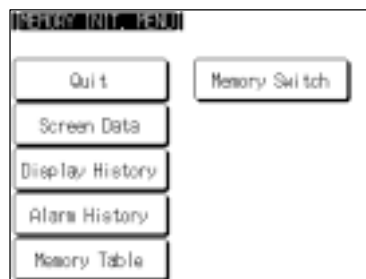

Select "Alarm History".



Select "Yes".

The alarm history record data is initialized. During initialization, the message "Initializing" is displayed.

- If "No" is selected, the NT631/NT631C returns to the "MEMORY INIT. MENU" screen without initializing the alarm history record data.

On completion of alarm history record data initialization, the message "Finished" is displayed and the NT631/NT631C returns to the "MEMORY INIT. MENU" screen.

6-4-4 Initializing the Memory Tables

It is possible to initialize the numeral memory tables and character string memory tables in the NT631/NT631C.

When these tables are initialized, the values are returned to those set by the Support Tool (they are not cleared).

When the memory tables are initialized, they are returned to their initial values regardless of the setting made for the resume function (page 199).

If "ON" is set for the "Resume Function" memory switch, the initial values set with the Support Tool will not be recorded in the memory tables unless they are initialized.

Reference

- If "OFF" is set for the "Resume Function" memory switch, the memory tables can be initialized just by switching the NT631/NT631C power off and back on again, or by resetting the NT631/NT631C (page 199).
- The bit memory table merely reflects the statuses of bits at the host and therefore cannot be initialized.

Initialize the memory tables by following the menu operation from the System Menu shown below.

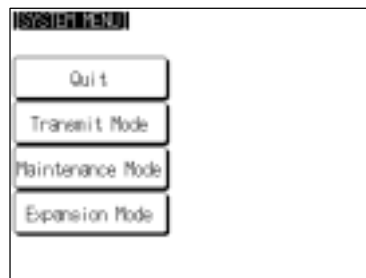

Select "Maintenance Mode".

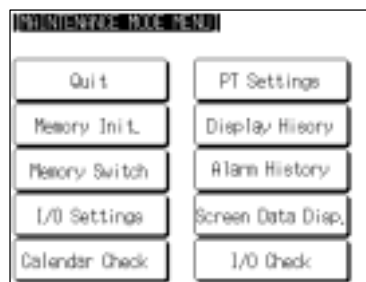

Select "Memory Init.".

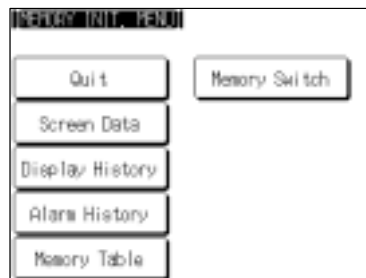

Select "Memory Table".





Select "Yes".

The memory tables are initialized. During initialization, the message "Initializing" is displayed.

- If "No" is selected, the NT631/NT631C returns to the "MEMORY INIT. MENU" screen without initializing the memory tables.

On completion of memory table initialization, the message "Finished" is displayed and the NT631/NT631C returns to the "MEMORY INIT. MENU" screen.

6-4-5 Initializing the Memory Switches

Initialization returns all the memory switches of the NT631/NT631C to their status on shipment.

Initialize the memory switches by following the menu operation from the System Menu shown below.

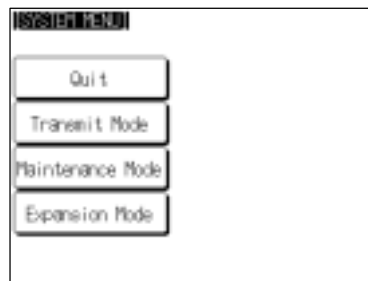

Select "Maintenance Mode".

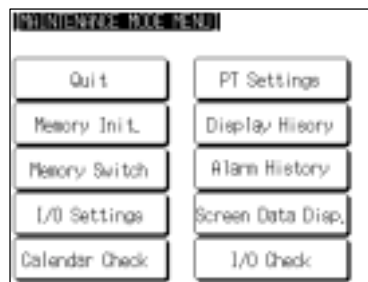

Select "Memory Init.".



Select "Memory Switch".





Select "Yes".

The memory tables are initialized. During initialization, the message "Initializing" is displayed.

- If "No" is selected, the NT631/NT631C returns to the "MEMORY INIT. MENU" screen without initializing the memory switches.

On completion of memory switch initialization, the message "Finished" is displayed and the NT631/NT631C returns to the "MEMORY INIT. MENU" screen.

After initialization, the memory switch statuses are as follows.

Memory Switch	Status
Start-up Wait Time	00
Key Press Sound	ON
Buzzer Sound	OFF
Printer Controller	ESC/P
Print Method	Tone (NT631C only)
Screen Saver Movement	Display erased
Screen Saver Start up Time	010
Hist. Disp. Method	From New Data
Resume Function	OFF
Comm. Auto-return	OFF
Time-out Interval	01
Retry Counts	005
Comm. A Method	Host Link (communications speed = 9600 bps)*
Comm. B Select	RS-232C
Comm. B Method	None

* The communication conditions for a bar code reader are initialized as follows:
Data bits: 7 bits; stop bit: 1 bit; parity: none; flow control: RS/CS.

6-5 Operations in the System Installer Mode

The following functions can be executed in the System Installer mode:

- Setting the display language (see below)
- Clearing/installing the system program (page 165)
- Disabling/enabling display of the System Menu (changing the system settings) (page 166)
- Disabling/enabling writing to the screen data memory (changing the system settings) (page 166)
- Clearing screen data (page 168)

For details on calling the System Installer mode, refer to “Calling the System Installer Mode” (page 155).

6-5-1 Setting the Display Language in the System Installer Mode

The first setting made in the System Installer mode is to select whether the display language is to be English or Japanese.



Select “English” or “Japanese”.

From here on, this manual assumes that “English” has been selected here.

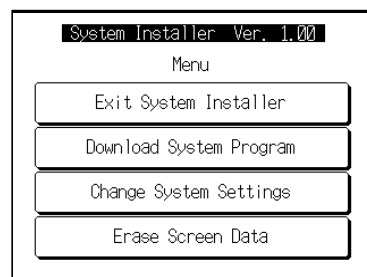

The System Installer mode menu is displayed.

If there is no system program or the system program has been corrupted, the message “System Program not exist or incorrect.” is displayed at the bottom of the screen.

6-5-2 Clearing/Installing the System Program

Use this function when the system program of the NT631/NT631C has been corrupted, or when installing a new system program.

- Reference**
- In order to install a system program, the system installer must also be installed at the Support Tool. The system installer is an accessory with the Support Tool (ZJ3AT1/ZJCAT1-EV2). When installing the Support Tool in a personal computer, install the system installer also. For details on the method for installing the system installer at the Support Tool side, and the operating procedure, refer to the NT-series Support Tool Ver. 2.0 for Windows95 Operation Manual (V045-E1).
 - When the system program is cleared by mistake, it becomes impossible to use the NT631/NT631C at all. Check that the system installer is installed at the Support Tool side before deleting the program. However, note that the registered screen data and memory switch settings are retained.
 - It becomes possible to install the system program inside the memory unit automatically by installing the memory unit at startup (Refer to 3-5 "Using Memory Unit (NT631/NT631C with V1)" page 46).

Clear/install the system program by following the menu operation from the System Installer mode menu shown below.

Clearing the System Program

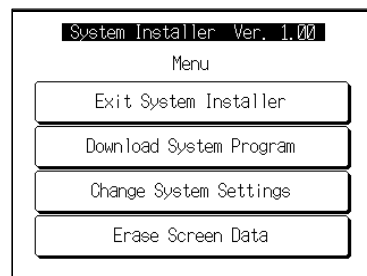

Select "Download System Program".



Select "Yes".

The system program is cleared. During clearance, the message "Erasing ..." is displayed.

- If "Return to Menu" is selected, the NT631/NT631C returns to the System Installer mode menu without clearing the system program.
- If clearance fails, a screen asking whether you wish to try again is displayed.

On completion of system program clearance, the NT631/NT631C enters the standby status for downloading of the system program.

Downloading the System Program

On normal completion of system program clearance, the standby status for system program downloading is automatically established.



When the NT631/NT631C enters this status, transmit the system program from the system installer at the personal computer.

During downloading, the progress of transmission is indicated on the screen.



Select "Run System".

- If "Abort" is selected during standby for downloading or during downloading, a screen asking whether you wish to download again is displayed.

When the system program is started, the NT631/NT631C starts up normally. If no screen data has been registered, the System Menu is displayed.

Reference

If the new system program is not downloaded successfully after deleting a system program, it is not possible to use the NT631/NT631C at all. After deleting the system program, be sure to download a new one.

6-5-3 Changing the System Settings

The NT631/NT631C allows the following settings to be made to prevent the screen data and memory switch settings from being changed or deleted by misoperation.

- Disabling/enabling System Menu display

When System Menu display is disabled by this setting, the System Menu cannot be displayed by touch panel operations or by using the touch switches. However, if a error occurs, the System Menu can be displayed from the error message screen.

- Disabling/enabling writing to the screen data memory

When writing to the screen data memory is disabled by this setting, it is impossible to use the following System Menu functions.

- Switching to the Transmit mode
- Displaying the memory switch setting screens
- Checking the screen data memory
- Displaying the initialization menu
- Displaying the calendar/time setting screen (the calendar/time display screen can be displayed)

Change the system settings by following the menu operation from the System Installer mode menu shown below.

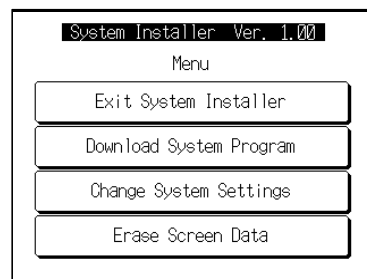

Select "Change System Settings".

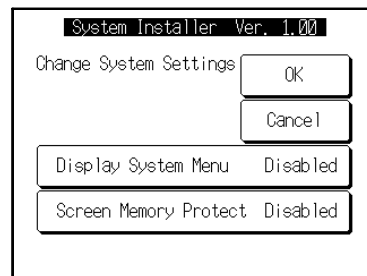

Select "Display System Menu" or "Screen Memory Protect".

Each time either of these items is selected, the setting switches from "Disabled" to "Enabled" or vice versa.

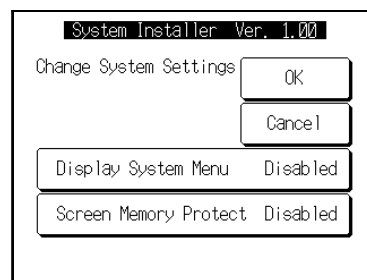

Select "OK".

The settings are written to the NT631/NT631C while the screen is displayed.

- If "Cancel" is selected, the NT631/NT631C returns to the System Installer mode menu without changing the settings. The settings remain as they were before the operation was started.
- If writing of the settings fails, a screen asking whether you wish to try again is displayed.

After the settings have been written, the System Installer mode menu screen is redisplayed.

6-5-4 Clearing Screen Data

If the screen data has been corrupted and the NT631/NT631C cannot be started normally, use this function to clear the screen data.

Note that only the screen data is cleared (initialized), and the memory switch settings and the display history/alarm history record data are retained.

Reference

- When this function is used, all of the screen data contents registered in the NT631/NT631C up to that point are cleared. Check that the created screens are backed up at the Support Tool before using it.
- The screen data can also be cleared from the System Menu (page 156).
- If the screen data is cleared in the System Installer mode, the message "Screen Data Corrupted" may be displayed on switching to the RUN mode. If this happens, initialize the screen data again from the "MEMORY INIT. MENU" screen.

Clear the screen data by following the menu operation from the System Installer mode menu shown below.

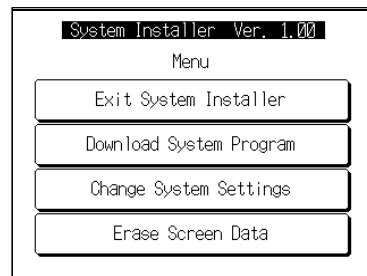

Select "Erase Screen Data".

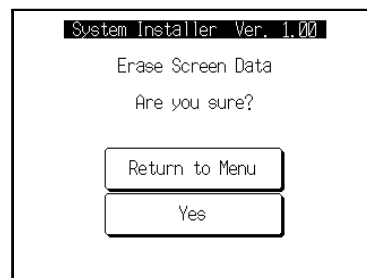

Select "Yes".

The screen data is cleared. During clearance, the message "Erasing ..." is displayed.

- If "Return to Menu" is selected, the NT631/NT631C returns to the "MEMORY INIT. MENU" screen without clearing the screen data.
- If screen data clearance fails, a screen asking if you wish to try again is displayed.

On completion of screen data clearance, the NT631/NT631C returns to the System Installer mode menu screen.

After the screen data has been cleared, if an attempt is made to set the NT631/NT631C to the RUN mode before screen data has been transmitted from the Support Tool or memory unit, an error message will be displayed and the RUN mode will not be established.

6-6 Transmitting the Screen Data

The screen data is created with the Support Tool and then transmitted to the NT631/NT631C. This section explains how to transmit the screen data.

For details on how to create the screen data and the operation at the operation at the Support Tool, refer to Sections 7 to 9 of this manual and the NT-series Support Tool Ver. 3.0 for Windows95/98 Operation Manual.

- Reference**
- The screen data can be transmitted also from the memory unit installed in the NT631/NT631C. For details on this method, refer to 3-5 "Using a Memory Unit (NT631/NT631C with V1)" (page 46) or 3-6 "Using Memory Unit (NT631/NT631C with V1)" (Page 56).
 - The screen data can be transmitted at a faster rate by setting "High" for "Baud Rate" on the "Comms. Setting..." window of the Support Tool.
 - If writing to the screen data memory is disabled by the setting made for "System Setting" in the System Installer mode, screen data transmission is not possible.

Screen Data Composition and Transmission Units

The screen data comprises the following types of data.

- User screen data (screen units)
- System memory (memory switch) settings
- Direct connection information
- Numeral memory table data
- Character string memory table data
- Bit memory table data
- Mark information
- Image/library data

It is possible to transmit the screen data (data for all the screens) in "file units", or to transmit individual data or the data of individual screens in "data units".

When data is transmitted in "file units", all of the screen data in the NT631/NT631C is cleared and then the new data is transmitted.

When data is transmitted in "data units", first the previous data is invalidated, then the new data is registered as valid data. Since the previous data is not cleared, free memory area in the NT631/NT631C will be insufficient when transmissions in "data units" are repeated. If this happens, write the screen data again by data transmission in "file units".

Transmitting Screen Data from the Support Tool

To transmit screen data from the Support Tool to the NT631/NT631C, follow the procedure below.

- Operation**
- 1 Connect the NT631/NT631C to a personal computer in which the Support Tool has been installed and turn the power to the NT631/NT631C ON.
 - 2 Turn ON the power to the personal computer and start up the Support Tool.

- 3 Establish the Transmit mode by following the menu operation from the System Menu shown below at the NT631/NT631C.

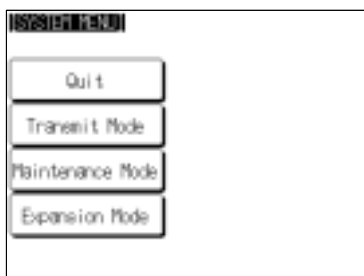

Select "Transmit Mode".



Select "Tool Transmit".



- 4 Open the screen data to be transmitted at the Support Tool, then select "Download (NTST → PT)" in the Support Tool's "Connect" menu and specify the data to be transmitted.
- 5 During screen data transmission, the transmission status is displayed.
- 6 On completion of screen data transmission, press the "Quit" touch switch. The NT631/NT631C returns to the Transmit mode.

If the screen data cannot be successfully transmitted from the Support Tool, use the communication check functions of the NT631/NT631C to check if communication between the NT631/NT631C is normal or not (page 231).

Precautions to Be Observed When Transmitting Screen Data

If any of the following, or a system error, occurs during transmission of screen data, the transmitted screen data will not be registered correctly in the NT631/NT631C. If this happens, the NT631/NT631C may not enter the RUN mode when started up, or there may be unpredictable malfunctions such as failure to display screens during operation. In this case, the screen data must be retransmitted in file units to register it correctly.

- The power to the NT631/NT631C is interrupted or the NT631/NT631C is reset.
- The power to the personal computer on which the Support Tool is running is interrupted or the computer is reset.
- The cable connecting the NT631/NT631C to the personal computer on which the Support Tool is running is disconnected or has a broken wire.
- The "Quit" touch switch on the NT631/NT631C screen is pressed to end screen data transmission.
- Screen data transmission is stopped by operation at the Support Tool.

Notice

When transferring the data in units of screens, if there are changes in memory table and/or direct access, transfer such data along with the screen data.

6-7 Setting the Conditions for Communications with the Host by Using the Memory Switches

The NT631/NT631C can be connected to the host by the following 6 types of communication methods can be used to communicate with a host.

- Host link method
- Memory link method
- NT link (1:1) method
- Mitsubishi A-computer link method
- NT link (1:N) method
- Mitsubishi FX method

The NT631/NT631C has the following two ports, either of which can be used for communications with the host, depending on the requirements.

- Serial port A (exclusively for RS-232C, 9-pin connector)
- Serial port B (RS-232C/RS-422A (selectable), 25-pin connector)

The method for setting the communication method for communications with the host is described here.

For details on setting the communication conditions for a bar code reader, refer to 6-10 "Setting the Bar Code Reader Input Function" (page 205).

Reference

- Apart from the host, it is also possible to connect the Support Tool or a bar code reader to serial port A. When a bar code reader is connected at serial port A, the host must be connected at serial port B. When serial port A is being used for communications with the host, the host must be disconnected so that the Support Tool can be connected.
 - There are four memory switch setting screens. The conditions for communications with the host are set on the fourth screen (the screen on which 4/4 is displayed). For details on setting memory switches other than those for setting the conditions for communications with the host, refer to 6-9 "Various System Settings" (page 186).
 - When using the Mitsubishi A-computer link method and Mitsubishi FX method, a system program for multi-venders is required. Install the system program to the NT631/631C by the system installer (refer to page 165). For details, refer to "PC Connection Operation Manual" (V042-E1-□)
-

6-7-1 About Communication Conditions

Items Set for Communication Conditions

The following settings are made for the communication conditions for communication between the NT631/NT631C and the host.

- Port communication method/communication type settings

Setting Item	Function	Setting Options	Page
Comm. A Method	Set the communication method used at serial port A. Depending on the communication method, further communication condition settings may be necessary.	A system program for OMRON model. None/Host Link/NT Link (1:1)/ NT Link (1:N)/Bar-Code Reader Memory link	Page 174 Page 176 Page 177 Page 179
Comm. B Select	Set whether serial port B is to be used for RS-232C or RS-422A communication.	RS-232C/RS-422A	Page 182
Comm. B Method	Set the communication method used at serial port B. Depending on the communication method, further communication condition settings may be necessary.	A system program for OMRON model. None/Host Link/NT Link (1:1)/ NT Link (1:N) Memory link	Page 174 Page 176 Page 177 Page 179

- Communication condition settings for the host link method

Setting Item	Function	Setting Options	Page
Comm. Speed (for host link only)	Sets the communications speed for communications with the host.	9600 bps/ 19200 bps	Page 174

- Communication condition settings for the NT link (1:1) method

No further communication conditions need to be set.

- Communication conditions settings for the NT link (1:N) method

Setting Item	Function	Setting Options	Page
Unit No. (for NT link (1:N) only)	Set the unit number of the NT631/NT631C.	0 to 7	Page 177

- Setting the conditions for communications with the memory link method

Setting Item	Function	Setting Options	Page
Data bits	Set the data bits length.	7, 8 bits	Page 179
Stop bits	Set the stop bits length.	1, 2 bits	Page 179
Parity	Set the parity.	None, even, odd	Page 179
Comm. Speed	Set the communications speed for communications with the host.	1200, 2400, 4800, 9600, 19200, 38400 bps	Page 179
Flow control	Set the flow control and its method.	None, RS/CS, XON/XOFF	Page 179
Response	Set whether the response is carried out for normal process of communication command or not.	Yes, No	Page 179

Possible Combinations of Communication Method Settings

The combinations of communication methods that can be set with the NT631/NT631C are indicated in the table below. Combinations other than these listed below cannot be set (when using a system for multi-venders, refer to the “PC Connection Operation Manual” (V042-E1-□)).

Serial port B	Serial port A					
	None	Host Link	NT Link (1:1)	NT Link (1:N)	Bar-code reader	Memory Link
None	✓	✓	✓	✓	✓	✓
Host Link	✓	×	×	×	✓	×
NT Link (1:1)	✓	×	×	×	✓	×
NT Link (1:N)	✓	×	×	×	✓	×
Memory Link	✓	×	×	×	✓	×

- ✓ : Possible combination
- × : Impossible combination

Combinations other than those indicated above cannot be set.

Reference When using serial port B for communication with the host, and serial port A for the transmission of screen data from the Support Tool, set the settings of serial port A to “None”.

6-7-2 Setting the Host Link Method

Set the communication conditions for the host link method at serial port A or serial port B by following the operation from the System Menu shown below.

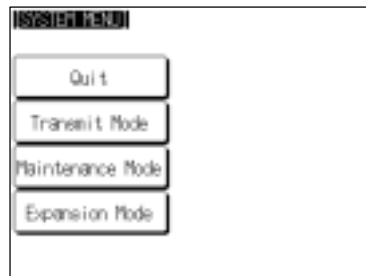

Select “Maintenance Mode”.

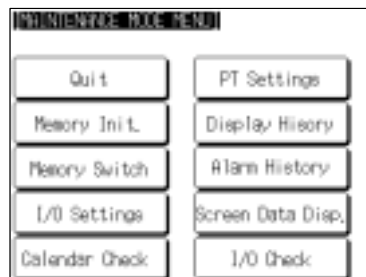

Select “Memory Switch”.





Display the fourth memory switch screen by pressing the [↓] (next screen) or [↑] (previous screen) touch switch.

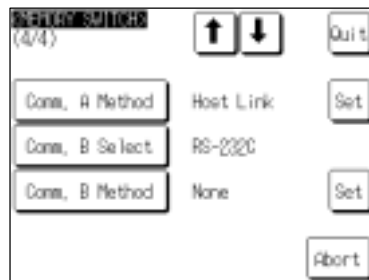

Press the touch switch corresponding to the port at which the host link method is to be set ("Comm. A Method" or "Comm. B Method") to display the setting option "Host Link".

The setting option changes each time the touch switch is pressed.

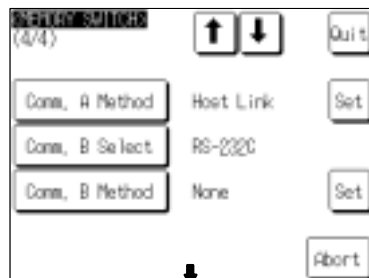

Press the "Set" touch switch to the right of the port at which the setting has been made.

In this example, serial port A is used.



Press the "Comm. Speed" touch switch to display the communications speed to be set.

The setting option changes each time the touch switch is pressed.

In this example, serial port A is used.



Press "Quit".

The communications speed is set.

- To quit the communications speed setting screen without setting the communications speed, press the “Abort” touch switch. The NT631/NT631C returns to the memory switch setting screen (4/4) and the previous communications speed remains in effect.

On completion of communications speed setting, the NT631/NT631C returns to the memory switch setting screen (4/4).

To set other memory switches, select the relevant screen using the [↓] (next screen) or [↑] (previous screen) touch switch, then make the setting.

- To confirm the settings and quit the memory switch setting screen, press the “Quit” touch switch. The settings made last will be set and the NT631/NT631C will return to the “MAINTENANCE MODE MENU” screen.
- To quit the memory switch setting screen without confirming the settings, press the “Abort” touch switch. The NT631/NT631C will return to the “MAINTENANCE MODE MENU” screen with the previous settings still in effect.

6-7-3 Setting the NT Link (1:1) Method

Set the communication conditions for the NT link (1:1) method at serial port A or serial port B by following the operation from the System Menu shown below.

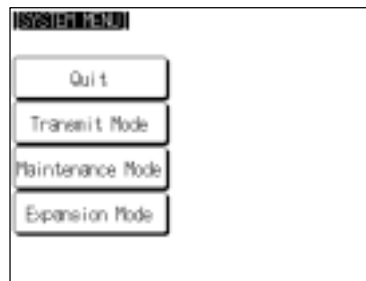

Select “Maintenance Mode”.

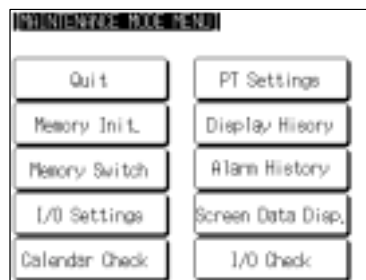

Select “Memory Switch”.



Display the fourth memory switch screen by pressing the [↓] (next screen) or [↑] (previous screen) touch switch.



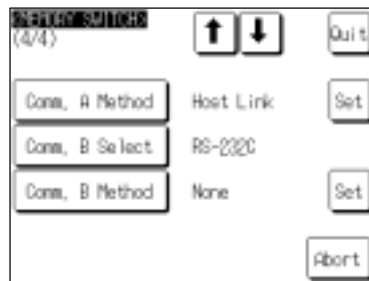

Press the touch switch corresponding to the port at which the NT link (1:1) method is to be set (“Comm. A Method” or “Comm. B Method”) to display the setting option “NT Link (1:1)”.

The setting option changes each time the touch switch is pressed.

To set other memory switches, select the relevant screen using the [↓] (next screen) or [↑] (previous screen) touch switch, then make the setting.

- To confirm the settings and quit the memory switch setting screen, press the “Quit” touch switch. The settings made last will be set and the NT631/NT631C will return to the “MAINTENANCE MODE MENU” screen.
- To quit the memory switch setting screen without confirming the settings, press the “Abort” touch switch. The NT631/NT631C will return to the “MAINTENANCE MODE MENU” screen with the previous settings still in effect.

6-7-4 Setting the NT Link (1:N) Method

Set the communication conditions for the NT link (1:N) method at serial port A or serial port B by following the operation from the System Menu shown below.

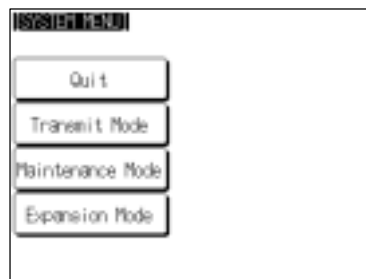

Select “Maintenance Mode”.



Select “Memory Switch”.





Display the fourth memory switch screen by pressing the [↓] (next screen) or [↑] (previous screen) touch switch.

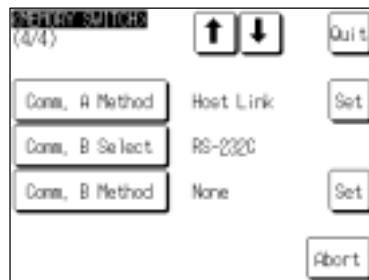

Press the touch switch corresponding to the port at which the NT link (1:N) method is to be set (“Comm. A Method” or “Comm. B Method”) to display the setting option “NT Link (1:N)”.

The setting option changes each time the touch switch is pressed.

In this example, serial port A is used.

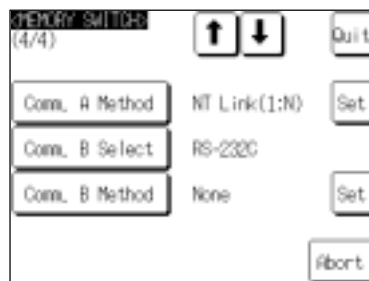

Press the “Set” touch switch to the right of the port at which the setting has been made.

In this example, serial port A is used.

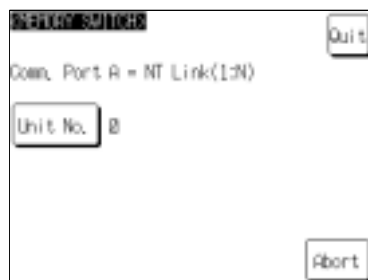

Press the “Unit No.” touch switch to display the unit number to be set.

The setting option changes each time the touch switch is pressed.

In this example, serial port A is used.



Press “Quit”.
The unit number is set.

- To quit the unit number setting screen without confirming the unit number settings, press the “Abort” touch switch. The NT631/NT631C will return to the memory switch setting screen (4/4) with the previous settings still in effect.

Reference “Unit numbers” are numbers assigned to each PT when multiple PTs are connected to one host, so that the host can identify the individual PTs. The units numbers that can be set differ according to the host model, as follows.

- C200HE(-ZE):
Unit numbers 0 to 3 (maximum of 4 PTs per host port)
- C200HG(-ZE), C200HX(-ZE):
Unit numbers 0 to 7 (maximum of 8 PTs per host port)

When making the settings, make sure there is no duplication of unit numbers among PTs.

On completion of unit number setting, the NT631/NT631C returns to the memory switch setting screen (4/4).

To set other memory switches, select the relevant screen using the [↓] (next screen) or [↑] (previous screen) touch switch, then make the setting.

- To confirm the settings and quit the memory switch setting screen, press the “Quit” touch switch. The settings made last will be set and the NT631/NT631C will return to the “MAINTENANCE MODE MENU” screen.
- To quit the memory switch setting screen without confirming the settings, press the “Abort” touch switch. The NT631/NT631C will return to the “MAINTENANCE MODE MENU” screen with the previous settings still in effect.

6-7-5 Setting the Memory Link Method

Set the communication conditions for the host link method at serial port A or serial port B by following the operation from the System Menu shown below. Check the communication settings of the host to be used.

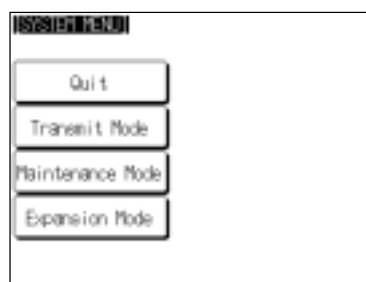

Select “Maintenance Mode”.

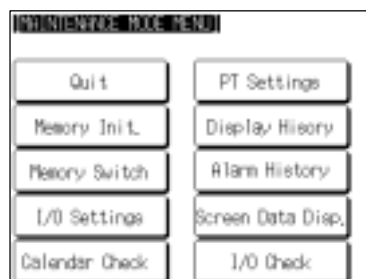

Select “Memory Switch”.





Display the fourth memory switch screen by pressing the [↓] (next screen) or [↑] (previous screen) touch switch.

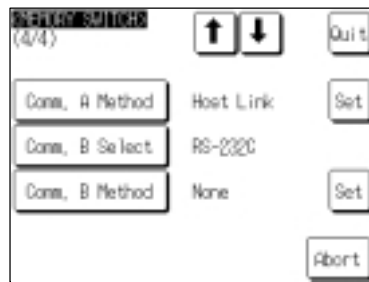

Press the touch switch corresponding to the port at which the memory link method is to be set ("Comm. A Method" or "Comm. B Method") to display the setting option "Memory Link".

The setting option changes each time the touch switch is pressed.

In this example, serial port A is used.

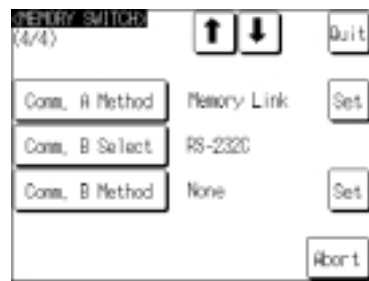

Press the "Set" touch switch to the right of the port at which the setting has been made.

In this example, serial port A is used.



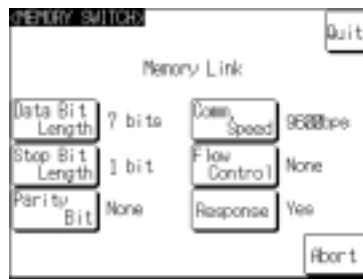

Display the data bits to be set (7 bits or 8 bits) by pressing the “Data Bit Length” touch switch.

Display the stop bits to be set (1 bit or 2 bits) by pressing the “Stop Bit Length” touch switch.

Display the parity to be set (None, even, odd) by pressing the “Parity Bit” touch switch.

Display the communication speed to be set (1200, 2400, 4800, 9600, 19200, 38400 bps.) by pressing the “Comm. Speed” touch switch.

Display the condition of the flow control to be set (None, RS/CS, XON/XOFF) by pressing “Flow Control” touch switch.

If the RS-422A is selected for serial port B setting, RS/CS is not displayed.

Display presence or absence of the response by pressing the “Response” touch switch.

The setting option changes each time the touch switch is pressed.

In this example, serial port A is used.

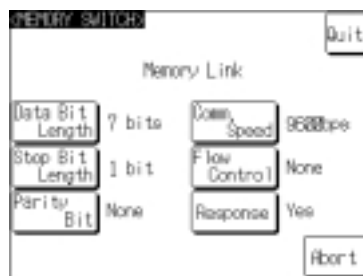

Press the “Quit” touch switch.

- To quit the communications speed setting screen without setting the communications speed, press the “Abort” touch switch. The NT631/NT631C returns to the memory switch setting screen (4/4) and the previous communications speed remains in effect.

On completion of communications speed setting, the NT631/NT631C returns to the memory switch setting screen (4/4).

To set other memory switches, select the relevant screen using the [↓] (next screen) or [↑] (previous screen) touch switch, then make the setting.

- To confirm the settings and quit the memory switch setting screen, press the “Quit” touch switch. The settings made last will be set and the NT631/NT631C will return to the “MAINTENANCE MODE MENU” screen.
- To quit the memory switch setting screen without confirming the settings, press the “Abort” touch switch. The NT631/NT631C will return to the “MAINTENANCE MODE MENU” screen with the previous settings still in effect.

6-7-6 Setting the Communication Type for Serial Port B

Set the communication type (RS-232C or RS-422A) for serial port B by following the operation from the System Menu shown below.

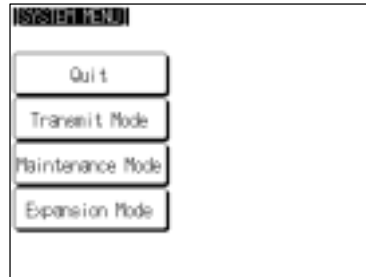

Select "Maintenance Mode".



Select "Memory Switch".

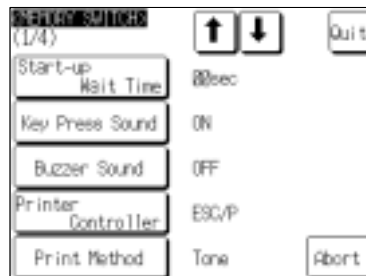

Display the fourth memory switch screen by pressing the [↓] (next screen) or [↑] (previous screen) touch switch.

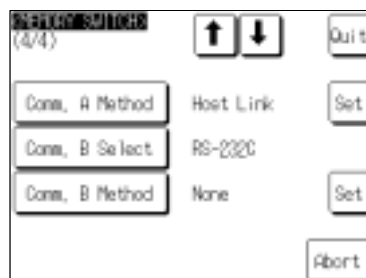

Press the "Comm. B Select" touch switch to display the communication type to be set.

The setting option changes each time the touch switch is pressed.

Reference If serial port B is used for RS-485 communications, “RS-422A” must be set as its communication type.

To set other memory switches, select the relevant screen using the [↓] (next screen) or [↑] (previous screen) touch switch, then make the setting.

- To confirm the settings and quit the memory switch setting screen, press the “Quit” touch switch. The settings made last will be set and the NT631/NT631C will return to the “MAINTENANCE MODE MENU” screen.
- To quit the memory switch setting screen without confirming the settings, press the “Abort” touch switch. The NT631/NT631C will return to the “MAINTENANCE MODE MENU” screen with the previous settings still in effect.

6-8 Starting Operation

After completing screen data transmission and setting the communication conditions, connect the NT631/NT631C to the host and start operation.

Notice

Check the operation of all screen data and host programs carefully before using them. If incorrect, the system may operate unpredictably.

Switching to the RUN Mode and Starting Operation

Press the “Quit” touch switch on the System Menu screen or other screen. The NT631/NT631C switches to the RUN mode and starts operation.

The operation at the start is as follows.

[Display of the “system initialization” screen]

When establishing the communication with a host, the “System initializing” character string is displayed on the screen. If the communication with the host cannot be established, the “System initializing” screen remains up. If this is the case, check the settings at the host and the PT side, the cables and wiring.

In addition, creating screen number 9000 enables the display of a screen other than the “System initialization” screen.

[Transmission of the contents of memory tables]

If the “Resume Function” memory switch is set to “ON”, or if the initial values of the memory tables are used, the contents of the numeral/character-string memory tables are copied to the allocated words at the host.

**[Display of the startup screen]**

The startup screen is displayed on reading the contents (screen number of the screen to be displayed) of the first word of the PT status control area.

If the contents are not correct for a screen number, or there is no data registered for the set screen number, an error message is displayed.

Confirming the Communications between the NT631/NT631C and the Host

Execute the host program and confirm that the following operations are performed normally.

- Confirm that the NT631/NT631C screens switch in accordance with the host program.

If the screens do not switch correctly, check the connection between the host and the NT631/NT631C, and also check if the hardware settings are correct. For details, refer to Section 4 "Connecting to the Host from the RS-232C Port", or Section 5 "Connecting to the Host from the RS-422A/485 Port".

- Confirm that the operation results of touch switch and numeric value/character string input at the NT631/NT631C are sent to the host correctly by displaying the contents of the host words and bits using a peripheral tool (e.g. SYSMAC support software).

If the results of operations at the NT631/NT631C are not sent to the host correctly, check the setting of the display elements. For details on setting display elements, refer to Section 7 "NT631/NT631C Functions".

6-9 Various System Settings

The NT631/NT631C allows a variety of functions which are convenient during operation to be set with memory switches. This section describes the memory switch settings relating to the operation environment.

Since the memory switch settings are backed up to the flash memory by the battery in the NT631/NT631C, they are not cleared when the power is switched OFF.

6-9-1 Memory Switch Setting Screens

There are four memory switch setting screens. The required screen can be displayed by using the [↓] (next screen) and [↑] (previous screen) touch switches.

The four memory switch setting screens are shown below.

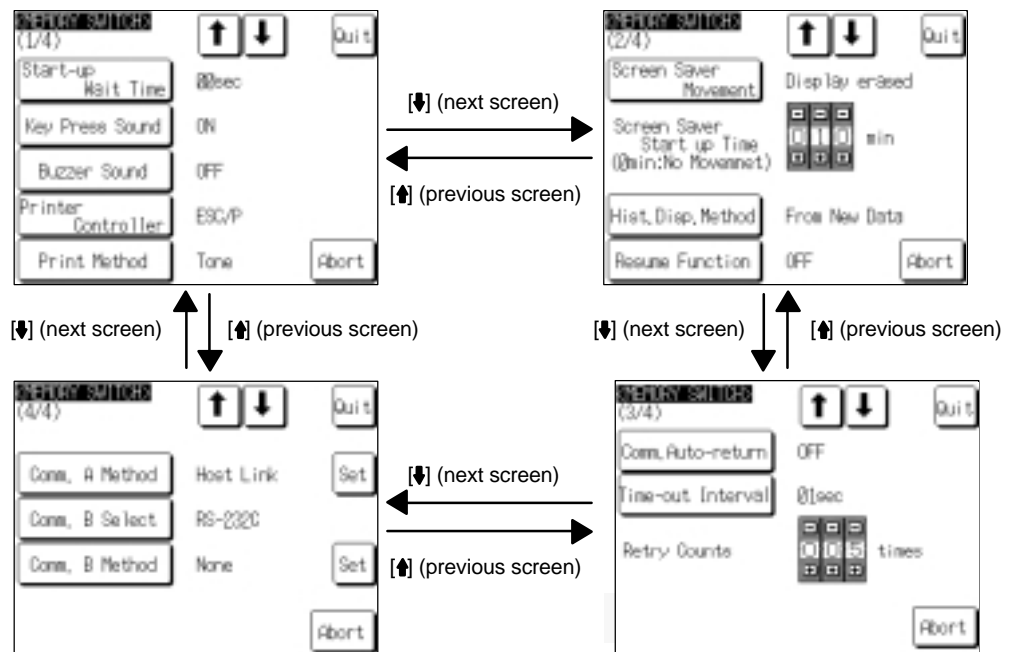

- Memory switch settings

A list of the memory switch settings is presented below.

- Start-up Wait Time page 187
- Key Press Sound page 188
- Buzzer Sound page 189
- Printer Controller page 191
- Print Method page 192
- Screen Saver Movement page 194
- Screen Saver Start up Time page 196
- Hist. Disp. Method page 197
- Resume Function page 199
- Comm. Auto-return page 200
- Time-out Interval page 202
- Retry Counts page 203
- Comm. A Method page 172
- (For the bar code reader, refer to page 205.)
- Comm. B Select page 182
- Comm. B Method page 172

For details on each setting, refer to the pages indicated.

6-9-2 Setting the “Start-up Wait Time”

The “Start-up Wait Time” is the time lapse until the NT631/NT631C switches to the RUN mode after its power has been switched ON or after it has been reset. Set this item if it takes some time for the host to start operation. Nothing is displayed during the “Start-up Wait Time”.

The setting range is 0 to 10 seconds. The default (factory) setting is “00sec”.

Set the system start-up wait time by following the menu operation from the System Menu shown below.

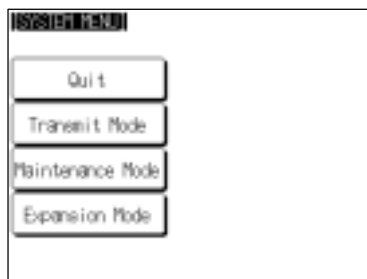

Select “Maintenance Mode”.



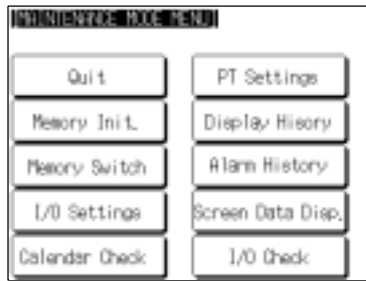

Select "Memory Switch".



Press "Start-up Wait Time" to display the required time lapse.

The setting option changes each time the touch switch is pressed, according to the following sequence.

01 → 02 → 03 → 09 → 10 → 00 → 01 →

To set other memory switches, select the relevant screen using the [↓] (next screen) or [↑] (previous screen) touch switch, then make the setting.

- To confirm the settings and quit the memory switch setting screen, press the "Quit" touch switch. The settings made last will be set and the NT631/NT631C will return to the "MAINTENANCE MODE MENU" screen.
- To quit the memory switch setting screen without confirming the settings, press the "Abort" touch switch. The NT631/NT631C will return to the "MAINTENANCE MODE MENU" screen with the previous settings still in effect.

6-9-3 Setting the "Key Press Sound"

It is possible to set whether or not the key sound is sounded when a touch switch on the NT631/NT631C screen is pressed.

- ON: When a touch switch is pressed, the key sound sounds for 0.2 seconds.
- OFF: The key sound does not sound when touch switches are pressed.

The default (factory) setting is "ON".

Set the key press sound by following the menu operation from the System Menu shown below.

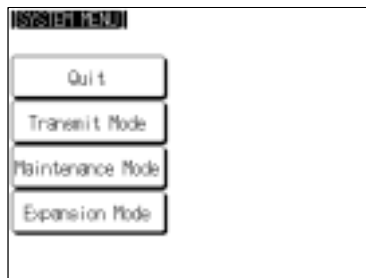

Select "Maintenance Mode".



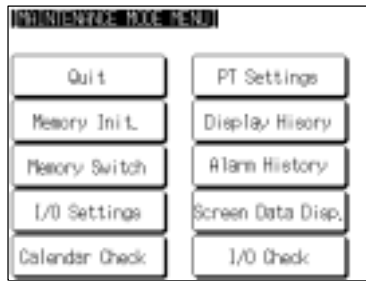

Select "Memory Switch".



Press "Key Press Sound" to display "ON" or "OFF".

The setting option changes each time the touch switch is pressed.

To set other memory switches, select the relevant screen using the [↓] (next screen) or [↑] (previous screen) touch switch, then make the setting.

- To confirm the settings and quit the memory switch setting screen, press the "Quit" touch switch. The settings made last will be set and the NT631/NT631C will return to the "MAINTENANCE MODE MENU" screen.
- To quit the memory switch setting screen without confirming the settings, press the "Abort" touch switch. The NT631/NT631C will return to the "MAINTENANCE MODE MENU" screen with the previous settings still in effect.

6-9-4 Setting the "Buzzer Sound"

The NT631/NT631C has a function for sounding a buzzer in response to an instruction from the host, or when an error occurs. It is possible to set whether or not the buzzer actually sounds with the memory switches.

- ON:
The buzzer sounds in response to instructions and when an error occurs.
- OFF:
The buzzer does not sound in response to instructions or when errors occur.
- ERROR ON:
The buzzer sounds only when an error occurs.

The default (factory) setting is "OFF".

Reference

- There are other instructions and settings relating to the buzzer, but this memory switch setting has the highest priority.
- For details on the buzzer, refer to 7-15-5 "Buzzer Function" (page 443).

Set the buzzer sound by following the menu operation from the System Menu shown below.

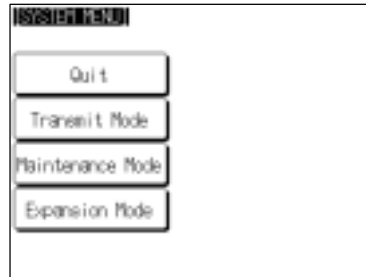

Select "Maintenance Mode".

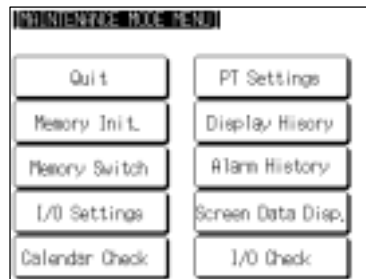

Select "Memory Switch".



Press "Buzzer Sound" to display "ON", "OFF", or "ERROR ON".

The setting option changes each time the touch switch is pressed.

To set other memory switches, select the relevant screen using the [↓] (next screen) or [↑] (previous screen) touch switch, then make the setting.

- To confirm the settings and quit the memory switch setting screen, press the "Quit" touch switch. The settings made last will be set and the NT631/NT631C will return to the "MAINTENANCE MODE MENU" screen.
- To quit the memory switch setting screen without confirming the settings, press the "Abort" touch switch. The NT631/NT631C will return to the "MAINTENANCE MODE MENU" screen with the previous settings still in effect.

6-9-5 Setting the “Printer Controller”

The NT631/NT631C has a function for printing out data at a printer connected to it in response to an instruction from the host or operation at the NT631/NT631C. Three types of printer can be connected to the NT631/NT631C: select the type used with this memory switch setting.

- ESC/P:
 - Printers that conform to the ESC/P 24-J83C (color) printer control specifications or printers that conform to the ESC/P 24-J82 (monochrome) control specifications.
- PC-PR201H:
 - Printers that can emulate the PC-PR201H, made by NEC Corp.
- PCL 5:
 - Printers that conform to the PCL 5 printer control specifications.

Note that the NT631 can only be used with the monochrome “Tone” setting and does not support color printing.

For the NT631, the “Print Method” is fixed as “Tone”.

The default (factory) setting is “ESC/P”.

- Reference**
- In addition to this setting, NT631C has the “Print Method” setting (page 192).
 - For details on the print function, refer to 7-15-7 “Print Function” (page 446).

Set the printer controller setting by following the menu operation from the System Menu shown below.

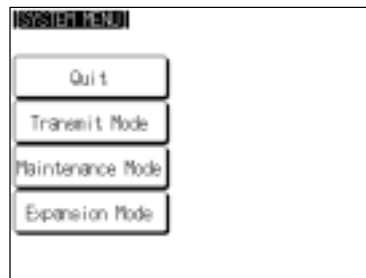

Select “Maintenance Mode”.

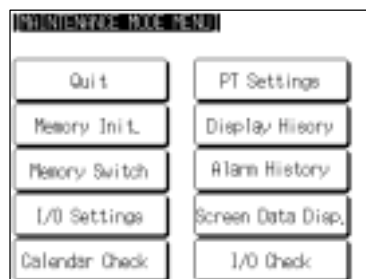

Select “Memory Switch”.





Press "Printer Controller" to display the required printer type.

The setting option changes each time the touch switch is pressed.

To set other memory switches, select the relevant screen using the [↓] (next screen) or [↑] (previous screen) touch switch, then make the setting.

- To confirm the settings and quit the memory switch setting screen, press the "Quit" touch switch. The settings made last will be set and the NT631/NT631C will return to the "MAINTENANCE MODE MENU" screen.
- To quit the memory switch setting screen without confirming the settings, press the "Abort" touch switch. The NT631/NT631C will return to the "MAINTENANCE MODE MENU" screen with the previous settings still in effect.

6-9-6 Setting the "Print Method" (NT631C Only)

The NT631/NT631C has a function for printing out data at a printer connected to it in response to an instruction from the host or operation at the NT631/NT631C.

When using the NT631C, the currently displayed screen image or other data can be printed out in color. You can select whether screen data is actually printed out in color, or in monochrome tones that represent colors, with this memory switch setting.

When PCL 5 is set for Printer Controller, the setting is fixed as "Tone".

- Color: Color images are printed in color.
- Tone: Color images are printed in monochrome tones.

The default (factory) setting is "Tone".

- Reference**
- In addition to this setting, NT631C has the "Printer Controller" setting (page 191).
 - For details on the print function, refer to 7-15-7 "Print Setting" (page 446).

Set the print method setting by following the menu operation from the System Menu shown below.

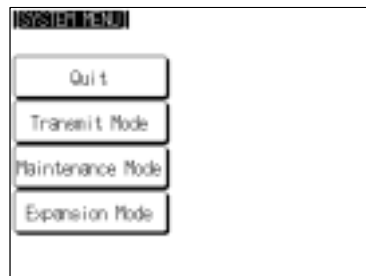

Select "Maintenance Mode".



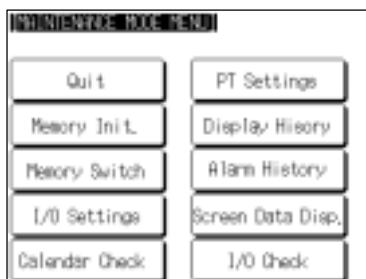

Select "Memory Switch".

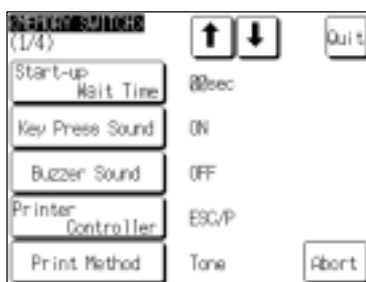

Press "Print Method" to display the required printing method.

The setting option changes each time the touch switch is pressed.

To set other memory switches, select the relevant screen using the [↓] (next screen) or [↑] (previous screen) touch switch, then make the setting.

- To confirm the settings and quit the memory switch setting screen, press the "Quit" touch switch. The settings made last will be set and the NT631/NT631C will return to the "MAINTENANCE MODE MENU" screen.
- To quit the memory switch setting screen without confirming the settings, press the "Abort" touch switch. The NT631/NT631C will return to the "MAINTENANCE MODE MENU" screen with the previous settings still in effect.

6-9-7 Setting “Screen Saver Movement”

The NT631/NT631C has a function to prevent the formation of an afterimage by turning off the screen display if no operation is performed for a certain period of time, and then displaying character strings at random positions and in random colors (the colors only change for the NT631C).

The “Screen Saver Movement” setting determines whether or not these character strings are displayed while the screen display is off.

If “Display” is selected, the character string stored in character string memory table No. 0 is displayed.

If “Display erase” is selected, the character string is not displayed, and the backlight is also turned off while the screen display is off.

The default (factory) setting is “Display erased”.

The screen saver can be canceled, and former screen redisplayed, by any of the following operations.

- Touching any part of the touch panel
- Screen switching due to PT status control area operations
- Screen switching due to bit memory table operations
- Execution of any of the following PT status control bit operations:
 - Changing the backlight mode
 - Screen printing (change from OFF to ON)
 - Screen display (change from OFF to ON)

Reference

- The time before the screen is turned OFF is set by the “Screen Saver Start up Time” setting. For details, refer to 6-9-8 “Setting the Screen Saver Start-up Time” (page 196).
- Even if its operation has been set with the “Screen Saver Movement” setting, the screen saver function will not be executed if “000” is set for “Screen Saver Start up Time”.
- Screen saver function is enabled only through “RUN” mode of NT631/NT631C. In “System Menu” or “System Installer” mode, this function is not started.

Set the screen saver operation by following the menu operation from the System Menu shown below.

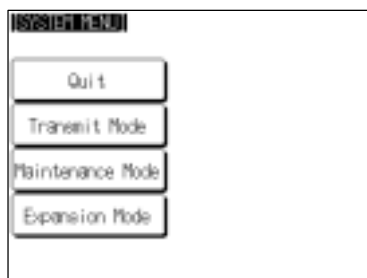

Select “Maintenance Mode”.

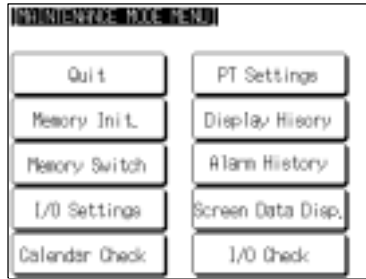

Select "Memory Switch".



Press [↓] (next screen) or [↑] (previous screen) to display the second memory switch setting screen.



Press "Screen Saver Movement" to display "Display" or "Display erased".

The setting option changes each time the touch switch is pressed.

To set other memory switches, select the relevant screen using the [↓] (next screen) or [↑] (previous screen) touch switch, then make the setting.

- To confirm the settings and quit the memory switch setting screen, press the "Quit" touch switch. The settings made last will be set and the NT631/NT631C will return to the "MAINTENANCE MODE MENU" screen.
- To quit the memory switch setting screen without confirming the settings, press the "Abort" touch switch. The NT631/NT631C will return to the "MAINTENANCE MODE MENU" screen with the previous settings still in effect.

6-9-8 Setting the Screen Saver Start-up Time

The NT631/NT631C has a function to maximize the service life of the backlight and prevent the formation of an afterimage by turning off the screen display and the backlight if no operation is performed for a certain period of time.

The "Screen Saver Start up Time" setting determines the time interval before the screen saver function operates.

The setting range is 0 to 255 minutes. The default (factory) setting is 10 minutes. If "000" is set, the screen saver function does not operate.

The screen saver can be canceled, and previous screen redisplayed, by any of the following operations.

- Touching any part of the touch panel
- Screen switching due to PT status control area operations
- Screen switching due to bit memory table operations
- Execution of any of the following PT status control bit operations:
 - Changing the backlight mode
 - Screen printing (change from OFF to ON)
 - Screen display (change from OFF to ON)

Reference

- It is possible to display the character string stored in character string memory table No. 0 at random positions and in random colors while the screen display is off. For details, refer to 6-9-7 "Setting Screen Saver Movement" (page 194). Note however that, when this feature is used, the backlight does not go off.
- For details on the screen saver function, refer to 7-15-4 "Screen Saver Function" (page 442).
- Screen saver function is enabled only through "RUN" mode of NT631/NT631C. In "System Menu" or "System Installer" mode, this function is not started.

Set the screen saver start-up time by following the menu operation from the System Menu shown below.

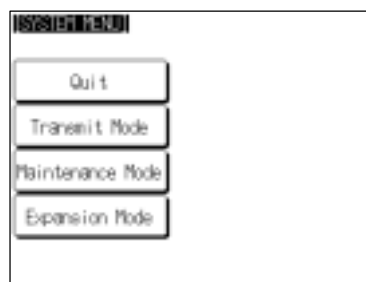

Select "Maintenance Mode".

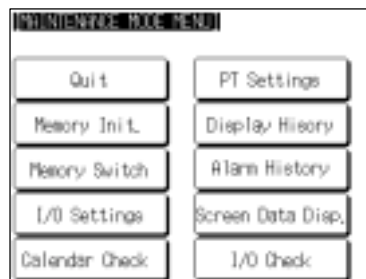

Select "Memory Switch".





Press [↓] (next screen) or [↑] (previous screen) to display the second memory switch setting screen.



Set a time in the input field to the right of "Screen Saver Start up Time".

Each of the digits can be incremented or decremented by pressing the associated "+" and "-" keys.

To set other memory switches, select the relevant screen using the [↓] (next screen) or [↑] (previous screen) touch switch, then make the setting.

- To confirm the settings and quit the memory switch setting screen, press the "Quit" touch switch. The settings made last will be set and the NT631/NT631C will return to the "MAINTENANCE MODE MENU" screen.
- To quit the memory switch setting screen without confirming the settings, press the "Abort" touch switch. The NT631/NT631C will return to the "MAINTENANCE MODE MENU" screen with the previous settings still in effect.

6-9-9 Setting the History Display Method

The NT631/NT631C features the "display history record function", which records the time at which screens are displayed during operation and the number of times they are displayed, and the "alarm history record function", which continually monitors bit statuses at the host and records the time when bits come ON and the number of times they come ON.

The "Hist. Disp. Method" setting determines whether — when these record data are displayed in "sort by occurrence" — the records are displayed in a progression from newest to oldest or from oldest to newest.

- From Old Data:
The records are displayed in sequence from the oldest to newest.
- From New Data:
The records are displayed in sequence from the newest to oldest.

The default (factory) setting is "From New Data".

Reference When the voltage of the NT631/NT631C's built-in battery becomes low, the history record contents cannot be retained.

For details on the display history record function and the alarm history record function, refer to 7-15-1 "Display History Record Function" (page 435) and 7-15-2 "Alarm History Record Function" (page 438).

Set the history display method by following the menu operation from the System Menu shown below.

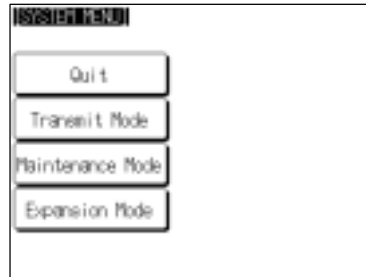

Select "Maintenance Mode".

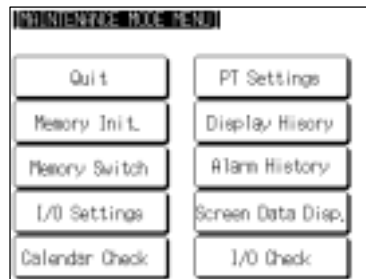

Select "Memory Switch".



Press [↓] (next screen) or [↑] (previous screen) to display the second memory switch setting screen.



Press "Hist. Disp. Method" to display the required display order.

The setting option changes each time the touch switch is pressed.

To set other memory switches, select the relevant screen using the [↓] (next screen) or [↑] (previous screen) touch switch, then make the setting.

- To confirm the settings and quit the memory switch setting screen, press the "Quit" touch switch. The settings made last will be set and the NT631/NT631C will return to the "MAINTENANCE MODE MENU" screen.
- To quit the memory switch setting screen without confirming the settings, press the "Abort" touch switch. The NT631/NT631C will return to the "MAINTENANCE MODE MENU" screen with the previous settings still in effect.

6-9-10 Setting the Resume Function

The NT631/NT631C has a function to keep the contents of the memory tables even when the power to the NT631/NT631C is OFF and write back them to the host when the power is turned ON.

If the resume function is OFF, the memory tables are initialized to these initial values on switching to the RUN mode. If the resume function is ON, these are not initialized and are kept the battery-backed contents.

When the memory table is initialized, its contents are reset to the initial state that is set by the Support Tool.

When the system is started up the next time, the screen is displayed using the previous contents of the memory table.

- ON: The resume function is used.
- OFF: The resume function is not used.

The default (factory) setting is "OFF".

Reference

- When the voltage of the NT631/NT631C's built-in battery becomes low, the memory table contents cannot be retained even if "ON" is set for the resume function.
- For details on the resume record function, refer to 7-15-3 "Resume Function" (page 441).

Set the resume function by following the menu operation from the System Menu shown below.

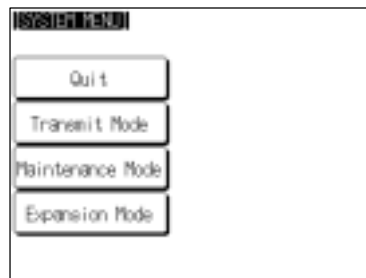

Select "Maintenance Mode".

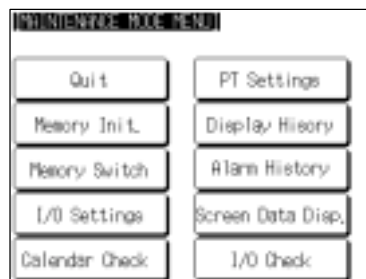

Select "Memory Switch".



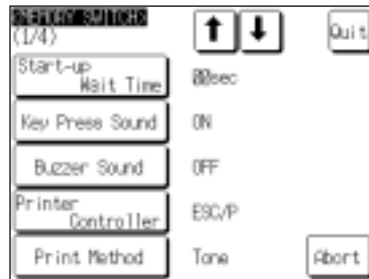

Press [↓] (next screen) or [↑] (previous screen) to display the second memory switch setting screen.



Press "Resume Function" to display the required setting.

The setting option changes each time the touch switch is pressed.

To set other memory switches, select the relevant screen using the [↓] (next screen) or [↑] (previous screen) touch switch, then make the setting.

- To confirm the settings and quit the memory switch setting screen, press the "Quit" touch switch. The settings made last will be set and the NT631/NT631C will return to the "MAINTENANCE MODE MENU" screen.
- To quit the memory switch setting screen without confirming the settings, press the "Abort" touch switch. The NT631/NT631C will return to the "MAINTENANCE MODE MENU" screen with the previous settings still in effect.

6-9-11 Setting the Automatic Reset Function

The NT631/NT631C has a function for ignoring communication errors and automatically returning to the RUN mode when they occur.

The "Comm. Auto-return" setting determines whether the automatic reset function is effective or not.

- ON:
When a communication error occurs, the NT631/NT631C automatically returns to the RUN mode without displaying an error screen (the "System Initializing" screen may be displayed).
- OFF:
When a communication error occurs, an error screen is displayed and operation stops. Pressing "OK" on the error screen returns the NT631/NT631C to the RUN mode.

The default (factory) setting is "OFF".

- Reference**
- If a communication error occurs when “OFF” is set for “Comm. Auto-return”, the NT631/NT631C makes the number of attempts at communication with the host specified by the setting for the “Retry Counts” touch switch (page 203). If communication cannot be re-established in any of these attempts, an error screen is displayed.
 - For details on communication errors, refer to 11-2-5 “Communication Errors and Their Remedies” (page 615).

Set the automatic reset function by following the menu operation from the System Menu shown below.

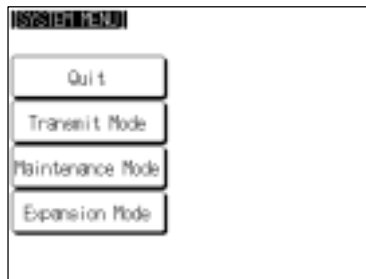

Select “Maintenance Mode”.

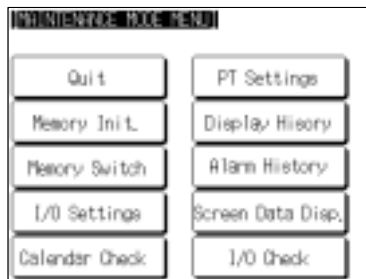

Select “Memory Switch”.

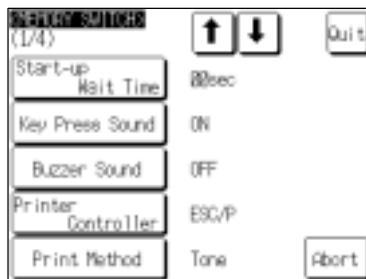

Press [↓] (next screen) or [↑] (previous screen) to display the third memory switch setting screen.

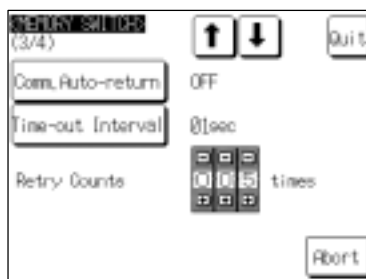

Press “Comm. Auto-return” to display the required setting.

The setting option changes each time the touch switch is pressed.

To set other memory switches, select the relevant screen using the [↓] (next screen) or [↑] (previous screen) touch switch, then make the setting.

- To confirm the settings and quit the memory switch setting screen, press the “Quit” touch switch. The settings made last will be set and the NT631/NT631C will return to the “MAINTENANCE MODE MENU” screen.
- To quit the memory switch setting screen without confirming the settings, press the “Abort” touch switch. The NT631/NT631C will return to the “MAINTENANCE MODE MENU” screen with the previous settings still in effect.

6-9-12 Setting the Time-out Interval

The NT631/NT631C goes into the time-out error status if no response is received from the host within a fixed time. The “Time-out Interval” setting specifies the time lapse at which time-out is judged to have occurred.

The setting range is 0 to 10 seconds. The default (factory) setting is 1 second.

Reference Whether or not an error screen is displayed when a time-out error occurs is determined by the setting for the “Comm. Auto-return” memory switch.

Set the time-out interval by following the menu operation from the System Menu shown below.

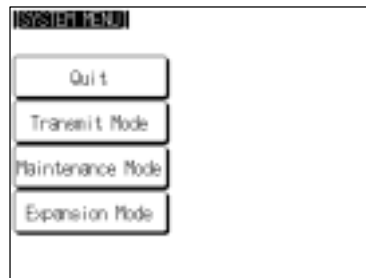

Select “Maintenance Mode”.

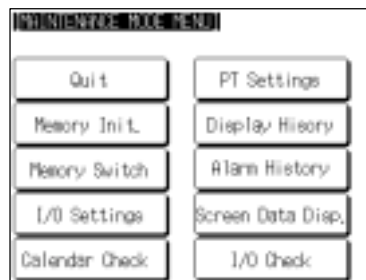

Select “Memory Switch”.



Press [↓] (next screen) or [↑] (previous screen) to display the third memory switch setting screen.



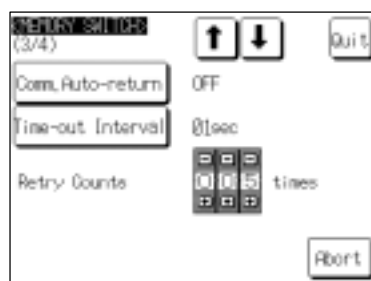

Press “Time-out Interval” to display the required time lapse.

The setting option changes each time the touch switch is pressed, according to the following sequence.

01 → 02 → 03 → 09 → 10 → 00 → 01 →

To set other memory switches, select the relevant screen using the [↓] (next screen) or [↑] (previous screen) touch switch, then make the setting.

- To confirm the settings and quit the memory switch setting screen, press the “Quit” touch switch. The settings made last will be set and the NT631/NT631C will return to the “MAINTENANCE MODE MENU” screen.
- To quit the memory switch setting screen without confirming the settings, press the “Abort” touch switch. The NT631/NT631C will return to the “MAINTENANCE MODE MENU” screen with the previous settings still in effect.

6-9-13 Setting the Retry Count

The NT631/NT631C does not immediately display an error screen when a communication error occurs, but tries to re-establish communication. The “Retry Counts” setting specifies the number of attempts to be made to re-establish communication. If communication cannot be recovered within this number of attempts, the following happens depending on the setting made for the “Comm. Auto-return” memory switch (page 200).

- Comm. Auto-return “ON”:

Operation in the RUN mode is continued without displaying an error screen. Regardless of the setting made for “Retry Counts”, attempts to re-establish communication are repeated until normal communication is achieved.

- Comm. Auto-return “OFF”:

The RUN mode is ended and an error screen is displayed. On pressing the “OK” touch switch on the error screen, the screen displayed immediately before is re-displayed and attempts are made to re-establish communication.

The System Menu can be displayed from the error screen by pressing any two of the four corners of the touch panel simultaneously.

The setting range is 0 to 255 times. The default (factory) setting is 5 times.

Reference

For details on communication errors, refer to 11-2-5 “Communication Errors and Their Remedies” (page 615).

Set the retry count by following the menu operation from the System Menu shown below.

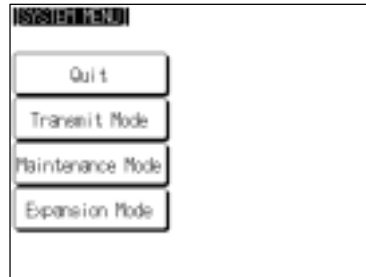

Select "Maintenance Mode".

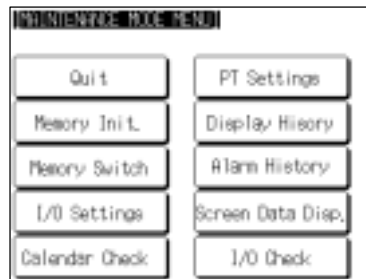

Select "Memory Switch".



Press [↓] (next screen) or [↑] (previous screen) to display the third memory switch setting screen.

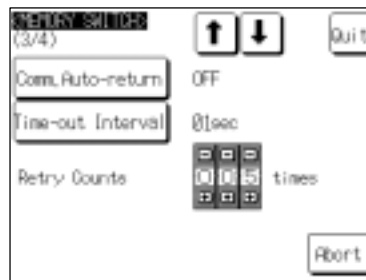

Set a number of times in the input field to the right of "Retry Counts".

Each of the digits can be incremented or decremented by pressing the associated "+" and "-" keys.

To set other memory switches, select the relevant screen using the [↓] (next screen) or [↑] (previous screen) touch switch, then make the setting.

- To confirm the settings and quit the memory switch setting screen, press the "Quit" touch switch. The settings made last will be set and the NT631/NT631C will return to the "MAINTENANCE MODE MENU" screen.
- To quit the memory switch setting screen without confirming the settings, press the "Abort" touch switch. The NT631/NT631C will return to the "MAINTENANCE MODE MENU" screen with the previous settings still in effect.

6-10 Setting the Bar Code Reader Input Function

The NT631/NT631C has a bar code reader input function which allows a bar code reader to be connected and bar code data to read as character strings into character string input fields.

This section describes the communication conditions for the bar code reader and the setting method for confirming the input data.

- Reference**
- For details on bar code reader types and connection methods, refer to 3-4 “Connecting a Bar Code Reader” (page 43) and for details on how to use a bar code reader refer to “Inputting a Character String Using a Bar Code Reader” (page 522).
 - The bar code reader is connected to serial port A. This means that serial port B must be used for communications with the host.

Communication Condition Settings for Bar Code Readers

Setting Item	Function	Setting Options	Page
Data bit length	Sets the bit length for the data bits.	7* or 8 bits	Page 206
Stop bit length	Sets the stop bit length for the data.	1 or 2* bits	Page 206
Parity bit	Sets the parity bit for the data.	None, odd, even*	Page 206
Communications speed	Sets the communications speed for the bar code reader	4800, 9600*, or 19200 bps	Page 206
Input method	Sets the method for confirming data when it is input to a character string input field. Manual: The data is confirmed with a touch switch. The data can be corrected and character strings can be added. Auto: The data is automatically confirmed when it is input.	Manual*, Auto	Page 206

* Default (factory) setting

Setting the Communication Conditions and Setting Method

Set the bar code reader communication conditions and method of confirmation at input by following the menu operation from the System Menu shown below.

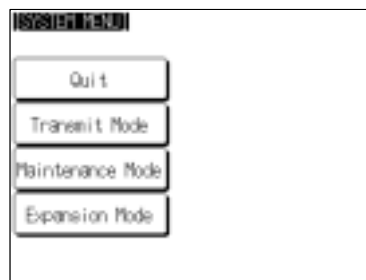

Select "Maintenance Mode".



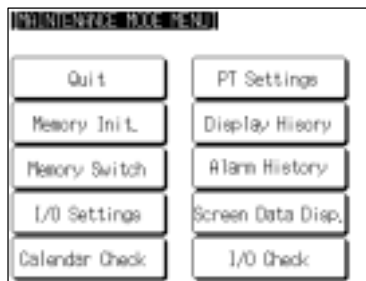

Select "Memory Switch".



Press [↓] (next screen) or [↑] (previous screen) to display the fourth memory switch setting screen.

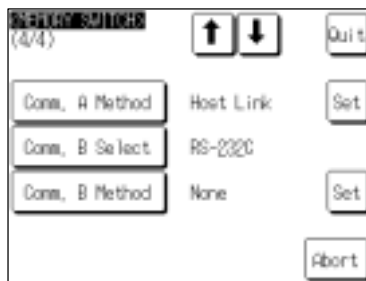

Press "Comm. A Method" to select "Bar-Code Reader".

The setting option changes each time the touch switch is pressed.

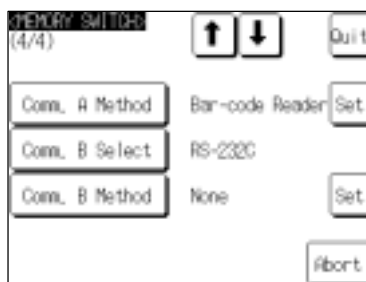

Press the "Set" touch switch to the right of "Comm. A Method".

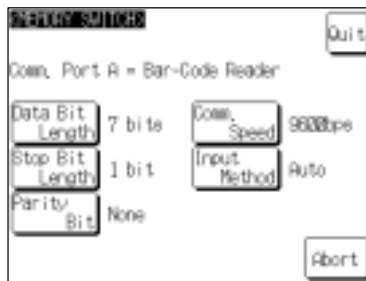

Display the required setting for each item by pressing the touch switches.

The setting option changes each time the touch switch is pressed.



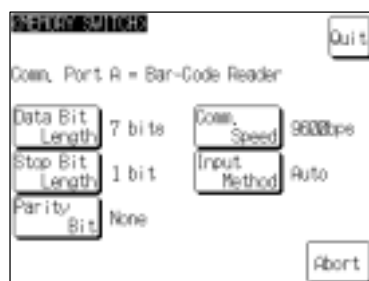

Press "Quit".

Pressing "Abort" on the communication condition/confirmation method setting screen causes the NT631/NT631C to return to the memory switch setting screen (4/4) without executing setting (with the previous settings still effective).

On completion of communication condition/confirmation method setting, the NT631/NT631C returns to the memory switch setting screen (4/4).

To set other memory switches, select the relevant screen using the [↓] (next screen) or [↑] (previous screen) touch switch, then make the setting.

- To confirm the settings and quit the memory switch setting screen, press the "Quit" touch switch. The settings made last will be set and the NT631/NT631C will return to the "MAINTENANCE MODE MENU" screen.
- To quit the memory switch setting screen without confirming the settings, press the "Abort" touch switch. The NT631/NT631C will return to the "MAINTENANCE MODE MENU" screen with the previous settings still in effect.

6-11 System Maintenance

The NT631/NT631C has the following maintenance and check functions.

Item		Function	Page
I/O Settings		Adjustment of display panel contrast and brightness of the backlight.	Page 208
Calendar Check		Display and setting of the time data of the NT631/NT631C clock function.	Page 211
PT Settings		Direct connection setting of the screen data in the NT631/NT631C and display of the setting statuses of the serial ports.	Page 213
Display history record		Display and printing of display history record data.	Page 215
Alarm history record		Display and printing of alarm history record data.	Page 217
Screen data check		Display of each screen stored in the NT631/NT631C.	Page 219
I/O check	Device check	Checking of the I/O functions of the NT631/NT631C.	Page 222
	I/F check	Checking of the communication functions of the NT631/NT631C.	Page 231

This section describes how to use these functions.

6-11-1 I/O Settings

This function is used to adjust the contrast of the display panel and the brightness of the backlight.

Contrast Adjustment (for NT631C–ST141□–EV1 only)

The NT631C–ST141□–EV1 allows the contrast to be adjusted in 100 steps. The “CONTRAST ADJUST” screen enables you to make the adjustment while actually checking the contrast on the screen. Once the contrast has been set, it remains in effect even if the power is turned OFF or the NT631/NT631C is reset (and even if the voltage of the built-in battery becomes low).

Adjust the contrast of the display panel by following the menu operation from the System Menu shown below.

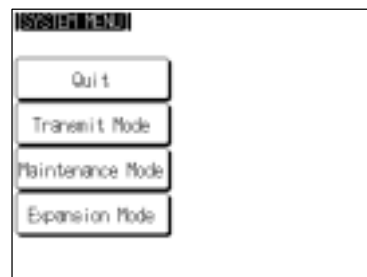

Select “Maintenance Mode”.

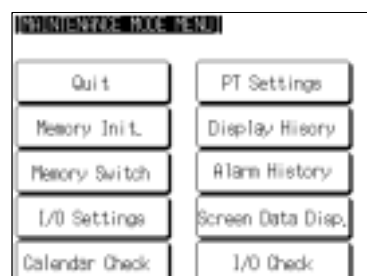

Select “I/O Settings”.



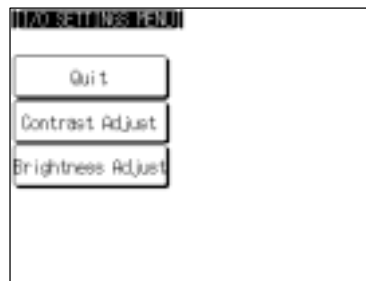

Select "Contrast Adjust".

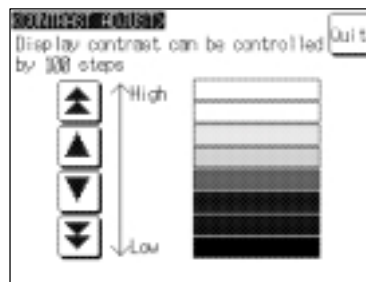

Adjust the contrast with the touch switches in the left half of the screen.

- [▲]: Increase 10 steps
- [▲]: Increase 1 step
- [▼]: Decrease 1 step
- [▼]: Decrease 10 steps

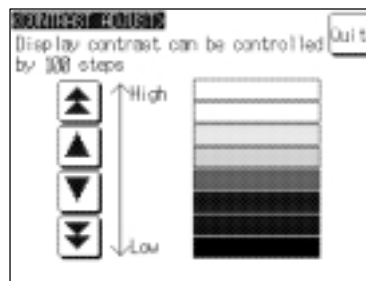

Press "Quit".

The contrast is set and the NT631/NT631C returns to the "I/O SETTINGS MENU" screen.

Backlight Brightness Adjustment (for NT631C-ST141□-EV1 only)

The NT631C-ST141□-EV1 allows the brightness of the backlight to be adjusted in 3 steps. The "BRIGHTNESS ADJUST" screen enables you to make the adjustment while actually checking the brightness on the screen.

Reference

In the NT631C-ST151□-EV1, adjustment is not possible even though this screen is displayed.

Adjust the backlight brightness by following the menu operation from the System Menu shown below.

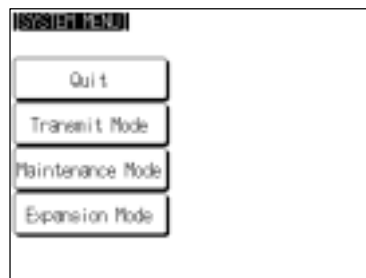

Select "Maintenance Mode".



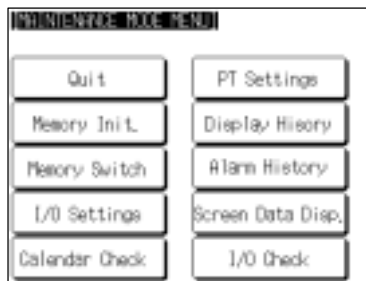

Select "I/O Settings".

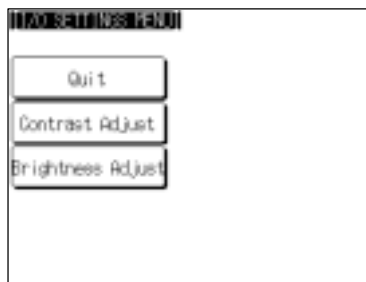

Select "Brightness Adjust".

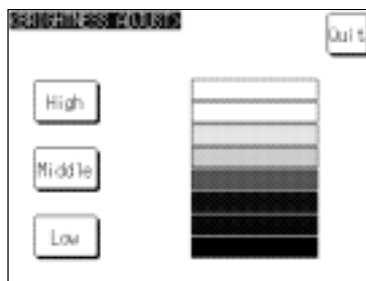

Adjust the contrast with the "High", "Middle", and "Low" touch switches in the left half of the screen.

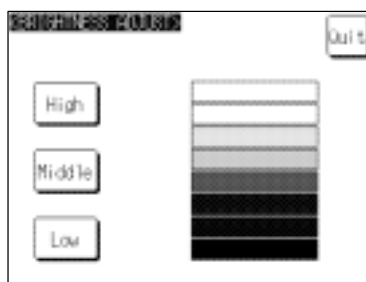

Press "Quit".

The contrast is set and the NT631/NT631C returns to the "I/O SETTINGS MENU" screen.

6-11-2 Displaying/Setting the Calendar and Clock

The NT631/NT631C has a “clock function” for setting and displaying the date and time.

This section describes how to display and set the clock data by menu operation from the System Menu.

Reference

- The clock function does not strictly check the date and day of the week settings. When setting the clock data, be sure to set the correct date and day of the week. If a mistake is made — for example entering a value in the range 13 to 19 when entering the month — the buzzer sounds three times. Make sure that the data is correct when the month changes.
- Numeral memory tables 247 to 255 are reserved for the clock function. Clock data can be displayed and set during operation of the NT631/NT631C by using these numeral memory tables.
- For details on the clock function, refer to 7-15-6 “Clock Function” (page 445).
- No clock data is set on shipment from the factory.
- The clock data is backed up by the built-in battery of the NT631/NT631C. If the battery voltage becomes low, the clock data cannot be retained when the power to the NT631/NT631C is turned OFF or the NT631/NT631C is reset and the clock function will not operate correctly.
- When writing to the screen data memory is disabled by the setting made for “System Setting” in the System Installer mode, it is not possible to set the date and time.

Display/set clock data by following the menu operation from the System Menu shown below.

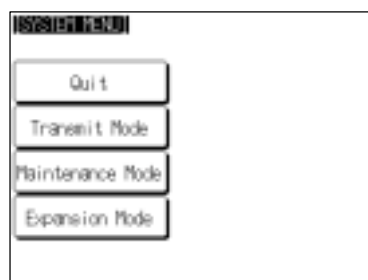

Select “Maintenance Mode”.

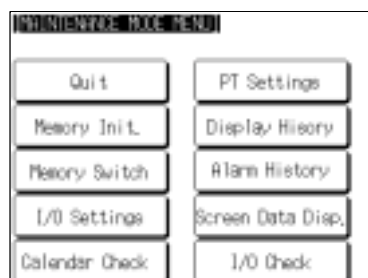

Select “Calendar Check”.





Press "Set".

If you are just checking the display, press "Quit" at this point; the NT631/NT631C will return to the "MAINTENANCE MODE MENU" screen.

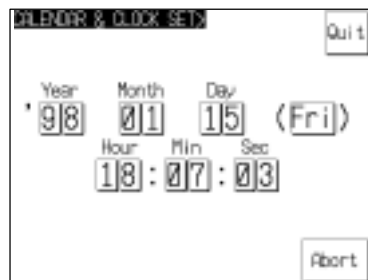

Set the date.

Each of the digits of the year, month, date, hour, minute, and second settings, and the day of the week setting, are touch switches: press these touch switches to change the corresponding settings.

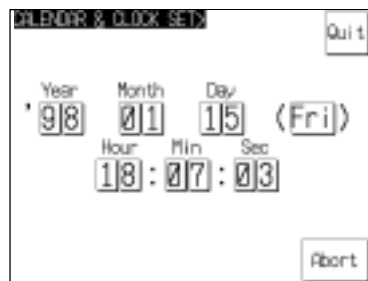

Press "Quit".

The clock data is set and the NT631/NT631C returns to the date and time display.

- Pressing "Abort" causes the NT631/NT631C to return to the date and time display without executing setting (with the previous settings still effective).

6-11-3 Checking the PT Setting Status

The direct connection settings of the NT631/NT631C screen data, and the settings for serial port A and serial port B, can be checked.

Screen Configuration and Display Contents

There are the following three PT setting status screens.

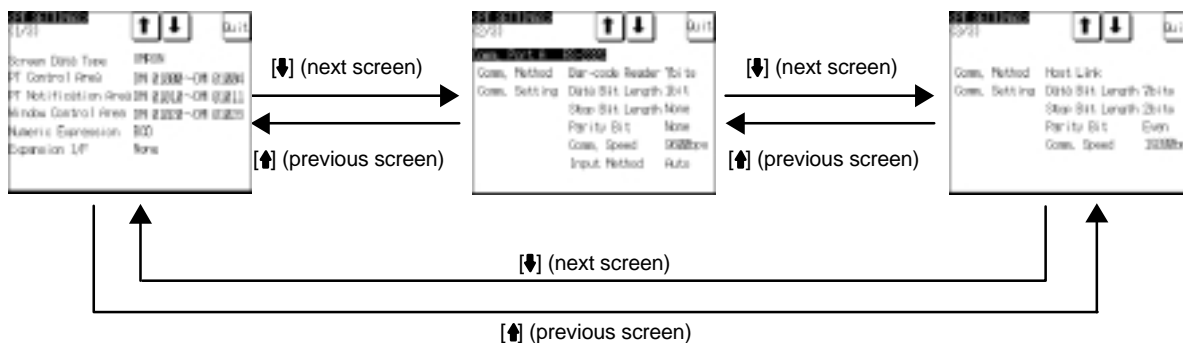

- Display contents of the first screen

Item	Meaning
Screen Data Type	The host type set for the screen data
PT Control Area	Word at the host to which the PT status control area is allocated
PT Notification Area	Word at the host to which the PT status notify area is allocated
Window Control Area	Word at the host to which the window control area is allocated
Numeric Expression	Default for the method of interpretation of the contents of host words to which numeral memory tables are allocated (numeric value storage method).
Expansion I/F	Type of unit installed at the expansion interface connector

- Display contents of the second screen

Item	Meaning
Comm. Port A	Communication type set for serial port A (fixed as RS-232C)
Comm. Method	Communication method set for serial port A
Comm. Setting	Communication conditions set for serial port A (display contents differ according to the communication method)

- Display contents of the third screen

Item	Meaning
Comm. Port B	Communication type set for serial port B (RS-232C/RS-422A)
Comm. Method	Communication method set for serial port B
Comm. Setting	Communication settings set for serial port B (display contents differ according to the communication method)

Display Method

Display the PT setting statuses by following the menu operation from the System Menu shown below.

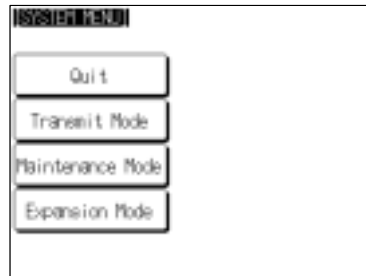

Select "Maintenance Mode".

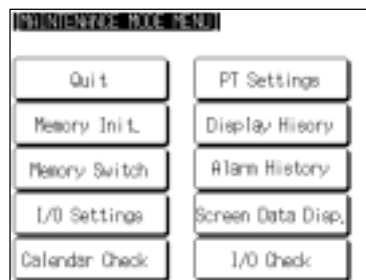

Select "PT Settings".

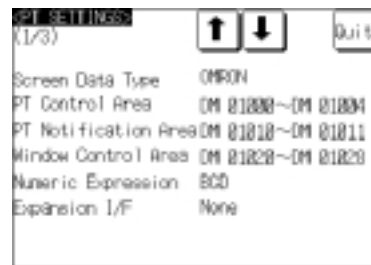

Switch the screen as required by pressing the [↓] (next screen) or [↑] (previous screen) touch switch.

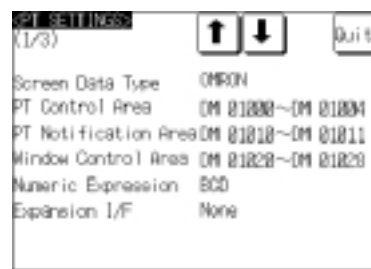

Press "Quit".

The NT631/NT631C returns to the "MAINTENANCE MODE MENU" screen.

6-11-4 Displaying and Printing the Display History Record

The “display history record function” is a function that records the order of display of each screen during operation, and the number of times each screen is displayed. Only the screens for which the “display history” screen attribute has been set in advance are processed by this function.

The record data can be displayed, and printed out at a printer connected to the NT631/NT631C by operation from the System Menu.

This section explains how to display and print out the display history record data recorded in the NT631/NT631C.

Note that there are two display methods “sort by occurrence” (display time order) and “sort by frequency” (order of number of times displayed).

Reference

- With the NT631/NT631C, the record data can also be displayed by calling screen No. 9001 (sort by occurrence) or screen No. 9002 (sort by frequency) during the RUN mode.
- For details on the display history record function, refer to 7-15-1 “Display History Record Function” (page 435).
- The order of display for “sort by occurrence” display (from oldest record or from newest record) is set with the “Hist. Disp. Method” memory switch (page 197).
- The printing method and other information must be set in advance with the “Printer Controller” (page 191) and “Print Method” (page 192) memory switches.

Display and print the display history record data by following the menu operation from the System Menu shown below.

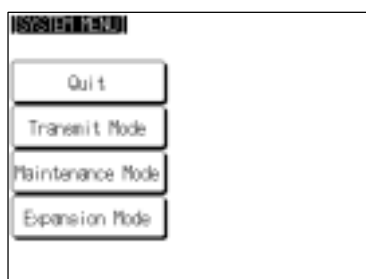

Select “Maintenance Mode”.

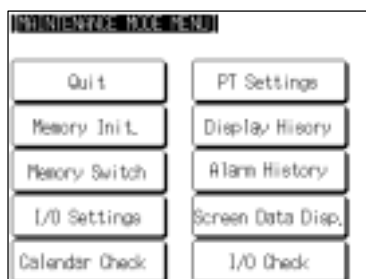

Select “Display History”.



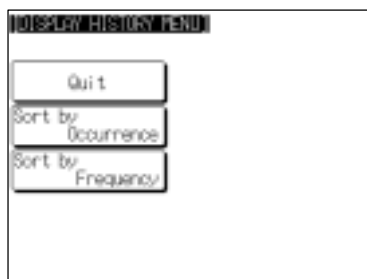

Select "Sort by Occurrence" or "Sort by Frequency".

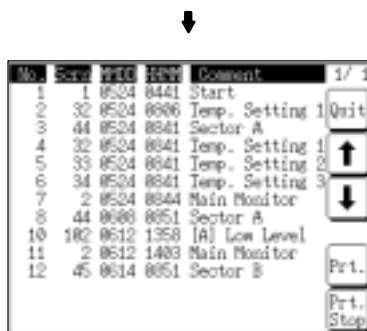

If necessary, select the next or previous screen by pressing [↓] (next screen) or [↑] (previous screen).

The example screen to the left shows a display for the "sort by occurrence" method (from oldest record).

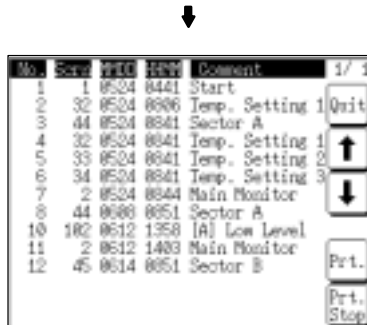

If required, press "Prt." to print the display history record data.

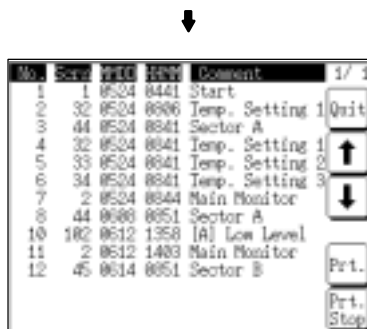

Press "Quit".

The NT631/NT631C returns to the "DISPLAY HISTORY MENU" screen.

• Example print-out

All of the recorded data is printed out in the same order as on the currently displayed screen.

Example: "Sort by occurrence", from oldest record

No.	Scrn	YY/MM/DD	HH:MM	Comment	01/01
1	1	98/01/12	10:21	Coolant Error	
2	2	98/01/12	11:53	Motor Error	
3	8	98/01/13	09:35	Compressor Error	
4	2000	98/01/13	14:22	Emergency Stop	

6-11-5 Displaying and Printing the Alarm History Record

The “alarm history record function” is a function that continually monitors, during operation, the status of bits at the host designated in advance with a bit memory table, and records the time when these bits come ON, and the number of times they come ON.

The record data can be displayed, and printed out at a printer connected to the NT631/NT631C by operation from the System Menu.

This section explains how to display and print out the alarm history record data recorded in the NT631/NT631C.

Note that there are two display methods “sort by occurrence” (“ON” time order) and “sort by frequency” (order of number of times the bits have come “ON”).

- Reference**
- With the NT631/NT631C, the record data can also be displayed by registering an “alarm history” display element on the screen.
 - For details on the alarm history record function, refer to 7-15-2 “Alarm History Record Function” (page 438).
 - The order of display for “sort by occurrence” display (from oldest record or from newest record) is set with the “Hist. Disp. Method” memory switch (page 197).
 - The printing method and other information must be set in advance with the “Printer Controller” (page 191) and “Print Method” (page 192) memory switches.

Display and print the alarm history record data by following the menu operation from the System Menu shown below.

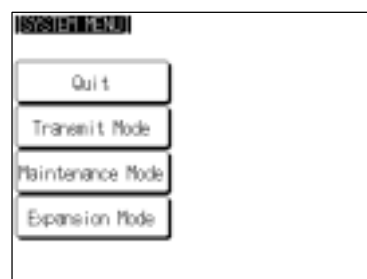

Select “Maintenance Mode”.

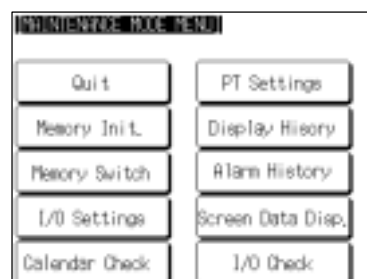

Select “Alarm History”.



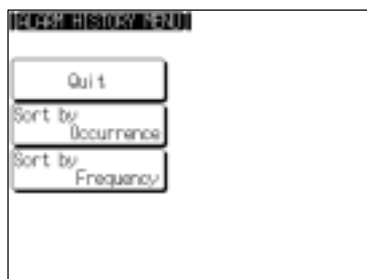

Select "Sort by Occurrence" or "Sort by Frequency".



If necessary, select the next or previous screen by pressing [↓] (next screen) or [↑] (previous screen).

The example screen to the left shows a display for the "sort by occurrence" method (from oldest record).

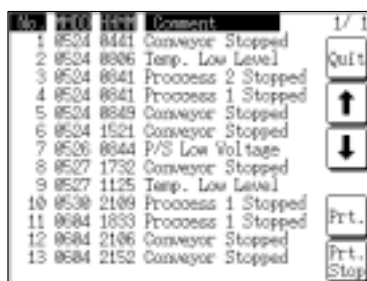

If required, press "Prt." to print the display history record data.



Press "Quit".

The NT631/NT631C returns to the "ALARM HISTORY MENU" screen.

• Example print-out

All of the recorded data is printed out in the same order as on the currently displayed screen.

Example: "Sort by occurrence" method, from oldest record

No.	Comment	YY/MM/DD	HH:MM	01/01
1	Remote I/O Error	98/02/06	16:02	
2	PIC Unit Error	98/02/07	09:21	
3	Cycle Time Over	98/02/17	15:44	

6-11-6 Checking Screen Data

The NT631/NT631C allows the registered screens (Nos. 1 to 3999) to be displayed and checked by operation from the System Menu.

- Reference**
- Window screens cannot be displayed by operation from the System Menu.
 - Only the user screens (Nos. 1 to 3999) can be displayed. Screens for system use cannot be displayed.

- Specifying the display method
Specify the display method for the screens as indicated in the table below.

Setting Item	Function	Setting Options
Display of Lamp/ Touch SW No.	Allows designation of whether the bit number of the lamp bit set for a lamp or touch switch is displayed or not. The display format is as follows "L□○○○○○○○○" (□: area type, ○○○○○○○○: bit number).	ON, OFF*
Display of Memory Table No.	Allows designation of whether the table numbers of numeral and character string memory tables are displayed or not. The display format for numeral memory tables is "N○○○○" and the display format for character string memory tables is "S○○○○". This function is valid for the following display elements. - Numeral displays - Character string displays - Bar graphs - Numeral setting input fields (including thumbwheel type) - Character string input fields	ON, OFF*
Display of image/ Library No.	Allows designation of whether image/library code numbers are displayed or not.	ON, OFF*
Display of Broken Line Frame	Allows designation of whether or not broken line frames are displayed around the display elements for showing the positions registered.	ON, OFF*

* Default (factory) setting

- Reference**
- Each setting of the screen data check is effective only on this menu. Exiting from this screen data check menu resets the settings to the default (all the settings are set to "OFF").

- Operations on the "SCREEN DATA CHECK" screen
The function shown below can be set on the "SCREEN DATA CHECK" screen. Use this function as required when displaying complex screens on which multiple display elements have been registered overlapping each other.

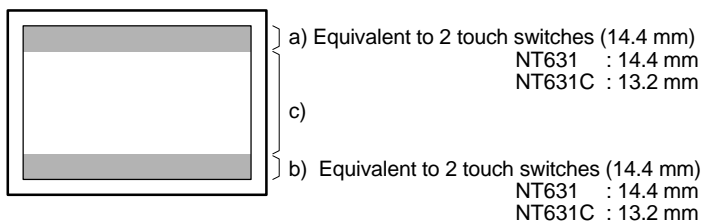

- a) Display the previous display element on the upper most portion of the screen in the order in which the display elements were registered (excluding fixed display elements).
- b) Display the next display element on the upper most portion of the screen in the order in which the display elements were registered (excluding fixed display elements).
- c) Return to the screen on which screens are specified.

Displaying the “SCREEN DATA CHECK” Screen

Display the “SCREEN DATA CHECK” screen by following the menu operation from the System Menu shown below.

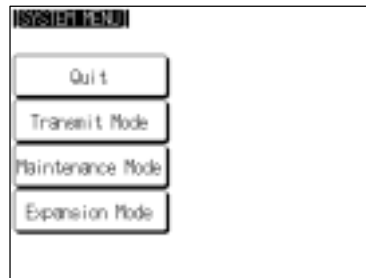

Select “Maintenance Mode”.

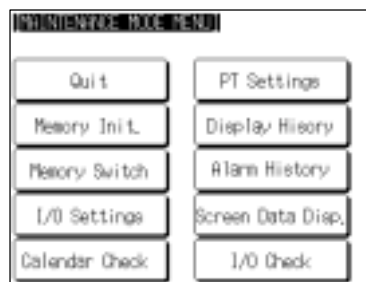

Select “Screen Data Disp.”

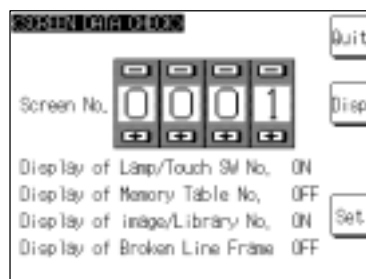

Specify the screen to be displayed in the input field in the middle of the screen.

Each of the digits can be incremented or decremented by pressing the associated “+” and “-” keys.

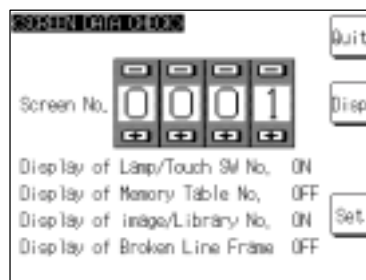

Press “Set”.



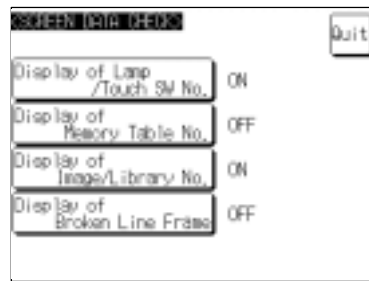

Press the touch switches to specify the display method in each case.

The setting option changes each time a touch switch is pressed.

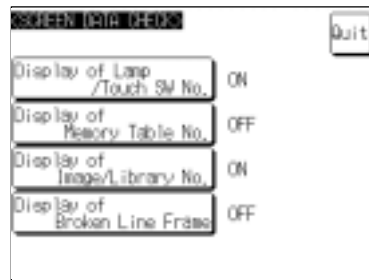

Press "Quit" to return to the screen number selection screen.

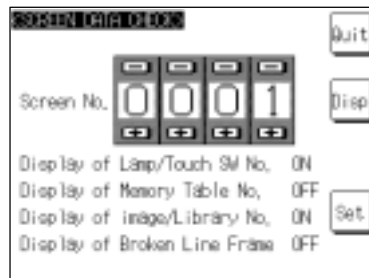

Press "Disp".

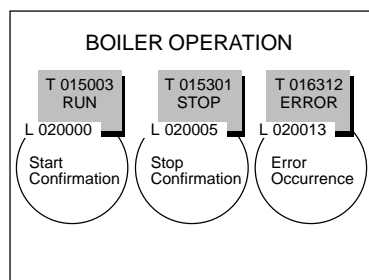

Touching the top or bottom of the screen changes the way the display elements overlap each other in the order in which they are registered.

In this example, the bottom portion of the touch switch, which is under the lamp, will be displayed over the lamp.

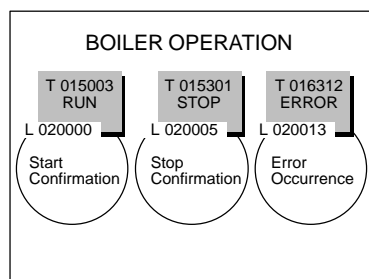

When you have finished checking the screen, press the central part of the screen to return to the screen number selection screen.

If you wish to continue by checking another screen, repeat the operation, starting by specifying the screen number.

To end the operation, press "Quit" on the screen number selection screen. The NT631/NT631C returns to the "MAINTENANCE MODE MENU" screen.

6-11-7 Device Check

The NT631/NT631C provides checks on the functions of the following items.

- Buzzer Page 222
- LED Page 223
- LCD Page 224
- Backlight Page 225
- Screen data memory Page 226
- Touch switches Page 228
- Battery voltage Page 229

Checking the Buzzer

Check if the buzzer sounds correctly.

Reference The buzzer will sound in this check regardless of the setting made with the "Buzzer Sound" memory switch.

Check the buzzer by following the menu operation from the System Menu shown below.

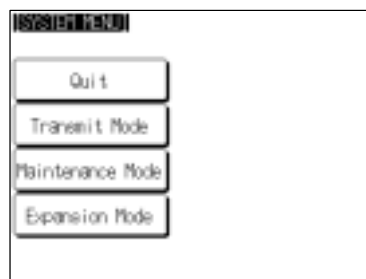

Select "Maintenance Mode".

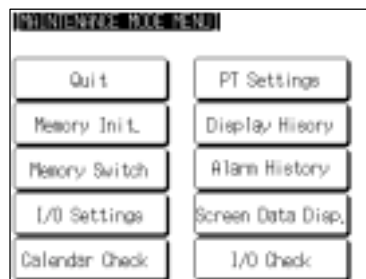

Select "I/O Check".



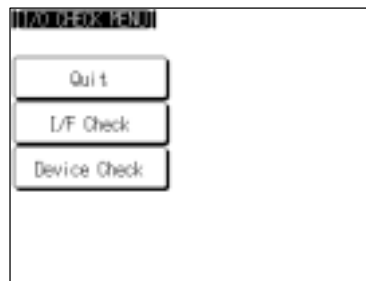

Select "Device Check".

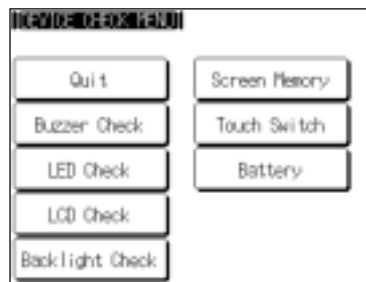

Select "Buzzer Check".

- If the buzzer functions correctly, it will sound continuously. At this time, the "Buzzer Check" touch switch will be displayed in reverse video.
- To stop the buzzer while it is sounding, press the "Buzzer Check" touch switch again.

Checking the RUN LED

Check if the RUN LED functions normally.

Check the RUN LED by following the menu operation from the System Menu shown below.

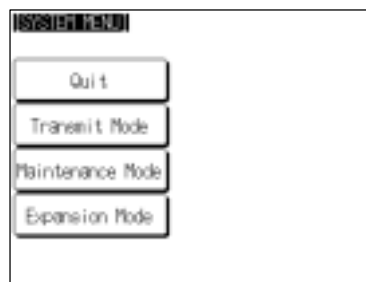

Select "Maintenance Mode".

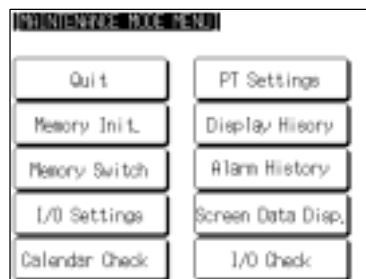

Select "I/O Check".



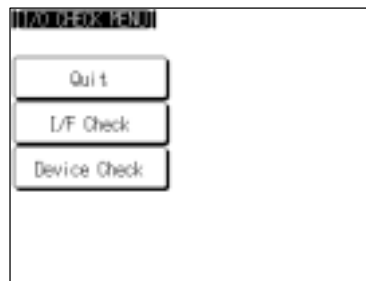

Select "Device Check".

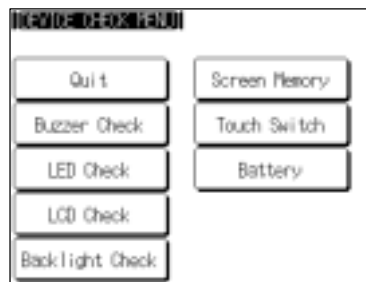

Select "LED Check".

- If the RUN LED is functioning normally, it will operate as follows. At this time the "LED Check" touch switch will be displayed in reverse video.
Lit in green → OFF → lit in red → OFF → lit in green...
- To end the LED check, press the "LED Check" touch switch on the "DEVICE CHECK MENU" screen again.

Checking the LCD (Screen Display)

Check if the LCD display (or EL display for NT631) functions normally by following the menu operation from the System Menu shown below.

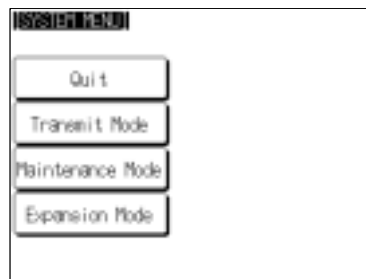

Select "Maintenance Mode".

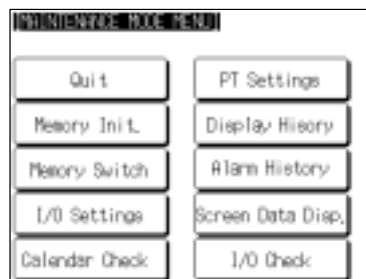

Select "I/O Check".



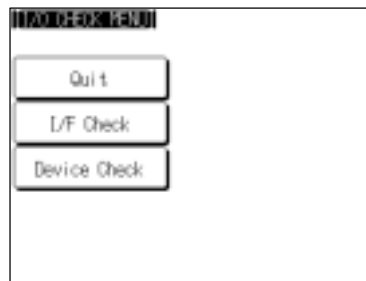

Select "Device Check".

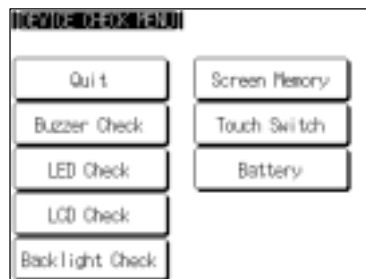

Select "LCD Check".

- The check screen displays all the dots on the screen: either press anywhere on the touch panel or wait for three seconds and all the dots will be cleared.

With the NT631C, the display and clearance of all the dots on the screen is repeated for each color in turn (red → green → blue → magenta → cyan → yellow → white → black).

On completion of the display and clearance of all dots, the NT631/NT631C returns to the "DEVICE CHECK MENU" screen.

- To abort the LCD check, press the top right corner of the touch panel. The NT631/NT631C will return to the "DEVICE CHECK MENU" screen.

Checking the Backlight (for NT631C only)

Check if the backlight functions normally with the NT631C by following the menu operation from the System Menu shown below. This function is not available with the NT631.

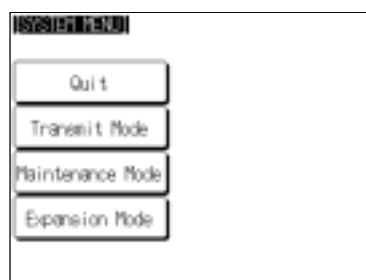

Select "Maintenance Mode".



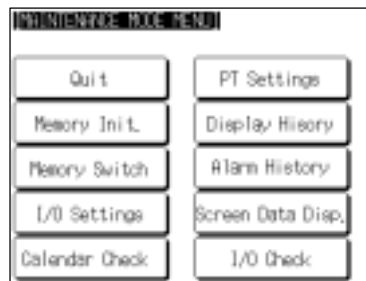

Select "I/O Check".

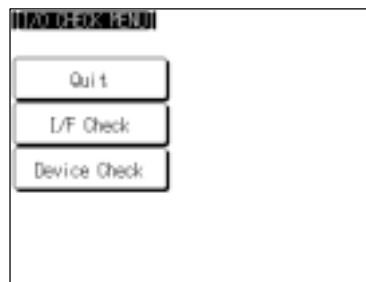

Select "Device Check".

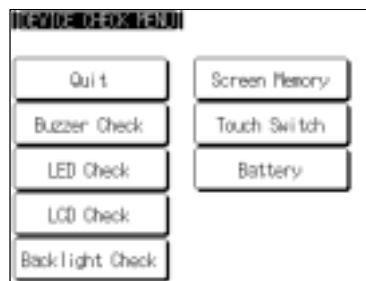

Select "Backlight Check".

- If the backlight is normal, it flashes. At this time, the "Backlight Check" touch switch is displayed in reverse video.
- To end the backlight check, press the "Backlight Check" touch switch again.

Screen Data Memory Check

Check if the screen data memory is functioning normally.

Reference

- In the screen data memory check, a write test is performed on the screen data memory. Since all the screen data in the NT631/NT631C is lost in this check, confirm that this data is backed up at the Support Tool or memory unit before executing it.
- If writing to the screen data memory is disabled by the setting for "System Settings" in the System Installer mode, it is not possible to execute a screen data check.
- Once a screen data check has been started, it cannot be stopped.

Check the screen data memory by following the menu operation from the System Menu shown below.

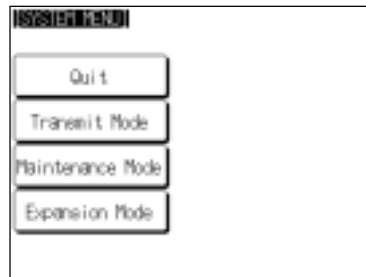

Select "Maintenance Mode".



Select "I/O Check".

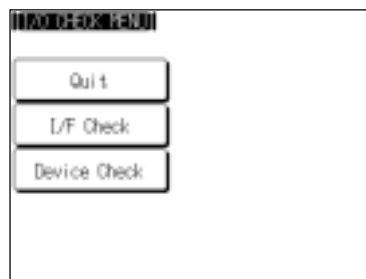

Select "Device Check".

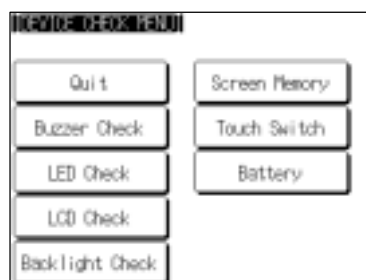

Select "Screen Memory".



Press "Execute".

- During the check, the message “Checking Now...” is displayed.
- On normal completion of the check, the message “Memory Check OK” is displayed.
- If an error is discovered in the check, the message “Memory Check NG” is displayed.

After confirming the result of the check, press “Quit”. The NT631/NT631C returns to the “DEVICE CHECK MENU” screen.

Checking Touch Switches

Check whether or not the touch switches function normally by following the menu operation from the System Menu shown below.

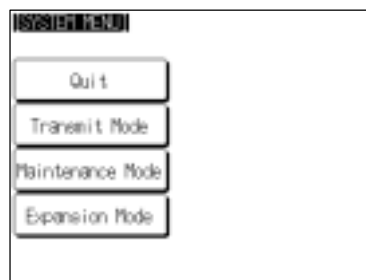

Select “Maintenance Mode”.

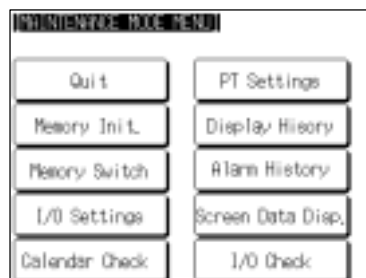

Select “I/O Check”.

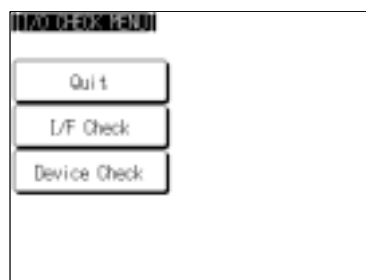

Select “Device Check”.



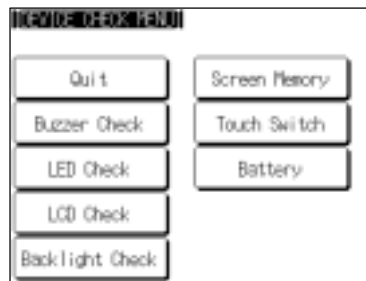

Select "Touch Switch".

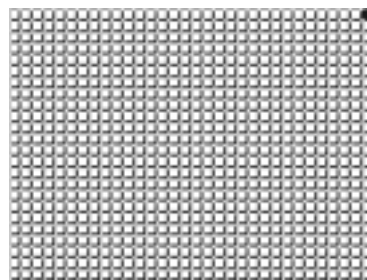

Press the touch switches displayed on the screen. A touch switch is normal if it is displayed in reverse video while pressed.

To end the check, press the touch switch at the top right corner (NT631: displayed in reverse video; NT631C: displayed in yellow). The NT631/NT631C will return to the "DEVICE CHECK MENU".

Reference

- The functions of touch switches pressed during the I/O check are not notified to the host.
- The check cannot be performed until the touch switch at the top right corner is displayed in reverse video (for NT631) or displayed in yellow (NT631C). Start the check after the status of the touch switch at the top right corner has changed.

Checking the Battery Voltage

Check the voltage of the NT631/NT631C's built-in battery by following the menu operation from the System Menu shown below.

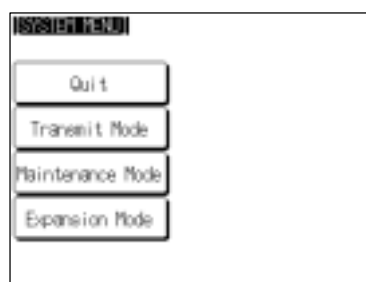

Select "Maintenance Mode".



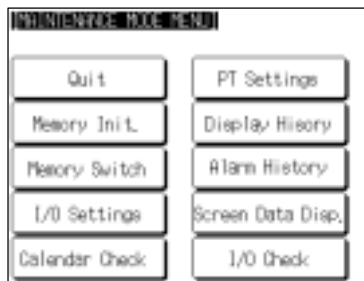

Select "I/O Check".

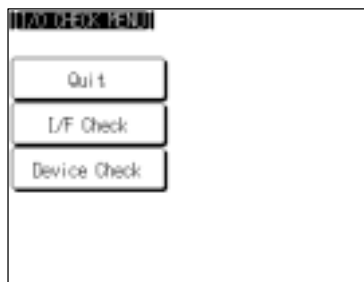

Select "Device Check".

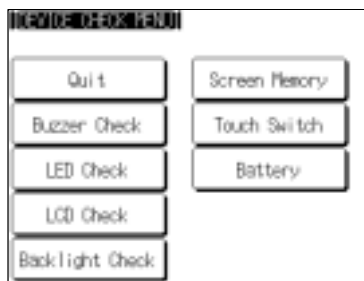

Select "Battery".



"The voltage is within the normal range." or "The voltage is lowered." is displayed.

After confirming the result of the check, press "Quit". The NT631/NT631C returns to the "DEVICE CHECK MENU" screen.

Notice

When "The voltage is lowered" is displayed, replace the built-in battery immediately. For details on the replacement method, refer to 11-3-1 "Replacing the Battery" (page 623).

6-11-8 Checking Interfaces

The NT631/NT631C allows the following communication functions to be checked.

- Communication with the Support Tool Page 231
- Communication at serial ports Page 232
- Communication with printers Page 235

Checking Communication with the Support Tool

Check communication with the Support Tool by following the menu operation from the System Menu shown below.

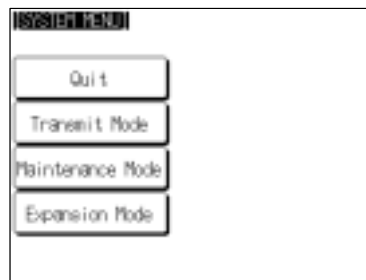

Select "Maintenance Mode".

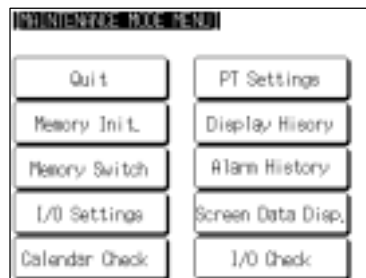

Select "I/O Check".

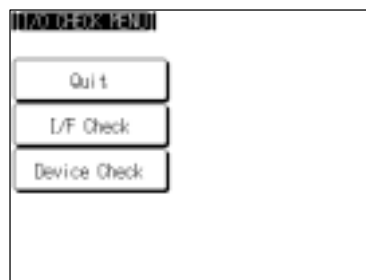

Select "I/F Check".

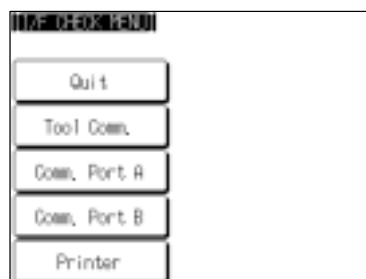

Select "Tool Comm.".





The check on communication with the Support Tool starts.

- If communication with the Support Tool is normal, data transmitted from the Support Tool is displayed as hexadecimal data when received by the NT631/NT631C.

After confirming the result of the test, press "Quit". The NT631/NT631C returns to the "I/F CHECK MENU" screen.

Checking Communication at Serial Ports

Check communication at the serial ports (A, B).

- Check screen

The check screen and check method differ according to the communication method set for the port to be checked.

- For host link

Example: Serial port A while using the host link

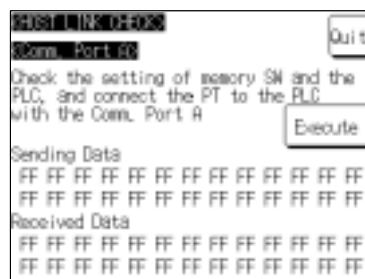

Press "Execute" to start the check. The data for checking communication is sent to the host, and is displayed as the "Sending Data" in hexadecimal.

- If communication with the host is normal, the reply from the host is displayed at "Received Data" in hexadecimal.
- If a communication error occurs while checking the communication conditions with the host, a communication error screen is displayed. Since this indicates that there is a communication fault, check the communication cables and settings.

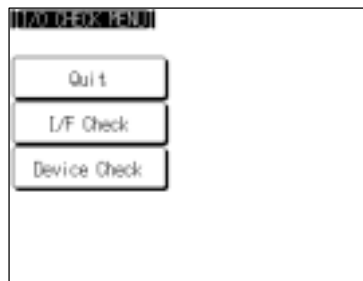

Select "I/F Check".

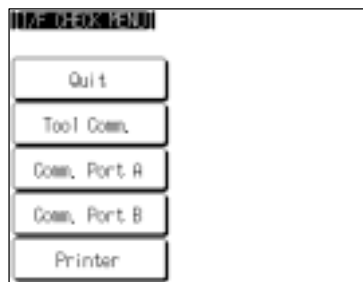

Select "Comm. Port A" or "Comm. Port B".
The check screen is displayed ("Check screen", page 232).

After confirming the result of the check, press "Quit". The NT631/NT631C returns to the "I/F CHECK MENU" screen.

Checking Communication with a Printer

Check communication with a printer by following the menu operation from the System Menu shown below.

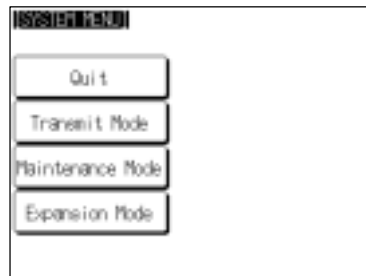

Select "Maintenance Mode".

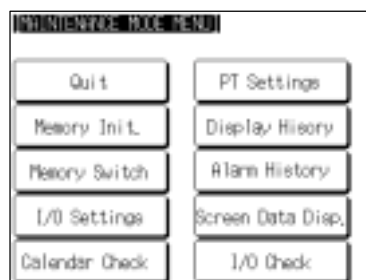

Select "I/O Check".



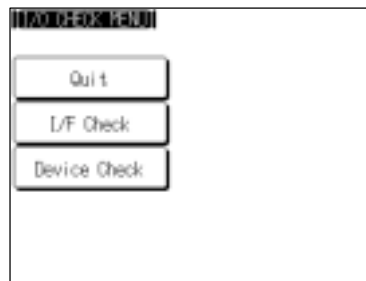

Select "I/F Check".

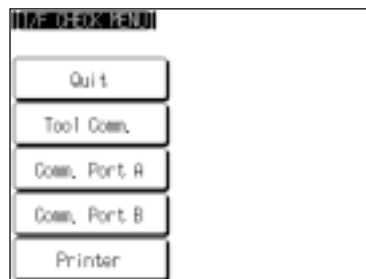

Select "Printer".



Confirm that a printer is connected to the NT631/NT631C, then press "Execute": "Printer Interface Check" will be printed out at the printer.

- While data is being sent to the printer, the message "Checking Now..." is displayed.
- When the sending of data to the printer is completed, "Finished Normal by "Printer Interface Check" is displayed.
- If data does not reach the printer within 60 seconds after sending starts, the message 'Finished Printer output failed' is displayed.

After confirming the result of the check, press "Quit". The NT631/NT631C returns to the "I/F CHECK MENU" screen.

6-12 Programming Console Function

As an expansion function, the NT631/NT631C features the “programming console function”, which allows it to be used instead of a programming console (type C200H-PRO27-E) for a C-series CPM1, CQM1, C200HX/HG/HE (-ZE), or CS1-series CS1G/CS1H.

Except for recording (saving) ladder programs on cassette tape and replaying (reading) them, almost all the functions of a programming console can be executed.

Notice

When the programmable controller functions are used, carefully check that the system is safe before carrying out the following operations.

- Changing monitor data
 - Switching the operating mode
 - Forced set or reset
 - Changing a present value or set value
-

6-12-1 Usable Systems

The programming console function can be used with an NT631/NT631C connected to a PC when using the communication method indicated below.

Communication Method	Communication Type	Applicable PCs	Connected Port
NT Link (1:1)	RS-232C	C200HE-CPU42-(Z)E ^(*1) C200HG-CPU43-(Z)E ^(*1) C200HG-CPU63-(Z)E ^(*1) C200HX-CPU44-(Z)E ^(*1) C200HX-CPU64-(Z)E ^(*1) C200HX-CPU65-ZE ^(*1) C200HX-CPU85-ZE ^(*1) CQM1-CPU4□-EV1 ^(*1) SRM1-C02-V1	CPU built-in RS-232C port
		CPM1-10CDR-□ CPM1-20CDR-□ CPM1-30CDR-□ CPM1A-10CD□-□ CPM1A-20CD□-□ CPM1A-30CD□-□ CPM1A-40CD□-□	Peripheral port ^(*2)
NT Link (1:N)		CS1G-CPU42-E ^(*1) CS1G-CPU43-E ^(*1) CS1G-CPU44-E ^(*1) CS1G-CPU45-E ^(*1) CS1H-CPU63-E ^(*1) CS1H-CPU64-E ^(*1) CS1H-CPU65-E ^(*1) CS1H-CPU66-E ^(*1) CS1H-CPU67-E ^(*1)	<ul style="list-style-type: none"> • CPU built-in RS-232C port • Peripheral port ^(*3)

- *1 The peripheral port programming console always has priority. If a programming console is connected later, the programming console function of the NT631/NT631C is invalidated and operation from the NT631/NT631C becomes impossible.
- *2 An RS-232C cable cannot be connected to the peripheral port. An RS-232C adapter (CPM1-CIF01) is required.
- *3 The RS-232C cable cannot be directly connected to the peripheral port. An RS-232C converting cable (CS1W-CN118) is required.

Reference

Note that the programming console function cannot be used with CPM1, CQM1, and C200HX/HG/HE PCs of the following lot numbers.

- CPM1: □□□5, □□*6
 where * is a number in the range 1 to 9 or the letter X or Y.
- CQM1: □□□3, □□□4, □□□5, □□*6
 where * is a number in the range 1 to 9 or the letter X or Y.
- C200HX/HG/HE: □□□5 □□*6
 where * is a number in the range 1 to 9 or the letter X or Y.

6-12-2 Connection Method

For CQM1, C200HX/HG/HE(-ZE), SRM1

The connection method is exactly the same as for the NT link (1:1). Make the connection to the PC by referring to Section 4 "Connecting to the Host from the RS-232C Port".

For CPM1

The connection method is the same as for the NT link (1:1). Connect the RS-232C cable to the peripheral port via an RS-232C converting adapter (CPM1-CIF01).

Make the connection to the PC by referring to Section 4 "Connecting to the Host from the RS-232C Port".

For CS1G/CS1H

The connection method is exactly the same as for the NT link (1:N). Make the connection to the PC by referring to Section 4 "Connecting to the Host from the RS-232C Port".

The programming console function can be used only when the PT side unit number is "0" and only one unit is connected. In addition, this function cannot be used simultaneously at the CPU built-in RS-232C port and a peripheral port.

6-12-3 Method of Use

For CS1G/CS1H

The connection method is exactly the same as for the NT link (1:N). Make the connection to the PC by referring to Section 4 "Connecting to the Host from the RS-232C Port".

The programming console function can be used only when the PT side model number is "0" and only one unit is connected. In addition, this function cannot be used simultaneously at the CPU built-in RS-232C port and a peripheral port.

Only the points of difference with an actual programming console are described here. For details on using the NT631/NT631C as a programming console, refer to the instruction manual for the programming console (C200H-PRO27-E).

The “programming console” screen is displayed by operating the system menu as described below.

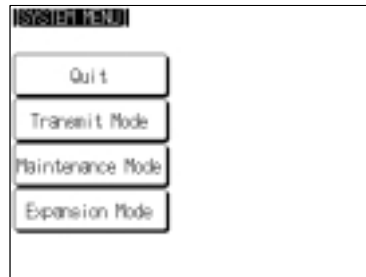

Select “Expansion Mode”.

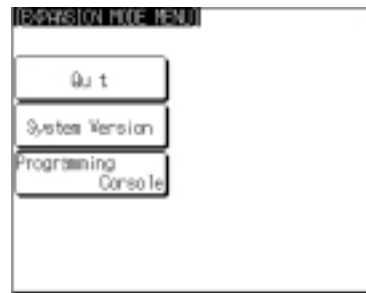

Select “Programming Console”.

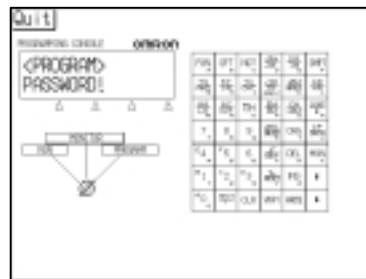

The programming console screen is displayed.

Press the programming console sheet keys (touch switches) for the operation.

Press the “Quit” touch switch to exit the screen.

An error is displayed if a wrong communication protocol is selected or a programming console is connected to a peripheral port.

Reference When an error screen is displayed, press the “Check” touch switch on the screen to return to the system menu. In addition, pressing two of the four corners of the touch panel simultaneously in the error screen enables the display of the system menu.

Key Operations

- Mode selection keys, mode lock key

The display element on the programming console screen shown below comprises the mode selection keys, which change the operation mode of the PC, and the mode lock key, which prevents unintended mode changes.

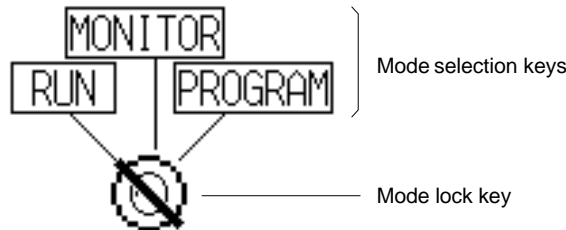

The RUN, MONITOR, and PROGRAM mode selection key elements are touch switches and pressing them causes the PC operation mode to change (unlike an actual programming console, it is possible to switch directly between the RUN mode and the PROGRAM mode.)

When the programming console function is started, the PC operation status is read and reflected at the PC.

The mode lock key element is also a touch switch, and it alternates between the “lock ON” (with no key displayed) and “lock OFF” (with key displayed) states when pressed. During the lock ON state, mode selection key operations are ineffective. The mode displays change as indicated in the figures below during the lock ON status and during the lock OFF status.

When the programming console function starts, the lock ON status is established.

If the RUN, MONITOR, or PROGRAM mode selection key is pressed in the lock OFF status, the mode changes and the lock ON status is established.

- During lock OFF

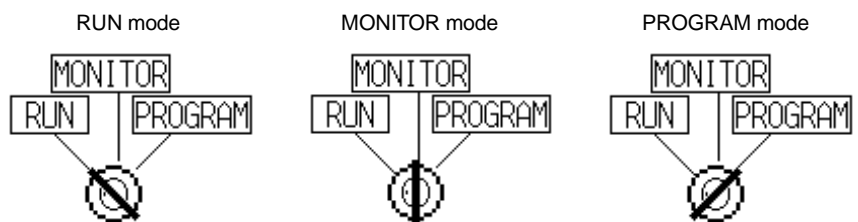

- During lock ON

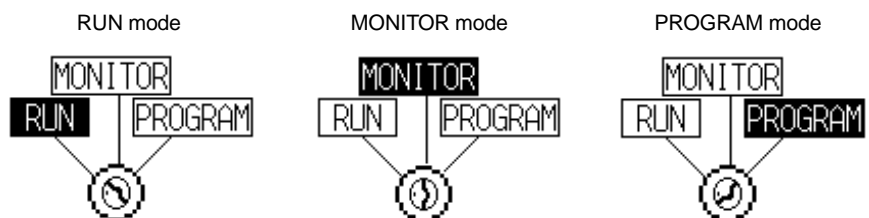

- Programming console keyboard

The programming console keyboard used on the screen when the programming console function is used is comprised entirely of touch switches (shown by the dashed line frames in the figure below). On pressing a touch switch, a key operation is executed. However, since there is a discrepancy between the size of the displayed keys and the size of the touch switches, take care to press as close to the center of the key as possible by referring to the figure below.

In addition, if the connected host is the CS1G/CS1H, the programming console key sheet for the CS1 series is automatically displayed.

[Standard Programming console key sheet]

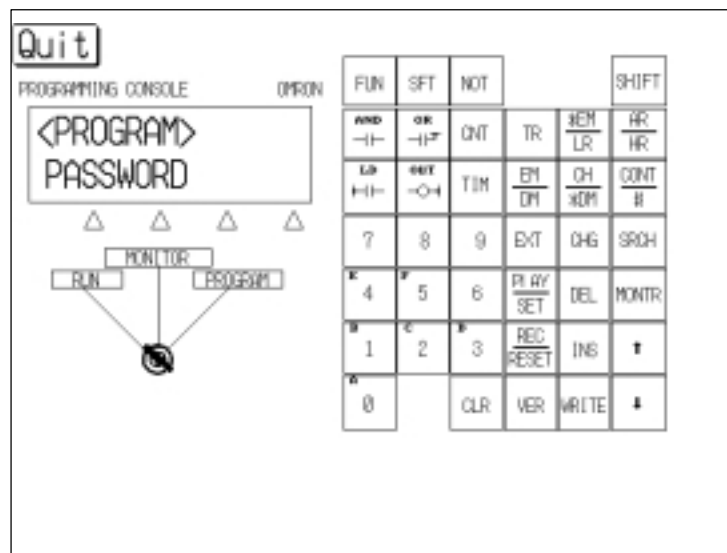

[Programming console key sheet for CS1 series]

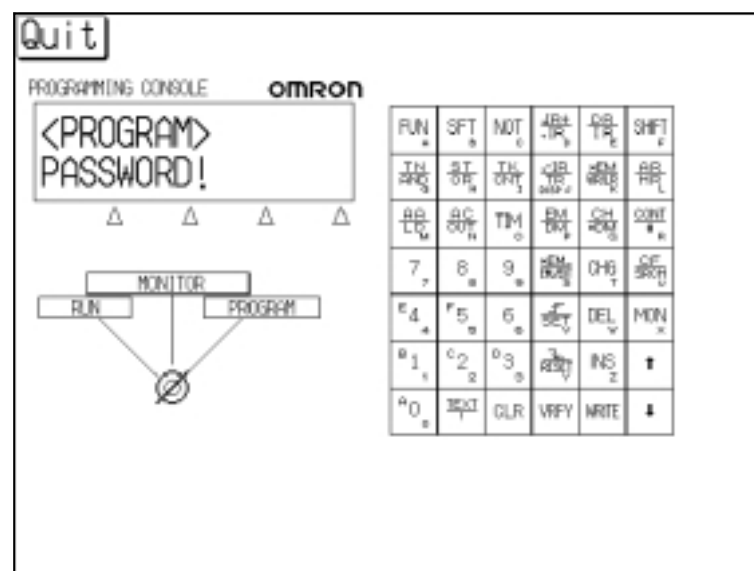

Differences with Respect to Programming Consoles

- Programs cannot be stored (recorded) or read (replayed). If it is necessary to store or read a program, use a peripheral tool.
- It is not possible to adjust the volume of the key press sound. Whether or not the key press sound sounds is determined by the setting for the “Key Press Sound” memory switch of the NT631/NT631C. It sounds when the setting is “ON” and does not when the setting is “OFF” (page 188).
- If an error occurs when using the programming console function, an error screen is displayed. Whether or not the buzzer sounds at this time is determined by the setting for the “Buzzer Sound” memory switch of the NT631/NT631C (page 189).

Reference

If, when using the programming console function, “Communication Condition Setting for RS-232C port” in the PC system setting area is changed, for example by memory clearance, a communication error occurs and it becomes impossible to use the programming console function.

SECTION 7

NT631/NT631C Functions

This section describes the functions of the NT631/NT631C.

7-1	NT631/NT631C Screen	246
7-1-1	Screen Composition	246
7-1-2	Screen Numbers	246
7-1-3	Screen Types	246
7-1-4	Screen Attributes	251
7-1-5	Color Display	254
7-1-6	Display Elements	257
7-2	Areas for Control/Notification	259
7-2-1	PT Status Control Area (Host ↔ NT631/NT631C)	259
7-2-2	PT Status Notify Area (NT631/NT631C to Host)	268
7-2-3	Window Control Area (Host ↔ NT631/NT631C)	272
7-3	Memory Tables	277
7-3-1	Numeral Memory Tables	277
7-3-2	Character String Memory Tables	284
7-3-3	Bit Memory Tables	288
7-4	Fixed Displays	294
7-4-1	Circles, Arcs, Sectors, Polylines, Polygons, Rectangles (Fixed Displays)	294
7-4-2	Text (Fixed Display)	303
7-4-3	Tiling	306
7-4-4	Marks	308
7-5	Image and Library Data	312
7-5-1	Image Data Display	312
7-5-2	Library Data Display	315
7-6	Lamps	319
7-7	Touch Switches	327
7-8	Numeral Display	347
7-9	Character String Display	355
7-10	Graphs	361
7-10-1	Bar Graphs	361
7-10-2	Analogue Meter	366
7-10-3	Broken Line Graphs	373
7-10-4	Trend Graphs	379
7-11	Alarm List, Alarm History	394
7-12	Inputting Numeric Values	405
7-12-1	Numeric Key Type (“Numerical Input”)	405
7-12-2	Thumbwheel Type (“Thumbwheel”)	413
7-13	Inputting Character Strings	421
7-14	Window Function	426
7-14-1	What are windows?	426
7-14-2	Window Type	427
7-14-3	Window Screens and Display Elements	428
7-14-4	Opening/Closing and moving a window	429
7-14-5	Size and display position of a window	430
7-14-6	Changing the displaying order of windows	430
7-14-7	Checking the display status of a window	431

7-14-8 Temporary Input Fields	432
7-14-9 Focus window	432
7-15 Special Functions	434
7-15-1 Display History Record Function	434
7-15-2 Alarm History Record Function	437
7-15-3 Resume Function	440
7-15-4 Screen Saver Function	441
7-15-5 Buzzer Function	442
7-15-6 Clock Function	444
7-15-7 Print Function	445
7-15-8 Programming Console Function (Expansion Function)	448
7-16 PT Configuration Settings	450
7-16-1 "PT Configuration" Settings	450

7-1 NT631/NT631C Screen

This section gives an outline of the screen, which is the basis of NT631/NT631C functions.

7-1-1 Screen Composition

The NT631/NT631C screen is 640 dots wide by 480 dots high. Each dot is set by a combination of an X coordinate (horizontal direction) and a Y coordinate (vertical direction). The coordinate origin (0, 0) is at the top left of the screen.

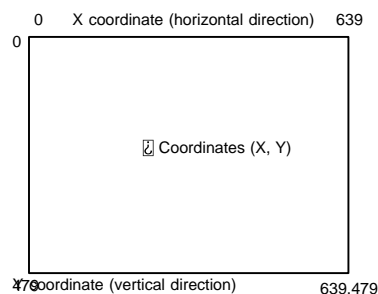

7-1-2 Screen Numbers

The screens of the NT631/NT631C are classified and managed by “screen numbers”.

Screen numbers are used to designate the first screen displayed when the NT631/NT631C is started up, and to designate the objective screen when switching the screen display, etc.

The NT631/NT631C allows up to 3999 screens to be registered, apart from those screens reserved for specific functions. For these 3999 screens, screen numbers can be designated without restriction within the range 1 to 3999. There are also no restrictions on the order of screen numbers, they can be discontinuous either.

When creating a screen at the NT631/NT631C with the Support Tool, designate a screen number and then register the display elements.

7-1-3 Screen Types

The screens that can be displayed by the NT631/NT631C are classified as follows according to their function.

- Normal (Standard) screens
- Overlapping screens
- Window screens
- System screens

Normal (Standard) Screens

Normal (Standard) screens are the basic screens of the NT631/NT631C. There are no specific functions themselves and their purpose is to display elements that have already been registered.

Normal (Standard) screens can be registered under any screen numbers in the range 1 to 3999.

Overlapping Screens

The NT631/NT631C allows up to 8 screens to be displayed overlapped as one screen. A group of overlapped screens is called an “overlapping screen”.

To allow distinction, the screen that results when the multiple component screens are overlapped is called the “parent screen”, and the individual component screens are called the “child screens”.

Both parent screens and child screens can be registered under any screen numbers in the range 1 to 3999. Note that a new screen must be designated as a parent screen.

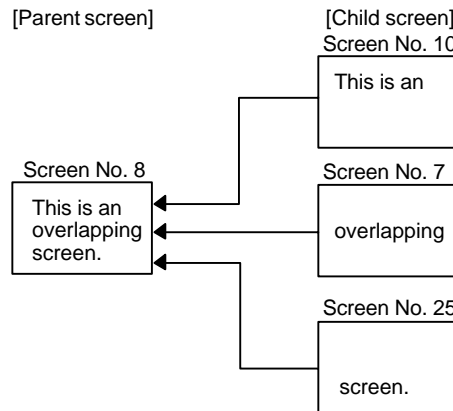

- Child screen registration and display result

Child screens are created as normal (standard) screens. Therefore they can also be displayed independently by designating their screen numbers.

Parent screens are special screens used for the purpose of displaying overlapping screens. They are created by designating a new screen as a parent screen at the Support Tool. Register only the screen numbers of the child screens to be overlapped for this new screen. Direct registration of elements on a parent screen is not possible.

To display an overlapping screen on the NT631/NT631C, designate the screen number of the parent screen. The child screens will be displayed in the order they were registered (i.e., the first one registered will be the “bottom-most” screen) to build up the compound image.

Note that the order in which the child screens are registered may affect the way that overlapped screens are displayed.

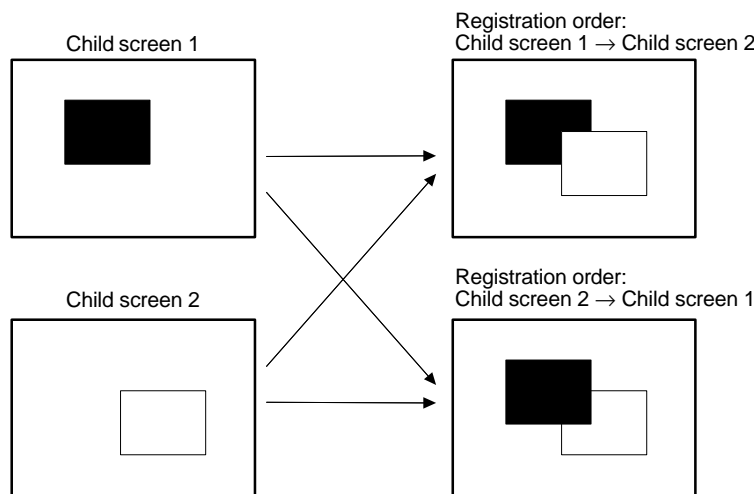

- Restrictions on overlapping screens

Note the following points, when creating an overlapping screen.

- “Numeral input” and “character string input” input fields — which allow the input of numeric values and character strings — can each only be set on one of the child screens. (Thumbwheel switches can be used but temporary input fields cannot.) For details on numeral input, refer to 7-12 “Inputting Numeric Values” (page 406), and for details on character string input, refer to 7-13 “Inputting Character Strings” (page 422).
- Arrange the touch switches registered for each child screen, so that they do not overlap on the parent screen. If touch switches are overlapped, the intended operation may not be performed when a touch switch is pressed.
- On an overlapping screen, the screen attributes of the child screens are invalid and the screen display is governed by the attributes of the parent screen. For details on screen attributes, refer to 7-1-4 “Screen Attributes” (page 252).

Window Screens

Apart from the normal (standard) screen display method, which a screen is displayed over the entire panel area, the NT631/NT631C also allows screens to be displayed in one part of the screen area only. This partial screen is called a “window”, and a screen on which a window is displayed is called a “window screen”. Window screens can be registered under any screen numbers 1 to 3999. However, screens that are registered as window screens cannot be displayed independently like normal (standard) screens.

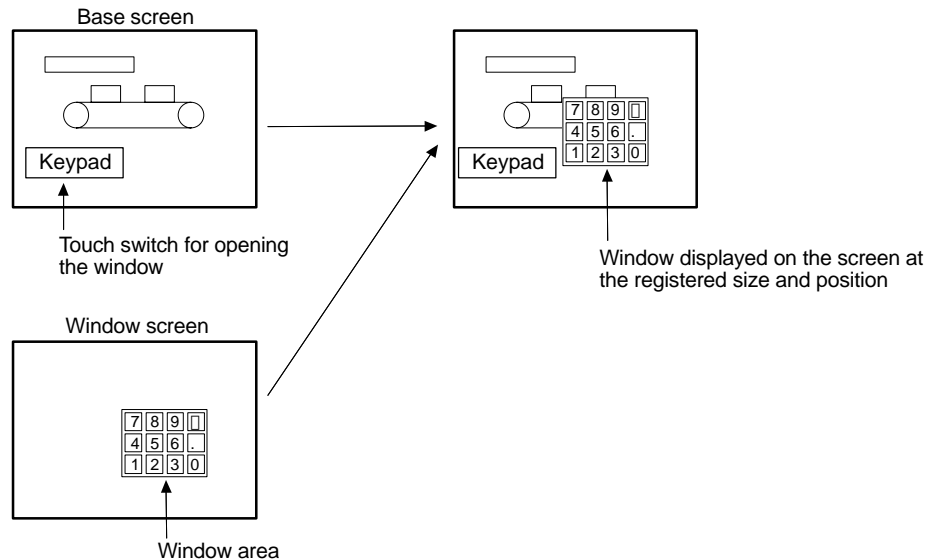

Windows can be called anytime, regardless of which screen is currently displayed. It is possible to display multiple windows (max : 3) on the same screen, and to open, close or move windows by the control from the host.

With NT631/NT631C, up to three windows can be displayed at the same time.

One of these window is called a “global window”. This window can be displayed all the time, regardless of which screen is currently displayed.

Other two windows are called “local windows”. These windows can be displayed by linking to the currently displayed screens. When the screen is switched, the local window is closed automatically.

For details, refer to 7-14 “Window Function” (page 427).

System Screens

Screens with predetermined functions are called “system screens”.

The types of system screens are indicated in the table below.

Screen No.	Name	Function
0	No-display screen	If screen number “0” is designated as the display screen, the screen of the NT631/NT631C is made blank.
9000	“System initializing” screen	This screen is displayed during the initial processing when the NT631/NT631C starts operation. During operation, screen number 9000 cannot be designated for display, but it is possible to create and register a screen under screen number 9000 at the Support Tool, and this screen can then be displayed instead of the default system initialization screen. Note however that only “fixed display” elements can be registered for screen number 9000.
9001	Occurrence history screen	The NT631/NT631C features the “display history record function”, which records the display status of screens. By designating screen number 9001 as the display screen, you can check the screens that have been displayed up to the present time in display order. You can set whether the records are presented in the order of newest first or oldest first by setting an NT631/NT631C memory switch.
9002	Frequency history screen	The NT631/NT631C features the “display history record function”, which records the display status of screens. By designating screen number 9002 as the display screen, you can check the screens that have been displayed up to the present time in order of frequency of display.
9020	Programming console function screen	As an expansion function, the NT631/NT631C features the “programming console” function, which allows equivalent functions to those of a programming console. When the NT631/NT631C is connected to a host which supports the programming console function, it can be used in the place of a programming console by designating screen number 9020 as the display screen.
9999	“Return to previous screen” designation	The NT631/NT631C has a function which allows the screen numbers of up to 32 screens to be recorded in their order of display. When screen number 9999 is designated as the display screen, the screen that was displayed immediately before the currently displayed screen is redisplayed. However, note that if a system screen is displayed in the middle of operation, the record of displayed screens is cleared.

For details on the display history function, refer to 7-15-1 “Display History Record Function” (page 435); for details on the programming console function, refer to 6-12 “Programming Console Function” (page 237); and for details on screen switching refer to 8-3-1 “Switching the Screen” (page 468).

7-1-4 Screen Attributes

The NT631/NT631C allows attributes to be set for each screen, so that the function specified by the attribute is executed when the screen is displayed. For example, when a screen for which the "buzzer attribute" has been set is displayed, the buzzer sounds.

Set the screen attributes as properties of each screen using the Support Tool.

The screen attributes that can be set are listed below. It is possible to set more than one attribute for the same screen at one time.

- Backlight (Light/Flash)
- Buzzer (None/Continuous/Long/Short)
- Background (NT631C only)
- Screen comment
- History (record/don't record)
- History title
- Load Local1 (Keyboard) (screen number)
- Load Local2 (screen number)
- Backlight (NT631C only)

Set if the backlight is to light continuously or flash when the screen is turned on.

Setting	Function
Light	The backlight is lit. (Default)
Flash	The backlight is flashed.

- Buzzer

The buzzer attribute allows the buzzer to sound when a screen is displayed. There are the following four types of buzzer attribute setting.

Setting	Function
None	The buzzer does not sound when the screen is displayed. (Default) If the buzzer is sounding when the screen is displayed, it stops.
Continuous	The buzzer sounds continuously when the screen is displayed. If a buzzer type other than continuous is sounding when the screen is displayed, the sound changes to continuous.
Long	The long intermittent buzzer sounds when the screen is displayed. If a buzzer type other than long intermittent is sounding when the screen is displayed, the sound changes to long intermittent. The "long intermittent" buzzer sound is the repeated alternation of 1.0 second on and 1.0 second off.
Short	The short intermittent buzzer sounds when the screen is displayed. If a buzzer type other than short intermittent is sounding when the screen is displayed, the sound changes to short intermittent. The "short intermittent" buzzer sound is the repeated alternation of 0.5 seconds on and 0.5 seconds off.

The setting for the "Buzzer Sound" memory switch at the NT631/NT631C takes priority in determining whether or not the buzzer actually sounds. When this memory switch is set to "ON", the buzzer set with a screen attribute can sound.

Reference

- The buzzer can also sound by PT status control bit operation (page 458).
- The following methods can be used to stop the buzzer when it is sounding.
 - Switching to a screen whose buzzer attribute is "None"
 - Stopping the buzzer by PT status control bit operation (page 459)
 - Registering the "buzzer stop" touch switch on the screen (page 460)

- Background color (NT631C only)

With the NT631C, the background color of the entire screen can be set for each screen. The following 8 background colors can be set.

Black, blue, red, magenta, green, cyan, yellow, white

- Screen comment

A comment indicating the contents of the screen can be set as any required character string of up to 24 characters.

- History

When a screen for which this attribute is set is displayed, the screen number, display time, number of times displayed, and history title of the displayed screen are recorded as display history data.

Setting	Function
Checked	When the screen is displayed, its data is recorded in the display history.
Not checked	When the screen is displayed, its data is not recorded in the display history. (Default)

Reference

The display history can be checked in the Maintenance mode of the NT631/NT631C, and can also be read during operation by displaying screen number 9001 (occurrence order) or screen number 9002 (frequency order). It is also possible to transmit the display history record data to the personal computer by operation at the Support Tool. For details, refer to NT-series Support Tool Ver. 3.0 for Windows95/98 Operation Manual, 11-5 "Receiving (Uploading) the History Record".

- History title

This attribute sets a character string to be recorded in the display history along with the display time and other information when a screen for which the "history" attribute is set is displayed.

The history title can be set as any required character string of up to 24 characters.

This setting is only valid for screens for which the "history" attribute is set. When a screen for which the "history title" attribute is set is displayed by the NT631/NT631C, the designated character string is recorded together with the screen number in the display history.

- Load Local1, Load Local2

Specify whether or not a window (Local1, Local2) pops up at the same time the screen is displayed by screen switching. Set the window screen number to be displayed when you check these attribute.

For details of a window, refer to 7-14 "Window Function" (page 427), and for details of using method of a window, refer to 8-4 "Display and Control of Windows" (page 477)

Reference

- A window can also be opened, closed or moved by the operation at Window control area (refer to page 480)
 - To control (open close or move) a window, follow the methods below.
 - Register "Input key-Window/Keyboard" touch switch or "Window Move" touch switch on ascreen. (refer to page 478, 480)
 - Register "Cursor Move" touch switch which has a window open function. (refer to page 479)
 - Operate Window control area from the host. (refer to page 480)
 - Switch to the screen which has "Load Local1" (keyboard) or "Load Local2" screen attribute.
-

Restrictions Relating to Screen Attributes

The functions of the backlight and buzzer attributes can also be performed using the PT status control bits. (And the buzzer can also be operated with a touch switch.) When a screen for which one of these attributes is set is displayed, the set function is executed regardless of the status of the PT status control bits, but the status of the backlight or buzzer can be changed later by using another operation.

Depending on the screen attribute settings and the PT status control bit statuses, the PT status control bit statuses may not match the actual operation (ex. the buzzer bit in the PT status control bits may be set to "stopped" although the buzzer is actually sounding). In such a case, carry out PT status control bit operations to make the statuses agree with the actual status of the NT631/NT631C.

For details on the PT status control bits, refer to 7-2-1 "PT Status Control Area" (page 260).

7-1-5 Color Display

The NT631C can display the entire screen, and elements such as text and graphics, in eight different colors. Specify a color as an attribute for each display element when creating a screen with the Support Tool.

Available Colors

The NT631C can display the following eight colors.

Black, blue, red, magenta, green, cyan, yellow, white

The four color combinations below are in an XOR relationship.

The NT631/NT631C has a function which prevents the display of an element on a background of the same color (making it invisible) by changing the color of the element to the color which is in XOR relationship with its present color.

Black \Leftrightarrow White, Blue \Leftrightarrow Yellow, Red \Leftrightarrow Cyan, Magenta \Leftrightarrow Green

The following kinds of display elements are displayed in the above combinations of colors.

- Frame of input fields for numeral/character string input, and screen background color (page 406).
- Display color of eight dots beyond the top of a bar graph, and screen background color (page 362).

Reference XOR is the abbreviation of eXclusive OR. Color combinations that are opposites in terms of the three primary colors — red, green, and blue — are called to be in an XOR relationship.

Example: Blue (red 0, blue 1, green 0) \Leftrightarrow Yellow (red 1, blue 0, green 1)

- Color correspondence between NT631C and NT631

The only colors that an NT631 can display are white and black.

The screen data for an NT631C can be displayed on an NT631 without alteration and in this case the color correspondences are as follows.

Colors at NT631C	Colors at NT631
Black, blue, red, magenta	White
Green, cyan, yellow, white	Black

Reference

When screen data is created for an NT631, black and white are displayed as white and black respectively at the Support Tool. On the display of a monochrome personal computer, the display at the NT631 matches the colors displayed at the Support Tool, but when a personal computer with a color display is used, the colors are reversed.

Transparent Display

When elements are displayed on top of others, normally the background color of the element on top conceals the element below so that it cannot be seen.

Besides the above eight colors, the color “transparent” is available for the background of some display elements.

When “transparent” is set, nothing appears behind a display element, and the display element or screen background color underneath it is visible.

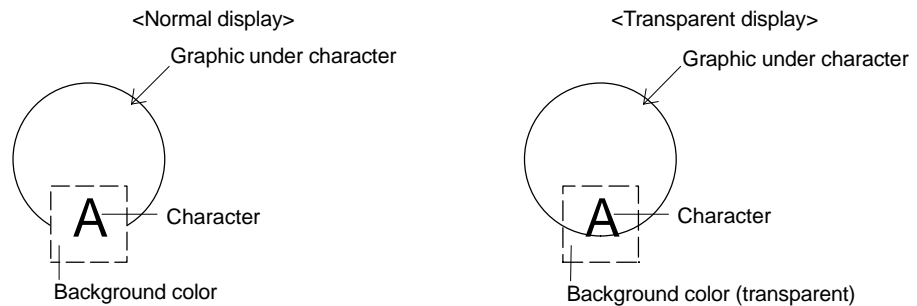

- Possible applications of the color designation “transparent”
 - Background color of normal display text
 - Background of labels for lamps and touch switches (fixed as “transparent”)
 - Display color of lamps and touch switches when they are off
 - Background color of tiling patterns for graphics
 - Background color of marks

- Impossible applications of the color designation “transparent”
 - Background of character strings displayed from character string memory tables
 - Background of numeric values displayed from numeral memory tables
 - Background of numeric values and character strings in numeral setting input fields and character string input fields
 - Background of characters indicating percentages (%) on graphs
 - Display color of lamps and touch switches when lit
 - Background color of temporary input fields
 - Display color of alarm list/history

Screen Background Color

The background color of the entire screen can be designated with the “Background” screen attribute. Screen attributes are properties set for each screen with the Support Tool.

Text Display Color

The color of characters (character color) and that of their rectangular frames (background color) can be specified.

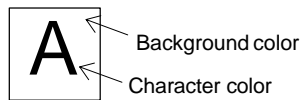

Graphics Display Color

The colors of lines and tiling patterns can be specified for graphics.

The colors that can be designated for tiling patterns are the color of the pattern itself, the background color of the pattern, and the color of the outline of the tiled area.

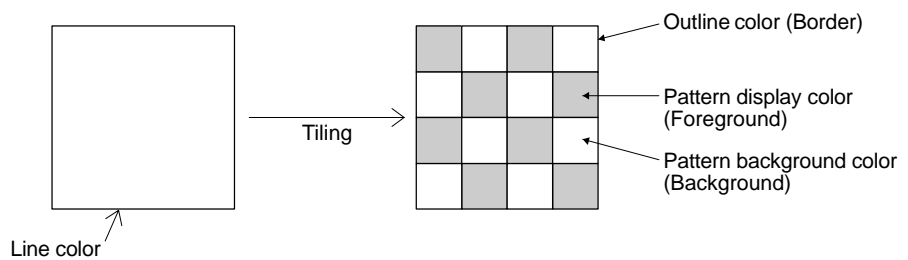

Reference

When a lamp, a touch switch, and a graphic are displayed in color, part of the frames of the display elements may be invisible because of the combination of the background, outline, and tiling colors. This is a phenomenon peculiar to a color LCD, not a failure of the system. In such a case, change the color combination.

7-1-6 Display Elements

The NT631/NT631C can display the following elements.

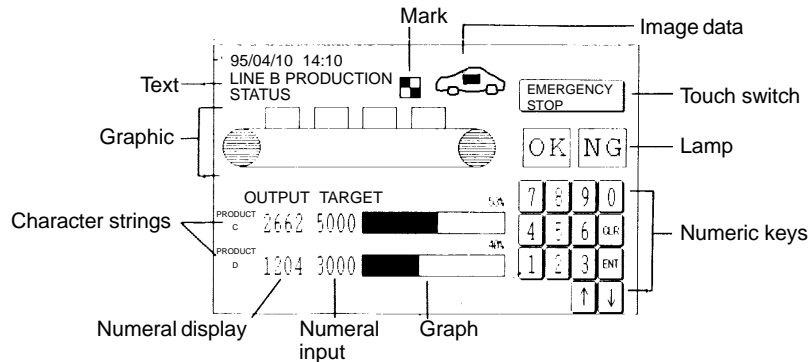

Element		Description	For Details, Refer to
Fixed display	Arcs	Possible display modes: standard/flash/inverse/inverse flash. Other display modes are not available.	Page 295
	Circles	Possible display modes: standard/flash/inverse/inverse flash. Other display modes are not available.	Page 295
	Rectangles	Possible display modes: standard/flash/inverse/inverse flash. Other display modes are not available.	Page 295
	Polygons	Possible display modes: standard/flash/inverse/inverse flash. Other display modes are not available.	Page 295
	Polylines	Possible display modes: standard/flash. Other display modes are not available.	Page 295
	Sectors	Possible display modes: standard/flash/inverse/inverse flash. Other display modes are not available.	Page 295
	Text	Character strings. Possible display modes: standard/flash/inverse flash. Other display modes are not available.	Page 304
	Tiling	The inside of an enclosed area is filled with a tiling pattern.	Page 307
	Image data	Graphics of any required size, composed of dots. The display mode cannot be changed.	Page 313
	Library data	These are groups of elements used as a single element. Fixed display graphics can be registered as library data.	Page 316
	Marks	These are graphics composed of 16 by 16 dots which are treated as characters.	Page 309
Lamps	Normal (Standard) lamps	These are graphics that light (flash) and go off depending on the status of a bit at the host. The following shapes can be selected for normal (standard) lamps: rectangles, polygons, circles, fans.	Page 320
	Image/library lamps	These are elements that display different image/library data depending on the status of a bit at the host.	Page 320
Touch switches		These are elements that can be used as switches: they allow the execution of various functions, such as notification to the host, to be executed by pressing the touch panel of the NT631/NT631C. They also have the same display functions as normal (standard) lamps. They can be displayed in any of the following forms: standard, shadow, 3-dimension, rectangle, circle, polygon, sector — (standard without frame can be displayed also.).	Page 328

Element		Description	For Details, Refer to
Numeral display		The contents of a numeral memory table in the internal memory of the NT631/NT631C are displayed. The display changes in accordance with changes in the data contents.	Page 348
Character string display		The contents of a character string memory table in the internal memory of the NT631/NT631C are displayed. The display changes in accordance with changes in the data contents.	Page 356
Graphs	Bar graphs	The data contents of a numeral memory table in the internal memory of the NT631/NT631C are displayed in bar graph form.	Page 362
	Analogue meter	The data contents of a numeral memory table in the internal memory of the NT631/NT631C are displayed in the form of a quarter, semi-circle or circle-shaped graph.	Page 367
	Broken line graphs	The data contents of multiple numeral memory tables in the internal memory of the NT631/NT631C are displayed in the form of a broken line graph.	Page 374
	Trend graphs	The data contents of multiple numeral memory tables in the internal memory of the NT631/NT631C are displayed in the form of a trend graph.	Page 380
Alarms	Alarm list	This element monitors the status of host bits designated in advance, and displays the message corresponding to the bit that comes ON. By pressing the displayed message, the corresponding image/library data can be displayed and the screen can be switched.	Page 395
	Alarm history	<input type="checkbox"/> Occurrence order This element monitors the status of host bits designated in advance, and displays the contents of the alarm history record (occurrence order) which records the time when the bits come ON, together with the messages corresponding to each bit. As with "alarm list", it is possible to display the messages or image/library data corresponding to each bit. <input type="checkbox"/> Frequency order This element monitors the status of host bits designated in advance, and displays the contents of the alarm history record (frequency order) which records the number of times each bit has come ON, together with the messages corresponding to each bit. As with "alarm list", it is possible to display the messages or image library data corresponding to each bit.	Page 395
Input Settings	Numeral input	This is an element for inputting numeric values to a numeral memory table by using touch switches as numeric keys.	Page 406
	Character string input	This is an element for inputting character strings to a character string memory table by using touch switches as input key – string.	Page 422
	Thumbwheel switch	This is an element for inputting numeric values to a numeral memory table by using "+" and "-" touch switches for each digit.	Page 414

7-2 Areas for Control/Notification

The following areas are provided for the control and exchanging information of PT (such as changes in status) between the NT631/NT631C and the host.

- PT status control area

This area is used to designate the screen to be displayed at the NT631/NT631C, to copy data contents between memory tables in the NT631/NT631C, and to control the status of the backlight and other statuses.

- PT status notify area

This area is used to notify the memory table number to the host when there is a change in the data contents of a memory table in the NT631/NT631C, and to notify information such as changes in the PT status.

- Window control area

This area is used to designate the window screen number or display position from the host, and to notify these information from PT.

Reference

- The PT status control area and PT status notify area must be allocated to the host. Screen data cannot be downloaded from the Support Tool unless they have been allocated.
- The PT status control area, PT status notify area and window control area must be set so that they do not overlap.
- When multiple PTs are connected to one PLC, the PT status control area, PT status notify area and window control area of each PT must be set so that they do not overlap, or the movement of PT will be unstable.
- Allocate window control area to the host only when the window is used and when the window is controlled from the host. Even if the window control area is not allocated to the host, a window can be controlled by touch switch operation etc.

7-2-1 PT Status Control Area (Host ↔ NT631/NT631C)

When data is written to this area from the host, the NT631/NT631C reads the data and operates accordingly. However, note that the number of the currently displayed screen is written to the “screen switch setting” word from the NT631/NT631C too.

The PT status control area is configured as five consecutive words as shown below. The first word (word n) is set in the “Control/Notify Area” settings in the PT configuration settings made with the Support Tool.

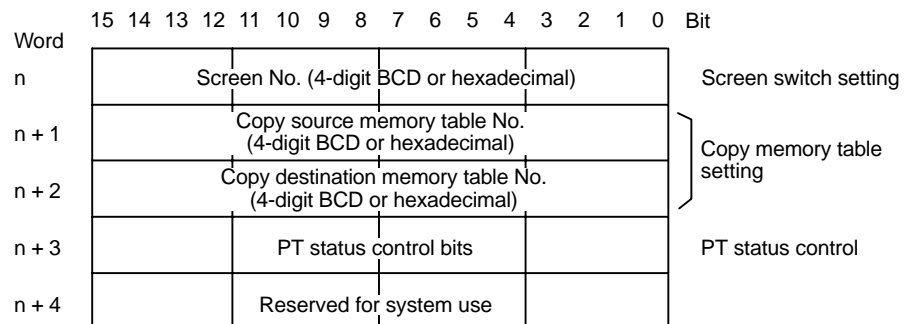

Allocated Words of the PT Status Control Area

The PT status control area (host ↔ NT631/NT631C) can be allocated to the following host (PC) areas.

Symbol	C Series PCs	Allocation	CVM1/CV Series PCs	Allocation	CS1 Series PCs	Allocation
DM	Data memory	✓	Data memory	✓	Data memory	✓
CH	I/O relay	✓	I/O relay	✓	I/O relay	✓
TIM	Timer present value	×	Timer present value	×	Timer present value	×
CNT	Counter present value	×	Counter present value	×	Counter present value	×
HR	Holding relay	✓	–	–	Holding relay	×
AR	Auxiliary relay	✓	Special auxiliary relay	×	Special auxiliary relay	×
LR	Link relay	✓	–	–	–	–
EM	EM Current Bank *1 *2	✓	EM Current Bank *2	Δ	EM Current Bank *2	✓

✓ : OK × : NG Δ : Host link not available

*1 : EM (Extended data memory) of C series is available only with C200HX/HG/HE (–Z).
 *2 : Only current bank can be allocated for EM (Extended data memory).

Since the special auxiliary relays of the CVM1/CV series PCs are all allocated to system functions, they cannot be used for purposes other than system use.

The range of each memory area differs according to the PC type. refer to APPENDIX L “PC Memory Map”, page 674.

Functions of the PT Status Control Area

- Screen switch setting

Data is written to the “screen switch setting” word from both the NT631/NT631C and the host. The meaning of the data differs according to whether it is written from the NT631/NT631C or the host. However, if the NT631/NT631C is currently operating, the number of the screen displayed is always written to the “screen switch setting” word.

- When data is written from the host

To switch the screen displayed at the NT631/NT631C by an instruction from the host, write the screen number, as a 4-digit BCD or hexadecimal value, to the “screen switch setting” word. Whether the value is expressed in BCD or hexadecimal is determined by the setting for numeral storage type in the PT configuration settings made with the Support Tool.

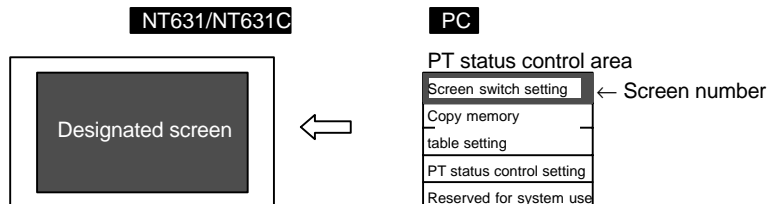

[Screen switch setting in the PT status control area]

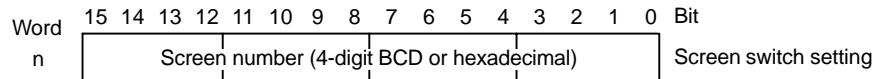

The screen numbers that can be set are as follows.

BCD	Hexadecimal	Screen
0000H	0000H	No-display (screen cleared)
0001 to 3999H	0001 to 0F9FH (3999)	Screen numbers 1 to 3999
9001H	2329H (9001)	Occurrence history screen
9002H	232AH (9002)	Frequency history screen

Reference

- The screen can also be switched by bit memory table operation (page 468), by touch switch operation (page 469), or by using the alarm list/history function (page 472).
- To display overlapping screens, designate the screen number of the parent screen.
- If there are no elements registered for the designated screen number, or if a keyboard screen is designated, the screen does not switch.
- When the NT631/NT631C starts operating, the screen is displayed according to the contents of the “screen switch setting” word. If the contents of the “screen switch setting” word are invalid, the screen is displayed according to the “Initial Screen” in the PT configuration settings made at the Support Tool. If the setting for “Initial Screen” is also invalid, an error message is displayed.

- When data is written from the NT631/NT631C

When the screen display has been switched by operation at the NT631/NT631C, the new screen number is written as a 4-digit BCD or hexadecimal value into the “screen switch setting” word by the NT631/NT631C. At the same time, the “ON” status is also notified to the screen switch strobe flag of the “PT status” word of the PT status notify area by the NT631/NT631C (after notification, the OFF status is re-established) (page 474). Whether the data is written in BCD or hexadecimal format is determined by the setting for “numeral storage type” in the PT configuration settings made at the Support Tool.

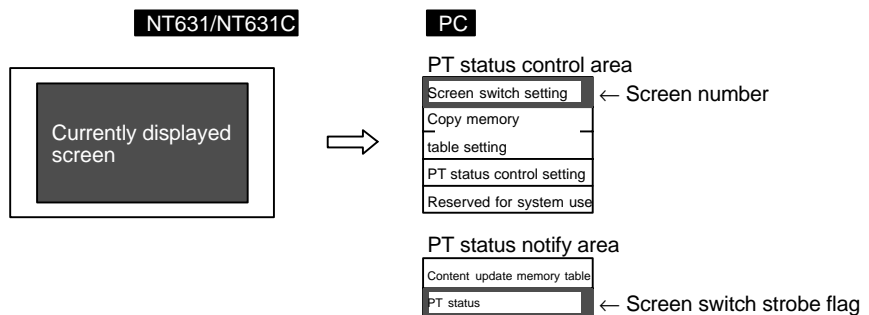

[“Screen switch setting” word of the PT status control area and “PT status” word of the PT status notify area]

PT status control area

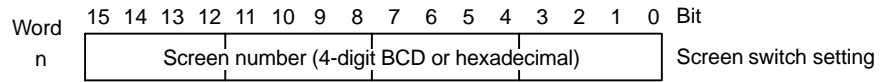

PT status notify area

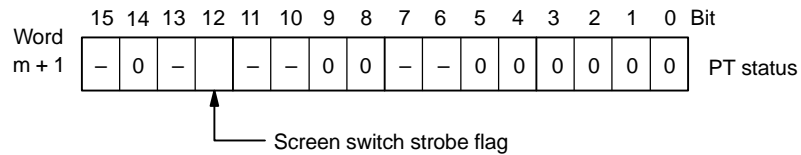

The screen numbers notified are as follows.

BCD	Hexadecimal	Screen
0000H	0000H	No-display (screen cleared)
0001 to 3999H	0001 to 0F9FH (3999)	Screen numbers 1 to 3999
9001H	2329H (9001)	Occurrence history screen
9002H	232AH (9002)	Frequency history screen

Reference

- The screen number is notified only when the screen is switched by operation at the NT631/NT631C.
- When an overlapping screen is displayed, the screen number of the parent screen is notified.

- Copy source/copy destination memory table numbers

Designate the memory table numbers of the copy source and copy destination memory tables as 4-digit BCD or hexadecimal values, when copying data between memory tables in the NT631/NT631C. Whether the values are BCD or hexadecimal is determined by the setting for numeral storage type in the PT configuration settings made with the Support Tool.

The memory table numbers that can be designated are indicated in the table below.

BCD	Hexadecimal	Numbers
0001 to 1999H	0000 to 07CFH (1999)	Memory table numbers 0 to 1999

Note that it is only possible to copy between the following combinations.

- A numeral memory table and a numeral memory table
- A character string memory table and a character string memory table

- Reference**
- What is designated here is the memory table number only. The type of memory table (numeral/character string) is set by the “memory table copy type” bit in the PT status control bits.
 - Copying is not executed just by writing the memory table numbers. It is executed when the “memory table copy execution” bit in the PT status control bits is turned ON.
 - Since the memory table numbers start from 0, if there are 2000 memory tables, the range is 0 to 1999, and if there are 1000, the range is 0 to 999.

• PT status control bits

The PT status control bits have the functions indicated below.

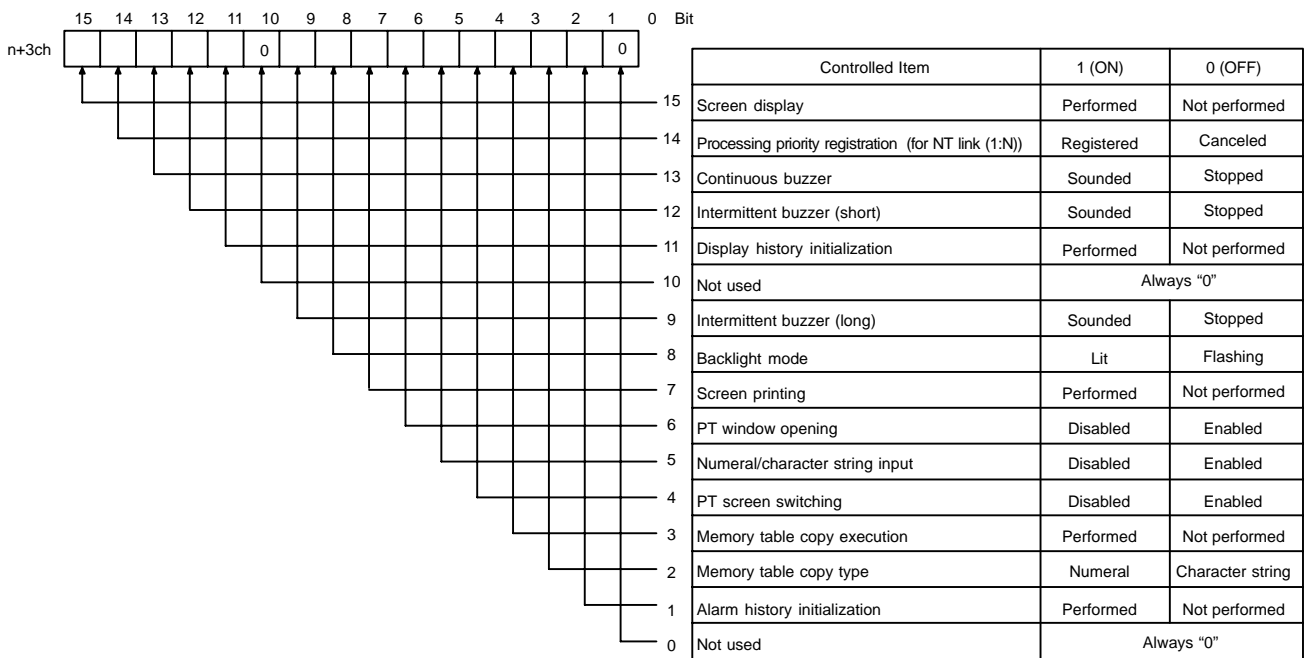

Note: The backlight mode (bit 8) is effective only for the NT631C.

- Reference**
- Since the statuses of the PT status control bits do not change even if the status of the NT631/NT631C changes in accordance with the settings of attributes or memory switches, the statuses of the PT status control bits may sometimes disagree with the status of the NT631/NT631C. For example, the buzzer may be sounding even though the “continuous buzzer” bit is OFF. In such a case, perform PT status control bit operations to achieve agreement with the status of the NT631/NT631C.
 - The PT status control bits are checked in bit units by the NT631/NT631C. The only functions that are actually performed are those for which the corresponding bits have changed in status.

- Screen display (bit 15)

The "screen display" bit displays and clears screens. It is used to prevent the formation of an afterimage on the display panel, etc. When bit 15 is turned OFF, the screen is cleared and the backlight also goes off. However, if the screen saver function is set with the memory switches of the NT631/NT631C, the screen saver is activated (the operation depends on the setting made for the screen saver function).

If bit 15 is turned ON (1), or the touch panel is pressed, while the screen is cleared (or while the screen saver function is working), the screen that was displayed immediately before the screen was cleared is redisplayed. The backlight also comes back on (or flashes).

Reference

Even when bit 15 is OFF, the designated screen will be displayed if screen switching is designated from the host, or the status of bit 7 (backlight mode) changes, or the touch panel of the NT631/NT631C is pressed.

- Processing priority registration (for NT link 1:N) (bit 14)

One of the PTs connected by the NT link (1:N) method can be registered for priority processing. The PT for which bit 14 is set to ON (1) is given priority over the other PTs, and has more rapid response time for screen display, touch switch operations, etc.

When bit 14 is set to OFF (0), this registration is canceled and the response speed is returned to normal. If priority registration is set for more than one PT, the one set last is given priority.

The unit number of the PT given priority registration can be checked by monitoring (reading) a word at the CS1G/CS1H, C200HX/HG/HE (-ZE). For details on the word monitoring operation at a PC, refer to the manual for the PC you are using.

The contents of the words that reflect the status of an NT link (1:N) system are indicated below.

Word	Bit	Function
<C200HX/HG/ HE (-Z)> Word 265 (standard port) Word 284 (port A)*1 Word 285 (port B)*1	0	“Communication in progress” flag of unit No. 0: ON when connected
	1	“Communication in progress” flag of unit No. 1: ON when connected
	2	“Communication in progress” flag of unit No. 2: ON when connected
<CS1G/CS1H> AR393 (RS-232C port) AR394 (pe- ripheral port) 1909CH (port1)*1 1919CH (port2)*1 n+9CH (port1)*2 n+19CH (port2)*2	3	“Communication in progress” flag of unit No. 3: ON when connected
	4	“Communication in progress” flag of unit No. 4: ON when connected
	5	“Communication in progress” flag of unit No. 5: ON when connected
	6	“Communication in progress” flag of unit No. 6: ON when connected
	7	“Communication in progress” flag of unit No. 7: ON when connected
	8	Priority registration flag of unit No. 0: ON when priority given
	9	Priority registration flag of unit No. 1: ON when priority given
	10	Priority registration flag of unit No. 2: ON when priority given
	11	Priority registration flag of unit No. 3: ON when priority given
	12	Priority registration flag of unit No. 4: ON when priority given
	13	Priority registration flag of unit No. 5: ON when priority given
	14	Priority registration flag of unit No. 6: ON when priority given
	15	Priority registration flag of unit No. 7: ON when priority given

*1 Communication board ports

*2 Communication unit board ports

$n=1500 + 25 \times \text{unit No. of communication unit}$

- Continuous buzzer (bit 13), short intermittent buzzer (bit 12), long intermittent buzzer (bit 9)

The “continuous buzzer” continues buzzing with no interruptions.

The short intermittent buzzer repeatedly alternates between sounding for 0.5 seconds and stopping for 0.5 seconds.

The long intermittent buzzer repeatedly alternates between sounding for 1.0 seconds and stopping for 1.0 seconds.

If more than one of these bits is ON at the same time, the buzzer sounds in accordance with the following order of priority.

1. Continuous buzzer
2. Short intermittent buzzer
3. Long intermittent buzzer

When stopping the buzzer by PT status control bit operation, set all three of the bits above to 0 (OFF).

- Reference**
- The buzzer will actually sound only when the "Buzzer Sound" memory switch of the NT631/NT631C is set to "ON".
 - The buzzer can also be stopped in other ways: by using a touch switch to which the buzzer stop attribute has been assigned (page 469), or by setting the screen attribute that stops the buzzer sound (page 252).
 - The buzzer can also be controlled by using the "Buzzer" screen attributes (page 252).

- Display history initialization (bit 11)

This bit is used to initialize the display history recorded in the NT631/NT631C. When it is switched from 0 (OFF) to 1 (ON), the display history in the NT631/NT631C is initialized.

After initialization, return its status to "0".

- Reference**
- The display history can also be initialized from the "MEMORY INIT. MENU" screen under the System Menu of the NT631/NT631C.

- Backlight mode (bit 8) (NT631C only)

The backlight mode is used for controlling the backlight of the NT631.

This function is not available with the NT631.

The status of bit 8 has the following effects.

- 1 (ON): lit
- 0 (OFF): flashing

- Screen printing (bit 7)

Hard copies of the screen can be made by connecting a printer to the NT631/NT631C.

When bit 7 is set from "0" (OFF) to "1" (ON), printing of the currently displayed screen starts. Note that it is not possible to stop printing while printing is in progress.

Check that bit 7 (printer operating status) of the PT status notify area is in the "0" (OFF) status before starting printing.

When printing starts and bit 7 has been set to the "1" (ON) status, return the "screen printing" bit to "0" (OFF).

- Reference**
- It is also possible to print screens by using a touch switch assigned the "Print screen" function.
 - The printer type (control protocol) and printing method, are set with the memory switches of the NT631/NT631C.

- PT window opening bit (bit 6)

The "PT window opening" bit is used to disable opening of a window by operation at the NT631/NT631C.

The status of bit 6 has the following effects.

Bit 6	Function
0 (OFF)	Windows can be opened by operation at the NT631/NT631C.
1 (ON)	Windows cannot be opened by operation at the NT631/NT631C (windows that are already open can be closed by operation at the NT631/NT631C). Also, when a local window (keyboard screen) attribute is designated for a screen, the window will not open when the screen is switched by operation at the NT631/NT631C.

- Numeral/character string input (bit 5)

This bit is used to disable the input of numeric values and character strings into numeral setting/character string input fields by operation at the NT631/NT631C. It also controls input from thumbwheel switches and bar code readers.

The status of bit 5 has the following effects.

Bit 5	Function
0 (OFF)	Input into numeral setting input fields and character string input fields is possible.
1 (ON)	Input into numeral setting input fields and character string input fields is disabled (it is also not possible to change the contents of numeral/character string memory tables by operation at the NT631/NT631C, such as copying memory tables with touch switches). The contents of numeral/character string memory tables can be changed without restriction from the host. It is also possible to copy memory tables using the PT status control area.

- PT screen switching (bit 4)

This bit is used to disable screen switching by operation at the NT631/NT631C.

The status of bit 4 has the following effects.

Bit 4	Function
0 (OFF)	Screen switching by operation at the NT631/NT631C is possible.
1 (ON)	Screen switching by operation at the NT631/NT631C is not possible. The screen can be switched by the instructions from the host ("screen switch setting" word of the PT status control area, bit memory table operations).

- Memory table copy execute (bit 3), memory table copy type (bit 2)

The "memory table copy execute" and "memory table copy type" bits are used to copy data between memory tables in the NT631/NT631C by PT status control area operations.

Proceed as follows to copy between memory tables using the PT status control area.

- Operation**
- 1 Set the numbers of the copy source and copy destination memory tables for “copy source memory table No.” (word n + 1) and “copy destination memory table No.” (word n + 2) of the PT status control area.
 - 2 Set the type of the memory table to be copied for “memory table copy type” (bit 2) of the PT status control bits (word n + 3) as follows.
 - 1 (ON): When copying between numeral memory tables
 - 0 (OFF): When copying between character string memory tables
 - 3 Set “1” (ON) for “memory table copy execution” (bit 3) of the PT status control bits (word n + 3).
The memory table data is copied.
 - 4 After copying has been executed, return “memory table copy execution” (bit 3) to “0”.

- Reference**
- If the display method or number of registered words is different for the copy source and copy destination memory tables, the data may not be displayed correctly.
 - If the contents of memory tables are changed by PT status control area operation, the change in memory table contents is not notified by the PT status notify area.

- Alarm history initialization (bit 1)
This bit is used to initialize the alarm history recorded in the NT631/NT631C. When it is switched from “0” (OFF) to “1” (ON), the alarm history in the NT631/NT631C is initialized. After initialization, return its status to “0”.

- Reference** The alarm history can also be initialized from the “MEMORY INIT. MENU” screen under the System Menu of the NT631/NT631C.

7-2-2 PT Status Notify Area (NT631/NT631C to Host)

The PT status notify area is provided to notify the host of changes in the status of the NT631/NT631C. The host can determine the status of the NT631/NT631C by reading this area.

The PT status notify area is configured as two consecutive words as shown below. The first word (word m) is set in the “Control/Notify Area” settings in the PT configuration settings made with the Support Tool.

Word	15	14	13	12	11	10	9	8	7	6	5	4	3	2	1	0	Bit
m	Numeral/character string memory table number (4-digit BCD or hexadecimal value)												Content update memory table				
m + 1	PT status notify bits												0	0	0	PT status	

Allocated Words of the PT Status Notify Area

The PT status notify area (NT631/NT631C → host) can be allocated to the following host (PC) areas.

Symbol	C Series PCs	Allocation	CVM1/CV Series PCs	Allocation	CS1 Series PCs	Allocation
DM	Data memory	✓	Data memory	✓	Data memory	✓
CH	I/O relay	✓	I/O relay	✓	I/O relay	✓
TIM	Timer present value	×	Timer present value	×	Timer present value	×
CNT	Counter present value	×	Counter present value	×	Counter present value	×
HR	Holding relay	✓	–	–	Holding relay	×
AR	Auxiliary relay	✓	Special auxiliary relay	×	Special auxiliary relay	×
LR	Link relay	✓	–	–	–	–
EM	EM Current Bank *1 *2	✓	EM Current Bank *2	△	EM Current Bank *2	✓

✓ : OK × : NG △ : Host link not available

*1 : EM (Extended data memory) of C series is available only with C200HX/HG/HE (–Z).

*2 : Only current bank can be allocated for EM (Extended data memory).

Since the special auxiliary relays of the CVM1/CV series PCs are all allocated to system functions, they cannot be used for purposes other than system use.

The range of each memory area differs according to the PC type. Refer to APPENDIX L “PC Memory Map”, page 674.

Notice

- Set so that there is no overlap between the PT status control area and PT status notify area.
- When using the NT link (1:N) method, allocate a PT status control area and PT status notify area — making sure that they do not overlap — for each connected NT631/NT631C.

Functions of the PT Status Notify Area

- Content update memory table number

When the contents of a numeral/character string memory table have been changed by operation at the NT631/NT631C, the number of the memory table subject to the change is written to the “content update memory table” word as a 4-digit BCD or hexadecimal value. Whether the value is expressed in BCD or hexadecimal is determined by the setting for numeral storage type in the PT configuration settings made with the Support Tool.

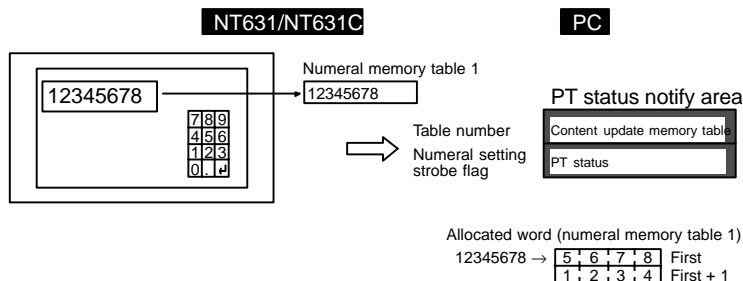

["Content update memory table" and "PT status" of the PT status notify area]

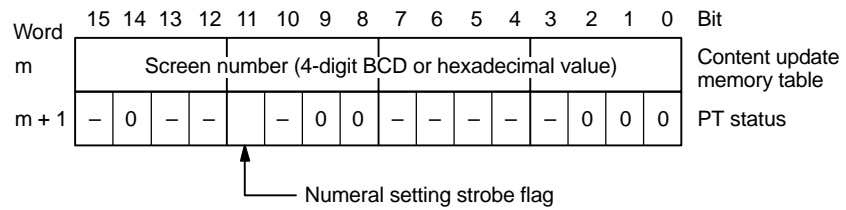

BCD	Hexadecimal	Numbers
0001 to 1999H	0000 to 07CFH	Memory table numbers 0 to 1999

Reference The memory table number is notified only when the memory table contents are changed by operation at the NT631/NT631C.

• PT status notify bits

The PT status notify bits have the functions shown below.

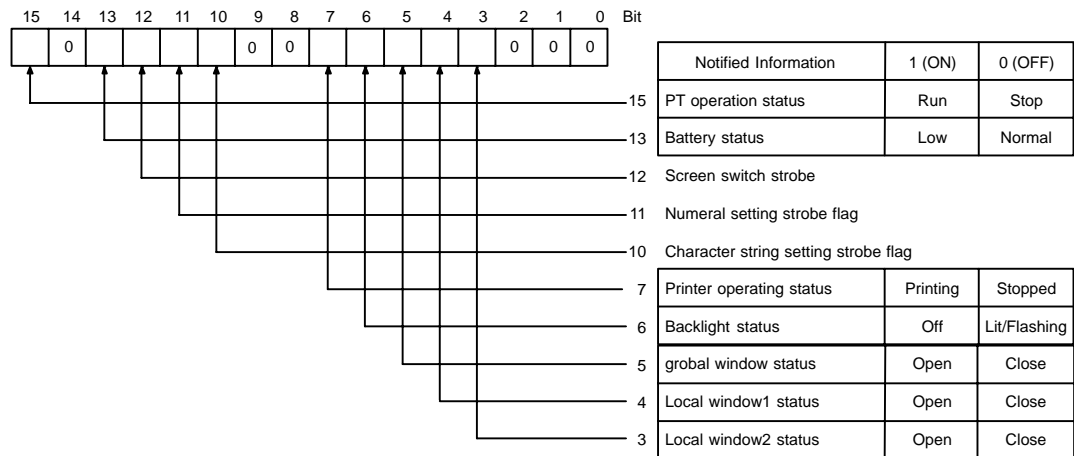

- PT operation status (bit 15)

When the NT631/NT631C is in the RUN mode, this bit is set to "1". In other modes, and when the System Menu screen is displayed, it is set to "0" (OFF). When this bit is set to "0" (OFF), the allocated bits and words are neither read or written.

During the RUN mode, "1" (ON) is periodically written to this bit. In order to check whether the NT631/NT631C is operating normally or not, write "0" (OFF) to this bit, then read it 30 seconds later. If the setting for the bit is "1" (ON), the NT631/NT631C is judged to be running, and if it is "0" (OFF), the NT631/NT631C is judged to be stopped.

Notice To ensure system safety, be sure to periodically read the PT operating status bit from the host in order to ensure that the PT is always operating normally.

- Battery status (bit 13)

This bit is set to "1" (ON) when the voltage of the battery that backs up the internal memory of the NT631/NT631C (built-in battery) is low.

If the battery voltage drops, it is impossible to retain data with the resume function and to retain history records, therefore the battery must be replaced with a new one within one week after the "battery" bit is set to "1" (ON). For details on how to replace the battery, refer to 11-3-1 "Replacing the Battery" (page 623).

- Screen switching strobe (bit 12)

This bit is set to "1" (ON) when the NT631/NT631C screen is changed by an instruction from the host or by operation at the NT631/NT631C (ex. use of screen changeover function). After notification to the host, it is automatically returned to "0" (OFF).

- Numeral setting strobe flag (bit 11)

This bit is set to "1" (ON) when a numeric value is input to a numeral memory table using the numeral input function of the NT631/NT631C. After notification to the host, it is automatically returned to "0" (OFF).

At the same time, the number of the numeral memory table to which the input was made is notified to the "content update memory table" word.

- Character string setting strobe flag (bit 10)

This bit is set to "1" (ON) when a character string is input to a character string memory table using the character string input function of the NT631/NT631C. After notification to the host, it is automatically returned to "0" (OFF).

At the same time, the number of the character string memory table to which the input was made is notified to the "content update memory table" word.

- Printer operating status (bit 7)

This bit is set to "1" (ON) when a printer connected to the NT631/NT631C is printing due to touch switch operation at the NT631/NT631C or an instruction from the host. On completion of printing, it returns to "0" (OFF). It is also returned to "0" (OFF) even while printing is in progress if the NT631/NT631C displays the System Menu or an error screen.

The NT631/NT631C can print the following data in the RUN mode.

- The currently displayed screen image (by touch switch operation, or operation of the "screen printing" bit of the PT status control bits)
- Display history record data (by pressing the "Print Screen" touch switch when screen number 9001 or 9002 is displayed)

- Backlight status (bit 6)

The EL screen status of the NT631 and the backlight status of the NT631C are notified as follows.

□ 1 (ON): The EL screen is cleared or the backlight is off.

□ 0 (OFF): The EL screen is displayed or the backlight is lit (flashing).

However, this bit is returned to "0" (OFF) when the NT631/NT631C displays the System Menu or an error screen.

Reference Whether the backlight is lit continuously or flashes when the “backlight status” bit is set to “1” (ON) is determined by the “backlight mode” bit (bit 8) of the PT status control bits and the “Backlight” screen attribute.

- Global window open status (bit5), local window1 open status (bit4), local window2 open status (bit3)

This bit is set to “1” (ON) when a corresponding window is open. It is returned to “0” (OFF) when a corresponding window is closed. (It remains “1” (ON) even if the window screen number is switched in the middle of operation.)

It is possible to know the screen number of the window which is currently open or the display position (bottom-left coordinate) by checking the window control area.

- Strobes

The screen switching, numeral setting, and character string setting strobes are automatically returned to “0” (OFF) after notification to the host. The status of operations at the NT631/NT631C can easily be ascertained by detecting the leading edges of these strobes.

However, when connected to a CVM1/CV series CPU, if the PC is set for asynchronous operation, the leading edge may not be detected.

7-2-3 Window Control Area (Host ↔ NT631/NT631C)

Data is written to the window control area from both the NT631/NT631C and the host. The status of the window is always written.

When the data is written to this area from the host, the NT631/NT631C reads the data and display the window with the specified number at the designated position.

When the display status of the window (screen No., display position) is changed due to the operation at NT631/NT631C, current status of the window is written to the area allocated to the host. The host can determine the display status of the window by reading this area.

The window control area is configured as nine consecutive words as shown below. The first word (word k) is set in the “Control/Notify Area” settings in the PT configuration settings made with the Support Tool.

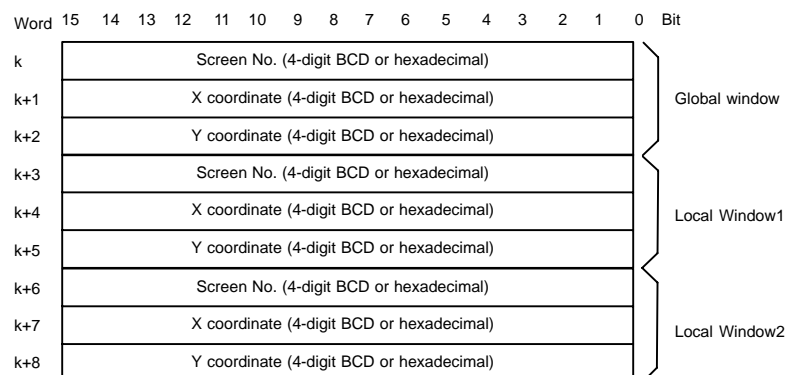

Reference It is not necessary to allocate word to window control area when the window is not controlled from the host or when the window is not used.

Allocated Words of the Window Control Area

The window control area (NT631/NT631C(host) can be allocated to the following host (PLC) areas.

Symbol	C Series PCs	Allocation	CVM1/CV Series PCs	Allocation	CS1 Series PCs	Allocation
DM	Data memory	✓	Data memory	✓	Data memory	✓
CH	I/O relay	✓	I/O relay	✓	I/O relay	✓
TIM	Timer present value	×	Timer present value	×	Timer present value	×
CNT	Counter present value	×	Counter present value	×	Counter present value	×
HR	Holding relay	✓	–	–	Holding relay	×
AR	Auxiliary relay	✓	Special auxiliary relay	×	Special auxiliary relay	×
LR	Link relay	✓	–	–	–	–
EM	EM Current Bank *1 *2	✓	EM Current Bank *2	△	EM Current Bank *2	✓

✓ : OK × : NG △ : Host link not available

*1 : EM (Extended data memory) of C series is available only with C200HX/HG/HE (–Z).

*2 : Only current bank can be allocated for EM (Extended data memory).

Since the special auxiliary relays of the CVM1/CV series PCs are all allocated to system functions, they cannot be used for purposes other than system use.

The range of each memory area differs according to the PC type. Refer to APPENDIX L “PC Memory Map”, page 674 .

The screen No. which can be specified is as follows.

BCD	Hexadecimal	Screen
0000	0000 _H	No display (window closed)
0001 ~ 3999	0001 ~ 0F9F _H	Window screen No. 1 ~ 3999

The X coordinate which can be specified is as follows.

BCD	Hexadecimal	Contents
0000 ~ 0620	0000 ~ 026C _H	X coordinate at the bottom left position of window 0 ~ 620 (multiple of 20)

The Y coordinate which can be specified is as follows.

BCD	Hexadecimal	Contents
0019 ~ 0479	0013 ~ 01DF _H	Y coordinate at the bottom left of window 19 ~ 479 (multiple of 20-1)

- Reference**
- Local window can be also opened, closed or moved by the operation of touch switch (page 478, 479). In addition, by setting the attribute of the screen (base screen) to be displayed, local window pops up at the same time the screen is displayed (refer to page 252).
 - Global window can be controlled only by writing to the window control area from the host.
 - Window position (coordinate) can be specified by 20 dot unit. (Y coordinate = multiple of 20-1, because of the bottom-left coordinate specification)
Window can not be controlled and the contents of the window remains unchanged when the number other than multiple of 20 is specified for X coordinate or when the number other than multiple of 20-1 is specified for Y coordinate. However, when opening a new window, the window is displayed at the position which was specified when the window screen was created using the Support Tool.

Functions of the Window Control Area

If the NT631/NT631C is currently operating, the status of the window is always written to the window control area. The contents of the window control area depends on the window type (global window/local window) and the circumstances as follows.

- When the window is opened by touch switch operation (local window only):
Window screen which is set for a touch switch pops up at the position which was specified when the window was created using the Support Tool. At this time, the status of the window is written to the "screen No.", "X coordinate" and "Y coordinate" of window control area (corresponding window type).
- When the window is closed by touch switch operation (local window only):
The "screen No.", "X coordinate" and "Y coordinate" of window control area (corresponding window type) are all cleared to "0".
- When the window screen No. is specified for "screen No." of window control area:
The specified window is opened as the corresponding window type. The window position follows the contents of "X coordinate" and "Y coordinate" of window control area. However, in the following cases, the window is opened at the position which was specified when the window was created using the Support Tool. (Window move operation is not performed and the X, Y coordinates return to the existing value when the incorrect "X coordinate" and "Y coordinate" are specified without changing the "screen No.".)
 - When the contents of X coordinate is not multiple of 20, or when the contents of Y coordinate is not multiple of 20-1
 - When the window will extend out of the screen with the specified value (ex. When X coordinate: 500, Y coordinate: 299 are specified for the window screen of 200 × 200 dots).
- When 0 is written to the "screen No." of window control area:
Window of the corresponding type is closed. The contents of "X coordinate" and "Y coordinate" is retained.

- When the screen is switched to the other while the window is being displayed (other than system screen):

The behavior depends on the screen type as follows. (Even when the global window and the local window were displayed before screen switching, the each screen also behaves as the table below.)

Window type	Screen No.	X coordinate	Y coordinate	Status
Global window	Retains the existing value			Remain opened
Local window	Cleared to 0			Closed (*)

- * If the local window open attribute is set for the screen switched to, the local window opens.
- When the screen is switched to system screen, error screen or system menu, while the window is being displayed.

The behavior depends on the screen type as follows. (Even when the global window and local window were displayed before screen switching, the each screen also behaves as the table below.)

Window type	Screen No.	X coordinate	Y coordinate	Status
Global window	Retains the existing value			Closed
Local window	Cleared to 0			Closed

If a standard screen or an overlapping screen is displayed again, the same global window will be opened at the same position but the local window will not be opened.

System screens which close global window are as follows:

- System initializing screen (screen No.9000)
- Programming console function screen (screen No.9020)
- No-display screen (screen No.0)

With Occurrence history screen (screen No.9001) and frequency history screen (screen No.9002) global window remains opened.

Data is written to the window control area from both the NT631/NT631C and the host. The meaning of the data differs according to whether it is written from the NT631/NT631C or the host.

- When the data is written from the host:

To switch, open, close or move a window on the NT631/NT631C by an instruction from the host, write the window screen number or coordinates to the “window No.,” “X coordinate” or “Y coordinate” as 4-digits BCD or hexadecimal. Whether the values are BCD or hexadecimal is determined by the setting for numeral storage type in the PT configuration settings made with the Support Tool.

By changing the “screen No.,” window can be switched, opened or closed.

It is possible to move the window position by changing the “X coordinate” and “Y coordinate”.

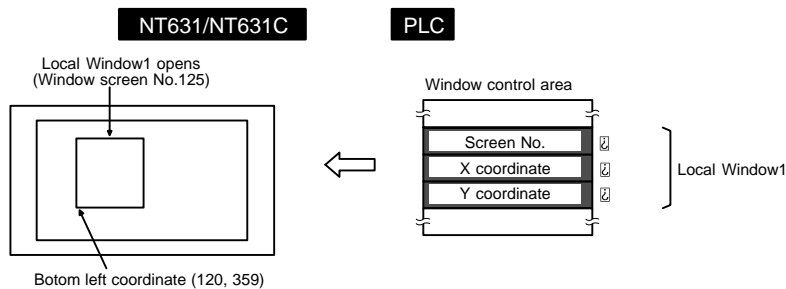

[“Screen No.,” “X coordinate” and “Y coordinate” of the window control area]

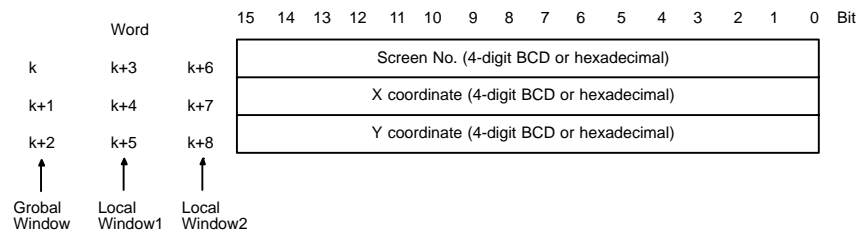

- When the data is written from the NT631/NT631C:

When the display status of the window is changed by the operation at NT631/NT631C, new window screen No. or coordinates is written to the “window No.,” “X coordinate” or “Y coordinate” as 4-digits BCD or hexadecimal from the NT631/NT631C. When the window is opened or closed, window open/close status is written to the “window open status” (page 483) of “PT status” in PT notify area.

Whether the values are BCD or hexadecimal is determined by the setting for numeral storage type in the PT configuration settings made with the Support Tool.

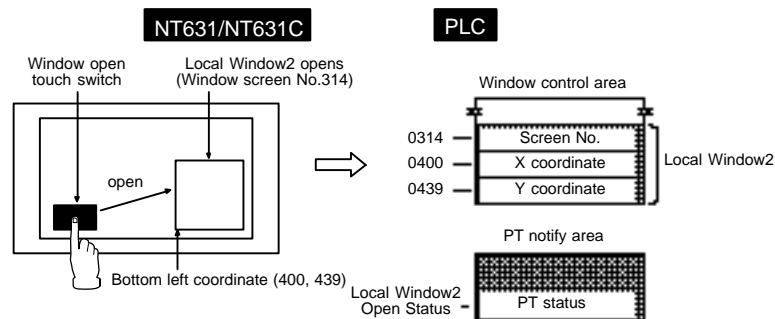

7-3 Memory Tables

The NT631/NT631C has the following three types of memory area that can be written to freely from the host.

- “Numeral memory tables” for numeric value data Page 278
- “Character string memory tables” for text data Page 285
- “Bit memory tables” for bit data Page 289

The contents of numeral/character string memory tables can be displayed for individual memory tables at the Support Tool, and set in table editing.

7-3-1 Numeral Memory Tables

[Function Outline]

“Numeral memory tables” are internal memories of the NT631/NT631C for recording numeric value data.

Since they can be allocated to words at the host, the contents of host words can be displayed as numeric values at the NT631/NT631C via numeral memory tables.

Numeral memory tables are assigned numeral memory table numbers so that they can be managed and designated individually.

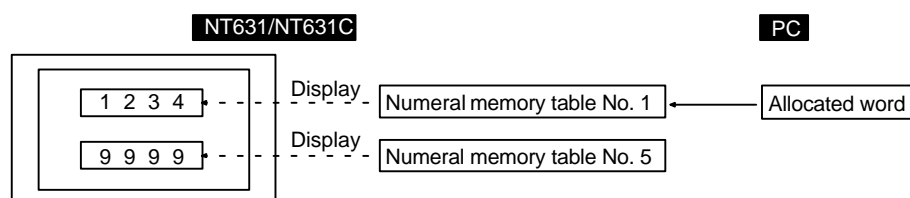

[Restrictions]

- The number of numeral memory tables can be set as one of the following in the “System” settings in the PT configuration settings made at the Support Tool.
 - 512 (numeral memory table numbers 0 to 511)
 - 1000 (numeral memory table numbers 0 to 999)
 - 2000 (numeral memory table numbers 0 to 1999)
- Since the numeral memory tables share memory area with the screen data, setting a large number of numeral memory tables reduces the memory area available for screen data.
- The data quantity of one numeral memory table can be set to either of the following by setting at the Support Tool.
 - 1 word (2 bytes)/2 words (4 bytes)
- Since numeral memory table numbers 1000 and higher are not backed up by the battery, they return to the initial values set with the Support Tool when the power to the NT631/NT631C is turned ON, when the NT631/NT631C is reset, and on transition from the System Menu to the RUN mode, regardless of the setting made for the resume function.
- Numeral memory table numbers 247 to 255 are used with the clock function of the NT631/NT631C. These tables cannot be used for other applications. For details on the clock function, refer to 7-15-6 “Clock Function” (page 445).

[Common Attributes]

Numeral memory tables have the following properties.

Property	Possible Settings
	Meaning
Value	<input type="checkbox"/> For BCD format: -9999999 to 99999999 <input type="checkbox"/> For binary format: -2147483648 (80000000H) to 2147483647 (7FFFFFFFH)
	<p>The initial values that can be set as the contents of memory tables by the Support Tool</p> <p>The format is determined by the system memory of the NT631/NT631C and the "Numeral Storage Type" setting ("Storage type and stored data", page 281).</p>
Initial	Check mark (initialize)/No check mark (do not initialize)
	<p>This setting determines whether or not the allocated words at the host are initialized when the power to the NT631/NT631C is turned ON, when the NT631/NT631C is reset, and on transition from the System Menu to the RUN mode.</p> <p>"Initialization" here means initialization of the allocated words at the host: when a check mark is set, the previously existing numeral memory table contents are written to the host words. When no check mark is set, the data at the host is read and set in the numeral memory tables.</p>
Storage Type	System/Binary/BCD
	<p>Method for storing numeric data in numeral memory tables.</p> <p>This setting is valid only when the numeral table is allocated to the host. Numeral memory tables that are not allocated to the host always use binary format. If a setting is made for "System", it complied with the "Numeral Storage Type" setting of PT configuration.</p> <p>For details, refer to "Storage type and stored data" (page 281).</p>
Words	1/2
	<p>The number of words used at the host when a numeral memory table is allocated to the host.</p> <p>For details, refer to "Allocated words" (page 280).</p>
PC Address	Any word address at the host
	<p>Word at the host to which the numeral memory table is allocated</p> <p>When the numeral memory table is allocated to two words, designate the first (lower) word.</p> <p>For details, refer to "Allocated words" (page 280).</p>
I/O Comment	Up to 16 characters of text
	Comment that describes the contents of a numeral memory table

- Storage type and stored data

Internally, numeral memory tables store numeric values comprising eight signed binary (or hexadecimal) digits. When the initial value or contents of the allocated word(s) are stored in a memory table, the numeric value is interpreted in accordance with the setting for "Storage Type" and is stored after conversion to signed binary data. Accordingly, the same data will be interpreted in different ways by the NT631/NT631C depending on the setting made for "Storage Type".

Reference

Signed binary data expresses negative values as the complement of two (the bits are inverted and 1 is added).

- Storage type for the BCD format

When using BCD format, the "Value" (initial value) and contents of the word(s) at the host are interpreted as BCD (binary coded decimal) data. However, since it is not possible to input a negative sign in a host word, the letter "F" at the most significant digit is used instead to denote negative values (a negative sign can be used in the setting for "Value", so negative values can be input in the normal manner for this setting).

If a value with a letter from "A" to "E" inclusive as its most significant digit, or a value with a letter from "A" to "F" inclusive at any position other than the most significant digit is stored in a host word, it is invalidated as illegal data and the existing value is retained.

If the contents of a numeral memory table exceed the range that can be handled by the allocated words of the host, the value is written to the host as "negative sign + less significant digits" (see below).

Contents of numeral memory table (decimal notation)		Data at host	Conditions
12345	→	2345	1 allocated word When using BCD format
-1234	→	F234	
123456789	→	23456789	2 allocated words When using BCD format
-12345678	→	F2345678	

- Storage type for binary format

When binary format is used, the initial value and contents of the host word(s) are interpreted as signed binary data and are stored without change in the numeral memory table.

With binary format, the most significant bit is the sign bit (when this bit is "1" it indicates a negative value). When there is one allocated word, the most significant bit is bit 15; when there are two allocated words it is bit 31.

However, when the initial value is input using the Support Tool, the basis for input is always the decimal system, regardless of the setting for "Storage Type". The "-" symbol can be input to indicate a negative value. If "\$" is input at the head of the input value, it will be input as a hexadecimal value (after confirmation of input, it is displayed in decimal).

- Stored data

The table below indicates how the set "Value" (initial value) and the contents of host words are stored in numeral memory tables.

Storage of "Value" set at the Support Tool

Input Value	Storage Type	Number of Words	Display After Confirmation	Stored Value
123456	BCD	2	123456	0001E240
	Binary		123456	0001E240
-123456	BCD	2	-123456	FFFE1DC0
	Binary		-123456	FFFE1DC0
\$F001	BCD	1	61441	0000F001
	Binary		61441	0000F001
\$FFFF	BCD	1	65535	0000FFFF
	Binary		65535	0000FFFF
\$FFFFFFFF	BCD	2	-1	FFFFFFFF
	Binary		-1	FFFFFFFF

Storage of contents of host words

Contents of Word	Storage Type	Number of Words	Stored Value	Decimal for Stored Value
1234	BCD	1	000004D2	1234
	Binary		00001234	4660
F123	BCD	1	FFFFFF85	-123
	Binary		FFFFF123	-3805
123B	BCD	1	(not stored ... existing value retained)	
	Binary		0000123B	4667
F0001234	BCD	2	FFFFFB2E	-1234
	Binary		F0001234	-268430796
FFFF	BCD	1	(not stored ... existing value retained)	
	Binary		FFFFFFFF	-1
0000FFFF	BCD	2	(not stored ... existing value retained)	
	Binary		0000FFFF	65535
FFFFFFFF	BCD	2	(not stored ... existing value retained)	
	Binary		FFFFFFFF	-1

- “Initial” setting and initial value

The “Initial” setting determines whether the contents of numeral memory tables are written to the allocated word(s) at the host when the power to the NT631/NT631C is turned ON, when the NT631/NT631C is reset, or on transition from the System Menu to the RUN mode.

Here, “Initial” (initialization) means the initialization of the contents of host word(s) as they are overwritten by the contents of the numeral memory table. If the numeral memory table is not allocated to a host word or words, this setting has no effect.

Reference When the NT631/NT631C starts operation, the contents of numeral memory tables is as follows depending on whether or not the numeral memory table is allocated to the host, on the “Initial” setting for the numeral memory table, and on whether or not the resume function is used.

Allocated to Host?	“Initial” Setting	Resume Function	
		Used	Not Used
Yes	Checked	Existing numeral memory table value retained (at host word(s) also)	Initial value of numeral memory table used (at host word(s) also)
		When the numeral memory table is initialized by System Menu operation: initial value of the numeral memory table (at host word(s) also)	
	Not checked	Contents of host word(s)	
No	(Ineffective)	Existing numeral memory table value	Initial value of numeral memory table
		When the numeral memory table is initialized by System Menu operation: initial value of the numeral memory table	

[Display Functions]

Numeral memory tables themselves have no display function.

To display the contents of numeral memory tables, use 7-8 “Numeral Display” (page 348) or 7-10 “Graphs” (page 362).

[Input Functions]

When a numeral memory table is allocated to a word or words at the host, the contents of the word are read and stored.

However, reading is only executed for those numeral memory tables that are being used for the currently displayed screen (when copying a memory table, the contents of the allocated word(s) of the copy source memory table are read).

[Output Functions]

When a numeral memory table is allocated to a word or words at the host, the contents of the numeral memory table are written to the word(s).

However, writing is only executed in the following cases.

- When the contents of the numeral memory table have changed as a result of operations at the NT631/NT631C, such as memory table copying by touch switch operation, or use of the numeral setting function
- When the “Initial” setting at the Support Tool is checked when the power to the NT631/NT631C is turned ON, the NT631/NT631C is reset, or on transition from the System Menu to the RUN mode (the contents of all numeral memory tables that are allocated to the host and whose “Initial” setting is checked are written)

[Processing Functions]

The set “Value” (initial value) and the contents of the allocated word(s) at the host are interpreted and stored in accordance with the set attributes (refer to “Common Attributes”, page 279).

[Relationship with Other Elements]

- When “numeral display” is used, the contents of numeral memory tables can be displayed in real time as numeric values (page 348).
- When a “bar graph” is used, the contents of a numeral memory table can be displayed in real time in bar graph form (page 362).
- When an “analogue meter” is used, the contents of a numeral memory table can be displayed in real time in the form of quarter, semi-circle or circle-shaped graph.
- When a “broken line graph” is used, the contents of multiple, consecutive numeral memory tables can be displayed in real time in the form of a broken line graph (page 374).
- When a “trend graph” is used, changes over time in the contents of a numeral memory table can be displayed in the form of a broken line graph (page 380).
- When a “numeral setting” is used, numeric values can be input into the numeral memory table from the screen of the NT631/NT631C (page 406).
- When the touch switch copy setting function is used, the contents of a numeral memory table can be copied, and constants can be input to the numeral memory table (page 328).
- By operation of the “PT status control area”, data can be copied between memory tables from the host (page 260).
- If the contents of numeral memory tables are changed by operation at the NT631/NT631C, the change is notified to the “PT status notify area” (page 269).

7-3-2 Character String Memory Tables

[Function Outline]

“Character string memory tables” are internal memories of the NT631/NT631C for recording character string data.

Since they can be allocated to words at the host, the contents of words at the host can be displayed as character strings at the NT631/NT631C via character string memory tables.

Character string memory tables are assigned character string memory table numbers so that they can be managed and designated individually.

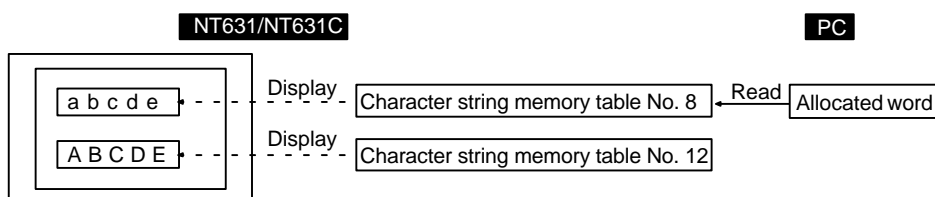

[Restrictions]

- The number of character string memory tables can be set as one of the following at the Support Tool.
 - 256 (character string memory table numbers 0 to 255)
 - 1000 (character string memory table numbers 0 to 999)
 - 2000 (character string memory table numbers 0 to 1999)

Since the character string memory tables share memory area with the screen data, setting a large number of character string memory tables reduces the memory area available for screen data.

- The data quantity of one character string memory table can be set as follows by setting at the Support Tool (a setting of “0” indicates no allocation).
 - 0 to 40 characters (= 0 to 40 bytes, which is 0 to 20 words)
- Character string memory table numbers 500 and higher always remain at the initial value set with the Support Tool. These values cannot be changed later and can only be read. These tables cannot be allocated to the host either.
- The characters that can be stored in character string memory tables are alpha-numerics, symbols, and marks (codes FF20 to FFFFH).

Reference

- If “00H” (NULL code) is encountered in a character string, the subsequent data is ignored.
- If codes outside the ranges indicated above are written to the allocated words at the host, the character strings may not be displayed correctly.

[Common Attributes]

Character string memory tables have the following properties.

Property	Possible Settings
	Meaning
Value	Alphanumerics and symbols, Marks
	Character string in the initial status after the contents of the character string memory table have been initialized.
Initial	Check mark (initialize)/No check mark (do not initialize)
	This setting determines whether or not the allocated words at the host are initialized when the power to the NT631/NT631C is turned ON, when the NT631/NT631C is reset, and on transition from the System Menu to the RUN mode. "Initialization" here means initialization of the allocated words at the host: when a check mark is set, the previous character string memory table contents are written to the host words. When no check mark is set, the data at the host is read and set in the character string memory tables.
PC Address	Any word address at the host
	Host word(s) to which the character string memory table is allocated Designate the first (lower) word. For details, refer to "Allocated words (page 286).
Words	1 to 20
	The number of words used at the host when a character string memory table is allocated to the host. For details, refer to "Allocated words" (page 286).
I/O Comment	Up to 16 characters of text
	Comment that describes the contents of a character string memory table

- Allocated words

Character string memory tables can be allocated to 1 to 20 words at the host.

Character string memory tables can be allocated to the following host (PC) areas.

Symbol	C Series PCs	Allocation	CVM1/CV Series PCs	Allocation	CS1 Series PCs	Allocation
DM	Data memory	✓	Data memory	✓	Data memory	✓
CH	I/O relay	✓	I/O relay	✓	I/O relay	✓
TIM	Timer present value	×	Timer present value	×	Timer present value	×
CNT	Counter present value	×	Counter present value	×	Counter present value	×
HR	Holding relay	✓	–	–	Holding relay	×
AR	Auxiliary relay	✓	Special auxiliary relay	×	Special auxiliary relay	×
LR	Link relay	✓	–	–	–	–
EM	EM Current Bank *1 *2	✓	EM Current Bank *2	△	EM Current Bank *2	✓

✓: OK ×: NG △: Host link not available

*1 : EM (Extended data memory) of C series is available only with C200HX/HG/HE (–Z).

*2 : Only current bank can be allocated for EM (Extended data memory).

Since the special auxiliary relays of the CVM1/CV series PCs are all allocated to system functions, they cannot be used for purposes other than system use.

The range of each memory area differs according to the PC type. Refer to APPENDIX L "PC Memory Map", page 674.

The relationships among the allocated words, the number of allocated words, and the contents of character string memory tables are indicated in the figure below.

Example: Number of allocated words = 4 words

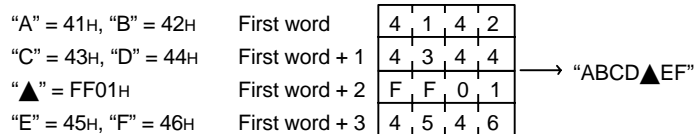

- "Initial" setting and initial value

The "Initial" setting determines whether the contents of character string memory tables are written to the allocated word(s) at the host when the power to the NT631/NT631C is turned ON, when the NT631/NT631C is reset, or on transition from the System Menu to the RUN mode.

Here, "Initial" (initialization) means the initialization of the contents of host word(s) as they are overwritten by the contents of the character string memory table. If the character string memory table is not allocated to a host word or words, this setting has no effect.

Reference When the NT631/NT631C starts operation, the contents of character string memory tables are as follows depending on whether or not the character string memory table is allocated to the host, on the "Initial" setting for the character string memory table, and on whether or not the resume function is used.

Allocated to Host?	"Initial" Setting	Resume Function	
		Used	Not Used
Yes	Checked	Existing character string memory table value retained (at host word(s) also)	Initial value of character string memory table used (at host word(s) also)
	Not checked	When the character string memory table is initialized by System Menu operation: initial value of the character string memory table (at host word(s) also)	
No	(Ineffective)	Existing character string memory table value	Initial value of character string memory table
		When the character string memory table is initialized by System Menu operation: initial value of the character string memory table	

[Display Functions]

Character string memory tables themselves have no display function.

To display the contents of character string memory tables, use 7-9 “Character String Display” (page 356).

Character strings can also be displayed as messages by using the “alarm list” (page 395) and “alarm history” (page 395) functions.

[Input Functions]

When a character string memory table is allocated to a word or words at the host, the contents of the word are read and stored.

However, reading is only executed for those character string memory tables that are being used for the currently displayed screen (when copying a character string memory table, the contents of the allocated word(s) of the copy source memory table are read).

[Output Functions]

When a character string memory table is allocated to a word or words at the host, the contents of the character string memory table are written to the word(s).

However, writing is only executed in the following cases.

- When the contents of the character string memory table have changed as a result of operations at the NT631/NT631C, such as memory table copying by touch switch operation, or use of the input setting function
- When the “Initial” setting of string table is checked when the power to the NT631/NT631C is turned ON, the NT631/NT631C is reset, or on transition from the System Menu to the RUN mode (the contents of all character string memory tables that are allocated to the host and whose “Initial” setting is checked are written.)

[Processing Functions]

Character string memory tables have no data processing function.

[Relationship with Other Elements]

- When “character string display” is used, the contents of character string memory tables can be displayed in real time as character strings (page 356).
- When “alarm list” or “alarm history” is used, the contents of the character string memory table can be displayed as a message (page 395).
- When “character string input” is used, character strings can be input into the character string memory table from the screen of the NT631/NT631C (page 422). It is also possible to input character strings from a bar code reader connected to the NT631/NT631C.
- When the touch switch copy setting function is used, the contents of a character string memory table can be copied (page 328).
- By operation of the “PT status control area”, data can be copied between memory tables from the host (page 270).
- If the contents of character string memory tables are changed by operation at the NT631/NT631C, the change is notified to the “PT status notify area” (page 269).

7-3-3 Bit Memory Tables

[Function Outline]

Bit memory tables are internal memories for bit data.

They are allocated to a bit at the host to monitors a bit, and can execute a specific function in accordance with the status of that bit.

Bit memory tables are assigned bit memory table numbers so that they can be managed and designated individually.

Bit memory tables have the following functions.

- Screen changeover function

When the host bit to which a bit memory table is allocated changes status from “0” (OFF) to “1” (ON), the screen whose screen number is set in the bit memory table is displayed.

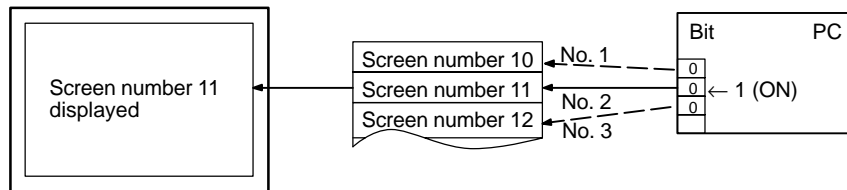

If the allocated bits of multiple bit memory tables come ON at the same time, the bit memory table with the smallest number takes priority.

- Alarm list/history function

When the status of the host bit to which a bit memory table is allocated changes to 1 (ON), the contents of the character string memory table (message), and image/library data set for that bit memory table are displayed (this is the “alarm list function”). In order to use the alarm list function, it must be registered for the screen in advance. If more than one bit memory table is set for the alarm list function, those with smaller bit memory table numbers are given display priority, therefore it is possible to assign an order or priority to displayed messages.

If registration in the alarm history is designated, the time when the status of the host bit to which the bit memory table is allocated changes to “1” (ON) is recorded in the alarm history (“alarm history function”).

For details, refer to 7-11 “Alarm List, Alarm History” (page 395).

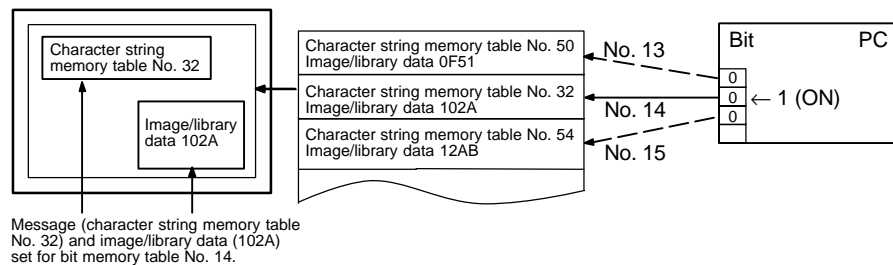

- Operation when using the alarm list/history function

The operation when using the alarm list/history function is as follows.

Reference

- For the alarm list function, display is in ascending order of bit memory table numbers. For the alarm history function display is in occurrence order (from newest record/from oldest record) or frequency order.
- With the alarm list function, when the host bit to which the bit memory table is allocated returns to "0" (OFF) during display, the message and image/library data is automatically cleared.

- (1) When the status of a bit memory table changes to "1" (ON), the contents of the set character string memory table are displayed as a message.

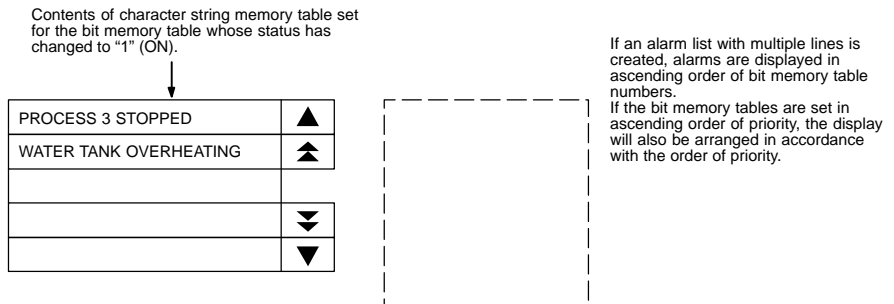

- (2) Each message area is a touch switch and pressing a message displays the set image/library data. At the same time, the pressed message is displayed in reverse video.

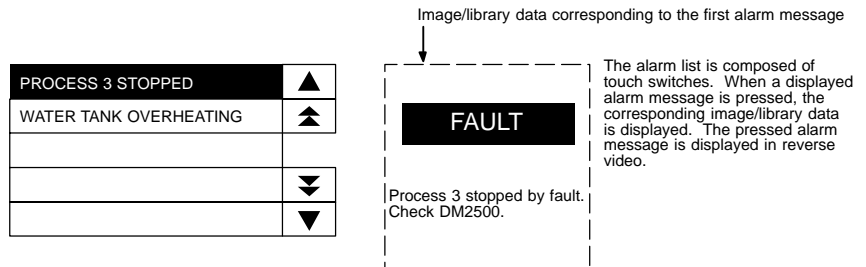

- (3) In case multiple messages are displayed, pressing another message will cause the newly pressed one to be displayed in reverse video, and the corresponding image/library data will be displayed.

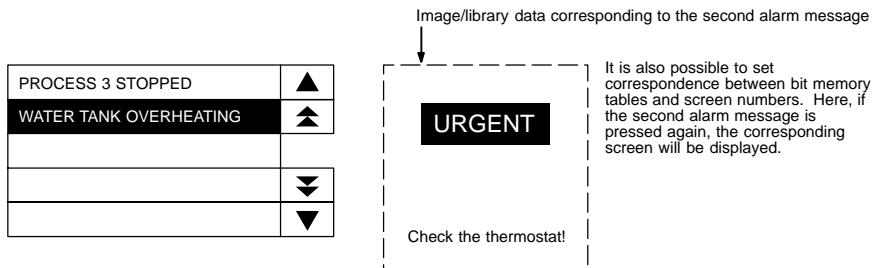

- (4) When a message displayed in reverse video is pressed again, the display will switch to the screen with the set screen number.

- Reference** - In the case described above, both “image/library display” and “screen changeover” functions are set. The operation when a touch switch is pressed is determined as follows in accordance with these settings.

Image/library display	Screen changeover	Touch switch	
		First time	Second time
Not set	Not set	No effect	No effect
Not set	Set	Screen changeover	–
Set	Not set	Image/library data display	No effect
Set	Set	Image/library data display	Screen changeover

- Note that the text will be invisible when the message is pressed, if the color of message display (color of bit memory table) and the background color in reverse video of alarm list/history are the same.

[Restrictions]

- The number of bit memory tables can be set as one of the following at the Support Tool.
 - 256 (bit memory table numbers 0 to 255)
 - 1000 (bit memory table numbers 0 to 999)

Since the bit memory tables share memory area with the screen data, setting a large number of bit memory tables reduces the memory area available for screen data.

[Common Attributes]

Bit memory tables have the following common properties.

Property	Possible Settings
	Meaning
Function	None/Switch screen/Alarm
	Function of the bit memory table When “None” is set, nothing will happen even if the host bit to which the table is allocated comes ON.
Description	
	Indicates the settings particular to each function.
PC Address	Any bit address at the host
	Host bit to which the bit memory table is allocated
I/O Comment	Up to 16 characters of text
	Comment that describes the contents of a bit memory table

- Allocated bit

Bit memory tables can be allocated to the following host (PC) areas.

Symbol	C Series PCs	Allocation	CVM1/CV Series PCs	Allocation	CS1 Series PCs	Allocation
DM	Data memory	✓	Data memory	✓	Data memory	✓
CH	I/O relay	✓	I/O relay	✓	I/O relay	✓
TIM	Timer present value	×	Timer present value	×	Timer present value	×
CNT	Counter present value	×	Counter present value	×	Counter present value	×
HR	Holding relay	✓	–	–	Holding relay	×
AR	Auxiliary relay	✓	Special auxiliary relay	×	Special auxiliary relay	×
LR	Link relay	✓	–	–	–	–
EM	EM Current Bank *1 *2	✓	EM Current Bank *2	△	EM Current Bank *2	✓

✓: OK ×: NG △: Host link not available

*1 : EM (Extended data memory) of C series is available only with C200HX/HG/HE (–Z).

*2 : Only current bank can be allocated for EM (Extended data memory).

Since the special auxiliary relays of the CVM1/CV series PCs are all allocated to system functions, they cannot be used for purposes other than system use.

The range of each memory area differs according to the PC type. Refer to APPENDIX L “PC Memory Map”, page 674.

If the data memory (DM) is designated, a bit number (00 to 15) must be specified after the word number.

[Display Functions]

- Screen changeover function

When using the screen changeover function, the following attribute must be set in addition to the common attributes.

Property	Possible Settings
	Meaning
Screen Number	0001 to 3999: Screen numbers 1 to 3999 9001: Occurrence history screen 9002: Frequency history screen 9020: Screen for programming console function (expansion function) 9999: “Return to previous screen” designation
	Number of screen displayed when bit memory table status changes to “1” (ON)

- When a bit memory table is used with the screen changeover function, when the status of the bit to which the bit memory table is allocated changes to “1” (ON), the display switches to the screen set for the bit memory table (this screen remains displayed even if the bit returns to “0” (OFF)).

- Reference**
- The screen display can also be switched by PT status control area operation (page 468), touch switch operation (page 469), and by using the alarm list/history function (page 472).
 - To display an overlapping screen, designate the screen number of the parent screen.
 - If there are no registered elements for the designated screen number, the screen does not switch.

- Alarm list/history function

When using the alarm list/history function, the following properties must be set in addition to the common attributes.

Property	Possible Settings
	Meaning
History	Check mark (record)/No check mark (do not record)
	Determines whether or not an alarm history is recorded When a check mark is set, a record is logged in the alarm history when the status of the allocated bit of the bit memory table changes to "1" (ON).
Switch Screen	Check mark (screen switched)/No check mark (screen not switched)
	Determines whether or not the screen changeover function is used When a check mark is set, pressing the message (which is displayed when the status of the bit allocated to the bit memory table changes to "1" (ON)) twice switches the display to the designated screen.
Screen No.	0001 to 3999: Screen numbers 1 to 3999 9001: Occurrence history screen 9002: Frequency history screen 9020: Screen for programming console function (expansion function) 9999: "Return to previous screen" designation
	Number of screen displayed when the message (which is displayed when the status of the allocated bit of the bit memory table changes to "1" (ON)) is pressed twice.
String Table Entry	0 to 1999 (within the character string memory table range)
	Number of the character string memory table whose contents are displayed as a message in the alarm list/history when the status of the allocated bit of the bit memory table changes to "1" (ON).
Image/Library Code	000H: No display (No check mark) 0001 to 0FFFH: Image data 1000 to 3FFFH: Library data
	Code (expressed as 4 hexadecimal digits) of the image/library data corresponding to the message displayed when the status of the allocated bit of the bit memory table changes to "1" (ON).
Fore-ground Color	Black/Blue/Red/Magenta/Green/Cyan/Yellow/White
	Color of message text (white and black for NT631)

- If the "alarm list" and "alarm history" functions are registered for a screen, messages and image/library data are displayed in accordance with the status of the bit memory table (refer to "Common Attributes", page 291).

Reference	The alarm history can also be checked by pressing the “Alarm History” touch switch on the “MAINTENANCE MODE MENU” screen of the NT631/NT631C. For details, refer to 6-11-5 “Displaying and Printing the Alarm History Record” (page 217).
------------------	---

[Input Functions]

When a bit memory table is allocated to a bit at the host, the contents of the bit are read and processing in accordance with the bit status is executed.

However, reading is only executed in the following case.

- When a function (screen changeover, alarm history) is set for the bit memory table.

[Output Functions]

Bit memory tables have no output function. The contents of bit memory tables are not written to bits at the host.

[Processing Functions]

Bit memory tables have no data processing function.

[Relationship with Other Elements]

- When the alarm list function is used, messages and image/library data can be displayed in real time in accordance with the status of bits at the host (page 395).
- When the alarm history function is used, the time when the status of the host bit changes to “1” (ON), and the number of times it comes ON, can be displayed (page 395).

Reference	<p>When the alarm history record area has become full, processing is carried out in accordance with the settings made for “History Setting” under “Tools” – “PT Configuration” – “System” at the Support Tool.</p> <ul style="list-style-type: none">- Alarm (Use Ring Buffer) If a check mark is set here, when an alarm occurs after the record area become full, the oldest record data is deleted in order to allow the new alarm history data to be stored (alarm pushup storage). If no check mark is set, no more new alarm history data is stored after the record area becomes full.- Screen (Use Ring Buffer) If a check mark is set here, when a screen for which the history property is set after the record area has become full, the oldest record data is deleted and new display history data is stored (alarm pushup storage). If no check mark is set here, when the record area becomes full, no more new display history data is stored.
------------------	--

7-4 Fixed Displays

“Fixed displays” are graphics and text that are always displayed on the screen and do not change. This section gives details of fixed displays.

There are the following types of fixed display.

- Text Page 304
- Circle Page 295
- Arc Page 295
- Sector Page 295
- Polyline Page 295
- Polygon Page 295
- Rectangle Page 295
- Tiling Page 307
- Mark Page 309

Reference

The Support Tool also includes image data and library data as fixed display elements, but since these are functionally different, they are dealt with separately in this manual. For details on image and library data, refer to 7-5 “Image and Library Data” (page 313).

7-4-1 Circles, Arcs, Sectors, Polylines, Polygons, Rectangles (Fixed Displays)

[Function Outline]

These are graphics that are always displayed. Standard, inverse, flash, and inverse flash displays are possible depending on the graphics.

Since fixed display graphics are always displayed in the order in which they were created at the Support Tool (graphics created early are overlaid by those created later), the order must be considered when creating them. However, the order of display within a fixed display graphic can be changed using the Support Tool.

□ Circle

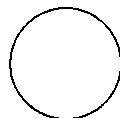

□ Arc



□ Sector



□ Polyline

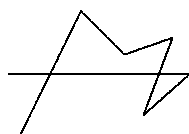

□ Polygon



□ Rectangle

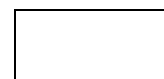

* A continuous straight line with up to 254 intermediate points can be drawn.

* A polygon with up to 255 vertices can be drawn.

[Restrictions]

- Up to 65535 of the following graphics can be registered on one screen. (Same for window screen.) For an overlapping screen comprising 8 child screens, the maximum is 524280 (65535 × 8 screens).

Fixed display text, circles, arcs, sectors, polylines, polygons, rectangles, tiling, marks

There is no restriction on the number of graphics that can be registered for one screen data file: any number can be registered as long as the data file capacity is not exceeded.

- One polyline can comprise up to 256 linked points including the start and end points.
- One polygon can be given up to 255 vertices.
- Elements that project out of the screen area cannot be specified (except for those parts of elements which are not actually drawn, such as the center point of an arc).

[Common Attributes]

The common attributes are described separately for each element.

[Display Functions]

- Arcs

The relationship between the properties of an arc and the displayed graphic are indicated below.

- Properties



General	
Position	
Center point	Coordinates of the center of the circle that includes the arc
Start point	Coordinates of the start point of an arc
End point	Coordinates of the end point of an arc
Size	
Radius	Radius of the circle that includes the arc (dot units)
Attribute	Display mode for the arc ("Display attribute and drawing result", page 297). Standard/Inverse/Flash/Inverse Flash
Color	
Foreground	Display color of the arc (colors other than black and white featured with NT631C only) Black/Blue/Red/Magenta/Green/Cyan/Yellow/White

The line style is fixed as "solid line" and thickness is fixed as one dot.

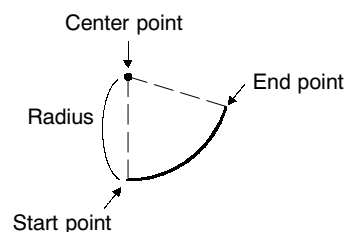
At the Support Tool, the center point, start point and end point are specified, as shown in the figure below. When the start point is set, the radius is automatically set accordingly.

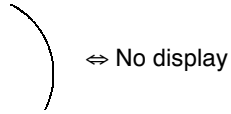
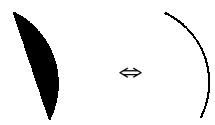

- Display attribute and drawing result

Attribute	Drawing Result
Standard	Only the line of the arc is drawn in the foreground color. 
Inverse	The area enclosed by the arc and a straight line drawn between its start and end points is displayed in the foreground color. 
Flash	Repeated alternation between "standard" display and no display. 
Inverse Flash	Repeated alternation between "inverse" and "standard" display. 

- Circle

The relationship between the properties of a circle and the displayed graphic are indicated below.

- Properties

General	
Position	
Center point	Coordinates of the center of the circle
Size	
Radius	Radius of the circle (dot units)
Attribute	Display mode for the circle ("Display attribute and drawing result", page 298). Standard/Inverse/Flash/Inverse Flash
Color	
Foreground	Display color of the circle (colors other than black and white featured with NT631C only) Black/Blue/Red/Magenta/Green/Cyan/Yellow/White

The line style is fixed as “solid line” and thickness is fixed as one dot.
 At the Support Tool, the center point and radius are specified as shown below.

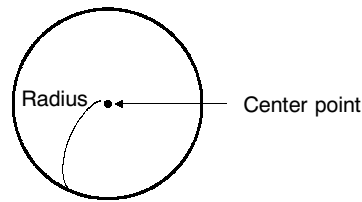

- Display attribute and drawing result

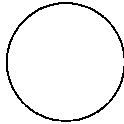
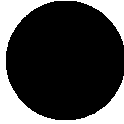
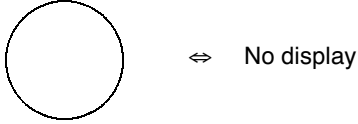
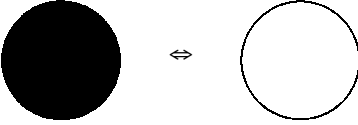
Attribute	Drawing Result
Standard	Only the line of the circle periphery is drawn in the foreground color. 
Inverse	The entire circle is displayed in the foreground color. 
Flash	Repeated alternation between “standard” display and no display. 
Inverse Flash	Repeated alternation between “inverse” and “standard” display. 

• Rectangle

The relationship between the properties of a rectangle and the displayed graphic are indicated below.

- Properties



General	
Position	Coordinates of the top left vertex of the rectangle
Size	Width and height of the rectangle (dot units)
Attribute	Display mode for the rectangle (“Display attribute and drawing result”, page 299). Standard/Inverse/Flash/Inverse Flash
Color	
Foreground	Display color of the rectangle (colors other than black and white featured with NT631C only) Black/Blue/Red/Magenta/Green/Cyan/Yellow/White

The line style is fixed as “solid line” and thickness is fixed as one dot.

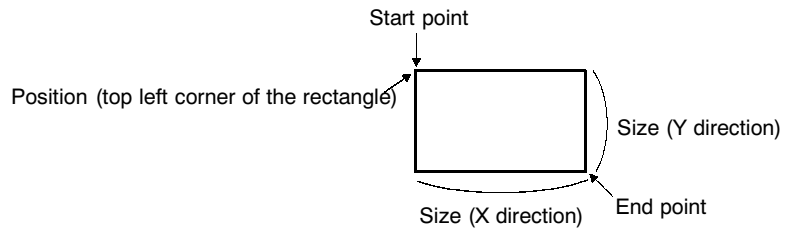
At the Support Tool, specify the start point and end point as shown in the figure below (it is not necessary to draw the rectangle from top left to bottom right). By setting the start point and end point, the position and size are automatically set.

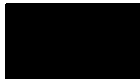
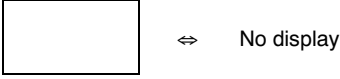

- Display attribute and drawing result

Attribute	Drawing Result
Standard	Only the boundary line of the rectangle is drawn in the foreground color. 
Inverse	The entire rectangle is displayed in the foreground color. 
Flash	Repeated alternation between "standard" display and no display. 
Inverse Flash	Repeated alternation between "inverse" and "standard" display. 

• Polygon

The relationship between the properties of a polygon and the displayed graphic are indicated below.

- Properties



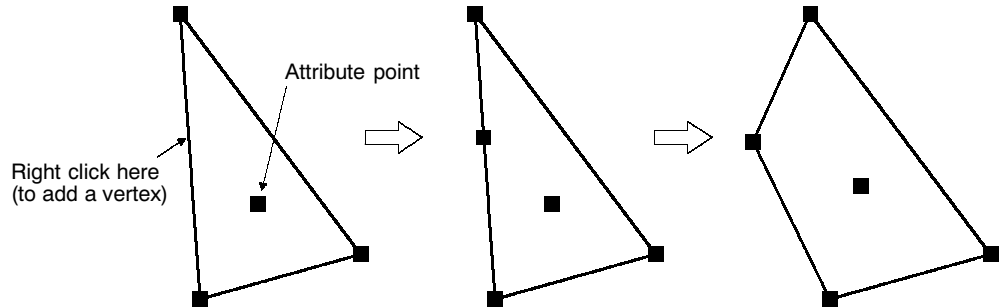

General	
Position	
Attribute Point	Coordinates of the point that will be the start position for tiling in inverse display or inverse flashing display.
Attribute	Display mode for the polygon ("Display attribute and drawing result", page 300). Standard/Inverse/Flash/Inverse Flash
Color	
Foreground	Display color of the polygon (colors other than black and white featured with NT631C only) Black/Blue/Red/Magenta/Green/Cyan/Yellow/White

The line style is fixed as "solid line" and thickness is fixed as one dot.

At the Support Tool, using a triangle as the base, create the polygon by changing the number and position of the vertices. The attribute point is automatically set inside the polygon (its position can be changed).

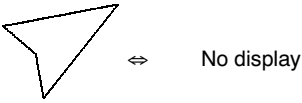

- Display attribute and drawing result

Attribute	Drawing Result
Standard	Only the boundary line of the polygon is drawn in the foreground color. 
Inverse	The inside of the polygon is displayed in the foreground color (see below). 
Flash	Repeated alternation between "standard" display and no display. 
Inverse Flash	Repeated alternation between "inverse" and "standard" display (see below). 

If inverse or inverse flash display is set for a polygon with multiple closed areas, like the one shown below, only the area that contains the attribute point is tiled.

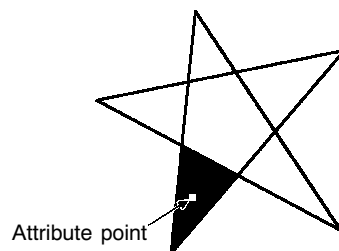

- Polyline

The relationship between the properties of a polyline and the displayed graphic are indicated below.

- Properties



General	
Line Style	Line type used for the polyline Solid line _____ Broken line - - - - - 1-dot chain line - · - · - · - 2-dot chain line - · · - · · -
Attribute	Display mode for the polyline ("Display attribute and drawing result", page 301). Standard/flash
Color	
Foreground	Display color of the polygon (colors other than black and white featured with NT631C only) Black/Blue/Red/Magenta/Green/Cyan/Yellow/White

The line thickness is fixed as one dot.

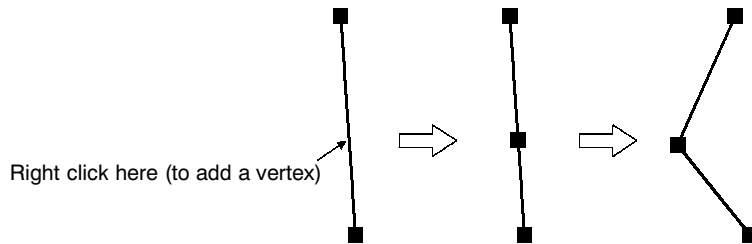
At the Support Tool, using a straight line as the base, create the polyline by changing the number and position of the vertices.



- Display attribute and drawing result

Attribute	Drawing Result
Standard	The polyline is displayed in the foreground color all the time. 
Flash	Repeated alternation between "standard" display and no display.  ⇔ No display

- Sector

The relationship between the properties of a sector and the displayed graphic are indicated below.

- Properties

General	
Position	
Center point	Coordinates of the circle that includes the sector.
Start point	Coordinates of the start point of the sector
End point	Coordinates of the end point of the sector
Size	
Radius	Radius of the circle including the sector (dot units)
Attribute	Display mode for the sector ("Display attribute and drawing result", page 303). Standard/Inverse/Flash/Inverse Flash
Color	
Foreground	Display color of the sector (colors other than black and white featured with NT631C only) Black/Blue/Red/Magenta/Green/Cyan/Yellow/White

The line style is fixed as "solid line" and thickness is fixed as one dot.

At the Support Tool, specify the center point, start point, and end point, as shown in the figure below. The radius is automatically set in accordance with the start point setting.

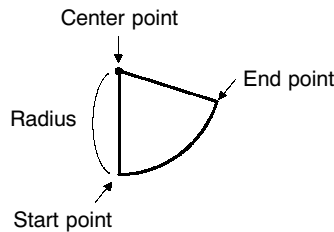

- Display attribute and drawing result

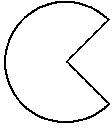
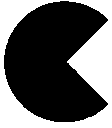
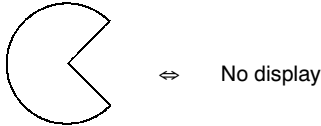
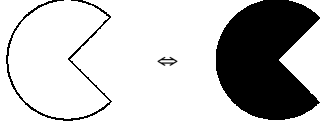
Attribute	Drawing Result
Standard	Only the boundary line of the sector is drawn in the foreground color. 
Inverse	The entire sector is displayed in the foreground color. 
Flash	Repeated alternation between "standard" display and no display. 
Inverse Flash	Repeated alternation between "inverse" and "standard" display. 

[Input Functions]

There are no input functions for circles, arcs, sectors, polylines, polygons, or rectangles.

[Output Functions]

There are no output functions for circles, arcs, sectors, polylines, polygons, or rectangles.

[Processing Functions]

There are no data processing functions for circles, arcs, sectors, polylines, polygons, or rectangles.

[Relationship with Other Elements]

- When tiling is used, an area enclosed by a continuous solid line can be tiled with the specified pattern (page 307). However, if the line is broken at any point, or if it flashes or is deleted, the tiling pattern will cover the area outside the line as well. Tiling will also spread outside the intended boundary line, in accordance with the display order, if it is displayed before the boundary line.
- It is possible to make a single library data display by combining multiple fixed display elements. If the display attribute for any of the elements in such a display is "Flash" or "Inverse Flash", the display flashes in accordance with this setting.
- The timing of the flashing is the same for all elements.
- Both text (page 304) and mark (page 309) fixed displays will overlap each other in accordance with the order in which they were created. However, the way in which they overlap can be changed with the Support Tool.

7-4-2 Text (Fixed Display)

[Function Outline]

These are character strings that are continually displayed as a fixed display. Standard, flash, and inverse flash displays are possible (inverse display can be specified by exchanging the foreground color and background color of the character string).

Since the order of display will always follow the order in which the elements are created with the Support Tool (character strings created later will overlay others created earlier), the order of creation must be considered when character strings are going to overlap.

Alphanumerics and symbols can be displayed.



[Restrictions]

- Up to 65535 of the following graphics can be registered on one screen just as on the window screen. For an overlapping screen comprising 8 child screens, the maximum is 524280 (65535 × 8 screens).

Fixed display text, circles, arcs, sectors, polylines, polygons, rectangles, tiling, marks

There is no restriction on the number of graphics that can be registered for one screen data file: any number can be registered as long as the data file capacity is not exceeded.

- The following numbers of character can be displayed in one text display element, depending on the scale.

1 × 1 (Equal): Up to 80 characters

1 × 2 (High): Up to 80 characters

2 × 1 (Wide): Up to 40 characters

2 × 2: Up to 40 characters

3 × 3: Up to 26 characters

4 × 4: Up to 20 characters

8 × 8: Up to 10 characters

- If the text size exceeds the screen size, the Support Tool changes its display position automatically so that the text is displayed within the screen. In case the text can not be displayed within the screen even if the Support Tool has changed its position, the error message will be displayed. In this case, change the number of characters or scale size.

[Display Functions]

The relationship between the properties of a text display element and the displayed graphic are indicated below.

- Properties

General	
Description	Displayed text Alphanumerics and symbols, Marks
Position	Coordinates of the top left corner of the rectangle that encloses the text.
Font Type	Font for alphanumerics Standard/Half Height
Scale	Scale at which the text is displayed ("Enlarged display", page 305). 1 × 1 (Equal), 1 × 2 (High), 2 × 1 (Wide), 2 × 2, 3 × 3, 4 × 4, 8 × 8
Smoothing	Whether or not smoothing is used for text with a scale of 2 × 2 or larger ("Smoothing", page 306). Check mark (smoothing executed)/ No check mark (smoothing not executed)
Attribute	Display mode for the text ("Display attribute and drawing result", page 305). Standard/Flash/Inverse Flash
Color	
Foreground	Display color of the text (colors other than black and white featured with NT631C only) Black/Blue/Red/Magenta/Green/Cyan/Yellow/White/ Transparent
Background	Background color of the text (colors other than black and white featured with NT631C only) Black/Blue/Red/Magenta/Green/Cyan/Yellow/White/ Transparent

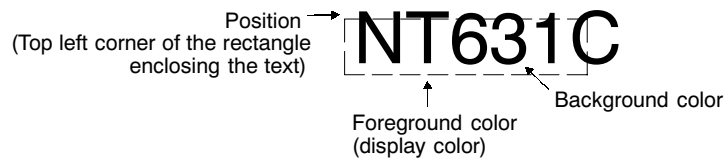

- Enlarged display

Character strings (text and marks) can be displayed at the following scales.

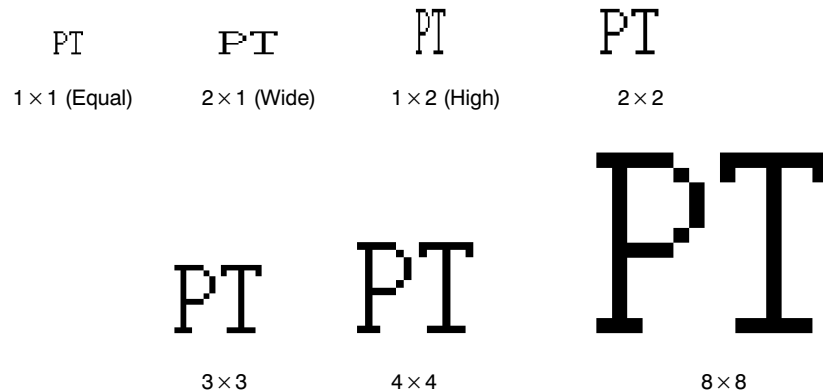

With "ISO8859-1" font type, the characters of 2x 2 or larger scale are automatically displayed in 32 dot high-definition font. However, the marks inserted into a string are always displayed in 16x 16 dot font.

Reference The 32 dot high-definition font is not displayed for the following models (16x 16 dot font is used.)

- NT631-ST211□-E
- NT631C-ST141□-E
- NT631C-ST151□-E
- Smoothing



Characters enlarged to a scale of 2x 2 or larger can be displayed with the outline automatically smoothed. This function is called "smoothing".

Note that smoothing cannot be used for marks.



Reference Smoothing is not performed for high-definition font.

- Display attribute and drawing result

Attribute	Drawing Result
Standard	The text element is displayed with the specified foreground color and background color. 
Flash	Repeated alternation of the "standard" display and no display. 
Inverse Flash	Repeated exchange of the foreground color and background color. 

[Input Functions]

Text displays have no input function.

[Output Functions]

Text displays have no output function.

[Processing Functions]

Text displays have no data processing function.

[Relationship with Other Elements]

- It is possible to make a single library data display by combining multiple fixed display elements. If the display attributes for any of the elements in such a display is “Flash” or “Inverse Flash”, the display flashes in accordance with these settings.
- The timing of the flashing is the same for all elements.
- Circles, arcs, sectors, polylines, polygons, rectangles (page 295) and marks (page 309) overlap each other in accordance with the order in which they were created. However, the way in which they overlap can be changed with the Support Tool.

7-4-3 Tiling**[Function Outline]**

The area enclosed by a line of the specified color is tiled with the specified tiling pattern.

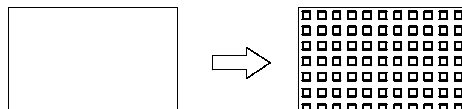
**[Restrictions]**

- Up to 65535 of the following graphics can be registered on one screen. For an overlapping screen comprising 8 child screens, the maximum is 524280 (65535 × 8 screens).

Fixed display text, circles, arcs, sectors, polylines, polygons, rectangles, tiling, marks









There is no restriction on the number of graphics that can be registered for one screen data file: any number can be registered as long as the data file capacity is not exceeded.

- The area to be tiled must be enclosed by a solid line of the same color. If the line is broken at any point, or if it flashes or is deleted, the tiling pattern will cover the area outside the line as well. Tiling will also spread outside the intended boundary line, in accordance with the display order, if it is displayed before the border line.
- Depending on the combination of the foreground color of a graphic (when tiled), the background color, and the border color, part of the frame of the graphic may be invisible. This is a phenomenon peculiar to a color LCD, not a failure of the PT. If this causes a problem, change the color combination.

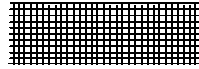
[Display Functions]

The relationship between the tiling properties and tiling method is indicated below.

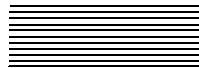
- Properties

General	
Position	Coordinates where tiling starts
Pattern	Tiling pattern ("Pattern and color", page 308) Uniform Slant right   Box Crosshatch   Slant left Grid   Stripe Border   Diamond Halftone  
Color	
Foreground	Display color of the tiling pattern (colors other than black and white featured with NT631C only) Black/Blue/Red/Magenta/Green/Cyan/Yellow/White
Background	Background color of the tiling pattern (colors other than black, white, and transparent featured with NT631C only) Black/Blue/Red/Magenta/Green/Cyan/Yellow/White/Transparent
Border	Color of the line enclosing the tiled area (colors other than black and white featured with NT631C only) Black/Blue/Red/Magenta/Green/Cyan/Yellow/White

- Pattern and color

The relationship between pattern and color is illustrated below, taking the "Grid" pattern as an example.

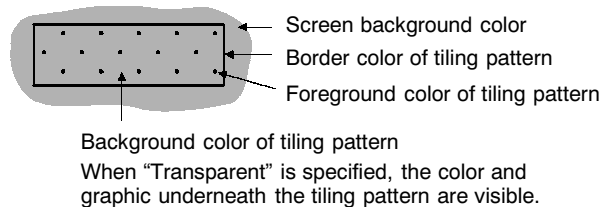

[Input Functions]

Tiling has no input function.

[Output Functions]

Tiling has no output function.

[Processing Functions]

Tiling has no data processing function.

[Relationship with Other Elements]

- Tiling can also be included in library data displays with other graphics.
- Circles, arcs, sectors, polylines, polygons, rectangles (page 295) and marks (page 309) overlap each other in accordance with the order in which they were created. However, the way in which they overlap can be changed with the Support Tool.
- “Colour Palette Symbol” is supplied with NT-series Support Tool for windows 95/98 (ver. 3.0). For colour palette symbol, combinations of foreground and background colors are registered by each tiling pattern. By copying the symbol, you can register the required tiling object on a screen easily while checking the display status of symbols. For details, refer to the operation manual of the Support Tool (V053-E1-1).

7-4-4 Marks**[Function Outline]**

Marks are pictograms comprising 16 by 16 dots. They are assigned to character codes.

Marks are created with the mark editor of the Support Tool, independently of screens, and as many as required can be displayed at any position on any screen. They can also be included in fixed display character strings and in character string memory tables, and displayed in accordance with the properties for characters.



- Procedure for creating and using marks

The procedure for creating marks and registering them on a screen is described briefly here. For details, refer to the Operation Manual of the Support Tool.

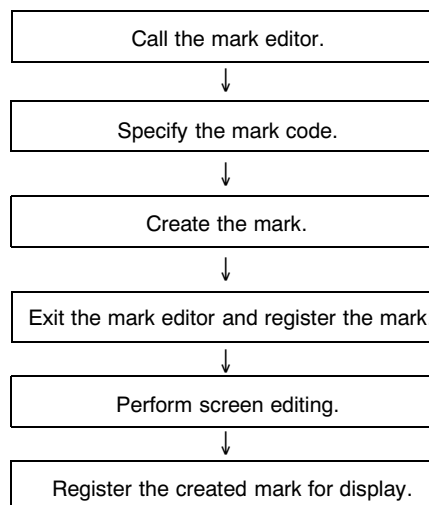

[Restrictions]

- A maximum of 224 marks can be created for one screen data file: each of the marks is assigned any required character code within the range FF20 to FFFFH so that it can be managed and specified. However, note that marks in the range FFEF to FFFFH are used by the system and if they are changed, touch switches may not be displayed correctly for trend graphs, etc. If marks are written to these codes, on conversion of data from a different model of PT, etc., copy the mark data to other codes, then reset the mark data. The marks at these codes will return to the initial status.
- Up to 65535 of the following graphics can be registered on one screen. (Same for window screen.) For an overlapping screen comprising 8 child screens, the maximum is 524280 (65535 × 8 screens).

Fixed display text, circles, arcs, sectors, polylines, polygons, rectangles, tiling, marks

There is no restriction on the number of graphics that can be registered for one screen data file: any number can be registered as long as the data file capacity is not exceeded.

- When a mark is included in a character string that is displayed enlarged with the smoothing function used, the mark is not subject to smoothing.
- Marks are displayed in 16□ 16 dot font with enlargement, even when the character string, to which marks are inserted, is 2□ 2 or larger scale and are displayed in 32 dot font.

[Display Functions]

The properties of mark displays and their relationship with displayed character strings are indicated below.

Here, “mark display”, whereby a single mark is displayed as a fixed display, is explained. For details on the display of marks when they are included in character strings, refer to 7-4-2 “Text (Fixed Display)” (page 304) and 7-9 “Character String Display” (page 356).

- Properties

General	
Position	Coordinates of the top left corner of the mark
Code	Character code of the mark FF20 to FFFFH
Attribute	Display mode for the mark (“Display attribute and drawing result”, page 311). Standard/Flash/Inverse Flash
Size	Scale at which the mark is displayed (“Enlarged display”, page 311). 1 × 1 (Equal), 1 × 2 (High), 2 × 1 (Wide), 2 × 2, 3 × 3, 4 × 4, 8 × 8
Color	
Foreground	Display color of the mark (colors other than black and white featured with NT631C only) Black/Blue/Red/Magenta/Green/Cyan/Yellow/White/Transparent
Background	Background color of the mark (colors other than black and white featured with NT631C only) Black/Blue/Red/Magenta/Green/Cyan/Yellow/White/Transparent

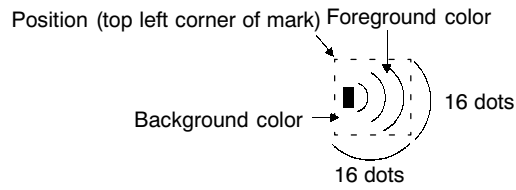

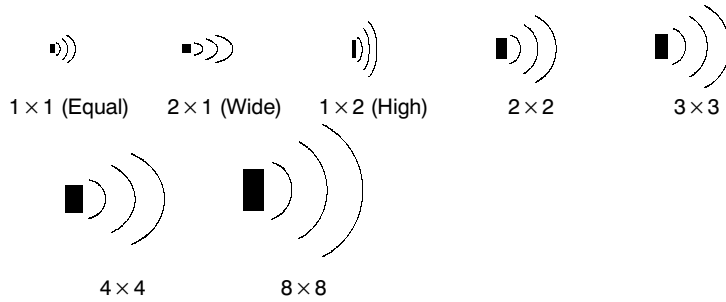

• Enlarged display

Marks can be displayed at the following scales.

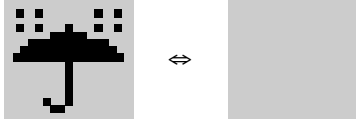

Even if a scale of 2 × 2 or larger is set for a mark, it will not be smoothed by the smoothing function.

- Display attribute and drawing result

Attribute	Drawing Result
Standard	The mark is displayed with the specified foreground color and background color. 
Flash	Repeated alternation of the “standard” display and background color only. 
Inverse Flash	Repeated exchange of the foreground color and background color. 

[Input Functions]

Marks have no input function.

[Output Functions]

Marks have no output function.

[Processing Functions]

Marks have no data processing function.

[Relationship with Other Elements]

- It is possible to make a single library data display by combining multiple fixed display elements. If the display attribute for any of the elements in such a display is “Flash” or “Inverse Flash”, the display flashes in accordance with this setting. The timing of the flashing is the same for all elements.
- Marks overlap with other fixed display elements in accordance with the order in which they were registered. However, the way in which they overlap can be changed with the Support Tool.

7-5 Image and Library Data

7-5-1 Image Data Display

[Function Outline]

Image data are images composed of dots. They can be set to any size within the following range.

Width: 8 to 320 dots, in 8-dot units

Height: 8 to 240 dots, in 8-dot units

Image data are created with the image editor of the Support Tool, independently of screens, and as many as required can be displayed at any position on any screen. It is also possible to import files in the BMP format of Windows95 and register them as image data.

Registering frequently used and complex images as image data allows them to be displayed easily whenever required.



When image data is created in the "2 Colors" mode, the foreground and background colors can be specified.

When image data is created in the "8 Colors" mode, colors (selected from the available eight) can be assigned to each dot.

When creating image data, it is possible to specify compression of the data. However, note that it takes a little longer to display compressed image data than data that has not been compressed.

- Procedure for creating and using image data

The procedure for creating image data and registering them on a screen is described simply here. For details, refer to the Operation Manual of the Support Tool.

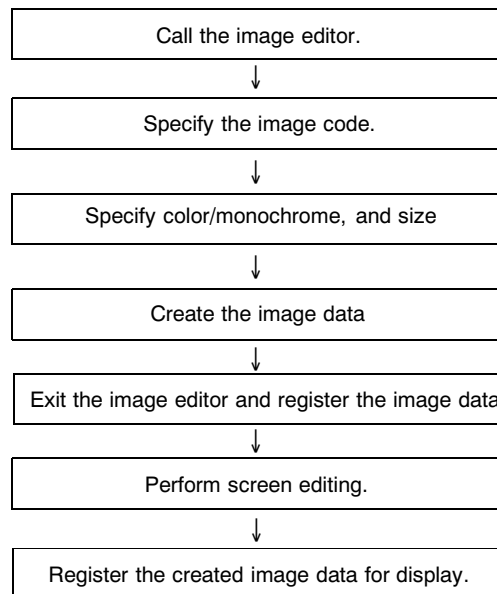

[Restrictions]

- A maximum of 4,095 image data can be created for one screen data file: each of the image data is assigned any required code within the range 0001 to 0FFFH (image/library code range) so that it can be managed and specified.
- A total of up to 256 of the following elements can be registered on one screen. For an overlapping screen comprising 8 child screens, the maximum is 1024.

Image data, library data

- The size of image data can be specified as follows.

Width: 8 to 320 dots, in 8-dot units

Height: 8 to 240 dots, in 8-dot units

- The codes used for image data are dedicated for image/library data use.

Image data cannot be included in character strings in the same way that marks can.

- Image data that projects out of the screen area cannot be specified.

[Display Functions]

The properties of image data and their relationship with the method of display are indicated below.

- Properties

General	
Position	Coordinates of the top left corner of the image data
Size	Size of the image data
Code	Image/library code of the image data 0001 to 0FFF _H
Mode	Color mode of the image data (specified with the image editor) 2 Colors/8 Colors
Comment	Comment assigned to the image data (specified with the image data)
Color (for NT631C, only valid when "2 Colors" is set for "Mode".	
Foreground	Display color of the image data Black/Blue/Red/Magenta/Green/Cyan/Yellow/White
Background	Background color of the image data Black/Blue/Red/Magenta/Green/Cyan/Yellow/White/ Transparent

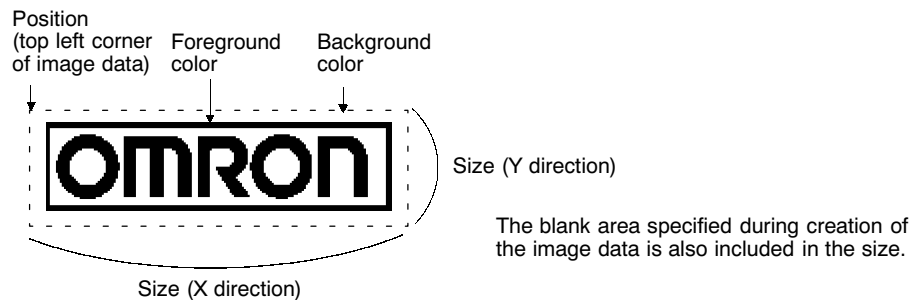

If there is a blank area surrounding the image data, this is also included in the image. Bear this in mind when specifying a background color in the "2 Colors" mode.

Reference When color data is pasted to "2 Colors" mode image data, all the colors except black become white.

- When an unregistered code is specified

When a code for which no image data is registered is specified, the symbol indicating an unregistered code (☒) is displayed on the Support Tool, but on the NT631/NT631C nothing is displayed.

[Input Functions]

Image data have no input function.

[Output Functions]

Image data have no output function.

[Processing Functions]

Image data have no data processing function.

[Relationship with Other Elements]

- Difference between image data and library data

Image data can take any form for it is composed of dots, but library data can only be created by assembling fixed display text and graphics.

Since only drawing information for characters and graphics is registered for library data, library data takes up less memory area than image data, which requires all the dots to be displayed on the screen to be registered as data.

Another difference is that “flash” and “inverse” display are not possible for image data, but library data can be displayed in these modes in accordance with the display attributes of the registered elements. The timing of the flashing is the same for all elements.

- It is possible to specify different image/library data for the graphic displayed when a lamp (image/library lamp) is ON and OFF (page 320).
- It is possible to specify different image/library data for each message displayed for the alarm list/alarm history function (page 396).
- Image data elements overlap with other fixed display elements in accordance with the order in which they were registered. However, the way in which they overlap can be changed with the Support Tool.

7-5-2 Library Data Display**[Function Outline]**

Library data are combinations of multiple fixed display text and graphic elements registered as single elements. Library data can be registered in any required size.

Library data are created with the library editor of the Support Tool, independently of screens, and as many as required can be displayed at any position on any screen.

Registering frequently used and complex images as library data allows them to be displayed easily whenever required.

Since the individual elements within a library data are displayed in the order they were created with the Support Tool (graphics created early are overlaid by those created later), the order must be considered when creating them.

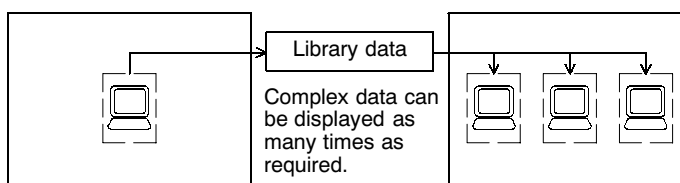

- Procedure for creating and using library data

The procedure for creating library data and registering them on a screen is described briefly here. For details, refer to the Operation Manual of the Support Tool.

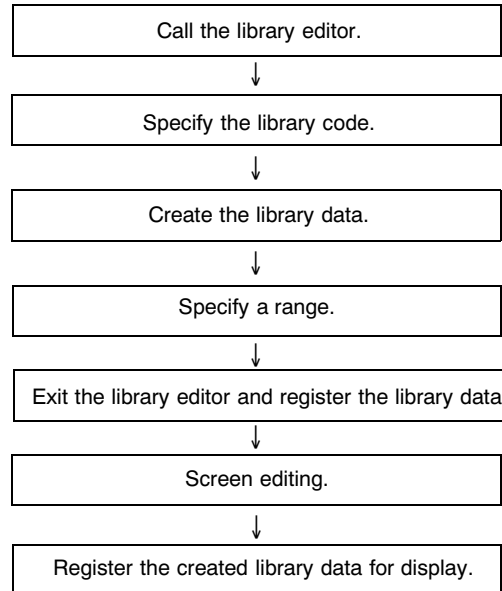

[Restrictions]

- A maximum of 12,288 library data can be created for one screen data file: each of the library data is assigned any required code within the range 1000 to 3FFFH (image/library code range) so that it can be managed and specified.
- A total of up to 256 of the following elements can be registered on one screen. (Same for window screen.) For an overlapping screen comprising 8 child screens, the maximum is also 256.

Image data, library data

- The maximum number of elements that can be registered for one library data is 64.
- The elements that can be registered in library data are the following fixed display elements: other elements cannot be registered.
Text, circles, arcs, sectors, polylines, polygons, rectangles, tiling, marks.
- The codes used for library data are dedicated for image/library data use.
Library data cannot be included in character strings in the same way that marks can.
- Library data that projects out of the screen area cannot be specified.

[Display Functions]

The properties of library data and their relationship with the method of display are indicated below.

- Properties

General	
Position	Coordinates of the top left corner of the library data
Size	Size of the library data
Code	Image/library code of the library data 1000 to 3FFF _H
Comment	Comment allocated to the library data (specified with the library editor)

Position (top left corner of library data)

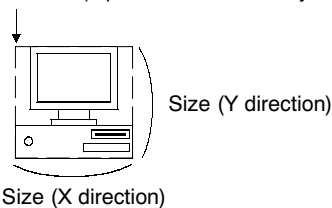

- When an unregistered code is specified

When a code for which no library data is registered is specified, the symbol indicating an unregistered code () is displayed on the Support Tool, but on the NT631/NT631C nothing is displayed.

[Input Functions]

Library data have no input function.

[Output Functions]

Library data have no output function.

[Processing Functions]

Library data have no data processing function.

[Relationship with Other Elements]

- Difference between image data and library data

Image data can take any form for it is composed of dots, but library data can only be created by assembling fixed display text and graphics.

Since only drawing information for characters and graphics is registered for library data, library data requires little memory area in comparison with image data, which requires all the dots to be displayed on the screen to be registered as data.

Another difference is that “flash” and “inverse” display are not possible for image data, but library data can be displayed in these modes in accordance with the display attributes of the registered elements. The timing of the flashing is the same for all elements.

- It is possible to specify different image/library data for the graphic displayed when a lamp (image/library lamp) is ON and OFF (page 320).

- It is possible to specify different image/library data for each message displayed for the alarm list/alarm history function (page 396).
- Library data elements overlap with other fixed display elements in accordance with the order in which they were displayed. However, the way in which they overlap can be changed with the Support Tool.

7-6 Lamps

[Function Outline]

Lamps are graphics that change in accordance with the status of a set bit. Lamps are classified into the two major categories indicated below.

- Normal (standard) lamps

Normal (standard) lamps change the display status (OFF/ON/flashing) of fixed display graphics.

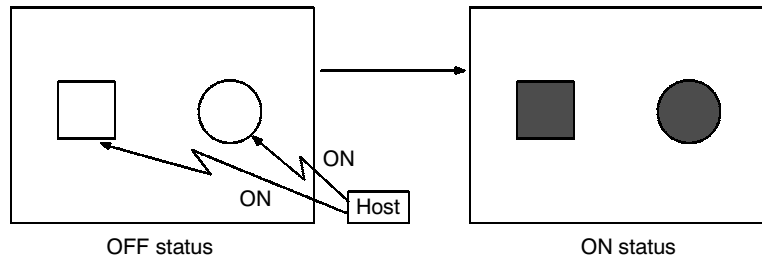

- Image/library lamps

Image/library lamps display different graphics (image/library data) in the ON and OFF statuses.

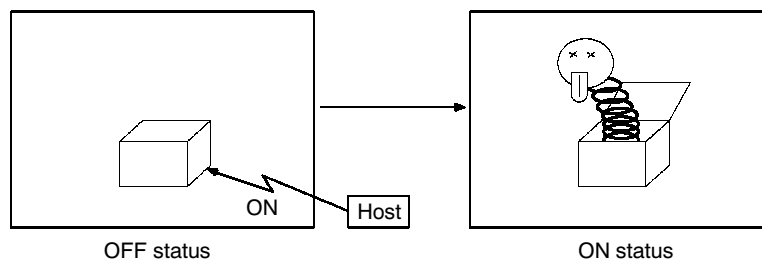

Lamps are arranged and set on the screen when creating screen data with the Support Tool.

[Restrictions]

- A maximum of 256 lamps can be registered for one screen. For an overlapping screen comprising 8 child screens, the maximum is 1024.

There is no restriction on the number of lamps that can be registered for one screen data file: any number can be registered as long as the data file capacity is not exceeded. However, if a large number of elements are registered, check that the restrictions on element display are complied with by referring to “Display Restrictions” (page 635).

- When polygons are used as the display graphics for normal (standard) lamps, one polygon can be given up to 255 vertices.
- Image/library lamps are subject to the maximum simultaneous display restriction imposed on image and library data. This means that a maximum total of 256 image/library lamps and image and library data can be displayed on one screen. For an overlapping screen comprising 8 child screens, the maximum is 1024.
- When library data is displayed with an image/library lamp, if the library data projects outside the screen area, nothing is displayed. Usually, the Support Tool ensures that the data does not project out of the screen area.
- If no data is registered for the specified image/library lamp code, nothing will be displayed.
- Among lamps, the display order is determined by the order in which the lamps were created. However, this order among lamps can be changed with the Support Tool.

[Common Attributes]

The common attributes vary widely according to the type of lamp, therefore they are described separately for each case.

[Display Functions]

- Normal (standard) Lamps

The relationship between the properties of a normal (standard) lamp and the displayed graphic are indicated below.

- Properties

General	
Position	Coordinates of the top left corner of the lamp display area
Size	Width and height of the lamp display area (in dot units)
Label	Presence or absence of a character string (label) affixed to the lamp Check mark (character string present)/ No check mark (no character string)
Description	Character string affixed to the lamp Alphanumerics and symbols, Marks A mark is recognized as two characters. For details on the properties of labels, refer to 7-4-2 "Text (Fixed Display)" (page 304).
Frame	Presence/absence of a frame for the lamp display graphic Check mark (frame used)/No check mark (no frame)
Shape	Shape of the lamp (display graphic) Rectangle, Polygon, Circle, Sector
Color	
Frame	Color of the frame (valid only when a check mark is set for "Frame" above). Colors other than white and black are featured with NT631C only. Black/Blue/Red/Magenta/Green/Cyan/Yellow/White
ON /Flashing	Color of the lamp in the ON or flashing states (colors other than white and black are featured with NT631C only) Black/Blue/Red/Magenta/Green/Cyan/Yellow/White
OFF	Color of the lamp in the OFF state (colors other than white and black are featured with NT631C only) Black/Blue/Red/Magenta/Green/Cyan/Yellow/White/ Transparent
Light Function	
Address	
PC Bit Address	Allocated bit of the lamp ("Allocated bit", page 323)
I/O Comments	Comment that indicates the contents of the allocated bit Character string of up to 16 alphanumerics and symbols
Lamp Attribute	
ON Type	Display mode when the lamp is ON Light/Flash

Reference Separate OFF and ON colors can be set for lamp labels. However, the background color is fixed as "transparent".

- Shape of lamps

Rectangle

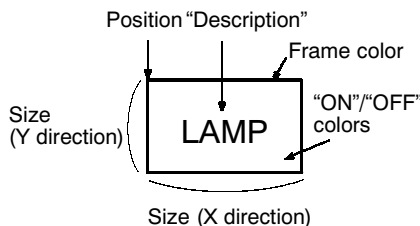

Polygon

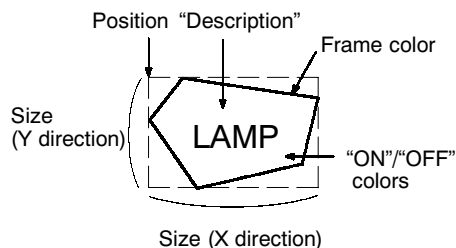

Circle

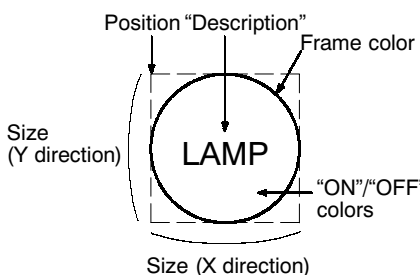

Sector

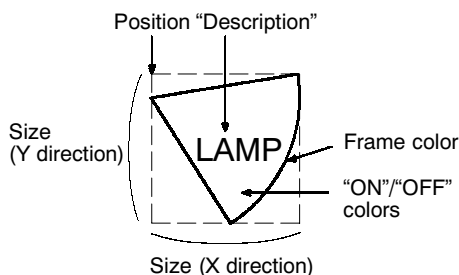

- Allocated bit

Lamp bits can be allocated to the following host (PC) areas.

Symbol	C Series PLC	Allocation	CVM1/CV Series PLC	Allocation	CS1 Series PLC	Allocation
DM	Data memory	✓	Data memory	✓	Data memory	✓
CH	I/O relay	✓	I/O relay	✓	I/O relay	✓
TIM	Timer present value	×	Timer present value	×	Timer present value	×
CNT	Counter present value	×	Counter present value	×	Counter present value	×
HR	Holding relay	✓	-	-	Holding relay	×
AR	Auxiliary relay	✓	Special auxiliary relay	×	Special auxiliary relay	×
LR	Link relay	✓	-	-	-	-
EM	Expansion data memory *1 *2	✓	Expansion data memory *2	☐	EM current Bank *2	✓

✓ : OK ☐ × : NG ☐ ☐ : Host link NG

*1 C-series EM (Expansion Memory) is available only in the C200HX/HG/HE (-Z).

*2 The EM (Expansion Memory) can be allocated only in the current bank.

Since the special auxiliary relays of the CVM1/CV series PCs are all allocated to system functions, they cannot be used for purposes other than system use.

The range of each memory area differs according to the PC type. Refer to APPENDIX L "PC Memory Map", page 675.

- Display of lamps

Lamps are displayed as follows according to the status of the allocated bit.

- 0 (OFF): OFF
- 1 (ON): ON, or flashing

Whether a lamp lights continuously or flashes when the lamp bit is set to “1” (ON) is determined by the “ON Type” attribute.

Note that the display when the lamp is ON or flashing also changes according to the presence or absence of a frame.

When there is a frame: The frame is always displayed.

When there is no frame: The lamp may be invisible when it is OFF depending on the OFF color.

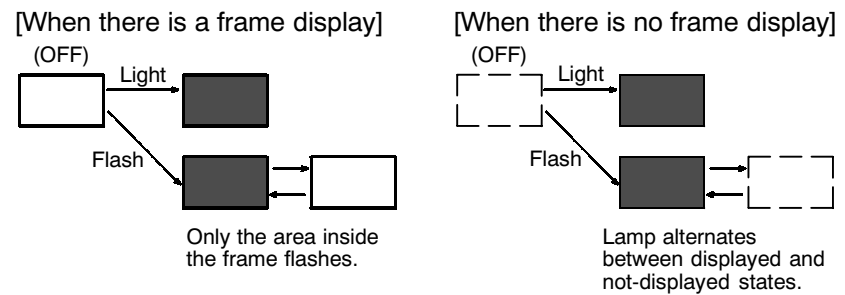

- To change labels

The labels of normal (standard) lamps are fixed display text. To make the label change in accordance with the conditions, create an image/library lamp and register different image/library data for its OFF and ON states.

- Image/library lamps

The relationship between the properties of an image/library lamp and the displayed graphic are indicated below.

- Properties

General	
OFF state	
X, Y	Coordinates of the top left corner of the image/library data display in the OFF state
Width, Height	Width/height of image/library data displayed in the OFF state
Code	Image/library code displayed in the OFF state
Color (valid only for image data whose color mode is "2 Colors")	
Foreground	Foreground color of the image/library lamp in the OFF state (colors other than white and black are featured with NT631C only) Black/Blue/Red/Magenta/Green/Cyan/Yellow/White
Background	Background color of the image/library lamp in the OFF state (colors other than white and black are featured with NT631C only) Black/Blue/Red/Magenta/Green/Cyan/Yellow/White/Transparent
ON State	
X, Y	Coordinates of the top left corner of the image/library data display when the lamp is ON
Width, Height	Width/height of image/library data displayed in the ON state
Code	Code of the image/library data displayed in the ON status
Color (valid only for image data whose color mode is "2 Colors")	
Foreground	Foreground color of the image/library lamp in the OFF state (colors other than white and black are featured with NT631C only) Black/Blue/Red/Magenta/Green/Cyan/Yellow/White
Background	Background color of the image/library lamp in the OFF state (colors other than white and black are featured with NT631C only) Black/Blue/Red/Magenta/Green/Cyan/Yellow/White/Transparent

Light Function	
Address	
PC Bit Address	Allocated bit of the lamp ("Allocated bit", page 326)
I/O Comments	Comment that indicates the contents of the allocated bit Up to 16 alphanumeric characters

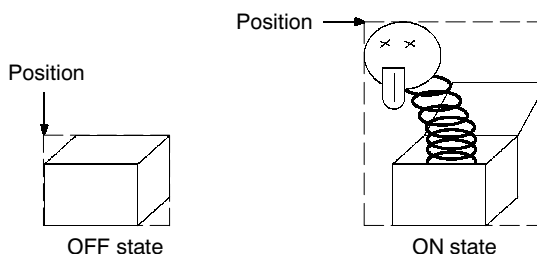

- Allocated bit

Lamp bits can be allocated to the following host (PC) areas.

Symbol	C Series PLC	Allocation	CVM1/CV Series PLC	Allocation	CS1 Series PLC	Allocation
DM	Data memory	✓	Data memory	✓	Data memory	✓
CH	I/O relay	✓	I/O relay	✓	I/O relay	✓
TIM	Timer present value	×	Timer present value	×	Timer present value	×
CNT	Counter present value	×	Counter present value	×	Counter present value	×
HR	Holding relay	✓	-	-	Holding relay	×
AR	Auxiliary relay	✓	Special auxiliary relay	×	Special auxiliary relay	×
LR	Link relay	✓	-	-	-	-
EM	Expansion data memory *1 *2	✓	Expansion data memory *2	□	EM current Bank *2	✓

✓ : OK □ × : NG □ □ : Host link NG

*1 C-series EM (Expansion Memory) is available only in the C200HX/HG/HE (-Z).

*2 The EM (Expansion Memory) can be allocated only in the current bank.

Since the special auxiliary relays of the CVM1/CV series PCs are all allocated to system functions, they cannot be used for purposes other than system use.

The range of each memory area differs according to the PC type. Refer to APPENDIX L "PC Memory Map", page 675.

[Input Functions]

Lamps read the contents of a bit at the host and execute processing in accordance with the bit status.

However, the bit is only read in the following case:

- When a lamp is used on the currently displayed screen

[Output Functions]

Lamps have no output function.

[Processing Functions]

Lamps have no data processing function.

[Relationship with Other Elements]

- Touch switches (page 328) have the same display functions as normal (standard) lamps.
- Lamps overlap with other elements in accordance with the order in which they were registered on the screen with the Support Tool. However, the way in which they overlap can be changed with the Support Tool.

7-7 Touch Switches

[Function Outline]

The NT631/NT631C allows input from the touch panel on the screen. By pressing (touching) the touch switches on the screen, the NT631/NT631C screen can be switched, and bit information can be sent to the host.

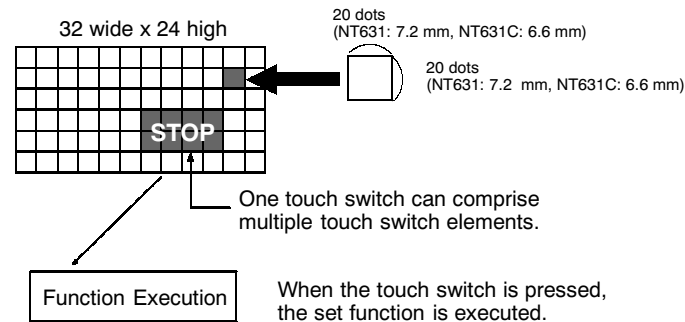

As with lamps, graphics which change in accordance with the status of a set bit are set for touch switches, and, besides, an area where the touching of the touch switch can be detected (the “touch switch area”) is also set for them.

Touch switches are arranged and set on screens when creating screen data with the Support Tool.

When a touch switch is pressed, the function set for it in advance is executed.

The way a touch switch is displayed and the processing when it is pressed can each be set independently.

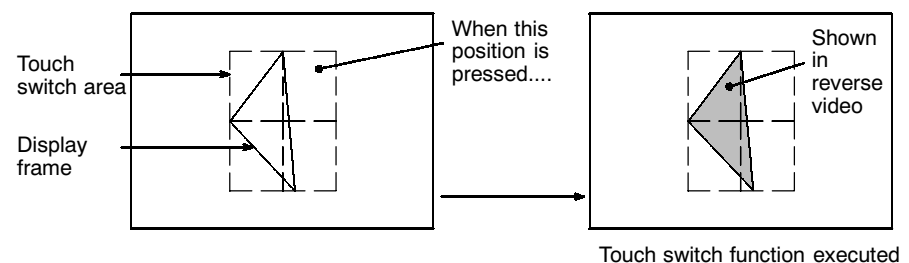

WARNING

Do not use the touch switch input function for applications where there is a danger to human life or the possibility of serious property damage, or for emergency stop switches.

Notice

- Do not press touch switches with a force of greater than 30 N.
- Do not press touch switches carelessly while the backlight is off or while nothing is displayed on the screen. Otherwise the system may operate unpredictably. Only press touch switches after confirming system safety.
- If touch switches are pressed in rapid succession, their inputs may not be successfully received.
Confirm that the input of a touch switch has been successfully received before moving on to the next operation.

Reference - Caution on pressing three touch switches

When multiple touch switches are arranged as shown in the example below and the three are pressed at the same time, a malfunction will occur due to a peculiarity of the touch switch mechanism.

Be careful how you arrange touch switches.

Example: When touch switches are created at positions A and B and at one of the points of intersection C or D

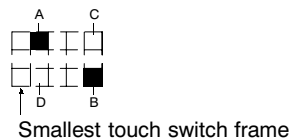

- If switches A, B, and C come ON at the same time, touch switch D will also come ON due to the touch switch mechanism.
- If switches A, B, and D come ON at the same time, touch switch C will also come ON due to the touch switch mechanism.

• Functions that can be set for touch switches

Any of the following functions can be set for touch switches. For details, refer to “Processing Functions” (page 336).

• Host notification function

When a touch switch is pressed, the status of a bit for notification purposes at the host (the “notify bit”) changes.

It may change in any of the four following ways.

- Momentary

The notify bit is set to “1” (ON) only while the touch switch is pressed, and returns to “0” (OFF) when the touch switch is released.

- Alternate

Each time the touch switch is pressed, the notify bit is switched to “1” (ON) if currently set to “0” (OFF), and to “0” (OFF) if currently set to “1” (ON).

- Set

When the touch switch is pressed the notify bit is set to “1” (ON).

- Reset

When the touch switch is pressed the notify bit is set to “0” (OFF).

NT631/NT631C

PC

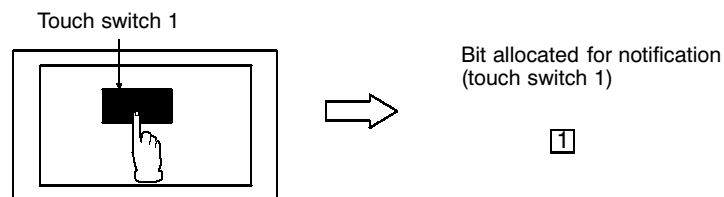

• Screen switching function

When a touch switch is pressed, the display switches to the set screen.

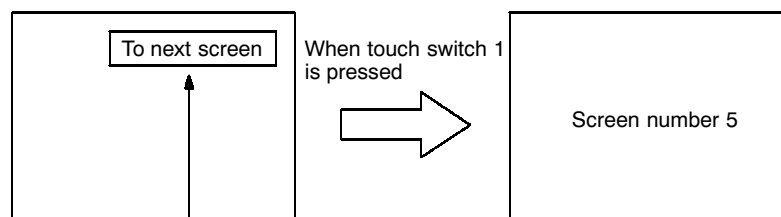

“Screen number 5” is set for touch switch 1.

- Input key – control function

When used in combination with the numeral/character string setting function, this function allows numeric values (labels) to be input into input fields. It is also possible to execute special functions such as checking and clearing input numeric values and character strings, and moving the cursor and moving between input fields with the arrow keys.

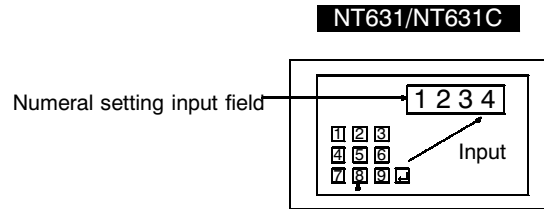

- Character string input key function

When this function is used in combination with the character string setting function, a label can be input into an input field by pressing a touch switch.

- Window key function

This function makes it possible to open and close windows by pressing touch switches.

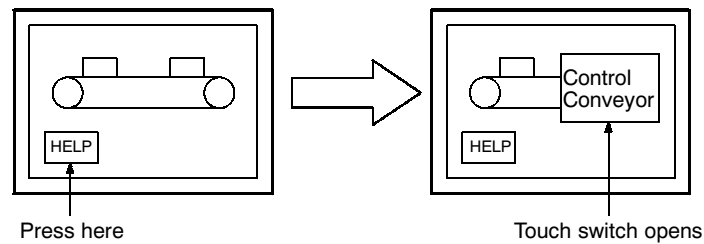

- Copy key function

This functions allows data or constants in memory tables to be copied to other memory tables or into numeral setting/character string input fields, by pressing a touch switch.

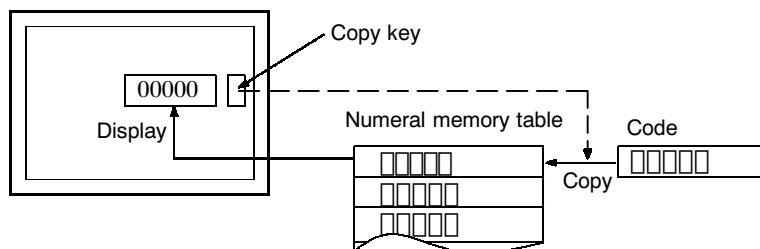

- Cursor moving key function

When there are a number of numeral setting or character string input fields on the screen, this function makes it possible to move the cursor to any required input field.

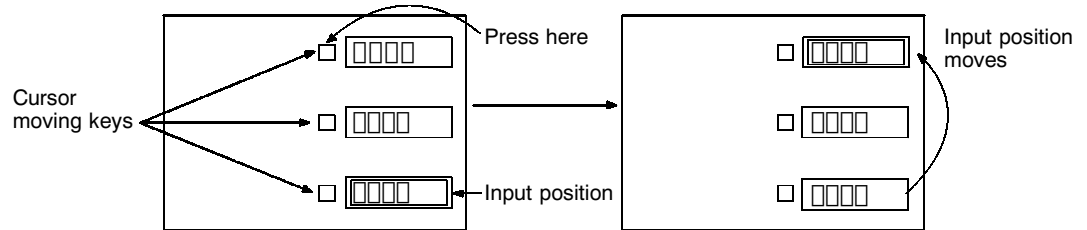

- Window move

By pressing a touch switch on a window, the window can be moved by touch panel operation at NT631/NT631C.

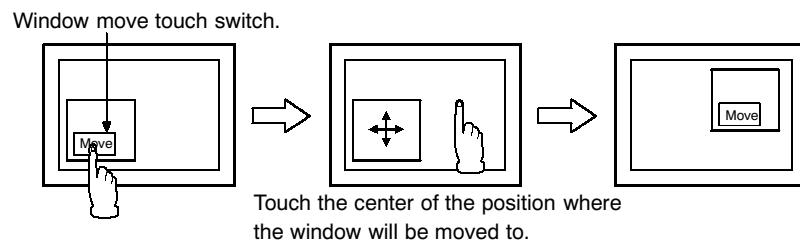

- Screen print key function

This function allows a hard copy of the currently displayed screen to be printed out at a printer connected to the NT631/NT631C by pressing a touch switch.

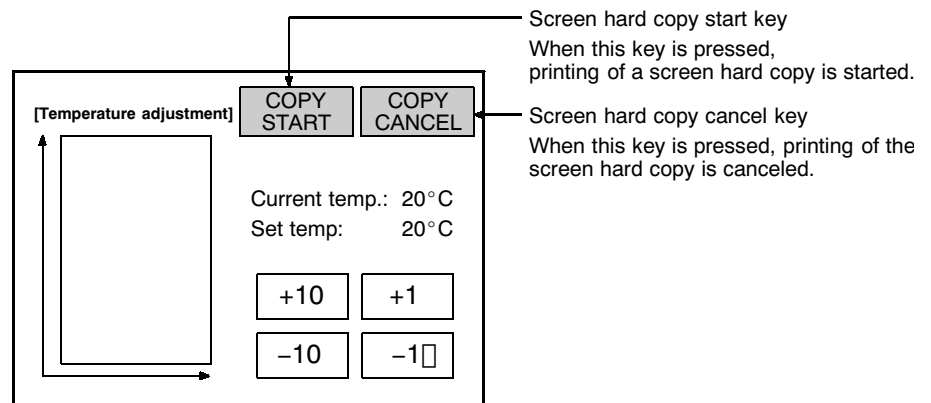

[Restrictions]

- A maximum of 256 touch switches can be registered for one screen. (Same for window screen.) For an overlapping screen comprising 8 child screens, the maximum is 256 per screen.

There is no restriction on the number of touch switches that can be registered for one screen data file: any number can be registered as long as the data file capacity is not exceeded. However, if a large number of elements are registered, check that the restrictions on element display are complied with by referring to "Display Restrictions" (page 635).

- When polygons are used as the display graphics for touch switches, one polygon can be given up to 255 vertices.

[Common Attributes]

The settings common to touch switches are indicated below. Depending on the function, further settings may be necessary.

- Properties

General	
Position	Coordinates of the top left corner of the touch switch display area
Size	Width and height of the touch switch display area (dot units)
Label	Presence or absence of a character string (label) on the touch switch Check mark (character string present)/ No check mark (no character string)
Description	Character string on the touch switch Alphanumerics and symbols, Marks A maximum of 40 alphanumerics and symbols (or equivalent) can be set for the label. A mark is recognized as two characters. For details on the properties of labels, refer to 7-4-2 "Text (Fixed Display)" (page 304).
Frame	Presence/absence of a frame for the touch switch display graphic. Check mark (frame used)/No check mark (no frame)
Shape	Shape of the touch switch (display graphic) · Fixed-shape display frame No frame/Standard/Shadow/3-Dimension · Free-shape display frame Rectangle, Polygon, Circle, Sector
Show ON State	Whether or not the lamp is displayed in reverse video when a touch switch is pressed.
Color	
Frame	Color of the frame (valid only when a check mark is set for "Frame" above). (Colors other than white and black are featured with NT631C only.) Black/Blue/Red/Magenta/Green/Cyan/Yellow/White
ON	Display color when the touch switch is ON (colors other than white and black are featured with NT631C only) Black/Blue/Red/Magenta/Green/Cyan/Yellow/White
OFF	Display color when the touch switch is OFF (colors other than white and black are featured with NT631C only) Black/Blue/Red/Magenta/Green/Cyan/Yellow/White/ Transparent
Settings	
Function	Processing functions executed when touch switches are pressed · Notify Bit · Switch Screen · Input Key – Control · Input Key – String · Input Key – Keyboard · Copy Setting · Cursor Move · Window Move · Print Screen

Light Function	
Address	
PC Bit Address	Allocated bit for displaying the touch switch ("Allocated bit", page 334)
I/O Comments	Comment that indicates the contents of the allocated bit Character string of up to 16 alphanumerics and symbols
Lamp Attribute	
On Type	Inverted display of the display graphic when the touch switch is ON (ineffective when "Shadow" and "3-Dimension" is set for "Shape") Light/Flash

- Lamp shape

<With fixed-shape display frame>

When a fixed-shape display is used, the lamp is displayed in the exact shape of the area that responds as a touch switch (the "touch switch area").

When "No frame" is selected, only the label is displayed unless a light (flash) instruction is received from the host or the touch switch is pressed (if no label is set, nothing will be displayed unless the touch switch is pressed).

No frame

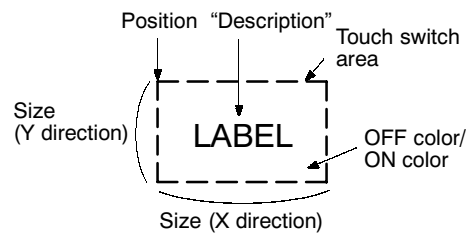

Standard

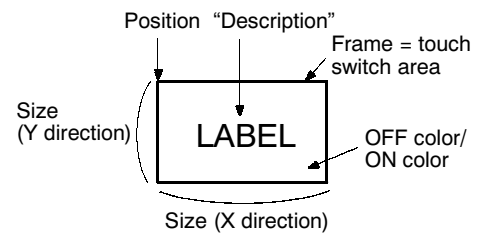

Shadow

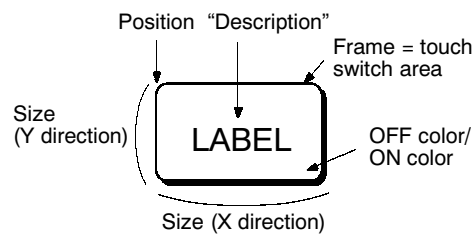

3-Dimension

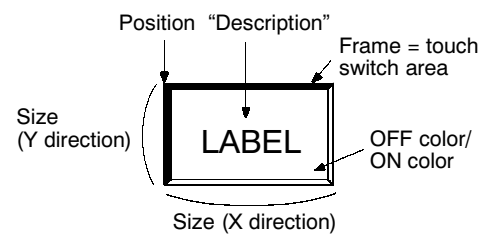

<With free-shape display frame>

When a free-shape display frame is used, the display graphic can be set anywhere, independently of the area that responds as a touch switch (touch switch area).

Rectangle

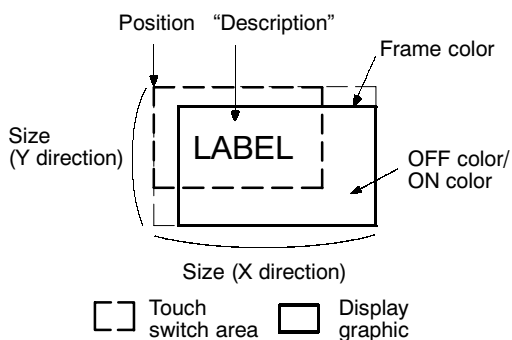

Polygon

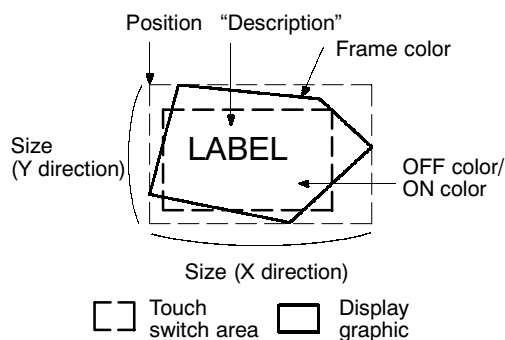

Circle

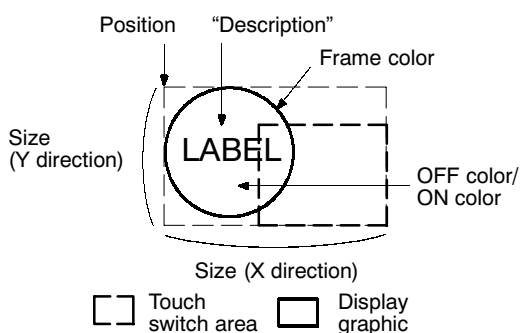

Sector

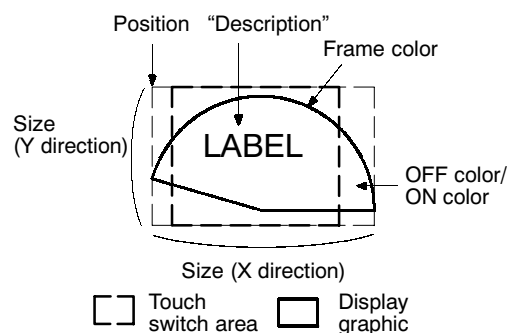

- Allocated bit

Lamp bits can be allocated to the following host (PC) areas.

Symbol	C Series PLC	Allocation	CVM1/CV Series PLC	Allocation	CS1 Series PLC	Allocation
DM	Data memory	✓	Data memory	✓	Data memory	✓
CH	I/O relay	✓	I/O relay	✓	I/O relay	✓
TIM	Timer present value	×	Timer present value	×	Timer present value	×
CNT	Counter present value	×	Counter present value	×	Counter present value	×
HR	Holding relay	✓	-	-	Holding relay	×
AR	Auxiliary relay	✓	Special auxiliary relay	×	Special auxiliary relay	×
LR	Link relay	✓	-	-	-	-
EM	Expansion data memory *1 *2	✓	Expansion data memory *2	☐	EM current Bank *2	✓

✓ : OK ☐ × : NG ☐ ☐ : Host link NG

*1 C-series EM (Expansion Memory) is available only in the C200HX/HG/HE (-Z).

*2 The EM (Expansion Memory) can be allocated only in the current bank.

Since the special auxiliary relays of the CVM1/CV series PCs are all allocated to system functions, they cannot be used for purposes other than system use.

The range of each memory area differs according to the PC type. Refer to APPENDIX L "PC Memory Map", page 675.

Reference

For touch switches for which the host notification function is set, a bit for host notification must be allocated in addition to the lamp bit.

[Display Functions]

As with lamps, it is possible to set a graphic area for a touch switch which is displayed in different ways according to the status of a bit at the host. The bit at the host that is allocated to control the touch switch display is called a "lamp bit".

The status of the lamp bit has the following effects.

- 0 (OFF): Lamp is OFF
- 1 (ON): Lamp is ON or flashing

Whether the lamp is ON or flashing when the lamp bit is set to "1" (ON) is determined by the setting made for the "On Type" property of the touch switch.

When a "lamp bit" is not allocated, touch switch performs only "Show ON State" function.

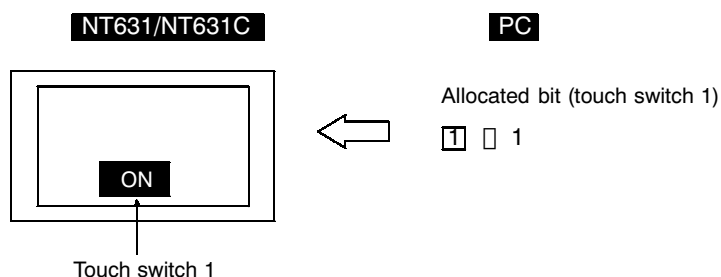

When "Show ON State" is set, the display graphic is displayed in reverse video when the touch switch is pressed.

[Input Functions]

The touch switch elements of the NT631/NT631C are arranged in a grid measuring 32 wide by 24 high on the screen. It is possible to create a single large rectangular touch switch using multiple touch switch elements.

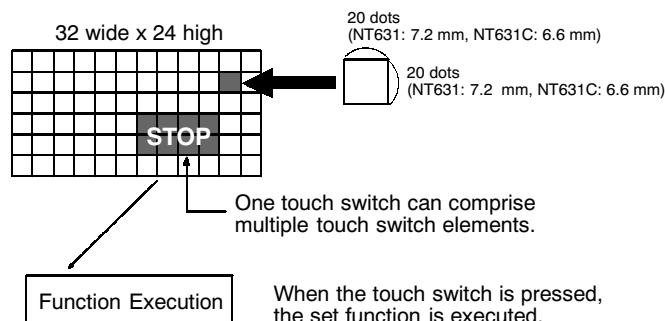

If any one of the touch switch elements within the set touch switch area is pressed, this is interpreted as the touch switch as a whole being pressed, and the set function is executed.

When "Show ON State" is set, for a moment, the display graphic is displayed in reverse video when the touch switch is pressed.

Reference	If a touch switch with the screen switching function or pop-up keyboard function is pressed while another touch switch is still being pressed, the key function will not be executed. Release the other key first.
------------------	--

[Output Functions]

Touch switches can make the following outputs depending on the processing function set for them.

- Host notification function

A bit at the host is overwritten in accordance with the set notification method.

- Screen print key function

A hard copy of the currently displayed screen can be printed out at a printer connected to the NT631/NT631C.

For details, see "Processing Functions" below.

It is possible to sound the "key press sound" when a touch switch is pressed.

Whether or not the key press sound is sounded can be set at "key press sound" with memory switch. (Refer to page 188)

[Processing Functions]

When a touch switch is pressed, the function set for it is executed.

There are eight functions that can be set for touch switches, as follows.

- Host notification function
- Screen switching function
- Control key function
- Character string input key function
- Window key function
- Copy key function
- Cursor moving key function
- Screen print key function

- Host notification function

This function notifies the host that a touch switch has been pressed.

When this function is used, a bit for notification (the notify bit) must be set for the touch switch. The input statuses of the touch switches displayed at the NT631/NT631C are always reflected by the notify bits. If the notify bit is not set, the touch switch will not function (it will function as a lamp only).

The properties for input notification are as follows.

Settings	
Address	
PC Bit Address	
I/O Comments	Comment that indicates the contents of the allocated bit Character string of up to 16 alphanumeric and symbols
Action Type	Notification operation when the touch switch is pressed Momentary, Alternative, Set, Reset

• Types of notification operation

The following four methods for notification to the host can be selected.

- Momentary

While a touch switch is pressed the notify bit is ON; it goes OFF when the switch is released.

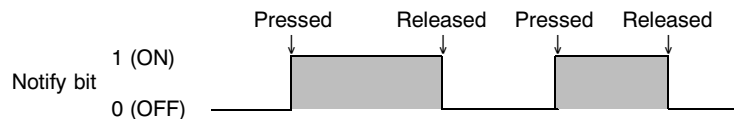

- Alternate

Each time the touch switch is pressed, it goes OFF if it is ON, or ON if it is OFF. The status of the notify bit does not change when the touch switch is released.



- Set

When the touch switch is pressed, the notify bit comes ON, and it remains ON after the switch is released.

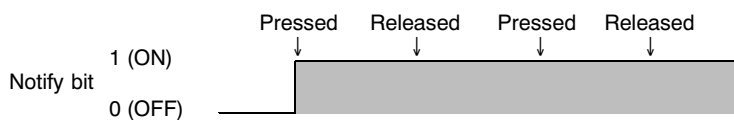

- Reset

When the touch switch is pressed, the notify bit goes OFF, and it remains OFF after the switch is released.



Reference

If there are multiple momentary touch switches on one screen that are allocated to the same bit, and these multiple switches are pressed and released at the same time, the OFF status will be notified each time the one of the switches is released.

• Notes on notification operations

The manner in which touch switch notification is executed differs according to the notification operation and communication method as follows.

Symbol	C Series PLC	Allocation	CVM1/CV Series PLC	Allocation	CS1 Series PLC	Allocation
DM	Data memory	✓	Data memory	✓	Data memory	✓
CH	I/O relay	✓	I/O relay	✓	I/O relay	✓
TIM	Timer present value	×	Timer present value	×	Timer present value	×
CNT	Counter present value	×	Counter present value	×	Counter present value	×
HR	Holding relay	✓	-	-	Holding relay	×
AR	Auxiliary relay	✓	Special auxiliary relay	×	Special auxiliary relay	×
LR	Link relay	✓	-	-	-	-
EM	Expansion data memory *1 *2	✓	Expansion data memory *2	□	EM current Bank *2	✓

✓ : OK □ × : NG □ □ : Host link NG

*1 C-series EM (Expansion Memory) is available only in the C200HX/HG/HE (-Z).

*2 The EM (Expansion Memory) can be allocated only in the current bank.

Since the special auxiliary relays of the CVM1/CV series PCs are all allocated to system functions, they cannot be used for purposes other than system use.

The range of each memory area differs according to the PC type. Refer to APPENDIX L "PC Memory Map", page 675.

- Screen switching function

This function allows the screen to be switched by touch switch operation at the NT631/NT631C, without instructions from the host.

When this function is used, the screen to be displayed is set for the touch switch. When the touch switch is pressed, the display switches to the set screen (at this time, the new screen number is notified via the PT status notify area).

Reference

- When a screen with a number other than those indicated below is allocated to a touch switch, the screen does not switch and the currently displayed screen remains displayed.
- The screen can also be switched by PT status control area operation (page 469), by bit memory table operation (page 472), and by the alarm/history function (page 473).
- To display an overlapping screen, specify the screen number of the parent screen.

The attributes for screen switching are as follows.

Settings	
Screen No.	Screen number of newly displayed screen 1 to 3999, 9001, 9002, 9020, 9999

- Specified screen number and display operation

The display operation at the NT631/NT631C depends on the specified screen number, as follows.

- Screen Nos. 1 to 3999

The display switches to the screen with the specified screen number. The screen number of the newly displayed screen is notified to the host.

- Screen No. 9001
The display history (occurrence order) screen is displayed. Screen number 9001 is notified to the host.
- Screen No. 9002
The display history (frequency order) screen is displayed. Screen number 9001 is notified to the host.
- Screen No. 9020
The programming console screen is displayed. Screen number 9020 is notified to the host.

This makes it possible to use the programming console function even in the RUN mode.

(However, the programming console function can be used only when the PT is connected to a PLC which can use the programming console function.) The RUM mode is canceled while the programming function is being used. Also, monitoring of PT control area, data logging function is not executed. To return from the programming console function, exit this function, by PT operation. (It is not possible to exit this function from the host.)

- Screen No. 9999
The screen displayed immediately before is displayed again. The screen number of the screen displayed is notified to the host.

Here, the touch switch functions as the screen switchover return key.

[Screens other than No. 9999]

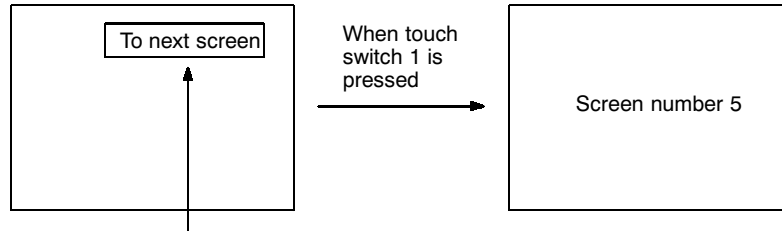

"Screen number 5" is set for touch switch 1

[Screen No. 9999]

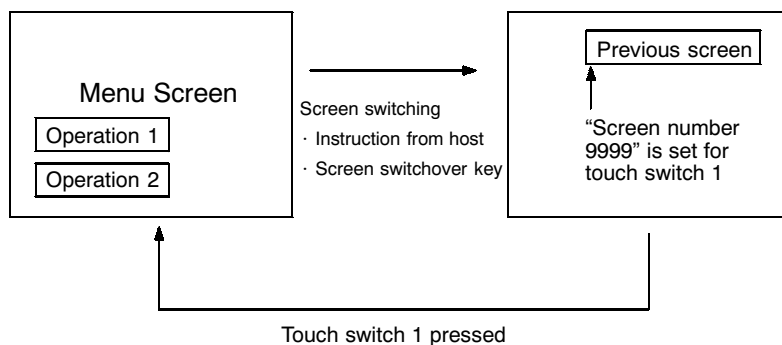

- Character string input key function
Used to input character strings when using the character string input function.
There are no attributes to be set for text keys. When touch switches are set as text keys, the labels of the touch switches are input into an input field.

- Reference**
- Input into character string input fields is also possible using the “control key” touch switches (0 to 9, A to F), and from a bar code reader connected to the NT631/NT631C.
 - A “control key” touch switch (ENT or ) is also necessary to confirm input character strings when “character string setting” is used.



- Control code input function

Control keys are used as numeric keys (0 to 9, A to F) for the numeral input function, and as special keys with fixed functions. By assigning an control key to a touch switch, it can be used to execute a specific function.

The attributes for control keys are as follows.

Settings	
Control key	Set control key

The following functions can be set for touch switch control keys.

Key	Function
0 to 9, A to F	Used to input numerals (1 digit)
CLR	Clears numeric values and character strings in input fields
±	Assigns the opposite sign to input numeric values
.	Used to input a decimal point
HOME	Used to move to the input field at the top left of the screen
↑, ↓, ←, →	Used to move to the required input field
	Confirms input without shifting to another input field
	Stops the buzzer
↕, ⇓	Shift between input fields
MENU	Used to display the System Menu
CA	Cancel text input
BS	Deletes the numeral or character immediately preceding the input cursor
DEL	Deletes the numeral or character at the input cursor location
◀, ▶	Used to shift the input cursor
ENT	Confirms input (after confirmation, the cursor shifts to the next input field)

- Pop-up window/keyboard function

This function is used to control the opening and closing of windows when using the window function (7-14 “Window Function”, page 428).

- Reference**
- When the “window opening” bit of the PT status control area is set to “1” (disabled), it is not possible to open windows by operations at the NT631/NT631C such as touch switch operations.
 - By associating windows with the “cursor moving key” touch switches with the Support Tool, windows can be opened by pressing the cursor moving keys.
 - It is not possible to control a global window by touch switch operation.

The attributes for the window key are as follows.

Settings	
Screen No.	
Local 1 (Keyboard)	Check this attribute when the local window 1 is to be controlled. • Specify the screen number of the window to be controlled. 1 to 3999
Local 2	Check this attribute when the local window 2 is to be controlled. • Specify the screen number of the window to be controlled. 1 to 3999
Window Position	
X	X coordinate at the bottom left position of the window 0 to 620 (multiple of 20)
Y	Y coordinate at the bottom left position of the window 19 to 479 (multiple of 20-1)
Action Type	Controlling method of the window Open/Close/Toggle
Replace Local Window	Specify the behaviour of the window when the other window of the same type (Local 1/Local 2) is already opened. Check mark (replace)/No check mark (no replace)

The window behaves as follows according to the settings for "Action Type" and "Replace Local Windows".

- Behaviour according to the "Action Type"

Open : Opens the specified window by the specified type (local 1 or local 2). Whether or not the window is actually opened depends on the display status and the setting for "Replace Local Window". The window is displayed at the position which is specified with the "Window Position" setting.

If the other window of the same type is already opened, the behaviour is determined according to the setting for "Replace Local Window".

If the specified window does not exist, no operation is performed.

Close : Closes the specified window of the specified type (local 1 or local 2). When the "close" window key is pressed, the specified window which is presently displayed by the specified type is closed. If the specified window is not displayed by the specified type, no operation is executed.

Toggle : Opens or closes the specified window of the specified type (local 1 or local 2).

If the specified window is not displayed by the specified type, the specified window is opened in the same way as the "Open" window key.

Whether or not the window is actually opened depends on the display status and the setting for "Replace Local Window".

The window is displayed at the position which is specified with the "Window Position" setting.

If the other window of the same type is already opened, the behaviour is determined according to the setting for "Replace Local Window".

If the specified window does not exist, no operation is performed.

If the specified window is already displayed by the specified type, the window is closed in the same way as "Close" window key.

- Behaviour according to the "Replace Local Window"

Check mark : If the other window of the same type is already displayed, the displayed window is closed first, and then the specified window is opened.

No check mark : If the other window of the same type is already displayed, no operation is performed.

- Copy key function

This function is used to copy the data or constants in a memory table to another memory table or an input field. It is useful for setting numeral/character string displays to their initial state, and for inputting the same contents (e.g. initial values) into multiple numeral/character string setting input fields.

Copying is possible between the following combinations.

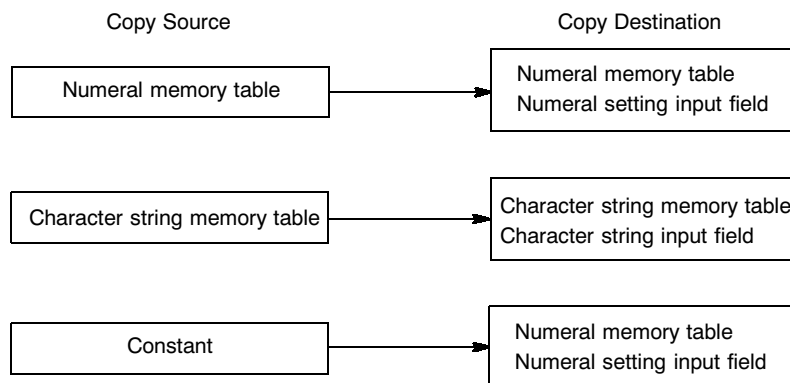

Reference

- It is also possible to copy between memory tables by operation with the PT status control area.
- If the contents of a numeral/character string memory table have been changed by operation at the NT631/NT631C such as use of the copy key the change is notified to the PT status notify area at the host.

The attributes for the copy key are as follows.

Settings	
Copy From	
Type	Type of copy source Numeral Table String Table Code
Memory Table Number/Fixed Value	Copy source memory table number, or value if a constant · For a numeral/character string memory table 0 to 1999 · For a constant -2147483648 to 2147483647
Copy To	
Type	Type of copy destination Numeral Table String Table Cursor Position (numeral/character string input field)
Memory Table Number	Memory table number of the copy destination (setting ineffective if "Cursor Position" is set for "Copy To") 0 to 1999

- Cursor moving key function

This function moves the cursor to a pre-designated numeral/character string input field in preparation for input.

It is also possible to open a designated window simultaneously with the cursor motion, and to automatically display a window in accordance with the input field.

Reference

- Cursor moving keys can also be created automatically when a numeral/character string input field is registered on a screen.
- Input fields can also be designated using the input key – control.

The attributes for the cursor moving keys are as follows.

Settings	
Use Window/Keyboard Screen	
	Open window/keyboard? Check mark (open)/No check mark (do not open)
Screen No.	
Local 1 (Keyboard)	Screen number of the window/keyboard to be opened (setting effective only if a check mark is set for "Local 1 (Keyboard)" of "Use Window/Keyboard Screen") 1 to 3999
Local 2	Screen number of the window to be opened (setting effective only if a check mark is set for "Local 2" of "Use Window/Keyboard Screen") 1 to 3999
Window Position	
X	X coordinate at the bottom left position of the window 0 to 620 (multiple of 20)
Y	Y coordinate at the bottom left position of the window 19 to 479 (multiple of 20-1)
Replace Local Window	Designate the behavior when other window of the specified type (local window 1/local window 2) is already opened Check mark (replace)/No check mark (do not replace)
Auto Arrange	
	Move together with the input field associated in editing at the Support Tool? Check mark (yes)/No check mark (no)

- Settings and action type of window to be used when using "Use Window/Keyboard Screen" is same as the input key-window/keyboard function which has "Open" action type.

Refer to "Window key function" (page 341).

- Settings and action type of window to be used when "Use Window/Keyboard attribute is set are same as those of the input key-window/keyboard function which has "Open" action type.

Refer to "Window key function" (page 341).

- Window moving key function

This function moves a window by pressing a window moving key, which is pre-registered on a window, while the NT631/NT631C is running. Window moving key can be registered on a window screen.

Reference

- Window can be moved also by the operation of window control area. (Refer to page 481)
- Window moving key can be used only on a local window. It does not function if the window screen is displayed as a global window.

Window moving key has no special attributes.

- Moving a window by the operation of a window moving key

To move a window by the operation of a window moving key, follow the procedure below.

- (1) Pre-register a window moving key on the window to be moved.
- (2) Press the window moving key on a window to be moved while the NT631/NT631C is running.
The window is changed to the frame display only as follows, with the \updownarrow mark at the center of it.

Window moving key

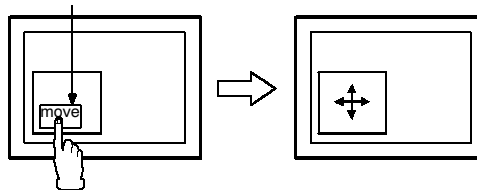

- (3) Press the touch panel of the NT631/NT631C at the moving destination.
Window is moved so that the center position of the window comes to the pressed position.
This time, "Display Position" of the corresponding window area is changed.

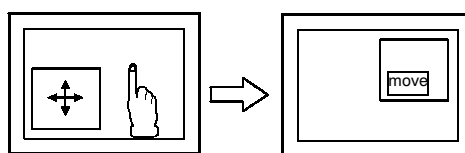

Press the moving destination

When the window is in a moving status (while \updownarrow mark is displayed at the center of the window), the following points differ from the normal running status.

- The elements which use the touch panel as an input do not function regardless of the screens (base/window) they are registered on. Only the specification of the window moving destination is possible.
- Switching to the system menu is not possible.
- Screen switching or window controlling due to the change in bit memory table, PT status control area or window control area is not possible.
- Screen saver function does not work.
- There is no time-limit for a window moving status. It will not return to the normal running status until the moving destination is specified.

- Reference**
- Window moves by a minimum touch switch size (20 × 20).
 - Be sure to complete all the window moving operation when in the window moving status, since its behaviour differs from the one when in the normal running status.

- Screen print key function
 This function allows starting and stopping of the printing of a hard copy of the currently displayed screen (screen image) at a printer connected to the NT631/NT631C.

- Reference**
- The NT631/NT631C continues operating during printing.
 - The printer type and printing method (color/monochrome (8 grayscale levels)) is determined by memory switch setting at the NT631/NT631C.
 - A hard copy of the screen can also be printed by operation with the “PT status control bits”. In this case also, printing can be stopped part way through by pressing a touch switch.

The attributes for screen printing are as follows.

Settings	
Print Screen	
Printing of Display Screen	Set whether the touch switch is to start printing or stop printing. Start/Abort

[Relationship with Other Elements]

- By using “input key – string” and “input key – control” in combination with “Numerical Input” (page 407) and “String Input” (page 423), numeric values and character strings can be input.

Registering these keys in windows makes it possible to switch among windows as required for versatile input.

- Special touch switches with specific functions (input key – control) are automatically created for the following elements.

Trend graphs (page 381), alarm list (page 396), alarm history (page 396), thumbwheel switches (page 415)

- Touch switches overlap with other elements according to the order in which the elements were registered on the screen with the Support Tool.

7-8 Numeral Display

[Function Outline]

The contents of numeral memory tables are displayed as numeric values.

The values can be displayed either in decimal or hexadecimal notation.

There are two methods for referencing a numeral memory table whose contents are to be displayed, as follows.

- Direct reference (reference of the number of the relevant numeral memory table)

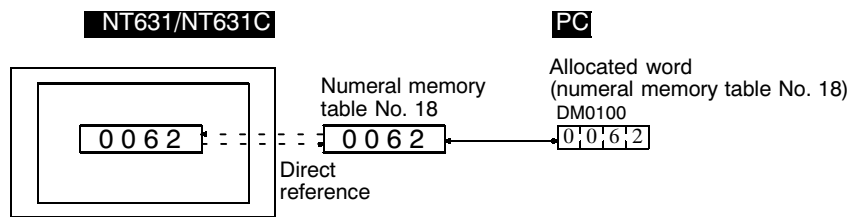

- Indirect reference (reference of the numeral memory table that stores the number of the relevant numeral memory table)

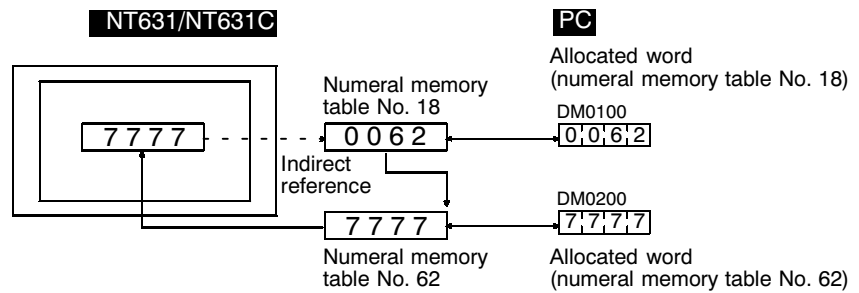

[Restrictions]

- A maximum of 256 numeral displays can be registered for one screen. (Same for window screen.) For an overlapping screen comprising 8 child screens, the maximum is 1024.

There is no restriction on the number of numeral displays that can be registered for one screen data file: any number can be registered as long as the data file capacity is not exceeded. However, if a large number of elements are registered, check that the restrictions on element display are complied with by referring to “Display Restrictions” (page 635).

- The maximum number of numeral display which can be displayed using “indirect reference” is 100 per screen combined with the number of character string display which is displayed using “indirect reference”. (Same restriction applies to overlapping screens or when displaying window screens.)
- The range of numeric values that can be displayed depends on the “Storage Type” (“BCD” or “Binary”), “Display Type” (“Decimal” or “Hexadecimal”), and “Display Sign” settings made for the numeral memory table. For details, refer to 7-3-1 “Numeral Memory Tables” (page 278).

[Common Attributes]

The relationship between the properties of a numeral display and the displayed numeric value is indicated below.

- Properties

General	
Position	Coordinates of the top left corner of the field in which the numeric value is displayed.
Font Type	Font for the characters Standard/Half Height/Double Width
Scale	Scale at which the numeric value is displayed ("Enlarged display", page 350). 1 × 1 (Equal), 1 × 2 (High), 2 × 1 (Wide), 2 × 2, 3 × 3, 4 × 4, 8 × 8
Smoothing	Whether or not smoothing is used for numerals with a scale of 2 × 2 or larger ("Smoothing", page 350). Check mark (smoothing executed)/ No check mark (smoothing not executed)
Attribute	Display mode for the numerals ("Display attributes and drawing result", page 350). Standard/Flash/Inverse Flash
Color	
Foreground	Display color of the numerals (colors other than black and white featured with NT631C only) Black/Blue/Red/Magenta/Green/Cyan/Yellow/White
Background	Background color of the numerals (colors other than black and white featured with NT631C only) Black/Blue/Red/Magenta/Green/Cyan/Yellow/White
Settings	
Reference	
Indirect Reference	Method for referencing the numeral memory table ("Direct reference and indirect reference", page 351) Check mark (Indirect Reference)/ No check mark (Direct Reference)
Table Entry	Numeral memory table number referenced for display ("Direct reference and indirect reference", page 351) 4-digit BCD value · When "Direct Reference" is specified: Table number of the numeral memory table in which the numeric value to be displayed is stored · When "Indirect Reference" is specified: Table number of the numeral memory table in which the number of the numeral memory table whose contents are to be displayed is stored.
Display Type	Display format for the numeric value ("Stored data and displayed numeric value", page 352) Decimal/Hexadecimal
Format ("Number of digits displayed", page 351)	
Integer	Number of digits in the integer part of the numeric value
Decimal	Number of digits in the decimal fraction of the numeric value

Settings	
Zero Suppression	Whether or not zero suppression is used ("Zero suppression", page 352) Check mark (zero suppression used)/ No check mark (zero suppression not used)
Display Sign	Whether or not negative numbers are indicated (setting ineffective if "Hexadecimal" has been set for "Display Format") Check mark (negative numbers indicated)/ No check mark (negative numbers not indicated)

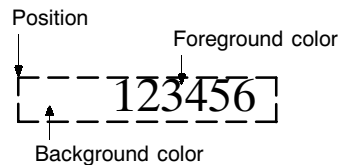

- Enlarged display

Numeric values can be displayed at the following scales.

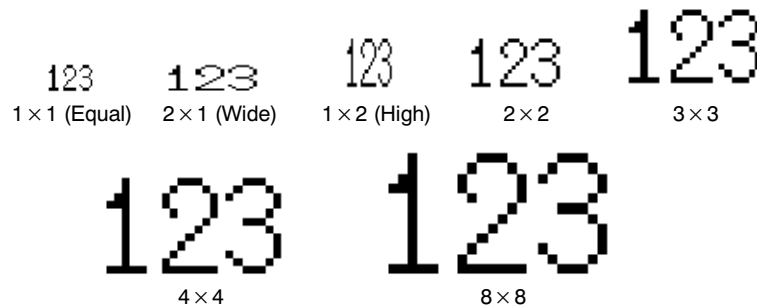

With "ISO 8859-1" font type, the numerals of 2 × 2 or larger scale are automatically displayed in 32 dot high-definition font.

Reference The 32 dot high-definition font is not displayed for the following models (16 × 16 dot font is used.)

- NT631-ST211□ -E
- NT631C-ST141□ -E
- NT631C-ST151□ -E

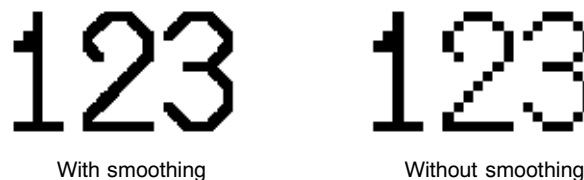

- Smoothing

Characters enlarged to a scale of 2 × 2 or greater can be displayed with the outline automatically smoothed. This function is called "smoothing".



Smoothing is not performed for high-definition font.

- Display attributes and drawing result

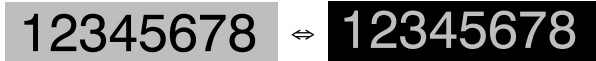
Attribute	Drawing Result
Standard	The numeral display is displayed with the specified foreground color and background color. 
Flash	Repeated alternation of the “standard” display and no display. 
Inverse Flash	Repeated exchange of the foreground color and background color. 

- Direct reference and indirect reference

Direct reference is a method whereby the memory table whose contents are to be displayed is specified directly.

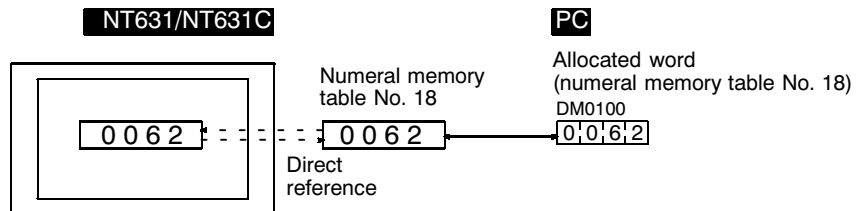

In indirect reference, the numeral memory table whose contents are to be displayed is not specified directly: the contents of the specified numeral memory table (a numeric value) are regarded as the number of a numeral memory table, and the contents of this numeral memory table are displayed. Note that more processing time is required for indirect reference than for direct reference.

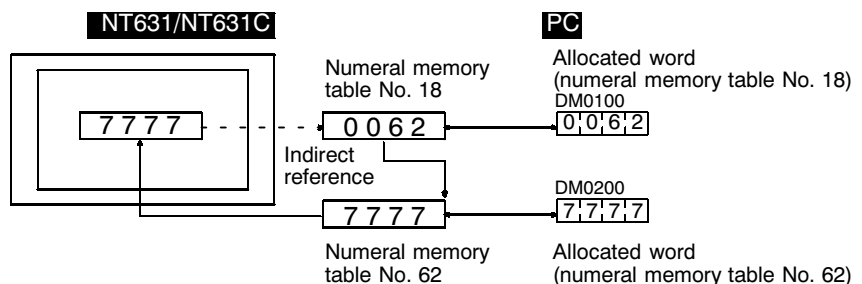

- Number of digits displayed

All contents of numeral memory tables are stored as integers. To display a numeric value that has a decimal fraction, set the “decimal” setting to “1” or higher to specify the number of places after the decimal point, then a decimal point is automatically inserted.

Note that if the number of digits of the numeric value is greater than the total of the settings for “Integer” and “Decimal”, an error occurs and “*” is displayed for all the digits.

An example is given below (here, the check mark is assumed to be set for “Zero Suppression”).

- Example:** Displaying "123456"
- Setting for "Integer" = 8; setting for "Decimal" = 0:
Resulting display: 00123456
 - Setting for "Integer" = 4; setting for "Decimal" = 4:
Resulting display: 0012.3456
 - Setting for "Integer" = 2, setting for "Decimal" = 4:
Resulting display: 12.3456
 - Setting for "Integer" = 1, setting for "Decimal" = 4:
Resulting display: *.****

- Zero suppression

The numeric value is displayed right-justified within the sum of the number of digits specified for "Integer" and the number of digits specified for "Decimal". Normally, when the number of digits of the numeric value is small, the excess digits at the left side are filled with zeros. When the check mark is set for "Zero Suppression", no zeros are set in the excess digits and they remain blank.

00012345	12345
Without zero suppression (when the number of digits displayed is 8)	With zero suppression

- Stored data and displayed numeric value

The conversion method for display and the range of numeric values that can be displayed depend on the following settings.

Display Type ("Decimal"/"Hexadecimal")

Display Sign (whether or not negative values are displayed)

<Conversion depending on "Display Type">

The data stored in a numeral memory table is converted as follows depending on the setting for "Display Type".

- "Decimal":

The numeric value (signed binary data) stored in the numeral memory table is converted to decimal notation.

- "Hexadecimal":

The numeric value (signed binary data) stored in the numeral memory table is displayed without alteration.

Reference Numeral memory tables store numeric values as signed binary data.

<Effect of sign on conversion>

For unsigned decimal values, if the result of conversion of the data in a numeral memory table is negative, it is displayed after conversion to an absolute value.

For signed decimal values, if the result of conversion is a negative value it is displayed with a minus sign "-".

<Permissible display range>

The permissible display range depends on the settings made for “Display Type” and “Display Sign”, as follows.

Display Type	Sign	Permissible Display Range
Decimal	Unsigned	0 to 2147483648*
	Signed	-2147483648 to 2147483647
Hexadecimal	–	0 to FFFFFFFFH

When displaying the contents of numeral memory tables that are allocated to host words, not only the numeral display properties but also the “Storage Type” and “Words” settings made for the numeral memory table have an effect on the permissible display range. The permissible display range is determined as follows depending on these properties.

Storage Type	Words	Display Type	Sign	Permissible Display Range
BCD	1	Decimal	Unsigned	0 to 9999
			Signed	-999 to 9999
		Hexadecimal	–	0 to 270FH
	2	Decimal	Unsigned	0 to 99999999
			Signed	-99999999 to 99999999
		Hexadecimal	–	0 to 5F5E0FFH
Binary	1	Decimal	Unsigned	0 to 32768*
			Signed	-32768 to 32767
		Hexadecimal	–	0 to FFFFH
	2	Decimal	Unsigned	0 to 2147483648*
			Signed	-2147483648 to 2147483647
		Hexadecimal	–	0 to FFFFFFFFH

* Note that this range is different from that for numeral input (page 407). 32768 is displayed when the contents of the numeral memory table are 8000H (-32768), and 2147483648 is displayed when the contents of the memory table are 8000000H (-2147483648). This is because when the value is unsigned, only the sign is omitted and the numeric value is displayed as an absolute value. It is not possible to input 32768 or 2147483648 as positive values.

<Relationship between contents of host words and displayed numeric value>

When displaying the contents of a numeral memory table allocated to a word at the host, the contents of the word are first converted to the format for storage in the numeral memory table (signed hexadecimal), and then converted again in accordance with the settings for “Display Type” and “Display Sign” settings in order to display them. Therefore the result also differs according to the settings made for “Words” and “Storage Type”.

An example is given below.

Contents of word at host	“Storage Type”	“Words”	Numeric value stored in numeral memory table	“Display Type”	Sign	Displayed numeric value			
1234	BCD	1	000004D2H	Decimal	Unsigned	1234			
F123			FFFFFF85H			123			
F0001234			FFFFFFB2EH			1234			
1234			000004D2H			1234			
F123			FFFFFF85H			-123			
F0001234			FFFFFFB2EH			-1234			
1234		1	000004D2H	Hexadecimal	-	4D2			
F123			FFFFFF85H			FF85			
F0001234			FFFFFFB2EH			FFFFFFB2E			
1234			2			00001234H	Decimal	Unsigned	4600
F123						FFFFFF123H			3805
F0001234						F0001234H			268430796
1234	00001234H	4660							
F123	FFFFFF123H	-3805							
F0001234	F0001234H	-268430796							
1234	1	00001234H	Hexadecimal	-	1234				
F123		FFFFFF123H			F123				
F0001234		F0001234H			F0001234				
1234		2			00001234H	Hexadecimal	-	1234	
F123					FFFFFF123H			F123	
F0001234					F0001234H			F0001234	

Reference Data is stored in the numeral memory table as signed data with a data length of 4 bytes.

If the setting for “Storage Type” is “BCD”, the contents of the host word(s) (BCD data) are converted to signed binary (hexadecimal) data and then stored in the numeral memory table. If the most significant digit in the word contents is “F”, it is regarded as a negative value. If the BCD data is not correct, it is not read out and the existing value is retained.

If the setting for “Storage Type” is “Binary”, the contents of the host word(s) are stored in the numeral memory table without alteration. However, if a negative value is written when the number of allocated host words is 1, the number of bits is increased to accommodate 2-word signed data before storage (refer to the example of “F123” above).

When the numeric value for display is designated as unsigned, it is displayed as an absolute value.

[Display Functions]

In numeral display, the numeric values are displayed in accordance with the “General” settings.

For details on the method of display depending on the “General” settings, refer to “Common Attributes” (page 349).

[Input Functions]

Numeral displays have no input function.

[Output Functions]

Numeral displays have no output function.

[Processing Functions]

With numeral displays, the contents of numeral memory tables are converted to displayed numeric values in accordance with the “General” settings.

For details on the method of conversion depending on the “General” settings, refer to “Common Attributes” (page 349).

[Relationship with Other Elements]

- The conversion method and display method used with numeral displays are the same as those used when displaying numeric values with “numeral input” (page 407).
- For details on how numeric values are stored in numeral memory tables, refer to 7-3-1 “Numeral Memory Tables” (page 278).
- Numeral displays overlap with other elements in accordance with the order in which they were registered for the screen with the Support Tool. However, the way in which they overlap can be changed with the Support Tool.

7-9 Character String Display

[Function Outline]

The contents of character string memory tables are displayed as character strings.

Alphanumerics and symbols can be displayed. It is also possible to display marks (character codes FF20 to FFFFH) in character strings.

There are two methods for referencing a character string memory table whose contents are to be displayed, as follows.

- Direct reference (reference of the number of the relevant character string memory table)

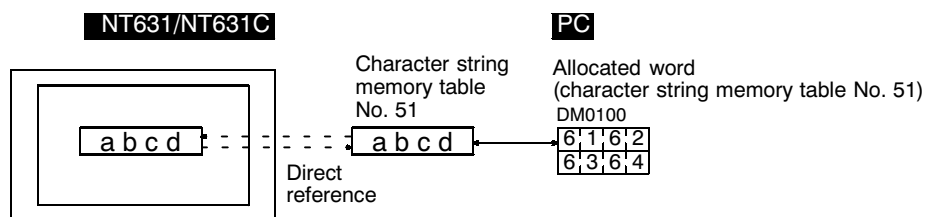

- Indirect reference (reference of the numeral memory table that stores the number of the relevant character string memory table)

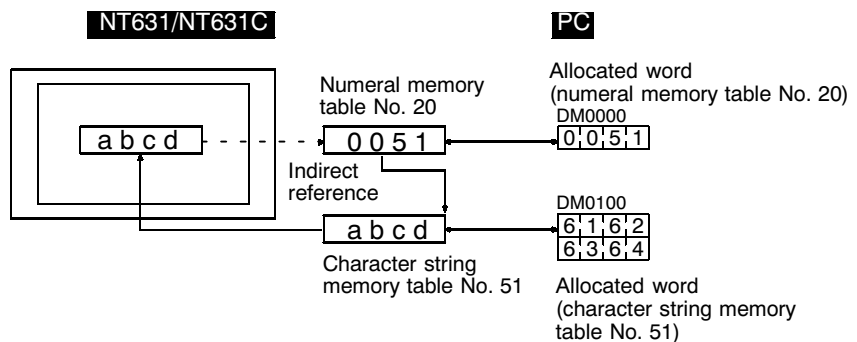

[Restrictions]

- A maximum of 256 character string displays can be registered for one screen. (Same for window screen.) For an overlapping screen comprising 8 child screens, the maximum is 1024.

There is no restriction on the number of character string displays that can be registered for one screen data file: any number can be registered as long as the data file capacity is not exceeded. However, if a large number of elements are registered, check that the restrictions on element display are complied with by referring to “Display Restrictions” (page 635).

The maximum number of character string display which can be displayed using “indirect reference” is 100 per screen combined with the number of numeral display which is displayed using “indirect reference”.

(Same restriction applies to overlapping screens or when displaying window screens.)

- The following numbers of characters can be displayed in one character string display, depending on the scale.

1 × 1 (Equal): Up to 40 characters

2 × 1 (Wide): Up to 40 characters

1 × 2 (High): Up to 40 characters

2 × 2: Up to 40 characters

3 × 3: Up to 26 characters

4 × 4: Up to 26 characters

8 × 8: Up to 10 characters

If the character string display size exceeds the screen size with the specified value, its display position is automatically changed so that the character string is displayed within the screen.

In case the character string display can not be displayed within the screen even if the Support Tool has changed its position, the error message will be displayed.

- The characters that can be displayed are alphanumerics, symbols and Marks. Marks are displayed at the standard height even if “Half Height” is set as the Font Type. Therefore, if normal alphanumerics and symbols are displayed after displaying a mark, part of the mark will remain displayed, as shown in the figure below.
- If “Half Height” is set for “Font Type”, and a character string is written after displaying Marks, a part of the Marks will remain displayed, as shown below.

A B C D E
a b c d e f g h i j

In this case, create blank characters as marks, write these marks, and then write the alphanumeric and symbol character string over them.

[Common Attributes]

The relationship between the properties of a character string display and the displayed character string is indicated below.

- Properties

General	
Position	Coordinates of the top left corner of the field in which the character string is displayed.
Font Type	Font for the characters Standard/Half Height
Scale	Scale at which the character string is displayed ("Enlarged display", page 359). 1 × 1 (Equal), 1 × 2 (High), 2 × 1 (Wide), 2 × 2, 3 × 3, 4 × 4, 8 × 8
Smoothing	Whether or not smoothing is used for characters with a scale of 2 × 2 or larger ("Smoothing", page 359). Check mark (smoothing executed)/ No check mark (smoothing not executed)
Attribute	Display mode for the character string ("Display attributes and drawing result", page 360). Standard/Flash/Inverse Flash
Color	
Foreground	Display color of the text (colors other than black and white featured with NT631C only) Black/Blue/Red/Magenta/Green/Cyan/Yellow/White
Background	Background color of the text (colors other than black and white featured with NT631C only) Black/Blue/Red/Magenta/Green/Cyan/Yellow/White
Settings	
Reference	
Indirect Reference	Method for referencing the character string memory table whose contents are to be displayed ("Direct reference and indirect reference", page 360) Check mark (Indirect Reference)/ No check mark (Direct Reference)
Table Entry	Numeral memory table number referenced for display ("Direct reference and indirect reference", page 360) · When "Direct Reference" is specified: Table number of the numeral memory table in which the character string to be displayed is stored. · When "Indirect Reference" is specified: Table number of the numeral memory table in which the number of the character string memory table whose contents are to be displayed is stored.
Length	Number of displayed characters 1 to 40

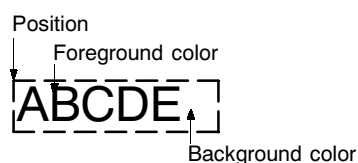

- Enlarged display

Character strings can be displayed at the following scales.

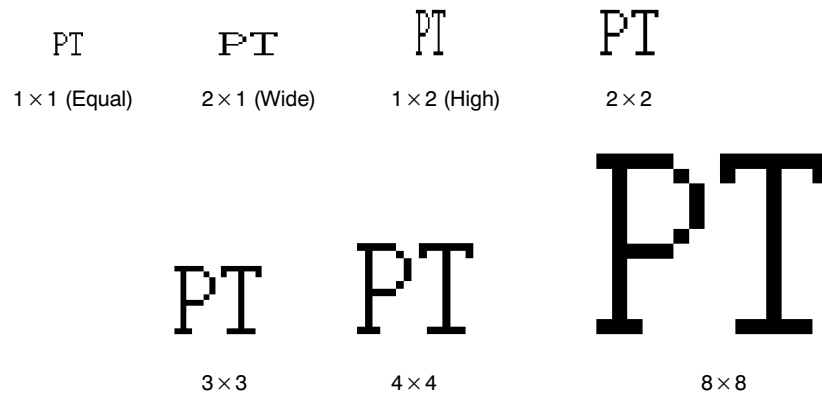

With "ISO 8859-1" font type, the character strings of 2x2 or larger scale are automatically displayed in 32 dot high-definition font. However, the marks inserted into a string are always displayed in 16x16 dot font.

Reference The 32 dot high-definition font is not displayed for the following models. (16x16 dot font is used.)

- NT 631-ST211□ -E
- NT631C-ST141□ -E
- NT631C-ST151□ -E
- Smoothing

Characters enlarged to a scale of 2x2 or greater can be displayed with the outline automatically smoothed. This function is called "smoothing".

Note that smoothing cannot be used for marks.

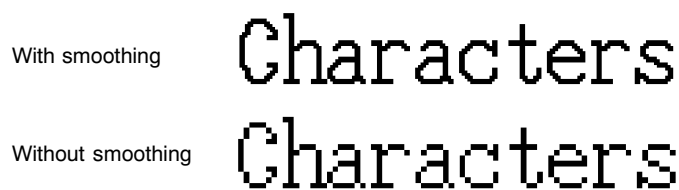



Smoothing is not performed for high-definition font.

- Discrepancy between "Length" and number of characters

If the actual number of characters of the data in the character string memory table is greater than the number specified for "Length", the surplus part is ignored.

If the actual number of characters of the data in the character string memory table is less than the number specified for "Length", the size of the field in which the character string is displayed is still determined by the settings for "Length" and "Scale". In such cases the character is displayed left-justified, with spaces filling the superfluous part. Therefore if the contents of the numeral memory table change to fewer characters, the characters of the previous data do not remain displayed at the right side.

- Display attributes and drawing result

Attribute	Drawing Result
Standard	The character string display element is displayed with the specified foreground color and background color. 
Flash	Repeated alternation of the “standard” display and no display. 
Inverse Flash	Repeated exchange of the foreground color and background color. 

- Direct reference and indirect reference

Direct reference is a method whereby the memory table whose contents are to be displayed is specified directly.

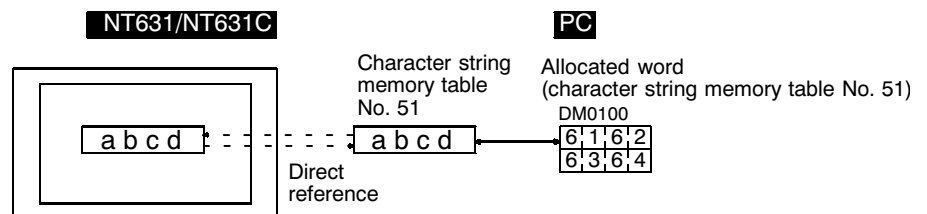

In indirect reference, the memory table whose contents are to be displayed is not specified directly: the contents of the specified numeral memory table (numeric value) are regarded as the number of a character string memory table, and the contents of this character string memory table are displayed. Note that more processing time is required for indirect reference than for direct reference.

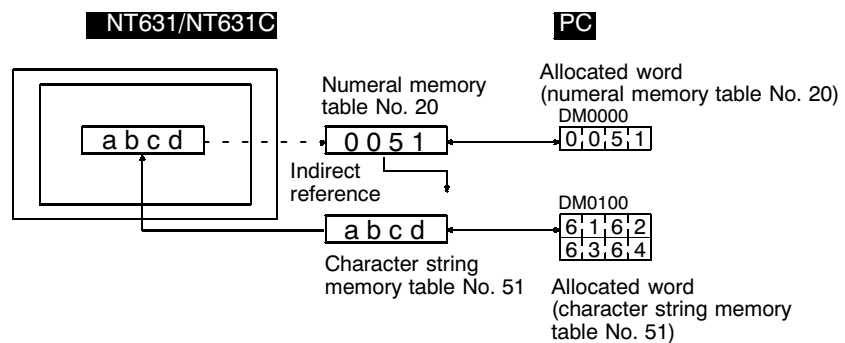

[Display Functions]

In character string display, the character string is displayed in accordance with the “General” settings.

For details on the method of display depending on the “General” settings, refer to “Common Attributes” (page 358).

[Input Functions]

Character string displays have no input function.

[Output Functions]

Character string displays have no output function.

[Processing Functions]

Character string displays have no processing function.

[Relationship with Other Elements]

- The conversion method and display method used with character string input (page 423) are the same as those used when for character string display.
- For details on how character strings are stored in character string memory tables, refer to 7-3-2 “Character String Memory Tables” (page 285).
- Character string displays overlap with other elements in accordance with the order in which they were registered for the screen with the Support Tool. However, the way in which they overlap can be changed with the Support Tool.

7-10 Graphs

The following three types of graphs can be used with the NT631/NT631C. The contents of memory tables are read out, and the graph display is updated, automatically. If the numeral memory table is allocated to a word or words at the host, changes in the word or words are continually reflected in the graph.

- Bar graphs Page 362
- Analog meter Page 367
- Broken line graphs Page 375
- Trend graphs Page 381

7-10-1 Bar Graphs

[Function Outline]

The contents of a numeral memory table are displayed in the form of a bar graph. The numeric value can also be indicated as a percentage of the designated numeric value.

60%



[Restrictions]

- A maximum of 50 bar graphs can be registered for one screen. (Same for window screen.) For an overlapping screen comprising 8 child screens, the maximum is 400.

There is no restriction on the number of bar graphs that can be registered for one screen data file: any number can be registered as long as the data file capacity is not exceeded. However, if a large number of elements are registered, check that the restrictions on element display are complied with by referring to "Display Restrictions" (page 635).

- Bar graphs cannot be specified indirectly using a numeral memory table. They must be specified by direct reference.

[Common Attributes]

The relationship between the properties of a bar graph and the display results is indicated below.

• Properties

General	
Position	Coordinates of the top left corner of the bar graph area.
Size	Width and height of the area in which the bar graph is displayed (dot units) Width: 2 to 640 Height: 2 to 480
Frame	Whether or not a frame is displayed for the graph area Check mark (frame displayed)/ No check mark (frame not displayed)
Display Sign	Whether or not a negative area is displayed. Check mark (displayed)/No check mark (not displayed)
Direction	Direction in which the bar graph extends ("Incremental Direction of Bar Graphs", page 365) Up/Down/Left/Right
Color	
Frame	Display color of the frame (colors other than black and white featured with NT631C only) Black/Blue/Red/Magenta/Green/Cyan/Yellow/White
+ Range	Display color of the positive range (colors other than black and white featured with NT631C only) Black/Blue/Red/Magenta/Green/Cyan/Yellow/White
- Range	Display color of the negative range (colors other than black and white featured with NT631C only) (effective only when a check mark is set for "Display Sign") Black/Blue/Red/Magenta/Green/Cyan/Yellow/White
Settings	
Value	
Table Entry	Number of numeral memory table whose contents are to be displayed.
Display %	Presence/absence of a percentage indication of the contents of the numeral memory table ("Method for calculating the percentage value", page 365) Check mark (percentage displayed)/ No check mark (no percentage display) For details on the "Display %" property, refer to 7-4-2 "Text (Fixed Display)" (page 304).*2
100%*1 (Specify 100% value using either of "Table Entry" or "Value".)	
Table Entry	Numeral memory table number checked to find the 100% value for percentage calculations · Designate the number of the numeral memory table that stores the 100% value. Range: 0 to 1999
Value	Checked to find the 100% value for percentage calculations · Designate the 100% value (default: 100) Range: -2147483648 to 2147483647

- Reference**
- It is not possible to specify a character attribute and transparent background for a percentage display.
 - It is possible to specify a double width font type for a percentage display.

Settings	
0%*1 (Specify 0% value using either of "Table Entry" or "Value".)	
Table Entry	Numeral memory table number checked to find the 0% value for percentage calculations · Designate the number of the numeral memory table that stores the 0% value. Range: 0 to 1999
Value	Checked to find the 0% value for percentage calculations · Designate the 0% value (default: 0) Range: -2147483648 to 2147483647
-100%*1 (Specify -100% value using either of "Table Entry" or "Value".)	
Table Entry	Numeral memory table number checked to find the -100% value for percentage calculations · Designate the number of the numeral memory table that stores the -100% value. Range: 0 to 1999
Value	Checked to find the -100% value for percentage calculations · Designate the -100% value (default: -100) Range: -2147483648 to 2147483647

*1 The -100% value, 0% value, and 100% value must comply with the following relationship:

$$-100\% < 0\% \text{ value} < 100\% \text{ value}$$

Either "Table Entry" or "Value" should be set for each value, not both. The choice of "Table Entry" or "Value" setting can be made independently for each value.

*2 It is not possible to specify a character attribute or background color for a percentage display.

• Resulting display

<When no check mark is set for "Display Sign">

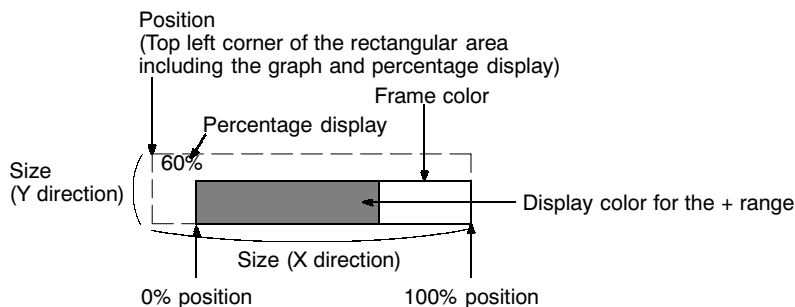

<When a check mark is set for "Display Sign">

In this case, the center of the graph is always the 0% position, regardless of the settings made for "100%", "0%", and "-100%".

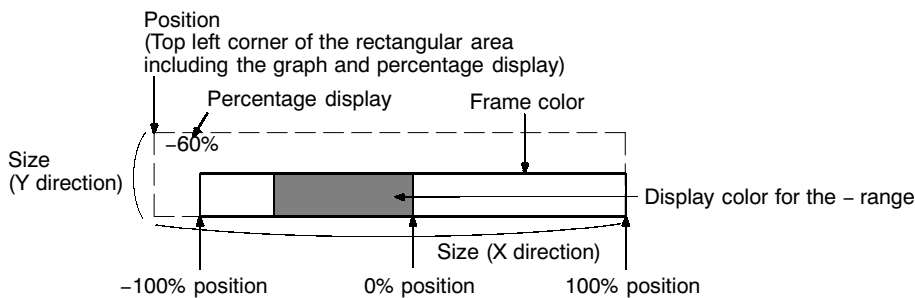

- Incremental direction of bar graphs

The incremental directions of the bar graph depending on the setting made for “Direction” are shown below (applies only when no check mark is set for “Display Sign”).

“Up”:
The bar graph increments upward.



“Down”:
The bar graph increments downward.



“Left”:
The bar graph increments to the left.

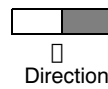

“Right”:
The bar graph increments to the right.

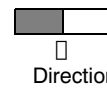

- Method for calculating the percentage value

The percentage value is calculated as follows, depending on whether it is larger or smaller than the “0%” value.

- When displayed numeric value \geq “0%”, and when no check mark is set for “Display Sign”:

$$\text{Percentage value} = \frac{\text{Displayed numeric value} - [0\%]}{[100\%] - [0\%]} \times 100$$

- When displayed numeric value $<$ “0%”:

$$\text{Percentage value} = \frac{\text{Displayed numeric value} - [0\%]}{[0\%] - [-100\%]} \times 100$$

- Differences in the bar graph display method according to the percentage value
The bar graph display method varies according to the percentage value range.

(1) When the percentage value is in the minus range

The display varies as follows according to the “Display Sign” setting.

- No check mark: The bar graph is displayed as 0% (“Display %” is shown in negative value.)
- Check mark: Displayed in the minus range

(2) When the absolute value of the percentage value is in the range of 100% to 999%

The percentage value is displayed as it is. The bar graph is displayed as follows according to the “Display Sign” setting.

- No check mark:
Display depends on the setting for “Frame”:

<When a frame is set>

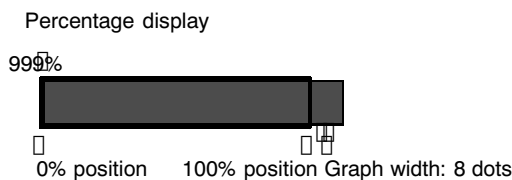

<When no frame is set>

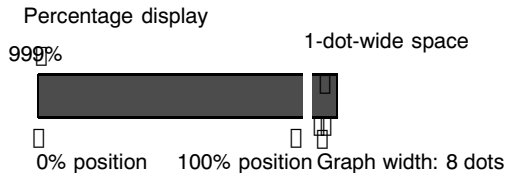

- Check mark:
The display follows the same pattern as when no check mark is set in the negative range of the graph.

(3) When the absolute value of the percentage value is greater than 1000%

The graph is displayed in the same way as described in (2) above.

The percentage value is displayed as follows according to the setting for “Display Sign”:

- No check mark: “****%”
- Check mark: “****%”

[Display Functions]

Bar graphs indicate numeric values in accordance with the “General” settings. For details on the method of display depending on the “General” settings, refer to “Common Attributes” (page 363).

[Input Functions]

Bar graphs have no input function.

[Output Functions]

Bar graphs have no output function.

[Processing Functions]

Bar graphs calculate the percentage value in accordance with the settings made for "Settings".

For details on the calculation method depending on the "Settings" settings, refer to "Common Attributes" (page 363).

[Relationship with Other Elements]

- For details on how numeric values are stored in numeral memory tables, refer to 7-3-1 "Numeral Memory Tables" (page 278).
- Bar graphs overlap with other elements in accordance with the order in which they were registered for the screen with the Support Tool. However, the way in which they overlap can be changed with the Support Tool.

7-10-2 Analogue Meter

[Function Outline]

The contents of a numeral memory table or host words are displayed in the form of a circle-shaped analogue meter.

The numeric value can also be indicated as a percentage of the designated numeric value. Also, scale display is possible.

**[Restrictions]**

- A maximum of 50 analogue meters can be registered for one screen. (same for window screen) For an overlapping screen comprising 8 child screens, the maximum is 400.
There is no restriction on the number of analogue meters that can be registered for one screen data file: any number can be registered as long as the data file capacity is not exceeded. However, if a large number of elements are registered, check that the restrictions on element display are complied with by referring to "Display Restrictions" (Page 635)
- Analogue meters can not be specified indirectly using a numeral memory table. They must be specified by direct reference.

[Common Attributes]

The relationship between the properties of an analogue meter and the display results is indicated below.

- Property

General	
Position	Coordinates of the top left corner of the analogue meter area. Coordinate of the center position of the meter part of an analogue meter.
Size	Radius 10 □ 320
Frame	Whether or not a frame is displayed for the graph area. Check mark (frame displayed)/ No check mark (frame not displayed)
	Display color of the frame (colors other than black and white featured with NT631C only) Black/Blue/Red/Magenta/Green/Cyan/Yellow/White
Display Sign	Whether or not a negative area is displayed. Check mark (displayed)/ No check mark (not displayed)
Direction	Direction in which the value extends ("Incremental direction of analogue meters", page371) Clock-wise/Anti-Clockwise
Shape	Quarter/Semi-Circle/Circle
Direction	Direction in which the analogue meter extends from 0% position □ / □ / □ / □
Type	Display method of the area between present value and 0% value. Needle/Fill
Width Rate	Meter width 10 □ 100% (regarding the radius as 100%)
Scale Display	
Scale	Whether or not a scale is displayed Check mark (scale displayed)/ No check mark (scale not displayed)
Distance	Position of the scale 0 □ 150% (regarding the radius as 100%) 100%=On circumference of the meter part
Scale Length	Scale length 10 □ 110% (regarding the radius as 100%) 100%=Same length as the radius of the meter part
No. of Division	Number of the division which the scale should be divided 1 □ 20
Scale Colour	Scale color (colors other than black and white featured with NT631C only) Black/Blue/Red/Magenta/Green/Cyan/Yellow/White

Meter Colour	
Foreground	Foreground color for the present value (needle or fill) of the meter part (colors other than black and white featured with NT631C only) Black/Blue/Red Magenta/Green/Cyan/Yellow/White
Background	Background color of the analogue meter (colors other than black and white featured with NT631C only) Black/Blue/Red/Magenta/Green/Cyan/Yellow/White
+Range	Display color for the positive range (colors other than black and white featured with NT631C only) Black/Blue/Red/Magenta/Green/Cyan/Yellow/White
-Range	Display color for the negative range (colors other than black and white featured with NT631C only) (effective only when a check mark is set for "Display Sign") Black/Blue/Red/Magenta/Green/Cyan/Yellow/White
Settings	
Value	
Table Entry	Number of numeral memory table whose contents are to be displayed.
Display %	Presence/absence of a percentage indication of the contents of the numeral memory table ("Method for calculating the percentage value", page372) Check mark (percentage displayed)/ No check mark (no percentage displayed) For details on the "Display %" property, refer to 7-4-2 "Text (Fixed Display)" (page 304)
100% *1 (Specify 100% value using either of "Table Entry" or "Value".)	
Table Entry	Numeral memory table number check to find the 100% value for percentage calculation <input type="checkbox"/> Designate the number of the numeral memory table that stores the 100% value. <input type="checkbox"/> Range: 0 <input type="checkbox"/> 1999
Value	Check to find the 100% value for percentage calculation <input type="checkbox"/> Designate the 100% value (default: 100) <input type="checkbox"/> Range: -2147483648 <input type="checkbox"/> 2147483647
0% *1 (Specify 0% value using either of "Table Entry" or "Value".)	
Table Entry	Numeral memory table number check to find the 0% value for percentage calculation <input type="checkbox"/> Designate the number of the numeral memory table that stores the 0% value. <input type="checkbox"/> Range: 0 <input type="checkbox"/> 1999
Value	Check to find the 0% value for percentage calculation <input type="checkbox"/> Designate the 0% value (default: 0) <input type="checkbox"/> Range: -2147483648 <input type="checkbox"/> 2147483647
-100% *1 (Specify -100% value using either of "Table Entry" or "Value".)	

	Table Entry	Numeral memory table number check to find the -100% value for percentage calculation <input type="checkbox"/> Designate the number of the numeral memory table that stores the -100% value. <input type="checkbox"/> Range: 0 <input type="checkbox"/> 1999
	Value	Check to find the -100% value for percentage calculation <input type="checkbox"/> Designate the -100% value (default: -100) <input type="checkbox"/> Range: -2147483648 <input type="checkbox"/> 2147483647

*1 The -100% value, 0% value, and 100% value must comply with the following relationship: -100% value < 0% value < 100% value

Even if the specified value was in an allowable range, it is discarded when an analogue meter sticks out of the screen with the specified value.

- Reference**
- It is not possible to specify a character attribute and transparent background for a percentage display.
 - It is possible to specify a double width font type for a percentage display.
 - Resulting display
 - <Example> Resulting display of quarter shape analogue meter
 - <When no check mark is set for “Display Sign”>

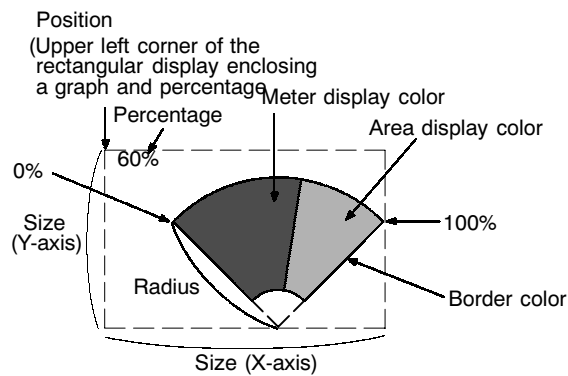

<When a check mark is set for “Display Sign”>

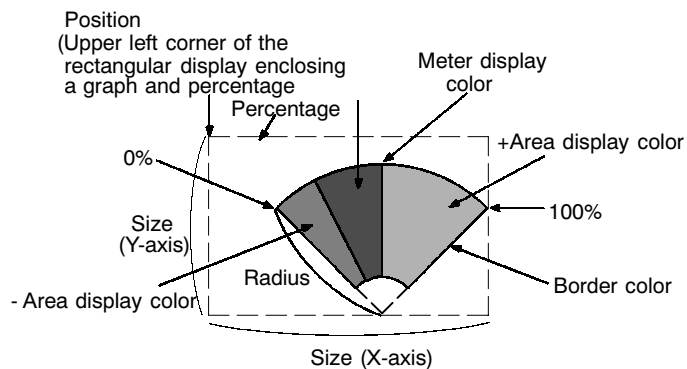

- Incremental direction of analogue meters

The incremental directions of the analogue meter depending on the setting made for “Meter Shape”, “Display Direction” and “Meter Direction” are shown below.

	<input type="checkbox"/>	<input type="checkbox"/>	<input type="checkbox"/>	<input type="checkbox"/>
Circle				
Semi-Circle				
Quarter				

0% position

0% position is determined by meter direction. It is not influenced by display direction.

With a display sign: 0% position comes at the center of the meter.

(Dotted line position in the figure)

No display sign (positive value only):

Clockwise = 0% position comes at the left side of the meter.

Anti-Clockwise = 0% position comes at the right side of the meter.

(Bold line position in the figure)

With a display sign: 0% position comes at the center of the meter

(Dotted line position in the figure)

No display sign (positive value only):

Clockwise = 0% position comes at the left side of the meter

Anti-Clockwise = 0% position comes at the right side of the meter

(Bold line position in the figure)

• Method for calculating the percentage value

The percentage is calculated as follows, depending on whether it is larger or smaller than the "0%" value.

When displayed numeric value \geq "0%", and when no check mark is set for "Display Sign":

$$\text{Percentage value} = \frac{\text{Displayed numeric value} - [0\%]}{[100\%] - [0\%]} \times 100$$

When displayed numeric value < "0%":

$$\text{Percentage value} = \frac{\text{Displayed numeric value} - [0\%]}{[0\%] - [-100\%]} \times 100$$

• Display Sign

Circle

When "Display Sign" is ON, center position of the meter (It depends on "Display Sign") will be 0%, and the each end side corresponds to 100% and -100%.

- When the value is more than 100%, it will be displayed same as 100%.

- When the value is less than -100%, it will be displayed same as -100%.

When "Display Sign" is OFF, 0% position and 100% position will be the same.

- When the value is less than 0%, it will be displayed same as 0%.

- When the value is more than 100%, it will be displayed same as 100%.

Overflow display is not performed for both cases.

Semi-Circle, Quarter

When "Display Sign" is ON, center position of the meter will be 0% and the each end side corresponds to 100% and -100%.

When "Display Sign" is OFF, from end to end of the meter correspond to 0% □ 100%.

For both cases, "Needle" or "Fill" is displayed outside of the meter to indicate that the value is outside the range (overflow display) when the value is more than 100% or less than -100%. In this case, frame position will not be tiled with "Fill" type. Therefore, when "Frame" is OFF, there will be a 1 dot interval when showing the overflow display.

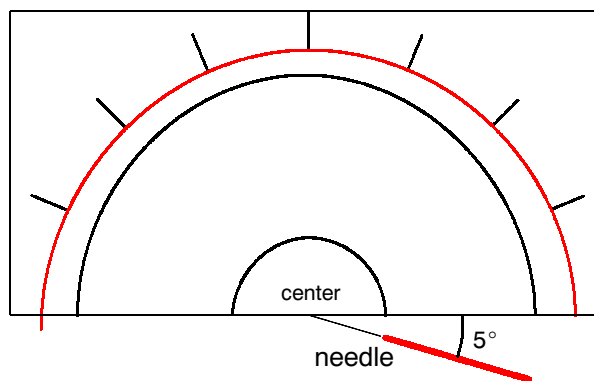

- Display method of the area between the present value and the 0% value

Present value of an analogue meter is displayed using needle or fill as a display type. If you specify needle, the present value is showed as a needle, if you specify fill, the area between 0% and the present value will be tiled in selected foreground color.

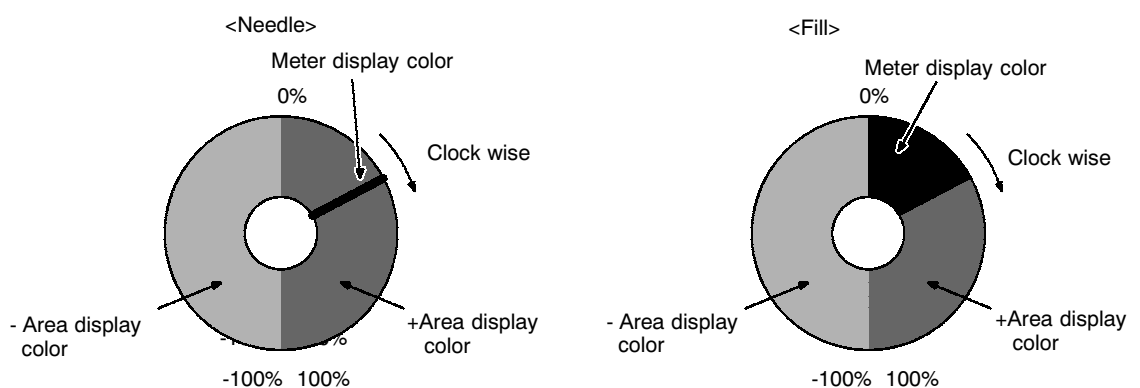

- Donut-shaped analogue meter (Width Rate)

Specify the meter width of an analogue meter in % format (0% □ 100%) regarding the radius as 100%. If you specify the value which is less than 100%, a donut-shaped analogue meter will be drawn.

Default value for width rate is set to 100%. With default status, therefore, donut-shaped analogue meter will not be drawn since there will be no inner circle.

• Scale Distance and Scale Length

Specify the scale position and scale length in % format regarding the radius as 100%.

Scale distance (0% - 150%) :

Specify the distance from the center of an analogue meter in % format regarding the radius as 100%.

- 0% None (Scale appears from center point of an analogue meter)
- 50% Scale appears inside the analogue meter.
- 100% Scale appears on circumference of an analogue meter.
- 110% Scale appears 10% outside the circumference of an analogue meter.

Scale length (10% - 110%) :

Specify the length from the scale position in % format regarding the radius as 100%.

No. of Division : Specify the number of the division which the scale should be divided for the range from 0 to 100%.

Since it specifies the number of division which the scale should be divided, "No. of Division" +1 scale lines are drawn.

Also, when "Display Sign" is ON, the same number of scale lines are drawn both for -100% - 0% and 0% - 100% range. Therefore, for -100% - 100% range, designated No. of division + 2 is applied.

Example) No. of Division =

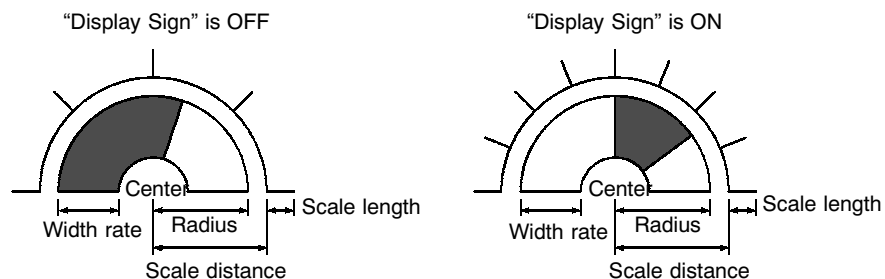

[Display Functions]

Analogue meters indicate numeric values in accordance with the "General" settings. For details on the method of display depending on the "General" settings, refer to "Common Attributes" (page 376).

[Input Functions]

Analogue meters have no input functions.

[Output Functions]

Analogue meters have no output functions.

7-10-3 Broken Line Graphs

[Function Outline]

Broken line graphs represent the contents of multiple consecutive numeral memory tables as one broken line. They enable the values of consecutive numeral memory tables to be taken in at a glance.

It is possible to display more than one broken line graph in the same frame so that they can be compared.

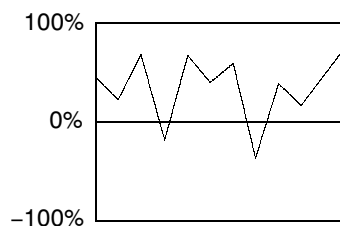

In this example, the values in 11 numeral memory tables are displayed with the sign indicated.

With broken line graphs, a 100% value, 0% value and -100% value can be set for each broken line in order to calculate and display the numeral memory table values in percentage terms. However, there are no percentage displays for individual numeral memory tables.

[Restrictions]

- One broken line graph frame can be registered for one screen. (Same for window screen.) For an overlapping screen comprising 8 child screens, up to 8 broken line graph frames can be displayed on one screen. Total maximum of 256 broken lines can be registered for one screen regardless of the number of frames. (Same for window screen.)

There is no restriction on the number of broken line graph frames that can be registered for one screen data file: any number can be registered as long as the data file capacity is not exceeded. However, if a large number of elements are registered, check that the restrictions on element display are complied with by referring to "Display Restrictions" (page 635).

- The contents of up to 512 consecutive numeral memory tables can be displayed in one broken line.
- Broken line graphs cannot be specified indirectly using a numeral memory table. They must be specified by direct reference.

Settings (properties of each broken line)	
100%*2 (Specify 100% value using either of "Table Entry" or "Value".)	
Table Entry	Numeral memory table number checked to find the 100% value for percentage calculations · Designate the number of the numeral memory table that stores the 100% value. Range: 0 to 1999
Value	Checked to find the 100% value for percentage calculations · Designate the 100% value (default: 100) Range: -2147483648 to 2147483647
0%*2 (Specify 0% value using either of "Table Entry" or "Value".)	
Table Entry	Numeral memory table number checked to find the 0% value for percentage calculations · Designate the number of the numeral memory table that stores the 0% value. Range: 0 to 1999
Value	Checked to find the 0% value for percentage calculations · Designate the 0% value (default: 0) Range: -2147483648 to 2147483647
-100%*2 (Specify -100% value using either of "Table Entry" or "Value".)	
Table Entry	Numeral memory table number checked to find the -100% value for percentage calculations · Designate the number of the numeral memory table that stores the -100% value. Range: 0 to 1999
Value	Checked to find the -100% value for percentage calculations · Designate the -100% value (default: -100) Range: -2147483648 to 2147483647

*1 When making the setting, ensure that the total of the Start Table Entry and No. of Points does not exceed the maximum table entry.

*2 The -100% value, 0% value, and 100% value must comply with the following relationship:

$$-100\% \text{ value} < 0\% \text{ value} < 100\% \text{ value}$$

Note that either "Table Entry" or "Value" should be set for each value, not both. The choice of "Table Entry" or "Value" setting can be made independently for each value.

The line thickness for broken line graphs is fixed as 1 dot.

Reference

If a small value is set for "Interval Type", even if "broken line", "1-dot chain line", or "2-dot chain line" is specified the line will appear to be a solid line.

- Resulting display

<When no check mark is set for "Display Sign">

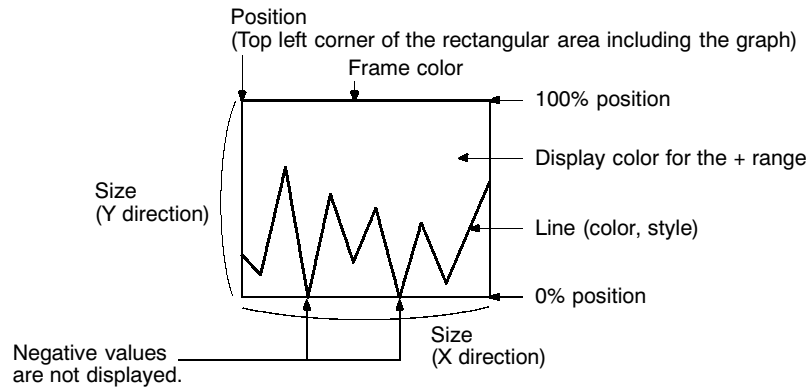

<When a check mark is set for "Display Sign">

In this case, the center of the graph is always the 0% position, regardless of the settings made for "100%", "0%", and "-100%".

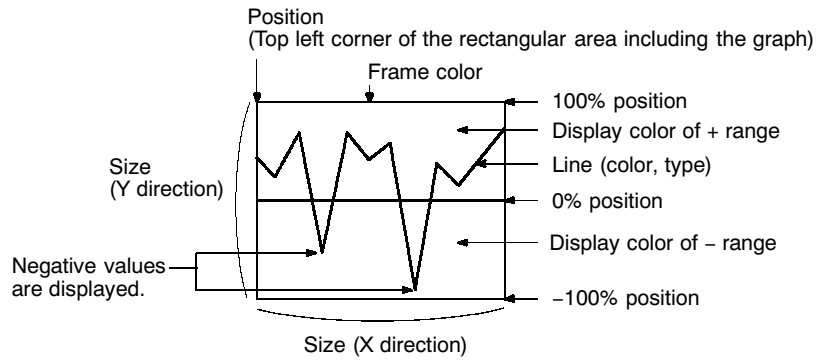

- Direction of broken line graphs

The directions of broken line graphs depending on the setting made for “Direction” are shown below. The “direction” of a broken line graph means the direction in which the values in numeral memory tables are plotted, starting from the numeral memory table with the smallest table number and proceeding through progressively larger table numbers.

The 100% value is at the top of the frame when the “Direction” is a lateral one and the right of the frame when the “Direction” is a longitudinal one.

“Up”
Graph that is drawn from bottom to top

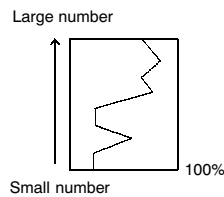

“Down”
Graph that is drawn from top to bottom

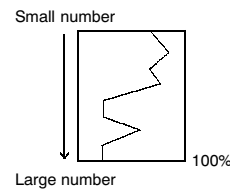

“Left”
Graph that is drawn from right to left

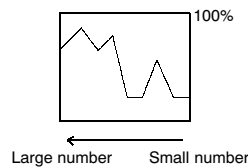

“Right”
Graph that is drawn from left to right

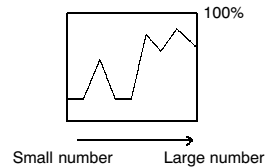

- Number of vertices

The maximum number of vertices (numeral memory tables) that can be displayed in one broken line is 512, but since a minimum interval of 1 dot is actually required between memory tables, the following restriction applies depending on the width (number of dots) of the graph frame.

$$\text{Width of graph frame (number of dots)} \geq \text{“No. of Points”}$$

- Interval between numeral memory tables

The display interval between memory tables can be set individually for each memory table. Adjust the intervals as required.

When “Even” is set for the “Interval Type”, the intervals are arranged evenly so as to make use of the entire width of graph area.

Example: Broken line graph where the interval changes

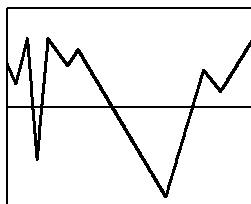

- Method for calculating the percentage value

The percentage value is calculated as follows, depending on whether it is larger or smaller than the “0%” value.

However, note that although each vertex of the broken line graph is displayed based on this value, individual percentage values are not displayed.

- When displayed numeric value \geq “0%”, and when no check mark is set for “Display Sign”:

$$\text{Percentage value} = \frac{\text{Displayed numeric value} - [0\%]}{[100\%] - [0\%]} \times 100$$

- When displayed numeric value $<$ “0%”:

$$\text{Percentage value} = \frac{\text{Displayed numeric value} - [0\%]}{[0\%] - [-100\%]} \times 100$$

- Differences in the broken line graph display method according to the percentage value

The broken line graph display method varies according to the percentage value range.

- (1) When the percentage value is in the minus range

The display varies as follows according to the “Display Sign” setting.

- No check mark: Displayed as 0%.
- Check mark: The graph is displayed in the minus range.

- (2) When the absolute value of the percentage value exceeds 100%

If the percentage value exceeds 100%, or breaks through -100% and protrudes out of the graph area, only the parts of the lines within the graph area are displayed.

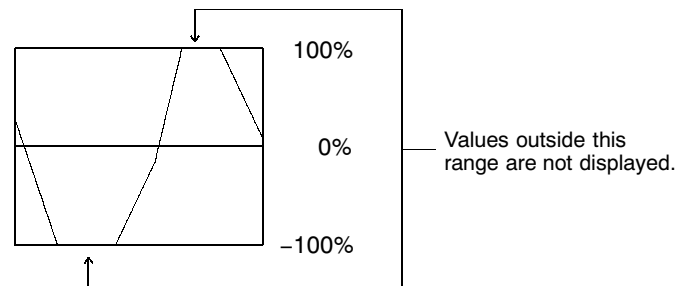

[Display Functions]

For broken line graphs, the graph area is displayed in accordance with the “General” settings, and the broken line is displayed in accordance with the “Settings” (line attribute) settings.

For details on the method of display depending on the “General” and “Settings” settings, refer to “Common Attributes” (page 376).

- When multiple broken lines are registered, they overwrite each other in the order they were registered. When broken lines overlay each other they are displayed according to the XOR principle (page 255), and consequently the line style and color may differ from those specified. The same principle applies when a broken line overlays the graph frame.

[Input Functions]

Broken line graphs have no input function.

[Output Functions]

Broken line graphs have no output function.

[Processing Functions]

Broken line graphs calculate the percentage value in accordance with the settings made for "Settings" (properties of each broken line).

For details on the calculation method depending on the "Settings" (properties of each broken line) settings, refer to "Common Attributes" (page 376).

[Relationship with Other Elements]

- For details on how numeric values are stored in numeral memory tables, refer to 7-3-1 "Numeral Memory Tables" (page 278).
- Broken line graphs overlap with other elements in accordance with the order in which they were registered for the screen with the Support Tool. However, the way in which they overlap can be changed with the Support Tool.

7-10-4 Trend Graphs

[Function Outline]

Trend graphs represent the changes over time in the contents of a numeral memory table as one line.

It is possible to display more than one such line in the same frame so that they can be compared.

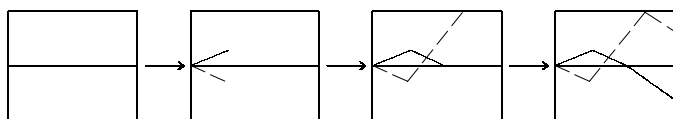

There are two types of trend graph: the standard type, where the graph is drawn as though a pen were moving across paper, and the "pen recording type", where the graph is drawn as though the paper were moving under a pen.

With trend graphs, a 100% value, 0% value and -100% value can be set for each line in order to calculate and display the numeral memory table values in percentage terms. The current percentage can be displayed.

Past values can be recorded, and then displayed by back tracking (the "logging function"), and the contents of numeral memory tables can be collected even while other screens are displayed (the "background function").

[Restrictions]

- One trend graph frame can be registered for one screen. (Same for window screen.) For an overlapping screen comprising 8 child screens, up to 8 trend graph frames can be registered on each screen. Total maximum of 50 broken lines can be registered on each screen. Total maximum of 50 broken lines can be registered for one screen regardless of the number of frames. (Same for window screen.)

There is no restriction on the number of trend graph frames that can be registered for one screen data file: any number can be registered as long as the data file capacity is not exceeded. However, if a large number of elements are registered, check that the restrictions on element display are complied with by referring to "Display Restrictions" (page 635).

In the case of trend graphs comprising past values recorded with the logging function, up to eight broken lines can be registered for one screen.

- Trend graphs cannot be specified indirectly using a numeral memory table. They must be specified by direct reference.
- If the set sampling cycle is shorter than the time taken for display update processing, sampling results that cannot be processed in time are skipped and the data will not be displayed correctly.

Example: The data indicated by × marks in the graph on left cannot be processed in time for screen updating, and is skipped; therefore only the data indicated by ○ is displayed and the result is as shown in the graph on the right.

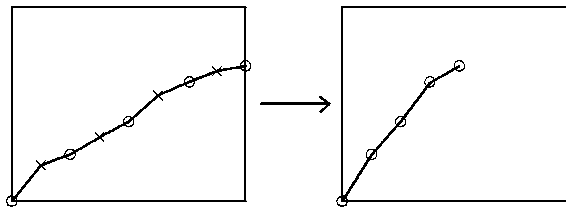

[Common Attributes]

The relationship between the properties of a trend graph and the display results is indicated below.

- Properties

General	
Position	Coordinates of the top left corner of the graph area.
Size	Width and height of the area in which the trend graph is displayed (dot units) Width: 2 to 640 Height: 2 to 480
Display	
Type	Method for drawing the line ("Line drawing method", page 388) Standard/Pen Reco
Drawing Width	Interval between consecutive data on the drawn graph in dot units ("Drawing width", page 387)
Frame	Whether or not a frame is displayed for the graph area Check mark (frame displayed)/ No check mark (frame not displayed)
Display Sign	Whether or not a negative area is displayed. Check mark (displayed)/No check mark (not displayed)
Direction	Direction of motion of the graph ("Line drawing method", page 388) Up/down/left/right · For standard type: Direction of motion from the latest drawing position · For pen recording type: Direction of motion of the line as a whole
Sampling Cycle	Cycle (time interval) for data reading (graph updating) Range: 0.5 to 6553.5 in 0.5 second units (5 to 65535 (× 0.1) for entry; must be a multiple of 5)

Settings (properties of each line)	
0%*1 (Specify 0% value using either of "Table Entry" or "Value".)	
Table Entry	Numeral memory table number checked to find the 0% value for percentage calculations (effective only when a check mark is set for "Display %") · Designate the number of the numeral memory table that stores the 0% value. Range: 0 to 1999
Value	Checked to find the 0% value for percentage calculations (effective only when a check mark is set for "Display %") · Designate the 0% value (default: 0) Range: -2147483648 to 2147483647
-100%*1 (Specify -100% value using either of "Table Entry" or "Value".)	
Table Entry	Numeral memory table number checked to find the -100% value for percentage calculations (effective only when a check mark is set for "Display %") · Designate the number of the numeral memory table that stores the -100% value. Range: 0 to 1999
Value	Checked to find the -100% value for percentage calculations (effective only when a check mark is set for "Display %") · Designate the -100% value (default: -100) Range: -2147483648 to 2147483647
Logging	
Data Logging	
	Whether or not the logging function is used ("Data logging function and background function", page 390) Check mark (logging function used)/ No check mark (logging function not used)
Background*2	Whether or not the background function is used ("Data logging function and background function", page 390) Check mark (background function used)/ No check mark (background function not used)
Forward*2	Presence/absence of a touch switch to proceed to the next page Check mark (touch switch set)/ No check mark (touch switch not set)
Rewind*2	Presence/absence of a touch switch to return to the previous page Check mark (touch switch set)/ No check mark (touch switch not set)
Clear Log*2	Presence/absence of a touch switch to clear the logging data Check mark (touch switch set)/ No check mark (touch switch not set)

Logging	
Touch Switches for Display Function	
Stop	Presence/absence of a touch switch to stop data sampling Check mark (touch switch set)/ No check mark (touch switch not set)
Clear Display	Presence/absence of a touch switch to clear the trend graph display Check mark (touch switch set)/ No check mark (touch switch not set)
Continue	Presence/absence of a touch switch to restart data sampling Check mark (touch switch set)/ No check mark (touch switch not set)

*1 The -100% value, 0% value, and 100% value must comply with the following relationship:

$$-100\% \text{ value} < 0\% \text{ value} < 100\% \text{ value}$$

Either "Table Entry" or "Value" should be set for each value, not both. The choice of "Table Entry" or "Value" setting can be made independently for each value.

*2 These settings are effective only when the logging function is used.

The line thickness for trend graphs is fixed as 1 dot.

Reference

- If a small value is set for "Interval Type", even if "broken line", "1-dot chain line", or "2-dot chain line" is specified the line will appear to be a solid line.
- In the case of a standard trend graph which determines the "100%", "0%" and "-100%" values according to the "Table Entry" settings, if the contents of the referenced numeral memory tables change, the graph becomes discontinuous.

Example:

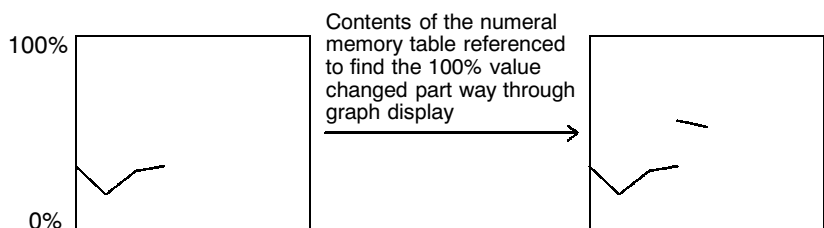

- Display elements of trend graph

A trend graph consists of three display elements. Except for the graph area, it is possible to choose whether or not the element is displayed.

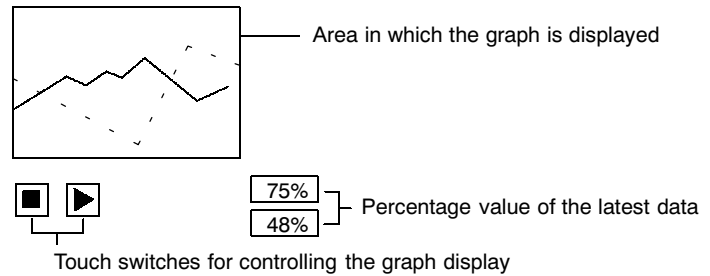

<Graph area>

The display method is determined by the setting made for the “General” properties of the trend graph.

<Percentage value>

This is displayed when a check mark is set for “Display %” in the “Settings” (properties of each line) settings.

The display method is determined by the “Display %” property. The position, size and color can be chosen as desired. “Standard” must always be set for “Display Attribute”.

<Touch switch>

Whether or not the touch switches are displayed can be determined by the setting made for “Touch Switch of Display Function”. The touch switch position can be changed; the size and the color cannot.

- Resulting display

<When no check mark is set for "Display Sign">

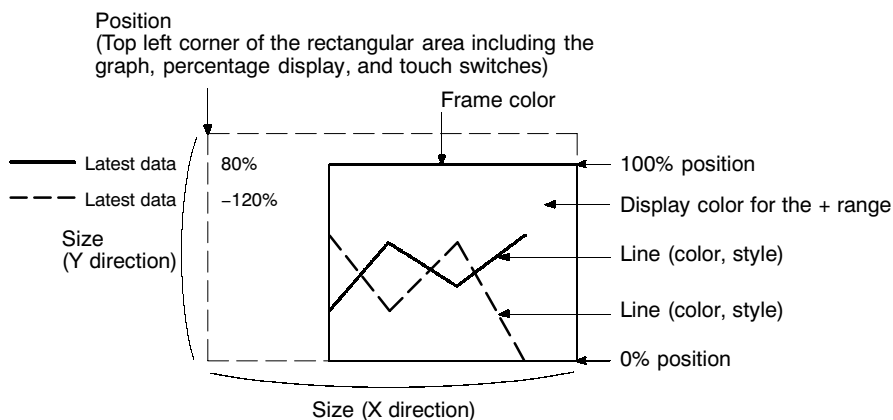

<When a check mark is set for "Display Sign">

In this case, the center of the graph is always the 0% position, regardless of the settings made for "100%", "0%", and "-100%".

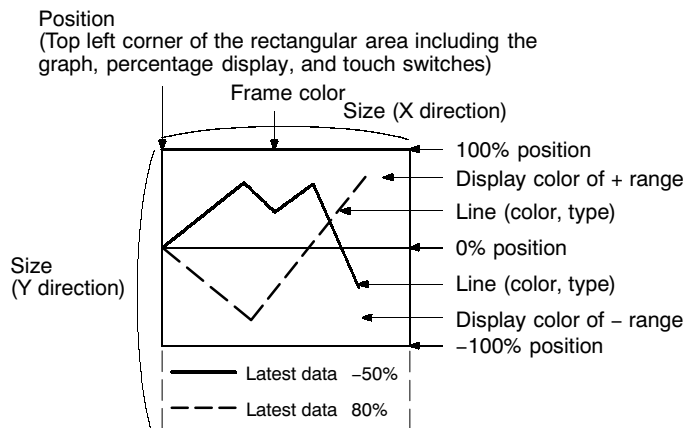

- Drawing width

The drawing width is the interval at which successive data are drawn in the direction of motion. If a value outside the display area of the graph is specified, the graph will not be displayed.

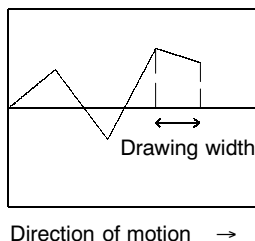

- Line drawing method

The graph is drawn as shown below depending on the settings made for “Type” and “Direction”.

The 100% value is at the top of the frame when the “Direction” is a lateral one and the right of the frame when the “Direction” is a longitudinal one.

<When “Standard” is set for “Type”>

With the standard type, the latest drawing position moves in the direction of motion specified by “Direction” with the passage of time. If the direction of motion is “right”, the display changes as indicated below. When the line reaches the edge of the graph area, the line is cleared and then displayed again from the beginning.

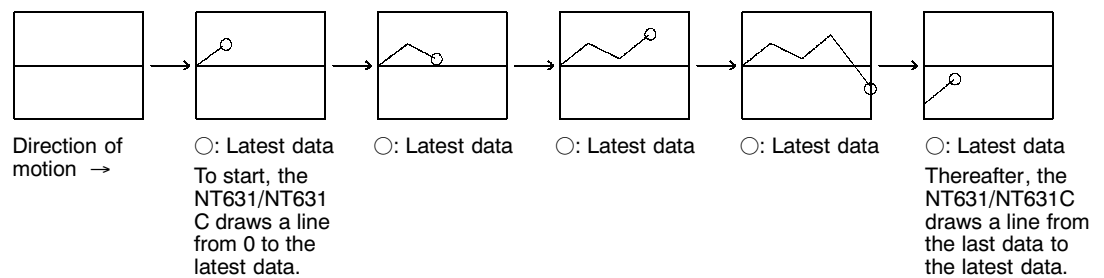

The drawing results with each “Direction” setting are indicated below.

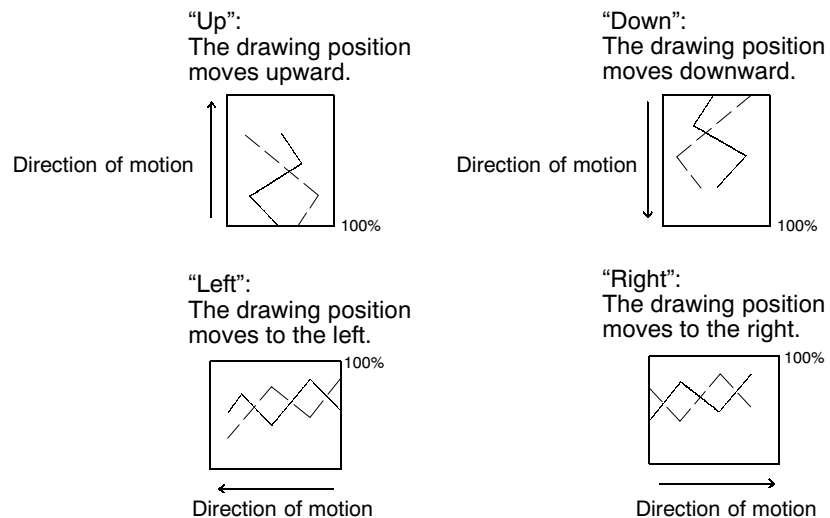

<When "Pen Reco" is set for "Type">

With the pen recorder type, the latest drawing position is always displayed at the edge of the graph area. As time passes, the part of the graph which is already displayed moves in the direction specified by "Direction" (as if paper were moving underneath a pen). When the direction of motion is "right", the display changes in the manner shown below. When the line reaches the edge of the graph area, the data is cleared from the oldest first.

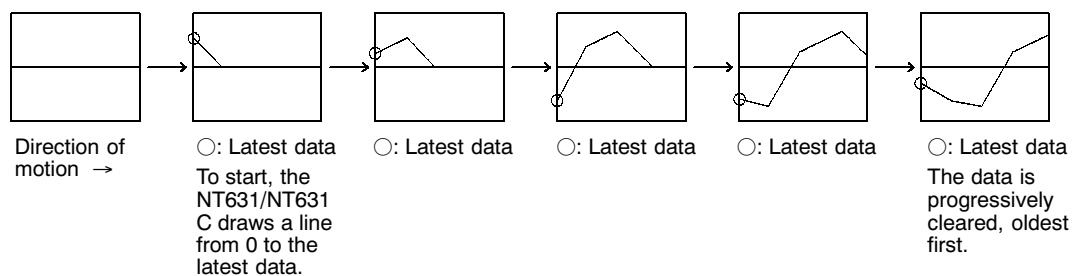

The drawing results with each "Direction" setting are indicated below.

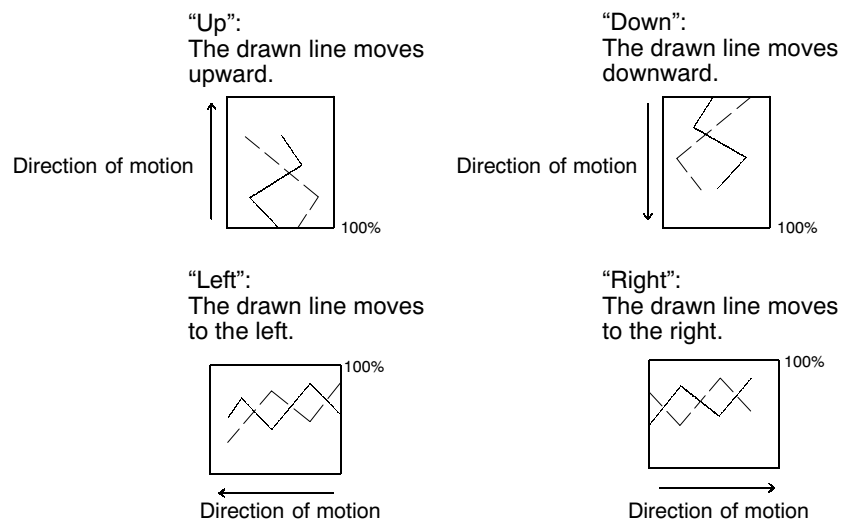

- Method for calculating the percentage value

The percentage value is calculated as follows, depending on whether it is larger or smaller than the "0%" value.

- When displayed numeric value \geq "0%", or when a check mark is set for "Display Sign":

$$\text{Percentage value} = \frac{\text{Displayed numeric value} - [0\%]}{[100\%] - [0\%]} \times 100$$

- When displayed numeric value $<$ "0%":

$$\text{Percentage value} = \frac{\text{Displayed numeric value} - [0\%]}{[0\%] - [-100\%]} \times 100$$

- Differences in trend graph display method according to percentage values

The display method of a trend graph differs according to the percentage value range.

- (1) When the percentage value is negative

The following happens, depending on the setting for “Display Sign”:

- No check mark: The graph line is displayed as 0% (“Display %” is shown in negative value).
- Check mark: Displayed in the minus range

- (2) When the absolute value of the percentage value is in the range of 100% to 999%

If the percentage value enters the range 100 to 999% or –100 to –999%, and the line projects out of the graph area, only the part of the line inside the graph area is displayed.

If a check mark is set for “Display %”, the calculated percentage value is displayed.

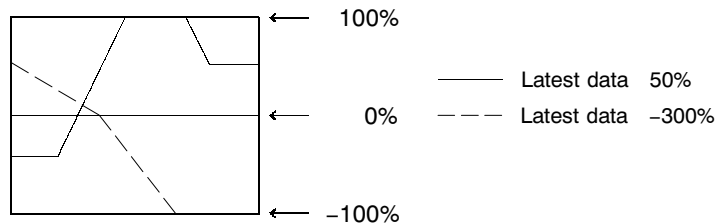

- (3) When the absolute value of the percentage value is greater than 1000%

If the percentage value exceeds 1000% or enters the range below –1000% and the line projects out of the graph area, only the part of the line inside the graph area is displayed, as in (2) above.

If a check mark is set for “Display %”, the percentage value is displayed as follows.

- “****%”

- Data logging function and background function

The data logging function is a function for recording (logging) the displayed values internally.

Normally, the data sampled for a trend graph is not recorded internally, but by using the data logging function it is possible to back track and display past data.

With the NT631/NT631C, the data logging function can be used for the data of up to 8 lines. The maximum data quantity that can be recorded for each is 1440 points, and when this limit is exceeded the data is deleted from the oldest points.

If the “Clear Log” touch switch has been set, the data can be cleared at any time.

The background function allows data to be sampled even while the trend graph is not displayed.

Usually, with trend graphs, data is only sampled while the graph is displayed and sampling is stopped when the screen is switched. By using the background function, sampling can be carried out even while the trend graph is not being displayed. The recorded data is displayed by back tracking when the trend graph is displayed.

The background function can only be used in conjunction with the data logging function, and the only data recorded is that for the data logging function. However, since sampling continues while the background function is being used, the processing of the NT631/NT631C may be delayed.

Reference

The retention of data by the data logging function remains effective until any of the following operations is performed.

- The power to the NT631/NT631C is turned OFF.
- The NT631/NT631C is reset.
- All the screen data is transmitted.
- Data is transmitted in screen units.

When operation is stopped, for example by displaying the System Menu, sampling is also stopped even if the background function is being used; it is restarted when operation is restarted (the data is retained and recording starts from the data following the last data).

Data is recorded as described below depending on whether or not the data logging function and background function are used.

<When neither the data logging function or background function is used>

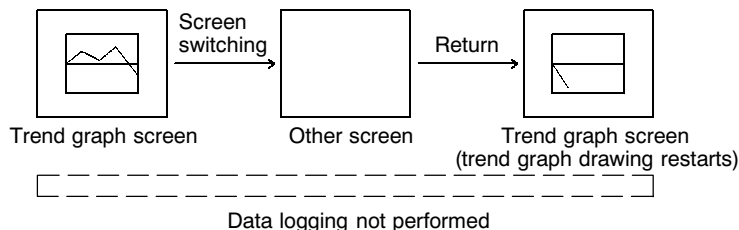

<When the data logging function is used and the background function is not used>

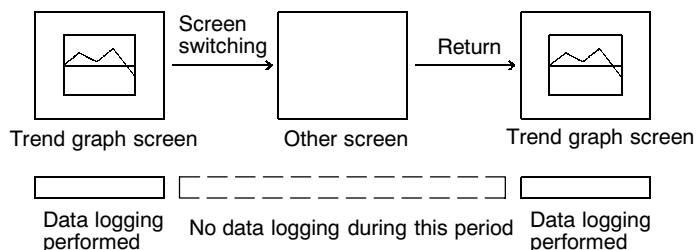

<When both the data logging function and the background function are used>

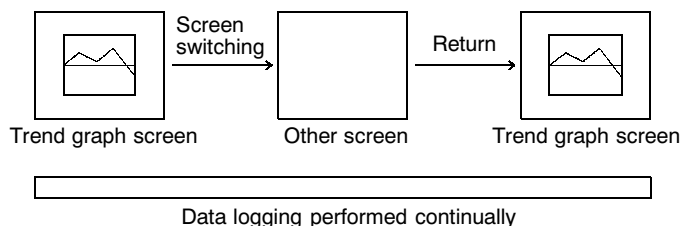

- Controls on display according to touch switches

Trend graphs can be displayed in the form shown below, with associated touch switches to control operations.

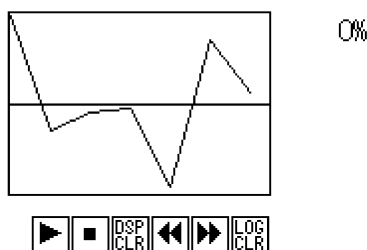

These dedicated touch switches can be used for data sampling and display operations.

The relevant functions are performed once only when the touch switches are pressed.

The positions of these touch switches can be set freely on the screen. However, the display colors, sizes and the marks cannot be changed.





“Stop” touch switch

Stops data sampling. Updating of the trend graph display is stopped at the same time.

While sampling is stopped, the “stop” touch switch is lit.

When the background function is used, pressing the “stop” touch switch stops sampling in the background.

When the last data recorded before sampling was stopped is displayed, it is displayed following the currently displayed graph.

After pressing the  (stop) touch switch, if the  (previous page (rewind)) touch switch is pressed to return to a past display and then the  (restart (continue)) touch switch is pressed to restart sampling, past data will not be displayed and the display of new data will start again.

Example:

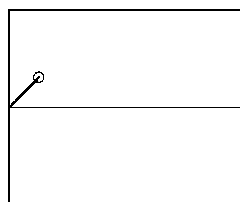

“Restart” (continue) touch switch

Restarts the sampling of data stopped by pressing the “stop” touch switch. Updating of the trend graph display is started at the same time. During sampling, the “restart” (continue) touch switch is lit.



“Display clear” (clear display) touch switch

Clears the trend graph display. The logging data is not cleared but retained.



“Log clear” (clear log) touch switch

Clears all the logging data. At the same time, the trend graph being displayed is also cleared. This switch clears only the trend graph being displayed. The trend graph plotted on other screens are not cleared. This switch is valid only when the data logging function is used. This touch switch is only effective when using the data logging function.



“Previous page” (rewind) touch switch

Displays logging data older than that of the currently displayed trend graph. This touch switch is only effective when using the data logging function.

With a standard type trendgraph, if this touch switch is pressed during display of the latest data to backtrack to past data, and then the “next page” (forward) touch switch is pressed to return to display of the latest data, the latest data is plotted following the past data.

Example:

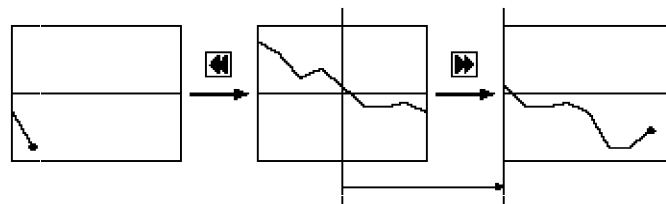

“Next page” (forward) touch switch

Displays logging data newer than that of the currently displayed trend graph. This touch switch is only effective when using the data logging function.

When the latest data is displayed during data logging, updating of the trend graph display is automatically restarted.

The “previous page” (rewind) or “next page” (forward) touch switch, whichever was pressed last, remains lit.

- Display direction of previous/next page touch switch

The display direction of previous/next page when “Right” is set for “Direction” is shown below.

[Type: Standard]

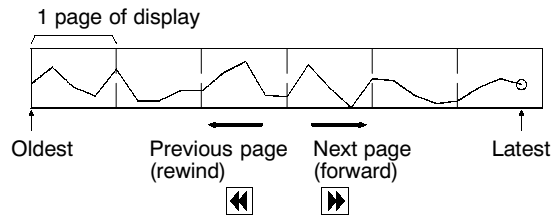

[Type: Pen Reco]

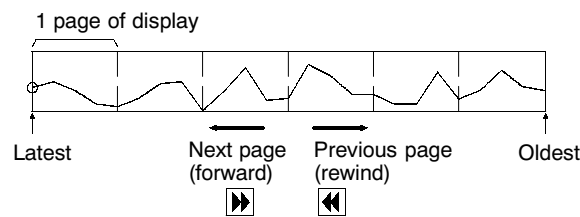

- When the display is rewinded from old dot to the latest.

When the page is rewinded to the latest display after displaying the old data, display is shown as follows.

- Standard type

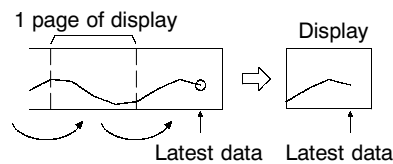

- Pen record type

With the pen recorder type, the latest drawing position is always displayed at the edge of the graph area. Therefore, depending on the number of data in the latest page, old data may be displayed discontinuously as shown below (Internally, the data is recorded countinuously.)

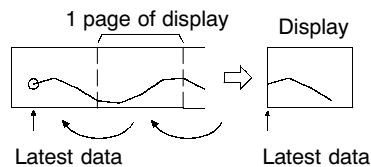

[Display Functions]

For trend graphs, the graph area is displayed in accordance with the “General” settings, and the broken line is displayed in accordance with the “Settings” (properties of each line) settings.

For details on the method of display depending on the “General” and “Settings” (properties of each line) settings, refer to “Common Attributes” (page 382).

- When multiple broken lines are registered, they overwrite each other in the order they were registered. When broken lines overlay each other they are displayed according to the XOR principle (page 255), and consequently the line style and color may differ from those specified. The same principle applies when a broken line overlays the graph frame.

[Input Functions]

Trend graphs have no input function.

[Output Functions]

Trend graphs have no output function.

[Processing Functions]

Trend graphs calculate the percentage value in accordance with the settings made for “Settings” (properties of each line).

For details on the calculation method depending on the “Settings” (properties of each line) settings, refer to “Common Attributes” (page 382).

[Relationship with Other Elements]

- For details on how numeric values are stored in numeral memory tables, refer to 7-3-1 “Numeral Memory Tables” (page 278).
- Trend graphs overlap with other elements in accordance with the order in which they were registered for the screen with the Support Tool. However, the way in which they overlap can be changed with the Support Tool.

Reference

Do not overlap percentage displays and other elements within the area in which a trend graph is plotted. This can cause the graph to be displayed incorrectly.

7-11 Alarm List, Alarm History

[Function Outline]

- Alarm list

The NT631/NT631C can monitor the status of bits at the connected host designated in bit memory tables and, when the status of a particular bit changes to “1” (ON), display the corresponding message (from a character string memory table) or image/library data. The element used to execute this function is called an “alarm list”.

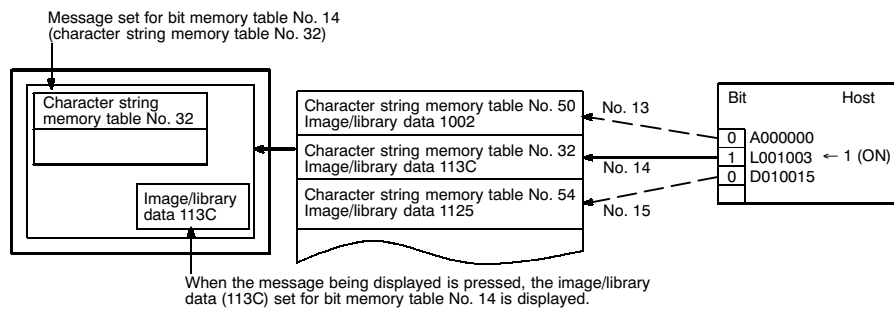

- Alarm history

The NT631/NT631C can continually monitor bits at the host designated in bit memory tables, record the time when their status changes to “1” (ON), and the number of times they come ON, and display this information together with the corresponding message (from a character string memory table) for the bit. The element used to execute this function is called an “alarm history”.

The alarm history record data is backed up by the built-in battery of the NT631/NT631C and is therefore retained even when the power to the NT631/NT631C is turned OFF or the NT631/NT631C is reset.

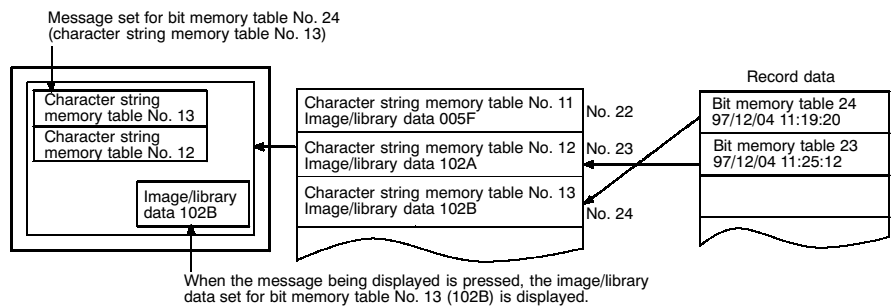

Reference

If the remaining capacity of the battery is insufficient, the alarm history data is all cleared when the power to the NT631/NT631C is turned OFF or the NT631/NT631C is reset.

When low battery voltage is detected, replace the battery immediately. For details on the method for replacing the battery, refer to 11-3-1 “Replacing the Battery” (page 624).

- Differences between alarm list and alarm history

The alarm list and alarm history differ in the following respects.

Item	Alarm List	Alarm History
Display method	As element only	As element, and as a screen displayed from the System Menu
Monitored data	Host bits allocated to bit memory tables within the designated range	Host bits allocated to bit memory tables for which "History" is set.
Monitor timing	While the alarm list element is displayed only	Continuous monitoring regardless of the displayed screen
Recording	No recording executed	Time of occurrence is recorded.
Message contents	When a message is displayed for an alarm list, the contents of the character string memory table set for the bit memory table are read.	<ul style="list-style-type: none"> - Occurrence order: When the status of a monitored bit at the host changes to "1" (ON), the contents of the character string memory table set for the bit memory table are read. - Frequency order: When a message is displayed for an alarm history, the contents of the character string memory table set for the bit memory table are read.
Output data to the Support Tool	Not possible for there is no record data	Possible (occurrence order and frequency order records transmitted simultaneously)
Display order	Ascending order of bit memory table numbers	Select either of the following: <ul style="list-style-type: none"> - Occurrence order: Chronological order in which the statuses of the monitored bits changed to "1" (ON) (displayed from the oldest record first or the newest record first depending on the memory switch setting at the NT631/NT631C) - Frequency order: Order based on the number of times the status of each bit has changed to "1" (ON), from most to least frequent.

- Outline of alarm list/alarm history operations

The operations of the alarm list and alarm history are described below.

Reference

- The alarm list only checks host bits allocated to bit memory tables within the designated range. This checking is performed only while the alarm list is displayed.
The alarm history only checks host bits allocated to bit memory tables for which "History" is set. The relevant host bits are checked continually. Consequently, if a large number of host bits is set the processing of the NT631/NT631C may be delayed.
- Alarm lists are displayed in ascending order of bit memory table numbers and alarm histories are displayed in frequency order or occurrence order. When an alarm history is displayed in occurrence order, the order can be specified as from the newest record or from the oldest record by setting the "Hist. Disp. Method" memory switch of the NT631/NT631C.
- In the case of alarm lists, if the status of a host bit allocated to a bit memory table changes to "0" (OFF), the message and image/library data are also automatically cleared at the same time.
In the case of alarm histories, even if the status of a host bit allocated to a bit memory table changes to "0" (OFF), the message and image/library data remain.
- The alarm history record data can also be displayed and printed out in the Maintenance mode under the System Menu of the NT631/NT631C.

- (1) When the status of an allocated bit of a bit memory table for which the alarm list/history function is set changes to "1" (ON), the contents of the set character string memory table are displayed as a message.

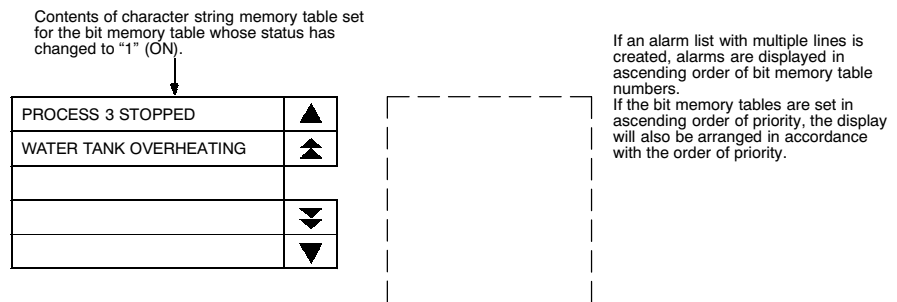

- (2) Each message area is a touch switch and pressing a message displays the set image/library data. At the same time, the pressed message is displayed in reverse video.

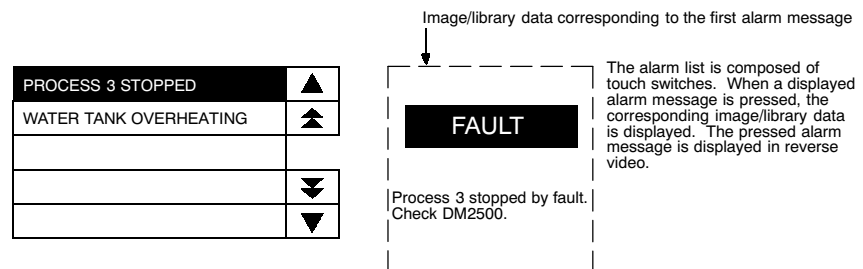

- (3) In case multiple messages are displayed, pressing another message will cause it to be displayed in reverse video, and the corresponding image/library data will be displayed.

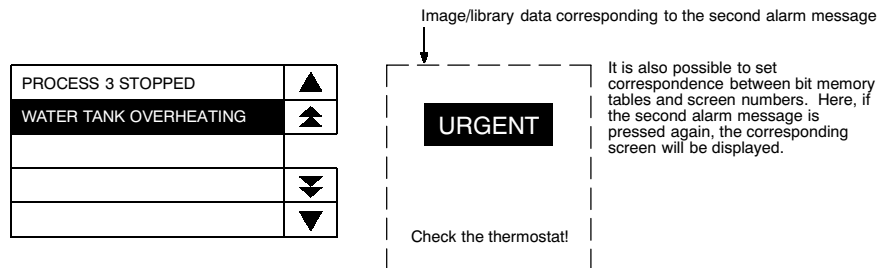

- (4) When a message displayed in reverse video is pressed again, the display will switch to the screen with the set screen number.

Reference

In the case described above, both “image/library display” and “screen changeover” functions are set. The operation when a touch switch is pressed is determined as follows in accordance with these settings.

Image/library display	Screen changeover	Touch switch	
		First time	Second time
Not set	Not set	No effect	No effect
Not set	Set	Screen changeover	–
Set	Not set	Image/library data display	No effect
Set	Set	Image/library data display	Screen changeover

[Restrictions]

- A combined total of up to 4 alarm lists and alarm histories can be displayed on one screen. (Same for window screen) In the case of an overlapping screen with 8 child screens, the maximum total is also 4.
- An alarm list/alarm history can display a maximum of 24 messages at the same time.
- An alarm list can monitor bit memory table in the range from No1 to No.1000. (When “1000” is set for number of bit memory table entries)
- The maximum number of data to be recorded with the alarm history is 256 for order of occurrence, and 255 for order of frequency.
- When displaying image/library data with alarm list/alarm history elements, the maximum simultaneous display restriction imposed on image and library data applies. Therefore a maximum combined total of 256 image/library data used for alarm lists/histories and image and library data used for other applications can be displayed on one screen. For an overlapping screen comprising 8 child screens, the maximum is 1024.
- If, when library data is displayed with an alarm list/history, the library data projects outside the image/library data display area, nothing is displayed. In the case of image data, only the part inside the area is displayed.
- If no data is registered for the image/library code specified for use with an alarm list/alarm history, nothing will be displayed.

- The contents of the character string memory tables displayed as messages for alarm lists and alarm histories are read at the following times.
 - When an entire alarm list or alarm history is displayed by screen switching
 - When a bit being monitored by the alarm list function changes status from OFF to ON, and the corresponding message is displayed.

Messages already displayed are unaffected even if the contents of character string memory tables change.

- The message display areas for alarm lists/histories are touch switches. Do not overlap them with other touch switches.

[Common Attributes]

The relationship between the common properties of alarm lists and alarm histories and the display result are indicated below.

- Properties

General	
Position	Coordinates of the top left corner of the alarm list/history.
Size	Width and height of the alarm list/history (in dot units) (But note that motion is in touch-switch-sized units only)
Message	
Length	Maximum number of characters in the displayed message Range: 1 to 40 For the alarm history function, the number of characters is decreased by the number required to display the "History Info". Restrictions also apply in accordance with the "Scale" setting.
Display Line Qty	Maximum number of displayed messages Range: 1 to 24
Scale	Scale at which messages are displayed ("Enlarged display", page 359) 1 × 1 (Equal), 1 × 2 (High), 2 × 1 (Wide), 2 × 2, 3 × 3, 4 × 4, 8 × 8
Smoothing	Whether or not smoothing is used for characters with a scale of 2 × 2 or larger ("Smoothing", page 359) Check mark (smoothing executed)/ No check mark (smoothing not executed)
Line Scroll Touch Switches	Presence/absence of touch switches for scrolling messages in line units Check mark (touch switches present)/ No check mark (touch switches absent)
Page Scroll Touch Switches	Presence/absence of touch switches for scrolling messages in page units Check mark (touch switches present)/ No check mark (touch switches absent)

General	
Color	
Frame	Color of the frame (colors other than white and black are featured with NT631C only) Black/Blue/Red/Magenta/Green/Cyan/Yellow/White
Background	
ON	ON color of the message display field (colors other than white and black are featured with NT631C only) Black/Blue/Red/Magenta/Green/Cyan/Yellow/White
OFF	OFF color of the message display field (colors other than white and black are featured with NT631C only) Black/Blue/Red/Magenta/Green/Cyan/Yellow/White
Image & Library	
Display ImageLib	Presence/absence of image library display Check mark (present)/No check mark (absent)
Color	
Foreground	Foreground color of images (valid only for image data in the "2 Colors" mode) (colors other than white and black are featured with NT631C only) Black/Blue/Red/Magenta/Green/Cyan/Yellow/White
Background	Background color of image/library displays (colors other than white and black are featured with NT631C only) Black/Blue/Red/Magenta/Green/Cyan/Yellow/White/ Transparent ("Transparent" is only possible for alarm lists)

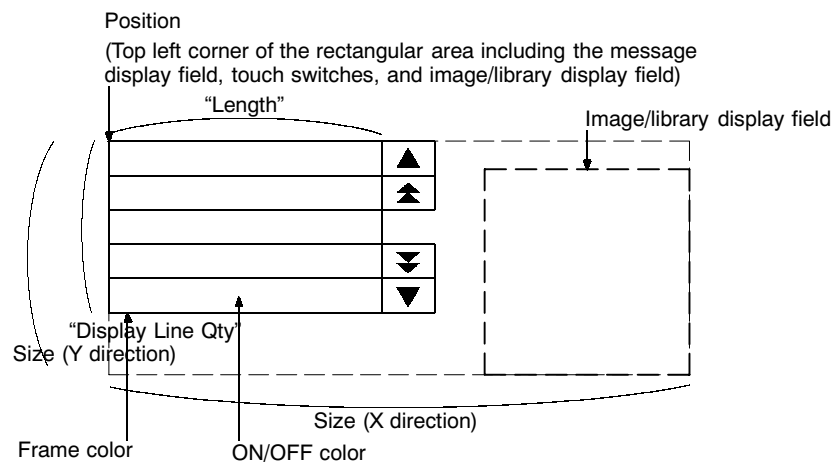

- The position and size of the Image/library display field can be changed without restriction.
- The positions of line/page scroll touch switches can be set without restriction. However, the display colors and sizes of them cannot be changed.

Reference

For details on the screen numbers that can be switched by the alarm list/history function and the image/library codes that can be set, refer to 7-3-3 "Bit Memory Tables" (page 289).

[Display Functions]

- Alarm list

Apart from the “Common Attributes”, alarm lists have the properties indicated below.

- Properties

Settings	
List Settings	
Start Bit Table Entry	First bit memory table number of the bit memory tables used for monitoring for the alarm list Range: 0 to 1999
No. of Bits Referenced	Number of bit memory tables used for monitoring for the alarm list Range: 1 to 1000

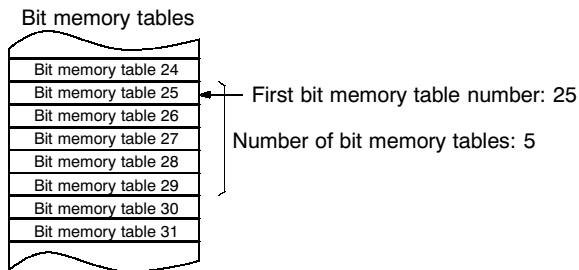

- Drawing result

An alarm list monitors host bits allocated to bit memory tables within the specified range in accordance with the bit memory table function property settings and executes display in accordance with the “General” settings.

For details on the method of display according to the “General” settings, refer to “Common Attributes” (page 400).

Alarm lists allow the screen to be switched in accordance with bit memory table settings. For details, refer to 7-3-3 “Bit Memory Tables” (page 289).

- Alarm history

Apart from the “Common Attributes”, alarm histories have the properties indicated below.

- Properties

Settings	
History Info	Presence/absence of occurrence time/occurrence frequency displays (this means the presence or absence of the time of occurrence in the case of “order of occurrence”, and the presence or absence of the occurrence frequency in the case of “order of frequency”) Check mark (present)/No check mark (absent)
Order Type	Type of display order of frequency/order of occurrence
Info Type	Method of display for the time of occurrence (setting effective only when “order of occurrence” is set for “Order Type” and a check mark is set for “History Info”). Y/M/D h:m Year/month/day hour:minute (15 digits) M/D h:m Month/day hour:minute (12 digits) h:m Hour:minute (6 digits)

- Display result

The history is displayed as follows depending on the settings made for “General” and “Settings”.

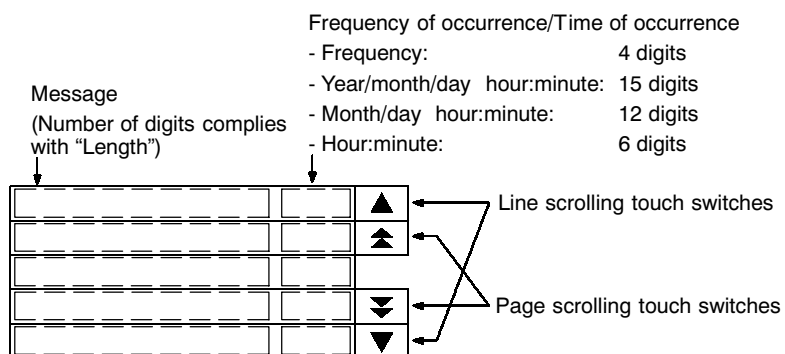

For details on the method of display according to the “General” settings, refer to “Common Attributes” (page 400).

Alarm histories allow the screen to be switched in accordance with bit memory table settings. For details, refer to 7-3-3 “Bit Memory Tables” (page 289).

- Timing of message reading

For alarm lists and alarm histories in frequency order, when a message is displayed, scrolling, or screen switching, the character string memory table set for the bit memory table is read, and the latest message is displayed.

In contrast, in the case of alarm histories in occurrence order, only when the status of the allocated bit of the bit memory table changes to "1" (ON), the character string memory table set for the bit memory table is read and its contents are recorded. Accordingly, even if the contents of the character string memory table change later, the displayed message will be kept the recorded contents. However, if the status of another monitored host bit changes to "1" (ON) while an alarm history in occurrence order is being displayed, the latest message at that point is displayed.

- Display at message update

When the status of a monitored host bit changes during display of an alarm list/ alarm history, the display changes as follows.

- With an alarm list

With an alarm list, when the status of a monitored host bit changes to "1" (ON), the corresponding message is displayed, and when it changes back to "0" (OFF), the message is cleared (the messages are displayed in ascending order of bit memory table numbers).

[When a message is added]

- If a message is added outside the display range (before or after the display range), there is no change in the messages being displayed.
- If a message is added within the display range, the new message is displayed, and the messages following it are shifted one line downward.

[When a message is deleted]

- If a message is deleted outside the display range (before or after the display range), there is no change in the messages being displayed.
- If a message is deleted within the display range, the messages following it are shifted one line upward, except when it is the topmost message in the display that is deleted, in which case the message immediately preceding the present display range is displayed in its place.

If all the displayed messages are deleted at the same time, messages are displayed starting with a message with the same serial number (counting from the top) as the topmost of those that were displayed. (For example, if the previous display started from serial number 7, the new display will also start from a message with serial number 7.)

- Alarm history in occurrence order

With an alarm history in occurrence order, when the status of the monitored host bit changes to "1" (ON), the corresponding message becomes the latest message (the messages are displayed from the oldest first or from the newest first, depending on the memory switch setting made at the NT631/NT631C). When the status of the bit changes back to "0" (OFF), the message remains displayed.

If the statuses of multiple bits change to "1" (ON) at the same time, the bit memory table with the smallest bit memory table number is given priority.

[Display from oldest record first]

- Since new messages are added at the end of the history, the displayed messages do not change. However, when the final page is displayed and a message is added below it, the  touch switch is displayed in reverse video to inform the operator that a message has been added.

[Display from the newest record first]

- New messages are added at the top of the history. When a message is added, the screen will switch to the display starting from the first message regardless of the current display position.

- Alarm history in frequency order

With an alarm history in frequency order, when the status of a monitored host bit changes to "1" (ON), the number of times that bit has changed to "1" (ON) is determined and the display is changed to reflect the new descending order of frequency of occurrence. When the bit status changes back to "0" (OFF), its frequency display remains unchanged.

If there are bits with the same frequency of occurrence, the one whose bit memory table has the smallest bit memory table number is displayed closest to the top of the history.

- The display contents change in real time according to the frequencies of occurrence, but the display range does not change. The serial number (counting from the top) of the message at the topmost position is retained until the display range is changed by touch switch operation.

- Lighting of the message display field and touch switches for scrolling

The message display field and touch switches for scrolling light as follows according to the alarm list/history status.

- Message display field

When a message field is pressed for the first time after it is displayed, or pressed after another message has been pressed, if image/library data is set for the corresponding bit memory table, the message field lights (the corresponding image/library data is also displayed at this time). This makes it possible to tell at a glance which message the displayed image/library data corresponds to.

- Line scrolling touch switches

When there are messages above or below the displayed range, these touch switches are lit. This makes it possible to tell at a glance whether there are any messages outside the displayed range.

- Page scrolling touch switches

If there is one page or more of messages above or below the displayed range, these touch switches are lit. This makes it possible to tell at a glance whether there are any messages outside the displayed range.

- Note on clearing alarm history record data

The alarm history record data can be cleared (initialized) by either of the following operations.

- Select “Maintenance Mode” → “Memory Init.” → “Alarm History” from the System Menu.
- Set bit 1 (alarm history initialization) of the PT status control bits to “1” (ON).

[Input Functions]

The alarm list and alarm history only read the statuses of bit memory tables and therefore have no direct input function.

For details on the method for monitoring host bits, refer to 7-3-3 “Bit Memory Tables” (page 289).

[Output Functions]

Alarm lists and alarm histories have no output function.

[Processing Functions]

Alarm lists and alarm histories have no data processing function.

[Relationship with Other Elements]

- Alarm lists and alarm histories monitor the statuses of host bits, display messages and image/library data, switch screens, etc., in accordance with the settings of bit memory tables. For details, refer to 7-3-3 “Bit Memory Tables” (page 289).
- Alarm lists and alarm histories overlap with other elements in accordance with the order in which they were registered for the screen with the Support Tool. However, the way in which they overlap can be changed with the Support Tool.

7-12 Inputting Numeric Values

7-12-1 Numeric Key Type (“Numeral Input”)

[Function Outline]

Numeric key type numeral setting input fields are input fields for inputting numeric values on the screen.

The numeric values input into a numeral setting input field using touch switches are written to a numeral memory table.

The values can be input either in decimal or hexadecimal format.

- Outline of operation

The basic operation of a numeric key type numeral setting input field is shown below.

- (1) A numeric value is input into a numeral setting input field using touch switches.

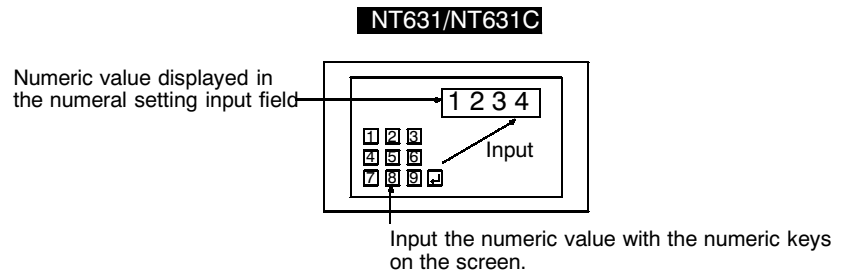

- (2) On confirming the input numeric value with the ENT key or  touch switch it is written to a numeral memory table.

At this time, the occurrence of change in the contents of the numeral memory table is notified to the host via the PT status notify area.

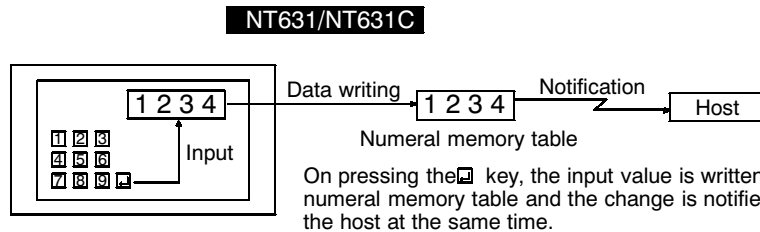

[Restrictions]

- A maximum combined total of 256 of the following elements can be registered for one screen (a thumbwheel type numeral setting input field cannot be used on the window screen. Either the numeric key type or the character string input fields, not both, can be registered on the window screen). Even in the case of an overlapping screen with eight child screens, it is only possible to register numeral setting input fields on one of the child screens.

Numeral setting input field (numeric key type),
Numeral setting input field (thumbwheel type)
Character string input field

There is no restriction on the number of input fields that can be registered for one screen data file: any number can be registered as long as the data file capacity is not exceeded. However, if a large number of elements are registered, check that the restrictions on element display are complied with by referring to “Display Restrictions” (page 635).

- It is not possible to set input from more than one numeral setting input field (numeric key type or thumbwheel type) on the same screen to one numeral memory table.
In cases where values at the host must be input both in decimal and hexadecimal, set numeral input into separate numeral memory tables, both allocated to the same area.
- The range of numeric values that can be input depends on the “Storage Type” (“BCD” or “Binary”) of the numeral memory table, and the “Display Type” (“Decimal” or “Hexadecimal”), and “Display Sign” settings made for the numeral setting input field. For details, refer to 7-3-1 “Numeral Memory Tables” (page 278).
- It is not possible to register multiple input fields (regardless of the type of numeric key or thumbwheel) which refer to the same numeral table entry on the same screen.

[Common Attributes]

The relationship between the properties of a numeral setting input field and the numeric values input and displayed is indicated below.

- Properties

General	
Position	Coordinates of the top left corner of the numeral setting input field
Font Type	Font for the numerals Standard/Half Height/Double Width
Scale	Scale at which the numeric value is displayed ("Enlarged display", page 350) 1 × 1 (Equal), 1 × 2 (High), 2 × 1 (Wide), 2 × 2, 3 × 3, 4 × 4, 8 × 8
Smoothing	Whether or not smoothing is used for numerals with a scale of 2 × 2 or larger ("Smoothing", page 350) Check mark (smoothing executed)/ No check mark (smoothing not executed)
Attribute	Display mode for the numerals ("Display attributes and drawing result", page 350) Standard/Flash/Inverse Flash
Color	
Foreground	Display color of the numerals (colors other than black and white featured with NT631C only) Black/Blue/Red/Magenta/Green/Cyan/Yellow/White
Background	Background color of the numerals (colors other than black and white featured with NT631C only) Black/Blue/Red/Magenta/Green/Cyan/Yellow/White

Settings		
Table Entry	Number of the numeral memory table into which the input numeric value is written Range: 0 to 1999	
Display Type	Display format for the numeric value ("Input numeric value and stored data", page 411) Decimal/Hexadecimal	
Format ("Number of digits displayed", page 411)		
Integer	Number of digits in the integer part of the numeric value Range: 1 to 10	Maximum combined total of 10 digits
Decimal	Number of digits in the decimal fraction of the numeric value Range: 0 to 9	
Limit ("Upper/lower (max./min.) limit check", page 414)		
Maximum	Upper limit for numeric values that can be input	
Minimum	Lower limit for numeric values that can be input	
Zero Suppression	Whether or not zero suppression is used ("Zero suppression", page 352) Check mark (zero suppression used)/ No check mark (zero suppression not used)	
Display Sign	Whether or not negative numbers are indicated (setting ineffective if "Hexadecimal" has been set for "Display Format") ("Input numeric value and stored data", page 411) Check mark (negative numbers indicated)/ No check mark (negative numbers not indicated)	
Focus Frame	Presence/absence of a frame indicating that the numeral setting input field has become ready to accept input Check mark (frame present)/ No check mark (frame not present)	
Focus Attribute	Display status before the input numeric value is confirmed ("Display attributes and drawing result", page 350) Standard/Inverse/Flash/Inverse Flash	

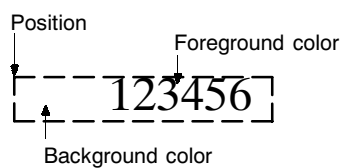

- Number of digits displayed

All contents of numeral memory tables are stored as integers. To display a numeric value that has a decimal fraction in a numeral setting input field, set the "Decimal" setting to "1" or higher to specify the number of places after the decimal point. A decimal point is then automatically inserted.

Note that if the number of digits of the numeric value is greater than the total of the settings for "Integer" and "Decimal", an error occurs and "*" is displayed for all the digits.

Example: Displaying "123456"

- Setting for "Integer" = 8; setting for "Decimal" = 0:
Resulting display: 00123456
- Setting for "Integer" = 4; setting for "Decimal" = 4:
Resulting display: 0012.3456
- Setting for "Integer" = 2, setting for "Decimal" = 4:
Resulting display: 12.3456
- Setting for "Integer" = 1, setting for "Decimal" = 4:
Resulting display: *****

For hexadecimal display, only the number of digits of the integral part is specified.

- Input numeric value and stored data

The range of numeric values that can be input and the conversion method for storage depend on the following settings.

- Display Type ("Decimal"/"Hexadecimal")
- Display Sign (whether or not negative values are displayed)

<Conversion depending on "Display Type">

The data is converted for storage in a numeral memory table as follows depending on the setting for "Display Type".

- "Decimal":

The numeric value input in decimal is converted to signed binary data and stored in the numeral memory table.

- "Hexadecimal":

The numeric value input in hexadecimal is stored in the numeral memory table without alteration.

Reference Numeral memory tables store numeric values as signed binary data.

<Permissible input range>

The permissible input ranges depending on the settings made for “Display Type” and “Display Sign” are indicated in the examples below.

Display Type	Sign	Permissible Input Range
Decimal	Unsigned	0 to 2147483647*
	Signed	-2147483648 to 2147483647
Hexadecimal	–	0 to FFFFFFFFH

When writing to numeral memory tables that are allocated to host words, not only the properties of the numeral setting input field but also the “Storage Type” and “Words” settings made for the numeral memory table have an effect on the permissible input range. The permissible input range is determined as follows depending on these properties. If input of a value outside this range is attempted, the NT631/NT631C checks and prevents the input.

Storage Type	Words	Display Type	Sign	Permissible Input Range
BCD	1	Decimal	Unsigned	0 to 9999
			Signed	-999 to 9999
		Hexadecimal	–	FC19 to FFFFH (negative numbers) 0 to 270FH (positive numbers)
	2	Decimal	Unsigned	0 to 99999999
			Signed	-99999999 to 99999999
		Hexadecimal	–	FF676981 to FFFFFFFFH (negative numbers) 0 to 5F5E0FFH (positive numbers)
Binary	1	Decimal	Unsigned	0 to 32767*
			Signed	-32768 to 32767
		Hexadecimal	–	0 to FFFFH
	2	Decimal	Unsigned	0 to 2147483647*
			Signed	-2147483648 to 2147483647
		Hexadecimal	–	0 to FFFFFFFFH

* Note that the values are different from those of the numeral display range. In numeral display, since negative numbers are displayed as absolute values when displaying unsigned decimal values, “32768” and “2147483648”, which cannot be input, may be displayed.

<Relationship between input numeric values and contents of host words>

When inputting a numeric value to a numeral memory table allocated to a word at the host, the value is first converted to signed hexadecimal in accordance with the settings for “Display Type” and “Display Sign” settings and stored in the numeral memory table, and then written to the host word in accordance with the “Words” and “Storage Type” settings for the numeral memory table. Therefore the result also differs according to the settings made for “Words” and “Storage Type” (“BCD” or “Binary”).

Input numeric value	“Display Type”	Sign	Numeric value stored in numeral memory table	Words	“Storage Type”	Contents of word at host
1234	Decimal	Unsigned	000004D2	1 word	BCD	1234
123			0000007B	1 word		0123
1234			000004D2	2 words		00001234
1234		Signed	000004D2	1 word		1234
-123			FFFFFF85	1 word		F123
-1234			FFFFFFB2E	2 words		F0001234
000004D2	Hexadecimal	-	000004D2	1 word		1234
FFFFFF85			FFFFFF85	1 word		F123
FFFFFFB2E			FFFFFFB2E	2 words		F0001234
4660	Decimal	Unsigned	00001234	1 word	Binary	1234
268430796			0FFFEDEC	2 words		0FFFEDEC
4660		Signed	00001234	1 word		1234
-32768			FFFF8000 (00008000)*	1 word		8000
-268430796			F0001234	2 words		F0001234
1234			Hexadecimal	-		00001234
F123	FFFF123 (0000F123)*	1 word			F123	
F0001234	F0001234	2 words			F0001234	

* The figures in parentheses are the values immediately after input. When data is read from the host after input, it is converted to a 32-bit negative number and the value in the numeral memory table changes.

Reference

When the “Storage Type” is “BCD”, the signed binary data (hexadecimal number) is converted to data for storage in the host word (BCD data) and written to the host. If the value is negative the most significant digit in the word is set as “F”. This means that the maximum number of digits for a negative number (integer part + decimal fraction part) is seven.

When the “Storage Type” is “Binary”, the contents of the numeral memory table are written without alteration to the host word.

However, when a negative number is written to a numeral memory table whose number of allocated words at the host is one, it is stored immediately after input as a 16-bit negative number.

When the data is read from the host subsequently, it is converted to a 32-bit negative number and the numeric value is changed.

- Upper/lower (max./min.) limit check

The NT631/NT631C has a function to check the correctness of an input numeric value to prevent a numeric value outside the allowable range from being input so that the input of an illegal value will not adversely affect the system.

For a numeric key type numeral setting input field, the check is executed when an attempt is made to confirm a numeric value. If the value is higher than the upper limit or lower than the lower limit, the buzzer sounds three times and the input value is cleared (the status returns to that before input was attempted).

Notice

When the numeral values entered are confirmed, upper/lower limits are checked.

[Display Functions]

Numeric values are displayed in the numeral setting input field in accordance with the “General” settings.

For details on the method of display according to the “General” settings, refer to “Common Attributes” (page 409).

[Input Functions]

Numeric values are input into numeral setting input fields by using the “control code input key” touch switches.

[Output Functions]

Numeral setting input fields only write input numeric values to numeral memory tables; they have no function for directly outputting data to external destinations (if the numeral memory table to which the numeric value is written is allocated to the host, the data can be output to the host indirectly).

However, the input of a numeric value is notified to the host via the PT status notify area.

[Processing Functions]

With numeral setting input fields, input numeric values are converted to signed binary data in accordance with the “Settings” property.

For details on the method of conversion depending on the “Settings” property, refer to “Common Attributes” (page 409).

[Relationship with Other Elements]

- “Numeral displays” (page 348) use the same conversion method and display method as numeral setting input fields.
- For details on how numeric values are stored in numeral memory tables, refer to 7-3-1 “Numeral Memory Tables” (page 278).
- Input and confirmation touch switches are required in order to use numeral setting input fields. In cases where there are multiple numeral setting input fields, it is also possible to select and move between input fields using touch switches (page 505).
- Numeral setting input fields overlap with other elements in accordance with the order in which they were registered for the screen with the Support Tool. However, the way in which they overlap can be changed with the Support Tool.

7-12-2 Thumbwheel Type (“Thumbwheel”)

[Function Outline]

Thumbwheel type numeric input fields are input fields for inputting numeric values on the screen.

Touch switches are provided to increment or decrement each digit of a numeric value, making it easy to change numeric values and to write them to numeral memory tables.

The values can be input either in decimal or hexadecimal format.

- Outline of operation

The basic operation of a thumbwheel type numeral setting input field is shown below.

- (1) The value in the numeral setting input field is changed using the incrementing and decrementing (+, -) touch switches.

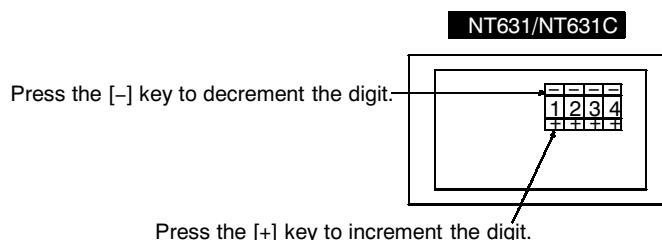

- (2) Each time a change is made to the numeric value it is confirmed and the occurrence of the change is notified to the host via the PT status notify area.

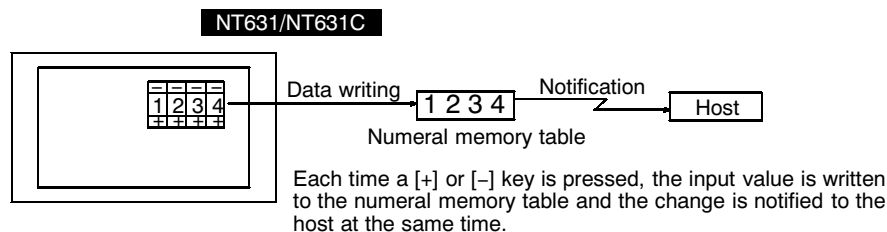

[Restrictions]

- A maximum combined total of 256 of the following elements can be registered for one screen (A thumbwheel type numeral setting input field cannot be used on the Windows screen). Even in the case of an overlapping screen with eight child screens, it is only possible to register numeral setting input fields on one of the child screens.

- Numeral setting input field (numeric key type)
- Numeral setting input field (thumbwheel type)
- Character string input field

There is no restriction on the number of input fields that can be registered for one screen data file: any number can be registered as long as the data file capacity is not exceeded. However, if a large number of elements are registered, check that the restrictions on element display are complied with by referring to “Display Restrictions” (page 635).

- It is not possible to set input from more than one numeral setting input field (numeric key type or thumbwheel type) on the same screen to one numeral memory table.
In cases where values at the host must be input both in decimal and hexadecimal, set numeral input into separate numeral memory tables, both allocated to the same area.
- The range of numeric values that can be input depends on the “Storage Type” (“BCD” or “Binary”) of the numeral memory table, and the “Display Type” (“Decimal” or “Hexadecimal”), and “Display Sign” settings made for the numeral setting input field. For details, refer to 7-3-1 “Numeral Memory Tables” (page 278).
- It is not possible to register multiple input fields (regardless of the type of numeric key or thumbwheel) which refer to the same numeral table entry on the same screen.

[Common Attributes]

The relationship between the properties of a thumbwheel type numeral setting input field and the numeric values input and displayed is indicated below.

- Properties

General	
Position	Coordinates of the top left corner of the numeral setting input field
Size	Size of the input field Small/Medium/Large
End Plate	Presence/absence of end plates at either end of the numeral setting input field Check mark (end plates used)/ No check mark (end plates not used)
Attribute	Display mode for the numerals (“Display attributes and drawing result”, page 350) Standard/Flash/Inverse Flash
Thumbwheel Color	
Frame	Color of the frame of the numeral setting input field (colors other than black and white featured with NT631C only) Black/Blue/Red/Magenta/Green/Cyan/Yellow/White
Foreground	Foreground color of the numeral setting input field (colors other than black and white featured with NT631C only) Black/Blue/Red/Magenta/Green/Cyan/Yellow/White
Background	Background color of the numeral setting input field (colors other than black and white featured with NT631C only) Black/Blue/Red/Magenta/Green/Cyan/Yellow/White
Character Color	
Foreground	Display color of the numerals (colors other than black and white featured with NT631C only) Black/Blue/Red/Magenta/Green/Cyan/Yellow/White
Background	Background color of the numerals (colors other than black and white featured with NT631C only) Black/Blue/Red/Magenta/Green/Cyan/Yellow/White

Settings		
Table Entry	Number of the numeral memory table into which the input numeric value is written Range: 0 to 1999	
Display Type	Display format for the numeric value ("Input numeric value and stored data", page 418) Decimal/Hexadecimal	
Format ("Number of digits displayed", page 418)		
Integer	Number of digits in the integer part of the numeric value Range: 1 to 10	Maximum combined total of 10 digits
Decimal	Number of digits in the decimal fraction of the numeric value Range: 0 to 9	
Limit ("Upper/lower (max./min.) limit check", page 421)		
Maximum	Upper limit for numeric values that can be input	
Minimum	Lower limit for numeric values that can be input	
Display Sign	Whether or not negative numbers are indicated (setting ineffective if "Hexadecimal" has been set for "Display Format") ("Input numeric value and stored data", page 418) Check mark (negative numbers indicated)/ No check mark (negative numbers not indicated)	

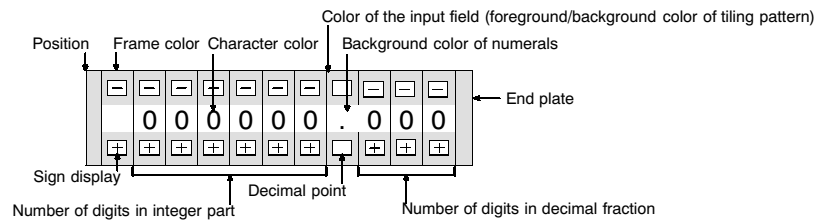

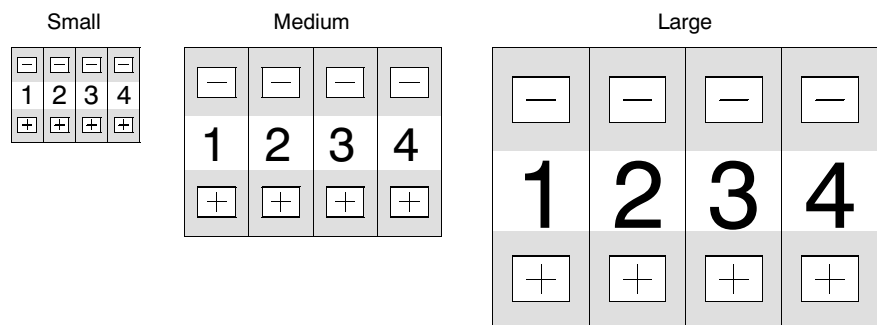

• Enlarged display

Thumbwheel type numeral setting input fields can be displayed in the following three sizes. The sizes of the touch switches in each case are 1 × 1, 2 × 2, and 3 × 3, taking the minimum unit (20 × 20 dots) as the reference.

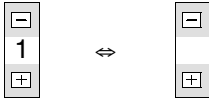

- Display attributes and drawing result

Display Attribute	Drawing Result
Standard	The numeral setting input field is displayed with the specified foreground color and background color. 
Flash	Repeated alternation of the “standard” display and no display. 
Inverse Flash	Repeated exchange of the foreground color and background color. 

- Number of digits displayed

All contents of numeral memory tables are stored as integers. To display a numeric value that has a decimal fraction in a numeral setting input field, set the “Decimal” setting to “1” or higher to specify the number of places after the decimal point. A decimal point is then automatically inserted.

The maximum combined total of digits in the integer part and decimal fraction part is 10 digits. The integer part must always comprise at least one digit.

Note that if the number of digits of the numeric value is greater than the total of the settings for “Integer” and “Decimal”, an error occurs and “*” is displayed for all the digits.

Example: Displaying “123456”

- Setting for “Integer” = 8; setting for “Decimal” = 0:
Resulting display: 00123456
- Setting for “Integer” = 4; setting for “Decimal” = 4:
Resulting display: 0012.3456
- Setting for “Integer” = 2, setting for “Decimal” = 4:
Resulting display: 12.3456
- Setting for “Integer” = 1, setting for “Decimal” = 4:
Resulting display: *****

- Input numeric value and stored data

The range of numeric values that can be input and the conversion method for storage depend on the following settings.

Display Type (“Decimal”/“Hexadecimal”)

Display Sign (whether or not negative values are displayed)

<Conversion depending on “Display Type”>

The data is converted for storage in a numeral memory table as follows depending on the setting for “Display Type” (decimal/hexadecimal) and “Display Sign” (whether or not negative values are indicated.).

- Decimal:

The numeric value input in decimal is converted to signed binary data and stored in the numeral memory table.

- Hexadecimal:

The numeric value input in hexadecimal is stored in the numeral memory table without alteration.

Reference Numeral memory tables store numeric values as signed binary data.

<Input range and conversion example>

The permissible input ranges depending on the settings made for “Display Type” and “Display Sign” are indicated in the example below.

Display Type	Sign	Permissible Input Range
Decimal	Unsigned	0 to 2147483647
	Signed	-2147483648 to 2147483647
Hexadecimal	–	0 to FFFFFFFFH

When writing to numeral memory tables that are allocated to host words, not only the properties of the numeral setting input field but also the “Storage Type” and “Words” settings made for the numeral memory table have an effect on the permissible input range. The permissible input range is determined as follows depending on these properties. If input of a value outside this range is attempted, the NT631/NT631C checks and prevents the input.

Storage Type	Words	Display Type	Sign	Permissible Input Range
BCD	1	Decimal	Unsigned	0 to 9999
			Signed	-999 to 9999
		Hexadecimal	–	FC19 to FFFFH (negative numbers) 0 to 270FH (positive numbers)
	2	Decimal	Unsigned	0 to 99999999
			Signed	-9999999 to 99999999
		Hexadecimal	–	FF676981 to FFFFFFFFH (negative numbers) 0 to 5F5E0FFH (positive numbers)
Binary	1	Decimal	Unsigned	0 to 32767*
			Signed	-32768 to 32767
		Hexadecimal	–	0 to FFFFH
	2	Decimal	Unsigned	0 to 2147483647*
			Signed	-2147483648 to 2147483647
		Hexadecimal	–	0 to FFFFFFFFH

* Note that the values are different from those of the numeral display range. In numeral display, since negative numbers are displayed as absolute values when displaying unsigned decimal values, “32768” and “2147483648”, which cannot be input, may be displayed.

Reference When the “Storage Type” is “BCD”, the signed binary data (hexadecimal number) is converted to data for storage in the host word (BCD data) and written to the host. If the value is negative the most significant digit in the word is set as “F”. This means that the maximum number of digits for a negative number (integer part + decimal fraction part) is seven.

When the “Storage Type” is “Binary”, the contents of the numeral memory table are written without alteration to the host word.

- Upper/lower (max./min.) limit check

The NT631/NT631C has a function to check the correctness of an input numeric value to prevent a numeric value outside the allowable range from being input so that the input of an illegal value will not adversely affect the system.

The upper/lower (max./min.) limit check is executed in the timing indicated below according to the type of a numeral setting input field.

For a thumbwheel type numeral setting input field, the check is executed each time the increment/decrement key of each digit position is pressed.

With a thumbwheel type numeral setting input field, if $n...n < m...m$ [upper limit: $1n...n$, lower limit: $0m...m$ (“n” and “m” are arbitrary values at each digit)], carry over and underflow are not possible at the highest digit position.

Example:

If the upper limit value and the lower limit value are 1200 and 201, respectively, the numeric value can be changed only in the following range: from 201 to 999 if an initial value is a 3-digit value and from 1000 to 1200 if an initial value is a 4-digit value.

The reason for this is that the upper/lower (max./min.) limit check function does not allow the numeric value at the highest digit position to change from 0 to 1 or from 1 to 0.

To avoid this, set the upper and lower limit values so that “ $n...n \geq m...m$ ”, or provide a touch switch separately to write a numeric value for carry over or underflow.

Notice

When the numeral values entered are confirmed, upper/lower limits are checked.

[Display Functions]

Numeric values are displayed in the numeral setting input field in accordance with the “General” settings.

For details on the method of display according to the “General” settings, refer to “Common Attributes” (page 416).

[Input Functions]

Numeric values are input into a thumbwheel type numeral setting input field by using the “+” and “-” touch switches provided for each digit.

[Output Functions]

Numeral setting input fields only write input numeric values to numeral memory tables; they have no function for directly outputting data to external destinations (if the numeral memory table to which the numeric value is written is allocated to the host, the value table can be output to the host indirectly).

However, the input of a numeric value is notified to the host via the PT status notify area.

[Processing Functions]

Numeral setting input fields have no data processing functions.

[Relationship with Other Elements]

- “Numeral displays” (page 348) use the same conversion method and display method as numeral setting input fields.
- For details on how numeric values are stored in numeral memory tables, refer to 7-3-1 “Numeral Memory Tables” (page 278).
- Numeral setting input fields overlap with other elements in accordance with the order in which they were registered for the screen with the Support Tool. However, the way in which they overlap can be changed with the Support Tool.

7-13 Inputting Character Strings

[Function Outline]

Character string input fields are input fields for inputting character strings on the screen.

The character string input into the character string input field using touch switches is written to a character string memory table.

Bar codes can also be read and input by using a bar code reader connected to the NT631/NT631C.

Reference

There are two input methods when inputting character strings from a bar code reader: “automatic confirmation”, where the character string is confirmed on input, and “manual confirmation”, where the character string has to be confirmed by touch switch operation. Which of these methods is used is determined by the setting made for communication port A with the memory switches of the System Menu (Set “Bar-Code Reader”, then set automatic confirmation or manual confirmation for “Comm. Setting”).

- Outline of operation

The basic operation of a character string input field is shown below.

- (1) Input a character string into a character string input field using touch switches or a bar code reader. The input text is inserted at the position of the input cursor.

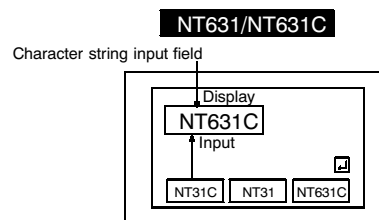

- (2) Confirm the input character string with the ENT key or  touch switch: it will be written to a character string memory table (when the input mode from a bar code reader is set as “automatic confirmation”, the character string is automatically confirmed on input).

At this time, the occurrence of a change in the contents of the character string memory table is notified to the host via the PT status notify area.

The writing of character string data to a character string memory table, and notification to the host, are not automatically executed merely by displaying a character string in a character string input field. Writing and notification are executed when the ENT key or  key touch switch is pressed.

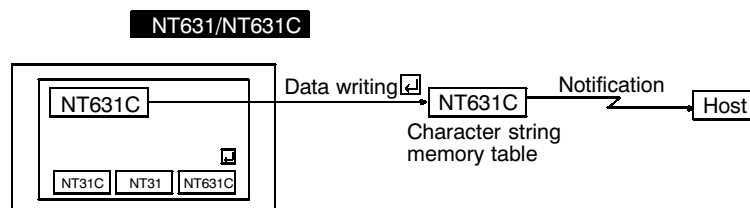

[Restrictions]

- A maximum combined total of 256 of the following elements can be registered for one screen (A thumbwheel type numeral setting input field cannot be used on the Windows screen. Either the numeric key type or the character string input fields, not both, can be registered on the Windows screen). Even in the case of an overlapping screen with eight child screens, it is only possible to register numeral setting input fields on one of the child screens.

Numeral setting input field (numeric key type)

Numeral setting input field (thumbwheel type)

Character string input field

There is no restriction on the number of input fields that can be registered for one screen data file: any number can be registered as long as the data file capacity is not exceeded. However, if a large number of elements are registered, check that the restrictions on element display are complied with by referring to "Display Restrictions" (page 635).

- It is not possible to set character string input from more than one character string input field on the same screen to one character string memory table.
- The following numbers of characters can be displayed in one character string input field, depending on the scale.

1 × 1 (Equal): Up to 40 characters

1 × 2 (High): Up to 40 characters

2 × 1 (Wide): Up to 40 characters

2 × 2: Up to 40 characters

3 × 3: Up to 26 characters

4 × 4: Up to 20 characters

8 × 8: Up to 10 characters

- The characters that can be displayed are alphanumeric, symbols and Marks. Marks are displayed at the standard height even if "Half Height" is set as the Font Type. Therefore, if normal alphanumerics and symbols are displayed after displaying a mark, part of the mark will remain displayed, as shown in the figure below.
- If "Half Height" is set for "Font Type", and a character string is written after displaying Marks, a part of the Marks will remain displayed, as shown below.

In this case, create blank characters as marks, write these marks, and then write the alphanumeric and symbol character string over them.

- It is not possible to register multiple input fields which refer to the same string table on the same screen.

[Common Attributes]

The relationship between the properties of a character string input field and the input and displayed character string is indicated below.

- Properties

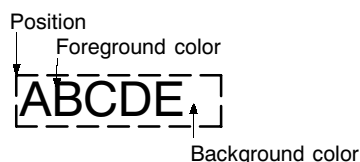

General	
Position	Coordinates of the top left corner of the character string input field
Font Type	Font for the characters Standard/Half Height
Scale	Scale at which the character string is displayed ("Enlarged display", page 359) 1 × 1 (Equal), 1 × 2 (High), 2 × 1 (Wide), 2 × 2, 3 × 3, 4 × 4, 8 × 8
Smoothing	Whether or not smoothing is used for characters with a scale of 2 × 2 or larger ("Smoothing", page 359) Check mark (smoothing executed)/ No check mark (smoothing not executed)
Attribute	Display mode for the text ("Display attributes and drawing result") Standard/Flash/Inverse Flash
Color	
Foreground	Display color of the text (colors other than black and white featured with NT631C only) Black/Blue/Red/Magenta/Green/Cyan/Yellow/White
Background	Background color of the text (colors other than black and white featured with NT631C only) Black/Blue/Red/Magenta/Green/Cyan/Yellow/White
Settings	
Table Entry	Number of the character string memory table to which the input character string is to be written Range: 0 to 1999
Length	Maximum number of characters in the input character string Range: 1 to 40
Focus Frame	Presence/absence of a frame indicating that the character string input field has become ready to accept input Check mark (frame present)/ No check mark (frame not present)
Focus Attribute	Display status before the input character string is confirmed ("Display attributes and drawing result", page 426) Standard/Inverse/Flash/Inverse Flash



If the number of characters actually input is greater than the number of input characters set for the character string input field, the excess characters are ignored.

If the number of characters actually input is less than the number of input characters set for the character string input field, the character string is input at the cursor position, and the characters that were to the right of the cursor position are shifted to the right. Therefore, when a character string with fewer than the set number of characters is input, characters that were displayed previously will be displayed following this character string. To make these characters blanks, either fill the surplus part with blanks, or use touch switches with the control code input function (“BS”, “DEL”, etc.) to delete the surplus characters before confirmation.

- Display attributes and drawing result

Attribute	Drawing Result
Standard	The character string input field is displayed with the specified foreground color and background color. 
Flash	Repeated alternation of the “standard” display and no display. 
Inverse Flash	Repeated exchange of the foreground color and background color. 

[Display Functions]

Character strings are displayed in the character string input field in accordance with the “General” settings.

For details on the method of display according to the “General” settings, refer to “Common Attributes” (page 425).

[Input Functions]

Character strings are input into the character string input field by using the “input key – string” and “input key – control” touch switches or a bar code reader.

For details on the connection and settings of the bar code reader, refer to 3-4 “Connecting a Bar Code Reader” (page 43).

[Output Functions]

Character string input fields only write input character strings to character string memory tables; they have no function for directly outputting data to external destinations (if the character string memory table to which the character string is written is allocated to the host, the data can be output to the host indirectly).

However, the input of a character string is notified to the host via the PT status notify area.

[Processing Functions]

Character string input fields have no processing function.

[Relationship with Other Elements]

- Character string displays (page 356) use the same display method as character string input fields.
- For details on how character strings are stored in character string memory tables, refer to 7-3-2 “Character String Memory Tables” (page 285).
- In order to use a character string input field, input and confirmation touch switches are required, unless a bar code reader is used with the “automatic confirmation” setting. In cases where there is more than one input field, switches for selecting and moving input fields are also required (page 521).
- Character string input fields overlap with other elements in accordance with the order in which they were registered for the screen with the Support Tool. However, the way in which they overlap can be changed with the Support Tool.

7-14 Window Function

The NT631/NT631C has “window function” which can display a window overlapping the currently displayed screen (base screen). Windows can be opened without restriction whenever necessary.

Reference The opening of windows by the operations at NT631/NT631C can be inhibited by a PT status control area operation.

7-14-1 What are windows?

A “window” is a screen that can be displayed overlaying a currently displayed screen (base screen). Its size and display position can be designated without restriction. Windows are mainly used for the applications indicated below.

- An explanatory message can be registered in a window, enabling it to be used as a HELP screen during operation.

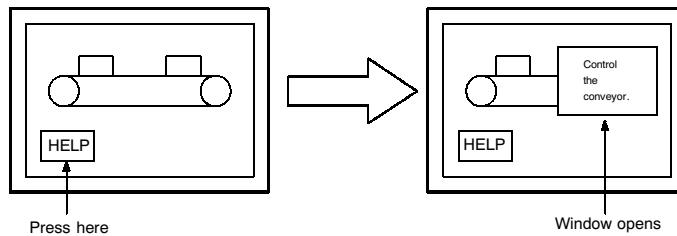

- By registering multiple input key-string (touch switches) for use in numeral/character string setting, the number of usable keys can be increased by switching windows as required, allowing various types of input.

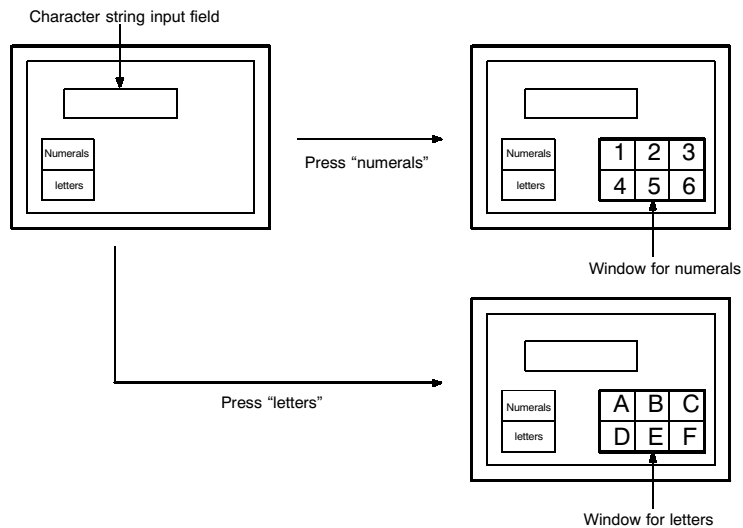

Reference In order to make numeral/character string settings, a key to confirm the input numeric value or character string is required. Allocate the ENT input key-control or Enter (↵) key to a touch switch to create this key.

- By registering multiple screen switching keys (touch switches), menus for screen switching can be created.

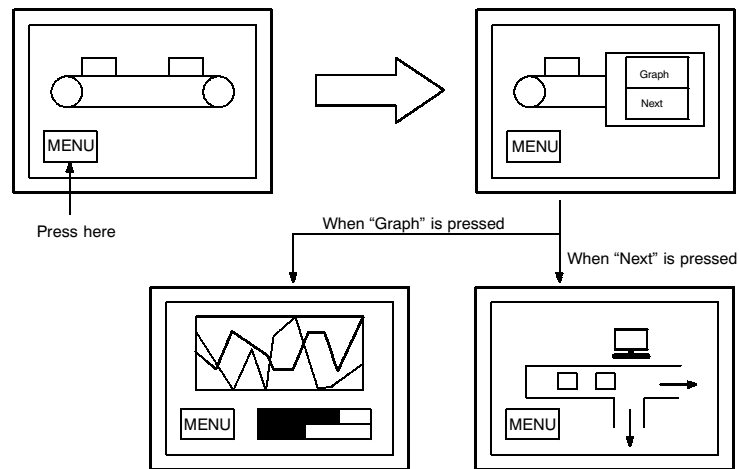

- The window can also be used as a sub screen for displaying a detailed information as required.

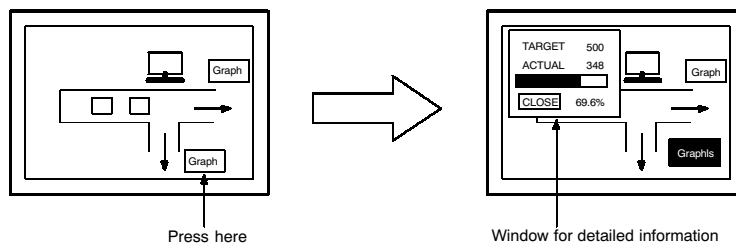

7-14-2 Window Type

The following two types of window are provided.

- Global window

This window can be displayed all the time while the NT631/NT631C is running regardless of the screen currently displayed. However, the global window is not displayed with the following screens.

- System menu
- System initializing screen (Screen No.9000)
- Error screen
- Programming console function screen (Screen No.9020)
- No-display screen (Screen No. 0)

Global window stays at the same position even when the screen is switched. (It can be moved also.)

Only one global window can be displayed at the same time.

Global window can be opened, closed or moved only by the operation of window control area from the host. For details of window control area, refer to "Window Control Area" (page 273).

- Local window

This window is closed at the same time the currently displayed screen is switched. By setting the local screen for the screen attribute, the specified screen can be opened at the same time the screen is displayed.

Up to two local window can be opened at the same time. (Local window 1/Local window2)

Opening, closing or moving a window can be performed by the following operations.

- Setting the screen attribute (A window pops up when the screen is displayed.)
- Touch switch operation (using input key-window/keyboard or window move function touch switch)
- Window control area operation from the host.

It is possible to specify the window type which is used for opening a window, therefore, the same window can be opened as a global window or as a local window. However, it is not possible to display the same window multiply using both window types.

Reference With NT631/NT631C, up to 3 windows can be opened at the same time. (1 global window and 2 local windows)

7-14-3 Window Screens and Display Elements

Using the window function, window can be created in any of the user screens, numbered 1 to 3999 (a screen for which a window is registered is called a “window screen”)

When a screen is registered as a window screen, the window area must be specified to set the size of the window. The window is always displayed at the “window area” size.

In addition, window position can be specified for the screen attribute, touch switch property or window control area when displaying the window. The window position can be moved later by touch switch operation or by a specification at window control area.

With NT631/NT631C, all elements other than thumbwheel switch can be registered.

However, only one temporary input field (numeral or string input) can be registered for a window.

By setting the “background color” screen attribute for a window screen, the window can be displayed with a different background color than that of the base screen.

Reference

- Elements that project beyond the window area will not be displayed when the window opens.
- While a window is open, display processing is slightly delayed.

7-14-4 Opening/Closing and moving a window

Window can be controlled by the following operations.

Opening windows by setting screen attribute

When creating a screen using the Support Tool, up to two windows can be specified as a pop-up window which is displayed at the same time the screen is opened. By this method, window is displayed at the position which was specified when window screen was created. This kind of window is a local window. For details of the setting, refer to "Screen Attributes" (page 252)

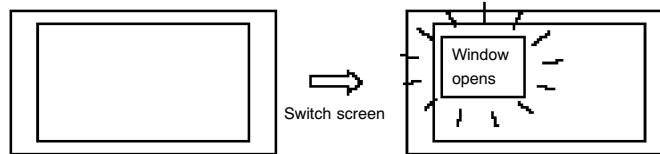

Opening/Closing and moving a window by touch switch operation

To create a pop-up window/keyboard touch switch on a screen or a window enables to open/close specified window. By this method, window is displayed at the position set for touch switch property. This kind of window is a local window.

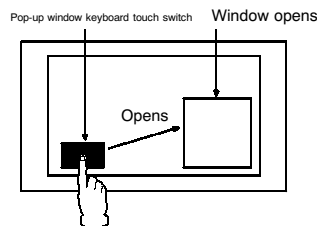

Also, by creating window move touch switch on window, it is possible to move a window by touch panel operation at the NT631/NT631C.

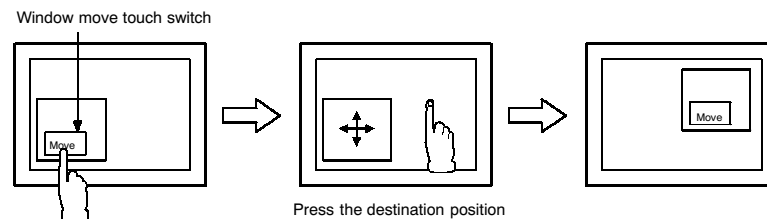

For details of touch switches, refer to 7-7 "Touch Switches". It is not possible to control global window by touch panel operation.

Opening/Closing and moving a window by the operation of window control area

While running the NT631/NT631C, by writing window screen number or X, Y coordinate of window position (bottom left) at window control area from the host, opening/closing, moving window are possible.

Window control area can control both global window and local window. For details, refer to 8-4 "Display and Control of Window" (page 478).

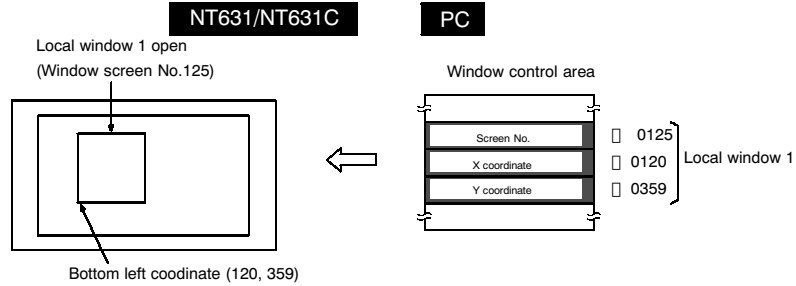

7-14-5 Size and display position of a window

Size of a window can be specified freely by 20 dot unit when creating a window screen. (Minimum window size: 20□ 20)

It is possible to display a window at a different position from where it was created, or to move a window. (Distance of movement has to be multiple of 20 also.)

Example:

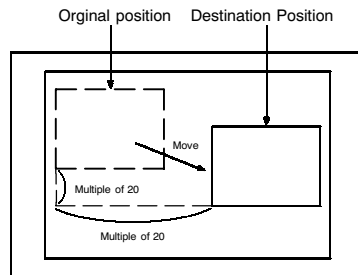

7-14-6 Changing the displaying order of windows

When multiple windows are displayed on a base screen, the part of the windows may overlap with each other. To move a window which is covered by the other window to the front, follow the methods below.

- Changing the displaying order by opening or moving operation of the window
The window which was opened or moved last comes to the front.

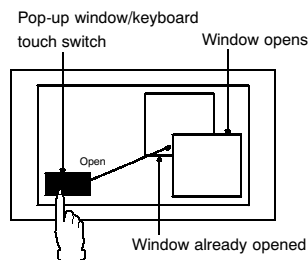

- Changing the displaying order by closing operation of the window
When the window at the front is closed, the window displayed next comes to the front.

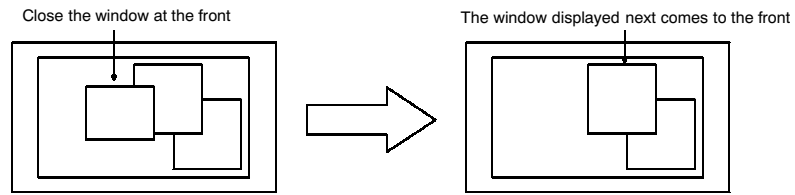

- Changing the displaying order by touch panel operation at the NT631/NT631C
When the window is touched, while it is being displayed, the touched window comes to the front automatically. However, if a touch switch is registered at the touched position, the touch switch function will be performed and the displaying order of windows is not changed.

- When a window other than touch switch position is pressed

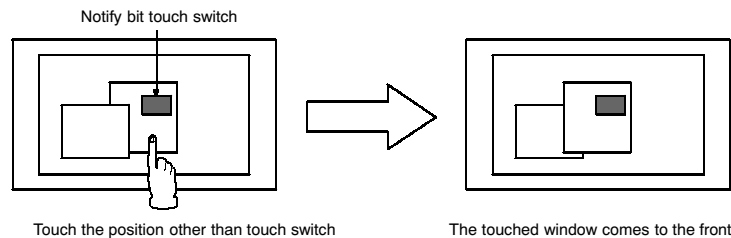

- When a touch switch on a window is pressed

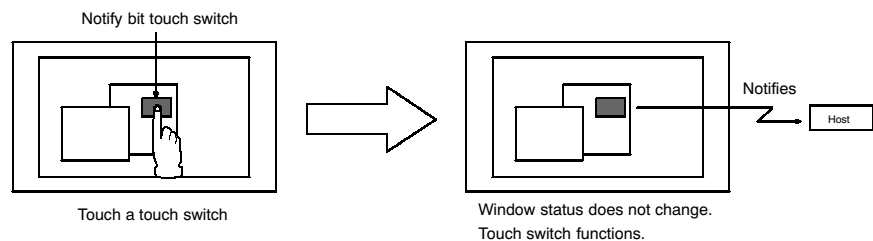

7-14-7 Checking the display status of a window

Whether window is opened or closed is written to “window open status” at PT status of PT notify area.

Window screen number and window position (bottom left coordinate) of currently displayed screen is written to window control area.

Checking these areas from the host enables to know the display status of window. For details, refer to 8-4 “Display and Control of Windows” (page 478).

7-14-8 Temporary Input Fields

Numeral/Character string input field registered on a window is a “temporary input field”.

(Only one numeral or character string input field can be registered for a window.) This input field can be used - in combination with a number of numeral and character string input fields on base screen - for provisional input before any data is input into the actual input field on the base screen.

The advantage of a temporary input field is that entries can be input into it while checking the current setting on the base screen.

Numeral input field Temporary input field (displays data being input)

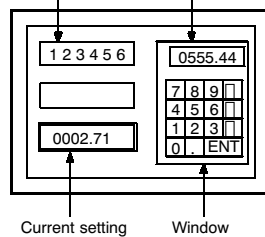

However, if there is not even one numeral setting input field (numeric key type) or character string input field on the base screen, the temporary input field will not be displayed (cannot be used).

If the temporary input field has fewer digits than the actual input field on the base screen (integer part + decimal fraction part + decimal point digit + sign digit), it will be displayed but can not be used.

If it is not possible to use a temporary input field, the data has to be input directly onto the base screen.

7-14-9 Focus window

“Focus window” is a screen on which currently activated input field (temporary input field) is registered. (In case there are no active input fields on windows even when multiple windows are displayed, it means that there are no focus windows.) When the data is input from touch switches or bar code reader, the data is input to a temporary input field on a focus window.

The focus window is determined by the following rules.

- When only one window has an active temporary input field.
The window with an active input field is a focus window.
- When there are multiple temporary input fields which are active.
The one at the front of all the windows which have active input fields is a focus window.

Example:

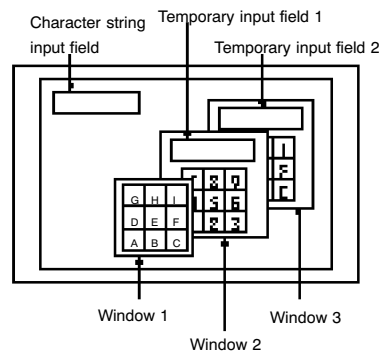

In the example above, window 2 is a focus window. All the input indicated below is performed to a temporary input field on window 2.

- Input from a character string key on base screen
- Input from a character string key on window 1
- Input from a character string key on window 2
- Input from a character string key on window 3
- Input from a bar code reader

Reference When a window 3 is touched on the position other than touch switch, the display order of the windows is switched and the window 3 will be the focus window.

7-15 Special Functions

Apart from the elements, the NT631/NT631C has the following functions which can be executed at the NT631/NT631C itself.

- Display history function Page 436
- Alarm history function Page 439
- Resume function Page 442
- Screen saver function Page 443
- Buzzer function Page 444
- Clock function Page 446
- Print function Page 447
- Programming console function (expansion function) Page 450

These special functions are described here.

7-15-1 Display History Record Function

The display history record function serves to record the order of display and display frequency of screens during operation. The recorded data can be displayed and checked either from the System Menu or during operation.

Procedure for Using the Display History Record Function

The procedure for using the display history record function is as follows.

(1) [Setting the screen attribute]

When creating screens with the Support Tool, set the "History" attribute for screens whose display history is to be recorded. For this setting, a character string ("title") can be registered to indicate the contents of the screen. Title is up to 24 characters in length.

Only screens for which the "History" attribute is set are objects of the display history record function.

(2) [Initializing the display history]

Before recording can be started, the display history must be initialized from the System Menu of the NT631/NT631C to clear the past records.

(3) [Recording the display history]

Operate the NT631/NT631C as usual.

When a screen for which the "History" attribute is set is displayed during operation, the time of display and number of times it has been displayed are recorded.

(4) [Checking the display history record]

Display and check the recorded display history record.

There are two methods for doing this: displaying the record from the System Menu, and displaying a screen with the display history record function during operation.

In either case, the records can be presented in occurrence order (order of display) or frequency order (order of frequency of display).

-
- Reference**
- The "History" attribute can only be set for user screens. It cannot be set for system screens and consequently these screens cannot be included in the display history record.
 - When an overlapping screen is displayed, the data for the parent screen is recorded.
 - Bit 11 (display history initialization) of the PT status control bits can also be used to initialize the display history record.
-

Recording Format for the Display History Record

For the display history record, the following data is recorded in the memory for screens with the "History" attribute.

- Screen number
- Time of display
- Display history title

-
- Reference**
- The display history record data is backed up by the built-in battery of the NT631/NT631C and is therefore retained even when the power to the NT631/NT631C is turned OFF or the NT631/NT631C is reset.
-

Maximum Number of Records

- Occurrence order

The data of up to 1024 screens can be recorded in the occurrence order display history record. The operation when 1024 records is exceeded depends on the setting made for "Screen (Use Ring Buffer)" on the "PT Configuration" – "System" screen at the Support Tool: select whether the record is to be stopped or the older records are to be deleted.

If no check mark is set for "Screen (Use Ring Buffer)", recording is stopped, and if a check mark is set, the new data is recorded and the older data is deleted instead.

- Frequency order

The data of up to 255 screens can be recorded in the frequency order display history record. Even if this limit is exceeded, still 255 records remain displayed.

Checking the Record

There are two methods for checking the display history record: checking the record contents in the Maintenance mode of the NT631/NT631C, and displaying a screen with the display history record function during operation.

- Displayed screens

In either case of order of occurrence or order of frequency, the number of records that can be displayed on one screen of the NT631/NT631C is 29. To view those records that are not displayed on the current screen, scroll the screen with the “up” and “down” touch switch arrow keys.

If no display history is recorded, the message “Display history is not found.” is displayed.

- Order of occurrence

The screen records are displayed in the order the screens were displayed. Whether the records are displayed from the oldest first or from the newest first is determined by memory switch setting at the NT631/NT631C.

No.	Sern	MDD	HHMM	Comment	1/ 1
1	1	0524	0441	Start	
2	32	0524	0606	Temp. Setting 1	Quit
3	44	0524	0841	Sector A	
4	32	0524	0841	Temp. Setting 1	↑
5	33	0524	0841	Temp. Setting 2	
6	34	0524	0841	Temp. Setting 3	↓
7	2	0524	0844	Main Monitor	
8	44	0608	0851	Sector A	
10	102	0612	1358	[A] Low Level	
11	2	0612	1403	Main Monitor	Prt.
12	45	0614	0851	Sector B	Prt. Stop

- Order of frequency

The screen records are displayed in the order of frequency of display (number of times displayed) of the corresponding screens.

No.	Sern	Ent.	Comment	1/ 1
1	1	164	Main Menu	
2	32	33	Temp. Setting 1	Quit
3	44	24	Sector A	

- Checking the record in the Maintenance mode

Select the Maintenance mode from the System Menu and display the history record.

For details on the System Menu operation, refer to 6-11-4 “Displaying and Printing the Display History Record” (page 215).

- Checking the record during operation

The display history record can be checked during operation by displaying either of the following screens.

Screen No. 9001: Occurrence history screen

Screen No. 9002: Frequency history screen

Reference	Screen numbers 9001 and 9002 are reserved for displaying the display history record. They cannot be used for other applications.
------------------	--

7-15-2 Alarm History Record Function

The alarm history record function continually monitors the status of host bits set in advance, and records the times at which the statuses of these bits change to “1” (ON). The setting for monitoring the bits can be made at bit memory table.

The recorded data can be displayed and checked even during operation, from the System Menu.

Procedure for Using the Alarm History Record Function

The procedure for using the alarm history function is as follows.

(1) [Setting the bit memory table]

At the Support Tool, allocate host bits to a bit memory table and set “History” as the function of the bit memory table. At this time, it is possible to specify character string memory tables that contain messages indicating the contents of alarms.

Only bits for which the “History” attribute is set are objects of the alarm history record function. Bits for which “History” is set are continually monitored during operation of the NT631/NT631C regardless of the screen being displayed.

(2) [Initializing the alarm history]

Before recording can be started, the alarm history must be initialized from the System Menu of the NT631/NT631C to clear the past records.

(3) [Recording the alarm history]

Operate the NT631/NT631C as usual.

When the status of a bit for which “History” is set changes to “1” during operation, the time of this event and the number of times the bit has come ON are recorded.

(4) [Checking the alarm history record]

Display and check the recorded alarm history record.

There are two methods for doing this: displaying the record from the System Menu, and displaying a screen for which an alarm history element is registered during operation.

In either case, the records can be presented in occurrence order (order of display) or frequency order (order of frequency of display).

Recording Format for the Alarm History Record

For the alarm history record, the following data is recorded in the memory for bit memory tables allocated to bits whose status changes to "1" (ON).

- Message (contents of a character string memory table set for the bit memory table)
- Time of display

Reference

- The alarm history record data is backed up by the built-in battery of the NT631/NT631C and is therefore retained even when the power to the NT631/NT631C is turned OFF or the NT631/NT631C is reset.
- Bit 1 (alarm history initialization) of the PT status control bits can also be used to initialize the alarm history.

Maximum Number of Records

- Occurrence order

The data of up to 256 bit memory tables (bits) can be recorded in the occurrence order alarm history record. The operation when 256 records is exceeded depends on the setting made for "Alarm (Use Ring Buffer)" on the "PT Configuration" – "System" screen at the Support Tool: select whether the record is to be stopped or the older records are to be deleted.

If no check mark is set for "Alarm (Use Ring Buffer)", recording is stopped, and if a check mark is set, the old records are progressively deleted.

- Frequency order

The data of up to 255 screens can be recorded in the frequency order alarm history record. Even if this limit is exceeded, still 255 records remain displayed.

Checking the Record

There are two methods for checking the alarm history record: checking the record contents in the Maintenance mode of the NT631/NT631C, and displaying a screen for which an alarm history element is registered during operation.

The display for the alarm history record function differs depending on whether it was called from the Maintenance mode or during operation.

- Displayed data

The data displayed with the alarm history record function are described below.

- Occurrence order

The records are displayed in the order in which the status of the set bit memory tables (bits) changed to "1" (ON). Whether the records are displayed from the oldest first or from the newest first is set with the memory switches at the NT631/NT631C.

- Frequency order

The records are displayed in the order of the number of times the statuses of the bit memory tables have changed to "1" (ON).

- Checking the record in the Maintenance mode

Select the Maintenance mode from the System Menu and display the alarm history record.

For details on the System Menu operation, refer to 6-11-5 “Displaying and Printing the Alarm History Record” (page 217).

When the record is checked in the Maintenance mode, screens like those shown below are displayed.

- Occurrence order screen

No.	MMDD	HHMM	Comment	1/ 1
1	0524	0441	Conveyor Stopped	Quit
2	0524	0606	Temp. Low Level	
3	0524	0841	Process 2 Stopped	↑
4	0524	0841	Process 1 Stopped	
5	0524	0849	Conveyor Stopped	↓
6	0524	1521	Conveyor Stopped	
7	0526	0844	P/S Low Voltage	Prt.
8	0527	1732	Conveyor Stopped	
9	0527	1125	Temp. Low Level	Prt. Stop
10	0530	2109	Process 1 Stopped	
11	0604	1833	Process 1 Stopped	
12	0604	2106	Conveyor Stopped	
13	0604	2152	Conveyor Stopped	

- Frequency order screen

No.	Snt.	Comment	1/ 1
1	129	Conveyor Stopped	Quit
2	106	Temp. Low Level	
3	49	Temp. High Level	↑
4	16	P/S Low Voltage	
5	15	Process 3 Stopped	↓
6	13	Water Tank Overheating	
7	11	Process 2 Stopped	Prt.
8	6	Process 1 Stopped	
9	4	Pin 1	Prt. Stop
10	2	Pin 2	
11	1	Setting Error	

- Checking the record during operation

The alarm history can be checked during operation by displaying a screen for which an alarm history element has been registered.

In this case, the alarm history element is displayed in the manner shown below. However, note that the width and height of the alarm history element, and the method of display for the time, can be changed by setting properties. For details, refer to 7-11 “Alarm List, Alarm History” (page 396). Occurrence order screen

Abnormal remote I/O	06/06	16:02	▲
Abnormal high function unit	06/07	09:21	▲
Cycle time over	06/17	15:44	
			▼
			▼

Occurrence of transmission abnormality

Check the remote I/O transmission line!

- Frequency order screen

Cycle time over	114	▲
Abnormal high function unit	53	▲
Abnormal remote I/O	39	
		▼
		▼

Cycle time
exceeds 100 msec!

The following countermeasure should be taken: Program is checked again.
Setting of cycle time over not detected (DM6655:X1XX)

7-15-3 Resume Function

The NT631/NT631C has a function to protect the contents of memory tables that have been changed during operation (by the numeral/character string setting function, or by an instruction from the host) and retain them even when the power to the NT631/NT631C is OFF or the NT631/NT631C is reset, so that operation can be restarted in the same status the next time the NT631/NT631C is started. This function is called the “resume function”.

When the resume function is set, the contents of the memory tables are not initialized when the power is turned OFF, when the NT631/NT631C is reset, or on existing from the System Menu.

This means that when operation is restarted the next time, the same screen as previously displayed can be displayed again by writing the data that was stored in the memory tables to the host. However, when a memory table is allocated to a word at the host and the memory table is set not to be initialized, the contents of the word at the host will be written to the memory table instead of the other way round, therefore the previous contents of the memory table will be lost.

Even if the resume function is set, if memory table initialization is executed, the memory table contents will be initialized to the defaults set with the Support Tool.

Whether the resume function is used or not is set with the memory switches of the NT631/NT631C. For details, refer to 6-9-10 “Setting the Resume Function” (page 199).

Reference

When the voltage of the NT631/NT631C’s built-in battery becomes low, the memory table contents cannot be retained even if “ON” is set for the resume function.

7-15-4 Screen Saver Function

The NT631/NT631C has a function to maximize the service life of the backlight and to prevent the formation of an afterimage by turning off the screen display and the backlight if no operation is performed for a certain period of time.

If the same data is displayed for a long time (about 24 hours), an afterimage will form on the screen. To prevent this, either use the screen saver function or periodically switch the screen.

There are the following two types of screen saver function.

- Screen saver that turns off the screen and the backlight
- Screen saver that displays the contents of character string memory table No. 0 for a set length of time each at random positions on the screen (with the NT631C, the color is also changed randomly). With this screen saver, the backlight is not turned off.

Notice	Do not press touch switches carelessly while the backlight is off or while nothing is displayed on the screen. Confirm system safety before pressing touch switches.
Notice	After images may remain if the same pattern is displayed for a long period (approx. 24 hours). To prevent the formation of an afterimage, either use the screen saver function or periodically switch screens.
Reference	It is also possible to start the screen saver function using bit 15 (screen display) of the PT status control bits.

Redisplaying a Cleared Screen

When a screen has been cleared due to activation of the screen saver function, this screen can be redisplayed by pressing an NT631/NT631C touch switch, or by a screen switching instruction from the host (if the backlight is off, it is also turned back on). The screen will not be redisplayed when display contents such as numeric values or character strings are changed.

Setting the Screen Saver Function

Whether or not the screen saver function is used and, if it is used, the waiting time for execution, is set with the memory switches of the NT631/NT631C.

For details on the setting method, refer to 6-9-7 "Setting "Screen Saver Movement" (page 194) and 6-9-8 "Setting the Screen Saver Start-up Time" (page 196).

7-15-5 Buzzer Function

The NT631/NT631C buzzer can be sounded to inform of emergencies and NT631/NT631C errors.

Reference Whether or not the buzzer actually sounds depends on the memory switch settings made at the NT631/NT631C. The following three buzzer settings can be made with the memory switches.

- OFF: The buzzer never sounds.
- ERR ON: The buzzer only sounds when an NT631/NT631C error occurs.
- ON: The buzzer sounds in response to instructions from the host and screen attributes.

For details, refer to 6-9-4 "Setting the "Buzzer Sound" (page 189).

Types of Buzzer

The following three types of buzzer can be sounded by the NT631/NT631C.

- Continuous buzzer
Buzzer that sounds continuously
- Short intermittent buzzer
Buzzer that repeatedly alternates between sounding and stopped states of 0.5 seconds duration each.
- Long intermittent buzzer
Buzzer that repeatedly alternates between sounding and stopped states of 1.0 seconds duration each.

If more than one buzzer type has been set with the PT status control bits, the order of priority below is followed (highest priority at the top).

- (1) Continuous buzzer
- (2) Short intermittent buzzer
- (3) Long intermittent buzzer

For example, if the continuous buzzer and short intermittent buzzer are specified together, the continuous buzzer sounds.

Sounding the Buzzer

Except the case the buzzer is set not to sound at all, the buzzer automatically sounds when an error occurs at the NT631/NT631C. Apart from this, there are the following two methods for sounding the buzzer.

- Sounding the buzzer by control from the host
The buzzer can be sounded from the host by operating the PT status control area during operation (page 459).

- A method to use the "Buzzer" screen attribute

By setting a "Buzzer" screen attribute when creating screen data with the Support Tool, the buzzer can be sounded when the created screen is displayed (page 458).

Stopping the Buzzer

When the buzzer is sounding, it can be stopped in the following ways.

- By operating the PT status control area from the host (page 460).

However, when this method is used, the buzzer will not be stopped unless the bits for all three buzzer types — continuous, short intermittent, and long intermittent — are set to “0” (OFF).

- By displaying a screen for which no buzzer attribute is set (page 460).
- By pressing a touch key assigned the buzzer stop function (page 461).

By creating a touch switch assigned the buzzer stop attribute (the [P]]) input key – control) on a screen for which a buzzer attribute is set, the buzzer can be stopped by pressing this switch.

7-15-6 Clock Function

The NT631/NT631C has a clock function for setting and displaying the date and time. The clock function is backed up by the built-in battery of the NT631/NT631C.

- Reference**
- When the battery voltage becomes low, the time data cannot be retained by turning off the power to the NT631/NT631C, or resetting the NT631/NT631C, consequently the clock function will not operate correctly.
 - The NT631/NT631C does not allow display and setting of clock data with the clock function from the Support Tool. To set the time, use System Menu or numeral memory table operations.
 - No calendar or time data is set on shipment from the factory.

Numeral Memory Tables Used with the Clock Function

The NT631/NT631C uses numeral memory tables No. 247 to 255 for clock data.

As shown in the table below, numbers 247 to 253 are for display and reading only, and numbers 254 and 255 are for time setting.

Numbers 247 through 253 store clock data which is updated by the internal clock of the NT631/NT631C. This data cannot be rewritten by the host.

Function	Numeral memory table	Digit position	Information	Value	Remarks
Display/reading only	247		Second	00 to 59	
	248		Minute	00 to 59	
	249		Hour	00 to 23	24-hour system
	250		Date	01 to 31	
	251		Month	01 to 12	
	252		Year	00 to 99	Last 2 digits of the year
	253		Day of week	00 to 06	See below.
Setting only	254		Second	00 to 59	
			Minute	00 to 59	
			Hour	00 to 23	24-hour system
			Date	01 to 31	
	255		Month	01 to 12	
			Year	00 to 99	Last 2 digits of the year
			Day of week	00 to 06	
			Vacant	00	

The numeric values that correspond to the days of the week are as follows.

Day of week	Sun	Mon	Tue	Wed	Thu	Fri	Sat
Value	00	01	02	03	04	05	06

Setting example: March 27 (Fri), 1998, 14:53:30

254 27145330
 255 00059803

Reference	Numeral memory tables No. 247 to 255 provided for clock data use cannot be allocated to host words.
------------------	---

Setting Clock Data

The following two methods can be used to set clock data.

- Setting from the System Menu

Display the menu for displaying and setting clock data from the System Menu and make the settings. For details, refer to 6-11-2 "Displaying/Setting the Calendar and Clock" (page 211).

- Rewriting numeral memory tables 254 and 255

Numeral memory tables number 254 and 255 for clock data setting are rewritten using the memory table copy function to set the clock data (it is not possible to rewrite numeral memory tables 254 and 255 from the host). For details, refer to 8-10 "Display and Setting of Calendar Clock" (page 533).

7-15-7 Print Function

The following data can be printed out by connecting a printer to the NT631/NT631C.

- The currently displayed screen (hard copy)
- Display history/alarm history record data

Settings for Printing

In order to print out data at a printer connected to the NT631/NT631C, the type of printer used and the printing method must be set with the memory switches of the NT631/NT631C.

- Type of printer:

The following printer types can be used: printers that emulate NEC PC-PR201H, and printers that comply with the ESC/P 24-J83C (color) or ESC/P 24-J82 (monochrome) standard, or printers that comply PCL 5.

- Printing method:

When a color printer is used, color printing can be performed without additional settings. When using a monochrome printer, printing in which colors are expressed as 8 grayscale levels ("tones") is possible. However, the NT631 is not capable of color printing or "tone" printing.

When PCL 5 is used, only "tone" printing is possible (color printing is not supported).

For details on the method for setting memory switches, refer to 6-9-5 "Setting the "Printer Controller" (page 191) and 6-9-6 "Setting the "Print Method" (NT631C Only)" (page 192).

Printing a Screen Image

The following two methods are available for printing out a hard copy of the currently displayed screen.

- Using a touch switch with the screen print function

When creating the screen to be printed out, register a touch switch with the screen print touch switch for it.

When this screen is displayed during operation, pressing the touch switch will cause a hard copy of the screen to be printed out.

For details, refer to 7-7 “Touch Switches” (page 328).

Reference

- The NT631/NT631C continues operation during printing.
- If a touch switch with the function for stopping printing has been registered for the screen, printing can be stopped by pressing this touch switch.

- Method using the PT status control bits

When the status of the “screen printing” bit (bit 7) of the PT status control bits is set to “1” (ON), a hard copy of the screen displayed at that time is printed out.

For details, refer to 7-2-1 “PT Status Control Area (Host to NT631/NT631C)” (page 260).

Reference

- The NT631/NT631C continues operation during printing.
- Before setting the status of the “screen printing” bit to “1” (ON), confirm that the status of “printer operating status” bit (bit 7) of the PT status notify bits is “0” (OFF).
- When printing is executed using the PT status control bits, it is not possible to stop printing part way through.

- Printing example



Printing Display History and Alarm History Record Data

The display history and alarm history recorded in the NT631/NT631C can be printed out by calling the “display history” and “alarm history” display screens from the System Menu.

To print when the NT631/NT631C is running, display a display history dedicated screen, or a screen for which an alarm history is registered, then print it using the screen print function.

Switch between screens by pressing a touch switch allocated the screen switching function, or by writing the screen number to the “screen switch setting” word in the PT status control area. To print a screen, either press a touch switch allocated the screen print function or set the “screen printing” bit in the PT status control bits to “ON”.

The display history dedicated screens are:

Occurrence history screen: 9001

Frequency history screen: 9002

- Printing example

- Display history

Occurrence order

No.	Scrn	YY/MM/DD	HH:MM	Comment	1/1
1	1	98/02/23	08:45	menu screen	
2	4	98/02/23	08:46	alarm screen	
3	3	98/02/23	08:47	setting screen	
4	4	98/02/23	08:47	alarm screen	
5	1	98/02/23	08:48	menu screen	
6	4	98/02/23	08:50	alarm screen	
7	3	98/02/23	08:51	setting screen	
8	1	98/02/23	08:55	menu screen	
9	4	98/02/23	09:06	alarm screen	
10	1	98/02/23	09:07	menu screen	
11	3	98/02/23	09:07	setting screen	
12	4	98/02/23	10:50	alarm screen	
13	1	98/02/23	10:51	menu screen	
14	3	98/02/23	10:52	setting screen	

Frequency order

No.	Scrn	Cnt.	Comment	1/1
1	1	14	menu screen	
2	4	10	alarm screen	
3	3	8	setting screen	

- Alarm history

Occurrence order

No.	Comment	YY/MM/DD	HH:MM	1/1
1	WATER TANK OVERHEATING	98/02/22	13:05	
2	PROCESS 3 STOPPED	98/02/22	13:06	
3	PROCESS 3 STOPPED	98/02/22	13:08	
4	SUPPLY MATERIAL A	98/02/22	13:09	
5	WATER TANK OVERHEATING	98/02/22	13:10	
6	WATER TANK TEMP. TOO LOW	98/02/22	13:12	
7	WATER TANK OVERHEATING	98/02/22	13:15	
8	PROCESS 5 EMERGENCY STOP	98/02/22	13:20	
9	TEMP. OUT OF SETTING RANGE	98/02/22	13:21	
10	SUPPLY LABEL PAPER	98/02/22	15:42	
11	SUPPLY MATERIAL A	98/02/22	15:42	
12	TEMP. OUT OF SETTING RANGE	98/02/22	15:45	
13	WATER TANK TEMP. TOO LOW	98/02/22	15:49	
14	SUPPLY MATERIAL A	98/02/22	15:52	
15	TEMP. OUT OF SETTING RANGE	98/02/22	15:57	

Frequency order

No.	Comment	Cnt.	1/1
1	WATER TANK OVERHEATING	15	
2	WATER TANK TEMP. TOO LOW	14	
3	PROCESS 3 STOPPED	10	
4	TEMP. OUT OF SETTING RANGE	8	
5	SUPPLY MATERIAL A	7	
6	PROCESS 5 EMERGENCY STOP	7	
7	SUPPLY LABEL PAPER	6	
8	SUPPLY MATERIAL B	5	
9	PROCESS 2 STOPPED	1	
10	PROCESS 1 STOPPED	1	

7-15-8 Programming Console Function (Expansion Function)

As an expansion function, the NT631/NT631C features the “programming console function”, which allows to be used in place of a programming console (model C200H-PRO27-E) for a CSI-series CS1G/CS1H C-series CPM1 (CPM1A), or a CQM1, C200HX/HG/HE-ZE.

Most of programming console functions are possible, with the exception of recording (storing) ladder programs on cassette tape and replaying (reading) them.

For details on the system configuration for using the programming console function, the method for connection to a PC, and how to use the programming console function, refer to 6-12 “Programming Console Function” (page 237).

Programming console function can be used even when the PLC is in running mode.

Note, however the NT631/NT631C will stop operating at the same time the programming console function is applied. (RUN LED goes OFF)

Pressing a “Quit” touch switch on the programming console function screen returns to a screen displayed just before the programming console function was called.

Reference The NT631/NT631C automatically distinguishes the model of connecte, PLC and automatically displays the programming console function screen which conforms to the PLC.

7-16 PT Configuration Settings

Apart from the settings of the memory switches at the NT631/NT631C itself, the basic operation of the NT631/NT631C is also determined by the “PT Configuration” settings made at the Support Tool.

This section describes the settings made under “PT Configuration”. However, note that the operations at the Support Tool are not described. For details on these operations, refer to the NT-series Support Tool Ver. 3.0 for Windows95 Operation Manual (V053-E1-□).

7-16-1 “PT Configuration” Settings

There are the following PT Configuration settings.

[PT Model]

Set the type of PT to be connected. (Refer to 8-1 “Screen Creation Procedure” (page 392)

[PLC Vendor]

Set the direct connection type from either of the followings

- OMRON
- Mitsubishi-A
- Mitsubishi-FX
- MEMLINK

[Font Type]

Set the font type used for the screen data to be created.
The following two font types are available.

- CP437
- ISO 8859-1

[Comments]

Set a comment relating to screen data here. This comment is displayed on the screen on manual transmission of memory unit.

[PT Control Area/PT Notify Area]

Set the allocated words for the PT status control area, PT status notify area and window control area here. Refer to 7-2 “Areas for Control/Notification” (page 260).

[Initial Screen]

Set the screen number of the screen that is displayed when NT631/NT631C operation starts. However, note that the screen set here is displayed as the initial screen only when the setting made for the “screen switch setting” word in the PT status control area is not a correct screen number. For details, refer to “Functions of the PT Status Control Area” (page 261).

[History Setting]

Set the processing method when the record areas for the display history function and alarm history function become full. Refer to “Alarm list/history function” (page 293).

[Number of Table Entries]

Set the numbers of numeral memory tables, character string memory tables, and bit memory tables here. For details on the numbers that can be set, refer to 7-3 "Memory Tables" (page 278).

[Numeral Storage Type]

Set whether the contents of numeral memory table allocated words are handled as BCD data or binary data. However, the numeric value storage method set here is only valid when "System" is set for "Storage Type" for each numeral memory table concerned. For details, refer to 7-3-1 "Numeral Memory Tables" (page 278).

SECTION 8

How to Use the PT

This section describes how to use the functions provided by the PT.

8-1	Screen Creation Procedure	454
8-2	Buzzer, Backlight, and Display Control	456
8-2-1	Sounding the Buzzer	456
8-2-2	Stopping the Buzzer Sound	458
8-2-3	Controlling the Backlight (for NT631C only)	460
8-2-4	Turning off the Screen	462
8-2-5	Redisplaying the Turned-off Screen	464
8-3	Screen Display and Notification	467
8-3-1	Switching the Screen	467
8-3-2	Finding the Screen Number of the Presently Displayed Screen	473
8-4	Display and Control of Windows	476
8-4-1	Opening/Closing/Moving a Window	476
8-4-2	Checking the display status of a window	482
8-4-3	Disabling/Enabling the Opening of a Window	485
8-5	Changing Numeral and Character String Display	486
8-5-1	Changing Numeric Values and Character Strings	486
8-6	Display of Graphs	502
8-6-1	Changing the Trend Graph Display	502
8-7	Input of Numeric Values and Character Strings	503
8-7-1	Inputting a Numeric Value	503
8-7-2	Inputting Character Strings	519
8-8	Using the Alarm List/History Function	523
8-8-1	How to Use the Alarm List/History	523
8-9	Using the Display History Function	528
8-9-1	How to Use the Display History	528
8-10	Display and Setting of Calendar Clock	531
8-10-1	Setting the Date and Time	532
8-10-2	Displaying the Date and Time	536
8-11	Printing Data and Checking the Printer Status	539
8-11-1	Printing the Screen	540
8-12	Enabling/Disabling PT Operations	543
8-12-1	Enabling and Disabling the Operation of the NT631/NT631C	543

8-1 Screen Creation Procedure

Follow the procedure shown below to create screens for the NT631/NT631C. The following gives the procedure assuming that the setting for the NT631/NT631C has been completed. The operating procedure for a Support Tool is not given here. For the operating procedure for the Support Tool, refer to the NT-series Support Tool Ver. 3.0 for Windows95 Operation Manual (V053-E1-□).

[Creating a New Screen]

Tool Setting (for PT Type)

Set "NT631" for creating a screen for NT631, and "NT631C" for NT631C.



System Setting (Memory Switch Setting)

Set the memory switches that determine the basic operation of the NT631/NT631C. The numeral/character string/bit memory table settings should also be made at this stage.



Setting for PT Status Control/Notify Area

Allocate the PT status control area and PT status notify area, necessary for the direct connection function, to words at the host. For details, refer to 7-2 "Areas for Control/Notification" (page 260).



Reference

If is not necessary to allocate words to window control area, when the window is not used or when the window is not controlled from the host.

[Correcting an Existing File]

File Designation

Designate a work file.



[Importing DOS Version Data]

File Designation

Designate the work file to be data converted.

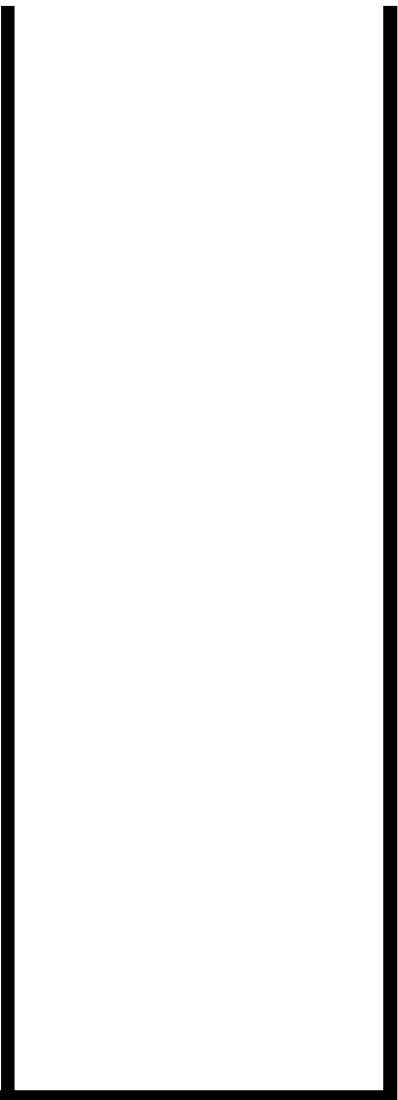



Creating and Correcting a Screen

After designating a screen, set the screen properties and register elements for the screen or correct the screen. If necessary, create marks, image data, and library data, and set the initial values of memory tables. For details of screens and elements, refer to SECTION 7 "NT631/NT631C Functions".



Saving a File

Save the created screen data to a file.



Transmitting the Screen Data

Transmit the created screen data to the NT631/NT631C. After setting the NT631/NT631C in the Transmit mode, execute the screen data transmission operation with the Support Tool.

NT631/NT631C



Support Tool



8-2 Buzzer, Backlight, and Display Control

The procedure for controlling the PT status including sounding the buzzer, backlight ON/OFF status, and turning ON/OFF the screen display is described below.

8-2-1 Sounding the Buzzer

The NT631/NT631C provides the following three types of buzzer sounds.

- Continuous sound
The buzzer sounds continuously.
- Short intermittent sound
The buzzer sounds intermittently at 0.5 second intervals.
- Long intermittent sound
The buzzer sounds intermittently at 1 second intervals.

With the NT631/NT631C, the following two methods are used for sounding the buzzer.

- Displaying a screen for which the buzzer attribute is set
- Using a PT status control area operation

Reference Whether or not the buzzer actually sounds depends on the setting of the memory switch in the NT631/NT631C. The memory switch has the following three setting positions.

- OFF: The buzzer never sounds.
- ERR ON: The buzzer only sounds when an NT631/NT631C error occurs.
- ON: The buzzer sounds in response to instructions from the host and screen attributes and when an error occurs.

To control the buzzer, set the memory switch at "ON". For details, refer to 7-15-5 "Buzzer Function" (page 444).

Sounding the Buzzer by Displaying a Screen for Which the Buzzer Attribute Is Set

If this method is used, the buzzer sounds automatically when a specific screen is displayed.

[Setting]

When creating a screen using the Support Tool, set any of the following buzzer attributes for the screen. Nothing is set in the default setting.

- Continuous
- Short beep
- Long beep

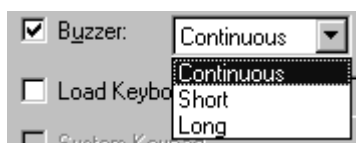

[Operation]

When the screen where the buzzer attribute has been set is displayed during the operation of the NT631/NT631C, the buzzer sounds automatically according to the setting. For the procedure for changing the screen, refer to 8-3-1 "Switching the Screen" (page 469).

Sounding the Buzzer by the Operation at the Status Control Area

This method allows the operator to sound the buzzer at any required time.

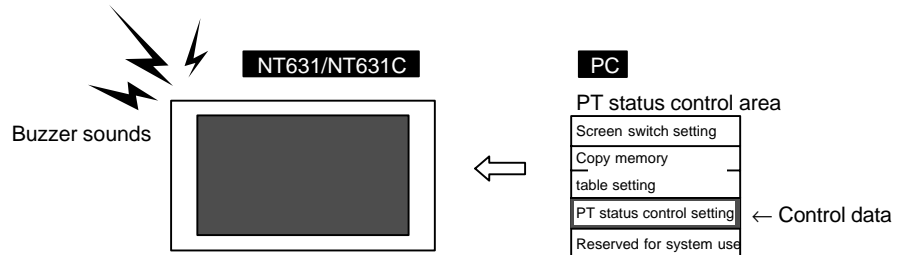

[Setting]

The PT status control area must be allocated to a word in the host and, accordingly, there are no special settings required for the control of buzzer.

[Operation]

The bit for controlling the PT status (PT status control bit) is provided at the fourth word (n + 3 words) from the beginning of the PT status control area.

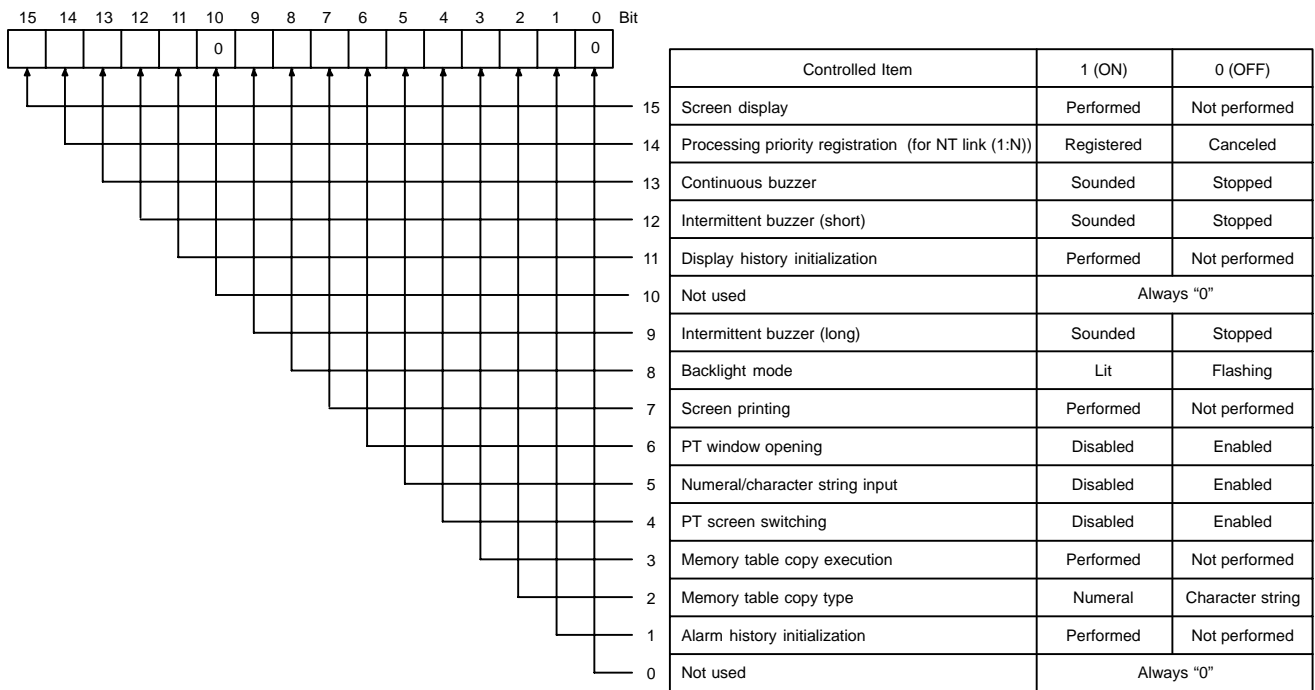

To sound the buzzer during the operation of the NT631/NT631C, operate the PT status control area as indicated below.

- (1) Set "1" (ON) for the following bit in the fourth word (n + 3 words) from the beginning of the PT status control area according to the required buzzer sound.
 - Continuous sound: Bit 13
 - Short intermittent sound: Bit 12
 - Long intermittent sound: Bit 9

8-2-2 Stopping the Buzzer Sound

With the NT631/NT631C, the following three methods are used for stopping the buzzer sound.

- Displaying a screen for which the buzzer attribute is not set
- Operating the PT status control area
- Pressing a touch switch which has the "buzzer stop" function

Stopping the Buzzer by Displaying a Screen for Which the Buzzer Attribute Is Not Set

When this method is used, the buzzer stops sounding automatically when the screen is switched to the one where the buzzer attribute is not set.

[Setting]

When creating a screen using the Support Tool, cancel the check mark for the buzzer attribute at the screens where the buzzer should not sound. (Usually, the buzzer attribute is not checked.)



[Operation]

When the screen for which the buzzer attribute is not checked is displayed during operation of the NT631/NT631C, the buzzer automatically stops sounding. For the procedure for switching the screen, refer to 8-3-1 "Switching the Screen" (page 469).

Stopping the Buzzer by the Operation at the PT Control Area

This method allows the operator to stop the buzzer at any required time.

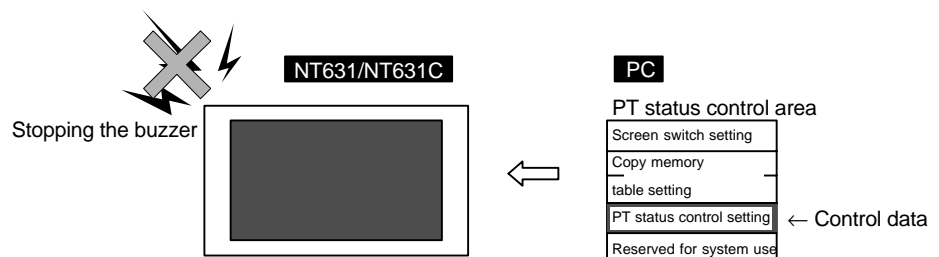

[Setting]

The PT status control area must be allocated to a word in the host and, accordingly, there are no special settings required for the control of buzzer.

[Operation]

The bit for controlling the PT status (PT status control bit) is provided at the fourth word (n + 3 words) from the beginning of the PT status control area.

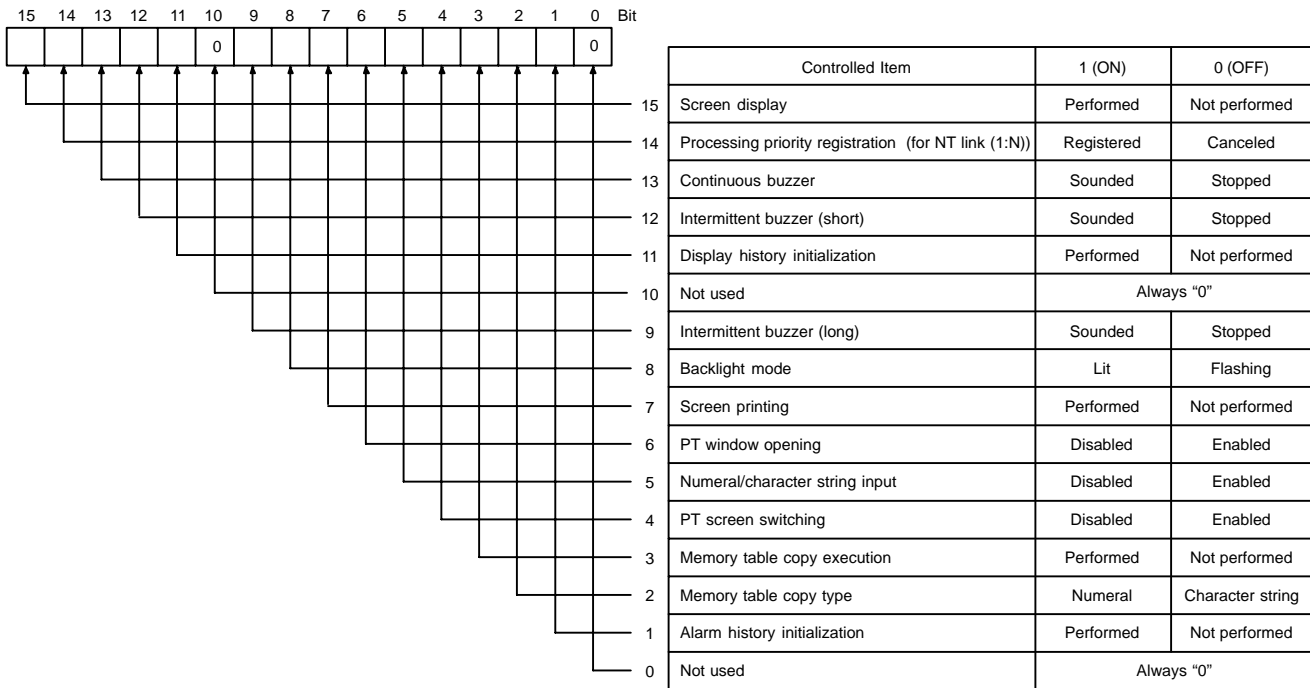

To stop the buzzer during operation of the NT631/NT631C, operate the PT status control area as indicated below.

- (1) Set "0" (OFF) for all of the following bits in the fourth word (n + 3 words) from the beginning of the PT status control area.
 - Continuous sound: Bit 13
 - Short intermittent sound: Bit 12
 - Long intermittent sound: Bit 9

Reference If more than one bit among the bits indicated above is "1" (ON) at the same time, only one type of buzzer sounds according to the priority: continuous buzzer > short intermittent sound > long intermittent sound. To stop the buzzer when it is sounding, set "0" (0) for all bits indicated above; setting "0" (OFF) only for the bit corresponding to the type of buzzer sound may not stop the buzzer.

Stopping the Buzzer by Pressing a Touch Switch Which Has the "Buzzer Stop" Function

Using this method, an operator can stop the buzzer by the operation at the NT631/NT631C. Usually, a "buzzer stop" touch switch is registered to a screen for which the buzzer attribute is set to sound the buzzer.

[Setting]

There is an "input key – control" touch switch that has the "buzzer stop" (Ⓟ) function.

Register this touch switch on the screen when creating it using the Support Tool.

[Operation]

- (1) Press the touch switch with the “buzzer stop” function to stop the buzzer.

8-2-3 Controlling the Backlight (for NT631C only)

The NT631/NT631C provides the following two backlight modes.

- Light: The backlight is lit continuously.
- Flash: The backlight alternates between lit and unlit states.

With the NT631/NT631C, the following two methods are used for controlling the backlight mode.

- Displaying a screen for which the backlight attribute is set
- Operating the PT status control area

Reference

If the screen saver function is set to “Display erased”, the backlight is turned off with the screen, which is turned off by the screen saver function if the NT631/NT631C not operated for a while, or by operation at the PT status control area. Even when the backlight has gone off, it may light or flash according to the setting if the backlight mode is changed by operation at the PT status control area. This setting has no effect for NT631.

Controlling the Backlight Status by Displaying a Screen for Which the “Backlight” Attribute Is Set

By using this method, it is possible to control the backlight automatically when a specific screen is displayed.

[Setting]

Set either of the following statuses for the “backlight” screen attribute of the screen for which the backlight is to be controlled when creating it using the Support Tool. (The default setting is “Light”.)

- Light
- Flash

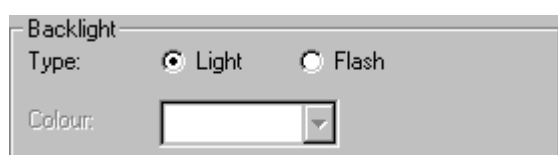
**[Operation]**

When the screen is changed over during the operation of the NT631/NT631C, the status of the backlight is controlled according to the setting for the backlight attribute of the newly called screen.

Controlling the Backlight Status by the Operation at the PT Status Control Area

Using this method, the backlight status (lit/flashing) can be controlled at any required time.

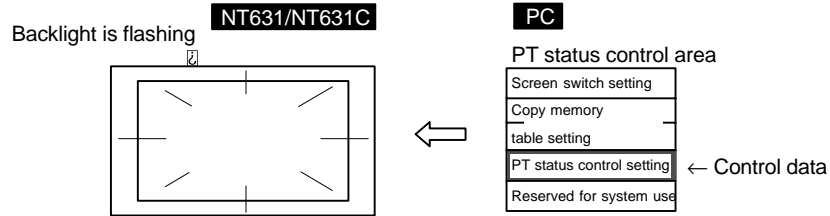

[Setting]

The PT status control area must be allocated to a word in the host, accordingly, no special settings are required for the control of buzzer.

[Operation]

The bit for controlling the PT status (PT status control bit) is provided at the fourth word (n + 3 words) from the beginning of the PT status control area.

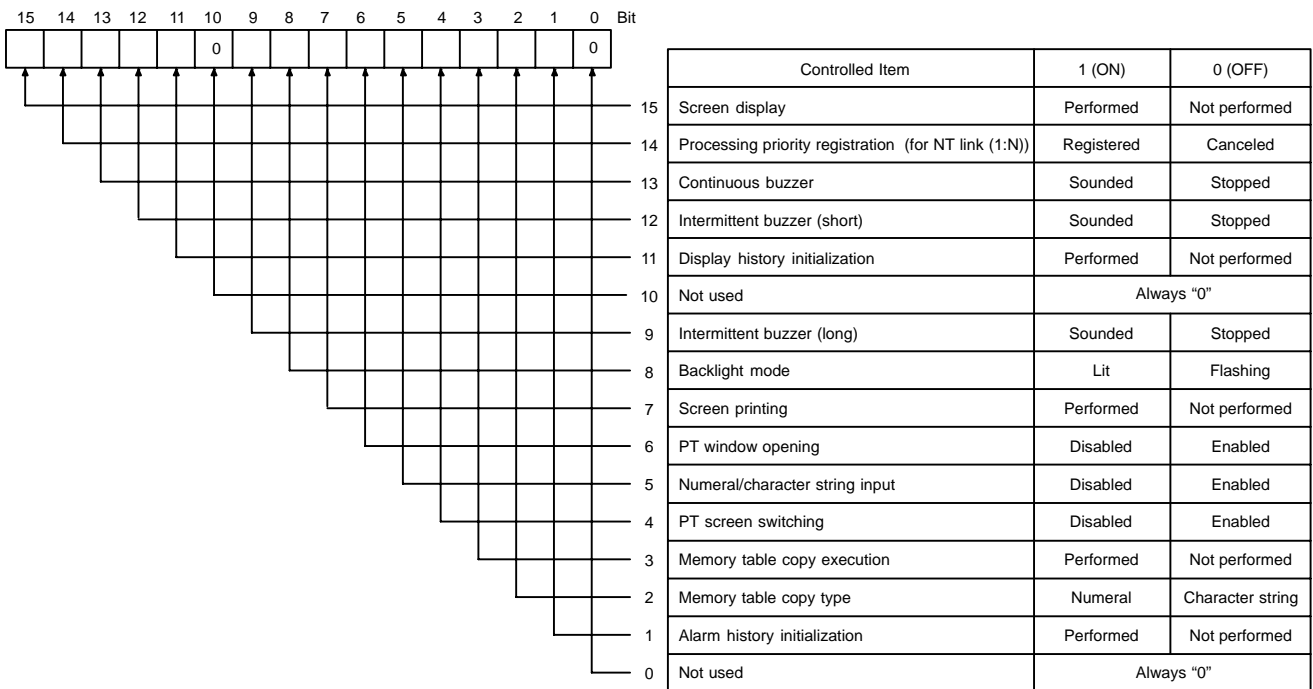

To control the backlight status during the operation of the NT631/NT631C, operate the PT status control area as indicated below.

- (1) Set "0" (OFF) or "1" (ON) for bit 8 in the fourth word (n + 3 words) from the beginning of the PT status control area.

Word n + 3, bit 8

- To turn the backlight on: 0 (OFF) → 1 (ON)
- To flash the backlight: 1 (ON) → 0 (OFF)

8-2-4 Turning off the Screen

By turning off the screen while it is not in use, the backlight lasts for a long time and, at the same time, afterimage on the display panel can be prevented. In the NT631C, the backlight is turned off automatically when the screen is turned off. If the screen saver function is set to "Display", however, it is not possible to prolong the life of the backlight since it is not turned off when the screen is turned off.

The NT631/NT631C provides the following two methods for turning off the screen.

- Using the screen saver function of the NT631/NT631C
- Operating the PT status control area

Notice To prevent the formation of an afterimage, either use the screen saver function or periodically switch screens.

Reference

- The screen can be made to enter the no-display state by specifying screen No. 0. In this state, however, the backlight remains lit or flashing.
- While the screen is in the no-display state, only screen switching operations from the host are permitted.
- While the screen is set off, the display of the screen immediately before the screen is turned off remains output by the NT631/NT631C.

Turning off the Screen Using the Screen Saver Function of the NT631/NT631C

If this method is used, the screen is automatically turned off when no operation is attempted for a preset length of time.

[Setting]

Using the system menu of the NT631/NT631C, set a value other than "000" for "Screen Saver Start up Time" (the length of time before the screen saver is activated after the last NT631/NT631C operation) and "Display erased" for "Screen Saver Movement". (The screen saver function is not executed if "000" is set for "Screen Saver Start up Time".)

Reference If a value is set other than "000" for "Screen Saver Start up Time" and "Display" for "Screen Saver Movement", the character string set in character string table No. 0 is displayed on the screen at random. In this case, the backlight is not turned off.

[Operation]

If the NT631/NT631C has not been operated (touch switch operation, screen switching operation) for the preset length of time during operation of the NT631/NT631C, the screen is automatically turned off.

Turning off the Screen by the Operation at the PT Status Control Area

This method makes it possible to turn off the screen at any required time.

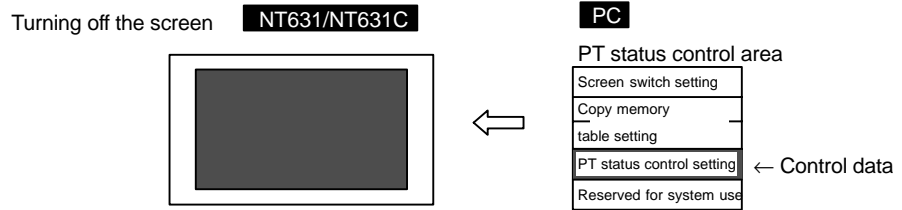

[Setting]

The PT status control area must be allocated to a word in the host, accordingly, no special settings are required for the control of buzzer.

[Operation]

The bit for controlling the PT status (PT status control bit) is provided at the fourth word (n + 3 words) from the beginning of the PT status control area.

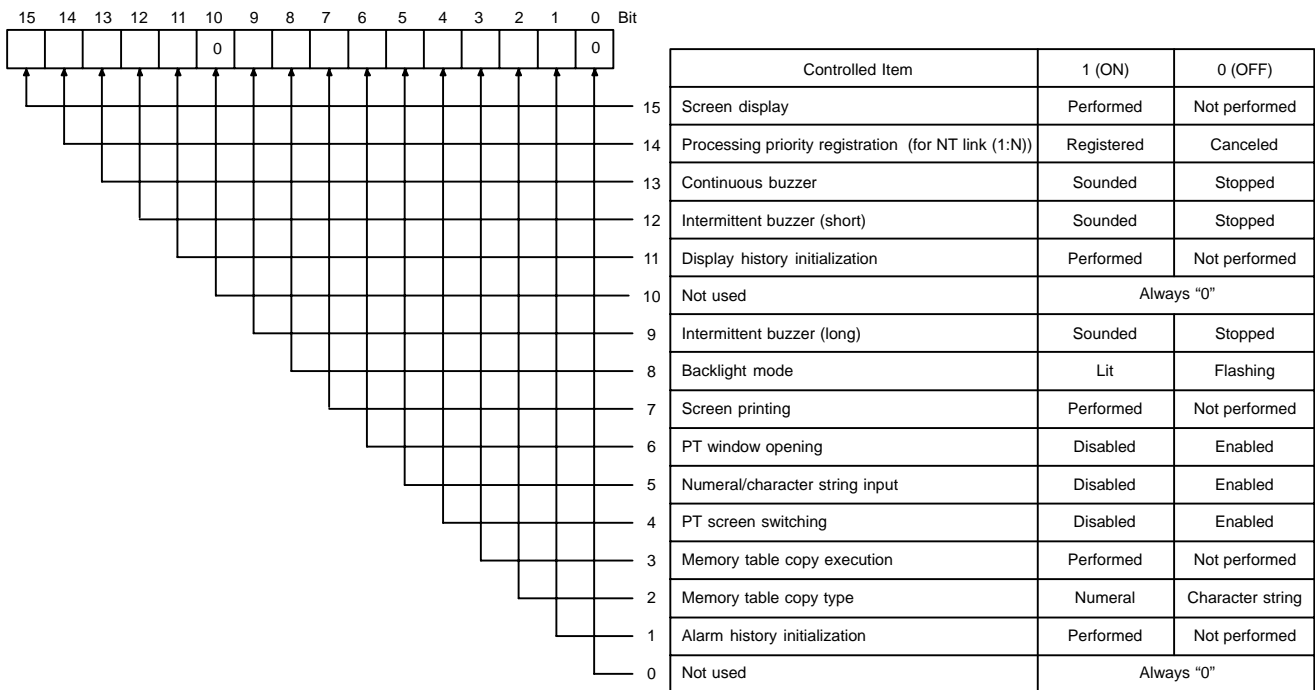

To turn off the screen during operation of the NT631/NT631C, operate the PT status control area as indicated below.

- (1) Set "0" (OFF) for bit 15 in the fourth word (n + 3 words) from the beginning of the PT status control area.

8-2-5 Redisplaying the Turned-off Screen

The following operations redisplay the screen which has been turned off by the screen saver function or due to the operation at the PT status control area.

- Switching the displayed screen (the new screen is displayed normally)
- Operation at the PT status control area (the previously displayed screen is re-displayed)
- Pressing the touch panel (the previously displayed screen is redisplayed)

Redisplaying the Screen by Switching the Displayed Screen

If this method is used, no special operation is necessary to redisplay the screen. The screen is redisplayed automatically.

[Setting]

No special setting is necessary.

[Operation]

Switching the screen during operation of the NT631/NT631C cancels the screen off status and displays the new screen. For the procedure for switching the screen, refer to 8-3-1 "Switching the Screen" (page 469).

Redisplaying the Screen by the Operation at the PT Status Control Area

This method allows the operator to redisplay the screen at any required time.

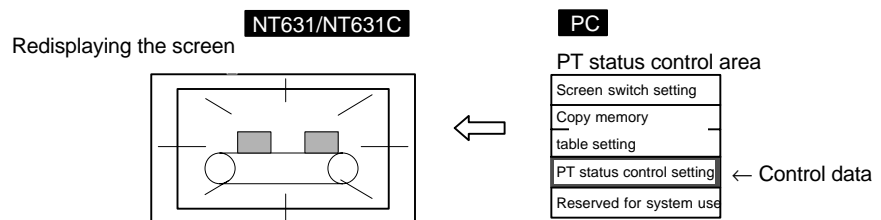

[Setting]

The PT status control area must be allocated to a word in the host, accordingly, no special settings are required for the control of buzzer.

[Operation]

The bit for controlling the PT status (PT status control bit) is provided at the fourth word (n + 3 words) from the beginning of the PT status control area.

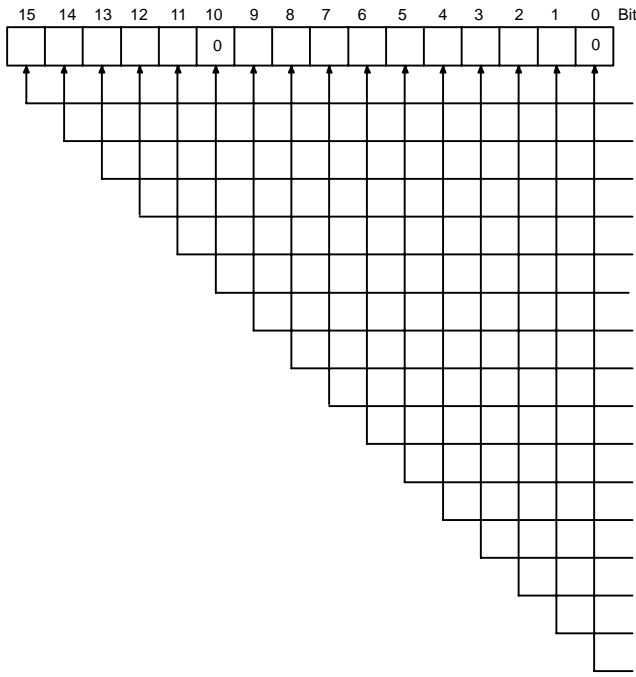

Controlled Item	1 (ON)	0 (OFF)
Screen display	Performed	Not performed
Processing priority registration (for NT link (1:N))	Registered	Canceled
Continuous buzzer	Sounded	Stopped
Intermittent buzzer (short)	Sounded	Stopped
Display history initialization	Performed	Not performed
Not used	Always "0"	
Intermittent buzzer (long)	Sounded	Stopped
Backlight mode	Lit	Flashing
Screen printing	Performed	Not performed
PT window opening	Disabled	Enabled
Numeral/character string input	Disabled	Enabled
PT screen switching	Disabled	Enabled
Memory table copy execution	Performed	Not performed
Memory table copy type	Numeral	Character string
Alarm history initialization	Performed	Not performed
Not used	Always "0"	

To redisplay the screen during the operation of the NT631/NT631C, operate the PT status control area as indicated below.

- (1) Set "1" (ON) for bit 15 in the fourth word (n + 3 words) from the beginning of the PT status control area.

Redisplaying the Screen by Pressing the Touch Panel

Using this method, an operator can redisplay the screen easily by operation at the NT631/NT631C.

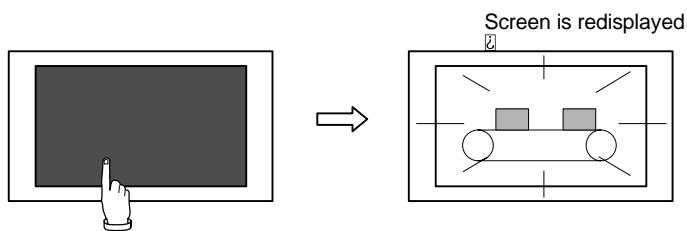

Notice Do not press the touch panel carelessly while the backlight is off or while the screen is displaying nothing.

Confirm system safety before pressing the touch panel.

- Reference**
- Even if a position on the touch panel where a touch switch is set is pressed, the touch switch function is not executed but the screen is displayed.
 - If the contents of an element have been changed while the screen is off, the element is redisplayed in the new state.

[Setting]

No special setting is necessary.

[Operation]

Pressing the touch panel cancels the screen off status to redisplay the screen which was displayed immediately before the screen was turned off.

8-3 Screen Display and Notification

This section describes the each procedure for changing and checking the screen displayed by the NT631/NT631C.

8-3-1 Switching the Screen

The NT631/NT631C provides the following four methods for switching the screen.

- Operation at the PT status control area
- Pressing a touch switch that has the “Switch Screen” function
- Using the screen switching function in the bit memory table
- Using the screen switching function of the alarm list/history function

Switching the Screen by the Operation at the PT Status Control Area

With this method, the screen can be switched to the required screen at the required time by the command given by the host.

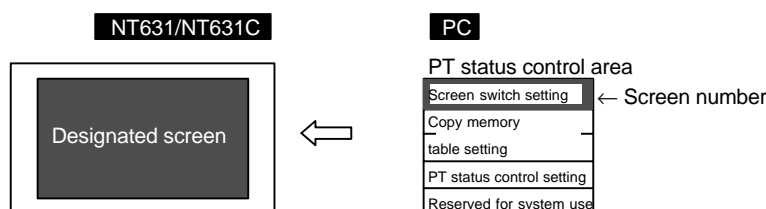

[Setting]

The PT status control area must be allocated to a word in the host, accordingly, no special settings are required for the control of buzzer.

[Operation]

At the beginning of the PT status control area (word n), there is an area (screen switch setting area) for the screen switching command and screen number notification.

Word	15	14	13	12	11	10	9	8	7	6	5	4	3	2	1	0	Bit
n	Screen No. (4-digit BCD or hexadecimal)																Screen switch setting
n + 1	Copy source memory table No. (4-digit BCD or hexadecimal)																
n + 2	Copy destination memory table No. (4-digit BCD or hexadecimal)																Copy memory table setting
n + 3	PT status control bits																
n + 4	Reserved for system use																PT status control

To switch the screen, operate the PT status control area as indicated below.

- (1) Write the screen number of the screen to be displayed at the beginning of the PT status control area (word n) either in 4-digit BCD or 4-digit hexadecimal. Which of the BCD or hexadecimal notation should be used is set for "Numeral Storage Type" of "Tools – PT Configuration – System" with the Support Tool.

The screen numbers that can be set are:

- 0000: No display (screen off)
- 0001 to 3999: Screen No. 1 to No. 3999
- 9001: Occurrence history screen
- 9002: Frequency history screen

Reference

- To display overlapping screens, specify the screen number of a parent screen.
- When the NT631/NT631C is started up, the screen of which screen number is stored for "Screen Switch Setting" in PT status control area is displayed. If the screen number stored for "Screen Switch Setting" is not correct, the screen is displayed according to the screen number set for "Initial Screen" of "System" in "PT Configuration". If the screen number set for "Initial screen" is not correct, the error screen (No Starting Screen) is displayed.
- The screen is not switched if elements have not been registered for the specified screen number.

Switching the Screen by Pressing the Touch Switch with the Switching Screen Function

This method allows the screen to be switched by operation at the NT631/NT631C.

Setting "screen No. 5" for the touch switch

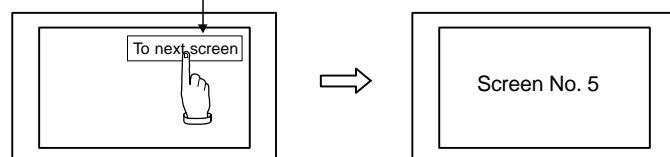

[Setting]

When creating the screen using the Support Tool, set the "Switch Screen" function for a touch switch and specify the screen number of the screen to be switched to. This screen number should be registered to the screen.

The screen numbers that can be specified are:

- 0001 to 3999: Screen No. 1 to No. 3999
- 9001: Occurrence history screen
- 9002: Frequency history screen
- 9020: Programming console function screen (expansion function)
- 9999: Return to the previous screen

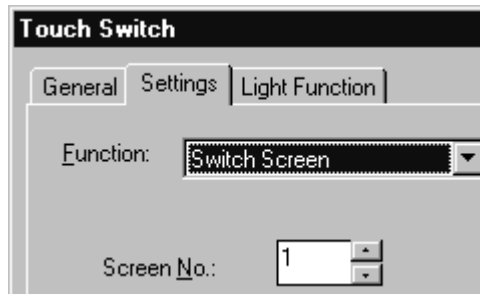

- Reference**
- To display overlapping screens, specify the screen number of a parent screen.
 - The screen is not switched if elements have not been registered to the specified screen number.

[Operation]

- (1) Press the touch switch with the screen switching function when the screen is to be switched.

- Reference**
- When the screen is changed over, the “screen switching strobe” of the PT status notify bit changes to “1” (ON), after the new screen number is written to the “screen switching setting area” in the PT status control area, so that the event of screen switching is notified to the host. After that the “screen switching strobe” returns to “0” (OFF) automatically.

[Example of Use]

[Screens other than No. 9999]

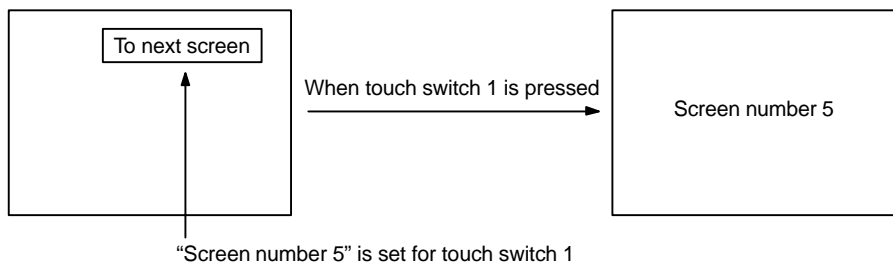

[Screen No. 9999]

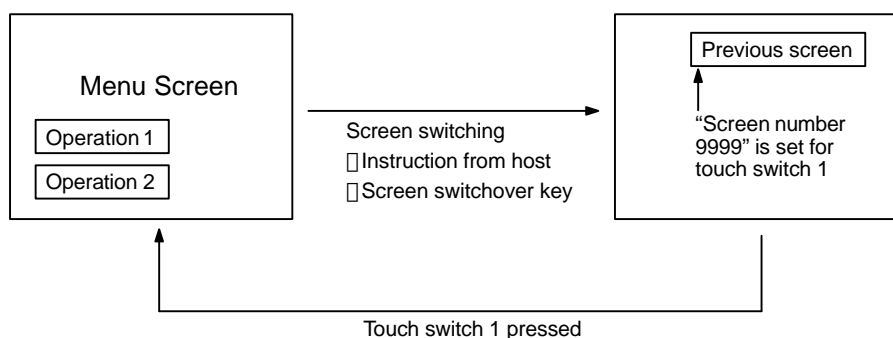

Switching the Screen by Using the Switch Screen Function of the Bit Memory Table

If this method is used, it is possible to switch the screen by bit operation at the host.

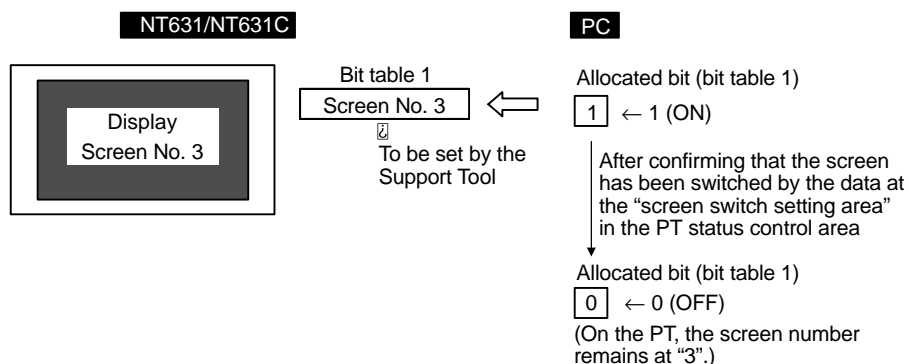

[Setting]

When creating a screen with the Support Tool, set the “Switch Screen” function in the bit memory table and specify the screen number of the screen to be displayed. Allocate the bit memory table to the bit in the host.

The screen numbers that can be specified are:

- 0001 to 3999: Screen No. 1 to No. 3999
- 9001: Occurrence history screen
- 9002: Frequency history screen
- 9020: Programming console function screen (expansion function)
- 9999: Return to the previous screen



- Reference**
- To display overlapping screens, specify the screen number of a parent screen.
 - The screen is not switched if elements have not been registered to the specified screen number.

[Operation]

- (1) Set the bit in the host to which the bit memory table with the “Switch Screen” function is allocated to “1” (ON) when switching the screen.
- (2) After making sure that the screen has been changed over from the data by referring to the “screen switch setting” word in the PT status control area or other data, return the bit in the host to “0” (OFF).

- Reference**
- The screen of the NT631/NT631C is switched at the timing the status of the bit to which the bit memory table is allocated is changed from “0” (OFF) to “1” (ON). Please note that the screen is not switched if it is changed from “1” (ON) to “0” (OFF).

Switching the Screen Using the Screen Switching Function of the Alarm List/History Function

This method allows the screen to be switched to the screen corresponding to the message displayed by the alarm list/history function.

The alarm list/history function monitors bits in the host via a bit memory table. If the specified bit in the host is turned to "1" (ON), the function displays the corresponding message (character string memory table) or image data/library data. The function can also switch over the screen to a specified one.

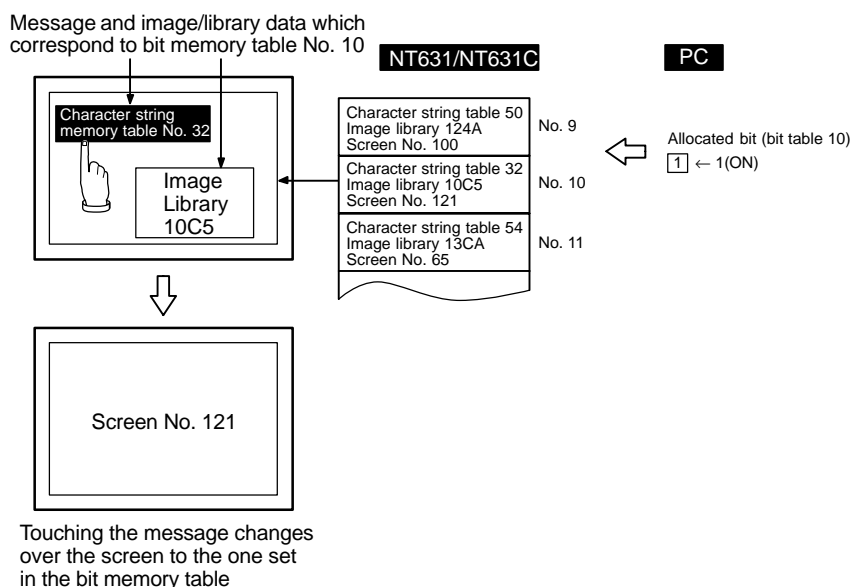

[Setting]

- (1) When creating a screen with the Support Tool, set the bit memory table as indicated below and allocate the bit memory table to the bit in the host.
 - Function:
Alarm (Alarm list/history function)
 - Switch Screen:
Check mark set
 - String Table Entry:
Table number of the character string memory table where the message to be displayed when the bit is "1" (ON) is stored.
□ 0 to 1999
 - Image/Library Code:
Code of the image data/library data which is displayed when the bit is "1" (ON).
□ 0001 to 0FFFH: Image data
□ 1000 to 3FFFH: Library data

- Screen number:
Screen number of the screen which corresponds to the "1" (ON) bit in the bit memory table (in the host).
- 0001 to 3999: Screen No. 1 to No. 3999
- 9001: Occurrence history screen
- 9002: Frequency history screen
- 9020: Programming console function screen (expansion function)
- 9999: Return to the previous screen

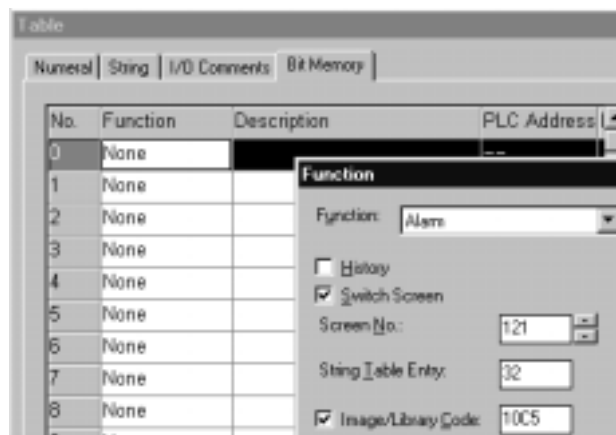

For details of the setting for bit memory tables, refer to 7-3-3 "Bit Memory Tables" (page 289).

- Reference**
- To display overlapping screens, specify the screen number of a parent screen.
 - The screen is not switched if elements have not been registered to the specified screen number.

- (2) When creating the screen, register an alarm list/history element for it.

For details of the alarm list/history, refer to 7-11 "Alarm List, Alarm History" (page 396).

[Operation]

- (1) If the specified allocated bit in the host changes to "1" (ON) while the element of the alarm list/history is displayed, the corresponding message is displayed (with the alarm list, the message is deleted from the list if the allocated bit returns to "0" (OFF)).
- (2) The message area is a touch switch and the set image data/library data is displayed when the touch switch is pressed. The message is displayed in reverse video at the same time.
- (3) The screen is switched to the specified screen when the reversed message is pressed again.

- Reference**
- The description above applies to the case where both the image/library code and the screen numbers are set in the bit memory table. If the image/library code is not set, the screen is switched over the first time the message is pressed.
 - The NT631/NT631C screen is switched when the reversed message is pressed. The screen is not switched if the status of the allocated bit changes from "1" (ON) to "0" (OFF).
 - When the screen is switched by operation at the NT631/NT631C, the "screen switching strobe" of the PT status notify bit changes to "1" (ON) so that the event of screen switching is notified to the host. The screen number of the new screen is written to the "screen switch setting" word in the PT status control area at the same time. (page 475)

[Example of Use]

For an example of use of screen switching using the alarm list/history function, refer to 8-8 "Using the Alarm List/History Function" (page 525).

8-3-2 Finding the Screen Number of the Presently Displayed Screen

The NT631/NT631C has a function to notify the host of the occurrence of a screen switching event, and the screen number of the new screen when the display screen is switched by operation at the NT631/NT631C.

The host uses the following method to ascertain the screen switching timing and the new screen number.

- Reading the PT status notify area and the PT status control area

Reading the PT Status Notify Area and the PT Status Control Area

When the screen is switched, it is notified to the following areas.

- Screen switching timing:
"Screen switching strobe" in the PT status notify area
- Screen number of the presently displayed screen:
"Screen switch setting" word in the PT status control area

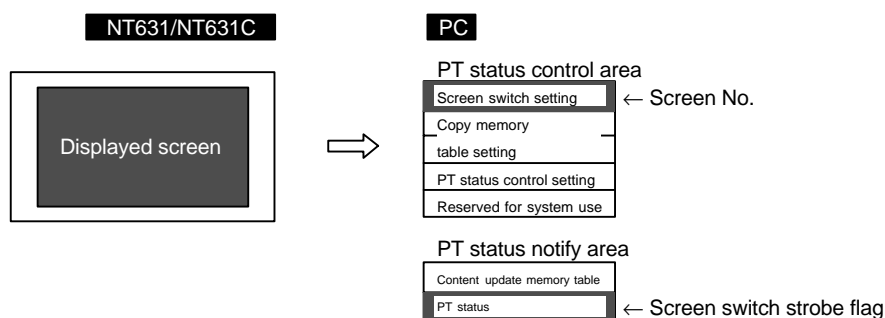

[Setting]

The PT status notify area and the PT status control area must be allocated to a word in the host, accordingly, no special settings are required for reading the status.

[Operation]

Follow the procedure indicated below to check the screen switching executed by operation at the NT631/NT631C.

- Reading screen switching timing

The bit for notifying the PT status (PT status notify bit) is provided at the second word (word m + 1) from the beginning of the PT status notify area.

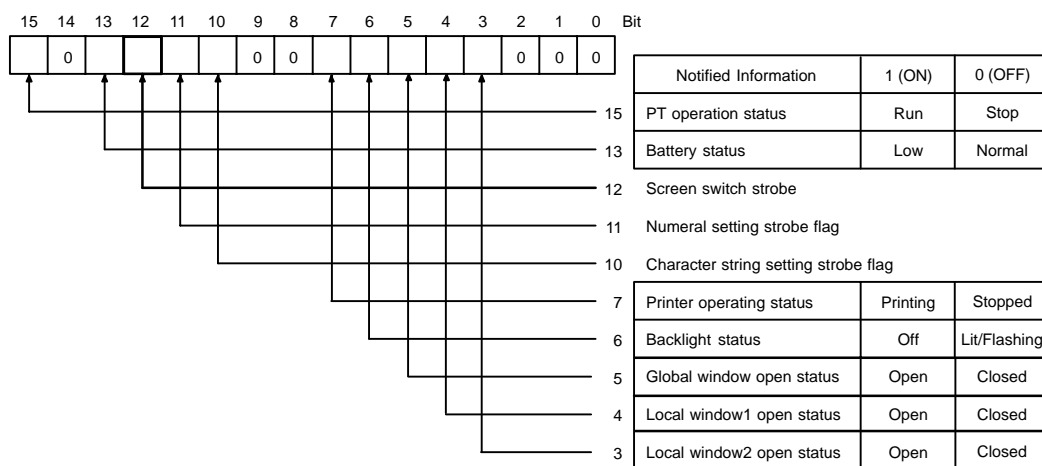

- (1) Make a program which runs in the host so that leading edge of bit 12 (screen switching strobe) in the second word (word m + 1) from the beginning of the PT status notify area is checked.

If this bit changes to “1” (ON), it indicates that the screen has been switched by operation at the NT631/NT631C.

Reference The screen switching strobe automatically returns to “0” (OFF) when the occurrence of the event is notified to the host.

- Notifying the screen number

The area for the screen switch command and notification of the screen number is provided at the beginning (word n) of the PT status notify area.

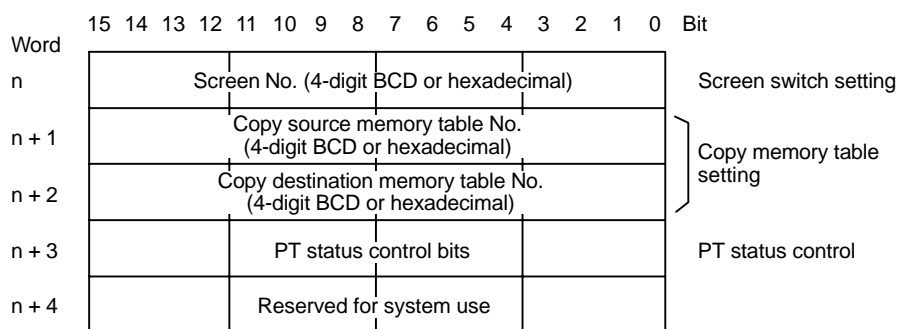

- (1) Read out the beginning (word n) of the PT status control area with the program in the host.

The screen number of the screen displayed at the NT631/NT631C is stored in a 4-digit BCD or a 4-digit hexadecimal. Whether BCD or hexadecimal notation is to be used is set for “Numeral Storage Type” of “PT Configuration” at the Support Tool.

Reference While the NT631/NT631C is running, the screen number of the currently displayed screen is always recorded in the “screen switch setting” word in the PT status control area (except when the screen displayed is an error screen or the System Menu screen, in which case the screen number of the screen displayed immediately before remains recorded).

[Example of Use]

An example of a PC program which reads the screen number each time the screen is switched by the NT631/NT631C is described below. This example program stores the previous screen number also.

- Setting with the Support Tool

Set the following words with the Support Tool.

- Allocated word in the PT status control area:
00100 (word 100 in the CIO area)
- Allocated word in the PT status notify area:
00110 (word 110 in the CIO area)

- PC program

Create the PC ladder program as indicated below.

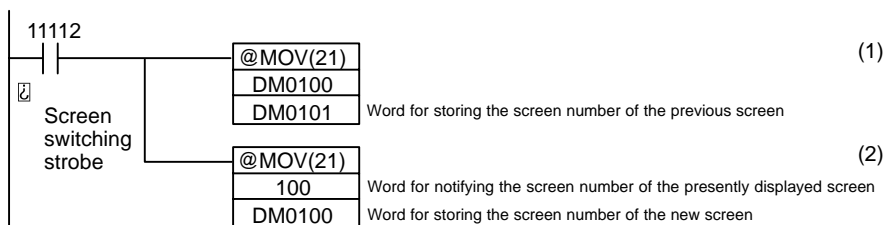

- Program operation

- (1) When the screen switching strobe (bit 11112) comes ON as the screen is switched by operation at the NT631/NT631C, the program transmits the data at DM0100 to DM0101. The previous screen number is saved to the word provided for that purpose.
- (2) The program reads out the new screen number that was notified to the NT631/NT631C to transmit it to DM0100. The screen number of the screen presently displayed at the NT631/NT631C is stored to DM0100.

8-4 Display and Control of Windows

A window means a partial screen which can be displayed on the presently displayed screen (base screen).

A window can be created by registering a screen under a screen number from 1 to 3999 as a "window screen".

This section describes the following types of operation which can be performed for a window.

- Opening/closing/moving a window
- Checking the display status of a window
- Disabling/enabling the opening of a window

-
- Reference**
- Window screen is called "window/keyboard screen" at the Support Tool.
 - Window has the following two types.
 - Global window :
 - Local window :
-

8-4-1 Opening/Closing/Moving a Window

The NT631/NT631C provides the following methods to open/close/move a window.

- Pressing a touch switch that has the "input key-window/keyboard" function. (Opening/closing are possible)
- Pressing a touch switch that has the "cursor moving key" function. (window opening only)
- Pressing a touch switch that has the "window moving key" function. (window moving only)
- Controlling the window by the operation of the window control area from the host (Window opening/closing/moving are possible)
- Setting "Load Local 1 (Keyboard)", "Load Local 2" screen attribute for a standard screen and perform screen switch. (window opening only)

-
- Reference**
- If "1" (disable) is set for the "window opening" PT status control bit, it is not possible to open a window by operation at the NT631/NT631C. (Closing of a window is allowed.)
 - If the window for which "open" is specified is not a window screen, the window open command is disregarded.
 - When creating a screen with the Support Tool, it is possible to designate a window which is opened at the same time the screen is displayed (set with the "Load Window/Keyboard Screen" attribute of Screen Property).
-

Opening/Closing a Window by Pressing a Touch Switch That Has the “Input Key – Keyboard” Function

If this method is used, the specified window can be opened and closed by operation at the NT631/NT631C.

By this method, only the local window can be controlled.

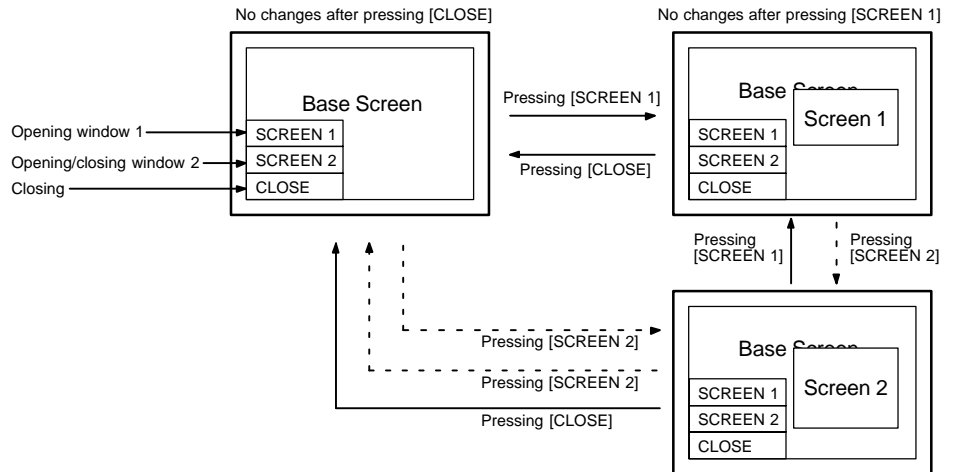

[Setting]

When creating a screen, set the “input key – keyboard” function which opens/closes a window for the touch switch and specify the window screen number (keyboard screen number) of the window to be opened. Register the window number for the screen.

The window screen numbers that can be set are:

0001 to 3999: Screen (keyboard screen) No. 1 to No. 3999

Reference If the specified number is not the number of a window screen, no window opens.

[Operation]

(1) Press a touch switch that has the “input key – keyboard” function to open/close a window.

The window set for the touch switch opens.

Reference When a window control area is allocated to a host, window screen number and the bottom left coordinate of the window which is opened are notified to the window control area. (Refer to page 484)

Also, window open status bit of the corresponding window type in PT status notify area goes ON. (Refer to page 484)

Opening/Closing a Window by Pressing a Touch Switch That Has the “Cursor Moving” Function

It is possible to give a “cursor moving key”, which is used to specify numeral or character string input fields, the function of opening a window.

By this method, only the local window can be controlled.

In this method, a specific window (keyboard screen) can be opened at the same time as a numeral or character string input field is specified by operation at the NT631/NT631C.

When a cursor moving key is used, the window opens in the same manner as an input key-window/keyboard function which has “open” action type.

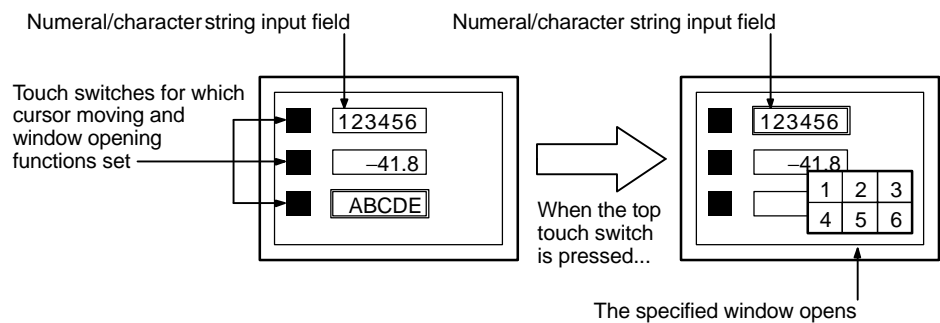

[Setting]

When creating a screen using the Support Tool, set the “cursor moving” function for a touch switch and specify the input field. Then, specify the window number of the window screen (keyboard screen) to be displayed at the same time and register them for the screen.

The window screen numbers that can be set are:

0001 to 3999: Screen (keyboard screen) No. 1 to No. 3999

Reference If the specified number is not the number of a window screen, no window opens.

[Operation]

- (1) Press the touch switch which has the “cursor moving” function to specify the numeral/character string input field. The specified window is automatically opened.

Reference When a window control area is allocated to a host, window screen number and the bottom left coordinate of the window which is opened are notified to the window control area. (Refer to page 484)

Also, window open status bit of the corresponding window type in PT status notify area goes ON. (Refer to page 484)

Opening a Window by Pressing a Touch Switch That Has the “Window Moving” Function

In this method, a window can be moved by operation at the NT631/NT631C.

By this method, only the local window can be controlled.

[Setting]

When creating a screen using the Support Tool, set the “window moving” function for a touch switch and register it for the window to be moved.

[Operation]

- (1) Press the touch switch which has the “window moving” function on the window to be moved.

The window is changed to a frame display only with a “+” mark at the center of it.

- (2) Press the touch panel of NT631/NT631C at a destination position of the window.

Window is moved to that position. (The center position of the window comes to the pressed position.)

If the window is going to extend out the screen boundary with the specified position, the position of the window is automatically adjusted so that the window comes within the screen.

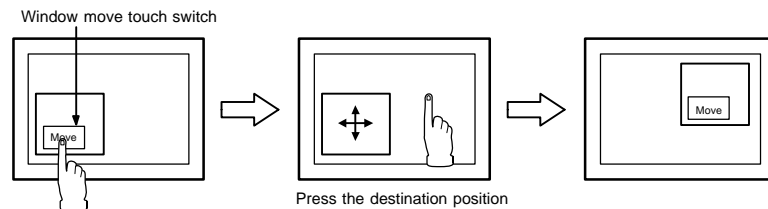

Reference When a window control area is allocated to a host, the bottom left coordinate of the window after moving operation is notified to the window control area. (Refer to page 484)

Opening/Closing/Moving a Window by the Operation of Window Control Area

If this method is used, the window can be opened, closed and moved by operation from the host.

By this method, both the global window and local window can be controlled.

[Setting]

To use a window control area, allocate the window control area to a word in the host when creating a screen using the Support Tool.

[Operation]

In the window control area, the following three words are provided for each global window, local window 1 and local window 2.

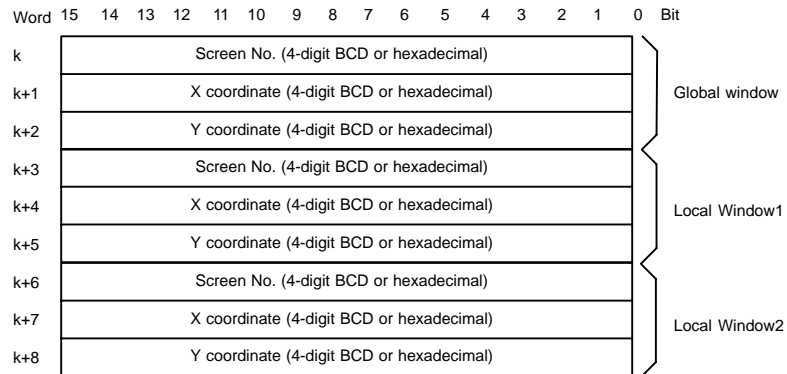

To control a window, operate the window control area as follows.

- (1) To open a window, write window screen number in 4-digit BCD or hexadecimal to “window screen number” of the window type to be used. Then, write the coordinate of window (bottom left coordinate of the window) in 4-digit BCD or hexadecimal to “X coordinate” and “Y coordinate”. Which of BCD or hexadecimal is used is determined by the setting of [Tools] – [PT Configuration] – [System] – [Numeral Storage Type] at the Support Tool.

The window screen numbers that can be set are:

0001 to 3999 : Screen (keyboard screen number) 1 to 3999

The coordinates that can be set are:

X coordinate : 0000 to 0620 Y coordinate : 0019 to 0479

Reference

- When a new window is opened (when a window screen number is changed from 0000), window open status bit of the corresponding window type in PT status notify area goes ON. (Refer to page 484) However, when a window which is already opened is switched (when a window screen number is changed), window open status bit does not change.
- The position on which a window is actually displayed is by 20 dot unit. When the X coordinate is not multiple of 20 or when Y coordinate is not multiple of 20 – 1, the specification is disregarded. (In case of moving operation, nothing is executed. In case of opening a new window, the window is displayed at the position which was specified when it was created.)
This rule also applies when the specification is made so that the window is going to extend out the screen boundary with the specified value.
- If the specified number is not the number of a window screen, no window is opened, and “window screen number” in window control area is returned to 0000, consequently, the window is closed.
- Displayed window is switched when the “window screen number” of presently displayed screen is changed.

- (2) To move the position of a presently displayed window, write the new coordinate to "X coordinate" and "Y coordinate" in the window control area which corresponds to the window.

The values which can be specified is same as for (1) (open).

- (3) To close a presently displayed window, write 0000 to "window screen number" in the window control area which corresponds to the window.

Window is closed, however, "X coordinate" and "Y coordinate" retain existing values.

Reference When a window is closed, window open status bit of the corresponding window type in the PT status notify area goes OFF. (Refer to page 484)

Opening a Window by Setting "Load Local 1 (Keyboard)" or "Load Local 2" Screen Attribute

If this method is used, the specified window can be opened automatically at the same time the screen is displayed by setting the screen number of the local window to be displayed for a screen attribute of a standard screen.

Each time the screen is switched to the one for which "Load Local 1 (Keyboard)" or "Load Local 2" screen attribute is set, the specified window opens.

By this method, only the local window can be opened. It is not possible to open a global window.

[Setting]

When creating a screen using the Support Tool, set "Load Local 1 (Keyboard)" or "Load Local 2" for a screen attribute.

Reference If the specified number is not the number of a window screen, no window opens.

[Operation]

- (1) Switch to a screen for which "Load Local 1 (Keyboard)" or "Load Local 2" screen attribute is set.
- (2) The set window opens. The window is opened by the size and at the position which was specified when it was created.

Reference When a window control area is allocated to a host, window screen number and the bottom left coordinate of the window which is opened are notified to the window control area. (Refer to page 484)
 Also, window open status bit of the corresponding window type in PT status notify area goes ON. (Refer to page 484)

- (3) When the screen is switched to others, the window is closed.

8-4-2 Checking the display status of a window

NT631/NT631C has a function to notify the open/close status of a window, the screen number and the position of presently displayed window to a host when the display status of a window is switched.

It is possible to know the occurrence of opening/closing of a window, window screen number and the display position from the host by the following method.

- Reading out the contents of PT status notify area and PT status control area

Reading Out the Contents of PT Status Notify Area and PT Status Control Area

Display status of a window is always written to the following areas

Opening/Closing status of a window:

“Window open status” in PT status notify area

Screen number of a presently displayed window:

“Window screen number” in window control area

Position of a presently displayed window (bottom left coordinate):

“X coordinate” and “Y coordinate” in window control area

[Setting]

The PT status notify area must be allocated to a word in the host, accordingly, no special settings are required for the control of a window.

To use a window control area, allocate the window control area to a word in the host when creating a screen using the Support Tool.

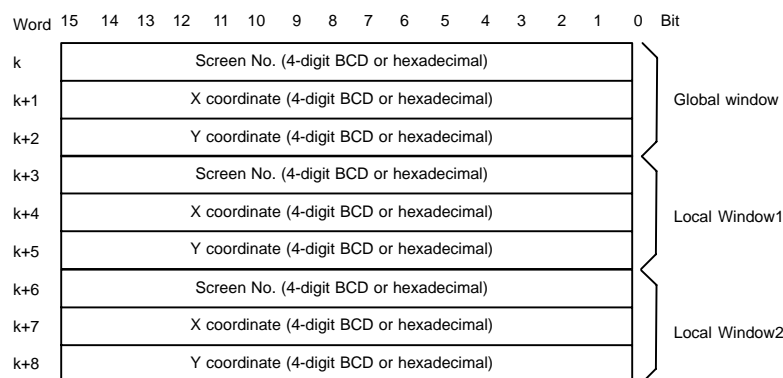

[Operation]

To check the display status of a window, operate as follows.

- Reading out the opening/closing status of a window

The bit for notifying the PT status (PT status notify bit) is provided at the second word (word m + 1) from the beginning of the PT status notify area.

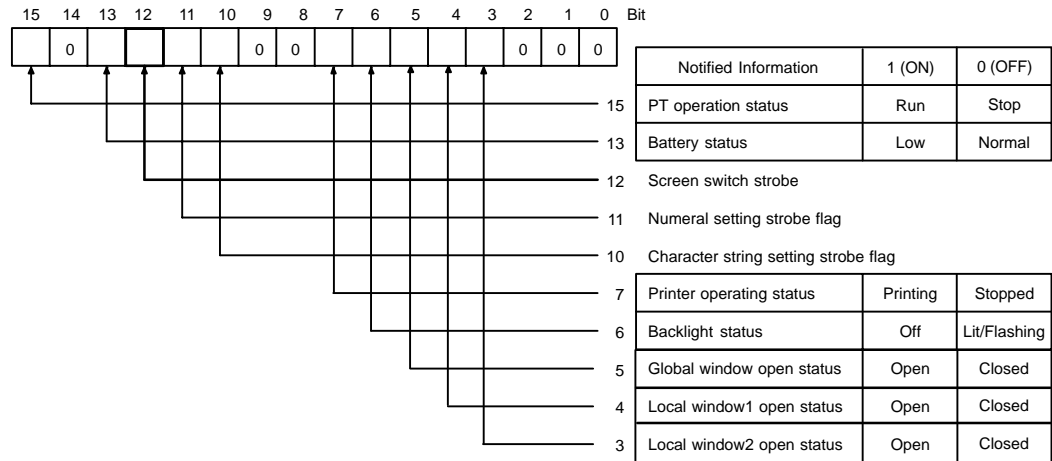

- (1) Check the bits from 3 to 5 of the second word (word m + 1) from the beginning of the PT status notify area with the program in the host.

The status of each bit and the correspondence to a window are as follows.

Bit	Name	1 (ON)	0 (OFF)
5	Global window open status	Open	Closed
4	Local window 1 open status	Open	Closed
3	Local window 2 open status	Open	Closed

By checking the status of the bit shift, it is possible to know the occurrence of opening/closing of the window.

- Notification of window screen number and coordinates

In the window control area, the following three words are provided for each global window, local window 1 and local window 2.

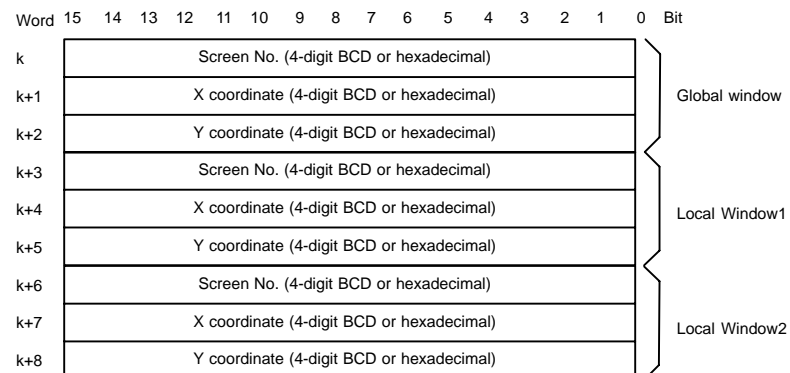

- (1) With the program in the host, read out “window screen number”, “X coordinate” and “Y coordinate” in a window control area which corresponds to the window of which display status is to be checked.

The window screen number and bottom left X, Y coordinates of the window which is presently displayed on the NT631/NT631C are stored in 4-digit BCD or hexadecimal. Which of BCD or hexadecimal is used is determined by the setting of “Numeral Storage Type” in “PT Configuration” at the Support Tool.

When the window is not displayed, 0000 is stored in “window screen number”. In the case of global window, however, when the screen other than user screen (such as system menu or error screen) is displayed, the window is automatically closed, but the window screen number retains the existing value.

The value in a window control area is effective only when the window is displayed.

Reference While the NT631/NT631C is operating (the user screen is being displayed), window display status is always reflected in the window control area.

8-4-3 Disabling/Enabling the Opening of a Window

Opening of a window by operation at the NT631/NT631C can be enabled/disabled by using the method indicated below.

- Controlling the window by operation at the PT status control area

Controlling the Window by Operation at the PT Status Control Area

This method allows the opening of a window by operation at the NT631/NT631C to be disabled. (Even if the opening of a window is disabled, it is possible to close the window by operation at the NT631/NT631C, or to move a window by a touch switch operation which has "window move" function. Also, opening/closing/moving a window by operation of the window control area is always possible.)

[Setting]

The PT status control area must be allocated to a word in the host, accordingly, no special settings are required for the control of a window.

[Operation]

The bit for controlling the PT status (PT status control bit) is provided at the fourth word (word n + 3) from the beginning of the PT status control area.

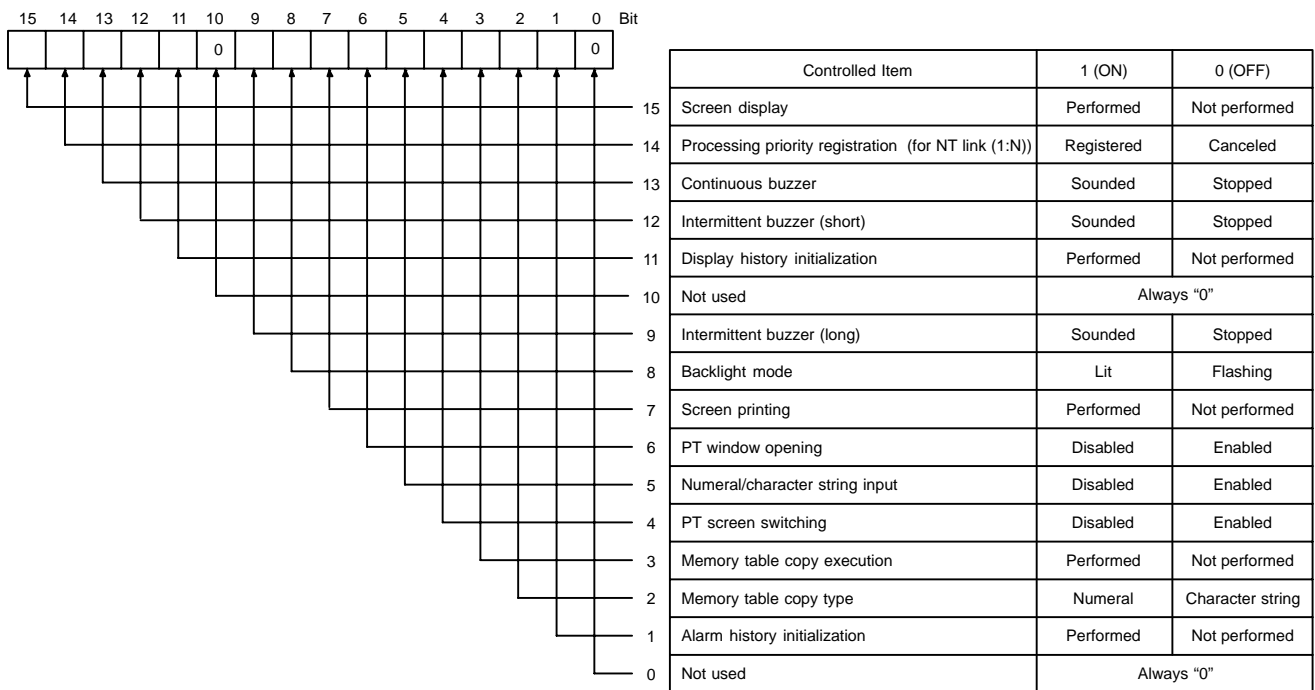

To disable the opening of a window by operation at the NT631/NT631C during the operation of the NT631/NT631C, operate the PT status control area as indicated below.

- (1) Set "1" (ON) for bit 6 in the fourth word (word n + 3) from the beginning of the PT status control area.

8-5 Changing Numeral and Character String Display

This section describes the procedure(s) for changing the contents of the numeral and character string memory tables which are allocated to the host and also the procedure for changing the display on the NT631/NT631C by operation at the host.

For the procedure for displaying the contents of the numeral and character string memory tables at the NT631/NT631C, refer to 7-8 "Numeral Display" (page 348) and 7-9 "Character String Display" (page 356).

8-5-1 Changing Numeric Values and Character Strings

The NT631/NT631C provides the following methods for changing the contents in the numeral and character string memory tables.

- Changing the contents of the allocated word of a numeral memory table
- Changing the contents of the allocated word of a character string memory table
- Copying the contents by operation at the PT status control area
- Pressing a touch switch which has the "Copy Setting" function

Reference It is possible to input the data to numeral memory tables and character string memory tables by operation at the NT631/NT631C using the numeral setting function and the character string setting function.

For details of this operation, refer to 8-7 "Input of Numeric Values and Character Strings" (page 505).

Changing the Contents of the Allocated Word of a Numeral Memory Table

By allocating a numeral table to a word in the host, it is easy to reflect changes made at the word in the host to the numeral memory table.

With this method, however, only the contents of the allocated words of memory tables being used for display on the current screen of the NT631/NT631C can be read out. Contents of an allocated word which is not related to the display are not read out.

- Direct specification

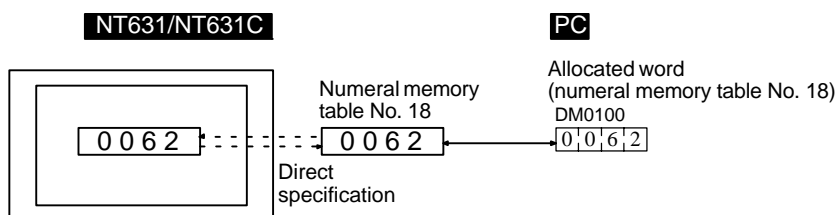

- Indirect specification

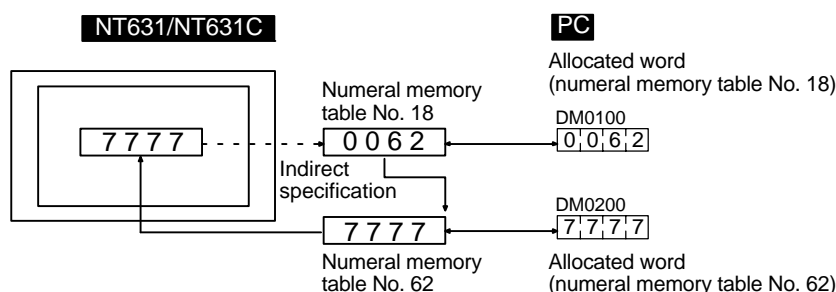

When allocating a numeral memory table to the host, the following properties can be specified. Even with the same data, the method of storage in a numeral memory table differs depending on these specifications.

- Storage type

- BCD:

The contents in the allocated word are regarded as BCD (binary coded decimal) and they are converted into the signed binary data to be stored to the table. If the data at the most significant bit is "F", the numeral is regarded as a negative value. If contents of the word are illegal ("A" to "E" at the most significant bit, or "A" to "F" at any bit other than the most significant bit), such a numeral is not stored to the table. (The previous contents are retained in the numeral memory table.)

- Binary:

The contents at the allocated word are stored to the numeral memory table as they are.

- Words

- 1 word:

The data of one word in the host is read out.

If the Storage Type is "Binary", the contents are converted into 2-word (32 bits) binary data to be stored to the numeral memory table. If the contents of the word are "FFF0" (-16 in decimal), they are first converted to "FFFFFFF0" to be stored to the numeral memory table.

- 2 words:

The data of 2 words in the host is read out. The words are ordered as follows: the word with the smaller word number is the lower word (least significant digits), and the word with the larger number is the higher word (most significant digits).

Reference

In a numeral memory table, a numeric value is stored as signed binary data.

- Examples of allocated word data stored in a numeral memory table

How the contents at a word in the host are stored to a numeral memory table is shown below.

Contents of a word in the host	Words	Storage Type	Contents of numeral memory table
1234	1 word	BCD	000004D2
		Binary	00001234
F123	1 word	BCD	FFFFFF85
		Binary	FFFFFF123
123B	1 word	BCD	(previous value is retained)
		Binary	0000123B
F0001234	2 words	BCD	FFFFFFB2E
		Binary	F0001234
FFFF	1 word	BCD	(previous value is retained)
		Binary	FFFFFFFF
0000FFFF	2 words	BCD	(previous value is retained)
		Binary	0000FFFF
FFFFFFFF	2 words	BCD	(previous value is retained)
		Binary	FFFFFFFF

- Examples of display of numeral memory table allocated to a host

How the contents of a numeral memory table allocated to the host are displayed is shown below.

In this case, the numeric value to be displayed differs depending on the selection for “Words” and “Storage Type” for the numeral memory table and the settings for “Display Type” and “Display Sign” for a numeral display.

Contents of word at host	Storage Type	Words	Numeric value stored in numeral memory table	Display Type	Sign	Displayed numeric value	
1234H	BCD	1	000004D2H	Decimal	Without	1234	
F123H			FFFFFF85H			123	
F0001234H		FFFFFFB2EH	1234				
1234H		1	000004D2H		Hexadecimal	With	1234
F123H			FFFFFF85H				-123
F0001234H		FFFFFFB2EH	-1234				
1234H	1	000004D2H	Hexadecimal	-		4D2	
F123H		FFFFFF85H				FFFFFF85	
F0001234H	FFFFFFB2EH	FFFFFFB2E					
1234H	Binary	1		00001234H	Decimal	Without	4660
F123H				FFFFFF123H			3805
F0001234H		2		F0001234H			268430796
1234H		1	00001234H	Hexadecimal		With	4660
F123H			FFFFFF123H				-3805
F0001234H		2	F0001234H				-268430796
1234H	1	00001234H	Hexadecimal		-	1234	
F123H		FFFFFF123H				F123	
F0001234H	2	F0001234H				F0001234	

Actually, a decimal point is set according to the “number of digits in integer part and decimal fraction part” (page 351).

As shown in the table above, although the contents of a word are displayed as they are for the combinations indicated below, the displayed numeric values are different from the contents in other cases.

- Displaying the contents of the numeral memory table for which the “Storage Type” is “BCD” in a numeric value for which “Display Type” is “decimal”.
- Displaying the contents of a numeral memory table for which “Storage Type” is “binary” in a numeral for which “Display Type” is “hexadecimal”.

[Setting]

When creating a screen using the Support Tool, set the allocated word for the numeral memory table. When making this setting, the “Words” and “Storage Type” settings must be taken into careful consideration.

Reference

The range of numeral memory table numbers which can actually be used depends on the number of numeral memory tables set for “Tools” – “PT Configuration” – “System” setting at the Support Tool.

[Operation]

- (1) Change the contents of the word in the host to which the numeral memory table is allocated.

The contents of the word are reflected to the numeral memory table according to the setting of the numeral memory table.

Note that the contents of a numeral memory table allocated word can only be read out when the memory table is being used for an element that is currently displayed by the NT631/NT631C (if the background function is set for a trend graph, the contents of the corresponding word are always read out). The contents of an allocated word which is not related to the display are not read out.

[Example of Use]

[Direct specification]

An example of displaying the contents of a PC word allocated to a numeral memory table as they are is shown below. The display on the NT631/NT631C screen changes as the contents of the PC word change.

• Setting at the Support Tool

Set as indicated below using the Support Tool.

- Numeral memory table No. 1:
D0000 (Words: 2, Storage Type: BCD)
- Numeral memory table No. 2:
D0002 (Words: 1, Storage Type: BCD)
- Contents to be registered for the screen:
Numeral display (numeral memory tables No. 1 and No. 2)

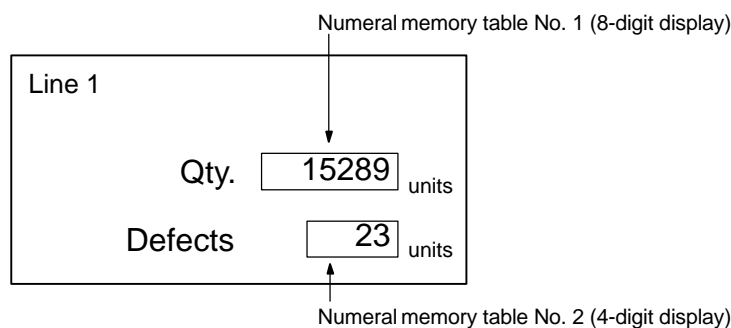

• PC program

Make a PC program as shown below.

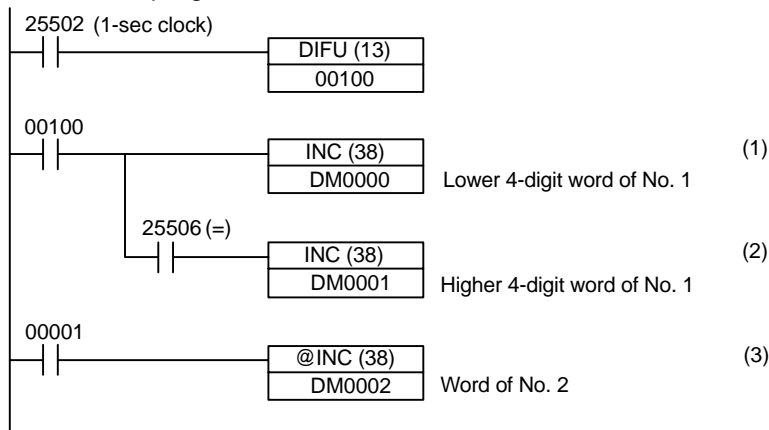

- Program operation
 - (1) The value “1” is added to the contents of D0000 every second. At the NT631/NT631C, the displayed value of the numeral memory table No. 1 increases by “1” every second.
 - (2) Each time carry over occurs during processing at (1) above, the contents of D0001 are incremented by 1. At the NT631/NT631C, the value of the higher 4 digits in numeral memory table No.1 increases by 1.
 - (3) When bit 00001 comes ON, the value “1” is added to the contents of D0002. At the NT631/NT631C, the displayed value of numeral memory table No. 2 increases by “1”.

[Indirect specification]

The following shows an example of changing the displayed numeric value by adding a value to the contents of a numeral memory table allocated word which is referenced in indirect specification.

- Setting at the Support Tool

Set as indicated below using the Support Tool.

- Numeral memory table No. 51:
D0000 (Value: 100, Words: 1, Storage Type: BCD)
- Numeral memory table No. 100:
D0010 (Words: 1, Storage Type: BCD)
- Numeral memory table No. 101:
D0011 (Words: 1, Storage Type: BCD)
- Touch switch (upper):
 - Function setting: “Notify Bit”
 - PC Address: 0000100
 - Action Type: “Momentary”
 - Label: TARGET
- Touch switch (lower):
 - Function setting: “Notify Bit”
 - PC Address: 0000101
 - Action Type: “Momentary”
 - Label: ACHIEVED
- Contents to be registered for the screen:
Numeral display (numeral memory table No. 51, indirect specification),
touch switches (two, indicated above)

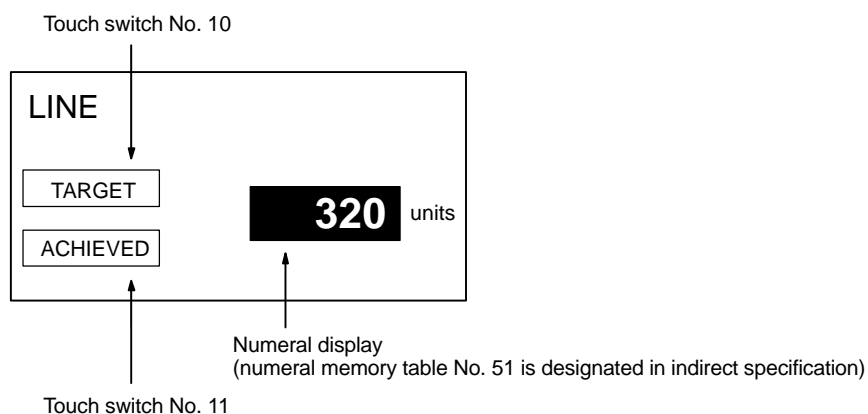

• PC program

Make a PC ladder program as shown below.

The program must also be made so that the value of "ACHIEVED" is stored to D0010 and the value of "TARGET" is stored to D0011.

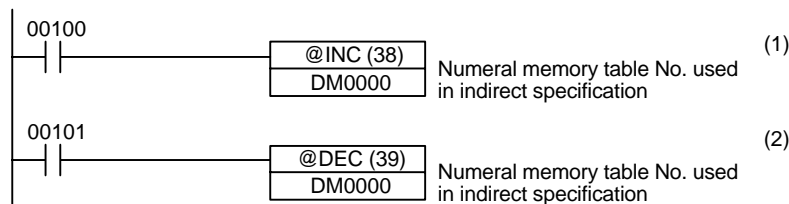

• Program operation

- (1) When "TARGET" (touch switch No. 10) is pressed, the contents of numeral memory table No. 101 (the value of the target production) is displayed.
- (2) When "ACHIEVED" (touch switch No. 11) is pressed, the contents of numeral memory table No. 100 (the value of the production actually achieved) is displayed.

In this example, the contents of numeral memory table No. 51, which is referenced in indirect specification is not checked. If the program is actually tested, the contents of numeral memory table No. 51 must not be outside the range of 0100 to 0101.

By using the lamp bit of the touch switch, it is possible to identify which of the numeral memory tables is used for display. For details, refer to 7-7 "Touch Switches" (page 328).

Changing the Contents of the Character String Memory Table Allocated Word

By allocating a character string table to a word in the host, changes made at the word in the host can be easily reflected to the character string memory table.

With this method, however, the contents of a memory table allocated word can only be read out when the character string memory table is being used for an element that is currently displayed by the NT631/NT631C. The contents of an allocated word which is not related to the display is not read out.

When a character code is written to a word at the host, the character code is stored without change in the character string memory table. By specifying FF20 to FFFH, it is possible to include marks in character strings.

Character codes stored in words at the host are stored in the following sequence in character string memory tables.

"A" = 41H, "B" = 42H	First word	<table border="1" style="display: inline-table; border-collapse: collapse; text-align: center;"><tr><td>4</td><td>1</td><td>4</td><td>2</td></tr></table>	4	1	4	2	→ "ABCD▲EF"
4	1	4	2				
"C" = 43H, "D" = 44H	First word + 1	<table border="1" style="display: inline-table; border-collapse: collapse; text-align: center;"><tr><td>4</td><td>3</td><td>4</td><td>4</td></tr></table>	4	3	4	4	
4	3	4	4				
"▲" = FF01H	First word + 2	<table border="1" style="display: inline-table; border-collapse: collapse; text-align: center;"><tr><td>F</td><td>F</td><td>0</td><td>1</td></tr></table>	F	F	0	1	
F	F	0	1				
"E" = 45H, "F" = 46H	First word + 3	<table border="1" style="display: inline-table; border-collapse: collapse; text-align: center;"><tr><td>4</td><td>5</td><td>4</td><td>6</td></tr></table>	4	5	4	6	
4	5	4	6				

When the code for mark data straddles two words:

"A" = 41H, "B" = 42H	First word	<table border="1" style="display: inline-table; border-collapse: collapse; text-align: center;"><tr><td>4</td><td>1</td><td>4</td><td>2</td></tr></table>	4	1	4	2	→ "ABC▲DEF"
4	1	4	2				
"C" = 43H	First word + 1	<table border="1" style="display: inline-table; border-collapse: collapse; text-align: center;"><tr><td>4</td><td>3</td><td>F</td><td>F</td></tr></table>	4	3	F	F	
4	3	F	F				
"▲" = FF01H	First word + 2	<table border="1" style="display: inline-table; border-collapse: collapse; text-align: center;"><tr><td>0</td><td>1</td><td>4</td><td>4</td></tr></table>	0	1	4	4	
0	1	4	4				
"D" = 44H, "E" = 45H,	First word + 3	<table border="1" style="display: inline-table; border-collapse: collapse; text-align: center;"><tr><td>4</td><td>5</td><td>4</td><td>6</td></tr></table>	4	5	4	6	
4	5	4	6				
"F" = 46H							

- Reference**
- If the control code 00H is written to a word, it is displayed as a space by the NT631/NT631C. The character string is displayed only up to this code since it is regarded as the end of the characters. When writing character codes to a word, do not write 00H in a character string.
 - When the NT631/NT631C reads out the words in a character string memory table, it reads the number of words specified in the "Words" setting. Character strings are not read out beyond this range.

[Setting]

When creating a screen using the Support Tool, set the allocated word for the character string memory table. The "Words" setting must be set carefully.

- Reference**
- The range of character string memory table numbers which can actually be used depends on the number of character string memory tables set in the "PT Configuration" – "System" settings at the Support Tool.

[Operation]

- (1) Change the contents of the word in the host to which the character string memory table is allocated.

The contents of the word are reflected to the character string memory table according to the setting of the character string memory table.

Note that the contents of a character string memory table allocated word can be only be read out when the memory table is being used for an element that is currently displayed by the NT631/NT631C. The contents of an allocated word which is not related to the display are not read out.

[Example of Use]

[Direct specification]

An example of displaying the contents of a PC word allocated to a character string memory table as they are is shown below. The display on the NT631/NT631C screen changes as the contents of the PC word change. If the system is so configured that the character string is written to the word using a personal computer via a communication unit, the required message can be displayed on the NT631/NT631C.

- Setting at the Support Tool

Set as indicated below using the Support Tool.

- Character string memory table No. 150:
D00300 (Words: 6)
- Contents to be registered for the screen:
Character string memory table No. 150

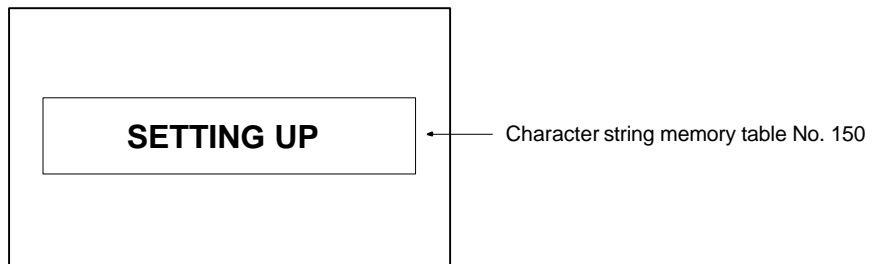

- PC program

When changing the contents of a word using a personal computer, no special ladder program used for controlling the NT631/NT631C is necessary.

- Program operation

The contents of the word are always displayed as a character string.

[Indirect specification]

The following shows an example of changing the displayed numeric value by adding a value to the contents of a numeral memory table allocated word which is referenced in indirect specification.

• Setting at the Support Tool

Set as indicated below using the Support Tool.

- Numeral memory table No. 51: D00000 (Words: 1), Value: 100
- Character string memory table No. 100: Value: "NT631C" (6 digits)
- Character string memory table No. 101: Value: "NT631 " (6 digits)
- Character string memory table No. 102: Value: "NT31C " (6 digits)
- Character string memory table No. 103: Value: "NT31 " (6 digits)
- Contents to be registered for the screen: Numeral display (numeral memory table No. 51, indirect specification)

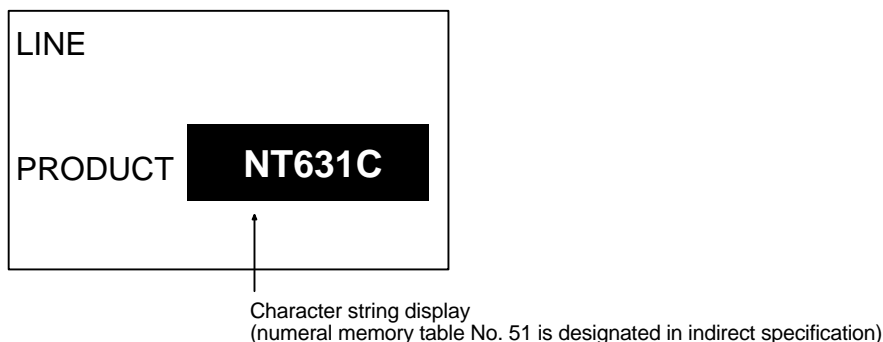

• PC program

Make a PC ladder program as shown below.

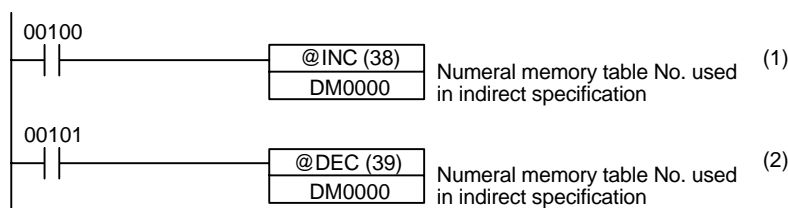

• Program operation

- (1) The display on the NT631/NT631C changes to the next item in the sequence "NT631C" → "NT631 " → "NT31C " → "NT31 " each time bit 00100 comes ON.
- (2) The display on the NT631/NT631C changes to the next item in the sequence "NT31 " → "NT31C " → "NT631 " → "NT631C" each time bit 00101 comes ON.

In this example, the contents of numeral memory table No. 51, which is referenced in indirect specification is not checked. If the program is actually tested, the contents of numeral memory table No. 51 must not be outside the range of 0100 to 0103.

Changing Numerals/Character Strings by Copying the Contents by Operation at the PT Status Control Area

If this method is used, contents can be copied between any required memory tables at any time in response to a command from the host. Note that this method is possible only for the following combinations.

- Numeral memory table → Numeral memory table
- Character string memory table → Character string memory table

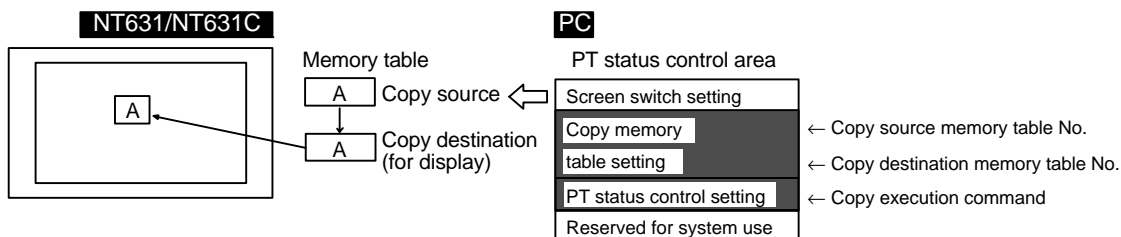

Reference If the “Words” settings differ between the memory tables (copy source and copy destination tables), numerals or character strings are copied correctly since 2 words are secured for a numeral memory table and 20 words for a character string memory table in the NT631/NT631C. If the memory table is allocated to a word in the host, however, copying may not be executed correctly if the “Words” settings differ between the memory tables (copy source and copy destination tables).

[Setting]

The PT status control area must be allocated to a word in the host, accordingly, no special settings are required for copying the data between memory tables.

[Operation]

The following areas are provided in the PT status control area to be used for copying the data between memory tables.

- 2nd word from the beginning of the area (word n + 1)
Copy source memory table No.
- 3rd word from the beginning of the area (word n + 2)
Copy destination memory table No.
- 4th word from the beginning of the area (word n + 3)
Memory table type (bit 2) and PT status control bit that instructs the execution of copying (bit 3)

(n: Beginning word number of the PT status control area)

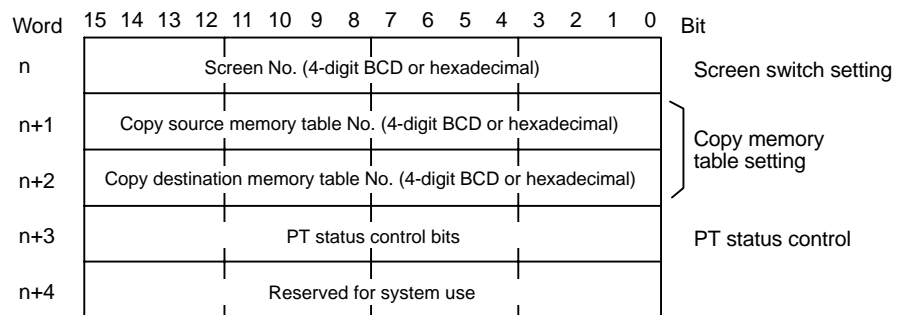

PT Status Control (word n + 3)

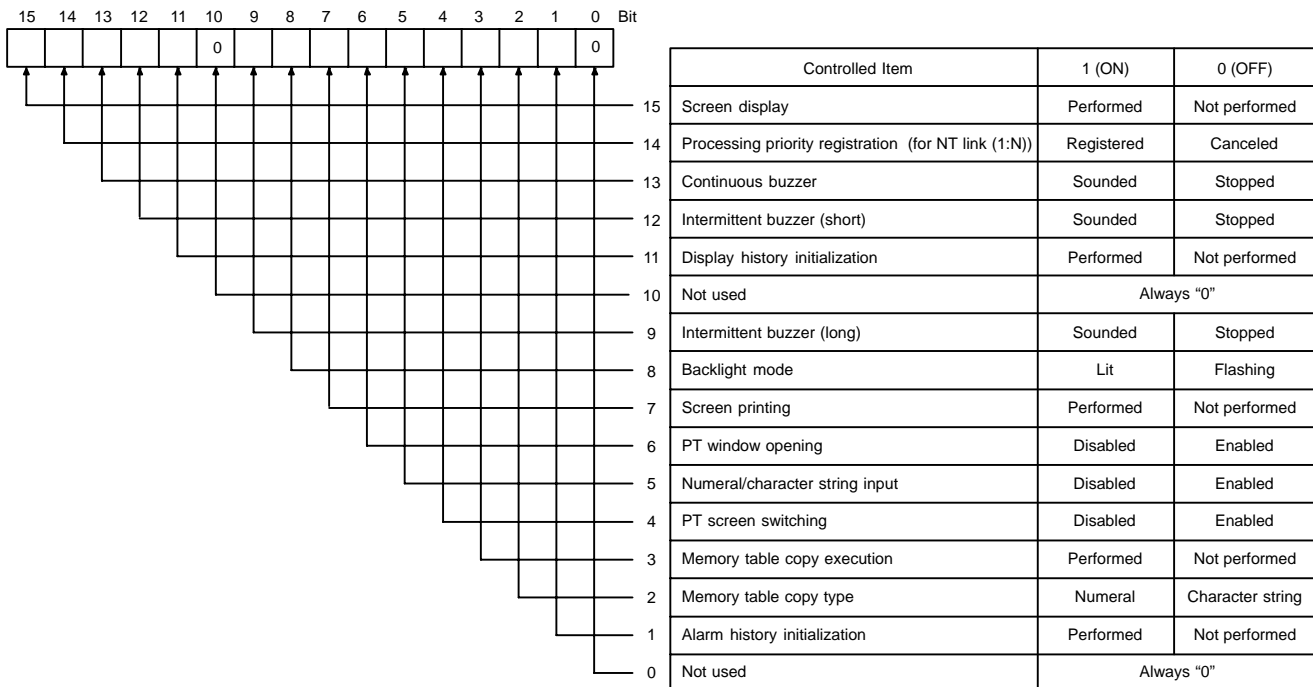

Operate the PT status control area in the manner shown below to copy data between memory tables.

- (1) Write the memory table numbers in the PT status control area as indicated below in either 4-digit BCD or 4-digit hexadecimal. Which of the BCD and hexadecimal notations is used is determined by the setting for "PT Configuration" – "Storage Type" made at the Support Tool.
 - 2nd word from the beginning (word n + 1)
0000 to 1999: Copy source memory table No. (0 to 1999)
 - 3rd word from the beginning (word n + 2)
0000 to 1999: Copy destination memory table No. (0 to 1999)

Reference

The range of numeral/character string memory table numbers which can actually be used depends on the number of numeral memory tables and the character string tables set in "PT Configuration" – "System" setting at the Support Tool.

- (2) Set bit 2 of the 4th word (word n + 3) from the beginning of the PT status control area as indicated below to match the type of memory table for which copying is to be executed.

Memory table type: Bit 2

- Character string memory table: 0 (OFF)
- Numeral memory table: 1 (ON)

- (3) Set "1" (ON) for bit 3 of the 4th word (word n + 3) from the beginning of the PT status control area.

Data copy is executed between the specified type and specified numbers of memory tables. If the copy destination table is allocated to a word in the host, the contents at the word in the host are also changed. Then, the occurrence of a change in the contents of the memory table is notified to the PT status notify area.

- (4) After the execution of memory table copying, return the setting for bit 3 of the 4th word (word n + 3) from the beginning of the PT status control area to "0" (OFF).

[Example of Use]

- Setting at the Support Tool

Set the word and the contents with the Support Tool as indicated below.

- Allocated word in the PT status control area:

00100 (word 100 in the CIO area)

- Contents to be registered for the screen:

Character string memory table No. 4

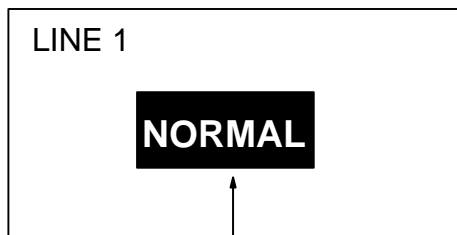

Character string memory table No. 4

Contents of setting in character string memory tables

No.	Contents	Number of digits
4	NORMAL	4 digits
10	FAULT	4 digits
11	NORMAL	4 digits

• PC program

Make a PC ladder program as shown below.

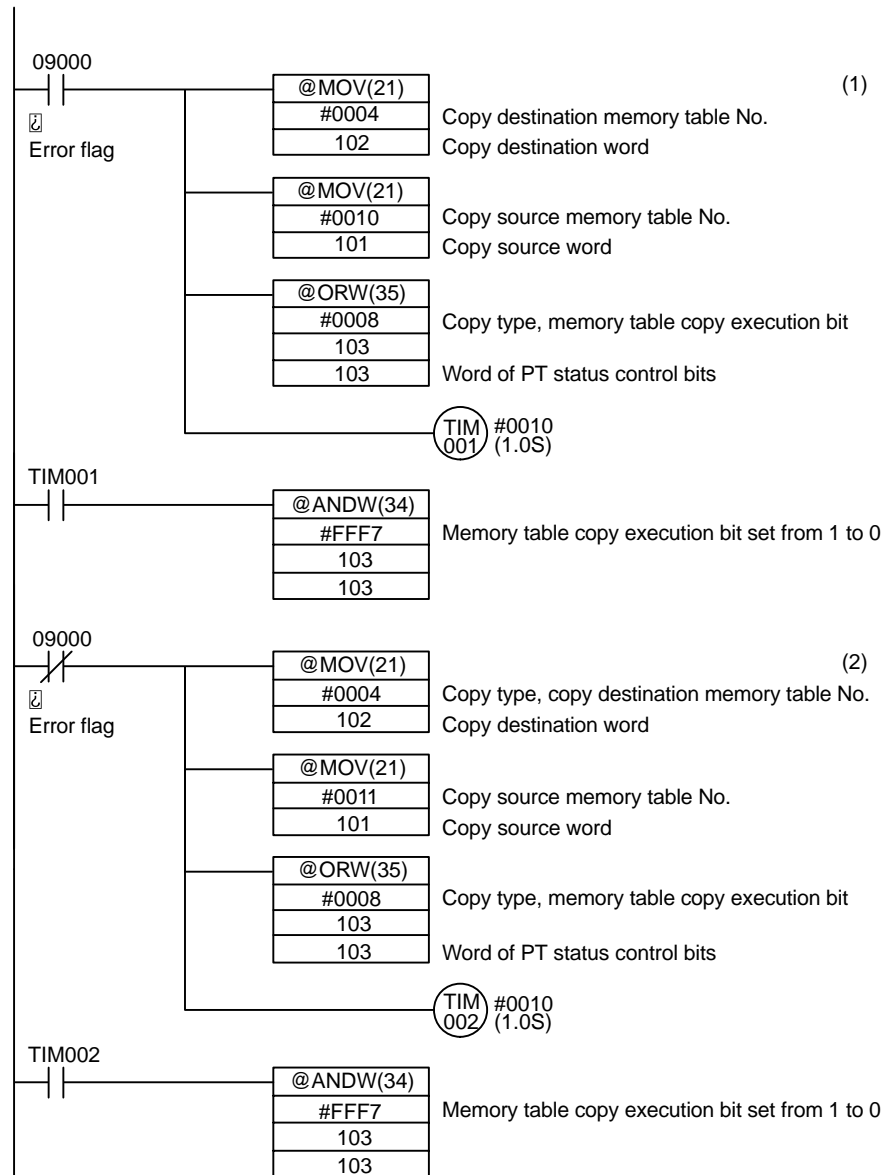

• Program operation

- (1) If an error occurs (bit 09000 goes ON), the display on the NT631/NT631C changes to "FAULT".
- (2) When the error is eliminated (bit 09000 goes OFF), the display on the NT631/NT631C returns to "NORMAL".

Changing Numerals/Character Strings by Pressing a Touch Switch Which Has the “Copy Setting” Function

This method allows an operator to change the contents of a memory table simply by operation at the NT631/NT631C. It is also possible to copy data to a numeral setting/character string input field by using this method. With the “Copy Setting” function, data can only be copied in accordance with the predetermined method. The touch switch “Copy Setting” function executes copying in the following combinations.

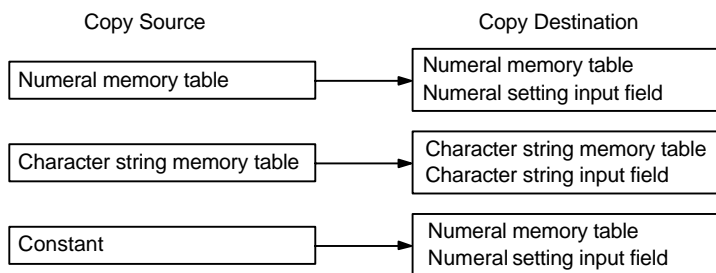

Example: A touch switch with the “Copy Setting” function is used to reset a counter.

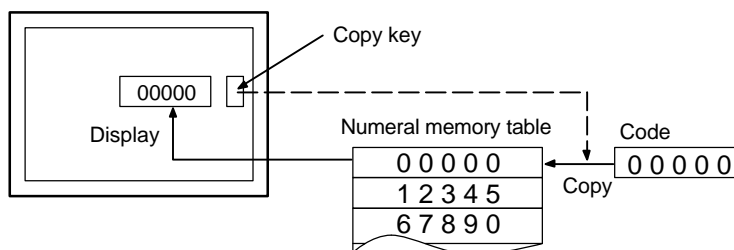

[Setting]

When creating a screen using the Support Tool, set the “Copy Setting” function for a touch switch. Specify the copy source and copy destination memory table numbers, values and input field, then register them for the screen.

The numbers and values that can be specified are:

- Memory table:
0000 to 1999: Numeral/character string memory table No. (0 to 1999)
- Constant:
-2147483648 to 2147483647
- Input field:
Specify an input field already registered for the screen.

Reference The range of numeral/character string memory table numbers which can actually be used depends on the number of numeral memory tables and the character string tables set in “PT Configuration” – “System” setting at the Support Tool.

[Operation]

(1) Press the touch switch with the “Copy Setting” function to copy data.

Reference If the contents of the numeral/character string memory table have been changed by operation at the NT631/NT631C, by using the copy key, etc., this event is notified to the PT status notify area in the host (page 270).

8-6 Display of Graphs

This section describes the method for changing the graph display which shows the contents of numeral memory table, taking the trend graph as an example.

For details of changing the contents of numeral memory table, refer to 8-5 “Changing Numeral and Character String Display” (page 488).

8-6-1 Changing the Trend Graph Display

For details of the graph, refer to 7-10 “Graphs”(page 362).

[Setting]

When creating the screen using the Support Tool, register a trend graph for the screen and set a check mark for the “data logging function”, with the setting for displaying special touch switches. The special touch switches will then be automatically attached to the screen. The position of these special touch switches can be moved using the element editing function of the Support Tool.

[Operation]

- (1) Press the touch switch which has the required function.

The trend graph display changes according to the function of the pressed touch switch.

For the examples of actual applications using the data logging function of trend graph, refer to “Continuously Reading Out the Contents of a PC Word and Displaying a Trend Graph by Backtracking” (page 599).

8-7 Input of Numeric Values and Character Strings

The procedure for inputting numeric values and character strings by operation at the NT631/NT631C is described below.

8-7-1 Inputting a Numeric Value

The touch switch “control code input function” is used to input numeric values. Basically, a numeric value is directly input into a numeral setting input field by using touch switches with the “control code input function” (referred to as “input key – control” hereafter) which are arranged on the same screen. If necessary, input key – control registered in a window (keyboard screen) and a “temporary input field” registered in a window can also be used. It is possible to register more than one numeral setting input field in one screen. For specifying the input objective among multiple input fields, input key – control for moving the input objective or cursor moving keys are used.

This section describes each of following operations.

- Inputting numeric values using the “input key – control” on the same screen
- Cases where multiple numeral setting input fields exist on a screen (without cursor moving keys)
- Cases where multiple numeral setting input fields exist on a screen (with cursor moving keys)
- Inputting numeric values using the “input key – control” in a window
- Inputting numeric values using a temporary input field

The method for using thumbwheel type numeral setting input fields is also described.

- Inputting numeric values using the thumbwheel type numeral setting input field

Inputting Numeric Values Using the “Input Key – Control” on the Same Screen

The following describes the basic numeric value input procedure using the “input key – control” on the same screen. The explanation of the procedure for inputting a numeric value into the numeral setting input field assumes that there is only one input field on the screen.

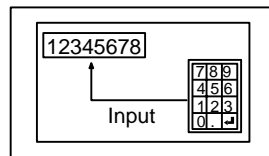

Reference



It is possible to copy a constant or contents in a numeral memory table to a numeral setting input field using the touch switch “Copy Setting” function (page 503).

[Setting]

When creating a screen using the Support Tool, set the elements indicated below on the screen.

- Numeral setting input field (numeric key type)
- Touch switch "input key – control"
 - 0 to 9
 - A to F (only for the numeral setting input field of the hexadecimal display format)
 - ENT or  (necessary for confirming the input)

The following keys can be registered if necessary.

- CLR (for clearing the numeric value being input)
-  (necessary for inputting a negative value)
- . (necessary for inputting a decimal fraction)
- CA (for canceling the input)
- BS (for deleting a character located immediately before the input cursor)
- DEL (for deleting a character located immediately after the input cursor)
- ,  (for moving the input cursor)

[Operation]

- (1) Display the screen where a numeral setting input field is registered.
- (2) Input a numeric value using the "input key – control".

For the procedure for inputting a numeric value, refer to "Inputting operation using touch switches" (page 507).

Reference When the screen has only one numeral setting input field, pressing a "control key" (0 to 9, A to F) automatically starts the input of a numeric value. It is not necessary to specify the objective numeral setting input field.

- (3) Press the ENT key of the "input key – control" or the  key to confirm the input.

When the input is confirmed, the input numeric value is stored to a numeral memory table. Then, the occurrence of a change in the contents of the numeral memory table is notified to the host via the PT status notify area (page 270).

Reference If the "upper/lower (max./min.) limit check" function is set for the numeral setting input field, the function checks if the input numeric value falls within the specified range when the input is confirmed. If the numeric value is outside the specified range, the buzzer sounds three times, the input numeric value is canceled, and the screen returns to the display before starting the input. In this case, neither writing to a numeral memory table nor notification to the host is executed.

- Inputting operation using touch switches

A numeric value can be input in the same manner as when using an electronic calculator by using the touch switch “input key – control”.

<Initial display>

When a numeral setting input field is displayed, the contents of a numeral memory table where the input numeric value is written are displayed.

<Cursor frame>

If a “Cursor frame” is set for the numeral setting input field, the frame that encloses the input field is displayed while the field is accepting input.

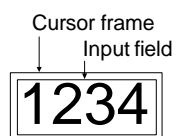

<Inputting an integer part and a decimal fraction part>

In the integer part, numerals are input from the lowest digit position and the input value is shifted to the left as new numerals are input. If the input value exceeds the number of display digits of the integer part, the numeral at the highest digit position is cleared.

After the input of a decimal point, the succeeding numeric input is regarded as a decimal fraction. In the decimal fraction part, the numeral input first is displayed in the first place. After that the input numerals are displayed to the right of the preceding input. If the input value exceeds the display range, the numeral occupying the first position to the right of the decimal point is cleared.

Key input	Displayed numeric value
(Initial state)	1234.5678
9	0009.0000
0	0090.0000
.	0090.0000
4	0090.4000
5	0090.4500

<Display of a sign>

If the numeral setting input field is assigned the “signed value” setting, the sign (+ and –) toggles each time the \square key is pressed.

<Confirming the input numeric value>

After inputting a numeric value, always press the ENT key or \square key to confirm the input. When the input is confirmed, the input numeric value is written to the numeral memory table and the occurrence of a change in the contents of the numeral memory table is notified to the PT status notify area (page 270).

The ENT key and the \square key differ from each other in the following respects.

- ENT key

When more than one numeric key type numeral setting input field exists on the screen, the input objective shifts to the next input field when the input is confirmed. The input objective shifts in the order specified by the Support Tool.

-  key

Even when more than one numeric key type numeral setting input field exists on the screen, the input objective does not shift after the confirmation of the input.

<Initial operation of input keys>

How the sign () key, the decimal point (.) key, and alphabetic letter (A to F) keys operate in the initial input (the first input after the screen is displayed or after the confirmation of the previous input) is described below.

- Sign () key:

The display is cleared to "0".

- Decimal point (.) key:

The display is cleared to "0" and the input starts in the decimal fraction part. If the number of digits of the decimal fraction part is "0", numeric input is not the input for the decimal fraction part.

- Alphabetic letter (A to F) key:

In decimal input: The input is disregarded, and the buzzer sounds three times.





















In hexadecimal input: The input alphabetic letter is displayed.

<Input example>

In actual numeric input, the input numeric value changes as shown below.















Input example 1)

Decimal display, signed, 4 digits in integer part, 3 digits in decimal fraction part

Order	Key	Displayed numeric value	Order	Key	Displayed numeric value	Order	Key	Displayed numeric value
Initial value		0000.000	7		-1524.000	14		0000.000
1		0001.000	8		-1524.000	15		0000.700
2		0015.000	9		-1524.100	16		0000.720
3		0152.000	10		-1524.150	17		0000.720
4		0152.000	11		-1524.152	18		0000.000
5		-0152.000	12		-1524.527	19		0001.000
6		-1524.000	13		-1524.527	20		-0001.000

Input example 2)

Decimal display, unsigned, 4 digits in integer part, 3 digits in decimal fraction part

Order	Key	Displayed numeric value	Order	Key	Displayed numeric value	Order	Key	Displayed numeric value
Initial value		0000.000	5		0152.000	10		1524.130
1		0001.000	6		1524.000	11		0000.000
2		0015.000	7		1524.000	12		0000.900
3		0152.000	8		1524.100	13		0000.950
4		0152.000	9		1524.130	14		0000.950

Cases Where Multiple Numeral Setting Input Fields Exist on a Screen (Without Cursor Moving Keys)

The following describes the procedure for inputting a numeric value at a screen which has multiple numeric key type numeral setting fields. The explanation is given for the operation which uses the “input key – control” without using the touch switch “cursor moving keys” to specify the input field.

For the operation using the “cursor moving keys”, refer to “Cases When Multiple Numeral Setting Input Fields Exist on a Screen (With Cursor Moving Keys)” (page 511).

Here, the basic method for inputting numeric values is not explained: the explanation concentrates on how the multiple numeral setting input fields should be handled. For the numeric value input procedure and other related operations, refer to “Inputting Numeric Values Using the “Input Key – Control” on the Same Screen” (page 505).

[Setting]

When creating a screen using the Support Tool, set the elements indicated below for the screen.

- Numeral setting input fields (numeric key type, without cursor moving keys) (2 or more fields)
- Touch switch “input key – control”

0 to 9

A to F (only for the numeral setting input field of the hexadecimal display format)

ENT or  (necessary for confirming the input)

HOME or , , , , ,  (necessary for specifying an input field)

The following keys can be registered if necessary.

CLR (for clearing the numeric value being input)

 (necessary for inputting a negative value)

. (necessary for inputting a decimal fraction)







CA (for canceling the input)

BS (for deleting a character located immediately before the input cursor)

DEL (for deleting a character located immediately after the input cursor)

,  (for moving the input cursor)

Reference

If the screen has multiple numeric key type numeral setting fields (without cursor moving keys), it is necessary to specify the input field using these keys: HOME, , , , , , .

[Operation]

- (1) Display the screen where a numeral setting input field is registered.
- (2) Specify the objective numeral setting input field using the "input key – control" (HOME, ↑, ↓, ←, →, ⬆, ⬇).
For the procedure for specifying the objective input field, refer to "Specifying the objective numeral setting input field using input key – control" (page 510).
- (3) Input a numeric value using the "input key – control".
For the procedure for inputting a numeric, refer to "Inputting operation using touch switches" (page 507).
- (4) Press the ENT key of the "input key – control" or the  key to confirm the input.
When the input is confirmed, the input numeric value is stored to a numeral memory table. Then, the occurrence of a change in the contents of the numeral memory table is notified to the host via the PT status notify area (page 270).

Reference

- If the objective input field is shifted before confirming the input, the input numeric value is canceled and the screen returns to the one displayed before the numeric value was input.
- If the "upper/lower (max./min.) limit check" function is set for the numeral setting input field, the function checks if the input numeric value falls within the specified range when the input is confirmed. If the numeric value is outside the specified range, the buzzer sounds three times, the input numeric value is canceled, and the screen returns to the display before starting the input. In this case, neither writing to a numeral memory table nor notification to the host is executed.
- If the  key is pressed to confirm the input, the same field remains as the objective input field even after the previous input has been confirmed. If the ENT key is used for the confirmation of the input, the next input field is selected as the objective input field.

- Specifying the objective numeral setting input field using the input key – control
To specify the objective numeral setting input field using the touch switch "input key – control", follow the procedure described below.

<Specifying the objective input field using the HOME, ↑, ↓, ←, → keys>

Pressing the HOME and ↑, ↓, ←, → keys selects the objective input field in the manner shown below.

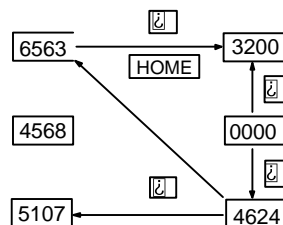

Pressing the HOME key selects the field at the upper left of the screen as the objective input field. If several input fields are arranged at the same distance from the upper left corner of the screen, the one at the left most position is selected as the objective input field.

<Specifying the objective input field using the \uparrow and \downarrow keys>

Pressing the \uparrow and \downarrow keys shift the objective input field in the order the input fields were created using the Support Tool.

When three numeral setting input fields have been created, for example, the objective input field shifts in the order they were created as shown below.

\uparrow key: 1st \rightarrow 2nd \rightarrow 3rd \rightarrow 1st \rightarrow ...

\downarrow key: 1st \rightarrow 3rd \rightarrow 2nd \rightarrow 1st \rightarrow ...

Cases When Multiple Numeral Setting Input Fields Exist on a Screen (With Cursor Moving Keys)

The following describes the procedure for inputting a numeric value at a screen which has multiple numeric key type numeral setting fields. The way in which the touch switch “cursor moving keys” are used to specify the input field is explained.

For the operation which uses the “input key – control” to specify the objective input field, refer to “Cases When Multiple Numeral Setting Input Fields Exist on a Screen (With Cursor Moving Keys)” (page 509).

When a numeric key type input field is registered on a screen using the Support Tool, a “cursor moving key” touch switch can be created overlapping the input field. This enables the input field to be selected to accept input just by pressing it.

Here, the basic method for inputting numeric values is not explained: the explanation concentrates on how the multiple numeral setting input fields should be handled. For the numeric value input procedure and other related operations, refer to “Inputting Numeric Values Using the “Input Key – Control” on the Same Screen” (page 505).

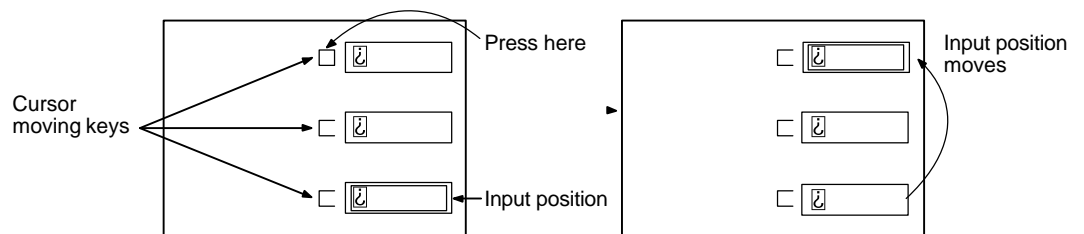

[Setting]

When creating a screen using the Support Tool, set the elements indicated below for the screen.

- Numeral setting input fields (numeric key type, with cursor moving keys)
(2 or more fields)
- Touch switch “input key – control”

0 to 9

A to F (only for the numeral setting input field of the hexadecimal display format)

ENT or  (necessary for confirming the input)

The following keys can be registered if necessary.

CLR (for clearing the numeric value being input)



 (necessary for inputting a negative value)

. (necessary for inputting a decimal fraction)

CA (for canceling the input)

BS (for deleting a character located immediately before the input cursor)

DEL (for deleting a character located immediately after the input cursor)

  (for moving the input cursor)

[Operation]

- (1) Display a screen where a numeral setting input field is registered.
- (2) Press the numeral setting input field where a numeric value is to be input to specify it as the objective input field.
- (3) Input a numeric value using the “input key – control”.

For the procedure for inputting a numeric value, refer to “Inputting operation using touch switches” (page 507).

- (4) Press the ENT key of the “input key – control” or the  key to confirm the input.

When the input is confirmed, the input numeric value is stored to a numeral memory table. Then, the event of changing the contents of numeral memory table is notified to the host via the PT status notify area (page 270).

Reference

- If the objective input field is shifted before confirming the input, the input numeric value is canceled and the screen returns to the one displayed before the numeric value was input.
- If the “upper/lower (max./min.) limit check” function is set for the numeral setting input field, the function checks if the input numeric value falls within the specified range when the input is confirmed. If the numeric value is outside the specified range, the buzzer sounds three times, the input numeric value is canceled, and the screen returns to the display before starting the input. In this case, neither writing to a numeral memory table nor notification to the host is executed.
- If the  key is pressed to confirm the input, the same field remains as the objective input field even after the previous input has been confirmed. If the ENT key is used for the confirmation of the input, the next objective input field is selected.

Inputting Numeric Values Using the “Input Key – Control” in a Window

The following describes the procedure for inputting a numeric value into a numeral setting input field in the base screen using the “input key – control” registered for the window.

Here, the basic method for inputting numeric values is not explained: the explanation concentrates on how the “input key – control” in a window should be handled. For the numeric value input procedure and the procedure for specifying the numeral setting input field, refer to the explanation for the numeric value input method given previously.

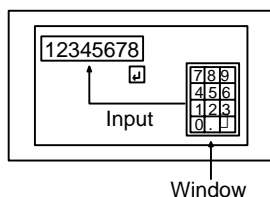
**[Setting]**

When creating a screen using the Support Tool, register the following elements for the screen.

- Numeral setting input field (numeric key type)
- “Window open key” touch switch

Specify the window screen number of the window used for inputting a numeric value.

(Used when opening the window for inputting a numeric value. This operation is not necessary if the “window open” function is set for the “cursor moving key”.)

Create the window screen used for the input and register the following elements for it.

- Touch switch “input key – control”
 - 0 to 9
 - A to F (only for the numeral setting input field of the hexadecimal display format)
 - (necessary for inputting a negative value)
 - . (necessary for inputting a decimal fraction)
 - ENT or (necessary for confirming the input)

The following keys can be registered if necessary.

- HOME or ↑, ↓, ←, →, ↑, ↓ (necessary for specifying an input field)
- CLR (for clearing the numeric value being input)
- CA (for canceling the input)
- BS (for deleting a character located immediately before the input cursor)
- DEL (for deleting a character located immediately after the input cursor)
- ◀, ▶ (for moving the input cursor)

Reference For the registration of touch switch “input key – control”, it is useful to register the keys which will be required for inputting the data on the base screen, and those which will be switched according to need during input — such as letters and numerals — in the window.

[Operation]

- (1) Display a screen on which numeral setting input fields are registered.
- (2) Specify the objective numeral setting input field using the “input key – control” and the “cursor moving keys”.

For the procedure for specifying the objective numeral setting input field, refer to “Specifying the objective numeral setting input field using the input key – control” (page 510).

Reference If the “window open” function is set to the “cursor moving keys”, the specified window automatically opens.

- (3) Press the “window open key” to open the window which is used for inputting a numeric value.

Reference The way in which the window is opened differs according to the property set for the “window open key” (page 341).

- (4) Input a numeric value using the “input key – control”.

For the procedure for inputting a numeric value, refer to “Inputting operation using touch switches” (page 507).

- (5) Press the ENT key in the “input key – control” or the  key to confirm the input.

When the input is confirmed, the input numeric value is stored to a numeral memory table. Then, the occurrence of a change in the contents of the numeral memory table is notified to the host via the PT status notify area (page 270).

Reference - If the objective input field is shifted before confirming the input, the input numeric value is canceled and the screen returns to the one displayed before the numeric value was input.

- If the “upper/lower (max./min.) limit check” function is set for the numeral setting input field, the function checks if the input numeric value falls within the specified range when the input is confirmed. If the numeric value is outside the specified range, the buzzer sounds three times, the input numeric value is canceled, and the screen returns to the display before starting the input. In this case, neither writing to a numeral memory table nor notification to the host is executed.

- If the  key is pressed to confirm the input, the same field remains as the objective input field even after the previous input has been confirmed. If the ENT key is used for the confirmation of the input, the objective input field shifts to the next.

Inputting Numeric Values Using the Temporary Input Field

The following describes the procedure for inputting a numeric using a “temporary input field” which is registered for a window. The term “temporary input field” means a numeric key type numeral setting input field registered for a window. It is used as a “temporary input field” before the input is confirmed.

When a temporary input field is used, it is possible to input a numeric value while leaving a numeric value which was active before the input in the numeral setting input field on the base screen.

Here, the explanation concentrates on how to use a “temporary input field” in a window. For the numeric value input procedure (page 505) and the procedure for specifying the numeral setting input field (page 509, 511) and for opening the window (page 513), refer to the explanation for the numeric value input method given previously.

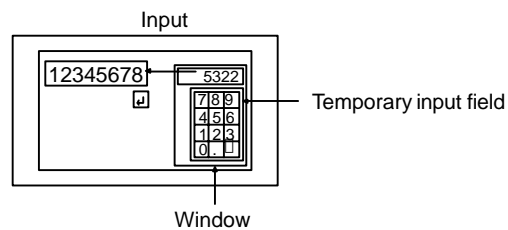

[Setting]

When creating a screen using the Support Tool, register the following elements for the screen.

- Numeral setting input field (numeric key type)
- Touch switch “input – key control”

ENT or (necessary for confirming the input)

The following keys can be registered if necessary.

HOME or ↑, ↓, ←, →, ▲, ▼ (necessary for specifying an input field)

CLR (for clearing the numeric value being input)

CA (for canceling the input)

BS (for deleting a character located immediately before the input cursor)

DEL (for deleting a character located immediately after the input cursor)

◀, ▶ (for moving the input cursor)

- “Window open key” touch switch

Specify the window screen number of the window used for inputting a numeric value.

(Used when opening the window for inputting a numeric value. This operation is not necessary if the “window open” function is set for the “cursor moving key”.)

- “Window close key” touch switch

Create the window screen used for the input and register the following elements for it.

- Touch switch “input key – control”

- 0 to 9

- A to F (only for the numeral setting input field of the hexadecimal display format)

- □ (necessary for inputting a negative value)

- . (necessary for inputting a decimal fraction)

- Numeral setting input field (numeric key type) (temporary input field) 1 field

Reference Only one numeral setting input field (numeric key type) can be registered in a window, and this numeral setting input field is used as a temporary input field (a thumbwheel type numeral setting input field cannot be registered for a window).

[Operation]

- (1) Display the screen where a numeral setting input field is registered.
- (2) Specify the objective numeral setting input field using the “input key – control” and the “cursor moving keys”.

For the procedure for specifying the objective numeral setting input field, refer to “Specifying the objective numeral setting input field using the input key – control” (page 510).

Reference If the “window open” function is set for the “cursor moving keys”, the specified window automatically opens.

- (3) Press the “window open key” to open the window which is used for inputting a numeric value.

Reference The way in which the window is opened differs according to the property set for the “window open key” (page 341).

- (4) Input a numeric value into the temporary input field using the “input key – control”.

The same procedure as used for inputting a numeric value into a normal numeral setting input field can be used. For the procedure for inputting a numeric value, refer to “Inputting operation using touch switches” (page 507).

For restrictions on using a temporary input field, refer to “Restrictions on using a temporary input field” (page 517).

-
- Reference**
- If a temporary input field is set in a window, the input is automatically set in the temporary input field.
When multiple windows are opened and each window has an input field (temporary input field), the data is set in the input field in a focus window.
For details of focus window, refer to "Focus Window" (page 434).
 - In the initial state, the initial state content of the objective input field is displayed in the temporary input field.
 - The objective input field on the base screen maintains the initial state display until the input is confirmed.
-
- (5) Press the ENT key in the "input key – control" or the  key to confirm the input.
When the input is confirmed, the input numeric value is stored to a numeral memory table. Then, the occurrence of a change in the contents of the numeral memory table is notified to the host via the PT status notify area (page 270).
-
- Reference**
- If the objective input field is shifted before confirming the input, the input numeric is canceled and the screen returns to the one displayed before the numeric value was input.
 - If the "upper/lower (max./min.) limit check" function is set for the numeral setting input field, it is checked if the input numeric value falls within the specified range when the input is confirmed. If the numeric value is outside the specified range, the buzzer sounds three times, the input numeric value is canceled, and the screen returns to the display before starting the input. In this case, neither writing to a numeral memory table nor notification to the host is executed.
-
- Restrictions on using a temporary input field
 - For a thumbwheel type numeral input field, it is not permissible to use a temporary input field.
 - If the number of digits in a temporary input field is smaller than the number of digits (integer part digits + fraction part digits + decimal point digit + sign digit) necessary for the objective input field on the base screen, the input is made within the range of the number of digits in the temporary input field.
 - If an input field does not exist on the base screen, a temporary input field is not displayed.

[Example of Use]

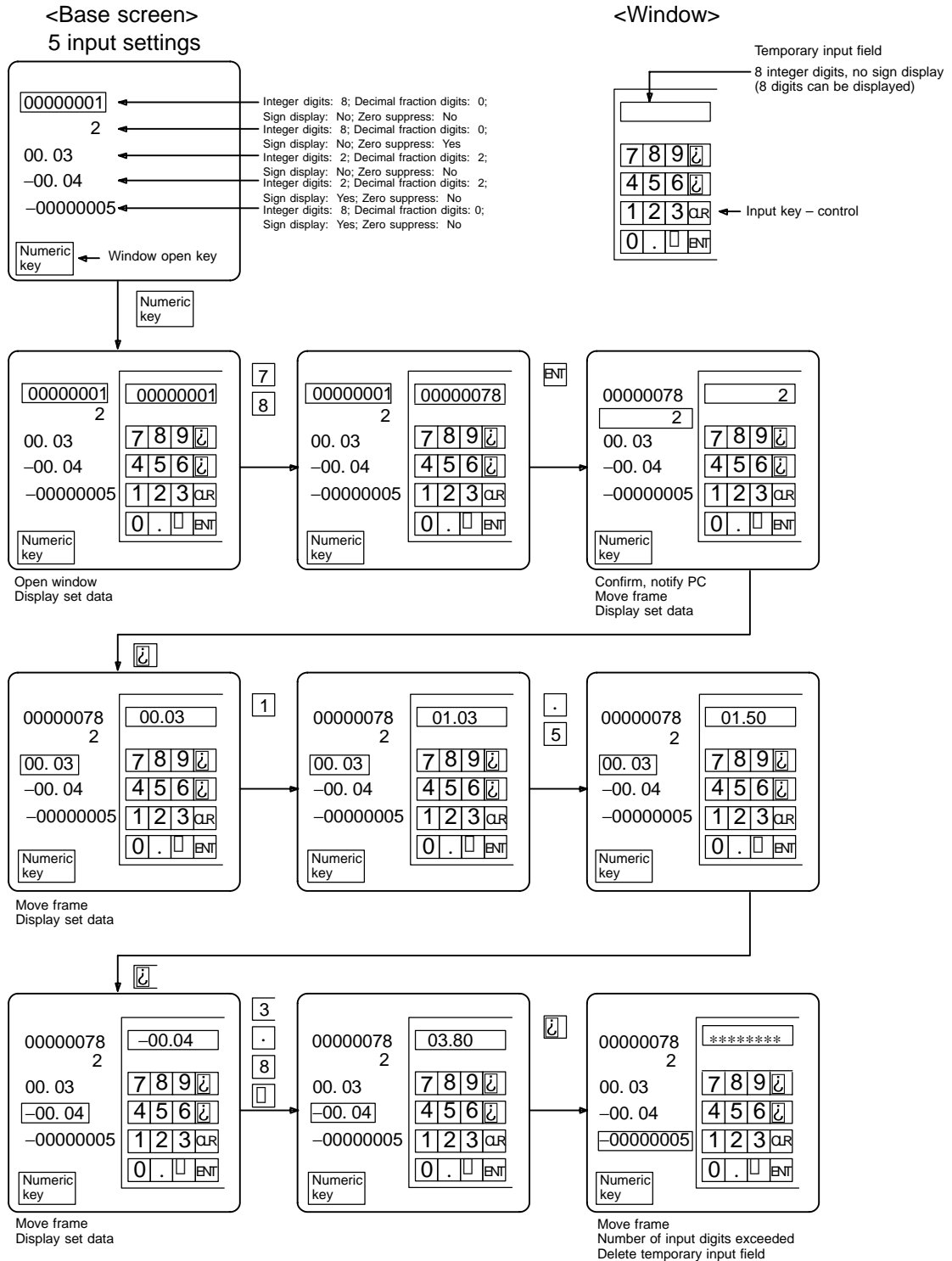

Inputting Numeric Values Using a Thumbwheel Type Input Field

The following describes the procedure for inputting a numeric value into a thumbwheel type input field.

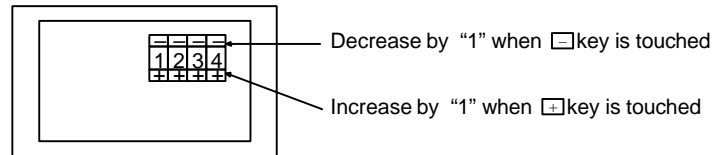
**[Setting]**

When creating a screen using the Support Tool, register the following element for the screen.

- Numeral setting input field (thumbwheel type)

Reference Since a thumbwheel type numeral setting field itself has a touch switch for inputting a numeric value, it is not necessary to register other elements for inputting a numeric value.

[Operation]

- (1) Display a screen which has a thumbwheel type numeral setting field.
- (2) Change the numeric value using the increment/decrement (+, -) keys provided at the top and bottom of each digit position of the thumbwheel type numeral setting field.

For the procedure for changing a numeric value, refer to "Using a thumbwheel type input field" (page 520).

Reference

- In a thumbwheel type numeral setting field, a numeric value is confirmed immediately after it is changed and written to a numeral setting field. At the same time, the occurrence of a change in the contents of the numeral setting memory table is notified to the host.
- When a thumbwheel type numeral setting field is displayed, the numeric value which has been stored in the numeral memory table prior to the input is displayed.
- Even if more than one thumbwheel type numeral setting field exists on a screen, specification of an objective input field is not necessary since input is performed by using the thumbwheel switch in the required input field.
- If the "upper/lower (max./min.) limit check" function is set for the numeral setting input field, the function checks if the input numeric value falls within the specified range when the input is confirmed. If the numeric value is outside the specified range, the buzzer sounds three times, the input numeric value is canceled, and the screen returns to the display before starting the input. In this case, neither writing to a numeral memory table nor notification to the host is executed.

- Using a thumbwheel type input field

At a thumbwheel type input field, input a numeric value using the increment/decrement (+, -) keys provided at each digit position of the thumbwheel type numeral setting field.

<Specifying a numeric value>

When an increment/decrement (+, -) key is pressed, the numeric value at the corresponding digit increases or decreases by "1". Each time the [+] key or the [-] key is pressed, the changed numeric value is stored to the numeral memory table and the occurrence of a change in the contents of the numeral memory table is notified to the host. It is not necessary to confirm the input numeric value by pressing the ENT key or the  key, which is required when a numeric key type input field is used.

With a thumbwheel type numeral setting input field, inputting of a numeric value using the "input key - control" is not possible.

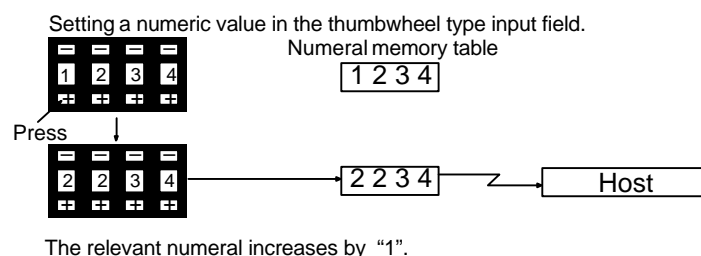

<Changing a sign>

If a check mark is set for "Display sign" of a thumbwheel type numeral setting input field, the [+] and [-] keys are used to change the sign if the keys in the sign display digit are pressed. Pressing the [+] key changes the sign to "+" and pressing the [-] key changes the sign to "-".

<Checking the upper/lower limit>

The NT631/NT631C has a function to check the correctness of an input numeric value to prevent a numeric value outside the allowable range from being input so that the input of an illegal value will not adversely affect the system.

The upper/lower (max./min.) limit check is executed in the timing indicated below according to the type of a numeral setting input field.

For a thumbwheel type numeral setting input field, the check is executed each time the increment/decrement key of each digit position is pressed.

With a thumbwheel type numeral setting input field, if $n...n < m...m$ [upper limit: $1n...n$, lower limit: $0m...m$ ("n" and "m" are arbitrary values at each digit)], carry over and underflow are not possible at the highest digit position.

Example:

If the upper limit value and the lower limit value are 1200 and 201, respectively, the numeric value can be changed only in the following range: from 201 to 999 if an initial value is a 3-digit value and from 1000 to 1200 if an initial value is a 4-digit value.

The reason for this is that the upper/lower (max./min.) limit check function does not allow the numeric value at the highest digit position to change from 0 to 1 or from 1 to 0.

To avoid this, set the upper and lower limit values so that " $n...n \square m...m$ ", or provide a touch switch separately to write a numeric value for carry over or underflow.

8-7-2 Inputting Character Strings

To input a character string, the touch switch “input key – string” is used. Basically, the “input key – string” arranged on the same screen is used to directly input a character string into a character string input field. It is also possible to use “input key – string” or a “temporary input field” registered for a “window”.

Registration of more than one character string input field in a screen is permitted. To specify the objective input field among multiple input fields, either the “input key – control” provided for shifting between input fields or a cursor moving key should be used.

When inputting a character string, the specification of an input field, window opening procedure, and the major purposes of a temporary input field are identical to those for inputting a numeric value. The explanation below concentrates on how a character string is input; other information is not discussed. For the procedure for specifying an input field and opening a window, and for the major purposes of a temporary input field, refer to the corresponding items in the description of the operation for “numeric value input”.

In character string input operation, bar code data can be input as a character string using a bar code reader which is connected to the NT631/NT631C.

Only the following topics are described here.

- Using the “input key – string” on the same screen
- Using a bar code reader
- Restrictions specific to character string input when using temporary input fields

When inputting a character string, a temporary input field can be used as for inputting a numeric value. But when using a temporary input field for inputting a character string, the following specific restrictions should be noted.

- When inputting a character string, the temporary input field must also be the character string input field.
- Even if the number of digits of a temporary input field is smaller than the number of digits of the objective input field on the base screen, the temporary input field can be used to input a character string. In this case, however, blank digits remain in the character string input field on the base screen and these blank digits are filled with spaces. In the initial display, characters which overflow the temporary input field are disregarded.
- Even if the number of digits of a temporary input field is larger than the number of digits of the objective input field on the base screen, the temporary input field can be used to input a character string. In this case, however the input character string will overflow the character string input field on the base screen and the overflowing characters are ignored.
- A temporary input field is not displayed if an input field does not exist on the base screen.

Inputting a Character String Using “Input Key – String” on the Same Screen

The following describes the basic character string input procedure — inputting a character string to a character string input field using the “input key – string” provided on the same screen when the screen has only one character string input field.

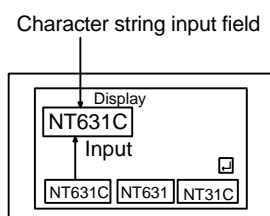

Reference It is possible to copy the contents in the character string memory table to the character string input field using the touch switch “Copy Setting” function (page 503).

[Setting]

When creating a screen using the Support Tool, register the following elements for the screen.

- Character string input field
- “Input key – string” for touch switches

Characters registered for “labels” are used for inputting a character string.

Marks can be input by specifying FF20 to FFFFH.

- Touch switch “input key – control”
 - ENT or  (necessary for confirming the input)

The following keys can be registered if necessary.

- CLR (for clearing the character string being input)
- CA (for canceling the input)
- BS (for deleting a character located immediately before the input cursor)
- DEL (for deleting a character located immediately after the input cursor)
- ◀, ▶ (for moving the input cursor)

Reference The “input key – control” of 0 to 9 and A to F can be used to input a character string.

[Operation]

- (1) Display a screen which has a character string input field.
- (2) Input a character string using the “input key – string”.

Reference If the screen has only one character string input field, input of a character string automatically starts when an “input key – string” is pressed. (Specification of an objective input field is not necessary.)

- (3) Press the ENT key or the  key to confirm the input.

When the input is confirmed, the input character string is stored to a character string memory table. Then, the occurrence of a change in the contents of the character string memory table is notified to the host via the PT status notify area (page 270).

Reference If the number of characters of the input character string is smaller than the number of characters of the character string memory table size, the digits left blank are filled with spaces.

Inputting a Character String Using a Bar Code Reader

The following describes the procedure for inputting a character string into a character string input field using a bar code reader when the screen has only one character string input field.

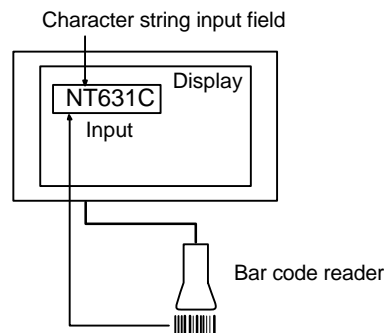

When a bar code reader is used, either of the following methods can be selected for confirming the input.

- Manual confirmation:

Use the ENT key or the  key to confirm the input character string.

- Automatic confirmation:

The input character string is automatically confirmed at the same time the bar code reader reads out the bar code data (character string).

Reference

- When "Manual" is selected for inputting a character string using a bar code reader, the touch switch "input key – string" can be used to correct the bar code data (character string) or add any required character
- Selection of "Auto/Manual" is made in the settings for the communication conditions of a bar code reader at the System Menu of the NT631/NT631C.
- It is possible to copy the contents in a character string memory table to a character string input field using the touch switch "Copy Setting" function (page 503).

[Setting]

When creating a screen using the Support Tool, register the following elements for the screen.

- Character string input field



If a bar code reader is used in "Manual", the following touch switch "input key – string" and "input key – control" may be set if necessary.

- Touch switch "input key – string"

Characters registered for "labels" are used for inputting a character string.

Marks can be input by specifying FF20H to FFFFH.

- Touch switch "input key – control"

- ENT or  (necessary for confirming the input)
- CLR (for clearing the character string being input)
- CA (for canceling the input)
- BS (for deleting a character located immediately before the input cursor)
- DEL (for deleting a character located immediately after the input cursor)
- ,  (for moving the input cursor)

Reference The "input key – control" of 0 to 9 and A to F can be used to input a character string.

[Operation]

- (1) Display a screen which has a character string input field.
- (2) Read out the bar code data using a bar code reader and input the read out data as a character string.

Reference

- When the bar code reader is used with "Auto", the input character string is confirmed at the same time the bar code data is read out. If the screen has other character string input fields, the objective input field shifts to the next input field automatically.
- If the screen has only one character string input field, input of a character string automatically starts when a "input key – string" is pressed. (Specification of an objective input field is not necessary.)

- (3) When the bar code reader is used with "Manual", press the ENT key or the  key to confirm the input.

When the input is confirmed, the input character string is stored to a character string memory table. Then, the occurrence of a change in the contents of the character string memory table is notified to the host via the PT status notify area (page 270).

Reference

- If the input character string is smaller than the number of characters of the character string memory table, the surplus part is filled with spaces.

8-8 Using the Alarm List/History Function

This section describes how to use the “alarm list” and the “alarm history” which monitor the status of bits in the host and, if a bit status changes to “1” (ON), display the corresponding message and the image/library data.

The alarm list/history can be checked using the System Menu of the NT631/NT631C. It is also possible to check them during operation by registering them to the screen as an element (alarm list can only be used as an element.).

The Support Tool can read out the alarm history record data stored to the NT631/NT631C to the host as a text file. For the procedure for reading the alarm history record data, refer to the NT-series Support Tool Ver. 3.0 for Windows95/98 Operation Manual (V053-E1-□).

8-8-1 How to Use the Alarm List/History

An alarm list can only be displayed as an element while an alarm history can be displayed on a confirmation screen which is called from the System Menu as well as displayed as an element.

Confirming during Operation as an Element

The status of the bit to be monitored (alarm list) and the record of bit status transition (alarm history) can be confirmed while the NT631/NT631C is operating.

- Alarm list

Message (character string table No. 32)
set for bit memory table No. 14

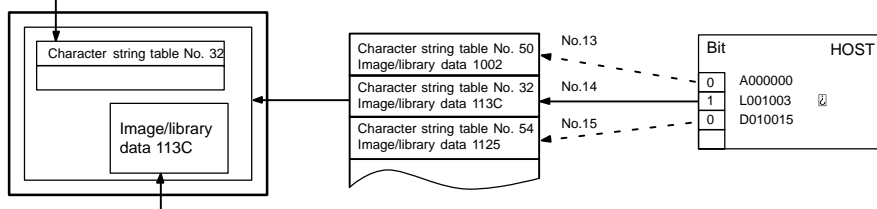

When the message displayed is pressed, the image/library data (113C) set for bit memory table No. 14 is displayed.

- Alarm history

Message (character string table No. 13)
set for bit memory table No. 24

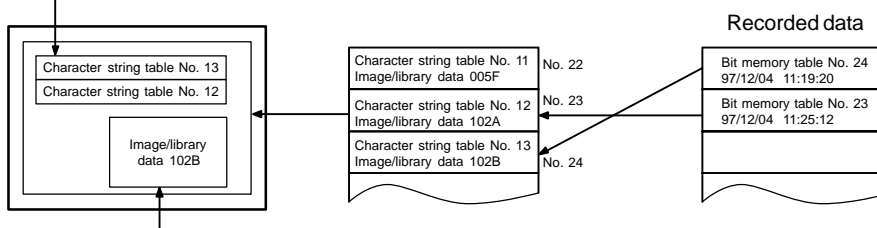

When the upper message displayed is pressed, the image/library data (102B) set for bit memory table No. 13 is displayed.

[Setting]

When creating a screen using the Support Tool, set the following.

- Bit memory table

Set as shown below for the number of bits in the host to be monitored (for information not indicated below, set as needed.).

- PC Address: Bits in the host to be monitored

- Function: Alarm

- History:

For alarm list: Check mark set or no check mark

For alarm history: Check mark set

- String Table Entry:

Table No. (0 to 1999) of the character string memory table to be displayed as a message

- Image/Library Code:

Image/library code displayed together with a message

0000H: No display

0001H to 0FFFH: Image

1000H to 3FFFH: Library

- Screen No.

Screen No. (0001 to 3999) of the screen to be displayed when the message is pressed twice.

This setting is valid only when switching the screen.

- Alarm list/history

Register an alarm list/history to a screen in the manner described below (for information not indicated below, set as needed.).

- Alarm list

Start bit table entry:

Table No. of the first bit memory table among the bit memory tables where the bits in the host to be monitored are registered.

No. of bits referenced:

The number of the bit memory tables where the bits in the host to be monitored are registered.

- Alarm history

Type: Order of frequency or order of occurrence

To display the alarm history in the order of occurrence, set the display order (From Old Data/From New Data) of the record data using the Hist. Disp. Method memory switch of the NT631/NT631C.

[Operation]

- (1) Initialize the recorded alarm history record data as needed.

To initialize the alarm history record data using System Menu operation, select "Alarm History" on the "MEMORY INIT. MENU" screen.

To initialize the alarm history record data by operation at the PT status control area, change the status of bit 1 in the 4th word (word n + 3) from the beginning of the PT status control area to "1" (ON).

After initializing the alarm history record data by operation at the PT status control area, return the status of bit 1 to "0" (OFF).

- (2) Display the screen where the alarm list/history is registered.

In the case of an alarm history, the recorded data is displayed on the screen. In the case of an alarm list, the content of the set character string memory table is displayed as a message if the status of the bit in the host to be monitored changes to "1" (ON).

Dedicated touch switches are provided for the alarm list/history. For the procedure for using these touch switches, refer to "How to use the touch switches of the alarm list/history" (page 528).

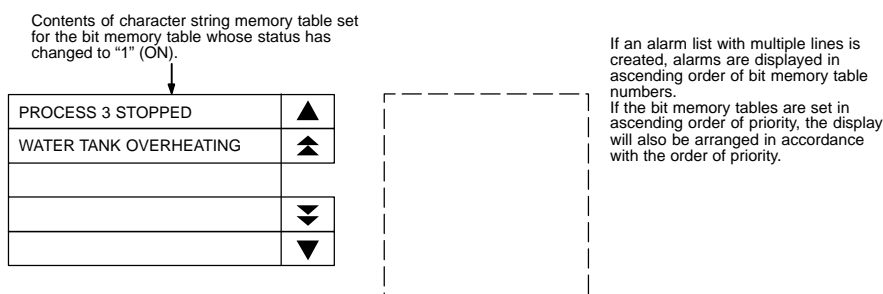

- (3) Since the message area is a touch switch, pressing the message causes the set image/library data to be displayed. At the same time, the pressed message is displayed in the ON color.

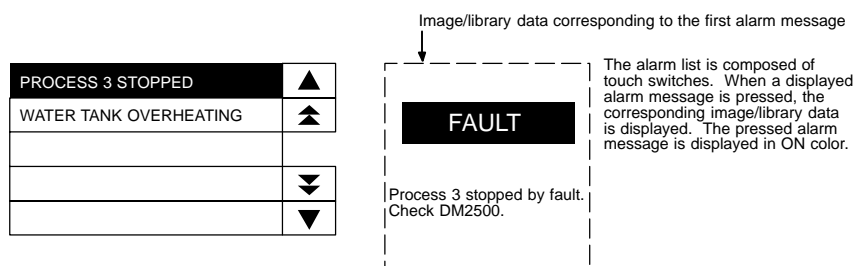

- (4) If another message is pressed, when more than one message is displayed, the newly pressed message is displayed in reverse video and the corresponding image/library data is displayed.

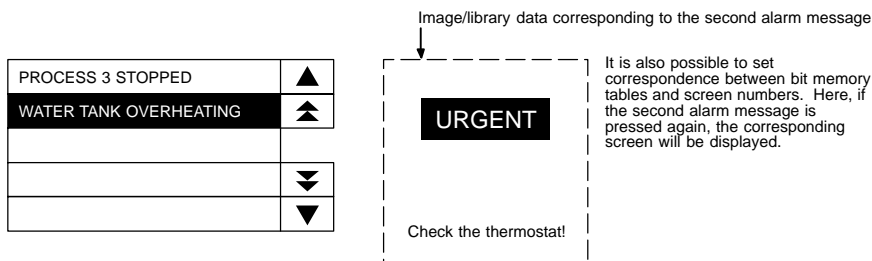

- (5) When the reverse video message is pressed, the screen changes to the screen with the set screen number.

- How to use the touch switches of the alarm list/history

The touch switches shown below are provided for the alarm list/history element.

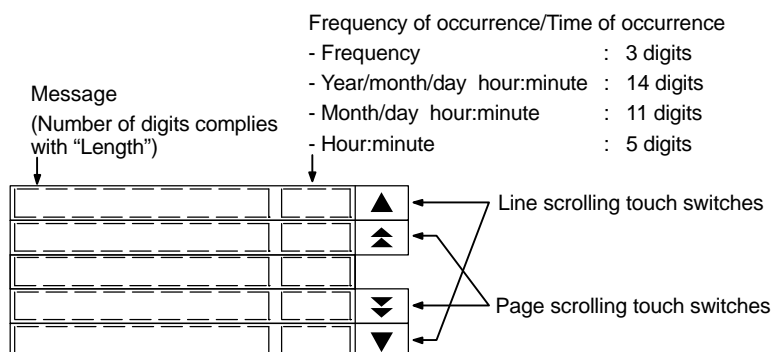

- Line scroll touch switches (scroll to the previous/next line)

The touch switches scroll the display range in units of a line forward and backward.

If data exist before and after the displayed range, the touch switches are displayed in reverse video. Pressing a touch switch not displayed in reverse video is disregarded.

- Page scroll touch switches (scroll to the previous/next page)

The touch switches scroll the display range in units of a page forward and backward.

If data exist before and after the displayed range, the touch switches are displayed in reverse video. Pressing a touch switch not displayed in reverse video is disregarded.

Displaying the Alarm History Record from the System Menu

The recorded alarm history record data can be confirmed from the System Menu. It is possible to print the alarm history record data using a printer connected to the NT631/NT631C.

- Display in the order of occurrence



- Display in the order of frequency



[Setting]

When creating a screen using the Support Tool, set the following.

- Bit memory table

Set as shown below by the number of bits in the host to be monitored (for information not indicated below, set as needed.).

- Allocated bits: Bits on the host to be monitored
- Function: Alarm
- History: Check mark set
- Switch Screen: No check mark
- String Table Entry: Table No. (0 to 1999) of the character string memory table to be displayed as a message

To display the alarm history in the order of occurrence, set the display order (From Old Data/From New Data) of the record data using the "Hist. Disp. Method" memory switch of the NT631/NT631C.

[Operation]

- (1) Initialize the recorded alarm history record data as needed.

To initialize the alarm history record data using System Menu operation, select "Alarm History" on the "MEMORY INIT. MENU" screen.

To initialize the alarm history record data by operation at the PT status control area, change the status of bit 1 in the 4th word (word n + 3) from the beginning of the PT status control area to "1" (ON).

After initializing the alarm history record data by operation at the PT status control area, return the status of bit 1 to "0" (OFF).

- (2) From the System Menu, display the alarm history confirmation screen.

The recorded alarm history record data is displayed.

Example: Display in the order of occurrence

No.	Bit	Unit	Comment	1/1
1	8524	8441	Conveyor Stopped	Quit
2	8524	8506	Temp. Low Level	↑
3	8524	8641	Process 2 Stopped	↓
4	8524	8641	Process 1 Stopped	Print
5	8524	8649	Conveyor Stopped	Print/Stop
6	8524	1521	Conveyor Stopped	
7	8526	8644	P/S Low Voltage	
8	8527	1732	Conveyor Stopped	
9	8527	1125	Temp. Low Level	
10	8530	2189	Process 1 Stopped	
11	8684	1833	Process 1 Stopped	
12	8684	2186	Conveyor Stopped	
13	8684	2152	Conveyor Stopped	

- (3) It is possible to display the previous and the next page by pressing the ↑ and ↓ keys.

- (4) To end the display, press the "Quit" touch switch.

Reference

For the procedure for displaying alarm history from the System Menu, refer to 6-11-5 "Displaying and Printing the Alarm History Record" (page 217).

8-9 Using the Display History Function

This section describes how to use the “display history” which records the order and frequency of screen display.

The display history can be checked using the System Menu of the NT631/NT631C. It is also possible to check it during operation by displaying the display history screen.

Concerning the display history record data stored to the NT631/NT631C, the Support Tool can read it out to the host as a text file. For the procedure for reading the display history record data, refer to the NT-series Support Tool Ver. 3.0 for Windows95/98 Operation Manual (V053-E1-□).

8-9-1 How to Use the Display History

A display history can be displayed in the special screen called out during operation or in the screen called out from the System Menu.

Displaying the Special Screen during Operation

The display history can be confirmed during the operation of the NT631/NT631C.

[Setting]

When creating a screen using the Support Tool, tick the check box of the “History” property of the screen to be recorded in the display history.

To display the alarm history in the order of occurrence, set the display order (From Old Data/From New Data) of the record data using the “Hist. Disp. Method” memory switch of the NT631/NT631C.

[Operation]

- (1) Initialize the recorded alarm history record data as needed.

To initialize the alarm history record data using System Menu operation, select “Alarm History” on the “MEMORY INIT. MENU” screen.

To initialize the alarm history record data by operation at the PT status control area, change the status of bit 11 in the 4th word (word n + 3) from the beginning of the PT status control area to “1” (ON).

After initializing the alarm history record data by the operation at the PT status control area, return the status of bit 11 to “0” (OFF).

- (2) Display the display history screen.

The screen number of the display history screen is:

Order of occurrence: No. 9001

Order of frequency: No. 9002

- Display in the order of occurrence (screen No. 9001)

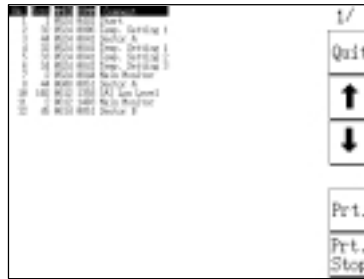

- Display in the order of frequency (screen No. 9002)



- (3) It is possible to display the previous and the next page by pressing the ↓ and ↑ keys.
- (4) To end the display, press the “Quit” touch switch.

Displaying the Confirmation Screen from the System Menu

The recorded display history record data can be confirmed from the System Menu. It is possible to print the display history record data using a printer connected to the NT631/NT631C.

[Setting]

When creating a screen using the Support Tool, tick the check box of the “History” property of the screen to be recorded in the display history.

To display the alarm history in the order of occurrence, set the display order (From Old Data/From New Data) of the record data using the “Hist. Disp. Method” memory switch of the NT631/NT631C.

[Operation]

- (1) Initialize the recorded display history record data as needed.
 - To initialize the alarm history record data using System Menu operation, select “Alarm History” on the “MEMORY INIT. MENU” screen.
 - To initialize the alarm history record data by operation at the PT status control area, change the status of bit 1 in the 4th word (word n + 3) from the beginning of the PT status control area to “11” (ON).
 - After initializing the alarm history record data by the operation at the PT status control area, return the status of bit 11 to “0” (OFF).
- (2) Display the display history confirmation screen from the System Menu.
 - The recorded display history record data is displayed.

- Display in the order of occurrence (screen No. 9001)

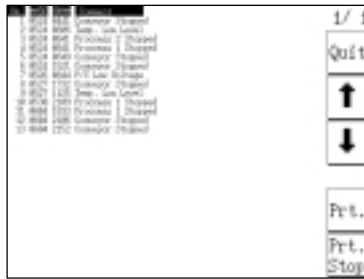

- Display in the order of frequency (screen No. 9002)



- (3) It is possible to display the previous and the next page by pressing the ↑ and ↓ keys.
- (4) To end the display, press the “Quit” touch switch.

Reference For the procedure for displaying display history from the System Menu, refer to 6-11-4 “Displaying and Printing the Display History Record” (page 215).

8-10 Display and Setting of Calendar Clock

The NT631/NT631C provides a function for displaying and setting the date and time. This section describes the procedure for using the clock function.

- Numeral memory table used by the clock function

Numeral memory tables No. 247 to No. 255 are reserved for the display and setting of the clock function.

Memory tables No. 247 to No. 253 are for display and reading, and No. 254 and No. 255 are for setting.

Memory tables No. 247 to No. 253 store the clock data which is updated according to the operation of the clock built into the NT631/NT631C. The data in these memory tables cannot be changed from the host.

Function	Numeral memory table	Digit position	Information	Value	Remarks	
Display/ reading only	247		Second	00 to 59		
	248		Minute	00 to 59		
	249		Hour	00 to 23	24-hour system	
	250		Date	01 to 31		
	251		Month	01 to 12		
	252		Year	00 to 99	Last 2 digits of the year	
	253		Day of week	00 to 06	See below.	
Setting only	254		Second	00 to 59		
			Minute	00 to 59		
			Hour	00 to 23	24-hour system	
			Date	01 to 31		
	255		Month	01 to 12		
			Year	00 to 99	Last 2 digits of the year	
			Day of week	00 to 06		
			Vacant	00		

The correspondence between the value and day of week is shown below.

Day of week	Sun	Mon	Tue	Wed	Thu	Fri	Sat
Value	00	01	02	03	04	05	06

Example of setting: March 27th, '98 (Fri.), 14 H 53 M 30 S

254 2'7'1'4'5'3'3'0
255 0'0'0'5'9'8'0'3

Reference

The numeral memory tables No. 247 to No. 255, reserved for the clock function, cannot be allocated to a word in the host.

8-10-1 Setting the Date and Time

The clock data can be set by the following methods.

- Setting from the System Menu
- Changing the value in numeral memory tables No. 254 and No. 255

The following explains the procedure for writing the required clock data to the numeral memory tables. For the procedure for setting the clock data using the System Menu, refer to 6-11-2 "Displaying/Setting the Calendar and Clock" (page 211).

Reference The clock has an accuracy of maximum monthly error of -39 to +65 seconds at a room temperature (25°C). Adjust the error periodically to operate the clock accurately.

Changing the Value in Numeral Memory Tables No. 254 and No. 255

Numeral memory tables No. 254 and No. 255 are specially used for setting the clock data.

These memory tables cannot be allocated to the area in the host. Therefore, to change the contents in these memory tables, write the data to be set in them into another numeral memory table first then copy the written value to numeral memory tables No. 254 and No. 255 using the memory table copy function.

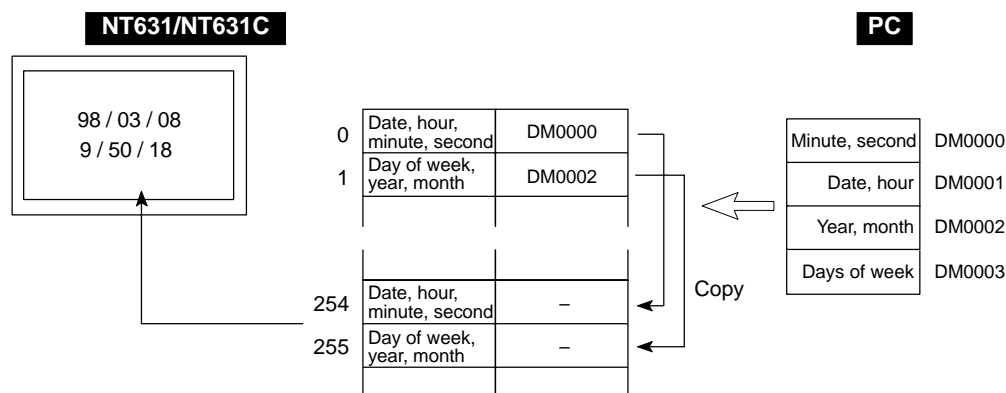

To copy a memory table, either use the PT status control area or the touch switch "copy setting" function. Here, the procedure for copying a memory table using the PT status control area is described. For the procedure for using the touch switch "copy setting" function, refer to "Changing Numeric Values/Character Strings by Pressing a Touch Switch Which Has the "Copy Setting" Function" (page 503).

Reference The NT631/NT631C does not check the set date and time data strictly. Therefore the data must be set correctly so that there is no discrepancy between the date and the day of a week.

[Setting]

Prepare two numeral memory tables to write the required values for copying it to numeral memory table No. 254 and No. 255.

- PC Address: Any word in the host
- Words: 2 words
- Storage Type: Binary

Use the PT status control area to copy memory tables. Since the PT control area must be allocated to a word in the host, no setting is necessary for copying memory tables.

[Operation]

In the PT status control area, the following areas are provided to be used for copying the data between memory tables.

- Second word from the beginning (word n + 1)
Copy source memory table No.
- Third word from the beginning (word n + 2)
Copy destination memory table No.
- Fourth word from the beginning (word n + 3)
Memory table type (bit 2) and PT status control bit specifying the execution of copying (bit 3)

(n: First word number in the PT status control area)

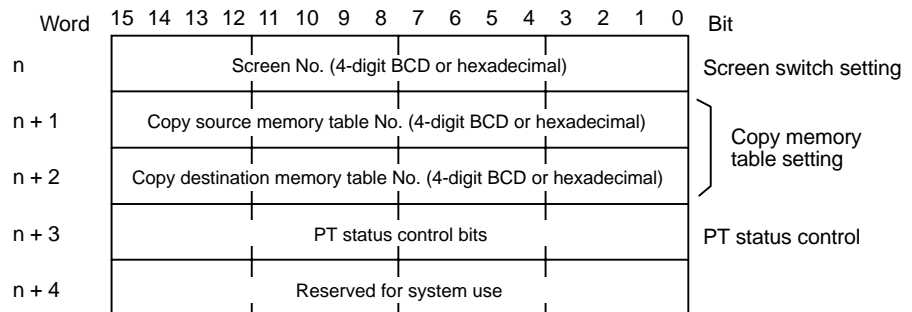

PT Status Control (word n + 3)

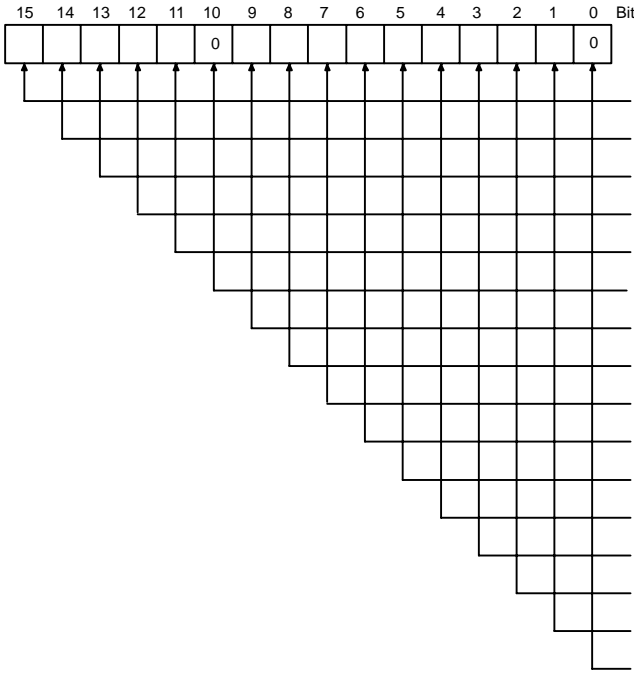

Controlled Item	1 (ON)	0 (OFF)
Screen display	Performed	Not performed
Processing priority registration (for NT link (1:N))	Registered	Canceled
Continuous buzzer	Sounded	Stopped
Intermittent buzzer (short)	Sounded	Stopped
Display history initialization	Performed	Not performed
Not used	Always "0"	
Intermittent buzzer (long)	Sounded	Stopped
Backlight mode	Lit	Flashing
Screen printing	Performed	Not performed
PT window opening	Disabled	Enabled
Numeral/character string input	Disabled	Enabled
PT screen switching	Disabled	Enabled
Memory table copy execution	Performed	Not performed
Memory table copy type	Numeral	Character string
Alarm history initialization	Performed	Not performed
Not used	Always "0"	

The operation for setting the date and time data is described below.

The following explains the operation for copying the numeric value from copy source numeral memory table A to copy destination numeral memory table No. 254 and from copy source numeral memory table B to copy destination numeral memory table No. 255. The numeric values in numeral memory tables A and B are stored in "BCD".

- Set the date and time data in the words where numeral memory table A is allocated (word A and word A+1, in the illustration below).

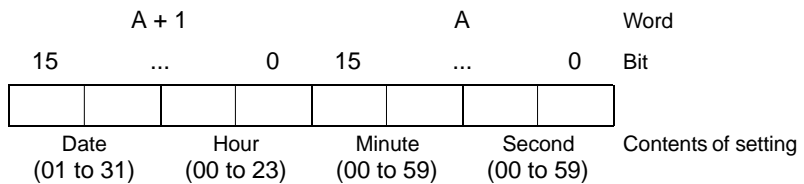

- Set the date and time data in the words where numeral memory table B is allocated (word B and word B+1, in the illustration below).

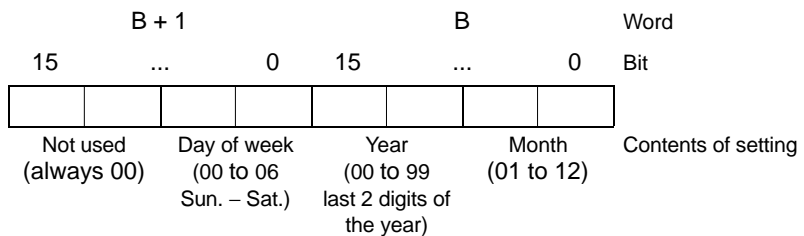

- (3) Write the memory table numbers to the PT status control area in 4-digit BCD as shown below (designation of copy source and copy destination memory table numbers).
 - Second word from the beginning (word n + 1): Table number of numeral memory table A
 - Third word from the beginning (word n + 2): 0254
- (4) Set "1" (ON) for bit 2 of the fourth word (word n + 3) from the beginning of the PT status control area (designation of memory table copy type as "numeric value").
- (5) Set "1" (ON) for bit 3 of the fourth word (word n + 3) from the beginning of the PT status control area (designation of memory table copy execution).

The contents of numeral memory table A are copied to numeral memory table No. 254 and the date, hour, minute, second are set for the NT631/NT631C.
- (6) Write the memory table numbers to the PT status control area in 4-digit BCD as shown below (designation of copy source and copy destination memory table numbers).
 - Second word from the beginning (word n + 1): Table number of numeral memory table B
 - Third word from the beginning (word n + 2): 0255
- (7) Set "1" (ON) for bit 2 of the fourth word (word n + 3) from the beginning of the PT status control area (designation of memory table copy type as "numeric value").
- (8) Set "1" (ON) for bit 3 of the fourth word (word n + 3) from the beginning of the PT status control area (designation of memory table copy execution).

Contents of numeral memory table B are copied to numeral memory table No. 255 and the day of week, year, and month are set for the NT631/NT631C.

[Example of Use]

Refer to the "Example of Use" (page 538) for the next item 8-10-2 "Displaying the Date and Time".

8-10-2 Displaying the Date and Time

The procedure for displaying the date and time data set using the clock function of the NT631/NT631C by the numeric value display of numeral memory tables No. 247 to No. 253 is described below.

Numeral memory tables No. 247 to No. 253 store the date and time data as shown below and the stored data is constantly updated.

Numeral memory table	Contents	Range	Comment
247	Sec.	0 to 59	
248	Min.	0 to 59	
249	Hour	0 to 23	24-hour notation
250	Date	1 to 31	
251	Month	1 to 12	
252	Year	0 to 99	Last 2 digits of the year
253	Day of week	0 to 6	Sunday through Saturday

The date and time data are stored in signed binary data in a numeral memory table. Therefore, to display a numeric value, it is necessary to set "Decimal" for "Display Type".

[Setting]

Register the "numeric value display" for the display of contents of numeral memory tables No. 247 to No. 253 for the screen according to the date and time data to be displayed.

The "Display Type" of "Numeral Display" must be "Decimal". Set other properties according to the display requirements.

[Operation]

The current date and time are continually displayed by the "Numeral Display" for displaying numeral memory tables No. 247 to No. 253.

[Example of Use]

The following describes an example of how to display the date and time, set at the PC, on the NT631/NT631C.

In this example a C200HX, which has a clock function, is used. The clock function is allocated to words AR18 to AR21 in the C200HX.

- Setting at the Support Tool

Set using the Support Tool as indicated below:

- PT status control area allocated words: 00100 (CIO area, word 100)
- Numeral memory table No. 264: DM0000 (number of words: 2)
- Numeral memory table No. 265: DM0002 (number of words: 2)
- Contents to be registered to the screen: Numeric value display (numeral memory table No. 247 to No. 252)

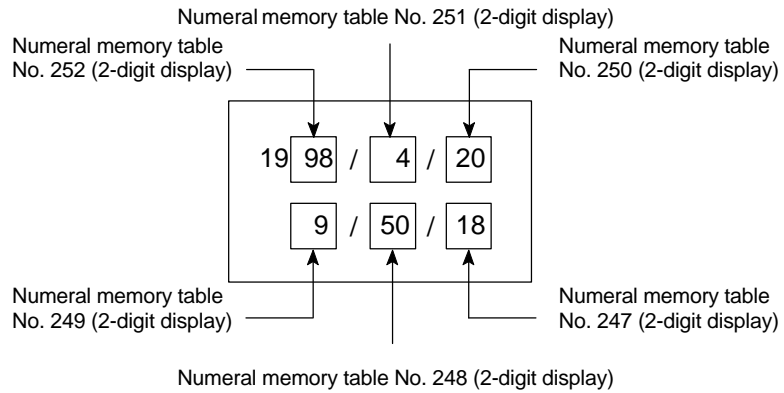

• PC program

Create the PC ladder program as shown below.

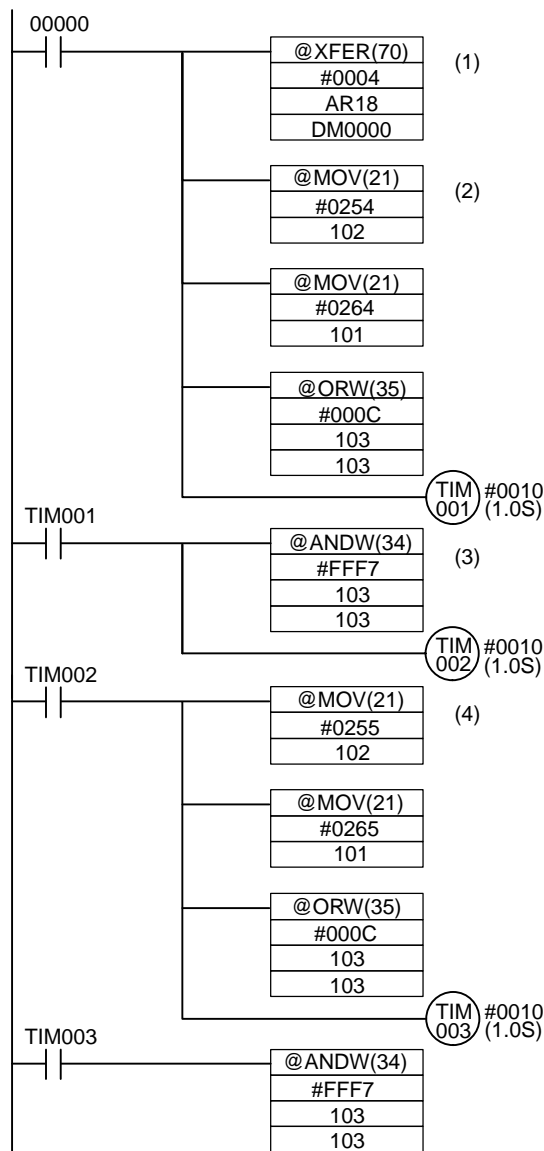

- Program operation

When the program is executed after displaying the created screen on the NT631/NT631C, the operation is controlled as follows.

- (1) When bit 00000 comes ON, the date and time (AR 18 to AR 21) set in the PC is read, and written to words (DM0000 to DM0003) allocated to numeral memory tables No. 264 and No. 265.
- (2) The contents in numeral memory table No. 264 (day, hour, minute, second) are copied to numeral memory table No. 254, which is used for setting the clock function.
- (3) After waiting about a second for the completion of the memory table copy operation in step (2), the memory table copy execution bit (10303) is returned to the OFF status.
- (4) After a wait of about one second for the NT631/NT631C to confirm that the memory table copy execution bit has gone OFF, the program copies the contents of numeral memory table No. 265 (day of the week, year, month) to numeral memory table No. 255, which is used for setting the clock function, in the same way as described in steps (2) and (3) above.

The date and time set at the PC is set for the NT631/NT631C and displayed.

8-11 Printing Data and Checking the Printer Status

The following data below can be output to a printer connected to the NT631/NT631C while the NT631/NT631C is operating.

- Hard copy of the screen

The status of the printer connected the NT631/NT631C can be checked from the host.

This section describes the procedure for printing data during operation and also the procedure for checking the printer operating status.

- Reference**
- In addition to the hard copy of the screen, some kinds of data can be output to a printer using the System Menu. For details of printing using the System Menu, refer to 6-11-4 "Displaying and Printing the Display History Record" (page 215) and 6-11-5 "Displaying and Printing the Alarm History Record" (page 217).
 - The "Printer Controller" and "Print Method" used by the NT631/NT631C for printing are set by the memory switches on the NT631/NT631C.

Checking the Printer Operating State

The printer operating status information in the PT status notify area indicates whether the printer is operating or not.

[Setting]

The PT status notify area must be allocated to a word in the host, accordingly, no special settings are required for reading the status.

[Operation]

The bit used to notify the PT status (PT status notify bit) is provided at the second word (word m + 1) from the beginning in the PT status notify area.

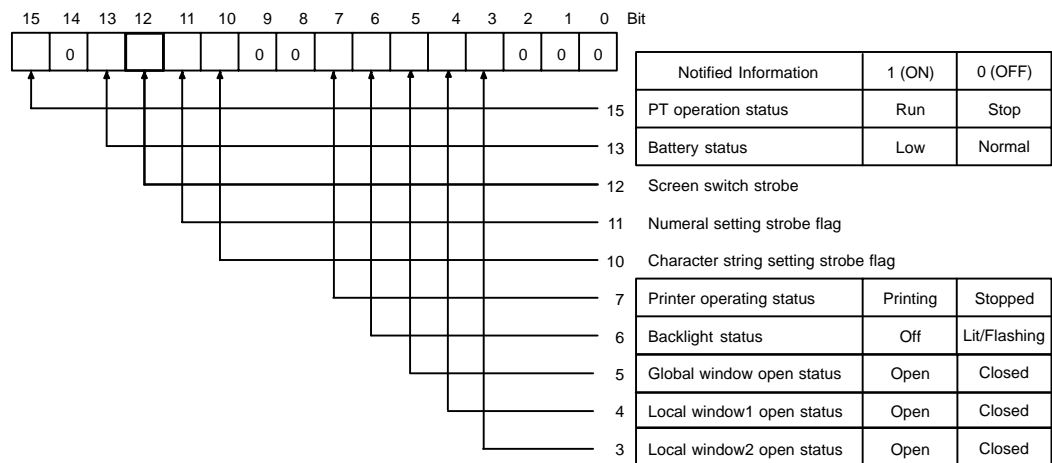

To check the operating status of the printer, operate the PT status notify area in the manner shown below.

- (1) Read the second word (word m + 1) from the beginning in the PT status notify area. Bit 7 in the PT status notify bits shows the operating status of the printer.

- 0 (OFF): Stopped
- 1 (ON): Printing

8-11-1 Printing the Screen

With the NT631/NT631C, the screen currently displayed can be printed by using either of the procedures indicated below.

- By the operation at the PT status control area
- By pressing a touch switch with the “print screen” function.

Printing a Hard Copy by Operation at the PT Status Control Area

When this method is used, an operator can print a hard copy of the screen at any time.

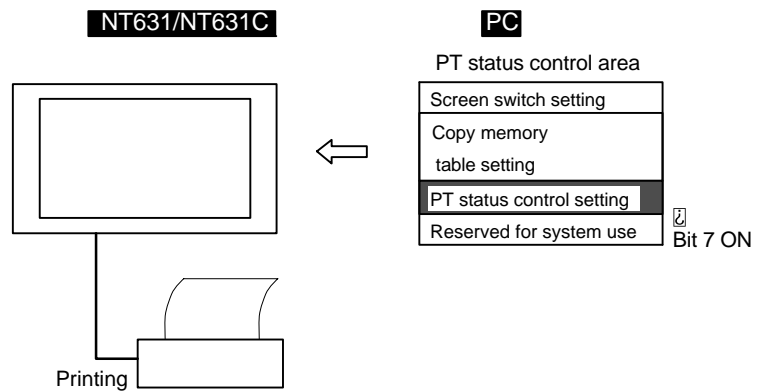

- Reference**
- The NT631/NT631C continues operation even while the screen hard copy is being printed.
 - It is necessary to ensure that the “printer operation status” (bit 7) among the PT status notify bits is “0” (OFF) before starting printing.
 - Once screen printing has been started by operation of the PT status control bit, it is not possible to stop printing.
 - If screen printing is specified during printing by the NT631/NT631C, the screen printing instruction is ignored.

[Setting]

The PT status control area must be allocated to a word in the host, accordingly, no special settings are required for printing a hard copy of the screen.

[Operation]

The bit used to control the PT status (PT status control bit) is provided at the fourth word (word n + 3) from the beginning in the PT status control area.

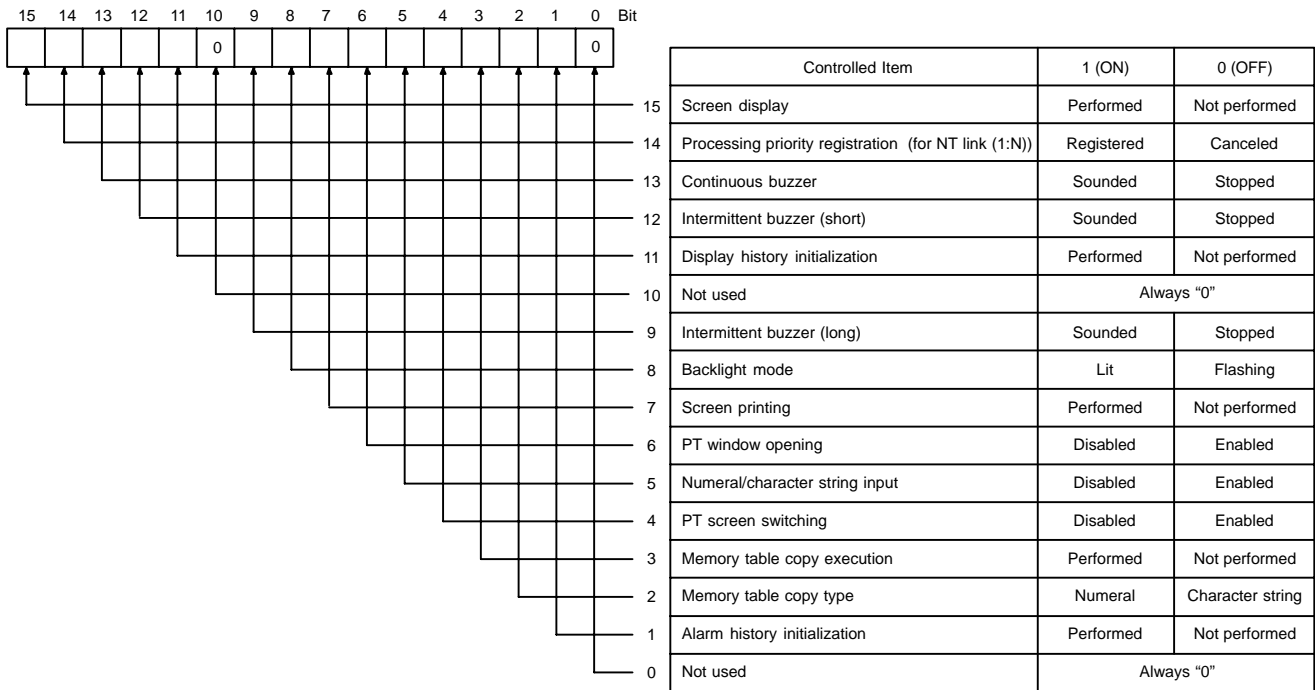

To print the hard copy of the screen, operate the PT status control area in the manner shown below.

- (1) Read the second word (word m + 1) from the beginning in the PT status notify area and make sure that bit 7 (printer operating status) in the PT status notify bits is "0" (OFF). (page 541)
- (2) Set "1" (ON) for bit 7 in the fourth word (word n + 3) from the beginning in the PT status control area.

Printing a Hard Copy by Pressing a Touch Switch with the "Print Screen" Function

If this method is used, the screen can be printed out by operation at the NT631/NT631C. To use this method for printing the screen, however, a touch switch which has the "print screen" function must be registered for the screen.

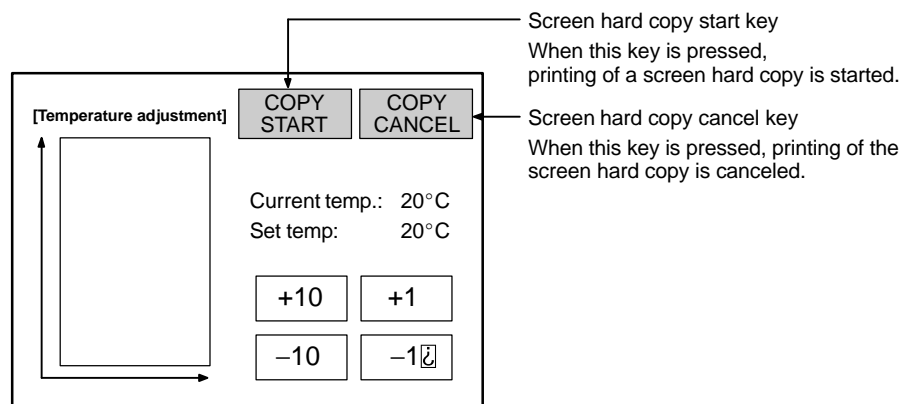

- Reference**
- The NT631/NT631C continues operation even while the screen hard copy is being printed.
 - By registering a touch switch with the print stop function, it is possible to stop printing by using this touch switch.
-

[Setting]

When creating a screen using the Support Tool, set the function "Print Screen" for a touch switch, set "Start" as the function, and register the touch switch for the screen.

If necessary, also register a touch switch for which the "Abort" function is set for "Print Screen" for the screen.

[Operation]

- (1) To start or stop screen printing, press the touch switch with the "Print Screen" function ("Start" for starting screen printing and "Abort" for stopping screen printing).

8-12 Enabling/Disabling PT Operations

For the following functions of the NT631/NT631C, operations can be enabled or disabled by instructions from the host.

- Opening a window
- Inputting numeric values and character strings
- Switching the screen

The procedure for enabling and disabling operation at the NT631/NT631C by instructions from the host is described below.

8-12-1 Enabling and Disabling the Operation of the NT631/NT631C

Operation at the NT631/NT631C can be enabled or disabled by the procedure shown below.

- By operation at the PT status control area

Reference

- When window opening is disabled, all kinds of window opening operations at the NT631/NT631C, such as operations which use a touch switch or screen property setting, are not possible. Note that window close operations are still possible.
- When input of numeric values and character strings is disabled, all kinds of numeric value and character string change operations at the NT631/NT631C, such as numeric value input (numeric key type input field, thumbwheel type input field), character string input, and copying memory tables using a touch switch, are not possible. Note that operations to change numeric values/character strings at the PT status control area by an instruction from the host (memory table copying and screen switching by operation at the PT status control area, changing the contents of allocated words, etc.) are still possible.
- When screen switching is disabled, all kinds of screen switching operations at the NT631/NT631C, such as screen switching using a touch switch and by the alarm list/history function, are not possible. Note that the display of the System Menu using the touch panel and screen switching by an instruction from the host using the PT status control area are still possible.
- It is possible to disable the input and change operation using the System Menu and the display of the System Menu by setting in the System Installer mode (page 166).

Controlling the Enabling/Disabling of PT Side Operation by Operation at the PT Status Control Area

If this method is used, it is possible to enable and disable the operation at the NT631/NT631C from the host.

[Setting]

The PT status control area must be allocated to a word in the host, accordingly, no special settings are required for reading the operation at the NT631/NT631C.

[Operation]

Bits used to control the PT status (PT status control bits) are provided at the fourth word (word n + 3) from the beginning in the PT status control area.

- Bit 6: Enabling/disabling the PT side window opening
- Bit 5: Enabling/disabling the inputting of numeric values and character strings
- Bit 4: Enabling/disabling the PT side screen switching

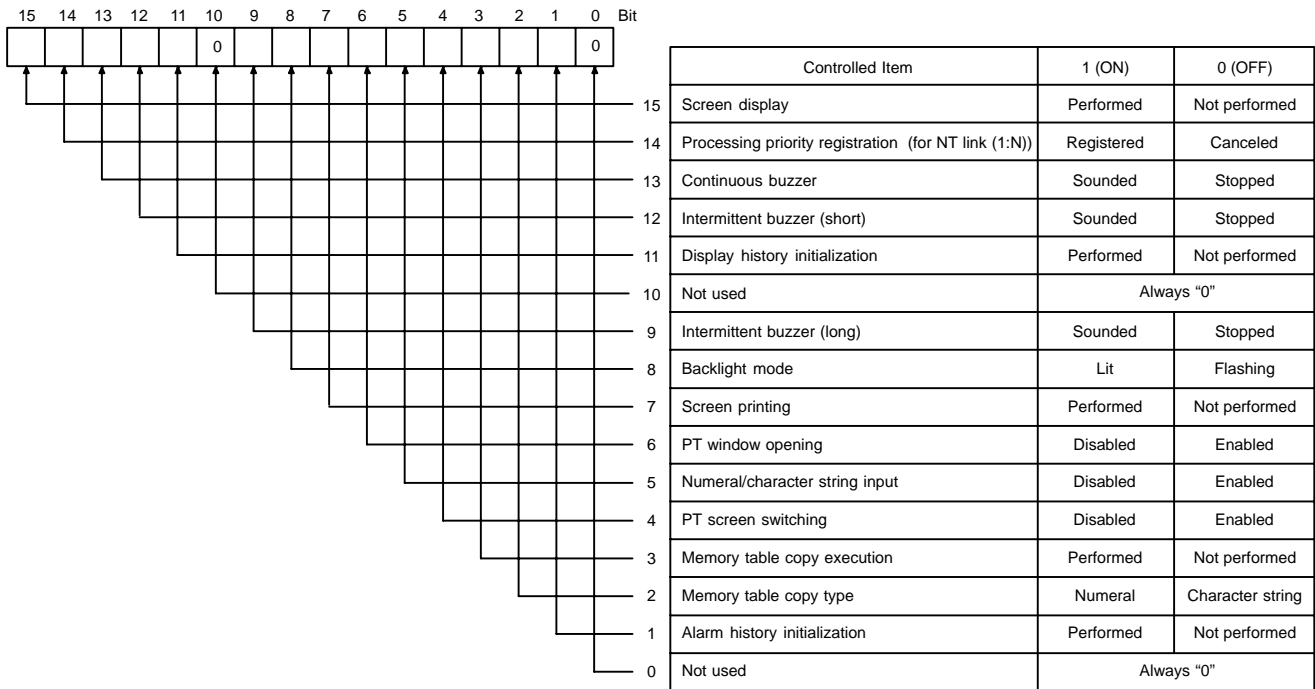

To control the operation by the NT631/NT631C while it is running, operate the PT status control area in the manner shown below.

- (1) Change the setting of the bits in the fourth word (word n + 3) from the beginning in the PT status control area as indicated below according to the required control.

word n + 3

- Bit 6: To control the PT side window opening
- Bit 5: To control the inputting of numeric values and character strings
- Bit 4: To control PT side screen switching
 - To disable operation: 1 (ON)
 - To enable operation: 0 (OFF)

SECTION 9

Using Memory Link

This section gives an overview of memory link operations and contains explanations centered on communications between the NT631/NT631C and host when using memory link.

9-1	Operation of the Memory Link	546
9-1-1	PT Memory	546
9-1-2	Memory Link Commands	547
9-2	Outline of Communications	549
9-2-1	Communication Protocol	549
9-2-2	Notes on Using Commands	551
9-3	Commands/Responses	553
9-3-1	PT memory read command	(Sent from host to PT) 553
9-3-2	Numeral memory table read command	(Sent from host to PT) 555
9-3-3	Character string memory table read command	(Sent from host to PT) 556
9-3-4	Bit memory table read command	(Sent from host to PT) 558
9-3-5	Screen data comment read command	(Sent from host to PT) 560
9-3-6	System status read command	(Sent from host to PT) 561
9-3-7	PT memory write command	(Sent from host to PT) 562
9-3-8	Numeral memory table write command	(Sent from host to PT) 564
9-3-9	Character string memory table write command	(Sent from host to PT) 566
9-3-10	Bit memory table write command	(Sent from host to PT) 567
9-3-11	PT memory batch write (FILL) command	(Sent from host to PT) 569
9-3-12	Numeral memory table clear command	(Sent from host to PT) 570
9-3-13	Character string memory table clear command	(Sent from host to PT) 571
9-3-14	Bit memory table clear command	(Sent from host to PT) 572
9-3-15	Touch switch input notify command	(Sent from PT to host) 573
9-3-16	Numerical input notify command	(Sent from PT to host) 574
9-3-17	Character string input notify command	(Sent from PT to host) 576
9-3-18	Direct area changing notify command	(Sent from PT to host) 577
9-3-19	PT memory changing notify command	(Sent from PT to host) 580
9-3-20	PT operation mode switching command	(Sent from host to PT) 581
9-3-21	Re-send request command	(Sent from host to PT) 582
9-3-22	Error response	(Sent from PT to host) 583

9-1 Operation of the Memory Link

This section describes the function of the memory link. For outline of the function of memory link, refer to 1-4 "Communication by Using Memory Link".

9-1-1 PT Memory

With memory link, allocation of element bit or word is performed for PT memory.

The PT memory is a virtual PC area within the NT631/NT631C. The NT631/NT631C read/write to the internal PT memory and a host controls/monitors the NT631/NT631C by reading/writing PT memory.

With PT memory, there is no classification of the area as there is with real PC areas: it consists of a memory link area of just 10000 words from 0000 to 9999.

Memory link can be treated in exactly the same way as direct connections such as host link and NT link, except that the channels to be allocated differ. The specification of bits is also the same.

A diagram of the PT memory is shown below.

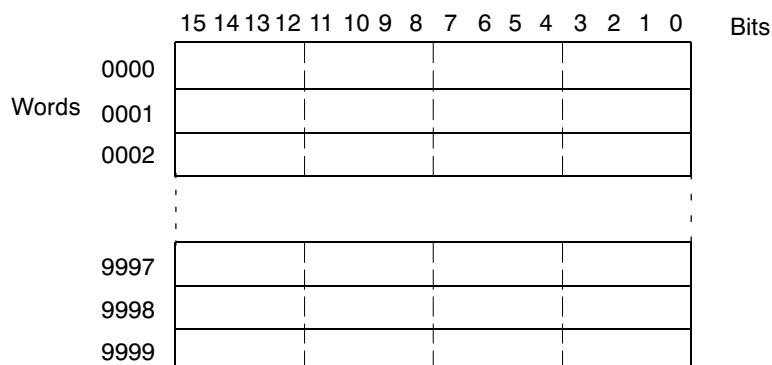

- Reference:**
- The PT memory is backed up by the battery even while the NT631/NT631C power is OFF.
 - The explanations in this section concentrate on the memory link communication method. For details on control and notification between the NT631/NT631C display elements and the PT memory, refer to Section 7 "NT631/NT631C Functions" and Section 8 "How to Use the PT".

9-1-2 Memory Link Commands

When using the memory link, data is sent and received between the host and NT631/NT631C using commands such as those indicated below.

- Data Read Commands/Responses

These are the commands for reading the contents of the PT memory and memory table in the NT631/NT631C. They are issued from the host and, as the response, the NT631/NT631C sends back to the specified data

There are the following six commands.

- PT memory read command Page 555
- Numeral memory table read command Page 557
- Character-string memory table read command Page 558
- Bit memory table read command Page 560
- Screen data comment read command Page 562
- System status read command Page 563

- Data Write Commands/Responses

These are the commands for writing data to the PT memory and memory tables in the NT631/NT631C. They are issued from the host and, as the response, the NT631/NT631C sends a reply indicating whether or not writing was completed normally. It is possible to omit the response by a memory switch setting when writing is successful.

There are the following eight commands.

- PT memory write command Page 564
- Numeral memory table write command Page 566
- Character-string memory table write command Page 568
- Bit memory table write command Page 569
- PT memory batch write (FILL) command Page 571
- Numeral memory table clear command Page 571
- Character-string memory table clear command Page 573
- Bit memory table clear command Page 574

- Notify commands

These commands serve to notify the host of the results of operation at the NT631/NT631C. Only these commands are issued by the NT631/NT631C and, therefore, there is no response for them.

There are the following five commands.

- Touch switch input notify command Page 575
- Numerical input notify command Page 576
- Character string input notify command Page 578
- Direct area changing notify command Page 579
- PT memory changing notify command Page 582

- Operation mode switching command

This command switches the NT631/NT631C operation mode from RUN mode to transmit mode. It is issued from the host and switches the NT631/NT631C operation mode.

- PT operation mode switching command Page 583

- Re-send command

This command lets the NT631/NT631C re-send a notify command. It is issued from the host and the notify command issued last is re-sent from the NT631/NT631C.

- Re-send request command Page 584

- Error response

This is a response from the host which is issued when the contents of command transmitted to the NT631/NT631C was incorrect.

- Error response Page 585

9-2 Outline of Communications

This section describes the basic communication protocol when using memory link and the program flow for using memory link, taking RS-232C communications using the BASIC language as an example.

9-2-1 Communication Protocol

Communication between the host and the NT631/NT631C takes place in accordance with the following protocol.

- (1) In order to perform communications, it is necessary to open the communication line. "Opening" here means making the line usable.
- (2) In accordance with the commands, the NT631/NT631C is controlled or notification is received from the NT631/NT631C.
- (3) To terminate communication, close the communication line.

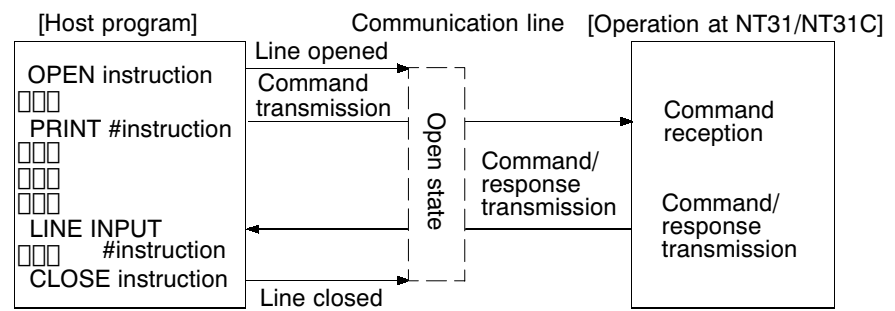

Once the line has been opened, it can be used until it is closed.

- Function of each instruction

- OPEN instruction : Opens the RS-232C line.
Also sets the communication conditions at the host side (see page 87, 131).
- PRINT #instruction : Sends commands to the NT631/NT631C via an RS-232C line.
- LINE INPUT #instruction : Receives the command or response from the NT631/NT631C.
In order to receive input delimited by commas and double quotation marks, use "LINE INPUT".
- CLOSE instruction : Closes the RS-232C line.

For detailed information on instructions, refer to the BASIC language instruction manual for the host.

- Operation When Using Instructions

The flow of communications between the host and the NT631/NT631C follows one of the three patterns indicated below, depending on the types of command and the settings made for “response” with the memory switches (see page 179).

- Pattern with write command when “No” is set for the response

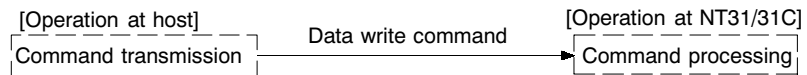

However, when an error occurs, an error response is returned.

- Pattern with data read command, re-send command, and data write command when response “Yes” is set.

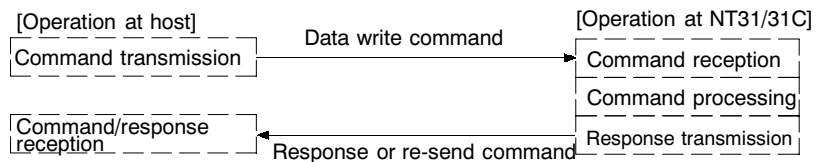

Sometimes multiple responses may be received for one command.

- Pattern when the operation at the NT631/NT631C is notified to the host.

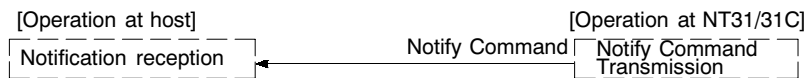

9-2-2 Notes on Using Commands

The points that should be observed when using commands are given below.

- Method for Specifying Commands

When a personal computer or similar device is used as the host and a high-level language such as BASIC or C is used for program writing, commands are specified as ASCII character strings.

Note that in the explanations in this section, parameters are denoted in lower case characters. When specifying a command, write those parts denoted in upper case without modification, for those parts denoted in lower case, write the numeric values (BCD or hexadecimal) or character string for parameters as ASCII character strings. Parts in square brackets, such as [ESC] and [CR] each indicate one control code (the [ESC] code, the [CR] code, etc.).

In the explanations of commands, expressions such as “4 BCD digits” and “2 hexadecimal digits” are used to mean (respectively) “the ASCII character string for a numerical value expressed as four BCD digits” and “the ASCII character string for a numerical value expressed as two hexadecimal digits”, etc. Do not specify BCD and hexadecimal data without alteration: always convert it into an ASCII character string before transmission.

Example: The format for the numeral value memory table read command is shown below.

[ESC]	R	M	m	t1	t2	t3	t4
1B	52	4E	* *	* *	* *	* *	* *
	(l1)	(l2)	(s1)	(s2)	[CR]		
	* *	* *	* *	* *	0D		

The following parameters are specified in this format.

m	:	1	(1 BCD digit)
t ₁ , t ₂ , t ₃ , t ₄	:	0123	(4 BCD digits)
l ₁ , l ₂	:	99	(2 BCD digits)
s ₁ , s ₂	:	24	(2 hexadecimal digits)

The character string actually transmitted is as shown below.

[ESC]	R	N	1	0	1	2	3
1B	52	4E	31	30	31	32	33
	9	9	2	4	[CR]		
	39	39	32	34	0D		

Reference

In the “Format” sections in the explanations for commands/responses, parentheses are used to indicate parts that can under some circumstances be omitted, and ** is used to indicate the ASCII code (two hexadecimal digits) of the specified character.

- Processing differences according to command length
 - If a command is too long because it has been incorrectly specified, an error response for a command length error is returned.
 - If a command is short because it has been incorrectly specified, a communication error (time out) occurs.
- Command transmission intervals
 - If commands are sent too frequently, processing at the NT631/NT631C will not be able to keep pace with them and a communication error (buffer overflow) will occur.
 - Use the flow control to prevent a buffer overflow.
- Order of priority of input communication commands
 - When a reason for input notification arises during processing of a command from the host, the input command is issued only after the ongoing command processing has been completed.
- Check sum
 - The checksum of the command response is the 2 digits ASCII code which is indicated using lower one-byte of the total sum (in unit of bytes) of the following, from the [ESC] code at the beginning to the character immediately before the checksum value. It can be omitted by specifying the parameter used to omit sum value.
If "ON" is set for the "Comm. Auto-return" memory switch, communication errors are not displayed on the screen even if they occurs. However, in case of time out error at the NT631/NT631C side, an error message is displayed on the screen and the operation is stopped.

Reference

Whether or not the error response is returned depends on the memory switch setting made for "Comm. Auto-return" and error type.
For details, refer to "Error Response" in page 585.

9-3 Commands/Responses

This section describes the commands used with the memory link and their responses.

9-3-1 PT memory read command (Sent from host to PT)

Command

[Format]

[ESC]	R	M	m	c1	c2	c3	c4
1B	52	4D	* *	* *	* *	* *	* *
			(l1)	(l2)	(s1)	(s2)	[CR]
			* *	* *	* *	* *	0D

- m : Check sum present/absent (1 BCD digit)
 0 : Absent
 1 : Present
 8 : Absent (1 word read)
 9 : Present (1 word read)
- c₁ to c₄ : First word number read (4 BCD digits)
 0000 to 9999
- l₁, l₂ : Number of read words (2 BCD digits)
 00 : 100 words
 01 to 99 : 1 to 99 words
 When m is 8 or 9, omit this setting.
- s1, s2 : Check sum (2 hexadecimal digits)
 When m is 0 or 8, omit this setting.

Response

[Format]

[ESC]	R	M	c1	c2	c3	c4	l1	l2
1B	52	4D	* *	* *	* *	* *	* *	* *
			Data of 1 word		Data of 1 word			
			d11	d1m	,	dn1	dnm	s1 s2 [CR]
			* *	* *	2C	* *	* *	* * 0D

- c₁ to c₄ : First word number read (4 BCD digits)
 0000 to 9999
- l₁, l₂ : Number of read words (2 BCD digits)
 01 to 50 : 1 to 50 words

- d1₁ to d1_m, ..., dn₁ to dn_m :
 - Contents of the read words (1 to 4 hexadecimal digits)
 - 0 to FFFF_H
 - Since initial zeroes are omitted, there may be less than 4 digits.
 - Individual words of data are delimited by commas.
- s₁, s₂ : Check sum (2 hexadecimal digits)
 - This is always added.

[Function]

- Reads the contents of the specified number of words from the specified word of the PT memory.
- Used to read the statuses of the PT notify area, window control area, lamps, touch switches and bit memory tables allocated to the PT memory, and the contents of numeral and character string memory tables.
- A maximum of 100 words can be read at one time.
- In the response, maximum of 50 words can be returned at one time. If reading of more than 50 words is specified, the response is split into two parts. In this case the first part always contains 50 words of data. Note also that the “first word number read” in the second part of the responses will be the word number of the first word in the response data.

Example

[Reading the PT status in the PT notify area (allocated words: 0010 to 0011)]

Assume that the following data is stored for PT notify area:

0010	CH	0123H
0011	CH	8000H

- Command

[ESC]	R	M	0	0	0	1	0	0	2	[CR]
1B	52	4D	30	30	30	31	30	30	32	0D

No check sum (2 word read), first word read = 0010

- Response

[ESC]	R	M	0	0	1	0	0	2			
1B	52	4D	30	30	31	30	30	32			
	1	2	3	,	8	0	0	0	6	7	[CR]
	31	32	33	2C	38	30	30	30	36	37	0D

9-3-2 Numeral memory table read command (Sent from host to PT)

Command

[Format]

[ESC]	R	N	m	t1	t2	t3	t4
1B	52	4E	* *	* *	* *	* *	* *
			(l1)	(l2)	(s1)	(s2)	[CR]
			* *	* *	* *	* *	0D

- m : Check sum present/absent (1 BCD digit)
 0 : Absent
 1 : Present
 8 : Absent (1 table read)
 9 : Present (1 table read)
- t₁ to t₄ : First numeral memory table read (4 BCD digits)
 0000 to 1999
- l₁, l₂ : Number of read tables (2 BCD digits)
 00 : 100
 01 to 99 : 1 to 99
 When m is 8 or 9, omit this setting.
- s₁, s₂ : Check sum (2 hexadecimal digits)
 When m is 0 or 8, omit this setting.

Reference

The maximum number which can be specified for “first numeral memory table read” depends on the setting for numbers of numeral table entries (512/1000/2000) made at the Support Tool.

Response

[Format]

[ESC]	R	N	t1	t2	t3	t4	l1	l2
1B	52	4E	* *	* *	* *	* *	* *	* *
			Data of 1 word		Data of 1 word		s1	s2
			d11	d1m	dn1	dnm	s1	s2
			* *	* *	* *	* *	* *	* *
			2C				0D	

- t₁ to t₄ : First numeral memory table number read (4 BCD digits)
 0000 to 1999
- l₁, l₂ : Number of read tables (2 BCD digits)
 01 to 20: 1 to 20 tables
- d₁₁ to d_{1m}, ..., dn₁ to dn_m:
 Contents of the read numeral memory tables (1 to 8 hexadecimal digits)
 0 to FFFFFFFF_H
 Since initial zeroes are omitted, there may be less than 8 digits.
 The data for individual tables is delimited by commas.

s₁, s₂ : Check sum (2 hexadecimal digits)
This is always added.

[Function]

- Reads the data from the specified number of numeral memory tables, starting from the specified numeral memory table.
- A maximum of 100 tables can be read at one time.
- In the response, the data of maximum of 20 tables can be returned at one time. If reading of more than 20 tables is specified, multiple responses are made, each comprising the data of 20 tables. Note that the "first word number read" in the second and later responses will be the word number of the first word of the response data.

9-3-3 Character string memory table read command (Sent from host to PT)

Command

[Format]

[ESC]	R	S	m	t ₁	t ₂	t ₃	t ₄
1B	52	53	* *	* *	* *	* *	* *
	(l1)	(l2)	(s1)	(s2)	[CR]		
	* *	* *	* *	* *	0D		

m : Check sum present/absent (1 BCD digit)
0 : Absent
1 : Present
8 : Absent (1 table read)
9 : Present (1 table read)

t₁ to t₄ : First character string memory table read (4 BCD digits)
0000 to 1999

l₁, l₂ : Number of read tables (2 BCD digits)
01 to 20 : 1 to 20
When m is 8 or 9, omit this setting.

s₁, s₂ : Check sum (2 hexadecimal digits)
When m is 0 or 8 omit this setting.

Reference

The maximum number which can be specified for "first character string memory table read" depends on the setting for numbers of character string table entries (256/1000/2000) made at the Support Tool.

Response

[Format]

[ESC]	R	S	t1	t2	t3	t4	d11	d12	
1B	52	53	* *	* *	* *	* *	* *	* *	
			dn1	dn2	s1	s2	[CR]		
			* *	* *	* *	* *	0D		

t₁ to t₄ : First character string memory table read (4 BCD digits)
0000 to 1999

d₁₁, d₁₂, ..., dn₁, dn₂:
Contents of the read character string memory table
(2 digits (hexadecimal) corresponding to 1 to 40 characters)
00 to FF_H (CP437 or ISO 8859-1)

s₁, s₂ : Check sum (2 hexadecimal digits)
This is always added.

[Function]

- Reads the data of the specified number of character string memory tables, starting from the specified character string memory table.
- A maximum of 20 tables can be read at the same time.
- In the response, data is returned in units of one table at a time. If reading of multiple tables is specified, a number of responses equal to the specified number of table is made. Note that the “read character string memory table number” is always the number of the data of the response.

9-3-4 Bit memory table read command (Sent from host to PT)

Command

[Format]

[ESC]	R	B	m	t1	t2	t3	t4
1B	52	42	* *	* *	* *	* *	* *
	(l1)	(l2)	(s1)	(s2)	[CR]		
	* *	* *	* *	* *	0D		

- m : Check sum present/absent (1 BCD digit)
 0 : Absent
 1 : Present
 8 : Absent (1 table read)
 9 : Present (1 table read)
- t₁ to t₄ : First bit memory table number read (4 BCD digits)
 0000 to 0999
- l₁, l₂ : Number of read tables (2 BCD digits)
 00 :100
 01 to 99 :1 to 99
 When m is 8 or 9, omit this setting.
- s₁, s₂ : Check sum (2 hexadecimal digits)
 When m is 0 or 8, omit this setting.

Reference The maximum number which can be specified for “first bit memory table read” depends on the setting for numbers of bit memory table entries (256/1000) made at the Support Tool.

Response

[Format]

[ESC]	R	B	t1	t2	t3	t4	l1	l2	d11	d12	d13	d14	,
1B	52	42	* *	* *	* *	* *	* *	* *	* *	* *	* *	* *	2C
	dn1	dn2	dn3	dn4	s1	s2	[CR]						
	* *	* *	* *	* *	* *	* *	0D						

- t₁ to t₄ : First bit memory number table read (4 BCD digits)
 0000 to 0999
- l₁, l₂ : Number of read tables (2 BCD digits)
 00 :100 tables
 01 to 99 :1 to 99 tables

$d_{11}, d_{12}, d_{13}, d_{14}, \dots, d_{n1}, d_{n2}, d_{n3}, d_{n4}$:
 Contents of the read bit memory tables (4 hexadecimal digits, $\square n$)
 0000 to FFFF_H
 The contents of bit memory table are represented as 1 bit data (OFF=0, ON=1) and 16 entries of bit memory table are read out as 4 hexadecimal digits value. (Table entries with smaller number is the rightmost bit.)
 The bit memory table data is delimited by commas by each 16 tables.

s_1, s_2 : Check sum (2 hexadecimal digits)
 This is always added.

[Function]

- Reads the data of the specified number of bit memory tables, starting from the specified bit memory table.
- A maximum of 100 tables can be read at one time.
- If number of table entries which is not multiple of 16 is specified, "0" is inserted in remaining bit (left most bit).
- The number (n) of 4 hexadecimal digits value to be read out is as follows:
 $n = (\text{"number of bit memory tables to be read"} - 1) \div 16 + 1$
 ("¥" indicates the subtraction of the integer.)

Example

[Reading the bit memory table from No.23 to No.40]

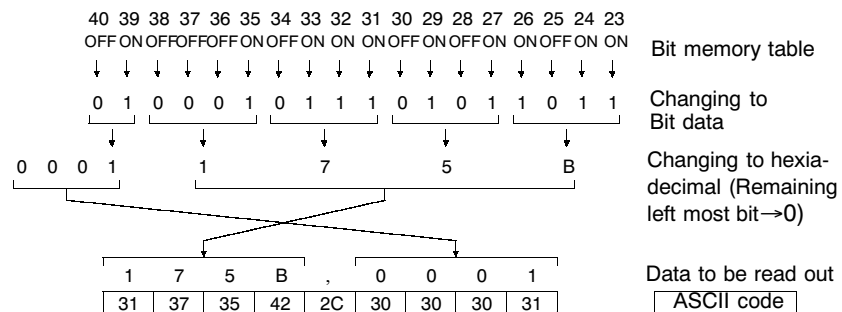

9-3-5 Screen data comment read command (Sent from host to PT)

Command

[Format]

[ESC]	F	R	m	(s1)	(s2)	[CR]
1B	46	52	* *	* *	* *	0D

m Check sum present/absent (1 BCD digit)
 0 : Absent
 1 : Present

s₁, s₂ : Check sum (2 hexadecimal digits)

Response

[Format]

[ESC]	F	R	d1	d2		
1B	46	52	* *	* *		
			d27	d28	s1	s2 [CR]
			* *	* *	* *	* * 0D

d₁, d₂, ..., d₂₇, d₂₈:
 Comments of the read screen data file
 (1 to 28 characters, space code (20H) is inserted in vacant area)

s₁, s₂ : Check sum (2 hexadecimal digits)
 This is always added.

[Function]

- Reads the operation mode of PT.

9-3-6 System status read command (Sent from host to PT)

Command

[Format]

[ESC]	P	T	m	(s1)	(s2)	[CR]
1B	50	54	* *	* *	* *	0D

m Check sum present/absent (1 BCD digit)
 0 : Absent
 1 : Present

s₁, s₂ : Check sum (2 hexadecimal digits)

Response

[Format]

[ESC]	P	T	0	0	s1	s2	[CR]
1B	50	54	30	30	31	46	0D

s₁, s₂ : Check sum (2 hexadecimal digits)
 This is always added (fixed as "1FH").

[Function]

- Reads the operation mode of PT.
- The responses above will be returned when PT is in RUN mode. With the modes other than RUN mode (when RUN LED is not lit in green), no responses will be returned even if this command is sent. Sending this command enables to know whether or not PT is running by checking the presence/absence of responses.

9-3-7 PT memory write command (Sent from host to PT)

Command

[Format]

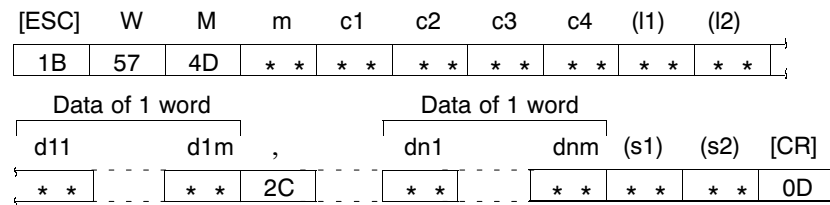

- m Check sum present/absent, write attribute (1 BCD digit)
 - 0 : Absent, SET attribute
 - 1 : Present, SET attribute
 - 2 : Absent, AND attribute
 - 3 : Present, AND attribute
 - 4 : Absent, OR attribute
 - 5 : Present, OR attribute
 - 6 : Absent, XOR attribute
 - 7 : Present, XOR attribute
 - 8 : Absent, SET attribute (writing 1 word)
 - 9 : Present, SET attribute (writing 1 word)

- c₁ to c₄ : First word No. written (4 BCD digits)
0000 to 9999

- l₁, l₂ : Number of words written (2 BCD digits)
01 to 50:1 to 50CH
If m is 8 or 9, omit this setting.

- d₁₁ to d_{1m}, ..., dn₁ to dn_m:
Data of written words (1 to 4 hexadecimal digits)
0 to FFFF_H
It is possible to omit initial zeroes so that there are less than 4 digits.

- s₁, s₂ : Check sum (2 hexadecimal digits)
If m is an even number, omit this setting.

Response

Only if “Yes” is set for the “Response” memory switch, the response indicated below is returned on normal completion.

[Format]

[ESC]	W	M	0	0	s1	s2	[CR]
1B	57	4D	30	30	31	46	0D

s₁, s₂ : Check sum (2 hexadecimal digits)
This is always added (fixed as “1FH”).

[Function]

- Writes the data of the specified number of words starting from the specified word in the PT memory.
- The result after executing the specified operation (write attribute) on the present contents of the PT memory and the written data is written as follows.
- A maximum of 50 words can be written at one time.

The write attribute specified by a command executes the following operation on the present data of the PT memory and the written data and writes the result.

- SET attribute : Specified data is written as it is regardless of the present data of PT.
- AND attribute : The result after executing the AND operation on the present data of the PT and the written data is written.
- OR attribute : The result after executing the OR operation on the present data of the PT and the written data is written.
- XOR attribute : The result after executing the XOR operation on the present data of the PT and the written data is written.

Example:

Write attribute	Written data	Present data of the PT memory	Result
SET attribute	1234 _H	3456 _H	1234 _H
AND attribute	1234 _H	3456 _H	1014 _H
OR attribute	1234 _H	3456 _H	3676 _H
XOR attribute	1234 _H	3456 _H	2662 _H

9-3-8 Numeral memory table write command (Sent from host to PT)

Command

[Format]

[ESC]	W	N	m	t1	t2	t3	t4	(l1)	(l2)
1B	57	4E	* *	* *	* *	* *	* *	* *	* *
Data of 1 word				Data of 1 word					
d11	d1m	,	dn1	dnm	(s1)	(s2)	[CR]		
* *	* *	2C	* *	* *	* *	* *	* *	0D	

- m : Check sum present/absent (1 BCD digit)
 - 0 : Absent
 - 1 : Present
 - 8 : Absent (only 1 table written)
 - 9 : Present (only 1 table written)
- t₁ to t₄ : First numeral memory number written to (4 BCD digits)
 - 0000 to 1999 (excluding 0247 to 0253)
- l₁, l₂ : Number of written tables (2 BCD digits)
 - 01 to 20:1 to 20 tables
 - When m is 8 or 9, omit this setting.
- d₁₁ to d_{1m}, ..., dn₁ to dn_m:
 - Contents of the written numeral memory tables (1 to 8 hexadecimal digits)
 - 0 to FFFFFFFFH
 - It is possible to omit initial zeroes so that there are less than 8 digits.
- s₁, s₂ : Check sum (2 hexadecimal digits)
 - When m is 0 or 8, omit this setting.

Reference The maximum number which can be specified for numeral memory table depends on the setting for numbers of numeral table entries (512/1000/2000) made at the Support Tool.

Response

Only if "Yes" is set for the "Response" memory switch, the response indicated below is returned on normal completion.

[Format]

[ESC]	W	N	0	0	s1	s2	[CR]
1B	57	4E	30	30	32	30	0D

s₁, s₂ : Check sum (2 hexadecimal digits)
This is always added (fixed as "20H").

[Function]

- Writes the data of the specified number of numeral memory tables, starting from the specified numeral memory tables.
- A maximum of 20 tables can be written at one time.
- When writing is executed to numeral memory tables from No.247 to No.253 (areas for clock data display/reading use only), operation will be finished normally without writing values.

Reference: • Data written by a numeral memory table write command is written according to the numeral storage type of the numeral. Numeral storage type can be set at the Support Tool. (It is possible to set it by a system memory at a PT collectively.) e.g.) Writing 1234 to the numeral memory table No.0 (allocated word: 1)

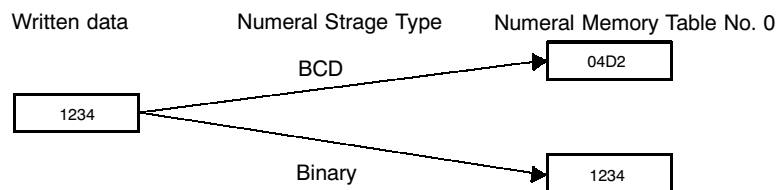

- For details of function and setting of numeral storage type, refer to "NT-series Support Tool for Windows 95/98 (Ver.3.0) Operation Manual" (V053-E1).

9-3-9 Character string memory table write command (Sent from host to PT)

Command

[Format]

[ESC]	W	S	m	t1	t2	t3	t4
1B	57	53	* *	* *	* *	* *	* *
			d11	d12	dn1	dn2	(s1) (s2) [CR]
			* *	* *	* *	* *	0D

m : Check sum present/absent (1 BCD digit)
 0 : Absent
 1 : Present

t₁ to t₄ : Character string memory number written to (4 BCD digits)
 0000 to 0499

d₁₁, d₁₂, ..., d_{n1}, d_{n2}:
 Contents of the written character string memory tables
 (1 to 40 characters)
 00 to FF_H
 In the case of character string memory tables allocated to the host, specify the registered number of words multiplied by 2, and in the case of character string memory tables not allocated to the host, specify the data for 40 characters.

s₁, s₂ : Check sum (2 hexadecimal digits)
 When m is 0, omit this setting.

Reference The maximum number which can be specified for character string memory table depends on the setting for numbers of character string table entries (256/1000/2000) made at the Support Tool. However, it is not possible to write to character string memory table of numbers higher than No.500 since they are used only as a reading area.

Response

Only if “Yes” is set for the “Response” memory switch, the response indicated below is returned on normal completion.

[Format]

[ESC]	W	S	0	0	s1	s2	[CR]
1B	57	53	30	30	32	35	0D

s₁, s₂ : Check sum (2 hexadecimal digits)
 This is always added (fixed as “25H”).

[Function]

- Writes specified data to the specified character string memory tables.

9-3-10 Bit memory table write command

(Sent from host to PT)

Command

[Format]

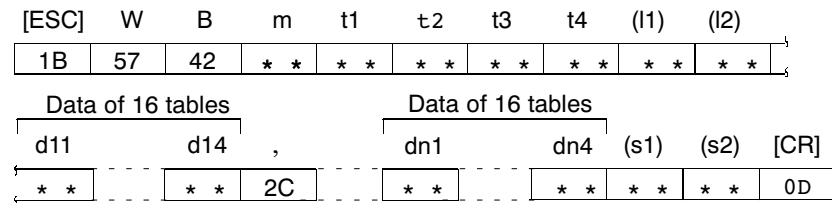

- m : Check sum present/absent (1 BCD digit)
 - 0 : Absent
 - 1 : Present
 - 8 : Absent (effective only when 1 table written)
 - 9 : Present (effective only when 1 table written)

- t₁ to t₄ : First bit memory table number written to (4 BCD digits)
 - 0000 to 0999

- l₁, l₂ : Number of written tables (2 BCD digits)
 - 00 :100 tables
 - 01 to 99 :1 to 99 tables
 - When m is 8 or 9, omit this setting.

- d₁₁ to d₁₄, ..., dn₁ to dn₄:
 - Contents of the written bit memory tables (4 hexadecimal digits, □n)
 - 0000 to FFFF_H
 - The contents of bit memory table are represented as 1 bit data (OFF=0, ON=1) and 16 entries of bit memory table are specified as 4 hexadecimal digits value. (Table entries with smaller number is the rightmost bit.)
 - If written data is less than 16, the specification is started from bit 0. (Remaining leftmost bit will be ignored.)
 - The bit memory table data (4 hexadecimal digits) is delimited by commas by each 16 tables.

- s₁, s₂ : Check sum (2 hexadecimal digits)
 - When m is 0 or 8, omit this setting.

Reference The maximum number which can be specified for bit memory table depends on the setting for numbers of bit memory table entries (256/1000) made at the Support Tool.

Response

Only if "Yes" is set for the "Response" memory switch, the response indicated below is returned on normal completion.

[Format]

[ESC]	W	B	0	0	s1	s2	[CR]
1B	57	42	30	30	31	34	0D

s₁, s₂ : Check sum (2 hexadecimal digits)
This is always added (fixed as "14H")

[Function]

- Writes the data of the specified number of bit memory tables, starting from the specified bit memory table.
- A maximum of 100 tables can be written at one time.
- If numbers of table entries which is not multiple of 16 is specified, insert "0" in remaining bit (leftmost bit).
- The number (n) of 4 hexadecimal digits value to be specified is as follows:
n=("number of written bit memory tables" - 1) ¥ 16 + 1
("¥" indicates the subtraction of the integer.)

Example

[Writing the bit memory table from No.51 to No. 70]

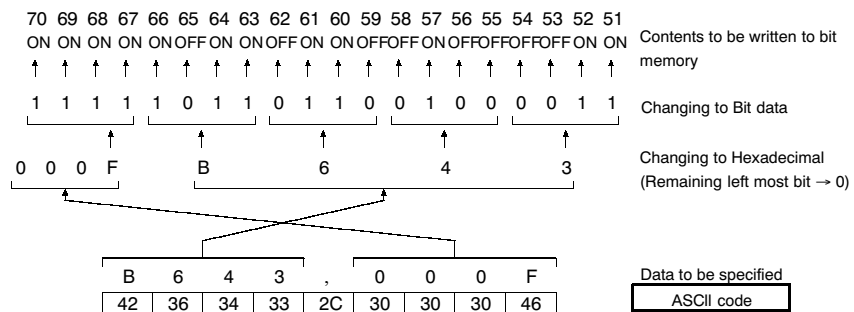

9-3-11 PT memory batch write (FILL) command (Sent from host to PT)

Command

[Format]

[ESC]	F	M	m	b1	b2	b3	b4	e1	e2
1B	46	4D	* *	* *	* *	* *	* *	* *	* *
	e3	e4	d1		d4	(s1)	(s2)	[CR]	
	* *	* *	* *		* *	* *	* *	0D	

- m : Check sum present/absent (1 BCD digit)
0 : Absent
1 : Present
- b₁ to b₄ : First written word number (4 BCD digits)
0000 to 9999
- e₁ to e₄ : Final written word number (4 BCD digits)
0000 to 9999
- d₁ to d₄ : Data to be written (1 to 4 hexadecimal digits)
0 to FFFF_H
It is possible to omit initial zeroes so that there are less than 4 digits.
- s₁, s₂ : Check sum (2 hexadecimal digits)
If m is 0, omit this setting.

[Response]

Only if “Yes” is set for the “Response” memory switch, the response indicated below is returned on normal completion.

[Format]

[ESC]	F	M	0	0	s1	s2	[CR]
1B	46	4D	30	30	30	45	0D

- s₁, s₂ : Check sum (2 hexadecimal digits)
This is always added (fixed as “0EH”).

[Function]

- Writes the specified data to all the words within the range specified by the “first written word number” and “final written word number”.

9-3-12 Numeral memory table clear command (Sent from host to PT)

Command

[Format]

[ESC]	C	N	m	(b1)	(b2)	(b3)	(b4)
1B	43	4E	* *	* *	* *	* *	* *
	(e1)	(e2)	(e3)	(e4)	(s1)	(s2)	[CR]
	* *	* *	* *	* *	* *	* *	0D

- m : Check sum present/absent (1 BCD digits)
0 : Absent
1 : Present
- b₁ to b₄ : First cleared numeral memory table number (4 BCD digits)
0000 to 1999
- e₁ to e₄ : Final cleared numeral memory table number (4 BCD digits)
0000 to 1999
- s₁, s₂ : Check sum (2 hexadecimal digits)
If m is 0, omit this setting.

Reference The maximum number which can be specified for numeral memory table depends on the setting for numbers of numeral memory table entries (512/1000/2000) made at the Support Tool.

Response

Only if “Yes” is set for the “Response” memory switch, the response indicated below is returned on normal completion.

[Format]

[ESC]	C	N	0	0	s1	s2	[CR]
1B	43	4E	30	30	30	43	0D

- s₁, s₂ : Check sum (2 hexadecimal digits)
This is always added (fixed as “0CH”).

[Function]

- Writes “0” to all the numeral memory tables within the specified range.
- If settings are omitted for both the “first cleared numeral memory table number” and the “final cleared numeral memory table number”, all the numeral memory tables are cleared. It is not possible to omit just one of these settings.
- When writing is executed to numeral memory tables from No.247 to No.253 (areas for clock data display/reading use only), operation will be finished normally without writing values.

9-3-13 Character string memory table clear command (Sent from host to PT)

Command

[Format]

[ESC]	C	S	m	(b1)	(b2)	(b3)	(b4)
1B	43	53	* *	* *	* *	* *	* *
	(e1)	(e2)	(e3)	(e4)	(s1)	(s2)	[CR]
	* *	* *	* *	* *	* *	* *	0D

- m : Check sum present/absent (1 BCD digit)
0 : Absent
1 : Present
- b₁ to b₄ : First cleared character string memory table number
(4 BCD digits)
0000 to 0499
- e₁ to e₄ : Final cleared character string memory table number
(4 BCD digits)
0000 to 0499
- s₁, s₂ : Check sum (2 hexadecimal digits)
When m is 0, omit this setting.

Reference The maximum number which can be specified for character string memory table depends on the setting for numbers of character string table entries (256/1000/2000) made at the Support Tool. However, it is not possible to clear character string memory table of numbers higher than No.500.

Response

Only if “Yes” is set for the “Response” memory switch, the response indicated below is returned on normal completion.

[Format]

[ESC]	C	S	0	0	s1	s2	[CR]
1B	43	53	30	30	31	31	0D

- s₁, s₂ : Check sum (2 hexadecimal digits)
This is always added (fixed as “11H”).

[Function]

- Writes 40 characters of space code (20H) to all the character string memory tables within the specified range.
- If settings are omitted for both the “first cleared character string memory table number” and the “final cleared character string memory table number”, all the character string memory tables are cleared. It is not possible to omit just one of these settings.

9-3-14 Bit memory table clear command (Sent from host to PT)

Command

[Format]

[ESC]	C	B	m	(b1)	(b2)	(b3)	(b4)
1B	43	42	* *	* *	* *	* *	* *
	(e1)	(e2)	(e3)	(e4)	(s1)	(s2)	[CR]
	* *	* *	* *	* *	* *	* *	0D

- m : Check sum present/absent (1 BCD digit)
0 : Absent
1 : Present
- b₁ to b₄ : First cleared bit memory table number (4 BCD digits)
0000 to 0999
- e₁ to e₄ : Final cleared bit memory table number (4 BCD digits)
0000 to 0999
- s₁, s₂ : Check sum (2 hexadecimal digits)
When m is 0, omit this setting.

Reference The maximum number which can be specified for bit memory table depends on the setting for numbers of bit memory table entries (256/1000) made at the Support Tool.

Response

Only if "Yes" is set for the "Response" memory switch, the response indicated below is returned on normal completion.

[Format]

[ESC]	C	B	0	0	s1	s2	[CR]
1B	43	42	30	30	30	30	0D

- s₁, s₂ : Check sum (2 hexadecimal digits)
This is always added (fixed as "00H").

[Function]

- Writes "OFF (0)" to all the bit memory tables within the specified range.

9-3-15 Touch switch input notify command (Sent from PT to host)

Command

[Format]

[ESC]	S	T	c1	c2	c3	c4	d1	d2			
1B	53	54	* *	* *	* *	* *	* *	* *			
			d3	d4	a1	a2	a3	a4	s1	s2	[CR]
			* *	* *	* *	* *	* *	* *	* *	* *	0D

- c₁ to c₄ : Changed word number (4 BCD digits)
0000 to 9999
This is the number of the word containing the allocated bit of the touch switch at which there has been a change.
- d₁ to d₄ : Contents of the word after the change (4 hexadecimal digits)
0000 to FFFF_H
- a₁ to a₄ : Changed bit information (4 hexadecimal digits)
0000 to FFFF_H
The changed bit in the “contents of the word after the change” is set to “1”.
- s₁, s₂ : Check sum (2 hexadecimal digits)
This is always added.

Response

[Format]

None

[Function]

- When the status of a touch switch changes because it has been touched or released, notifies the change of status to the host.
- Normally, one command notifies the change in status of one allocated bit only, but when multiple bits in the same word change simultaneously, those changes are all notified together with one command.

Reference When the screen is switched after pressing a “momentary” key, this command goes OFF. The change is also notified to the host.

Example

- Command

[ESC]	S	T	0	1	0	2	3	0	
1B	53	54	30	31	30	32	33	30	
	1	3	0	0	0	1	0	D	[CR]
	31	33	30	30	30	31	30	44	0D

Changed word number : 0102CH

Contents of the word after the change (hexadecimal):
3013H (binary notation: 0011 0000 0001 0011)

Changed bit information (hexadecimal):
0001H (binary notation: 0000 0000 0000 0001)

Check sum (hexadecimal) : 0DH

From the “changed word number” and “changed bit information”, it is ascertained that the change relates to the touch switch allocated to bit 00 of word 0102CH, and because “1” is set at the relevant position in the “contents of the word after the change”, it is ascertained that the touch switch has been pressed (if the change is to “OFF”, since the operation differs according to the type of touch switch, it cannot be determined from a change in the bit status alone whether the touch switch has been touched or released.)

9-3-16 Numerical input notify command (Sent from PT to host)

Command

[Format]

[ESC]	S	N	t1	t2	t3	t4	d1	d2	
1B	53	4E	* *	* *	* *	* *	* *	* *	
		d3	d4	d5	d6	d7	d8	s1	s2 [CR]
		* *	* *	* *	* *	* *	* *	* *	0D

t₁ to t₄ : Input numeral memory table number (4 BCD digits)
0000 to 1999
This is the number of numeral memory table for which there has been numerical input.

d₁ to d₈ : Input numeric data (8 hexadecimal digits)
00000000 to FFFFFFFFH

s₁, s₂ : Check sum (2 hexadecimal digits)
This is always added.

Response

[Format]

None

[Function]

- In accordance with operations at the PT, such as numeral setting and copying of memory tables, notifies the host that a numeric value has been input to the numeral memory table.
- Since it is not possible to write to numeral memory tables from No.247 to No253 (areas for clock data display/reading use only), notification of these tables is not executed.

Example

- Command

[ESC]	S	N	t1	t2	t3	t4	d1	d2	
1B	53	4E	* *	* *	* *	* *	* *	* *	
		d3	d4	d5	d6	d7	d8	s1	s2 [CR]
		* *	* *	* *	* *	* *	* *	* *	* *
									0D

Input numeral memory table number : No.150

Input numeric value data (hexadecimal) : 30000H

Check sum (hexadecimal) : 05H

Here, it is ascertained that 30000 has been input to numeral memory table No.150 (whether this is 30000 in hexadecimal or 30000 in BCD is determined by the numeral storage type set for the numeral memory table).

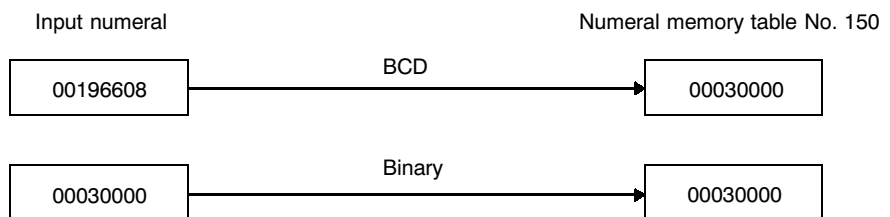

9-3-17 Character string input notify command (Sent from PT to host)

Command

[Format]

[ESC]	S	S	t1	t2	t3	t4	d11 d12	
1B	53	53	* *	* *	* *	* *	* *	* *
			dn1	dn2	s1	s2	[CR]	
			* *	* *	* *	* *	0D	

t₁ to t₄ : Input character string memory table number (4 BCD digits)
0000 to 0499
This is the number of the character string memory table for which there has been character string input.

d₁₁, d₁₂, ..., dn₁, dn₂:
Input character string data (1 to 40 characters)
00 to FF_H
In the case of character string memory tables allocated to the host, this is the registered number of words multiplied by 2, and the case of character string memory tables not allocated to the host, it is data for 40 characters.

s₁, s₂ : Check sum (2 hexadecimal digits)
This is always added.

Response

[Format]

None

[Function]

- In accordance with operations at the PT, such as character string settings and copying of character string memory tables, notifies the host that a character string has been input to the character string memory tables.

Example

- Command

[ESC]	S	S	0	2	1	0	O	M
1B	53	53	30	32	31	30	4F	4D
			R	O	N	O	F	[CR]
			52	4F	4E	30	46	0D

Input character string memory table number : No.210
Input character string data (hexadecimal) : OMRON
Check sum (hexadecimal) : 0FH

Here, it is ascertained that “OMRON” has been input to character string memory table No.210.

9-3-18 Direct area changing notify command (Sent from PT to host)

Command

[Format]

[ESC]	P	M	c1	c2	c3	c4	l1	l2	d11	d12	
1B	50	4D	* *	* *	* *	* *	* *	* *	* *	* *	
		d13	d14	,	dn1	dn2	dn3	dn4	s1	s2	[CR]
		* *	* *	2C		* *	* *	* *	* *	* *	0D

c₁ to c₄ : Word number of the changed direct area (4 BCD digits)
0000 to 9999

Area type of the changed direct area	Word number
PT control area	First allocated word
PT notify area	First allocated word + 1 word
Window control area	First allocated word

l₁, l₂ : No. of changed word (2 BCD digits)
01 to 03

Area type of the changed direct area	No. of the changed word
PT control area	01
PT notify area	01
Window control area	03

d₁₁, d₁₂, d₁₃, d₁₄, ..., dn₁, dn₂, dn₃, dn₄:
: Contents of the direct area after the change (1 to 4 hexadecimal digits)
0 to FFFF_H

Area type of the changed direct area	Contents to be changed
PT control area	Screen number
PT notify area	PT status notify bit
Window control area	Window number Window X coordinate Window Y coordinate

It is possible to omit initial zeroes so that there are less than 4 digits.

Individual words of data are delimited by commas.

s₁, s₂ : Check sum (2 hexadecimal digits)
This is always added.

Response

[Format]

None

[Function]

- Notifies to the host the fact that there has been a change in the status of the PT and the contents of the direct areas (PT control area, PT notify area and window control area) have changed.

However, in the following cases, a dedicated command is issued and therefore the direct area changing notify command is not issued.

When numeric input has occurred : Numerical input notify command

When character string input has occurred : Character string input notify command

For details of direct area, refer to 7-2 “Areas for Control/Notification” in page 260.

Example

[Example 1. Notification of change in the PT control area]

Notification of change in the PT control area is issued when screen is switched by operations at the PT, such as touch switch operation. In the example below, it is ascertained that the screen has been switched to screen number 21 (BCD) by a switch screen touch switch.

- Command

[ESC]	P	M	0	1	0	0	0	1	1	5	4	0	[CR]
1B	50	4D	30	31	30	30	30	31	31	35	34	30	0D

First word number of PT control area : 100CH

Number of changed words in PT control area : 1CH

Screen number (hexadecimal) : 15H (screen No.21 in BCD)

Check sum : 40H

[Example 2. Notification of change in the PT notify area]

Notification of change in the PT notify area is issued when the status of the PT is changed (such as screen printing). In the example below, it is ascertained that the printing is being executed currently from the fact that the bit 7 (screen printing) in the PT notify bit is ON (1).

- Command

[ESC]	P	M	0	1	1	1	0	1
1B	50	4D	30	31	31	31	30	31
	8	0	8	0	A	C	[CR]	
	38	30	38	30	41	43	0D	

First word number of PT notify area : 110CH
 Number of changed words in PT control area : 1CH
 PT status notify bit (hexadecimal) : 8080H
 (PT operation status bit, screen printing bit: ON)
 Check sum : ACH

[Example 3. Notification of change in the window control area]

Notification of change in the window control area is issued when a window is controlled by the operation at the PT. It is possible to know the screen number of the window which is opened and the display position of the window (bottom left coordinate (X, Y) of the window). In the example below, it is ascertained that the window screen No.16 is displayed at the position on X: 280, Y: 99.

• Command

[ESC]	P	M	0	1	2	0	0	3
1B	50	4D	30	31	32	30	30	33
	1	0	,	1	1	8	,	6
	31	30	2C	31	31	38	2C	36
	3	9	A	[CR]				
	33	39	41	0D				

First word number of window control area : 120CH
 Number of changed words in window control area : 3CH
 Screen number (hexadecimal) : 10H
 (screen No.16 in BCD)
 Window X coordinate (hexadecimal) : 118H (280 in BCD)
 Window Y coordinate (hexadecimal) : 63H (99 in BCD)
 Check sum : 9AH

} Contents of direct area after the change

- Reference:**
- With memory link communication, bit 12 (screen switch strobe), bit 11 (numeral setting strobe flag) and bit 10 (character string setting strobe flag) of PT status notify bit do not go ON/OFF. It is possible to know them by direct area changing notify command, numeral input notify command and character string input notify command.
 - When the PT was switched to RUN mode from system menu or error screen, notification of change in PT notify area (PT operation status: ON) is issued to the host.
 Also, when the PT was switched to system menu or error screen from RUN mode, notification of change in PT notify area (PT operation status: OFF) is issued to the host.

9-3-19 PT memory changing notify command (Sent from PT to host)

Command

[Format]

[ESC]	S	M	c1	c2	c3	c4	l1	l2	d11	d12	
1B	53	4D	* *	* *	* *	* *	* *	* *	* *	* *	
		d13	d14	,	dn1	dn2	dn3	dn4	s1	s2	[CR]
		* *	* *	2C					* *	* *	0D

- c₁ to c₄ : First word number of PT memory (4 BCD digits)
0000 to 9999
- l₁, l₂ : Number of words in direct area (2 BCD digits)
01 to 50
- d₁₁, d₁₂, d₁₃, d₁₄, ..., dn₁, dn₂, dn₃, dn₄:
Contents of the direct area (1 to 4 hexadecimal digits)
0 to FFFF_H
It is possible to omit initial zeroes so that there are less than 4 digits.
Individual words of data are delimited by commas.
- s₁, s₂ : Check sum (2 hexadecimal digits)

Response

[Format]

None

[Function]

- Notifies to the host of the change in PT memory.

9-3-20 PT operation mode switching command (Sent from host to PT)

Command

[Format]

[ESC]	M	C	m	0	0	(s1)	(s2)	[CR]
1B	4D	43	* *	30	30	* *	* *	0D

- m : Check sum present/absent (1 BCD digit)
0 : Absent
1 : Present
- c₁, c₂ : Operation mode of PT to be switched to (2 BCD digits)
Fixed as 00 (transmit mode)
- s₁, s₂ : Check sum (2 hexadecimal digits)
When m is 0, omit this setting.

Response

Only if "Yes" is set for the "Response" memory switch, the response indicated below is returned on normal completion.

[Format]

[ESC]	M	C	0	0	s1	s2	[CR]
1B	4D	43	30	30	30	42	0D

Data Part

- s₁, s₂ : Check sum (2 hexadecimal digits)
This is always added (fixed as "0BH").

Normally, data part is "00", however, it is "10" (31H, 30H) when serial port B is used. (see below)

[Function]

- Changes the operation mode of PT from RUN mode to transmit mode by the instruction from the host.
- This command can change the PT mode from RUN mode to transmit mode forcibly even if the setting of “Display System Menu” was set to “Disabled” by system installer mode.
- After the mode was switched to transmit mode by this command, screen data transmission is possible even if the setting of “Screen Memory Protect” was set to “Disabled” by system installer mode.
- Use this command when the PT is communicating to the host at serial port A. If you use this command when the PT is communicating to the host at serial port B, “10” (check sum error) is returned to data part and it is not possible to switch to the transmit mode.
- When the PT mode is switched to transmit mode by this command, direct area changing notify command (notification of PT operation status OFF in PT notify area) will be issued.
- If the PT received this command while the momentary touch switch is being pressed, PT issues “PT memory changing notify command” (notification of corresponding word OFF(0)) first and then changes the operation mode to transmit mode.

9-3-21 Re-send request command

(Sent from host to PT)

Command

[Format]

[ESC]	R	R	m	(s1)	(s2)	[CR]
1B	52	52	* *	* *	* *	0D

m : Check sum present/absent (1 BCD digit)
 0 : Absent
 1 : Present

s₁, s₂ : Check sum (2 hexadecimal digits)
 When m is 0, omit this setting.

Response

[Format]

None

[Function]

- The input notify command last sent from the PT is re-sent.
- Requests re-issue of the last input notify command (touch switch input notification, numeral input notification, character string input notification, direct area changing notification and PT memory changing notification) issued by the PT. The PT re-sends the last issued input notify command.

9-3-22 Error response

(Sent from PT to host)

Response

[ESC]	E	R	c1	c2	s1	s2	[CR]
1B	45	52	* *	* *	* *	* *	0D

- c₁, c₂ : Error code (2 BCD digits)
- 01 : Invalid command
A non-exist command has been used.
 - 02 : Command length error
The command length differs from the stipulated length.
 - 03 : Range error
The word/table number is outside the setting range.
 - 04 : Check sum present/absent specification error
A value other than those stipulated has been set for the check sum present/absent specification.
 - 05 : Format error
A format other than that stipulated has been used, for example the word number has been specified with 5 digits or a character code outside the permissible range has been used.
 - 06 : Re-send request error
A re-send request command has been issued although there is no input notify command to re-send.
 - 10 : Check sum error
The specified sum value and calculated sum value differ.
This error code is returned also when the "PT operation mode switching command" is issued when the PT is communicating to the host at serial port B.
 - 11 : Communication error
A parity error, overrun error, or framing error has occurred. (This error code is only issued when "Comm. Auto-return" memory switch is ON.)
- s₁, s₂ : Check sum (2 hexadecimal digits)

[Function]

- If there is an error in a command received by the PT, an error code is notified to the host. The command in which the error occurred is invalidated.

SECTION 10

Function Applications

This section presents a collection of simple practical examples that will give you hints on how to make best use of the functions of the NT631/NT631C.

Please use these examples for reference when using the NT631/NT631C.

10-1	Examples of Actual Applications of Direct Access	586
10-2	Examples of Actual Applications of Memory Link	600

10-1 Examples of Actual Applications of Direct Access

Some examples that will give you an idea of how to actually apply the functions of the NT631/NT631C such as those indicated below are presented here.

- Continually monitoring a specific PC bit and displaying an alarm when it comes ON page 588
- Changing display contents in accordance with PC bit status page 593
- Displaying online help with a touch switch page 596
- Continually monitoring a specific PC bit and displaying a message on a window when it comes ON page 597
- Continuously reading out the contents of a PC word and displaying a trend graph by backtracking page 599
- Displaying the day of the week using the clock data in the PT page 600

In these examples, only the necessary settings are shown. Make the unspecified settings according to your requirements. In some of the examples, colors other than black and white are used for the display colors; note that these examples can be applied even with monochrome type PTs, for example by setting the display of black and white in reverse video.

For the method for creating screens with the Support Tool, refer to the NT-Series Support Tool Ver. 3.0E for Windows95/98 Operation Manual (V053-E1-□).

Continually Monitoring a Specific PC Bit and Displaying an Alarm When It Comes ON

Example: Displaying "TEMPERATURE ABNORMAL" in red, regardless of the screen currently displayed, when the monitored bit at the PC comes ON.

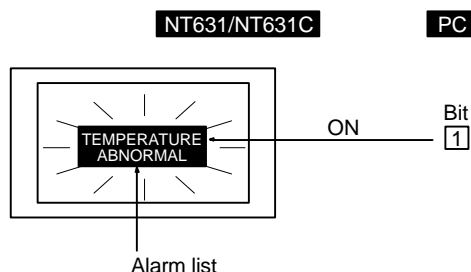

- (1) Set "TEMPERATURE ABNORMAL" as the initial value for any character string memory table.
- (2) Make the following settings for any bit memory table.
 - PC Address: PC bit number to be monitored
 - Function: Alarm
 - String table entry: Number of the character string memory table for which settings were made in (1).

- (3) Register an alarm list, set as indicated below, for any screen.
 - "Color" setting, "Frame":
Black (same as the background color of other screens)
 - "Color" setting, "Background", "ON":
Red
 - List Settings:
Set the "Start Bit Table Entry" and "No. of Bits Referenced" so as to include the bit memory table set in (2) above.
- (4) Set overlapping screens so that all screens displayed on the PT are overlapped by the screen created in (3).

Hints

- In order to display "TEMPERATURE ABNORMAL" with no frame, make its background color the same as that of other screens ("Alarm list", page 396).
- So that "TEMPERATURE ABNORMAL" is displayed regardless of which screen is currently displayed, display the overlapping screens created in (4) at the PT ("Overlapping Screens", page 248).
- As an alternative to making every screen an overlapping screen, the same result can be achieved by registering an alarm list on every screen.

Example: Displaying a screen with "TEMPERATURE ABNORMAL" in black on a red background when the monitored PC bit comes ON.

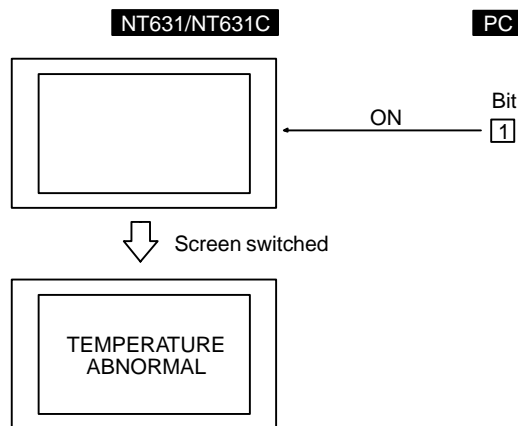

- (1) Set the properties of the screen displayed when the bit comes ON as follows.
 - "Background" color: Red
- (2) Register a fixed display text element for the screen set in (1) as follows.
 - Text: TEMPERATURE ABNORMAL
 - "Foreground" color: Black
 - "Background" color: Transparent

- (3) Make the following settings for any bit memory table.
- PC Address: Number of the PC bit to be monitored
 - Function: Switch screen
 - Screen No.: Number of the screen set in (1) and (2)

Hints

- In this method, after switching to the error screen, the error screen remains displayed even if the status of the monitored PC bit changes back from ON to OFF (7-3-3 "Bit Memory Tables", page 289). After checking the error at the equipment, one of the following methods must be used to return to the screen that was displayed before the error occurred: using a touch switch with the switch screen function (page 328), writing a screen number to the control area (page 260), or switching the screen by using a bit memory table (page 289).

Example: Displaying a screen that shows details of the error when the "TEMPERATURE ABNORMAL" alarm message is pressed.

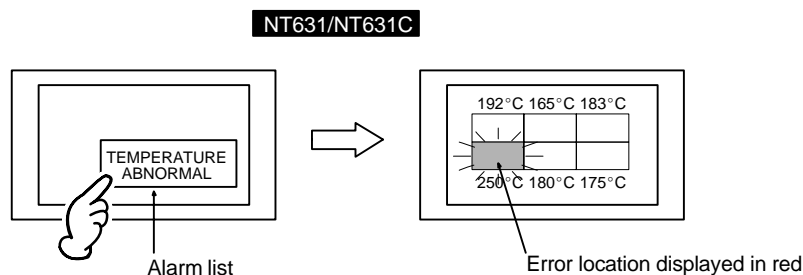

- (1) Set "TEMPERATURE ABNORMAL" as the initial value for any character string memory table.
- (2) Make the following settings for any bit memory table.
 - PC Address:
 - PC bit number to be monitored
 - Function:
 - Alarm
 - Switch screen:
 - Check mark set
 - Screen No.:
 - Number of the screen that displays details of the error (refer to (4))
 - String table entry:
 - Number of the character string memory table for which settings were made in (1).

- (3) Register an alarm list, set as indicated below, for any screen.
 - "Color" setting, "Background", "ON":
Red
 - List Settings:
Set the "Start Bit Table Entry" and "No. of Bits Referenced" so as to include the bit memory table set in (2) above.
- (4) Register the following elements on the screen that displays the error details.

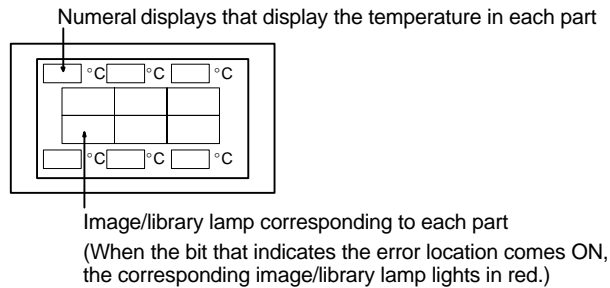

Hints

- The ladder program must be written so that at the same time as the bit that indicates the temperature error comes ON, the bit that indicates the error location for the relevant temperature also comes ON.

Example: Displaying a screen with details of the times at which alarms occurred in the past when the "TEMPERATURE ABNORMAL" alarm message is pressed.

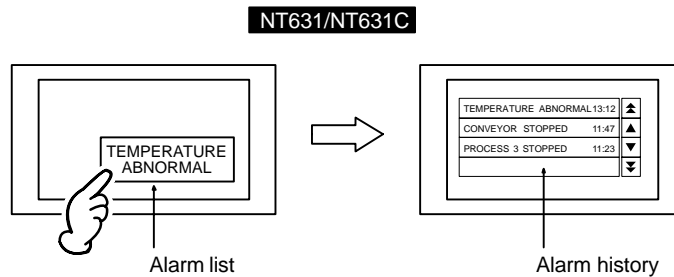

- (1) Set "TEMPERATURE ABNORMAL" as the initial value for any character string memory table.

- (2) Make the following settings for any bit memory table.
- PC Address:
PC bit number to be monitored
 - Function:
Alarm
 - History:
Check mark set
 - Switch screen:
Check mark set
 - Screen No.:
Number of the screen that displays the alarm history (refer to (4))
 - String table entry:
Number of the character string memory table for which settings were made in (1).
- (3) Register an alarm list, set as indicated below, for any screen.
- "Color" setting, "Background", "ON":
Red
 - List Settings:
Set the "Start Bit Table Entry" and "No. of Bits Referenced" so as to include the bit memory table set in (2) above.
- (4) Register the set alarm history as follows on the screen that displays the alarm history.
- History Info: Check mark set
 - Order type: Order of occurrence

Hints

- When designating the screen number with a bit memory table, the alarm history can also be displayed by designating the following screen numbers.
 - No. 9001: Occurrence History Screen (page 436)
 - No. 9002: Frequency History Screen (page 436)

In this case, there is no need to register an alarm list.

Example: Displaying the corrective action (help information) when the alarm message "TEMPERATURE ABNORMAL" is pressed.

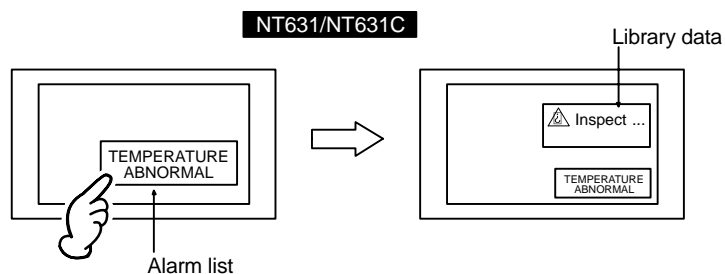

- (1) Set "TEMPERATURE ABNORMAL" as the initial value for any character string memory table.
- (2) Create library data, registering for it a fixed display text element in which the corrective action for the temperature alarm (for example "Inspect ...") is written.
- (3) Make the following settings for any bit memory table.
 - PC Address:
PC bit number to be monitored
 - Function:
Alarm
 - String table entry:
Number of the character string memory table for which settings were made in (1)
 - Image/library code:
Check mark set, code of the library data created in (2)
- (4) Register an alarm list, set as indicated below, for any screen.
 - "Color" setting, "Background", "ON":
Red
 - "Display ImageLib":
Check mark set
 - List Settings:
Set the "Start Bit Table Number" and "No. of Bits Referenced" so as to include the bit memory table set in (3) above.

Changing Display Contents in Accordance with PC Bit Status

Example: Changing the status of a graphic depicting the opening and closing of a valve in accordance with the status of one PC bit.

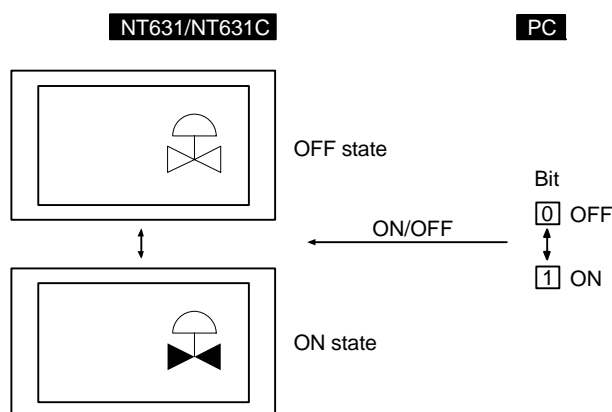

- (1) Create figures depicting the valve when open (“A” in the figure below) and the valve when closed (“B” in the figure below), either by using library data (fixed display graphic) or image data (comprised of dots).

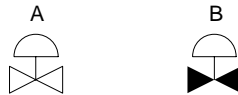

- (2) Register image/library data set as indicated below for the screen.
 - “OFF State”, “Code”:
Check mark set, code of the figure depicting the closed valve created in (1)
 - “ON State”, “Code”:
Check mark set, code of the figure depicting the open valve created in (1)
 - PC Address:
Number of the bit used to change between the figures

Example: When the displayed character string is changed in accordance with the status of one PC bit

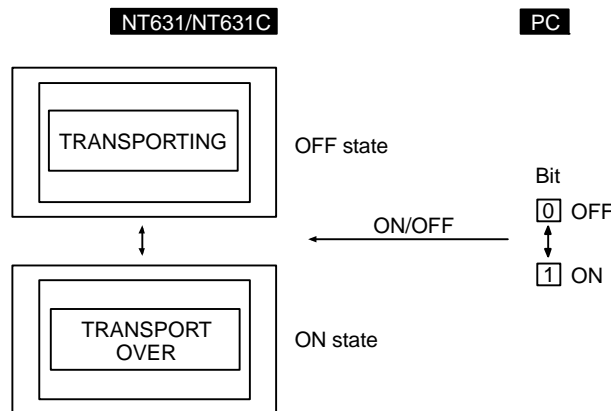

- (1) Create library data with fixed display text reading “TRANSPORTING”, and another library data with fixed display text reading “TRANSPORT OVER”.
- (2) Register an image/library lamp set as indicated below for the screen.
 - “OFF State”, “Code”:
Check mark set, code of the library data reading “TRANSPORTING” created in (1)
 - “ON State”, “Code”:
Check mark set, code of the library data reading “TRANSPORT OVER” created in (1)
 - PC Address:
Number of the bit used to change between the text items

Example: PC bits 0 to 15 come ON according to the position of an automatic guided vehicle, and the position of the vehicle is shown on the screen.

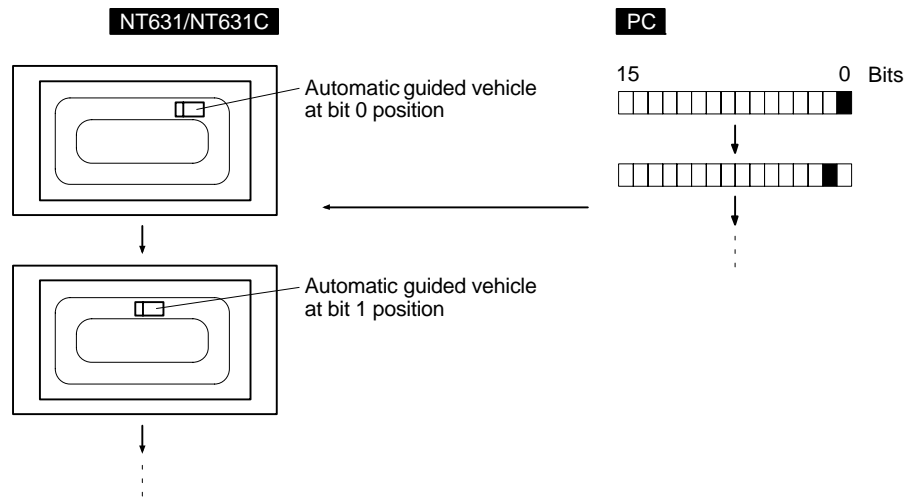

- (1) Create figures depicting the automatic guided vehicle with library data (fixed display graphics) or image data (composed of dots). If there is a figure with a different orientation, create it separately.
- (2) Register image/library lamp set as shown below for the position corresponding to bit 0 on the screen.
 - "OFF State", "Code":
Check mark not set
 - "ON State", "Code":
Check mark set, code for the library data for the automatic guided vehicle created in (1) (shape corresponding to the position)
 - PC Address:
Bit number of bit 0 indicating the automatic guided vehicle's position
- (3) Register image/library lamps set for bits 1 to 15 in the same way as in (2).

Reference With NT631/NT631C, once an element has been drawn, it is not redrawn unless the display contents change (this applies even with overlapping screens). Consequently, if a rail is drawn as a fixed display element underneath the automatic guided vehicle, when the automatic guided vehicle moves, the rail underneath the position where the automatic guided vehicle was originally placed, cleared together as the vehicle moves. Bear this in mind when creating the screen data.

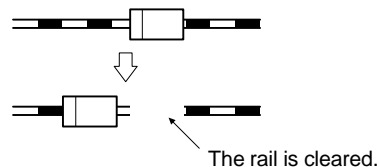

Displaying Online Help with a Touch Switch

Example: Displaying help information in a window when a touch switch is pressed.

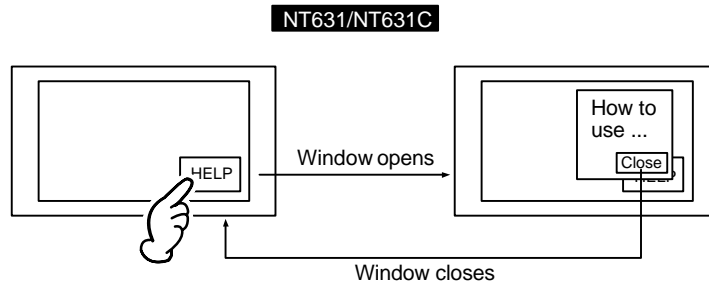

- (1) Create a new screen as a keyboard screen.
- (2) Register help information as text and graphics for the screen created in (1).
- (3) Make settings like those indicated below to register a touch switch for the screen created in (1).
 - Label: Check mark set, Description "Close"
 - Function: Input key – keyboard
 - Keyboard screen No.: Number of keyboard screen currently being created
 - Action type: Close
- (4) Specify the area to be displayed as a window, making sure that it will accommodate the help information and the touch switch created in (3).
- (5) Register a touch switch on the screen on which the help information is to be displayed (base screen), making the following settings for it.
 - Label: Check mark set, Description "HELP"
 - Function: Input key – keyboard
 - Keyboard screen No.: Numbers of keyboard screens created in (1) to (4)
 - Action type: Open

By setting the action type of the touch switch on the base screen as "Toggle", the window can be opened and closed from the base screen.

Continually Monitoring a Specific PC Bit and Displaying a Message on a Window When It Comes ON

Example: Opening a window and displaying an error message on it when the monitored bit at the PC comes ON.

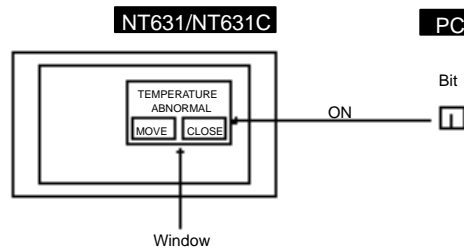

- (1) Set "TEMPERATURE ABNORMAL" as the initial value for any character string memory table.
- (2) Make the following settings for any bit memory table.
 - PC Address: PC bit number to be monitored
 - Function: Alarm
 - String table entry: Number of the character string memory table for which settings were made in (1).
- (3) Register an alarm list, set as indicated below, for window screen.
 - List Settings: Set the "Start Bit Table Entry" and "No. of Bits Referenced" so as to include the bit memory table set in (2) above.
- (4) Register "Window Move" touch switch and "Window Close" touch switch on a window same as (3).

- (5) Create the following ladder program so that the window is opened from the host when the bit comes ON. (Word numbers are not shown in the ladder program below, set the value when programming.)

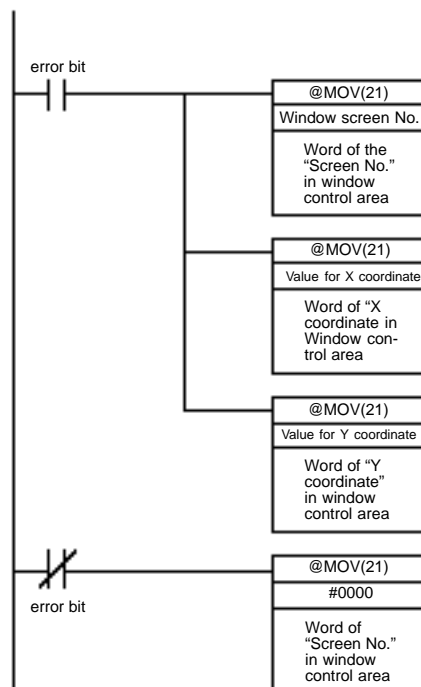

With this ladder program, the specified window is displayed at the designated position when the error bit comes ON, and the window is closed when the error bit goes OFF.

Hints

- Window can be moved closed or opened by the operation of touch switch, when the window move touch switch is registered on the window like the example above.
- Detailed screen is displayed, or the screen is switched by pressing on the message position in an alarm list on the window. (Refer to page 590)
- Multiple windows can be displayed at the same time (up to three windows). (Refer to page 430)
- It is possible to display windows so that they do not overlap when multiple windows are displayed, since the position of each window can be specified. (Refer to page 481)
- When the windows are overlapped, the displaying order of windows can be changed by touching the window which is displayed under the other window. (Refer to page 433)

Continuously Reading Out the Contents of a PC Word and Displaying a Trend Graph by Backtracking

Example: Utilizing the trend graph logging function and background function

(1) Register a trend graph set as indicated below for the screen.

- Line Properties:
Word No. of the PC word to be monitored
- Data Logging:
Check mark set
- Background:
Check mark set
- Touch switches for logging:
Check marks set for all
- Touch switches for display function:
Check marks set for all

Regardless of whether or not the trend graph is displayed, reading of the contents of the word starts at the same time as PT operation is started.

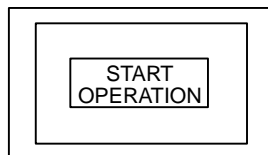

Due to the background function, data reading is started at the same time as operation is started.



When the trend graph screen is displayed, the latest status is displayed.

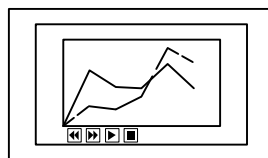

The latest trend graph is displayed on the basis of collected data.



Even if another screen is displayed during data collection, the contents of the word continue being read by the background function.

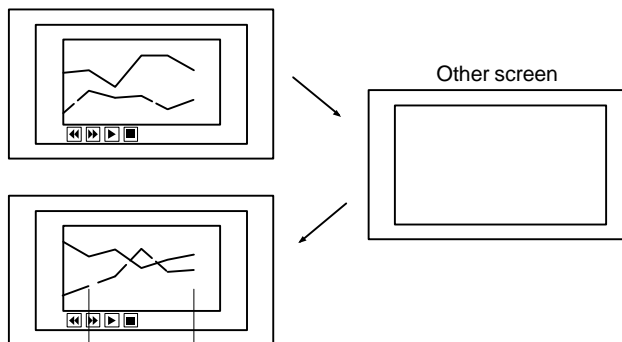

Data collected while the other screen was displayed.



If required, past status changes can be displayed as a trend graph.

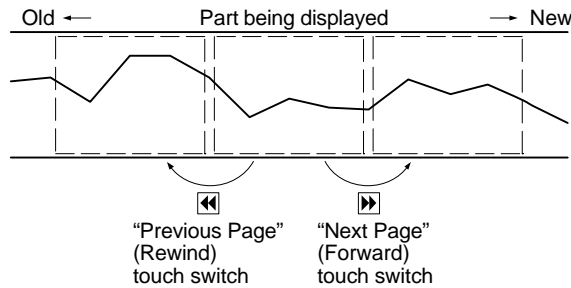

Hints

- Apart from the “Previous Page” (Rewind) and “Next Page” (Forward) touch switches indicated above, the following touch switches can be created without restriction to control the display and data recording (7-10-4 “Trend Graphs”, page 381).
 - “Stop” touch switch
Stops data sampling.
 - “Restart” (Continue) touch switch
Restarts data sampling when it has been stopped.
 - “Display Clear” (Clear display) touch switch
Clears the currently displayed trend graph, then starts drawing the graph from the new status (past records are retained).
 - “Log Clear” (Clear log) touch switch
Clears past records.

Displaying the Day of the Week Using Clock Data in the PT

At the PT, numeric values are stored in numeral memory table No. 253 as shown below.

Value (decimal)	0	1	2	3	4	5	6
Day of week	Sun	Mon	Tue	Wed	Thu	Fri	Sat

By indirect reference of character string displays, the displayed characters are changed using these values to change, the character string memory table whose contents are to be displayed.

Example: Displaying “Sun” to “Sat”, stored in character string memory tables No. 0 to 6, by indirect reference of numeral memory table No. 253.

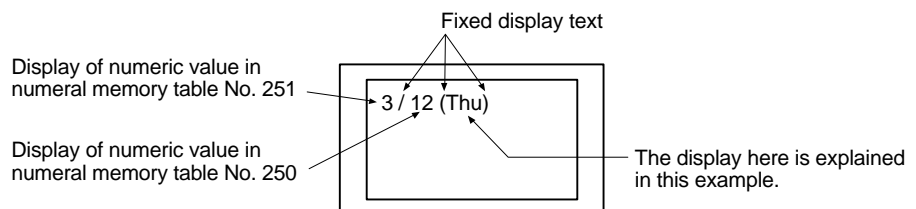

- (1) Set the initial values indicated below for character string memory tables No. 0 to No. 6. Do not allocate these character string memory tables to words at the host.

Character string memory table	0	1	2	3	4	5	6
Initial value	Sun	Mon	Tue	Wed	Thu	Fri	Sat

- (2) Register the part that displays the month and day for the screen, following the example given above.
- (3) Register the part that displays the day of the week by indirect specification of a character string display, as indicated below.
- Indirect Reference:
Check mark set
 - Table Entry:
253 (numeral memory table that stores the day of the week data)

The settings above will display the month and day set with the “calendar and clock” in the System Menu.

Hints

- The clock data can be set on the “CALENDAR & CLOCK SET” screen in the System Menu (page 211).
- To set the year, month, date, and day of the week in numeral memory tables 254 and 255, the memory table copy function must be used (pages 498 and 503).
- If character string memory tables No. 0 to No. 6 are used for other applications at the same time as they are used to display the day of the week.
 - (1) Copy the contents of numeral memory table 253 to a number that can be allocated to a PC word by using the memory table copy function.
 - (2) To achieve correspondence between the numbers of the character string memory tables that store “Sun” to “Sat” and the contents of numeral memory table No. 253 (0 to 6), add a constant.
 - (3) Display the day of the week indirectly by following the example above.

Example: Storing “Sun” to “Sat” in character string memory tables No. 200 to 206.

Character string memory table	200	201	202	203	204	205	206
Initial value	Sun	Mon	Tue	Wed	Thu	Fri	Sat

Adding 200 to the contents of numeral memory table No. 253 enables indirect specification of the character string memory tables that store Sun to Sat.

10-2 Examples of Actual Applications of Memory Link

Some examples that will give you an idea of how to actually apply the memory link are presented below.

- Switching screen by the operation at PT control area Page 602
- To know the event that a numeral/character string is input to PT Page 603

The examples below give you the explanation centered on which commands are sent to apply the function and the method to use the responses returned from PT. For method on using programming language which is run at the host, refer to the manual of each programming language etc. For details of commands used with memory link, refer to Section 9 "Using Memory Link".

Switching screen by the operation at PT control area

Example: Switching screen by the operation at PT control area:
Allocated word in PT control area: 0100CH

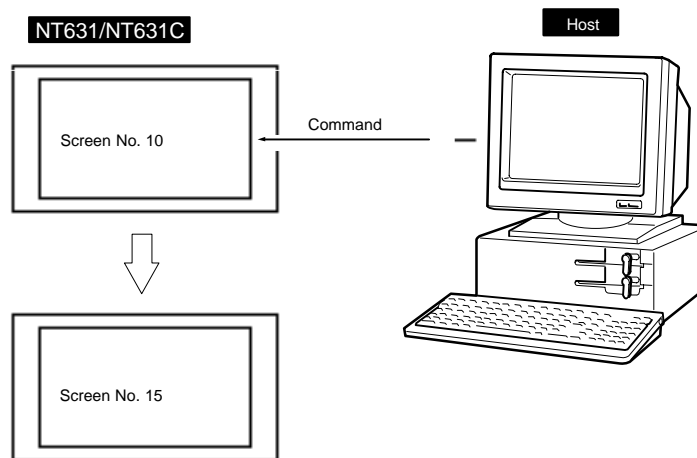

Use "PT memory write command" (sent from host to PT) for this case since it is necessary to write new screen number to the first word in PT control area.

- Command

[ESC]	W	M	8	0	1	0	0	0	0	0	F	[CR]
1B	57	4D	38	30	31	30	30	30	30	30	46	0D
			(1)			(2)			(3)			

- Explanation

- (1) Write attribute : Check sum absent, SET attribute (writing 1 word)
- (2) First word No. written : 0100CH
Number of words written : Omitted, since the write attribute is as above.
- (3) Data of written word : 000FH

Screen switch is executed by writing the screen number to the first word in PT control area.

In this example, screen is switched from screen No.10 to screen No.15. "000F" is specified in the example above since it is necessary to specify data of written word in PT memory write command in binary.

If "Yes" is set for the "Response" memory switch for the communication setting of memory link, the response indicated below is returned from PT after sending command. (If "No" is set, no responses will be returned.)

• Response

[ESC]	W	M	0	0	1	F	[CR]
1B	57	4D	38	30	31	46	0D

• Explanation

Format of response is fixed.

Hint

- In the same way, by changing the status of PT control bit, buzzer can be beeped or backlight ON/OFF status can be controlled from the host. see page ??
- By writing the value in window control area, it is possible to control window (open/close/move). see page ??
- Use "bit memory table write command" to switch screens by the operation of bit memory table. see page ??

To know the event that a numeral/character string is input to PT

Example:

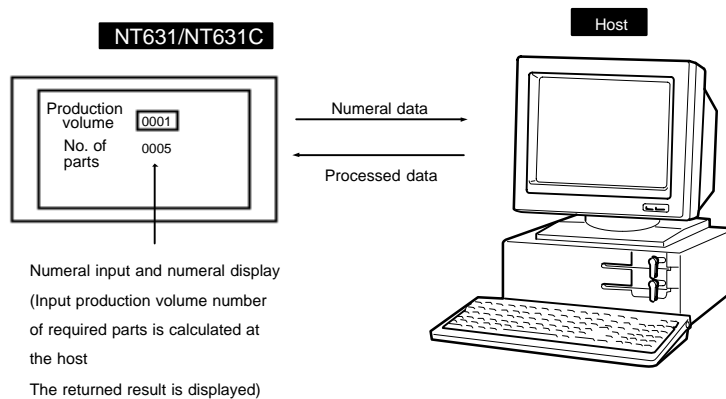

When the numeral was input on PT, "numeral input notify command" (sent from PT to host) is issued from the PT. At the host, numeral data was taken out and processed, then it is written to the PT by the "numeral memory table write command" (sent from host to PT).

(1) When numeral data is input on PT ("numeral input notify command" sent from PT to host):

• Command

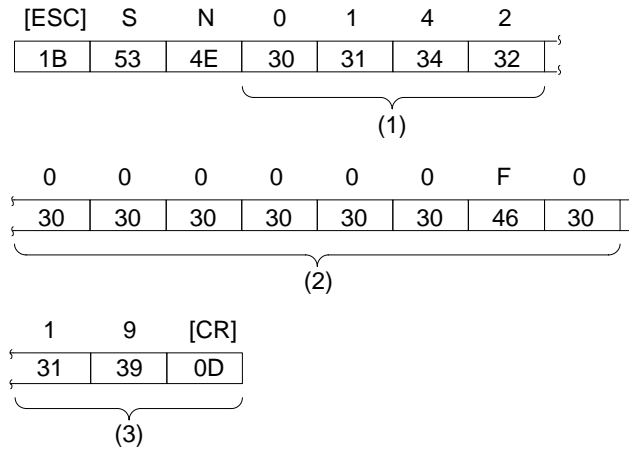

• Explanation

- Numeral memory table number : 142
- Input numeral : 00000000F0_H (240 in decimal)
- Check sum : 19H

It is ascertained that "240" is input to numeral memory table No.142. With numeral input notify command, input numeral data is expressed as binary. Here, input data (240) is expressed as binary (000000F0_H).

(2) When numeral is written to PT ("numeral memory table write command" (sent from host to PT))

• Command

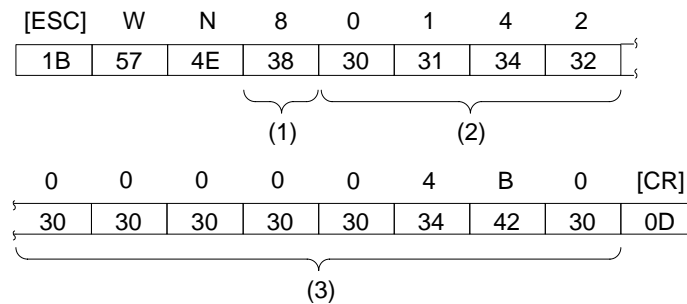

- Explanation

- Check sum present/absent : None (writing 1 word)
- First numeral memory table No. written : 142
- Data of written numeral memory table : 000004B0_H (1200 in decimal)

In this way, numeral data which is input from the PT is processed at the host and the result is notified to the PT.

Hints

- Same as numeral, “character string input notify command” (sent from PT to host) is issued from the PT for the character string which is input at PT. (see page)
- Character string which is input from bar code reader is also notified to the host. (see page)
- Data of numeral/character string memory table can be cleared by “memory table clear command”. (Numerals are cleared to “0”, and character strings are cleared to the space code “20 H”) (see page)

SECTION 11

Troubleshooting and Maintenance

This section describes the action to take when NT631/NT631C errors occur, and how to carry out maintenance and inspection to prevent the occurrence of errors.

11-1	Troubleshooting	606
11-2	Responding to Displayed Error Messages	609
11-2-1	Errors Occurring at Start of Operation and Their Remedies	609
11-2-2	Errors Occurring during Operation and Their Remedies	611
11-2-3	Errors Occurring on Screen Data Initialization and Transmission	612
11-2-4	Errors in the System Installer Mode and Their Remedies	613
11-2-5	Communication Errors and Their Remedies	614
11-3	Maintenance of the NT631/NT631C	616
11-3-1	Replacing the Battery	622
11-4	Inspection and Cleaning	624

11-1 Troubleshooting

When a fault relating to the operation of the NT631/NT631C occurs, find the symptoms in the table below and respond by following the corresponding "Remedy" indicated in the table.

Notice

- Confirm system safety before turning the power ON/OFF or resetting.
- Do not disassemble the PT for repair or modification.

NT631/NT631C Symptoms	Cause	Remedy
Power LED fails to come ON	Power is not being supplied.	Check the connections and make sure that power is supplied correctly. (3-1-3 "Power Supply Connection", page 39)
	Power supply fuse has blown.	Contact your OMRON service center.
Nothing is displayed on the screen.	Screen No. 0 has been read at the host side.	This is not an error. Change the screen number. (8-3 "Screen Display and Notification", page 469)
	The system startup waiting time has not elapsed yet.	This is not an error. The display will appear after the waiting time has elapsed.
Cannot communicate with the Support Tool	The Transmit mode has not been established.	Display the System Menu and select the Transmit mode. (6-6 "Transmitting the Screen Data", page 169)
	Not connected to the Support Tool.	Check the installation of the connector cable. (3-2 "Connecting to the Support Tool", page 41)
	The PT model setting and direct connection setting at the Support Tool do not match the NT631/NT631C.	Using the "PT Configuration" settings of the Support Tool, set the PT model and direct connection settings that match the NT631/NT631C.
Cannot communicate with the host Cannot switch from the system initializing screen. Communication error message is displayed when communicating to the host.	Memory switch settings do not match.	Check the communication setting in the "Memory Switch" menu of the Maintenance mode, and match the communication protocol settings for the host and NT631/NT631C. (6-7 "Setting the Conditions for Communications with the Host by Using the Memory Switches", page 172)
	NT631/NT631C and host are not correctly connected.	Check that the type, length, and installation of the connector cable match the specifications. (Section 4 "Connecting to the Host from the RS-232C Port", and Section 5 "Connecting to the Host from the RS-422A/485 Port")
	In an RS-422A/485 connection, the terminator setting is incorrect.	Make the NT631/NT631C and PC termination resistance settings correctly. (Section 4 "Connecting to the Host from the RS-232C Port", and Section 5 "Connecting to the Host from the RS-422A/485 Port")
	In an NT link (1:N) connection, there is duplication in the unit numbers.	Make the settings again so that there is no duplication. (6-7-4 "Setting the NT Link (1:N) Method", page 177)
	The power to the NT631/NT631C, NT-AL001 or host is OFF.	Check the power supply.
The buzzer has sounded and the RUN LED is OFF.	Malfunction due to external noise	Carry out grounding work in accordance with the conditions by referring to 3-1-4 "Grounding", page 40.
	The NT631/NT631 has developed trouble.	Contact your OMRON service center.
The touch panel does not respond.	Malfunction due to external noise	Carry out grounding work in accordance with the conditions by referring to 3-1-4 "Grounding", page 40.
	The touch panel is broken.	Test the touch panel with "I/O Check" in the MAINTENANCE MODE menu. If there is an error, contact your OMRON service center.

NT631/NT631C Symptoms	Cause	Remedy
The PC mode has changed to the monitor mode.	The NT631/NT631C changes the mode when host link communication is used.	This is an NT631/NT631C specification. When using a PC that can also be connected using the NT link method, use an NT link connection (there is no mode change with the NT link method).
The graph display does not change.	One of the percentage display settings — “-100%”, “0%”, or “100%” — is incorrect.	Set the “-100%”, “0%”, and “100%” values in the following relationship: -100% value < 0% value < 100% value
The trend graph display does not agree with the actual time axis.	The cycle for graph display update processing is longer than the set sampling cycle.	Delete other elements on the same screen as the trend graph that are allocated to the host and have a high update frequency. Or lengthen the sampling cycle.
The programming console function cannot be used.	The communication settings are incorrect.	Set the communication method/communication port as follows when using the programming console function. - With C series PLC : NT Link : 1 : 1 - With CS1 series PLC : NT Link : 1 : N
	A programming console is connected.	It is not possible to use a programming console and the programming console function at the same time. Disconnect the programming console.
	The PC does not support the programming console function.	Not all PCs support the programming console function. Check the model of PC you are using. (6-12 “Programming Console Function”, page 237)
The memory table display contents differ from the initial value set at the Support Tool.	Since the memory table is allocated to the host memory, the display is updated in accordance with the contents of the host memory.	When the contents of the memory table are set as a fixed value, do not allocate the memory table to the host.
	The battery voltage has dropped and the data in the memory table has been destroyed.	Replace the battery and execute “memory table initialization”. (11-3-1 “Replacing the Battery”, page 624, and 6-4-4 “Initializing the Memory Tables”, page 161)
	Since ON is set for the “resume function”, the initial values of the screen data memory are not written to the memory tables.	Execute “memory table initialization”. (6-4-4 “Initializing the Memory Tables”, page 161) If the resume function does not need to be used, use the NT631/NT631C with the resume function OFF. (6-9-10 “Setting the Resume Function”, page 199)
Updating of numeric values and text is delayed.	Malfunction due to external noise	Carry out grounding work in accordance with the conditions by referring to 3-1-4 “Grounding”, page 40.
	There are too many numeral/text displays on the displayed screen.	Reduce the number of numeral/text displays on the screen for which updating is delayed.
	The cycle time is extended due to heavy processing at the host.	Shorten the host cycle time.
	In an RS-422A/485 connection, there is illegal branching or an erroneous terminator setting.	Wire correctly by referring to Section 5 “Connecting to the Host from the RS-422A/485 Port”.
Some of the elements arranged on a normal screen are not displayed.	The quantity of read data exceeds the stipulated restriction.	Check the maximum number of elements by referring to “Display Restrictions” (page 635), create the screen data again, then transmit all of the screen data in a batch to the NT631/NT631C.
	The total of the element coefficients for the displayed screen is greater than 1024.	
On an overlapping screen, some of the set elements are not displayed.	Since the data is transmitted from the host in screen units, the number of elements on the overlapping screen has exceeded the maximum permissible without being checked by the Support Tool.	Check the maximum number of elements by referring to “Display Restrictions” (page 635), create the screen data again, then send all the screen data in a batch to the NT631/NT631C.

NT631/NT631C Symptoms	Cause	Remedy
The System Menu cannot be called up.	"Display System Menu" under "Change System Settings" in the System Installer mode is set to "Disabled".	In the System Installer mode, set "Display System Menu" to "Enabled" (page 167).
The following System Menu operations are not possible. - Establishing the Transmit mode - Displaying the memory switch setting screens - Screen data memory check - Displaying the initialization menu - Displaying the calendar/time setting screen	"Screen Memory Protect" under "Change System Setting" in the System Installer mode is set to "Disabled".	In the System Installer mode, set "Screen Memory Protect" to "Enabled" (page 167).
	"Screen Memory Protect" has been set to "Disabled" because the PT power supply was turned OFF during deletion of screen data.	Do not turn the PT power OFF during deletion of screen data. In the System Installer mode, first change the setting for "Screen Memory Protect" to "Enabled", then repeat the screen data delete operation (pages 167 and 168)
Cannot input numeric values	The upper/lower (max./min.) limit check for numeric value input is in effect.	Check the screen data's upper/lower (max./min.) limit check setting for numeric value input, and correct it if necessary (for numeric key type, refer to page 414; for thumbwheel type, refer to page 421).
Cannot input numeric values/character strings.	Bit 5 of the PT status control area (numeral/character string input) is set to "1" (ON).	Set bit 5 to "0" (OFF) (page 268).
Window screen does not open	Bit 6 of the PT status control area (PT window opening) is set to "1" (ON).	Set bit 6 to "0" (OFF) (page 268).
Cannot switch screens with touch switches	Bit 4 of the PT status control area (PT screen switching) is set to "1" (ON).	Set bit 4 to "0" (OFF) (page 268).
The display is dim.	Insufficient contrast or brightness	Increase the contrast/brightness (pages 208 and 209).
	Backlight defective, or its life has expired	Replace the backlight (page 619).
The display is too faint.	The contrast is too high.	Reduce the contrast (page 208).

11-2 Responding to Displayed Error Messages

When the NT631/NT631C displays an error message, find the corresponding symptoms in the appropriate table below and respond by following the “Remedy” indicated in the table.

For details of the error messages displayed when using memory unit and corrective action to take for them, refer to 3-5 “Using a Memory Unit (NT631/NT631C with V1)” in page 46 or 3-6 “Using a Memory Unit (NT631/NT631C without V1)” in page 56.

11-2-1 Errors Occurring at Start of Operation and Their Remedies

The table below shows the errors that can occur when the power to the NT631/NT631C is turned ON and when operation starts, and their remedies.

Message	Cause	Remedy
[No Comm. Protocol] Set the comm. Protocol by MAINTENANCE MODE.	No communication protocol has been set. Communication protocol and screen data type are mismatched	Using the memory switches, set the communication method to be used for communication with the host. (6-7 “Setting the Conditions for Communications with the Host by Using the Memory Switches”, page 172)
[Screen Data Error] Screen Data corrupted. Initialize Screen Memory, and download Screen Data again.	- The power was switched OFF during screen data initialization, checking, or transmission. - Transmission of screen data was interrupted. - Illegal data has been written to the screen data memory.	Initialize the screen data memory by operation at the System Menu, then re-transmit the screen data. (6-4-1 “Clearing Screen Data”, page 156) If the problem persists, contact your OMRON service center.
[No Screen Data] No Screen Data is saved in Screen Memory. Download Screen Data using by the Support Tool. Then set the PT to the TRANSMIT MODE, and download Screen Data again.	No screen data is registered.	Transmit screen data from the Support Tool.
[No Direct Connection Info.] No Direct Connection Information is set in Screen Data. Set Direct Connecting Information in Screen Data using by the Support Tool. Then set the PT to the TRANSMIT MODE and download Screen Data again.	Allocated words have not been set for the PT status control area and PT status notify area.	Allocate words for the PT status control area and PT status notify area with the Support Tool and then transmit the direct connection information to the NT631/NT631C.
[Incorrect Screen Data] Screen Data in Screen Memory do not match with the System Program. Initialize Screen Memory, and download Screen Data again.	The type of registered screen data does not match that at the NT631/NT631C.	Initialize the screen data memory, then transmit the correct screen data. (6-4-1 “Clearing Screen Data”, page 156)
[No Starting Screen] Specified Starting Screen is not saved. Fix Screen Data using by the Support Tool. Then set the PT to the TRANSMIT MODE and download Screen Data again.	No data is registered for either the screen number set in the PT status control area or the “Initial Screen” set with the Support Tool. Or the screen number which does not exist are registered.	Either specify a screen number for which data is registered at the PT status control area, or set the screen as the “Initial Screen” in the “System” settings under “PT Configuration” at the Support Tool.

Message	Cause	Remedy
[Touch Panel is disconnected]	The touch panel cable (film cable) inside the NT631/NT631C is disconnected.	If this message appears after the backlight is replaced, reinstall the touch panel properly referring to "Replacing the Backlight" (page 619). If the message keeps appearing, contact your OMRON service center.
[Memory Switch Corrupted] Because Memory Switch setting was last. Initialized Memory Switch setting. Press Confirm to return to the SYSTEM MENU.	The memory switches have been initialized due to discovery of an error in the memory switch settings.	Set the memory switches again using the System Menu and the "System" settings under "PT Configuration" at the Support Tool. (Section 6 "System Menu Operation") If the problem recurs, contact your OMRON service center.
[Calendar Data Error] Calendar Data is incorrect. Set to the MAINTENANCE MODE and set Calendar Data.	There is an error in the date/time values due, for example, to low battery voltage.	Check the battery voltage by checking the color of the RUN LED and with the battery check in the System Menu; if the voltage is low, replace the battery with a new one. ("Checking the Battery Voltage", page 229, and 11-3-1 "Replacing the Battery", page 624) If the battery voltage is confirmed to be normal, set the calendar clock correctly from the System Menu. (6-11-2 "Displaying/Setting the Calendar and Clock", page 211)
[Backup Data Error] Memory table and History data was initialized by backup failure. It can be caused by lowered voltage of the battery.	Initialization has been executed because of an error in the backup data area.	Check the battery voltage by checking the color of the RUN LED and with the battery check in the System Menu; if the voltage is low, replace the battery with a new one. ("Checking the Battery Voltage", page 229, and 11-3-1 "Replacing the Battery", page 624) The re-transmit the memory table data from the Support Tool. If the voltage is normal and the problem recurs, contact your OMRON service center.
[With memory switch setting screen] Invalid Comm. Method	Protocol settings for serial port A and serial port B are mismatched.	Refer to "Posable Combinations of Communication Method Settings" in page 174 and set the protocol of serial port A and serial port B so that their settings are matched. * Set serial port A to "None" when connecting the Support Tool and the host at the same time.

11-2-2 Errors Occurring during Operation and Their Remedies

The table below shows the errors that can occur during operation of the NT631/NT631C and their remedies.

Message	Cause	Remedy
[Address Setting Error] Addressing Error exists in the Screen. Correct address setting by the Support Tool.	The host side allocated words and bits set with the Support Tool are incorrect.	Set correct words and bits after checking the area used at the host side by referring to APPENDIX L "PC Memory Map" (page 675), and the manual for the PC being used.
[Memory Table No. Error] Memory table No. is out of limit. Correct the table No. by the Support Tool.	The memory table number set with the Support Tool is outside the range for the number of memory tables set in the system memory.	Either increase the number of memory tables in the "System" settings under "PT Configuration" at the Support Tool, or set the memory table number again within the established range.
[Programming Console Error] Setting of Programming Console Function is inadequate. Confirm the PC model and comm. protocol.	The communication settings are incorrect.	Set the communication method/communication port as follows when using the programming console function. - With C series PLC : NT Link : 1 : 1 - With CS1 series PLC : NT Link : 1 : N
	The PC used does not support the programming console function.	Not all PCs support the programming console function. Check the model of the PC you are using. (6-12 "Programming Console Function", page 237)
[Programming Consol Error] PROGRAMMING CONSOLE function does not RUN. It can be caused by: • faulty connecting cable. • Protocol mismatch between the PT and PC. Set the PC to NT LINK 1:1.	The connecting cable is defective.	Check the cable connection and perform a conductivity test. If there is a fault, replace the cable.
	Malfunction due to external noise	Carry out grounding work in accordance with the conditions by referring to 3-1-4 "Grounding", page 40.
	A programming console is connected.	It is not possible to use a programming console and the programming console function at the same time. Disconnect the programming console.
	The communication conditions at the PC have been changed in accordance with the NT631/NT631C programming console function.	Set the communication conditions at the PC to match the conditions set in the System Menu.

11-2-3 Errors Occurring on Screen Data Initialization and Transmission

The table below shows the errors that can occur when the NT631/NT631C data is initialized, and during data setting and transmission, and their remedies.

Message	Cause	Remedy
[Flash Memory Error] Flash Memory I/O Error. If this happens frequently, Flash Memory may be broken. Press Reset Switch to restart.	There is a hardware fault, or the flash memory (memory for storing screen data) has reached the end of its service life.	If the same message is displayed even after clearing the screen data or transmitting screen data several times, contact your OMRON service center.
[Calendar Data Error] Calendar Data is incorrect. Set to the MAINTENANCE MODE and set Calendar Data.	Hardware fault, or system program error	Set the calendar clock again from the System Menu. If the problem recurs, delete the program in the System Installer mode, then re-install the program. (6-5-2 "Clearing/Installing the System Program", page 165) If this does not solve the problem, contact your OMRON service center.
[Tool Transmit Error] **** Error detected while downloading by the following case: • faulty connecting cable. • corrupted data by noise.	The connecting cable is defective. Malfunction due to external noise	Check the cable connection and perform a conductivity test. If there is a fault, replace the cable. (APPENDIX F "Making the Cable for Connecting a PC", page 655) Carry out grounding work in accordance with the conditions by referring to 3-1-4 "Grounding", page 40.
[Tool Transmit Error] Check Sum Error occurs while downloading by the following case: • corrupted data by noise.	Malfunction due to external noise	Carry out grounding work in accordance with the conditions by referring to 3-1-4 "Grounding", page 40.
[Tool Transmit Error] Time-out Error occurs while downloading by the following case: • faulty connecting cable.	The connecting cable is defective.	Check the cable connection and perform a conductivity test. If there is a fault, replace the cable.
[Tool Transmit Error] Reception was failed by Buffer Over Flow Error.	The receive buffer has overflowed.	Retransmit the data from the Support Tool.

11-2-4 Errors in the System Installer Mode and Their Remedies

This section describes the errors that may occur in the System Installer mode of the NT631/NT631C, and the remedies for these errors.

Message	Cause	Remedy
System Program not exist or incorrect.	<ul style="list-style-type: none"> - The system program has not been installed. - The system program has been deleted due to a hardware fault, or because the flash memory (memory for storing the system program) has reached its life. 	<p>Select "Download System Program" and download the system program (6-5-2 "Clearing/Installing the System Program", page 165).</p> <p>If this does not solve the problem, contact your OMRON service center.</p>
Unable to erase System Program.	Hardware fault, or flash memory (memory for storing the system program) has reached its life.	<p>If the same message is displayed on repeating selection of "Download System Program" and attempting to delete the system program several times, contact your OMRON service center (6-5-2 "Clearing/Installing the System Program", page 165).</p>
Unable to download System Program.	<ul style="list-style-type: none"> - A communication error occurred during downloading of the system program. - Illegal data has been written into the screen data memory. - Hardware fault, or flash memory (memory for storing the system program) has reached its life. 	<p>Select "Download System Program" and download the system program again (6-5-2 "Clearing/Installing the System Program", page 165).</p> <p>Also refer to 11-2-3 "Errors Occurring on Screen Data Initialization and Transmission" (page 614), and take the corrective action described for tool transmission errors.</p> <p>If this does not solve the problem, contact your OMRON service center.</p>
Unable to write System Settings.	Hardware fault, or flash memory (memory for storing the system program) has reached its life.	<p>If the same message is displayed on repeating writing of system settings several times, contact your OMRON service center.</p> <p>If writing is normally terminated after the error message was once displayed, the "Memory Switch" setting for system program may have been altered. In such a case, check and re-set the setting in the "Memory Switch" menu of the Maintenance mode.</p>
Unable to erase Screen Data.	Hardware fault, or flash memory (memory for storing the system program) has reached its life.	<p>If the same message is displayed on repeating screen data deletion several times, contact your OMRON service center.</p>

11-2-5 Communication Errors and Their Remedies

This section describes the errors relating to communication that can occur during operation, and their remedies.

Operation When a Communication Error Occurs

When a communication error occurs, the error message is displayed at the NT631/NT631C, and the buzzer sounds, provided the setting made for "Buzzer Sound" in the System Menu is other than "OFF". An error message is displayed provided the setting for the "Comm. Auto-Return" memory switch is not "ON" (note that some error messages are displayed even if the setting is "ON").

Operation When Communication Errors Occur

When an error message is displayed, press the "OK" touch switch displayed on the screen. The NT631/NT631C will return to the screen that was displayed before the error occurred, and operation will restart.

Display of Communication Errors

For communication errors, the name of the port at which the error occurred, the error classification (send or receive error), the details of the error, the probable cause, and the remedy, are displayed as shown below.

Example: Parity error at serial port A

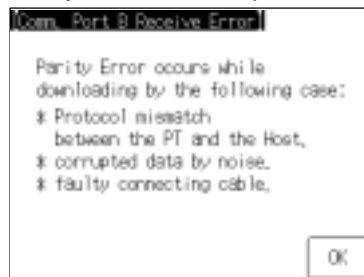

- Receive errors

The following errors can occur when receiving data.

- Parity error
- Framing error
- Overrun error
- FCS (sum value) error
- Time out error
- Data over flow error
- PC unit No. error (host link only)
- NAK received (in the case of the host link, the end code is also displayed)
- Undefined command error

- Send errors

The following errors can occur when receiving data.

- Time out error
- Data over flow error

Probable Causes and Remedies

The remedies to take in accordance with the displayed cause are indicated in the table below.

Error Details	Displayed Probable Cause	Remedy
Parity Error Framing Error Over-run Error	Communication parameters/ conditions set incorrectly.	Check if the settings at the host for parity bit, frame length, communications speed, stop bit length and flow control agree with those at the NT631/NT631C.
	The connecting cables are not connected correctly.	Check the communication cable connection and perform a conductivity test. If there is a fault, replace the cable. For details on communication cables, refer to Section 4 "Connecting to the Host from the RS-232C Port", and Section 5 "Connecting to the Host from the RS-422A/485 Port".
	Noise caused data corruption during communication.	Carry out grounding work in accordance with the conditions by referring to 3-1-4 "Grounding", page 40.
FCS (Check Sum) Error	Noise caused data corruption during communication.	Carry out grounding work in accordance with the conditions by referring to 3-1-4 "Grounding", page 40.
	The PC is transmitting incorrect data.	Check the operation at the host side.
Time-out Error	The connecting cables are not connected correctly. (Send/Receive)	Check the communication cable connection and perform a conductivity test. If there is a fault, replace the cable. For details on communication cables, refer to Section 4 "Connecting to the Host from the RS-232C Port", and Section 5 "Connecting to the Host from the RS-422A/485 Port".
	The communication service of the host is stopped. (Send/Receive)	Check that the host is capable of communicating with the NT631/NT631C (confirm that the communication settings of the host and NT631/NT631C match).
	Time-out Interval is too short. (Send)	Set a longer value for "Time-out Interval" at the host side.
	Time-out Interval is too short. (Receive)	Set a longer value for "Time-out Interval" in the System Menu. (6-9-12 "Setting the Time-out Interval", page 202) It may also be possible to solve the problem by shortening the host cycle time.
PC Unit No. Error	The unit # does not match that set on the PC.	Re-set the unit number at the host side to "0".
	Noise caused data corruption during communication.	Carry out grounding work in accordance with the conditions by referring to 3-1-4 "Grounding", page 40.
NAK received	—	Check the settings for allocated words and bits. If noise is a possible factor, distance the cable from sources of noise and insert a noise filter in the power supply line. If using the equipment in a location subject to a lot of noise, use a cable with a high degree of protection against noise for the transmission route. Also make the cable as short as possible.
Undefined Command Error	The host is not supported.	Check the PC model used for the host.
	Instruction level 3 is not effective.	Check that the instruction level setting for the host is "level 1, 2, 3".
Data Over Flow Error	Communication command from the host is too long. (With memory link)	Set flow control method in the host. Increase transmission interval.
	Command transmission to the host is not possible.	Check the communication cable. Check the control method at the PT and the host. Increase the communication on speed when it to slow.

11-3 Maintenance of the NT631/NT631C

Carry out maintenance work in order to ensure that the NT631/NT631C is always used in its optimum condition.



WARNING

Do not attempt to take the unit apart and do not touch any internal parts while the power is being supplied. Doing either of these may result in electrical shock.



Spare PT

It is advisable to have a spare NT631/NT631C available to minimize system downtime in the event of an NT631/NT631C failure or if the screen display becomes difficult to read due to deterioration of the display unit.

Backlight (for NT631C only)

When the backlight in the display is getting dim and the screen cannot be read easily, replace the backlight. The backlight can be replaced at the rear of the NT631/NT631C while it is mounted in an operation panel.

- Replaceable backlight model
NT631C-CFL01 (for NT631C-ST151□-EV1)
NT631C-CFL02 (for NT631C-ST141□-EV1)

- Guide to backlight replacement

Use the following as a guide to backlight replacement.

NT631C-ST141□-EV1 : Approx. 25,000 hours

NT631C-ST151□-EV1 : Approx. 30,000 hours

The life of the backlight varies, particularly in accordance with the temperature in the environment in which it is used. It should be replaced when it becomes dim and the screen becomes hard to read.

Notes on Replacing the Backlight

Pay attention to the following points when replacing the backlight.

- Carry out the replacement work in a location where there is no danger that dust or foreign bodies will enter the unit, and where no water will drip onto it.

Do not touch the printed circuit boards of the NT631/NT631C with your bare hands.

Also, discharge the static electricity from your body before starting the work.

- Do not carry the backlight unit by holding only its cable, or pull on the cable. Do not subject the backlight to excessive force or shock.
- Do not disassemble the product to repair or modify it.

Replacing the Backlight

Use the following procedure to replace the backlight.

WARNING

Switch OFF the NT631C power before replacing the backlight. Otherwise you could sustain an electric shock.

Replace the backlight by following the procedure given below:

NT631C–CFL01 (for NT631C–ST151□–E)

- Procedure**
- 1 Turn the power supply to the NT631C OFF. Be sure to do so to avoid an electric shock.
 - 2 Disconnect the terminal block wiring, the communication cable, and the printer cable. If a memory unit or interface unit is mounted, remove that unit also.
 - 3 Loosen four screws at corners on the rear face of the NT631C, and remove the rear case. Be careful not to lose these screws. From this step on, exert added care not to touch any electronic parts or printed circuit boards inside the unit. Otherwise the PT may sustain static damage.
 - 4 Disengage two backlight connectors at the top and the bottom, and pull out the touch panel cable.

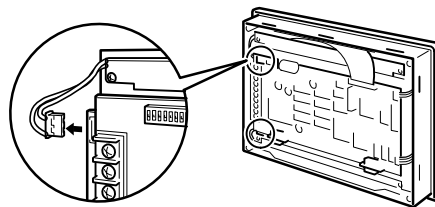

[Removing and fitting the touch panel cable]

- Removing the touch panel cable:

Pull the arrow-marked sections up to the cable side to unlock the connector, and remove the cable.



- Fitting the touch panel cable:

While unlocking the connector, insert the touch panel cable fully. Then, lock the connector.



- 5 Loosen two mounting screws, and remove the backlight. When loosening or tightening screws for backlights, be sure to use a magnetized Phillips screwdriver. If any screw falls inside the unit, it must be extricated without fail.

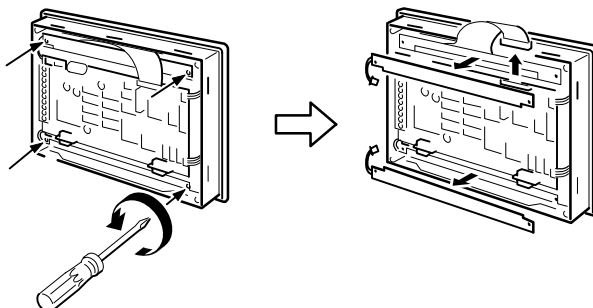

- 6 Fit new backlights. The backlight for the top is different from that for the bottom. Each backlight has three projections. Slot these projections into slits on the unit, and tighten the screws while lightly holding the backlight by fingers. Make sure that the cable does not come out of the backlight. If it comes out, put it in the backlight and then tighten the screws. The tightening torque must be 0.2 N \cdot m.

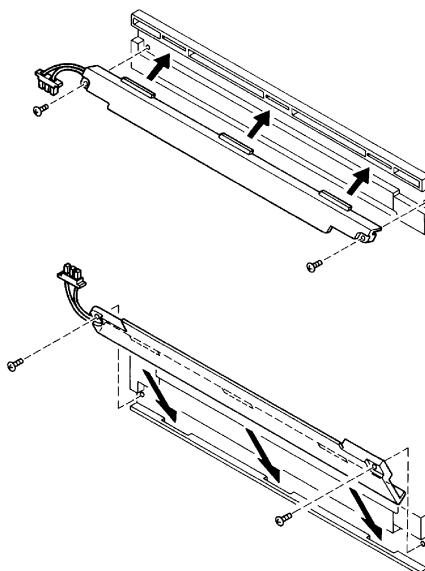

- 7 Engage backlight connectors at the top and the bottom respectively in place. The backlight cable has a polarity; refer to the figure below.

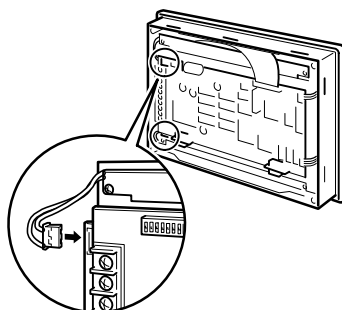

- 8 Fit the touch panel cable. Be sure to lock the connector as in step 4 after fitting.
- 9 Close the rear case, and tighten four screws. Make sure that the internal cable is not trapped.
- 10 Reconnect the wiring, cables, and units disconnected in 2, and tighten the screws at a torque of 0.4 N \cdot m
Turn the power on, and check that the RUN LED is not flashing and that no buzzer is sounding.
 - If the RUN LED flashes at 1-sec intervals and a buzzer sounds intermittently, the touch panel cable is disconnected. Follow the above steps from 1, and check the lock status of the connector.
- 11 Before starting normal operation, confirm that the following tests can be executed correctly by using the I/O check in the Maintenance menu. Also perform a communication test with the host.
 - Touch switch
 - Backlight
- 12 On confirming that all the tests in 11 can be executed normally, start operation.

NT631C-CFL02 (for NT631C-ST141□-EV1)

- Procedure**
- 1 Turn the power supply to the NT631C OFF.
Be sure to do so to avoid an electric shock.
 - 2 Disconnect the terminal block wiring, the communication cable, and the printer cable. If a memory unit or interface unit is mounted, remove that unit also.
 - 3 Loosen four screws at corners on the rear face of the NT631C, and remove the rear case.
Be careful not to lose these screws.
From this step on, exert added care not to touch any electronic parts or printed circuit boards inside the unit. Otherwise the PT may sustain static damage.
 - 4 Disengage two backlight connectors at the top and the bottom, and pull out two touch panel cables at the top.

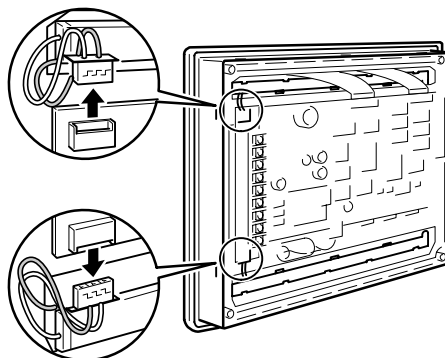

[Removing and fitting the touch panel cable]

- Removing the touch panel cable:

Pull the arrow-marked sections up to the cable side to unlock the connector, and remove the cable.



- Fitting the touch panel cable:

While unlocking the connector, insert the touch panel cable fully. Then, lock the connector.

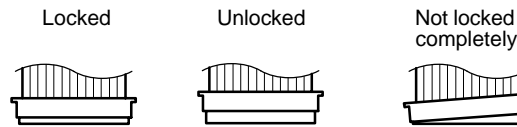

5 Loosen mounting screws, and remove backlights.

Shift the backlight to the right, and pull it out.

When loosening or tightening screws for backlights, be sure to use a magnetized Phillips screwdriver. If any screw falls inside the unit, it must be extricated without fail.

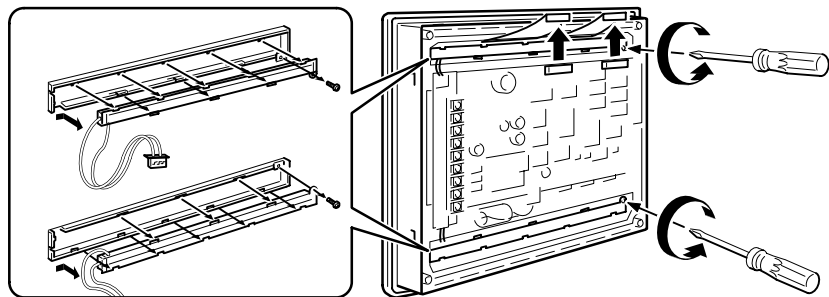

6 Fit new backlights.

The backlight for the top is different from that for the bottom.

Fit projections and dents of the backlight with those on the fixture, and shift the backlight to the left. Check that the backlight is in contact with the left end of the fixture and the cable comes out from the notch without being trapped.

When the backlight is correctly fit, tighten the screws at a torque of 0.1 N \cdot m

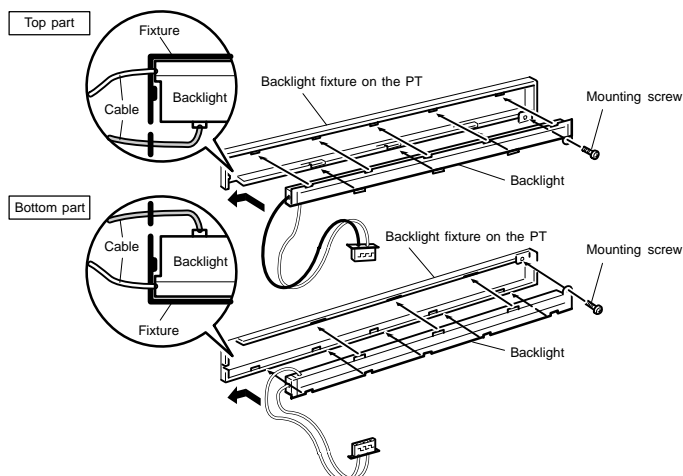

- 7 Engage backlight connectors at the top and the bottom respectively in place. The backlight cable has a polarity; refer to the figure below.

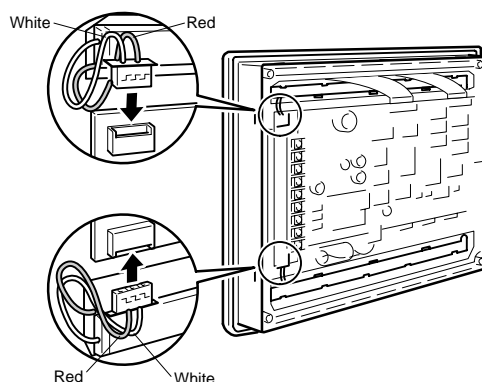

- 8 Fit two touch panel cables at the top. Be sure to lock the connectors as in step 4 after fitting.
- 9 Close the rear case, and tighten four screws. Make sure that the internal cable is not trapped.
- 10 Reconnect the wiring, cables, and units disconnected in 2, and tighten the screws at a torque of 0.4 N \cdot m. Turn the power on, and check that the RUN LED is not flashing and that no buzzer is sounding.
- If the RUN LED flashes at 1-sec intervals and a buzzer sounds intermittently, the touch panel cable is disconnected. Follow the above steps from 1, and check the lock status of the connector.
- 11 Before starting normal operation, confirm that the following tests can be executed correctly by using the I/O check in the Maintenance menu. Also perform a communication test with the host.
- Touch switch
 - Backlight
- 12 On confirming that all the tests in 11 can be executed normally, start operation.

11-3-1 Replacing the Battery

The NT631/NT631C uses a lithium battery to back up the memory contents.

The battery life is about 5 years if the NT631/NT631C is used in a location where the ambient temperature is 25°C. If the temperature at the location of use is higher than this, the battery life will be shorter. Change the battery at suitable intervals in accordance with the operating environment of the NT631/NT631C.

It is advisable to keep a spare battery so that the battery can be replaced immediately when replacement becomes necessary.

- Battery type

3G2A9-BAT08 (for both NT631 and NT631C)

- Guide to replacement

Replace the battery in the following cases. The battery must be replaced within 5 days.

- When 5 years have passed since the installation of a new battery.
- When the RUN LED is lit in orange (during operation) or in red (when stopped).
- When the message "The voltage is lowered." is displayed on switching on the power or resetting the NT631/NT631C.
- When "The voltage is lowered" is displayed in the "Battery" check in the battery check menu of the Maintenance mode.

- Battery replacement method

Replace the battery by following the procedure given below.

To protect the contents of the memory, the battery must be replaced within 5 minutes.

Procedure 1 Keep the power ON for at least 5 minutes and then turn it OFF.

Reference Unless the power is kept ON for at least 5 minutes, the memory contents cannot be retained for more than 5 minutes without a battery.

- 2 Insert a flat blade screwdriver at the top of the battery cover located at the left of the rear face of the NT631/NT631C and pull it toward you.

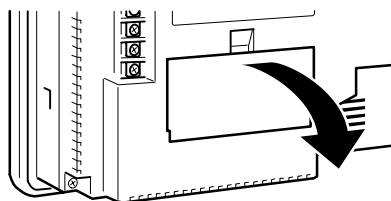

- 3 Remove the battery that is secured under the battery cover, grip the cable, and pull the connector straight out.

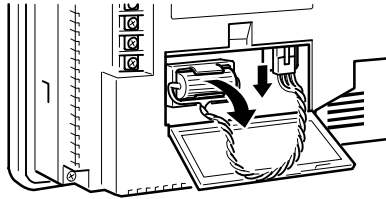

- 4 Insert the connector of the new battery into the connector on the NT631/NT631C and fit the battery under the battery cover.

When inserting the battery connector, make sure that the projection on it faces to the left, and press it fully home while keeping it straight.

The connector of the new battery must be connected within 5 minutes after disconnecting the old battery's connector. However, the battery can be replaced while the NT631/NT631C power is on, and in this case there is no time restriction.

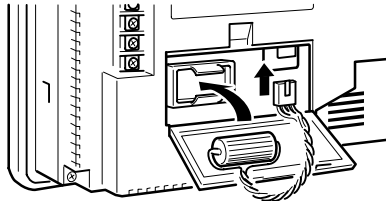

- 5 Close the battery cover, making sure that the cable is not trapped.

11-4 Inspection and Cleaning

Clean and inspect the NT631/NT631C regularly to ensure that it is always used in its optimum condition.

Cleaning Method

If the display is dirty the screen is difficult to see. Clean the screen from time to time as follows.

- In daily cleaning, wipe the display with a soft dry cloth. If the soiling is particularly heavy, attempting to remove it by wiping with a dry cloth may damage the front sheet of the unit. In this case, wipe with a damp cloth.
- If the soiling cannot be removed with a dry cloth, wet the cloth with diluted neutral detergent (2%), wring it out well and wipe the display with it.
- If rubber or vinyl products, tape, etc., are left stuck to the display for long periods they will cause staining. If such items are stuck to the display, remove them during cleaning.

Notice

Never use volatile solvents such as benzene or thinners, or chemical dusters.

Inspection Method

In normal environments, inspect the NT631/NT631C at intervals of between 6 months and a year. In environments that are extremely hot and humid, or very dusty environments, shorten the inspection interval.

- Items required for the inspection

Prepare the following items before starting the inspection.

- Screwdrivers (Philips, flat head)
- Tester (or digital voltmeter)
- Industrial alcohol
- 100% cotton cloth
- Hygrometer (required in some cases)
- Thermometer (required in some cases)
- Synchroscope (required in some cases)
- Pen-writing oscilloscope (required in some cases)

• Points inspected

Inspect the following points to determine if there is any divergence from the stated criteria. If there is, either improve the surrounding environment so that the values fall within the stated range, or adjust the NT631/NT631C, for example by re-tightening screws.

Point Inspected	Inspection Details	Criterion	Inspection Instrument
Power supply voltage	Fluctuation in power supply terminal voltage	Permissible voltage fluctuation range (24 VDC -15% to +10%)	Tester
Ambient environmental conditions	Ambient temperature (temperature in the operation panel)	0 to 50°C	Thermometer
	Ambient humidity (humidity in the operation panel)	35% to 85% RH	Hygrometer
	Presence/absence of dust	Dust must not be settled	Visual inspection
Mounting conditions	Looseness of mounting brackets, etc.	To be no looseness	Philips screwdriver
	Connector connections of connecting cable	To be fully inserted and locked, with no looseness	Philips screwdriver
	Looseness of screws in external wiring	To be no looseness	Philips screwdriver
	Conditions of external connecting cables	Faults such as incipient disconnection	Visual inspection
Components with limited lives	Brightness of the backlight (NT631C only)	Must be sufficiently bright. Backlight life: (Under the normal range of ambient temperature and humidity) NT631C-ST141□-EV1 : Approx. 25,000 hours or longer NT631C-ST151□-EV1 : Approx. 30,000 hours or longer (Brightness setting is not available for the NT631C-ST151□-V1.)	Visual inspection

Notice

- Do not disassemble for repairs or modification.
- The disposal of the unit (including batteries to be disposed and backlight) may be regulated by national or local authorities. Dispose of them in accordance with the laws and regulations of the relevant country and local authority.

Reference

Desire on replacing the NT631/NT631C
When replacing the NT631/NT631C after discovering a fault during inspections, note the following points:

- Be sure to switch the power OFF before starting replacement.
- After replacement, check that the new NT631/NT631C is not subject to the same error.
- If a faulty unit is returned for repairs, write as detailed a description of the fault as possible and send this description together with the unit to the OMRON address indicated on the back cover of this book.

APPENDICES

APPENDIX A	Specifications	628
	General Specifications	628
	Performance Specifications	629
	Communications Specifications	637
APPENDIX B	Dimensions	640
APPENDIX C	Using an RS-232C/RS-422A Convertor Unit	643
	Dimensions	643
	Methods for Mounting and Removal	643
	Specifications	645
	DIP Switch Settings	646
	Pin Arrangement	647
	Block Diagram	648
APPENDIX D	Transporting and Storing the NT631/NT631C	649
APPENDIX E	Making the Cable	650
	Cable Preparation	650
	Soldering	651
	Hood Assembly	652
APPENDIX F	Making the Cable for Connecting a PC	653
	Assembly of Connecting Cables	653
APPENDIX G	Making the Cable for Connection to a Bar Code Reader	654
APPENDIX H	Making the Cable for Connection to a Printer	655
APPENDIX I	Compatibility with Screen Data of Other PT Models	656
	Differences between the NT620S/NT620C/NT625C and the NT631/NT631C	657
	Differences between the NT631/NT631C without “V1” and the NT631/NT631C with “V1”	661
	Relationship between system program and hardware	663
APPENDIX J	Model List	664
	PT	664
	Host Link Unit	664
	CompoBus/S Master Control Unit	664
	Communication Unit	664
	CPUs (For Connection via a Host Link)	665
	CPUs (For Connection via an NT Link (1:1))	666
	CPUs (For Connection via an NT Link (1:N))	667
	RS-232C/RS-422A Convertor Unit	667
	RS-232C Adaptor, RS-422A Adaptor	667
	Related Parts and Equipment for PT	668
APPENDIX K	Option List	670
APPENDIX L	PC Memory Map	673
	OMRON C-Series PC, SRM1 Memory Map	673
	OMRON CVM1/CV-Series PC Memory Map	674
	OMRON CS1-Series PC Memory Map	674
APPENDIX M	Keycode Tables	675
	ISO 8859/1	675
	MS-DOS CP437	676

APPENDIX A

Specifications

General Specifications

Item	Specification			
	NT631-ST211□-EV1	NT631C-ST141□-EV1	NT631C-ST151□-EV1	
Rated power supply voltage	24 VDC			
Allowable power supply voltage range	20.4 VDC to 26.4 VDC (24 VDC -15% to +10%)			
Allowable power interruption time	No regulation			
Power consumption	30 W max.	18 W max.		
Power starting time	200 ms max.	-		
Operating ambient temperature	0 to +50°C	0 to +40°C	0 to +50°C	
Storage ambient temperature	-20 to +60°C			
Operating ambient humidity	35 to 85% RH (with no condensation)			
Operating environment	No corrosive gases			
Noise resistance	Common mode: 1000 Vp-p (between power supply terminals and panel) Normal mode: 300 Vp-p Pulse width of 100 ns to 1 μs, pulse rise time of 1 ns			
Vibration resistance (operating)	- 10 to 57 Hz with 0.075 mm amplitude for 30 minutes in each of X, Y, Z directions	- 10 to 57 Hz with 0.075 mm amplitude - 57 to 150 Hz with 1G {9.8 m/s ² } acceleration for 30 minutes in each of X, Y, Z directions		
Shock resistance (operating)	147 m/s ² {15G} 3 times in each of X, Y, and Z directions			
Dimensions	315 (W) × 250 (H) × 54 (D) mm (With expansion unit mounted: 315 (W) × 250 (H) × 74 (D) mm)			
Weight	2.5 kg max.			
Panel cutout dimensions	184 ^{+0.5} ₀ × 125 ^{+0.5} ₀ Circle of panel pressure 1.6 to 4.8 mm			
Enclosure ratings	Front panel: Equivalent to IP65F (NEMA4)*			
Grounding	Class 3 grounding			
Applicable EC directives or standards	EC directives ^d	EMC directive 89/336/EEC, 92/31/EEC		
		Low voltage directive 73/23/EEC		
	Standards	EMI	EN50081-2: 1993	
		EMS	EN61131-2: 1995	
	Electrical safety	EN61131-2: 1995		

* The NT631/NT631C may not be used at a location where it is exposed to splashing oil for a long period.

Performance Specifications

Display Specifications

Item		Specification		
		NT631-ST211□-EV1	NT631C-ST141□-EV1	NT631C-ST151□-EV1
Display panel	Display device	EL (monochrome)	Color STN LCD (with backlight)	Color TFT LCD (with backlight)
	Number of dots (resolution)	640 dots horizontally × 480 dots vertically		
	Effective display area	211 mm horizontally × 158 mm vertically (10.4 inches)	229 mm horizontally × 172 mm vertically (11.3 inches)	211 mm horizontally × 158 mm vertically (10.4 inches)
	View angle	(No restriction)	Up/down: □ 30° Left: 55° Right: 45°	Up: 40° Down: 55° Left: 55° Right: 55°
	Display color	Black, white (2 colors)	8 colors (and intermediate colors can be displayed with tiling patterns)	
	Life expectancy	30,000 hours minimum (until brightness reduced by 30%)	50,000 hours minimum (until brightness reduced by half)	
	Contrast adjustment	(Not provided)	Adjustable in 100 levels by operation at the touch panel	(Not provided)
Backlight (white cold cathode tube)	Life expectancy (at high brightness)	–	25,000 hours minimum*1	30,000 hours minimum*1
	Replacement	–	Can be replaced from the rear	
	Brightness adjustment	(Not provided)	Adjustable in 3 levels by at the touch panel	(Not provided)
	Automatic turn-off function	Can be set to turn off in 1 to 255 minutes, or to remain on		
Indicators	POWER (green LED)	Lit while power is being supplied		
	RUN	Lit in green : Running normally, Memory unit automatic transmission done Flash in green : Memory unit automatic transmission being executed, memory unit automatic transmission error Lit in orange : Low battery voltage (during operation) Flash in red : Low battery voltage (when NT631/NT631C is stopped)		

*1 Time taken for brightness to reduce to half at normal temperature and humidity

*2 Sharp brightness adjustment is not available.

Panel Specifications

Item	Specification
Touch panel	Type: Resistive type
	Number of switches: 768 (32 horizontally × 24 vertically) Maximum number that can be registered on one screen: 256
	Cell size: NT631-ST211□-EV1 5.9 × 5.9 mm NT631-ST141□-EV1 6.5 × 6.5 mm NT631-ST151□-EV1 5.9 × 5.9 mm
	Input: Pressure-sensitive type
	Operating force: 1 N minimum
	Life expectancy: One million operations minimum

External Interface Specifications

Item		Specification
Serial communication	Serial port A	Conforms to EIA RS-232C D-SUB 9-pin connector (female) +5 V (250 mA max.) output at pin No. 6
	Serial port B connector*	EIA RS-232C (Serial port B terminal block selectable by memory switch setting) D-SUB 9-pin connector (female)
	Serial port B terminal block*	EIA RS-422A/485 (Serial port B connector selectable by memory switch setting) Terminal block
Parallel interface		Conforms to Centronics standard, 20-pin half pitch connector
Expansion interface		Dedicated connector

* Serial port B is used for either a connector or terminal block.

Notice

Check that the current capacity of the equipment to be supplied is within 250 mA before using the +5 V output of pin No. 6.
The +5 V output of the unit delivers +5 V \pm 5% and 250 mA maximum.

Programming environment

Item	Specification
Programming System	Programming support software
Programming Tool	Programming support software NT-series Support Tool for Windows 95/98 (Ver. 3.0), made by OMRON Personal Computer Use a personal computer which can run Microsoft Window 95 or 98 RAM : At least 32 M bytes Fore Area in bord disk : At least 25 M bytes (To install sample colection, more 12 MB is required) Input device : Keyboard, mouse

Display Capacity

Item	Specification
Character displays (fixed display)	Fixed character data (character strings registered for each screen) Maximum combined total with other fixed display elements of 65535 per screen (maximum of 524280 for an overlapping screen)
Character string displays	Up to 256 per screen (1024 for an overlapping screen) (40 bytes per string)
Numeral displays	Up to 256 per screen (1024 for an overlapping screen), max. 10-digit display
Bar graph displays	Up to 50 per screen (400 for an overlapping screen*1), percentage display and sign display are possible
Mark displays (fixed display)	Up to 65535 per screen (52480 for an overlapping screen*1)
Analogue meter	Up to 50 per screen (400 for an overlapping screen *1), percentage display and sign display are possible.
Trend graphs	One frame per screen (max. of 8 frames on an overlapping screen) Without the data logging function: 50 graphs per screen data file With the data logging function: 8 graphs per screen data file
Broken line graphs	One frame per screen (max. of 8 frames on an overlapping screen), 256 graphs per frame, 320 points per graph
Graphic displays (fixed display)	Can be displayed wherever required Maximum combined total with other fixed display elements of 65535 per screen (maximum of 524280 for an overlapping screen)
Lamps	Up to 256 per screen (1024 for an overlapping screen)
Touch switches	Up to 256 per screen (same restriction applies to overlapping screens)
Image data	Combined total, with library data, of 256 per screen (1024 for an overlapping screen)
Library data	Combined total, with image data, of 256 per screen (same restriction applies to overlapping screens)
Numeral inputs	Combined total, with thumbwheel switches, of 256 per screen (Can only be registered on one child screen of an overlapping screen)
Character string inputs	Up to 256 per screen (Can only be registered on one child screen of an overlapping screen)
Alarm lists	Up to 4 groups per screen (32 groups for an overlapping screen)
Alarm histories	(For alarm histories, 1 group each in occurrence order and frequency order on normal screens/child screens)*2
Clock display	Time display of the built-in clock using the numeral display function
Normal screen	The normal screen display
Overlapping screens	A maximum of 8 registered screens can be displayed overlapped with each other.
Window screens	Up to 3 screens (2 local windows and 1 global window) can be displayed at the same time. All objects other than thumbwheel type numeric input can be registered.
Display history screens	Order of occurrence (max. 1024 screens), order of frequency (max. 255 times)
Screen attributes	Buzzer, display history, background color (NT631C only), backlight, keyboard screen number (local window 1/local window 2)

Item		Specification
	Max. number of registered screens	3999 screens
Nu	Screen No.	0: No display 1 to 3999: User registered screens 9000: "Initializing system" screen 9001: Display history (occurrence order) screen 9002: Display history (frequency order) screen 9020: Programming console function screen 9999: Return to the previous screen
Screen registration method		By transmitting screen data created using the Support Tool to the NT631/NT631C By transmitting screen data stored in a memory unit to the NT631/NT631C (automatic/manual)
Screen saving method (screen data memory)		Flash memory (screen data memory in the PT)

*1 Limits on numbers of elements on a window is same as on a standard screen.

Therefore, when 3 windows are displayed, the maximum number is increased by 3 screens.

*2 However, when displaying image/library, the limitation of image/library should be also followed.

Display Element Specifications

Item	Specification
Display characters	- Half-height characters (8 × 8 dots): Alphanumerics and symbols - Standard characters (8 × 16, 16 × 32 dots*1): Alphanumerics and symbols - Marks (16 × 16 dots): User-defined pictographs
Enlargement function	Wide, high, 2 × 2, 3 × 3, 4 × 4, 8 × 8
High-definition font	Characters of 2 × 2 or larger scale*1 (except half height characters and marks)
Character display attributes	Standard, flash, inverse flash, transparent
Image data	Variable-size pictographs Size: Min. 8 × 8 dots, max. 640 × 480 dots The size can be set as required in 8-dot units. Enlarged display, smoothing processing, and display attributes such as inverse and flash cannot be set.
Library data	Combinations of any graphics Size: Min. 1 × 1 dots, max. 640 × 480 dots Any size can be set within this range. Enlarged display, smoothing processing, and display attributes such as inverse and flash are implemented according to the setting registered. The maximum number of elements that can be registered for one library data is 64.
Graphics	Polyline, circle, arc, sector, rectangle, polygon
Line type	4 types only for polylines (solid line, broken line, alternate long and short dash, long and two short dashes)
Tiling	10 types
Graphic display attributes	Standard, inverse, flash, inverse flash
Display colors	NT631: 2 colors (black, white) NT631C: 8 colors (black, blue, red, magenta, green, cyan, yellow, white)
Color specification	Foreground color, background color, boundary color (line color)

*1 Usable only when "ISO8859-1" font type is selected at the Support Tool.

Display Restrictions

Apart from the restrictions on the maximum number that can be displayed, the following restrictions apply to individual elements.

- Restrictions on data reading

With NT631/NT631C, the maximum quantity of data that can be read simultaneously is fixed, and elements that exceed this data quantity limit are not displayed on the screen. Note that even if the same data is read from different elements, each instance is counted separately.

The table below shows the maximum data quantities for each type of read data.

Item	Maximum data quantity
Host bit	1024
Numeral memory tables	1024
Character string memory tables	1024
Bit memory tables	1024
Memory table indirect references	100
Background memory tables	128

The data quantity restrictions for each type of element read are indicated in the table below. Ensure that the totals for a displayed screen are within the range restrictions indicated above.

Element	Restriction on Read Data	
Fixed displays (text, graphics)	None	
Image data	None	
Library data	None	
Marks	None	
Touch switches	Zero to two host bit (number of host bits set with touch switch property)	
Lamps	One host bit	
Numeral inputs	One numeral memory table	
Character string inputs	One character string memory tables	
Thumbwheel switches	One numeral memory table	
Numerals displays	Direct specification	One numeral memory table
	Indirect specification	One numeral memory table One memory table indirect reference
Character string displays	Direct specification	One character string memory table
	Indirect specification	One character string memory table One memory table indirect reference
Bar graphs	One numeral memory table When numeral memory tables are designated for each of the “-100%”, “0%”, and “100%” settings for each graph line, one numeral memory table is read for each of these settings.	
Analogue meter	One numeral memory table When numeral memory tables are designated for each of the “-100%”, “0%”, and “100%” settings for each graph line, one numeral memory table is read for each of these settings.	
Broken line graphs	Number of numeral memory tables determined by “number of graph lines” × “number of vertices” When numeral memory tables are designated for each of the “-100%”, “0%”, and “100%” settings for each graph line, one numeral memory table is read for each of these settings.	

Element	Restriction on Read Data	
Trend graphs	Data logging function not used	Number of numeral memory tables determined by the number of graph lines When numeral memory tables are designated for each of the “-100%”, “0%”, and “100%” settings for each graph line, one numeral memory table is read for each of these settings.
	Data logging function used	Number of background memory tables determined by the number of graph lines When numeral memory tables are designated for each of the “-100%”, “0%”, and “100%” settings for each graph line, one numeral memory table is read for each of these settings.
Alarm lists	Number of bit memory tables referenced.	
Alarm history	None	

- Restrictions due to element coefficients

The NT631/NT631C uses “element coefficients” to manage display elements. The maximum number of display coefficients that can be used at the same time is 1024.

If the total of the element coefficients on a screen exceeds 1024, the elements after this total has been reached are not displayed.

The element coefficients for each element are indicated in the table below. Ensure that the total for the screen to be displayed is not greater than 1024.

Element	Element Coefficient
Fixed displays (text, graphics)	1, regardless of how many there are on the screen
Image data	
Library data	
Marks	
Touch switches	1
Lamps	1
Numeral inputs	1 (or 2 if there is a cursor moving key touch switch) + number of dedicated touch switches
Character string inputs	1 (or 2 if there is a cursor moving key touch switch) + number of dedicated touch switches
Thumbwheel switches	1 + number of displayed digits × 2
Numeral displays	1
Character string displays	1
Bar graphs	1
Analogue meter	1
Broken line graphs	1
Trend graphs	1 + number of dedicated touch switches
Alarm lists	1 + number of display lines + number of dedicated touch switches If image/library data is displayed, the total is increased by another 64.
Alarm histories	1 + number of display lines + number of dedicated touch switches If image/library data is displayed, the total is increased by another 64.

Special Features

Item	Specifications
Buzzer	<p>Three kinds of buzzer sound (continuous, short intermittent, and long intermittent)</p> <p>ON: On reception of a command from the host, display of a screen with a buzzer setting, or display of an error screen such as for a receive error.</p> <p>OFF: On reception of a command from the host, or display of a screen with no buzzer setting.</p> <p>Setting: Set "ON" for "Buzzer Sound" in the memory switch menu, or set "ERROR ON" for the buzzer to sound only when an error occurs.</p> <p>The buzzer sounds three times in response to prohibited input.</p>
Touch switch input sound	<p>Touch switches</p> <p>Input sound: Sounding for 0.2 seconds</p> <p>Setting: Set "ON" for "Key Press Sound" in the memory switch menu.</p>
Maintenance function	<ul style="list-style-type: none"> - Memory switch setting - Self-test functions, such as for the memory and external interface - Setting condition confirmation function - Communication check function - Initialization of internal memory data - Display of display/alarm history data - Registered data test display function
Battery backup	<ul style="list-style-type: none"> - Backup of numeral/character string memory table data in the NT631/NT631C - Backup of display/alarm history data - Backup of calendar and clock setting <p>Battery life: 5 years (at 25°C)</p> <p>When voltage becomes low: RUN LED lights in orange or red The communication flag to the PC (BAT LOW) comes ON (1).</p>
Resume function	<p>Retains the contents of the numeral/character string memory tables (i.e., they are not initialized) when the power is turned ON, when the NT631/NT631C is reset, and when the operation mode is changed.</p> <p>Setting: Set "ON" for "Resume Function" in the memory switch menu.</p>
Screen print function	<p>Functions: - Prints a hard copy of the screen display - Prints display/alarm histories</p> <p>Setting: Set the printing protocol ("Print Controller") and printing type ("Print Method") in the memory switch menu.</p> <p>"ESC/P", "Color": Color printing conforming to ESC/P 24-J83C</p> <p>"PC-PR201H", "Color": Color printing conforming to PC-PR201PL</p> <p>"ESC/P", "Tone": Monochrome printing in 8 grayscale levels, conforming to ESC/P 24-J82</p> <p>"PC-PR201H", "Tone": Monochrome printing in 8 grayscale levels, conforming to PC-PR201PL</p> <p>"PCL 5", "Tone": Monochrome printing in 8 grayscale levels, conforming to PCL 5</p> <p>However, the NT631 supports monochrome printing only.</p>
Calendar and clock function	<ul style="list-style-type: none"> - Displays the current time in accordance with the built-in clock - Displayed and set with "Calendar Check" in the "MAINTENANCE MODE" menu
Programming console function	<p>Executes functions equivalent to those of a programming console (model C200H-PRO27-E) with C series CPM1, CPM1A, CQM1 (-EV1 only), C200HX/HG/HE(-ZE), and SRM1 (C02-V1 only).</p> <p>Executes functions as a programming console for CS1 series PLC.</p>

Item		Specifications
Transmission functions	System program transmission	Downloads the system program from the system installer Downloads/Upload the system program with a memory unit.
	Screen data transmission	- Function for downloading screen data to and uploading screen data fromn the Support Tool - Function for transmitting screen data to and from the memory unit.
	History data uploading	Function for uploading display/alarm history data from PT.

Communications Specifications

- For a Host Link (RS-232C Type)

Item	Specification
Communications standard	EIA RS-232C
Communications settings	Start-stop synchronization Communications speed: 9600, 19200 bps Data length: 7 bits Stop bit: 2 bits Parity: Even
Connector	9-pin D-SUB connector (female) (serial port A, B)
Number of units connected	1:1
Transmission distance	Max. 15 m*
Communications protocol	C-series SYSWAY (1:N)

* When using an NT-AL001, the specifications are as follows.

- RS-232C cable: Max. 2 m
- RS-422A cable: Total length 500 m max.

- For a Host Link (RS-422A Type)

Item	Specification
Communications standard	EIA RS-422A
Communications settings	Start-stop synchronization Communications speed: 9600, 19200 bps Data length: 7 bits Stop bit: 2 bits Parity: Even
Connector	Terminal Block (serial port B)
Number of units connected	1:1
Transmission distance	Max. 500 m
Communications protocol	C-series SYSWAY (1:N)

- For an NT Link (1:1, RS-232C Type)

Item	Specification
Communications standard	EIA RS-232C
Connector	9-pin D-SUB connector (female) (serial port A, B)
Number of units connected	1:1
Transmission distance	Max. 15 m*

* When using an NT-AL001, the specifications are as follows.

- RS-232C cable: Max. 2 m
- RS-422A cable: Total length 500 m max.

- For an NT Link (1:1, RS-422A Type)

Item	Specification
Communications standard	EIA RS-422A
Connector	Terminal block (serial port B)
Number of units connected	1:1
Transmission distance	Max. 500 m

- For an NT Link (1:N, RS-232C Type)

Item	Specification
Communications standard	EIA RS-232C
Connector	9-pin D-SUB connector (female) (serial port A, B)
Number of units connected	1:1 to 8
Transmission distance	Max. 15 m*

* To connect two or more PTs, NT-AL001 units are required. When using an NT-AL001, the specifications are as follows.

- RS-232C cable: Max. 2 m
- RS-422A/485 cable: Total length 500 m max.

- For an NT Link (1:N, RS-422A/485 Type)

Item	Specification
Communications standard	EIA RS-422A/485
Connector	Terminal block
Number of units connected	1:1 to 8
Transmission distance	Max. 500 m

- For a Memory Link (RS-232C Type)

Item	Specification
Communications standard	EIA RS-232C
Communications settings	Start-stop synchronization Communications speed: 1200, 2400, 4800, 9600, 19200, 38400bps Data length: 7, 8 bits Stop bit: 1, 2 bits Parity: None, even, odd Flow control: None, RS/CS, XON/XOFF Response: Presence/absence
Connector	9-pin D-SUB connector (female) (serial port A, B)
Number of units connected	1:1
Transmission distance	Max. 15 m*
Communications protocol	Memory link

* When using NT-AL001, specification is as follows:

- RS-232C: Max. 2 m
- RS-422A: Max. total length 500 m

- For a Memory Link (RS-422A Type)

Item	Specification
Communications standard	EIA RS-422A
Communications settings	Start-stop synchronization Communications speed: 1200, 2400, 4800, 9600, 19200, 38400bps Data length: 7, 8 bits Stop bit: 1, 2 bits Parity: None, even, odd Flow control: None, XON/XOFF Response: Presence/absence
Connector	Terminal block
Number of units connected	1:1
Transmission distance	Max. 500 m*
Communications protocol	Memory link

- For a Bar Code Reader

Item	Specification
Communications standard	EIA RS-232C
Communications settings	Start-stop synchronization Communications speed: 4,800, 9600, 19200 bps Data length: 7, 8 bits Stop bit: 1, 2 bits Parity: None, even, odd Flow control: RS/CS
Connector	9-pin D-SUB connector (female) (serial port A)
Number of units connected	1:1
Transmission distance	Max. 15 m
Communications protocol	Non-protocol mode
Data format	[STX] Data (0 to 40 bytes) [ETX]

APPENDIX B

Dimensions

Body

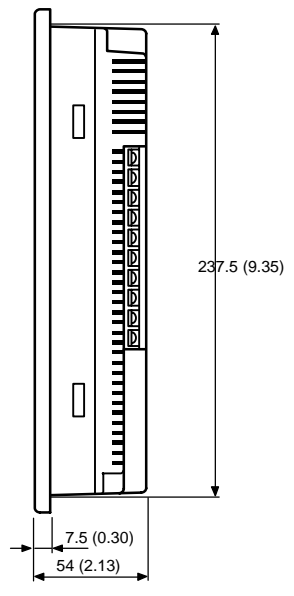
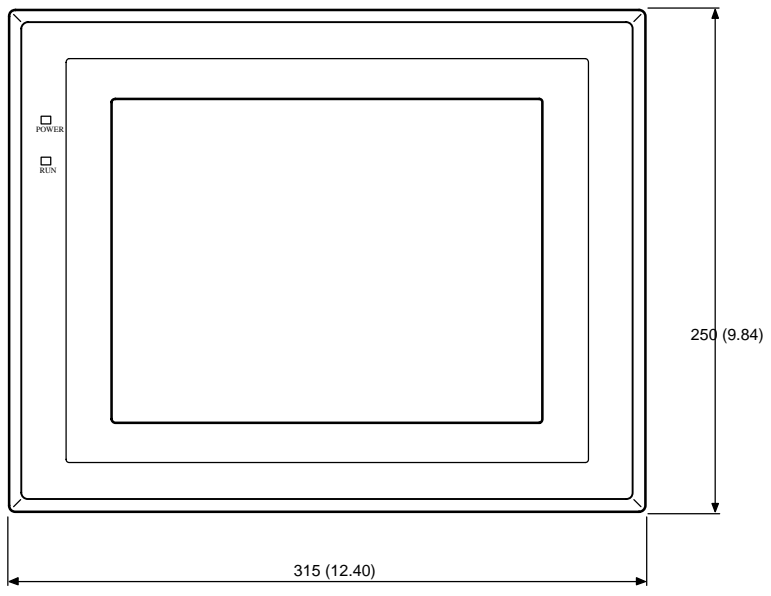
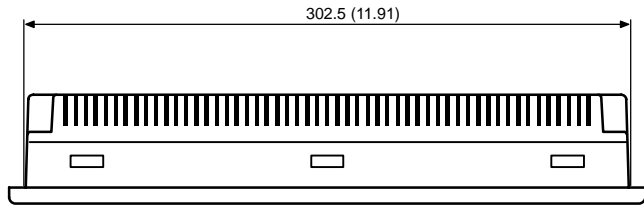

Units: mm (inch)

With memory unit installed
(NT-MF261)

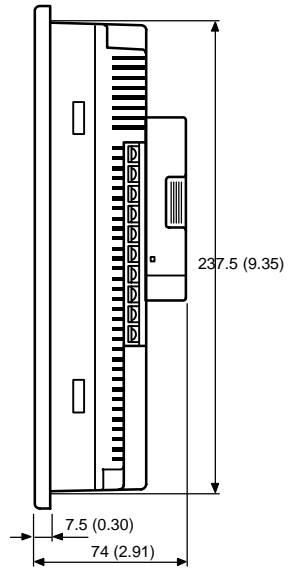

Mounting Dimensions

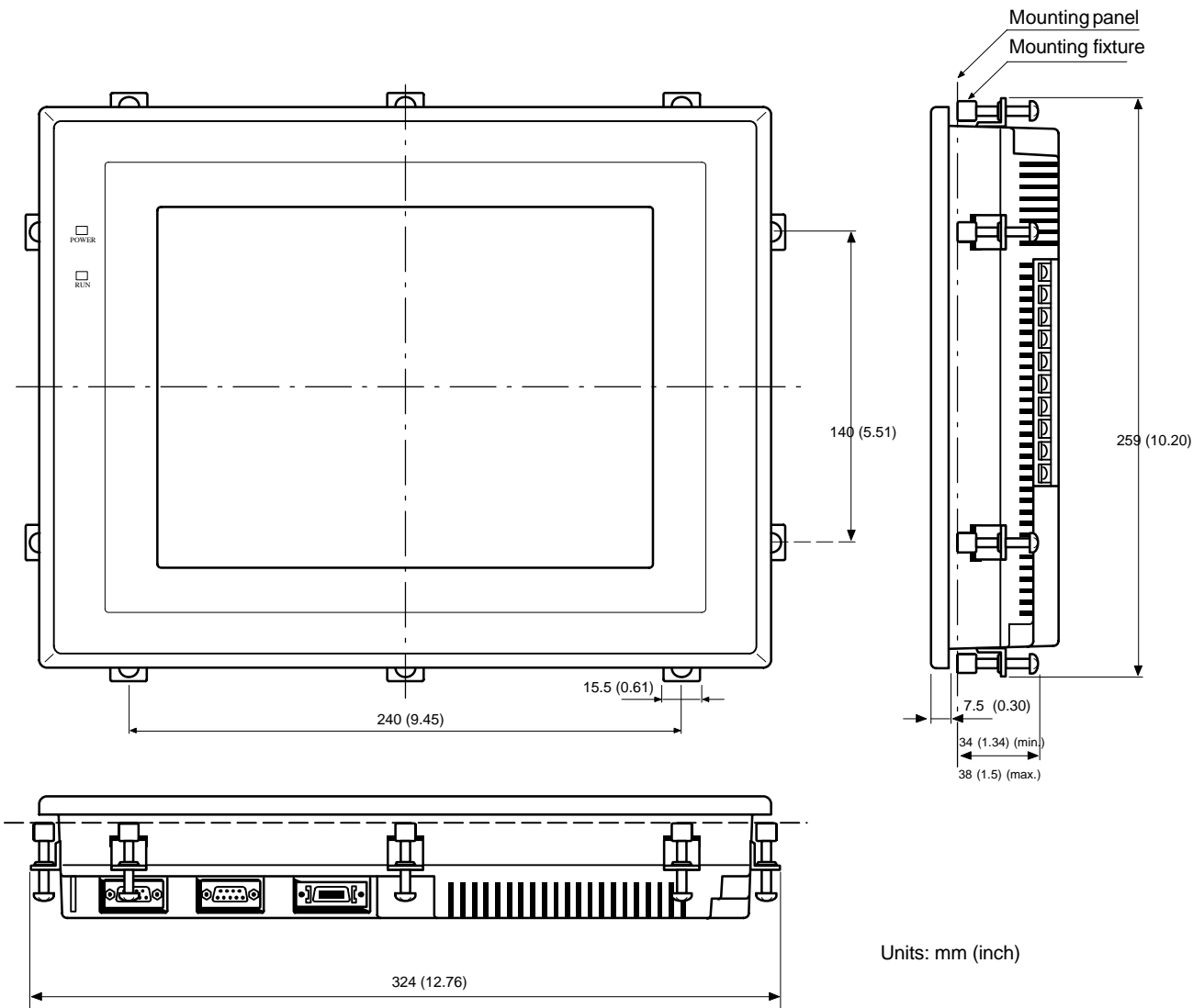

Cable Connection Dimensions (with NT-MF261)

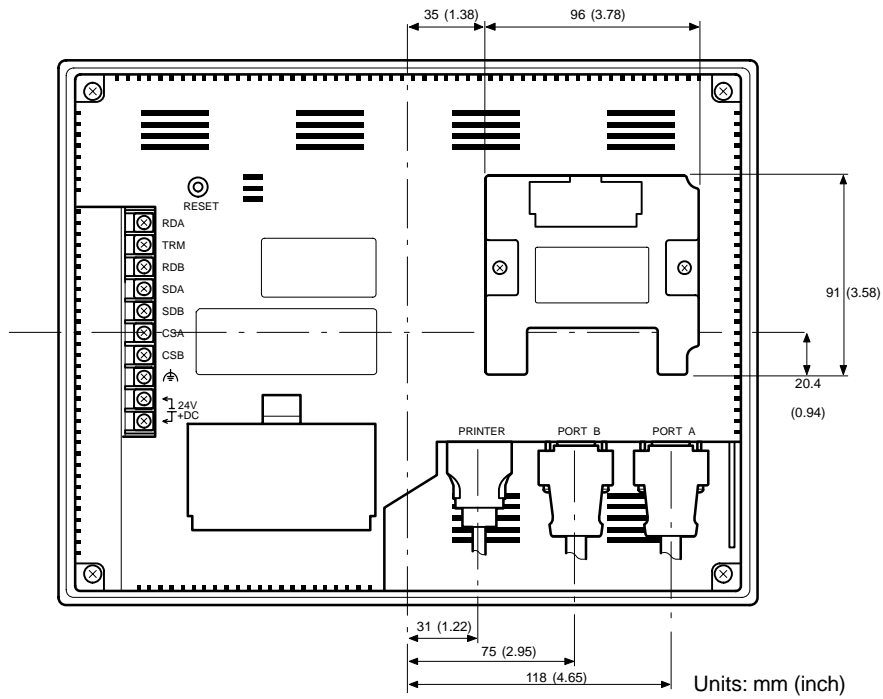

APPENDIX C

Using an RS-232C/RS-422A Convertor Unit

This section outlines the external dimensions, procedure for mounting and removal, and specifications of an RS-232C/RS-422A convertor unit (NT-AL001). Refer to this information when designing the control panel. For details, refer to the instruction manual supplied with the NT-AL001.

Dimensions

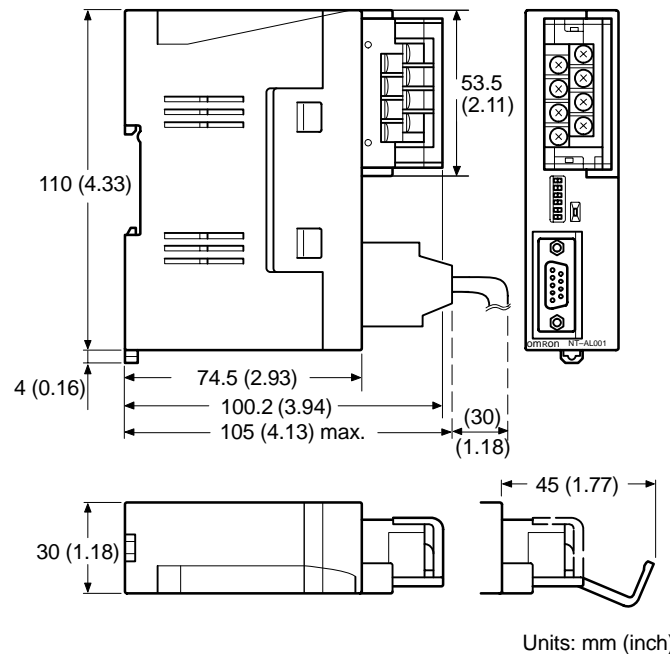

30 (W) × 114 (H) × 100.2 (D) mm: with the RS-422A terminal block cover closed

30 (W) × 114 (H) × 119.5 (D) mm: with the RS-422A terminal block cover open

Methods for Mounting and Removal

The RS-232/RS-422 convertor unit (NT-AL001) can be mounted on a DIN rail or in an operation panel.

The RS-422A terminal block of the convertor unit can be easily removed.

Mounting to a DIN Rail

Latch the top part of the rear face of the converter unit (“a” in the figure) onto the top edge of the DIN rail, and push the unit in the direction indicated by “b” in the figure.

Now fit end plates at the right and left of the converter unit to secure it and ensure that it cannot shift laterally.

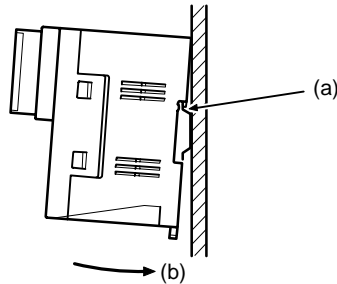

Removal from a DIN Rail

Remove the end plates at right and left of the converter unit and, as shown in the figure below, insert a flat blade screwdriver into the rail stopper at the bottom face of the converter unit and prize it free.

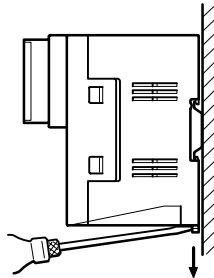

Mounting to an Operation Panel

Drill two mounting screw holes in an operation panel with a thickness of at least 2 mm (0.08 inch) and secure the converter unit with screws.

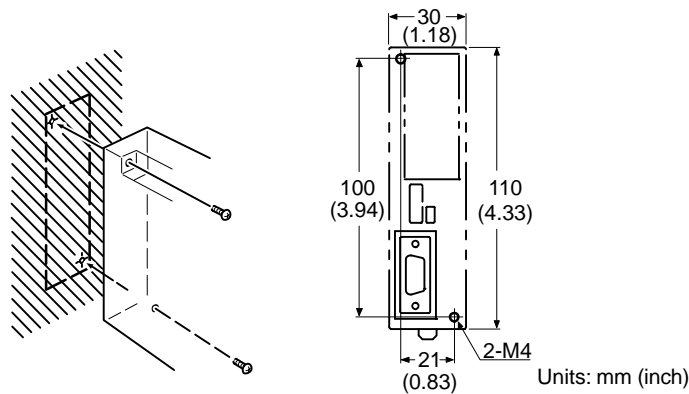

Notice

In order to ensure a secure and strong mount, mount the converter unit in an operation panel with a thickness of at least 2 mm (0.08 inch).

Specifications

The general specifications and communications specifications of the converter unit are shown below.

General Specifications

Item	Specification
Dimensions	30 (W) × 114 (H) × 100.2 (D) mm: with the RS-422A terminal block cover closed 30 (W) × 114 (H) × 119.5 (D) mm: with the RS-422A terminal block cover open
Weight	200 g max.
Operating ambient temperature	0 to 55°C
Operating ambient humidity	10 to 90% RH (with no condensation)
Rated power supply voltage	+5 V □ 10% (using pin No. 6 of the RS-232C connector)
Rated power supply current	150 mA max.
Rush current	0.8 A max.
Insulation resistance	20 MΩ or higher, measured between all RS-422A terminal signal lines collectively and functional ground terminal with a 500 VDC megger
Dielectric strength	1500 VAC for 1 minute between all RS-422A terminal signal lines collectively and functional ground terminal Leakage current: 10 mA max.
Operating environment	No corrosive gases
Storage ambient temperature	-20 to +75°C
Vibration resistance	Conforms to JIS C0911 60 minutes in each of X, Y, and Z directions
Shock resistance	Conforms to JIS C0912 47m/s ² , 3 times in each of X, Y, and Z directions

Communications Specifications

- RS-232C Interface

Item	Specification
Communications speed	Max. 64k bps
Transmission distance	Max. 2 m
Connector	9-pin D-SUB connector (female)

- RS-422A/485 Interface

Item	Specification
Communications speed	Max. 64k bps (depends on the RS-232C communications speed)
Transmission distance	Max. 500 m
Connector	8-terminal detachable terminal block, M3.0

DIP Switch Settings

The convertor unit has 6 digits DIP switch for setting the RS-422A/485 communication conditions. Before connecting the cable to the convertor unit, make the DIP switch settings.

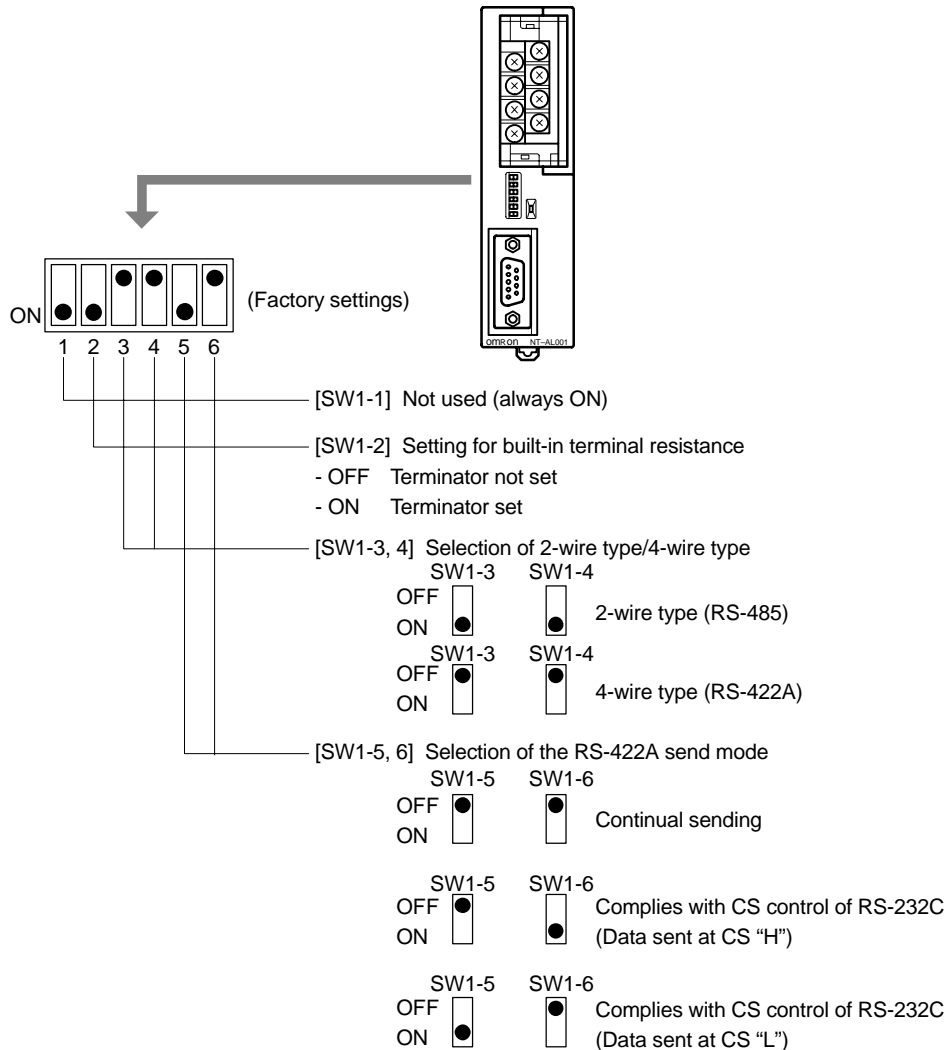

When using the host link or NT link (1:1), set the RS-422A send mode to "continual sending" (set both SW1-5 and 6 "OFF").

When using the NT link (1:N), set the RS-422A send mode to "complies with CS control of RS-232C" (i.e., one of SW1-5 and SW1-6 must be ON).

Notice

- Do not set both SW1-5 and SW1-6 ON at the same time. This may damage internal circuits.
- The power supply to the device supplying +5 V must be turned OFF before starting wiring work.
- Before connecting the RS-232C cable and turning on the power to an RS-232C device such as a PT (i.e., turning on the power to the converter unit), check that the cable is wired correctly and that the DIP switch settings are correct. If the power is turned on while there is a wiring fault, the internal circuits of the converter unit or the RS-232C device may be damaged.
- When the converter unit is connected to a C200HX/HG/HE (-ZE) model of OMRON PC as an RS-422A device, set DIP switches SW1-5 and SW1-6 as indicated below.

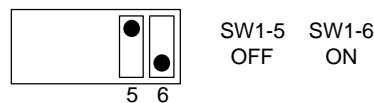
**Pin Arrangement**

The converter unit has a terminal block for an RS-422A/485 interface connection and a connector for an RS-232C interface connection.

The pin arrangements for the RS-422A/485 terminal block and the RS-232C connector are as follows.

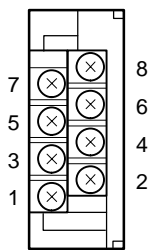
RS-422A/485 Terminal Block

Terminal block pin No.	Signal name	Abbreviation	Signal direction (converter unit ↔ RS-422 device)
8	Request to send (-)	CSA	→
7	Request to send (+)	CSB	→
6	Receive data (-)	RDA	←
5	Receive data (+)	RDB	←
4	Send data (-)	SDA	→
3	Send data (+)	SDB	→
2	Signal ground	SG (GND)	-
1	Functional ground		-

* The CSB and CSA signals are for specialized applications.

RS-232C Connector

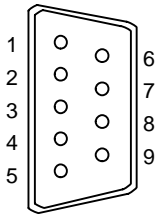

Connector pin No.	Signal name	Abbreviation	Signal direction (convertor unit ↔ RS-232C device)
1	Not used	–	–
2	Send data	SD	←
3	Receive data	RD	→
4	Request to send (shorted to CS internally)	RS	←
5	Clear to send (shorted to RS internally)	CS	→
6	+5 V (150 mA) input for convertor unit	+5 V	→
7	Data set ready (shorted to ER internally)	DR	→
8	Data terminal ready (shorted to DR internally)	ER	←
9	Signal ground	SG	–

* The hood is connected to the functional ground terminal of the RS-422A terminal block.

Block Diagram

A diagram showing the internal blocks of the convertor unit is shown below. Refer to this diagram when making cables yourself, or when connecting devices with special interfaces.

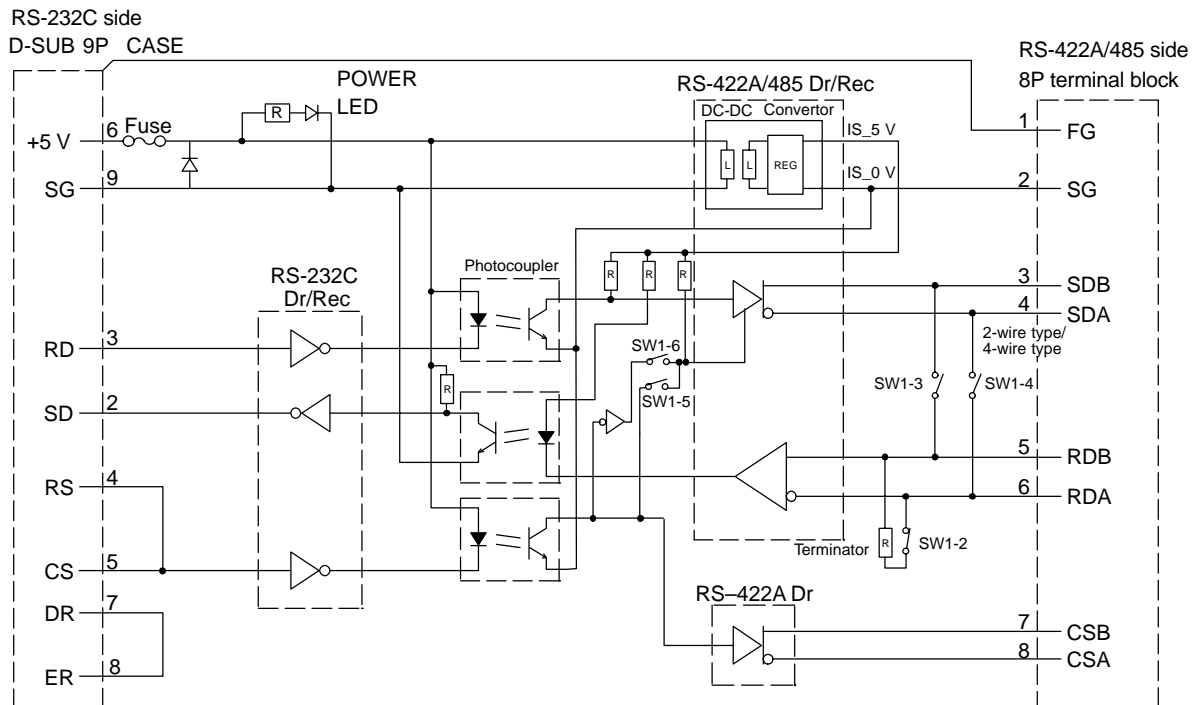

APPENDIX D

Transporting and Storing the NT631/NT631C

- When transporting the NT631/NT631C, use the packaging intended for it.
- When storing the NT631/NT631C, observe the following conditions.

Storage ambient temperature: -20 to +60°C

Storage ambient humidity: 35 to 85% RH

APPENDIX E

Making the Cable

The procedure for making up the cable is described below.

Also refer to this procedure for making a connecting cable for use with RS-422A/485 type connections.

Cable Preparation

The preparation of the cable differs according to whether or not the shielding wire is to be connected to the FG.

- Cable with shielding wire connected to FG

- (1) Cut the cable to the required length.
- (2) Remove the external vinyl insulation from the cable with a razor blade. Take care not to damage the shielding underneath.
- (3) Cut back the shielding wire with scissors.
- (4) Use wire strippers to strip the insulation from each wire.
- (5) Fold back the shielding wire.
- (6) Wrap aluminum foil tape around the folded-back shielding wire.

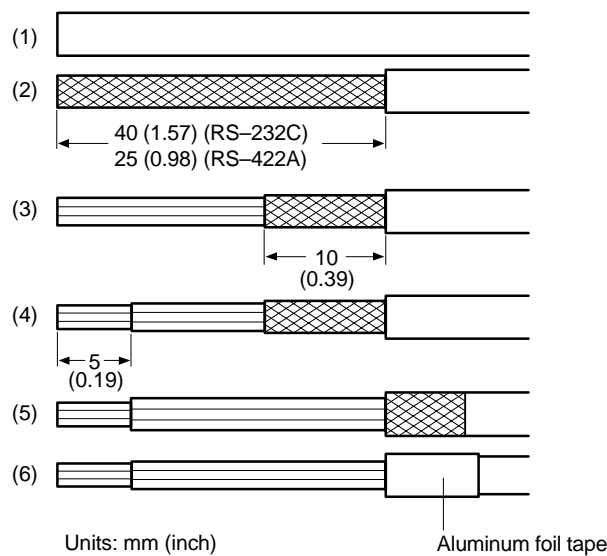

• Cable with shielding wire not connected to FG

- (1) Cut the cable to the required length.
- (2) Remove the external vinyl insulation from the cable with a razor blade. Take care not to damage the shielding underneath.
- (3) Cut back the shielding wire with scissors.
- (4) Use wire strippers to strip the insulation from each wire.
- (5) Wrap vinyl tape over the cut off end of the shielding wire.

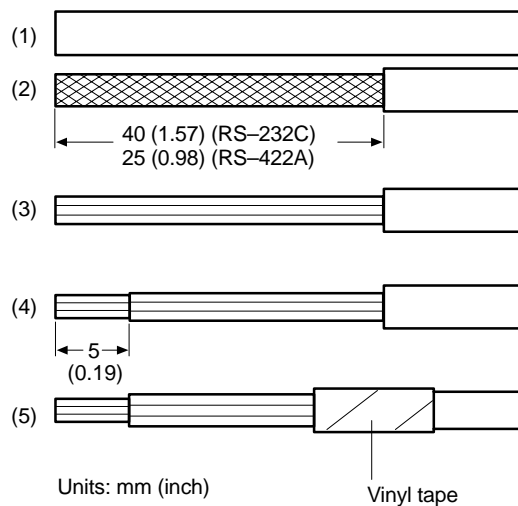

Soldering

- (1) Slide heat-shrink tube over each wire.
- (2) Pre-solder each wire and connector terminal.
- (3) Solder each wire to each connector terminal.

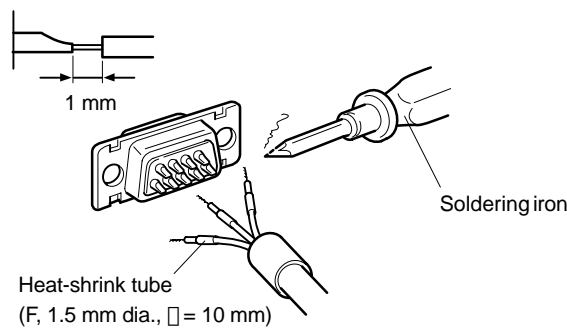

- (4) Push the heat shrink tube over the soldered joint and heat the tube to shrink it in place.

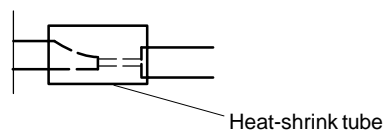

Hood Assembly

Assemble the connector hood as shown below.

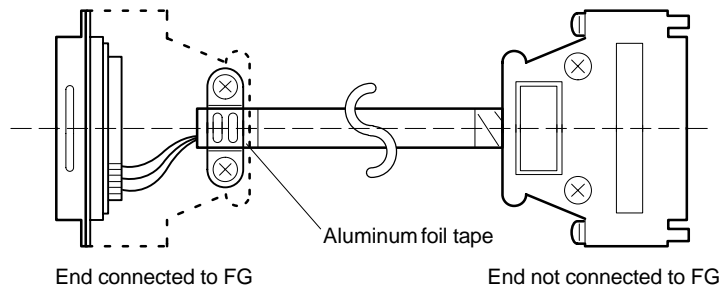

APPENDIX F

Making the Cable for Connecting a PC

Refer to the following when making a cable for connecting the Support Tool.

Assembly of Connecting Cables

Wiring should be carried out in one of the following ways, depending on the type of RS-232C connector.

- 25-pin connector

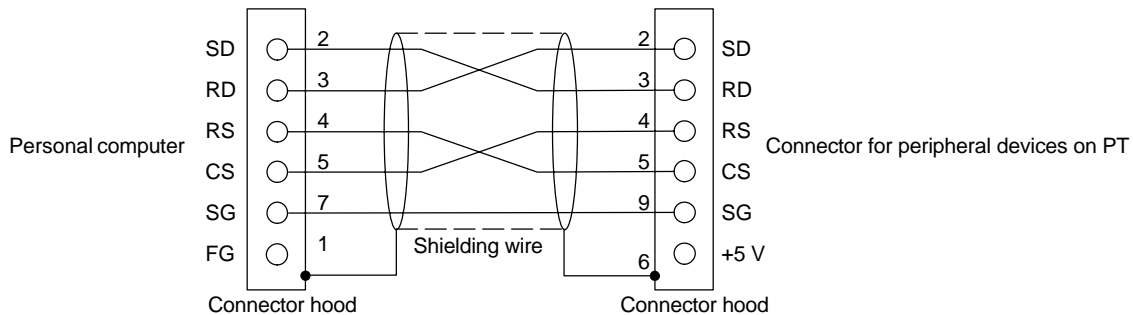

Use the following recommended products when making the connecting cable.

Name	Model	Remarks
Connector	XM2D-2501	25-pin, made by OMRON, for personal computer side
	XM2A-0901	9-pin, made by OMRON, for PT side
Connector hood	XM2S-2511	25-pin, made by OMRON, for personal computer side
	XM2S-0911	9-pin, made by OMRON, for PT side
Cable	AWG28 × 5P IFVV-SB	Multi-core shielded cable, made by Fujikura Ltd.
	CA-MA-VV-SB 5P × 28AWG	Multi-core shielded cable, made by Hitachi Cable, Ltd.

- 9-pin Connector

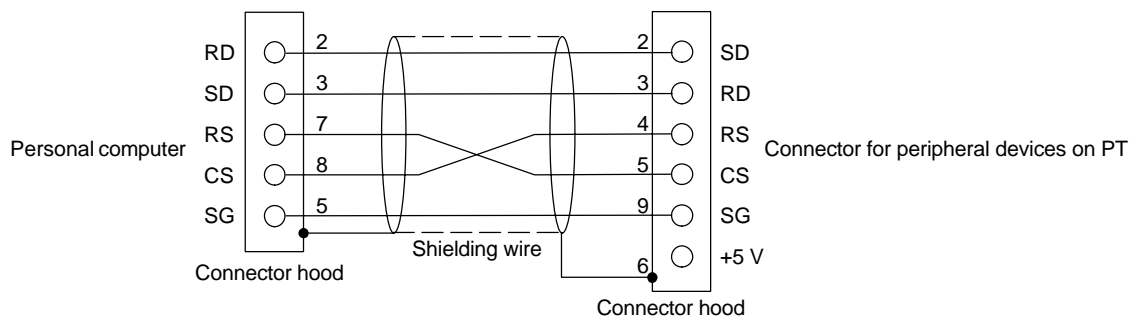

Use the following recommended products when making the connecting cable.

Name	Model	Remarks
Connector	XM2D-0901	9-pin, made by OMRON, for personal computer
	XM2A-0901	9-pin, made by OMRON, for PT
Connector hood*	XM2S-0911	9-pin, mm pitch screw, made by OMRON
	XM2S-0913	9-pin, inch pitch screw, made by OMRON
Cable	AWG28 × 5P IFVV-SB	Multi-core shielded cable, made by Fujikura Ltd.
	CA-MA-VV-SB 5P × 28AWG	Multi-core shielded cable, made by Hitachi Cable, Ltd.

* One XM2S-0911 (for PT) and either one XM2S-0911 or -0913 (for your personal computer) are needed.

APPENDIX G

Making the Cable for Connection to a Bar Code Reader

Refer to the following when making the cable for connection to a bar code reader.

- Wiring method

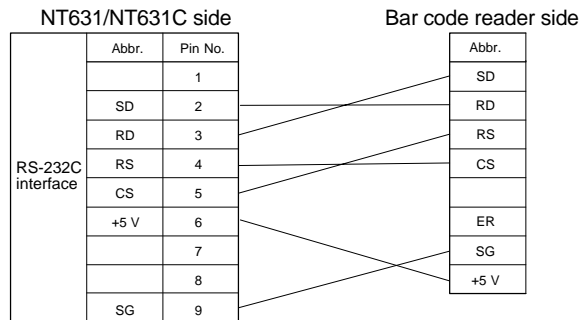

When using the +5 V output of serial port A of the NT631/NT631C, limit the cable length to within 2 m. If a cable longer than 2 m is used, connect an external power supply to the bar code reader.

- Connector and related parts

Use the parts which are specified by bar code reader and following recommended products when making the connecting cable.

Name	Model	Remarks
Connector	XM2A-0901	9-pin type, made by OMRON, PT side
Connector hood	XM2S-0911	9-pin, made by OMRON
Cable	AWG28 × 5P IFVV-SB	Multi-core shielded cable, made by Fujikura Ltd.
	CA-MA-VV-SB 5P × 28AWG	Multi-core shielded cable, made by Hitachi Cable, Ltd.

APPENDIX H

Making the Cable for Connection to a Printer

The following product is recommended as the cable for connecting a printer.

NT-CNT121 (made by OMRON, cable length 1.5 m, 20-pin – 36-pin)

Refer to the following when making a cable for connection to a printer.

- Connector pin arrangement and wiring

Connector for a printer
on PT side

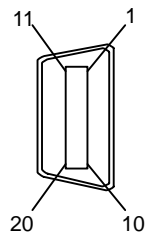

Abbr.	Pin No.	Shielding wire	Pin No.
	Connector hood		Connector hood
0V	1		20
D7	11		9
N.C.	2		N.C.
D6	12		8
D5	3		7
0V	13		21
D4	4		6
N.C.	14		N.C.
D3	5		5
0V	15		22
0V	6		23
D2	16		4
N.C.	7		N.C.
D1	17		3
D0	8		2
0V	18		24
STROB	9		1
N.C.	19		N.C.
BUSY	10		11
0V	20		19

Printer side

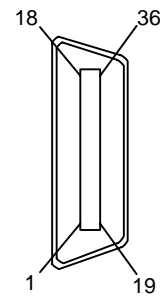

APPENDIX I



Compatibility with Screen Data of Other PT Models

The screen data of the NT631/NT631C does not have complete upward compatibility with the screen data for earlier PT models. Consequently, when the data for an earlier PT model is converted for an NT631/NT631C use, partial modification may be necessary.

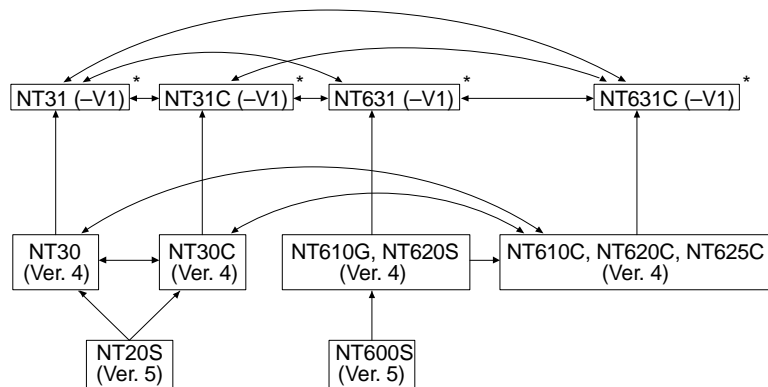
The combinations for which data conversion is possible are shown below. Note that “Ver. □” indicates the direct connection version. The NT-series Support Tool Ver. 2.0 for Windows95 is compatible with the latest version of each PT model.



* Data conversion is not possible from the new models with “-V1” to the new models without “-V1”.

However, data for models with no “-V□” suffix of NT20S-ST121 and NT600S-ST121/211, cannot be read with the Support Tool (NT-ZJ3M  

After data conversion, the following discrepancies may occur; in this case modify the data.

- When the data of NT20S, NT600S, NT610G, or NT620S is converted, the position and size of touch switches may change due to the difference in the dot size of touch switches.
- Since the size and contents of the PT status control area and PT status notify area differ between the new models (NT31, NT31C, NT631, NT631C) and earlier models, the program at the host (PC) must be modified.

Differences between the NT620S/NT620C/NT625C and the NT631/NT631C

The differences on screen creation and programming between the NT620S/NT620C/NT625C and the NT631/NT631C are indicated below. Here, the explanation is subjected to the NT631/NT631C with "V1". For details of the differences between the NT631/NT631C without "V1" and the NT631/NT631C with "V1", refer to "Differences between the NT631/NT631C without "V1" and the NT631/NT631C with "V1" (page 663). For details of the difference in function, refer to 1-2 "Functions of the NT631/NT631C" (page 4).

Item	NT620S/NT620C/NT625C	NT631/NT631C																																																																																																																																										
Foreground/background relationships in screen drawing	<table border="1"> <thead> <tr> <th>Display</th> <th>Element Type</th> </tr> </thead> <tbody> <tr> <td>Foreground ↑ ↓ Background</td> <td> Contents of display elements that have data System keypad Frames of broken line graphs Frames of trend graphs Input settings (numeral, character string, thumbwheel, temporary) Frames of bar graphs Fixed displays Lamps (normal lamp frames) Alarm list/history frames Touch switches Image/library data Screen background </td> </tr> </tbody> </table>	Display	Element Type	Foreground ↑ ↓ Background	Contents of display elements that have data System keypad Frames of broken line graphs Frames of trend graphs Input settings (numeral, character string, thumbwheel, temporary) Frames of bar graphs Fixed displays Lamps (normal lamp frames) Alarm list/history frames Touch switches Image/library data Screen background	<table border="1"> <thead> <tr> <th>Display</th> <th>Element Type</th> </tr> </thead> <tbody> <tr> <td>Foreground ↑ ↓ Background</td> <td> Image/library lamps Alarm list/history frames Temporary input Character string input Thumbwheel type input Numeral input Trend graphs Broken line graphs Analogue meter Frames of bar graphs Numeral displays Character string displays Fixed displays Lamp displays Touch switches Image/library Screen background </td> </tr> </tbody> </table>	Display	Element Type	Foreground ↑ ↓ Background	Image/library lamps Alarm list/history frames Temporary input Character string input Thumbwheel type input Numeral input Trend graphs Broken line graphs Analogue meter Frames of bar graphs Numeral displays Character string displays Fixed displays Lamp displays Touch switches Image/library Screen background																																																																																																																																		
Display	Element Type																																																																																																																																											
Foreground ↑ ↓ Background	Contents of display elements that have data System keypad Frames of broken line graphs Frames of trend graphs Input settings (numeral, character string, thumbwheel, temporary) Frames of bar graphs Fixed displays Lamps (normal lamp frames) Alarm list/history frames Touch switches Image/library data Screen background																																																																																																																																											
Display	Element Type																																																																																																																																											
Foreground ↑ ↓ Background	Image/library lamps Alarm list/history frames Temporary input Character string input Thumbwheel type input Numeral input Trend graphs Broken line graphs Analogue meter Frames of bar graphs Numeral displays Character string displays Fixed displays Lamp displays Touch switches Image/library Screen background																																																																																																																																											
PT status control area	<table border="1"> <thead> <tr> <th>Word</th> <th>Bit</th> </tr> </thead> <tbody> <tr> <td>Word n</td> <td>Screen number (4 BCD digits)</td> </tr> <tr> <td>Word n+1</td> <td>0 Copy source memory table number (3 BCD digits)</td> </tr> <tr> <td>Word n+2</td> <td>Copy type Copy destination memory table number (3 BCD digits)</td> </tr> <tr> <td>Word n+3</td> <td>PT status control bits 0 0</td> </tr> </tbody> </table> <p>PT status control bits</p> <table border="1"> <thead> <tr> <th>Word</th> <th>Controlled Item</th> <th>1 (ON)</th> <th>0 (OFF)</th> </tr> </thead> <tbody> <tr><td>15</td><td>Screen display</td><td>Performed</td><td>Not performed</td></tr> <tr><td>14</td><td>Processing priority registration</td><td>Registered</td><td>Canceled</td></tr> <tr><td>13</td><td>Continuous buzzer</td><td>Sounded</td><td>Stopped</td></tr> <tr><td>12</td><td>Intermittent buzzer (short)</td><td>Sounded</td><td>Stopped</td></tr> <tr><td>11</td><td>Display history initialization</td><td>Performed</td><td>Not performed</td></tr> <tr><td>10</td><td>Not used</td><td colspan="2">Always "0"</td></tr> <tr><td>9</td><td>Intermittent buzzer (long)</td><td>Sounded</td><td>Stopped</td></tr> <tr><td>8</td><td>Not used</td><td colspan="2">Always "0"</td></tr> <tr><td>7</td><td>Screen printing</td><td>Performed</td><td>Not performed</td></tr> <tr><td>6</td><td>Window opening</td><td>Disabled</td><td>Enabled</td></tr> <tr><td>5</td><td>Numeral/character string input</td><td>Disabled</td><td>Enabled</td></tr> </tbody> </table> <p>Reflected in word unit</p>	Word	Bit	Word n	Screen number (4 BCD digits)	Word n+1	0 Copy source memory table number (3 BCD digits)	Word n+2	Copy type Copy destination memory table number (3 BCD digits)	Word n+3	PT status control bits 0 0	Word	Controlled Item	1 (ON)	0 (OFF)	15	Screen display	Performed	Not performed	14	Processing priority registration	Registered	Canceled	13	Continuous buzzer	Sounded	Stopped	12	Intermittent buzzer (short)	Sounded	Stopped	11	Display history initialization	Performed	Not performed	10	Not used	Always "0"		9	Intermittent buzzer (long)	Sounded	Stopped	8	Not used	Always "0"		7	Screen printing	Performed	Not performed	6	Window opening	Disabled	Enabled	5	Numeral/character string input	Disabled	Enabled	<table border="1"> <thead> <tr> <th>Word</th> <th>Bit</th> </tr> </thead> <tbody> <tr> <td>Word n</td> <td>Screen number (4 BCD or hexadecimal digits)</td> </tr> <tr> <td>Word n+1</td> <td>Copy source memory table number (4 BCD or hexadecimal digits)</td> </tr> <tr> <td>Word n+2</td> <td>Copy destination memory table number (4 BCD or hexadecimal digits)</td> </tr> <tr> <td>Word n+3</td> <td>PT status control bits</td> </tr> <tr> <td>Word n+4</td> <td>Reserved for system use</td> </tr> </tbody> </table> <p>PT status control bits</p> <table border="1"> <thead> <tr> <th>Word</th> <th>Controlled Item</th> <th>1 (ON)</th> <th>0 (OFF)</th> </tr> </thead> <tbody> <tr><td>15</td><td>Screen display</td><td>Performed</td><td>Not performed</td></tr> <tr><td>14</td><td>Processing priority registration</td><td>Registered</td><td>Canceled</td></tr> <tr><td>13</td><td>Continuous buzzer</td><td>Sounded</td><td>Stopped</td></tr> <tr><td>12</td><td>Intermittent buzzer (short)</td><td>Sounded</td><td>Stopped</td></tr> <tr><td>11</td><td>Display history initialization</td><td>Performed</td><td>Not performed</td></tr> <tr><td>10</td><td>Not used</td><td colspan="2">Always "0"</td></tr> <tr><td>9</td><td>Intermittent buzzer (long)</td><td>Sounded</td><td>Stopped</td></tr> <tr><td>8</td><td>Backlight mode</td><td>Lit</td><td>Flashing</td></tr> <tr><td>7</td><td>Screen printing</td><td>Performed</td><td>Not performed</td></tr> <tr><td>6</td><td>PT window opening</td><td>Disabled</td><td>Enabled</td></tr> <tr><td>5</td><td>Numeral/character string input</td><td>Disabled</td><td>Enabled</td></tr> <tr><td>4</td><td>PT screen switching</td><td>Disabled</td><td>Enabled</td></tr> <tr><td>3</td><td>Memory table copy execution</td><td>Performed</td><td>Not performed</td></tr> <tr><td>2</td><td>Memory table copy type</td><td>Numeral</td><td>Character string</td></tr> <tr><td>1</td><td>Alarm history initialization</td><td>Performed</td><td>Not performed</td></tr> <tr><td>0</td><td>Not used</td><td colspan="2">Always "0"</td></tr> </tbody> </table> <p>Reflected in bit unit</p>	Word	Bit	Word n	Screen number (4 BCD or hexadecimal digits)	Word n+1	Copy source memory table number (4 BCD or hexadecimal digits)	Word n+2	Copy destination memory table number (4 BCD or hexadecimal digits)	Word n+3	PT status control bits	Word n+4	Reserved for system use	Word	Controlled Item	1 (ON)	0 (OFF)	15	Screen display	Performed	Not performed	14	Processing priority registration	Registered	Canceled	13	Continuous buzzer	Sounded	Stopped	12	Intermittent buzzer (short)	Sounded	Stopped	11	Display history initialization	Performed	Not performed	10	Not used	Always "0"		9	Intermittent buzzer (long)	Sounded	Stopped	8	Backlight mode	Lit	Flashing	7	Screen printing	Performed	Not performed	6	PT window opening	Disabled	Enabled	5	Numeral/character string input	Disabled	Enabled	4	PT screen switching	Disabled	Enabled	3	Memory table copy execution	Performed	Not performed	2	Memory table copy type	Numeral	Character string	1	Alarm history initialization	Performed	Not performed	0	Not used	Always "0"	
Word	Bit																																																																																																																																											
Word n	Screen number (4 BCD digits)																																																																																																																																											
Word n+1	0 Copy source memory table number (3 BCD digits)																																																																																																																																											
Word n+2	Copy type Copy destination memory table number (3 BCD digits)																																																																																																																																											
Word n+3	PT status control bits 0 0																																																																																																																																											
Word	Controlled Item	1 (ON)	0 (OFF)																																																																																																																																									
15	Screen display	Performed	Not performed																																																																																																																																									
14	Processing priority registration	Registered	Canceled																																																																																																																																									
13	Continuous buzzer	Sounded	Stopped																																																																																																																																									
12	Intermittent buzzer (short)	Sounded	Stopped																																																																																																																																									
11	Display history initialization	Performed	Not performed																																																																																																																																									
10	Not used	Always "0"																																																																																																																																										
9	Intermittent buzzer (long)	Sounded	Stopped																																																																																																																																									
8	Not used	Always "0"																																																																																																																																										
7	Screen printing	Performed	Not performed																																																																																																																																									
6	Window opening	Disabled	Enabled																																																																																																																																									
5	Numeral/character string input	Disabled	Enabled																																																																																																																																									
Word	Bit																																																																																																																																											
Word n	Screen number (4 BCD or hexadecimal digits)																																																																																																																																											
Word n+1	Copy source memory table number (4 BCD or hexadecimal digits)																																																																																																																																											
Word n+2	Copy destination memory table number (4 BCD or hexadecimal digits)																																																																																																																																											
Word n+3	PT status control bits																																																																																																																																											
Word n+4	Reserved for system use																																																																																																																																											
Word	Controlled Item	1 (ON)	0 (OFF)																																																																																																																																									
15	Screen display	Performed	Not performed																																																																																																																																									
14	Processing priority registration	Registered	Canceled																																																																																																																																									
13	Continuous buzzer	Sounded	Stopped																																																																																																																																									
12	Intermittent buzzer (short)	Sounded	Stopped																																																																																																																																									
11	Display history initialization	Performed	Not performed																																																																																																																																									
10	Not used	Always "0"																																																																																																																																										
9	Intermittent buzzer (long)	Sounded	Stopped																																																																																																																																									
8	Backlight mode	Lit	Flashing																																																																																																																																									
7	Screen printing	Performed	Not performed																																																																																																																																									
6	PT window opening	Disabled	Enabled																																																																																																																																									
5	Numeral/character string input	Disabled	Enabled																																																																																																																																									
4	PT screen switching	Disabled	Enabled																																																																																																																																									
3	Memory table copy execution	Performed	Not performed																																																																																																																																									
2	Memory table copy type	Numeral	Character string																																																																																																																																									
1	Alarm history initialization	Performed	Not performed																																																																																																																																									
0	Not used	Always "0"																																																																																																																																										

Item	NT620S/NT620C/NT625C	NT631/NT631C																																																																																																																								
PT status notify area	<p>Bit</p> <p>Word 15 14 13 12 11 10 9 8 7 6 5 4 3 2 1 0</p> <p>Word m</p> <table border="1"> <tr> <td colspan="4">Screen number (4 BCD digits)</td> </tr> </table> <p>Word m+1</p> <table border="1"> <tr> <td>0</td> <td colspan="3">Numeral/character string memory table number (3 BCD digits)</td> </tr> </table> <p>Word m+2</p> <table border="1"> <tr> <td colspan="3">PT status notify bits</td> <td>0</td> <td>0</td> <td>0</td> <td>0</td> </tr> </table> <p>PT status notify bits</p> <table border="1"> <thead> <tr> <th>Word</th> <th>Notified Information</th> <th>1 (ON)</th> <th>0 (OFF)</th> </tr> </thead> <tbody> <tr> <td>15</td> <td>PT operation status</td> <td>Run</td> <td>Stop</td> </tr> <tr> <td>14</td> <td>Not used</td> <td colspan="2">Always "0"</td> </tr> <tr> <td>13</td> <td>Battery</td> <td>Low</td> <td>Normal</td> </tr> <tr> <td>12</td> <td>Screen switch strobe</td> <td>ON</td> <td>OFF</td> </tr> <tr> <td>11</td> <td>Numeral setting strobe</td> <td>ON</td> <td>OFF</td> </tr> <tr> <td>10</td> <td>Character string setting strobe</td> <td>ON</td> <td>OFF</td> </tr> <tr> <td>9</td> <td>Not used</td> <td colspan="2">Always "0"</td> </tr> <tr> <td>8</td> <td>Not used</td> <td colspan="2">Always "0"</td> </tr> <tr> <td>7</td> <td>Printer operating status</td> <td>Printing</td> <td>Stopped</td> </tr> </tbody> </table>	Screen number (4 BCD digits)				0	Numeral/character string memory table number (3 BCD digits)			PT status notify bits			0	0	0	0	Word	Notified Information	1 (ON)	0 (OFF)	15	PT operation status	Run	Stop	14	Not used	Always "0"		13	Battery	Low	Normal	12	Screen switch strobe	ON	OFF	11	Numeral setting strobe	ON	OFF	10	Character string setting strobe	ON	OFF	9	Not used	Always "0"		8	Not used	Always "0"		7	Printer operating status	Printing	Stopped	<p>Bit</p> <p>Word 15 14 13 12 11 10 9 8 7 6 5 4 3 2 1 0</p> <p>Word m</p> <table border="1"> <tr> <td colspan="4">Numeral/character string memory table number (BCD or hexadecimal 4 digits)</td> </tr> </table> <p>Word m+1</p> <table border="1"> <tr> <td colspan="2">PT status notify bits</td> <td>0</td> <td>0</td> <td>0</td> </tr> </table> <p>PT status notify bits</p> <table border="1"> <thead> <tr> <th>Word</th> <th>Notified Information</th> <th>1 (ON)</th> <th>0 (OFF)</th> </tr> </thead> <tbody> <tr> <td>15</td> <td>PT operation status</td> <td>Run</td> <td>Stop</td> </tr> <tr> <td>14</td> <td>Not used</td> <td colspan="2">Always "0"</td> </tr> <tr> <td>13</td> <td>Battery</td> <td>Low</td> <td>Normal</td> </tr> <tr> <td>12</td> <td>Screen switch strobe</td> <td>ON</td> <td>OFF</td> </tr> <tr> <td>11</td> <td>Numeral setting strobe</td> <td>ON</td> <td>OFF</td> </tr> <tr> <td>10</td> <td>Character string setting strobe</td> <td>ON</td> <td>OFF</td> </tr> <tr> <td>9</td> <td>Not used</td> <td colspan="2">Always "0"</td> </tr> <tr> <td>8</td> <td>Not used</td> <td colspan="2">Always "0"</td> </tr> <tr> <td>7</td> <td>Printer operating status</td> <td>Printing</td> <td>Stopped</td> </tr> <tr> <td>6</td> <td>Backlight status</td> <td>OFF</td> <td>Lit/flashing</td> </tr> <tr> <td>5*</td> <td>Global window open status</td> <td>Open</td> <td>Close</td> </tr> <tr> <td>4*</td> <td>Local window "1" open status</td> <td>Open</td> <td>Close</td> </tr> <tr> <td>3*</td> <td>Local window "2" open status</td> <td>Open</td> <td>Close</td> </tr> </tbody> </table> <p>* : Added for V1 The contents of Screen number of the displayed screen (PT status notify area mCH of NT620S/NT620C/NT625C) is written to PT status control area nCH.</p>	Numeral/character string memory table number (BCD or hexadecimal 4 digits)				PT status notify bits		0	0	0	Word	Notified Information	1 (ON)	0 (OFF)	15	PT operation status	Run	Stop	14	Not used	Always "0"		13	Battery	Low	Normal	12	Screen switch strobe	ON	OFF	11	Numeral setting strobe	ON	OFF	10	Character string setting strobe	ON	OFF	9	Not used	Always "0"		8	Not used	Always "0"		7	Printer operating status	Printing	Stopped	6	Backlight status	OFF	Lit/flashing	5*	Global window open status	Open	Close	4*	Local window "1" open status	Open	Close	3*	Local window "2" open status	Open	Close
Screen number (4 BCD digits)																																																																																																																										
0	Numeral/character string memory table number (3 BCD digits)																																																																																																																									
PT status notify bits			0	0	0	0																																																																																																																				
Word	Notified Information	1 (ON)	0 (OFF)																																																																																																																							
15	PT operation status	Run	Stop																																																																																																																							
14	Not used	Always "0"																																																																																																																								
13	Battery	Low	Normal																																																																																																																							
12	Screen switch strobe	ON	OFF																																																																																																																							
11	Numeral setting strobe	ON	OFF																																																																																																																							
10	Character string setting strobe	ON	OFF																																																																																																																							
9	Not used	Always "0"																																																																																																																								
8	Not used	Always "0"																																																																																																																								
7	Printer operating status	Printing	Stopped																																																																																																																							
Numeral/character string memory table number (BCD or hexadecimal 4 digits)																																																																																																																										
PT status notify bits		0	0	0																																																																																																																						
Word	Notified Information	1 (ON)	0 (OFF)																																																																																																																							
15	PT operation status	Run	Stop																																																																																																																							
14	Not used	Always "0"																																																																																																																								
13	Battery	Low	Normal																																																																																																																							
12	Screen switch strobe	ON	OFF																																																																																																																							
11	Numeral setting strobe	ON	OFF																																																																																																																							
10	Character string setting strobe	ON	OFF																																																																																																																							
9	Not used	Always "0"																																																																																																																								
8	Not used	Always "0"																																																																																																																								
7	Printer operating status	Printing	Stopped																																																																																																																							
6	Backlight status	OFF	Lit/flashing																																																																																																																							
5*	Global window open status	Open	Close																																																																																																																							
4*	Local window "1" open status	Open	Close																																																																																																																							
3*	Local window "2" open status	Open	Close																																																																																																																							
Window control area	None	<p>Bit</p> <p>Word 15 14 13 12 11 10 9 8 7 6 5 4 3 2 1 0</p> <p>Word k</p> <table border="1"> <tr> <td colspan="4">Global window Screen No. (4-digit BCD or hexadecimal)</td> </tr> </table> <p>Word k+1</p> <table border="1"> <tr> <td colspan="4">Global window X coordinate (4-digit BCD or hexadecimal)</td> </tr> </table> <p>Word k+2</p> <table border="1"> <tr> <td colspan="4">Global window Y coordinate (4-digit BCD or hexadecimal)</td> </tr> </table> <p>Word k+3</p> <table border="1"> <tr> <td colspan="4">Local window1 Screen No. (4-digit BCD or hexadecimal)</td> </tr> </table> <p>Word k+4</p> <table border="1"> <tr> <td colspan="4">Local window1 X coordinate (4-digit BCD or hexadecimal)</td> </tr> </table> <p>Word k+5</p> <table border="1"> <tr> <td colspan="4">Local window1 Y coordinate (4-digit BCD or hexadecimal)</td> </tr> </table> <p>Word k+6</p> <table border="1"> <tr> <td colspan="4">Local window2 Screen No. (4-digit BCD or hexadecimal)</td> </tr> </table> <p>Word k+7</p> <table border="1"> <tr> <td colspan="4">Local window2 X coordinate (4-digit BCD or hexadecimal)</td> </tr> </table> <p>Word k+8</p> <table border="1"> <tr> <td colspan="4">Local window2 Y coordinate (4-digit BCD or hexadecimal)</td> </tr> </table>	Global window Screen No. (4-digit BCD or hexadecimal)				Global window X coordinate (4-digit BCD or hexadecimal)				Global window Y coordinate (4-digit BCD or hexadecimal)				Local window1 Screen No. (4-digit BCD or hexadecimal)				Local window1 X coordinate (4-digit BCD or hexadecimal)				Local window1 Y coordinate (4-digit BCD or hexadecimal)				Local window2 Screen No. (4-digit BCD or hexadecimal)				Local window2 X coordinate (4-digit BCD or hexadecimal)				Local window2 Y coordinate (4-digit BCD or hexadecimal)																																																																																							
Global window Screen No. (4-digit BCD or hexadecimal)																																																																																																																										
Global window X coordinate (4-digit BCD or hexadecimal)																																																																																																																										
Global window Y coordinate (4-digit BCD or hexadecimal)																																																																																																																										
Local window1 Screen No. (4-digit BCD or hexadecimal)																																																																																																																										
Local window1 X coordinate (4-digit BCD or hexadecimal)																																																																																																																										
Local window1 Y coordinate (4-digit BCD or hexadecimal)																																																																																																																										
Local window2 Screen No. (4-digit BCD or hexadecimal)																																																																																																																										
Local window2 X coordinate (4-digit BCD or hexadecimal)																																																																																																																										
Local window2 Y coordinate (4-digit BCD or hexadecimal)																																																																																																																										
Screen display	<p>0: No display</p> <p>1 to 1899: Normal screens</p> <p>1900 to 1979: Window screens, normal screens</p> <p>1980 to 1996: Expansion functions, normal screens</p> <p>1997: Display history (occurrence order) screen</p> <p>1998: Display history (frequency order) screen</p> <p>1999: "Connected to host" screen</p>	<p>0: No display</p> <p>1 to 3999 : Normal screens, window screens, overlapping screens</p> <p>9000: "System Initializing" screen</p> <p>9001: Display history (occurrence order) screen</p> <p>9002: Display history (frequency order) screen</p> <p>9020: Screen for programming console function</p> <p>9999: Return to the previous screen</p>																																																																																																																								
Continuous screens	Possible	<p>Not possible</p> <p>A parent screen is deleted after the data conversion, such as from NT620S/NT620C/NT625C.</p> <p>Use aswitch screen touch switch instead.</p>																																																																																																																								
Initial screen	"Host connect" screen	"System initializing" screen																																																																																																																								
System keypad	Possible	<p>Not possible</p> <p>Use touch switches instead.</p> <p>Also, symbol manager can be used at the Support Tool.</p>																																																																																																																								

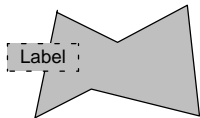
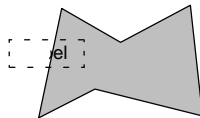
Item	NT620S/NT620C/NT625C	NT631/NT631C														
Image/library data	Image data: FE20 to FEFFH Library data: FA20 to FAFFH FB20 to FBFFH FC20 to FCFFH FD20 to FDFFH	Image data: 0001 to 0FFFH Library data: 1000 to 3FFFH * On data conversion from the NT620S/NT620C/NT625C, the codes are automatically converted.														
Data to be handled as a string	Half-size/standard-size characters, marks, image/library data.	Half-size/standard-size characters, marks * Image/library object can be used instead of image/library data														
Window	<ul style="list-style-type: none"> Only 1 window can be displayed Display elements which can be registered on a window Fixed display Touch switch (Notify bit, cursor move and print screen functions are not available) Numeral/character string input (only 1 of these)	<ul style="list-style-type: none"> Up to 3 screens can be displayed (1 global window, 2 local windows) Display elements which can be registered on a window All the display elements other than thumbwheel type numeral input (However, only 1 numeral/character string input (temporary input field) can be displayed)														
Display items treated as string character	Half-size/standard-size characters, marks, image/library data.	Half-size/standard-size characters, marks														
Control codes in character strings	00 to 20H: Space	00H, 0AH: Cut out subsequent display 01 to 09H, 0B to 20H: Space														
Numeral display, character string display attributes	Normal, reverse, flashing, reverse and flashing, transparent display	Standard, flash, inverse flash, transparent display														
Bit memory table setting	Simultaneous setting of recording in an alarm history and screen switching is possible.	Simultaneous setting of recording in an alarm history and screen switching is not possible (if NT620S/NT620C/NT625C data in which simultaneous operation is specified is converted for use with an NT631/NT631C, only the alarm history recording operation is performed).														
Memory table copy	Numeral/character string type: Set at word n+2 (copy type) of the PT status control area (0: character string memory table, 1: numeral memory table) Copy timing: When the value of the n + 1 word or the n + 2 word in the PT status control area changes.	Numeral/character string type: Set at word n+2 (memory table copy type) of the PT status control area (0: character string memory table, 1: numeral memory table) Copy timing: Copying is executed when the word n+3 bit3 (Memory table copy execution) of the PT status control area changes to 1.														
Indirect display	When a number outside the range of table numbers set in the system settings is specified as a jump destination: <input type="checkbox"/> Up to 999: The display contents are cleared. <input type="checkbox"/> 1000 or above: The previous display remains displayed Example: 512 character string memory tables	When a number outside the range of table numbers set in the system settings is specified as a jump destination: <input type="checkbox"/> The previous display remains displayed in all cases. Example: 512 character string memory tables														
	<table border="1"> <thead> <tr> <th>Jump destination number specification</th> <th>Display contents</th> </tr> </thead> <tbody> <tr> <td>0 to 511</td> <td>Table contents</td> </tr> <tr> <td>512 to 999</td> <td>Display cleared</td> </tr> <tr> <td>1000 or above</td> <td>Display not updated</td> </tr> </tbody> </table>	Jump destination number specification	Display contents	0 to 511	Table contents	512 to 999	Display cleared	1000 or above	Display not updated	<table border="1"> <thead> <tr> <th>Jump destination number specification</th> <th>Display contents</th> </tr> </thead> <tbody> <tr> <td>0 to 511</td> <td>Table contents</td> </tr> <tr> <td>512 or above</td> <td>Display not updated</td> </tr> </tbody> </table>	Jump destination number specification	Display contents	0 to 511	Table contents	512 or above	Display not updated
Jump destination number specification	Display contents															
0 to 511	Table contents															
512 to 999	Display cleared															
1000 or above	Display not updated															
Jump destination number specification	Display contents															
0 to 511	Table contents															
512 or above	Display not updated															
Touch switches lamp with free-shape display frames	All of the graphic part and label are displayed in reverse video. Example: 	Only the graphic part is displayed in reverse video; projecting parts are not displayed. Example: 														
Overlapping of input notification touch switches	Alternate – Alternate: Not possible Alternate – Set: Not possible Set – Set: Not possible Momentary – Momentary: Possible Momentary – Set: Not Possible Momentary – Alternate: Not Possible	All the combinations indicated to the left are possible.														

Item	NT620S/NT620C/NT625C	NT631/NT631C
Overlapping of touch switches/lamps and fixed displays	When the touch switch/lamp goes ON/OFF, the fixed display is displayed in XOR inverse color of ON/OFF color of touch switch/lamp which is behind it.	Even if the touch switch/lamp goes ON/OFF, the fixed display is always displayed in the specified color.
Pop-up window function touch switch	Only Keyboard screen can be controlled. Window display position can not be changed.	Local window1 or local window2 can be controlled. Window display position can be changed.
Window move function touch switch	Not available	Available

Apart from the above, due to difference between PT models, it may be necessary to modify screen data and programs at the host. For details, refer to the NT-series Support Tool Ver. 3.0 for Windows95/98 Operation Manual (V053-E1-□).

Differences between the NT631/NT631C without “V1” and the NT631/NT631C with “V1”

Item	NT631/NT631C (without V1)	NT631/NT631C (with V1)																																																																																																																																																																																																										
Drawing order of objects	<table border="1"> <thead> <tr> <th>Display</th> <th>Object Types</th> </tr> </thead> <tbody> <tr> <td style="text-align: center;">Top ↑ ↓ Bottom</td> <td>Image/library lamp Alarm list/history frame Temporary input String input Thumbwheel Numeral input Trend graph Broken line graph Bar graph Numeral display String display Fixed display Lamp Touch switch Image/library Screen background</td> </tr> </tbody> </table>	Display	Object Types	Top ↑ ↓ Bottom	Image/library lamp Alarm list/history frame Temporary input String input Thumbwheel Numeral input Trend graph Broken line graph Bar graph Numeral display String display Fixed display Lamp Touch switch Image/library Screen background	<table border="1"> <thead> <tr> <th>Display</th> <th>Object Types</th> </tr> </thead> <tbody> <tr> <td style="text-align: center;">Top ↑ ↓ Bottom</td> <td>Image/library lamp Alarm list/history frame Temporary input String input Thumbwheel Numeral input Trend graph Broken line graph Analogue meter Bar graph Numeral display String display Fixed display Lamp Touch switch Image/library Screen background</td> </tr> </tbody> </table>	Display	Object Types	Top ↑ ↓ Bottom	Image/library lamp Alarm list/history frame Temporary input String input Thumbwheel Numeral input Trend graph Broken line graph Analogue meter Bar graph Numeral display String display Fixed display Lamp Touch switch Image/library Screen background																																																																																																																																																																																																		
Display	Object Types																																																																																																																																																																																																											
Top ↑ ↓ Bottom	Image/library lamp Alarm list/history frame Temporary input String input Thumbwheel Numeral input Trend graph Broken line graph Bar graph Numeral display String display Fixed display Lamp Touch switch Image/library Screen background																																																																																																																																																																																																											
Display	Object Types																																																																																																																																																																																																											
Top ↑ ↓ Bottom	Image/library lamp Alarm list/history frame Temporary input String input Thumbwheel Numeral input Trend graph Broken line graph Analogue meter Bar graph Numeral display String display Fixed display Lamp Touch switch Image/library Screen background																																																																																																																																																																																																											
PT status notify area	<p style="text-align: center;">Bit</p> <table border="1"> <tr> <td>Word</td> <td>15</td><td>14</td><td>13</td><td>12</td><td>11</td><td>10</td><td>9</td><td>8</td><td>7</td><td>6</td><td>5</td><td>4</td><td>3</td><td>2</td><td>1</td><td>0</td> </tr> <tr> <td>Word m</td> <td colspan="16" style="text-align: center;">Numeral/character string memory table number (BCD or hexadecimal 4 digits)</td> </tr> <tr> <td>Word m+1</td> <td colspan="16" style="text-align: center;">PT status notify bits</td> </tr> </table> <p>PT status notify bits</p> <table border="1"> <thead> <tr> <th>Word</th> <th>Notified Information</th> <th>1 (ON)</th> <th>0 (OFF)</th> </tr> </thead> <tbody> <tr><td>15</td><td>PT operation status</td><td>Run</td><td>Stop</td></tr> <tr><td>14</td><td>Not used</td><td colspan="2" style="text-align: center;">Always "0"</td></tr> <tr><td>13</td><td>Battery</td><td>Low</td><td>Normal</td></tr> <tr><td>12</td><td>Screen switch strobe</td><td>ON</td><td>OFF</td></tr> <tr><td>11</td><td>Numeral setting strobe</td><td>ON</td><td>OFF</td></tr> <tr><td>10</td><td>Character string setting strobe</td><td>ON</td><td>OFF</td></tr> <tr><td>9</td><td>Not used</td><td colspan="2" style="text-align: center;">Always "0"</td></tr> <tr><td>8</td><td>Not used</td><td colspan="2" style="text-align: center;">Always "0"</td></tr> <tr><td>7</td><td>Printer operating status</td><td>Printing</td><td>Stopped</td></tr> <tr><td>6</td><td>Backlight status</td><td>OFF</td><td>Lit/flashing</td></tr> </tbody> </table>	Word	15	14	13	12	11	10	9	8	7	6	5	4	3	2	1	0	Word m	Numeral/character string memory table number (BCD or hexadecimal 4 digits)																Word m+1	PT status notify bits																Word	Notified Information	1 (ON)	0 (OFF)	15	PT operation status	Run	Stop	14	Not used	Always "0"		13	Battery	Low	Normal	12	Screen switch strobe	ON	OFF	11	Numeral setting strobe	ON	OFF	10	Character string setting strobe	ON	OFF	9	Not used	Always "0"		8	Not used	Always "0"		7	Printer operating status	Printing	Stopped	6	Backlight status	OFF	Lit/flashing	<p style="text-align: center;">Bit</p> <table border="1"> <tr> <td>Word</td> <td>15</td><td>14</td><td>13</td><td>12</td><td>11</td><td>10</td><td>9</td><td>8</td><td>7</td><td>6</td><td>5</td><td>4</td><td>3</td><td>2</td><td>1</td><td>0</td> </tr> <tr> <td>Word m</td> <td colspan="16" style="text-align: center;">Numeral/character string memory table number (BCD or hexadecimal 4 digits)</td> </tr> <tr> <td>Word m+1</td> <td colspan="16" style="text-align: center;">PT status notify bits</td> </tr> </table> <p>PT status notify bits</p> <table border="1"> <thead> <tr> <th>Word</th> <th>Notified Information</th> <th>1 (ON)</th> <th>0 (OFF)</th> </tr> </thead> <tbody> <tr><td>15</td><td>PT operation status</td><td>Run</td><td>Stop</td></tr> <tr><td>14</td><td>Not used</td><td colspan="2" style="text-align: center;">Always "0"</td></tr> <tr><td>13</td><td>Battery</td><td>Low</td><td>Normal</td></tr> <tr><td>12</td><td>Screen switch strobe</td><td>ON</td><td>OFF</td></tr> <tr><td>11</td><td>Numeral setting strobe</td><td>ON</td><td>OFF</td></tr> <tr><td>10</td><td>Character string setting strobe</td><td>ON</td><td>OFF</td></tr> <tr><td>9</td><td>Not used</td><td colspan="2" style="text-align: center;">Always "0"</td></tr> <tr><td>8</td><td>Not used</td><td colspan="2" style="text-align: center;">Always "0"</td></tr> <tr><td>7</td><td>Printer operating status</td><td>Printing</td><td>Stopped</td></tr> <tr><td>6</td><td>Backlight status</td><td>OFF</td><td>Lit/flashing</td></tr> <tr><td>5</td><td>Global window open status</td><td>Open</td><td>Close</td></tr> <tr><td>4</td><td>Local window "1" open status</td><td>Open</td><td>Close</td></tr> <tr><td>3</td><td>Local window "2" open status</td><td>Open</td><td>Close</td></tr> </tbody> </table>	Word	15	14	13	12	11	10	9	8	7	6	5	4	3	2	1	0	Word m	Numeral/character string memory table number (BCD or hexadecimal 4 digits)																Word m+1	PT status notify bits																Word	Notified Information	1 (ON)	0 (OFF)	15	PT operation status	Run	Stop	14	Not used	Always "0"		13	Battery	Low	Normal	12	Screen switch strobe	ON	OFF	11	Numeral setting strobe	ON	OFF	10	Character string setting strobe	ON	OFF	9	Not used	Always "0"		8	Not used	Always "0"		7	Printer operating status	Printing	Stopped	6	Backlight status	OFF	Lit/flashing	5	Global window open status	Open	Close	4	Local window "1" open status	Open	Close	3	Local window "2" open status	Open	Close
Word	15	14	13	12	11	10	9	8	7	6	5	4	3	2	1	0																																																																																																																																																																																												
Word m	Numeral/character string memory table number (BCD or hexadecimal 4 digits)																																																																																																																																																																																																											
Word m+1	PT status notify bits																																																																																																																																																																																																											
Word	Notified Information	1 (ON)	0 (OFF)																																																																																																																																																																																																									
15	PT operation status	Run	Stop																																																																																																																																																																																																									
14	Not used	Always "0"																																																																																																																																																																																																										
13	Battery	Low	Normal																																																																																																																																																																																																									
12	Screen switch strobe	ON	OFF																																																																																																																																																																																																									
11	Numeral setting strobe	ON	OFF																																																																																																																																																																																																									
10	Character string setting strobe	ON	OFF																																																																																																																																																																																																									
9	Not used	Always "0"																																																																																																																																																																																																										
8	Not used	Always "0"																																																																																																																																																																																																										
7	Printer operating status	Printing	Stopped																																																																																																																																																																																																									
6	Backlight status	OFF	Lit/flashing																																																																																																																																																																																																									
Word	15	14	13	12	11	10	9	8	7	6	5	4	3	2	1	0																																																																																																																																																																																												
Word m	Numeral/character string memory table number (BCD or hexadecimal 4 digits)																																																																																																																																																																																																											
Word m+1	PT status notify bits																																																																																																																																																																																																											
Word	Notified Information	1 (ON)	0 (OFF)																																																																																																																																																																																																									
15	PT operation status	Run	Stop																																																																																																																																																																																																									
14	Not used	Always "0"																																																																																																																																																																																																										
13	Battery	Low	Normal																																																																																																																																																																																																									
12	Screen switch strobe	ON	OFF																																																																																																																																																																																																									
11	Numeral setting strobe	ON	OFF																																																																																																																																																																																																									
10	Character string setting strobe	ON	OFF																																																																																																																																																																																																									
9	Not used	Always "0"																																																																																																																																																																																																										
8	Not used	Always "0"																																																																																																																																																																																																										
7	Printer operating status	Printing	Stopped																																																																																																																																																																																																									
6	Backlight status	OFF	Lit/flashing																																																																																																																																																																																																									
5	Global window open status	Open	Close																																																																																																																																																																																																									
4	Local window "1" open status	Open	Close																																																																																																																																																																																																									
3	Local window "2" open status	Open	Close																																																																																																																																																																																																									

Item	NT631/NT631C (without V1)	NT631/NT631C (with V1)																																													
Window control area	None	<div style="text-align: center;"> Bit Word 15 14 13 12 11 10 9 8 7 6 5 4 3 2 1 0 </div> <table border="1" style="margin-left: auto; margin-right: auto;"> <tr> <td>Word k</td> <td colspan="4">Global window Screen No. (4-digit BCD or hexadecimal)</td> </tr> <tr> <td>Word k+1</td> <td colspan="4">Global window X coordinate (4-digit BCD or hexadecimal)</td> </tr> <tr> <td>Word k+2</td> <td colspan="4">Global window Y coordinate (4-digit BCD or hexadecimal)</td> </tr> <tr> <td>Word k+3</td> <td colspan="4">Local window1 Screen No. (4-digit BCD or hexadecimal)</td> </tr> <tr> <td>Word k+4</td> <td colspan="4">Local window1 X coordinate (4-digit BCD or hexadecimal)</td> </tr> <tr> <td>Word k+5</td> <td colspan="4">Local window1 Y coordinate (4-digit BCD or hexadecimal)</td> </tr> <tr> <td>Word k+6</td> <td colspan="4">Local window2 Screen No. (4-digit BCD or hexadecimal)</td> </tr> <tr> <td>Word k+7</td> <td colspan="4">Local window2 X coordinate (4-digit BCD or hexadecimal)</td> </tr> <tr> <td>Word k+8</td> <td colspan="4">Local window2 Y coordinate (4-digit BCD or hexadecimal)</td> </tr> </table>	Word k	Global window Screen No. (4-digit BCD or hexadecimal)				Word k+1	Global window X coordinate (4-digit BCD or hexadecimal)				Word k+2	Global window Y coordinate (4-digit BCD or hexadecimal)				Word k+3	Local window1 Screen No. (4-digit BCD or hexadecimal)				Word k+4	Local window1 X coordinate (4-digit BCD or hexadecimal)				Word k+5	Local window1 Y coordinate (4-digit BCD or hexadecimal)				Word k+6	Local window2 Screen No. (4-digit BCD or hexadecimal)				Word k+7	Local window2 X coordinate (4-digit BCD or hexadecimal)				Word k+8	Local window2 Y coordinate (4-digit BCD or hexadecimal)			
Word k	Global window Screen No. (4-digit BCD or hexadecimal)																																														
Word k+1	Global window X coordinate (4-digit BCD or hexadecimal)																																														
Word k+2	Global window Y coordinate (4-digit BCD or hexadecimal)																																														
Word k+3	Local window1 Screen No. (4-digit BCD or hexadecimal)																																														
Word k+4	Local window1 X coordinate (4-digit BCD or hexadecimal)																																														
Word k+5	Local window1 Y coordinate (4-digit BCD or hexadecimal)																																														
Word k+6	Local window2 Screen No. (4-digit BCD or hexadecimal)																																														
Word k+7	Local window2 X coordinate (4-digit BCD or hexadecimal)																																														
Word k+8	Local window2 Y coordinate (4-digit BCD or hexadecimal)																																														
Window	<ul style="list-style-type: none"> Only 1 window can be displayed Display elements which can be registered on a window Fixed display Touch switch (Notify bit, cursor move and print screen functions are not available) Numeral/character string input (only 1 of these)	<ul style="list-style-type: none"> Up to 3 screens can be displayed (1 global window, 2 local windows) Display elements which can be registered on a window All the display elements other than thumbwheel type numeral input (However, only 1 numeral/character string input (temporary input field) can be displayed)																																													
Pop-up window function touch switch	Only Keyboard screen can be controlled. Window position can not be changed.	Local window1 or local window2 can be controlled. Window position can be changed.																																													
Window move function touch switch	Not available	Available																																													
Analogue meter	Not available	Available																																													
High-definition font display	Not available	Characters of 2 × 2 or larger scale is displayed in high-definition font* (excluding marks)																																													
Connection to Mitsubishi PLCs	Not possible	Possible																																													
Memory link	Not possible	Possible																																													
Installation of system program using memory unit	Not possible (screen data only)	Possible																																													
Programming console function screen for CS1-series CS1G/H	Not possible	Possible																																													

* Usable only when "ISO 8859-1" font type is selected at the Support Tool.

Relationship between system program and hardware

Here, relationship between system program and hardware is described.

NT631/NT631C have following models.

NT631-ST211□-E	Conventional product
NT631C-ST141□-E	
NT631C-ST151□-E	
NT631-ST211□-EV1	Version up model of the products above
NT631C-ST141□-EV1	
NT631C-ST151□-EV1	

System programs indicated below are installed for the models shown above in the default state. Also, system programs are supplied with the Support Tool as follows.

- System programs for NT631-ST211□-E/NT631C-ST141□-E/NT631C-ST151□-E (System programs supplied with NT-ZJ3PC1 -EV2/ZJ3DV1-EV2/ZJCMX1-EV2)
- System programs for NT631-ST211□-EV1/NT631C-ST141□-EV1/NT631C-ST151□-EV1 (System programs supplied with NT-ZJ3MX1- EV3/ZJCMX1-EV3)

These system programs have mutual compatibility, therefore, they can be installed and used for NT631-ST211□-E/NT631C-ST141□-E/NT631C-ST151□-E/NT631-ST211□-EV1/NT631C-ST141□-EV1/NT631C-ST151□-EV1 each.

However, there will be a limitation on function depending on the combination. Refer to the following table.

		Hardware	
		NT631-ST211□-E NT631C-ST141□-E NT631C-ST151□-E	NT631-ST211□-EV1 NT631C-ST141□-EV1 NT631C-ST151□-EV1
System program	For NT631-ST211□-E, NT631C-ST141□-E, NT631C-ST151□-E	The following functions can not be used <ul style="list-style-type: none"> • Analogue meter • High-definition font display • Installation of system programs using memory unit • Connection to Mitsubishi PLCs • Memory link • Window control from the host • Multiple display of window screens • Moving a window 	The following functions can not be used <ul style="list-style-type: none"> • Analogue meter • High-definition font display • Connection to Mitsubishi PLCs • Memory link • Window control from the host • Multiple display of window screens • Moving a window * Installation of system programs using memory unit is possible
	For NT631-ST211□-EV1, NT631C-ST141□-EV1, NT631C-ST151□-EV1,	The following functions can not be used <ul style="list-style-type: none"> • Installation of system programs using memory unit • High-definition font display* 	All the functions described in this manual can be used.

* Even though you have Hardware NT31/631 (without V1) and version up the system program of NT31/631 series to “-V1” system program, you can use only “CP437” as font type.

The table above shows only the relationship between the hardware and system program.

For details of the relationship with the screen data created using the Support Tool, refer to NT-series Support Tool for Windows 95/98 (Ver.3.0) Operation Manual (V053-E1-□).

APPENDIX J

Model List

PT

Model	Specification
NT631-ST211-EV1	High-intensity EL display (yellow), ivory
NT631-ST211B-EV1	High-intensity EL display (yellow), black
NT631C-ST141-EV1	STN color display, ivory
NT631-ST141B-EV1	STN color display, black
NT631C-ST151-EV1	High-intensity STN color display, ivory
NT631C-ST151B-EV1	High-intensity STN color display, black

Host Link Unit

Model	Specification	Applicable PC
3G2A6-LK201-EV1	CPU-mounted type with RS-232C connector	C-series C200H C1000H C2000H
3G2A6-LK202-EV1	CPU-mounted type with RS-422A connector	C-series C200H C1000H C2000H
C200H-LK201-V1	Rack-mounting unit with RS-232C connector for C200H	C-series C200H C200HS C200HX/HG/HE(-ZE)
C200H-LK202-V1	Rack-mounting unit with RS-422A connector for C200H	C-series C200H C1000H C2000H
3G2A5-LK201-EV1	Features a selectable RS-232C/RS-422A connector	C-series C1000H C2000H
C500-LK203	Rack-mounting unit for C500	C-series C1000H(F) C2000H
CV500-LK201	Features an RS-232C connector and a selectable RS-232C/RS-422A connector Rack-mounting unit for CVM1/CV	CVM1/CV-series CV500 CV1000 CV2000 CVM1

CompoBus/S Master Control Unit

Model	Specification	Model Name
SRM1-C02-V1	Features an RS-232C port	SRM1

Communication Unit

Model	Specification	Applicable PLC
CS1W-SCU21	RS-232C (2 ports) Rack-mounting unit	CS1-series CS1G/H

CPUs (For Connection via a Host Link)

Model	Specification	PC Type
CPM1-10CDR-□ CPM1-20CDR-□ CPM1-30CDR-□ CPM1A-10CD□-□ CPM1A-20CD□-□ CPM1A-30CD□-□ CPM1A-40CD□-□	RS-232C adapter/RS-422A adapter connected to the peripheral port	C-series CPM1
CQM1-CPU21-E CQM1-CPU41-EV1 CQM1-CPU42-EV1 CQM1-CPU43-EV1 CQM1-CPU44-EV1 CQM1-CPU45-EV1	Features a 9-pin connector for RS-232C connections	C-series CQM1
C200HS-CPU21-E C200HS-CPU23-E C200HS-CPU31-E C200HS-CPU33-E	Features a connector for RS-232C connections (selectable/9-pin)	C-series C200HS
C200HE-CPU32-(Z)E(*) C200HE-CPU42-(Z)E	Features a connector for RS-232C connections (selectable/9-pin)	C-series C200HE(-ZE)
C200HG-CPU33-(Z)E(*) C200HG-CPU43-(Z)E C200HG-CPU53-(Z)E(*) C200HG-CPU63-(Z)E	Features a connector for RS-232C connections (selectable/9-pin)	C-series C200HG(-ZE)
C200HX-CPU34-(Z)E(*) C200HX-CPU44-(Z)E C200HX-CPU54-(Z)E(*) C200HX-CPU64-(Z)E C200HX-CPU65-ZE C200HX-CPU85-ZE	Features a connector for RS-232C connections (selectable/9-pin)	C-series C200HX(-ZE)
CS1G-CPU42-E CS1G-CPU43-E CS1G-CPU44-E CS1G-CPU45-E	Features a connector for RS-232C connections (9-pin)	CS1-series CS1G
CS1H-CPU63-E CS1H-CPU64-E CS1H-CPU65-E CS1H-CPU66-E CS1H-CPU67-E	Features a connector for RS-232C connections (9-pin)	CS1-series CS1H
CV500-CPU01-EV1 CV1000-CPU01-EV1 CV2000-CPU01-EV1 CVM1-CPU01-EV2 CVM1-CPU11-EV2 CVM1-CPU21-EV2	Features a connector for RS-232C connections (selectable/9-pin)	CVM1/CV-series CV500 CV1000 CV2000 CVM1

* Either of the communication boards C200HW-COM02/COM04/COM05/COM06-V1 is required.

CPUs (For Connection via an NT Link (1:1))

Model	Specification	PC Type
CPM1-10CDR-□ CPM1-20CDR-□ CPM1-30CDR-□ CPM1A-10CD□-□ CPM1A-20CD□-□ CPM1A-30CD□-□ CPM1A-40CD□-□	RS-232C adapter connected to the peripheral port (RS-422A adapter cannot be used)	C-series CPM1
CQM1-CPU41-EV1 CQM1-CPU42-EV1 CQM1-CPU43-EV1 CQM1-CPU44-EV1 CQM1-CPU45-EV1	Features a 9-pin connector for RS-232C connections	C-series CQM1
C200HS-CPU21-E C200HS-CPU23-E C200HS-CPU31-E C200HS-CPU33-E	Features a connector for RS-232C connections (selectable/9-pin)	C-series C200HS
C200HE-CPU32-(Z)E(*) C200HE-CPU42-(Z)E	Features a connector for RS-232C connections (selectable/9-pin)	C-series C200HE(-ZE)
C200HG-CPU33-(Z)E(*) C200HG-CPU43-(Z)E C200HG-CPU53-(Z)E(*) C200HG-CPU63-(Z)E	Features a connector for RS-232C connections (selectable/9-pin)	C-series C200HG(-ZE)
C200HX-CPU34-(Z)E(*) C200HX-CPU44-(Z)E C200HX-CPU54-(Z)E(*) C200HX-CPU64-(Z)E C200HX-CPU65-ZE C200HX-CPU85-ZE	Features a connector for RS-232C connections (selectable/9-pin)	C-series C200HX(-ZE)
CV500-CPU01-EV1 CV1000-CPU01-EV1 CV2000-CPU01-EV1 CVM1-CPU01-EV2 CVM1-CPU11-EV2 CVM1-CPU21-EV2	Features a connector for RS-232C connections (selectable/9-pin)	CVM1/CV-series CV500 CV1000 CV2000 CVM1

* Either of the communication boards C200HW-COM02/COM04/COM05/COM06-V1 is required.

CPUs (For Connection via an NT Link (1:N))

Model	Specification	PC Type
C200HE-CPU32-(Z)E(*) C200HE-CPU42-(Z)E	Features a connector for RS-232C connections (selectable/9-pin)	C-series C200HE(-ZE)
C200HG-CPU34-(Z)E(*) C200HG-CPU43-(Z)E C200HG-CPU53-(Z)E(*) C200HG-CPU63-(Z)E	Features a connector for RS-232C connections (selectable/9-pin)	C-series C200HG(-ZE)
C200HX-CPU34-(Z)E(*) C200HX-CPU44-(Z)E C200HX-CPU54-(Z)E(*) C200HX-CPU64-(Z)E C200HX-CPU65-ZE C200HX-CPU85-ZE	Features a connector for RS-232C connections (selectable/9-pin)	C-series C200HX(-ZE)
CS1G-CPU42-E CS1G-CPU43-E CS1G-CPU44-E CS1G-CPU45-E	Features a connector for RS-232C connections (9-pin)	CS1-series CS1G
CS1H-CPU63-E CS1H-CPU64-E CS1H-CPU65-E CS1H-CPU66-E CS1H-CPU67-E	Features a connector for RS-232C connections (9-pin)	CS1-series CS1H

* Either of the communication boards C200HW-COM02/COM04/COM05/COM06-V1 is required.

RS-232C/RS-422A Convertor Unit

Model	Specification
NT-AL001	RS-232C: 9-pin connector RS-422A: 8-pin terminal block

RS-232C Adaptor, RS-422A Adaptor

Model	Specification
CPM1-CIF01	Links the RS-232C port of an NT631/NT631C and the peripheral port of a CPM1 (compatible with host link, and NT link (1:1))
CPM1-CIF11	Links the RS-422A port of an NT631/NT631C and the peripheral port of a CPM1 (compatible with host link)

Related Parts and Equipment for PT

Name	Model	Remark
Support Tool*	NT-ZJ3M ☒	Compatible with PC/AT personal computers For Windows95/98 (English version) 3.5 inch FD
	NT-ZJCM1-EV3	Compatible with PC/AT personal computers For Windows95/98 (English version) CD-ROM
Options	NT631C-CFL01	Replaceable backlight (for NT631C-ST151□-EV1)
	NT631C-CFL02	Replaceable backlight (for NT631C-ST141□-EV1)
	NT610C-KBA04	Reflection suppressing protective sheet for NT631/NT631C
	NT625-KBA01	Chemical-resistant cover for NT631/NT631C
	NT-MF261	Memory unit for NT631/NT631C
	3G2A9-BAT08	Spare battery

* The Support Tool indicated above includes the system installer and the standard system programs for the NT31, NT31C, NT631, and NT631C.

Cables with Connectors (PT ↔ PLC/NT-AL001)

Model	Cable Length	Applicable units	Communication Method	Specification
XW2Z-200S	2 m	Host link units with a 25-pin connector	Serial port A host link (RS-232C only)	9-pin ↔ 25-pin
XW2Z-500S	5 m			
XW2Z-200T	2 m	Host link units with a 9-pin connector	Serial port A host link, NT link (1:1) (RS-232C only)	9-pin ↔ 9-pin
XW2Z-500T	5 m			
XW2Z-S002	2 m	Personal computer with a 9-pin connector	Serial port A for using NT Support Tool	9-pin ↔ 9-pin

*1 Only the PLC C200HX/HG/HE (-Z) and CSI-Series can supply +5V

Cables with Connectors

Model	Cable Length	Specification
CV500-CN228	2 m	25-pin (male) ↔ 9-pin (male)
XW2Z-S002	2 m	9-pin (female) ↔ 9-pin (male)

Connection Cable

Model	Specification
AWG28 × 5P IFVV-SB	Multicore cable, manufactured by Fujikura, Ltd.
CO-MA-VV-SB 5P × 28AWG	Multicore cable, manufactured by Hitachi Cable, Ltd.

Applicable Connectors

Name	Model	Specification
Connector	XM2A-2501	25-pin type (male), made by OMRON
	XM2D-2501	25-pin type (female), made by OMRON (for personal computers)
	XM2A-0901	9-pin type (male), made by OMRON
	XM2D-0901	9-pin type (female), made by OMRON (for personal computers)
	DB-25P	25-pin type (male), made by JAE
Connector hood	XM2S-2511	25-pin type, mm pitch screw, made by OMRON
	XM2S-2513	25-pin type, inch pitch screw, made by OMRON
	XM2S-0911	9-pin type, mm pitch screw, made by OMRON
	XM2S-0911-E	9-pin type, mm pitch screw, made by OMRON
	XM2S-0913	9-pin type, inch pitch screw, made by OMRON
	DB-C2-J9	25-pin type, made by JAE

Printer Cable

Model	Specification
NT-CNT121	Printer cable for half pitch (1.5 m), made by OMRON

Cable for peripheral port of CS1-series PLC

Model	Specification
CS1W-CN118	Made by OMRON

APPENDIX K

Option List

Replaceable Backlights ... NT631C-CFL01 (for NT631C-ST151□)

These are backlights for NT631C for replacement purposes. Two pieces make a set.

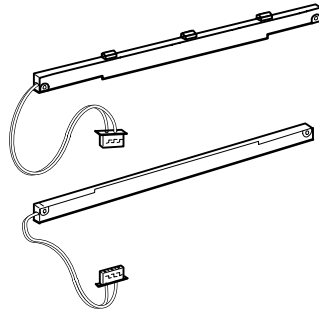

Replaceable Backlights ... NT631C-CFL02 (for NT631C-ST141□)

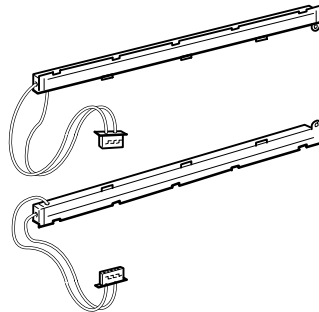

Protective Sheet ... NT610C-KBA04

Stuck to the display to prevent irregular reflection or contamination. The entire sheet is colorless and transparent. The five sheets make a set.

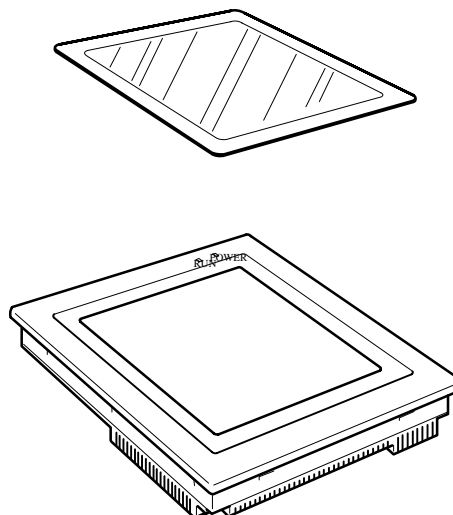

Chemical-resistant Cover ... NT625-KBA01

Covers the front panel and protects it from various chemical agents. The entire sheet is milky white and made of silicone rubber.

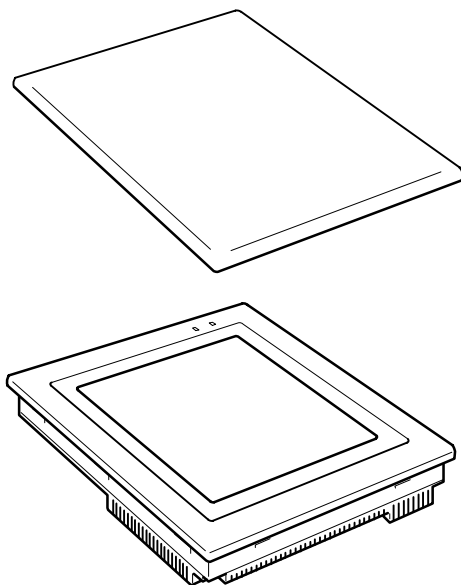

The sheet offers protection against the following chemical agents.

Protects against	Does not protect against
Boric acid	Hexane
Sulfuric acid	Lubricating oil
Nitrogen	Benzene
Ammonia gas	Butane
Carbonic acid gas	Carbonic acid
Phenol	Chlorinated solvents
Glycerin	Napthalene
Ammonia water	Soy bean oil
Calcium chloride	Toluene
Developing fluid (hypo)	
Acetaldehyde	
Lard	

For information on chemical agents not listed in the table above, please inquire whether or not protection is offered (if the chemical agent is one against which silicone rubber is recognized as offering protection, please use this product even if the agent is not listed in the "Protects against" column of the table above).

Replacement Battery ... 3G2A9-BAT08

This is a lithium battery used for memory backup.

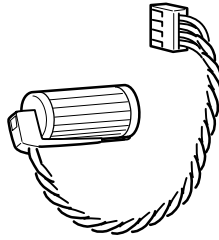
**Memory Unit ... NT-MF261**

This is a dedicated unit for reading/writing the screen data and the system programs in an NT631/NT631C. Data is transmitted by DIP switch setting at the memory unit.

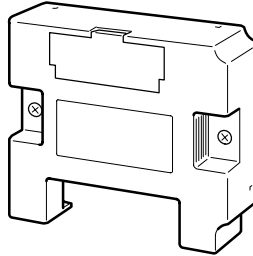

APPENDIX L

PC Memory Map

OMRON C-Series PC, SRM1 Memory Map

<Host Link / NT Link (1:1) / NT Link (1:N)>

Area	Relay Area (CIO)	Holding Relays (HR)	Auxiliary Relays (AR)	Link Relays (LR)	Timer/Counter Present Values (TIM/CNT)	Data Memory (DM)	Extended Data Memory (Current Bank) (EM)
C200H	00000 to 00255	00000 to 00099	00000 to 00027	00000 to 00063	00000 to 00511	00000 to 01999	-
C200HS							-
C200HE(-ZE) C200HG(-ZE) C200HX(-ZE)	00000 to 00511	00000 to 00099	00000 to 00027	00000 to 00063	00000 to 00511	00000 to 06655 07000 to 09999	00000 to 06143
C500	00000 to 00063	00000 to 00031	-	00000 to 00031	00000 to 00127	00000 to 00511	-
C1000H						00000 to 04095	-
C2000H CQM1	00000 to 00255	00000 to 00099	00000 to 00027	00000 to 00063	00000 to 00511	00000 to 06655	-
CPM1/CPM1A	00000 to 00019 00200 to 00255	00000 to 00019	00000 to 00015	00000 to 00015	00000 to 00127	00000 to 01023 06144 to 06655	-
SRM1	00000 to 00019 00200 to 00255	00000 to 00019	00000 to 00015	00000 to 00015	00000 to 00127	00000 to 02021 06144 to 06655	-

OMRON CVM1/CV-Series PC Memory Map

<Host Link>

Area	Relay Area (CIO)	Holding Relays (HR)	Auxiliary Relays (AR)	Link Relays (LR)	Timer/Counter Present Values (TIM/CNT)	Data Memory (DM)	Extended Data Memory (Current Bank) (EM)
CV500 CVM1-CPU01-EV□	00000 to 02555	—	00000 to 00511	—	00000 to 00511	00000 to 08191	—
CVM1-CPU11-EV□	00000 to 02555	—	00000 to 00511	—	00000 to 01023	00000 to 09999	—
CV1000 CVM1-CPU11-EV□ CV2000 CVM1-CPU21-EV□	00000 to 02555	—	00000 to 00511	—	00000 to 01023	00000 to 09999	—

<NT Link (1:1)>

Area	Relay Area (CIO)	Holding Relays (HR)	Auxiliary Relays (AR)	Link Relays (LR)	Timer/Counter Present Values (TIM/CNT)	Data Memory (DM)	Extended Data Memory (Current Bank) (EM)
CV500 CVM1-CPU01-EV□	00000 to 02555	—	00000 to 00511	—	00000 to 00511	00000 to 08191	—
CVM1-CPU11-EV□	00000 to 02555	—	00000 to 00511	—	00000 to 01023	00000 to 24575	—
CV1000 CVM1-CPU11-EV□ CV2000 CVM1-CPU21-EV□	00000 to 02555	—	00000 to 00511	—	00000 to 01023	00000 to 24575	00000 to 32765

OMRON CS1-Series PC Memory Map

<Host Link>

Area	Relay Area (CIO)	Holding Relays (HR)	Auxiliary Relays (AR)	Link Relays (LR)	Timer/Counter Present Values (TIM/CNT)	Data Memory (DM)	Extended Data Memory (Current Bank) (EM)
CS1G/CS1H	00000 to 06143	—	00448 to 00959	—	00000 to 02047	00000 to 09999	00000 to 09999

<NT Link (1:N)>

Area	Relay Area (CIO)	Holding Relays (HR)	Auxiliary Relays (AR)	Link Relays (LR)	Timer/Counter Present Values (TIM/CNT)	Data Memory (DM)	Extended Data Memory (Current Bank) (EM)
CS1G/CS1H	00000 to 02555	—	00448 to 00511	—	00000 to 01023	00000 to 24575	00000 to 32765

APPENDIX M

Keycode Tables

ISO 8859/1

	20	30	40	50	60	70	80	90	A0	B0	C0	D0	E0	F0
0		0	@	P	'	p	Space	Space	NBSP	°	À	Ð	à	ð
	32	48	64	80	96	112	128	144	160	176	192	208	224	240
1	!	1	A	Q	a	q	Space	Space	;	±	Á	Ñ	á	ñ
	33	49	65	81	97	113	129	145	161	177	193	209	225	241
2	”	2	B	R	b	r	Space	Space	¢	²	Â	Ò	â	ò
	34	50	66	82	98	114	130	146	162	178	194	210	226	242
3	#	3	C	S	c	s	Space	Space	£	³	Ã	Ó	ã	ó
	35	51	67	83	99	115	131	147	163	179	195	211	227	243
4	\$	4	D	T	d	t	Space	Space	¤	,	Ä	Ô	ä	ô
	36	52	68	84	100	116	132	148	164	180	196	212	228	244
5	%	5	E	U	e	u	Space	Space	¥	□	Å	Õ	å	õ
	37	53	69	85	101	117	133	149	165	181	197	213	229	245
6	&	6	F	V	f	v	Space	Space	¦	¶	Æ	Ö	æ	ö
	38	54	70	86	102	118	134	150	166	182	198	214	230	246
7	'	7	G	W	g	w	Space	Space	§	¦	Ç	×	ç	÷
	39	55	71	87	103	119	135	151	167	183	199	215	231	247
8	(8	H	X	h	x	Space	Space	¨	'	È	Ø	è	ø
	40	56	72	88	104	120	136	152	168	184	200	216	232	248
9)	9	I	Y	i	y	Space	Space	©	¹	É	Ù	é	ù
	41	57	73	89	105	121	137	153	169	185	201	217	233	249
A	*	:	J	Z	j	z	Space	Space	ª	º	Ê	Ú	ê	ú
	42	58	74	90	106	122	138	154	170	186	202	218	234	250
B	+	;	K	[k	{	Space	Space	«	»	Ë	Û	ë	û
	43	59	75	91	107	123	139	155	171	187	203	219	235	251
C	,	<	L	\	l	 	Space	Space	¬	¼	Ï	Ü	ì	ü
	44	60	76	92	108	124	140	156	172	188	204	220	236	252
D	–	=	M]	m	}	Space	Space	¯	½	Í	Ý	í	ý
	45	61	77	93	109	125	141	157	173	189	205	221	237	253
E	.	>	N	^	n	~	Space	Space	®	¾	Î	Þ	î	þ
	46	62	78	94	110	126	142	158	174	190	206	222	238	254
F	/	?	O	_	o		Space	Space	–	¿	Ï	ß	ï	NOT USED 255
	47	63	79	95	111	127	143	159	175	191	207	223	239	

Reference For details of keycode conversion rule (ISO8859/1↔CP437), refer to NT-series Support Tool for Windows 95/98 (Ver 3.0) Operation Manual (V053-E1-□).

MS-DOS CP437

	20	30	40	50	60	70	80	90	A0	B0	C0	D0	E0	F0
0		0	@	P	'	p	Ç	É	á	■	┌	⊥	α	≡
	32	48	64	80	96	112	128	144	160	176	192	208	224	240
1	!	1	A	Q	a	q	ü	æ	Í	■	└	⌋	β	±
	33	49	65	81	97	113	129	145	161	177	193	209	225	241
2	”	2	B	R	b	r	é	Æ	ó	■	┘	⌌	Γ	≥
	34	50	66	82	98	114	130	146	162	178	194	210	226	242
3	#	3	C	S	c	s	â	ô	ú		┐	⌍	π	≤
	35	51	67	83	99	115	131	147	163	179	195	211	227	243
4	\$	4	D	T	d	t	ä	ö	ñ	+	—	⌎	Σ	∫
	36	52	68	84	100	116	132	148	164	180	196	212	228	244
5	%	5	E	U	e	u	à	ò	Ñ	≡	+	┘	σ	J
	37	53	69	85	101	117	133	149	165	181	197	213	229	245
6	&	6	F	V	f	v	å	û	a	≡	┘	⌏	μ	÷
	38	54	70	86	102	118	134	150	166	182	198	214	230	246
7	'	7	G	W	g	w	ç	ù	o	┘	┘	⌐	τ	≈
	39	55	71	87	103	119	135	151	167	183	199	215	231	247
8	(8	H	X	h	x	ê	ÿ	ı	┘	┘	≠	Φ	°
	40	56	72	88	104	120	136	152	168	184	200	216	232	248
9)	9	I	Y	i	y	ë	Ö	¬	≡	┘	┘	Θ	•
	41	57	73	89	105	121	137	153	169	185	201	217	233	249
A	*	:	J	Z	j	z	è	Ü	¬		⊥	┘	Ω	.
	42	58	74	90	106	122	138	154	170	186	202	218	234	250
B	+	;	K	[k	{	ï	ç	½	┘	┘	■	δ	√
	43	59	75	91	107	123	139	155	171	187	203	219	235	251
C	,	<	L	\	l		î	£	¼	≡	┘	■	∞	∞
	44	60	76	92	108	124	140	156	172	188	204	220	236	252
D	—	=	M]	m	}	ì	¥	ı	⊥	≡	■	φ	2
	45	61	77	93	109	125	141	157	173	189	205	221	237	253
E	.	>	N	^	n	~	Ä	Pts	«	≡	┘	■	ε	■
	46	62	78	94	110	126	142	158	174	190	206	222	238	254
F	/	?	O	_	o	⏏	À	f	»	┘	⊥	■	∩	NOT USED 255
	47	63	79	95	111	127	143	159	175	191	207	223	239	

Reference For details of keycode conversion rule (ISO8859/1↔CP437), refer to NT-series Support Tool for Windows 95/98 (Ver 3.0) Operation Manual (V053-E1-□).

INDEX

A

Alarm history	394
Alarm history initialization (PT status control bits)	268
Alarm history record function	437
Alarm list	394
Alarm list/history function (bit memory table)	288
Allowable power supply voltage range	628
Alternate (touch switch)	336
Analogue Meter	366
Applicable connectors	669
Arcs	295
Automatic confirmation	521
Automatic transmission (memory unit)	49, 58

B

Background color (screen attributes)	252
Background function (trend graph)	388
Backlight	616
Backlight (for NT631C only)	616
Backlight (screen attributes)	251
Backlight brightness adjustment	208
Backlight mode (PT status control bits)	266
Backlight status (PT status notify bits)	271
Backlight unit	36
Bar graphs	361
Battery cover	36
Battery status (PT status notify bits)	271
BCD(Numeral storage type)	280
Before operating	28
Binary(Numeral storage type)	280
Bit memory table clear command	572

Bit memory table read command	558
Bit memory table write command	567
Bit memory tables	288
Brightness adjustment	625
Broken line graphs	373
Buzzer (screen attributes)	251
Buzzer function	442

C

Cable connection dimensions	642
Cable for peripheral port of CS1-series PLC	669
Cables with connectors	668
Calling the System Installer mode	154
Calling the System Menu	153
Cell size (Touch panel)	629
Changing numeric values and character strings	486
Changing the displaying order of windows	430
Changing the system settings	165
Changing the trend graph display	502
Character string display	355
Character string input key function	339
Character string input key function (touch switch)	329
Character string memory table clear command	571
Character string memory table read command	556
Character string memory table write command	566
Character string memory tables	284
Character string setting strobe flag (PT status notify bits)	271

Checking communication at serial ports	231	Communication errors and their remedies	614
Checking communication with a printer	234	Communication method for communications with the host	171
Checking communication with the support tool	230	Communication method settings	173
Checking interfaces	230	Communication methods	32
Checking screen data	218	Communication port	32
Checking the backlight (for NT631 only)	224	Communication Protocol (Memory link)	549
Checking the battery voltage	228	Communication type	32
Checking the buzzer	221	Communication Unit	664
Checking the display status of a window	482	Communications specifications	637
Checking the LCD (screen display)	223	Comparison between NT631 and NT631C	6
Checking the printer operating state	539	Compatibility with screen data	656
Checking the PT setting status	212	Connecting a bar code reader	43
Checking the RUN LED	222	Connecting a printer	42
Checking touch switches	227	Connecting directly between RS–232C ports	87
Chemical–resistant cover	671	Connecting to other model PCs	23
Circle	296	Connecting to the Support Tool	41
Cleaning method	624	Connection cable	668
Clearing screen data	155, 167	Connection method	32
Clearing/installing the system program	164	Content update memory table	270
Clock function	444	Continuous buzzer (PT status control bits)	265
Color display	254	Contrast adjustment	207
Comm. A Method	172	Control code input function	340
Comm. B Method	172	Controlling the backlight	460
Comm. B Select	172	Copy destination memory table numbers	262
Comments (PT configuration settings)	450	Copy key function (touch switch)	329, 342
Communication board	65, 66, 79, 82, 113	Copy source/copy destination memory table numbers	262
Communication boards	125	CP437	676
Communication by Using Memory Link	24	CPU	113
Communication condition	172	CPUs	79, 82, 125, 128
Communication condition settings for bar code readers	204	CPUs (for connection via a host link)	665
Communication condition settings for the host link method	172		

CPU's connectable with host link units or expansion communication board	113
Cursor moving key function (touch switch)	330, 343

D

Data logging function (trend graph)	388
Device check	221
Differences between alarm list and alarm history	395
Differences between the NT631/NT631C and the NT631/NT631C	657
Differences between the NT631/NT631C without "V1" and the NT631/NT631C with "V1"	661
Dimensions	628
Direct area changing notify command	577
Direct connection function	15
Direct reference	350, 359
Disabling/enabling System Menu display	165
Disabling/enabling the opening of a window ...	485
Disabling/enabling writing to the screen data memory	166
Display	35
Display capacity	631
Display color	629
Display device	629
Display element specifications	632
Display elements	257
Display history initialization (PT status control bits)	266
Display history record function	434
Display restrictions	633
Display specifications	629
Displaying and printing the display history record	214
Displaying and setting of calendar clock	531
Displaying the date and time	536

Displaying/setting the calendar and clock	210
Downloading the system program	165

E

Effective display area	629
Enclosure ratings	628
Enlarged display	358
Error messages	609
Errors in the system installer mode and their remedies	613
Errors occurring at start of operation	609
Errors occurring during operation	611
Errors occurring on screen data initialization and transmission	612
Errors when using a memory unit	54, 61
Expansion interface connector	36
Expansion Mode	151
External interface specifications	630

F

Finding the screen number of the presently displayed screen	473
Focus window	432
Frequency history screen	250
Functional ground terminal	40
Functions of the allocated bits and words	18

G

General specifications	628
Global window	427
Global window open status	272
GR terminal	36
Grounding	40, 628

H

History (screen attributes)	252
History Setting (PT configuration settings) ...	450
History title (screen attributes)	252

Host link	16
Host link method	65, 112
Host link unit	65, 66, 664
Host notification function	335
Host notification function (touch switch)	328
I	
I/O settings	207
Image data display	312
Image/library lamps	323
In the panel	4
Indirect reference	350, 359
Initial Screen (PT configuration)	450
“Initial” setting and initial value	282
Initializing alarm history record data	158
Initializing display history record data	157
Initializing the memory switches	161
Initializing the memory tables	160
Input key – control function (touch switch)	329
Input numeric value and stored data	409
Inputting a character string using a bar code reader	521
Inputting a numeric value	503
Inputting character strings	421, 519
Inputting numeric values and character strings	543
Inputting numeric values using a thumbwheel type input field	517
Inputting numeric values Using the “input key – control” in a window	511
Inputting operation using touch switches	505
Inspection method	624
Installation environment	38
Installation in the operation panel	38
ISO 8859/1	675

L

Lamps	319
Library data display	315
Life expectancy (backlight)	629
Life expectancy (display panel)	629
Life expectancy (touch panel)	629
Line scrolling touch switches (alarm list/history)	403
Load Local1	253
Load Local1 (Keyboard) (screen number)	251
Load Local2	253
Load Local2 (screen number)	251
Local window	428
Local window1 open status	272
Local window2 open status	272
Long intermittent buzzer (PT status control bits)	265

M

Maintenance Mode	151
Making the cable	650
Making the cable for connecting a PC	653
Making the cable for connection to a bar code reader	654
Making the cable for connection to a printer	655
Manual confirmation	521
Manual transmission (memory unit)	52, 60
Manuals	29
Marks	308
Memory initialization	155
Memory Link Method	130
Memory link method	86
Memory switch	171
Memory switch setting screen	185
Memory table (PT configuration settings)	451

Memory table copy execute (PT status control bits)	267
Memory table copy type (PT status control bits)	267
Memory tables	277
Memory unit	672
Menu tree	152
RUN mode	150
System Installer Mode	150
Momentary (touch switch)	336
Mounting dimensions	641

N

No–display screen	250
Noise resistance	628
Normal (Standard) screens	246
Normal lamps	319, 321
NT link	16
NT link (1:1) method	79
NT link (1:N) method	82, 128
NT–AL001	643
Number of dots	629
Number of switches (touch panel)	629
Numeral display	347
Numeral input	405
Numeral input notify command	574
Numeral memory table clear command	570
Numeral memory table read command	555
Numeral memory table used by the clock function	531
Numeral memory table write command	564
Numeral setting strobe flag (PT status notify bits)	271
Numeral storage Type (PT configuration settings)	451

Numeral/character string input (PT status control bits)	267
Numeric Key Type ("Numerical Input")	405

O

Occurrence history screen	250
Opening a window	543
Opening/Closing/Moving a Window	476
Operating ambient humidity	628
Operating ambient temperature	628
Operating environment	628
Operating force	629
Operation at startup	149
Operation modes	150
Operation of the Memory Link	546
Overlapping screens	247
1:N connection among RS–422A ports	137
1:N connection among RS–485 ports	140
1:N connection between RS–422A/485 at the NT631/NT631C and RS–232C at the host	102

P

Page scrolling touch switches (alarm list/history)	404
Peripheral devices that can be connected	26
Permissible display range (numeral display)	352
Polygon	298
Polyline	300
Pop–up window/keyboard function	340
Power consumption	628
Power input terminals	36
POWER LED	35
Power supply connection	39
Precautions to be observed when transmitting screen data	170

Principal functions of NT631/NT631C	8
Print function	445
Printer cable	669
Printer connector	36
Printer operating status (PT status notify bits)	271
Printing a screen image	446
Printing display history and alarm history record data	447
Printing the screen	540
Procedure for creating and using image data	313
Procedure for creating and using library data	316
Processing priority registration (PT status control bits)	264
Programming console function	236
Programming console function screen	250
Programming environment	630
Protective sheet	670
PT	664
Comments (PT Configuration Settings)	450
PT Control Area/PT Notify Area (PT configuration settings)	450
PT Memory	24, 546
PT memory batch write (FILL) command	569
PT memory changing notify command	580
PT memory read command	553
PT memory write command	562
PT Model (PT configuration settings)	450
PT operation mode switching command	581
PT operation status (PT status notify area) ...	270
PT screen switching (PT status control bits) ...	267
PT status control area	259
PT status control bits	263

684

PT status notify area	268
PT status notify bits	270
PT window opening bit (PT status control bits)	267

R

Rated power supply voltage	628
Re-send request command	582
Recommended printers	42
Rectangle	297
Redisplaying the turned-off screen	464
Relationship between contents of host words and displayed numeric value	353
Relationship between input numeric values and contents of host words	411
Relationship between system program and hardware	663
Relationships among modes	150
Replace Local Windows	341
Replaceable backlight	670
Replacement battery	672
Replacing the backlight	617
Replacing the battery	622
Reset (touch switch)	336
Reset switch	36
Restrictions due to element coefficients	634
Restrictions on data reading	633
Restrictions on overlapping screens	248
Restrictions on using a temporary input field ..	515
Restrictions specific to character string input when using temporary input fields	519
Resume function	440
“Return to previous screen” designation	250
RS-232C adaptor	667
RS-232C/RS-422A convertor unit	96, 667
RS-422A adaptor	667

RUN	150
RUN LED	35
RUN mode	160

S

Scale	372
Screen attributes	251
Screen changeover function (bit memory table)	288
Screen comment (screen attributes)	252
Screen composition	246
Screen creation procedure	454
Screen data comment read command	560
Screen data composition and transmission units	168
Screen data memory check	225
Screen display (PT status control bits)	264
screen No.	272
Screen No. (Window control area)	273
Screen numbers	246
Screen print key function (touch switch)	330, 345
Screen printing (PT status control bits)	266
Screen saver function	441
Screen switch setting	260
Screen switching function	338
Screen switching strobe (PT status notify area)	271
Screen types	246
Sector	301
Selecting menu items	154
Serial communication board	65, 112
serial communication boards	82
Serial communication unit	65, 112
Serial port A	27, 32

Serial port A connector	36
Serial port B	27, 32
Serial port B connector	36
Set	174
Set (touch switch)	336
Setting "Screen Saver Movement"	193
Setting the automatic reset function	199
Setting the bar code reader input function	204
Setting the "Buzzer Sound"	188
Setting the communication type for serial port B	181
Setting the conditions for communications with the memory link method	172
Setting the date and time	532
Setting the display language in the System Installer mode	163
Setting the history display method	196
Setting the host link method	173
Setting the "Key Press Sound"	187
Setting the Memory Link Method	178
Setting the NT link (1:1) method	175
Setting the NT link (1:N) method	176
Setting the "Print Method"	191
Setting the "Printer Controller"	190
Setting the resume function	198
Setting the retry count	202
Setting the screen saver start-up time	195
Setting the "Start-up Wait Time"	186
Setting the terminal resistance	110, 144
Setting the time-out interval	201
Shock resistance (operating)	628
Short intermittent buzzer (PT status control bits)	265
Size and display position of a window	430

Smoothing	358
Sounding the buzzer	456
Special features	635
Specifying the objective numeral setting input field using the input key – control	508
Standard type (trend graphs)	386
Starting operation	183
Starting the NT631/NT631C	149
Stopping the buzzer sound	458
Storage ambient temperature	628
Storage type and stored data	280
Storage type for the BCD format	280
Stored data and displayed numeric value	351
Supplemental functions to V1	6
Support Tool	668
Switching from the System Menu to the RUN mode	154
Switching the screen	467, 543
Switching to the RUN mode	183
System configuration	26
System Installer Mode	150
“System initializing” screen	250
System Menu	150
System screens	250
System status read command	561

T

Terminal resistance setting terminal	110
Text (fixed display)	303
Thumbwheel type	413
Thumbwheel type (Numeric input)	413
Tiling	306
Touch switch input notify command	573
Touch switches	327
Transmit Mode	151

686

Transmitting the screen data	168
Transparent	255
Transparent display	255
Transporting and storing the NT631/NT631C ..	649
Trend graphs	379
Turning off the screen	462

U

Upper/lower (max./min.) limit check	412
Usable systems (programming console function)	237
Using a Memory Unit(NT631/NT631C with V1) .	46
Using an RS–232C/RS–422A convertor unit ..	643
Using the alarm list/history function	523
Using the display history function	528

V

Vibration resistance (operating)	628
View angle	629

W

Warning label	36
Waterproofed	4
Weight	624
Window Control Area	272
Window key function (touch switch)	329
Window move key function	330
Window screens	249
Window Type	427

X

X coordinate	272
X coordinate (Window control area)	273
XOR	254

Y

Y coordinate	272
Y coordinate (Window control area)	273

Z

Zero suppression 351

Revision History

A manual revision code appears as a suffix to the catalog number on the front cover of the manual.

Cat. No. V044-E1-2

↑
Revision code

The following table outlines the changes made to the manual during each revision. Page numbers refer to the previous version.

Revision code	Date	Revised content
1	July 1998	Original production
2	March 1999	Revisions associated with model change