

NT31 and NT31C

Programmable Terminals

SETUP MANUAL



OMRON

NT31and NT31C Programmable Terminals

Setup Manual

Produced July 2000

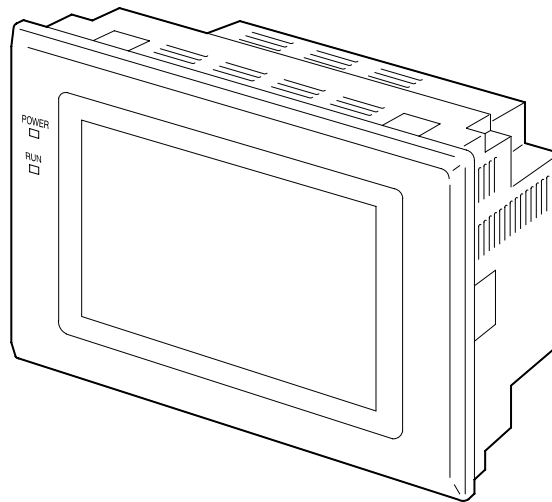



Notice:

OMRON products are manufactured for use according to proper procedures by a qualified operator and only for the purposes described in this manual.

The following conventions are used to indicate and classify precautions in this manual. Always heed the information provided with them. Failure to heed precautions can result in injury to people or damage to property.

 **DANGER** Indicates an imminently hazardous situation which, if not avoided, will result in death or serious injury.

 **WARNING** Indicates a potentially hazardous situation which, if not avoided, could result in death or serious injury.

 **Caution** Indicates a potentially hazardous situation which, if not avoided, may result in minor or moderate injury, or property damage.

OMRON Product References

All OMRON products are capitalized in this manual. The word "Unit" is also capitalized when it refers to an OMRON product, regardless of whether or not it appears in the proper name of the product.

The abbreviation "Ch," which appears in some displays and on some OMRON products, often means "word" and is abbreviated "Wd" in documentation in this sense.

The abbreviation "PC" means Programmable Controller and is not used as an abbreviation for anything else.

Visual Aids

The following headings appear in the left column of the manual to help you locate different types of information.

Note Indicates information of particular interest for efficient and convenient operation of the product.

1, 2, 3... 1. Indicates lists of one sort or another, such as procedures, checklists, etc.

© OMRON, 2000

All rights reserved. No part of this publication may be reproduced, stored in a retrieval system, or transmitted, in any form, or by any means, mechanical, electronic, photocopying, recording, or otherwise, without the prior written permission of OMRON.

No patent liability is assumed with respect to the use of the information contained herein. Moreover, because OMRON is constantly striving to improve its high-quality products, the information contained in this manual is subject to change without notice. Every precaution has been taken in the preparation of this manual. Nevertheless, OMRON assumes no responsibility for errors or omissions. Neither is any liability assumed for damages resulting from the use of the information contained in this publication.

TABLE OF CONTENTS

PRECAUTIONS	xi
1 Intended Audience	xii
2 General Precautions	xii
3 Safety Precautions	xii
SECTION 1	
General	1
1-1 Role and Operation of the NT31/NT31C	2
1-2 Functions of the NT31/NT31C	4
1-3 System Configuration	16
1-4 Communications with the Host	17
1-5 Communications Using Memory Links	20
1-6 Before Operating	22
SECTION 2	
Preparing for Connection	25
2-1 Method for Connection to the Host	26
2-2 Names and Functions of Parts	29
SECTION 3	
Hardware Settings and Connections	31
3-1 Installation	32
3-2 Connecting to the Support Tool	35
3-3 Connecting a Printer	36
3-4 Connecting a Bar Code Reader	37
3-5 Using a Memory Unit (-V□ Versions)	39
3-6 Using a Memory Unit (Versions without the -V□ Suffix)	47
SECTION 4	
Connecting to the Host from the RS-232C Port	53
4-1 Connecting to the RS-232C Port at the Host	54
SECTION 5	
Connecting to the Host from the RS-422A/485 Port	85
5-1 Connecting to the Host's RS-232C Port	86
5-2 Connecting to the Host's RS-422A/485 Port	100
SECTION 6	
System Menu Operation	131
6-1 System Menu Operation Flow	133
6-2 Starting the NT31/NT31C	134
6-3 Operation Modes and the System Menu	135
6-4 Memory Initialization	140
6-5 Operations in the System Installer Mode	150
6-6 Transmitting the Screen Data	155
6-7 Setting Conditions for Communications with Host by Using Memory Switches	157
6-8 Starting Operation	168
6-9 System Settings	168
6-10 Setting the Bar Code Reader Input Function	188
6-11 System Maintenance	191
6-12 Programming Console Function	221
6-13 Device Monitor Function	227
6-14 Version Display	230

TABLE OF CONTENTS

SECTION 7

Troubleshooting and Maintenance 231

7-1 Troubleshooting	232
7-2 Responding to Displayed Error Messages	235
7-3 Maintenance of the NT31/NT31C	241
7-4 Inspection and Cleaning	245

Appendices

A Specifications	247
B Dimensions	255
C Using an RS-232C/RS-422A Convertor Unit	259
D Transporting and Storing the NT31/NT31C	265
E Making the Cable	267
F Making the Cable for Connecting a PC	269
G Making the Cable for Connection to a Bar Code Reader	271
H Making the Cable for Connection to a Printer	273
I Relationship between System Program and Hardware	275
J Model List	277
K Option List	283

Index 285

Revision History 289

About this Manual:

This manual describes connecting the NT-series NT31 and NT31C Programmable Terminals to a PC (Programmable Controller) or other host and peripheral devices and the settings required for communications and applications. It includes the sections described below.

Please read this manual carefully and be sure you understand the information provided before attempting to install and operate the Programmable Terminal.

Section 1 provides fundamental information about the functions and features of the PTs, types of connection, communication methods, etc. This information will enable you to understand the applications of the PTs.

Section 2 describes the connection methods that are possible with the PTs, and the functions of the parts of PTs, as the required knowledge before connecting to the host and to the peripheral devices.

Section 3 describes the settings of the PTs and methods for connection to peripheral devices.

Section 4 describes the method for connecting to the host using the RS-232C port of the PT.

Section 5 describes the method for connecting to the host using the RS-422A/485 port of the PT.

Section 6 describes the operation of the System Menu, focusing on the procedure to start the PT. Functions that are convenient when using the PT and those that are useful for system maintenance are also explained here.

Section 7 describes the action to take when errors occur in the PT, and how to carry out maintenance and inspection to prevent the occurrence of errors.

The **Appendices** provide specifications, dimensions, procedures for using an RS-232C/RS-422A Converter Unit, procedures for transporting and storing the PT, information on cable preparation, information on the relationship between the system program and hardware, and product lists.



WARNING Failure to read and understand the information provided in this manual may result in personal injury or death, damage to the product, or product failure. Please read each section in its entirety and be sure you understand the information provided in the section and related sections before attempting any of the procedures or operations given.

Related Manuals:

Related manuals are listed below.

The □ symbol at the end of the catalog number is the revision number.

Connecting and Setting Up the Programmable Terminal

- NT31 and NT31C PT Setup Manual (V062-E1-□, this manual)

This manual describes connecting the Programmable Terminals to a host and peripheral devices and settings required for communications and applications.

The functions and actual operating methods for the NT31 and NT31C PTs are provided in the *Reference Manual* (V064-E1-□).

Programmable Terminal Functions and Operation

- NT31/31C/631/631C PT Reference Manual (V064-E1-□)

This manual is used for any of the following PTs: NT31, NT31C, NT631, and NT631C. It describes screen configurations, part functions, host control methods, and other application information.

PT connection and setup procedures are described in the *NT31 and NT31C PT Setup Manual* (V062-E1-□).

Creating and Transferring Screen Data, and Installing the System Program

- NT-series Support Tool for Windows Ver. 4.1 Operation Manual (V061-E1-□)

The screens displayed on the NT31 and NT31C PTs are created with the Support Tool and transferred to the PT. This manual describes how to create and transfer screen data. It also describes how to download a system program to a PT using the System Installer.

The NT-series Support Tool for Windows is normally referred to as merely the Support Tool.

Connecting to Controllers Not Made by OMRON

- PC Connection Manual (V042-E1-□)

The NT31 and NT31C PTs can be connected to controllers in the following series: Mitsubishi A Series and FX Series. This manual describes the connection and setup methods for these controllers.

The NT-series Support Tool for Windows Version 4.1 is required to connect the NT31 and NT31C PTs to these controllers.

- NT31/NT631 Multi Vendor Connection Manual (V060-E1-□)

The NT31 and NT31C PTs can be connected to controllers in the following series: Allen-Bradley SLC 500 Series, GE Fanuc 90-20 and 90-30 Series, and Siemens S7-300 and S7-400 Series. This manual describes the connection and setup methods for these controllers.

PRECAUTIONS

This section provides general precautions for using the Programmable Terminal.

The information contained in this section is important for the safe and reliable application of the Programmable Terminal. You must read this section and understand the information contained before attempting to set up or operate a Programmable Terminal.

1 Intended Audience	xii
2 General Precautions	xii
3 Safety Precautions	xii

1 Intended Audience

This manual is intended for the following personnel, who must also have knowledge of electrical systems (an electrical engineer or the equivalent).

- Personnel in charge of introducing FA systems into production facilities.
- Personnel in charge of designing FA systems.
- Personnel in charge of installing and connecting FA systems.
- Personnel in charge of managing FA systems and facilities.

2 General Precautions

The user must operate the product according to the performance specifications described in the operation manuals.

Before using the product under conditions which are not described in the manual or applying the product to nuclear control systems, railroad systems, aviation systems, vehicles, combustion systems, medical equipment, amusement machines, safety equipment, and other systems, machines and equipment that may have a serious influence on lives and property if used improperly, consult your OMRON representative.

Make sure that the ratings and performance characteristics of the product are sufficient for the systems, machines, and equipment, and be sure to provide the systems, machines, and equipment with double safety mechanisms.

This manual provides information for using the Programmable Terminal. Be sure to read this manual before attempting to use the software and keep this manual close at hand for reference during operation.

 **WARNING** It is extremely important that Programmable Terminals and related devices be used for the specified purpose and under the specified conditions, especially in applications that can directly or indirectly affect human life. You must consult with your OMRON representative before applying Programmable Terminals to the above-mentioned applications.

 **WARNING** Do not use input functions such as PT touch switches for applications where danger to human life or serious damage is possible, or for emergency switch applications.

3 Safety Precautions

Read these safety precautions carefully and make sure you understand them before using the Programmable Terminal so that you can use it safely and correctly.

Safety Conventions and their Meanings

This operation manual uses the following conventions and symbols to indicate cautions, warnings, and dangers in order to ensure safe use of the NT31/31C. The cautions, warnings, and dangers shown here contain important information related to safety. This instructions in these cautions, warnings, and dangers must be observed.

The conventions used and their meanings are presented below.

 **WARNING** Indicates information that, if not heeded, could possibly result in loss of life or serious injury.

Caution Indicates information that, if not heeded, could result in relatively serious or minor injury, damage to the product, or faulty operation.

 **WARNING**

Do not attempt to take the unit apart and do not touch any internal parts while the power is being supplied. Doing either of these may result in electrical shock.

 **WARNING**

Switch OFF the NT31/NT31C power before replacing the backlight. Otherwise you could sustain an electric shock.

 **CAUTION**

Do not touch the backlight immediately after switching OFF the power supply.
Otherwise burn injuries may result due to the high temperatures.



SECTION 1

General

This section provides fundamental information about the functions and features of the PTs, types of connection, communication methods, etc. This information will enable you to understand the applications of the PTs.

1-1	Role and Operation of the NT31/NT31C	2
1-1-1	Operation of an NT31/NT31C at an FA Production Site	2
1-1-2	Operations of the NT31/NT31C	3
1-2	Functions of the NT31/NT31C	4
1-2-1	Features	4
1-2-2	Comparison between NT31 and NT31C	5
1-2-3	Additional Functions of the V2 Versions	6
1-2-4	Comparison between NT30/NT30C and NT31/NT31C	7
1-2-5	Principal Functions of NT31/NT31C	9
1-2-6	Displays	11
1-3	System Configuration	16
1-3-1	Peripheral Devices That Can Be Connected	16
1-3-2	Connecting to the Host	17
1-4	Communications with the Host	17
1-4-1	Direct Connection Function	17
1-4-2	Host Link	18
1-4-3	NT Link	18
1-4-4	Connecting to other Companies' PCs	20
1-5	Communications Using Memory Links	20
1-5-1	Memory Link	20
1-5-2	Comparison between Direct Connection and Memory Link	21
1-5-3	Memory Link Online Transfer Function	21
1-6	Before Operating	22

1-1 Role and Operation of the NT31/NT31C

The NT31/NT31C is a sophisticated display unit (programmable terminal) which automatically displays information and can also be used for operations when necessary. The following gives a general description of the role and operation of the NT31/NT31C for those using a programmable terminal (PT) for the first time.

1-1-1 Operation of an NT31/NT31C at an FA Production Site

Production Line Status Monitoring

The NT31/NT31C displays real-time information about the system and equipment operating status, etc. Its power of expression is enhanced by graphs and other visuals, making the displays easy to understand.

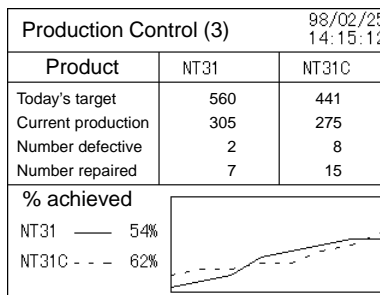

Directions to Workers on the Shop Floor

The NT31/NT31C warns of system or equipment failures and prompts the appropriate remedial action.

Alarm

Assembly line B

Positioning pin

is defective. Line stopped.

Check the following.

1. Defective pin L3
2. Position of dog M2
3. Mounting of photosensor P5

Panel Switch Functions

Setting touch switches on the NT31/NT31C allows workers to use the NT31/NT31C as an operating panel; the results of the operations are transmitted to the host.

Electroplating control			
Transport	Electr. head	Wash. head	Corr. prv. head
<div style="display: flex; justify-content: space-around;"> <div style="text-align: center;"> ↑ Clamp ← → ↓ Unclamp </div> <div style="text-align: center;"> UP DOWN </div> <div style="text-align: center;"> UP DOWN </div> <div style="text-align: center;"> UP DOWN </div> </div>	<div style="display: flex; justify-content: space-around;"> <div style="text-align: center;"> Adv. Rev. </div> <div style="text-align: center;"> Electro-lyte </div> <div style="text-align: center;"> Wash </div> <div style="text-align: center;"> Corr. prv.fluid </div> </div>		

1-1-2 Operations of the NT31/NT31C

Displays Screens

The information to be displayed (screen data) can be created on a computer using the Support Tool and stored in the NT31/NT31C. The screen data can be displayed on the NT31/NT31C in response to instructions from the host or touch switch operation.

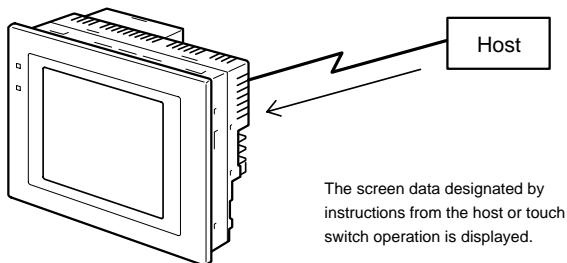

Receives Data from a Host

The NT31/NT31C can be connected to the host by a host link or NT link and receive necessary data from the host.

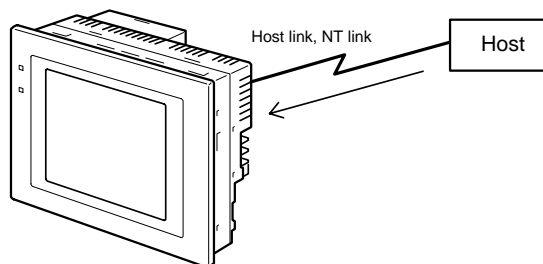

Sends Data to a Host

Data input using the touch panel (switch ON/OFF statuses, numeric values, character strings) can be transmitted to the host.

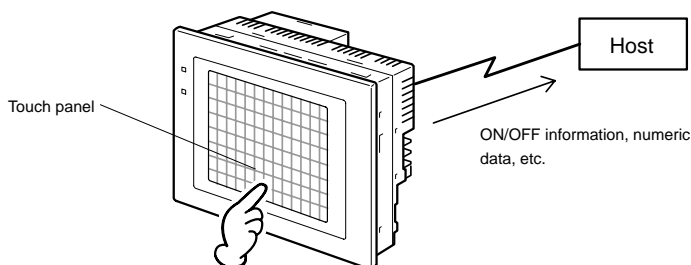

Screen Data

The screen data to be displayed on the NT31/NT31C can be created on a personal computer using the Support Tool. Connect the NT31/NT31C to the personal computer with an RS-232C cable and transmit the screen data to the NT31/NT31C.

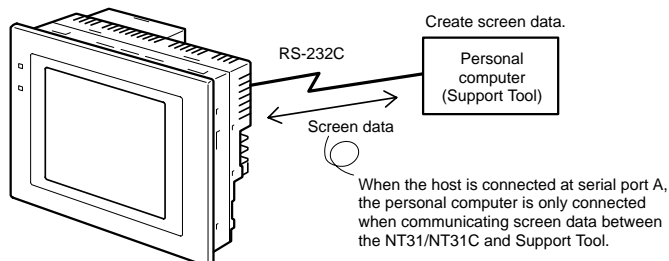

1-2 Functions of the NT31/NT31C

The NT31/NT31C has the following features.

1-2-1 Features

Downsized Body

- Slim body (50 mm or less in the panel*).
 - The communication cable connectors are housed in the unit so that they do not protrude from the unit.
- * When mounted in a panel of the recommended thickness (page 32).

Construction Best Suited to the FA Environment

- The panel is an STN monochrome LCD type with backlight for the NT31 and an STN color LCD type with backlight for the NT31C.
 - The backlight unit and battery can be replaced at the operation site.
 - Waterproofed equivalent to the NEMA4 standard and to IP65F*.
- * The panel may not be usable in environments where it is exposed to oil for long periods.

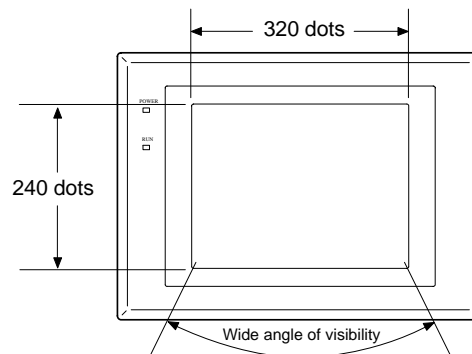

Touch Switch Operation

Contrast and brightness are adjustable by touch switch operations.

Compatibility with Other PTs

- There is upward compatibility between the NT31/NT31C and the following models for screen data and user programs: NT11S, NT20S, NT30, NT30C, NT600S, NT610G, NT610C, NT620S, NT620C, NT625C, NT631, NT631. (After being read to the Support Tool, screens must be modified in accordance with the screen size. Depending on the function used, partial modification of programs may also be necessary. For details on the compatibility of screen data, refer to the *NT31/NT31C/NT631/NT631C Programmable Terminal Reference Manual* and the *NT-series Support Tool Operation Manual*.)
- The dimensions of the panel cut-out to accommodate the NT31/NT31C are the same as for the NT30/NT30C.

Two Ports Featured as Standard:

Port A for Common Use by Support Tool/Host and Port B for Exclusive Use by the Host

- Communication with the host is possible via another port while connected to the Support Tool.
- Reading bar code data from a bar code reader is possible via another port while communicating with the host.

Rapid System Program & Screen Data Changes Possible Using a Memory Unit

- Installing a memory unit (type NT-MF261) on the rear of the NT31/NT31C makes it easy to write screen data into the NT31/NT31C on site. This enables a rapid response to setup changes.
- NT31/NT31C can store a system program into a memory unit. This enables the system to handle more flexible setups.

Screen Data Check Function	Screen data can be checked simply by operations at the NT31/NT31C system menu, without connecting up to the Support Tool.
Increased Screen Data Capacity	The data capacity of 1 MB is twice that of the NT30/NT30C, enabling storage of a larger quantity of screen data.
Large Increase in Maximum Number of Registered Elements	The number of elements that can be registered on one screen has been considerably increased, making it possible to create more expressive screens. For details, refer to <i>Display Restrictions</i> in <i>Appendix A Specifications</i> of the <i>NT31/NT31C/NT631/NT631C Programmable Terminal Reference Manual</i> .
Binary Data can be Read to/Written from the Host	It is now possible to write binary data stored in words at the host directly to the NT31/NT31C. This makes data conversion by a program at the host unnecessary, reducing the load on the host.
Character Display Using High Definition Fonts	Any quadrupled characters are displayed with a 32 dot high-definition font.
Simple Version Upgrades	By using the system installer supplied with the Support Tool (Type NT-ZJCAT1-EV4), the system program at the NT31/NT31C can be changed easily from a personal computer.
Complies with International Standards	The NT31/NT31C meets UL/CSA standards and EC directives.
Compatible with Other Vendors' Devices	Compatible with Sequencers in the following series: Mitsubishi A-series (Calculator Link) and FX-series (Programming Console), Allen-Bradley SLC 500 Series, GE Fanuc 90-20 and 90-30 Series, and Siemens S7-300 and S7-400 Series. Specialized system programs can be installed that allow the NT31/NT31C to be controlled from other companies' Sequencers.
Multiple Windows	Up to 3 windows can be displayed simultaneously in the normal screen. A 9-word window control area has been allocated to the host; the contents of these 9 words can be changed from the Host to open, close, and move windows.

1-2-2 Comparison between NT31 and NT31C

Two NT31 models — the NT31, which is capable of versatile graphic displays, and the NT31C, which is also capable of color display — are available. The differences between the NT31 and NT31C are tabled below:

Function	NT31	NT31C
Type	NT31-ST121-EV2 (Beige) NT31-ST121B-EV2 (Black)	NT31C-ST141-EV2 (Beige) NT31C-ST141B-EV2 (Black)
Display panel	STN monochrome LCD display type (with white backlight)	STN color LCD type (with white backlight)

Beige and black are the front panel colors of each NT31/NT31C types.

1-2-3 Additional Functions of the V2 Versions

The V2 versions of NT31/NT31C are supplemented and enhanced by the following functions.

High-speed 1:N NT Link	The V2 versions are compatible with the high-speed 1:N NT Link as well as the earlier standard 1:N NT Link.
Additional Mathematical Functions	Operands (values referenced by formula) can be registered to allow the PT to perform calculations automatically and write the results of those calculations to numeral memory tables or words in the host.
Device Monitor Function	The new device monitor function can be used to change the PC's operating mode or display/change values in the PC's memory areas. The present values (PVs) of several words can be listed with the device monitor.
Interlock Function	PT operations and inputs can be disabled from the PC if interlock bits have been allocated in the PC for the corresponding PT touch switches, numeric inputs, or string inputs.
Improved Lamp/Touch Switch Labels	<p>The following displays can be performed with lamp or touch switch labels:</p> <ul style="list-style-type: none"> • Display several lines of labels. • Switch the display between different labels when OFF and ON. • Display the numeral memory table contents as labels. • Display the string memory table contents as labels.
NT30/NT30C and NT620S/NT620C/NT625C Emulation	<p>The word configuration of the PT status control area and PT status notify area can be set to emulate those of the NT30/NT30C or NT620S/NT620C/NT625C; this mode is called NT30/620 compatible mode.</p> <p>When the PT is operating in NT30/620 compatible mode, it will be equivalent to an NT30/NT30C or NT620S/NT620C/NT625C in the functions listed below. The PT retains full V2 functionality in all functions other than the ones listed below. Refer to <i>Appendix C</i> in the <i>NT31/NT31C/NT631/NT631C Programmable Terminal Reference Manual</i> for more details.</p> <ul style="list-style-type: none"> • Word configuration and functions of the PT status control area and PT status notify area • Image/library codes • Insertion of image/library data into character strings
Additional CS1 Data Areas Accessible	<p>Data areas in CS1 PCs that were previously inaccessible can be accessed. The data areas listed below can be accessed (read/written).</p> <p style="padding-left: 40px;">All banks in the EM area, timer completion flags (TU), counter completion flags (CU), Work areas (WR), Task flags (TK), and the HR area.</p>
Recipe Function	You can set the data (numeric values) for multiple words in record units using the tabular elements on the PT screen, and write these settings in a single operation to words on the host (i.e., PC or PT memory) using a touch switch operation on the PT Unit. Also, multiple words of numeric data can be read from the host in one operation. In this way, groups of parameter settings can be edited at the PT Unit, and written to or read from the host.
Adjusting Contrast and Brightness During PT Operation	You can display the brightness and contrast adjustment screen using either the touch switch or commands from the host, even while the PT is in operation.

1-2-4 Comparison between NT30/NT30C and NT31/NT31C

Item		NT30/NT30C	NT31/NT31C
Support Tool used		NT-ZJCAT1-EV4 or NT-ZA3AT-EV2	NT-ZJCAT1-EV4
DIP switches		On rear of unit	None (software settings)
Use of B7A unit		Possible	Not possible
Use of memory unit		Not possible	Possible
RS-232C interface		Connector (9-pin) also used as port for screen data transfer.	- Serial port A connector (also used for screen data transfer, 9-pin) - Serial port B connector (for host communications only, 25-pin)
RS-422A/485 interface		Terminal block	Serial port B (25-pin D-SUB connector)
Replacement backlight		NT30-CFL01/NT30C-CFL01	NT31C-CFL01 (common use)
NT31/NT31C system program data		NT-ZS3AT-EV1 (including system installer)	The system installer and system program data are supplied with the Support Tool.
High-speed 1:N NT Link		Not possible	Possible* ¹
Memory Link	System program	Exclusive use by Memory Link	Same as OMRON connection
	Screen data	Shared with OMRON connection	Exclusive use by Memory Link
LCD contrast adjustment		By a control on the rear of the unit	By touch panel operation
Backlight brightness adjustment		Not possible	By touch panel operation
Number of user-registered screens		Maximum of 2000	Maximum of 3999
Screen data capacity* ² (User program memory)		512 KB	1 MB
Numeral string data		Maximum of 1000	Maximum of 2000
Character string data		Maximum of 1000	Maximum of 2000
Bit data		256	Maximum of 1000
Mathematical tables		None	256 max. Calculations can be executed automatically in the PT.* ¹
Image data		Maximum of 224	Maximum of 4095* ³
Library data		Maximum of 896	Maximum of 12288* ³
Method for storing numeric values (numeral memory data and PT status control area)		Fixed as BCD (binary coded decimal)	Selectable from BCD (binary coded decimal) or binary
PT status control area size		4 words	5 words (partial change of contents)* ³
PT status notify area size		3 words	2 words (partial change of contents)* ³
Window control area size		None	9 CH* ²
Registering continuous screen		Possible	Not possible (Use a screen switchover as a substitute.)
Lamp/Touch switch labels		Fixed display (1 line only)	- Multiple lines can be displayed* ¹ - ON/OFF switching is possible* ¹ - Numeral display is possible* ¹ - Character string display is possible* ¹
Interlock function		None	Operations can be disabled from the PC by allocating interlock bits to the corresponding touch switch, numeral input, or character string input.* ¹
Device monitor function		Not possible	Possible* ¹

Item	NT30/NT30C	NT31/NT31C
Recipe function	None	Possible
Accessible CS1 PC data areas	---	The data areas listed below can be accessed in addition to the data areas accessible with the NT30/NT30C.*5 - EM banks (EM_0 to EM_C) - Timer completion flags (TU) - Counter completion flags (CU) - Work areas (WR) - Task flags (TK) - HR area

*1: These functions are available only in V2 versions of the NT31/NT31C.

*2: This is the capacity of the flash memory that stores screen data.

*3: The values are the same as the NT30/NT30C when the PT is in NT30/620 compatible mode.

*4: The window control area can be used only in the V□ versions of the NT31/NT31C.

For differences in programming, refer to *Appendix B* in the *NT31/NT31C/NT631/NT631C Programmable Terminal Reference Manual*.

1-2-5 Principal Functions of NT31/NT31C

The following are the principal functions of the NT31/NT31C.

Functions relating to data display

Character display
 Characters of various sizes can be displayed. Characters can be flashed and displayed in reverse video. High grade fonts are available for the characters with their size enlarged.

Graphic display
 Polylines, rectangles, polygons, circles, circular arcs, and sector shapes can be displayed. They can also be tiled with various patterns, flashed, or displayed in reverse video.

Memory data display
 The contents of character string memory tables and numeral memory tables can be displayed. The contents of memory tables can be changed from the host.

Graph display
 Not only bar graphs but also broken line graphs, trend graphs, and analogue meter graphs can be displayed using numeral memory tables

Lamp display
 Lamps can be turned on and flashed under the control of the host. It is also possible to display different graphics in the ON and OFF states.

Alarm list/history display
 Warning messages are automatically displayed in a list in response to the state of a host bit. The time and the number of times of the messages appeared can also be displayed.

Functions relating to data output

Buzzer
 A built-in buzzer can be sounded.

Screen printing
 A hard copy of the currently displayed screen can be printed at the printer connected to the NT31/NT31C.

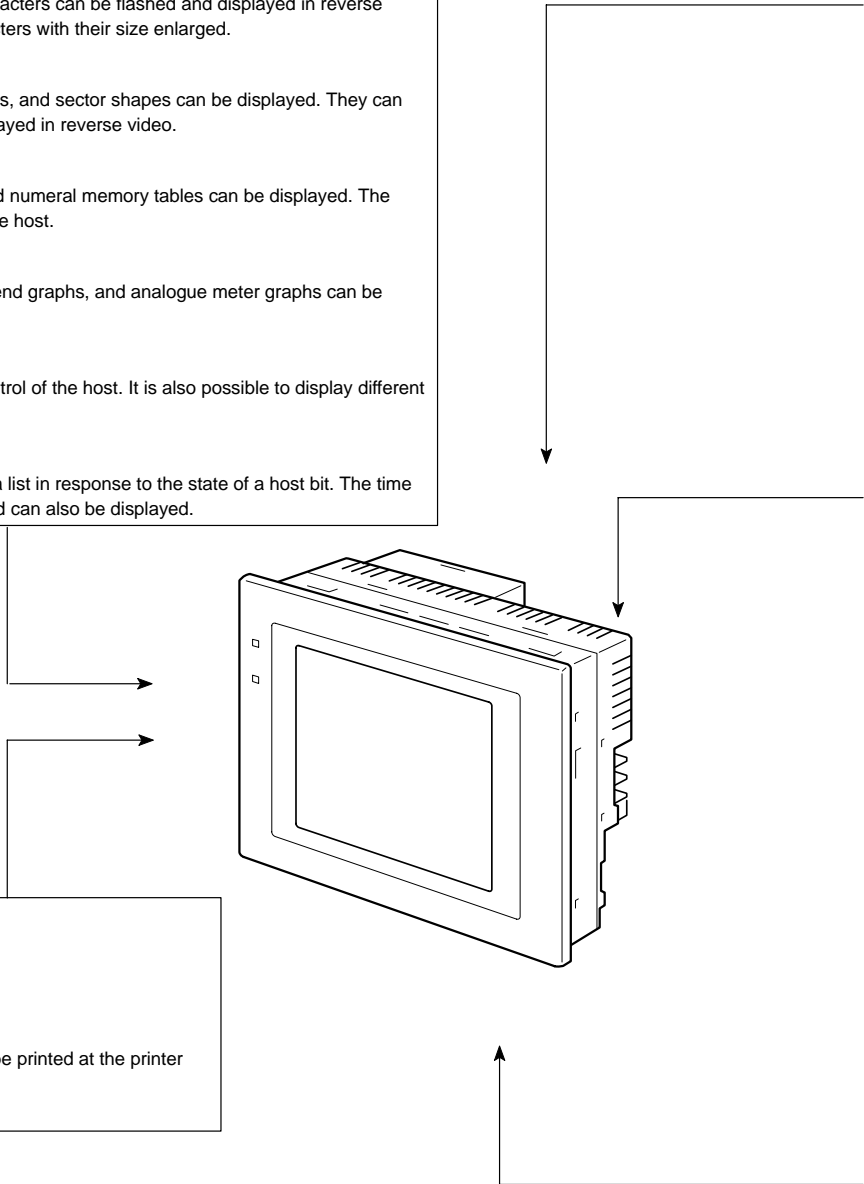
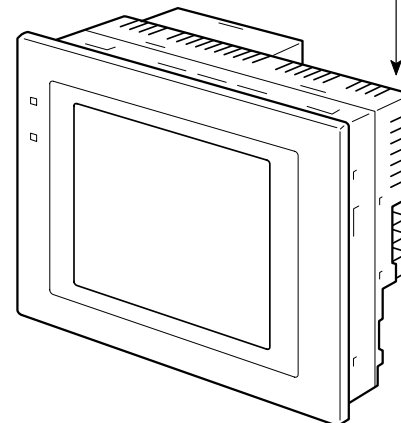

Functions relating to data input

Input by touch switches

Data can be input by simply touching touch switches displayed on the screen.
The possible functions of touch switches include sending data to the host and changing the screen display.
Inputs can be enabled and disabled from the host when interlock bits have been allocated.

Pop-up window function

A window overlaying the currently displayed screen can be alternately opened and closed by pressing a touch switch.
In addition to fixed character and graphic displays, control keys and character keys created as touch switches can also be set inside the window. A maximum of three windows can be displayed simultaneously. Since the window need only be opened when input is required, the screen can be used efficiently.

Numeral/character string setting function

Numeric keys and character keys can be assigned to touch switches so that numeric values and character strings can be input at the operation site.
The input data is written to numeral/character string memory tables and also sent to the host. It is also possible to disable input by control from the host.

Recipe function

Several words of numeric data can be edited at the PT Unit, and written to or read from the host in one operation.

Input from a bar code reader

Data read with a bar code reader can be input to a character string input field.

Functions relating to communication

Communications with the host

The NT31/NT31C can communicate with the host by four methods: host link, 1:1 NT Link, 1:N NT link (standard or high-speed), and Memory link. Data can be read from the host, and data input by means of touch switches and numeral/character string settings can be sent to the host. It is also possible to connect with other model PCs.

Functions relating to the system

System menu

System settings and maintenance can be performed by selecting from system menus displayed on the screen.

Creation of screen data

Screen data created using the Support Tool at a personal computer can be transferred and stored in the built-in screen data memory.

Resume function

The status and memory table contents of the NT31/NT31C immediately before its operation is stopped can be stored while operation is stopped, or while the power is off, and then displayed on the screen again when operation is restarted.

Screen saver function

This function serves to extend the service life of the backlight and prevent the formation of an afterimage on the screen.

Clock function

The time can be displayed in accordance with the internal clock data.

Programming Console function

The PT can perform the same operations as a C200H-PR027-E Programming Console when the PT is connected to a CPM1, CPM2A, CPM2C, CQM1, CQM1H, C200HX/HG/HE-(Z)E, or SRM1 PC in a 1:1 NT Link connection, or a CS1G/CS1H PC in a 1:N NT Link connection.

Device Monitor function

When the PT is connected to a PC in a 1:1 NT Link or 1:N NT Link, the PT can be used for operations such as changing the PC's operating mode, displaying or changing the PVs of words, or reading the error log.

System program install function

The system program of the NT31/NT31C can be changed by using the system installer supplied with the Support Tool (NT-ZJ3AT1/ZJCAT-EV2). It can also be installed by using a memory unit (NT-MF261).

Screen display history function/alarm history function

The screen display history function records the time at which specific screens are displayed and the number of times they are displayed.
The alarm history function records the time at which specific bits at the host are turned ON and the number of times they are turned ON.

Trend graph logging function and background function

Changes in the contents of numeral memory tables displayed in trend graphs can be recorded (logging function). Also, the record can be maintained even when the trend graph is not displayed (background function).

Mathematical function

This function allows calculations to be executed continuously during PT operation when mathematical table has been set in screen data. Arithmetic operations, bit operations, logic operations, and comparison operations can be performed. Operations with up to 5 terms are possible.

1-2-6 Displays

The NT31/NT31C can display various kinds of elements such as characters, numeric values, graphs, lamps, and touch switches, on a screen. The screen data displayed by the NT31/NT31C are created by using the Support Tool at a personal computer.

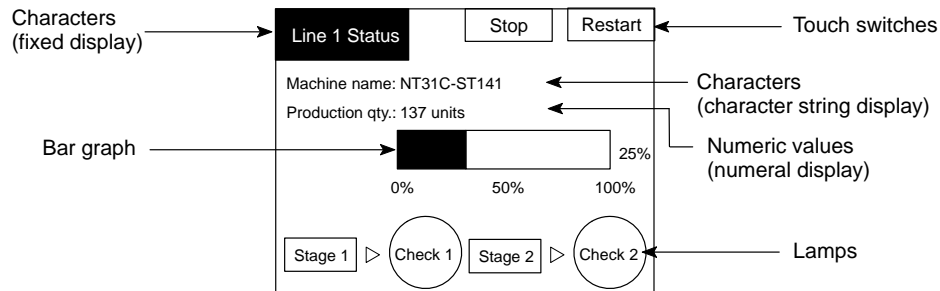

Fixed Displays

Characters and various graphics (circles, circular arcs, sectors, polylines, polygons and rectangles) whose display does not have to be changed, and mark data, image data, and library data that has already been registered, can be written directly onto the screen.

Circle

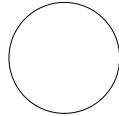

Arc



Sector



Polyline

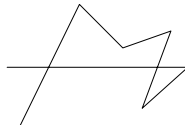

Polygon

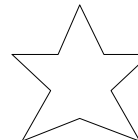

Rectangle



* A continuous straight line with up to 256 points can be drawn.

* A polygon with up to 255 vertices can be drawn.

Marks are graphics comprising 16 by 16 dots that can be used as characters. They can be used as custom characters within character strings.

Image data are graphics comprising any required area of dots. They are registered in advance and as many as required can be displayed at any position on the screen.

Windows bit map (BMP) data can be used for images.

There is a two-color mode, in which the display color and background color of the image are specified when it is registered in a screen, and an eight-color mode in which colors are assigned to the image in advance.

Since image data is composed of dots, it requires a large data size but offers great powers of expression.

Library data are combinations of fixed display graphics registered as a single graphic. They are registered in advance and as many as required can be displayed at any position on the screen.

Since it is generated by combining graphics, library data has a small data size.

Mark Image data Library data



Lamps

These are graphics whose display status changes in accordance with the states of bits at the host. Squares, circles, sectors and polygons can be used for lamps (normal (standard) lamps). In accordance with the status of the host bit, they can be lit (displayed in reverse video) or flashed (repeated alternation between normal and reverse video display states).

Lamps can also display different image/library data for the ON and OFF states of the host bit (such lamps are called image/library lamps).

There are four standard lamp labels: fixed display character strings, ON/OFF switching character strings, numeral displays, and character string displays. When fixed display character strings or ON/OFF switching character strings are used, several lines of labels can be displayed.

Normal (Standard) Lamps

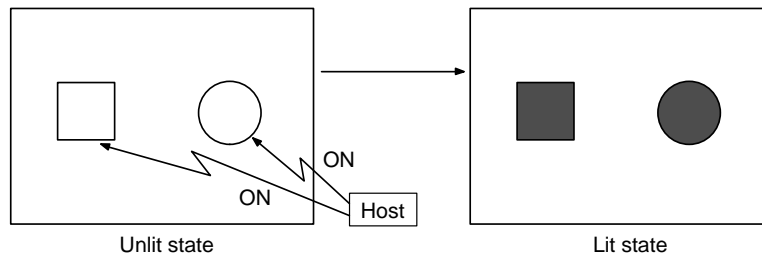
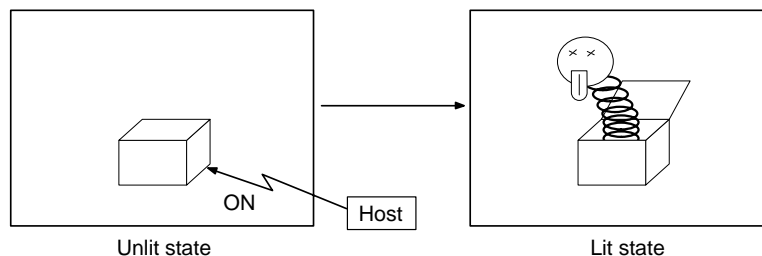

Image Library Lamps



Touch Switches

These switches can be set at any location on the screen. Pressing a touch switch on the screen where a touch switch has been set can have the following effects:

- Notification to a host bit (input notification function)
- Changing the displayed screen (screen switching function)
- Input of a numeric value or character string (input key function)
- Copying of a numeric value or character string (copy key function)
- Shifting to another numeric value or character string input field (cursor moving key function)
- Obtaining a hard copy of the screen (screen print function)
- Opening / Closing a window
- Moving a window

Touch switches can be made to light or flash in accordance with the status of a host bit in the same way as lamps.

The following 8 types of display graphic can be used for touch switches: Standard, shadow, 3-dimension, no display frame, rectangle, circle, polygon, sector. When rectangle, circle, polygon, or sector is selected as the shape, the area within which pressing of the touch switch is sensed (the touch switch area) can be set independently of the position where the display graphic is set.

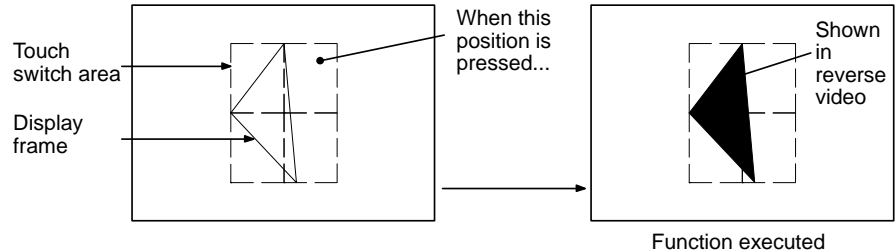

There are four touch-switch labels: fixed display character strings, ON/OFF switching character strings, numeral displays, and character string displays. When fixed display character strings or ON/OFF switching character strings are used, several lines of labels can be displayed.

Numerical Displays

Numeric values stored in the numeral memory tables are displayed. The displayed numerals can be changed by changing the data stored in the numeral memory tables.

Hexadecimal values can also be displayed.

When decimal values are displayed, the number of digits for the integral part and fractional part of displayed values can be specified in advance.

String Displays

Character strings stored in the character string memory tables are displayed. The displayed character strings can be changed by changing the data stored in the character string memory tables.

Numerical Inputs

Numeric values can be input at the PT by using touch switches. The input numeric values can also be stored in a numeral memory table and notified to the host.

Numerical inputs can be enabled and disabled from the host when an interlock bit has been allocated.

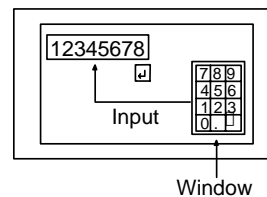

String Inputs

Character strings can be input at the PT by using touch switches, bar code readers, etc. The input character strings can also be stored in a character string memory table and notified to the host.

String inputs can be enabled and disabled from the host when an interlock bit has been allocated.

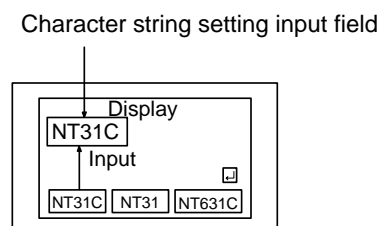

Thumbwheel Switches

Numeric values can be input by incrementing or decrementing each digit with the corresponding touch switch (+, -). The input numeric values can also be stored in a numeral memory table and notified to the host.

Thumbwheel switch inputs can be enabled and disabled from the host when an interlock bit has been allocated.

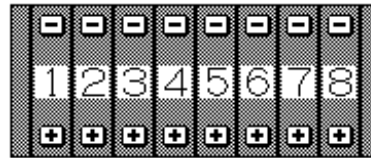

Graphs

These are graphics whose display changes in accordance with the numeric values stored in numeral memory tables. There are the following four types.

Bar Graphs

Bar graphs display the present value in a numeral memory table converted to a percentage within the range -100% to +100% of a preset value.



Analog Meters

Analogue meters display, using a quarter, half, or full circle shape, the present value in a numeral memory table converted to a percentage within the range -100% to +100% of the preset value. Users can choose from moving pointer type and filling area type displays. Users can also add graduation to the graph.



Broken Line Graphs

Broken line graphs display, in an easy-to-read form, a sequence of numeral memory table values converted to a percentage within the range -100% to +100% of a preset value.

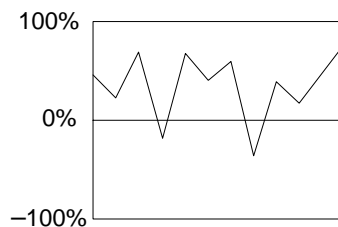

Example showing a series of 11 numeral memory table values (with a check mark set for the display sign)

Trend Graphs

Trend graphs display chronological changes in the value in a numeral memory table, converting the value to a percentage within the range -100% to +100% of a preset value. The trend graph shifts position with the passage of time.

Past data can also be recorded, and the numeral memory table can be read (sampled) even while the trend graph is not being displayed.

The user can choose to stop sampling, restart sampling, or display past data, by pressing touch switches.

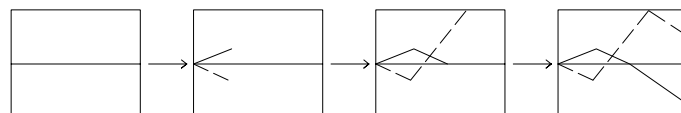

Alarm List/History

The alarm list/history function displays messages in list form, or graphics (image/library data), in accordance with changes in bit memory table statuses. For the alarm list, a series of bit memory tables are monitored, and messages (contents of character string memory tables) set for bit memory tables that come ON are displayed.

For the alarm history, bit memory tables for which the history property is set are continually monitored, and the time when they come ON and number of times they come ON are recorded and displayed together with the message (character string) set for the bit memory table.

The NT31/NT31C allows selection of the display order as the newest record first or the oldest record first by memory switch setting.

The alarm list function is used to determine which bits are ON at the present time. The alarm history function is used to determine the times at which alarms occurred in the past and how many times alarms have occurred.

Alarm List

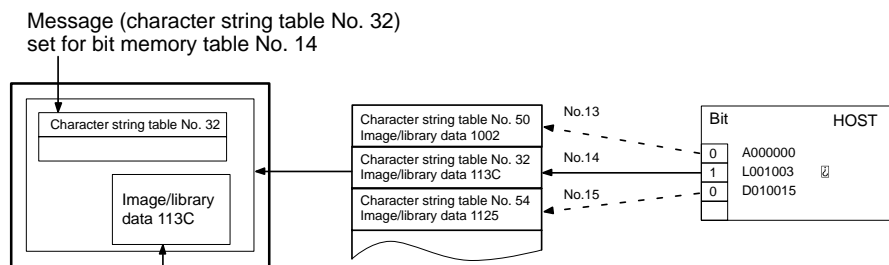

When the message displayed is pressed, the image/library data (113C) set for bit memory table No. 14 is displayed.

Alarm History

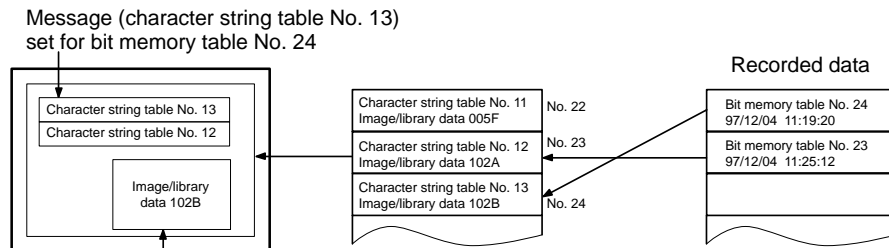

When the upper message displayed is pressed, the image/library data (102B) set for bit memory table No. 13 is displayed.

Recipe

You can set several words of numeric data at the PT in tabular format, and write it to the host. You can also read several words of numeric data from the host and display it on the PT screen.

1-3 System Configuration

This section shows the configuration of a system that uses an NT31/NT31C. For details on product models, refer to *Appendix J Model List* (page 277).

1-3-1 Peripheral Devices That Can Be Connected

The following peripheral devices can be connected to an NT31/NT31C.

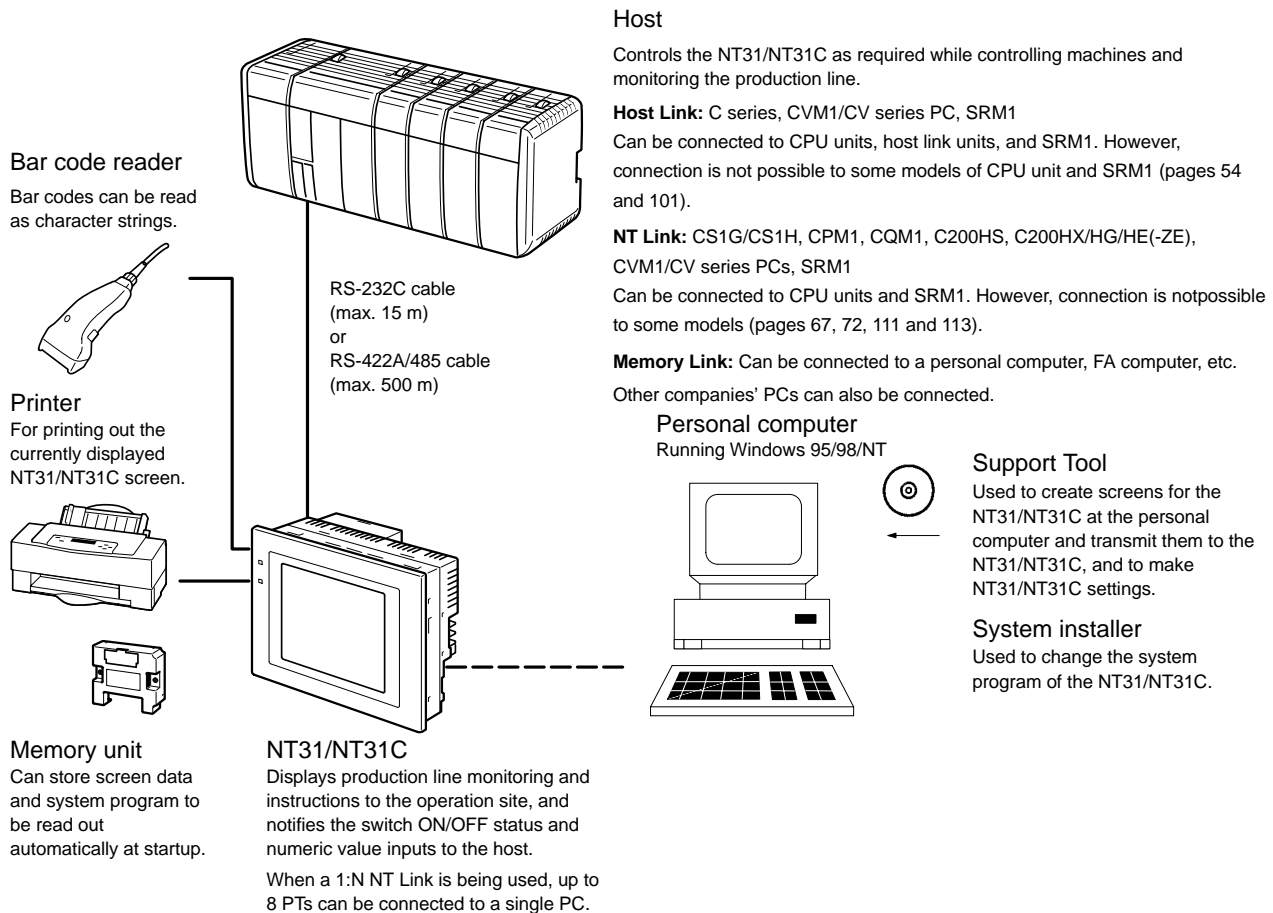

- Bar code reader (page 37)
- Recommended printers (page 36)

It is also possible to use printers that can emulate an NEC PC-PR201H (using the NEC PC-PR201PL control protocol), and printers that comply with one of the following EPSON control standards: ESC/P 24-J83C (color), or ESC/P 24-J82 (monochrome).

- Memory unit (pages 39 and 47)
NT-MF261 (made by OMRON)
- Support Tool (page 35)
NT-series Support Tool Version 4.0 for Windows (Made by OMRON)
 - NT-ZJCAT1-EV4 (CD-ROM version)
- System installer (page 35)
System installer (made by OMRON)
The system installer is supplied as a standard accessory with the Support Tool (NTZJCAT1-EV4).

Reference: The following optional devices are available. All of them can be used either with NT31 or NT31C.

Replacement backlight	NT31C-CFL01
Reflection-suppressing protective sheet	NT30-KBA04
Chemical-resistant cover	NT30-KBA01
Replacement battery	3G2A9-BAT08

1-3-2 Connecting to the Host

The NT31/NT31C has the following two communication ports.

- Serial port A:

D-SUB 9-pin connector

For RS-232C use only (The Support Tool and bar code readers can be connected here.)

- Serial port B:

D-SUB 25-pin connector

For RS-232C or RS-422A/485 (Selectable by memory switch)

(The Support Tool and bar code readers cannot be connected here.)

The host can be connected at either of these two ports.

The connection methods for each communication method at the PT and host sides are indicated below. Make the settings in accordance with the communication method that can be used with the PC to be connected and the conditions at the operation site.

Reference: When using an RS-232C/422A convertor unit (NT-AL001) with the host link or NT link (1:1) communication method, RS-485 cannot be used. The connection must be made with RS-232C or RS-422A.

1-4 Communications with the Host

The NT31/NT31C is connected to the host by one of the following communication methods.

The following communications can be used to connect an OMRON PC:

- Host link
- 1:1 NT Link
- 1:N NT Link (standard or high-speed)

The following communications can be used to connect another companies' PC or FA computer:

- Communications protocol supported by the other company's PC
- Memory link

In all of these communication methods that can be used with NT31/NT31C, data communication with host is by direct connection (Memory link is, however, a quasi-direct connection).

In the following, the host link and NT link that carry out the direct connection will be discussed. Memory links will be explained in *1-5 Communications Using Memory Links*.

1-4-1 Direct Connection Function

With the NT31/NT31C, the bits and words referring to data required for display, and those for storing input data, can be allocated to any part of the PC memory area.

The NT31/NT31C can directly write to and read from such allocated bits and words to change the display status of the elements on the PT screen, control the PT operating status, and notify statuses to the host.

This function, which directly reads and writes the statuses of words and bits without using a PC program is called the direct connection function.

The words and bits allocated for direct connection are called the allocated words and allocated bits.

The direct connection function allows the data to be displayed at the NT31/NT31C to be read from the memory area in the PC and written to memory tables in the NT31/NT31C. Also, the data input at the NT31/NT31C can be written to the memory area in the PC. The NT31/NT31C screen can be changed in accordance with statuses in the PC memory area, and the NT31/NT31C's status data can be written to the PC's memory area.

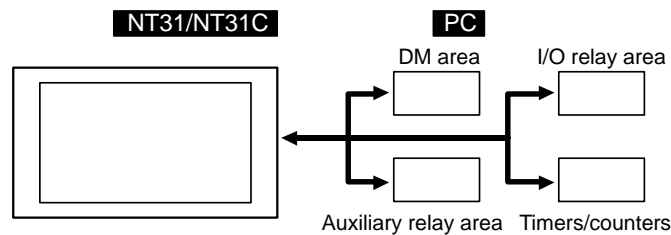

Features of the Direct Connection Function

The direct connection function has the following features.

- The bits and words referring to operating status and work instruction information and those for storing input data can be freely allocated to almost any area of the PC memory.
- Since the NT31/NT31C can directly refer to PC bit and word data without using the program at the PC, it can be connected to the PC without changing the PC program which controls the currently running production line.
- The area to control and notify the NT31/NT31C statuses, including display screens, display/no display status, and buzzer output, can be freely allocated to any part of the PC data area. This means that the PC status can be read and controlled just by reading this area at the PC side, without preparing a special communication program.

The direct connection function allows the NT31/NT31C to directly read and write almost all bits and words in the PC and to automatically change the NT31/NT31C screen display. This function can reduce the load on the PC so that its program development efficiency is improved.

1-4-2 Host Link

The host is connected to a PT in a 1:1 connection, and the words and bits of the host are read and displayed by host link communication. This method can be used for connection to the majority of PC types.

1-4-3 NT Link

NT link is a method for high-speed communication with a PC using the direct connection function. The PCs that can be connected with the NT link are as follows.

- When using the built-in host link function of a CPU unit or SRM1:
 CPM1, CPM2A, CPM2C, CQM1, CQM1H, C200HS, C200HX/HG/HE(-Z)E, CS1G/CS1H-E(V1), CVM1/CV-series PC (-EV1 or later version), SRM1

Besides the 1:1 NT Link method, in which one PC is connected to one PT, the NT31/NT31C can also use the 1:N connection NT Link method, which allows a maximum of eight PTs to be connected to one PC port.

PCs that can be connected with the 1:N connection NT Link method are as follows: CQM1H, C200HX/HG/HE (-Z)E, CS1G/CS1H-E(V1).

The NT31/NT31C also supports OMRON's high-speed 1:N NT Link that provides faster 1:N communications. The only PCs that support the high-speed 1:N NT Link are the -EV1 and higher versions of the CS1G/CS1H PCs.

In the following sections, the term NT Link is used to refer to the NT Link communication method in general, the term 1:1 NT Link is used to refer specifically to NT Links with a 1:1 connection, and the term 1:N NT Link is used to refer to both standard and high speed NT Links with 1:N connections. When necessary, the standard 1:N NT Link is distinguished from the high-speed 1:N NT Link.

Features of the NT Link

The NT link has the following features.

- High-speed communications with specific types of PCs can be executed. The NT31/NT31C also supports OMRON's high-speed 1:N NT Link.
- Writing in units of bits to the PC memory area is possible.
 - This enables the other bits of words to which a touch switch has been allocated to be allocated for other purposes (e.g. a lamp).
 - However, since data is written to the DM area in word units, the other bits of words allocated to touch switches in this area cannot be used for other purposes.
- The NT link can be used even when the PC is in the RUN mode. (When the host link method is used, the NT31/NT31C switches to the monitor mode when the PC is in the RUN mode.)
- In the case of PTs that support the standard 1:N NT Link (NT20S, NT31, NT31C, NT600S, NT620S, NT620C, NT625C, NT631, NT631C) up to 8 PTs can be connected to one port of the PC and used at the same time. Up to 8 PTs (NT31, NT31C, NT631, and NT631C) can also be connected simultaneously when the high-speed 1:N NT Link is being used.
 - All of the PTs connected to a PC port must use either the standard or high-speed 1:N NT Link; the two communications systems cannot share a single port.
- When using a C200HX/HG/HE-(Z)E PC and standard 1:N NT Links, up to three 1:N NT Link systems (i.e., 24 PTs) can be connected by installing a communication board in the option slot of the CPU. (Only the standard 1:N NT Link can be used.) For details on the Communications Board, refer to the *SYSMAC Communications Board Operation Manual (W304-E1-□)*.
- When using a CQM1H PC and standard 1:N NT Links, multiple 1:N NT Link systems can be connected by installing Serial Communications Boards in the Inner Board slots. For details on the Serial Communications Board, refer to the *CQM1H Serial Communications Board Operation Manual (W365-E1-□)*.
- When using CS1G or CS1H PC, multiple 1:N NT Link systems (standard or high-speed) can be connected by installing a Serial Communications Board in the INNER Board slot or installing a Serial Communications Unit in the Backplane. For details on the communication board/communication unit, refer to the *CS1-series Serial Communications Board/Unit Operation Manual (W336-E1-□)*.
- If the PC used supports the Programming Console function, the NT31/NT31C can be used as a Programming Console.
- If the PC being used supports the Device Monitor function, the NT31/NT31C can be used to change the PC's operating mode and read/change data in the PC's memory areas.

The NT link is compatible with the host link. The NT31/NT31C screen data and PC programs used with the host link direct connection method can be used with the NT link method as they are.

1-4-4 Connecting to other Companies' PCs

Installing a system program for multi-vendors by using a specific system installer enables the NT31/NT31C to be connected to the PCs of other models in direct connection. This system installer is supplied with the Support Tool (NT-ZJCAT1-EV4).

Compatible PC

The NT31/NT31C can be connected to the following model PCs.

- Mitsubishi A series programmable controller (computer link module)
- Mitsubishi FX series programmable controller
- SLC 500 Series by Allen-Bradley
- 90-20 and 90-30 Series by GE Fanuc
- S7-300 and S7-400 Series by Siemens

For details on the procedure for connecting to other model PCs, refer to the *PC Connection Manual* or *NT31/631 Multi Vendor Connection Manual*.

1-5 Communications Using Memory Links

In this section, a communication method other than the direct connection, called the memory link, is discussed.

1-5-1 Memory Link

Memory link is a method to send and receive data between a personal computer or a FA computer and the NT31/NT31C by using RS-232C/422A communication.

In memory link, there is an area called PT Memory, as shown below, inside the NT31/NT31C, and this area is treated as a virtual area on the PC. This allows PT memory and the display elements of the NT31/NT31C to make a quasi-direct connection. By sending a command for the memory link, the host can make the NT31/NT31C execute processes through PT memory. Frequently used commands are kept handy for read and write tasks of the numeral memory table, character-string memory table, and bit memory table.

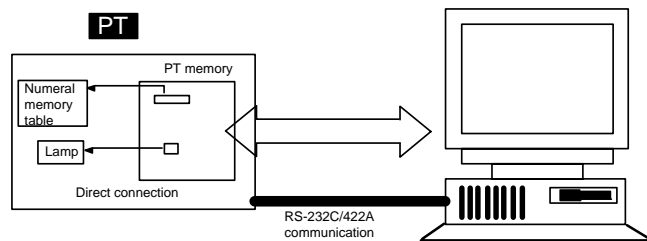

In the memory link method, the only difference is that the NT31/NT31C finds its communication target inside instead of outside. In the memory link method, therefore, change of the target is all that is needed to be capable of using the exact screen data that is acquired by the direct connection. (With the NT31/NT31C, the Support Tool must be used to convert the data to screen data for the memory link.)

When compared to the direct connection of the host link or NT link methods, the memory link method has some restrictions regarding the use of some functions, as described below.

- The Programming Console and Device Monitor functions cannot be used.
- The following strobes of PT status notify bits does not turn on (page 7 to 27).

Screen switching strobe
Numerals input strobe
Character-string input strobe

- The usable area for allocation is the PT memory only.

1-5-2 Comparison between Direct Connection and Memory Link

The major differences between the direct connection and the memory link are as follows:

- In the memory link method, the communication with the host should be carried out by using commands. Compared to the ordinal direct connection, which can be used requiring almost no programs, the memory link method requires a program that is necessary for interchange of commands. This, however, gives advantages to the memory link method by using a large variety of functions available in the direct connections from major models such as a personal computer and a FA computer equipped with RS-232C/RS-422A communication means, allowing the PT to be suited for larger usage.
- Actual PCs have many kinds of areas, where as PT memory is a single area with only one kind. When creating screen data by using the memory link methods, it is always necessary to allocate display parts in the PT memory.

For communication between the host and the PT by the memory link method and for handling screen display elements, refer to the *NT31/NT31C/NT631/NT631C Programmable Terminal Reference Manual*.

1-5-3 Memory Link Online Transfer Function

When memory link communications are being used, the NT31/NT31C can be switched to Transmit mode from the host even if the NT31/NT31C is operating and screen data can be written. (The NT31/NT31C can be returned to RUN mode after the screen data is written.)

The memory link online transfer function can be used to replace screen data at a fixed time each day or replace screen data with maintenance screen data for maintenance.

For more details on the memory link online transfer function, refer to information on the memory link online transfer function in the *NT31/NT31C/NT631/NT631C Programmable Terminal Reference Manual*.

1-6 Before Operating

Follow the procedure given below to start the system of the NT31/NT31C.

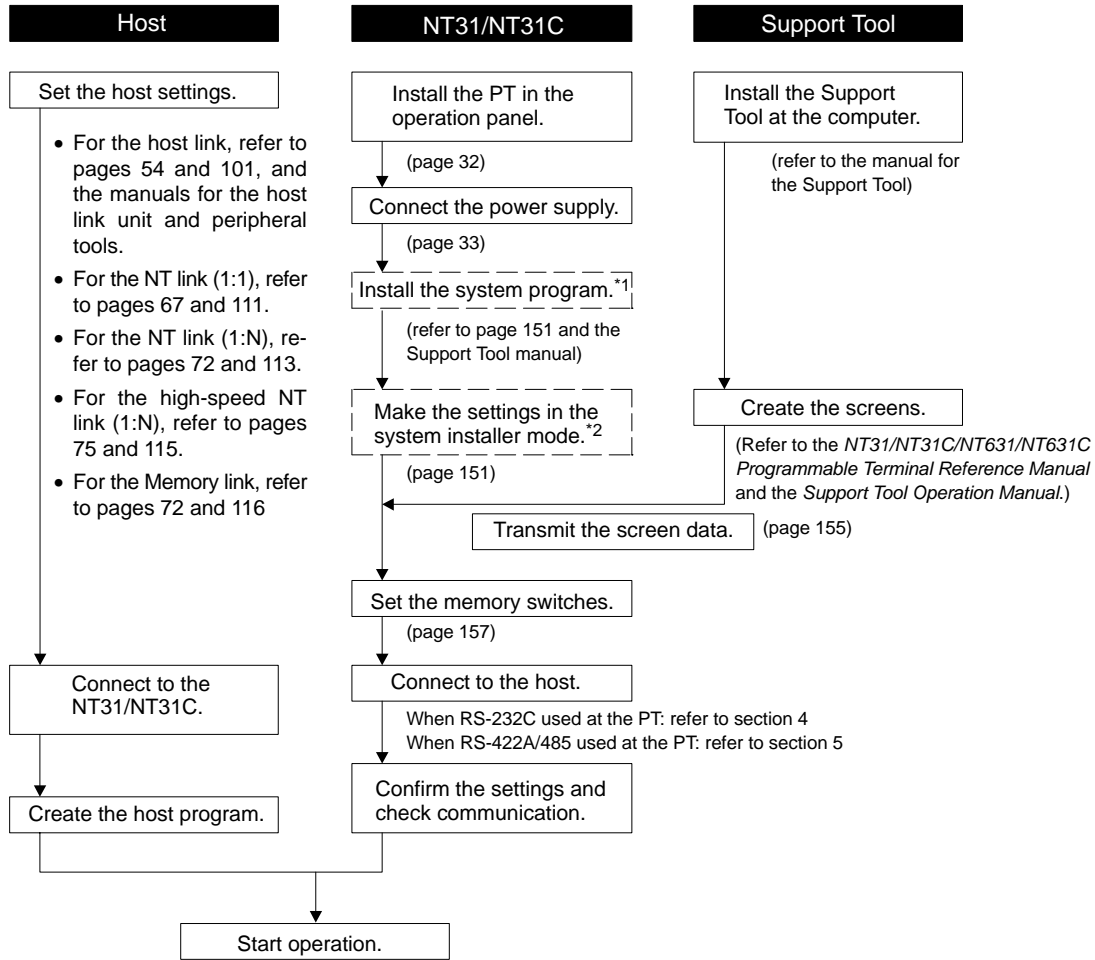

*1: System program installation is only done in special circumstances, for example when changing the system program, or to recover the original status of the installed program. This operation is not normally necessary. When using other PC models (sequencers), however, it is necessary to install specific system programs.

*2: Display of the system menu, and all change operations, can be inhibited. This enables you to prevent the accidental deletion or alteration of screens and settings.

- Reference:**
- For the system program, use the NT31/NT31C system program supplied as an accessory with the NT-series Support Tool (NT-ZJCAT1-EV4).
 - For the Support Tool, use NT-series Support Tool for Windows (Ver. 4.1).

Refer to the following manuals for the devices and software.

Device or Software	Manual Title	Manual Number
NT31/NT31C, NT631/NT631C	Reference Manual	V064-E1-1
System Installer	NT-series Support Tool for Windows (Ver. 4.1) Operation Manual	V061-E1-□
Support Tool	NT-series Support Tool for Windows (Ver. 4.1) Operation Manual	V061-E1-□

Device or Software	Manual Title	Manual Number
PC	SYSMAC CPM1 Operation Manual	W262-E1-□
	SYSMAC CPM1A Operation Manual	W317-E1-□
	SYSMAC CPM2A Operation Manual	W352-E1-□
	SYSMAC CPM2C Operation Manual	W356-E1-□
	SYSMAC C200H Operation Manual (for CPU01/03/11) (programming)	W130-E1-□
	SYSMAC C200H Operation Manual (for CPU21/23/31) (programming)	W217-E1-□
	SYSMAC C200HS Installation Guide	W236-E1-□
	SYSMAC C200HS Operation Manual (programming)	W235-E1-□
	SYSMAC C200HX/HG/HE (-Z) Installation Guide	W302-E1-□
	SYSMAC C200HX/HG/HE Programming Manual	W303-E1-□
	SYSMAC C200HX/HG/HE-Z Programming Manual	W322-E1-□
	SYSMAC C1000H/C2000H Operation Manual (programming)	W140-E1-□
	SYSMAC CQM1 Programming Manual	W228-E1-□
	SYSMAC CQM1H Operation Manual	W363-E1-□
	SYSMAC CVM1/CV500/CV1000/CV2000 Operation Manual: Ladder Diagrams	W202-E1-□
	CS1-series CS1G/H-CPU □□-E Programmable Controllers Operation Manual	W339-E1-□
	CS1-series Serial Communication Boards/Units Operation Manual	W336-E1-□
	SYSMAC CQM1H Series Serial Communications Board Operation Manual	W365-E1-□
CompoBus Master Control Unit	SRM1 Operation Manual	W318-E1-□
Programming Devices	SYSMAC Support Software Operation Manual: C-series PCs	W248-E1-□
	SYSMAC Support Software Operation Manual: CVM1 PCs	W249-E1-□
	SYSMAC CPT User Manual and Quick Start Guide	W332-E1-□ W333-E1-□
	CX-Programmer User Manual	-
Host Link Unit/ Serial Communications Board	SYSMAC C-series Host Link Unit Operation Manual	W143-E1-□
	SYSMAC CVM1/CV-series Host Link Operation Manual	W205-E1-□
	SYSMAC C200HW-COM01 C200HW-COM02-V1 to C200HW-COM06-EV1 Serial Communications Board Operation Manual	W304-E1-□

SECTION 2

Preparing for Connection

This section describes the connection methods that are possible with the PTs, and the functions of the parts of PTs, as the required knowledge before connecting to the host and to the peripheral devices.

2-1	Method for Connection to the Host	26
2-2	Names and Functions of Parts	29

2-1 Method for Connection to the Host

This section describes the methods for connection to the host used with the NT31/NT31C, and the relationship between the connection method and the communication method.

NT31/NT31C Communication Ports and Communication Methods

The NT31/NT31C has two communication ports. Their uses are indicated in the table below.

Communication Port	Usable Communication Methods	Communication Type
Serial port A	Host link NT link (1:1) NT link (1:N)* Memory link (Support Tool connection) (bar code reader input function)	RS-232C
Serial port B	Host link NT link (1:1) NT link (1:N)* Memory link	RS-232C RS-422A/485 (select between RS-232C and RS-422A/485)

* There are two NT Link (1:N) communications rates: standard and high-speed.

Communication Methods That Can Be Used with the Host

The following communication methods can be used with the hosts that can be connected to the NT31/NT31C.

- RS-232C
- RS-422A
- RS-485

The communication types that are actually supported differ depending on the host unit. For details, refer to *Section 4 Connecting to the Host from the RS-232C Port* and *Section 5 Connecting to the Host from the RS-422A/485 Port*.

Converting the Communication Type with an RS-232C/RS-422A Convertor Unit

The following communication type conversions are possible by using an RS-232C/RS-422A convertor unit (NT-AL001-E, made by OMRON).

- RS-232C ⇔ RS-422A
- RS-232C ⇔ RS-485

Combinations of Communication Method and Connection Method

The connection methods that can be used depending on the communication method used and the communication type for communication between the NT31/NT31C and the host are indicated in the table below.

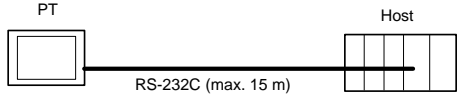
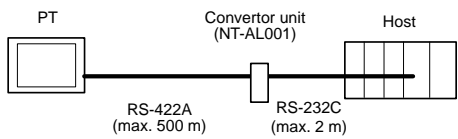
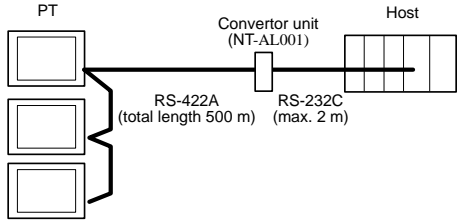
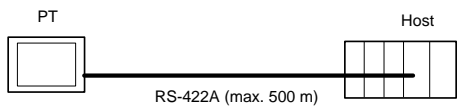
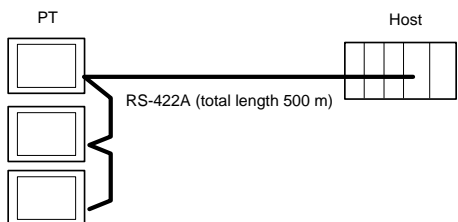
Communication Type at PT	Communication Type at Host	Usable Connection Method	Usable Communication Method				Details
			Host link	NT Link (1:1)	NT Link (1:N)	Memory link	
RS-232C	RS-232C	Direct 1:1 connection 	○	○	○	○	78
RS-422A	RS-232C	1:1 connection via a convertor unit 	○	○	○	○	88
		1:N connection via a convertor unit 	×	×	○	×	92
	RS-422A	Direct 1:1 connection 	○	○	○	○	117
		1:N connection 	×	×	○	×	122

○: Connection possible ×: Connection not possible

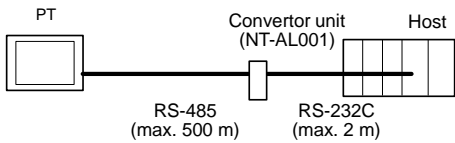
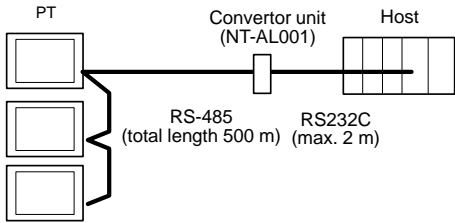
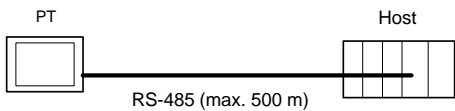
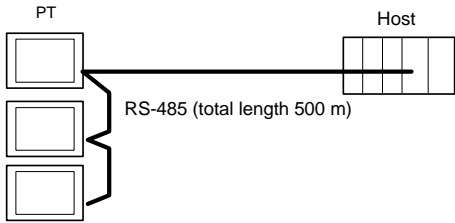
Communication Type at PT	Communication Type at Host	Usable Connection Method	Usable Communication Method				Details
			Host link	NT Link (1:1)	NT Link (1:N)	Memory link	
RS-485	RS-232C	1:1 connection via a convertor unit 	×	×	○	×	88
		1:N connection via a convertor unit 	×	×	○	×	92
	RS-485	Direct 1:1 connection 	×	×	○	×	121
		1:N connection 	×	×	○	×	125

○: Connection possible ×: Connection not possible

- The RS-232C/RS-422A convertor unit (NT-AL001) requires +5 V, 150 mA at pin 6 of the RS-232C connector. Check the signals of the RS-232C connector at the host.
- +5 V is not output from serial port B of the NT31/NT31C. When connecting an NT-AL001 at serial port B, a separate power supply is required for the NT-AL001.
- The cable of an NT-AL001 cannot be connected or disconnected while the power is ON. Always connect or disconnect the cable while the power supply from the RS-232C cable is OFF (while the host power supply is OFF).
- NT link (1:N) connection is possible even when RS-232C is used at the NT31/NT31C side for communication with the host, but in this case one NT-AL001 unit is required for each NT31/NT31C. In this case, it is convenient to use serial port A of the NT31/NT31C. +5 V is not output from serial port B.

2-2 Names and Functions of Parts

Before starting operation, the names and functions of the parts of the NT31/NT31C are described here as a confirmation. A method of hardware settings is also described.

Front View

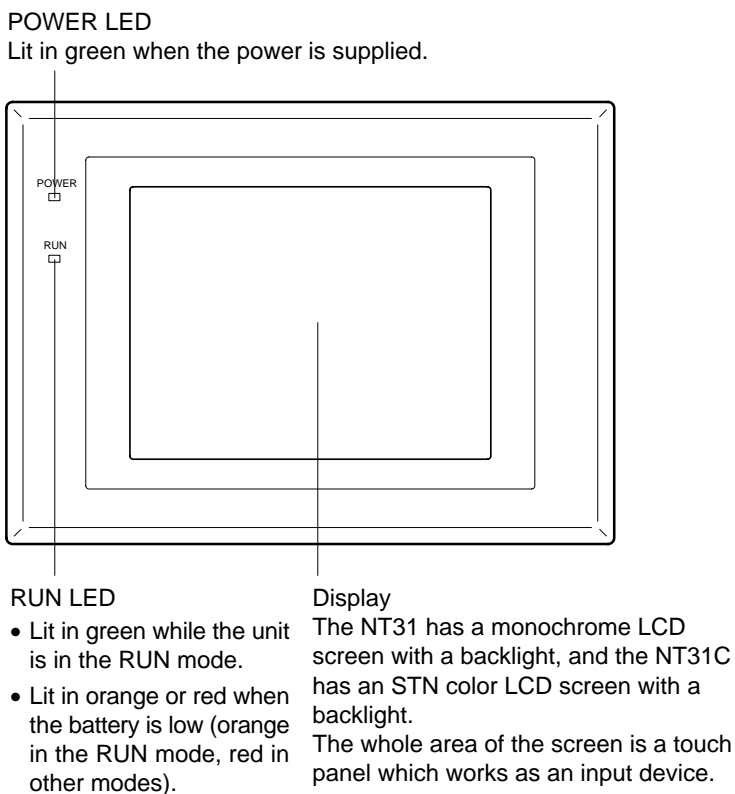

Reference: The NT31/NT31C comes in two body colors.

NT31	NT31C	Body Color
NT31-ST121-EV2	NT31C-ST141-EV2	Beige
NT31-ST121B-EV2	NT31C-ST141B-EV2	Black

Rear View

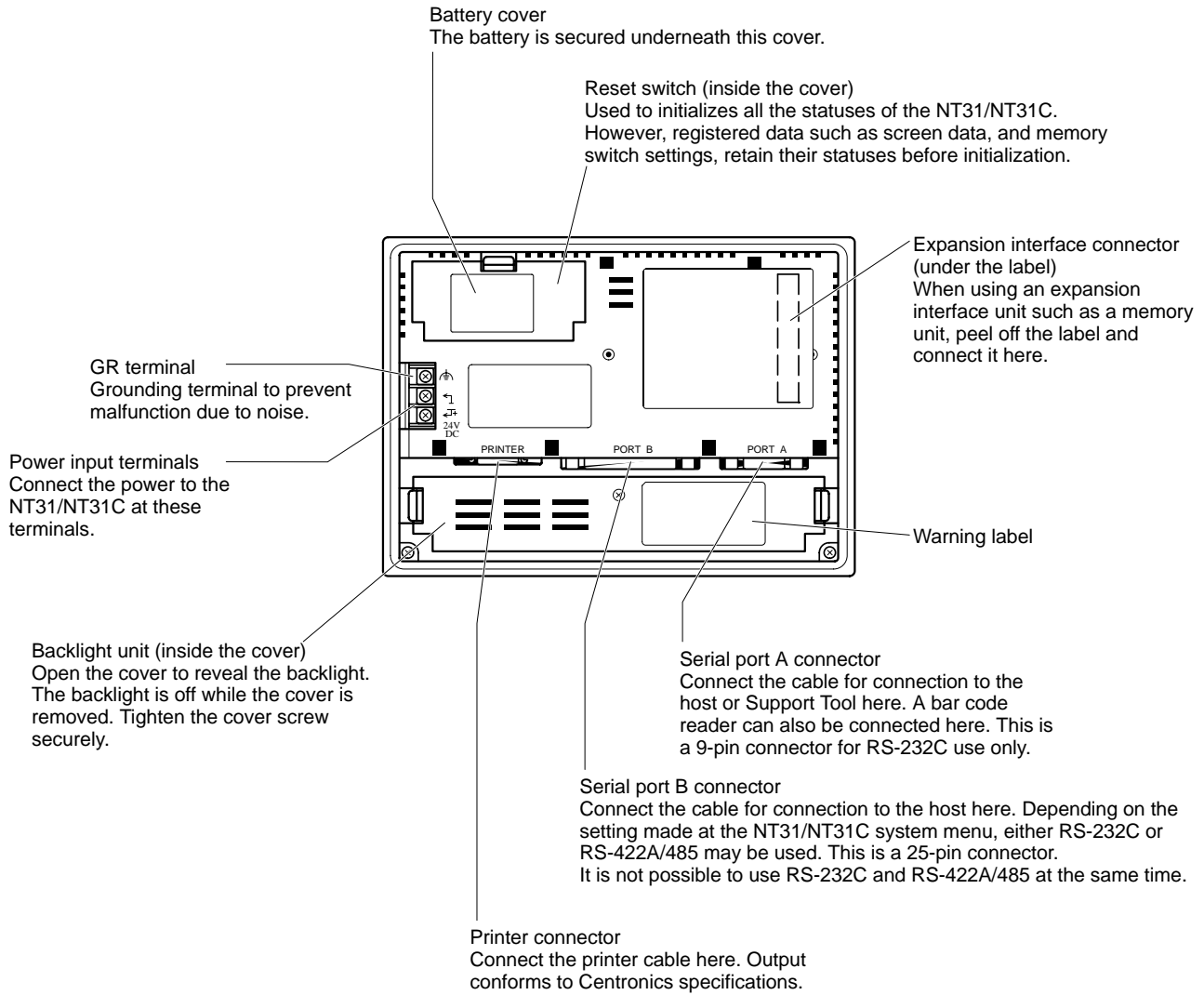

Note Confirm system safety before turning the power ON/OFF or resetting.

SECTION 3

Hardware Settings and Connections

This section describes the settings of the PTs and methods for connection to peripheral devices.

For details on connecting to the host, refer *Section 4 Connecting to the Host from the RS-232C Port* or *Section 5 Connecting to the Host from the RS-422A/485 Port*.

3-1	Installation	32
3-1-1	Installation Environment	32
3-1-2	Installation in the Operation Panel	32
3-1-3	Power Supply Connection	33
3-1-4	Grounding	34
3-2	Connecting to the Support Tool	35
3-3	Connecting a Printer	36
3-3-1	Connection Method	36
3-4	Connecting a Bar Code Reader	37
3-4-1	Connection Method	37
3-4-2	Setting a Bar Code Reader	37
3-4-3	Data Format	38
3-5	Using a Memory Unit (-V□ Versions)	39
3-5-1	Installation Method	40
3-5-2	Method of Use	40
3-6	Using a Memory Unit (Versions without the -V□ Suffix)	47
3-6-1	Installation Method	48
3-6-2	Method of Use	48

Note On unpacking the NT31/NT31C and peripheral devices, check their external appearance and confirm that there is no damage. Also confirm that there is no abnormal noise on shaking the unit lightly.

3-1 Installation

Install the NT31/NT31C in the operation panel and connect the power to the NT31/NT31C as described below.

3-1-1 Installation Environment

Observe the following points when installing the PT in an operation panel.

- Note**
- Do not install the unit at sites subject to the following conditions.
 - Severe temperature variations
 - Temperatures or humidities outside the ranges stated in the specifications
 - High humidity, condensation
 - Splashing chemical agents
 - Severe oil splashing
 - Corrosive or flammable gases
 - Strong vibrations or shocks
 - Direct exposure to wind and rain (outdoor sites)
 - Strong ultra-violet irradiation
 - Take adequate measures to ensure shielding if the unit is used at a location subject to any of the following conditions.
 - Static electricity, or noise from other equipment
 - Strong electromagnetic fields
 - Nearby power cables
 - Potential exposure to radioactivity

3-1-2 Installation in the Operation Panel

The NT31/NT31C is mounted in an operation panel by embedding it in the panel. Use the panel fittings and tool (Philips screwdriver) included in the product package and follow the procedure below.

- 1, 2, 3... 1. Open a hole of the dimensions shown below in the panel and install the NT31/NT31C from the front side of the panel.

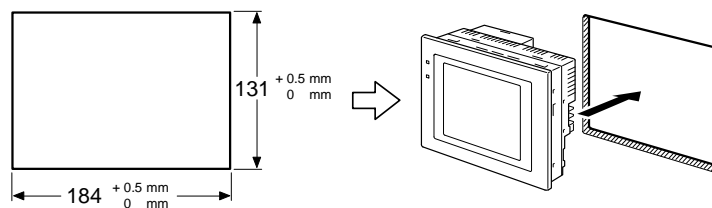

2. Attach the panel fittings at the four positions at top and bottom and two positions at right and left, shown below, from the rear of the NT31/NT31C.

Fit the hook of the fitting in the square hole in the body and tighten the screw with the Philips head screwdriver while lightly pulling the fitting.

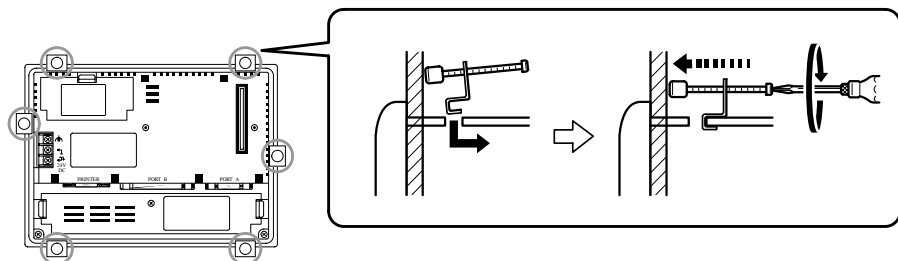

- Note**
1. During work at the panel, take care to ensure that no metal scraps enter the unit.
 2. The thickness of applicable operation panel is 1.6 mm to 4.8 mm. All fittings must be tightened uniformly to a torque of 0.5 to 0.6 N·m in order to ensure water- and dust-resistance. Front sheet of NT31/NT31C may be warped if the tightening is too strong or not uniformity. The panel must not be soiled or warped, and must be able to support an installation that will remain secure and strong.

3-1-3 Power Supply Connection

Connect a 24 VDC power supply to the power input terminals.

- Note**
1. Depending on how the power is switched ON/OFF, the entire system may stop. Follow the correct procedure when switching the power ON/OFF.
 2. Carefully check the wiring before switching ON the power.
 3. Do not connect AC power to the DC terminals.
 4. Use DC power supplies with low voltage fluctuation.
 5. Do not perform a dielectric strength test.
 6. If complying with EC directives (low voltage directives), use a power supply with reinforced insulation (compliance with EC directives is planned for June 1998).

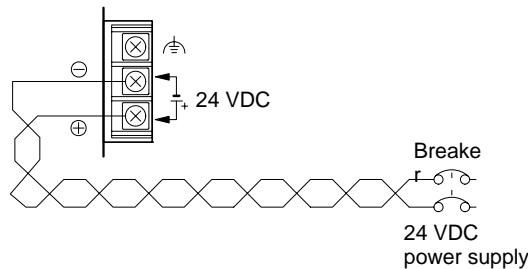

Power Supply

The applicable power supply specifications are as follows.

Item	Value
Power supply	24 VDC
Allowable power supply voltage fluctuation range	20.4 VDC to 26.4 VDC (24 VDC -15%, +10%)
Power supply voltage capacity	15 W or more

Parts Used for Connection

- Note** For the connection to the power supply terminal block, twisted wires of 2 mm² or greater cross sectional area and M3.5 size crimp terminals must be used.

Tighten the screws on the terminal block to a torque of 0.8 N·m.

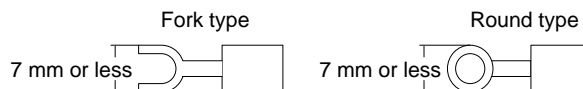

Recommended Terminals

Maker	Type (fork type)	Type (round type)	Applicable Wire (stranded wire)
Japan Solderless Terminal MFG	2-YS3A	2-3.5	2.0 to 2.63 mm ²
Fuji Terminal	2-YAS3.5	V2-S3.5	
Nichifu Terminal	2Y-3.5	2-3.5	

3-1-4 Grounding

The NT31/NT31C has a functional ground terminal (⏏).

Carry out wiring under the following conditions.

- 1, 2, 3...**
1. In cases where the distance between the NT31/NT31C is small and it is assumed that there is no potential difference between grounds, ground as shown in Fig. (a) below.
 2. In cases where there is a potential difference between the grounds of the NT31/NT31C and the host, ground as shown in Fig. (b). If there is some distance between the NT31/NT31C and host and grounding at a single point is difficult, do not connect the functional ground terminal (⏏) of the NT31/NT31C.
 3. If the NT31/NT31C is installed in the same panel as equipment that generates noise, such as a motor or inverter, do not ground the functional ground terminal (⏏) of the NT31/NT31C.

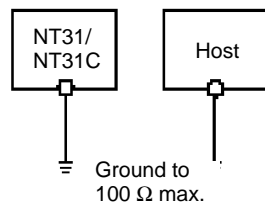

Fig. (a)

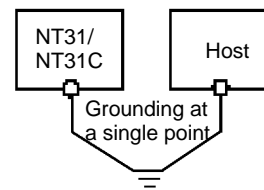

Fig. (b)

Note Carry out grounding correctly in order to prevent operating errors due to noise.

3-2 Connecting to the Support Tool

In order to install the system program in the NT31/NT31C, or to transmit screen data created with the Support Tool to the NT31/NT31C, the NT31/NT31C must be connected to a personal computer with an RS-232C cable.

The NT31/NT31C connects the RS-232C cable from a personal computer at serial port A. When the host is connected at serial port B, the connection with the host can be maintained as it is while the NT31/NT31C is connected to the RS-232C cable from a personal computer.

However, when a bar code reader is being used, it must be disconnected, so that the RS-232C cable can be connected, since they both use serial port A.

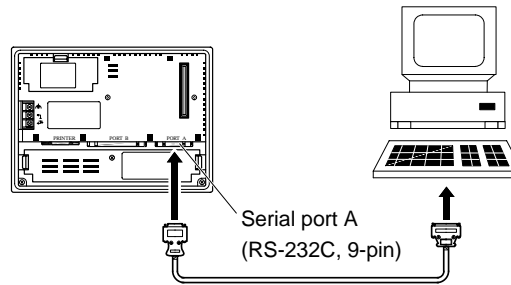

Communication Conditions

The communication conditions are automatically set when the system installer and Support Tool are started.

Recommended Connector Cable

Use the cable indicated below.

- CV500-CN228 (length: 2 m), made by OMRON (D-SUB 9-pin, male ↔ D-SUB 25-pin, male)
- XW2Z-S001 (conversion cable), made by OMRON (D-SUB 25-pin, female ↔ half pitch 14-pin, male)
- XW2Z-S002 (length: 2 m), made by OMRON (D-SUB 9-pin, male ↔ D-SUB 9-pin, female)

For details on making a connector cable, refer to *Appendix F Making the Cable for Connecting a PC* (page 269).

3-3 Connecting a Printer

Connecting a printer to the NT31/NT31C enables printing of hard copies of the currently displayed screen (printing of screen images), and, by system menu operations, printing of the screen display history and alarm history.

The following types of data can be printed, depending on the printer connected to the NT31/NT31C. For details, refer to the pages cited.

- Hard copies of the screen (Refer to information on printing data and checking the printer status in the *NT31/NT31C/NT631/NT631C Programmable Terminal Reference Manual*.)
- Screen display history record data (page 198)
- Alarm history record data (page 200)

3-3-1 Connection Method

Connect the printer to the NT31/NT31C with a Centronics cable, as shown below. The length of the cable should not exceed 1.5 m.

Reference: If the connector cable is connected or disconnected while the power to the printer is on, the NT31/NT31C may malfunction. Always turn off the power to the printer before connecting or disconnecting the cable.

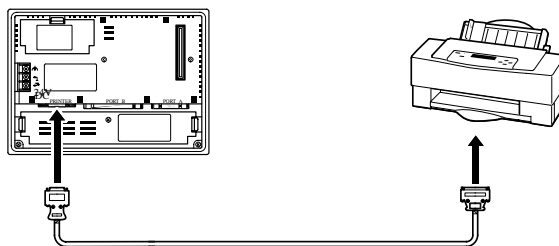

Recommended Connector Cable

The following connection cables are recommended.

- NT-CNT121 (1.5 m, 20-pin to 36-pin), made by OMRON

Recommended Printers

When using a printer, use one that can emulate an NEC PC-PR201H (using the NEC PC-PR201PL control protocol) or complies with one of the following EPSON control standards: ESC/P 24-J83C (color), or ESC/P 24-J82 (monochrome).

When using a monochrome printer with an NT31C, set Tone printing with the NT31C memory switches (page 174).

3-4 Connecting a Bar Code Reader

Connecting a bar code reader to the NT31/NT31C enables bar code data to read as character strings into character string input fields, and set in character string memory tables.

In order to use a bar code reader, the Comm. A Method memory switch must be set to Bar-Code Reader.

For details on the method for inputting character strings with a bar code reader, refer to 3-7 *Input of Numeric Values and Character Strings* in the *NT31/NT31C/NT631/NT631C Programmable Terminal Reference Manual*.

Note Make sure that the power supply to the bar code reader and the power supply to the PT are both OFF before connecting or disconnecting the cable.

3-4-1 Connection Method

Connect the bar code reader to serial port A of the NT31/NT31C, as shown in the figure below.

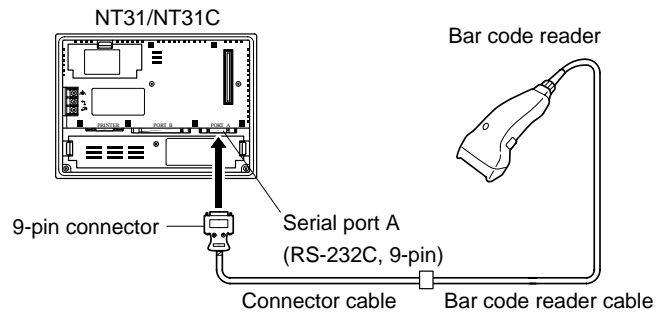

Bar code reader must match the communication setting (3-4-2 *Setting a Bar Code Reader*, page 37) and data format (3-4-3 *Data Format*, page 38) in order to connect to the NT31/NT31C. Please confirm the specification of the bar code reader before using.

For details on making a connector cable, refer to *Appendix G Making the Cable for Connection to a Bar Code Reader* (page 271).

Reference: The bar code reader must be connected to serial port A. This means that it cannot be connected at the same time as the Support Tool. Note also that when a bar code reader is used, the host must be connected at serial port B.

3-4-2 Setting a Bar Code Reader

After connecting a bar code reader, set the communication conditions and other settings for it by selection from the system menu.

Settings at the NT31/NT31C

At the NT31/NT31C, set the communication conditions for communication with the bar code reader by using the memory switches, selecting from the options indicated in the table below.

For more detailed information on the actual system menu operations, refer to 6-10 *Setting the Bar Code Reader Input Function* (page 188).

Item	Possible Settings	Default Setting
Data bits	7 or 8 bits	7 bits
Stop bit(s)	1 or 2 bits	2 bits
Parity	None, odd, even	Even
Communications speed	4800, 9600, 19200 bps	9600 bps
Input Method	Manual, Auto	Manual

Settings at the Bar Code Reader

Make the settings shown in the table below at the bar code reader. Make sure that the communications speed, parity, stop bit, and data bit settings match the communication settings made at the NT31/NT31C. For details on the setting method, refer to the instruction manual for the bar code reader used.

Item	Possible Settings
Communications speed	4800, 9600, 19200 bps
Parity	EVEN, ODD, NONE
Stop bits	1 or 2 bits
Data bits	7 or 8 bits
Preamble	STX
Postamble	ETX
RS/CS control	Available
Communication protocol	No-protocol mode
Transmission of number of bar code label digits	Transmission prohibited
Transmission of ID characters	Transmission prohibited
Bar code types	Multi-reading (all types can be read)
Trigger switch setting	Automatic reading mode

About RS/CS Control

During bar code reading, the NT31/NT31C performs RS/CS control. When the Input Method setting of the NT31/NT31C is set to Auto, the RS signal is turned OFF, prohibiting the next input, until the read data has been notified to the host. Because of this, when the Auto setting is made, the next input is not possible until the data has been notified to the host.

However, when the setting is Auto and the RS/CS signals of the cable are shorted, RS/CS control is ineffective. Consequently, data input from the bar code reader to the NT31/NT31C is updated regardless of whether or not the data is notified to the host.

For details, refer to the instruction manual for the bar code reader used.

3-4-3 Data Format

The data format for communication when using the bar code input function of the NT31/NT31C is shown below.

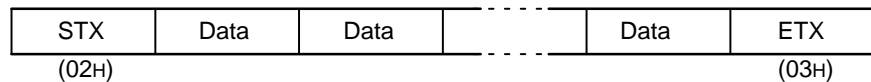

The characters which are effective as data are hexadecimal codes from 20 to 7FH, and the maximum data length is 40 bytes.

Data which does not follow the data format described above is invalidated and discarded.

3-5 Using a Memory Unit (-V□ Versions)

This section discusses the use of a memory unit with a V1 or V2 version of an NT31/NT31C PT (NT31-ST121□-EV□ or NT31C-ST141□-EV□).

Reference: Depending on the PT model and the system program which is installed, the function and using method of memory unit varies as follows.

PT Model	System Program	Function of Memory Unit
Without V□ suffix	Earlier than Ver. 2	Conventional memory unit function. (Refer to 56.) (System programs can not be transmitted using memory unit.)
	Ver. 2 or later	
With V□ suffix	Earlier than Ver. 2	New memory unit function. (System programs can be transmitted using memory unit.)
	Ver. 2 or later	

The memory unit functions are determined by the model of PT being used, regardless of the version of the system program installed in the PT.

By installing a memory unit (NT-MF261) on the NT31/NT31C, the screen data in the NT31/NT31C can be recorded (backed up) in the memory unit.

In addition, the screen data in the memory unit can be automatically read into the NT31/NT31C when it starts up. This means that system program and screen data can be changed easily at the operation site without connecting to the Support Tool.

The data in the memory unit is retained without backup by a battery or other means.

In systems where there are frequent setup changes, by preparing a number of memory units in advance and recording screen data in them in accordance with the control performed in each case, the NT31/NT31C screen data can be changed simply by installing the memory unit, without connecting to the Support Tool.

In addition, even if NT31/NT31C is replaced, the previous status can be maintained simply by installing the memory unit that retains the system program and screen data of the previous NT31/NT31C.

By using the following combinations, data can be stored (backed up) to a memory unit.

- Screen data for two PTs.
- System program for two PTs.
- System program and screen data for one PT.

One memory unit can store the screen data for two PTs.

- Note**
1. Make sure that the power supply to the PT is OFF before connecting or disconnecting a memory unit.
After mounting a memory unit, be sure to tighten its two screws.
 2. During data transmission, do not turn off the power supply to the NT31/NT31C or reset it.
 3. Do not touch the PCB (printed circuit board) with bare hands.

- Reference:**
- When a memory unit is mounted, the NT31/NT31C cannot be set to the operating status. On completion of data transmission with a memory unit, always disconnect the memory unit from the NT31/NT31C before starting NT31/NT31C operation.
 - Memory units (NT-MF261) can be used in common for the following PT models: NT31, NT31C, NT631, and NT631C (with or without the V□ suffix). One memory unit can store screen data for up to two PTs of different models. However, since the data compatibility is not complete between NT31/NT31C and NT631/NT631C, an error may occur if an attempt is made to read NT631C data with an NT31C. (The data must be converted using the Support Tool.)
 Note also that although there is data compatibility between the NT31 and NT31C, and between the NT631 and NT631C, the display may not be correct since these models have different numbers of colors.
 - One memory unit can store a system program for up to two PTs of different models. In order to transmit a system program from the memory unit to the NT31/NT31C, the system program must be compatible to the target PT model.
 - The statuses of memory switch settings and system settings can be recorded to the memory unit besides screen data. When the data in the memory unit is written into the NT31/NT31C, make sure that these settings can be adapted to the NT31/NT31C used before transmission.

3-5-1 Installation Method

Install the memory unit (NT-MF261) at the expansion interface connector at the rear of the NT31/NT31C as shown in the figure below (the expansion interface connector is located underneath the note label.).

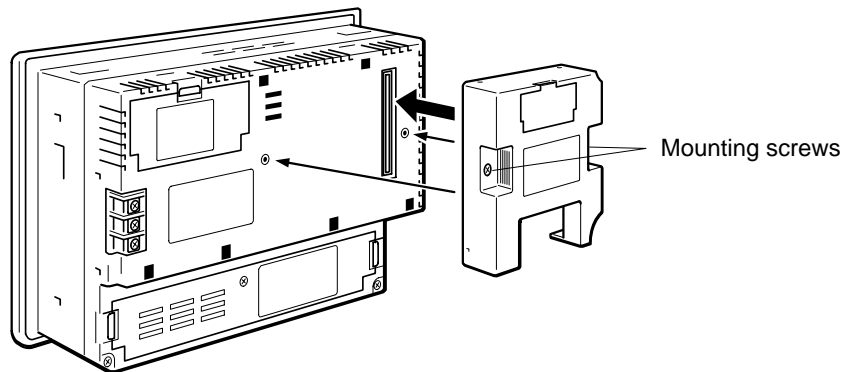

3-5-2 Method of Use

As shown in the figure below, a memory unit has two sets of four DIP switches, and the operation is determined by the DIP switches that are set at startup.

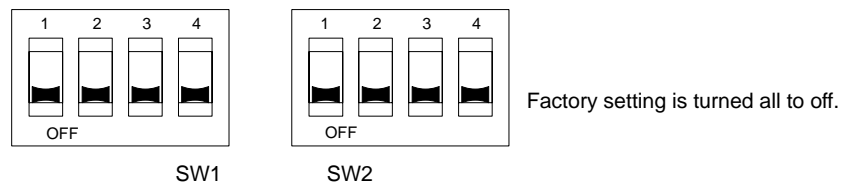

- Note**
1. Always confirm that the power to the NT31/NT31C is off before setting the DIP switches.
 2. Do not touch the PCB (printed circuit board) directly with bare hands.

DIP Switch Functions

The functions of the DIP switches on the memory unit are indicated in the table below.

- SW1

Switch	Function	
SW1-1	Automatic transmission (writing from the memory unit to the PT)	OFF: Not executed ON : Executed
SW1-2	Automatic transmission (writing from the PT to the memory unit)	OFF: Not executed ON : Executed
SW1-3	Manual transmission (Direction of transmission and bank used selected at the PT touch panel)	OFF: Not executed ON : Executed
SW1-4	Data type to transfer	OFF: Screen data ON : System program

- SW2

Switch	Function	
SW2-1	Disable/enable writing to PT	OFF: Disable ON : Enable
SW2-2	Disable/enable writing to the memory unit	OFF: Disable ON : Enable
SW2-3	Area (bank) selection of automatic transmission. *	OFF: Bank 0 ON : Bank 1
SW2-4	System/Screen simultaneous transmission	OFF: Disable ON : Enable

* The memory unit stores system program or screen data for one PT in each of areas (bank 0, bank 1). (The total data storage is for two PTs.) SW2-3 sets which of these two banks is used for automatic transmission.

Reference:

- The DIP switch function of the memory unit is supplemented to NT31/NT31C with the V□ suffix.
- In the following cases, a mode setting error occurs.
 - More than one of the SW1-1 to SW1-3 switches are set to ON.
 - None of the SW1-1 to SW1-3 switches are set to ON.
- In the following case, a protect setting error occurs.

Transmitting to the write destination has been disabled by the setting for SW2-1 or SW2-2.
- In the following cases, a data transmission error occurs.
 - An attempt is made to transmit data other than the system program to PT system program area.
 - An attempt is made to transmit the system program to PT screen data area.
- For details on mode setting errors and protect setting errors, refer to *Errors When Using a Memory Unit* (page 45).

Writing Screen Data to a Memory Unit Using Automatic Transmission (PT to Memory Unit)

In this mode, system program or the screen data in the NT31/NT31C is forcibly written to the memory unit irrespective of the setting status of the NT31/NT31C. This mode is convenient if the touch panel is broken and touch switch operation is not possible, or if someone unfamiliar with touch switch operation at the operation site is using the system.

Reference: When screen data is written to the memory unit, the data that has been stored in the specified area up until that point is lost (if the data is written into only one Bank, the other Bank will not be affected).

Method of Execution

Use the following procedure to write the screen data in the NT31/NT31C to the memory unit by automatic transmission.

- 1, 2, 3...**
1. Check that the power supply to the NT31/NT31C is OFF, then set the DIP switches of the memory unit as follows after installing memory unit to NT31/NT31C.

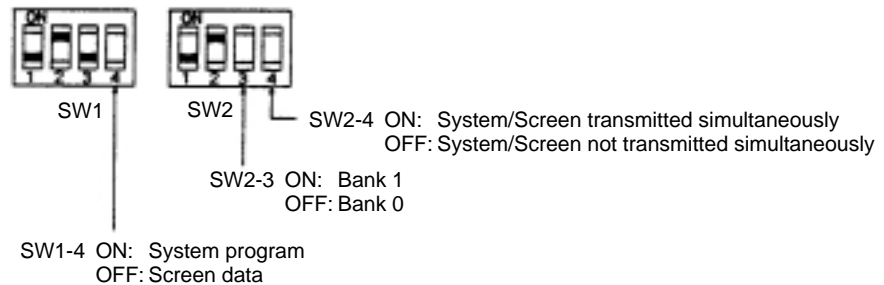

It is not strictly necessary to set SW2-1 to OFF (to disable writing to the PT), but it is recommended to do so to avoid loss of data in the event of operating errors.

- Reference:**
- Setting SW2-4 to ON (System/Screen transmitted simultaneously) disables the setting of SW1-4.
 - Setting SW2-4 to ON (System/Screen transmitted simultaneously) disables the setting of SW2-3, writes the system program into bank 0, and the screen data into bank 1 at all times.

2. Switch the NT31/NT31C power ON.

The screen data is automatically written into the memory unit. The screen data in the NT31/NT31C is preserved.

The messages Preparing, Transmitting, Verifying, and Finished are displayed on the screen in accordance with the progress of data writing.

At the same time, the progress of the data writing status is displayed by the means of the number of bytes and blocks (1 bank = 16 block = 1024k byte).

RUN LED operates as follows according to the processing status.

Preparing	: flashes at intervals of 1 second
Transmitting	: flashes at intervals of 0.5 second
Verifying	: flashes at intervals of 0.5 second
Finished	: lights up

3. Switch the NT31/NT31C power OFF, remove the memory unit.

To operate NT31/NT31C continuously, switch the NT31/NT31C power back ON.

Writing Screen Data to the PT Using Automatic Transmission (Memory Unit to PT)

In this mode, the system program or screen data in the memory unit is forcibly written to NT31/NT31C irrespective of the setting status of the NT31/NT31C. Since data transmission by this method is faster than when the Support Tool or system installer is used, it can save a lot of time. When transmitting the same system program or screen data to multiple NT31/NT31C, this mode becomes convenient.

Reference: When data is written to the NT31/NT31C, the data that has been stored up until that point is lost. When the system program is changed, the operation of NT31/NT31C also changes.

Method of Execution

Use the following procedure to write the screen data in the memory unit to the NT31/NT31C by automatic transmission.

- 1, 2, 3... 1. Check that the NT31/NT31C power is OFF, then set the DIP switches on the memory unit as follows after installing memory unit to NT31/NT31C.

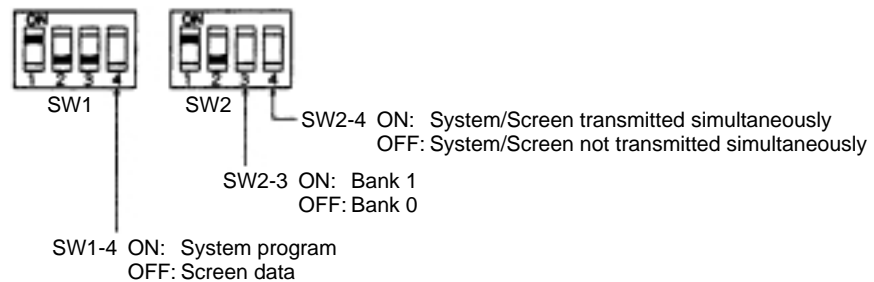

It is not strictly necessary to set SW2-2 to OFF (to disable writing to the memory unit), but it is recommended to do so to avoid loss of data in the event of operating errors.

- Reference:**
- Setting SW2-4 to ON (System/Screen transmitted simultaneously) disables the setting of SW1-4.
 - Setting SW2-4 to ON (System/Screen transmitted simultaneously) disables the setting of SW2-3. In this case, the data transmission becomes possible only if the data inside memory unit is in either of following combinations.
 - Bank 0: system program, Bank 1: other than system program
 - Bank 0: other than system program, Bank 1: system program
 If the combination is not as listed above, a data transmitting error occurs.
 - When writing the system program into the NT31/NT31C, the type of system program inside memory unit and the type of PT unit must be corresponding.

2. Switch the NT31/NT31C power ON.

The screen data is automatically written into the PT.

The messages Preparing, Transmitting, Verifying and Finished are displayed on the screen in accordance with the progress of data writing.

At the same time, the progress of data writing status is displayed by the means of the number of bytes and blocks (1 bank = 16 block = 1024k byte).

The RUN LED operates as follows according to the processing status.

Preparing	: flashes at intervals of 1 second
Transmitting	: flashes at intervals of 0.5 second
Verifying	: flashes at intervals of 0.5 second
Finished	: lights up

3. Switch the NT31/NT31C power OFF, remove the memory unit.

To operate NT31/NT31C continuously, switch the NT31/NT31C power back ON.

Reading and Writing Data by Manual Transmission

In this method, the direction of transmission and area of the memory unit used are set by touch switch operations at the NT31/NT31C. Transmission can be executed while checking the settings.

Reference: When data is written to the NT31/NT31C or memory unit, the data that has been stored up until that point is lost.

Method of Execution

Use the following procedure to write screen data using manual transmission.

- 1, 2, 3...** 1. Check that the NT31/NT31C power is OFF, then set the DIP switches on the memory unit as follows.

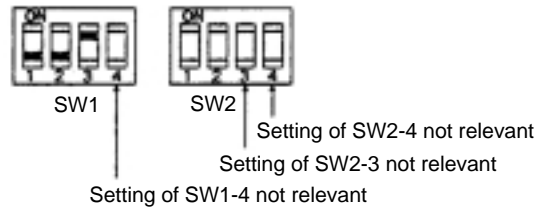

In order to avoid loss of data in the event of operating errors, it is advisable to set SW2-1 and SW2-2 so as to disable writing to the unit from which the data is to be read.

2. Switch the NT31/NT31C power ON.
Display language select screen appears.



3. Press the Japanese or English touch switches to select the display language.
The following descriptions are for when English is selected.
The screen shown below is displayed.



Current PT Screen Data, System

The first line: Compatible PT type for the system program inside PT.

The second line: System program name and Version for the system program inside PT.

(The second line may not be displayed in the kind of system program.)

Current PT Screen Data, Screen

The comment for the screen data in the NT31/NT31C is displayed here.

Current Memory Unit Screen Data

- In the case of system program:

The first line: Compatible PT type for the system program inside the memory unit.

The second line: System program name and Version for the system program inside the memory unit.

(The second line may not be displayed in the system program for some models.)

- In the case of screen data:

The comment for the screen data in the NT31/NT31C is displayed here.

The available transmitting destinations are altered depending on the settings of the origin of transmitting as described in the table below.

Source	Destination
[PT]screen	
[PT]system	
[PT]system/screen	[Memory unit] Bank 0/1 (fixed)
[Memory unit] Bank 0	<ul style="list-style-type: none"> • If system program is selected [PT]system (fixed)
[Memory unit] Bank 1	<ul style="list-style-type: none"> • If screen data is selected [PT]screen (fixed)
[Memory unit] Bank 0/1	[PT]system/screen (fixed)

- Reference:**
- When transmitting the system program and screen data simultaneously from the PT to the memory unit, the setting of banks is Bank 0: system program, Bank 1: screen data, and when transmitting them from the memory unit to the PT, either of the following combinations must be used.
 - Bank 0: system program, Bank 1: other than system program
 - Bank 0: other than system program, Bank 1: system program
 - When writing the system program into the NT31/NT31C, the type of system program inside memory unit and the type of PT unit must be corresponding.

4. Press Execute.

The data is transmitted.

The messages Preparing, Transmitting, Verifying, and Finished are displayed in accordance with the progress of data transmission. At the same time, the progress of data transmitting status is displayed by the means of the number of bytes and blocks (1 bank = 16 block = 1024k byte).

When the data transmission is operated manually, RUN LED remains OFF.

5. Switch the NT31/NT31C power OFF, remove the memory unit, then switch the NT31/NT31C power back ON.

Errors When Using a Memory Unit

If an error occurs when using the memory unit, the NT31/NT31C operates as follows.

- The details of the error and remedial action are displayed on the screen.

Each screen has touch switches to change the display language from one to the other. When the manual data transmission is operating, the content of error and remedial action are shown with selected language. When the automatic transmission is operating, it is displayed in Japanese.

- The continuous buzzer sounds.
- The RUN LED flashes.

If a protect setting error occurs when executing manual transmission, it is possible to return to the memory unit manual transmission screen by pressing the OK touch switch, but in the case of other errors, the status described above remains in effect until the NT31/NT31C power is turned OFF or reset.

When an error occurs, take remedial action by referring to the table below.

Error	Probable Cause	Remedial Action
Mode setting error	DIP switches SW1-1 to SW1-3 are all OFF, or more than one is ON.	Turn the NT31/NT31C power OFF, set the memory unit DIP switches correctly, then turn the NT31/NT31C power back ON.
Protect setting error (automatic transmission)	Writing to the data write destination has been prohibited by the setting of SW2-1 or SW2-2.	Turn the NT31/NT31C power OFF, set the memory unit DIP switches correctly, then turn the NT31/NT31C power back ON.
Protect setting error (manual transmission)	Writing to the data write destination has been prohibited by the setting of SW2-1 or SW2-2.	Perform either of the following procedures. <ul style="list-style-type: none"> • Press the OK touch switch to return to the memory unit manual transmission screen, make the correct settings, then try again. • Turn the NT31/NT31C power OFF, correct the DIP switches settings of the memory unit, then turn the power back ON.
Flash memory error	An error occurred during initialization of the NT31/NT31C or memory unit flash memory, or during write processing.	Turn the NT31/NT31C power OFF, then back ON. If the error recurs, the flash memory at the write destination may be faulty. In this case, replace the unit.
Verify error	An error occurred during verification processing at the flash memory of the NT31/NT31C or the memory unit.	Turn the NT31/NT31C power OFF, then back ON. If the error recurs, the flash memory at the write destination may be faulty. In this case, replace the unit.
Transmitting data error (The automatic transmission only)	An attempt is made to transmit data other than a system program or the system program of a different PC model into the NT31/NT31C as the system program. An attempt is made to write a system program into the NT31/NT31C as screen data.	Perform either of the following procedures. <ul style="list-style-type: none"> • Turn the NT31/NT31C power OFF, correct the DIP switch settings of the memory unit, and then turn the power back ON. • Turn the NT31/NT31C power OFF, set the DIP switch settings to the manual transmission, and then check the data inside the memory unit.

3-6 Using a Memory Unit (Versions without the -V□ Suffix)

This section discusses the use of a memory unit with the basic versions of the NT31/NT31C PTs (NT31-ST121□-E or NT31C-ST141□-E).

Reference: In this case, the function and use of the memory unit are the same as ones for the NT31/NT31C without the V□ suffix. (The system program transmission by using a memory unit cannot be processed.)

By installing a memory unit (NT-MF261) on the NT31/NT31C, the screen data in the NT31/NT31C can be recorded (backed up) in the memory unit.

In addition, the screen data in the memory unit can be automatically read into the NT31/NT31C when it starts up. This means that screen data can be changed easily at the operation site without connecting to the Support Tool.

The data in the memory unit is retained without backup by a battery or other means.

In systems where there are frequent setup changes, by preparing a number of memory units in advance and recording screen data in them in accordance with the control performed in each case, the NT31/NT31C screen data can be changed simply by changing the memory unit, without connecting to the Support Tool.

One memory unit can store the screen data for two PTs.

- Note**
1. Make sure that the power supply to the PT is OFF before connecting or disconnecting a memory unit. After mounting a memory unit, be sure to tighten its two screws.
 2. During data transmission, do not turn off the power supply to the NT31/NT31C or reset it.
 3. Do not touch the PCB (printed circuit board) with bare hands.

Reference:

- When a memory unit is mounted, the NT31/NT31C cannot be set to the operating status. On completion of data transmission with a memory unit, always disconnect the memory unit from the NT31/NT31C before starting NT31/NT31C operation.

- Memory units (NT-MF261) can be used in common for the following PT models: NT31, NT31C, NT631, NT631C (with or without the V□ suffix). One memory unit can store screen data for up to two PTs of different models. However, since the data compatibility is not complete between NT31/NT31C and NT631/NT631C, the data of NT631 cannot be used in NT31C without putting it through a conversion (the data must be converted using the Support Tool).

Note also that although there is data compatibility between the NT31 and NT31C, and between the NT631 and NT631C, the display may not be correct since these models have different numbers of colors.

The screen data for NT31/NT31C PTs with system program Ver. 2 or later cannot be used with PTs with system program earlier than Ver. 2.

- The statuses of memory switch settings and system settings can be recorded to the memory unit besides screen data. When the data in the memory unit is written into the NT31/NT31C, make sure that these settings can be adapted to the NT31/NT31C used before transmission.
-

3-6-1 Installation Method

Install the memory unit (NT-MF261) at the expansion interface connector at the rear of the NT31/NT31C as shown in the figure below. (The expansion interface connector is located underneath the note label.)

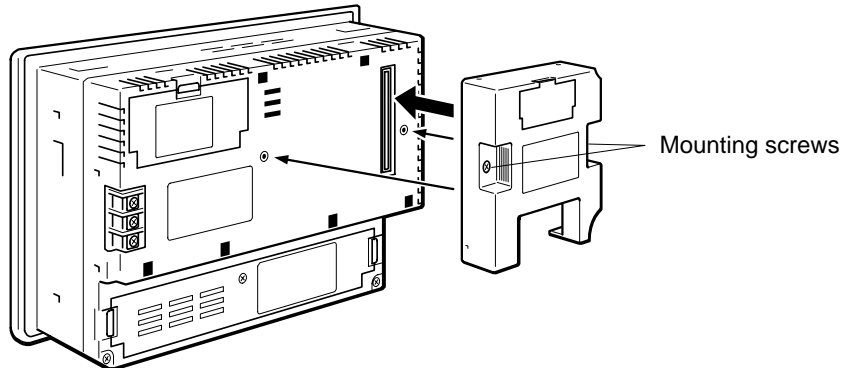

3-6-2 Method of Use

As shown in the figure below, a memory unit has two sets of four DIP switches, and the operation is determined by the DIP switches that are set at startup.

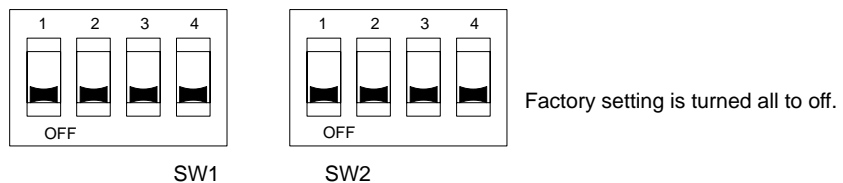

- Note**
1. Always confirm that the power to the NT31/NT31C is off before setting the DIP switches.
 2. Do not touch the PCB (printed circuit board) directly with bare hands.

DIP Switch Functions

The functions of the DIP switches on the memory unit are indicated in the table below.

• SW1

Switch	Function	
SW1-1	Automatic transmission (writing from the memory unit to the PT)	OFF: Not executed ON : Executed
SW1-2	Automatic transmission (writing from the PT to the memory unit)	OFF: Not executed ON : Executed
SW1-3	Manual transmission (Direction of transmission and bank used selected at the PT touch panel)	OFF: Not executed ON : Executed
SW1-4	Reserved for system use (must be set to OFF)	

• SW2

Switch	Function	
SW2-1	Disable/enable writing to PT	OFF: Disable ON : Enable
SW2-2	Disable/enable writing to the memory unit	OFF: Disable ON : Enable
SW2-3	Area (bank) selection of automatic transmission.	OFF: Bank 0 ON : Bank 1
SW2-4	Reserved for system use (must be set to OFF)	

* The memory unit stores screen data for one PT in each area (bank 0, bank 1). (The total data storage is for two PTs.) SW2-3 sets which of these two banks is used for automatic transmission.

- Reference:**
- In the following cases, a mode setting error occurs.
 - More than one of the SW1 switches are set to ON.
 - None of the SW1 switches are set to ON.
 - In the following case, a protect setting error occurs.
 - Writing to the write destination has been disabled by the setting for SW2-1 or SW2-2.
 - For details on mode setting errors and protect setting errors, refer to *Errors When Using a Memory Unit* (page 3 to 25).

Writing Screen Data to a Memory Unit Using Automatic Transmission (PT to Memory Unit)

In this mode, the screen data in the NT31/NT31C is forcibly written to the memory unit irrespective of the setting status of the NT31/NT31C.

This mode is convenient if the touch panel is broken and touch switch operation is not possible, or if someone unfamiliar with touch switch operation at the operation site is using the system.

- Reference:** When screen data is written to the memory unit, the data that has been stored in the specified area up until that point is lost (there is no effect on the other area).

Method of Execution

Use the following procedure to write the screen data in the NT31/NT31C to the memory unit by automatic transmission.

- 1, 2, 3...**
1. Check that the power supply to the NT31/NT31C is OFF, then set the DIP switches of the memory unit as follows after installing the memory unit in NT31/NT31C.

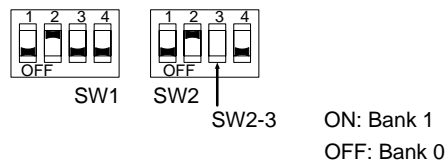

It is not strictly necessary to set SW 2-1 to OFF (to disable writing to the memory unit), but it is recommended to do so to avoid loss of data in the event of operating errors.

2. Switch the NT31/NT31C power ON.

The screen data is automatically written into the memory unit. The screen data in the NT31/NT31C is preserved.

The messages Preparing, Transmitting, Verifying, and Finished are displayed on the screen in accordance with the progress of data writing.

When messages Preparing, Transmitting, and Verifying are displayed, the RUN LED flashes, and when the message Finished is displayed, the RUN LED lights.
3. Switch the NT31/NT31C power OFF, remove the memory unit. To operate NT31/NT31C continuously, switch the NT31/NT31C power back ON.

Writing Screen Data to the PT Using Automatic Transmission (Memory Unit to PT)

In this mode, screen data is forcibly written from the memory unit to the NT31/NT31C irrespective of the setting status of the NT31/NT31C.

Since data transmission by this method is faster than when the Support Tool is used, it can save a lot of time. When transmitting the same system program or screen data to multiple NT31/NT31C, this mode becomes convenient.

Reference: When data is written to the NT31/NT31C, the data that has been stored up until that point is lost.

Method of Execution

Use the following procedure to write the screen data in the memory unit to the NT31/NT31C by automatic transmission.

- 1, 2, 3...** 1. Check that the NT31/NT31C power is OFF, then set the DIP switches on the memory unit as follows after installing the memory unit in NT31/NT31C.

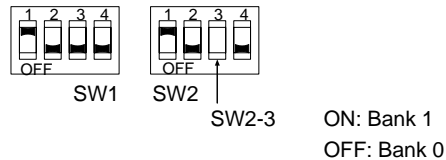

It is not strictly necessary to set SW2-2 to OFF (to disable writing to the memory unit), but it is recommended to do so to avoid loss of data in the event of operating errors.

2. Switch the NT31/NT31C power ON.

The screen data is automatically written into the PT.

The messages Preparing, Transmitting, Verifying and Finished are displayed on the screen in accordance with the progress of data writing.

When messages Preparing, Transmitting, and Verifying are displayed, the RUN LED flashes, and when the message Finished is displayed, the RUN LED lights.

3. Switch the NT31/NT31C power OFF, and remove the memory unit.
To operate NT31/NT31C continuously, switch the NT31/NT31C power back ON.

Reading and Writing Data by Manual Transmission

In this method, the direction of transmission and area of the memory unit used are set by touch switch operations at the NT31/NT31C. Transmission can be executed while checking the settings.

Reference: When data is written to the NT31/NT31C or memory unit, the data that has been stored up until that point is lost.

Method of Execution

Use the following procedure to read and write screen data using manual transmission.

- 1, 2, 3...** 1. Check that the NT31/NT31C power is OFF, then set the DIP switches on the memory unit as follows.

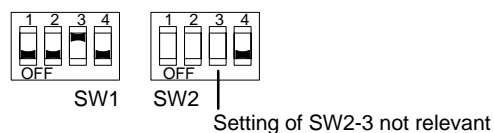

In order to avoid loss of data in the event of operating errors, it is advisable to set SW2-1 and SW2-2 so as to disable writing to the unit from which the data is to be read.

- Switch the NT31/NT31C power ON.
The screen shown below is displayed.
(Example)

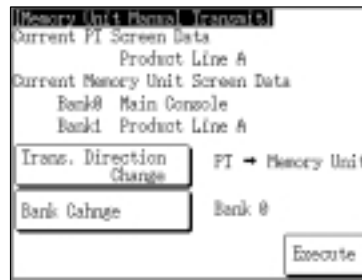

Current PT Screen Data

The comment for the screen data in the NT31/NT31C is displayed here.

Current Memory Unit Screen Data

The comments for the screen data in each area are displayed here.

Pressing the Trans. Direction Change and Bank Change touch switches changes the selections for the direction of transmission and the area of the memory unit used.

- Press Execute.

The data is transmitted.

The messages Preparing, Transmitting, Verifying, and Finished are displayed in accordance with the progress of data transmission.

- Switch the NT31/NT31C power OFF, remove the memory unit, then switch the NT31/NT31C power back ON.

Errors When Using a Memory Unit

If an error occurs when using the memory unit, the NT31/NT31C operates as follows.

- The details of the error and remedial action are displayed on the screen.
- The continuous buzzer sounds.
- The RUN LED flashes.

If a protect setting error occurs when executing manual transmission, it is possible to return to the memory unit manual transmission screen by pressing the OK touch switch, but in the case of other errors, the status described above remains in effect until the NT31/NT31C power is turned OFF or reset.

When an error occurs, take remedial action by referring to the table below.

Error	Probable Cause	Remedial Action
Mode setting error	DIP switches SW1-1 to SW1-3 are all OFF, or more than one is ON.	Turn the NT31/NT31C power OFF, set the memory unit DIP switches correctly, then turn the NT31/NT31C power back ON.
Protect setting error (automatic transmission)	Writing to the data write destination has been prohibited by the setting of SW2-1 or SW2-2.	Turn the NT31/NT31C power OFF, set the memory unit DIP switches correctly, then turn the NT31/NT31C power back ON.
Protect setting error (manual transmission)	Writing to the data write destination has been prohibited by the setting of SW2-1 or SW2-2.	Perform either of the following procedures. <ul style="list-style-type: none"> Press the OK touch switch to return to the memory unit manual transmission screen, make the correct settings, then try again. Turn the NT31/NT31C power OFF, correct the DIP switches settings of the memory unit, then turn the power back ON.

Error	Probable Cause	Remedial Action
Flash memory error	An error occurred during initialization of the NT31/NT31C or memory unit flash memory, or during write processing.	Turn the NT31/NT31C power OFF, then back ON. If the error recurs, the flash memory at the write destination may be faulty. In this case, replace the unit.
Verify error	An error occurred during verification processing at the flash memory of the NT31/NT31C or the memory unit.	Turn the NT31/NT31C power OFF, then back ON. If the error recurs, the flash memory at the write destination may be faulty. In this case, replace the unit.

SECTION 4

Connecting to the Host from the RS-232C Port

This section describes the method for connecting to the host using the RS-232C port of the PT.

4-1	Connecting to the RS-232C Port at the Host	54
4-1-1	Host Types and Settings	54
4-1-2	Connecting Directly between RS-232C Ports	78

4-1 Connecting to the RS-232C Port at the Host

The method for connecting between the RS-232C port of the PT and the RS-232C port of the host is as follows.

The following discussion is focused on the connection method to OMRON PCs (By using the memory link method, a connection can be made to any arbitrary RS-232 unit). When making a connection to a host other than OMRON PCs, refer to the *PC Connection Manual (V042-E1-□)* or *NT31/631 Multi Vendor Connection Manual (V060-E1-□)*.

Direct Connection Between The RS-232C Ports Using an RS-232C Cable (Page 111)

This is the easiest connection method. Depending on the host to which the connection is to be made, it may be possible to use OMRON cables with connectors.

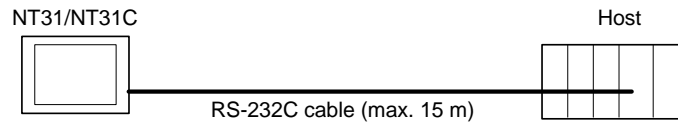

Reference: The CS1 series CPU cannot be connected with the 1:1 connection NT link method. Use the 1:N connection NT link method instead to make the 1:1 connection. For details, refer to *Using the NT Link (1:N) Method (page 72)* or *Using the High-speed NT Link (1:N) Method (page 75)*.

4-1-1 Host Types and Settings

The types of host that can be connected to a PT by using the RS-232C ports of both units, and the settings to be made at the host, are described here.

When Using the Host Link Method

Compatible Host Units

Some models and series of OMRON PCs have the host link function built in.

In the CS1-series or CQM1H PCs, the host link method can be used by installing a Serial Communication Board. In addition, some C200HX/HG/HE(-Z)E have an integral CPU that can be connected in the host link method by installing a Communication Board.

Check the model and series of the PC, the type of installed Serial Communication Board, Serial Communication Unit, or Host Link Unit before making a connection.

The host units that can be connected to the NT31/NT31C by the host link method using the RS-232C ports of both units are indicated in the table below.

PC Series	Units with Built-in Host Link Function	CPUs Connectable with Host Link Units or Expansion Communication Board	Host Link Unit/ Communication Board	Connectable to
CS1 Series	CS1G-CPU42/43/44/45-EV1 CS1H-CPU63/64/65/66/67-EV1	CS1G-CPU42/43/44/45-EV1 CS1H-CPU63/64/65/66/67-EV1	CS1W-SCU21 CS1W-SCB21 CS1W-SCB41	CS1G CS1H
C Series	---	C1000H-CPU01-EV1 C2000H-CPU01-EV1	C120-LK201-EV1	C1000H C2000H
	---	C200HS-CPU01/03/21/23/31/33-E C200HE-CPU11/32/42-E C200HE-CPU11/32/42-ZE C200HG-CPU33/43/53/63-E C200HG-CPU33/43/53/63-ZE C200HX-CPU34/44/54/64-E C200HX-CPU34/44/54/64/65/85-ZE	C200H-LK201-EV1	C200HS C200HE C200HE-Z C200HG C200HG-Z C200HX C200HX-Z
	C200HS-CPU21/23/31/33-E	---	---	C200HS
	C200HE-CPU42-E C200HE-CPU42-ZE	C200HE-CPU32/42-E C200HE-CPU32/42-ZE	C200HW-COM02/04/ 05/06-EV1	C200HE C200HE-Z
	C200HG-CPU43/63-E C200HG-CPU43/63-ZE	C200HG-CPU33/43/53/63-E C200HG-CPU33/43/53/63-ZE		C200HG C200HG-Z
	C200HX-CPU44/64-E C200HX-CPU44/64/65/85-ZE	C200HX-CPU34/44/54/64-E C200HX-CPU34/44/54/64/65/85-ZE		C200HX C200HX-Z
	---	C1000H-CPU01-EV1 C2000H-CPU01-EV1		C500-LK201-EV1
	---	C1000H-CPU01-EV1 C1000HF-CPU01-EV1 C2000H-CPU01-EV1	C500-LK203	C1000H (F) C2000H
	CPM1-10/20/30CDR-□ +CPM1-CIF01	---	---	CPM1
	CPM1A-10/20/30/40CD□-□ +CPM1-CIF01	---	---	
	CPM2A-30/40/60CD□□-□ +CPM1-CIF01 (Peripheral port connection)	---	---	CPM2A
	CPM2C-10/20□□□□□□-□ (*1)	---	---	CPM2C
	CQM1-CPU21-E CQM1-CPU41/42/43/44-EV1	---	---	CQM1
	CQM1H-CPU11/21/51/61 (*2)	CQM1H-CPU51/61	CQM1H-SCB41	CQM1H
CV Series (*3)	CV500-CPU01-EV1	CV500-CPU01-EV1	CV500-LK201	CV500
	CV1000-CPU01-EV1	CV1000-CPU01-EV1		CV1000
	CV2000-CPU01-EV1	CV2000-CPU01-EV1		CV2000
CVM1 Series (*3)	CVM1-CPU01-EV2 CVM1-CPU11-EV2 CVM1-CPU21-EV2	CVM1-CPU01-EV2 CVM1-CPU11-EV2 CVM1-CPU21-EV2	CV500-LK201	CVM1
Compo-Bus/S master control unit	SRM1-C02-V1	---	---	SRM1

*1: Use a CPM2C-CN111 or CS1W-CN114/118 Connecting Cable, CPM1-CIF01 RS-232C Adapter, or CPM1-CIF11 RS-422A Adapter to connect.

*2: The CQM1H-CPU11 does not have a built-in RS-232C port, so connect to the peripheral port to the PT with a CS1W-CN118 Connecting Cable.

*3: CPUs of CVM1/CV-series PCs without the suffix -EV□ cannot be connected.

Settings at the Host

When using the host link method, the settings shown below must be made at the host (depending on the unit, some of these settings may not be necessary, or settings not shown here may be necessary).

Item	Switch Setting
I/O port	RS-232C
Communications speed	Set the same speed as for the NT31/NT31C. (*1)
Transfer code	ASCII, 7 data bits, 2 stop bits
Parity	Even
1-to-1/1-to-N	1-to-N(*2)
Instruction level	Level 1, 2, 3
Unit #	00

*1 Set the host link communications speed at 9600 bps or 19200 bps with the memory switch at the NT31/NT31C. For details, refer to *Setting the Host Link Method* (page 160).

*2 The 1-to-N setting enables BCC (Block Check Character). It is not actually possible to connect more than one NT31/NT31C in a single host link.

The setting methods for each type of unit are described in the following.

Connecting to a C-series Host Link Unit

**C200H/C200HS/C200HE/HG/HX (-Z)E Backplane mounted type:
C200H-LK201-V1**

Setting the Front Switches

Set each switch with a flat blade screwdriver so that the values or symbols in the setting value window agree with the following.

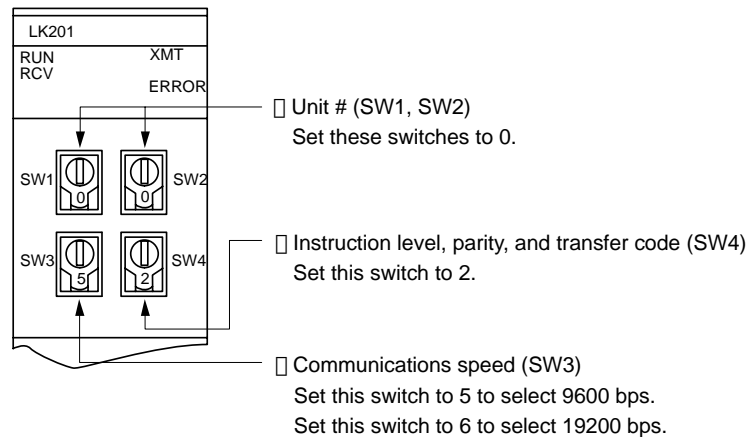

Setting the Rear Switches

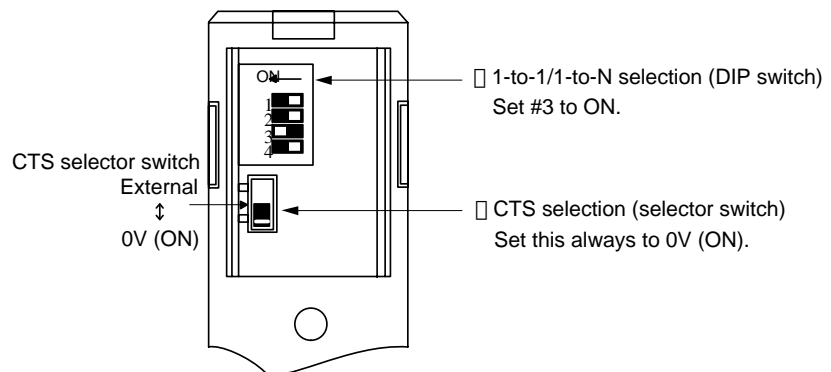

C1000H(F)/C2000H Backplane mounted type: 3G2A5-LK201-EV1

Setting the Front Switches

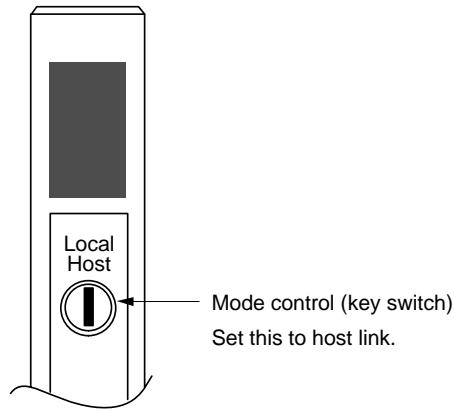

Setting the Rear Switches

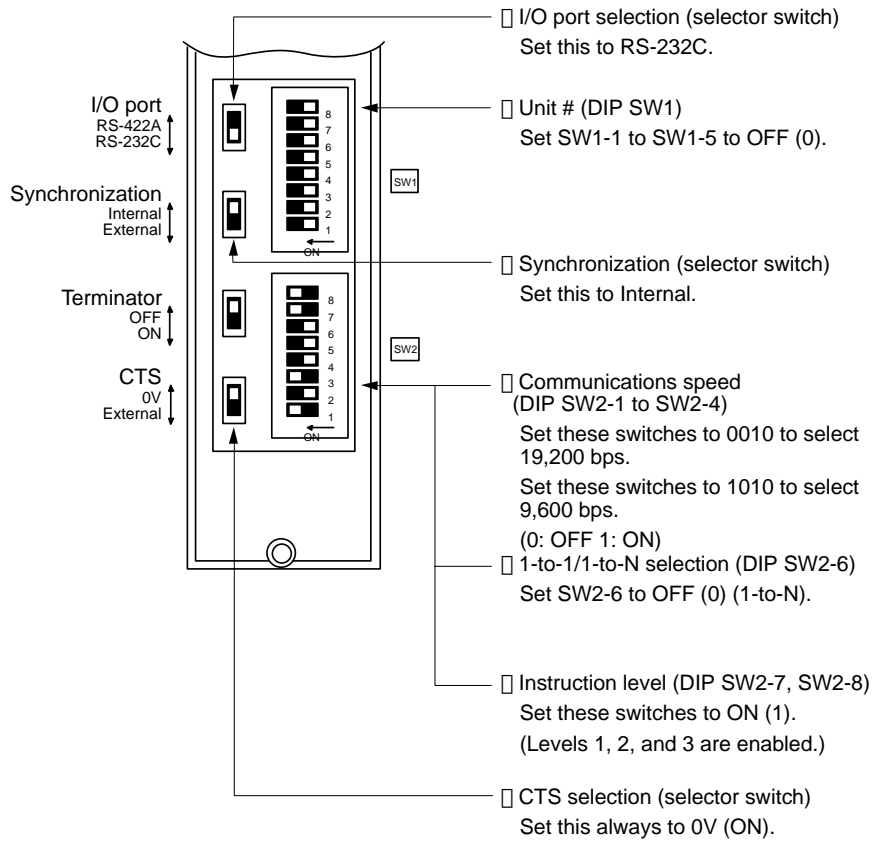

C1000H/C2000H Backplane mounted type: C500-LK203

Setting the Rear Switches

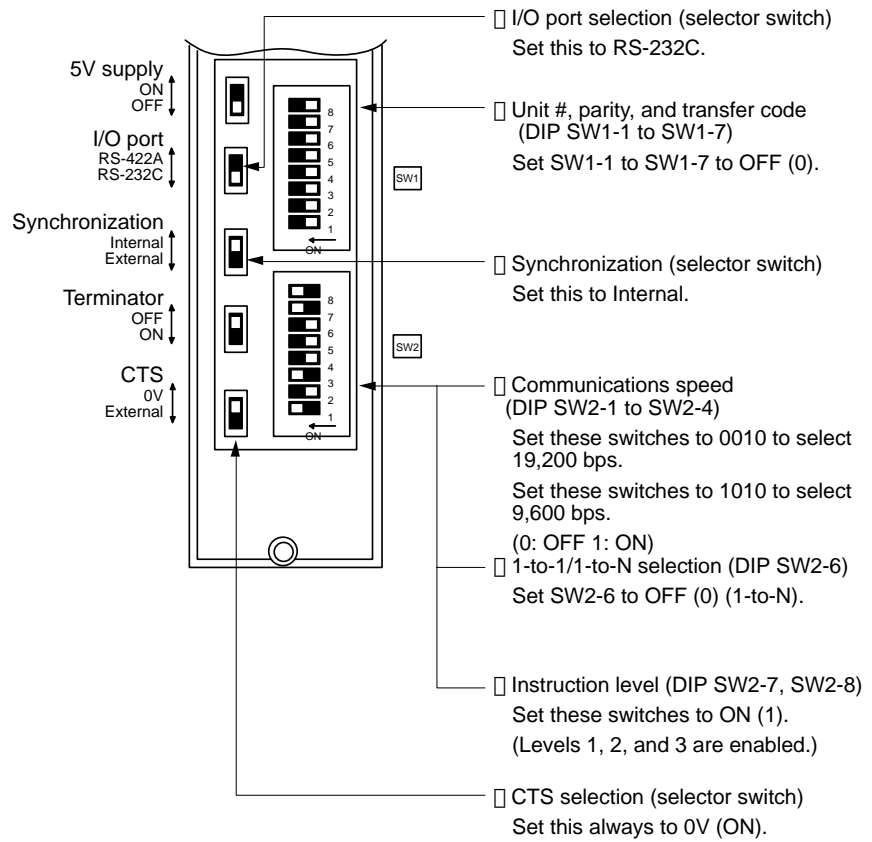

C200H/C1000H/C2000H CPU mounting type: 3G2A6-LK201-EV1

Setting the Rear Switches

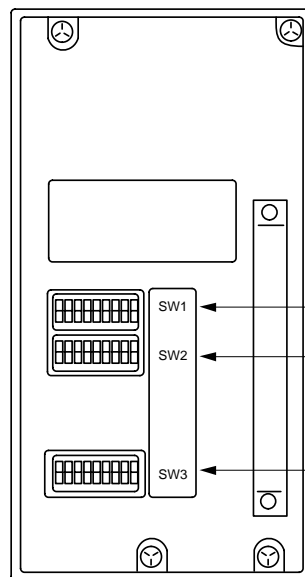

- Unit #, parity, and transfer code (DIP SW1-1 to SW1-5)
Set SW1-1 to SW1-5 to OFF (0).
* Parity is fixed at Even Parity. Transfer code is fixed at ASCII 7 data bits and 2 stop bits.
- Communications speed (DIP SW2-1 to SW2-4)
Set these switches to 0010 to select 19,200 bps.
Set these switches to 1010 to select 9,600 bps.
(0: OFF 1: ON)
- 1-to-1/1-to-N selection (DIP SW2-6)
Set SW2-6 to OFF (0) (1-to-N).
- Instruction level (DIP SW2-7, SW2-8)
Set these switches to ON (1).
(Levels 1, 2, and 3 are enabled.)
- CTS selection (DIP SW3-1 and SW3-2)
Set SW3-1 to ON (1), and SW3-2 to OFF (0).
(Set this always to 0V.)
- Synchronization (DIP SW3-3 to SW3-6)
Set SW3-3, SW3-5, and SW3-6 to ON (1), and SW3-4 to OFF (0). (Set these to Internal.)

Connecting to a CVM1/CV Series Host Link Unit

CVM1/CV series backplane mounted type: CV500-LK201

A CVM1/CV series host link unit (CV500-LK201) has two connectors (communication ports 1 and 2). Either of these ports can be used for connection to an NT31/NT31C by the RS-232C method. However, since the connectors at these ports are of different types, a cable that matches the connector must be prepared.

- Communication port 1
Communication port 1 is a 25-pin connector for RS-232C use only.
- Communication port 2
Communication port 2 is a 9-pin connector which allows selection of the RS-232C or RS-422A method. When this port is used with the RS-232C method, the I/O port selector switch on the front of the unit must be set to RS-232C (the upper position).

CPU Bus Unit Settings

When connecting to a CVM1/CV series host link unit, set the following communication conditions for the CPU bus unit settings.

Item	Setting at Host
Communications speed	Set the same speed as set at the NT31/NT31C(*1)
Transfer code	ASCII, 7 data bits, 2 stop bits
Parity	Even
1-to-1, 1-to-N	1-to-N(*2)
Instruction level	Level 1, 2, 3

*1 Set the host link communications speed at 9600 bps or 19200 bps with the memory switch at the NT31/NT31C. For details, refer to *Setting the Host Link Method* (page160).

*2 The 1-to-N setting enables BCC (Block Check Character). It is not actually possible to connect more than one NT31/NT31C in a single host link.

Set the CPU bus unit settings directly from a Programming Device (e.g. SYSMAC support software).

For details on the CPU bus unit settings, refer to the *SYSMAC CVM1/CV-series Host Link Unit Operation Manual (W205-E1-□)*.

Setting the Front Switches

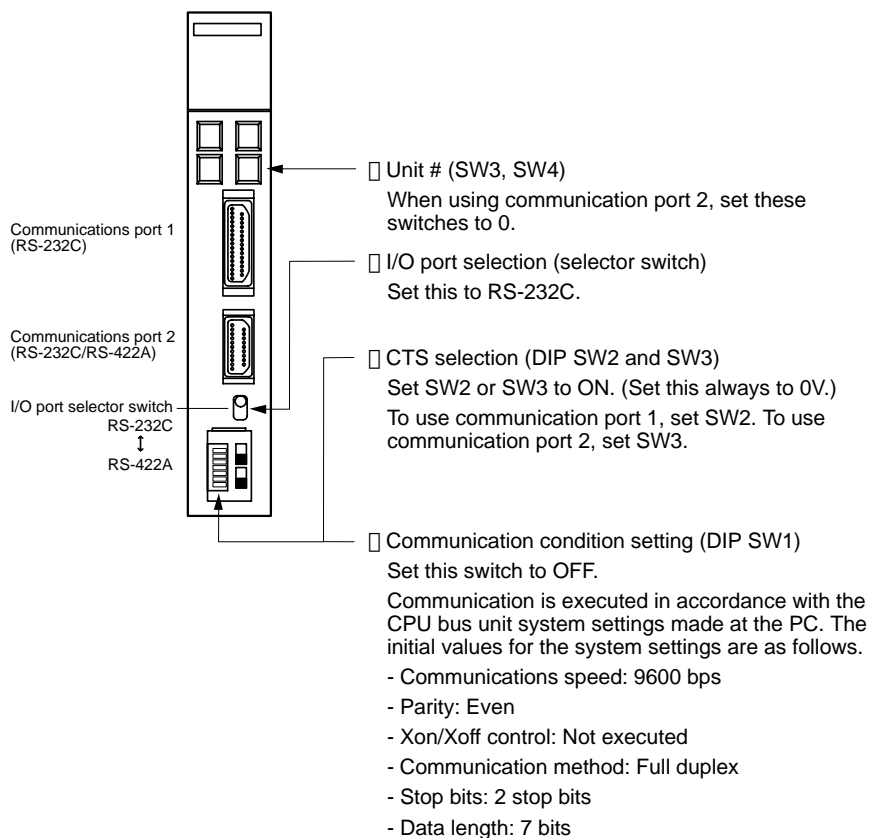

Connecting to a CS1-series Serial Communication Unit

CS1 series Backplane mounted type: CS1W-SCU21

Setting the Front Switches

Set the unit number of the serial communication unit by using the rotary switch located on the front panel. Set each switch with a flat blade screwdriver so that the values or symbols in the setting value window agree with the following.

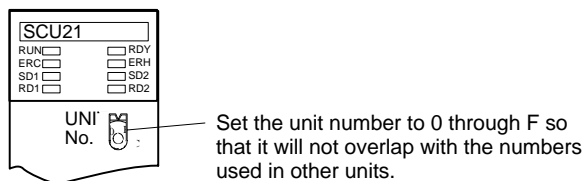

Allocation DM Area Settings for CPU

Settings are written from the Programming Device (a Programming Console or CX-Programmer) directly into the allocation DM area (system setting area) of the CPU. After the settings are written, they become effective by turning the power ON, restarting the unit, restarting the communication port, or execution of the STUP command.

In the following, the channel numbers of the allocation DM area and the settings are shown.

$$m = \text{DM30000} + 100 \times \text{unit \# (CH)}$$

Allocation DM area (CH)		Writing Value	Settings
Port 1	Port 2		
m	m+10	8000	host link mode, 2 stop bits, even parity, data length 7 bits
m+1	m+11	0000	Communication speed 9600 bps.
		0007	Communication speed 19200 bps.
m+2	m+12	0000	Transmit delay time 0 ms.
m+6	m+16	0000	No CTS control Unit No.0 for host link

Connecting to a CPU Unit**CV-series and CVM1/CV-series (-EV□) CPU Units**

- CV500-CPU01-EV1/CV1000-CPU01-EV1/CV2000-CPU01-EV1
- CVM1-CPU01-EV2/CVM1-CPU11-EV2/CVM1-CPU21-EV2

PC Setup

When connecting to a CVM1/CV series CPU, set the following communication conditions for the PC Setup.

Item	Setting at Host
Communications speed	Set the same speed as set at the NT31/NT31C ^(*1)
Stop bit	2 stop bits
Parity	Even
Data length	ASCII 7 bits
Unit #	00

*1 Set the host link communications speed at 9600 bps or 19200 bps with the memory switch at the NT31/NT31C. For details, refer to *Setting the Host Link Method* (page 160).

Either set PC Setup directly from a Programming Device (e.g. SYSMAC support software), or transmit the PC Setup made at a Programming Device to the CPU. For details on the PC Setup, refer to the *SYSMAC CVM1/CV500/1000/2000 Operation Manual: Ladder Diagrams (W202-E1-□)*.

Setting the Front Switches

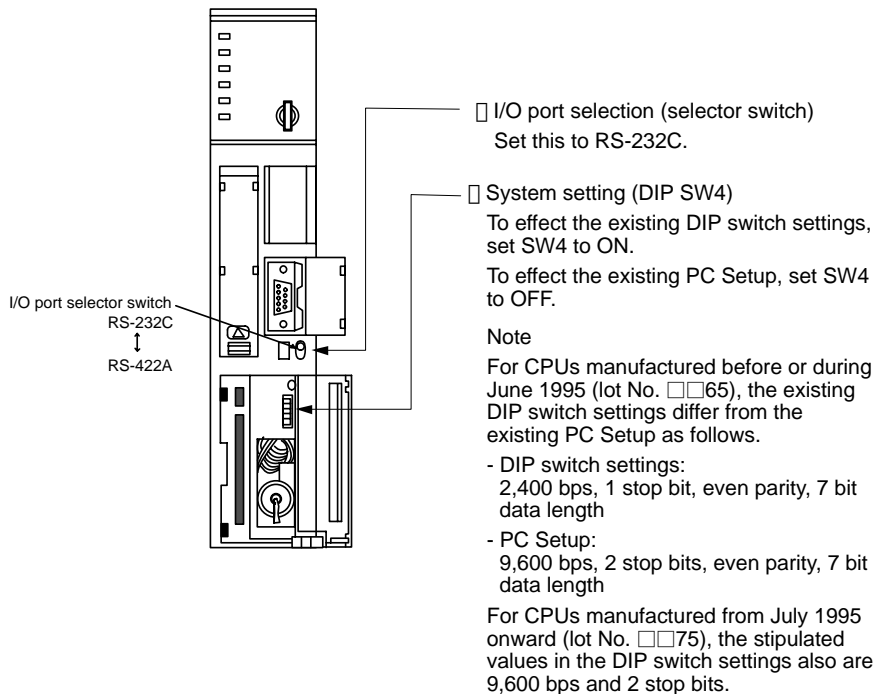

C-series C200HS, C200HX/HG/HE(-Z)E, CPM1, CPM2A, CPM2C, CQM1, CQM1H CPUs, SRM1

The connection method depends upon the model of PC being used, as shown in the following table.

PC model	Connection method
C200HS, CQM1	Connect to the CPU Unit's built-in RS-232C port.
C200HX/HG/HE(-Z)E	<ul style="list-style-type: none"> Connect to the CPU Unit's built-in RS-232C port. Connect to one of the RS-232C ports (port A or port B) on a Serial Communications Board.
CQM1H	<ul style="list-style-type: none"> Connect to the CPU Unit's built-in RS-232C port. Connect to the peripheral port through a CS1W-CN118 Connecting Cable. Connect to the RS-232C port (port 1) on a Serial Communications Board.
CPM1	Connect to the peripheral port through a CPM1-CIF01 RS-232C Adapter.
CPM2A, SRM1	<ul style="list-style-type: none"> Connect to the CPU Unit's built-in RS-232C port. Connect to the peripheral port through a CPM1-CIF01 RS-232C Adapter.
CPM2C	<p>Connect to the CPU Unit's RS-232C port or the peripheral port through a Connecting Cable (CPM2C-CN111, CS1W-CN118, or CS1W-CN114).</p> <p>(The CPM2C-CN111 splits the Unit's Communication Port into a RS-232C port and a peripheral port. A CPM1-CIF01 RS-232C Adapter is also required to connect to this peripheral port.)</p>

PC Setup Area Settings

When connecting to a C200HS, C200HX/HG/HE(-Z)E, CPM1, CPM2A, CPM2C, CQM1, or CQM1H CPU, or SRM1, set the following communication conditions for the PC Setup area.

Item	Setting at Host
Communication mode	Host link mode
Communications speed	Set the same speed as set at the NT31/NT31C ^(*1)
Stop bit	2 stop bits
Parity	Even
Data length	ASCII 7 bits
Unit #	00

*1 Set the host link communications speed at 9600 bps or 19200 bps with the memory switch at the NT31/NT31C. For details, refer to *Settings the Host Link Method* (page160).

Set the PC Setup area settings directly from a Programming Device (e.g. the CX-Programmer support software).

For details on operations relating to the PC Setup area, refer to the manual for the PC which is used.

The PC Setup area word numbers and settings to be made depending on the unit and port to which the connection is made are shown below.

CPM2A, CPM2C, CQM1H, or SRM1: Peripheral port connection

Word #	Writing Value	Settings
DM6650	0001	Host link mode, no CTS control Communication conditions set by the contents of DM
DM6651	0303	Data length 7 bits, 2 stop bits, even parity, communications speed: 9600 bps
	0304	Data length 7 bits, 2 stop bits, even parity, communications speed: 19200 bps
DM6653	0000	Unit # 00

C200HS, C200HX/HG/HE(-Z)E, CPM2A, CPM2C, CQM1, CQM1H (other than the CPU11), or SRM1: Built-in RS-232C port connection

Word #	Writing Value	Settings
DM6645	0001	Host link mode, no CTS control Communication conditions set by the contents of DM
DM6646	0303	Data length 7 bits, 2 stop bits, even parity, communications speed: 9600 bps
	0304	Data length 7 bits, 2 stop bits, even parity, communications speed: 19200 bps
DM6648	0000	Unit # 00

C200HX/HG/HE(-Z)E: Serial Communications Board port A

CQM1H: Serial Communications Board port 1

Word #	Writing Value	Settings
DM6555	0001	Host link mode, no CTS control Communication conditions set by the contents of DM
DM6556	0303	Data length 7 bits, 2 stop bits, even parity, communications speed: 9600 bps
	0304	Data length 7 bits, 2 stop bits, even parity, communications speed: 19200 bps
DM6558	0000	Unit # 00

C200HX/HG/HE(-Z)E: Serial Communications Board port B

Word #	Writing Value	Settings
DM6550	0001	Host link mode, no CTS control Communication conditions set by the contents of DM
DM6551	0303	Data length 7 bits, 2 stop bits, even parity, communications speed: 9600 bps
	0304	Data length 7 bits, 2 stop bits, even parity, communications speed: 19200 bps
DM6553	0000	Unit # 00

CPM1: Peripheral port connection through a CPM1-CIF01 RS-232C Adapter

Word #	Writing Value	Settings
DM6650	0001	Host link mode Communication conditions set by the contents of DM
DM6651	0303	Data length 7 bits, 2 stop bits, even parity, communications speed: 9600 bps
	0304	Data length 7 bits, 2 stop bits, even parity, communications speed: 19200 bps
DM6653	0000	Unit # 00

Connecting to a CPM2C

The CPM2C PCs do not have the same kind of port connectors found on CS1-series PCs. The CPM2C's communication port handles both RS-232C and peripheral port connections which are divided internally. Therefore, when using the CPM2C, it is necessary to select RS-232C or peripheral port connections, according to the kind of cable and port (on the cable) used, as shown in the following table. Refer to the *CPM2C Operation Manual* for more details.

Port connecting to PT	PC Setup
RS-232C port (D-Sub 9-pin) of CPM2C-CN111	Built-in RS-232C port settings
Peripheral port of CPM2C-CN111	Peripheral port settings
RS-232C port (D-Sub 9-pin) of CS1W-CN118	Built-in RS-232C port settings
Peripheral port of CS1W-CN114	Peripheral port settings

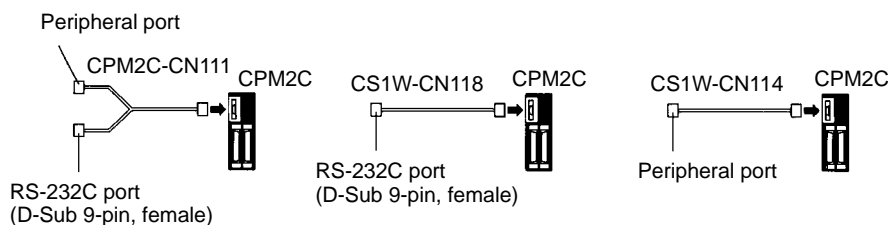

Setting the DIP Switches of a C200HX/HG/HE(-Z)E, CQM1, or CQM1H

When using a C200HX/HG/HE(-Z)E, CQM1, or CQM1H, the DIP switches on the front panel must be set as shown below in order to make the settings in the PC Setup area (data memory) effective.

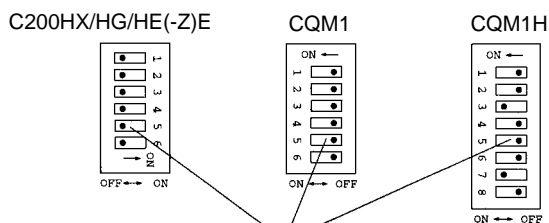

RS-232C port communication condition setting
Set DIP SW5 to OFF to make the settings made in PC Setup effective.

When using the CQM1H's built-in peripheral port, turn ON SW7.

Setting the Switches of a CPM2A

When using a CPM2A, the switches on the front panel must be set as shown below in order to make the PC Setup settings effective.

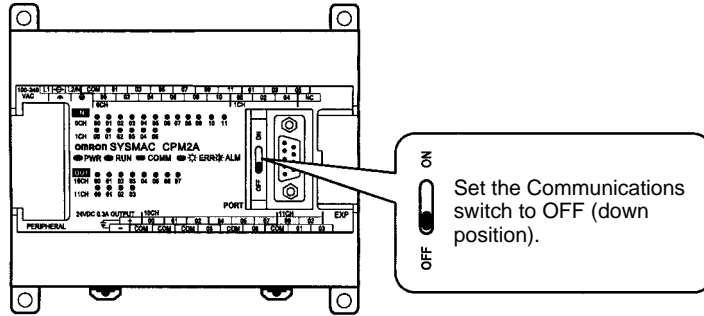

Setting the Switches of a CPM2C

When using a CPM2C, the switches on the front panel must be set as shown below in order to make the PC Setup settings effective.

The settings for SW1 and SW2 depend upon the usage of the peripheral port and RS-232C port.

- Connecting PT to peripheral port
- Connecting PT to built-in RS-232C port
(A device that requires non-standard communications settings is connected to the peripheral port.)

SW1: OFF
SW2: ON

- Connecting PT to built-in RS-232C port
(A Programming Console is connected to the peripheral port.)

SW1: OFF
SW2: OFF

Setting the Switches on an RS-232C Adapter

When using a CPM1-CIF01 RS-232C Adapter, set the mode switch as shown in the following diagram.

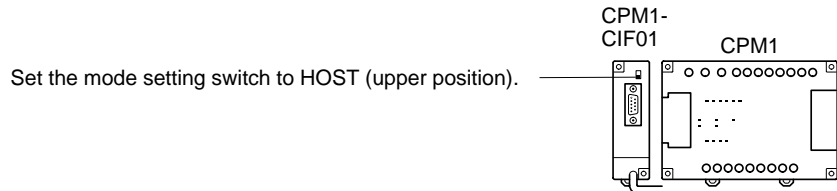

CS1 series CPU type : CS1G/H-CPU□□-E (-V1)

Connect to the built-in RS-232C port of the CPU, or the RS-232C port of the communication board. Note that the connection to a peripheral port must be made via an RS-232C adapter (CS1W-CN118) specially designed for connecting to a peripheral port.

PC Setup

When connecting to a CS1 series CPU, set the following communication conditions for the PC Setup area. Since the settings shown below are the PC default settings for the CPU, no change to the PC Setup is necessary as long as the communication speed is maintained at 9600 bps.

Item	Setting at Host
Communication speed	Set the same speed as set at the NT31/NT31C(*1)
Stop bits	2 stop bits
Parity	Even
Data length	ASCII 7 bits
Unit No. for the host link	00

*1 Set the host link communications speed at 9600 bps or 19200 bps with the memory switch at the NT31/NT31C. For details, refer to *Settings the Host Link Method* (page 160). When the communication speed is set to 19200 bps, the PC Setup of the CPU need to be changed.

Either set the PC Setup directly from a Programming Device (Programming Console), or transmit the PC Setup made at a Programming Device (CX-Programmer) to the CPU.

For details on PC Setup, refer to the *SYSMAC CS1-series Operation Manual* (W339-E1-□).

When using the built-in RS-232C port of CS1G/H

Word #	Writing Value	Settings
160	8000	Host link mode, data length 7 bits, 2 stop bits, even parity
161	0000	Communication speed: 9600 bps.
	0007	Communication speed: 19200 bps.
166	0000	Unit #00

When using the peripheral port of CS1G/H

Word #	Writing Value	Settings
144	8000	Host link mode, data length 7 bits, 2 stop bits, even parity
145	0000	Communication speed: 9600 bps.
	0007	Communication speed: 19200 bps.
150	0000	Unit #00

Setting the Front Switches

Set the CPU DIP switches to 4 or 5 in accordance with the port NT31/NT31C is connected to.

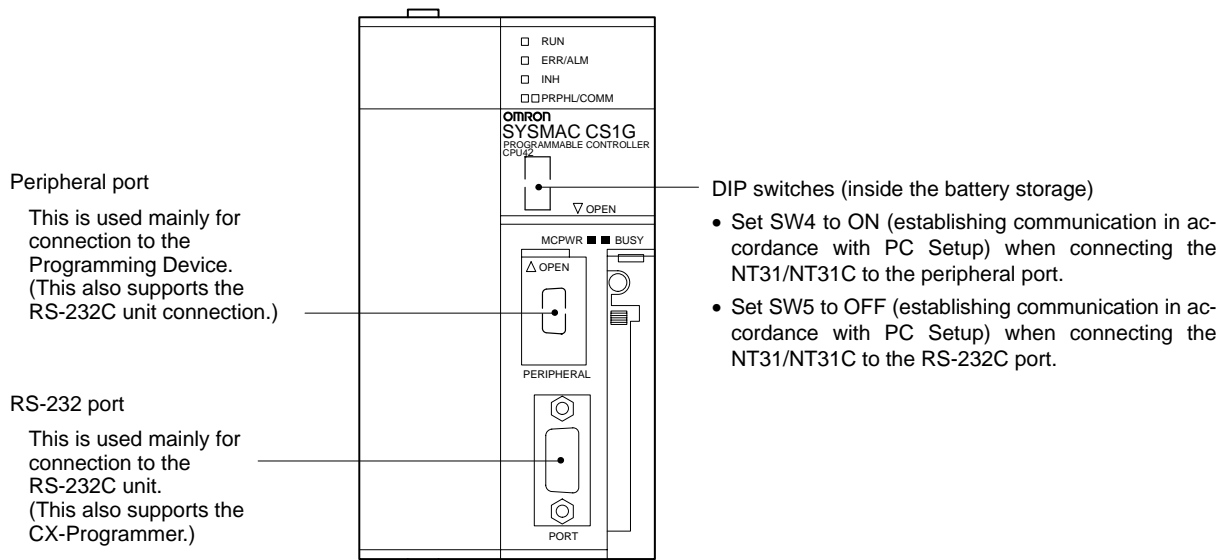

Connecting to CS1-series Serial Communications Board

Serial Communications Board equipped with a RS-232C port for CS1-series CPU Units: CS1W-SCB41/21

Allocation DM Area Settings for CPU Unit

Settings are written from the Programming Device (a Programming Console or CX-Programmer) directly into the allocation DM area (system setting area) of the CPU. After the settings are written, they become effective by turning the power ON, restarting the unit, restarting the communication port, or execution of the STUP command.

In the following, the channel numbers of the allocation DM area and the settings are shown.

Allocation DM area (CH)		Writing Value	Settings
Port 1	Port 2		
DM32000	DM32010	8000	Host link mode, 2 stop bits, even parity, data length 7 bits
DM32001	DM32011	0000	Communication speed 9600 bps.
		0007	Communication speed 19200 bps.
DM32002	DM32012	0000	Transmit delay time 0 ms.
DM32006	DM32016	0000	No CTS control Unit No.0 for host link

When Using the NT Link (1:1) Method

Compatible Host Units

Some models and series of OMRON PCs have the NT link (1:1) function built in. With CQM1H PCs, a Serial Communications Board can be added to provide 1:1 NT Link communications. Some C200HX/HG/HE(-Z)E CPUs can be connected by the NT link (1:1) method by installing a Communication Board.

Check the model and series of the PC against the type of CPU before making the connections.

The host units that can be connected to the NT31/NT31C by the NT link (1:1) method using the RS-232C ports of both units are indicated in the table below.

PC Series	CPUs with Built-in NT Link Function	CPUs Connectable with Expansion Communication Board ^(*1)	Connectable to
C series	C200HS-CPU21-E, -EC C200HS-CPU23-E C200HS-CPU31-E C200HS-CPU33-E	---	C200HS
	C200HE-CPU42-(Z)E	C200HE-CPU32-(Z)E C200HE-CPU42-(Z)E	C200HE (-Z)E
	C200HG-CPU43-(Z)E C200HG-CPU63-(Z)E	C200HG-CPU33-(Z)E C200HG-CPU43-(Z)E C200HG-CPU53-(Z)E C200HG-CPU63-(Z)E	C200HG (-Z)E
	C200HX-CPU44-(Z)E C200HX-CPU64-(Z)E X200HX-CPU65-ZE C200HX-CPU85-ZE	C200HX-CPU34-(Z)E C200HX-CPU44-(Z)E C200HX-CPU54-(Z)E C200HX-CPU64-(Z)E C200HX-CPU65-ZE C200HX-CPU85-ZE	C200HX (-Z)E
	CPM1-10CDR-□ ^(*2) CPM1-20CDR-□ ^(*2) CPM1-30CDR-□ ^(*2) CPM1A-10CD□-□ ^(*2) CPM1A-20CD□-□ ^(*2) CPM1A-30CD□-□ ^(*2) CPM1A-40CD□-□ ^(*2)	---	CPM1
	CPM2A-30CD□□-□ CPM2A-40CD□□-□ CPM2A-60CD□□-□	---	CPM2A
	CPM2C-10□□□□□□-□ ^(*3) CPM2C-20□□□□□□-□ ^(*3)	---	CPM2C
	CQM1-CPU41-EV1 CQM1-CPU42-EV1 CQM1-CPU43-EV1 CQM1-CPU44-EV1 CQM1-CPU45-EV1	---	CQM1
	CQM1H-CPU21-E CQM1H-CPU51-E CQM1H-CPU61-E	CQM1H-CPU51 ^(*4) CQM1H-CPU61 ^(*4)	CQM1H
CV series ^(*5)	CV500-CPU01-EV1	---	CV500
	CV1000-CPU01-EV1	---	CV1000
	CV2000-CPU01-EV1	---	CV2000
CVM1 series ^(*5)	CVM1-CPU01-EV2 CVM1-CPU11-EV2 CVM1-CPU21-EV2	---	CVM1
CompoBus/S master control unit	SRM1-C02-V1	---	SRM1

*1 One of the following communication boards is required:
C200HW-COM02/COM04/COM05/COM06-EV1.

*2 A CPM1-CIF01 adapter is required.

*3 Use a CPM2C-CN111 or CS1W-CN114/118 Connecting Cable, CPM1-CIF01 RS-232C Adapter, or CPM1-CIF11 RS-422A Adapter to connect.

*4 A CQM1H-SCB41 Serial Communications Board is required.

*5 CPUs of CVM1/CV series PCs without the suffix -EV□ cannot be connected.

Reference: CS1 series CPU cannot be connected with the 1:1 connection NT link method. Use the 1:N connection NT link method (standard or high-speed) instead to make the 1:1 connection. For details, refer to *Using the NT Link (1:N) Method* (page 72) or *Using the High-speed NT Link (1:N) Method* (page 75).

Settings at The Host

The setting methods for each unit are as follows:

Connecting to a C-series C200HS, C200HX/HG/HE(-Z)E, CPM1, CPM2A, CPM2C, CQM1, CQM1H, or SRM1

PC Setup Area Settings

Write the PC Setup area (data memory) settings directly from a Programming Device (e.g. SYSMAC support software) in accordance with the host model and port.

Host Model	Word #	Writing Value	Setting
RS-232C port of C200HS, C200HX/HG/HE(-Z)E, CPM2A, CPM2C, CQM1, CQM1H, SRM1	DM6645	4000	Use NT link (1:1)
Port A of C200HX/HG/HE(-Z)E (*1) Port 1 of CQM1H (*2)	DM6555		
Port B of C200HX/HG/HE(-Z)E (*1)	DM6550		
CPM1	DM6650		

*1 RS-232C port of the Communication Board

*2 RS-232C port of the Serial Communications Board

For details on operations relating to the PC Setup area, refer to the manual for the PC which is used.

Connecting to a CPM2C

The CPM2C PCs do not have the same kind of port connectors found on CS1-series PCs. The CPM2C's communication port handles both RS-232C and peripheral port connections which are divided internally. Therefore, when using the CPM2C, it is necessary to select RS-232C or peripheral port connections, according to the kind of cable and port (on the cable) used, as shown in the following table. Refer to the *CPM2C Operation Manual* for more details.

Port connecting to PT	PC Setup
RS-232C port (D-Sub 9-pin) of CPM2C-CN111	Built-in RS-232C port settings
Peripheral port of CPM2C-CN111	Peripheral port settings
RS-232C port (D-Sub 9-pin) of CS1W-CN118	Built-in RS-232C port settings
Peripheral port of CS1W-CN114	Peripheral port settings

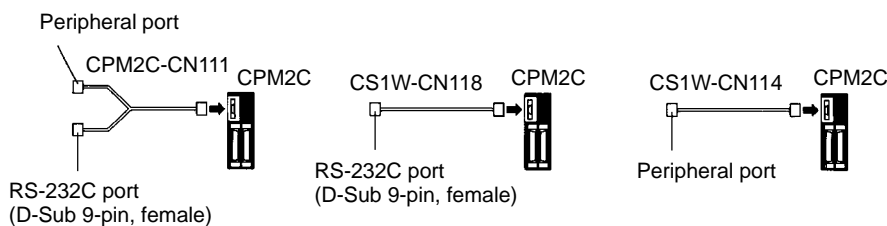

Setting the DIP Switches on the Front of a C200HX/HG/HE(-Z)E, CQM1, CQM1H

When using a C200HX/HG/HE(-Z)E, CQM1, or CQM1H, the DIP switches on

the front panel must be set as shown below in order to make the settings in the PC Setup area (data memory) effective.

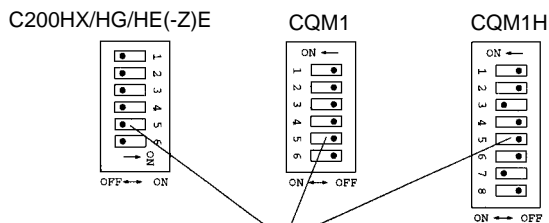

RS-232C port communication condition setting
Set DIP SW5 to OFF to make the settings made in PC Setup effective.

Setting the Switches of a CPM2A

When using a CPM2A, the switches on the front panel must be set as shown below in order to make the PC Setup settings effective.

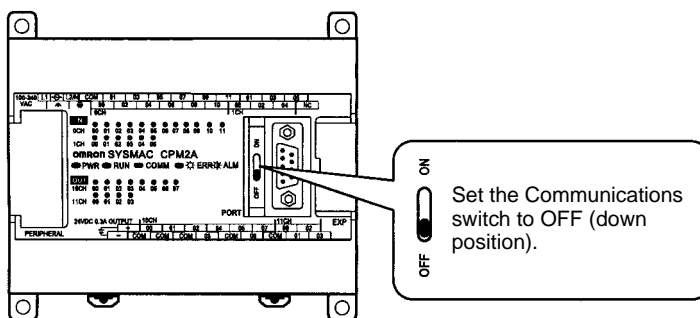

Setting the Switches of a CPM2C

When using a CPM2C, the switches on the front panel must be set as shown below in order to make the PC Setup settings effective.

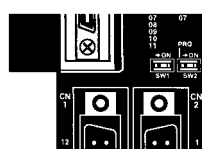

The settings for SW1 and SW2 depend upon the usage of the peripheral port and RS-232C port.

- Connecting PT to peripheral port
- Connecting PT to built-in RS-232C port (A device that requires non-standard communications settings is connected to the peripheral port.)

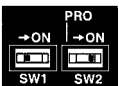

- Connecting PT to built-in RS-232C port (A Programming Console is connected to the peripheral port.)

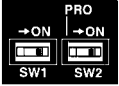

Setting the Switches on an RS-232C Adapter

When using a CPM1-CIF01 RS-232C Adapter, set the mode switch as shown in the following diagram.

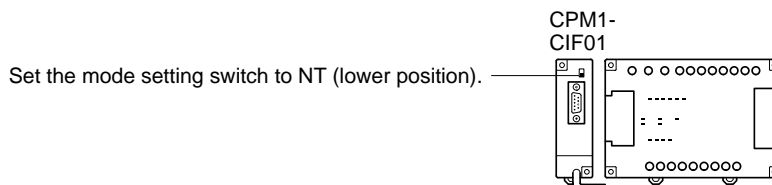

Connecting to CVM1/CV Series (-EV□)

Set the DIP switches on the front panel as follows.

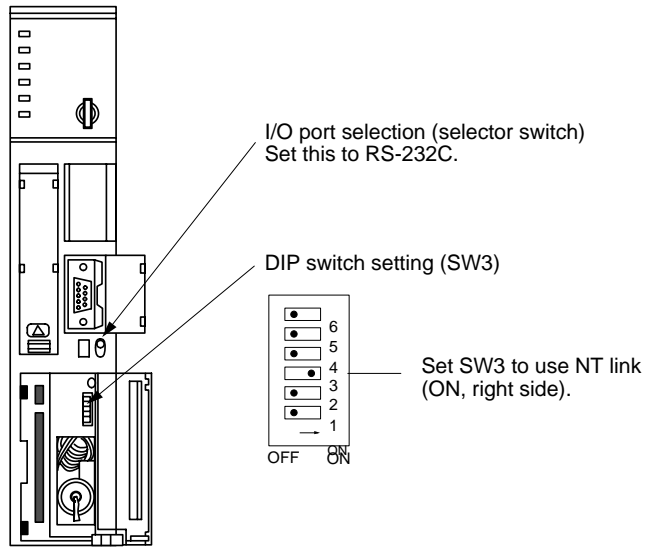

When using the CVM1/CV series, CPU execution processing (execution control 2) in the PC Setup must be set to Simultaneous processing.

Using the NT Link (1:N) Method

Compatible Host Units

The OMRON PCs that can be connected using the NT link (1:N) method are the CS1-series CS1G/H and the C-series C200HX/HG/HE(-Z)E, CQM1H, and SRM1 only. With the CS1-series PCs, it is possible to connect a 1:N NT Link using a CS1W-SCU21 Serial Communications Unit.

Check the model and series of the PC as well as the model of Serial Communications Board or Unit being used before making the connections.

The host units that can be connected to the NT31/NT31C by the NT link (1:N) method using the RS-232C ports of both units are indicated in the table below.

PC Series	CPUs with Built-in NT Link Function	CPUs Connectable with Communications Board or Unit ^(*1)	Connectable to
CS1 series	CS1G-CPU42/43/44/ 45-EV1 CS1H-CPU63/64/65/ 66/67-EV1	CS1G-CPU42/43/44/ 45-EV1 CS1H-CPU63/64/65/ 66/67-EV1	CS1G CS1H
C series	C200HE-CPU42-(Z)E	C200HE-CPU32-(Z)E ^(*2) C200HE-CPU42-(Z)E ^(*2)	C200HE (-Z)E
	C200HG-CPU43-(Z)E C200HG-CPU63-(Z)E	C200HG-CPU33-(Z)E ^(*2) C200HG-CPU43-(Z)E ^(*2) C200HG-CPU53-(Z)E ^(*2) C200HG-CPU63-(Z)E ^(*2)	C200HG (-Z)E
	C200HX-CPU44-(Z)E C200HX-CPU64-(Z)E C200HX-CPU65-ZE C200HX-CPU85-ZE	C200HX-CPU34-(Z)E ^(*2) C200HX-CPU44-(Z)E ^(*2) C200HX-CPU54-(Z)E ^(*2) C200HX-CPU64-(Z)E ^(*2) C200HX-CPU65-ZE ^(*2) C200HX-CPU85-ZE ^(*2)	C200HX (-Z)E
	---	CQM1H-CPU51 ^(*3) CQM1H-CPU61 ^(*3)	CQM1H
CompoBus/S Master Control Unit	SRM1-C02-V2	---	SRM1

*1 A CS1W-SCB21 or CS1W-SCB41 Serial Communication Board or CS1W-SCU21 Serial Communications Unit is required.

*2 One of the following Communication Boards is required:
C200HW-COM02/COM04/COM05/COM06 (-EV1)

*3 A CQM1H-SCB41 Serial Communication Board is required.

Reference: The -V1 versions of CS1-series PCs support the high-speed 1:N NT Link as well as the standard 1:N NT Link. Furthermore, the high-speed 1:N NT Link can be used in earlier versions of CS1-series PCs by installing a new version of Serial Communications Board or Unit. For details, refer to *Using the High-speed NT Link (1:N) Method* (page 75).

Settings at the Host

The Settings required for each Unit are described below.

• Connecting a C-series C200HX/HG/HE(-Z)E, CQM1H, or SRM1

PC Setup Area Settings

Write the PC Setup area (data memory) settings directly from a Programming

Device (e.g. SYSMAC support software) in accordance with the host model and port.

Connection to	Word #	Writing Value	Setting
C200HX/HG/HE(-Z)E, SRM1 Built-in RS-232C port	DM6645	5□00	Use NT link (1:N) □ = highest unit number of the connected PTs (1 to 7) (*3)
C200HX/HG/HE(-Z)E Communication Board port A*1 CQM1H port 1*2	DM6555		
C200HX/HG/HE(-Z)E Communication Board port B*1	DM6550		

*1 RS-232C port on the Communications Board

*2 RS-232C port on the Serial Communications Board

*3 When using a C200HE (-Z)E, the maximum PT unit number is 3.

Refer to the PC's operation manual for details on changing PC Setup settings.

Setting the DIP Switches of a C200HX/HG/HE(-Z)E

When using a C200HX/HG/HE(-Z)E, the DIP switches on the front panel must be set as shown below in order to make the settings in the PC Setup area (data memory) effective.



RS-232C port communication condition setting
Set DIP SW5 to OFF to make the settings made in PC Setup effective.

Connecting to CS1-series CPU Units

CS1-series CPU Unit: CS1G/H-CPU□□-E(V1)

PC Setup

When connecting to a CS1 series CPU, set the following communication conditions for the PC Setup area, in accordance with the communication port to be used.

When using the built-in RS-232C port of CS1G/H

Word #	Writing Value	Settings
160	8200	NT link (1:N) mode
161	0000 to 0009 (*1)	Communications baud rate (standard)
166	000□	□ = The largest model number of the connected PT (0 – 7)

*1 Set any value between 0000 and 0009 Hex for the communications baud rate. The same baud rate will be used regardless of the value as long as it is between 0000 and 0009 Hex.

When using the peripheral port of CS1G/H

Word #	Writing Value	Settings
144	8200	NT link (1:N) mode
145	0000 to 0009 (*1)	Communications baud rate (standard)
150	000□	□ = The largest model number of the connected PT (0 – 7)

*1 Set any value between 0000 and 0009 Hex for the communications baud rate. The same baud rate will be used regardless of the value as long as it is between 0000 and 0009 Hex.

When connecting PT with its model number 0, 2-5 to the built-in RS-232C port, for example, set the value 8200 Hex to 160 CH, and 0005 Hex to 166CH.

Either set PC Setup directly from a Programming Device (Programming Console), or transmit the PC Setup made at a Programming Device (CX-Programmer) to the CPU.

For details on PC Setup, refer to the *SYSMAC CS1-series Operation Manual* (W339-E1-□).

Setting the Front Switches

Set the CPU DIP switch to 4 or 5 in accordance with the port NT31/NT31C is connected to.

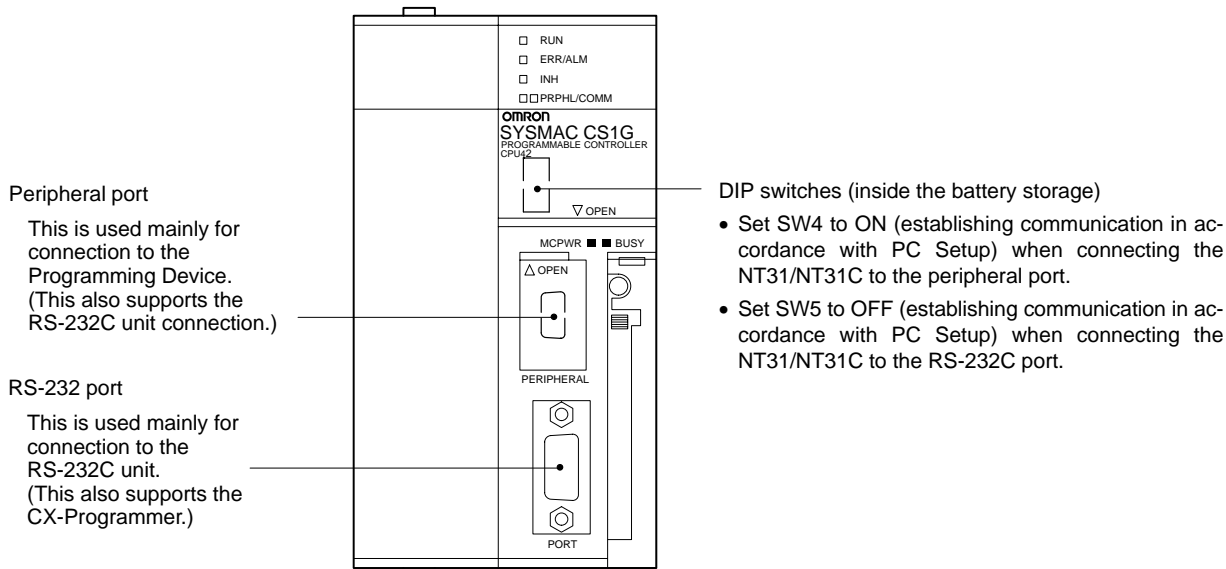

Connecting to CS1 Series Serial Communications Board

Serial Communications Board equipped with a RS-232C port for CS1-series CPU Units: CS1W-SCB41/21

CPU Allocation DM Area Settings

Setting is written from the Programming Device (a Programming Console or CX-Programmer) directly into the allocation DM area (system setting area) of the CPU. After the setting is written, it becomes effective by turning the power ON, restarting the unit, restarting the communication port, or execution of the STUP command.

In the following, the channel numbers of the allocation DM area and settings are shown.

Allocation DM area (CH)		Writing Value	Settings
Port 1	Port 2		
DM32000	DM32010	8200	NT link (1:N) mode
DM32001	DM32011	0000 to 0009 (*1)	Communications baud rate (standard)
DM32006	DM32016	000□	□ = The largest model number of the connected PT (0 – 7)

*1 Set any value between 0000 and 0009 Hex for the communications baud rate. The same baud rate will be used regardless of the value as long as it is between 0000 and 0009 Hex.

When connecting PTs with model numbers 3 to 6 to port 1, for example, set the value 8200 Hex to DM32000, 0000 Hex to DM32001, and 0006 Hex to DM32006.

Connecting to CS1 Series Serial Communication Unit

A CS1 series backplane mounted type : CS1W-SCU21

Setting the Front Switches

Set the unit number of the serial communication unit by using the rotary switch

located on the front panel. Set each switch with a flat blade screwdriver so that the values or symbols in the setting value window agree with the following.

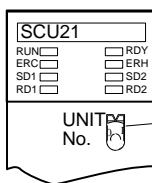

Allocation DM Area Settings for CPU

Setting is written from the Programming Device (a Programming Console or CX-Programmer) directly into the allocation DM area (system setting area) of the CPU. After the setting is written, it becomes effective by turning the power ON, restarting the unit, restarting the communication port, or execution of the STUP command.

In the following, the channel numbers of the allocation DM area and settings are shown.

$$m = DM30000 + 100 * \text{unit number (CH)}$$

Allocation DM area (CH)		Writing Value	Settings
Port 1	Port 2		
m	m+10	8200	NT link (1:N) mode
m+1	m+11	0000 to 0009 (*1)	Communications baud rate (standard)
m+6	m+16	000□	□ = The largest model number of the connected PT (0 - 7)

*1 Set any value between 0000 and 0009 Hex for the communications baud rate. The same baud rate will be used regardless of the value as long as it is between 0000 and 0009 Hex.

Using the High-speed NT Link (1:N) Method

Compatible Host Units

Only the -V1 versions of OMRON's CS1H and CS1G PCs support the high-speed 1:N NT Link directly. Other CS1-series PCs can use the high-speed 1:N NT Link indirectly through a CS1W-SCU21 Serial Communications Unit. (If a Serial Communications Unit is used, even CS1-series Units without the "-V1" suffix can be connected via high-speed 1:N NT Link.)

Be sure to check the model number of the PC and Serial Communications Board/Unit before trying to establish the high-speed 1:N NT Link.

The following table shows which CS1-series PCs can be connected to an NT31/NT31C with the high-speed 1:N NT Link.

CPU Units with Built-in NT Link Function	CPUs Connectable only through a Serial Communication Board or Unit
CS1G-CPU42/43/44/45-EV1 (*1)	CS1G-CPU42/43/44/45-E(V1) (*2)
CS1H-CPU63/64/65/66/67-EV1 (*1)	CS1H-CPU63/64/65/66/67-E(V1) (*2)

*1 The high-speed 1:N NT Link is not supported in a direct connection to the CPU Unit of a CS1-series PC without the -V1 suffix.

*2 A CS1W-SCB21 or CS1W-SCB41 Serial Communication Board or CS1W-SCU21 Serial Communications Unit is required.

Settings at the Host

The Settings required for each Unit are described below.

• **Connecting CS1-series CPU Units**

CS1 series CPU type : CS1G/H-CPU□□-EV1

PC Setup

When connecting to a CS1 series CPU, set the following communication condi-

tions for the PC Setup area, in accordance with the communication port to be used.

When using the built-in RS-232C port of CS1G/H

Word #	Writing Value	Settings
160	8200	NT link (1:N) mode
161	000A	Communications baud rate (high-speed)
166	000□	□ = The largest model number of the connected PT (0 – 7)

When using the peripheral port of CS1G/H

Word #	Writing Value	Settings
144	8200	NT link (1:N) mode
145	000A	Communications baud rate (high-speed)
150	000□	□ = The largest model number of the connected PT (0 – 7)

When connecting PTs with model numbers 0, 2, 3, 4, and 5 to the built-in RS-232C port, for example, set the value 8200 Hex to word 160, 000A Hex to word 161, and 0005 Hex to word 166.

Either set PC Setup directly from a Programming Device (Programming Console), or transmit the PC Setup made at a Programming Device (CX-Programmer) to the CPU.

For details on PC Setup, refer to the *SYSMAC CS1-series Operation Manual* (W339-E1-□).

Reference: When using the CX-Programmer to set the high-speed 1:N NT Link, set the communications baud rate to 115,200 bps.

Setting the Front Switches

Set the CPU DIP switch to 4 or 5 in accordance with the port NT31/NT31C is connected to.

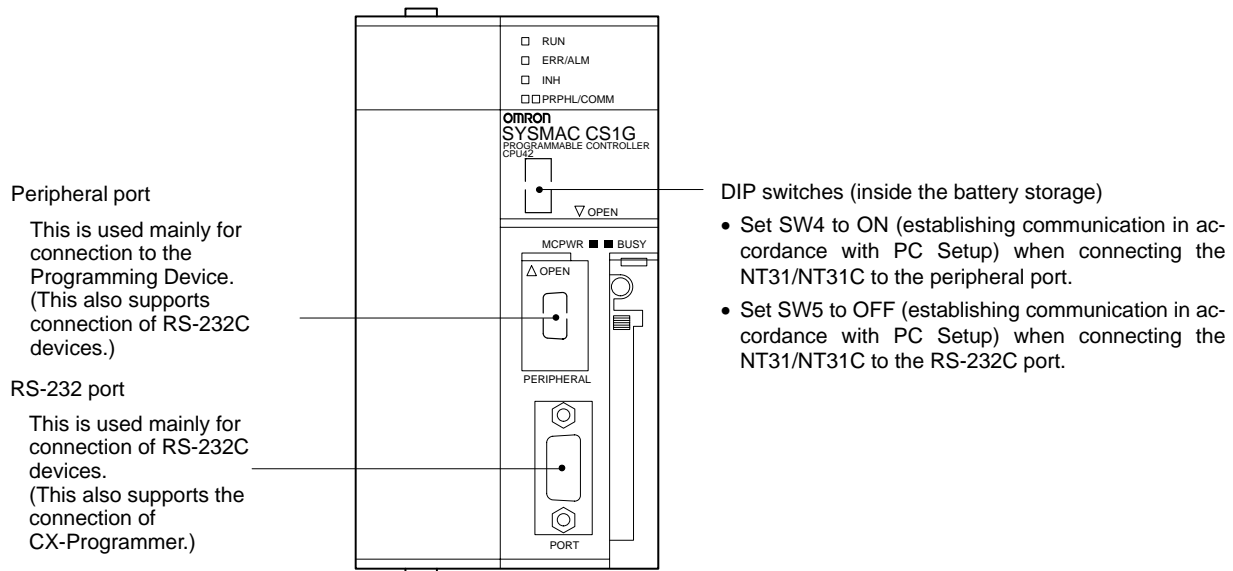

Connecting to a CS1 Series Serial Communications Board

Serial Communications Board equipped with a RS-232C port for CS1-series CPU Units: CS1W-SCB41/21

Reference: Serial Communications Boards and Serial Communications Units with lot number 991220 (12/20/99) and later support the high-speed 1:N NT Link. Boards and Units with earlier lot numbers **cannot** be used.

CPU Allocation DM Area Settings

Setting is written from the Programming Device (a Programming Console or CX-Programmer) directly into the allocation DM area (system setting area) of the CPU. After the setting is written, it becomes effective by turning the power ON, restarting the unit, restarting the communication port, or execution of the STUP command.

In the following, the channel numbers of the allocation DM area and settings are shown.

Allocation DM area (CH)		Writing Value	Settings
Port 1	Port 2		
DM32000	DM32010	8200	NT link (1:N) mode
DM32001	DM32011	000A	Communications baud rate (high-speed)
DM32006	DM32016	000□	□ = The largest model number of the connected PT (0 – 7)

For example, when connecting PTs with model numbers 3, 4, 5, and 6 to port 1, set the value 8200 Hex to DM32000, 000A Hex to DM32001, and 0006 Hex to DM32006.

Connecting to a CS1 Series Serial Communication Unit

A CS1 series backplane mounted type : CS1W-SCU21

Reference: Serial Communications Boards and Serial Communications Units with lot number 991220 (12/20/99) and later support the high-speed 1:N NT Link. Boards and Units with earlier lot numbers **cannot** be used.

Setting the Front Switches

Set the unit number of the serial communication unit by using the rotary switch located on the front panel. Set each switch with a flat blade screwdriver so that the values or symbols in the setting value window agree with the following.

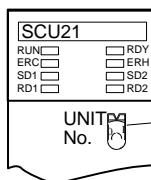

Set the unit number to 0 through F so that it will not overlap with the numbers used in other units.

Allocation DM Area Settings for CPU

Setting is written from the Programming Device (a Programming Console or CX-Programmer) directly into the allocation DM area (system setting area) of the CPU. After the setting is written, it becomes effective by turning the power ON, restarting the unit, restarting the communication port, or execution of the STUP command.

In the following, the channel numbers of the allocation DM area and settings are shown.

$$\text{Word } m = \text{DM30000} + (100 \times \text{unit number})$$

Allocation DM area (CH)		Writing Value	Settings
Port 1	Port 2		
m	m+10	8200	NT link (1:N) mode

m+1	m+11	000A	Communications baud rate (high-speed)
m+6	m+16	000□	□ = The largest model number of the connected PT (0 - 7)

When Using the Memory Link Method

In the memory link method, the connection can be made to a personal computer with RS-232 and an FA computer, etc.

When connecting to the host in the memory link method, it is necessary to create a program for the memory link at the host side.

The following are the communication conditions that can be used in the memory link method. For the host (a personal computer, an FA computer, etc.), its setting should be compatible to one of the communication conditions listed in the following table. Set the same communication conditions at the NT31/NT31C by the memory switch. (page 165).

Item	Settings at the host
Input/Output port	RS-232C
Communication speed	1200, 2400, 4800, 9600, 19200, 38400 bps.
Data bits length	7 bits, 8 bits
Stop bits length	1 bits, 2 bits
Parity	None, even, odd
Flow control	None, RS/CS, XON/XOFF

4-1-2 Connecting Directly between RS-232C Ports

The method for connection between the RS-232C ports of the NT31/NT31C and the host is described here.

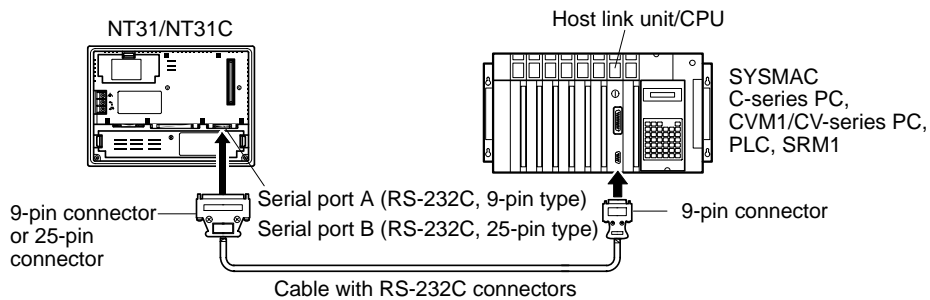

Recommended Connector Cable

When making the connector cable, as far as possible use the recommended connectors, connector hoods, and cables indicated in the table below. Some units come supplied with one connector and one connector hood.

Check the required components and prepare them in advance.

Name	Model	Remarks	Delivered with
Connector	XM2A-0901	9-pin Made by OMRON	CS1-series CS1G/CS1H C-series CQM1, C200HS, C200HX/HG/HE(-Z)E, CVM1/CV-series CPUs CV500-LK201
	XM24-2501	25-pin Made by OMRON	C500-LK203 CV500-LK201 C200H-LK201-EV1
	DB-25P	25-pin Made by JAE	3G2A5-LK201-EV1 3G2A6-LK201-EV1

Name	Model	Remarks	Delivered with
Connector hood	XM2S-0911	9-pin Made by OMRON	C-series CQM1, C200HS, C200HX/HG/HE-(Z)E, CVM1/CV-series CPUs CV500-LK201
	XM2S-0913	9-pin Made by OMRON	
	XM2S-0911-E	9-pin Made by OMRON	CS1-series CS1G/CS1H
	XM2S-2511	25-pin Made by OMRON	C500-LK203 CV500-LK201 C200H-LK201-EV1
	DB-C2-J9	25-pin Made by JAE	3G2A5-LK201-EV1 3G2A6-LK201-EV1
Cable	AWG28 × 5P IFVV-SB	Multi-core shielded cable Made by Fujikura, Ltd.	
	CO-MA-VV-SB 5P × 28AWG	Multi-core shielded cable Made by Hitachi Cable, Ltd.	

Note After connecting a communication cable, always secure it with the screws.

OMRON Cables with Connectors

When a connection is made at serial port A in other than the memory link method, OMRON cables with connectors shown below are available.

Model	Cable Length	Connector Specification
XW2Z-200S	2 m	9-pin ↔ 25 pin
XW2Z-500S	5 m	
XW2Z-200T	2 m	9-pin ↔ 9-pin
XW2Z-500T	5 m	

When a connection is made to a personal computer at serial port A in the memory link method, OMRON cable with connectors shown below are available.

Model	Cable Length	Connector Specification
CV500-CN228	2 m	9-pin ↔ 25 pin
XW2Z-S002	2 m	9-pin ↔ 9 pin

When a connection is made at serial port B in other than the memory link method, OMRON cables with connectors shown are available.

Model	Cable Length	Connector Specification
XW2Z-200P	2 m	25-pin ↔ 25 pin
XW2Z-500P	5 m	
XW2Z-200S	2 m	25-pin ↔ 9-pin
XW2Z-500S	5 m	

Note The cable's tensile load is 30 N. Do not subject it to loads greater than this.

Wiring for a Host Link Unit (25-pin) Connection

Applicable units: C200H-LK201-EV1
3G2A5-LK201-EV1
C500-LK203
3G2A6-LK201-EV1
CV500-LK201 (communication port 1)

Cables with connectors that can be used at serial port A:

XW2Z-200S (9-pin ↔ 25-pin, 2 m)

XW2Z-500S (9-pin ↔ 25-pin, 5 m)

Cables with connectors that can be used at serial port B:

XW2Z-200P (25-pin ↔ 25-pin, 2 m)

XW2Z-500P (25-pin ↔ 25-pin, 5 m)

CVM1/CV-series host link units (CV500-LK201) have two types of connector; a 25-pin connector (communication port 1), and a 9-pin connector (communication port 2). When using communication port 2, refer to *Wiring for Other Connections (Other Than the Memory Link Method)* (page80).

Serial Port A

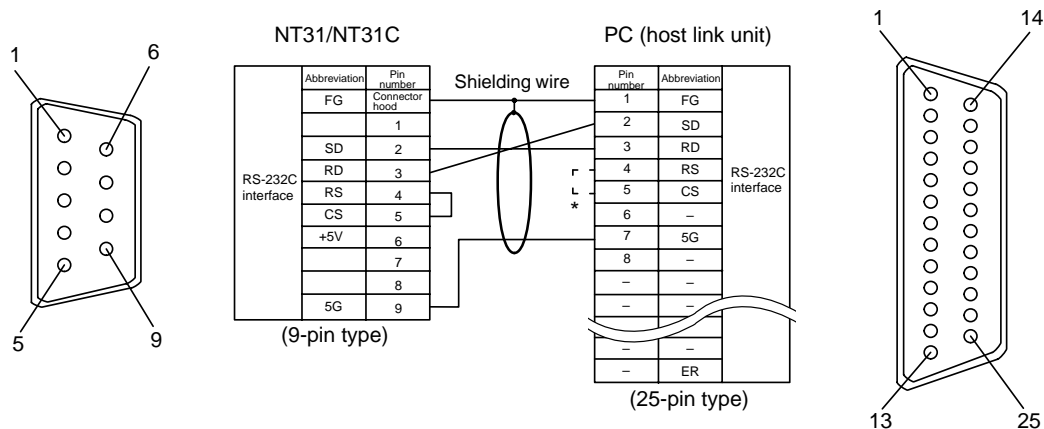

* For units that have a CTS setting selector switch, RS and CS do not have to be shorted if this switch is set to 0V.

Serial Port B

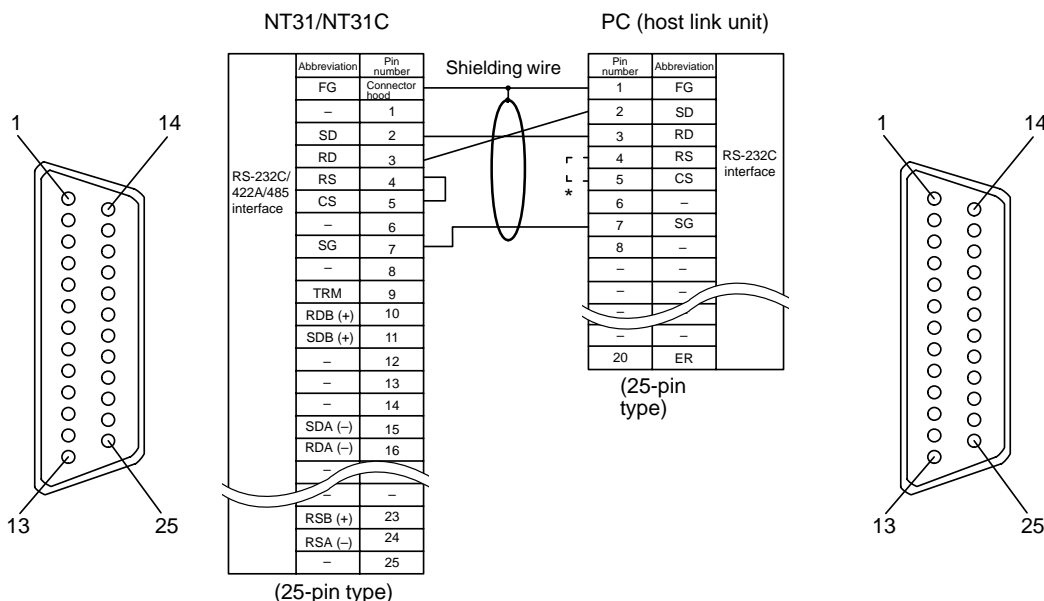

* For units that have a CTS setting selector switch, RS and CS do not have to be shorted if this switch is set to 0V.

Wiring for Other Connections

Applicable units :

CV500-LK201 (communication port 2)

CS1W-SCU21

CPM1-10CDR-□

CPM1-20CDR-□

CPM1A-10CD□-□

CPM1A-20CD□-□

- CPM1A-30CD□-□
- CPM2A-30CD□-□
- CPM2A-60CD□-□
- CPM2C-10□□□□□□□-□
- CPM2C-20□□□□□□□-□
- CQM1-CPU21-E
- CQM1-CPU41-EV1
- CQM1-CPU43-EV1
- CQM1H-CPU11
- CQM1H-CPU51
- CS1G-CPU42-E(V1)
- CS1G-CPU44-E(V1)
- CS1H-CPU63-E(V1)
- CS1H-CPU65-E(V1)
- CS1H-CUP67-E(V1)
- C200HS-CPU21-E, -EC
- C200HS-CPU31-E
- C200HE-CPU32-(Z)E
- C200HG-CPU33-(Z)E
- C200HG-CPU53-(Z)E
- C200HX-CPU34-(Z)E
- C200HX-CPU54-(Z)E
- C200HX-CPU65-ZE
- CV500-CPU01-EV1
- CV2000-CPU01-EV1
- CVM1-CPU01-EV2
- CVM1-CPU21-EV2
- SRM1-C02-V2
- CPM1A-40CD□-□
- CPM2A-40CD□-□
- CQM1-CPU42-EV1
- CQM1-CPU44-EV1
- CQM1H-CPU21
- CQM1H-CPU61
- CS1G-CPU43-E(V1)
- CS1G-CPU45-E(V1)
- CS1H-CPU64-E(V1)
- CS1H-CPU66-E(V1)
- C200HS-CPU23-E
- C200HS-CPU33-E
- C200HE-CPU42-(Z)E
- C200HG-CPU43-(Z)E
- C200HG-CPU63-(Z)E
- C200HX-CPU44-(Z)E
- C200HX-CPU64-(Z)E
- C200HX-CPU85-ZE
- CV1000-CPU01-EV1
- CVM1-CPU11-EV2

Cables with connectors that can be used at serial port A:

- XW2Z-200T (9-pin ↔ 9-pin, 2 m)
- XW2Z-500T (9-pin ↔ 9-pin, 5 m)

Cables with connectors that can be used at serial port B:

- XW2Z-200S (25-pin ↔ 9-pin, 2 m)
- XW2Z-500S (25-pin ↔ 9-pin, 5 m)

CPUs of CVM1/CV-series PCs without the suffix -EV□ cannot be connected by any connection method.

Serial Port A

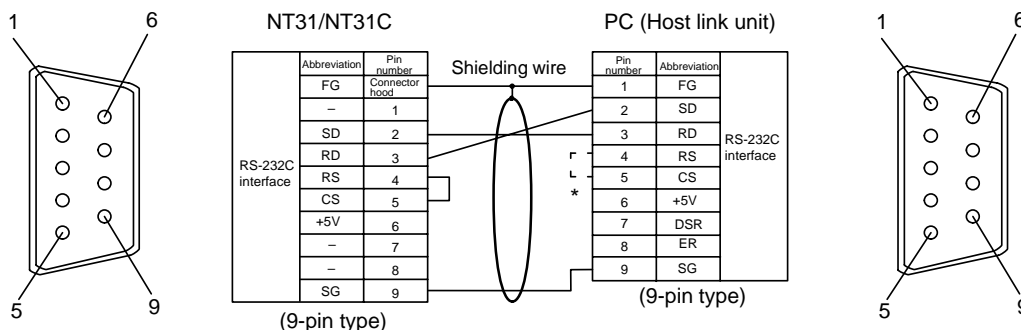

Serial Port B

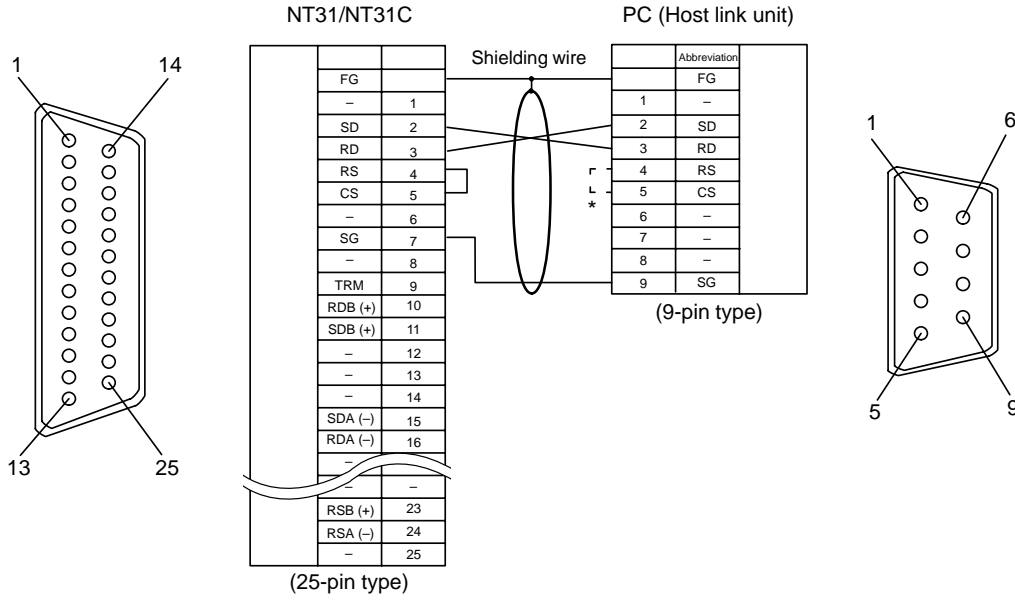

* In case 0V is set for those unit which has CTS setting selector, it is not necessary to shorten between RS and CS.

Wiring for a Memory Link Connection

Cables with connectors that can be used at serial port A:

CV500-CN228 (9-pin↔25-pin, 2 m)

XW2Z-S002 (9-pin↔9-pin, 2 m)

Serial Port A

Prepare the adapter cable while referring to the following diagram.

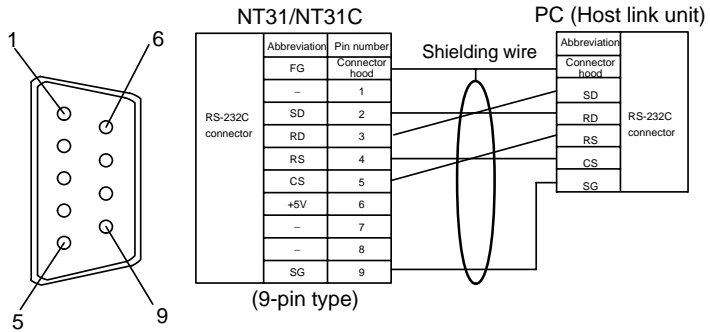

Serial Port B

Prepare the adapter cable while referring to the following diagram.

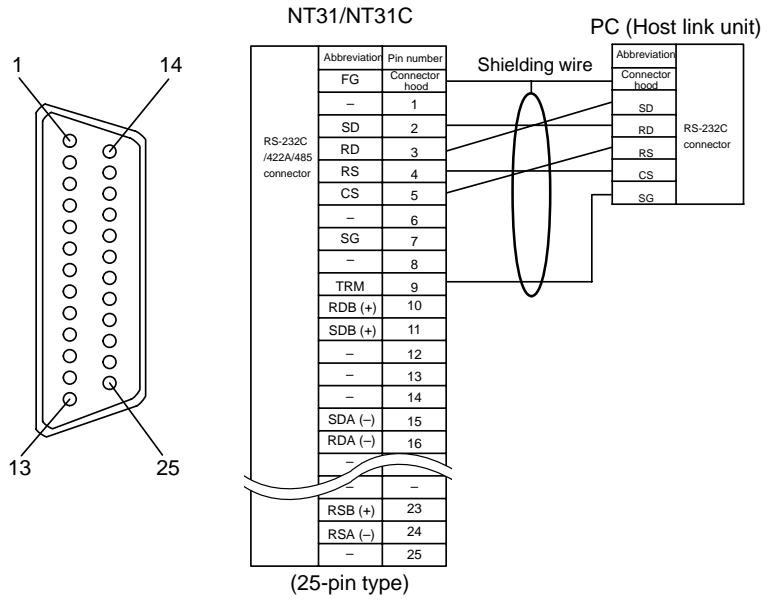

SECTION 5

Connecting to the Host from the RS-422A/485 Port

This section describes the method for connecting to the host using the RS-422A/485 port of the PT.

5-1	Connecting to the Host's RS-232C Port	86
5-1-1	The Type of Host and Settings	87
5-1-2	1:1 Connection between RS-422A/485 at the PT and RS-232C at the Host	88
5-1-3	1:N Connection between RS-422A/485 at the PT and RS-232C at the Host	92
5-1-4	Recommended Connectors, Cables, and Crimp Terminals	97
5-1-5	Setting the Terminal Resistance for RS-422A/485 Communications	99
5-2	Connecting to the Host's RS-422A/485 Port	100
5-2-1	Host Types and Settings	101
5-2-2	Direct Connection between RS-422A Ports at Both Units	117
5-2-3	Direct Connection between RS-485 Ports at Both Units	121
5-2-4	1:N Connection among RS-422A Ports	122
5-2-5	1:N Connection among RS-485 Ports	125
5-2-6	Recommended Connectors, Cables and Crimp Terminals	127
5-2-7	Setting the Terminal Resistance for RS-422A/485 Communications	128

5-1 Connecting to the Host's RS-232C Port

The methods for connecting the RS-422A/485 port of the NT31/NT31C and the RS-232C port of the host are described here. There are the following methods. The following discussion is focused on the connection method to OMRON PCs (By using the memory link method, a connection can be made to any arbitrary RS-232C unit). When making a connection to a host other than OMRON PCs, refer to the *PC Connection Manual (V042-E1-□)* or *NT31/631 Multi Vendor Connection Manual (V060-E1-□)*.

- Method in which the RS-422A port of the NT31/NT31C and the RS-232C port of the host are connected in a 1:1 connection via an RS-232C/RS-422A converter unit (page 88).

When this method is used, the cable length can be extended up to 500 m.

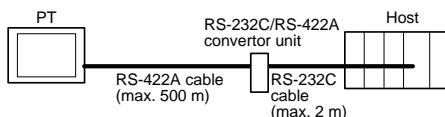

- Method in which the RS-485 port of the NT31/NT31C and the RS-232C port of the host are connected in a 1:1 connection via an RS-232C/RS-422A converter unit (page 88).

When this method is used, the cable length can be extended up to 500 m. This connection method can be used only with the NT link (1:N) method of type RS-485.

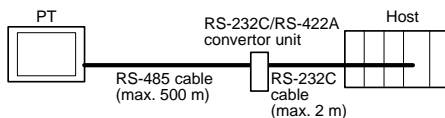

- Method in which the RS-422A ports of multiple NT31/NT31Cs and the RS-232C port of the host are connected in a 1:N connection via an RS-232C/RS-422A converter unit (page 92).

This connection method is used with the RS-422A type NT link (1:N) method.

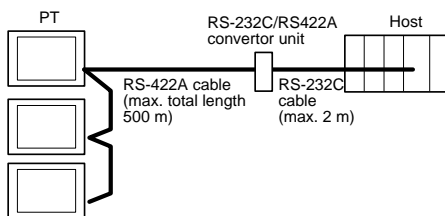

- Method in which the RS-485 ports of multiple NT31/NT31Cs and the RS-232C port of the host are connected in a 1:N connection via an RS-232C/RS-422A converter unit (page 92).

This connection method is used with the RS-485 type NT link (1:N) method (standard or high-speed).

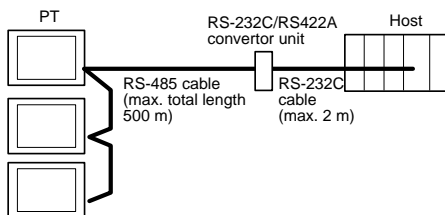

Note One end of the wire must always be connected to the host (PC), and there must be no branching. Branching will cause problems such as transmission delays and communication failures.

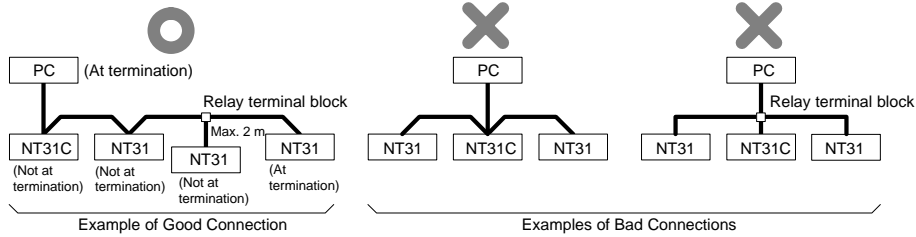

Reference: CS1 series CPUs cannot be connected with the 1:1 connection NT link method. Use the 1:N connection NT Link method (standard or high-speed) instead to make the 1:1 connection. For details, refer to *Using the NT link (1:N) method* (page 72) or *Using the High-speed NT link (1:N) method* (page 75).

5-1-1 The Type of Host and Settings

The using condition is the same as the connecting PT side RS-232C and the host side RS-232C.

For the available type and settings of the host, refer to the pages listed below.

Method	Reference
Host link	Host Link Method (page 54)
NT link (1:1)	NT Link (1:1) method (page 67)
NT link (1:N)	Using the NT Link (1:N) Method (page 72)
High-speed NT link (1:N)	Using the High-speed NT Link (1:N) Method (page 75)
Memory link	Memory Link Method (page 78)

Settings at the RS-232C/RS-422A Converter Unit (NT-AL001)

When making a connection between RS-232C and RS-422A/485 ports using an RS-232C/RS-422A converter unit, set the DIP switches on the NT-AL001 as follows.

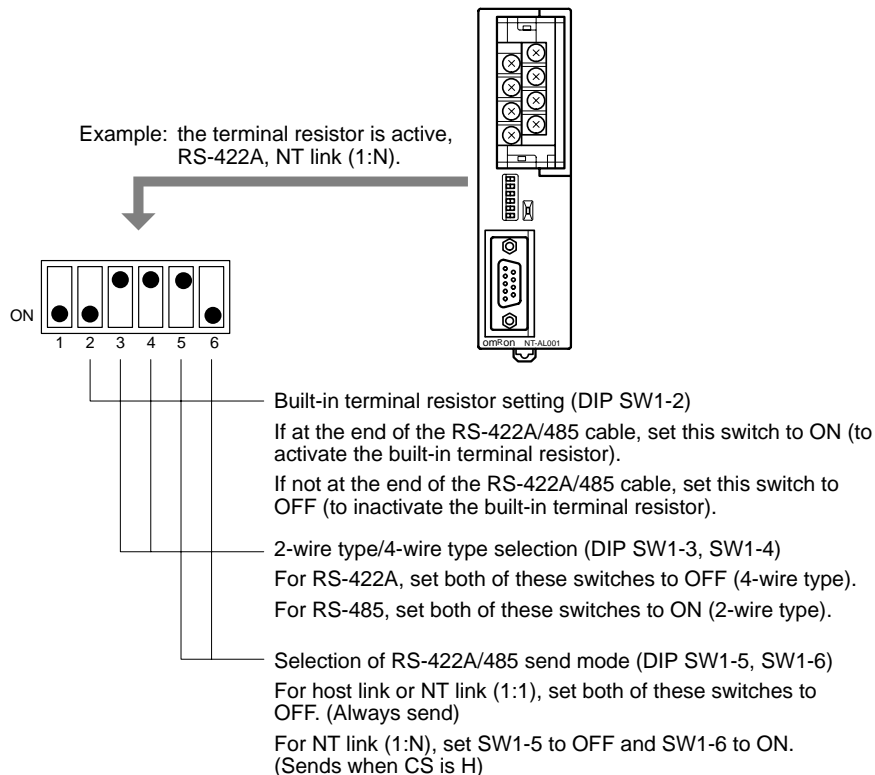

Note Read the manual supplied with the NT-AL001 carefully before using the unit.

5-1-2 1:1 Connection between RS-422A/485 at the PT and RS-232C at the Host

The connection method in which the RS-422A/485 port of an NT31/NT31C and the RS-232C port of a host are connected via a converter unit is described here.

An RS-232C/RS-422A converter unit (NT-AL001) is used to convert between the RS-232C and RS-422A communication methods.

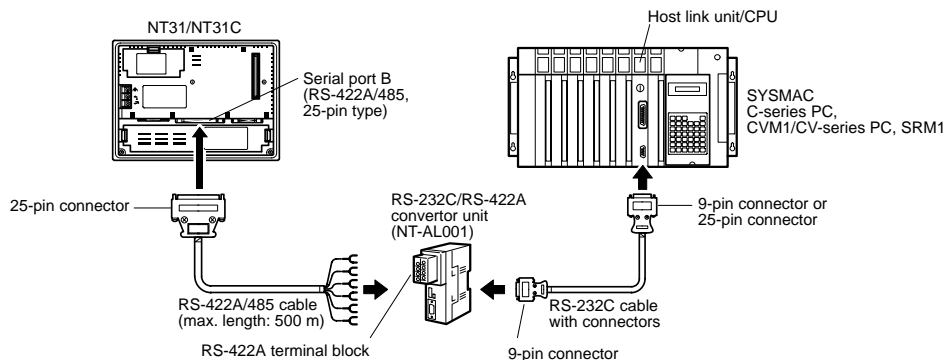

Reference: When using RS-485 as a port for the NT31/NT31C, only NT link (1:N) method (standard or high-speed) can be used.

Connecting an NT31/NT31C and NT-AL001 (RS-422A)

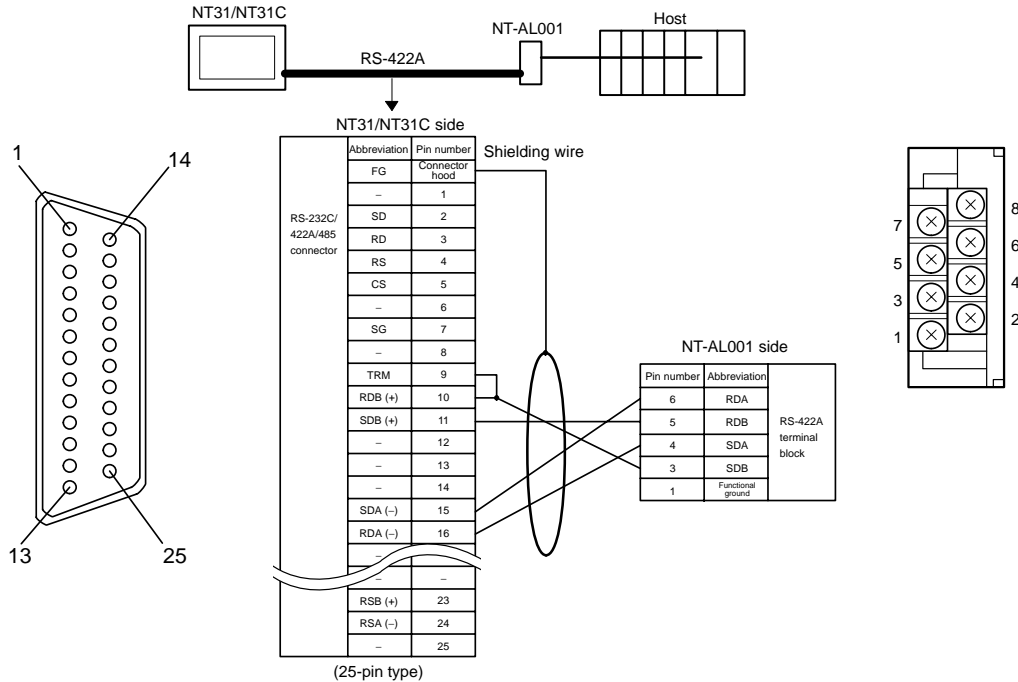

In order to avoid an FG ground loop, do not make the connection between the functional ground of the NT-AL001 and the shielding.

Connecting an NT31/NT31C and NT-AL001 (RS-485)

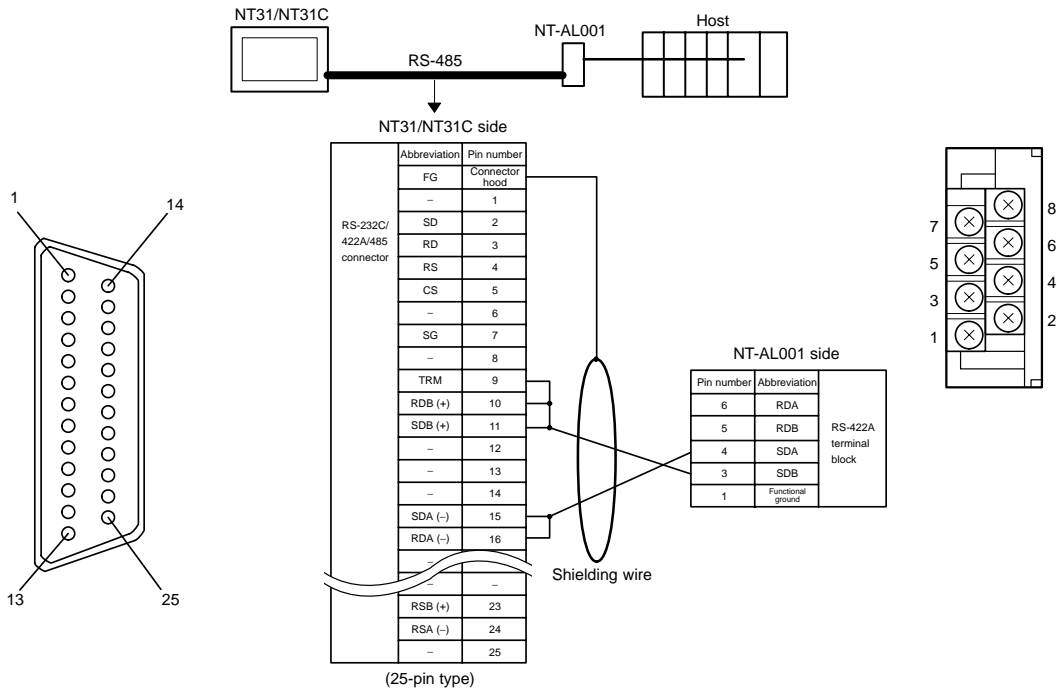

In order to avoid an FG ground loop, do not make the connection between the functional ground of the NT-AL001 and the shielding.

Reference: When using RS-485 as a port for the NT31/NT31C, only NT link (1:N) method (standard or high-speed) can be used.

Connecting an NT-AL001 and Host

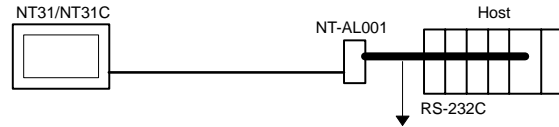

Wiring When Connecting a Host Link Unit (25-pin)

Applicable units:

- C200H-LK201-V1
- 3G2A5-LK201-EV1
- C500-LK203
- 3G2A6-LK201-EV1
- CV500-LK201 (communication port 1)

Cables with connectors that can be used:

- XW2Z-200S (9-pin ↔ 25-pin, 2 m)
- XW2Z-500S (9-pin ↔ 25-pin, 5 m)

CVM1/CV-series host link unit (CV500-LK201) has two types of connector: a 25-pin connector (communication port 1), and a 9-pin connector (communication port 2). When using the communication port, refer to *Wiring for Connections other than Memory Link* (page 90).

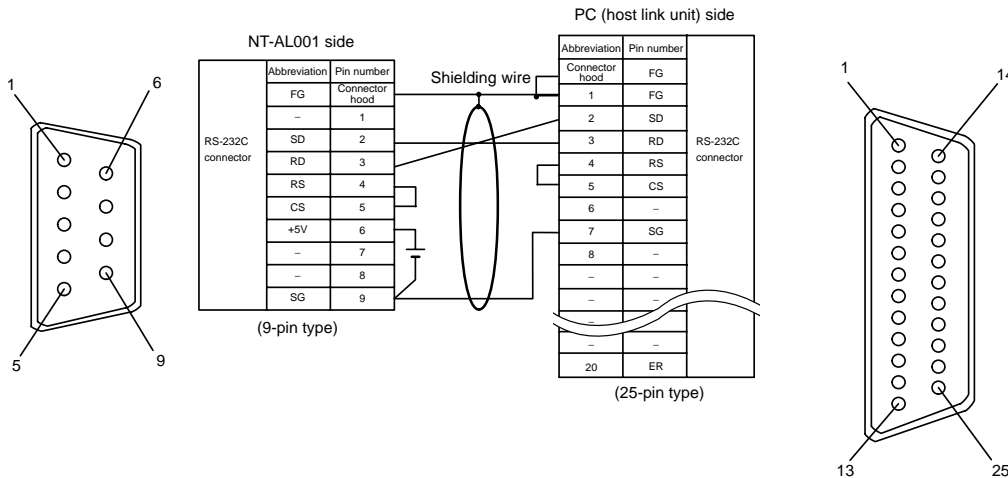

Wiring for Connections Other Than Memory Link

Applicable units:

- CV500-LK201 (communication port 2)
- CS1W-SCU21
- CPM1-10CDR-□
- CPM1A-10CD□-□
- CPM1A-30CD□-□
- CPM2A-30CD□□-□
- CPM2A-60CD□□-□
- CPM2C-10□□□□□□-□
- CQM1-CPU21-E
- CQM1-CPU41-EV1
- CQM1-CPU43-EV1
- CQM1H-CPU11
- CQM1H-CPU51
- CS1G-CPU42-E(V1)
- CS1G-CPU44-E(V1)
- CPM1-20CDR-□
- CPM1A-20CD□-□
- CPM1A-40CD□-□
- CPM2A-40CD□□-□
- CPM2C-20□□□□□□-□
- CQM1-CPU42-EV1
- CQM1-CPU44-EV1
- CQM1H-CPU21
- CQM1H-CPU61
- CS1G-CPU43-E(V1)
- CS1G-CPU45-E(V1)

CS1H-CPU63-E(V1)	CS1H-CPU64-E(V1)
CS1H-CPU65-E(V1)	CS1H-CPU66-E(V1)
CS1H-CPU67-E(V1)	
C200HS-CPU21-E	C200HS-CPU23-E
C200HS-CPU31-E	C200HS-CPU33-E
C200HE-CPU32-E	C200HE-CPU42-E
C200HG-CPU33-E	C200HG-CPU43-E
C200HG-CPU53-E	C200HG-CPU63-E
C200HX-CPU34-E	C200HX-CPU44-E
C200HX-CPU54-E	C200HX-CPU64-E
C200HE-CPU32-ZE	C200HE-CPU42-ZE
C200HG-CPU33-ZE	C200HG-CPU43-ZE
C200HG-CPU53-ZE	C200HG-CPU63-ZE
C200HX-CPU34-ZE	C200HX-CPU44-ZE
C200HX-CPU54-ZE	C200HX-CPU64-ZE
C200HX-CPU65-ZE	C200HX-CPU85-ZE
CV500-CPU01-EV1	CV1000-CPU01-EV1
CV2000-CPU01-EV1	
CVM1-CPU01-EV2	CVM1-CPU11-EV2
CVM1-CPU21-EV2	
SRM1-C02-V2	

Usable Cables with Attached Connectors:

- For host link and 1:1 NT Link only (+5 V power wire attached)
 - SJ45007-102 (9-pin to 9-pin, 0.7 m)
 - SSJ45007-202 (9-pin to 9-pin, 2 m)
- For host link, 1:1 NT Link, or 1:N NT Link (+5 V power supplied from PC)
 - XW2Z-070T-1 (9-pin to 9-pin, 0.7 m)
 - XW2Z-200T-1 (9-pin to 9-pin, 2 m)
 - SJ46006-102 (9-pin to 9-pin, 1 m)
 - SSJ46006-202 (9-pin to 9-pin, 2 m)

CVM1/CV-series CPUs whose model names do not have the suffix -EV□ cannot be connected by any connection method.

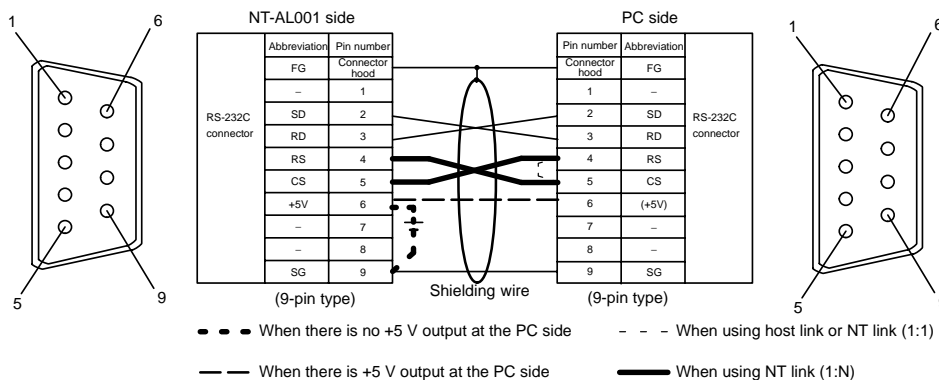

- When using the host link or NT link (1:1) method, short the RS and CS terminals at the PC side with each other (leave the RS and CS terminals at the NT-AL001 side open).
- When using the NT link (1:N), cross-connect the RS and CS terminals at the NT-AL001 and PC sides.

If there is +5 V output at the PC side, no external power supply is required for the NT-AL001.

Wiring for a Memory Link Connection

Prepare the adapter cable while referring to the diagram shown below.

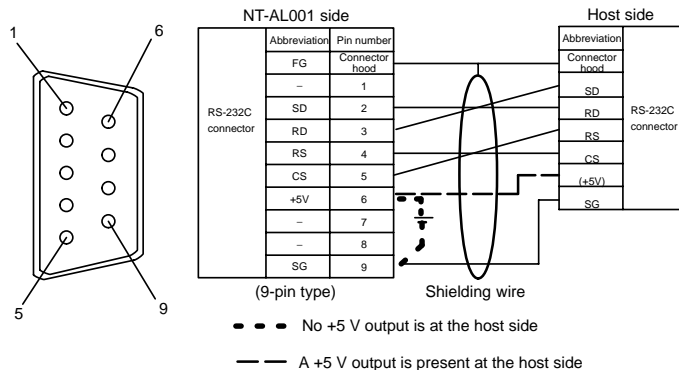

Since it is necessary to input a voltage of +5 V to the number 6 pin of NT-AL001, supplying a voltage of 5 V from the host or an external voltage supply for NT-AL001 is required.

5-1-3 1:N Connection between RS-422A/485 at the PT and RS-232C at the Host

The connection method in which the RS-422A/485 ports of multiple NT31/NT31Cs are connected to the RS-232C port of one host in a 1:N connection is described here.

An RS-232C/RS-422A converter unit (NT-AL001) is used to convert between the RS-232C and RS-422A/485 communication methods.

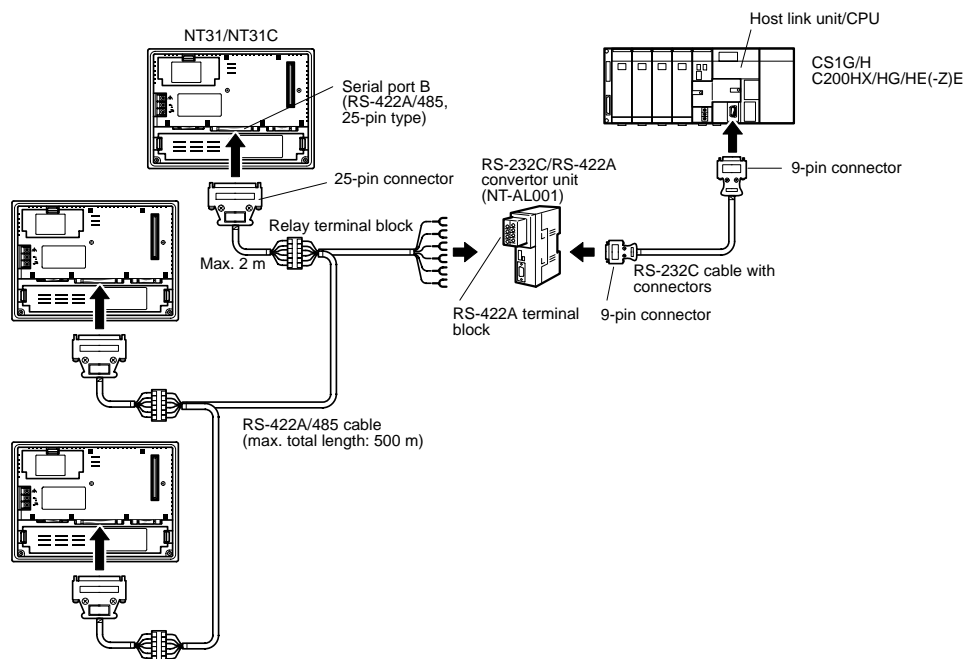

Connecting an NT31/NT31C and NT-AL001 (RS-422A)

The relay terminal board is not included in the figure below. Insert a relay terminal board so as to achieve the wiring configuration indicated below.

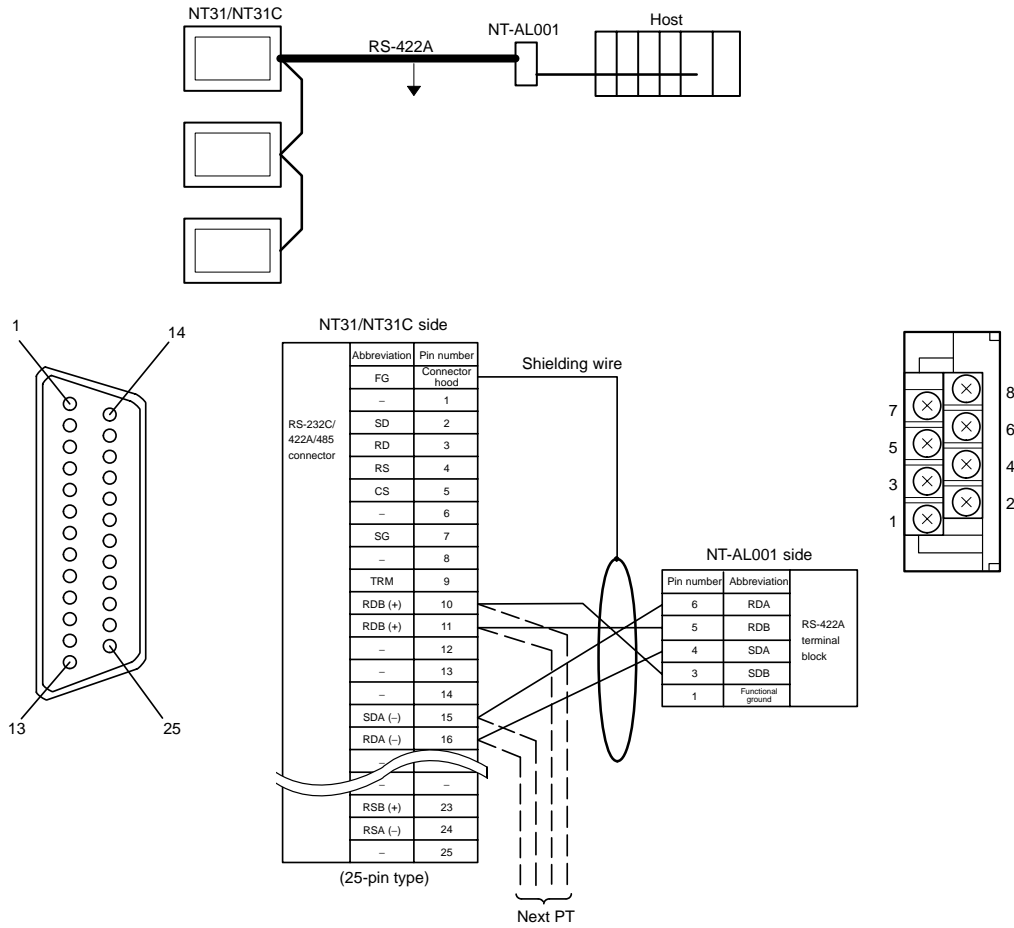

In order to avoid an FG ground loop, do not make the connections between the functional ground of the NT-AL001 and the shielding.

Connecting an NT31/NT31C and NT-AL001 (RS-485)

The relay terminal board is not included in the figure below. Insert a relay terminal board so as to achieve the wiring configuration indicated below.

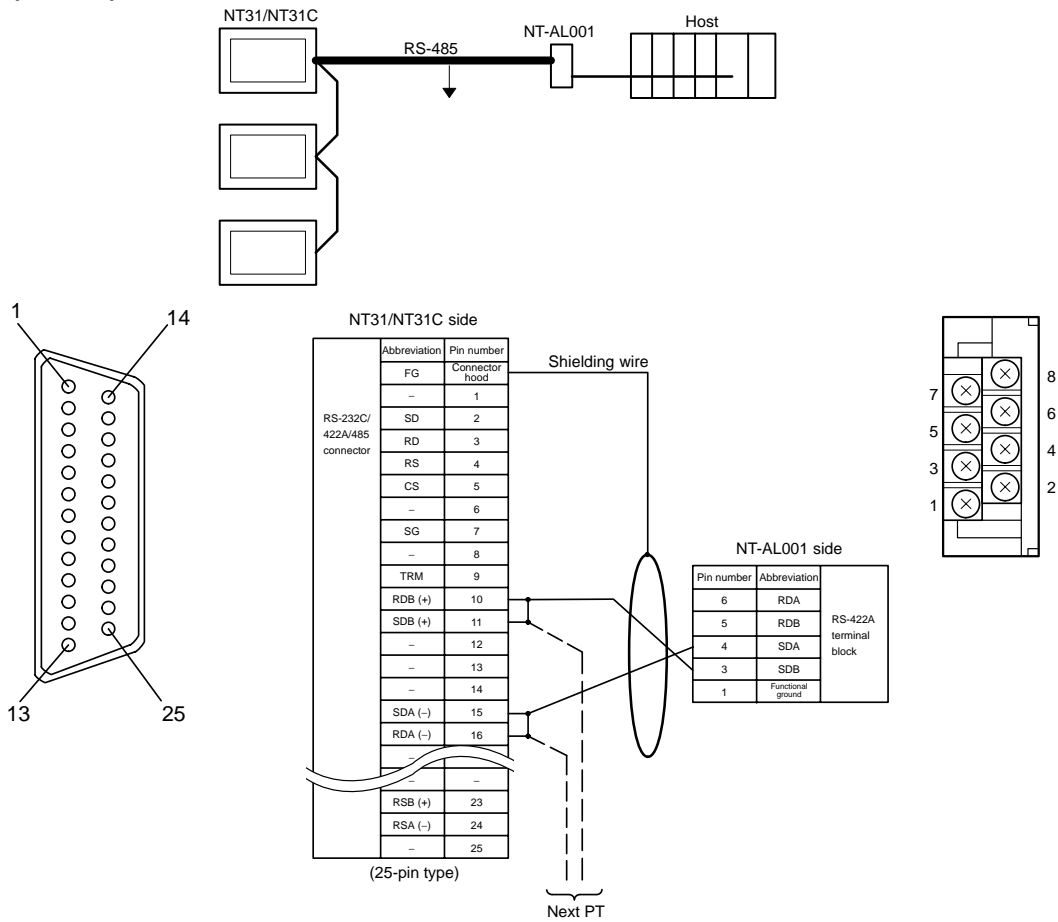

In order to avoid an FG ground loop, do not make the connections between the functional ground of the NT-AL001 and the shielding.

Connection between NT31/NT31C Units (RS-422A)

The relay terminal board is not included in the figure below. Insert a relay terminal board so as to achieve the wiring configuration indicated below.

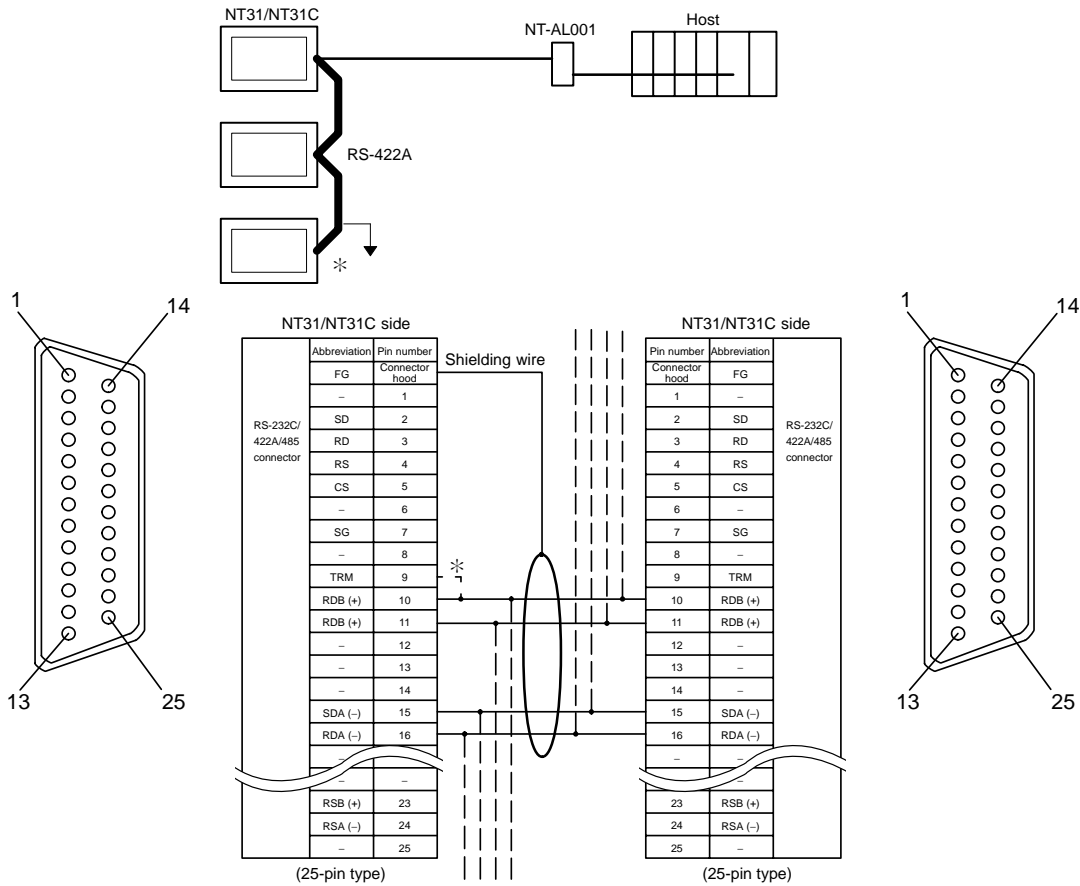

* Make the connection between pin numbers 9 and 10 at the terminal NT31/NT31C (marked * in the figure above) only.

In order to avoid an FG ground loop, make the connection between the connector and the shielding at one side only.

Connection between NT31/NT31C Units (RS-485)

The relay terminal board is not included in the figure below. Insert a relay terminal board so as to achieve the wiring configuration indicated below.

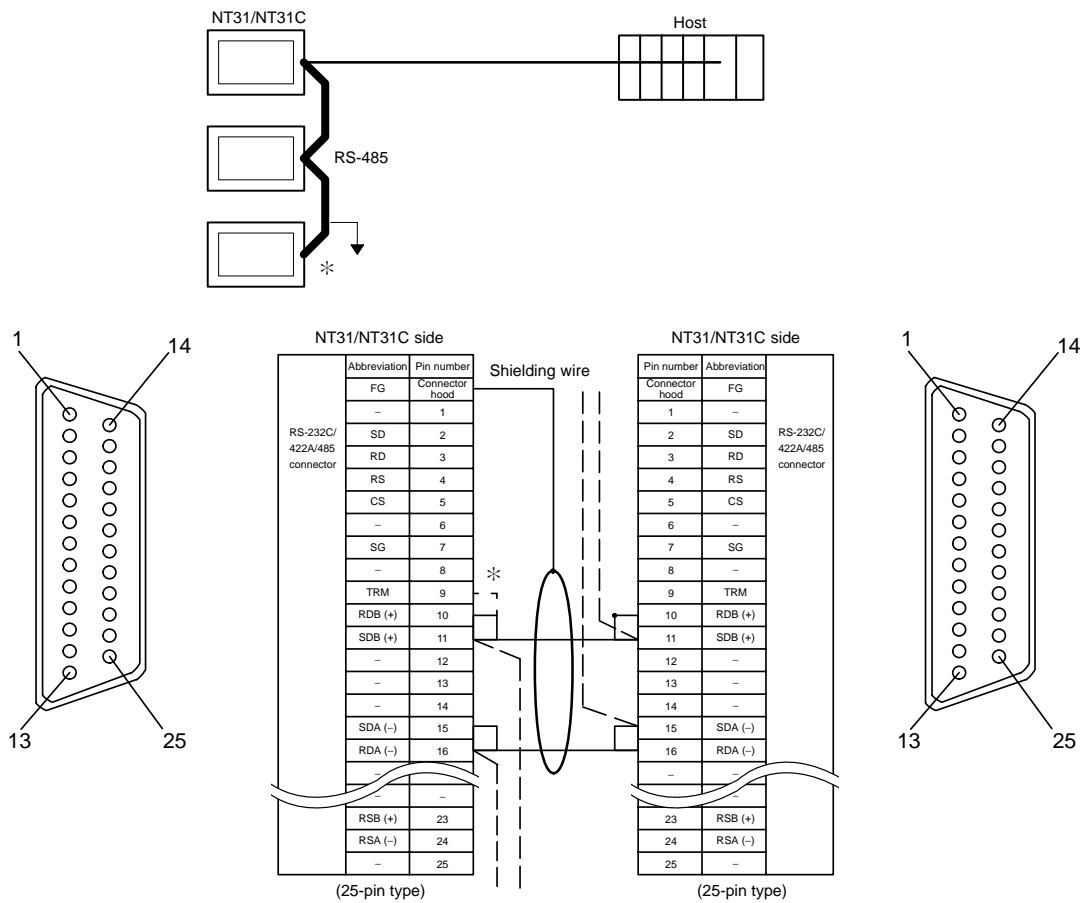

* Make the connection pin numbers 9 and 10 at the terminal NT31/NT31C (marked * in the figure above).

In order to avoid an FG ground loop, make the connection between the connector hood and the shielding at the one side only.

Connecting an NT-AL001 and Host

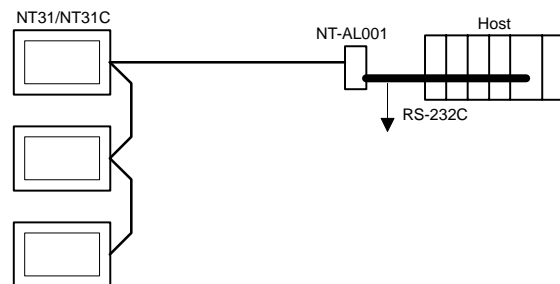

Wiring when connecting a CS1-series CS1G/H Serial Communications Board, CQM1H Serial Communications Board, or C-series C200HX/HG/HE(-Z)E Communications Board.

Applicable PCs:

- CS1G-CPU42-E(V1)
- CS1G-CPU44-E(V1)
- CS1H-CPU63-E(V1)
- CS1H-CPU65-E(V1)
- CS1G-CPU43-E(V1)
- CS1G-CPU45-E(V1)
- CS1H-CPU64-E(V1)
- CS1H-CPU66-E(V1)

CS1H-CPU67-E(V1)	
CQM1H-CPU51	CQM1H-CPU61
C200HE-CPU32-(Z)E	C200HE-CPU42-(Z)E
C200HG-CPU33-(Z)E	C200HG-CPU43-(Z)E
C200HG-CPU53-(Z)E	C200HG-CPU63-(Z)E
C200HX-CPU34-(Z)E	C200HX-CPU44-(Z)E
C200HX-CPU54-(Z)E	C200HX-CPU64-(Z)E
C200HX-CPU65-ZE	C200HX-CPU85-ZE

Usable Cables with Attached Connectors:

- For host link, 1:1 NT Link, or 1:N NT Link (+5 V power supplied from PC)

XW2Z-070T-1	(9-pin to 9-pin, 0.7 m)
XW2Z-200T-1	(9-pin to 9-pin, 2 m)
SJ46006-102	(9-pin to 9-pin, 1 m)
SSJ46006-202	(9-pin to 9-pin, 2 m)

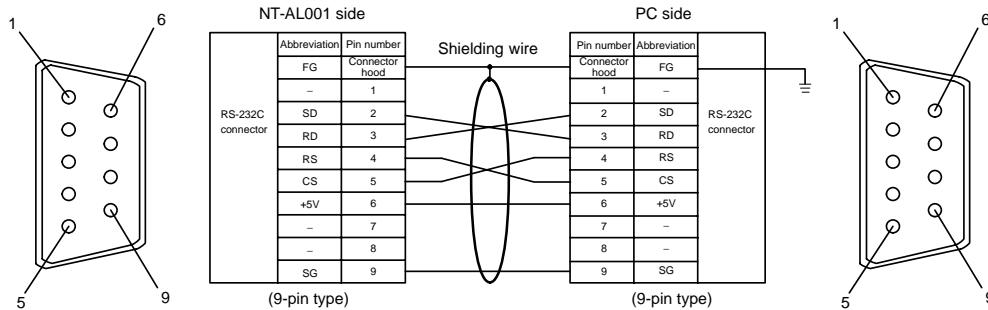

Since the CS1G/H, CQM1H, and C200HX/HG/HE(-Z)E have a +5 V output, no external power supply is required for the NT-AL001.

5-1-4 Recommended Connectors, Cables, and Crimp Terminals

Connectors and Cables Recommended for RS-232C

When making an RS-232C connecting cable, as far as possible use the recommended parts indicated in the table below. Some units come supplied with one connector and connector hood.

Check the required parts and prepare them in advance.

Name	Model	Remarks	Delivered with
Connector	XM2A-0901	9-pin type Made by OMRON	CS1-series CS1G/H C-series CQM1, C200HS, C200HX/HG/HE(-Z)E CVM1/CV-series CPUs CV500-LK201
	XM2A-2501	25-pin type Made by OMRON	C500-LK203 3G2A5-LK201-EV1 C200H-LK201-V1
	DB-25P	25-pin type Made by JAE	3G2A5-LK201-EV1 3G2A6-LK201-EV1

Name	Model	Remarks	Delivered with
Connector hood	XM2S-0911	9-pin type Made by OMRON	C-series CQM1, C200HS, C200HX/HG/HE(-Z)E CVM1/CV-series CPUs CV500-LK201
	XM2S-0913	Made by OMRON 9-pin	---
	XM2S-0911-E	Made by OMRON 9-pin	CS1 series CS1G/CS1H
	XM2S-2511	25-pin type Made by OMRON	C500-LK203 3G2A5-LK201-EV1 C200H-LK201-V1
	DB-C2-J9	25-pin type Made by JAE	3G2A5-LK201-EV1 3G2A6-LK201-EV1
Cable	AWG28×5P IFVV-SB	Multi-core shielded cable Made by Fujikura, Ltd.	---
	CO-MA-VV-SB 5P×28AWG	Multi-core shielded cable Made by Hitachi, Ltd.	---

Cables with Connectors Made by OMRON

When connecting an NT-AL001 and a PC, use the OMRON cables with connectors indicated in the table below.

Model	Cable Length	Connector Specification
XW2Z-200S	2 m	9-pin ↔ 25-pin
XW2Z-500S	5 m	Host link, NT link (1:1)
XW2Z-200T	2 m	9-pin ↔ 9-pin
XW2Z-500T	5 m	Host link, NT link (1:1)
SJ45007-102	1 m	9-pin ↔ 9-pin Host link, NT link (1:1)
SJ45007-202	2 m	+5 V power supply wire attached (Use when the PC does not have a +5 V output.)
XW2Z-070T-1	0.7 m	9-pin ↔ 9-pin Host link, NT link (1:1), NT link (1:N)
XW2Z-200T-1	2 m	+5 V power supplied from PC (Use when the PC has a +5 V output.)
SJ46006-102	1 m	9-pin ↔ 9-pin Host link, NT link (1:1), NT link (1:N)
SJ46006-202	2 m	+5 V power supplied from PC (Use when the PC has a +5 V output.)

Note The maximum tensile load of the recommended cable is 30 N. Do not exceed this load.

- After connecting a connecting cable, always tighten the connector screws.
- Recommended connectors, cables and crimp terminals for RS-422A/485

When making an RS-422A/485 connecting cable, as far as possible use the recommended parts indicated in the table below. Some units come supplied with one connector and connector hood.

Check the required parts and prepare them in advance.

Name	Model	Maker	Remarks
Connector	XM2A-2501	25-pin type Made by OMRON	Delivered with the following units: C500-LK203
	DB-25P F-N	25-pin type Made by JAE	Delivered with the following units: 3G2A6-LK201-EV1 3G2A5-LK201-EV1
Connector hood	XM2S-2511	25-pin type Made by OMRON	Delivered with the following units: C500-LK203
	DB-C2-J9	25-pin type Made by JAE	Delivered with the following units: 3G2A6-LK201-EV1 3G2A5-LK201-EV1
Cable	TKVVBS4P-03	Tachii Electric Wire Co., Ltd.	
Crimp terminals	1.25-N3A (fork type)	Japan Solderless Terminal MFG	Recommended cable size: AWG22 to 18 (0.3 to 0.75 mm ²)
	Y1.25-3.5L (fork type)	Molex Inc.	

The terminal screws of the NT-AL001 are M3 specification. When wiring, use crimp terminals for M3 use. Tighten terminal screws with a tightening torque of 0.5 N□m.

Note Always use crimp terminals for wiring.

Examples of applicable terminals

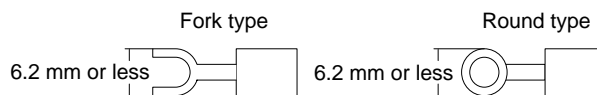

5-1-5 Setting the Terminal Resistance for RS-422A/485 Communications

The serial port B connector of the NT31/NT31C has a terminal resistance setting terminal (TRM).

In RS-422A/485 communications, a terminal resistor must be set at the device at the end of the communication cable, but not at any other device.

The NT31/NT31C has a built-in terminal resistor, and whether or not the terminal resistance is applied is set by the wiring at the terminal resistance setting terminals (pins No. 9 and 10 of serial port B). The terminal resistance is 120 Ω. When carrying out RS-422A/485 communications using serial port B, short between terminals No. 9 and 10 at the NT31/NT31C at the end of the RS-422A/485 cable. Leave terminals No. 9 and 10 open at NT31/NT31C units other than the one at the end of the cable.

When not using RS-422A/485 communications, the terminal resistance setting is ineffective.

In order to set the terminal resistance, wiring work is required at the cable's connector: carry out the wiring correctly by referring to APPENDIX E Making the Cable, page 267.

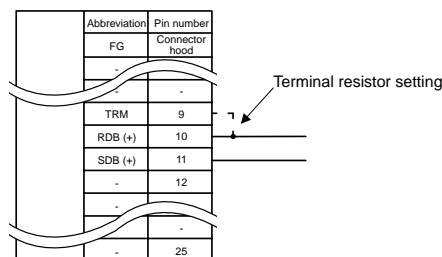

Pin Nos. 9 and 10	Function
Shorted	Terminal resistance is applied. Short only at the NT31/NT31C connected to the end of an RS-422A/485 cable.
Open	Terminal resistance is not applied. Leave the terminals open when connecting an NT31/NT31C anywhere other than at the end of the RS-422A/485 cable.

Note Before connecting or disconnecting cables between devices, make sure that the power supply to all of the connected devices (NT31/NT31C, PC, etc.) is OFF.

Reference: • The internal circuit of the NT31/NT31C is shown below.

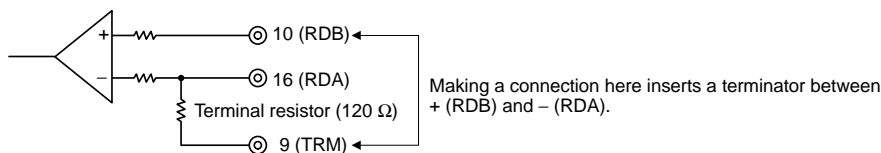

• For details on setting the terminal resistance of NT-AL001-E, refer to *Settings at the RS-232C/RS-422A Convertor Unit (NT-AL001-E)* (page 88).

5-2 Connecting to the Host's RS-422A/485 Port

The methods for connecting the RS-422A/485 port of the NT31/NT31C and the RS-422A/485 port of the host are described here. There are the following methods.

The following discussion is focused on the connection method to OMRON PCs (By using the memory link method, a connection can be made to any arbitrary RS-422 unit). When making a connection to a host other than OMRON PCs, refer to the *PC Connection Manual (V042-E1-□)* or *Multi Vendor Connection Manual (V060-E1-□)*.

• Method in which the RS-422A ports of the NT31/NT31C and host are connected directly by an RS-422A cable (page 117).

When this method is used, the cable length can be extended up to 500 m.

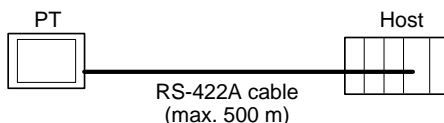

• Method in which the RS-485 ports of the NT31/NT31C and host are connected by an RS-485 cable (page 121).

When this method is used, the cable length can be extended up to 500 m.

This connection method can be used only with the NT link (1:N) method (standard or high-speed) of type RS-485.

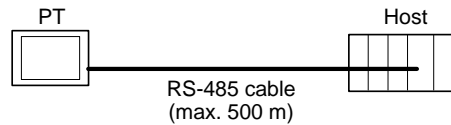

- Method in which the RS-422A ports of multiple NT31/NT31Cs and the RS-422A port of the host are connected in a 1:N connection (page 122). This connection method is used with the RS-422A type NT link (1:N) method (standard or high-speed).

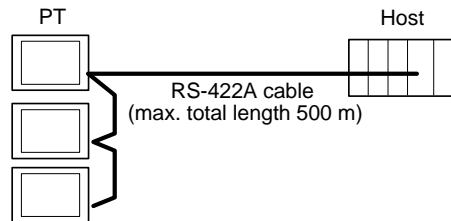

- Method in which the RS-485 ports of multiple NT31/NT31Cs and the RS-485 port of the host are connected in a 1:N connection (page 125). This connection method is used with the RS-485 type NT link (1:N) method (standard or high-speed).

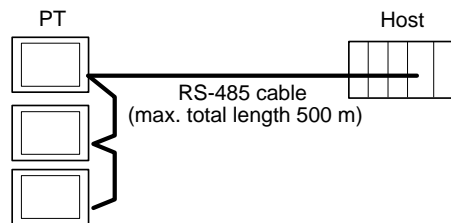

Note One end of the wire must always be connected to the host (PC), and there must be no branching. Branching will cause problems such as transmission delays and communication failures.

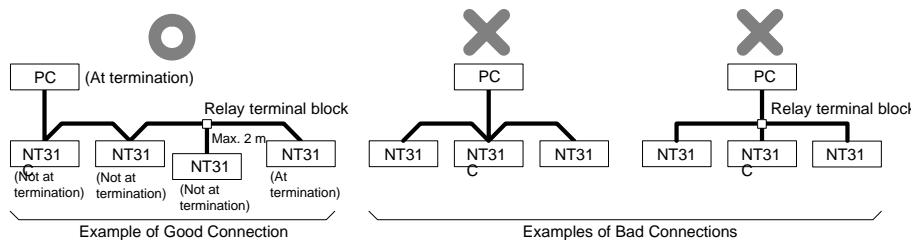

Reference: CS1 series CPUs cannot be connected with the 1:1 connection NT link method. Use the 1:N connection NT link method (standard or high-speed) instead to make the 1:1 connection. For details, refer to *Using the NT link (1:N) Method* (page 113) or *Using the High-speed NT link (1:N) Method* (page 115).

5-2-1 Host Types and Settings

The types of host that have an RS-422A port and can be connected to the RS-422A/485 port of the NT31/NT31C, and the settings to be made at the host, are described here.

When Using the Host Link Method

Compatible Host Units

Some models and series of OMRON PCs have the RS-422A/485 type host link

function built in. With the CS1-series and CQM1H, the host link method can be used by installing a serial communication board. In addition, some C200HX/HG/HE(-Z)E devices have an integral CPU that can be connected in the host link method by installing a communication board.

With the CPM2A and CPM2C, an RS-422A type of 1:1 NT Link can be created through a CPM1-CIF11 RS-422A Adapter.

Check the model and series of the PC and the type of the installed Board or Unit before making a connection.

The host units featuring the RS-422A/485 type host link function and can be connected to the RS-422A/485 port of the NT31/NT31C are indicated in the table below.

PC Series	Units with Built-in Host Link Function		CPUs Connectable with Host Link Units or Expansion Communication Board	Connectable to
	Host Link Unit / Communication Board	CPU		
CS1 series	CS1W-SCB41-E		CS1G-CPU42/43/44/45-EV1 CS1H-CPU63/64/65/66/67-EV1	CS1G CS1H
C series	3G2A6-LK202-EV1		C1000H-CPU01-EV1 C2000H-CPU01-EV1	C1000H C2000H
	C200H-LK202-V1		C200HS-CPU01/03/21/23/31/33-E C200HS-CPU01/21-EC C200HE-CPU11/32/42-E C200HE-CPU11/32/42-ZE C200HG-CPU33/43/53/63-E C200HG-CPU33/43/53/63-ZE C200HX-CPU34/44/54/64-E C200HX-CPU34/44/54/64/65/85-ZE	C200HS C200HE C200HE-ZE C200HG C200HG-ZE C200HX C200HX-ZE
	C200HW-COM03/06-EV1		C200HE-CPU32/42-E C200HE-CPU32/42-ZE	C200HE C200HE-ZE
			C200HG-CPU33/43/53/63-E C200HG-CPU33/43/53/63-ZE	C200HG C200HG-ZE
			C200HX-CPU34/44/54/64-E C200HX-CPU34/44/54/64/65/85-ZE	C200HX C200HX-ZE
	3G2A5-LK201-EV1		C1000H-CPU01-EV1 C2000H-CPU01-EV1	C1000H C2000H
	C500-LK203		C1000H-CPU01-EV1 C2000H-CPU01-EV1	C1000H C2000H
		CPM1-10/20/30CDR-□ +CPM1-CIF11		CPM1
		CPM1A-10/20/30/40CD□-□ +CPM1-CIF11		
		CPM2A-30/40/60CD□-□ +CPM1-CIF11 (Peripheral port connection)		CPM2A
		CPM2C-10/20□□□□□□□□ (*1)		CPM2C
	CQM1H-SCB41		CQM1H-CPU51/61	CQM1H
CV series (*2)	CV500-LK201	CV500-CPU01-EV1	CV500-CPU01-EV1	CV500
		CV1000-CPU01-EV1	CV1000-CPU01-EV1	CV1000
		CV2000-CPU01-EV1	CV2000-CPU01-EV1	CV2000
CVM1 series (*2)	CV500-LK201	CVM1-CPU01-EV2 CVM1-CPU11-EV2 CVM1-CPU21-EV2	CVM1-CPU01-EV2 CVM1-CPU11-EV2 CVM1-CPU21-EV2	CVM1
SRM1		SRM1-C02-V1+CPM1-CIF11		SRM1

*1: Use a CPM2C-CN111 or CS1W-CN114/118 Connecting Cable, CPM1-CIF01 RS-232C Adapter, or CPM1-CIF11 RS-422A Adapter to connect.

*2: CPUs of CVM1/CV-series PCs without the suffix -EV□ cannot be connected.

The host link method cannot be used when an NT31/NT31C is connected using RS-485. To use the host link method, connect by RS-422A.

Settings at the Host

When using the RS-422A type host link method, the settings shown below must be made at the host (depending on the unit, some of these settings may not be necessary, or settings not shown here may be necessary).

Item	Setting at Host
I/O port	RS-422A
Communications speed	Set the same speed as for the NT31/NT31C. (*1)
Transfer code	ASCII, 7 data bits, 2 stop bits
Parity	Even
1-to-1/1-to-N	1-to-N(*2)
Instruction level	Level 1, 2, 3
Unit #	00

*1 Set the host link communications speed at 9600 bps or 19200 bps with the Comm. Speed memory switch at the NT31/NT31C. For details, refer to *Setting the Host Link Method* (page 158).

*2 The 1-to-N setting enables BCC (Block Check Character). It is not actually possible to connect more than one NT31/NT31C in a single host link.

The setting methods for each type of unit are described in the following.

Connecting to a C Series Host Link Unit

C200H/C200HS/C200HE(-Z)E/C200HG(-Z)E/C200HX(-Z)E

Backplane mounting type: C200H-LK201-V1

Setting the Front Switches

Set each switch with a flat blade screwdriver so that the values or symbols in the setting value window agree with the following:

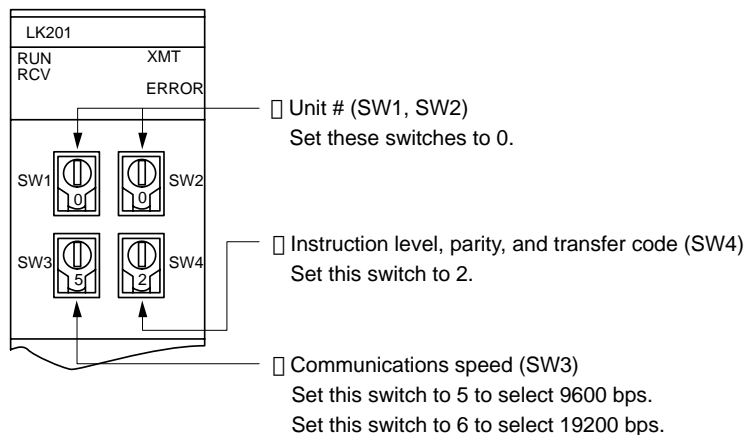

Setting the Rear Switches

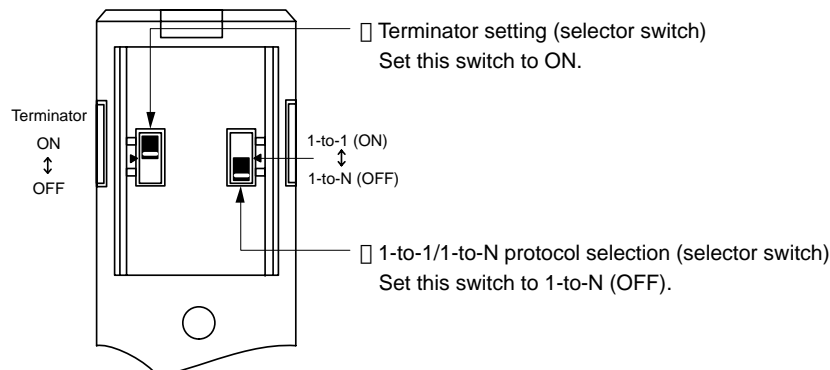

C1000H/C2000H rack-mounting type: 3G2A5-LK201-EV1

Setting the Front Switches

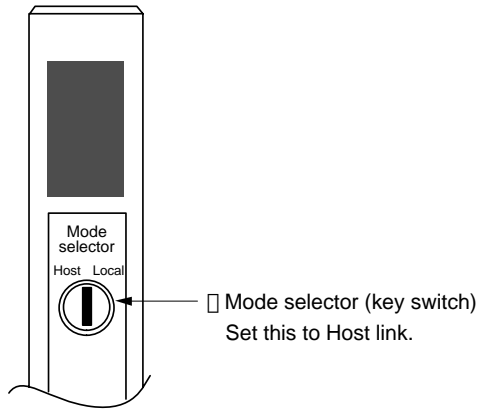

Setting the Rear Switches

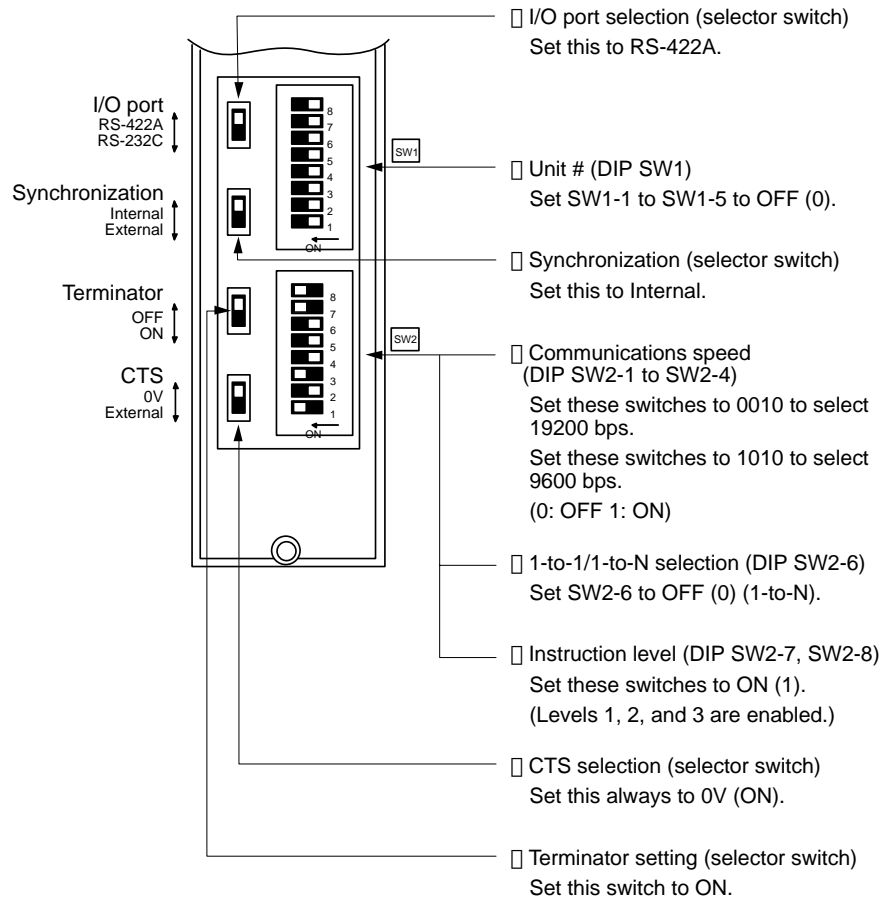

C1000H/C2000H rack-mounting type: C500-LK203

Setting the Rear Switches

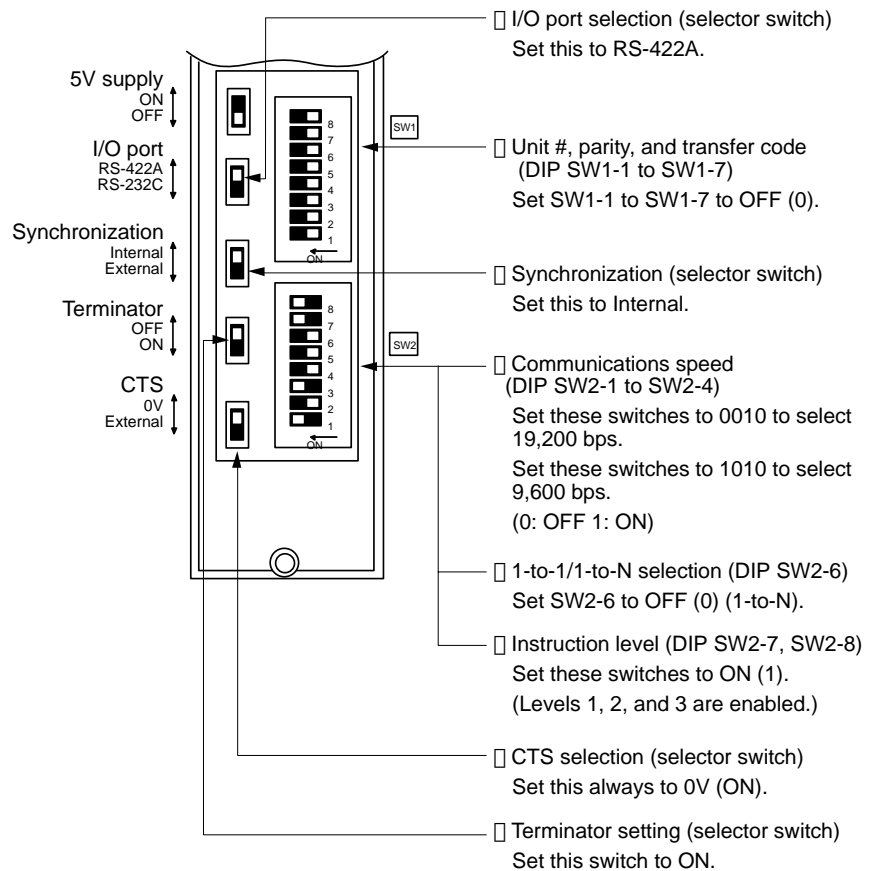

C200H/C1000H/C2000H CPU mounting type: 3G2A6-LK202-EV1

Setting the Rear Switches

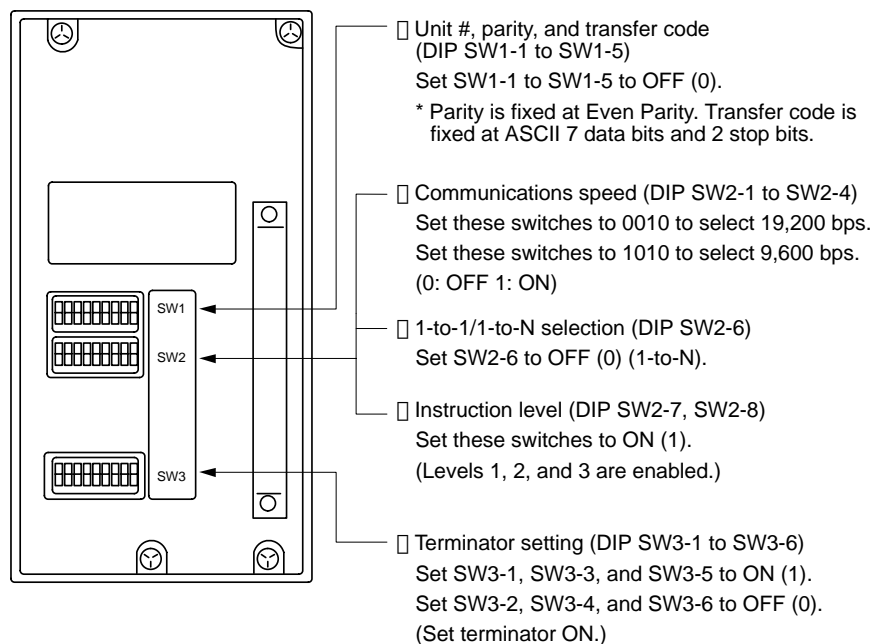

Connecting to a CVM1/CV Series Host Link Unit**CVM1/CV series rack-mounting type: CV500-LK201**

A CVM1/CV series host link unit (CV500-LK201) has two connectors (communication ports 1 and 2). To use the RS-422A type host link method, set communication port 2 to RS-422A.

Communication port 2 is a 9-pin connector which allows selection of the RS-232C or RS-422A method. When this port is used with the RS-422A method, the I/O port selector switch on the front of the unit must be set to RS-422A (the lower position).

CPU Bus Unit Settings

When connecting to a CVM1/CV series host link unit, set the following communication conditions for the CPU bus unit settings.

Item	Setting at Host
Communications speed	Set the same speed as for the NT31/NT31C. (*1)
Transfer code	ASCII, 7 data bits, 2 stop bits
Parity	Even
1-to-1/1-to-N	1-to-N(*2)
Instruction level	Level 1, 2, 3

*1 Set the host link communications speed at 9600 bps or 19200 bps with the Comm. Speed memory switch at the NT31/NT31C. For details, refer to *Setting the Host Link Method* (page 158).

*2 The 1-to-N setting enables BCC (Block Check Character). It is not actually possible to connect more than one NT31/NT31C in a single host link.

Set the CPU bus unit settings directly from a Programming Device (e.g. SYSMAC support software).

For details on the CPU bus unit settings, refer to the *SYSMAC CVM1/CV-series Host Link Unit Operation Manual* (W205-E1-□).

Setting the Front Switches

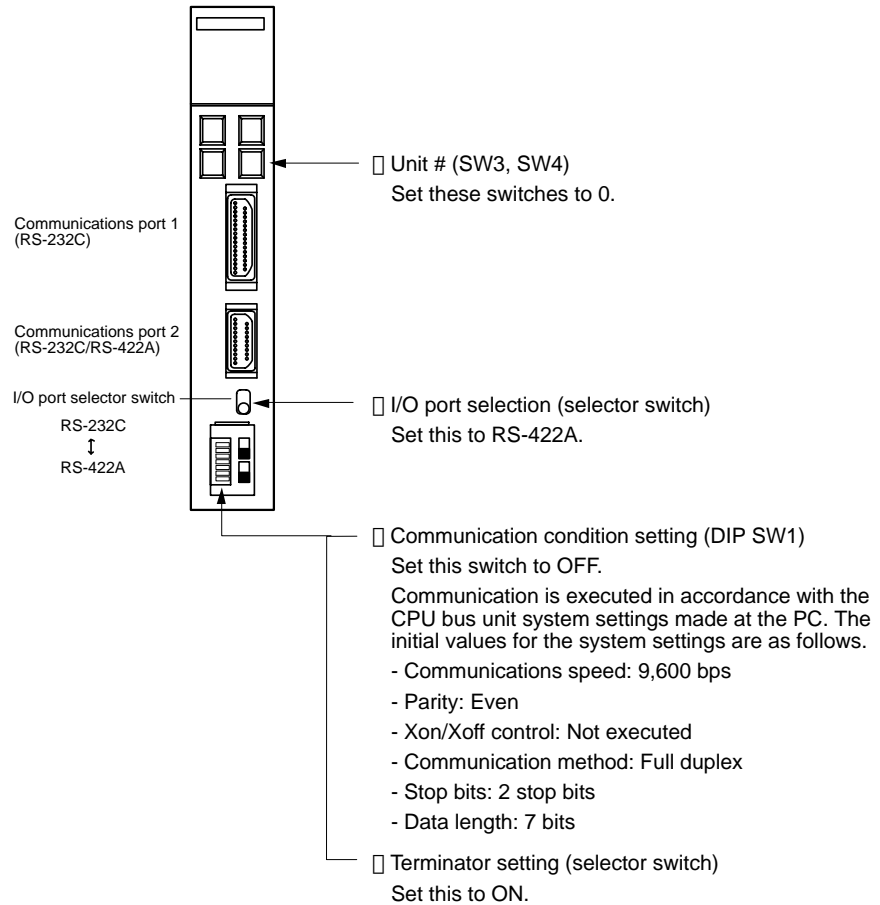

Connecting to a CPU Unit

CVM1/CV-series (-EV□) CPUs

- CV500-CPU01-EV1/CV1000-CPU01-EV1/CV2000-CPU01-EV1
- CVM1-CPU01-EV2/CVM1-CPU11-EV2/CVM1-CPU21-EV2

PC Setup

When connecting to a CVM1/CV series CPU, set the following communication conditions for the PC Setup.

Item	Setting at Host
Communications speed	Set the same speed as for the NT31/NT31C. (*1)
Stop bit	2 stop bits
Parity	Even
Data length	ASCII 7 bits
Unit #	00

*1 Set the host link communications speed at 9600 bps or 19200 bps with the Comm. Speed memory switch at the NT31/NT31C. For details, refer to *Setting the Host Link Method* (page 158).

Either set PC Setup directly from a Programming Device (e.g. SYSMAC support software), or transmit the PC Setup made at a Programming Device to the CPU. For details on the PC Setup, refer to the *SYSMAC CVM1/CV500/CV1000/CV2000 Operation Manual: Ladder Diagrams (W202-E1-□)*.

Setting the Front Switches

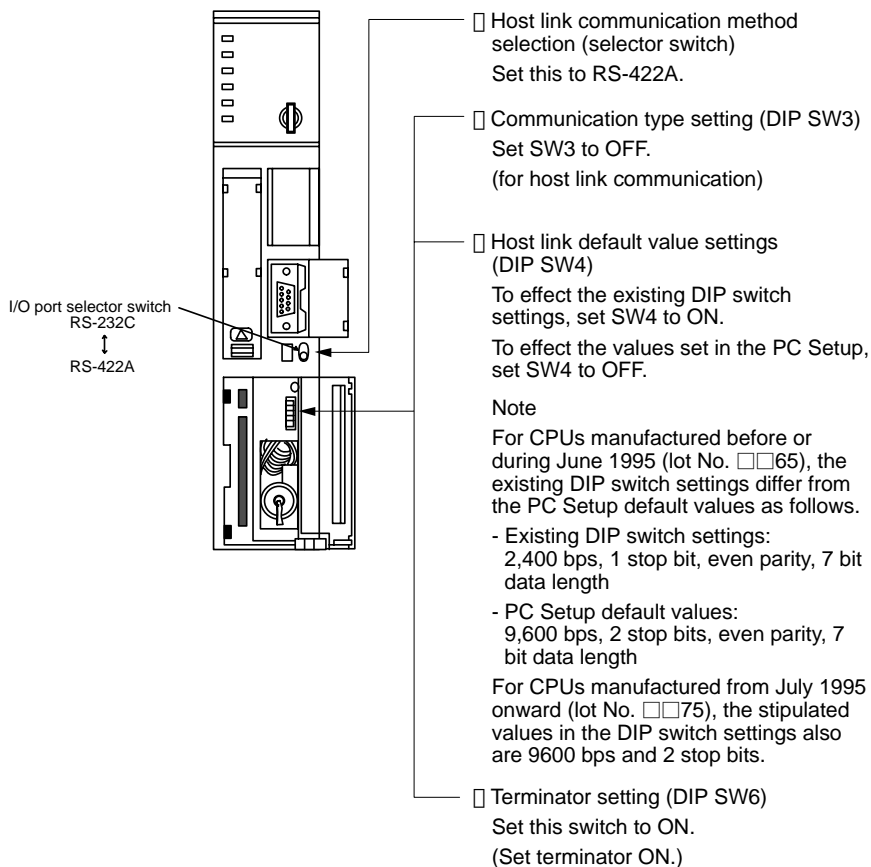

C200HX/HG/HE(-Z)E, CPM1, CPM2A, CPM2C, CQM1H, or SRM1

The connection method depends upon the model of PC being used, as shown in the following table.

PC model	Connection method
C200HX/HG/HE(-Z)E	<ul style="list-style-type: none"> • Connect to the RS-422A port (port A) on a Communications Board.
CQM1H	<ul style="list-style-type: none"> • Connect to the RS-422A port (port 2) on a Serial Communications Board.
CPM1	<ul style="list-style-type: none"> • Connect to the peripheral port through a CPM1-CIF11 RS-422A Adapter.
CPM2A, SRM1	<ul style="list-style-type: none"> • Connect to the peripheral port through a CPM1-CIF11 RS-422A Adapter.
CPM2C	<ul style="list-style-type: none"> • Connect to the peripheral port (on a CPM2C-CN111 or CS1W-CN114 Connecting Cable) through a CPM1-CIF11 RS-422A Adapter. <p>(The CPM2C-CN111 splits the Unit's Communication Port into a RS-232C port and a peripheral port.)</p>

- Reference:**
- There are no Communication Boards for the C200HX/HG/HE(-Z)E in which port B is the RS-422A port.
 - There are no Serial Communication Boards for the CQM1H in which port 1 is the RS-422A port.

PC Setup Area Settings

When connecting to a C200HX/HG/HE(-Z)E or CPM1, CPM2A, CPM2C,

CQM1H CPUs or SRM1, set the following communication conditions for the PC Setup area.

Item	Setting at Host
I/O port	RS-422A
Communication mode	Host link mode
Communications speed	Set the same speed as for the NT31/NT31C. (*1)
Stop bit	2 stop bits
Parity	Even
Data length	ASCII 7 bits
Unit #	00

*1 Set the host link communications speed at 9600 bps or 19200 bps with the Comm. Speed at the NT31/NT31C. For details, refer to *Setting the Host Link Method* (page 158).

Set the PC Setup area settings directly from a Programming Device (e.g. CX-Programmer).

For details on operations relating to the PC Setup area, refer to the manual for the PC which is used.

The PC Setup area word numbers and settings to be made depending on the unit to which the connection is made are shown below.

When using port A of the communication board of C200HX/HG/HE(-Z)E

Word #	Writing Value	Settings
DM6555	0001	Host link mode, no CTS control Communication conditions set by the contents of DM
DM6556	0303	Data length 7 bits, 2 stop bits, even parity, communications speed: 9600 bps
	0304	Data length 7 bits, 2 stop bits, even parity, communications speed: 19200 bps
DM6558	0000	Unit # 00

When using a CPM1, CPM2A, CPM2C, SRM1

Word #	Writing Value	Settings
DM6650	0001	Host link mode, no CTS control Communication conditions set by the contents of DM
DM6651	0303	Data length 7 bits, 2 stop bits, even parity, communications speed: 9600 bps
	0304	Data length 7 bits, 2 stop bits, even parity, communications speed: 19200 bps
DM6653	0000	Unit # 00

When using a CQM1H

Word #	Writing Value	Settings
DM6550	0001	Host link mode, no CTS control Communication conditions set by the contents of DM
DM6551	0303	Data length 7 bits, 2 stop bits, even parity, communications speed: 9600 bps
	0304	Data length 7 bits, 2 stop bits, even parity, communications speed: 19200 bps
DM6553	0000	Unit # 00

Connecting to a CPM2C

The CPM2C PCs do not have the same kind of port connectors found on CS1-series PCs. The CPM2C's communication port handles both RS-232C and peripheral port connections which are divided internally. Therefore, when using the CPM2C, it is necessary to select RS-232C or peripheral port connections, according to the kind of cable and port (on the cable) used, as shown in the following table. Refer to the *CPM2C Operation Manual* for more details.

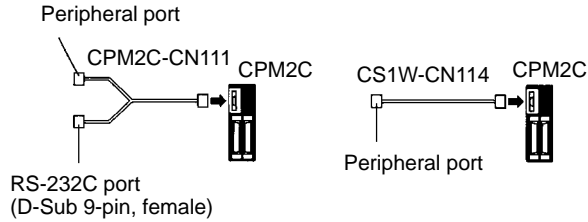

Setting Switches on a C200HX/HG/HE(-Z)E Communications Board

Set the switches on a C200HX/HG/HE(-Z)E communication board as follows.

Switch 1: Set to 4 (4-wire type, for RS-422A)

Switch 2 : Set to ON for terminator ON (termination resistance applied)

Setting Switches on a CQM1H Serial Communications Board

Set the switches on a CQM1H Serial Communications Board as follows.

Wire selection (WIRE): Set to 4 (4-wire type, for RS-422A)

Terminator (TERM): Set to ON for termination ON.

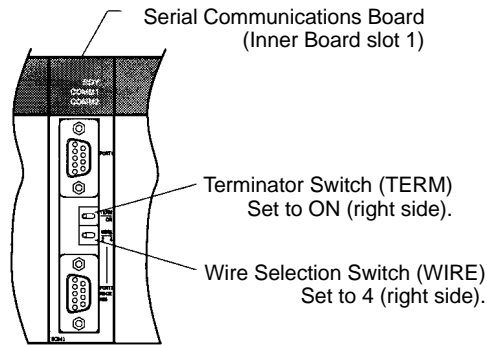

Setting the Switches on an RS-422A Adapter

Set the terminator selector switch to ON (upper position).

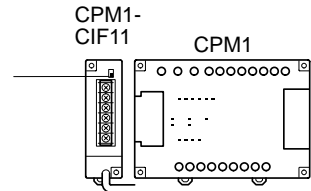

Connecting to a CS1 Series Serial Communications Board

Serial Communications Board with RS-422A/485 port equipped for CS1 series CPU Type :

CS1W-SCB41 (The port 2 is RS-422A/485 port.)

Allocation DM Area Settings for CPU

Settings are written from the Programming Device (a Programming Console or CX-Programmer) directly into the allocation DM area (system setting area) of the CPU. After the settings are written, they become effective by turning the power ON, restarting the unit, restarting the communication port, or executing the STUP command.

In the following, the channel numbers of the allocation DM area and the settings are shown.

Allocation DM area (CH)	Writing Value	Settings
Port 2		
DM32010	8000	Host link mode, 2 stop bits, data length 7 bits, even parity,
DM32011	0000	Communication speed 9600 bps.
	0007	Communication speed 19200 bps.
DM32012	0000	Transmit delay time 0 ms.
DM32016	0000	No CTS control Unit No.0 for host link

Using the NT Link (1:1) Method

Compatible Host Units

Some models and series of OMRON PCs have the RS-422A type NT link (1:1) function built in.

- The C200HX/HG/HE(-Z)E CPUs can be connected by the RS-422A type NT link (1:1) method by installing a Communications Board.
- The CQM1H CPUs can be connected by the RS-422A type NT link (1:1) method by installing a Serial Communications Board.

Check the model and series of the PC against the type of CPU before making the connections.

The host units that can be connected to the RS-422A port of the NT31/NT31C by the RS-422A type NT link (1:1) method are indicated in the table below.

PC Series	CPUs with Built-in RS-422A type NT Link (1:1) Function	Model Name	
C series	C200HE-CPU32-(Z)E ^(*1) C200HE-CPU42-(Z)E ^(*1)	C200HE (-Z)E	
	C200HG-CPU33-(Z)E ^(*1) C200HG-CPU43-(Z)E ^(*1) C200HG-CPU53-(Z)E ^(*1) C200HG-CPU63-(Z)E ^(*1)	C200HG (-Z)E	
	C200HX-CPU34-(Z)E ^(*1) C200HX-CPU44-(Z)E ^(*1) C200HX-CPU54-(Z)E ^(*1) C200HX-CPU64-(Z)E ^(*1) C200HX-CPU65-ZE ^(*1) C200HX-CPU85-ZE ^(*1)	C200HX (-Z)E	
	CQM1H-CPU51/61	CQM1H	
	CV series ^(*2)	CV500-CPU01-EV1	CV500
		CV1000-CPU01-EV1	CV1000
CV2000-CPU01-EV1		CV2000	
CVM1 series ^(*2)	CVM1-CPU01-EV2 CVM1-CPU11-EV2 CVM1-CPU21-EV2	CVM1	

*1 One of the following communication boards is required:
C200HW-COM03-EV1 or C200HW-COM06-EV1.

*2 A CQM1H-SCB41 Serial Communication Board is required.

*3 CPUs of CVM1/CV series PCs without the suffix -EV□ cannot be connected.

The NT link (1:1) method cannot be used using RS-485. To use the NT link (1:1) method, connect by RS-422A.

NT link connection using RS-422A/485 is not possible with CPM1.

Settings at the Host

The setting methods for each type of unit are described in the following.

- Connecting to a CVM1/CV-series (-EV□) CPUs
 - CV500-CPU01-EV1/CV1000-CPU01-EV1/CV2000-CPU01-EV1
 - CVM1-CPU01-EV2/CVM1-CPU11-EV2/CVM1-CPU21-EV2

PC Setup

When connecting to the CVM1/CV series CPU by the NT link (1:1) method, no particular settings are required at the PC Setup.

Setting the Front Switches

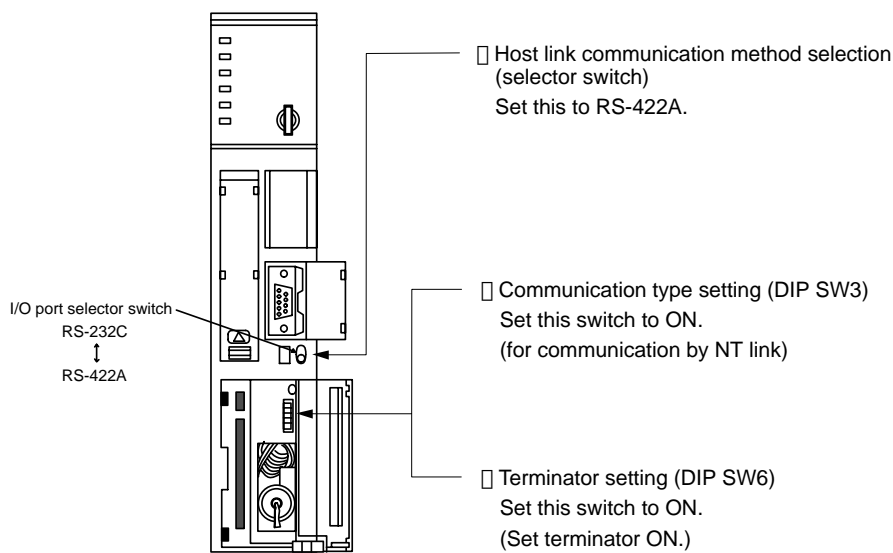

Connecting to a C-series C200HX/HG/HE(-Z)E or CQM1H

PC Setup Area Settings

Write the PC Setup area (data memory) settings directly from a Programming Device (e.g. CX-Programmer) in accordance with the host model.

Host Model	Word #	Writing Value	Setting
Port A of C200HX/HG/HE(-Z)E*1	DM6555	4000	Use NT link (1:1)
Port 2 of CQM1H*2	DM6550	4000	

*1 RS-422A port of the communication board

*2 RS-422A port of the Serial Communications Board

For details on operations relating to the PC Setup area, refer to the manual for the PC you are using.

Setting the DIP Switches on a C200HX/HG/HE(-Z)E Communication Board

Set the switches on a C200HX/HG/HE(-Z)E communication board as follows.

Switch 1: Set to 4 (4-wire type, for RS-422A)

Switch 2: Set to ON for terminator ON (termination resistance applied)

Setting Switches on a CQM1H Serial Communications Board

Set the switches on a CQM1H Serial Communications Board as follows.

Wire selection (WIRE): Set to 4 (4-wire type, for RS-422A)

Terminator (TERM): Set to ON for termination ON.

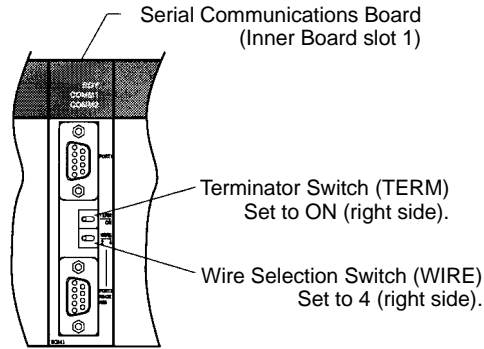

Using the NT Link (1:N) Method

Compatible Host Units

The OMRON PCs that can be connected using the RS-422A/485 type NT link (1:N) method are the CS1G/H, C200HX/HG/HE(-Z)E, and CQM1H models only. A Serial Communications Board or a communications board must be installed to make the connection.

Check the model and series of the PC against the type of CPU or communications board before making the connections.

The host units that can be connected to the RS-232C port of the NT31/NT31C by the RS-422A type NT link (1:N) function via a convertor are indicated in the table below.

PC Series	CPUs with Built-in RS-422A type NT Link (1:N) Function	CPU that becomes connectable by installing a communication board	Model Name
CS1 series	---	CS1G-CPU42/43/44/45-E(V1) ^(*1)	CS1G
	---	CS1H-CPU63/64/65/66/67-E(V1) ^(*1)	CS1H
C series	---	C200HE-CPU32-(Z)E ^(*2) C200HE-CPU42-(Z)E ^(*2)	C200HE (-Z)E
	---	C200HG-CPU33-(Z)E ^(*2) C200HG-CPU43-(Z)E ^(*2) C200HG-CPU53-(Z)E ^(*2) C200HG-CPU63-(Z)E ^(*2)	C200HG (-Z)E
	---	C200HX-CPU34-(Z)E ^(*2) C200HX-CPU44-(Z)E ^(*2) C200HX-CPU54-(Z)E ^(*2) C200HX-CPU64-(Z)E ^(*2) C200HX-CPU65-ZE ^(*2) C200HX-CPU85-ZE ^(*2)	C200HX (-Z)E
	---	CQM1H-CPU51/61 ^(*3)	CQM1H

*1 The serial CS1W-SCB41-E communication board is required.

*2 A C200HW-COM03-V1 or C200-COM06-V1 communication board is required.

*3 A CQM1H-SCB41 Serial Communication Board is required.

Settings at the Host

C-series C200HX/HG/HE(-Z)E and CQM1H

PC Setup Area Settings

Write the communication conditions directly into the PC Setup area (data memory) using a Programming Device (e.g. CX-Programmer).

Make the setting indicated in the word shown below.

Connection to	Word #	Writing Value	Setting
Port A of a C200HX/HG/HE(-Z)E*1	DM6555	5□00	Use NT link (1:N) □ = highest unit number of the connected PTs (1 to 7)*3
Port 2 of a CQM1H*2	DM6550	5□00	

*1 The Communications Board's RS-422A/485 port

*2 The Serial Communications Board's RS-422A/485 port

*3 When using C200HE(-Z)E, the maximum PT unit number is 3.

For details on setting the PC Setup area settings, refer to the PC's operation manual.

- Reference:**
- There are no Serial Communication Boards for the C200HX/HG/HE(-Z)E in which port B is the RS-422A/485 port.
 - There are no Serial Communication Boards for the CQM1H in which port 1 is the RS-422A/485 port.

Setting the DIP Switches on a C200HX/HG/HE(-Z)E Communication Board

Set the switches on a C200HX/HG/HE(-Z)E communication board as follows.

Switch 1: Set to 4 (4-wire type, for RS-422A), or

Set to 2 (2-wire type, for RS-485)

Switch 2 : Set to ON for terminator ON (termination resistance applied)

Setting Switches on a CQM1H Serial Communications Board

Set the switches on a CQM1H Serial Communications Board as follows.

Wire selection (WIRE): Set to 4 (4-wire type, for RS-422A)

or

Set to 2 (2-wire type, for RS-485)

Terminator (TERM): Set to ON for termination ON.

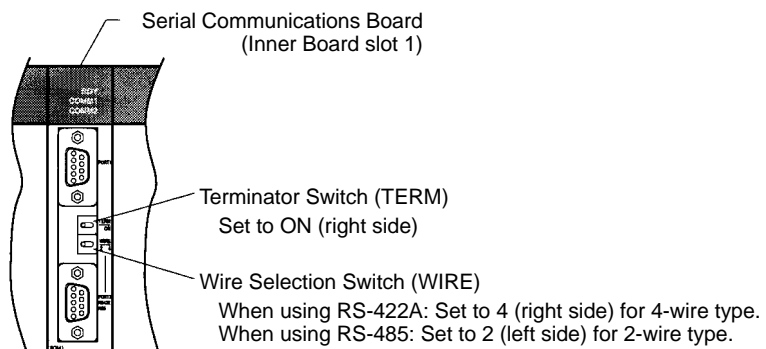

Connecting to CS1 Series Serial Communication Board

Serial Communications Board with RS-422A/485 port equipped for CS1 series CPU type :

CS1W-SCB41 (The port 2 is RS-422A/485 port.)

Setting the Front Switches

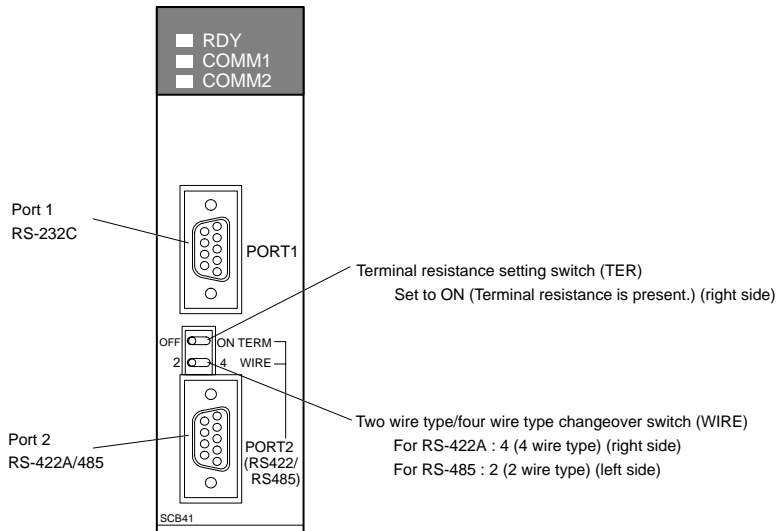

Allocation DM Area Settings for CPU

Settings are written from the Programming Device (a Programming Console or CX-Programmer) directly into the allocation DM area (system setting area) of the CPU. After settings are written, they become effective by turning the power ON, restarting the unit, restarting the communication port, or executing the STUP command.

In the following, the channel numbers of the allocation DM area and settings are shown.

Allocation DM area (CH)	Writing Value	Settings
Port 2		
DM32010	8200	NT link (1:N) mode
DM32011	0000 to 0009 (*1)	Communications baud rate (standard)
DM32016	000□	□ = The largest model number of the connected PT (0 – 7)

*1 Set any value between 0000 and 0009 Hex for the communications baud rate. The same baud rate will be used regardless of the value as long as it is between 0000 and 0009 Hex.

For example, when connecting PTs with model numbers 3, 4, 5, and 6 to port 2 in the NT link (1:N), set a value of 8200 Hex for D32010, 0000 Hex for DM32011, and 0006 Hex for D32016.

Using the High-speed NT Link (1:N) Method

Compatible Host Units

Only OMRON's CS1H and CS1G PCs support the high-speed 1:N NT Link through RS-422A/RS-485. The high-speed 1:N NT Link must be established through a CS1W-SCB41-E Serial Communications Board. (If a Serial Communications Board is used, even CS1-series Units without the "-V1" suffix can be connected via high-speed 1:N NT Link.)

Be sure to check the model number of the PC and Board/Unit before trying to establish the high-speed 1:N NT Link.

The following table shows which CS1-series PCs can be connected to an NT31/NT31C with the high-speed 1:N NT Link through RS-422A/RS-485.

PCs supporting direct connection to the CPU Unit	PCs supporting connection through a Serial Communication Board
---	CS1G-CPU42/43/44/45-E(V1) (*1) CS1H-CPU63/64/65/66/67-E(V1) (*1)

*1 A CS1W-SCB41 Serial Communication Board is required.

Settings at the Host

Connecting to a CS1 Series Serial Communications Board

Serial Communications Board equipped with an RS-422A/485 port for CS1-series CPU Units:

CS1W-SCB41 (Port 2 is an RS-422A/485 port.)

Reference: Serial Communications Boards and Serial Communications Units with lot number 991220 (12/20/99) and later support the high-speed 1:N NT Link. Boards and Units with earlier lot numbers **cannot** be used.

Setting the Front Switches

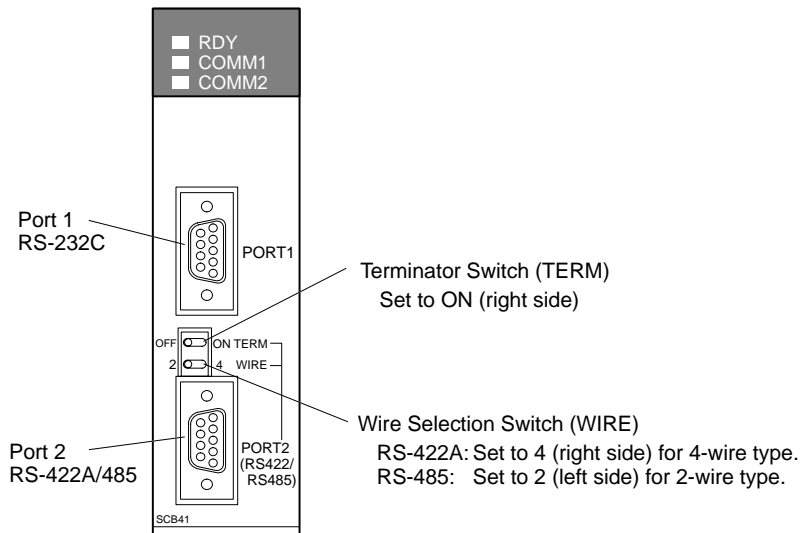

CPU Allocation DM Area Settings

Setting is written from the Programming Device (a Programming Console or CX-Programmer) directly into the allocation DM area (system setting area) of the CPU. After the setting is written, it becomes effective by turning the power ON, restarting the unit, restarting the communication port, or execution of the STUP command.

In the following table, the relevant word addresses in the allocation DM area and settings are shown.

Allocation DM area	Writing Value	Settings
Port 2		
DM32010	8200	NT link (1:N) mode
DM32011	000A	Communications baud rate (high-speed)
DM32016	000□	□ = The largest model number of the connected PT (0 – 7)

For example, when connecting PTs with model numbers 3, 4, 5, and 6 to port 2, set the value 8200 Hex to DM32010, 000A Hex to DM32011, and 0006 Hex to DM32016.

When using the Memory Link Method

With the memory link method, the connection can be made to a personal computer and an FA computer with RS-422A.

When connecting to the host with the memory link method, it is necessary to create a program for the memory link at the host side.

The following are the communication conditions that can be used with the memory link method. For the host (a personal computer, an FA computer, etc.), its setting should be compatible to one of the communication conditions listed in the following table. Set the same communication conditions at the NT31/NT31C by the memory switch. (page 165).

Item	Setting at Host
Input/Output board	RS-422A
Communication speed	1200, 2400, 4800, 9600, 19200, 38400 bps.
Data bits length	7 bits, 8 bits
Stop bits length	1 bit, 2 bits
Parity	None, even, odd
Flow control	None, XON/XOFF

5-2-2 Direct Connection between RS-422A Ports at Both Units

The connection method in which the RS-422A ports of an NT31/NT31C and a host are connected is described here.

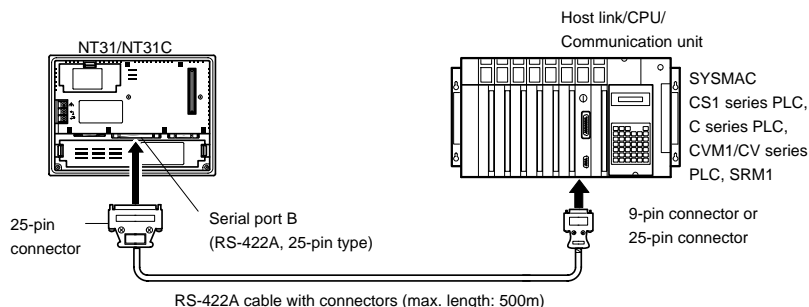

Connecting an NT31/NT31C and Host (RS-422A)

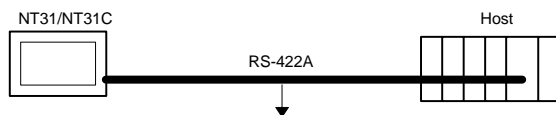

Wiring When Connecting a C-series Host Link Unit or CPM1 (Host Link)

Applicable units:

- C200H-LK202-V1
- 3G2A5-LK201-EV1

C500-LK203
3G2A6-LK202-EV1

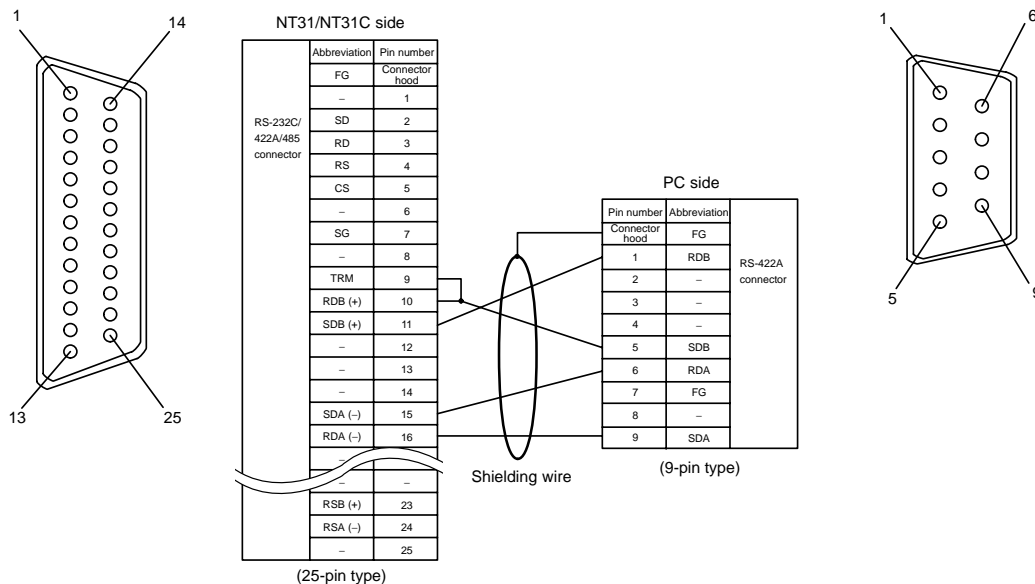

In order to avoid an FG ground loop, do not connect the functional ground of the NT31/NT31C to the shielding of the RS-422A cable.

Wiring When Connecting CPM1, CPM2A, CPM2C, or SRM1

Applicable units:

- CPM1-10CDR-□
- CPM1A-10CD□-□
- CPM1A-30CD□-□
- CPM2A-30CD□□-□
- CPM2A-60CD□□-□
- CPM2C-10□□□□□□-□
- SRM1-C02-V2
- CPM1-20CDR-□
- CPM1A-20CD□-□
- CPM1A-40CD□-□
- CPM2A-40CD□□-□
- CPM2C-20□□□□□□-□

Connect to the PC through a CPM1-CIF11 RS-422A Adapter.

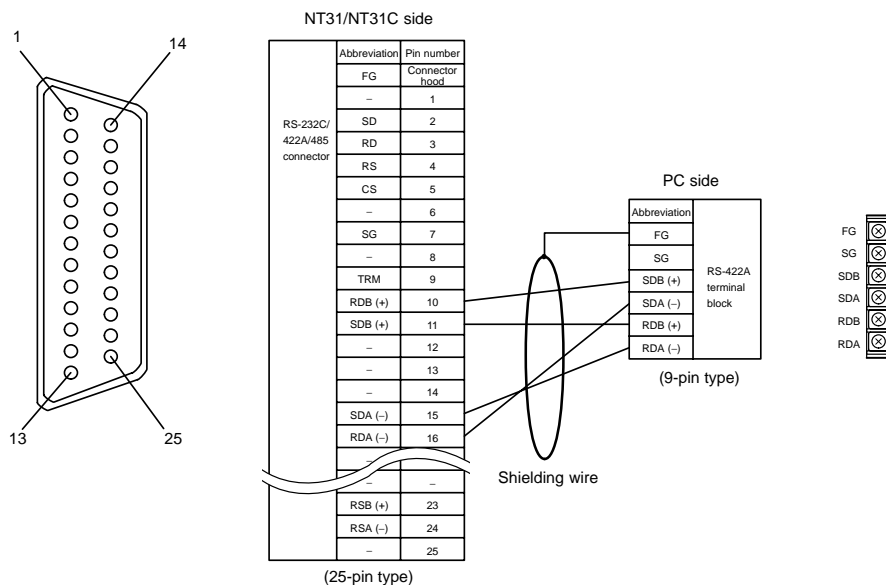

In order to avoid an FG ground loop, do not connect the functional ground of the NT31/NT31C to the shielding of the RS-422A cable.

Wiring When Connecting a CS1-series CS1G/H Serial Communications Board, C series C200HX/HG/HE(-Z)E Communication Board, CQM1H Serial Communications Board, or CVM1/CV-series Host Link Unit

Applicable units:

- | | |
|------------------------------------|-------------------|
| CS1G-CPU42-E(V1) | CS1G-CPU43-E(V1) |
| CS1G-CPU44-E(V1) | CS1G-CPU45-E(V1) |
| CS1H-CPU63-E(V1) | CS1H-CPU64-E(V1) |
| CS1H-CPU65-E(V1) | CS1H-CPU66-E(V1) |
| CS1H-CPU67-E(V1) | |
| C200HE-CPU32-(Z)E | C200HE-CPU42-(Z)E |
| C200HG-CPU33-(Z)E | C200HG-CPU43-(Z)E |
| C200HG-CPU53-(Z)E | C200HG-CPU63-(Z)E |
| C200HX-CPU34-(Z)E | C200HX-CPU44-(Z)E |
| C200HX-CPU54-(Z)E | C200HX-CPU64-(Z)E |
| C200HX-CPU65-ZE | C200HX-CPU85-ZE |
| CQM1H-CPU51 | CQM1H-CPU61 |
| CV500-LK201 (communication port 2) | |

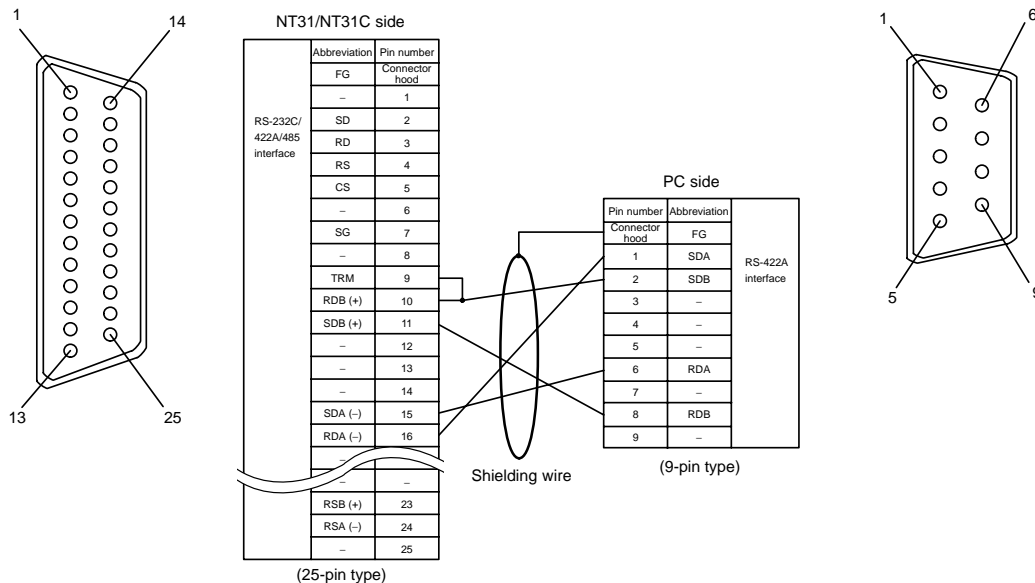

In order to avoid an FG ground loop, do not connect the functional ground of the NT31/NT31C to the shielding of the RS-422A cable.

Wiring When Connecting a CVM1/CV-series CPU

Applicable units:

- | | |
|------------------|------------------|
| CV500-CPU01-EV1 | CV1000-CPU01-EV1 |
| CV2000-CPU01-EV1 | |
| CVM1-CPU01-EV□ | CVM1-CPU11-EV□ |
| CVM1-CPU21-EV□ | |

CVM1/CV-series CPUs whose model names do not have the suffix -EV□ cannot be connected by any connection method.

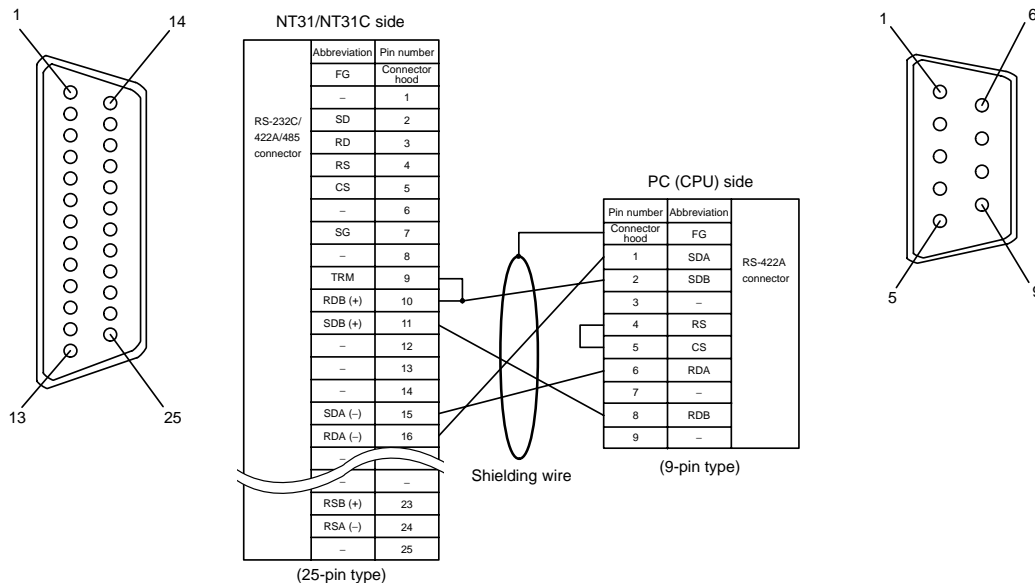

In order to avoid an FG ground loop, do not connect the functional ground of the NT31/NT31C to the shielding of the RS-422A cable.

Wiring for a Memory Link Connection

Prepare the adapter cable while referring to the following diagram.

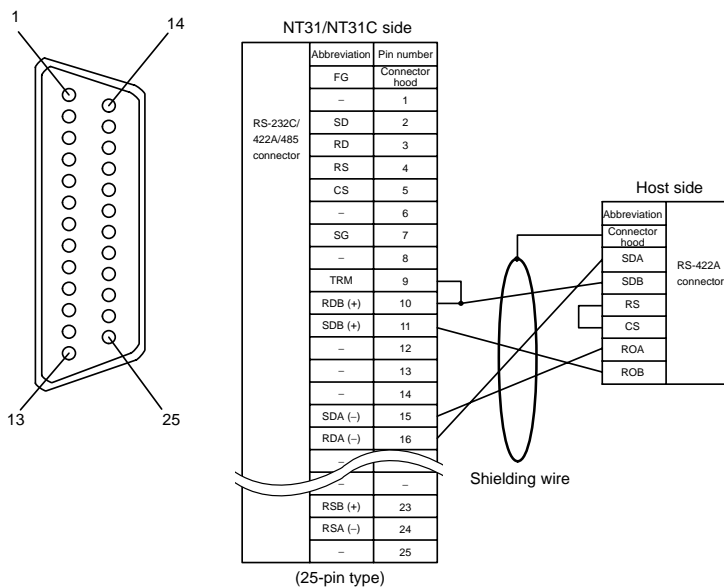

In order to avoid an FG ground loop, do not connect the functional ground of the NT31/NT31C to the shielding of the RS-422A cable.

5-2-3 Direct Connection between RS-485 Ports at Both Units

The connection method in which the RS-485 ports of an NT31/NT31C and a host are connected is described here.

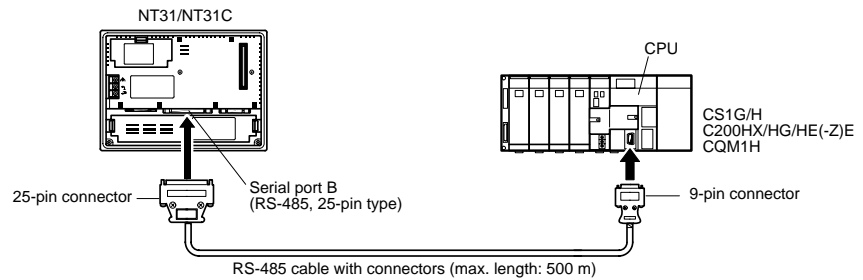

Reference: When RS-485 is used at the PT side, only the NT link (1:N) method (standard or high-speed) can be used.

Connecting an NT31/NT31C and Host

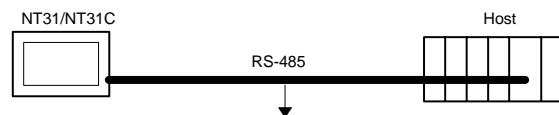

Wiring When Connecting a CS1-series CS1G/H Serial Communications Board and C Series C200HX/HG/HE(-Z)E Communications Board, or CQM1H Serial Communications Board

Applicable units:

- | | |
|-------------------|-------------------|
| CS1G-CPU42-E(V1) | CS1G-CPU43-E(V1) |
| CS1G-CPU44-E(V1) | CS1G-CPU45-E(V1) |
| CS1H-CPU63-E(V1) | CS1H-CPU64-E(V1) |
| CS1H-CPU65-E(V1) | CS1H-CPU66-E(V1) |
| CS1H-CPU67-E(V1) | |
| C200HE-CPU32-(Z)E | C200HE-CPU42-(Z)E |
| C200HG-CPU33-(Z)E | C200HG-CPU43-(Z)E |
| C200HG-CPU53-(Z)E | C200HG-CPU63-(Z)E |
| C200HX-CPU34-(Z)E | C200HX-CPU44-(Z)E |
| C200HX-CPU54-(Z)E | C200HX-CPU64-(Z)E |

C200HX-CPU65-ZE
CQM1H-CPU51

C200HX-CPU85-ZE
CQM1H-CPU61

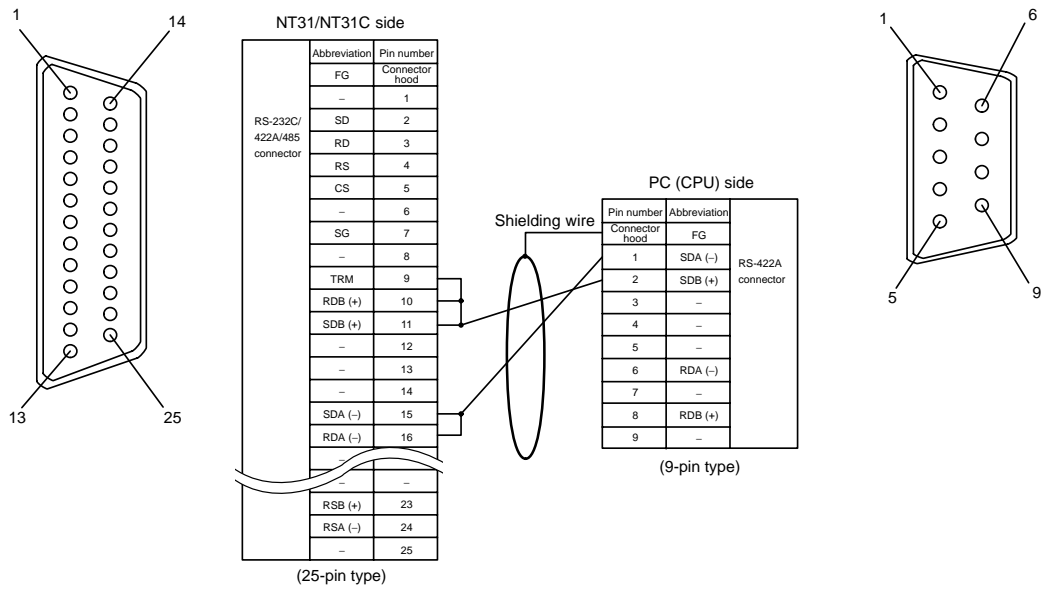

In order to avoid an FG ground loop, do not connect the functional ground of the NT31/NT31C to the shielding of the RS-422A cable.

5-2-4 1:N Connection among RS-422A Ports

The connection method in which the RS-422A ports of multiple NT31/NT31Cs and one host are connected in a 1:N connection is described here.

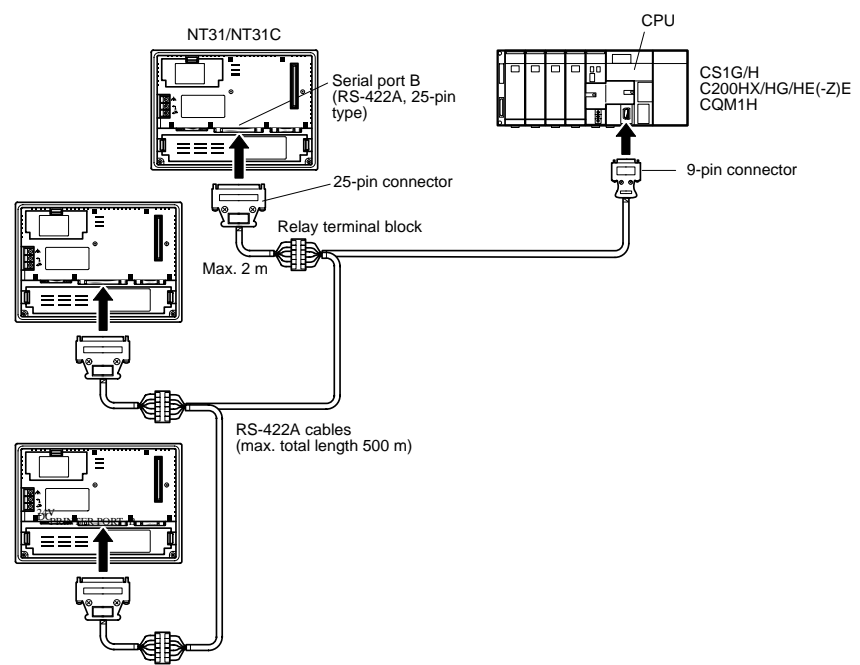

- Reference:**
- Communication using the RS-422A type **standard** NT link (1:N) method is possible only when a CS1W-SCB41 Serial Communications Board is installed in a CS1 series CS1G/H, a Communications Board is installed in a C200HX/HG/HE(-Z)E, or a CQM1H-SCB41 Serial Communications Board is installed in a CQM1H.
 - Communication using the RS-422A type **high-speed** NT link (1:N) method is possible only when a CS1W-SCB41 Serial Communications Board is installed in a CS1 series CS1G/H.

Connecting between NT31/NT31C Units

The relay terminal block is not included in this figure. Insert the relay terminal block so as to achieve the wiring configuration shown below.

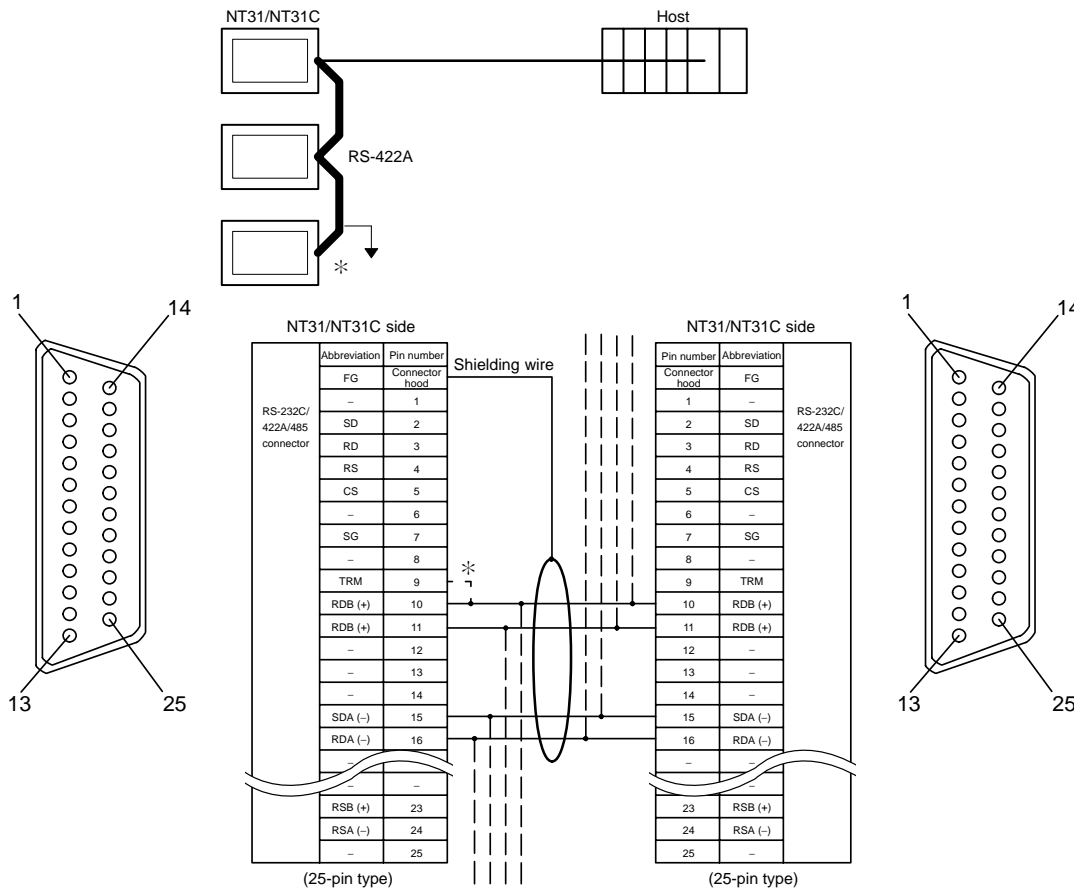

* Make the connection between pin numbers 9 and 10 at the NT31/NT31C at the end of the RS-422A cable (marked * in the figure above) only.

In order to avoid an FG ground loop, connect the functional ground of only one of the NT31/NT31C units to the shielding of the RS-422A cable.

Connecting an NT31/NT31C and a Host

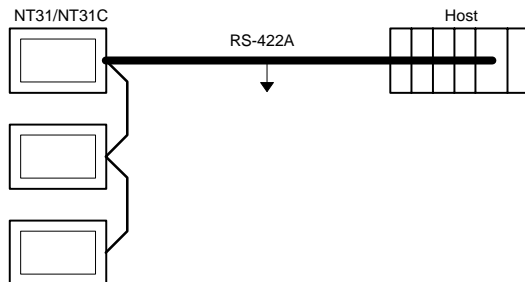

Wiring When Connecting a CS1-series CS1G/H Serial Communication Board, C Series C200HX/HG/HE(-Z)E Communication Board, or CQM1H Serial Communications Board

Applicable units:

- | | |
|-------------------|-------------------|
| CS1G-CPU42-E(V1) | CS1G-CPU43-E(V1) |
| CS1G-CPU44-E(V1) | CS1G-CPU45-E(V1) |
| CS1H-CPU63-E(V1) | CS1H-CPU64-E(V1) |
| CS1H-CPU65-E(V1) | CS1H-CPU66-E(V1) |
| CS1H-CPU67-E(V1) | |
| C200HE-CPU32-(Z)E | C200HE-CPU42-(Z)E |
| C200HG-CPU33-(Z)E | C200HG-CPU43-(Z)E |
| C200HG-CPU53-(Z)E | C200HG-CPU63-(Z)E |
| C200HX-CPU34-(Z)E | C200HX-CPU44-(Z)E |
| C200HX-CPU54-(Z)E | C200HX-CPU64-(Z)E |
| C200HX-CPU65-ZE | C200HX-CPU85-ZE |
| CQM1H-CPU51 | CQM1H-CPU61 |

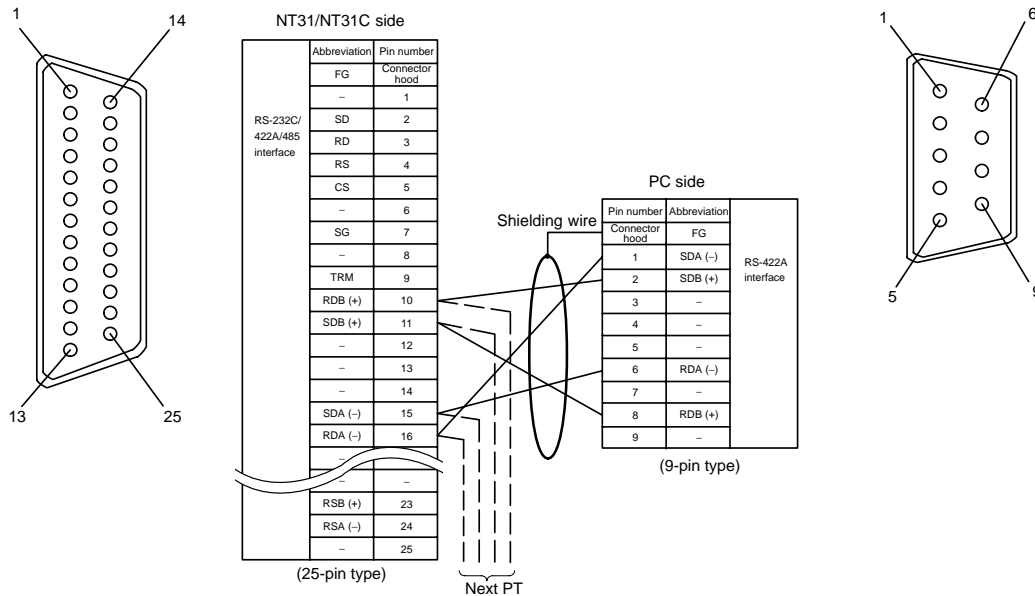

In order to avoid an FG ground loop, do not connect the functional ground of the NT31/NT31C to the shielding of the RS-422A cable.

5-2-5 1:N Connection among RS-485 Ports

The connection method in which the RS-485 ports of multiple NT31/NT31Cs and one host are connected in a 1:N connection is described here.

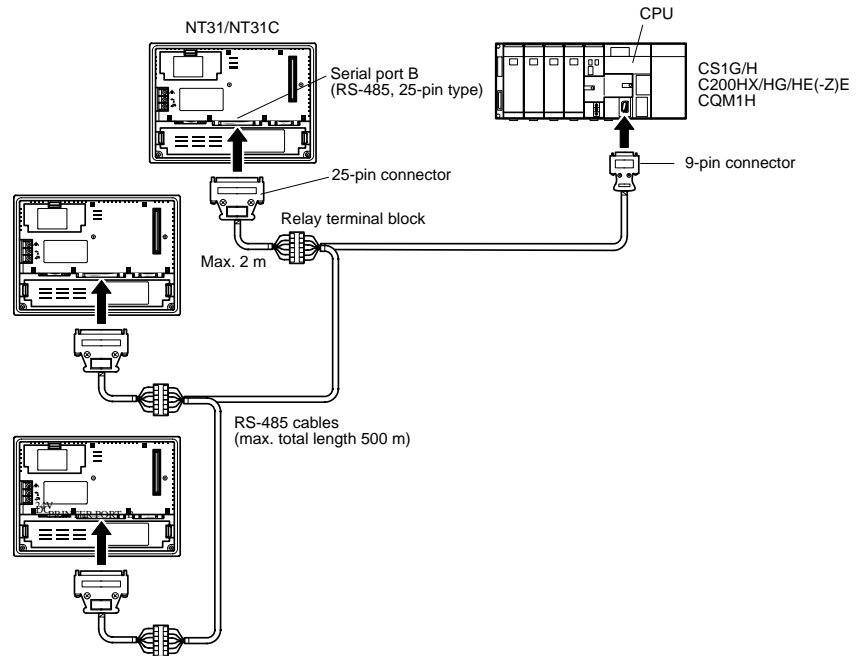

- Reference:**
- Communication using the RS-485 type **standard** NT link (1:N) method is possible only when a CS1W-SCB41 Serial Communications Board is installed in a CS1 series CS1G/H, a Communications Board is installed in a C200HX/HG/HE(-Z)E, or a CQM1H-SCB41 Serial Communications Board is installed in a CQM1H.
 - Communication using the RS-485 type **high-speed** NT link (1:N) method is possible only when a CS1W-SCB41 Serial Communications Board is installed in a CS1 series CS1G/H.

Connecting between NT31/NT31C Units

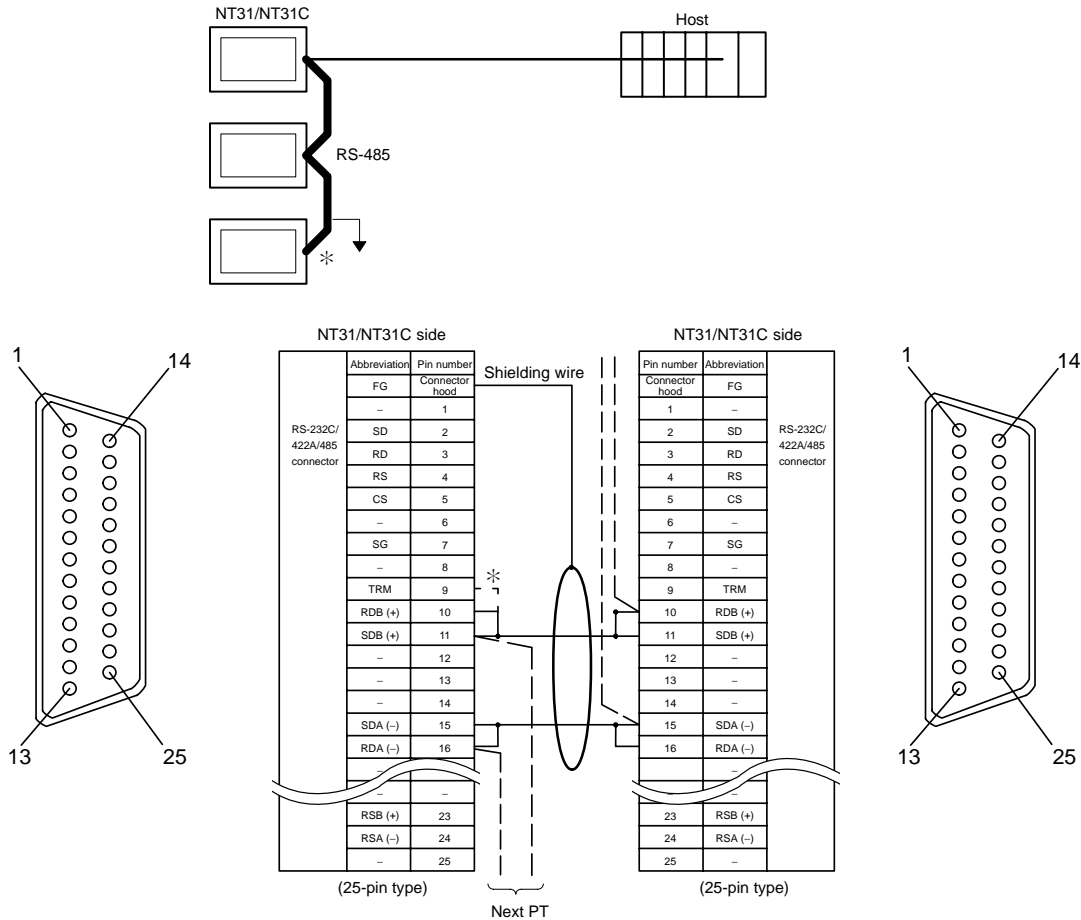

* Make the connection between pin numbers 9 and 10 at the NT31/NT31C at the end of the RS-485 cable (marked * in the figure above) only.

In order to avoid an FG ground loop, do not connect the functional ground of the NT31/NT31C to the shielding of the RS-422A cable.

The relay terminal block is not included in this figure. Insert the relay terminal block so as to achieve the wiring configuration shown below.

Connecting an NT31/NT31C and a Host

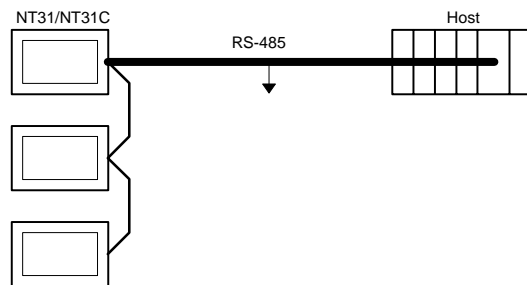

Wiring When Connecting a CS1-series CS1G/H Serial Communication Board, C Series C200HX/HG/HE(-Z)E Communication Board, or CQM1H Serial Communications Board

Applicable units:

- | | |
|------------------|------------------|
| CS1G-CPU42-E(V1) | CS1G-CPU43-E(V1) |
| CS1G-CPU44-E(V1) | CS1G-CPU45-E(V1) |
| CS1H-CPU63-E(V1) | CS1H-CPU64-E(V1) |
| CS1H-CPU65-E(V1) | CS1H-CPU66-E(V1) |

- | | |
|-------------------|-------------------|
| CS1H-CPU67-E(V1) | C200HE-CPU42-(Z)E |
| C200HE-CPU32-(Z)E | C200HG-CPU43-(Z)E |
| C200HG-CPU33-(Z)E | C200HG-CPU63-(Z)E |
| C200HG-CPU53-(Z)E | C200HX-CPU44-(Z)E |
| C200HX-CPU34-(Z)E | C200HX-CPU64-(Z)E |
| C200HX-CPU54-(Z)E | C200HX-CPU85-ZE |
| C200HX-CPU65-ZE | CQM1H-CPU61 |
| CQM1H-CPU51 | |

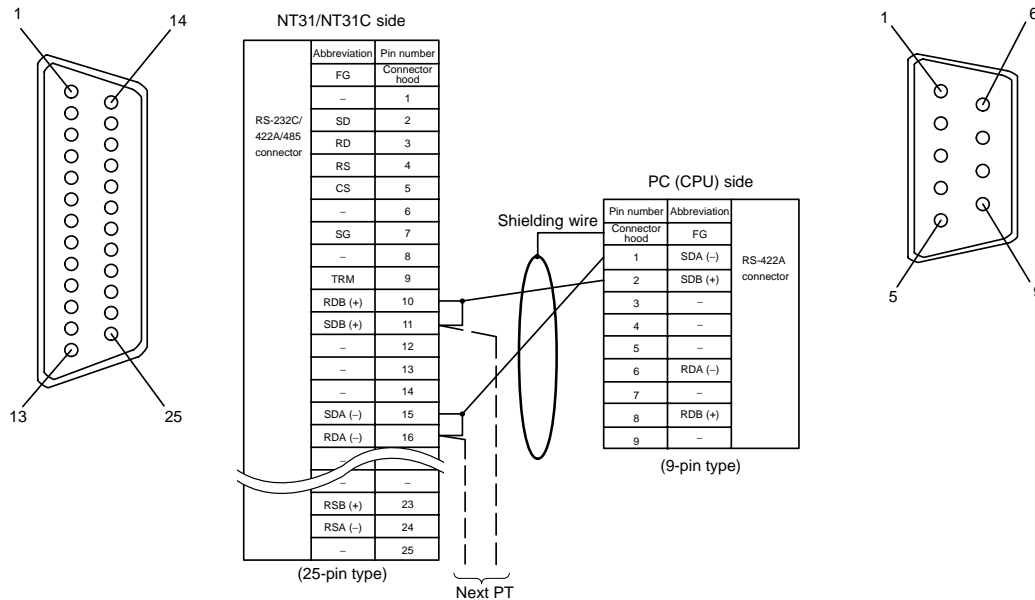

In order to avoid an FG ground loop, do not connect the functional ground of the NT31/NT31C to the shielding of the RS-485A cable.

5-2-6 Recommended Connectors, Cables and Crimp Terminals

Connectors and Cables Recommended for RS-422A/485

When making an RS-422A/485 connecting cable, as far as possible use the recommended parts indicated in the table below. When using the memory link method, however, use a connector that matches with the RS-422A port at the CPU (CP) side. Some units come supplied with one connector and connector hood.

Check the required parts and prepare them in advance.

Name	Model	Maker	Remarks
Connector	XM2A-2501	25-pin type Made by OMRON	Delivered with the following units: C500-LK203
	DB-25P F-N	25-pin type Made by JAE	Delivered with the following units: 3G2A6-LK201-EV1 3G2A5-LK201-EV1
Connector hood	XM2S-2511	25-pin type Made by OMRON	Delivered with the following units: C500-LK203
	DB-C2-J9	25-pin type Made by JAE	Delivered with the following units: 3G2A6-LK201-EV1 3G2A5-LK201-EV1

Name	Model	Maker	Remarks
Cable	TKVVBS4P-03	Tachii Electric Wire Co., Ltd.	
Crimp terminals	1.25-N3A (fork type)	Japan Solderless Terminal MFG	Recommended cable size: AWG22 to 18 (0.3 to 0.75 mm ²)
	Y1.25-3.5L (fork type)	Molex Inc.	

The terminal screws of the RS-422A adaptor (CPM1-CIF11) are M3 specification. When wiring, use crimp terminals for M3 use. Tighten terminal screws with a tightening torque of 0.5 N·m.

Use the same specification of the terminal screws which is used in the relay terminal block.

Note Always use crimp terminals for wiring.

Examples of applicable terminals

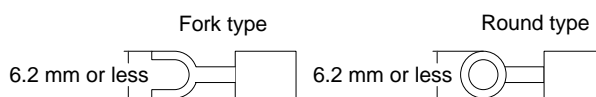

5-2-7 Setting the Terminal Resistance for RS-422A/485 Communications

The serial port B connector of the NT31/NT31C has a terminal resistance setting terminal (TRM).

In RS-422A/485 communications, a terminal resistor must be set at the device at the end of the communication cable, but not at any other device.

The NT31/NT31C has a built-in terminal resistor, and whether or not the terminal resistance is applied is set by the wiring at the terminal resistance setting terminals (pins No. 9 and 10 of serial port B). The terminal resistance is 120 Ω. When carrying out RS-422A/485 communications using serial port B, short between terminals No. 9 and 10 at the NT31/NT31C at the end of the RS-422A/485 cable. Leave terminals No. 9 and 10 open at NT31/NT31C units other than the one at the end of the cable.

When not using RS-422A/485 communications, the terminal resistance setting is ineffective.

In order to set the terminal resistance, wiring work is required at the cable's connector: carry out the wiring correctly by referring to APPENDIX E Making the Cable, page 267.

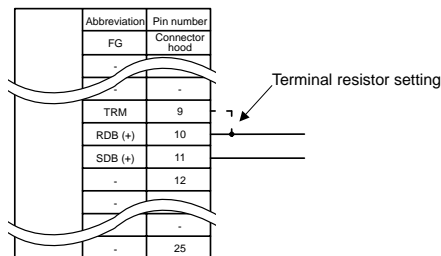

Pin Nos. 9 and 10	Function
Shorted	Terminal resistance is applied. Short only at the NT31/NT31C connected to the end of an RS-422A/485 cable.
Open	Terminal resistance is not applied. Leave the terminals open when connecting an NT31/NT31C anywhere other than at the end of the RS-422A/485 cable.

Note Before connecting or disconnecting cables between devices, make sure that the power supply to all of the connected devices (NT31/NT31C, PC, etc.) is OFF.

Reference: • The internal circuit of the NT31/NT31C is shown below.

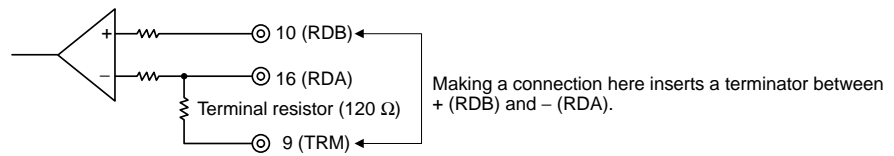

- For details on setting the terminal resistance of the host unit, refer to setting methods for each type of the communication.

SECTION 6

System Menu Operation

This section describes the operation of the System Menu, focusing on the procedure to start the PT. Functions that are convenient when using the PT and those that are useful for system maintenance are also explained here.

6-1	System Menu Operation Flow	133
6-2	Starting the NT31/NT31C	134
6-2-1	Operation at Startup	134
6-3	Operation Modes and the System Menu	135
6-3-1	Relationships among Modes	135
6-3-2	Menu Tree	137
6-3-3	Operations with the System Menu	138
6-4	Memory Initialization	140
6-4-1	Clearing Screen Data	140
6-4-2	Initializing Display History Record Data	142
6-4-3	Initializing Alarm History Record Data	144
6-4-4	Initializing the Recipe Tables	145
6-4-5	Initializing the Memory Tables	147
6-4-6	Initializing the Memory Switches	149
6-5	Operations in the System Installer Mode	150
6-5-1	Setting the Display Language in the System Installer Mode	151
6-5-2	Clearing/Installing the System Program	151
6-5-3	Changing the System Settings	153
6-5-4	Clearing Screen Data	154
6-6	Transmitting the Screen Data	155
6-7	Setting Conditions for Communications with Host by Using Memory Switches	157
6-7-1	About Communication Conditions	157
6-7-2	Setting the Host Link Method	160
6-7-3	Setting the NT Link (1:1) Method	162
6-7-4	Setting the NT Link (1:N) Method (Standard/High-speed)	163
6-7-5	Setting the Memory Link Method	165
6-7-6	Setting the Communication Type for Serial Port B	167
6-8	Starting Operation	168
6-9	System Settings	168
6-9-1	Memory Switch Setting Screens	168
6-9-2	Setting the Start-up Wait Time	169
6-9-3	Setting the Key Press Sound	170
6-9-4	Setting the Buzzer Sound	171
6-9-5	Setting the Printer Controller	172
6-9-6	Setting the Print Method (NT31C Only)	174
6-9-7	Setting Screen Saver Movement	175
6-9-8	Setting the Screen Saver Start-up Time	177
6-9-9	Setting the History Display Method	179
6-9-10	Setting the Resume Function	181
6-9-11	Setting the Automatic Reset Function	183
6-9-12	Setting the Time-out Interval	185
6-9-13	Setting the Retry Count	186
6-10	Setting the Bar Code Reader Input Function	188

6-11	System Maintenance	191
6-11-1	I/O Settings	191
6-11-2	Displaying/Setting the Calendar and Clock	195
6-11-3	Checking the PT Setting Status	197
6-11-4	Displaying and Printing the Display History Record	198
6-11-5	Displaying and Printing the Alarm History Record	200
6-11-6	Checking Screen Data	202
6-11-7	Device Check	205
6-11-8	Checking Interfaces	215
6-12	Programming Console Function	221
6-12-1	Usable Systems	221
6-12-2	Connection Method	223
6-12-3	Method of Use	224
6-13	Device Monitor Function	227
6-13-1	Compatible Systems	228
6-13-2	Connection Method	228
6-13-3	Method of Use	229
6-14	Version Display	230
6-14-1	Method of Use	230

6-1 System Menu Operation Flow

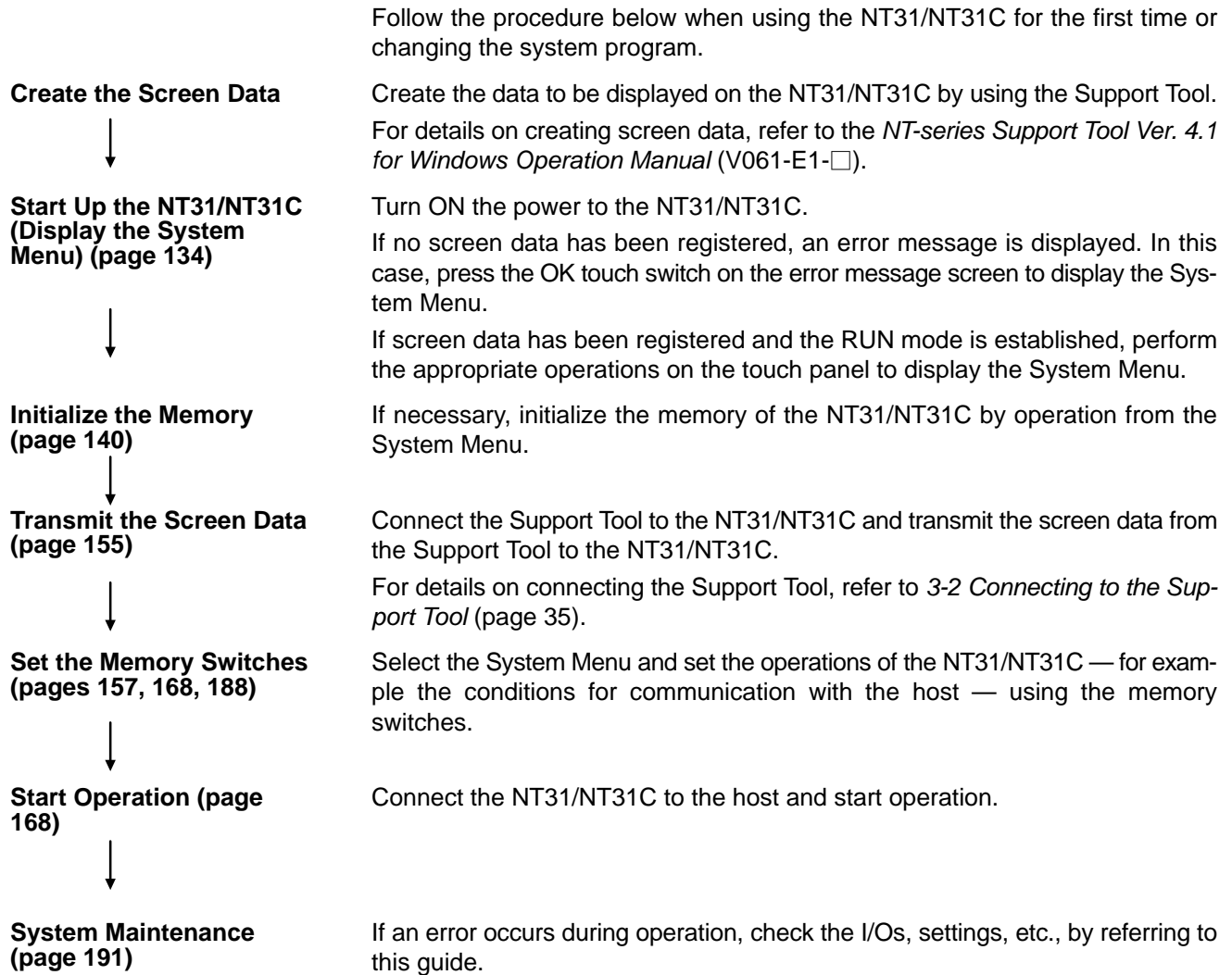

6-2 Starting the NT31/NT31C

After checking that the hardware has been connected correctly, switch on the power to the NT31/NT31C to start it up.

This section describes the operation of the NT31/NT31C when it is started up.

6-2-1 Operation at Startup

The NT31/NT31C operates as follows when the power is switched ON, or when it is reset.

Initial Processing



Self diagnosis — including a check on the internal memory of the NT31/NT31C and a system program check — and the internal processing required for startup, are performed.

If an error occurs during initial processing, an error screen is displayed.

If there is an error in the system program, the system program must be re-installed. For details on the installation procedure, refer to *6-5 Operations in the System Installer Mode* (page 150).

Memory Unit Check and Processing



Check if a memory unit is installed. If a memory unit is installed, processing (screen data and system program reading/writing) is executed in accordance with its DIP switch settings (pages 39 and 47).

If there is an error in the screen data, an error screen is displayed. Pressing the OK touch switch on the error screen will return the display to that immediately before the error occurred. It is also possible to display the System Menu from the error screen by pressing two of the four corners of the touch panel simultaneously. If there is an error in the system program, the main menu of the system installer mode is displayed. If this is the case, reinstall the proper system program.

Initialize the memory or change the settings as required.

Start of Communication with the Host



Communication with the host starts in accordance with the communication method set in the system memory of the NT31/NT31C. During the interval until communication is established, the system initialization screen (screen No. 9000) is displayed.

For details, refer to *6-8 Starting Operation* (page 168).

If the system initialization screen remains on, display the System Menu by pressing two of the four corners of the touch panel simultaneously, and check the settings for the communication conditions for communication with the host.

Operation Start

The RUN mode is established, and operation starts in accordance with the screen data in the NT31/NT31C.

When changing the settings or checking the statuses, perform the appropriate operation by displaying the System Menu. For details on displaying the System Menu, refer to *6-3-3 Operations with the System Menu* (page 138).

6-3 Operation Modes and the System Menu

The NT31/NT31C operates in four modes: the RUN, Transmit, Maintenance, and Expansion modes. These modes are selected from the System Menu.

In addition, the NT31/NT31C also features the System Installer mode which is used specifically for installing the system program.

The System Installer mode is selected by operation at the panel when the NT31/NT31C power is switched ON.

6-3-1 Relationships among Modes

The relationships among the System Menu, each of the operation modes, and the System Installer mode, are indicated in the figure below.

For details on system menu operation, refer to 6-3-3 *Operations with the System Menu* (page 138).

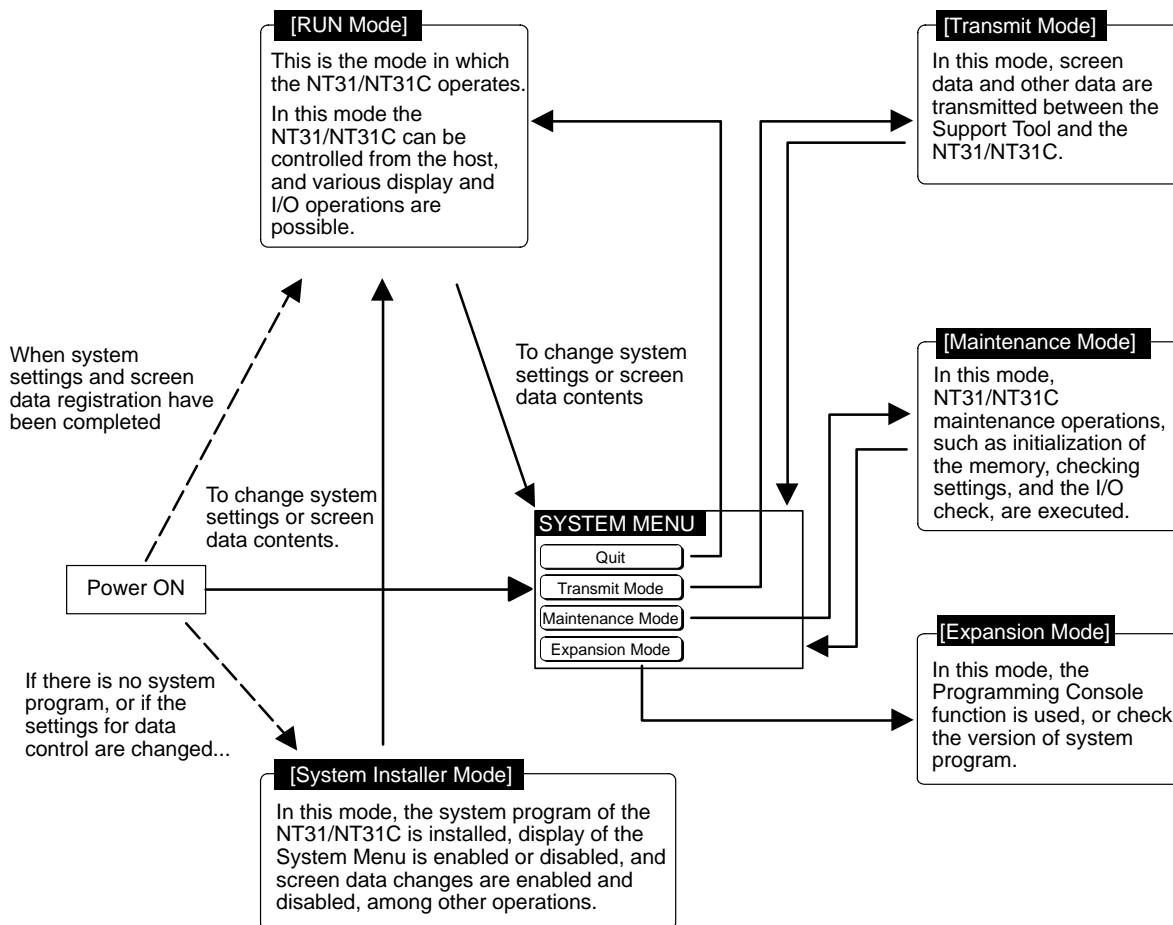

Items in the System Menu

The items displayed in the system menu and their functions are as follows.

Menu Item	Function
Quit	Clear the System Menu screen and return to the RUN mode screen.
Transmit Mode	Display the Transmit Mode screen to allow transmission for screen data between the Support Tool and the NT31/NT31C. For details on transmission of screen data, refer to 6-6 <i>Transmitting the Screen Data</i> (page 155).
Maintenance Mode	Display the Maintenance Mode menu to allow system maintenance of the NT31/NT31C, and various NT31/NT31C settings.
Expansion Mode	Display the Expansion Mode menu to allow selection of the expansion functions supported by the NT31/NT31C. The following expansion functions are supported: <ul style="list-style-type: none"> • Version Display Displays the version of system program, the date it was created, and the PT model. For details, refer to 6-14 <i>Version Display</i>. • Programming Console Function Allows the NT31/NT31C to be used as a Programming Console for a CS1G/CS1H, CPM1, CPM2A, CPM2C, CQM1, CQM1H, C200HX/HG/HE(-Z), or SRM1. For details, refer to 6-12 <i>Programming Console Function</i>. • Device Monitor Function Allows the NT31/NT31C to change the PC's operating mode and display/change the contents of words in a CS1G/CS1H, CPM1, CPM2A, CPM2C, CQM1, CQM1H, C200HX/HG/HE(-Z), or SRM1. For details, refer to 6-13 <i>Device Monitor Function</i> in this manual or 2-16 <i>Device Monitor Function</i> in the <i>Reference Manual</i>.

Functions of the System Installer Mode

The following functions can be executed in the System Installer mode.

- Setting the display language
- Clearing and installing system programs
- Disabling/enabling display of the System Menu.
- Disabling/enabling writing to the screen data memory
- Clearing screen data

For details on these functions, refer to 6-5 *Operations in the System Installer Mode* (page 150).

6-3-2 Menu Tree

The System Menu allows the various functions of the NT31/NT31C to be executed by using touch switches displayed on the touch panel. The menu tree, starting from the System Menu, is shown below.

For details on System Menu operations, refer to 6-3-3 *Operations with the System Menu* (page 138).

The menu tree may differ according to the system program installed in the NT31/NT31C. The menu tree for the system program that is installed in the NT31/NT31C on shipment is shown below.

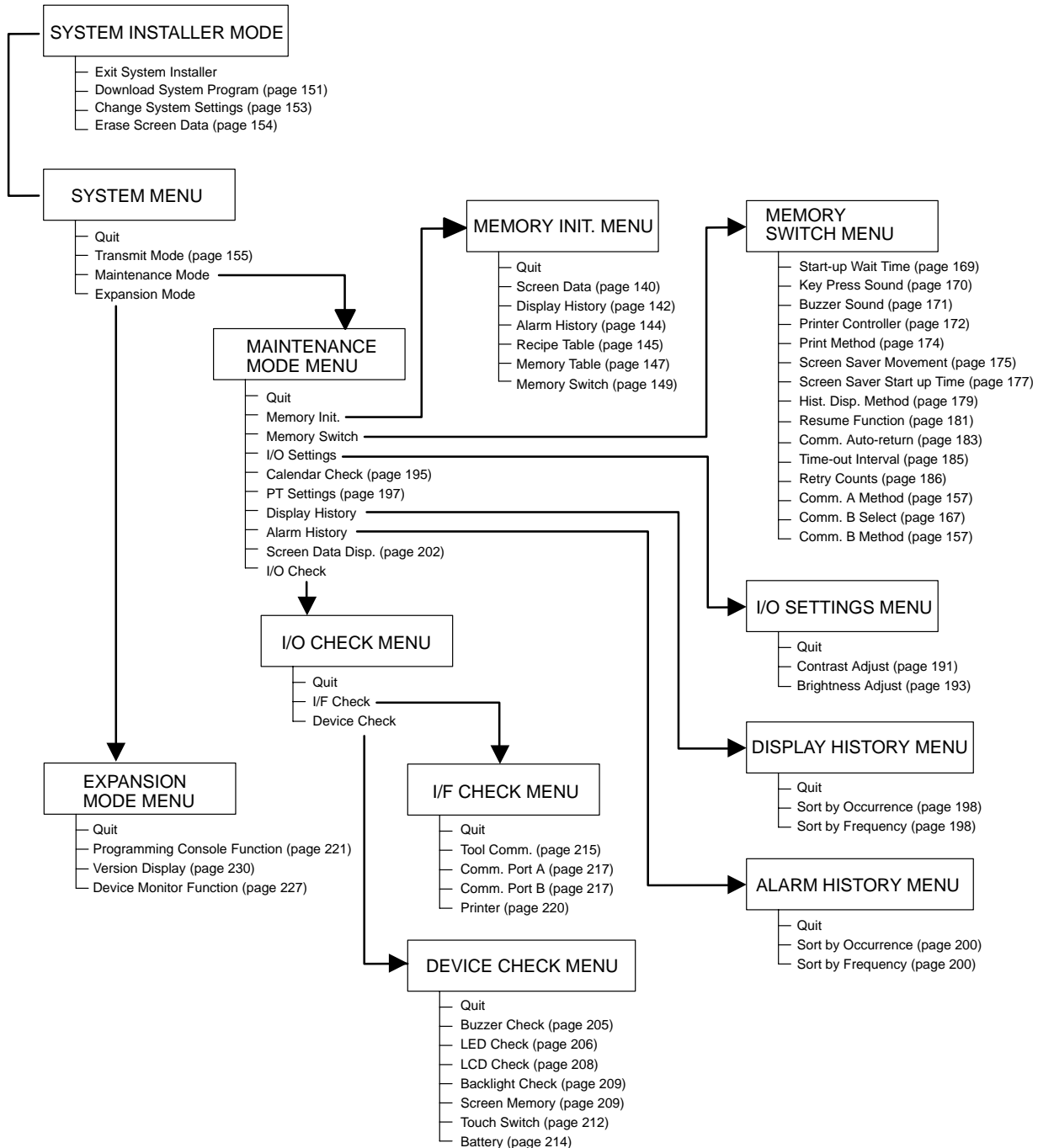

6-3-3 Operations with the System Menu

This section describes how to use the menus, including how to call the System Menu, how to call the System Installer mode, and how to select menu items.

Calling the System Menu

The System Menu can be displayed by either of the following two methods.

- Touching the corners of the touch panel
- Pressing a touch switch that displays the System Menu

- Reference:**
- If display of the System Menu is disabled by the setting made in the System Installer mode, the System Menu cannot be displayed (this does not apply if an error has occurred).
 - At the same as the System Menu is displayed, the operation of the NT31/NT31C stops and the RUN LED goes OFF.

Touching The Corners of The Touch Panel

When two of the four corners of the touch panel (see the figure below) are touched simultaneously, the System Menu is displayed.

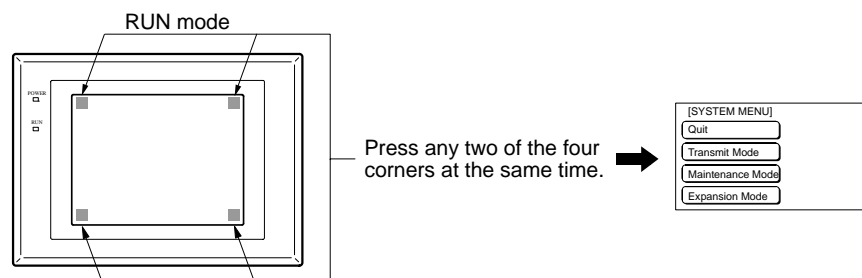

Note that the touch switches used to call the System Menu are not displayed at corners on the screen. If a touch switch displayed in a corner is pressed first, the touch switch will function and the System Menu will not be displayed. In particular, when the touch switch has switch screen function, as a result of screen switch over, it means the corner is not pressed even if it is kept pressing. To successfully call the System Menu, first press a corner where no touch switch is displayed, and then press any other corner regardless of the presence of a touch switch.

- Reference:** With the NT31/NT31C, the System Menu can be displayed even if the screen has touch switches registered at all four corners.

Pressing a Touch Switch That Displays The System Menu

There is a control key that has the function of displaying the System Menu.

By registering the touch switch for System Menu display ([MENU]) on a screen when creating it, the System Menu can be displayed just by pressing this switch.

Calling the System Installer Mode

If the NT31/NT31C has no system program installed, or if the system program is destroyed, the System Installer mode is automatically established when the power is switched ON.

To establish the System Installer mode in order to install a system program or make settings for data management, either turn the power ON, or reset the

NT31/NT31C, while pressing the touch switch at the top left corner of the touch panel (size: 7.2 mm × 7.2 mm).

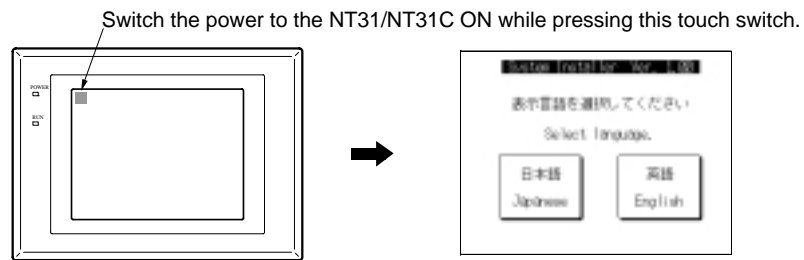

Selecting Menu Items

The menu items in the System Menu are displayed on the NT31/NT31C screen as touch switches. Menu items can be selected simply by pressing them.

Example: Displaying the MAINTENANCE MODE MENU screen by pressing Maintenance Mode in the System Menu.

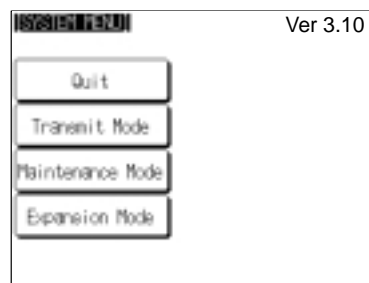

Press Maintenance Mode.

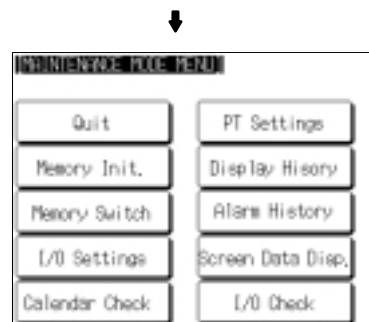

Switching from the System Menu to the RUN Mode

Return to the RUN mode by selecting Quit in the System Menu and other menus.

Reference: Unlike previous PT models, the NT31/NT31C does not return to the RUN mode automatically if no operations are performed.

6-4 Memory Initialization

The NT31/NT31C has the following initialization functions. Use them as necessary.

- Clearing screen data Page 140
- Initializing memory tables Page 147
- Initializing memory switches Page 149
- Initializing display history record data Page 142
- Initializing alarm history record data Page 144
- Initializing recipe tables Page 145

Reference: If writing to the screen data memory has been disabled by the System Setting setting in the System Installer mode, memory initialization is not possible.

6-4-1 Clearing Screen Data

Use this function if the screen data has been corrupted and the NT31/NT31C cannot be started up correctly.

This operation clears (initializes) only the screen data and contents of the mathematical tables. The memory switch settings and display history/alarm history record data are retained.

-
- Reference:**
- When this function is used, all of the screen data contents registered in the NT31/NT31C up to that point are cleared. Check that the created screens are backed up at the Support Tool before using it.
 - The screen data can be cleared in the System Installer mode too (page 151).
 - The following types of data can be initialized individually.
 - Contents of numeral/character string memory tables (page 144)
 - Memory switch settings (page 147)
 - Display history record data (page 142)
 - Alarm history record data (page 144)
-

Clear the screen data by following the menu operation from the System Menu shown below.

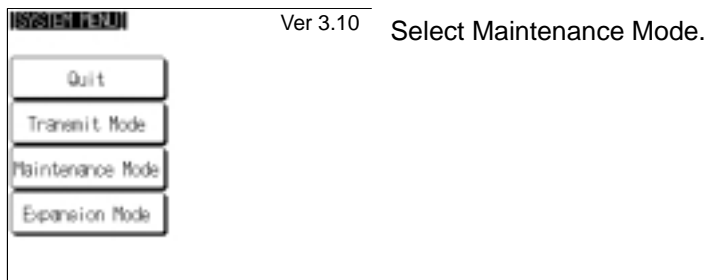

Select Maintenance Mode.



Select Memory Init..



Select Screen Data.



Select Yes.

The screen data is cleared. During clearance, the message Erasing Now... is displayed.

If No is selected, the NT31/NT31C returns to the MEMORY INIT. MENU screen without clearing the screen data.

On completion of screen data clearance, the NT31/NT31C returns to the MEMORY INIT. MENU screen.

After the screen data has been cleared, if an attempt is made to set the NT31/NT31C to the RUN mode before screen data has been transmitted from the Support Tool or memory unit, an error message will be displayed and the RUN mode will not be established.

6-4-2 Initializing Display History Record Data

The display history record function keeps a record of the order of display of the screens displayed during operation, and the number of times each screen is displayed. These records are kept only for screens for which the History attribute has been set.

The maximum number of records is 1024 for sort by occurrence (order of display occurrence) and 255 for sort by frequency (order of the number of times each screen has been displayed).

Use the display history record initialization function to clear the history record data to 0, for example when the screen data has been changed, etc. Also, if Alarm (Use Ring Buffer) under History Setting of System in PT Configuration (Tools) has not been checked, no more records will be stored after the maximum number of records has been kept, and therefore the records must be periodically initialized. If Alarm (Use Ring Buffer) is checked, when the maximum number of records is reached the oldest record is deleted and the newest data is recorded.

Reference: The NT31/NT31C also allows the display history record data to be initialized by controlling the PT status control area from the host. For details, refer to 2-2-1 *PT Status Control Area* in the *Reference Manual*.

Initialize the display history record data by following the menu operation from the System Menu shown below.

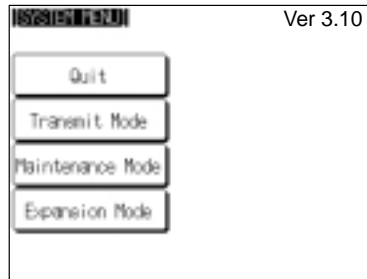

Select Maintenance Mode.



Select Memory Init..

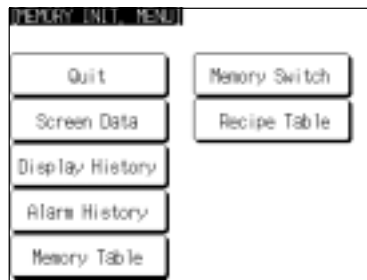

Select Display History.



Select Yes.

The display history record data is initialized. During initialization, the message Initializing is displayed.

If No is selected, the NT31/NT31C returns to the MEMORY INIT. MENU screen without initializing the display history record data.

On completion of display history record data initialization, the message Finished is displayed and the NT31/NT31C returns to the MEMORY INIT. MENU screen.

6-4-3 Initializing Alarm History Record Data

The alarm history record function continually checks the status of host bits that have been designated in advance with a bit memory table, and records the time when any of the bits is set to 1 (comes ON), and the number of times that each bit comes ON.

The maximum number of records is 256 for sort by occurrence (order of error occurrence) and 255 for sort by frequency (order of the number of times each error has occurred).

Use the alarm history record initialization function to reset the alarm history record data to 0, for example when the screen data has been changed, etc. Also, if Screen (Use Ring Buffer) under History Setting in the PT Environment Settings – System Settings has not been checked, no more records will be stored after the maximum number of records has been kept, and therefore the records must be periodically initialized. If Screen (Use Ring Buffer) is checked, when the maximum number of records is reached the oldest record is deleted and the newest data is recorded.

Reference: The NT31/NT31C also allows the alarm history record data to be initialized by controlling the PT status control area from the host. For details, refer to 2-2-1 *PT Status Control Area* in the *Reference Manual*.

Initialize the alarm history record data by following the menu operation from the System Menu shown below.

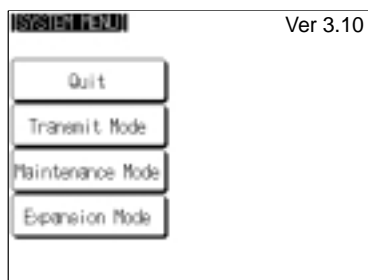

Select Maintenance Mode.



Select Memory Init..



Select Alarm History.



Select Yes.

The alarm history record data is initialized. During initialization, the message Initializing is displayed.

If No is selected, the NT31/NT31C returns to the MEMORY INIT. MENU screen without initializing the alarm history record data.

On completion of alarm history record data initialization, the message Finished is displayed and the NT31/NT31C returns to the MEMORY INIT. MENU screen.

6-4-4 Initializing the Recipe Tables

You can initialize the recipe tables (i.e., all the recipe data) edited in the NT31/NT31C. Here, “initializing” the recipe tables means to restore the battery backup memory (“recipe data memory”) to the values in flash memory at that time. If, after downloading from the Support Tool, you do not upload the data even once, initialization will restore the initial values set using the Support Tool. The values will not be cleared.

Initialize the recipe tables by following the menu operation from the System Menu shown below.

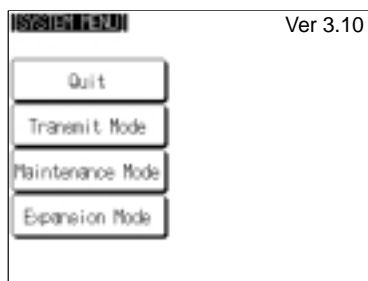

Select Maintenance Mode.



Select Memory Init..



Select Recipe Table.



Select Yes.
The recipe tables are initialized. During initialization, the message Initializing is displayed.

If No is selected, the NT31/NT31C returns to the MEMORY INIT. MENU screen without initializing the recipe tables.

On completion of memory table initialization, the message Finished is displayed and the NT31/NT31C returns to the MEMORY INIT. MENU screen.

6-4-5 Initializing the Memory Tables

It is possible to initialize the numeral memory tables and character string memory tables in the NT31/NT31C.

When these tables are initialized, the values are returned to those set by the Support Tool (they are not cleared).

When the memory tables are initialized, they are returned to their initial values regardless of the setting made for the resume function (page 181).

If ON is set for the Resume Function memory switch, the initial values set with the Support Tool will not be recorded in the memory tables unless they are initialized.

-
- Reference:**
- If OFF is set for the Resume Function memory switch, the memory tables can be initialized just by switching the NT31/NT31C power off and back on again, or by resetting the NT31/NT31C (page 181).
 - The bit memory table merely reflects the statuses of bits at the host and therefore cannot be initialized.
-

Initialize the memory tables by following the menu operation from the System Menu shown below.

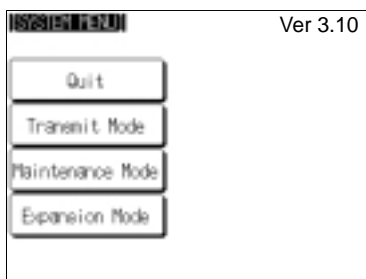

Select Maintenance Mode.



Select Memory Init..

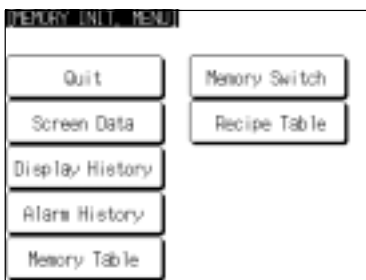

Select Memory Table.



Select Yes.

The memory tables are initialized. During initialization, the message Initializing is displayed.

If No is selected, the NT31/NT31C returns to the MEMORY INIT. MENU screen without initializing the memory tables.

On completion of memory table initialization, the message Finished is displayed and the NT31/NT31C returns to the MEMORY INIT. MENU screen.

6-4-6 Initializing the Memory Switches

Initialization returns all the memory switches of the NT31/NT31C to their status on shipment.

Initialize the memory switches by following the menu operation from the System Menu shown below.

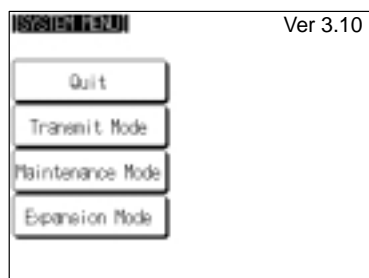

Select Maintenance Mode.



Select Memory Init..



Select Memory Switch.



Select Yes.

The memory tables are initialized. During initialization, the message Initializing is displayed.

If No is selected, the NT31/NT31C returns to the MEMORY INIT. MENU screen without initializing the memory switches.

On completion of memory switch initialization, the message Finished is displayed and the NT31/NT31C returns to the MEMORY INIT. MENU screen.

After initialization, the memory switch statuses are as follows.

Memory Switch	Status
Start-up Wait Time	00
Key Press Sound	ON
Buzzer Sound	OFF
Printer Controller	ESC/P
Print Method	Tone (NT31C only)
Screen Saver Movement	Display erased
Screen Saver Start up Time	010
Hist. Disp. Method	From New Data
Resume Function	OFF
Comm. Auto-return	OFF
Time-out Interval	01
Retry Counts	005
Comm. A Method	Host Link (communications speed = 9600 bps)*
Comm. B Select	RS-232C
Comm. B Method	None

* The communication conditions for a bar code reader are initialized as follows:
Data bits: 7 bits; stop bit: 1 bit; parity: none; flow control: RS/CS.

6-5 Operations in the System Installer Mode

The following functions can be executed in the System Installer mode:

- Setting the display language (see below)
- Clearing/installing the system program (page 151)
- Disabling/enabling display of the System Menu (changing the system settings) (page 153)
- Disabling/enabling writing to the screen data memory (changing the system settings) (page 153)
- Clearing screen data (page 154)

For details on calling the System Installer mode, refer to Calling the System Installer Mode (page 138).

6-5-1 Setting the Display Language in the System Installer Mode

The first setting made in the System Installer mode is to select whether the display language is to be English or Japanese.



Select English or Japanese.

From here on, this manual assumes that English has been selected here.

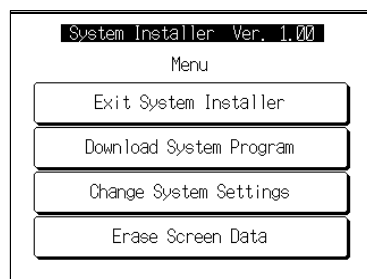

The System Installer mode menu is displayed.

If there is no system program or the system program has been corrupted, the message System Program not exist or incorrect. is displayed at the bottom of the screen.

6-5-2 Clearing/Installing the System Program

Use this function when the system program of the NT31/NT31C has been corrupted, or when installing a new system program.

- Reference:**
- In order to install a system program, the system installer must also be installed at the Support Tool. The system installer is an accessory with the Support Tool (NT-ZJCAT1-EV4). When installing the Support Tool in a personal computer, install the system installer also. For details on the method for installing the system installer at the Support Tool side, and the operating procedure, refer to the *NT-series Support Tool Ver. 4.1 for Windows Operation Manual (V061-E1-□)*.
 - When the system program is cleared by mistake, it becomes impossible to use the NT31/NT31C at all. Check that the system installer is installed at the Support Tool side before deleting the program. However, note that the registered screen data and memory switch settings are retained.
 - It becomes possible to install the system program inside the memory unit automatically by installing the memory unit at startup. (Refer to *3-5 Using a Memory Unit (-V□ Versions)*.)

Clear/install the system program by following the menu operation from the System Installer mode menu shown below.

Clearing the System Program

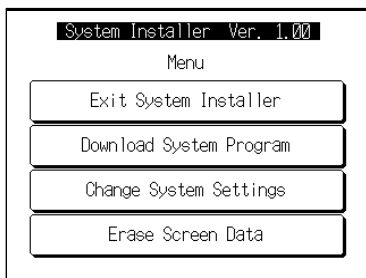

Select Download System Program.



Select Yes.
The system program is cleared. During clearance, the message Erasing ... is displayed.

- If Return to Menu is selected, the NT31/NT31C returns to the System Installer mode menu without clearing the system program.
 - If clearance fails, a screen asking whether you wish to try again is displayed.
- On completion of system program clearance, the NT31/NT31C enters the standby status for downloading of the system program.

Downloading the System Program

On normal completion of system program clearance, the standby status for system program downloading is automatically established.



When the NT31/NT31C enters this status, transmit the system program from the system installer at the personal computer. During downloading, the progress of transmission is indicated on the screen.



Select Run System.

If Abort is selected during standby for downloading or during downloading, a screen asking whether you wish to download again is displayed. When the system program is started, the NT31/NT31C starts up normally. If no screen data has been registered, an error message will be displayed indicating that screen data hasn't been registered. Transfer the screen data and proceed.

Reference: If the new system program is not downloaded successfully after deleting a system program, it is not possible to use the NT31/NT31C at all. After deleting the system program, be sure to download a new one.

6-5-3 Changing the System Settings

The NT31/NT31C allows the following settings to be made to prevent the screen data and memory switch settings from being changed or deleted by operating errors.

Disabling/enabling System Menu Display

When System Menu display is disabled by this setting, the System Menu cannot be displayed by touch panel operations or by using the touch switches. However, if an error occurs, the System Menu can be displayed from the error message screen.

Disabling/enabling Writing to The Screen Data Memory

When writing to the screen data memory is disabled by this setting, it is impossible to use the following System Menu functions.

- Switching to the Transmit mode
- Displaying the memory switch setting screens
- Checking the screen data memory
- Displaying the initialization menu
- Displaying the calendar/time setting screen (the calendar/time display screen can be displayed)

Change the system settings by following the menu operation from the System Installer mode menu shown below.

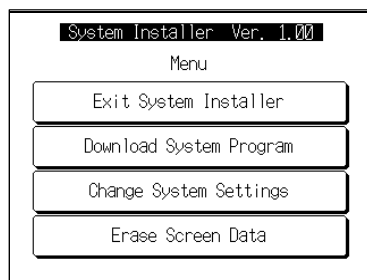

Select Change System Settings.

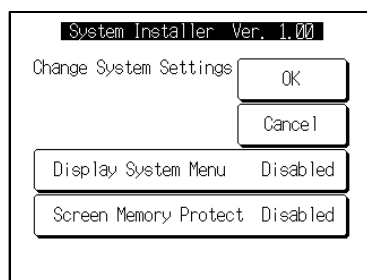

Select Display System Menu or Screen Memory Protect .

Each time either of these items is selected, the setting switches from Disabled to Enabled or vice versa.

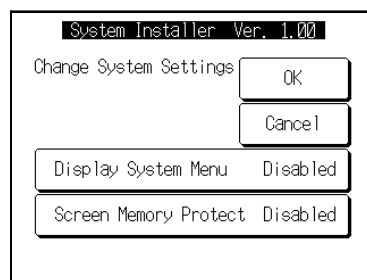

Select OK.

The settings are written to the NT31/NT31C while the screen is displayed.

- If Cancel is selected, the NT31/NT31C returns to the System Installer mode menu without changing the settings. The settings remain as they were before the operation was started.

- If writing of the settings fails, a screen asking whether you wish to try again is displayed.

After the settings have been written, the System Installer mode menu screen is redisplayed.

6-5-4 Clearing Screen Data

If the screen data has been corrupted and the NT31/NT31C cannot be started normally, use this function to clear the screen data.

Note that only the screen data is cleared (initialized), and the memory switch settings and the display history/alarm history record data are retained.

- Reference:**
- When this function is used, all of the screen data contents registered in the NT31/NT31C up to that point are cleared. Check that the created screens are backed up at the Support Tool before using it.
 - The screen data can also be cleared from the System Menu (page 140).
 - If the screen data is cleared in the System Installer mode, the message Screen Data Corrupted may be displayed on switching to the RUN mode. If this happens, initialize the screen data again from the MEMORY INIT. MENU screen.

Clear the screen data by following the menu operation from the System Installer mode menu shown below.

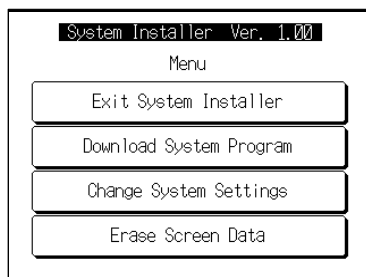

Select Erase Screen Data.



Select Yes.

The screen data is cleared. During clearance, the message Erasing ... is displayed.

- If Return to Menu is selected, the NT31/NT31C returns to the MEMORY INIT. MENU screen without clearing the screen data.
- If screen data clearance fails, a screen asking if you wish to try again is displayed.

On completion of screen data clearance, the NT31/NT31C returns to the System Installer mode menu screen.

After the screen data has been cleared, if an attempt is made to set the NT31/NT31C to the RUN mode before screen data has been transmitted from the Support Tool or memory unit, an error message will be displayed and the RUN mode will not be established.

6-6 Transmitting the Screen Data

The screen data is created with the Support Tool and then transmitted to the NT31/NT31C. This section explains how to transmit the screen data.

For details on how to create the screen data and the operation of the Support Tool, refer to the *Reference Manual* and the *NT-series Support Tool Ver. 4.1 for Windows Operation Manual* (V061-E1-□).

- Reference:**
- The screen data can be transmitted also from the memory unit installed in the NT31/NT31C. For details on this method, refer to *3-5 Using a Memory Unit (-V□ Versions)* or *3-6 Using a Memory Unit (Versions without the V□ Suffix)*.
 - The screen data can be transmitted at a faster rate by setting High for Baud Rate on the Comms. Setting... window of the Support Tool.
 - If writing to the screen data memory is disabled by the setting made for System Setting in the System Installer mode, screen data transmission is not possible.

Screen Data Composition and Transmission Units

The screen data comprises the following types of data.

- User screen data (screen units)
- System memory (memory switch) settings
- Direct connection information
- Numeral memory table data
- Character string memory table data
- Bit memory table data
- Mathematical table data
- Mark information
- Image/library data
- Recipe table data

It is possible to transmit the screen data (data for all the screens) in file units, or to transmit individual data or the data of individual screens in data units. (It is not possible to transmit mathematical table data in data units.)

When data is transmitted in file units, all of the screen data in the NT31/NT31C is cleared and then the new data is transmitted.

When data is transmitted in data units, first the previous data is invalidated, then the new data is registered as valid data. Since the previous data is not cleared, free memory area in the NT31/NT31C will be insufficient when transmissions in data units are repeated. If this happens, write the screen data again by data transmission in file units.

Transmitting Screen Data from the Support Tool

To transmit screen data from the Support Tool to the NT31/NT31C, follow the procedure below.

Operation

- 1, 2, 3...**
1. Connect the NT31/NT31C to a personal computer in which the Support Tool has been installed and turn the power to the NT31/NT31C ON.
 2. Turn ON the power to the personal computer and start up the Support Tool.

- Establish the Transmit mode by following the menu operation from the System Menu shown below at the NT31/NT31C.

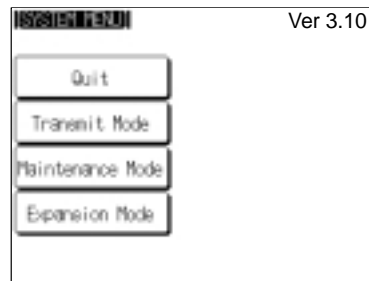

Select Transmit Mode.



Select Tool Transmit.



- Open the screen data to be transmitted at the Support Tool, then select Download (NTST PT) in the Support Tool's Connect menu and specify the data to be transmitted.
- During screen data transmission, the transmission status is displayed.
- On completion of screen data transmission, press the Quit touch switch. The NT31/NT31C returns to the Transmit mode.

If the screen data cannot be successfully transmitted from the Support Tool, use the communication check functions of the NT31/NT31C to check if communication between the NT31/NT31C is normal or not (page 215).

Precautions to Be Observed When Transmitting Screen Data

If any of the following, or a system error, occurs during transmission of screen data, the transmitted screen data will not be registered correctly in the NT31/NT31C. If this happens, the NT31/NT31C may not enter the RUN mode when started up, or there may be unpredictable malfunctions such as failure to display screens during operation. In this case, the screen data must be retransmitted in file units to register it correctly.

- The power to the NT31/NT31C is interrupted or the NT31/NT31C is reset.
- The power to the personal computer on which the Support Tool is running is interrupted or the computer is reset.
- The cable connecting the NT31/NT31C to the personal computer on which the Support Tool is running is disconnected or has a broken wire.
- The Quit touch switch on the NT31/NT31C screen is pressed to end screen data transmission.

- Screen data transmission is stopped by operation at the Support Tool.

Note When transferring the data in units of screens, if there are changes in memory table and/or direct access, transfer such data along with the screen data.

6-7 Setting Conditions for Communications with Host by Using Memory Switches

The NT31/NT31C can be connected to the host by the following 7 types of communication methods can be used to communicate with a host.

- Host link
- NT Link (1:1)
- NT Link (1:N)
- High-speed NT Link (1:N)
- Memory link method
- Mitsubishi A-computer link method
- Mitsubishi FX method

The NT31/NT31C has the following two ports, either of which can be used for communications with the host, depending on the requirements.

- Serial port A (exclusively for RS-232C, 9-pin connector)
- Serial port B (RS-232C/RS-422A (selectable), 25-pin connector)

The method for setting the communication method for communications with the host is described here.

For details on setting the communication conditions for a bar code reader, refer to *6-10 Setting the Bar Code Reader Input Function* (page 188).

-
- Reference:**
- Apart from the host, it is also possible to connect the Support Tool or a bar code reader to serial port A. When a bar code reader is connected at serial port A, the host must be connected at serial port B. When serial port A is being used for communications with the host, the host must be disconnected so that the Support Tool can be connected.
 - There are four memory switch setting screens. The conditions for communications with the host are set on the fourth screen (the screen on which 4/4 is displayed). For details on setting memory switches other than those for setting the conditions for communications with the host, refer to *6-9 System Settings* (page 168).
 - When using the Mitsubishi A-computer link method and Mitsubishi FX method, a system program for multi-venders is required. Install the system program to the NT31/31C by the system installer (refer to page 151). For details, refer to *PC Connection Manual* (V042-E1-□).
 - When using PLCs manufactured by Allen-Bradley, GE Fanuc, or Siemens, refer to *NT31/631 Multi Vendor Connection Manual* (V060-E1-□).
-

6-7-1 About Communication Conditions

Items Set for Communication Conditions

The following settings are made for the communication conditions for communication between the NT31/NT31C and the host.

Port Communication Method/Communication Type Settings

Setting Item	Function	Setting Options	Page
Comm. A Method	Set the communication method used at serial port A. Depending on the communication method, further communication condition settings may be necessary.	A system program for OMRON model. None/Host Link/NT Link (1:1)/ NT Link (1:N) (standard or high-speed)/Bar-Code Reader Memory link	Page 160 Page 162 Page 163 Page 165
Comm. B Select	Set whether serial port B is to be used for RS-232C or RS-422A communication.	RS-232C/RS-422A	Page 167
Comm. B Method	Set the communication method used at serial port B. Depending on the communication method, further communication condition settings may be necessary.	A system program for OMRON model. None/Host Link/NT Link (1:1)/ NT Link (1:N) (standard or high-speed) Memory link	Page 160 Page 162 Page 163 Page 165

Communication Condition Settings for The Host Link Method

Setting Item	Function	Setting Options	Page
Comm. Speed (for host link only)	Sets the communications speed for communications with the host.	9600 bps/ 19200 bps	Page 160

Communication Condition Settings for The NT link (1:1) Method

No further communication conditions need to be set.

Communication Conditions Settings for The NT Link (1:N) Method

Setting Item	Function	Setting Options	Page
Unit No. (for NT link (1:N) only)	Set the unit number of the NT31/NT31C.	0 to 7	Page 163
Comm. Speed	Sets the communications speed for communications with the host.	Standard or high-speed	

Setting The Conditions for Communications with The Memory Link Method

Setting Item	Function	Setting Options	Page
Data bits	Set the data bits length.	7, 8 bits	Page 165
Stop bits	Set the stop bits length.	1, 2 bits	
Parity	Set the parity.	None, even, odd	
Comm. Speed	Set the communications speed for communications with the host.	1200, 2400, 4800, 9600, 19200, 38400 bps	
Flow control	Set the flow control and its method.	None, RS/CS, XON/XOFF	
Response	Set whether the response is carried out for normal process of communication command or not.	Yes, No	

Possible Combinations of Communication Method Settings

The combinations of communication methods that can be set with the NT31/NT31C are indicated in the table below. Combinations other than these listed below cannot be set (when using a system for multi-vendors, refer to the *PC Connection Manual* (V042-E1-□) or *NT31/631 Multi Vendor Connection Manual* (V060-E1-□).

Serial port B	Serial port A					
	None	Host Link	NT Link (1:1)	NT Link (1:N)	Bar-code reader	Memory Link
None	○	○	○	○	○	○
Host Link	○	×	×	×	○	×
NT Link (1:1)	○	×	×	×	○	×
NT Link (1:N) (Standard or high-speed)	○	×	×	×	○	×
Memory Link	○	×	×	×	○	×

○: Possible combination

×: Impossible combination

Combinations other than those indicated above cannot be set.

Reference: When using serial port B for communication with the host, and serial port A for the transmission of screen data from the Support Tool, set the settings of serial port A to None.

6-7-2 Setting the Host Link Method

Set the communication conditions for the host link method at serial port A or serial port B by following the operation from the System Menu shown below.

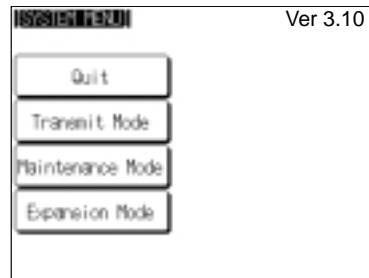

Select Maintenance Mode.



Select Memory Switch.

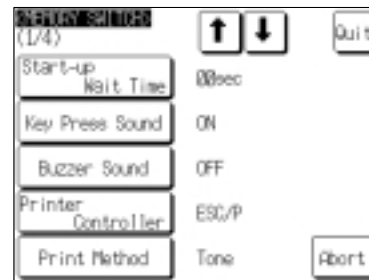

Display the fourth memory switch screen by pressing the [↓] (next screen) or [↑] (previous screen) touch switch.

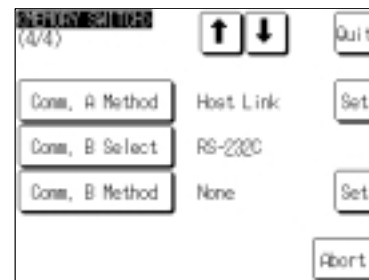

Press the touch switch corresponding to the port at which the host link method is to be set (Comm. A Method or Comm. B Method) to display the setting option Host Link.

The setting option changes each time the touch switch is pressed.



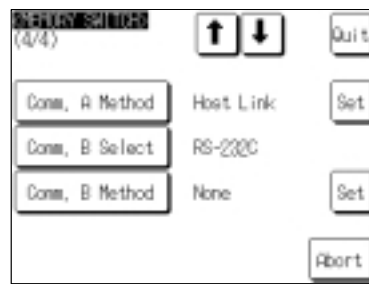

Press the Set touch switch to the right of the port at which the setting has been made.

In this example, serial port A is used.



Press the Comm. Speed touch switch to display the communications speed to be set.

The setting option changes each time the touch switch is pressed.

In this example, serial port A is used.



Press Quit.

The communications speed is set.

- To quit the communications speed setting screen without setting the communications speed, press the Abort touch switch. The NT31/NT31C returns to the memory switch setting screen (4/4) and the previous communications speed remains in effect.

On completion of communications speed setting, the NT31/NT31C returns to the memory switch setting screen (4/4).

To set other memory switches, select the relevant screen using the [↓] (next screen) or [↑] (previous screen) touch switch, then make the setting.

- To confirm the settings and quit the memory switch setting screen, press the Quit touch switch. The settings made last will be set and the NT31/NT31C will return to the MAINTENANCE MODE MENU screen.
- To quit the memory switch setting screen without confirming the settings, press the Abort touch switch. The NT31/NT31C will return to the MAINTENANCE MODE MENU screen with the previous settings still in effect.

6-7-3 Setting the NT Link (1:1) Method

Set the communication conditions for the NT link (1:1) method at serial port A or serial port B by following the operation from the System Menu shown below.

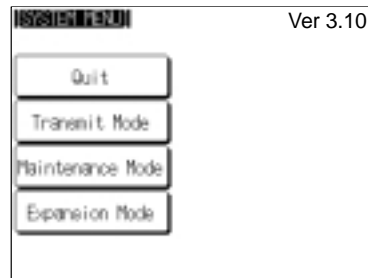

Select Maintenance Mode.

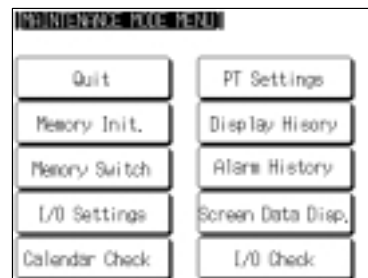

Select Memory Switch.

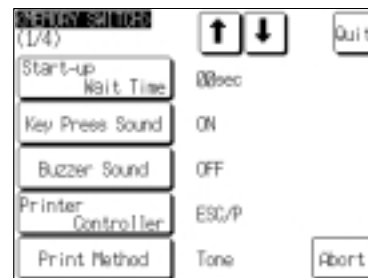

Display the fourth memory switch screen by pressing the [↓] (next screen) or [↑] (previous screen) touch switch.

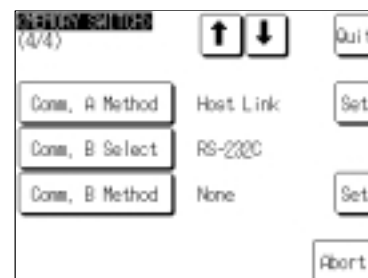

Press the touch switch corresponding to the port at which the NT link (1:1) method is to be set (Comm. A Method or Comm. B Method) to display the setting option NT Link (1:1).

The setting option changes each time the touch switch is pressed.

To set other memory switches, select the relevant screen using the [↓] (next screen) or [↑] (previous screen) touch switch, then make the setting.

- To confirm the settings and quit the memory switch setting screen, press the Quit touch switch. The settings made last will be set and the NT31/NT31C will return to the MAINTENANCE MODE MENU screen.
- To quit the memory switch setting screen without confirming the settings, press the Abort touch switch. The NT31/NT31C will return to the MAINTENANCE MODE MENU screen with the previous settings still in effect.

6-7-4 Setting the NT Link (1:N) Method (Standard/High-speed)

Set the communication conditions for the NT link (1:N) method at serial port A or serial port B by following the operation from the System Menu shown below.

The communications speed determines whether the 1:N NT Link is standard or high-speed.

Standard: Standard 1:N NT Link
 High-speed: High-speed 1:N NT Link

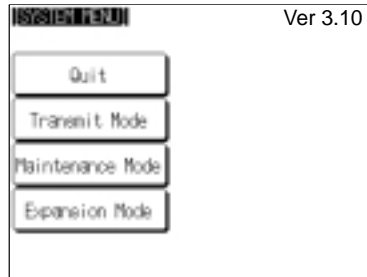

Select Maintenance Mode.

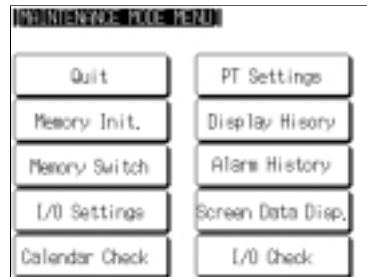

Select Memory Switch.

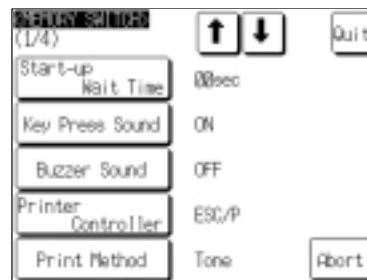

Display the fourth memory switch screen by pressing the [↓] (next screen) or [↑] (previous screen) touch switch.

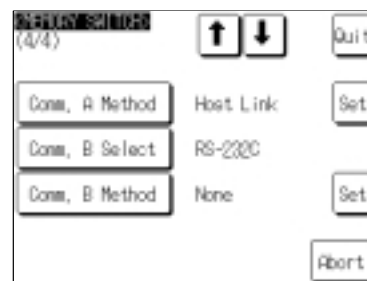

Press the touch switch corresponding to the port at which the NT link (1:N) method (standard or high-speed) is to be set (Comm. A Method or Comm. B Method) to display the setting option NT Link (1:N).

The setting option changes each time the touch switch is pressed.

In this example, serial port A is used.



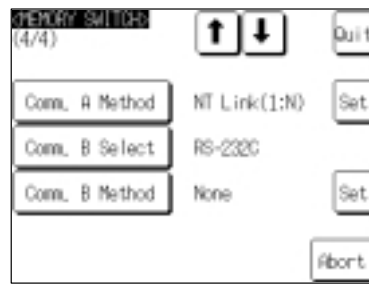

Press the Set touch switch to the right of the port at which the setting has been made.

In this example, serial port A is used.

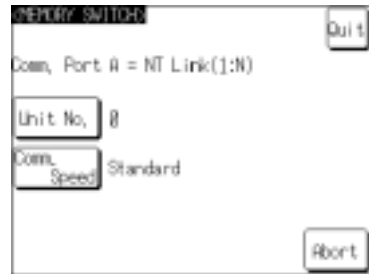

Press the Unit No. touch switch to display the unit number to be set. Press the Comm. Speed touch switch to display the communications speed, standard or 115.2-kbps high-speed. (The Comm. Speed setting determines which method of 1:N NT Link is used.)

The setting option changes each time the touch switch is pressed. In this example, serial port A is used for a standard 1:N NT Link.



Press Quit.

The unit number and communications speed are set.

- To quit the unit number/communications speed setting screen without confirming the unit number/communications speed settings, press the Abort touch switch. The NT31/NT31C will return to the memory switch setting screen (4/4) with the previous settings still in effect.

Reference: Unit numbers are numbers assigned to each PT when multiple PTs are connected to one host, so that the host can identify the individual PTs. The units numbers that can be set differ according to the host model, as follows.

- C200HE(-ZE):
Unit numbers 0 to 3 (maximum of 4 PTs per host port)
- C200HG(-ZE), C200HX(-ZE):
Unit numbers 0 to 7 (maximum of 8 PTs per host port)

When making the settings, make sure there is no duplication of unit numbers among PTs.

On completion of unit number/communications speed setting a, the NT31/NT31C returns to the memory switch setting screen (4/4).

To set other memory switches, select the relevant screen using the [↓] (next screen) or [↑] (previous screen) touch switch, then make the setting.

- To confirm the settings and quit the memory switch setting screen, press the Quit touch switch. The settings made last will be set and the NT31/NT31C will return to the MAINTENANCE MODE MENU screen.
- To quit the memory switch setting screen without confirming the settings, press the Abort touch switch. The NT31/NT31C will return to the MAINTENANCE MODE MENU screen with the previous settings still in effect.

6-7-5 Setting the Memory Link Method

Set the communication conditions for the host link method at serial port A or serial port B by following the operation from the System Menu shown below. Check the communication settings of the host to be used.

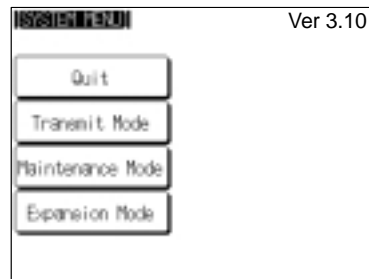

Select Maintenance Mode.

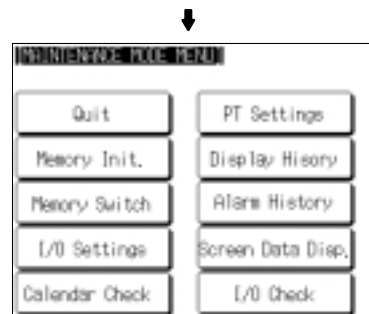

Select Memory Switch.

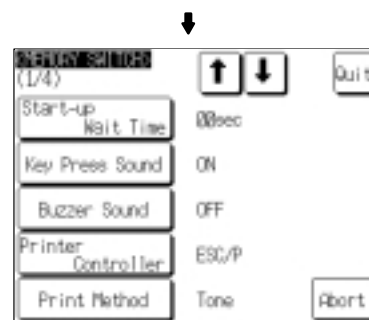

Display the fourth memory switch screen by pressing the [↓] (next screen) or [↑] (previous screen) touch switch.

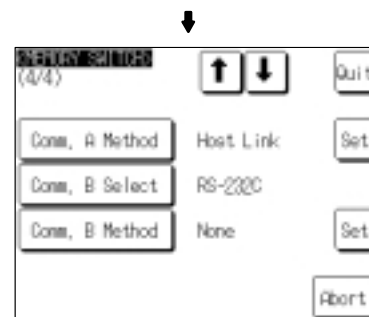

Press the touch switch corresponding to the port at which the memory link method is to be set (Comm. A Method or Comm. B Method) to display the setting option Memory Link.

The setting option changes each time the touch switch is pressed.

In this example, serial port A is used.

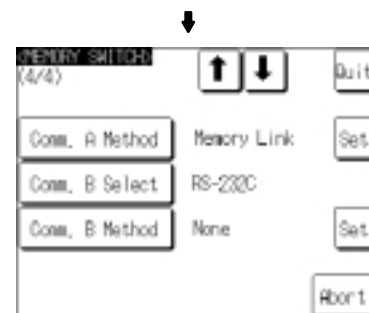

Press the Set touch switch to the right of the port at which the setting has been made.

In this example, serial port A is used.

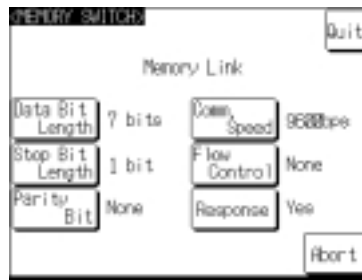

Display the data bits to be set (7 bits or 8 bits) by pressing the Data Bit Length touch switch.

Display the stop bits to be set (1 bit or 2 bits) by pressing the Stop Bit Length touch switch.

Display the parity to be set (None, even, odd) by pressing the Parity Bit touch switch.

Display the communication speed to be set (1200, 2400, 4800, 9600, 19200, 38400 bps.) by pressing the Comm. Speed touch switch.

Display the condition of the flow control to be set (None, RS/CS, XON/XOFF) by pressing Flow Control touch switch.

If the RS-422A is selected for serial port B setting, RS/CS is not displayed.

Display presence or absence of the response by pressing the Response touch switch.

The setting option changes each time the touch switch is pressed.

In this example, serial port A is used.

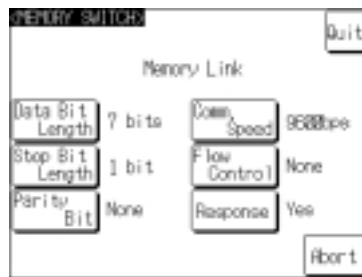

Press the Quit touch switch.

- To quit the communications speed setting screen without setting the communications speed, press the Abort touch switch. The NT31/NT31C returns to the memory switch setting screen (4/4) and the previous communications speed remains in effect.

On completion of communications speed setting, the NT31/NT31C returns to the memory switch setting screen (4/4).

To set other memory switches, select the relevant screen using the [↓] (next screen) or [↑] (previous screen) touch switch, then make the setting.

- To confirm the settings and quit the memory switch setting screen, press the Quit touch switch. The settings made last will be set and the NT31/NT31C will return to the MAINTENANCE MODE MENU screen.
- To quit the memory switch setting screen without confirming the settings, press the Abort touch switch. The NT31/NT31C will return to the MAINTENANCE MODE MENU screen with the previous settings still in effect.

6-7-6 Setting the Communication Type for Serial Port B

Set the communication type (RS-232C or RS-422A) for serial port B by following the operation from the System Menu shown below.

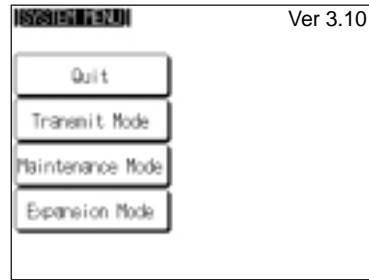

Select Maintenance Mode.



Select Memory Switch.

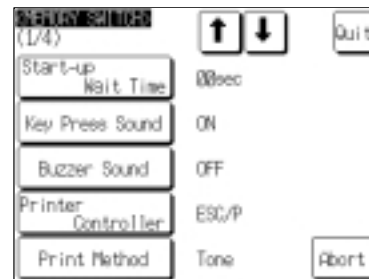

Display the fourth memory switch screen by pressing the [↓] (next screen) or [↑] (previous screen) touch switch.

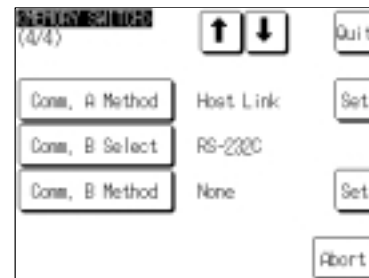

Press the Comm. B Select touch switch to display the communication type to be set. The setting option changes each time the touch switch is pressed.

Reference: If serial port B is used for RS-485 communications, RS-422A must be set as its communication type.

To set other memory switches, select the relevant screen using the [↓] (next screen) or [↑] (previous screen) touch switch, then make the setting.

- To confirm the settings and quit the memory switch setting screen, press the Quit touch switch. The settings made last will be set and the NT31/NT31C will return to the MAINTENANCE MODE MENU screen.
- To quit the memory switch setting screen without confirming the settings, press the Abort touch switch. The NT31/NT31C will return to the MAINTENANCE MODE MENU screen with the previous settings still in effect.

6-8 Starting Operation

After completing screen data transmission and setting the communication conditions, connect the NT31/NT31C to the host and start operation.

Note Check the operation of all screen data and host programs carefully before using them. If incorrect, the system may operate unpredictably.

Switching to the RUN Mode and Starting Operation

Press the Quit touch switch on the System Menu screen or other screen. The NT31/NT31C switches to the RUN mode and starts operation.

The operation at the start is as follows.

Display of The System Initialization Screen

When establishing the communication with a host, the System initializing character string is displayed on the screen. If the communication with the host cannot be established, the System initializing screen remains up. If this is the case, check the settings at the host and the PT side, the cables and wiring.

In addition, creating screen number 9000 enables the display of a screen other than the System initialization screen.

Transmission of The Contents of Memory Tables

If the Resume Function memory switch is set to ON, or if the initial values of the memory tables are used, the contents of the numeral/character-string memory tables are copied to the allocated words at the host.

↓

Display of The Startup Screen

The startup screen is displayed on reading the contents (screen number of the screen to be displayed) of the first word of the PT status control area.

If the contents are not correct for a screen number, or there is no data registered for the set screen number, an error message is displayed.

Confirming the Communications between the NT31/NT31C and the Host

Execute the host program and confirm that the following operations are performed normally.

- Confirm that the NT31/NT31C screens switch in accordance with the host program.

If the screens do not switch correctly, check the connection between the host and the NT31/NT31C, and also check if the hardware settings are correct. For details, refer to *Section 4 Connecting to the Host from the RS-232C Port*, or *Section 5 Connecting to the Host from the RS-422A/485 Port*.

- Confirm that the operation results of touch switch and numeric value/character string input at the NT31/NT31C are sent to the host correctly by displaying the contents of the host words and bits using a Programming Device (e.g. CX-Programmer).

If the results of operations at the NT31/NT31C are not sent to the host correctly, check the setting of the display elements. For details on setting display elements, refer to the description of each display element in the *Reference Manual*.

6-9 System Settings

The NT31/NT31C allows a variety of functions which are convenient during operation to be set with memory switches. This section describes the memory switch settings relating to the operation environment.

Since the memory switch settings are backed up to the flash memory by the battery in the NT31/NT31C, they are not cleared when the power is switched OFF.

6-9-1 Memory Switch Setting Screens

There are four memory switch setting screens. The required screen can be displayed by using the [↓] (next screen) and [↑] (previous screen) touch switches.

The four memory switch setting screens are shown below.

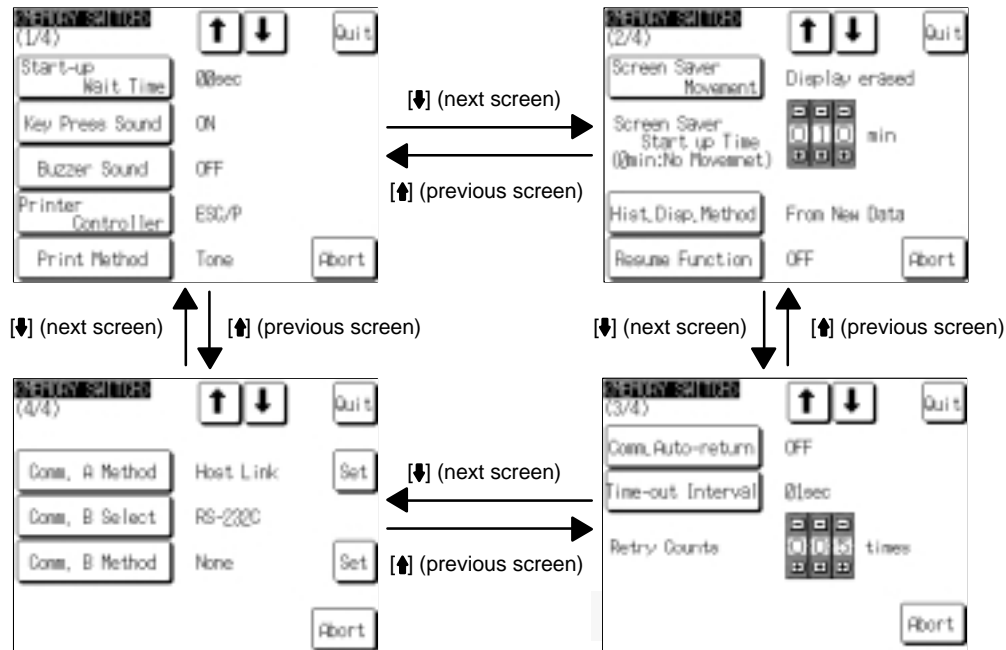

Memory Switch Settings

A list of the memory switch settings is presented below.

- Start-up Wait Time page 169
- Key Press Sound page 170
- Buzzer Sound page 171
- Printer Controller page 172
- Print Method page 174
- Screen Saver Movement page 175
- Screen Saver Start up Time page 177
- Hist. Disp. Method page 179
- Resume Function page 181
- Comm. Auto-return page 183
- Time-out Interval page 185
- Retry Counts page 186
- Comm. A Method page 157
- (For the bar code reader, refer to page 188.)
- Comm. B Select page 167
- Comm. B Method page 157

For details on each setting, refer to the pages indicated.

6-9-2 Setting the Start-up Wait Time

The Start-up Wait Time is the time lapse until the NT31/NT31C switches to the RUN mode after its power has been switched ON or after it has been reset. Set this item if it takes some time for the host to start operation. Nothing is displayed during the Start-up Wait Time.

The setting range is 0 to 10 seconds. The default (factory) setting is 00sec.

Set the system start-up wait time by following the menu operation from the System Menu shown below.

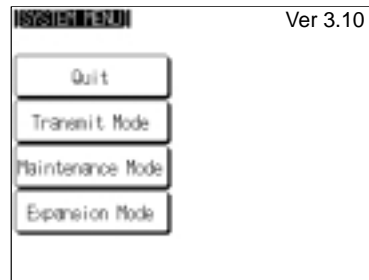

Select Maintenance Mode.

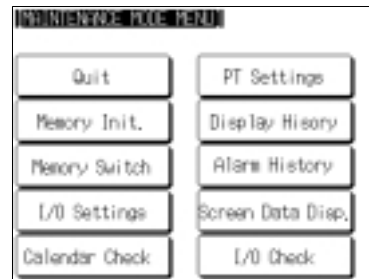

Select Memory Switch.

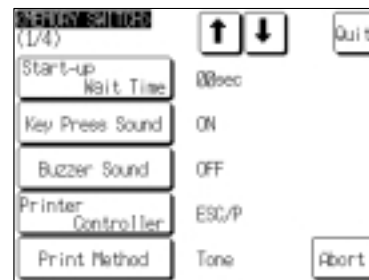

Press Start-up Wait Time to display the required time lapse.

The setting option changes each time the touch switch is pressed, according to the following sequence.

01 02 03 09 10 00 01

To set other memory switches, select the relevant screen using the [↓] (next screen) or [↑] (previous screen) touch switch, then make the setting.

- To confirm the settings and quit the memory switch setting screen, press the Quit touch switch. The settings made last will be set and the NT31/NT31C will return to the MAINTENANCE MODE MENU screen.
- To quit the memory switch setting screen without confirming the settings, press the Abort touch switch. The NT31/NT31C will return to the MAINTENANCE MODE MENU screen with the previous settings still in effect.

6-9-3 Setting the Key Press Sound

It is possible to set whether or not the key sound is sounded when a touch switch on the NT31/NT31C screen is pressed.

- ON: When a touch switch is pressed, the key sound sounds for 0.2 seconds.
- OFF: The key sound does not sound when touch switches are pressed.

The default (factory) setting is ON.

Set the key press sound by following the menu operation from the System Menu shown below.

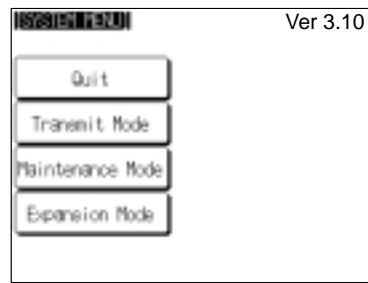

Select Maintenance Mode.

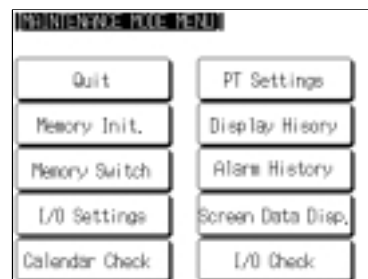

Select Memory Switch.

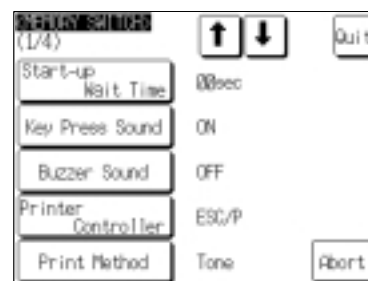

Press Key Press Sound to display ON or OFF.

The setting option changes each time the touch switch is pressed.

To set other memory switches, select the relevant screen using the [↓] (next screen) or [↑] (previous screen) touch switch, then make the setting.

- To confirm the settings and quit the memory switch setting screen, press the Quit touch switch. The settings made last will be set and the NT31/NT31C will return to the MAINTENANCE MODE MENU screen.
- To quit the memory switch setting screen without confirming the settings, press the Abort touch switch. The NT31/NT31C will return to the MAINTENANCE MODE MENU screen with the previous settings still in effect.

6-9-4 Setting the Buzzer Sound

The NT31/NT31C has a function for sounding a buzzer in response to an instruction from the host, or when an error occurs. It is possible to set whether or not the buzzer actually sounds with the memory switches.

- ON:
The buzzer sounds in response to instructions and when an error occurs.
- OFF:
The buzzer does not sound in response to instructions or when errors occur.
- ERROR ON:
The buzzer sounds only when an error occurs.

The default (factory) setting is OFF.

- Reference:**
- There are other instructions and settings relating to the buzzer, but this memory switch setting has the highest priority.
 - For details on the buzzer, refer to 2-15-5 *Buzzer Function* in the *Reference Manual*.

Set the buzzer sound by following the menu operation from the System Menu shown below.

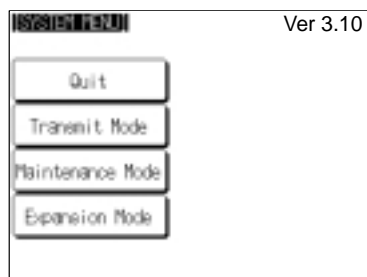

Select Maintenance Mode.

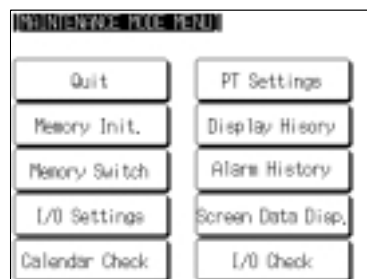

Select Memory Switch.

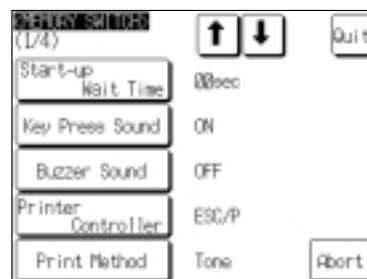

Press Buzzer Sound to display ON, OFF, or ERROR ON.

The setting option changes each time the touch switch is pressed.

To set other memory switches, select the relevant screen using the [↓] (next screen) or [↑] (previous screen) touch switch, then make the setting.

- To confirm the settings and quit the memory switch setting screen, press the Quit touch switch. The settings made last will be set and the NT31/NT31C will return to the MAINTENANCE MODE MENU screen.
- To quit the memory switch setting screen without confirming the settings, press the Abort touch switch. The NT31/NT31C will return to the MAINTENANCE MODE MENU screen with the previous settings still in effect.

6-9-5 Setting the Printer Controller

The NT31/NT31C has a function for printing out data at a printer connected to it in response to an instruction from the host or operation at the NT31/NT31C. Three types of printer can be connected to the NT31/NT31C: select the type used with this memory switch setting.

- ESC/P:

Printers that conform to Epson's ESC/P 24-J83C (color) printer control specifications or printers that conform to Epson's ESC/P 24-J82 (monochrome) control specifications.

- PC-PR201H:
Printers that can emulate the PC-PR201H, made by NEC Corp.
- PCL 5:
Printers that conform to the PCL 5 printer control specifications.

Note that the NT31 can only be used with the monochrome Tone setting and does not support color printing.

For the NT31, the Print Method is fixed as Tone.

The default (factory) setting is ESC/P.

- Reference:**
- In addition to this setting, NT31C has the Print Method setting (page 174).
 - For details on the print function, refer to 2-15-7 *Print Function* in the *Reference Manual*.

Set the printer controller setting by following the menu operation from the System Menu shown below.

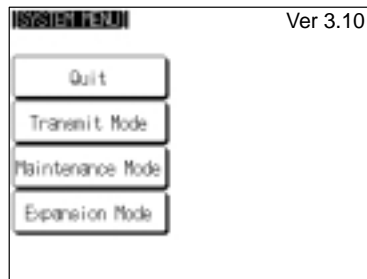

Select Maintenance Mode.

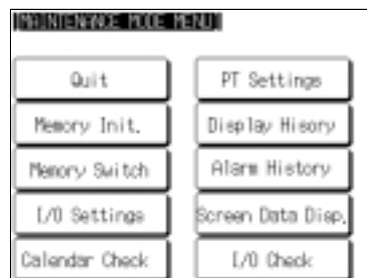

Select Memory Switch.

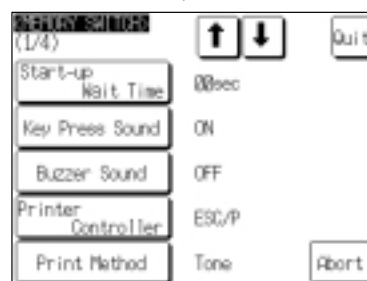

Press Printer Controller to display the required printer type.

The setting option changes each time the touch switch is pressed.

To set other memory switches, select the relevant screen using the [↓] (next screen) or [↑] (previous screen) touch switch, then make the setting.

- To confirm the settings and quit the memory switch setting screen, press the Quit touch switch. The settings made last will be set and the NT31/NT31C will return to the MAINTENANCE MODE MENU screen.
- To quit the memory switch setting screen without confirming the settings, press the Abort touch switch. The NT31/NT31C will return to the MAINTENANCE MODE MENU screen with the previous settings still in effect.

6-9-6 Setting the Print Method (NT31C Only)

The NT31/NT31C has a function for printing out data at a printer connected to it in response to an instruction from the host or operation at the NT31/NT31C.

When using the NT31C, the currently displayed screen image or other data can be printed out in color. You can select whether screen data is actually printed out in color, or in monochrome tones that represent colors, with this memory switch setting.

When PCL 5 is set for Printer Controller, the setting is fixed as Tone.

- Color: Color images are printed in color.
- Tone: Color images are printed in monochrome tones.

The default (factory) setting is Tone.

- Reference:**
- In addition to this setting, NT31C has the Printer Controller setting (page 172).
 - For details on the print function, refer to 2-15-7 *Print Function* in the *Reference Manual*.

Set the print method setting by following the menu operation from the System Menu shown below.

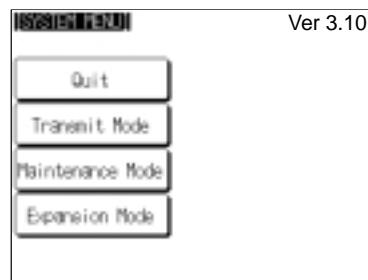

Select Maintenance Mode.

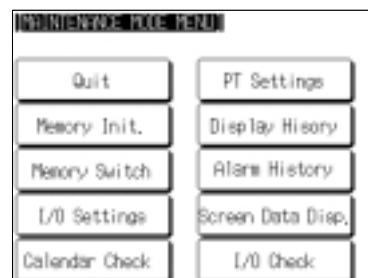

Select Memory Switch.

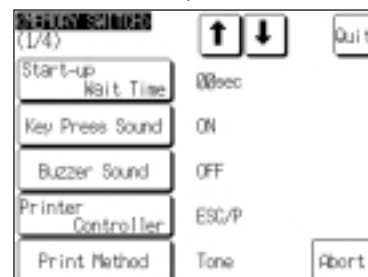

Press Print Method to display the required printing method.

The setting option changes each time the touch switch is pressed.

To set other memory switches, select the relevant screen using the [↓] (next screen) or [↑] (previous screen) touch switch, then make the setting.

- To confirm the settings and quit the memory switch setting screen, press the Quit touch switch. The settings made last will be set and the NT31/NT31C will return to the MAINTENANCE MODE MENU screen.

- To quit the memory switch setting screen without confirming the settings, press the Abort touch switch. The NT31/NT31C will return to the MAINTENANCE MODE MENU screen with the previous settings still in effect.

6-9-7 Setting Screen Saver Movement

The NT31/NT31C has a function to prevent the formation of an afterimage by turning off the screen display if no operation is performed for a certain period of time, and then displaying character strings at random positions and in random colors (the colors only change for the NT31C).

The Screen Saver Movement setting determines whether or not these character strings are displayed while the screen display is off.

If Display is selected, the character string stored in character string memory table No. 0 is displayed.

If Display erase is selected, the character string is not displayed, and the backlight is also turned off while the screen display is off.

The default (factory) setting is Display erased.

The screen saver can be canceled, and former screen redisplayed, by any of the following operations.

- Touching any part of the touch panel
- Screen switching due to PT status control area operations
- Screen switching due to bit memory table operations
- Execution of any of the following PT status control bit operations:
 - Changing the backlight mode
 - Screen printing (change from OFF to ON)
 - Screen display (change from OFF to ON)

-
- Reference:**
- The time before the screen is turned OFF is set by the Screen Saver Start up Time setting. For details, refer to *6-9-8 Setting the Screen Saver Start-up Time* (page 177).
 - Even if its operation has been set with the Screen Saver Movement setting, the screen saver function will not be executed if 000 is set for Screen Saver Start up Time.
 - Screen saver function is enabled only through RUN mode of NT31/NT31C. In System Menu or System Installer mode, this function is not started.
-

Set the screen saver operation by following the menu operation from the System Menu shown below.

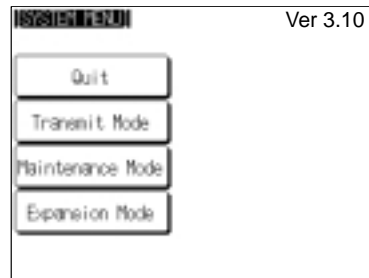

Select Maintenance Mode.

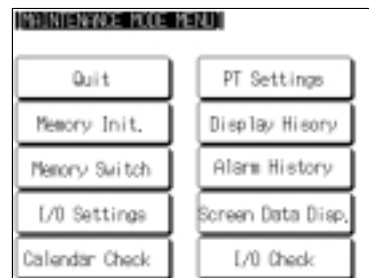

Select Memory Switch.

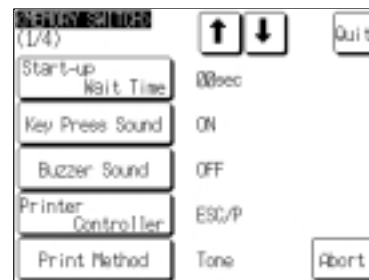

Press [↓] (next screen) or [↑] (previous screen) to display the second memory switch setting screen.

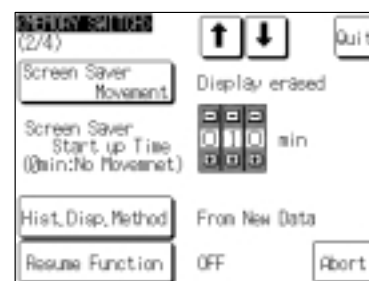

Press Screen Saver Movement to display Display or Display erased. The setting option changes each time the touch switch is pressed.

To set other memory switches, select the relevant screen using the [↓] (next screen) or [↑] (previous screen) touch switch, then make the setting.

- To confirm the settings and quit the memory switch setting screen, press the Quit touch switch. The settings made last will be set and the NT31/NT31C will return to the MAINTENANCE MODE MENU screen.
- To quit the memory switch setting screen without confirming the settings, press the Abort touch switch. The NT31/NT31C will return to the MAINTENANCE MODE MENU screen with the previous settings still in effect.

6-9-8 Setting the Screen Saver Start-up Time

The NT31/NT31C has a function to maximize the service life of the backlight and prevent the formation of an afterimage by turning off the screen display and the backlight if no operation is performed for a certain period of time.

The Screen Saver Start up Time setting determines the time interval before the screen saver function operates.

The setting range is 0 to 255 minutes. The default (factory) setting is 10 minutes. If 000 is set, the screen saver function does not operate.

The screen saver can be canceled, and previous screen redisplayed, by any of the following operations.

- Touching any part of the touch panel
- Screen switching due to PT status control area operations
- Screen switching due to bit memory table operations
- Execution of any of the following PT status control bit operations:
 - Changing the backlight mode
 - Screen printing (change from OFF to ON)
 - Screen display (change from OFF to ON)

-
- Reference:**
- It is possible to display the character string stored in character string memory table No. 0 at random positions and in random colors while the screen display is off. For details, refer to *6-9-7 Setting Screen Saver Movement* (page 175). Note however that, when this feature is used, the backlight does not go off.
 - For details on the screen saver function, refer to *2-15-4 Screen Saver Function* in the *Reference Manual*.
 - Screen saver function is enabled only through RUN mode of NT31/NT31C. In System Menu or System Installer mode, this function is not started.
-

Set the screen saver start-up time by following the menu operation from the System Menu shown below.

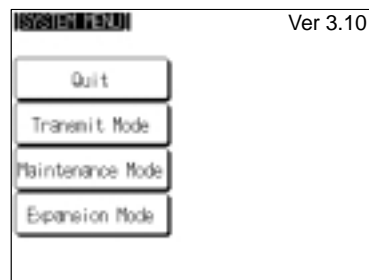

Select Maintenance Mode.

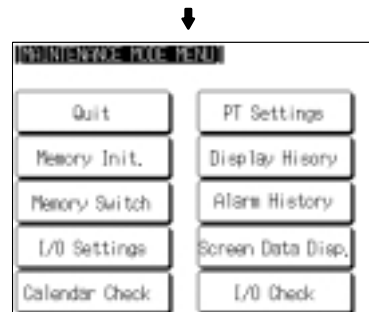

Select Memory Switch.

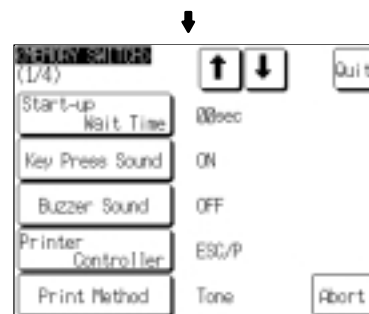

Press [↓] (next screen) or [↑] (previous screen) to display the second memory switch setting screen.

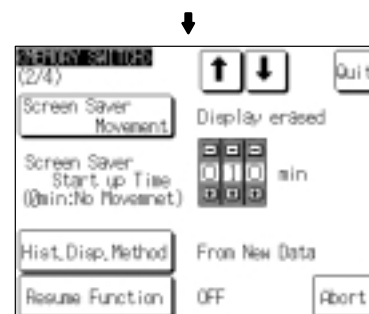

Set a time in the input field to the right of Screen Saver Start up Time.

Each of the digits can be incremented or decremented by pressing the associated + and – keys.

To set other memory switches, select the relevant screen using the [↓] (next screen) or [↑] (previous screen) touch switch, then make the setting.

- To confirm the settings and quit the memory switch setting screen, press the Quit touch switch. The settings made last will be set and the NT31/NT31C will return to the MAINTENANCE MODE MENU screen.
- To quit the memory switch setting screen without confirming the settings, press the Abort touch switch. The NT31/NT31C will return to the MAINTENANCE MODE MENU screen with the previous settings still in effect.

6-9-9 Setting the History Display Method

The NT31/NT31C features the display history record function, which records the time at which screens are displayed during operation and the number of times they are displayed, and the alarm history record function, which continually monitors bit statuses at the host and records the time when bits come ON and the number of times they come ON.

The Hist. Disp. Method setting determines whether — when these record data are displayed in sort by occurrence — the records are displayed in a progression from newest to oldest or from oldest to newest.

- From Old Data:
The records are displayed in sequence from the oldest to newest.
- From New Data:
The records are displayed in sequence from the newest to oldest.

The default (factory) setting is From New Data.

Reference:

- When the voltage of the NT31/NT31C's built-in battery becomes low, the history record contents cannot be retained.
 - For details on the display history record function and the alarm history record function, refer to *2-15-1 Display History Record Function* and *2-15-2 Alarm History Record Function* in the *Reference Manual*.
-

Set the history display method by following the menu operation from the System Menu shown below.

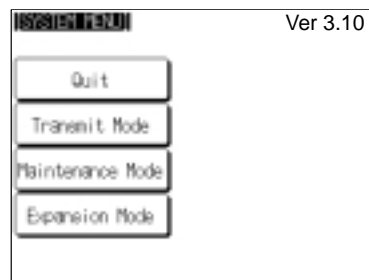

Select Maintenance Mode.

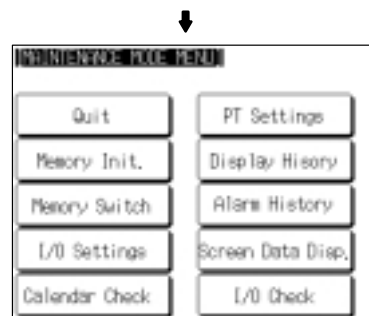

Select Memory Switch.

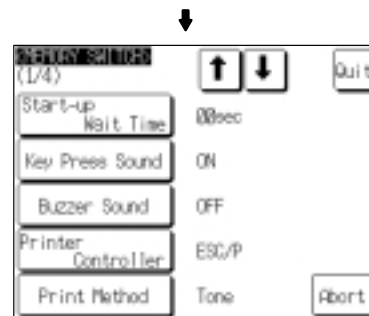

Press [↓] (next screen) or [↑] (previous screen) to display the second memory switch setting screen.

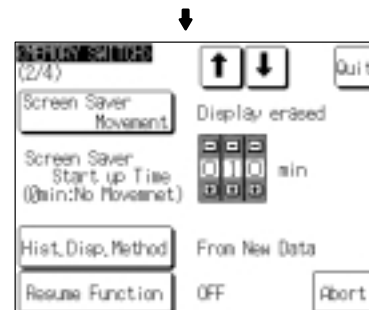

Press Hist. Disp. Method to display the required display order. The setting option changes each time the touch switch is pressed.

To set other memory switches, select the relevant screen using the [↓] (next screen) or [↑] (previous screen) touch switch, then make the setting.

- To confirm the settings and quit the memory switch setting screen, press the Quit touch switch. The settings made last will be set and the NT31/NT31C will return to the MAINTENANCE MODE MENU screen.
- To quit the memory switch setting screen without confirming the settings, press the Abort touch switch. The NT31/NT31C will return to the MAINTENANCE MODE MENU screen with the previous settings still in effect.

6-9-10 Setting the Resume Function

The NT31/NT31C has a function to keep the contents of the memory tables even when the power to the NT31/NT31C is OFF and write back them to the host when the power is turned ON.

If the resume function is OFF, the memory tables are initialized to these initial values on switching to the RUN mode. If the resume function is ON, these are not initialized and are kept the battery-backed up contents.

When the memory table is initialized, its contents are reset to the initial state that is set by the Support Tool.

When the system is started up the next time, the screen is displayed using the previous contents of the memory table.

- ON: The resume function is used.
- OFF: The resume function is not used.

The default (factory) setting is OFF.

-
- Reference:**
- When the voltage of the NT31/NT31C's built-in battery becomes low, the memory table contents cannot be retained even if ON is set for the resume function.
 - For details on the resume record function, refer to 2-15-3 *Resume Function* in the *Reference Manual*.
-

Set the resume function by following the menu operation from the System Menu shown below.

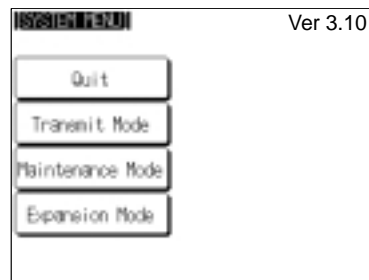

Select Maintenance Mode.

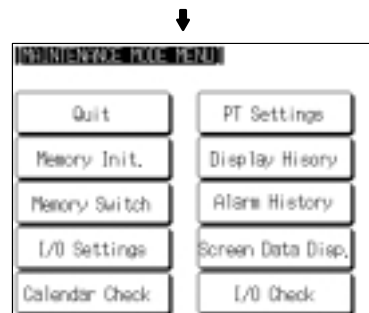

Select Memory Switch.

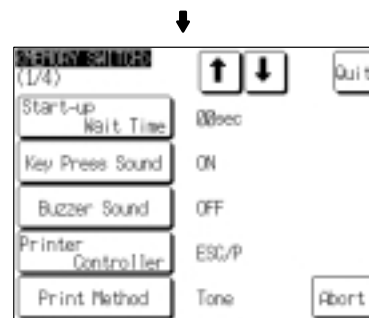

Press [↓] (next screen) or [↑] (previous screen) to display the second memory switch setting screen.

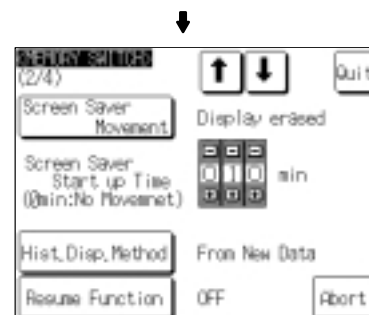

Press Resume Function to display the required setting.

The setting option changes each time the touch switch is pressed.

To set other memory switches, select the relevant screen using the [↓] (next screen) or [↑] (previous screen) touch switch, then make the setting.

- To confirm the settings and quit the memory switch setting screen, press the Quit touch switch. The settings made last will be set and the NT31/NT31C will return to the MAINTENANCE MODE MENU screen.
- To quit the memory switch setting screen without confirming the settings, press the Abort touch switch. The NT31/NT31C will return to the MAINTENANCE MODE MENU screen with the previous settings still in effect.

6-9-11 Setting the Automatic Reset Function

The NT31/NT31C has a function for ignoring communication errors and automatically returning to the RUN mode when they occur.

The Comm. Auto-return setting determines whether the automatic reset function is effective or not.

- ON:
When a communication error occurs, the NT31/NT31C automatically returns to the RUN mode without displaying an error screen (the System Initializing screen may be displayed).
- OFF:
When a communication error occurs, an error screen is displayed and operation stops. Pressing OK on the error screen returns the NT31/NT31C to the RUN mode.

The default (factory) setting is OFF.

-
- Reference:**
- If a communication error occurs when OFF is set for Comm. Auto-return, the NT31/NT31C makes the number of attempts at communication with the host specified by the setting for the Retry Counts touch switch (page 186). If communication cannot be re-established in any of these attempts, an error screen is displayed.
 - For details on communication errors, refer to *7-2-5 Communication Errors and Their Remedies* (page 239).
-

Set the automatic reset function by following the menu operation from the System Menu shown below.

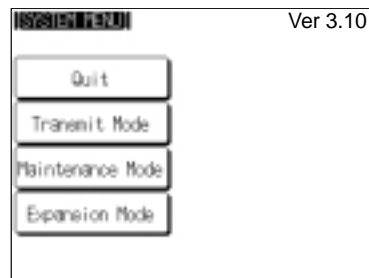

Select Maintenance Mode.

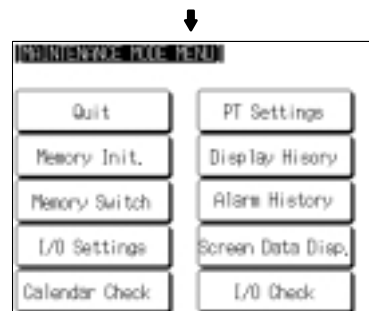

Select Memory Switch.

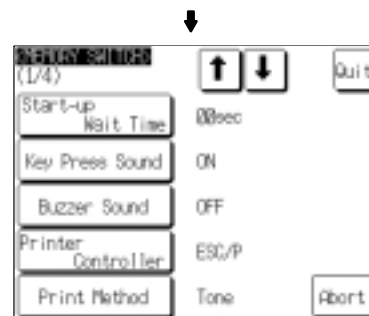

Press [↓] (next screen) or [↑] (previous screen) to display the third memory switch setting screen.

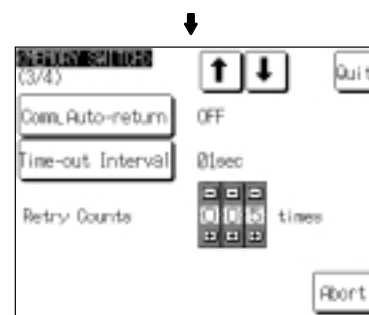

Press Comm. Auto-return to display the required setting.

The setting option changes each time the touch switch is pressed.

To set other memory switches, select the relevant screen using the [↓] (next screen) or [↑] (previous screen) touch switch, then make the setting.

- To confirm the settings and quit the memory switch setting screen, press the Quit touch switch. The settings made last will be set and the NT31/NT31C will return to the MAINTENANCE MODE MENU screen.
- To quit the memory switch setting screen without confirming the settings, press the Abort touch switch. The NT31/NT31C will return to the MAINTENANCE MODE MENU screen with the previous settings still in effect.

6-9-12 Setting the Time-out Interval

The NT31/NT31C goes into the time-out error status if no response is received from the host within a fixed time. The Time-out Interval setting specifies the time lapse at which time-out is judged to have occurred.

The setting range is 0 to 10 seconds. The default (factory) setting is 1 second.

Reference: Whether or not an error screen is displayed when a time-out error occurs is determined by the setting for the Comm. Auto-return memory switch.

Set the time-out interval by following the menu operation from the System Menu shown below.

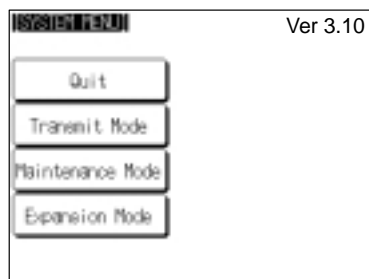

Select Maintenance Mode.

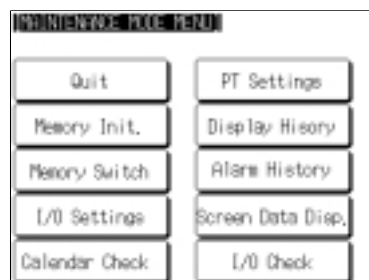

Select Memory Switch.



Press [↓] (next screen) or [↑] (previous screen) to display the third memory switch setting screen.

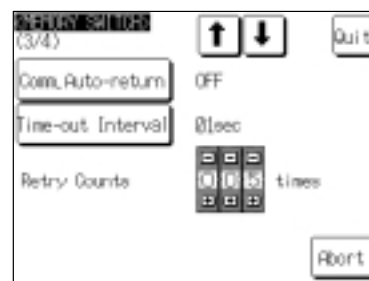

Press Time-out Interval to display the required time lapse.

The setting option changes each time the touch switch is pressed, according to the following sequence.
01 02 03 09 10 00 01

To set other memory switches, select the relevant screen using the [↓] (next screen) or [↑] (previous screen) touch switch, then make the setting.

- To confirm the settings and quit the memory switch setting screen, press the Quit touch switch. The settings made last will be set and the NT31/NT31C will return to the MAINTENANCE MODE MENU screen.

- To quit the memory switch setting screen without confirming the settings, press the Abort touch switch. The NT31/NT31C will return to the MAINTENANCE MODE MENU screen with the previous settings still in effect.

6-9-13 Setting the Retry Count

The NT31/NT31C does not immediately display an error screen when a communication error occurs, but tries to re-establish communication. The Retry Counts setting specifies the number of attempts to be made to re-establish communication. If communication cannot be recovered within this number of attempts, the following happens depending on the setting made for the Comm. Auto-return memory switch (page 183).

- Comm. Auto-return ON:
Operation in the RUN mode is continued without displaying an error screen. Regardless of the setting made for Retry Counts, attempts to re-establish communication are repeated until normal communication is achieved.
- Comm. Auto-return OFF:
The RUN mode is ended and an error screen is displayed. On pressing the OK touch switch on the error screen, the screen displayed immediately before is redisplayed and attempts are made to re-establish communication. The System Menu can be displayed from the error screen by pressing any two of the four corners of the touch panel simultaneously.

The setting range is 0 to 255 times. The default (factory) setting is 5 times.

Reference: For details on communication errors, refer to *7-2-5 Communication Errors and Their Remedies* (page 239).

Set the retry count by following the menu operation from the System Menu shown below.

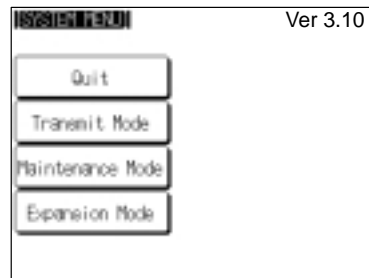

Select Maintenance Mode.

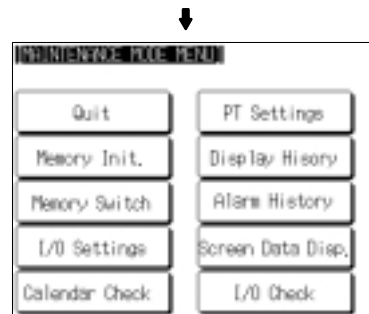

Select Memory Switch.

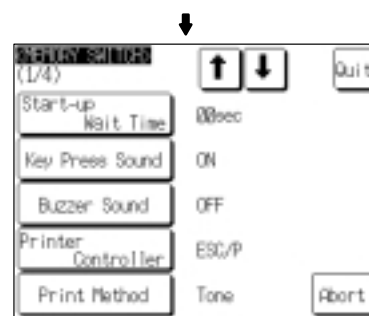

Press [↓] (next screen) or [↑] (previous screen) to display the third memory switch setting screen.

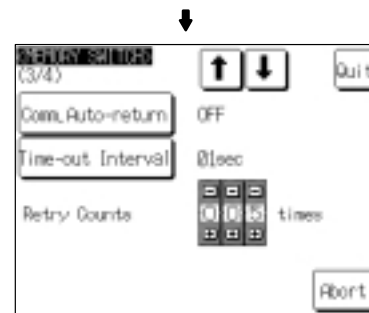

Set a number of times in the input field to the right of Retry Counts. Each of the digits can be incremented or decremented by pressing the associated + and – keys.

To set other memory switches, select the relevant screen using the [↓] (next screen) or [↑] (previous screen) touch switch, then make the setting.

- To confirm the settings and quit the memory switch setting screen, press the Quit touch switch. The settings made last will be set and the NT31/NT31C will return to the MAINTENANCE MODE MENU screen.
- To quit the memory switch setting screen without confirming the settings, press the Abort touch switch. The NT31/NT31C will return to the MAINTENANCE MODE MENU screen with the previous settings still in effect.

6-10 Setting the Bar Code Reader Input Function

The NT31/NT31C has a bar code reader input function which allows a bar code reader to be connected and bar code data to read as character strings into character string input fields.

This section describes the communication conditions for the bar code reader and the setting method for confirming the input data.

- Reference:**
- For details on bar code reader types and connection methods, refer to 3-4 *Connecting a Bar Code Reader* in this manual and for details on how to use a bar code reader refer to 3-7 *Input of Numeric Values and Character Strings* in the *Reference Manual*.
 - The bar code reader is connected to serial port A. This means that serial port B must be used for communications with the host.

Communication Condition Settings for Bar Code Readers

Setting Item	Function	Setting Options	Page
Data bit length	Sets the bit length for the data bits.	7* or 8 bits	Page 189
Stop bit length	Sets the stop bit length for the data.	1 or 2* bits	Page 189
Parity bit	Sets the parity bit for the data.	None, odd, even*	Page 189
Communications speed	Sets the communications speed for the bar code reader	4800, 9600*, or 19200 bps	Page 189
Input method	Sets the method for confirming data when it is input to a character string input field. Manual: The data is confirmed with a touch switch. The data can be corrected and character strings can be added. Auto: The data is automatically confirmed when it is input.	Manual*, Auto	Page 189

* Default (factory) setting

Setting the Communication Conditions and Setting Method

Set the bar code reader communication conditions and method of confirmation at input by following the menu operation from the System Menu shown below.

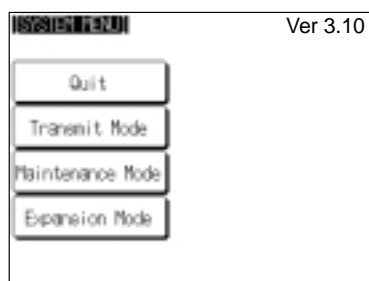

Select Maintenance Mode.

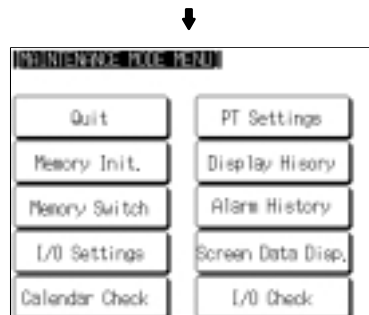

Select Memory Switch.

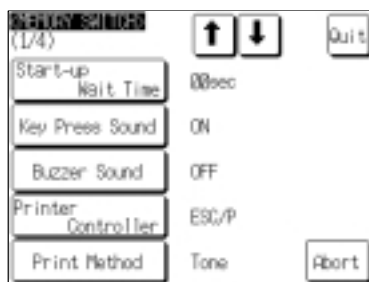

Press [↓] (next screen) or [↑] (previous screen) to display the fourth memory switch setting screen.

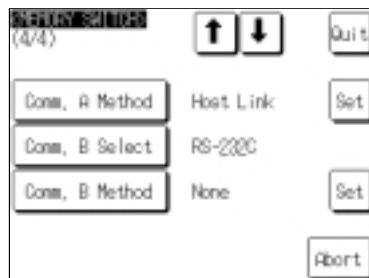

Press Comm. A Method to select Bar-Code Reader.

The setting option changes each time the touch switch is pressed.

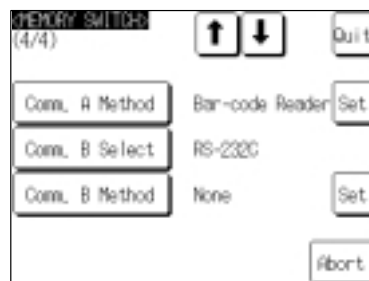

Press the Set touch switch to the right of Comm. A Method.

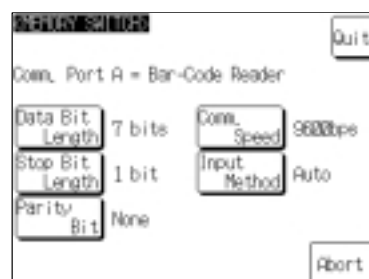

Display the required setting for each item by pressing the touch switches.

The setting option changes each time the touch switch is pressed.

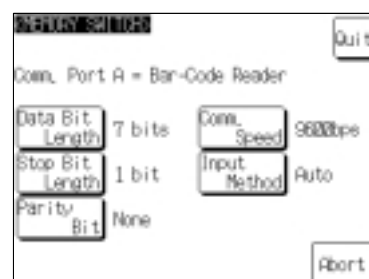

Press Quit.

Pressing Abort on the communication condition/confirmation method setting screen causes the NT31/NT31C to return to the memory switch setting screen (4/4) without executing setting (with the previous settings still effective).

On completion of communication condition/confirmation method setting, the NT31/NT31C returns to the memory switch setting screen (4/4).

To set other memory switches, select the relevant screen using the [↓] (next screen) or [↑] (previous screen) touch switch, then make the setting.

- To confirm the settings and quit the memory switch setting screen, press the Quit touch switch. The settings made last will be set and the NT31/NT31C will return to the MAINTENANCE MODE MENU screen.
- To quit the memory switch setting screen without confirming the settings, press the Abort touch switch. The NT31/NT31C will return to the MAINTENANCE MODE MENU screen with the previous settings still in effect.

6-11 System Maintenance

The NT31/NT31C has the following maintenance and check functions.

Item	Function	Page
I/O Settings	Adjustment of display panel contrast and brightness of the backlight.	Page 191
Calendar Check	Display and setting of the time data of the NT31/NT31C clock function.	Page 195
PT Settings	Direct connection setting of the screen data in the NT31/NT31C and display of the setting statuses of the serial ports.	Page 197
Display history record	Display and printing of display history record data.	Page 198
Alarm history record	Display and printing of alarm history record data.	Page 200
Screen data check	Display of each screen stored in the NT31/NT31C.	Page 202
I/O check	Device check	Checking of the I/O functions of the NT31/NT31C.
	I/F check	Checking of the communication functions of the NT31/NT31C.

This section describes how to use these functions.

6-11-1 I/O Settings

This function is used to adjust the contrast of the display panel and the brightness of the backlight.

With the NT31/31C, you can adjust the contrast and brightness settings using either of the following two methods.

Setting from the System Menu

Adjusting the contrast: Select System Menu/Maintenance Mode/I/O Settings/Contrast Adjust.

Adjusting the brightness: Select System Menu/Maintenance Mode/I/O Settings/Brightness Adjust.

Setting Using Special Screen During PT Operation

You can set the brightness and contrast by displaying the screen with the following number, using a touch switch with a switch screen function, or by specifying the display screen in the PT status control area.

Screen number 9030: Brightness and contrast adjustment screen.

Contrast Adjustment

The NT31/NT31C allows the contrast to be adjusted in 100 steps. The CONTRAST ADJUST screen enables you to make the adjustment while actually checking the contrast on the screen. Once the contrast has been set, it remains in effect even if the power is turned OFF or the NT31/NT31C is reset (and even if the voltage of the built-in battery becomes low).

Setting from the System Menu

Adjust the contrast of the display panel by following the menu operation from the System Menu shown below.

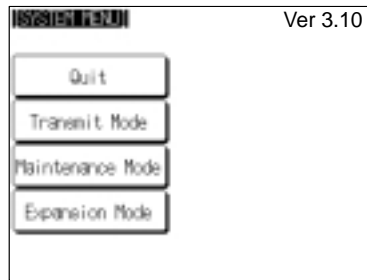

Select Maintenance Mode.

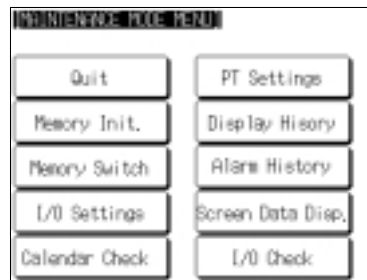

Select I/O Settings.



Select Contrast Adjust.

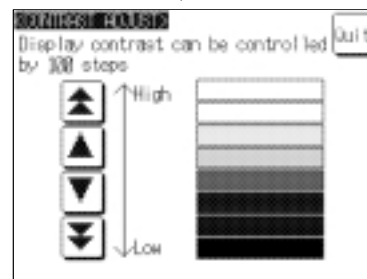

Adjust the contrast with the touch switches in the left half of the screen.

[▲]: Increase 10 steps

[▲]: Increase 1 step

[▼]: Decrease 1 step

[▼]: Decrease 10 steps

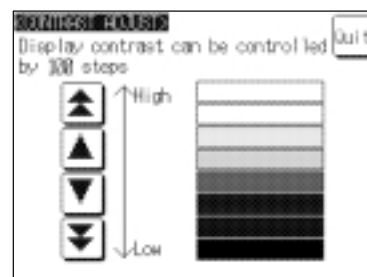

Press Quit.

The contrast is set and the NT31/NT31C returns to the I/O SETTINGS MENU screen.

Setting Using Brightness and Contrast Adjustment Screen

Display screen number 9030 using either a touch switch with switch screen function, or by specifying the display screen in the PT status control area.

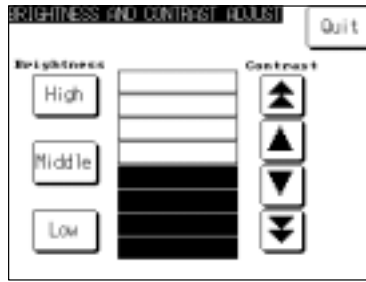

Adjust the contrast with the touch switches in the right half of the screen.

[▲]: Increase 10 steps

[▲]: Increase 1 step

[▼]: Decrease 1 step

[▼]: Decrease 10 steps

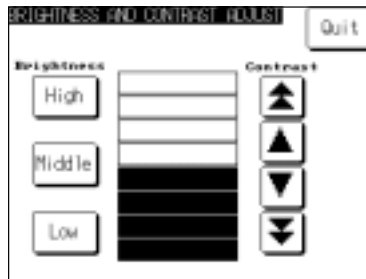

Press Quit.

The contrast is set, and the NT31/NT31C returns to the previous screen.

Backlight Brightness Adjustment

The NT31/NT31C allows the brightness of the backlight to be adjusted in 3 steps. The BRIGHTNESS ADJUST screen enables you to make the adjustment while actually checking the brightness on the screen. The length of hours the backlight lasts in a normal temperature are as follows.

High contrast: 10000 hours

Low, middle contrast: 25000 hours

Setting from the System Menu

Adjust the backlight brightness by following the menu operation from the System Menu shown below.

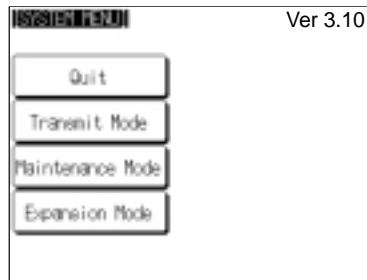

Select Maintenance Mode.

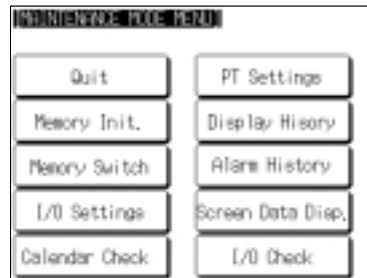

Select I/O Settings.



Select Brightness Adjust.

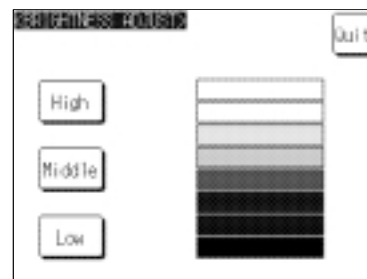

Adjust the contrast with the High, Middle, and Low touch switches in the left half of the screen.

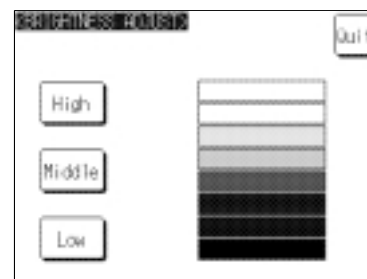

Press Quit.

The contrast is set and the NT31/NT31C returns to the I/O SETTINGS MENU screen.

Setting Using Brightness and Contrast Adjustment Screen

Display screen number 9030 using either a touch switch with switch screen function, or by specifying the display screen in the PT status control area.

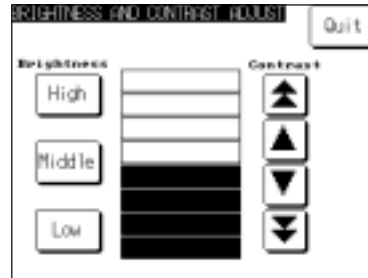

Adjust the brightness with the touch switches (High, Middle, Low) in the left half of the screen.

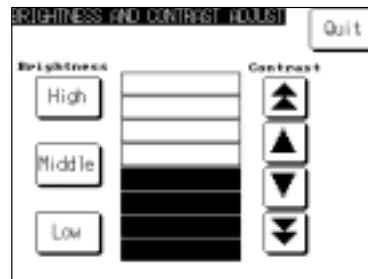

Press Quit.

The brightness is set, and the NT31/NT31C returns to the previous screen.

6-11-2 Displaying/Setting the Calendar and Clock

The NT31/NT31C has a clock function for setting and displaying the date and time.

This section describes how to display and set the clock data by menu operation from the System Menu.

- Reference:**
- The clock function does not strictly check the date and day of the week settings. When setting the clock data, be sure to set the correct date and day of the week. If a mistake is made — for example entering a value in the range 13 to 19 when entering the month — the buzzer sounds three times. Make sure that the data is correct when the month changes.
 - Numeral memory tables 247 to 255 are reserved for the clock function. Clock data can be displayed and set during operation of the NT31/NT31C by using these numeral memory tables.
 - For details on the clock function, refer to 2-15-6 *Clock Function* in the *Reference Manual*.
 - No clock data is set on shipment from the factory.
 - The clock data is backed up by the built-in battery of the NT31/NT31C. If the battery voltage becomes low, the clock data cannot be retained when the power to the NT31/NT31C is turned OFF or the NT31/NT31C is reset and the clock function will not operate correctly.
 - When writing to the screen data memory is disabled by the setting made for System Setting in the System Installer mode, it is not possible to set the date and time.

Display/set clock data by following the menu operation from the System Menu shown below.

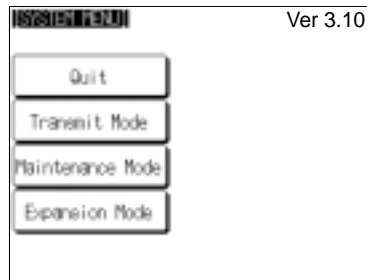

Select Maintenance Mode.

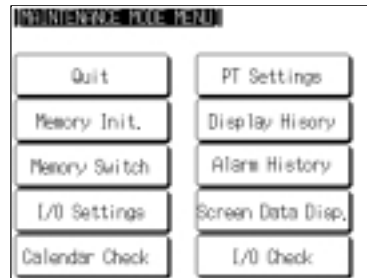

Select Calendar Check.



Press Set.

If you are just checking the display, press Quit at this point; the NT31/NT31C will return to the MAINTENANCE MODE MENU screen.

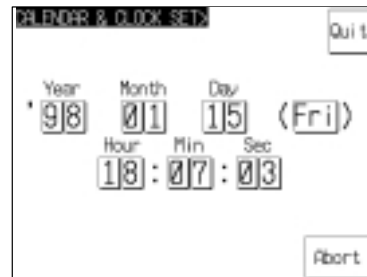

Set the date.

Each of the digits of the year, month, date, hour, minute, and second settings, and the day of the week setting, are touch switches: press these touch switches to change the corresponding settings.

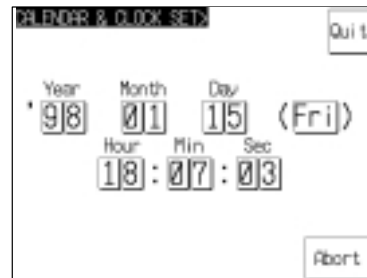

Press Quit.

The clock data is set and the NT31/NT31C returns to the date and time display.

- Pressing Abort causes the NT31/NT31C to return to the date and time display without executing setting (with the previous settings still effective).

6-11-3 Checking the PT Setting Status

The direct connection settings of the NT31/NT31C screen data, and the settings for serial port A and serial port B, can be checked.

Screen Configuration and Display Contents

There are the following three PT setting status screens.

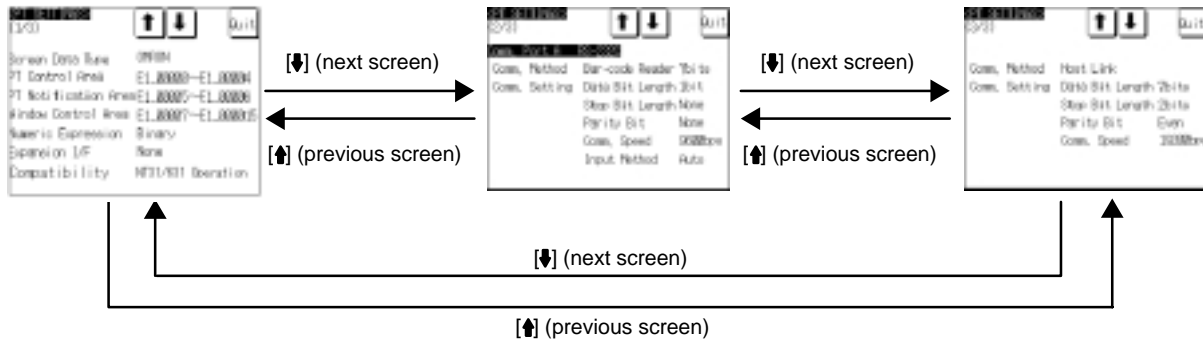

Display Contents of The First Screen

Item	Meaning
Screen Data Type	The host type set for the screen data
PT Control Area	Word at the host to which the PT status control area is allocated
PT Notification Area	Word at the host to which the PT status notify area is allocated
Window Control Area	Word at the host to which the window control area is allocated
Numeric Expression	Default for the method of interpretation of the contents of host words to which numeral memory tables are allocated (numeric value storage method).
Expansion I/F	Type of unit installed at the expansion interface connector
Compatibility	Sets whether or not to use NT30/620 compatible mode for screen data. (Sets whether to operate as a normal NT31/631 or emulate many key NT30/620 characteristics.)

Display Contents of The Second Screen

Item	Meaning
Comm. Port A	Communication type set for serial port A (fixed as RS-232C)
Comm. Method	Communication method set for serial port A
Comm. Setting	Communication conditions set for serial port A (display contents differ according to the communication method)

Display Contents of The Third Screen

Item	Meaning
Comm. Port B	Communication type set for serial port B (RS-232C/RS-422A)
Comm. Method	Communication method set for serial port B
Comm. Setting	Communication settings set for serial port B (display contents differ according to the communication method)

Display Method

Display the PT setting statuses by following the menu operation from the System Menu shown below.

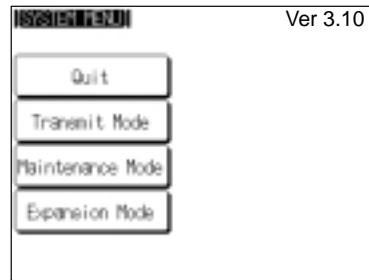

Select Maintenance Mode.



Select PT Settings.

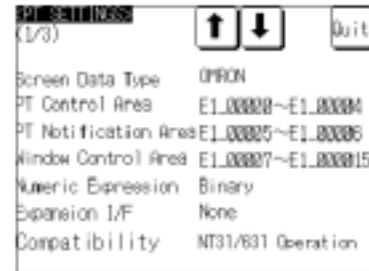

Switch the screen as required by pressing the [↓] (next screen) or [↑] (previous screen) touch switch.

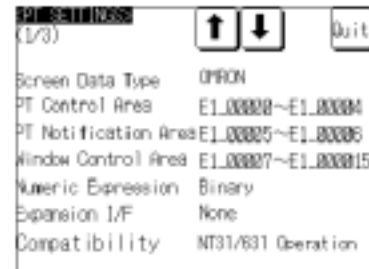

Press Quit.
The NT31/NT31C returns to the MAINTENANCE MODE MENU screen.

6-11-4 Displaying and Printing the Display History Record

The display history record function is a function that records the order of display of each screen during operation, and the number of times each screen is displayed. Only the screens for which the display history screen attribute has been set in advance are processed by this function.

The record data can be displayed, and printed out at a printer connected to the NT31/NT31C by operation from the System Menu.

This section explains how to display and print out the display history record data recorded in the NT31/NT31C.

Note that there are two display methods sort by occurrence (display time order) and sort by frequency (order of number of times displayed).

- Reference:**
- With the NT31/NT31C, the record data can also be displayed by calling screen No. 9001 (sort by occurrence) or screen No. 9002 (sort by frequency) during the RUN mode.
 - For details on the display history record function, refer to 2-15-1 *Display History Record Function* in the *Reference Manual*.
 - The order of display for sort by occurrence display (from oldest record or from newest record) is set with the Hist. Disp. Method memory switch (page 179).
 - The printing method and other information must be set in advance with the Printer Controller (page 172) and Print Method (page 174) memory switches.

Display and print the display history record data by following the menu operation from the System Menu shown below.

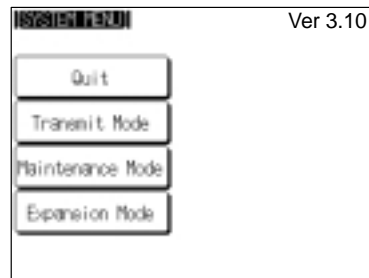

Select Maintenance Mode.

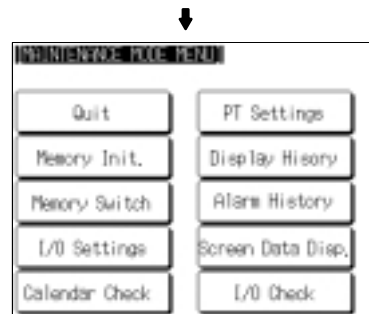

Select Display History.

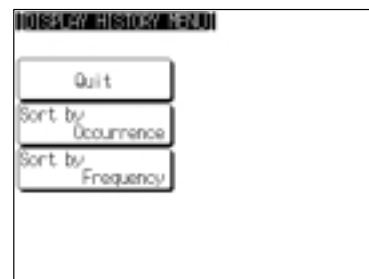

Select Sort by Occurrence or Sort by Frequency.

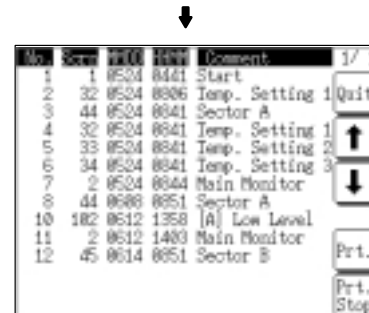

If necessary, select the next or previous screen by pressing [↓] (next screen) or [↑] (previous screen).

The example screen to the left shows a display for the sort by occurrence method (from oldest record).

No.	Scrn	YY/MM/DD	HH:MM	Comment	1/1
1	1	9504	0441	Start	
2	32	9504	0806	Temp. Setting 1	Quit
3	44	9504	0841	Sector A	
4	32	9504	0841	Temp. Setting 1	↑
5	33	9504	0841	Temp. Setting 2	
6	34	9504	0841	Temp. Setting 3	↓
7	2	9504	0844	Main Monitor	
8	44	0608	0851	Sector A	
10	182	0612	1358	[A] Low Level	
11	2	0612	1403	Main Monitor	Prt.
12	45	0614	0651	Sector B	Prt. Stop

If required, press Prt. to print the display history record data.



No.	Scrn	YY/MM/DD	HH:MM	Comment	1/1
1	1	9504	0441	Start	
2	32	9504	0806	Temp. Setting 1	Quit
3	44	9504	0841	Sector A	
4	32	9504	0841	Temp. Setting 1	↑
5	33	9504	0841	Temp. Setting 2	
6	34	9504	0841	Temp. Setting 3	↓
7	2	9504	0844	Main Monitor	
8	44	0608	0851	Sector A	
10	182	0612	1358	[A] Low Level	
11	2	0612	1403	Main Monitor	Prt.
12	45	0614	0651	Sector B	Prt. Stop

Press Quit.

The NT31/NT31C returns to the DISPLAY HISTORY MENU screen.

Example Print-out

All of the recorded data is printed out in the same order as on the currently displayed screen.

Example:

Sort by occurrence, from oldest record

No.	Scrn	YY/MM/DD	HH:MM	Comment	01/01
1	1	98/01/12	10:21	Coolant Error	
2	2	98/01/12	11:53	Motor Error	
3	8	98/01/13	09:35	Compressor Error	
4	2000	98/01/13	14:22	Emergency Stop	

6-11-5 Displaying and Printing the Alarm History Record

The alarm history record function is a function that continually monitors, during operation, the status of bits at the host designated in advance with a bit memory table, and records the time when these bits come ON, and the number of times they come ON.

The record data can be displayed, and printed out at a printer connected to the NT31/NT31C by operation from the System Menu.

This section explains how to display and print out the alarm history record data recorded in the NT31/NT31C.

Note that there are two display methods sort by occurrence (ON time order) and sort by frequency (order of number of times the bits have come ON).

Reference:

- With the NT31/NT31C, the record data can also be displayed by registering an alarm history display element on the screen.
- For details on the alarm history record function, refer to *2-15-2 Alarm History Record Function* in the *Reference Manual*.
- The order of display for sort by occurrence display (from oldest record or from newest record) is set with the Hist. Disp. Method memory switch (page 179).
- The printing method and other information must be set in advance with the Printer Controller (page 172) and Print Method (page 174) memory switches.

Display and print the alarm history record data by following the menu operation from the System Menu shown below.

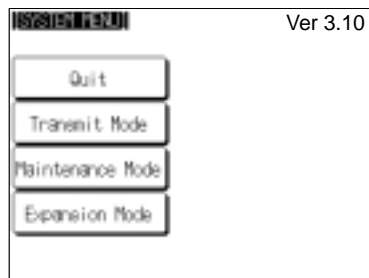

Select Maintenance Mode.

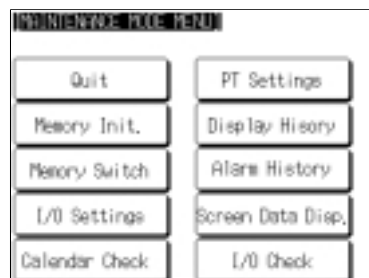

Select Alarm History.

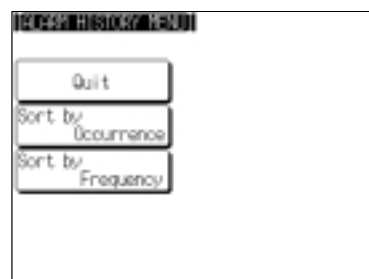

Select Sort by Occurrence or Sort by Frequency.



If necessary, select the next or previous screen by pressing [↓] (next screen) or [↑] (previous screen).

The example screen to the left shows a display for the sort by occurrence method (from oldest record).



If required, press Prt. to print the display history record data.



Press Quit.

The NT31/NT31C returns to the ALARM HISTORY MENU screen.

Example Print-out

All of the recorded data is printed out in the same order as on the currently displayed screen.

Example:

Sort by occurrence method, from oldest record

No.	Comment	YY/MM/DD	HH:MM	01/01
1	Remote I/O Error	98/02/06	16:02	
2	PIC Unit Error	98/02/07	09:21	
3	Cycle Time Over	98/02/17	15:44	

6-11-6 Checking Screen Data

The NT31/NT31C allows the registered screens (Nos. 1 to 3999) to be displayed and checked by operation from the System Menu.

- Reference:**
- Window screens cannot be displayed by operation from the System Menu.
 - Only the user screens (Nos. 1 to 3999) can be displayed. Screens for system use cannot be displayed.

Specifying The Display Method

Specify the display method for the screens as indicated in the table below.

Setting Item	Function	Setting Options
Display of Lamp/ Touch SW No.	Allows designation of whether the bit number of the lamp bit set for a lamp or touch switch is displayed or not. The display format is as follows L□○○○○○○○○ (□: area type, ○○○○○○○○: bit number).	ON, OFF*
Display of Memory Table No.	Allows designation of whether the table numbers of numeral and character string memory tables are displayed or not. The display format for numeral memory tables is N○○○○ and the display format for character string memory tables is S○○○○. This function is valid for the following display elements. - Numeral displays - Character string displays - Bar graphs - Numeral setting input fields (including thumbwheel type) - Character string input fields	ON, OFF*
Display of image/ Library No.	Allows designation of whether image/library code numbers are displayed or not.	ON, OFF*
Display of Broken Line Frame	Allows designation of whether or not broken line frames are displayed around the display elements for showing the positions registered.	ON, OFF*

* Default (factory) setting

- Reference:** Each setting of the screen data check is effective only on this menu. Exiting from this screen data check menu resets the settings to the default (all the settings are set to OFF).

Operations On The SCREEN DATA CHECK Screen

The function shown below can be set on the SCREEN DATA CHECK screen. Use this function as required when displaying complex screens on which multiple display elements have been registered overlapping each other.

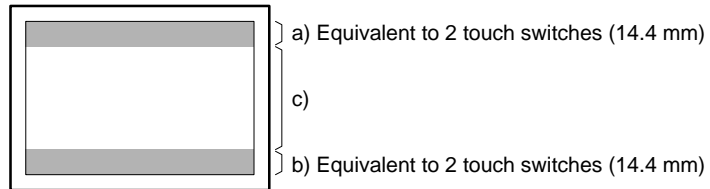

- a) Display the previous display element on the upper most portion of the screen in the order in which the display elements were registered (excluding fixed display elements).
- b) Display the next display element on the upper most portion of the screen in the order in which the display elements were registered (excluding fixed display elements).
- c) Return to the screen on which screens are specified.

Displaying the SCREEN DATA CHECK Screen

Display the SCREEN DATA CHECK screen by following the menu operation from the System Menu shown below.

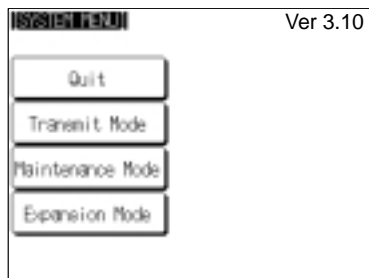

Select Maintenance Mode.



Select Screen Data Disp.

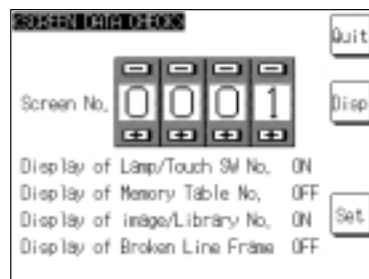

Specify the screen to be displayed in the input field in the middle of the screen.

Each of the digits can be incremented or decremented by pressing the associated + and – keys.

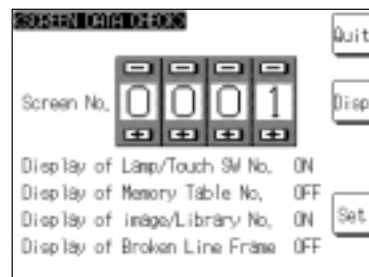

Press Set.

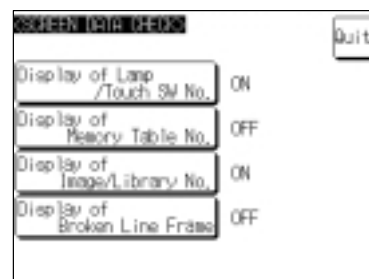

Press the touch switches to specify the display method in each case.

The setting option changes each time a touch switch is pressed.



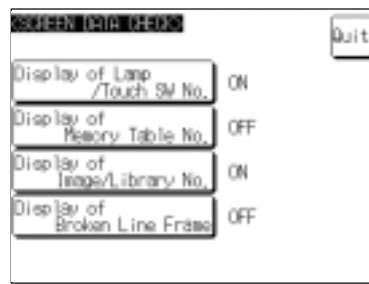

Press Quit to return to the screen number selection screen.

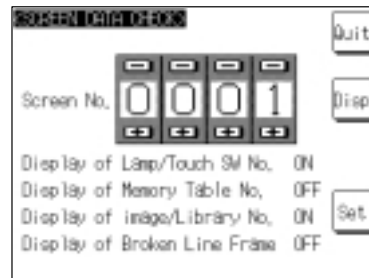

Press Disp.

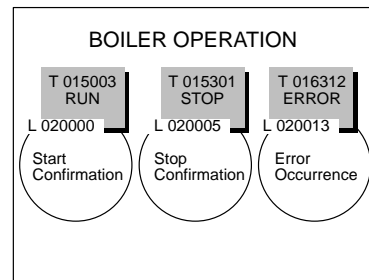

Touching the top or bottom of the screen changes the way the display elements overlap each other in the order in which they are registered.

In this example, the bottom portion of the touch switch, which is under the lamp, will be displayed over the lamp.

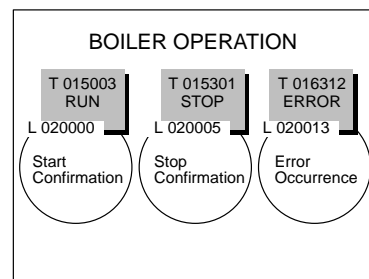

When you have finished checking the screen, press the central part of the screen to return to the screen number selection screen.

If you wish to continue by checking another screen, repeat the operation, starting by specifying the screen number.

To end the operation, press Quit on the screen number selection screen. The NT31/NT31C returns to the MAINTENANCE MODE MENU screen.

6-11-7 Device Check

The NT31/NT31C provides checks on the functions of the following items.

- Buzzer Page 205
- LED Page 206
- LCD Page 208
- Backlight Page 209
- Screen data memory Page 209
- Touch switches Page 212
- Battery voltage Page 214

Checking the Buzzer

Check if the buzzer sounds correctly.

Reference: The buzzer will sound in this check regardless of the setting made with the Buzzer Sound memory switch.

Check the buzzer by following the menu operation from the System Menu shown below.

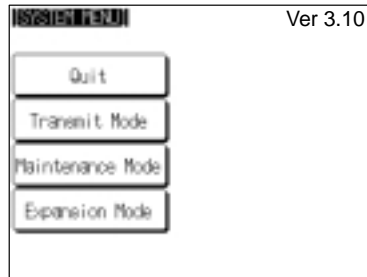

Select Maintenance Mode.

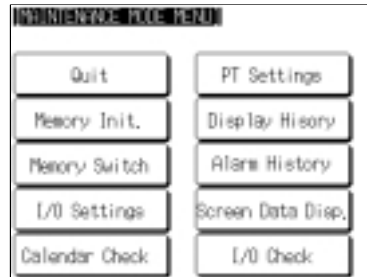

Select I/O Check.

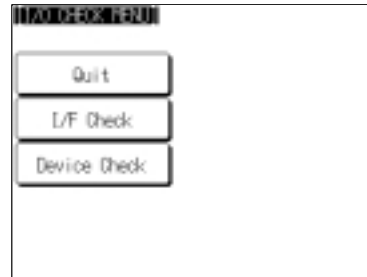

Select Device Check.

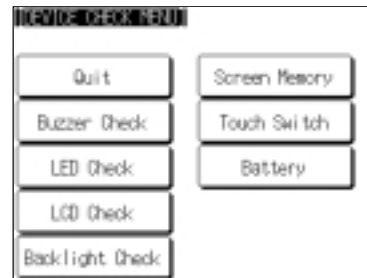

Select Buzzer Check.

- If the buzzer functions correctly, it will sound continuously. At this time, the Buzzer Check touch switch will be displayed in reverse video.
- To stop the buzzer while it is sounding, press the Buzzer Check touch switch again.

Checking the RUN LED

Check if the RUN LED functions normally.

Check the RUN LED by following the menu operation from the System Menu shown below.

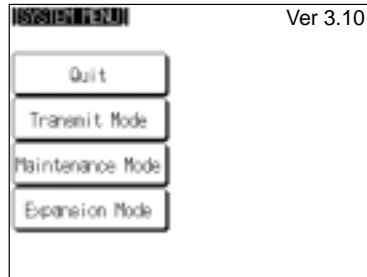

Select Maintenance Mode.

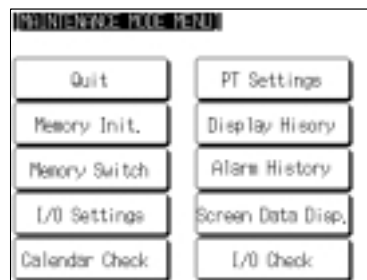

Select I/O Check.

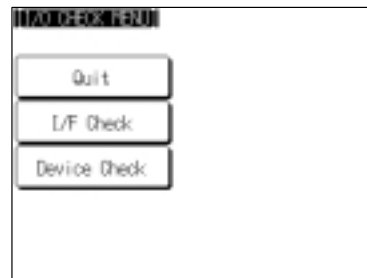

Select Device Check.

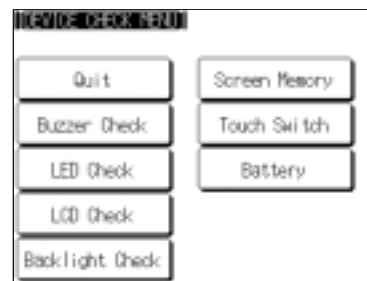

Select LED Check.

- If the RUN LED is functioning normally, it will operate as follows. At this time the LED Check touch switch will be displayed in reverse video.

Lit in green OFF lit in red OFF lit in green...

- To end the LED check, press the LED Check touch switch on the DEVICE CHECK MENU screen again.

Checking the LCD (Screen Display)

Check if the LCD (screen display) functions normally by following the menu operation from the System Menu shown below.

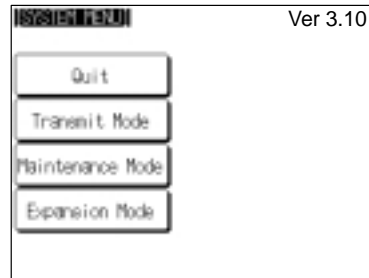

Select Maintenance Mode.



Select I/O Check.



Select Device Check.

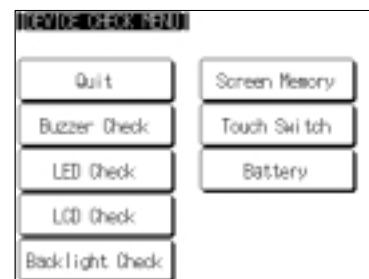

Select LCD Check.

- The check screen displays all the dots on the screen: either press anywhere on the touch panel or wait for three seconds and all the dots will be cleared.
 With the NT31C, the display and clearance of all the dots on the screen is repeated for each color in turn (red green blue magenta cyan yellow white black).
 On completion of the display and clearance of all dots, the NT31/NT31C returns to the DEVICE CHECK MENU screen.
- To abort the LCD check, press the top right corner of the touch panel. The NT31/NT31C will return to the DEVICE CHECK MENU screen.

Checking the Backlight

Check if the backlight functions normally by following the menu operation from the System Menu shown below.

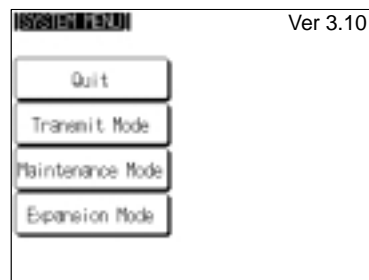

Select Maintenance Mode.



Select I/O Check.



Select Device Check.

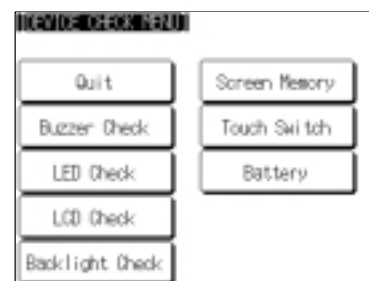

Select Backlight Check.

- If the backlight is normal, it flashes. At this time, the Backlight Check touch switch is displayed in reverse video.
- To end the backlight check, press the Backlight Check touch switch again.

Screen Data Memory Check

Check if the screen data memory is functioning normally.

Reference:

- In the screen data memory check, a write test is performed on the screen data memory. Since all the screen data in the NT31/NT31C is lost in this check, confirm that this data is backed up at the Support Tool or memory unit before executing it.
- If writing to the screen data memory is disabled by the setting for System Settings in the System Installer mode, it is not possible to execute a screen data check.

- Once a screen data check has been started, it cannot be stopped.

Check the screen data memory by following the menu operation from the System Menu shown below.

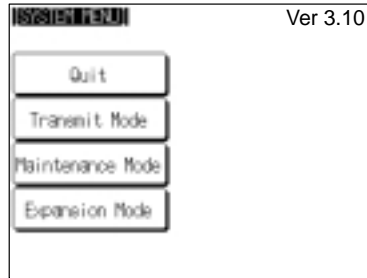

Select Maintenance Mode.

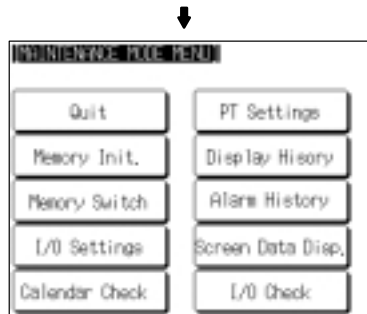

Select I/O Check.

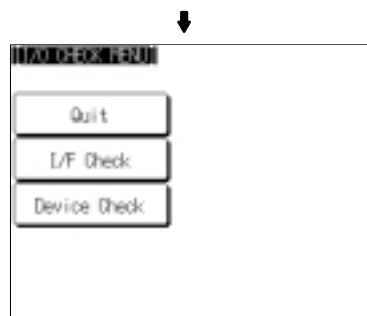

Select Device Check.

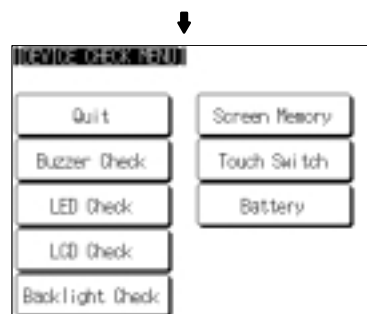

Select Screen Memory.



Press Execute.

- During the check, the message Checking Now... is displayed.

- On normal completion of the check, the message Memory Check OK is displayed.
- If an error is discovered in the check, the message Memory Check NG is displayed.

After confirming the result of the check, press Quit. The NT31/NT31C returns to the DEVICE CHECK MENU screen.

Checking Touch Switches

Check whether or not the touch switches function normally by following the menu operation from the System Menu shown below.

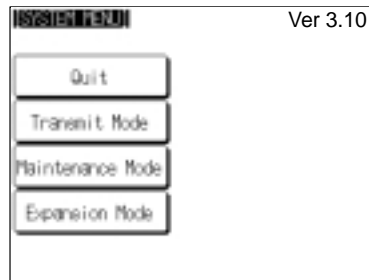

Select Maintenance Mode.

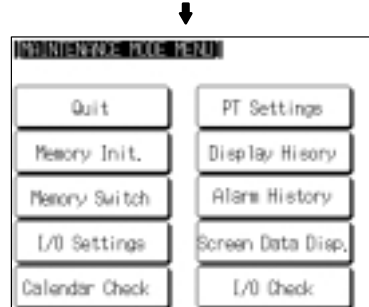

Select I/O Check.

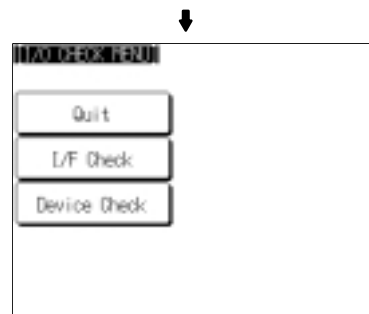

Select Device Check.

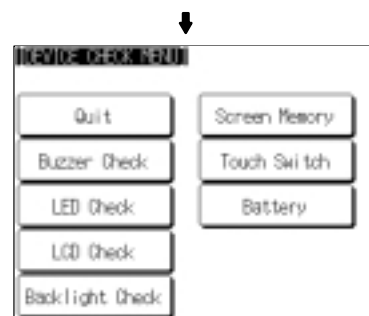

Select Touch Switch.

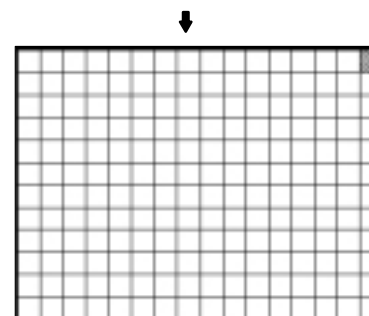

Press the touch switches displayed on the screen. A touch switch is normal if it is displayed in reverse video while pressed.

To end the check, press the touch switch at the top right corner (NT31: displayed in reverse video; NT31C: displayed in yellow). The NT31/NT31C will return to the DEVICE CHECK MENU.

- Reference:**
- The functions of touch switches pressed during the I/O check are not notified to the host.
 - The check cannot be performed until the touch switch at the top right corner is displayed in reverse video (for NT31) or displayed in yellow (NT31C). Start the check after the status of the touch switch at the top right corner has changed.
-

Checking the Battery Voltage

Check the voltage of the NT31/NT31C's built-in battery by following the menu operation from the System Menu shown below.

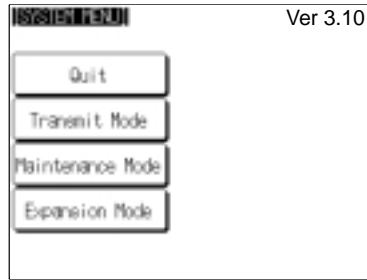

Select Maintenance Mode.



Select I/O Check.



Select Device Check.

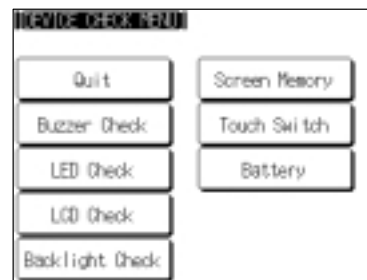

Select Battery.

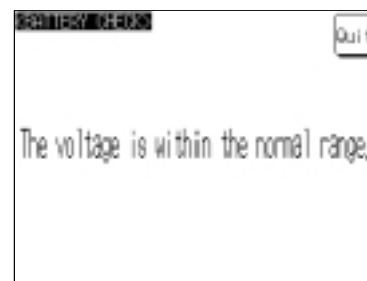

The voltage is within the normal range. or
The voltage is lowered. is displayed.

After confirming the result of the check, press Quit. The NT31/NT31C returns to the DEVICE CHECK MENU screen.

Note When The voltage is lowered is displayed, replace the built-in battery immediately. For details on the replacement method, refer to *7-3-1 Replacing the Battery* (page 244).

6-11-8 Checking Interfaces

The NT31/NT31C allows the following communication functions to be checked.

- Communication with the Support Tool Page 215
- Communication at serial ports Page 217
- Communication with printers Page 220

After confirming the result of the test, press Quit. The NT31/NT31C returns to the I/F CHECK MENU screen.

**Checking
Communication at Serial
Ports**

Check communication at the serial ports (A, B).

Check Screen

The check screen and check method differ according to the communication method set for the port to be checked.

For Host Link

Example: Serial port A while using the host link



Press Execute to start the check. The data for checking communication is sent to the host, and is displayed as the Sending Data in hexadecimal.

- If communication with the host is normal, the reply from the host is displayed at Received Data in hexadecimal.
- If a communication error occurs while checking the communication conditions with the host, a communication error screen is displayed. Since this indicates that there is a communication fault, check the communication cables and settings.

For NT Link (1:1 or 1:N)

Example: Serial port B while using the NT Link (1:N)

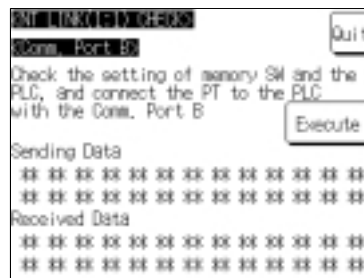

Press Execute to start the check. The data for checking communication is sent to the host, and is displayed as ** symbols at Sending Data.

- If communication with the host is normal, the reply from the host is displayed at Received Data as ** symbols.
- If a communication error occurs while checking the communication conditions with the host, a communication error screen is displayed. Since this indicates that there is a communication fault, check the communication cables and settings.

For Memory Link

Example: Serial port A while using the memory link

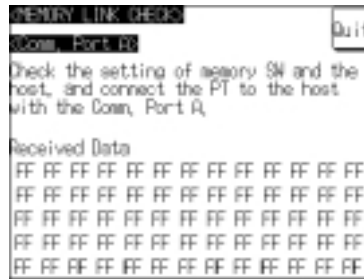

The check is started as soon as the check screen is displayed. Send the command from the host.

- If communication with the host is normal, the data received from the host is displayed in hexadecimal text code at Received Data.
- If nothing is displayed at Received Data when the command is sent from the host, there is a communication fault: check the communication cables and settings.

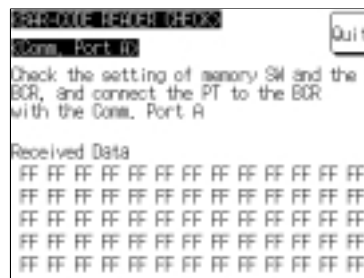
For a Bar Code Reader

The check starts when the check screen is displayed. Read data with the bar code reader in this status.

- If communication with the bar code reader is normal, the read character strings are displayed in hexadecimal text code at Received Data.
- If nothing is displayed at Received Data when data is read with the bar code reader, there is a communication fault: check the communication cables and settings.

Check Method

Check communication with the serial ports by following the menu operation from the System Menu shown below.

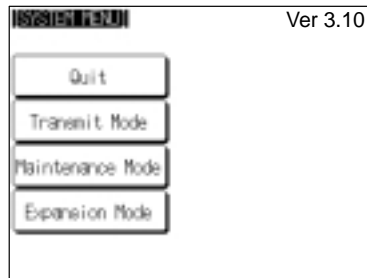

Select Maintenance Mode.



Select I/O Check.

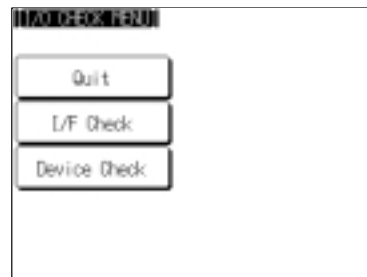

Select I/F Check.



Select Comm. Port A or Comm. Port B.

The check screen is displayed (Check screen, page 217).

After confirming the result of the check, press Quit. The NT31/NT31C returns to the I/F CHECK MENU screen.

Checking Communication with a Printer

Check communication with a printer by following the menu operation from the System Menu shown below.

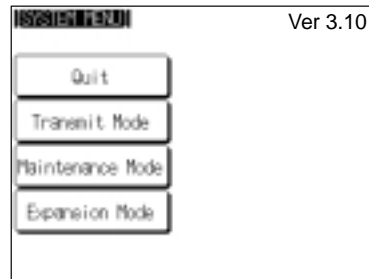

Select Maintenance Mode.



Select I/O Check.

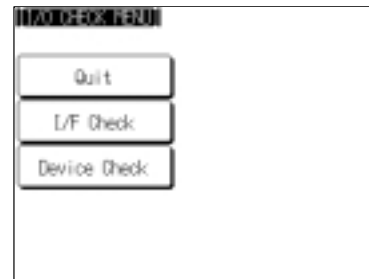

Select I/F Check.



Select Printer.



Confirm that a printer is connected to the NT31/NT31C, then press Execute: Printer Interface Check will be printed out at the printer.

- While data is being sent to the printer, the message Checking Now... is displayed.
- When the sending of data to the printer is completed, Finished Normal by Printer Interface Check is displayed.

- If data does not reach the printer within 60 seconds after sending starts, the message 'Finished Printer output failed' is displayed.

After confirming the result of the check, press Quit. The NT31/NT31C returns to the I/F CHECK MENU screen.

6-12 Programming Console Function

The NT31/NT31C features has been equipped with the Programming Console function, which allows it to be used like a C200H-PRO27-E Programming Console for CPM1, CPM2A, CPM2C, CQM1, CQM1H, C200HX/HG/HE (-Z)E, CS1-series CS1G/CS1H, or SRM1 PCs.

Except for recording (saving) ladder programs on cassette tape and replaying (reading) them, almost all the functions of a Programming Console can be executed.

Note When the programmable controller functions are used, carefully check that the system is safe before carrying out the following operations.

- Changing monitor data
- Switching the operating mode
- Forced set or reset
- Changing a present value or set value

6-12-1 Usable Systems

The Programming Console function can communicate with the PC with the communication methods indicated in the following table.

Commu- nication Method	Commu- nication Type	Applicable PCs	Connected Port
NT Link (1:1)	RS-232C	C200HE-CPU42-(Z)E ^(*1) C200HG-CPU43-(Z)E ^(*1) C200HG-CPU63-(Z)E ^(*1) C200HX-CPU44-(Z)E ^(*1) C200HX-CPU64-(Z)E ^(*1) C200HX-CPU65-ZE ^(*1) C200HX-CPU85-ZE ^(*1) CPM2A-30CD□□-□ ^(*1) CPM2A-40CD□□-□ ^(*1) CPM2A-60CD□□-□ ^(*1) CPM2C-10□□□□□□-□ ^(*2) CPM2C-20□□□□□□-□ ^(*2) CQM1-CPU4□-EV1 ^(*1) CQM1H-CPU21 ^(*1) CQM1H-CPU51 ^(*1) CQM1H-CPU61 ^(*1) SRM1-C02-V2	CPU built-in RS-232C port
		CPM1-10CDR-□ CPM1-20CDR-□ CPM1A-10CD□-□ CPM1A-20CD□-□ CPM1A-30CD□-□ CPM1A-40CD□-□	Peripheral port ^(*3)
NT Link (1:N)		CS1G-CPU42-E(V1) ^(*1) CS1G-CPU43-E(V1) ^(*1) CS1G-CPU44-E(V1) ^(*1) CS1G-CPU45-E(V1) ^(*1) CS1H-CPU63-E(V1) ^(*1) CS1H-CPU64-E(V1) ^(*1) CS1H-CPU65-E(V1) ^(*1) CS1H-CPU66-E(V1) ^(*1) CS1H-CPU67-E(V1) ^(*1)	<ul style="list-style-type: none"> • CPU built-in RS-232C port • Peripheral port ^(*4)

*1: The peripheral port Programming Console always has priority. If a Programming Console is connected later, the Programming Console function of the NT31/NT31C is invalidated and operation from the NT31/NT31C becomes impossible.

*2: The CPM2C-CN111 Connecting Cable splits the PC's Communication Port into a RS-232C port and a peripheral port.

*3: An RS-232C cable cannot be connected to the peripheral port. An RS-232C adapter (CPM1-CIF01) is required.

*4: The RS-232C cable cannot be directly connected to the peripheral port. An RS-232C converting cable (CS1W-CN118) is required.

Reference: Note that the Programming Console function cannot be used with CPM1, CQM1, and C200HX/HG/HE PCs of the following lot numbers.

CPM1: □□□5, □□*6

where * is a number in the range 1 to 9 or the letter X or Y.

CQM1: □□□3, □□□4, □□□5, □□*6

where * is a number in the range 1 to 9 or the letter X or Y.

C200HX/HG/HE: □□□5 □□*6

where * is a number in the range 1 to 9 or the letter X or Y.

6-12-2 Connection Method

CQM1, CQM1H, C200HX/HG/HE(-ZE), or SRM1

The connection method is exactly the same as for the NT Link (1:1). Refer to *Section 4 Connecting to the Host from the RS-232C Port* or *Section 5 Connecting to the Host from the RS-422A/485 Port* for details on connecting to the PC.

* When using the Programming Console function with a CQM1H, turn ON pin 7 of the DIP switch on the front of the CQM1H's CPU Unit.

CPM1 or CPM2A

The connection method is the same as for the NT Link (1:1). With a CPM1, connect the RS-232C cable to the peripheral port via a CPM1-CIF01 RS-232C Adapter or CPM1-CIF11 RS-422A Adapter.

Refer to *Section 4 Connecting to the Host from the RS-232C Port* or *Section 5 Connecting to the Host from the RS-422A/485 Port* for details on connecting to the PC.

CPM2C

The connection method is the same as for the NT Link (1:1). Connect to the PC's communications connector with a CPM2C-CN111 or CS1W-CN114/118 Connecting Cable, a CPM1-CIF01 RS-232C Adapter, or a CPM1-CIF11 RS-422A Adapter.

Refer to *Section 4 Connecting to the Host from the RS-232C Port* or *Section 5 Connecting to the Host from the RS-422A/485 Port* for details on connecting to the PC.

* When using the Programming Console function with a CPM2C, turn ON pin 2 of the DIP switch on the front of the CPM2C's CPU Unit.

CS1G/CS1H

The connection method is exactly the same as for the NT Link (1:N) (standard or high-speed). Refer to *Section 4 Connecting to the Host from the RS-232C Port* or *Section 5 Connecting to the Host from the RS-422A/485 Port* for details on connecting to the PC. The standard or high-speed 1:N NT Link can be used.

The Programming Console function can be used only when the PT's unit number is set to 0. Only one unit using the Programming Console function can be connected to each of the PC's ports (built-in RS-232C port and peripheral port).

With the CS1G/CS1H, the Programming Console function can be used simultaneously at both the built-in RS-232C port and peripheral port. Furthermore, the Programming Console function can be started at the RS-232C port while a Programming Console is connected to the peripheral port.

6-12-3 Method of Use

The Programming Console screen is displayed by operating the system menu as described below.

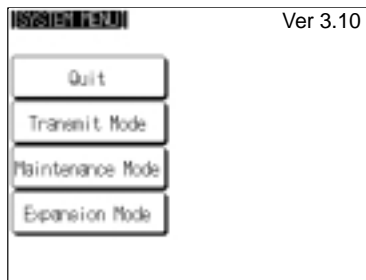

Select Expansion Mode.

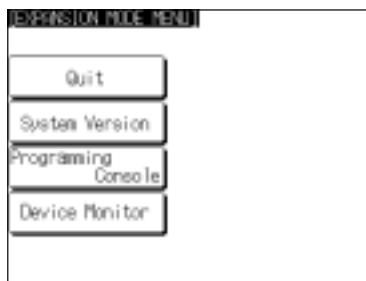

Select Programming Console.

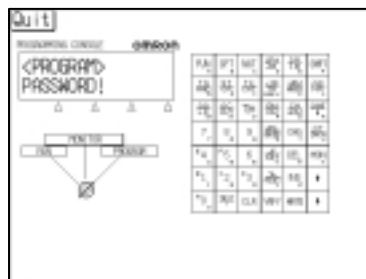

The Programming Console screen is displayed.

Press the Programming Console sheet keys (touch switches) for the operation.

Press the Quit touch switch to exit the screen.

An error is displayed if a wrong communication protocol is selected or a Programming Console is connected to the peripheral port.^(*1)

*1: With the CS1G/CS1H, the Programming Console function can be used simultaneously at both the built-in RS-232C port and peripheral port.

Reference: When an error screen is displayed, press the Check touch switch on the screen to return to the system menu. In addition, pressing two of the four corners of the touch panel simultaneously in the error screen enables the display of the system menu.

Key Operations

Mode Selection Keys, Mode Lock Key

The display element on the Programming Console screen shown below comprises the mode selection keys, which change the operation mode of the PC, and the mode lock key, which prevents unintended mode changes.

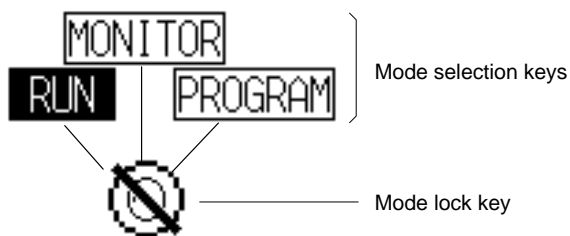

The RUN, MONITOR, and PROGRAM mode selection key elements are touch switches and pressing them causes the PC operation mode to change (unlike an actual Programming Console, it is possible to switch directly between the RUN mode and the PROGRAM mode.)

When the Programming Console function is started, the PC operation status is read and reflected at the PC.

The mode lock key element is also a touch switch, and it alternates between the lock ON (with no key displayed) and lock OFF (with key displayed) states when pressed. During the lock ON state, mode selection key operations are ineffective. The mode displays change as indicated in the figures below during the lock ON status and during the lock OFF status.

When the Programming Console function starts, the lock ON status is established.

If the RUN, MONITOR, or PROGRAM mode selection key is pressed in the lock OFF status, the mode changes and the lock ON status is established.

During Lock OFF

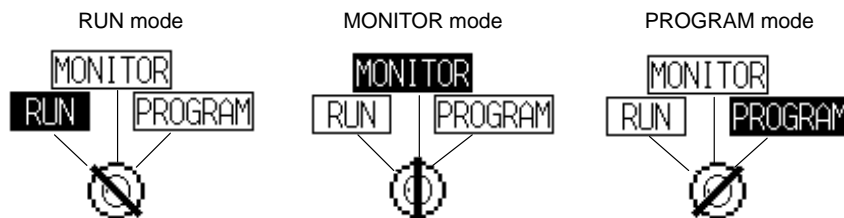

During Lock ON

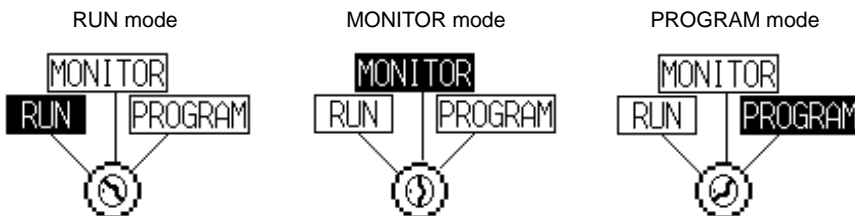

Programming Console Keyboard

The Programming Console keyboard used on the screen when the Programming Console function is used is comprised entirely of touch switches (shown by the dashed line frames in the figure below). On pressing a touch switch, a key operation is executed. However, since there is a discrepancy between the size of the displayed keys and the size of the touch switches, take care to press as close to the center of the key as possible by referring to the figure below.

In addition, if the connected host is the CS1G/CS1H, the Programming Console key sheet for the CS1 series is automatically displayed.

Standard Programming Console Key Sheet

Quit		PROGRAMMING CONSOLE					OMRON		
<PROGRAM> PASSWORD △ △ △ △ MONITOR RUN PROGRAM 		FUN	SET	NOT			SHIFT		
		AND #	OR #	CNT	TR	*EM LR	AR HR		
		LD #	OUT #	TIM	EM DM	CH *DM	CONT #		
		7	8	9	EXT	CHG	SRCH		
E 4	F 5	6	PLAY SET	DEL	MONTR				
B 1	C 2	D 3	REC RESET	INS	↑				
A 0		CLR	VER	WRITE	↓				

Programming Console Key Sheet for CS1 Series

Quit		PROGRAMMING CONSOLE					OMRON		
<PROGRAM> PASSWORD △ △ △ △ MONITOR RUN PROGRAM 		FUN A	SFT B	NOT C	IR+ IR D	DR IR E	SHIFT F		
		TN AND G	ST OR H	TK CNT I	IR- TR DISP J	*EM WR/LR K	AR HR L		
		AA LD M	AC OUT N	TIM O	EM DM P	CH *DM Q	CONT # R		
		7 7	8 8	9 9	*EM EM/EXT S	CHG T	CF SRCH U		
E 4 4	F 5 5	6 6	↑ SET V	DEL W	MON X				
B 1 1	C 2 2	D 3 3	↓ RESET Y	INS Z	↑				
A 0 0	TEXT !	CLR	VERFY	WRITE	↓				

Differences with Respect to Programming Consoles

- Programs cannot be stored (recorded) or read (replayed). If it is necessary to store or read a program, use a Programming Device.
- It is not possible to adjust the volume of the key press sound. Whether or not the key press sound sounds is determined by the setting for the Key Press Sound memory switch of the NT31/NT31C. It sounds when the setting is ON and does not when the setting is OFF (page 170).
- If an error occurs when using the Programming Console function, an error screen is displayed. Whether or not the buzzer sounds at this time is determined by the setting for the Buzzer Sound memory switch of the NT31/NT31C (page 171).

Reference: A communications error will occur if you use the Programming Console function to change the communications settings (in the PC's PC Setup) that govern the port to which the NT31/NT31C is connected. In this case, the Programming Console function will be unusable.

6-13 Device Monitor Function

The NT31/NT31C has been equipped with the Device Monitor function which can be used to change the PC's operating mode, read/change words in the PC's data areas, and display the PC's error log of a CS1G/CS1H, CPM1, CPM2A, CPM2C, CQM1, CQM1H, C200HX/HG/HE(-Z)E, or SRM1.

The Device Monitor can perform the following operations:

- Changing the PC's operating mode
- Displaying/changing the contents of words, displaying/changing the status of bits, force-setting/force-resetting the status of bits (Registration Monitor)
- Listing the contents of a range of words (Continuous Monitor)
- Displaying the error log and clearing errors (Error Log)

This section provides an overview of the Device Monitor function and explains how to connect to the PC. For more details, refer to 2-16 *Device Monitor Function* in the *Reference Manual*.

**Caution**

Be sure that it is safe to proceed before using the Device Monitor function to perform one of the following operations from the PT.

- Changing monitored data
- Switching the PC's operating mode
- Force setting or force resetting bits
- Changing PVs or SVs

Reference:

- The Device Monitor function can be used with Ver. 3.0 and higher versions of the PT system program only.
- The Device Monitor functions are almost identical to the functions of the Data Access Console (DAC).
- The Device Monitor function cannot be used with host link or memory link communications.

6-13-1 Compatible Systems

The following table shows the combinations of communications methods and PCs that can support the PT's Device Monitor function.

Communications method	PC model	
1:1 NT Link	C200HS-CPU21-E	CPM1-10CDR-□* ¹
	C200HS-CPU23-E	CPM1-20CDR-□* ¹
	C200HS-CPU31-E	CPM1A-10CD□-□* ¹
	C200HS-CPU33-E	CPM1A-20CD□-□* ¹
	C200HE-CPU32 (-Z)E	CPM1A-30CD□-□* ¹
	C200HE-CPU42 (-Z)E	CPM1A-40CD□-□* ¹
	C200HG-CPU33 (-Z)E	CPM2A-30CD□□-□
	C200HG-CPU43 (-Z)E	CPM2A-40CD□□-□
	C200HG-CPU53 (-Z)E	CPM2A-60CD□□-□
	C200HG-CPU63 (-Z)E	CPM2C-10□□□□□□-□* ²
	C200HX-CPU34 (-Z)E	CPM2C-20□□□□□□-□* ²
	C200HX-CPU44 (-Z)E	CQM1-CPU4□-EV1
	C200HX-CPU54 (-Z)E	CQM1H-CPU21
	C200HX-CPU64 (-Z)E	CQM1H-CPU51
	C200HX-CPU65-ZE	CQM1H-CPU61
	C200HX-CPU85-ZE	SRM1-C02-V2
1:N NT Link	C200HE-CPU32 (-Z)E	CQM1H-CPU21
	C200HE-CPU42 (-Z)E	CQM1H-CPU51
	C200HG-CPU33 (-Z)E	CQM1H-CPU61
	C200HG-CPU43 (-Z)E	SRM1-C02-V2
	C200HG-CPU53 (-Z)E	CS1G-CPU42-E(V1)
	C200HG-CPU63 (-Z)E	CS1G-CPU43-E(V1)
	C200HX-CPU34 (-Z)E	CS1G-CPU44-E(V1)
	C200HX-CPU44 (-Z)E	CS1G-CPU45-E(V1)
	C200HX-CPU54 (-Z)E	CS1H-CPU63-E(V1)
	C200HX-CPU64 (-Z)E	CS1H-CPU64-E(V1)
	C200HX-CPU65-ZE	CS1H-CPU65-E(V1)
	C200HX-CPU85-ZE	CS1H-CPU66-E(V1)
		CS1H-CPU67-E(V1)

*1: A CPM1-CIF01 RS-232C Adapter is required.

*2: Use a Conversion Cable (CPM2C-CN111 or CS1W-CN114/118), CPM1-CIF01 RS-232C Adapter, or CPM1-CIF11 RS-422A Adapter to connect to the PC.

6-13-2 Connection Method

CQM1H or C200HX/HG/HE(-ZE)

The 1:1 NT Link or 1:N NT Link can be used. The connection method is exactly the same as for the 1:1 NT Link or 1:N NT Link. Refer to *Section 4 Connecting to the Host from the RS-232C Port* or *Section 5 Connecting to the Host from the RS-422A/485 Port* for details on connecting to the PC.

CQM1 or C200HS

The 1:1 NT Link can be used. The connection method is exactly the same as for the 1:1 NT Link. Refer to *Section 4 Connecting to the Host from the RS-232C Port* or *Section 5 Connecting to the Host from the RS-422A/485 Port* for details on connecting to the PC.

CPM1, CPM2A, or SRM1

The 1:1 NT Link can be used in all CPUs and the 1:N NT Link can also be used in -V2 and higher versions of the SRM1. The connection method is exactly the same as for the 1:1 NT Link or 1:N NT Link. With a CPM1, connect the RS-232C cable to the peripheral port via a CPM1-CIF01 RS-232C Adapter or CPM1-CIF11 RS-422A Adapter.

Refer to *Section 4 Connecting to the Host from the RS-232C Port* or *Section 5 Connecting to the Host from the RS-422A/485 Port* for details on connecting to the PC.

CPM2C

The 1:1 NT Link can be used. The connection method is the same as for the NT Link (1:1). Connect to the PC's communications connector with a CPM2C-

CN111 or CS1W-CN114/118 Connecting Cable, a CPM1-CIF01 RS-232C Adapter, or a CPM1-CIF11 RS-422A Adapter.

Refer to *Section 4 Connecting to the Host from the RS-232C Port* or *Section 5 Connecting to the Host from the RS-422A/485 Port* for details on connecting to the PC.

CS1G/CS1H

The 1:N NT Link (standard or high-speed) can be used. The connection method is exactly the same as for the 1:N NT Link.

Refer to *Section 4 Connecting to the Host from the RS-232C Port* or *Section 5 Connecting to the Host from the RS-422A/485 Port* for details on connecting to the PC.

6-13-3 Method of Use

The Device Monitor screen is displayed by operating the system menu as described below.

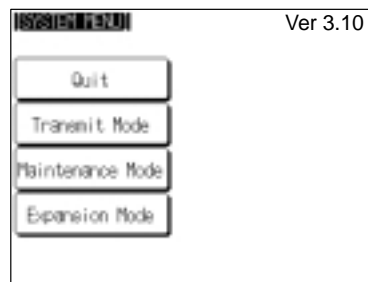

Select Expansion Mode.



Select Device Monitor.

An error message will be displayed if the wrong communications protocol is selected.

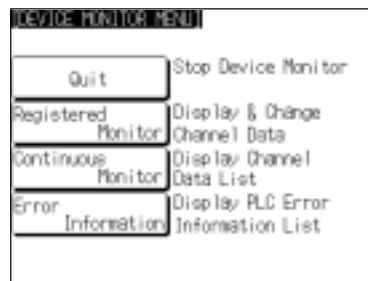

The Device Monitor screen is displayed.

Reference: When an error screen is displayed, press the Check touch switch on the screen to return to the system menu. In addition, pressing two of the four corners of the touch panel simultaneously in the error screen enables the display of the system menu.

For more details on operations of the Device Monitor function, refer to *2-16 Device Monitor Function* in the *Reference Manual*.

6-14 Version Display

Use the Version Display function to check the version of the NT31/NT31C's system program. The Version Display screen shows the model, creation date, and version of the system program installed in the NT31/31C.

6-14-1 Method of Use

The Version Display screen is displayed by operating the system menu as described below.

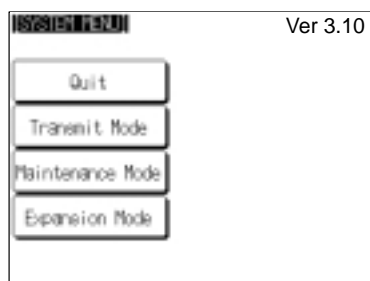

Select Expansion Mode.

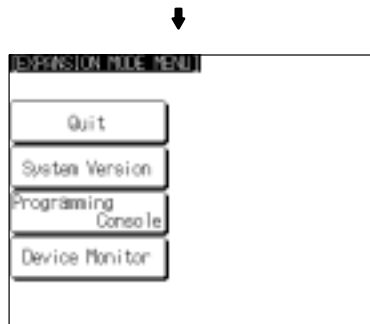

Select Version Display.

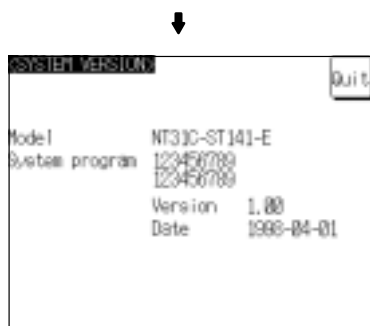

The system program's version information will be displayed as described below. Press the Quit touch switch to exit the Version Display screen and return to the Expansion Mode screen.

- PT Model: PT model number
- System program: System program name
- Version System program version
- Date Date program was created.

This screen is an example. Actual screens will show the information specific to the PT and system program being used.

After checking the version information, press the Quit touch switch to exit the Version Display screen and return to the Expansion Mode screen.

- Reference:**
- The PT model always shows the model number of the ivory model of the PT. The B suffix will not be displayed, even for black models.
 - The system program's version number is also displayed in the upper-right corner of the System Menu.
 - The creation date does not always match the file date of the system program installed with the System Installer.

SECTION 7

Troubleshooting and Maintenance

This section describes the action to take when errors occur in the PT, and how to carry out maintenance and inspection to prevent the occurrence of errors.

7-1	Troubleshooting	232
7-2	Responding to Displayed Error Messages	235
7-2-1	Errors Occurring at Start of Operation and Their Remedies	235
7-2-2	Errors Occurring during Operation and Their Remedies	237
7-2-3	Errors Occurring on Screen Data Initialization and Transmission	238
7-2-4	Errors in the System Installer Mode and Their Remedies	239
7-2-5	Communication Errors and Their Remedies	239
7-3	Maintenance of the NT31/NT31C	241
7-3-1	Replacing the Battery	244
7-4	Inspection and Cleaning	245

7-1 Troubleshooting

When a fault relating to the operation of the NT31/NT31C occurs, find the symptoms in the table below and respond by following the corresponding *Remedy* indicated in the table.

- Note**
1. Confirm system safety before turning the power ON/OFF or resetting.
 2. Do not disassemble the PT for repair or modification.

NT31/NT31C Symptoms	Cause	Remedy
Power LED fails to come ON	Power is not being supplied.	Check the connections and make sure that power is supplied correctly. (3-1-3 <i>Power Supply Connection</i> , page 33)
	Power supply fuse has blown.	Contact your OMRON service center.
Nothing is displayed on the screen.	Screen No. 0 has been read at the host side.	This is not an error. Change the screen number from screen number 0. (Setting the screen number to 0 turns the screen off.)
	The system startup waiting time has not elapsed yet.	This is not an error. The display will appear after the waiting time has elapsed.
Cannot communicate with the Support Tool	The Transmit mode has not been established.	Display the System Menu and select the Transmit mode. (6-6 <i>Transmitting the Screen Data</i> , page 155)
	Not connected to the Support Tool.	Check the installation of the connector cable. (3-2 <i>Connecting to the Support Tool</i> , page 35)
	The PT model setting and direct connection setting at the Support Tool do not match the NT31/NT31C.	Using the PT Configuration settings of the Support Tool, set the PT model and direct connection settings that match the NT31/NT31C.
Cannot communicate with the host Cannot switch from the system initializing screen. Communication error message is displayed when communicating to the host.	Memory switch settings do not match.	Check the communication setting in the Memory Switch menu of the Maintenance mode, and match the communication protocol settings for the host and NT31/NT31C. (6-7 <i>Setting Conditions for Communications with Host by Using Memory Switches</i> , page 157)
	NT31/NT31C and host are not correctly connected.	Check that the type, length, and installation of the connector cable match the specifications. (Section 4 <i>Connecting to the Host from the RS-232C Port</i> , and Section 5 <i>Connecting to the Host from the RS-422A/485 Port</i>)
	In an RS-422A/485 connection, the terminator setting is incorrect.	Make the NT31/NT31C and PC termination resistance settings correctly. (Section 4 <i>Connecting to the Host from the RS-232C Port</i> , and Section 5 <i>Connecting to the Host from the RS-422A/485 Port</i>)
	In an NT Link (1:N) connection, there is duplication in the unit numbers.	Make the settings again so that there is no duplication. (6-7-4 <i>Setting the NT Link (1:N) Method (Standard/High-speed)</i> , page 163)
	The power to the NT31/NT31C, NT-AL001 or host is OFF.	Check the power supply.
The buzzer has sounded and the RUN LED is OFF.	Malfunction due to external noise	Carry out grounding work in accordance with the conditions by referring to 3-1-4 <i>Grounding</i> , page 34.
	The NT31/NT31 has developed trouble.	Contact your OMRON service center.
The touch panel does not respond.	Malfunction due to external noise	Carry out grounding work in accordance with the conditions by referring to 3-1-4 <i>Grounding</i> , page 34.
	The touch panel is broken.	Test the touch panel with I/O Check in the MAINTENANCE MODE menu. If there is an error, contact your OMRON service center.
The PC mode has changed to the monitor mode.	The NT31/NT31C changes the mode when host link communication is used.	This is an NT31/NT31C specification. When using a PC that can also be connected using the NT Link method, use an NT Link connection (there is no mode change with the NT Link method).

NT31/NT31C Symptoms	Cause	Remedy
The graph display does not change.	One of the percentage display settings — -100%, 0%, or 100% — is incorrect.	Set the -100%, 0%, and 100% values in the following relationship: -100% value < 0% value < 100% value
The trend graph display does not agree with the actual time axis.	The cycle for graph display update processing is longer than the set sampling cycle.	Delete other elements on the same screen as the trend graph that are allocated to the host and have a high update frequency. Or lengthen the sampling cycle.
The Programming Console function cannot be used.	The communication settings are incorrect.	Set the communication method as follows when using the Programming Console function. • With C-series PLC: 1:1 NT Link • With CS1-series PLC: 1:N NT Link (standard or high-speed)
	A Programming Console is connected.	It is not possible to use a Programming Console and the Programming Console function at the same time. Disconnect the Programming Console.
	The PC does not support the Programming Console function.	Not all PCs support the Programming Console function. Check the model of PC you are using. (6-12 Programming Console Function, page 221)
	The system program for other vendor's PCs has been installed. (PC models other than OMRON.)	The Programming Console function can be used only when the system program for OMRON PCs is installed. Install the correct system program.
The Device Monitor function cannot be used.	The communications settings are not correct.	Set the communication method as follows when using the Device Monitor function. • With C-series PLCs: 1:1 NT Link or 1:N NT Link • With CS1-series PLCs: 1:N NT Link (standard or high-speed)
	The PC does not support the Device Monitor function.	Not all PCs support the Device Monitor function. Check the model of PC you are using. Refer to 6-13 Device Monitor Function for details.
	The system program installed in the PT is for a PC maker other than OMRON.	The Device Monitor function can be used only when the PT is connected to a PT with the system program for OMRON PCs installed. Install a system program that supports the Device Monitor function.
The memory table display contents differ from the initial value set at the Support Tool.	Since the memory table is allocated to the host memory, the display is updated in accordance with the contents of the host memory.	When the contents of the memory table are set as a fixed value, do not allocate the memory table to the host.
	The battery voltage has dropped and the data in the memory table has been destroyed.	Replace the battery and execute memory table initialization. (7-3-1 Replacing the Battery, page 244, and 6-4-5 Initializing the Memory Tables, page 147)
	Since ON is set for the resume function, the initial values of the screen data memory are not written to the memory tables.	Execute memory table initialization. (6-4-5 Initializing the Memory Tables, page 147) If the resume function does not need to be used, use the NT31/NT31C with the resume function OFF. (6-9-10 Setting the Resume Function, page 181)
	The numeral memory table is specified as the destination for a mathematical table's results.	Calculations are executed continuously while the PT is operating and the calculation results are automatically written to the memory table. Specify another numeral memory table or a word in the host.

NT31/NT31C Symptoms	Cause	Remedy
Updating of numeric values and text is delayed.	Malfunction due to external noise	Carry out grounding work in accordance with the conditions by referring to <i>3-1-4 Grounding</i> , page 34.
	There are too many numeral/text displays on the displayed screen.	Reduce the number of numeral/text displays on the screen for which updating is delayed.
	The cycle time is extended due to heavy processing at the host.	Shorten the host cycle time.
	In an RS-422A/485 connection, there is illegal branching or an erroneous terminator setting.	Wire correctly by referring to <i>Section 5 Connecting to the Host from the RS-422A/485 Port</i> .
Some of the elements arranged on a normal screen are not displayed.	The quantity of read data exceeds the stipulated restriction.	Check the maximum number of elements by referring to <i>Display Restrictions</i> in <i>Appendix A of the Reference Manual</i> . Create the screen data again and then transmit all of the screen data in a batch to the NT31/NT31C.
	The total of the element coefficients for the displayed screen is greater than 1024.	
On an overlapping screen, some of the set elements are not displayed.	Since the data is transmitted from the host in screen units, the number of elements on the overlapping screen has exceeded the maximum permissible without being checked by the Support Tool.	Check the maximum number of elements by referring to <i>Display Restrictions</i> in <i>Appendix A of the Reference Manual</i> . Create the screen data again and then send all the screen data in a batch to the NT31/NT31C.
The System Menu cannot be called up.	Display System Menu under Change System Settings in the System Installer mode is set to Disabled.	In the System Installer mode, set Display System Menu to Enabled (page 153).
The following System Menu operations are not possible. - Establishing the Transmit mode - Displaying the memory switch setting screens - Screen data memory check - Displaying the initialization menu - Displaying the calendar/time setting screen	Screen Memory Protect under Change System Setting in the System Installer mode is set to Disabled.	In the System Installer mode, set Screen Memory Protect to Enabled (page 153). Do not turn the PT power OFF during deletion of screen data. In the System Installer mode, first change the setting for Screen Memory Protect to Enabled, then repeat the screen data delete operation (pages 153 and 154)
	Screen Memory Protect has been set to Disabled because the PT power supply was turned OFF during deletion of screen data.	
Cannot input numeric values	The upper/lower (max./min.) limit check for numeric value input is in effect.	Check the screen data's upper/lower (max./min.) limit check setting for numeric value input, and correct it if necessary. Refer to <i>2-12 Inputting Numeric Values</i> in the Reference Manual for details.
Cannot input numeric values/character strings.	Bit 5 of the PT status control area (numeral/character string input) is set to 1 (ON).	Set bit 5 to 0 (OFF). Refer to <i>2-2-1 PT Status Control Area (Host ↔ PT)</i> in the Reference Manual for details.
	The interlock function is set for the input field and the controlling interlock bit is OFF.	Inputs are prohibited in input fields when the corresponding interlock bit is OFF. Check the status of the corresponding interlock bit and turn it ON.
Window screen does not open	Bit 6 of the PT status control area (PT window opening) is set to 1 (ON).	Set bit 6 to 0 (OFF). Refer to <i>2-2-1 PT Status Control Area (Host ↔ PT)</i> in the Reference Manual for details.
Cannot switch screens with touch switches	Bit 4 of the PT status control area (PT screen switching) is set to 1 (ON).	Set bit 4 to 0 (OFF). Refer to <i>2-2-1 PT Status Control Area (Host ↔ PT)</i> in the Reference Manual for details.
Touch switch does not work. (Buzzer sounds.)	The interlock function is set for the touch switch and the controlling interlock bit is OFF.	Touch switches are disabled when the corresponding interlock bit is OFF. Check the status of the corresponding interlock bit and turn it ON.

NT31/NT31C Symptoms	Cause	Remedy
The display is dim.	Insufficient contrast or brightness	Increase the contrast/brightness (pages 191 and 193).
	Backlight defective, or its life has expired	Replace the backlight (page 242).
The display is too faint.	The contrast is too high.	Reduce the contrast (page 191).
The digits in numeral display come out as *.	The number of digits of a numeric value in a numeral memory table exceeds the set number.	<ul style="list-style-type: none"> • Confirm the values of the PC words allocated to the numeral memory table. • Allocate one PC word to each numeral memory table.

7-2 Responding to Displayed Error Messages

When the NT31/NT31C displays an error message, find the corresponding symptoms in the appropriate table below and respond by following the Remedy indicated in the table.

For details of the error messages displayed when using memory unit and corrective action to take for them, refer to 3-5 *Using a Memory Unit (NT31/NT31C with V□)* in page 39 or 3-6 *Using a Memory Unit (NT31/NT31C without V□)* in page 47.

7-2-1 Errors Occurring at Start of Operation and Their Remedies

The table below shows the errors that can occur when the power to the NT31/NT31C is turned ON and when operation starts, and their remedies.

Message	Cause	Remedy
[No Comm. Protocol] Set the comm. Protocol by MAINTENANCE MODE.	No communication protocol has been set. Communication protocol and screen data type are mismatched	Using the memory switches, set the communication method to be used for communication with the host. (6-7 <i>Setting Conditions for Communications with Host by Using Memory Switches</i> , page 157)
[Screen Data Error] Screen Data corrupted. Initialize Screen Memory, and download Screen Data again.	<ul style="list-style-type: none"> - The power was switched OFF during screen data initialization, checking, or transmission. - Transmission of screen data was interrupted. - Illegal data has been written to the screen data memory. 	Initialize the screen data memory by operation at the System Menu, then re-transmit the screen data. (6-4-1 <i>Clearing Screen Data</i> , page 140) If the problem persists, contact your OMRON service center.
[No Screen Data] No Screen Data is saved in Screen Memory. Download Screen Data using by the Support Tool. Then set the PT to the TRANSMIT MODE, and download Screen Data again.	No screen data is registered.	Transmit screen data from the Support Tool.
[No Direct Connection Info.] No Direct Connection Information is set in Screen Data. Set Direct Connecting Information in Screen Data using by the Support Tool. Then set the PT to the TRANSMIT MODE and download Screen Data again.	Allocated words have not been set for the PT status control area and PT status notify area.	Allocate words for the PT status control area and PT status notify area with the Support Tool and then transmit the direct connection information to the NT31/NT31C.

Message	Cause	Remedy
[Incorrect Screen Data] Screen Data in Screen Memory do not match with the System Program. Initialize Screen Memory, and download Screen Data again.	The type of registered screen data does not match that at the NT31/NT31C.	Initialize the screen data memory, then transmit the correct screen data. (6-4-1 <i>Clearing Screen Data</i> , page 140)
[No Starting Screen] Specified Starting Screen is not saved. Fix Screen Data using by the Support Tool. Then set the PT to the TRANSMIT MODE and download Screen Data again.	No data is registered for either the screen number set in the PT status control area or the Initial Screen set with the Support Tool. Or the screen number which does not exist are registered.	Either specify a screen number for which data is registered at the PT status control area, or set the screen as the Initial Screen in the System settings under PT Configuration at the Support Tool.
[Touch Panel is disconnected]	The touch panel cable (film cable) inside the NT31/NT31C is disconnected.	Contact your OMRON service center.
[Memory Switch Corrupted] Because Memory Switch setting was last. Initialized Memory Switch setting. Press Confirm to return to the SYSTEM MENU.	The memory switches have been initialized due to discovery of an error in the memory switch settings.	Set the memory switches again using the System Menu and the System settings under PT Configuration at the Support Tool. (<i>Section 6 System Menu Operation</i>) If the problem recurs, contact your OMRON service center.
[Calendar Data Error] Calendar Data is incorrect. Set to the MAINTENANCE MODE and set Calendar Data.	There is an error in the date/time values due, for example, to low battery voltage.	Check the battery voltage by checking the color of the RUN LED and with the battery check in the System Menu; if the voltage is low, replace the battery with a new one. (<i>Checking the Battery Voltage</i> , page 214, and 7-3-1 <i>Replacing the Battery</i> , page 244) If the battery voltage is confirmed to be normal, set the calendar clock correctly from the System Menu. (6-11-2 <i>Displaying/Setting the Calendar and Clock</i> , page 195)
[Backup Data Error] Memory table and History data was initialized by backup failure. It can be caused by lowered voltage of the battery.	Initialization has been executed because of an error in the backup data area.	Check the battery voltage by checking the color of the RUN LED and with the battery check in the System Menu; if the voltage is low, replace the battery with a new one. (<i>Checking the Battery Voltage</i> , page 214, and 7-3-1 <i>Replacing the Battery</i> , page 244) The re-transmit the memory table data from the Support Tool. If the voltage is normal and the problem recurs, contact your OMRON service center.
[With memory switch setting screen] Invalid Comm. Method	Protocol settings for serial port A and serial port B are mismatched.	Refer to Possible Combinations of Communication Method Settings in page 158 and set the protocol of serial port A and serial port B so that their settings are matched. * Set serial port A to None when connecting the Support Tool and the host at the same time.

7-2-2 Errors Occurring during Operation and Their Remedies

The table below shows the errors that can occur during operation of the NT31/NT31C and their remedies.

Message	Cause	Remedy
[Address Setting Error] Addressing Error exists in the Screen. Correct address setting by the Support Tool.	The host side allocated words and bits set with the Support Tool are incorrect.	Set correct words and bits after checking the area used at the host side by referring to PC Memory Map in <i>Appendix D</i> of the <i>Reference Manual</i> or the operation manual for the PC being used.
[Memory Table No. Error] Memory table No. is out of limit. Correct the table No. by the Support Tool.	The memory table number set with the Support Tool is outside the range for the number of memory tables set in the system memory.	Either increase the number of memory tables in the System settings under PT Configuration at the Support Tool, or set the memory table number again within the established range.
[Programming Console Error] Setting of Programming Console Function is inadequate. It can be caused by: <ul style="list-style-type: none"> This PLC does not support Programming Console Function. Protocol mismatch. Set the PLC to NT Link. "PROGRAMMING CONSOLE" is connected to PLC. 	The communication settings are incorrect.	Set the communication method/communication port as follows when using the Programming Console function. <ul style="list-style-type: none"> With C-series PLCs:1:1 NT Link With CS1-series PLCs: 1:N NT Link (standard or high-speed)
	The PC used does not support the Programming Console function.	Not all PCs support the Programming Console function. Check the model of the PC you are using. (<i>6-12 Programming Console Function</i> , page 221)
	A Programming Console is connected.	It is not possible to use a Programming Console and the Programming Console function at the same time. Disconnect the Programming Console.
[Programming Consol Error] Programming Console Function does not RUN. It can be caused by: <ul style="list-style-type: none"> Connecting cable is faulty. "PROGRAMMING CONSOLE" is connected to PLC. Protocol mismatch between the PT and PLC. Set the PLC to NT Link. 	The connecting cable is defective.	Check the cable connection and perform a conductivity test. If there is a fault, replace the cable.
	Malfunction due to external noise	Carry out grounding work in accordance with the conditions by referring to <i>3-1-4 Grounding</i> , page 34.
	A Programming Console is connected.	It is not possible to use a Programming Console and the Programming Console function at the same time. Disconnect the Programming Console.
	The communication conditions at the PC have been changed in accordance with the NT31/NT31C Programming Console function.	Set the communication conditions at the PC to match the conditions set in the System Menu.

7-2-3 Errors Occurring on Screen Data Initialization and Transmission

The table below shows the errors that can occur when the NT31/NT31C data is initialized, and during data setting and transmission, and their remedies.

Message	Cause	Remedy
[Flash Memory Error] Flash Memory I/O Error. If this happens frequently, Flash Memory may be broken. Press Reset Switch to restart.	There is a hardware fault, or the flash memory (memory for storing screen data) has reached the end of its service life.	If the same message is displayed even after clearing the screen data or transmitting screen data several times, contact your OMRON service center.
[Calendar Data Error] Calendar Data is incorrect. Set to the MAINTENANCE MODE and set Calendar Data.	Hardware fault, or system program error	Set the calendar clock again from the System Menu. If the problem recurs, delete the program in the System Installer mode, then re-install the program. (6-5-2 <i>Clearing/Installing the System Program</i> , page 151) If this does not solve the problem, contact your OMRON service center.
[Tool Transmit Error] **** Error detected while downloading by the following case: • faulty connecting cable. • corrupted data by noise.	The connecting cable is defective.	Check the cable connection and perform a conductivity test. If there is a fault, replace the cable. (<i>Appendix F Making the Cable for Connecting a PC</i> , page 269)
	Malfunction due to external noise	Carry out grounding work in accordance with the conditions by referring to 3-1-4 <i>Grounding</i> , page 34.
[Tool Transmit Error] Check Sum Error occurs while downloading by the following case: • corrupted data by noise.	Malfunction due to external noise	Carry out grounding work in accordance with the conditions by referring to 3-1-4 <i>Grounding</i> , page 34.
[Tool Transmit Error] Time-out Error occurs while downloading by the following case: • faulty connecting cable.	The connecting cable is defective.	Check the cable connection and perform a conductivity test. If there is a fault, replace the cable.
[Tool Transmit Error] Reception was failed by Buffer Over Flow Error.	The receive buffer has overflowed.	Retransmit the data from the Support Tool.

7-2-4 Errors in the System Installer Mode and Their Remedies

This section describes the errors that may occur in the System Installer mode of the NT31/NT31C, and the remedies for these errors.

Message	Cause	Remedy
System Program not exist or incorrect.	<ul style="list-style-type: none"> - The system program has not been installed. - The system program has been deleted due to a hardware fault, or because the flash memory (memory for storing the system program) has reached its life. 	<p>Select Download System Program and download the system program (6-5-2 <i>Clearing/Installing the System Program</i>, page 151).</p> <p>If this does not solve the problem, contact your OMRON service center.</p>
Unable to erase System Program.	Hardware fault, or flash memory (memory for storing the system program) has reached its life.	If the same message is displayed on repeating selection of Download System Program and attempting to delete the system program several times, contact your OMRON service center (6-5-2 <i>Clearing/Installing the System Program</i> , page 151).
Unable to download System Program.	<ul style="list-style-type: none"> - A communication error occurred during downloading of the system program. - Illegal data has been written into the screen data memory. - Hardware fault, or flash memory (memory for storing the system program) has reached its life. 	<p>Select Download System Program and download the system program again (6-5-2 <i>Clearing/Installing the System Program</i>, page 151).</p> <p>Also refer to 7-2-3 <i>Errors Occurring on Screen Data Initialization and Transmission</i> (page 238), and take the corrective action described for tool transmission errors.</p> <p>If this does not solve the problem, contact your OMRON service center.</p>
Unable to write System Settings.	Hardware fault, or flash memory (memory for storing the system program) has reached its life.	<p>If the same message is displayed on repeating writing of system settings several times, contact your OMRON service center.</p> <p>If writing is normally terminated after the error message was once displayed, the Memory Switch setting for system program may have been altered. In such a case, check and re-set the setting in the Memory Switch menu of the Maintenance mode.</p>
Unable to erase Screen Data.	Hardware fault, or flash memory (memory for storing the system program) has reached its life.	If the same message is displayed on repeating screen data deletion several times, contact your OMRON service center.

7-2-5 Communication Errors and Their Remedies

This section describes the errors relating to communication that can occur during operation, and their remedies.

Operation When a Communication Error Occurs

When a communication error occurs, the error message is displayed at the NT31/NT31C, and the buzzer sounds, provided the setting made for Buzzer Sound in the System Menu is other than OFF. An error message is displayed provided the setting for the Comm. Auto-Return memory switch is not ON (note that some error messages are displayed even if the setting is ON).

Operation When Communication Errors Occur

When an error message is displayed, press the OK touch switch displayed on the screen. The NT31/NT31C will return to the screen that was displayed before the error occurred, and operation will restart.

Display of Communication Errors

For communication errors, the name of the port at which the error occurred, the error classification (send or receive error), the details of the error, the probable cause, and the remedy, are displayed as shown below.

Example:

Parity error at serial port A



Receive Errors

The following errors can occur when receiving data.

- Parity error
- Framing error
- Overrun error
- FCS (sum value) error
- Time out error
- Data over flow error
- PC unit No. error (host link only)
- NAK received (in the case of the host link, the end code is also displayed)
- Undefined command error

Send Errors

The following errors can occur when receiving data.

- Time out error
- Data over flow error

Probable Causes and Remedies

The remedies to take in accordance with the displayed cause are indicated in the table below.

Error Details	Displayed Probable Cause	Remedy
Parity Error Framing Error Over-run Error	Communication parameters/ conditions set incorrectly.	Check if the settings at the host for parity bit, frame length, communications speed, stop bit length and flow control agree with those at the NT31/NT31C.
	The connecting cables are not connected correctly.	Check the communication cable connection and perform a conductivity test. If there is a fault, replace the cable. For details on communication cables, refer to <i>Section 4 Connecting to the Host from the RS-232C Port</i> , and <i>Section 5 Connecting to the Host from the RS-422A/485 Port</i> .
	Noise caused data corruption during communication.	Carry out grounding work in accordance with the conditions by referring to <i>3-1-4 Grounding</i> , page 34.
FCS (Check Sum) Error	Noise caused data corruption during communication.	Carry out grounding work in accordance with the conditions by referring to <i>3-1-4 Grounding</i> , page 34.
	The PC is transmitting incorrect data.	Check the operation at the host side.

Error Details	Displayed Probable Cause	Remedy
Time-out Error	The connecting cables are not connected correctly. (Send/Receive)	Check the communication cable connection and perform a conductivity test. If there is a fault, replace the cable. For details on communication cables, refer to <i>Section 4 Connecting to the Host from the RS-232C Port</i> , and <i>Section 5 Connecting to the Host from the RS-422A/485 Port</i> .
	The communication service of the host is stopped. (Send/Receive)	Check that the host is capable of communicating with the NT31/NT31C (confirm that the communication settings of the host and NT31/NT31C match).
	Time-out Interval is too short. (Send)	Set a longer value for Time-out Interval at the host side.
	Time-out Interval is too short. (Receive)	Set a longer value for Time-out Interval in the System Menu. (<i>6-9-12 Setting the Time-out Interval</i> , page 185) It may also be possible to solve the problem by shortening the host cycle time.
PC Unit No. Error	The unit # does not match that set on the PC.	Re-set the unit number at the host side to 0.
	Noise caused data corruption during communication.	Carry out grounding work in accordance with the conditions by referring to <i>3-1-4 Grounding</i> , page 34.
NAK received	—	Check the settings for allocated words and bits. If noise is a possible factor, distance the cable from sources of noise and insert a noise filter in the power supply line. If using the equipment in a location subject to a lot of noise, use a cable with a high degree of protection against noise for the transmission route. Also make the cable as short as possible.
Undefined Command Error	The host is not supported.	Check the PC model used for the host.
	Instruction level 3 is not effective.	Check that the instruction level setting for the host is level 1, 2, 3.
Data Over Flow Error	Communication command from the host is too long. (With memory link)	Set flow control method in the host. Increase transmission interval.
	Command transmission to the host is not possible.	Check the communication cable. Check the control method at the PT and the host. Increase the communication on speed when it to slow.

7-3 Maintenance of the NT31/NT31C

Carry out maintenance work in order to ensure that the NT31/NT31C is always used in its optimum condition.



WARNING

Do not attempt to take the unit apart and do not touch any internal parts while the power is being supplied. Doing either of these may result in electrical shock.



Spare PT

It is advisable to have a spare NT31/NT31C available to minimize system downtime in the event of an NT31/NT31C failure or if the screen display becomes difficult to read due to deterioration of the display unit.

Backlight

When the backlight in the display is getting dim and the screen cannot be read easily, replace the backlight. The backlight can be replaced at the rear of the NT31/NT31C while it is mounted in an operation panel.

Replaceable Backlight Model

NT31C-CFL01 (for both NT31 and NT31C)

Guide to Backlight Replacement

Under normal conditions it can be assumed that the backlight will need to be replaced after about 25,000 hours when used at medium brightness (the figure is about 10,000 hours when used at the high brightness setting). However, the life of the backlight does vary, particularly in accordance with the temperature in the environment in which it is used, and it should be replaced when it is getting dim and the screen is getting hard to read.

Notes on Replacing the Backlight

Pay attention to the following points when replacing the backlight.

- Carry out the replacement work in a location where there is no danger that dust or foreign bodies will enter the unit, and where no water will drip onto it.

Do not touch the printed circuit boards of the NT31/NT31C with your bare hands.

Also, discharge the static electricity from your body before starting the work.

- Do not carry the backlight unit by holding only its cable, or pull on the cable. Do not subject the backlight to excessive force or shock.
- Do not disassemble the product to repair or modify it.

Replacing the Backlight

Use the following procedure to replace the backlight.

WARNING

Switch OFF the NT31/NT31C power before replacing the backlight. Otherwise you could sustain an electric shock.

**CAUTION**

Do not touch the backlight immediately after switching OFF the power supply. Otherwise burn injuries may result due to the high temperatures.



Replace the backlight by following the procedure given below:

Procedure

- 1, 2, 3... 1. Turn the power supply to the NT31/NT31C OFF.
2. Disconnect the terminal block wiring, the communication cable, and the printer cable. If a memory unit or interface unit is mounted, remove that unit also.
3. Open the cover of the CFL unit housing by following the procedure described below.
 - a) Unscrew the screw in the center of the cover.
The screw is designed so that it cannot be removed, but if it does come out for some reason and falls inside the NT31/NT31C, it must be extricated without fail.
 - b) Open the cover while pressing the tabs at its left and right inward.

- c) When the cover has opened far enough, remove it.

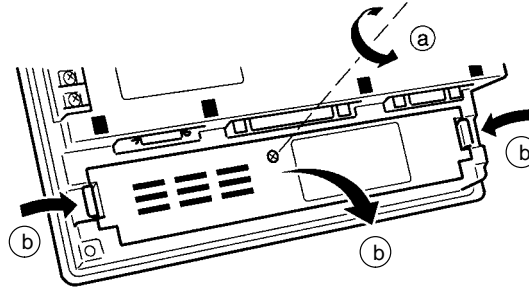

4. Remove the CFL unit by following the procedure described below.

- a) Disengage the connector.
- b) Sufficiently loosen the screw that secures the CFL unit.
The screw is designed so that it cannot be removed, but if it does come out for some reason and falls inside the NT31/NT31C, it must be extricated without fail.
- c) Shift the CFL unit to the right.
- d) Pull out the CFL unit.

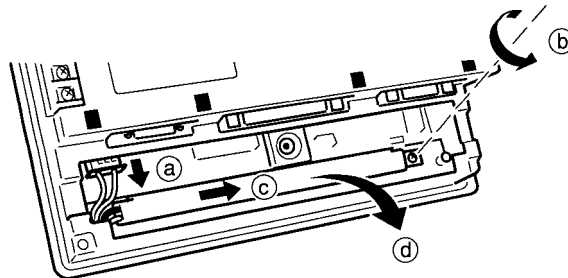

5. Fit a new CFL unit by following the procedure described below.

- a) Slot the projection on the left end of the CFL unit into the hole in the fixture inside the PT.
- b) Engage the CFL unit with the fixture inside the PT.
Check that the CFL unit is in contact with the left end of the fixture and is parallel with the fixture during this engagement.
- c) Tighten the screw of the CFL unit to secure it.
The tightening torque is 0.2 N□m.
- d) Engage the connector of the CFL unit with the connector of the NT31/NT31C so that the red cable is at the left side.
Insert the connector so that it clicks firmly into place.

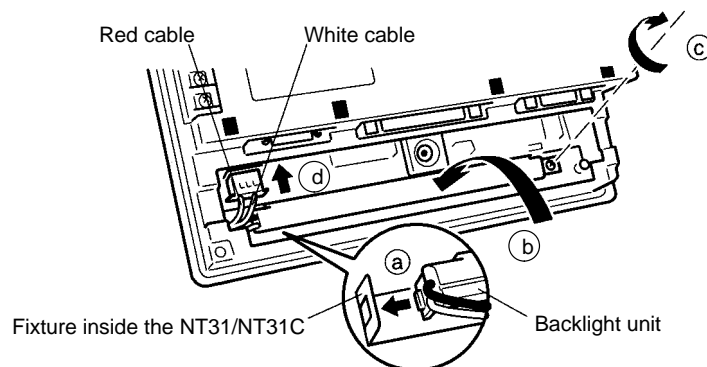

6. Fit the cover and secure it with the screw.

7. Reconnect the wiring, cables, and units disconnected in **2**, and tighten the screws.
8. Before starting normal operation, confirm that the following tests can be executed correctly by using the I/O check in the Maintenance menu. Also perform a communication test with the host.
 - Touch switch
 - Backlight
9. On confirming that all the tests in **8** can be executed normally, start operation.

7-3-1 Replacing the Battery

The NT31/NT31C uses a lithium battery to back up the memory contents.

The battery life is about 5 years if the NT31/NT31C is used in a location where the ambient temperature is 25°C. If the temperature at the location of use is higher than this, the battery life will be shorter. Change the battery at suitable intervals in accordance with the operating environment of the NT31/NT31C.

It is advisable to keep a spare battery so that the battery can be replaced immediately when replacement becomes necessary.

Battery Type

3G2A9-BAT08 (for both NT31 and NT31C)

Guide to Replacement

Replace the battery in the following cases. The battery must be replaced within 5 days.

- When 5 years have passed since the installation of a new battery.
- When the RUN LED is lit in orange (during operation) or in red (when stopped).
- When the message The voltage is lowered. is displayed on switching on the power or resetting the NT31/NT31C.
- When The voltage is lowered is displayed in the Battery check in the battery check menu of the Maintenance mode.

Battery Replacement Method

Replace the battery by following the procedure given below.

To protect the contents of the memory, the battery must be replaced within 5 minutes.

Procedure

- 1, 2, 3...** 1. Keep the power ON for at least 5 minutes and then turn it OFF.

Reference: Unless the power is kept ON for at least 5 minutes, the memory contents cannot be retained for more than 5 minutes without a battery.

2. Insert a flat blade screwdriver at the top of the battery cover located at the left of the rear face of the NT31/NT31C and pull it toward you.

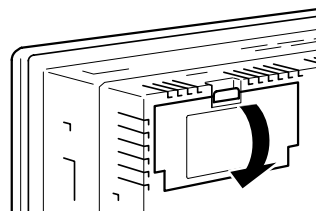

- Remove the battery that is secured under the battery cover, grip the cable, and pull the connector straight out.

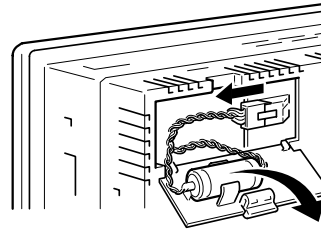

- Insert the connector of the new battery into the connector on the NT31/NT31C and fit the battery under the battery cover.

When inserting the battery connector, make sure that the projection on it faces to the left, and press it fully home while keeping it straight.

The connector of the new battery must be connected within 5 minutes after disconnecting the old battery's connector. However, the battery can be replaced while the NT31/NT31C power is on, and in this case there is no time restriction.

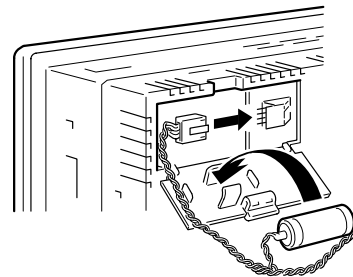

- Close the battery cover, making sure that the cable is not trapped.

7-4 Inspection and Cleaning

Clean and inspect the NT31/NT31C regularly to ensure that it is always used in its optimum condition.

Cleaning Method

If the display is dirty the screen is difficult to see. Clean the screen from time to time as follows.

- In daily cleaning, wipe the display with a soft dry cloth. If the soiling is particularly heavy, attempting to remove it by wiping with a dry cloth may damage the front sheet of the unit. In this case, wipe with a damp cloth.
- If the soiling cannot be removed with a dry cloth, wet the cloth with diluted neutral detergent (2%), wring it out well and wipe the display with it.
- If rubber or vinyl products, tape, etc., are left stuck to the display for long periods they will cause staining. If such items are stuck to the display, remove them during cleaning.

Note Never use volatile solvents such as benzene or thinners, or chemical dusters.

Inspection Method

In normal environments, inspect the NT31/NT31C at intervals of between 6 months and a year. In environments that are extremely hot and humid, or very dusty environments, shorten the inspection interval.

Items Required for The Inspection

Prepare the following items before starting the inspection.

- Screwdrivers (Philips, flat head)
- Tester (or digital voltmeter)
- Industrial alcohol

- 100% cotton cloth
- Hygrometer (required in some cases)
- Thermometer (required in some cases)
- Synchroscope (required in some cases)
- Pen-writing oscilloscope (required in some cases)

Points Inspected

Inspect the following points to determine if there is any divergence from the stated criteria. If there is, either improve the surrounding environment so that the values fall within the stated range, or adjust the NT31/NT31C, for example by re-tightening screws.

Point Inspected	Inspection Details	Criterion	Inspection Instrument
Power supply voltage	Fluctuation in power supply terminal voltage	Permissible voltage fluctuation range (24 VDC -15% to +10%)	Tester
Ambient environmental conditions	Ambient temperature (temperature in the operation panel)	0 to 50°C	Thermometer
	Ambient humidity (humidity in the operation panel)	35% to 85% RH	Hygrometer
	Presence/absence of dust	Dust must not be settled	Visual inspection
Mounting conditions	Looseness of mounting brackets, etc.	To be no looseness	Philips screwdriver
	Connector connections of connecting cable	To be fully inserted and locked, with no looseness	Philips screwdriver
	Looseness of screws in external wiring	To be no looseness	Philips screwdriver
	Conditions of external connecting cables	Faults such as incipient disconnection	Visual inspection
Components with limited lives	Brightness of the backlight	Must be sufficiently bright. Backlight life: Brightness is halved after about 25,000 hours in use at medium brightness, or about 10,000 hours in use at high brightness.	Visual inspection

- Note**
1. Do not disassemble for repairs or modification.
 2. The disposal of the unit (including batteries to be disposed and backlight) may be regulated by national or local authorities. Dispose of them in accordance with the laws and regulations of the relevant country and local authority.

Reference: Desire on replacing the NT31/NT31C

When replacing the NT31/NT31C after discovering a fault during inspections, note the following points:

- Be sure to switch the power OFF before starting replacement.
- After replacement, check that the new NT31/NT31C is not subject to the same error.
- If a faulty unit is returned for repairs, write as detailed a description of the fault as possible and send this description together with the unit to the OMRON address indicated on the back cover of this book.

Appendix A

Specifications

General Specifications

Item	Specification
Rated power supply voltage	24 VDC
Allowable power supply voltage range	20.4 VDC to 26.4 VDC (24 VDC -15% to +10%)
Allowable power interruption time	No regulation
Power consumption	15 W max.
Operating ambient temperature	0 to +50°C
Storage ambient temperature	-20 to +60°C
Operating ambient humidity	35% to 85% (with no condensation)
Operating environment	No corrosive gases
Noise resistance	Common mode: 1000 Vp-p (between power supply terminals and panel) Normal mode: 300 Vp-p Pulse width of 100 ns to 1 μs, pulse rise time of 1 ns
Vibration resistance (operating)	- 10 to 57 Hz with 0.075 mm amplitude - 57 to 150 Hz with 1G {9.8 m/s ² } acceleration for 60 minutes in each of X, Y, Z directions
Shock resistance (operating)	147 m/s ² {15G} 3 times in each of X, Y, and Z directions
Dimensions	195 (W) × 142 (H) × 54 (D) mm (With expansion unit mounted: 195 (W) × 142 (H) × 74 (D) mm)
Weight	1 kg max.
Panel cutout dimensions	184 ^{+0.5} ₀ × 131 ^{+0.5} ₀ mm Circle of panel pressure 1.6 to 4.8 mm
Enclosure ratings	Front panel: Equivalent to IP65F (NEMA4)*
Grounding	D-type grounding (Ground to 100 Ω or less)

* The NT31/NT31C may not be used at a location where it is exposed to splashing oil for a long period.

Performance Specifications

Display Specifications

Item	Specification	
Display panel	Display device	NT31: Monochrome STN LCD (with backlight) NT31C: Color STN LCD (with backlight)
	Number of dots (resolution)	320 dots horizontally × 240 dots vertically
	Size of a standard character	NT 31-ST121□-EV2 : Height 5.76 mm, Width : 2.88 mm NT 31C-ST141□-EV2 : Height 5.76 mm, Width : 2.88 mm
	Effective display area	118.2 mm horizontally × 89.4 mm vertically (5.7 inches)
	View angle	NT31: Up: 20° Down: 30° Left/right: □ 30° NT31C: Up: 45° Down: 60° Left/right: □ 50°
	Display color	NT31: Black, white (2 colors) NT31C: 8 colors (and intermediate colors can be displayed with tiling patterns)
	Life expectancy (until brightness reduced by half)	50,000 hours minimum
Contrast adjustment	Adjustable in 100 levels by operation at the touch panel	
Backlight (white cold cathode tube)	Life expectancy	At low or medium brightness : 25,000 hours minimum At high brightness : 10,000 hours minimum
	Replacement	Can be replaced from the rear
	Brightness adjustment	Adjustable in 3 levels by touch switch operation at the touch panel
	Automatic turn-off function	Can be set to turn off in 1 to 255 minutes, or to remain on
Indicators	POWER (green LED)	Lit while power is being supplied
	RUN	Lit in green : Running normally, Memory unit automatic transmission done Flash in green : Memory unit automatic transmission being executed, memory unit automatic transmission error Lit in orange : Low battery voltage (during operation) Flash in red : Low battery voltage (when NT31/NT31C is stopped)

*1: Time taken for brightness to reduce to half at normal temperature and humidity

Panel Specifications

Item	Specification	
Touch panel	Type :	Resistive type
	Number of switches:	192 (16 horizontally × 12 vertically)
	Maximum number that can be registered on one screen:	192
	Cell size:	NT31/NT31C 6.3 × 6.3 mm
	Input:	Pressure-sensitive type
	Operating force:	1 N minimum
Life expectancy:	One million operations minimum	

External Interface Specifications

Item		Specification
Serial communication	Serial port A	Conforms to EIA RS-232C D-SUB 9-pin connector (female) +5 V (250 mA max.) output at pin No. 6
	Serial port B	EIA RS-232C or RS-422A/485 (selectable, by memory switch setting) D-SUB 25-pin connector (female)
Parallel interface		Conforms to Centronics standard, 20-pin half pitch connector
Expansion interface		Dedicated connector

Note Check that the current capacity of the equipment to be supplied is within 250 mA before using the +5 V output of pin No. 6. The +5 V output of the unit delivers +5 V \pm 5% and 250 mA maximum.

Programming Environment

Item	Specification
Programming System	Programming support software
Programming Tool	Programming support software: NT-series Support Tool for Windows (Ver. 4.0), by OMRON

Special Features

Item	Specifications
Buzzer	Three kinds of buzzer sound (continuous, short intermittent, and long intermittent) ON: On reception of a command from the host, display of a screen with a buzzer setting, or display of an error screen such as for a receive error. OFF: On reception of a command from the host, or display of a screen with no buzzer setting. Setting: Set "ON" for "Buzzer Sound" in the memory switch menu, or set "ERROR ON" for the buzzer to sound only when an error occurs. The buzzer sounds three times in response to prohibited input.
Touch switch input sound	Touch switches Input sound: Sounding for 0.2 seconds Setting: Set "ON" for "Key Press Sound" in the memory switch menu.
Maintenance function	<ul style="list-style-type: none"> - Memory switch setting - Self-test functions, such as for the memory and external interface - Setting condition confirmation function - Communication check function - Initialization of internal memory data - Display of display/alarm history data - Registered data test display function
Battery backup	<ul style="list-style-type: none"> - Backup of numeral/character string memory table data in the NT31/NT31C - Backup of display/alarm history data - Backup of calendar and clock setting Battery life: 5 years (at 25°C) When voltage becomes low: RUN LED lights in orange or red The communication flag to the PC (BAT LOW) comes ON (1).
Resume function	Retains the contents of the numeral/character string memory tables (i.e., they are not initialized) when the power is turned ON, when the NT31/NT31C is reset, and when the operation mode is changed. Setting: Set "ON" for "Resume Function" in the memory switch menu.

Item	Specifications	
Screen print function	Functions: <ul style="list-style-type: none"> - Prints a hard copy of the screen display - Prints display/alarm histories Setting: Set the printing protocol ("Print Controller") and printing type ("Print Method") in the memory switch menu. <ul style="list-style-type: none"> "ESC/P", "Color": Color printing conforming to ESC/P 24-J83C "PC-PR201H", "Color": Color printing conforming to PC-PR201PL "ESC/P", "Tone": Monochrome printing in 8 grayscale levels, conforming to ESC/P 24-J82 "PC-PR201H", "Tone": Monochrome printing in 8 grayscale levels, conforming to PC-PR201PL "PCL 5", "Tone": Monochrome printing in 8 grayscale levels, conforming to PCL 5 However, the NT31 supports monochrome printing only.	
Calendar and clock function	<ul style="list-style-type: none"> - Displays the current time in accordance with the built-in clock - Displayed and set with "Calendar Check" in the "MAINTENANCE MODE" menu 	
Programming Console function	Executes functions equivalent to those of al C200H-PRO27-E Programming Console for CPM1, CPM1A, CPM2A, CPM2C, CQM1 (-EV1 only), CQM1H, C200HX/HG/HE(-Z)E, and SRM1 (C02-V2 only) PCs.	
	Executes functions as a Programming Console for CS1 series PLC.	
Device Monitor function	The Device Monitor function can be used to change the PC's operating mode, read/change words in the PC's data areas, and display the PC's error log. Compatible PCs include the CPM1, CPM1A, CPM2A, CPM2C, CQM1, CQM1H, C200HX/HG/HE(-Z)E, SRM1, and CS1-series PCs.	
Mathematical function	Up to 256 calculation expressions can be registered along with the screen data. The calculation function reads the required data from numeral memory tables or host words, executes the registered calculations, and writes the results. Arithmetic operators, logic operators, bit operators, and comparative operators can be used.	
Transmission functions	System program transmission	Downloads the system program from the system installer Downloads/Upload the system program with a memory unit.
	Screen data transmission	<ul style="list-style-type: none"> - Function for downloading screen data to and uploading screen data from the Support Tool - Function for transmitting screen data to and from the memory unit.
	History data uploading	Function for uploading display/alarm history data from PT.

Communications Specifications

For a Host Link , RS-232C Type

Item	Specification
Communications standard	EIA RS-232C
Communications settings	Start-stop synchronization Communications speed: 9600, 19200 bps Data length: 7 bits Stop bit: 2 bits Parity: Even
Connector	9-pin D-SUB connector (female) (serial port A) 25-pin D-SUB connector (female) (serial port B)
Number of units connected	1:1
Transmission distance	Max. 15 m*
Communications protocol	C-series SYSMAC WAY (1:N)

* When using an NT-AL001, the specifications are as follows.

- RS-232C cable: Max. 2 m
- RS-422A cable: Total length 500 m max.

For a Host Link , RS-422A Type

Item	Specification
Communications standard	EIA RS-422A
Communications settings	Start-stop synchronization Communications speed: 9600, 19200 bps Data length: 7 bits Stop bit: 2 bits Parity: Even
Connector	25-pin D-SUB connector (female) (serial port B)
Number of units connected	1:1
Transmission distance	Max. 500 m
Communications protocol	C-series SYSWAY (1:N)

For an NT Link , 1:1, RS-232C Type

Item	Specification
Communications standard	EIA RS-232C
Connector	9-pin D-SUB connector (female) (serial port A) 25-pin D-SUB connector (female) (serial port B)
Number of units connected	1:1
Transmission distance	Max. 15 m*

* When using an NT-AL001, the specifications are as follows.

- RS-232C cable: Max. 2 m
- RS-422A cable: Total length 500 m max.

For an NT Link , 1:1, RS-422A Type

Item	Specification
Communications standard	EIA RS-422A
Connector	25-pin D-SUB connector (female) (serial port B)
Number of units connected	1:1
Transmission distance	Max. 500 m

For an NT Link , 1:N, RS-232C Type

Item	Specification
Communications standard	EIA RS-232C
Connector	9-pin D-SUB connector (female) (serial port A) 25-pin D-SUB connector (female) (serial port B)
Number of units connected	1:1 to 8
Transmission distance	Max. 15 m*

* To connect two or more PTs, NT-AL001 units are required. When using an NT-AL001, the specifications are as follows.

- RS-232C cable: Max. 2 m
- RS-422A/485 cable: Total length 500 m max.

For an NT Link , 1:N, RS-422A/485 Type

Item	Specification
Communications standard	EIA RS-422A/485
Connector	25-pin D-SUB connector (female) (serial port B)
Number of units connected	1:1 to 8
Transmission distance	Max. 500 m

For a High-speed NT Link , 1:N, RS-232C Type

Item	Specification
Communications standard	EIA RS-232C
Connector	9-pin D-SUB connector (female) (serial port A) 25-pin D-SUB connector (female) (serial port B)
Number of units connected	1:1 to 8
Transmission distance	Max. 15 m*

* To connect two or more PTs, NT-AL001 units are required. When using an NT-AL001, the specifications are as follows.

- RS-232C cable: Max. 2 m
- RS-422A/485 cable: Total length 500 m max.

For a High-speed NT Link , 1:N, RS-422A/485 Type

Item	Specification
Communications standard	EIA RS-422A/485
Connector	25-pin D-SUB connector (female) (serial port B)
Number of units connected	1:1 to 8
Transmission distance	Max. 500 m

For a Memory Link , RS-232C Type

Item	Specification
Communications standard	EIA RS-232C
Communications settings	Start-stop synchronization Communications speed: 1200, 2400, 4800, 9600, 19200, 38400bps Data length: 7, 8 bits Stop bit: 1, 2 bits Parity: None, even, odd Flow control: None, RS/CS, XON/XOFF Response: Presence/absence
Connector	9-pin D-SUB connector (female) (serial port A) 25-pin D-SUB connector (female) (serial port B)
Number of units connected	1:1
Transmission distance	Max. 15 m*
Communications protocol	Memory link

* When using NT-AL001, specification is as follows:

- RS-232C: Max. 2 m
- RS-422A: Max. total length 500 m

For a Memory Link , RS-422A Type

Item	Specification
Communications standard	EIA RS-422A
Communications settings	Start-stop synchronization Communications speed: 1200, 2400, 4800, 9600, 19200, 38400bps Data length: 7, 8 bits Stop bit: 1, 2 bits Parity: None, even, odd Flow control: None, XON/XOFF Response: Presence/absence
Connector	25-pin D-SUB connector (female) (serial port B)
Number of units connected	1:1
Transmission distance	Max. 500 m*
Communications protocol	Memory link

For a Bar Code Reader

Item	Specification
Communications standard	EIA RS-232C
Communications settings	Start-stop synchronization Communications speed: 4,800, 9600, 19200 bps Data length: 7, 8 bits Stop bit: 1, 2 bits Parity: None, even, odd Flow control: RS/CS
Connector	9-pin D-SUB connector (female) (serial port A)
Number of units connected	1:1
Transmission distance	Max. 15 m
Communications protocol	Non-protocol mode
Data format	[STX] Data (0 to 40 bytes) [ETX]

Appendix B

Dimensions

Body

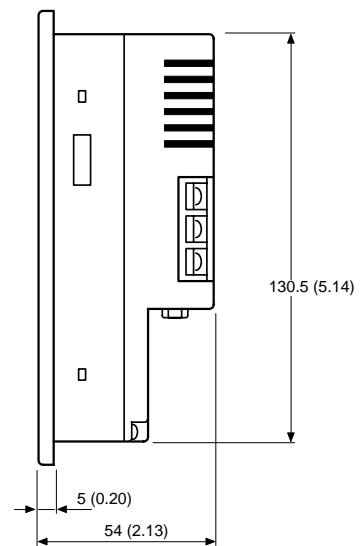
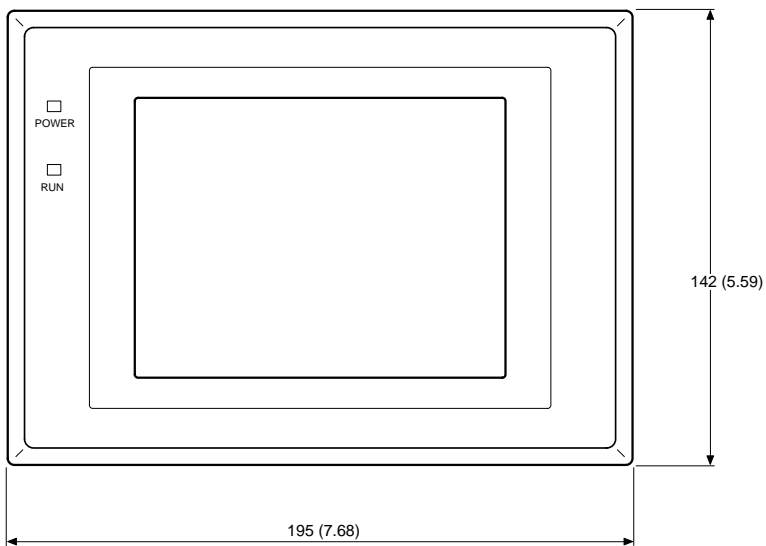
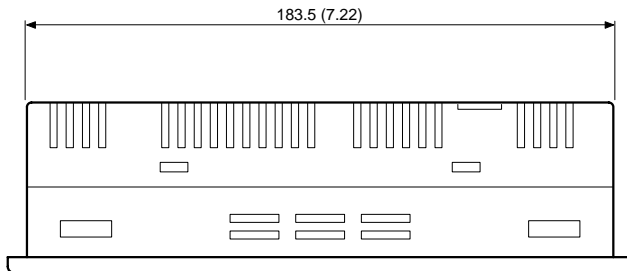

Units: mm (inch)

With memory unit installed
(NT-MF261)

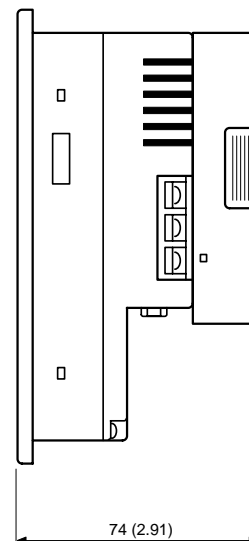

Mounting Dimensions

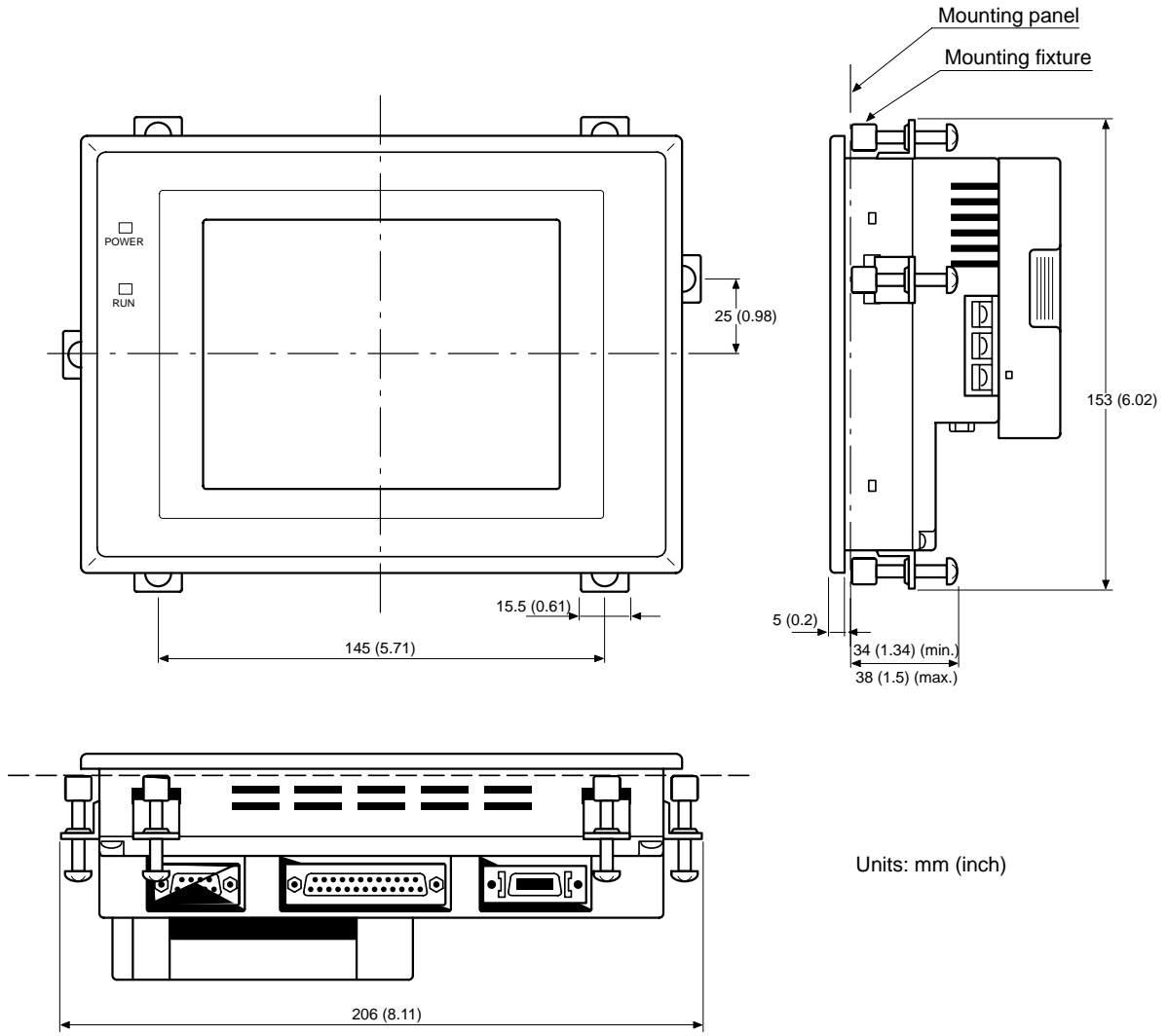

Units: mm (inch)

Cable Connection Dimensions (with NT-MF261)

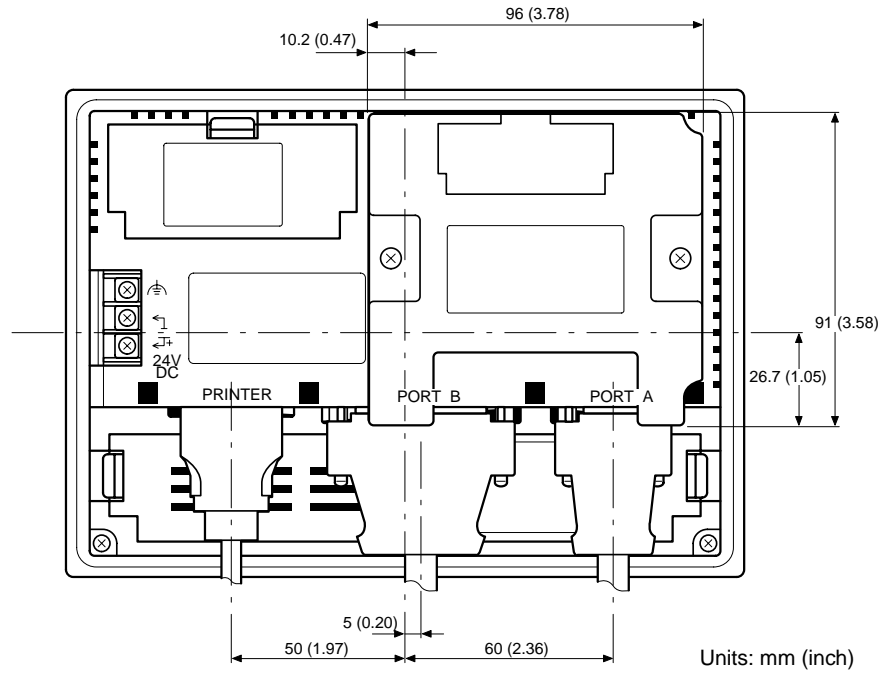

Appendix C

Using an RS-232C/RS-422A Converter Unit

This section outlines the external dimensions, procedure for mounting and removal, and specifications of an RS-232C/RS-422A converter unit (NT-AL001-E). Refer to this information when designing the control panel. For details, refer to the instruction manual supplied with the NT-AL001-E.

Dimensions

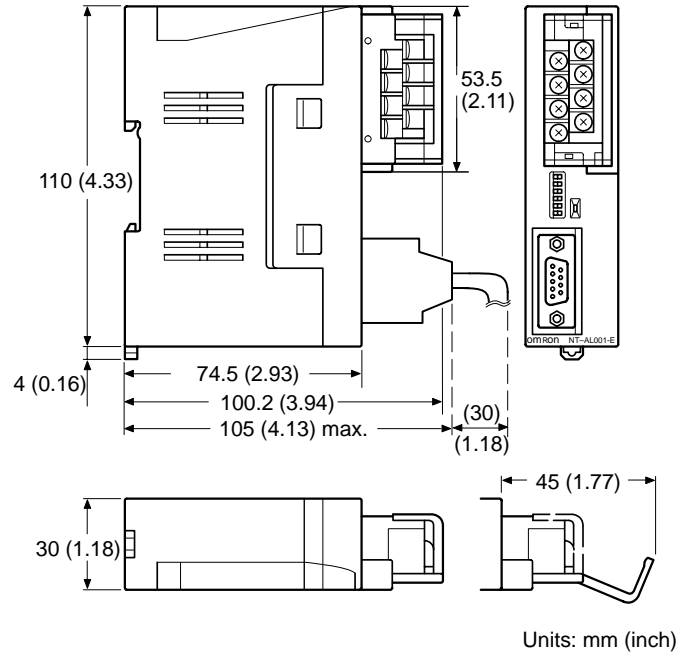

- 30 (W) × 114 (H) × 100.2 (D) mm: with the RS-422A terminal block cover closed
- 30 (W) × 114 (H) × 119.5 (D) mm: with the RS-422A terminal block cover open

Methods for Mounting and Removal

The RS-232/RS-422 converter unit (NT-AL001-E) can be mounted on a DIN rail or in an operation panel. The RS-422A terminal block of the converter unit can be easily removed.

Mounting to a DIN Rail

Latch the top part of the rear face of the converter unit (a in the figure) onto the top edge of the DIN rail, and push the unit in the direction indicated by b in the figure.

Now fit end plates at the right and left of the converter unit to secure it and ensure that it cannot shift laterally.

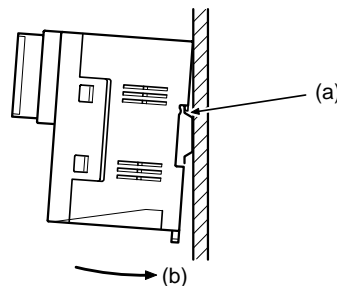

Removal from a DIN Rail

Remove the end plates at right and left of the converter unit and, as shown in the figure below, insert a flat blade screwdriver into the rail stopper at the bottom face of the converter unit and prize it free.

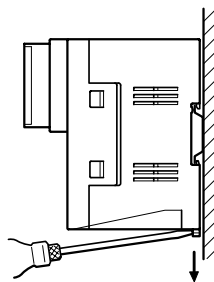

Mounting to an Operation Panel

Drill two mounting screw holes in an operation panel with a thickness of at least 2 mm (0.08 inch) and secure the converter unit with screws.

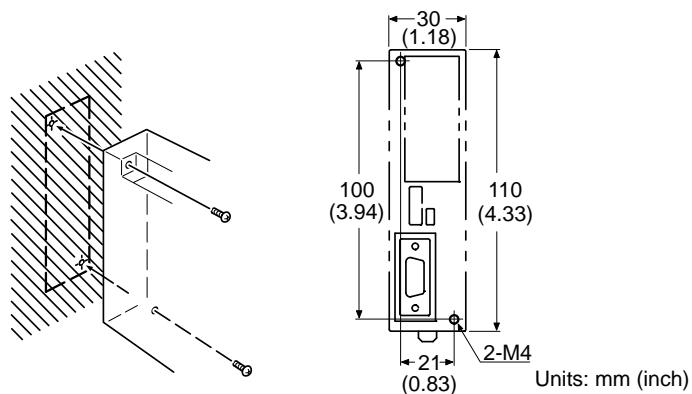

Note In order to ensure a secure and strong mount, mount the converter unit in an operation panel with a thickness of at least 2 mm (0.08 inch).

Specifications

The general specifications and communications specifications of the convertor unit are shown below.

General Specifications

Item	Specification
Dimensions	30 (W) × 114 (H) × 100.2 (D) mm: with the RS-422A terminal block cover closed 30 (W) × 114 (H) × 119.5 (D) mm: with the RS-422A terminal block cover open
Weight	200 g max.
Operating ambient temperature	0 to 55°C
Operating ambient humidity	10% to 90% (with no condensation)
Rated power supply voltage	+5 V □ 10% (using pin No. 6 of the RS-232C connector)
Rated power supply current	150 mA max.
Rush current	0.8 A max.
Insulation resistance	20 MΩ or higher, measured between all RS-422A terminal signal lines collectively and functional ground terminal with a 500 VDC megger
Dielectric strength	1500 VAC for 1 minute between all RS-422A terminal signal lines collectively and functional ground terminal Leakage current: 10 mA max.
Operating environment	No corrosive gases
Storage ambient temperature	-20 to +75°C
Vibration resistance	Conforms to JIS C0911 60 minutes in each of X, Y, and Z directions
Shock resistance	Conforms to JIS C0912 47m/s ² , 3 times in each of X, Y, and Z directions

Communications Specifications

RS-232C Interface

Item	Specification
Communications speed	Max. 115.2k bps
Transmission distance	Max. 2 m
Connector	9-pin D-SUB connector (female)

RS-422A/485 Interface

Item	Specification
Communications speed	Max. 115.2k bps (depends on the RS-232C communications speed)
Transmission distance	Max. 500 m
Connector	8-terminal detachable terminal block, M3.0

DIP Switch Settings

The converter unit has 6 digits DIP switch for setting the RS-422A/485 communication conditions. Before connecting the cable to the converter unit, make the DIP switch settings.

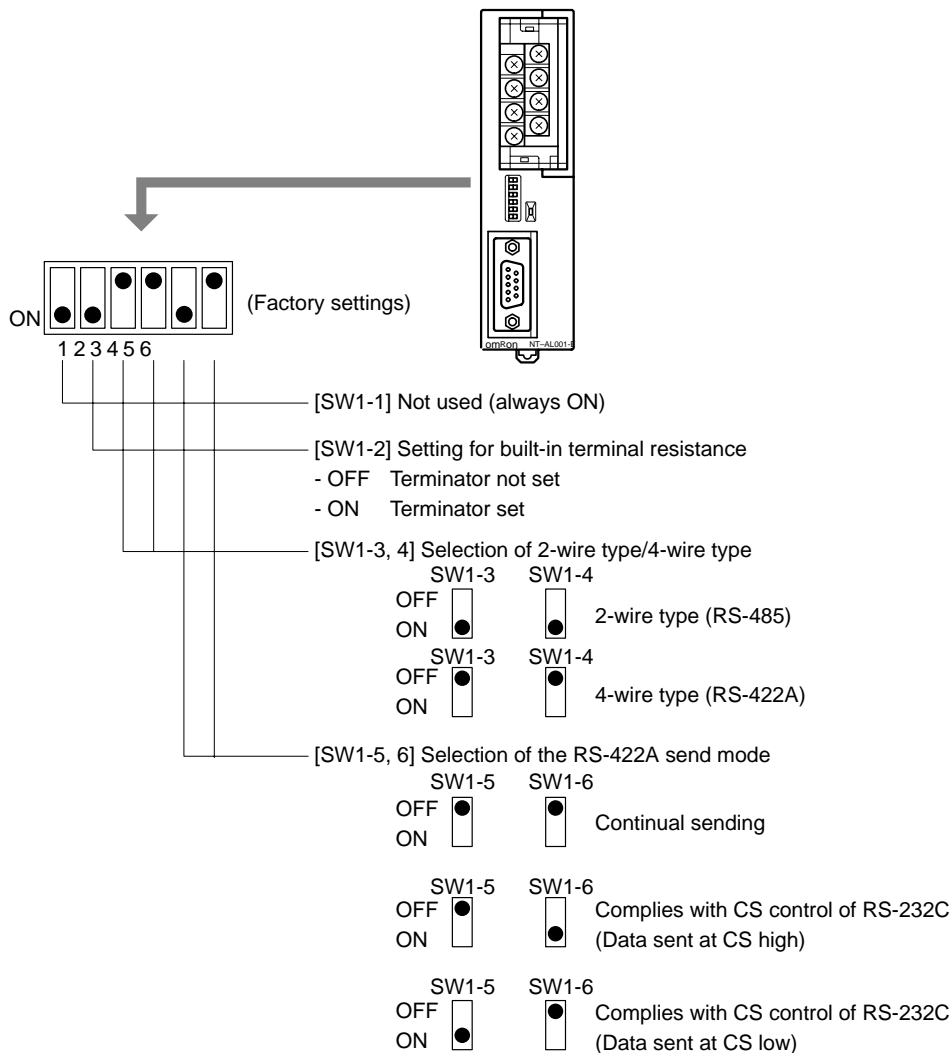

When using the host link or 1:1 NT Link, set the RS-422A send mode to continual sending (set both SW1-5 and 6 OFF).

When using the 1:N NT Link (standard or high-speed), set the RS-422A send mode to complies with CS control of RS-232C (i.e., one of SW1-5 and SW1-6 must be ON).

- Note**
- Do not set both SW1-5 and SW1-6 ON at the same time. This may damage internal circuits.
 - The power supply to the device supplying +5 V must be turned OFF before starting wiring work.
 - Before connecting the RS-232C cable and turning on the power to an RS-232C device such as a PT (i.e., turning on the power to the converter unit), check that the cable is wired correctly and that the DIP switch settings are correct. If the power is turned on while there is a wiring fault, the internal circuits of the converter unit or the RS-232C device may be damaged.
 - When the converter unit is connected to a C200HX/HG/HE (-ZE), CQM1H, CS1G/H model of OMRON PC as an RS-422A device, set DIP switches SW1-5 and SW1-6 as indicated below.

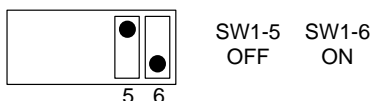

Pin Arrangement

The converter unit has a terminal block for an RS-422A/485 interface connection and a connector for an RS-232C interface connection.

The pin arrangements for the RS-422A/485 terminal block and the RS-232C connector are as follows.

RS-422A/485 Terminal Block

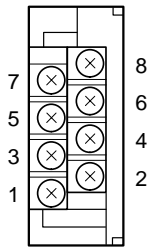

Terminal block pin No.	Signal name	Abbreviation	Signal direction (converter unit ↔ RS-422 device)
8	Request to send (-)	CSA	→
7	Request to send (+)	CSB	→
6	Receive data (-)	RDA	←
5	Receive data (+)	RDB	←
4	Send data (-)	SDA	→
3	Send data (+)	SDB	→
2	Signal ground	SG (GND)	-
1	Functional ground		-

* The CSB and CSA signals are for specialized applications.

RS-232C Connector

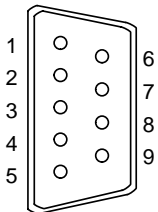

Connector pin No.	Signal name	Abbreviation	Signal direction (converter unit ↔ RS-232C device)
1	Not used	-	-
2	Send data	SD	←
3	Receive data	RD	→
4	Request to send (shorted to CS internally)	RS	←
5	Clear to send (shorted to RS internally)	CS	→
6	+5 V (150 mA) input for converter unit	+5 V	→
7	Data set ready (shorted to ER internally)	DR	→
8	Data terminal ready (shorted to DR internally)	ER	←
9	Signal ground	SG	-

* The hood is connected to the functional ground terminal of the RS-422A terminal block.

Block Diagram

A diagram showing the internal blocks of the converter unit is shown below. Refer to this diagram when making cables yourself, or when connecting devices with special interfaces.

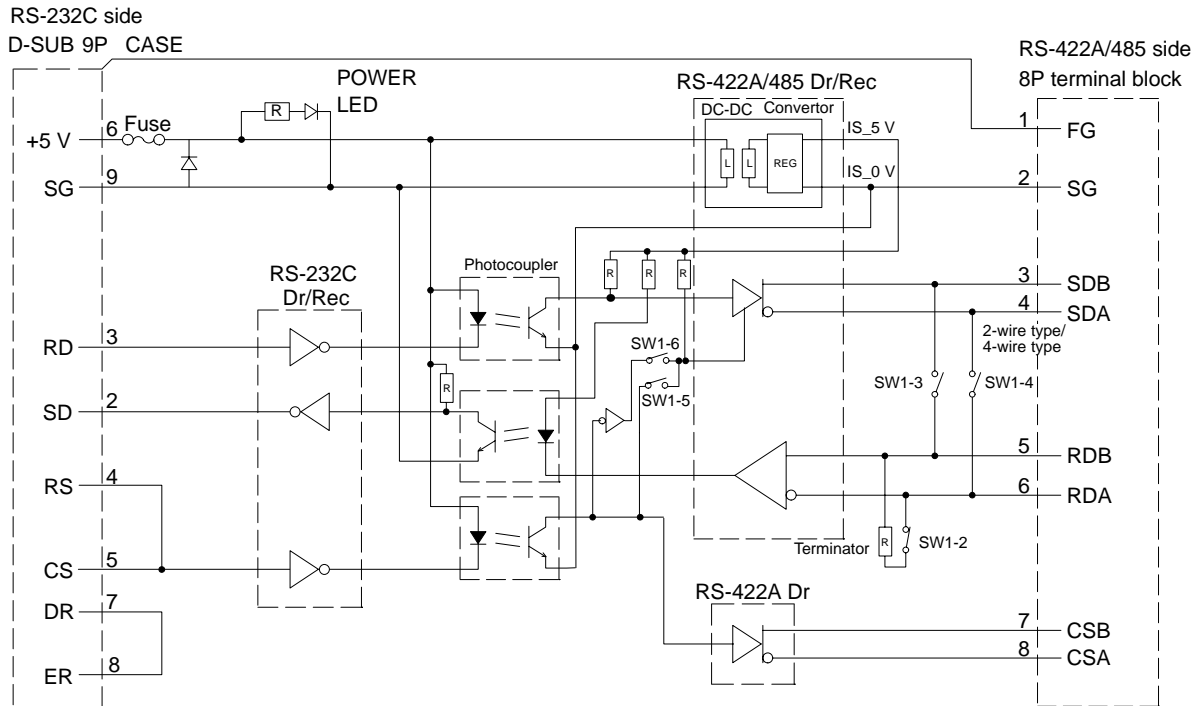

Appendix D

Transporting and Storing the NT31/NT31C

- When transporting the NT31/NT31C, use the packaging intended for it.
- When storing the NT31/NT31C, observe the following conditions.

Storage ambient temperature: -20 to +60°C

Storage ambient humidity: 35% to 85%

Appendix E

Making the Cable

The procedure for making up the cable is described below.

Also refer to this procedure for making a connecting cable for use with RS-422A/485 type connections.

Cable Preparation

The preparation of the cable differs according to whether or not the shielding wire is to be connected to the FG.

Cable with Shielding Wire Connected to FG

- 1, 2, 3...**
1. Cut the cable to the required length.
 2. Remove the external vinyl insulation from the cable with a razor blade. Take care not to damage the shielding underneath.
 3. Cut back the shielding wire with scissors.
 4. Use wire strippers to strip the insulation from each wire.
 5. Fold back the shielding wire.
 6. Wrap aluminum foil tape around the folded-back shielding wire.

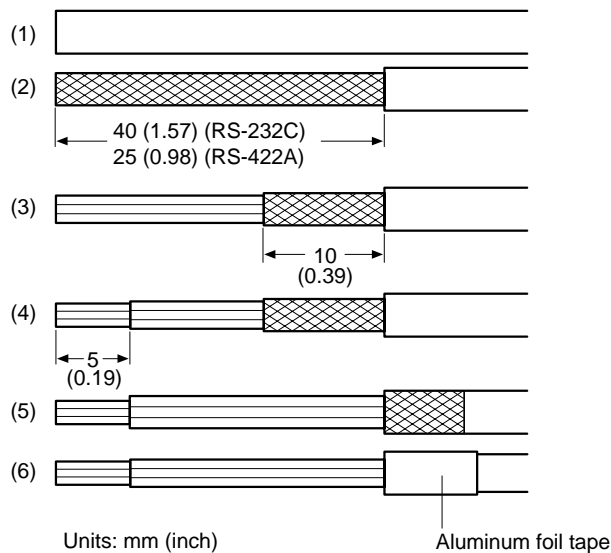

Cable with Shielding Wire Not Connected to FG

- 1, 2, 3...**
1. Cut the cable to the required length.
 2. Remove the external vinyl insulation from the cable with a razor blade. Take care not to damage the shielding underneath.
 3. Cut back the shielding wire with scissors.
 4. Use wire strippers to strip the insulation from each wire.

5. Wrap vinyl tape over the cut off end of the shielding wire.

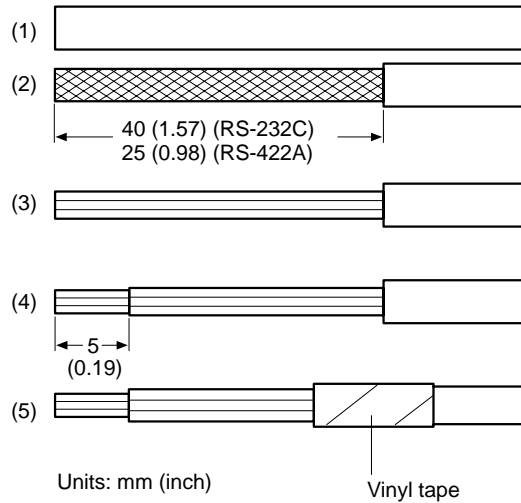

Soldering

- 1, 2, 3...
1. Slide heat-shrink tube over each wire.
 2. Pre-solder each wire and connector terminal.
 3. Solder each wire to each connector terminal.

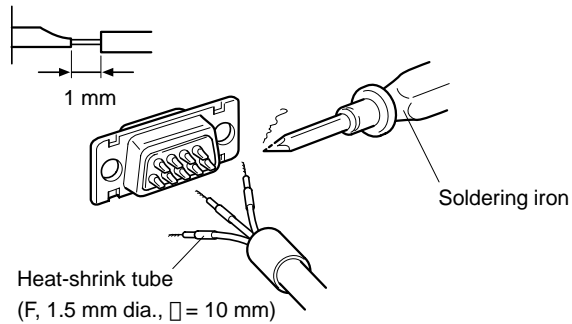

4. Push the heat shrink tube over the soldered joint and heat the tube to shrink it in place.

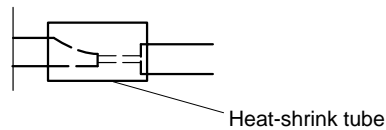

Hood Assembly

Assemble the connector hood as shown below.

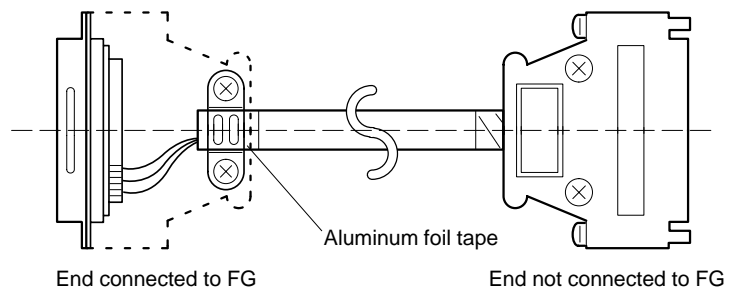

Appendix F

Making the Cable for Connecting a PC

Refer to the following when making a cable for connecting the Support Tool.

Assembly of Connecting Cables

Wiring should be carried out in one of the following ways, depending on the type of RS-232C connector.

25-pin Connector

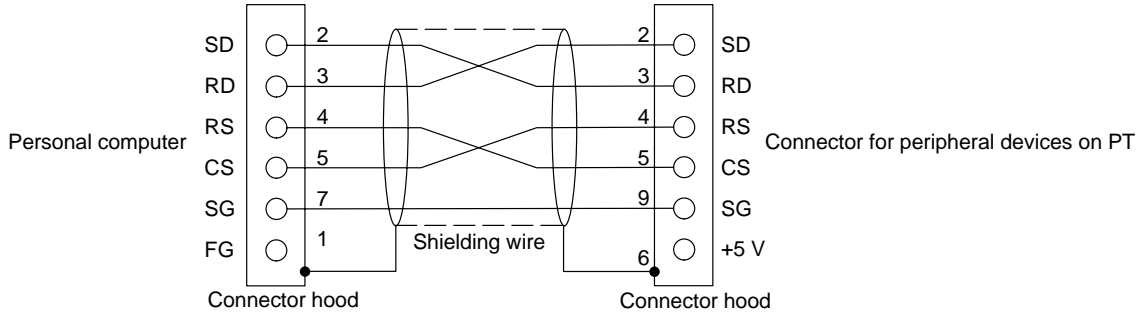

Use the following recommended products when making the connecting cable.

Name	Model	Remarks
Connector	XM2D-2501	25-pin, made by OMRON, for personal computer side
	XM2A-0901	9-pin, made by OMRON, for PT side
Connector hood	XM2S-2511	25-pin, made by OMRON, for personal computer side
	XM2S-0911	9-pin, made by OMRON, for PT side
Cable	AWG28 × 5P IFVV-SB	Multi-core shielded cable, made by Fujikura Ltd.
	CA-MA-VV-SB 5P × 28AWG	Multi-core shielded cable, made by Hitachi Cable, Ltd.

9-pin Connector

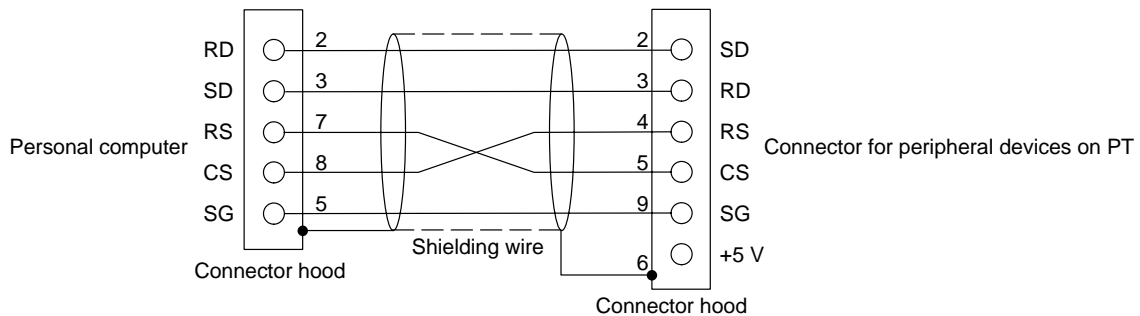

Use the following recommended products when making the connecting cable.

Name	Model	Remarks
Connector	XM2D-0901	9-pin, made by OMRON, for personal computer
	XM2A-0901	9-pin, made by OMRON, for PT
Connector hood*	XM2S-0911	9-pin, mm pitch screw, made by OMRON
	XM2S-0913	9-pin, inch pitch screw, made by OMRON
Cable	AWG28 × 5P IFVV-SB	Multi-core shielded cable, made by Fujikura Ltd.
	CA-MA-VV-SB 5P × 28AWG	Multi-core shielded cable, made by Hitachi Cable, Ltd.

* One XM2S-0911 (for PT) and either one XM2S-0911 or -0913 (for your personal computer) are needed.

Appendix G

Making the Cable for Connection to a Bar Code Reader

Refer to the following when making the cable for connection to a bar code reader.

Wiring Method

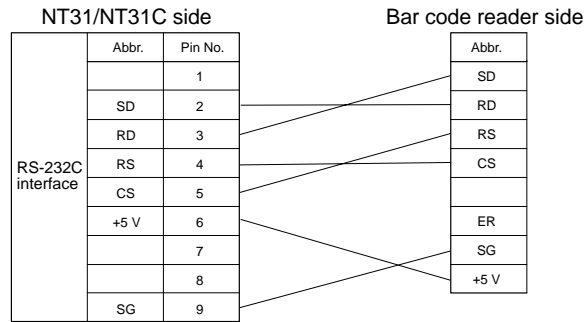

When using the +5 V output of the NT31/NT31C, limit the cable length to within 2 m. If a cable longer than 2 m is used, connect an external power supply to the bar code reader.

Connector and Related Parts

Use the parts which are specified by bar code reader and following recommended products when making the connecting cable.

Name	Model	Remarks
Connector	XM2A-0901	9-pin type, made by OMRON, PT side
Connector hood	XM2S-0911	9-pin, made by OMRON
Cable	AWG28 × 5P IFVV-SB	Multi-core shielded cable, made by Fujikura Ltd.
	CA-MA-VV-SB 5P × 28AWG	Multi-core shielded cable, made by Hitachi Cable, Ltd.

Appendix H

Making the Cable for Connection to a Printer

The following product is recommended as the cable for connecting a printer.

NT-CNT121 (made by OMRON, cable length 1.5 m, 20-pin – 36-pin)

Refer to the following when making a cable for connection to a printer.

- Connector pin arrangement and wiring

Connector for a printer
on PT side

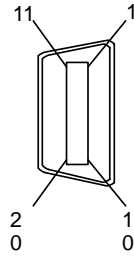

Abbr.	Pin No.	Shielding wire	Pin No.
	Connector hood		Connector hood
0V	1		20
D7	11		9
N.C.	2		N.C.
D6	12		8
D5	3		7
0V	13		21
D4	4		6
N.C.	14		N.C.
D3	5		5
0V	15		22
0V	6		23
D2	16		4
N.C.	7		N.C.
D1	17		3
D0	8		2
0V	18		24
STROB	9		1
N.C.	19		N.C.
BUSY	10		11
0V	20		19

Printer
side

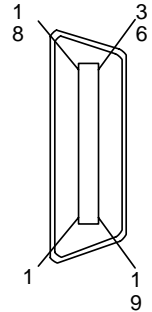

Appendix I

Relationship between System Program and Hardware

Here, relationship between system program and hardware is described.

NT31/NT31C have following models.

NT31-ST121□-E	Conventional product
NT31C-ST141□-E	
NT31-ST121□-EV1	Version upgrade model of the products above (12/98)
NT31C-ST141□-EV1	
NT31-ST121□-EV2	Version upgrade model of the products above (12/99)
NT31C-ST141□-EV2	

System programs indicated below are installed for the models shown above in the default state. Also, system programs are supplied with the Support Tool as follows.

- System programs for NT31-ST121□-E/NT31C-ST141□-E: System Program Ver. 1.0□
(System programs supplied with NT-ZJ3AT1-EV2/ZJCAT1-EV2)
- System programs for NT31-ST121□-EV1/NT31C-ST141□-EV1: System Program Ver. 2.0□ or 2.1□
(System programs supplied with NT-ZJ3AT1-EV3/ZJCAT1-EV3)
- System programs for NT31-ST121□-EV2/NT31C-ST141□-EV2: System Program Ver. 3.0□
(System programs supplied with NT-ZJCAT1-EV4)
(A system program for the earlier NT30/620 PTs is also included with the NT-ZJCAT1-EV4.)

These system programs have mutual compatibility, therefore, they can be installed and used for NT31-ST121□-E/NT31C-ST141□-E/NT31-ST121□-EV1/NT31C-ST141□-EV1/NT31-ST121□-EV2/NT31C-ST141□-EV2 each.

However, there will be a limitation on function depending on the combination. Refer to the following table.

Limitations of System Program/PT Combinations

The following table shows only the relationship between the hardware and system program.

For details of the relationship with the screen data created using the Support Tool, refer to NT-series Support Tool for Windows (Ver. 4.1) Operation Manual (V061-E1-□).

Combining a -V1 Version and Version without a -V□ Suffix

	Hardware	
	NT31-ST121□-E NT31C-ST141□-E	NT31-ST121□-EV1 NT31C-ST141□-EV1
System program Ver. 1.0□	The following functions cannot be used <ul style="list-style-type: none"> • Analogue meter • High-definition font display • Installation of system programs using memory unit • Connection to Mitsubishi PLCs • Memory link • Window control from the host • Multiple display of window screens • Moving a window Refer to the following table for details on new functions supported by the -V2 versions.	The following functions cannot be used <ul style="list-style-type: none"> • Analogue meter • High-definition font display • Connection to Mitsubishi PLCs • Memory link • Window control from the host • Multiple display of window screens • Moving a window Refer to the following table for details on new functions supported by the -V2 versions. * Installation of system programs using memory unit is possible
System program Ver. 2.0□ or Ver. 2.1□	The following functions cannot be used <ul style="list-style-type: none"> • Installation of system programs using memory unit • High-definition font display Refer to the following table for details on new functions supported by the -V2 versions.	The new functions supported by the -V2 versions cannot be used. Refer to the following table for details.

* The system program's version can be checked from the System Menu.

Combining a -V1 Version and -V2 Version

	Hardware	
	NT31-ST121□-EV1 NT31C-ST141□-EV1	NT31-ST121□-EV2 NT31C-ST141□-EV2
System program Ver. 2.0□ or Ver. 2.1□	The following functions (new functions supported by the -V2) cannot be used: <ul style="list-style-type: none"> • Additional data areas accessible in CS1-series PCs • The CS1-series high-speed 1:N NT Link • Interlock function that controls touch switches, numeral inputs, and character string inputs • Mathematical function • Device Monitor function • NT30/620 compatible mode • Expanded capabilities for label (guide character) displays, including multiple lines of text, ON/OFF switching displays, numeral memory table displays, and character string memory table displays 	
System program Ver. 3.0□	All of the functions described in the Setup Manual and Reference Manual can be used.	

* The system program's version can be checked from the System Menu.

Combining a -V2 Version and Version without a -V□ Suffix

	Hardware	
	NT31-ST121□-E NT31C-ST141□-E	NT31-ST121□-EV2 NT31C-ST141□-EV2
System program Ver. 1.0□	The following functions cannot be used <ul style="list-style-type: none"> • Analogue meter • High-definition font display • Installation of system programs using memory unit • Connection to Mitsubishi PLCs • Memory link • Window control from the host • Multiple display of window screens • Moving a window • Additional data areas accessible in CS1-series PCs • The CS1-series high-speed 1:N NT Link • Interlock function that controls touch switches, numeral inputs, and character string inputs • Mathematical function • Device Monitor function • NT30/620 compatible mode • Expanded capabilities for label (guide character) displays, including multiple lines of text, ON/OFF switching displays, numeral memory table displays, and character string memory table displays 	The following functions cannot be used <ul style="list-style-type: none"> • Analogue meter • High-definition font display • Connection to Mitsubishi PLCs • Memory link • Window control from the host • Multiple display of window screens • Moving a window • Additional data areas accessible in CS1-series PCs • The CS1-series high-speed 1:N NT Link • Interlock function that controls touch switches, numeral inputs, and character string inputs • Mathematical function • Device Monitor function • NT30/620 compatible mode • Expanded capabilities for label (guide character) displays, including multiple lines of text, ON/OFF switching displays, numeral memory table displays, and character string memory table displays * Installation of system programs using memory unit is possible
System program Ver. 3.0□	The following functions cannot be used <ul style="list-style-type: none"> • Installation of system programs using memory unit • High-definition font display 	All of the functions described in the Setup Manual and Reference Manual can be used.

* The system program's version can be checked from the System Menu.

Appendix J Model List

PTs

Model	Specification
NT31-ST121-EV2	STN monochrome display, ivory
NT31-ST121B-EV2	STN monochrome display, black
NT31C-ST141-EV2	STN color display, ivory
NT31C-ST141B-EV2	STN color display, black

Host Link Units

Model	Specification	Applicable PC
3G2A6-LK201-EV1	CPU-mounted type with RS-232C connector	C-series C1000H C2000H
3G2A6-LK202-EV1	CPU-mounted type with RS-422A connector	
C200H-LK201-V1	Rack-mounting unit with RS-232C connector for C200H	C-series C200HS C200HX/HG/HE(-Z)E
C200H-LK202-V1	Rack-mounting unit with RS-422A connector for C200H	
3G2A5-LK201-EV1	Features a selectable RS-232C/RS-422A connector	C-series C1000H C2000H
C500-LK203	Rack-mounting unit for C500	
CV500-LK201	Features an RS-232C connector and a selectable RS-232C/RS-422A connector Rack-mounting unit for CVM1/CV	CVM1/CV-series CV500 CV1000 CV2000 CVM1

CompoBus/S Master Control Unit

Model	Specification	Model Name
SRM1-C02-V2	Features an RS-232C port	SRM1

Communications Unit

Model	Specification	Applicable PC
CS1W-SCU21	RS-232C (2 ports) Rack-mounting unit	CS1-series CS1G/H

CPU Units for Connection via a Host Link

Model	Specification	PC Type
CPM1-10CDR-□ CPM1-20CDR-□ CPM1A-10CD□-□ CPM1A-20CD□-□ CPM1A-30CD□-□ CPM1A-40CD□-□	RS-232C adapter/RS-422A adapter connected to the peripheral port	C-series CPM1
CPM2A-30CD□□-□ CPM2A-40CD□□-□ CPM2A-60CD□□-□	Features a 9-pin connector for RS-232C connections	C-series CPM2A

Model	Specification	PC Type
CPM2C-10□□□□□□-□ CPM2C-20□□□□□□-□	The PC's communications connector can be split into an RS-232C port and peripheral port with a CPM2C-CN111 Connecting Cable. (The CS1W-CN114/118 Connecting Cables convert the connector to a single RS-232C or peripheral port.)	C-series CPM2C
CQM1-CPU21-E CQM1-CPU41-EV1 CQM1-CPU42-EV1 CQM1-CPU43-EV1 CQM1-CPU44-EV1 CQM1-CPU45-EV1	Features a 9-pin connector for RS-232C connections	C-series CQM1
CQM1H-CPU11 CQM1H-CPU21 CQM1H-CPU51 CQM1H-CPU61	Features a 9-pin connector for RS-232C connections (The CQM1H-CPU11-E has only a peripheral port.)	C-series CQM1H
C200HS-CPU21-E C200HS-CPU23-E C200HS-CPU31-E C200HS-CPU33-E	Features a connector for RS-232C connections (selectable/9-pin)	C-series C200HS
C200HE-CPU32-(Z)E(*) C200HE-CPU42-(Z)E	Features a connector for RS-232C connections (selectable/9-pin)	C-series C200HE(-Z)E
C200HG-CPU33-(Z)E(*) C200HG-CPU43-(Z)E C200HG-CPU53-(Z)E(*) C200HG-CPU63-(Z)E	Features a connector for RS-232C connections (selectable/9-pin)	C-series C200HG(-Z)E
C200HX-CPU34-(Z)E(*) C200HX-CPU44-(Z)E C200HX-CPU54-(Z)E(*) C200HX-CPU64-(Z)E C200HX-CPU65-ZE C200HX-CPU85-ZE	Features a connector for RS-232C connections (selectable/9-pin)	C-series C200HX(-Z)E
CS1G-CPU42-E(V1) CS1G-CPU43-E(V1) CS1G-CPU44-E(V1) CS1G-CPU45-E(V1)	Features a connector for RS-232C connections (9-pin)	CS1-series CS1G
CS1H-CPU63-E(V1) CS1H-CPU64-E(V1) CS1H-CPU65-E(V1) CS1H-CPU66-E(V1) CS1H-CPU67-E(V1)	Features a connector for RS-232C connections (9-pin)	CS1-series CS1H
CV500-CPU01-EV1 CV1000-CPU01-EV1 CV2000-CPU01-EV1 CVM1-CPU01-EV2 CVM1-CPU11-EV2 CVM1-CPU21-EV2	Features a connector for RS-232C connections (selectable/9-pin)	CVM1/CV-series CV500 CV1000 CV2000 CVM1

* Either of the communication boards C200HW-COM02/COM04/COM05/COM06-EV1 is required.

CPU Units for Connection via a 1:1 NT Link

Model	Specification	PC Type
CPM1-10CDR-□ CPM1-20CDR-□ CPM1A-10CD□-□ CPM1A-20CD□-□ CPM1A-30CD□-□ CPM1A-40CD□-□	RS-232C adapter connected to the peripheral port (RS-422A adapter cannot be used)	C-series CPM1
CPM2A-30CD□□-□ CPM2A-40CD□□-□ CPM2A-60CD□□-□	Features a 9-pin connector for RS-232C connections	C-series CPM2A

Model	Specification	PC Type
CPM2C-10□□□□□□-□ CPM2C-20□□□□□□-□	Connect to the RS-232C port of a CPM2C-CN111 Connecting Cable.	C-series CPM2C
CQM1-CPU41-EV1 CQM1-CPU42-EV1 CQM1-CPU43-EV1 CQM1-CPU44-EV1 CQM1-CPU45-EV1	Features a 9-pin connector for RS-232C connections	C-series CQM1
CQM1H-CPU21 CQM1H-CPU51 CQM1H-CPU61	Features a 9-pin connector for RS-232C connections	C-series CQM1H
C200HS-CPU21-E C200HS-CPU23-E C200HS-CPU31-E C200HS-CPU33-E	Features a connector for RS-232C connections (selectable/9-pin)	C-series C200HS
C200HE-CPU32-(Z)E(*) C200HE-CPU42-(Z)E	Features a connector for RS-232C connections (selectable/9-pin)	C-series C200HE(-Z)E
C200HG-CPU33-(Z)E(*) C200HG-CPU43-(Z)E C200HG-CPU53-(Z)E(*) C200HG-CPU63-(Z)E	Features a connector for RS-232C connections (selectable/9-pin)	C-series C200HG(-Z)E
C200HX-CPU34-(Z)E(*) C200HX-CPU44-(Z)E C200HX-CPU54-(Z)E(*) C200HX-CPU64-(Z)E C200HX-CPU65-ZE C200HX-CPU85-ZE	Features a connector for RS-232C connections (selectable/9-pin)	C-series C200HX(-Z)E
CV500-CPU01-EV1 CV1000-CPU01-EV1 CV2000-CPU01-EV1 CVM1-CPU01-EV2 CVM1-CPU11-EV2 CVM1-CPU21-EV2	Features a connector for RS-232C connections (selectable/9-pin)	CVM1/CV-series CV500 CV1000 CV2000 CVM1

* Either of the communication boards C200HW-COM02/COM04/COM05/COM06-EV1 is required.

CPU Units for Connection via a 1:N NT Link

Model	Specification	PC Type
CQM1H-CPU51 ^(*) CQM1H-CPU61 ^(*)	Features a 9-pin connector for RS-232C connections	C-series CQM1H
C200HE-CPU32-(Z)E(*) C200HE-CPU42-(Z)E	Features a connector for RS-232C connections (selectable/9-pin)	C-series C200HE(-Z)E
C200HG-CPU34-(Z)E(*) C200HG-CPU43-(Z)E C200HG-CPU53-(Z)E(*) C200HG-CPU63-(Z)E	Features a connector for RS-232C connections (selectable/9-pin)	C-series C200HG(-Z)E
C200HX-CPU34-(Z)E(*) C200HX-CPU44-(Z)E C200HX-CPU54-(Z)E(*) C200HX-CPU64-(Z)E C200HX-CPU65-ZE C200HX-CPU85-ZE	Features a connector for RS-232C connections (selectable/9-pin)	C-series C200HX(-Z)E

Model	Specification	PC Type
CS1G-CPU42-E(V1) CS1G-CPU43-E(V1) CS1G-CPU44-E(V1) CS1G-CPU45-E(V1)	Features a connector for RS-232C connections (9-pin)	CS1-series CS1G
CS1H-CPU63-E(V1) CS1H-CPU64-E(V1) CS1H-CPU65-E(V1) CS1H-CPU66-E(V1) CS1H-CPU67-E(V1)	Features a connector for RS-232C connections (9-pin)	CS1-series CS1H

*1: A CQM1H-SCB41 Serial Communications Board is required.

*2: Either of the communication boards C200HW-COM02/COM04/COM05/COM06-EV1 is required.

CPU Units for Connection via a High-speed NT Link (1:N)

Model	Specification	PC Type
CS1G-CPU42-E(V1) CS1G-CPU43-E(V1) CS1G-CPU44-E(V1) CS1G-CPU45-E(V1)	Features a 9-pin connector for RS-232C connections	CS1-series CS1G
CS1H-CPU63-E(V1) CS1H-CPU64-E(V1) CS1H-CPU65-E(V1) CS1H-CPU66-E(V1) CS1H-CPU67-E(V1)	Features a 9-pin connector for RS-232C connections	CS1-series CS1H

Reference: Serial Communications Boards (CS1W-SCB41) and Serial Communications Units (CS1W-SCU21) with lot number 991220 (12/20/99) and later support the high-speed 1:N NT Link. Boards and Units with earlier lot numbers **cannot** be used to establish a high-speed 1:N NT Link.

RS-232C/RS-422A Converter Unit

Model	Specification
NT-AL001	RS-232C: 9-pin connector RS-422A: 8-pin terminal block

RS-232C Adaptor, RS-422A Adaptor

Model	Specification
CPM1-CIF01	Links the RS-232C port of an NT31/NT31C and the peripheral port of a CPM1, CPM2A, CPM2C, SRM1 (compatible with host link, and NT Link (1:1))
CPM1-CIF11	Links the RS-422A port of an NT31/NT31C and the peripheral port of a CPM1, CPM2A, CPM2C, SRM1 (compatible with host link)

Related Parts and Equipment for PT

Name	Model	Remark
Support Tool*	NT-ZJCAT1-EV4	Compatible with PC/AT personal computers For Windows 95/98/NT (English version) CD-ROM
Options	NT31C-CFL01	Replaceable backlight (common to NT31 and NT31C)
	NT30-KBA04	Reflection suppressing protective sheet for NT31/NT31C
	NT30-KBA01	Chemical-resistant cover for NT31/NT31C
	NT-MF261	Memory unit for NT31/NT31C
	3G2A9-BAT08	Spare battery

* The Support Tool indicated above includes the system installer and the standard system programs (Ver. 3.0) for the NT31, NT31C, NT631, and NT631C. System programs for the earlier NT30/620 PTs are also included.

Cables with Connectors for PT ↔ PC/NT-AL001-E

Model	Cable Length	Applicable units	Communication Method	Specification
XW2Z-200S	2 m	Host link units with a 25-pin connector	Serial port A host link (RS-232C only)	9-pin ↔ 25-pin
XW2Z-500S	5 m			
XW2Z-200T	2 m	Host link units with a 9-pin connector	Serial port A host link, NT Link (1:1) (RS-232C only)	9-pin ↔ 9-pin
XW2Z-500T	5 m			
XW2Z-200P	2 m	Host link units with a 25-pin connector	Serial port B host link (RS-232C only)	25-pin ↔ 25-pin
XW2Z-500P	5 m			
XW2Z-200S	2 m	Host link units with a 9-pin connector	Serial port B host link, NT Link (1:1) (RS-232C only)	25-pin ↔ 9-pin
XW2Z-500S	5 m			
SJ45007-102	1 m	CPU Units with a 9-pin connector (A +5 V power supply wire is attached for NT-AL001-E connections.)	Host Link or 1:1 NT Link using NT-AL001-E	9-pin ↔ 9-pin
SJ45007-202	2 m			
XW2Z-070T-1	0.7 m	CPU Units with a 9-pin connector (The PC ^(*) supplies +5 V for NT-AL001-E connections.)	Host Link, 1:1 NT Link, or 1:N NT Link using NT-AL001-E	9-pin ↔ 9-pin
XW2Z-200T-1	2 m			
SJ46006-102	1 m	CPU Units with a 9-pin connector (The PC ^(*) supplies +5 V for NT-AL001-E connections.)	Host Link, 1:1 NT Link, or 1:N NT Link using NT-AL001-E	9-pin ↔ 9-pin
SJ46006-202	2 m			

*1: The following PCs can supply +5 V: C200HX/HG/HE(-Z)E, CQM1H, CPM2A, CPM2C, and CS1G/H.

Cables with Connectors

Model	Cable Length	Specification
CV500-CN228	2 m	25-pin (male) ↔ 9-pin (male)
XW2Z-S001*	15 cm	25-pin (female) ↔ 14-pin (male)
XW2Z-S002	2 m	9-pin (female) ↔ 9-pin (male)

* The XW2Z-S001 is a converting cable. A CV500-CN228 must be purchased separately for connection to a computer.

Connection Cable

Model	Specification
AWG28 × 5P IFVV-SB	Multicore cable, manufactured by Fujikura, Ltd.
CO-MA-VV-SB 5P × 28AWG	Multicore cable, manufactured by Hitachi Cable, Ltd.

Applicable Connectors

Name	Model	Specification
Connector	XM2A-2501	25-pin type (male), made by OMRON
	XM2D-2501	25-pin type (female), made by OMRON (for personal computers)
	XM2A-0901	9-pin type (male), made by OMRON
	XM2D-0901	9-pin type (female), made by OMRON (for personal computers)
	DB-25P	25-pin type (male), made by JAE
Connector hood	XM2S-2511	25-pin type, mm pitch screw, made by OMRON
	XM2S-2513	25-pin type, inch pitch screw, made by OMRON
	XM2S-0911	9-pin type, mm pitch screw, made by OMRON
	XM2S-0911-E	9-pin type, mm pitch screw, made by OMRON
	XM2S-0913	9-pin type, inch pitch screw, made by OMRON
	DB-C2-J9	25-pin type, made by JAE

Printer Cable

Model	Specification
NT-CNT121	Printer cable for half pitch (1.5 m), made by OMRON

Cable for Peripheral Port of CS1-series PC

Model	Specification
CS1W-CN118	Made by OMRON (CS1-series peripheral port ↔ D-Sub, 9-pin, female)

Connecting Cable for the CPM2C Communications Connector

Model	Specification
CPM2C-CN111	Made by OMRON (CPM2C communications port ↔ D-Sub, 9-pin, female, C-series peripheral port)

Appendix K Option List

Replaceable Backlight ... NT31C-CFL01 (Used for Both NT31/NT31C)

This is a backlight (CFL unit) for replacement purposes.

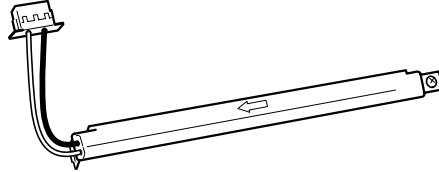

Protective Sheet ... NT30-KBA04 (Used for Both NT31/NT31C)

Stuck to the display to prevent irregular reflection or contamination. The entire sheet is colorless and transparent. The five sheets make a set.

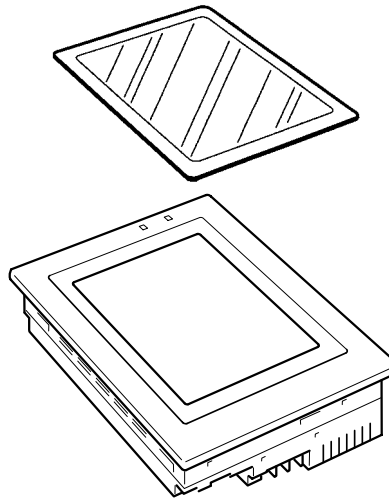

Chemical-resistant Cover ... NT30-KBA01

Covers the front panel and protects it from various chemical agents. The entire sheet is milky white and made of silicone rubber.

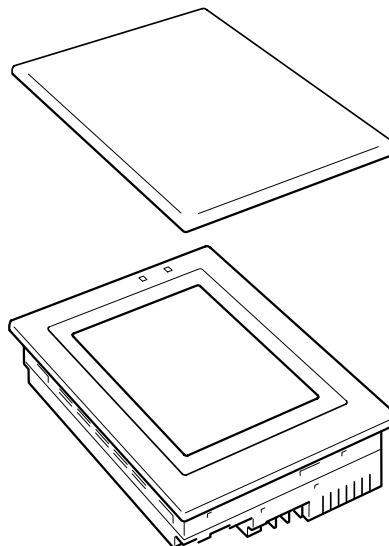

The sheet offers protection against the following chemical agents.

Protects against	Does not protect against
Boric acid	Hexane
Sulfuric acid	Lubricating oil
Nitrogen	Benzene
Ammonia gas	Butane
Carbonic acid gas	Carbonic acid
Phenol	Chlorinated solvents
Glycerin	Napthalene
Ammonia water	Soy bean oil
Calcium chloride	Toluene
Developing fluid (hypo)	
Acetaldehyde	
Lard	

For information on chemical agents not listed in the table above, please inquire whether or not protection is offered (if the chemical agent is one against which silicone rubber is recognized as offering protection, please use this product even if the agent is not listed in the "Protects against" column of the table above).

Replacement Battery ... 3G2A9-BAT08

This is a lithium battery used for memory backup.

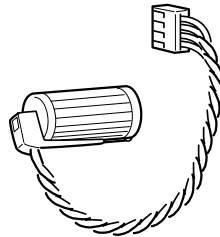

Memory Unit ... NT-MF261

This is a dedicated unit for reading/writing the screen data and the system programs in an NT31/NT31C. Data is transmitted by DIP switch setting at the memory unit.

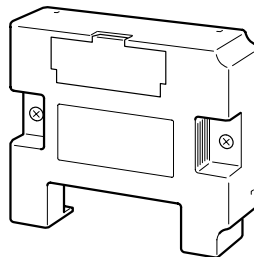

Index

Numbers

- 1:N connection among RS-422A ports, 122
- 1:N connection among RS-485 ports, 125
- 1:N connection between RS-422A/485 at the NT31/NT31C and RS-232C at the host, 92

A

- Allowable power supply voltage range, 247
- Applicable connectors, 281
- Automatic transmission (memory unit), 42, 49

B

- Backlight, 241
- Backlight brightness adjustment, 193
- Backlight unit, 30
- Battery cover, 30
- Before operating, 22
- Brightness adjustment, 248

C

- Cable connection dimensions, 257
- Cable for peripheral port of CS1-series PLC, 282
- Cables with connectors, 281
- Calling the System Installer mode, 138
- Calling the System Menu, 138
- Cell size (Touch panel), 248
- Changing the system settings, 153
- Checking communication at serial ports, 217
- Checking communication with a printer, 220
- Checking communication with the support tool, 216
- Checking interfaces, 215
- Checking screen data, 202
- Checking the backlight, 209
- Checking the battery voltage, 214
- Checking the buzzer, 205
- Checking the LCD (screen display), 208
- Checking the PT setting status, 197
- Checking the RUN LED, 206
- Checking touch switches, 212

- Chemical-resistant cover, 283
- Cleaning method, 245
- Clearing screen data, 140, 154
- Clearing/installing the system program, 151
- Comm. A Method, 158
- Comm. B Method, 158
- Comm. B Select, 158
- Communication board, 55, 68, 72, 75, 102
- Communication boards, 111
- Communication by Using Memory Link, 20
- Communication condition, 157
- Communication condition settings for bar code readers, 188
- Communication condition settings for the host link method, 158
- Communication errors and their remedies, 239
- Communication method for communications with the host, 157
- Communication method settings, 158
- Communication methods, 26
- Communication port, 26
- Communication type, 26
- Communication Unit, 277
- Communications specifications, 251
- Comparison between NT31 and NT31C, 5
- Connecting a bar code reader, 37
- Connecting a printer, 36
- Connecting directly between RS-232C ports, 78
- Connecting to other model PCs, 20
- Connecting to the Support Tool, 35
- Connection cable, 281
- Connection method, 26
- Contrast adjustment, 191
- CPU, 102
- CPUs, 68, 72, 75, 111, 113
- CPUs (for connection via a host link), 277
- CPUs connectable with host link units or expansion communication board, 102

D

- Device check, 205
- Device Monitor function, 227
- Dimensions, 247
- Direct connection function, 17
- Disabling/enabling System Menu display, 153

Disabling/enabling writing to the screen data memory, 153
Display, 29
Display color, 248
Display device, 248
Display specifications, 248
Displaying and printing the display history record, 198
Displaying/setting the calendar and clock, 195
Downloading the system program, 152

E

Effective display area, 248
Enclosure ratings, 247
Error messages, 235
Errors in the system installer mode and their remedies, 239
Errors occurring at start of operation, 235
Errors occurring during operation, 237
Errors occurring on screen data initialization and transmission, 238
Errors when using a memory unit, 45, 51
Expansion interface connector, 30
Expansion Mode, 136
External interface specifications, 249

F-H

Functional ground terminal, 34
General specifications, 247
GR terminal, 30
Grounding, 34, 247
Host link, 18
Host link method, 54, 101
Host link unit, 55, 277

I

I/O settings, 191
In the panel, 4
Initializing alarm history record data, 144
Initializing display history record data, 142
Initializing the memory switches, 149
Initializing the memory tables, 147
Initializing the recipe tables, 145
Inspection method, 245

Installation environment, 32
Installation in the operation panel, 32

L-M

Life expectancy (backlight), 248
Life expectancy (display panel), 248
Life expectancy (touch panel), 248
Maintenance Mode, 136
Making the cable, 267
Making the cable for connecting a PC, 269
Making the cable for connection to a bar code reader, 271
Making the cable for connection to a printer, 273
Manual transmission (memory unit), 44, 50
Manuals, 22
Memory initialization, 140
Memory link method, 78, 116
Memory switch, 157
Memory switch setting screen, 168
Memory unit, 284
Menu tree, 137
RUN mode, 135
System Installer Mode, 135
Mounting dimensions, 256

N

Noise resistance, 247
NT link, 18
NT link (1:1) method, 67
NT link (1:N) method, 72, 113
 high-speed, 75, 115
NT-AL001, 259
Number of dots, 248
Number of switches (touch panel), 248

O

Operating ambient humidity, 247
Operating ambient temperature, 247
Operating environment, 247
Operating force, 248
Operation at startup, 134
Operation modes, 135

P

Peripheral devices that can be connected, 16
Power consumption, 247
Power input terminals, 30
POWER LED, 29
Power supply connection, 33
precautions, xi
Precautions to be observed when transmitting screen data, 156
Principal functions of NT31/NT31C, 9
Printer cable, 282
Printer connector, 30
Programming console function, 221
Programming environment, 249
Protective sheet, 283
PT, 277
PT Memory, 20

R

Rated power supply voltage, 247
Recipe function, 6
Recommended printers, 36
Relationship between system program and hardware, 275
Relationships among modes, 135
Replaceable backlight, 283
Replacement battery, 284
Replacing the backlight, 242
Replacing the battery, 244
Reset switch, 30
RS-232C adaptor, 280
RS-232C/RS-422A convertor unit, 88, 280
RS-422A adaptor, 280
RUN, 135
RUN LED, 29

S

Screen data composition and transmission units, 155
Screen data memory check, 209
Selecting menu items, 139
Serial communication board, 54, 72, 75, 102, 116
Serial communication unit, 54
Serial port A, 17, 26
Serial port A connector, 30

Serial port B, 17, 26
Serial port B connector, 30
Set, 161
Setting "Screen Saver Movement", 175
Setting the automatic reset function, 183
Setting the bar code reader input function, 188
Setting the "Buzzer Sound", 171
Setting the communication type for serial port B, 167
Setting the conditions for communications with the memory link method, 158
Setting the display language in the System Installer mode, 151
Setting the history display method, 179
Setting the host link method, 160
Setting the "Key Press Sound", 170
Setting the Memory Link Method, 165
Setting the NT link (1:1) method, 162
Setting the NT link (1:N) method, 163
Setting the "Print Method", 174
Setting the "Printer Controller", 172
Setting the resume function, 181
Setting the retry count, 186
Setting the screen saver start-up time, 177
Setting the "Start-up Wait Time", 169
Setting the terminal resistance, 99, 128
Setting the time-out interval, 185
Shock resistance (operating), 247
Special features, 249
Starting operation, 168
Starting the NT31/NT31C, 134
Storage ambient temperature, 247
Supplemental functions to V2, 6
Support Tool, 280
Switching from the System Menu to the RUN mode, 139
Switching to the RUN mode, 168
System configuration, 16
System Menu, 135

T-U

Terminal resistance setting terminal, 99
Transmit Mode, 136
Transmitting the screen data, 155
Transporting and storing the NT31/NT31C, 265
Usable systems (programming console function), 221
Using a Memory Unit(NT31/NT31C with V1), 39
Using an RS-232C/RS-422A convertor unit, 259

V

Vibration resistance (operating), 247

View angle, 248

W

Warning label, 30

Waterproofed, 4

Weight, 247

Revision History

A manual revision code appears as a suffix to the catalog number on the front cover of the manual.

Cat. No. V062-E1-1
 ↑
 └─ Revision code

The following table outlines the changes made to the manual during each revision. Page numbers refer to the previous version.

Revision code	Date	Revised content
1	July 2000	Original production