

USER'S MANUAL

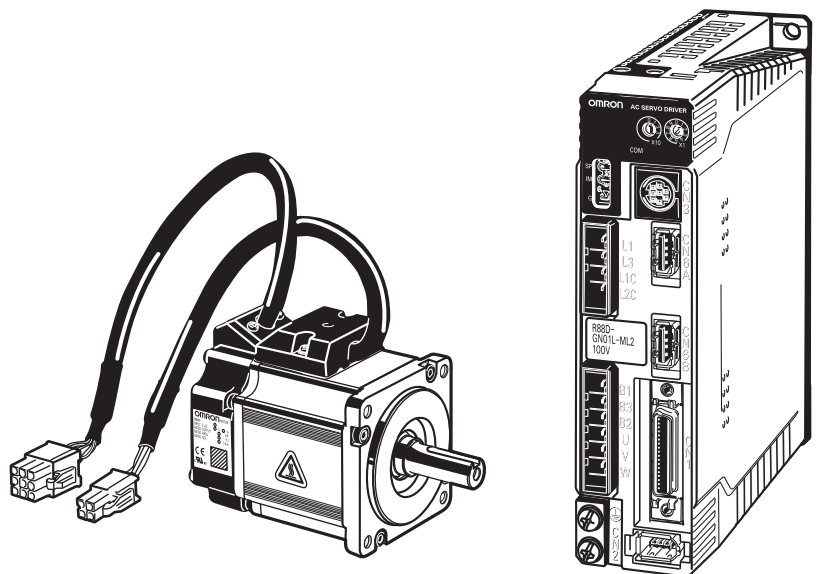

OMNUC G SERIES

R88M-G□
(AC Servomotors)
R88D-GN□-ML2
(AC Servo Drives)

AC SERVOMOTORS/SERVO DRIVES WITH BUILT-IN MECHATROLINK-II COMMUNICATIONS

Trademarks and Copyrights

- Product names and system names in this manual are trademarks or registered trademarks of their respective companies.
- MECHATROLINK is a registered trademark of the MECHATROLINK Members Association.

© OMRON, 2008

All rights reserved. No part of this publication may be reproduced, stored in a retrieval system, or transmitted, in any form, or by any means, mechanical, electronic, photocopying, recording, or otherwise, without the prior written permission of OMRON.

No patent liability is assumed with respect to the use of the information contained herein. Moreover, because OMRON is constantly striving to improve its high-quality products, the information contained in this manual is subject to change without notice. Every precaution has been taken in the preparation of this manual. Nevertheless, OMRON assumes no responsibility for errors or omissions. Neither is any liability assumed for damages resulting from the use of the information contained in this publication.

Introduction

Thank you for choosing the OMNUC G Series. This User's Manual describes installation/wiring methods and parameter setting procedures required for the operation of the OMNUC G Series as well as troubleshooting and inspection methods.

Intended Readers

This manual is intended for the following personnel.
Those with knowledge of electrical systems (a qualified electrical engineer or the equivalent) as follows:

- ♦ Personnel in charge of introducing FA equipment
- ♦ Personnel in charge of designing FA systems
- ♦ Personnel in charge of managing FA systems and facilities

NOTICE

This manual contains information necessary to ensure safe and proper use of the OMNUC G Series and its peripheral devices. Please read this manual thoroughly and understand its contents before using the products.

Please keep this manual handy for future reference.

Make sure this User's Manual is delivered to the actual end user of the products.

Read and Understand This Manual

Please read and understand this manual before using the product. Please consult your OMRON representative if you have any questions or comments.

Warranty and Limitations of Liability

WARRANTY
<p>OMRON's exclusive warranty is that the products are free from defects in materials and workmanship for a period of one year (or other period if specified) from date of sale by OMRON.</p> <p>OMRON MAKES NO WARRANTY OR REPRESENTATION, EXPRESS OR IMPLIED, REGARDING NON-INFRINGEMENT, MERCHANTABILITY, OR FITNESS FOR PARTICULAR PURPOSE OF THE PRODUCTS. ANY BUYER OR USER ACKNOWLEDGES THAT THE BUYER OR USER ALONE HAS DETERMINED THAT THE PRODUCTS WILL SUITABLY MEET THE REQUIREMENTS OF THEIR INTENDED USE. OMRON DISCLAIMS ALL OTHER WARRANTIES, EXPRESS OR IMPLIED.</p>

LIMITATIONS OF LIABILITY
<p>OMRON SHALL NOT BE RESPONSIBLE FOR SPECIAL, INDIRECT, OR CONSEQUENTIAL DAMAGES, LOSS OF PROFITS OR COMMERCIAL LOSS IN ANY WAY CONNECTED WITH THE PRODUCTS, WHETHER SUCH CLAIM IS BASED ON CONTRACT, WARRANTY, NEGLIGENCE, OR STRICT LIABILITY.</p> <p>In no event shall the responsibility of OMRON for any act exceed the individual price of the product on which liability is asserted.</p> <p>IN NO EVENT SHALL OMRON BE RESPONSIBLE FOR WARRANTY, REPAIR, OR OTHER CLAIMS REGARDING THE PRODUCTS UNLESS OMRON'S ANALYSIS CONFIRMS THAT THE PRODUCTS WERE PROPERLY HANDLED, STORED, INSTALLED, AND MAINTAINED AND NOT SUBJECT TO CONTAMINATION, ABUSE, MISUSE, OR INAPPROPRIATE MODIFICATION OR REPAIR.</p>

Application Considerations

SUITABILITY FOR USE

OMRON shall not be responsible for conformity with any standards, codes, or regulations that apply to the combination of products in the customer's application or use of the products.

At the customer's request, OMRON will provide applicable third party certification documents identifying ratings and limitations of use that apply to the products. This information by itself is not sufficient for a complete determination of the suitability of the products in combination with the end product, machine, system, or other application or use.

The following are some examples of applications for which particular attention must be given. This is not intended to be an exhaustive list of all possible uses of the products, nor is it intended to imply that the uses listed may be suitable for the products:

- Outdoor use, uses involving potential chemical contamination or electrical interference, or conditions or uses not described in this manual.
- Nuclear energy control systems, combustion systems, railroad systems, aviation systems, medical equipment, amusement machines, vehicles, safety equipment, and installations subject to separate industry or government regulations.
- Systems, machines, and equipment that could present a risk to life or property.

Please know and observe all prohibitions of use applicable to the products.

NEVER USE THE PRODUCTS FOR AN APPLICATION INVOLVING SERIOUS RISK TO LIFE OR PROPERTY WITHOUT ENSURING THAT THE SYSTEM AS A WHOLE HAS BEEN DESIGNED TO ADDRESS THE RISKS, AND THAT THE OMRON PRODUCTS ARE PROPERLY RATED AND INSTALLED FOR THE INTENDED USE WITHIN THE OVERALL EQUIPMENT OR SYSTEM.

PROGRAMMABLE PRODUCTS

OMRON shall not be responsible for the user's programming of a programmable product, or any consequence thereof.

Disclaimers

CHANGE IN SPECIFICATIONS

Product specifications and accessories may be changed at any time based on improvements and other reasons.

It is our practice to change model numbers when published ratings or features are changed, or when significant construction changes are made. However, some specifications of the products may be changed without any notice. When in doubt, special model numbers may be assigned to fix or establish key specifications for your application on your request. Please consult with your OMRON representative at any time to confirm actual specifications of purchased products.

DIMENSIONS AND WEIGHTS

Dimensions and weights are nominal and are not to be used for manufacturing purposes, even when tolerances are shown.

PERFORMANCE DATA

Performance data given in this manual is provided as a guide for the user in determining suitability and does not constitute a warranty. It may represent the result of OMRON's test conditions, and the users must correlate it to actual application requirements. Actual performance is subject to the OMRON Warranty and Limitations of Liability.

ERRORS AND OMISSIONS



The information in this manual has been carefully checked and is believed to be accurate; however, no responsibility is assumed for clerical, typographical, or proofreading errors, or omissions.

Precautions for Safe Use

- To ensure safe and proper use of the OMNUC G Series and its peripheral devices, read the “Precautions for Safe Use” and the rest of the manual thoroughly to acquire sufficient knowledge of the devices, safety information, and precautions before using the products.
- Make sure this User’s Manual is delivered to the actual end users of the products.
- Please keep this manual close at hand for future reference.

Explanation of Signal Words





- The precautions indicated here provide important information for safety. Be sure to heed the information provided with the precautions.
- The following signal words are used to indicate and classify precautions in this manual.

 WARNING	<p>Indicates a potentially hazardous situation which, if not avoided, could result in death or serious injury. Additionally, there may be severe property damage.</p>
 Caution	<p>Indicates a potentially hazardous situation which, if not avoided, may result in minor or moderate injury, or property damage.</p>











Failure to heed the precautions classified as “Caution” may also lead to serious results. Always heed these precautions.

Safety Precautions



- This manual may include illustrations of the product with protective covers or shields removed in order to show the components of the product in detail. Make sure that these protective covers and shields are put in place as specified before using the product.
- Consult your OMRON representative when using the product after a long period of storage.

 WARNING	
	<p>Always connect the frame ground terminals of the Servo Drive and the Servomotor to 100 Ω or less. Incorrect grounding may result in electric shock.</p>
	<p>Do not touch the inside of the Servo Drive. Doing so may result in electric shock.</p>
	<p>When turning OFF the main circuit power supply, turn OFF the RUN command (RUN) at the same time. Residual voltage may cause the Servomotor to continue rotating and result in injury or equipment damage even if the main circuit power supply is turned OFF externally, e.g., with an emergency stop.</p>
	<p>Do not remove the front cover, terminal covers, cables, or optional items while the power is being supplied. Doing so may result in electric shock.</p>



Precautions for Safe Use

	Installation, operation, maintenance, or inspection must be performed by authorized personnel. Not doing so may result in electric shock or injury.
	Wiring or inspection must not be performed for at least 15 minutes after turning OFF the power supply. Doing so may result in electric shock.
	Do not damage or pull on the cables, place heavy objects on them, or subject them to excessive stress. Doing so may result in electric shock, stopping product operation, or burning.
	Do not touch the rotating parts of the Servomotor during operation. Doing so may result in injury.
	Do not modify the product. Doing so may result in injury or damage to the product.
	Provide a stopping mechanism on the machine to ensure safety. *The holding brake is not designed as a stopping mechanism for safety purposes. Not doing so may result in injury.
	Provide an external emergency stopping mechanism that can stop operation and shut off the power supply immediately. Not doing so may result in injury.
	Do not come close to the machine immediately after resetting momentary power interruption to avoid an unexpected restart. Doing so may result in injury. Take appropriate measures to secure safety against an unexpected restart.
	Confirm safety after an earthquake has occurred. Failure to do so may result in electric shock, injury, or fire.
	Do not use external force to drive the Servomotor. Doing so may result in fire.

WARNING



	Do not place any flammable materials near the Servomotor, Servo Drive, or Regeneration Resistor. Doing so may result in fire.
	Mount the Servomotor, Servo Drive, and Regeneration Resistor on metal or other non-flammable materials. Failure to do so may result in fire.
	Do not frequently and repeatedly turn the main power supply ON and OFF. Doing so may result in product failure.

Caution

	Use the Servomotors and Servo Drives in a specified combination. Using them incorrectly may result in fire or damage to the products.
	Do not store or install the product in the following places. Doing so may result in fire, electric shock, or damage to the product. <ul style="list-style-type: none"> ♦ Locations subject to direct sunlight. ♦ Locations subject to temperatures outside the specified range. ♦ Locations subject to humidity outside the specified range. ♦ Locations subject to condensation as the result of severe changes in temperature. ♦ Locations subject to corrosive or flammable gases. ♦ Locations subject to dust (especially iron dust) or salts. ♦ Locations subject to exposure to water, oil, or chemicals. ♦ Locations subject to shock or vibration.
	Do not touch the Servo Drive radiator, Servo Drive regeneration resistor, or Servomotor while the power is being supplied or soon after the power is turned OFF. Doing so may result in burn injuries.















■ Storage and Transportation Precautions

Caution









	Do not hold the product by the cables or motor shaft while transporting it. Doing so may result in injury or malfunction.
	Do not place any load exceeding the figure indicated on the product. Doing so may result in injury or malfunction.
	Use the motor eye-bolts only for transporting the Servomotor. Using them for transporting the machinery may result in injury or malfunction.

Precautions for Safe Use



■ Installation and Wiring Precautions

 Caution	
	Do not step on or place a heavy object on the product. Doing so may result in injury.
	Do not cover the inlet or outlet ports and prevent any foreign objects from entering the product. Covering them or not preventing entry of foreign objects may result in fire.
	Be sure to install the product in the correct direction. Not doing so may result in malfunction.
	Provide the specified clearances between the Servo Drive and the control panel or with other devices. Not doing so may result in fire or malfunction.
	Do not subject Servomotor shaft or Servo Drive to strong impacts. Doing so may result in malfunction.
	Be sure to wire correctly and securely. Not doing so may result in motor runaway, injury, or malfunction.
	Be sure that all the mounting screws, terminal screws, and cable connector screws are tightened properly. Incorrect tightening torque may result in malfunction.
	Use crimp terminals for wiring. Do not connect bare stranded wires directly to the protective ground terminal. Doing so may result in burning.
	Always use the power supply voltage specified in the User's Manual. An incorrect voltage may result in malfunction or burning.
	Take appropriate measures to ensure that the specified power with the rated voltage and frequency is supplied. Be particularly careful in places where the power supply is unstable. An incorrect power supply may result in equipment damage.
	Install external breakers and take other safety measures against short-circuiting in external wiring. Insufficient safety measures against short-circuiting may result in burning.
	Take appropriate and sufficient shielding measures when installing systems in the following locations. Failure to do so may result in damage to the product. <ul style="list-style-type: none">◆ Locations subject to static electricity or other forms of noise.◆ Locations subject to strong electromagnetic fields and magnetic fields.◆ Locations subject to possible exposure to radioactivity.◆ Locations close to power supplies.
	Connect an emergency stop cutoff relay in series with the brake control relay. Failure to do so may result in injury or product failure.
	Do not reverse the polarity of the battery when connecting it. Reversing the polarity may damage the battery or cause it to explode.

■ Operation and Adjustment Precautions

 <h1 style="margin: 0;">Caution</h1>	
	<p>Confirm that no adverse effects will occur in the system before performing the test operation. Not doing so may result in equipment damage.</p>
	<p>Check the newly set parameters for proper operation before actually running them. Not doing so may result in equipment damage.</p>
	<p>Do not make any extreme adjustments or setting changes. Doing so may result in unstable operation and injury.</p>
	<p>Separate the Servomotor from the machine, check for proper operation, and then connect to the machine. Not doing so may cause injury.</p>
	<p>When an alarm occurs, remove the cause, reset the alarm after confirming safety, and then resume operation. Not doing so may result in injury.</p>
	<p>Do not use the built-in brake of the Servomotor for ordinary braking. Doing so may result in malfunction.</p>
	<p>Do not operate the Servomotor connected to a load that exceeds the applicable load moment of inertia. Doing so may result in malfunction.</p>

■ Maintenance and Inspection Precautions

 <h1 style="margin: 0;">Caution</h1>	
	<p>Resume operation only after transferring to the new Unit the contents of the data required for operation. Not doing so may result in equipment damage.</p>
	<p>Do not attempt to disassemble or repair any of the products. Any attempt to do so may result in electric shock or injury.</p>

Precautions for Safe Use

■ Warning Label Position

Warning labels are located on the product as shown in the following illustration.
Be sure to follow the instructions given there.

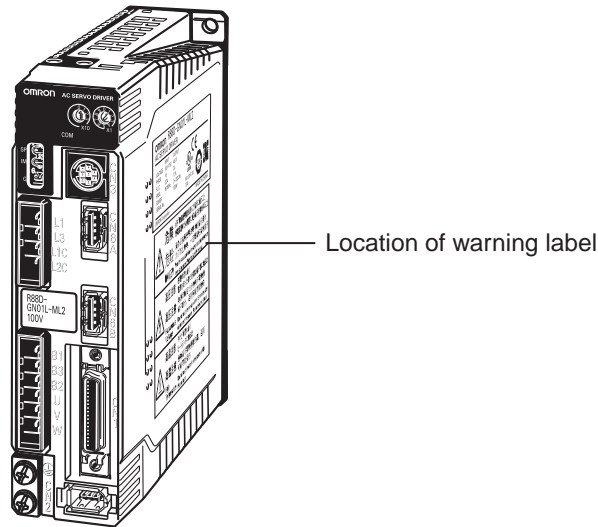

(R88D-GN01H-ML2)

■ Warning Label Contents

	危険 危険 DANGER	必ず取扱説明書を読んで指示に従うこと 感電保護のため確実に⊕端子を接地すること 请务必按照使用说明书的指示操作 为了防止触电，一定要接好接地端子 Read the manual and follow the safety instructions before use. Never fail to connect Protective Earth(PE) terminal.
	高压注意 高压注意 Hazardous Voltage	感電の恐れあり 電源を切った後15分間は端子部に触るな! 电源切断后15分钟内不要触摸 端子部分，否则可能导致触电 Do not touch terminals within 15 minutes after disconnect the power. Risk of electric shock.
	高温注意 高温注意 High Temperature	やけどの恐れあり ヒートシンクに触るな! 通电后不要触摸散热器，否则 可能导致受伤 Do not touch heatsink when power is ON. Risk of burn.

■ Disposing of the Product

- Dispose of the batteries according to local ordinances and regulations. Wrap the batteries in tape or other insulative material before disposing of them.
- Dispose of the product as industrial waste.

Items to Check When Unpacking

Check the following items after removing the product from the package.

- Has the correct product been delivered?
- Has the product been damaged in shipping?

■ Accessories Provided with Product

Safety Precautions document × 1

- No connectors or mounting screws are provided. They have to be prepared by the user.
- Should you find any problems (missing parts, damage to the Servo Drive, etc.), please contact your local sales representative or OMRON sales office.

■ Understanding Servo Drive Model Numbers

The model number provides information such as the Servo Drive type, the applicable Servomotor capacity, and the power supply voltage.

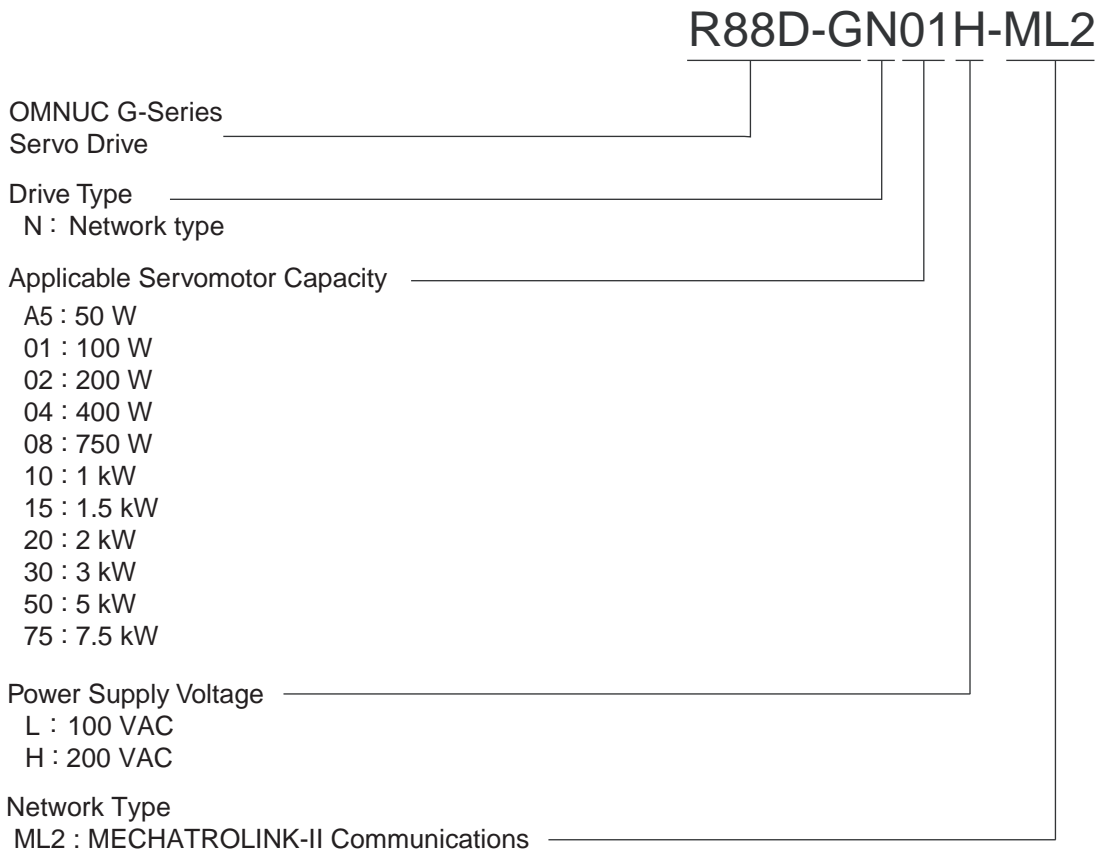

Items to Check When Unpacking

■ Understanding Servomotor Model Numbers

R88M-GP10030H-BOS2

G-Series
Servomotor

Motor Type
Blank: Cylinder type
P: Flat type

Servomotor Capacity

050: 50 W
100: 100 W
200: 200 W
400: 400 W
750: 750 W
900: 900 W
1K0: 1 kW
1K5: 1.5 kW
2K0: 2 kW
3K0: 3 kW
4K0: 4 kW
4K5: 4.5 kW
5K0: 5 kW
6K0: 6 kW
7K5: 7.5 kW

Rated Rotation Speed

10: 1,000 r/min
15: 1,500 r/min
20: 2,000 r/min
30: 3,000 r/min

Applied Voltage

H: 200 VAC with incremental encoder specifications
L: 100 VAC with incremental encoder specifications
T: 200 VAC with absolute encoder specifications
S: 100 VAC with absolute encoder specifications

Option

Blank: Straight shaft
B: With brake
O: With oil seal
S2: With key and tap

■ Understanding Decelerator Model Numbers (Backlash = 3' Max.)

R88G-HPG14A05100PBJ

Decelerator for _____
 G-Series Servomotors
 Backlash = 3' Max.

Flange Size Number _____
 11A :□40
 14A :□60
 20A :□90
 32A :□120
 50A :□170
 65A :□230

Gear Ratio _____
 05 :1/5
 09 :1/9 (only frame number 11A)
 11 :1/11 (except frame number 65A)
 12 :1/12 (only frame number 65A)
 20 :1/20 (only frame number 65A)
 21 :1/21 (except frame number 65A)
 25 :1/25 (only frame number 65A)
 33 :1/33
 45 :1/45

Applicable Servomotor Capacity _____
 050 : 50 W
 100 :100 W
 200 :200 W
 400 :400 W
 750 :750 W
 900 :900 W
 1K0 :1 kW
 1K5 :1.5 kW
 2K0 :2 kW
 3K0 :3 kW
 4K0 :4 kW
 4K5 :4.5 kW
 5K0 :5 kW
 6K0 :6 kW
 7K5 :7 kW

Motor Type _____
 Blank :3,000-r/min cylindrical Servomotors
 P :flat Servomotors
 S :2,000-r/min Servomotors
 T :1,000-r/min Servomotors

Backlash _____
 B :3' max.

Option _____
 Blank :Straight shaft
 J :With key and tap

Items to Check When Unpacking

■ Understanding Decelerator Model Numbers (Backlash = 15' Max.)

R88G-VRSF09B100PCJ

Decelerator for _____
G-Series Servomotors
Backlash = 15' Max.

Gear Ratio _____
05 :1/5
09 :1/9
15 :1/15
25 :1/25

Flange Size Number _____
B :□52
C :□78
D :□98

Applicable Servomotor Capacity _____
050 : 50 W
100 :100 W
200 :200 W
400 :400 W
750 :750 W

Motor Type _____
Blank :3,000-r/min cylindrical Servomotors
P :flat Servomotors

Backlash _____
C :15' max.

Option _____
J :With key and tap

About This Manual

This manual consists of the following chapters. Refer to this table and chose the required chapters of the manual.

		Overview
Chapter 1	Features and System Configuration	Describes the features and names of parts of the product as well as the EC Directives and the UL standards.
Chapter 2	Standard Models and Dimensions	Provides the model numbers, external and mounting hole dimensions for Servo Drives, Servomotors, Decelerators, and peripheral devices.
Chapter 3	Specifications	Provides the general specifications, characteristics, connector specifications, and I/O circuit specifications for Servo Drives, and the general specifications and characteristics for Servomotors, as well as specifications for accessories such as encoders.
Chapter 4	System Design	Describes the installation conditions for Servo Drives, Servomotors, and Decelerators, EMC conforming wiring methods, calculations of regenerative energy, and performance information on the External Regeneration Resistor.
Chapter 5	Operating Functions	Describes the control functions, parameter settings, and operation.
Chapter 6	Operation	Describes operating procedures and operating methods for each mode.
Chapter 7	Adjustment Functions	Describes gain adjustment functions, setting methods, and precautions.
Chapter 8	Troubleshooting	Describes items to check for troubleshooting, error diagnoses using alarm LED displays and the countermeasures, error diagnoses based on the operation status and the countermeasures, and periodic maintenance.
Chapter 9	Appendix	Provides the parameter tables.

Table of Contents

Introduction	1
Read and Understand This Manual	2
Precautions for Safe Use	5
Items to Check When Unpacking	11
About This Manual	15
Chapter 1 Features and System Configuration	
1-1 Overview.....	1-1
1-2 System Configuration	1-2
1-3 Names of Parts and Functions	1-3
1-4 System Block Diagrams	1-5
1-5 Applicable Standards.....	1-10
Chapter 2 Standard Models and Dimensions	
2-1 Standard Models	2-1
2-2 External and Mounting Hole Dimensions	2-23
Chapter 3 Specifications	
3-1 Servo Drive Specifications.....	3-1
3-2 Servomotor Specifications.....	3-17
3-3 Decelerator Specifications.....	3-32
3-4 Cable and Connector Specifications	3-42
3-5 Parameter Unit Specifications	3-78
3-6 External Regeneration Resistor Specifications	3-79
3-7 Reactor Specifications.....	3-80
Chapter 4 System Design	
4-1 Installation Conditions	4-1
4-2 Wiring	4-11
4-3 Wiring Conforming to EMC Directives	4-26
4-4 Regenerative Energy Absorption.....	4-44

Chapter 5 Operating Functions

5-1	Position Control	5-1
5-2	Speed Control	5-4
5-3	Torque Control	5-7
5-4	Forward and Reverse Drive Prohibit	5-10
5-5	Brake Interlock	5-11
5-6	Torque Limit	5-16
5-7	Soft Start	5-18
5-8	Acceleration/Deceleration Time Settings	5-19
5-9	Moving Average Time	5-20
5-10	Electronic Gear	5-21
5-11	Speed Limit	5-22
5-12	Sequence Input Signals	5-23
5-13	Sequence Output Signals	5-25
5-14	Backlash Compensation	5-27
5-15	Overrun Protection	5-29
5-16	Gain Switching	5-31
5-17	Speed Feed-forward	5-38
5-18	Torque Feed-forward	5-39
5-19	Speed Feedback Filter Selection	5-40
5-20	P Control Switching	5-41
5-21	Torque Command Filter Time Constant	5-42
5-22	Notch Filter	5-43
5-23	Adaptive Filter	5-45
5-24	Instantaneous Speed Observer	5-48
5-25	Damping Control	5-50
5-26	User Parameters	5-55
5-27	Details on Important Parameters	5-86

Chapter 6 Operation

6-1	Operational Procedure	6-1
6-2	Preparing for Operation	6-2
6-3	Using the Parameter Unit	6-8
6-4	Setting the Mode	6-9
6-5	Trial Operation	6-31

Chapter 7 Adjustment Functions

7-1	Gain Adjustment	7-1
7-2	Realtime Autotuning	7-3
7-3	Normal Mode Autotuning	7-9
7-4	Manual Tuning	7-14

Table of Contents

Chapter 8 Troubleshooting

8-1	Error Processing.....	8-1
8-2	Alarm Table	8-3
8-3	Troubleshooting.....	8-7
8-4	Overload Characteristics (Electronic Thermal Function).....	8-20
8-5	Periodic Maintenance	8-21

Chapter 9 Appendix

9-1	Parameter Tables.....	9-1
-----	-----------------------	-----

Chapter 1

Features and System Configuration

1-1	Overview	1-1
	Overview	1-1
	Features	1-1
1-2	System Configuration	1-2
1-3	Names of Parts and Functions	1-3
	Servo Drive Part Names	1-3
	Servo Drive Functions	1-4
1-4	System Block Diagrams	1-5
1-5	Applicable Standards	1-10
	EC Directives	1-10
	UL and CSA Standards	1-10

1-1 Overview

Overview

The OMNUC G Series AC Servo Drives (with built-in MECHATROLINK-II communications support) are a series of Servo Drives supporting the MECHATROLINK-II high-speed motion field network. When used with the MECHATROLINK-II Position Control Unit (CJ1W-NCF71 or CS1W-NCF71), a sophisticated positioning control system can be made easily with one communications cable connecting the Servo Drive and Controller.

With realtime autotuning, adaptive filter, notch filter, and damping control, you can set up a system that provides stable operation by suppressing vibration in low-rigidity machines.

Features

■ Data Transmission Using MECHATROLINK-II Communications

When used with the MECHATROLINK-II Position Control Unit (CJ1W-NCF71 or CS1W-NCF71), all control data between the Servo Drive and Controller can be exchanged through data communications.

Since the various control commands are transmitted via data communications, Servomotor's operational performance is maximized without being limited by interface specifications such as the response frequency of the encoder feedback pulses.

This makes it possible to use the Servo Drive's various control parameters and monitor data via a host controller, allowing you to unify the system data control.

■ Suppressing Vibration of Low-rigidity Mechanisms during Acceleration/Deceleration

The damping control function suppresses vibration of low-rigidity mechanisms or devices whose ends tend to vibrate.

Two vibration filters are provided to enable switching the vibration frequency automatically according to the direction of the rotation. Furthermore, the settings can be made easily by just setting the vibration frequency and filter values, and you are assured of stable operation even if the settings are inappropriate.

■ High-speed Positioning via Resonance Suppression Control

The realtime autotuning function automatically estimates the load inertia of the machine in realtime and sets the optimal gain.

The adaptive filter automatically suppresses vibration caused by resonance.

Two independent notch filters make it possible to reduce the vibration of a mechanism with multiple resonance frequencies.

■ Command Control Mode Switching

Operations can be performed by switching between two of the following control modes: Position control, speed control, and torque control. Therefore, a variety of applications can be supported by one Servo Drive.

1-2 System Configuration

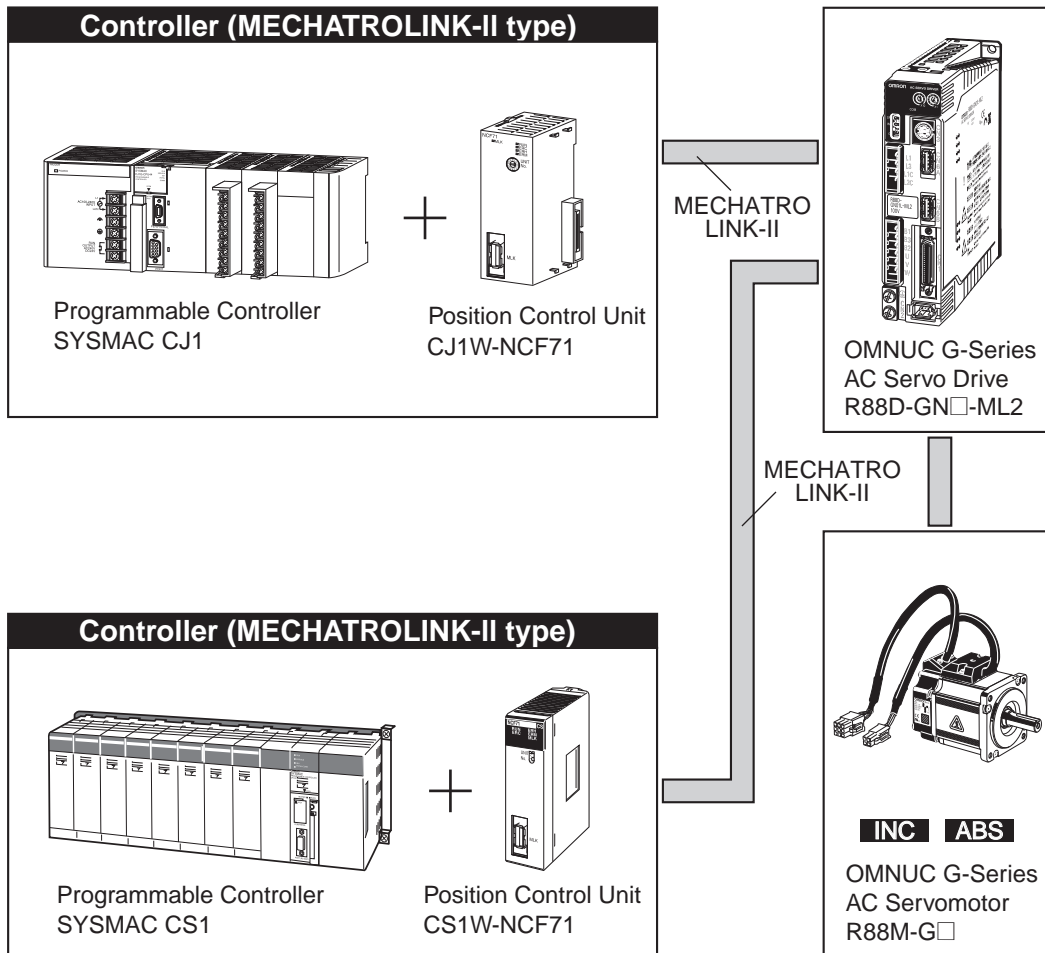

1-3 Names of Parts and Functions

Servo Drive Part Names

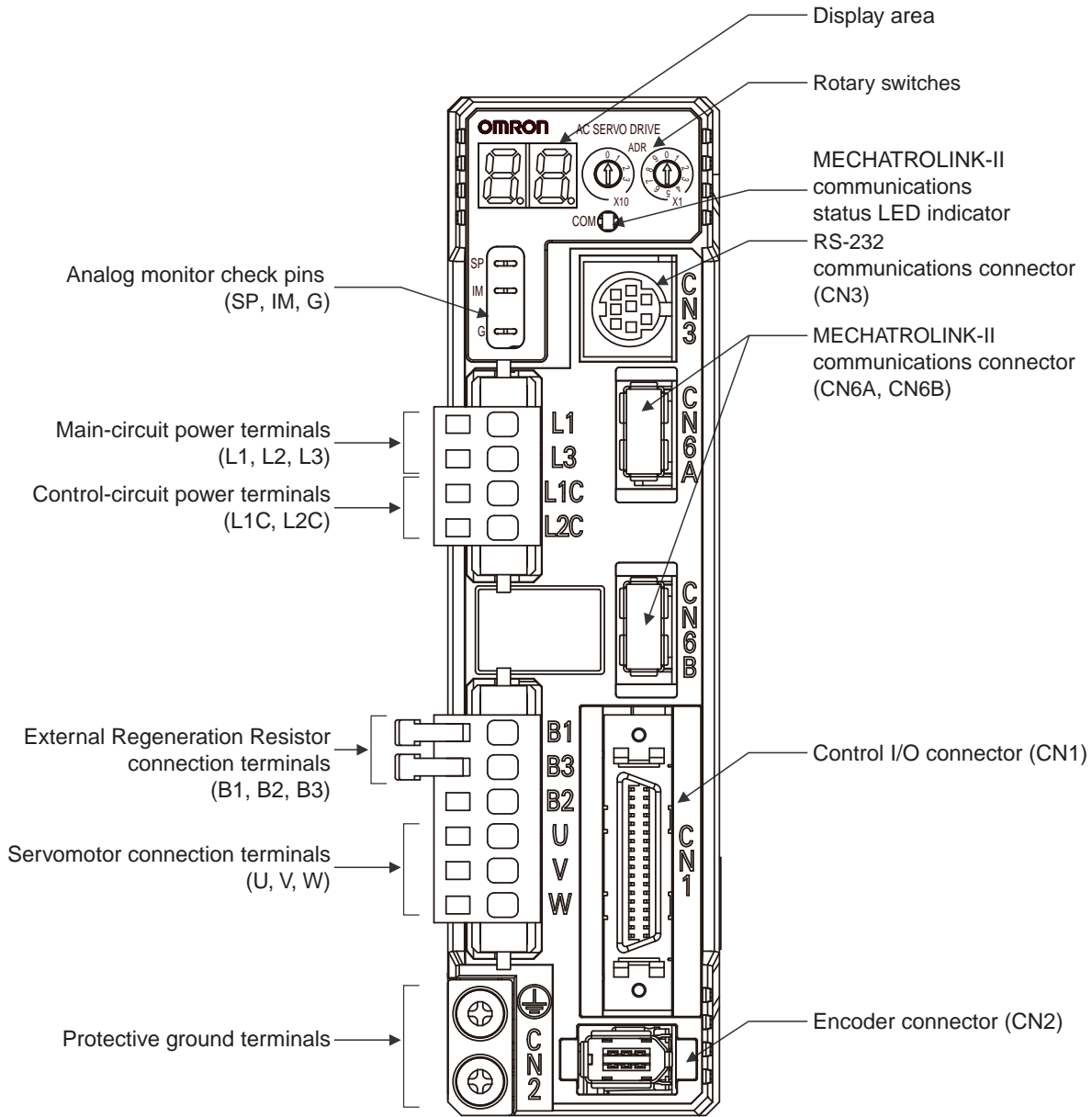

Servo Drive Functions

■ Display Area

A 2-digit 7-segment LED display shows the Servo Drive status, alarm codes, parameters, and other information.

■ Analog Monitor Check Pins (SP, IM, and G)

The actual motor speed, command speed, torque, and number of accumulated pulses can be measured based on the analog voltage level by using an oscilloscope.

Set the type of signal to be output and the output voltage level by setting the Speed Monitor (SP) Selection (Pn007) and Torque Monitor (IM) Selection (Pn008).

For details, refer to *User Parameters* on page 5-55.

■ MECHATROLINK-II Status LED Indicator

Indicates the communications status of the MECHATROLINK-II.

For details, refer to *MECHATROLINK-II Status LED Indicator* on page 6-4.

■ Rotary Switches

Sets the node address.

For details, refer to *Servo Drive Display and Settings* on page 6-3.

1-4 System Block Diagrams

R88D-GNA5L-ML2/-GN01L-ML2/-GN02L-ML2/-GN01H-ML2/ -GN02H-ML2/-GN04H-ML2

Features and System Configuration

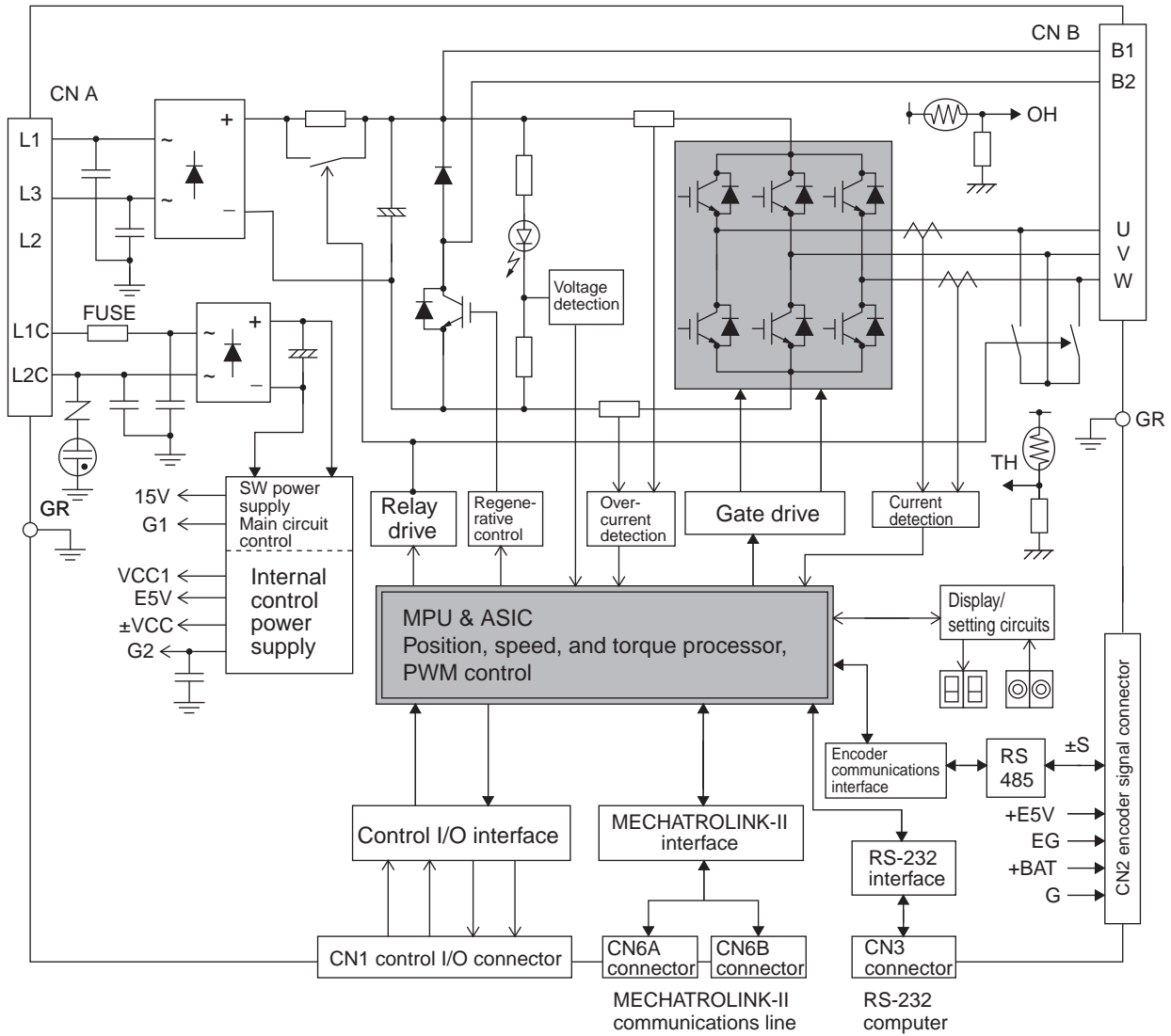

R88D-GN04L-ML2/-GN08H-ML2/-GN10H-ML2/-GN15H-ML2

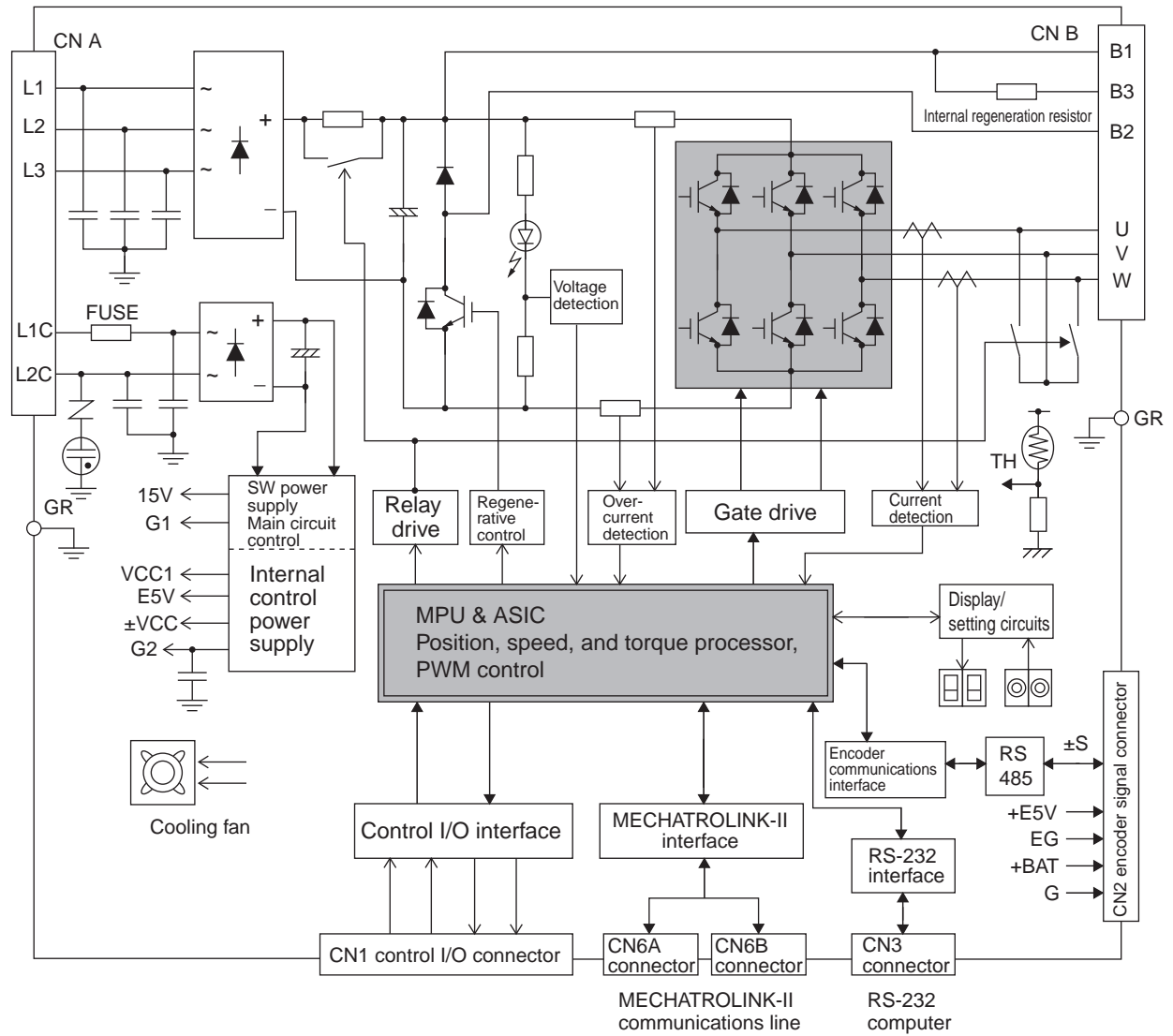

R88D-GN20H-ML2

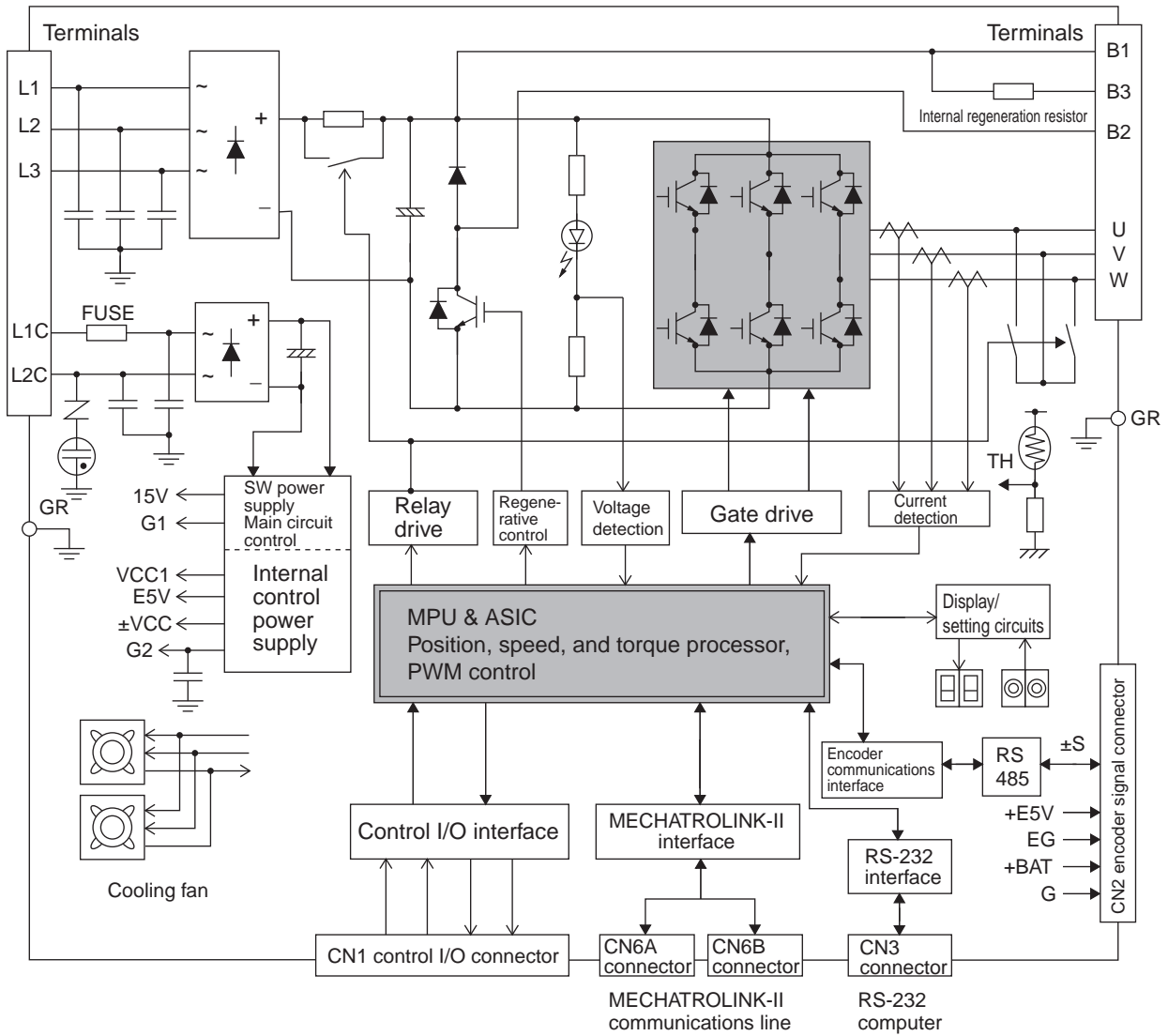

R88D-GN30H-ML2/GN50H-ML2

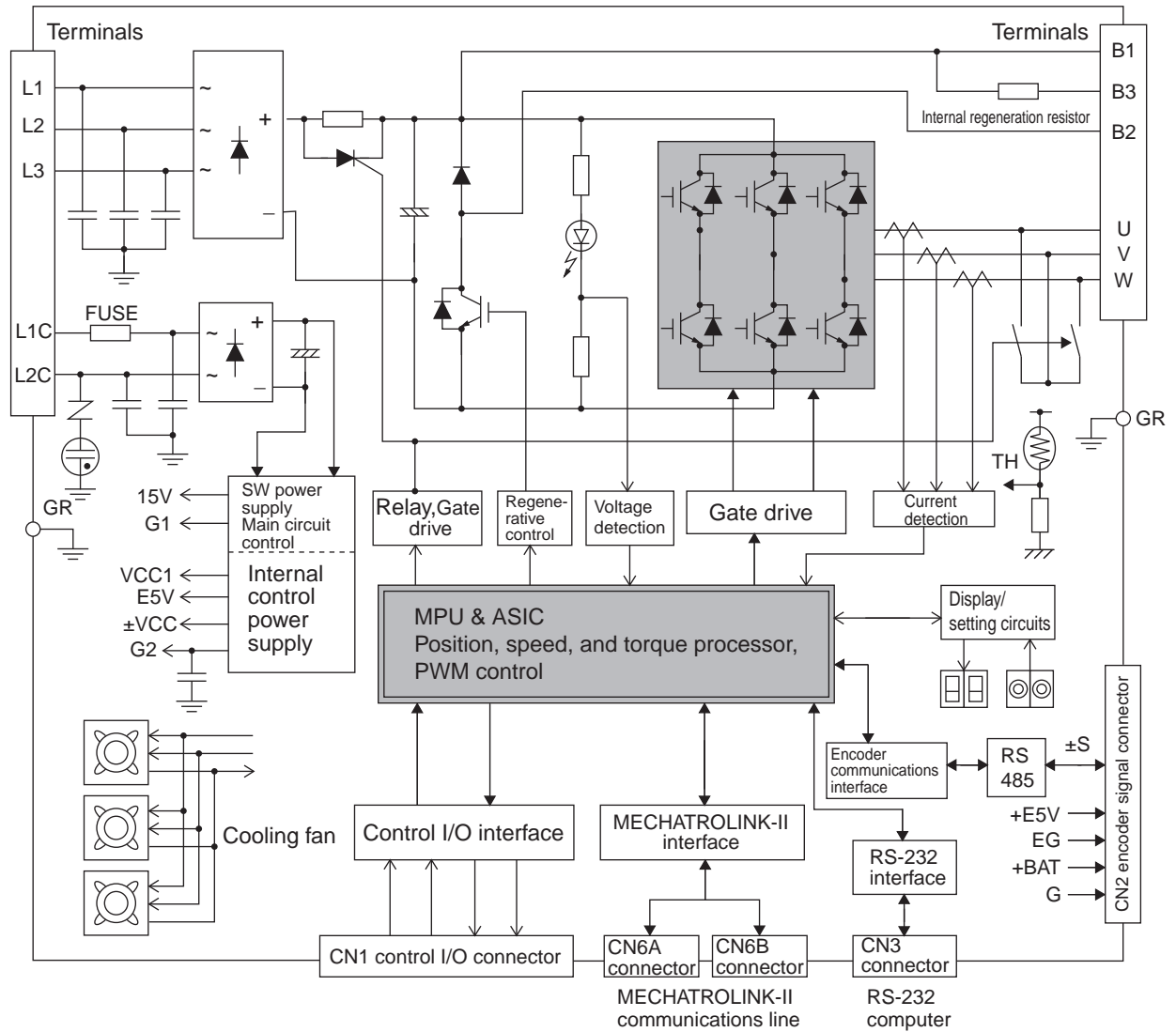

R88D-GN75H-ML2

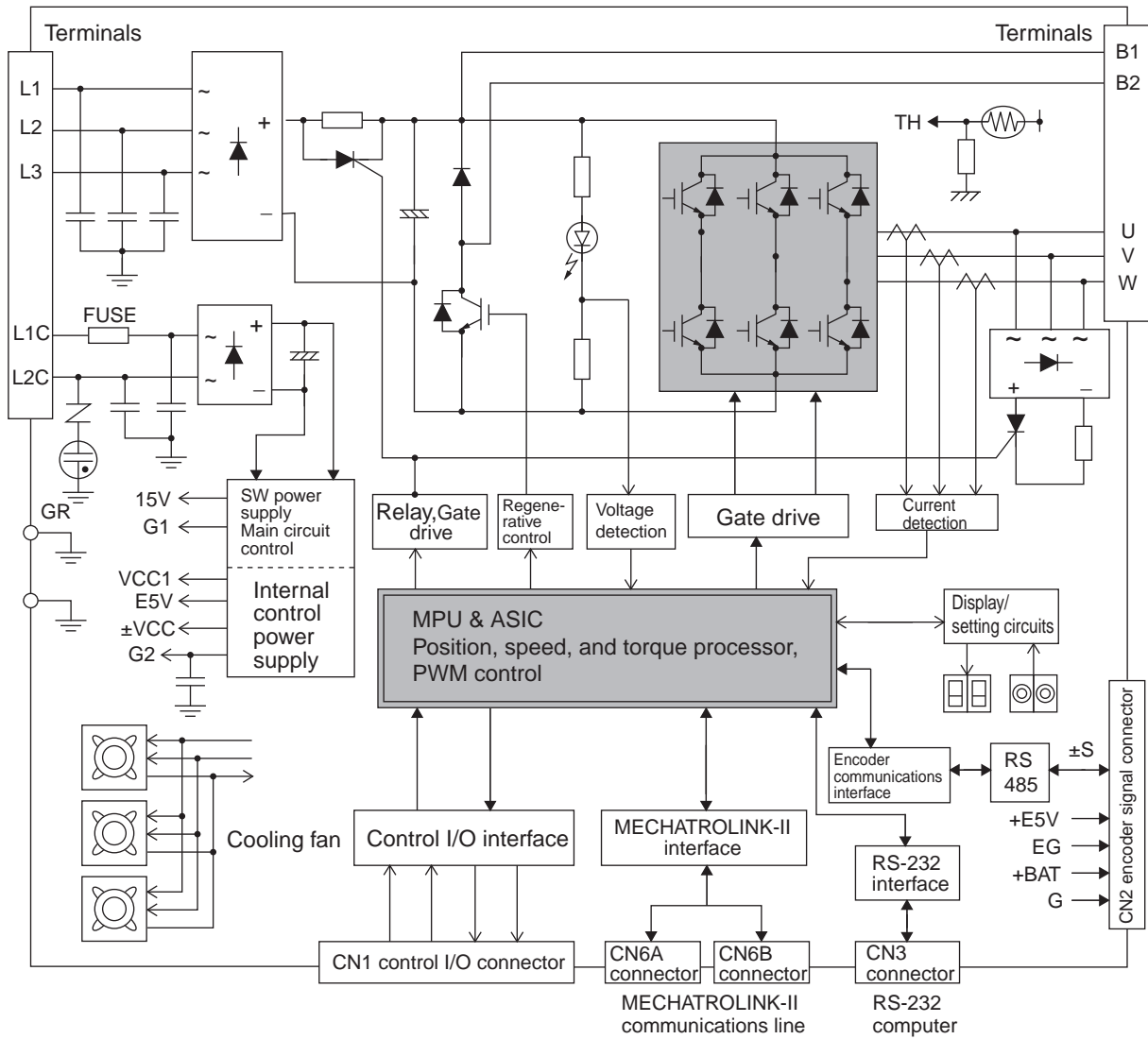

1-5 Applicable Standards

EC Directives

EC Directives	Product	Applicable standards	Comments
Low Voltage Directive	AC Servo Drive	EN 50178	Safety requirements for electrical equipment for measurement, control, or laboratory use
	AC Servomotors	IEC 60034-1/-5	Rotating electrical machines
EMC Directive	AC Servo Drive AC Servomotors	EN 55011 Class A Group 1	Limits of radio disturbance and measurement methods for industrial, scientific, and medical radio-frequency equipment
		EN 61000-6-2	Electromagnetic compatibility (EMC) Immunity standard for industrial environments
		IEC 61000-4-2	Electrostatic discharge immunity testing
		IEC 61000-4-3	Radio frequency radiation field immunity testing
		IEC 61000-4-4	Electrical fast transient burst immunity testing
		IEC 61000-4-5	Lightning surge immunity testing
		IEC 61000-4-6	High-frequency conduction immunity testing
		IEC 61000-4-11	Momentary power interruption immunity testing

Note To conform to the EMC Directives, the Servomotor and Servo Drive must be installed under the conditions described in *Wiring Conforming to EMC Directives* on page 4-26.

UL and CSA Standards

Standard	Product	Applicable standards	File number	Comments
UL standards	AC Servo Drive	UL 508C	E179149	Power conversion equipment
	AC Servomotors *1	UL 1004	E179189	Electric motor
CSA standards	AC Servomotors *1	CSA22.2 No.100	E179189	Motor and generator

*1. UL approval is pending for motor capacities of 6 to 7.5 kW.

Chapter 2

Standard Models and Dimensions

2-1	Standard Models	2-1
	Servo Drives	2-1
	Servomotors.....	2-2
	Servo Drive-Servomotor Combinations	2-5
	Decelerators.....	2-7
	Accessories and Cables	2-14
2-2	External and Mounting Hole Dimensions	2-23
	Servo Drives	2-23
	Servomotors.....	2-33
	Parameter Unit Dimensions	2-43
	Servomotor and Decelerator Combinations.....	2-44
	Decelerator Dimensions.....	2-47
	External Regeneration Resistor Dimensions	2-61
	Reactor Dimensions.....	2-62

2-1 Standard Models

Servo Drives

Specifications		Model
Single-phase 100 VAC	50 W	R88D-GNA5L-ML2
	100 W	R88D-GN01L-ML2
	200 W	R88D-GN02L-ML2
	400 W	R88D-GN04L-ML2
Single-phase 200 VAC	50 W	R88D-GN01H-ML2
	100 W	
	200 W	R88D-GN02H-ML2
	400 W	R88D-GN04H-ML2
Single-phase/three-phase 200 VAC	750 W	R88D-GN08H-ML2
	1 kW	R88D-GN10H-ML2
	900 W	R88D-GN15H-ML2
	1 kW	
	1.5 kW	
Three-phase 200 VAC	2 kW	R88D-GN20H-ML2
	2 kW	R88D-GN30H-ML2
	3 kW	
	3 kW	R88D-GN50H-ML2
	4 kW	
	4.5 kW	
	5 kW	R88D-GN75H-ML2
	6 kW	
7.5 kW		

Servomotors

■ 3,000-r/min Servomotors

Specifications		Model					
		With incremental encoder		With absolute encoder			
		Straight shaft without key	Straight shaft with key and tap	Straight shaft without key	Straight shaft with key and tap		
Without brake	100 V	50 W	R88M-G05030H	R88M-G05030H-S2	R88M-G05030T	R88M-G05030T-S2	
		100 W	R88M-G10030L	R88M-G10030L-S2	R88M-G10030S	R88M-G10030S-S2	
		200 W	R88M-G20030L	R88M-G20030L-S2	R88M-G20030S	R88M-G20030S-S2	
		400 W	R88M-G40030L	R88M-G40030L-S2	R88M-G40030S	R88M-G40030S-S2	
	200 V	50 W	R88M-G05030H	R88M-G05300H-S2	R88M-G05030T	R88M-G05030T-S2	
			R88M-G10030H	R88M-G10030H-S2	R88M-G10030T	R88M-G10030T-S2	
			R88M-G20030H	R88M-G20030H-S2	R88M-G20030T	R88M-G20030T-S2	
			R88M-G40030H	R88M-G40030H-S2	R88M-G40030T	R88M-G40030T-S2	
			R88M-G75030H	R88M-G75030H-S2	R88M-G75030T	R88M-G75030T-S2	
		1 kW	---	---	R88M-G1K030T	R88M-G1K030T-S2	
			1.5kW	---	---	R88M-G1K530T	R88M-G1K530T-S2
			2 kW	---	---	R88M-G2K030T	R88M-G2K030T-S2
			3 kW	---	---	R88M-G3K030T	R88M-G3K030T-S2
			4 kW	---	---	R88M-G4K030T	R88M-G4K030T-S2
5 kW	---	---	R88M-G5K030T	R88M-G5K030T-S2			
With brake	100 V	50 W	R88M-G05030H-B	R88M-G05030H-BS2	R88M-G05030T-B	R88M-G05030T-BS2	
		100 W	R88M-G10030L-B	R88M-G10030L-BS2	R88M-G10030S-B	R88M-G10030S-BS2	
		200 W	R88M-G20030L-B	R88M-G20030L-BS2	R88M-G20030S-B	R88M-G20030S-BS2	
		400 W	R88M-G40030L-B	R88M-G40030L-BS2	R88M-G40030S-B	R88M-G40030S-BS2	
	200 V	50 W	R88M-G05030H-B	R88M-G05030H-BS2	R88M-G05030T-B	R88M-G05030T-BS2	
			R88M-G10030H-B	R88M-G10030H-BS2	R88M-G10030T-B	R88M-G10030T-BS2	
			R88M-G20030H-B	R88M-G20030H-BS2	R88M-G20030T-B	R88M-G20030T-BS2	
			R88M-G40030H-B	R88M-G40030H-BS2	R88M-G40030T-B	R88M-G40030T-BS2	
			R88M-G75030H-B	R88M-G75030H-BS2	R88M-G75030T-B	R88M-G75030T-BS2	
		1 kW	---	---	R88M-G1K030T-B	R88M-G1K030T-BS2	
			1.5kW	---	---	R88M-G1K530T-B	R88M-G1K530T-BS2
			2 kW	---	---	R88M-G2K030T-B	R88M-G2K030T-BS2
			3 kW	---	---	R88M-G3K030T-B	R88M-G3K030T-BS2
			4 kW	---	---	R88M-G4K030T-B	R88M-G4K030T-BS2
5 kW	---	---	R88M-G5K030T-B	R88M-G5K030T-BS2			

Note Models with oil seals are also available.

2-1 Standard Models

■ 3,000-r/min Flat Servomotors

Specifications		Model				
		With incremental encoder		With absolute encoder		
		Straight shaft without key	Straight shaft with key and tap	Straight shaft without key	Straight shaft with key and tap	
Without brake	100 V	100 W	R88M-GP10030L	R88M-GP10030L-S2	R88M-GP10030S	R88M-GP10030S-S2
		200 W	R88M-GP20030L	R88M-GP20030L-S2	R88M-GP20030S	R88M-GP20030S-S2
		400 W	R88M-GP40030L	R88M-GP40030L-S2	R88M-GP40030S	R88M-GP40030S-S2
	200 V	100 W	R88M-GP10030H	R88M-GP10030H-S2	R88M-GP10030T	R88M-GP10030T-S2
		200 W	R88M-GP20030H	R88M-GP20030H-S2	R88M-GP20030T	R88M-GP20030T-S2
		400 W	R88M-GP40030H	R88M-GP40030H-S2	R88M-GP40030T	R88M-GP40030T-S2
With brake	100 V	100 W	R88M-GP10030L-B	R88M-GP10030L-BS2	R88M-GP10030S-B	R88M-GP10030S-BS2
		200 W	R88M-GP20030L-B	R88M-GP20030L-BS2	R88M-GP20030S-B	R88M-GP20030S-BS2
		400 W	R88M-GP40030L-B	R88M-GP40030L-BS2	R88M-GP40030S-B	R88M-GP40030S-BS2
	200 V	100 W	R88M-GP10030H-B	R88M-GP10030H-BS2	R88M-GP10030T-B	R88M-GP10030T-BS2
		200 W	R88M-GP20030H-B	R88M-GP20030H-BS2	R88M-GP20030T-B	R88M-GP20030T-BS2
		400 W	R88M-GP40030H-B	R88M-GP40030H-BS2	R88M-GP40030T-B	R88M-GP40030T-BS2

Note Models with oil seals are also available.

■ 2,000-r/min Servomotors

Specifications		Model		
		With absolute encoder		
		Straight shaft without key	Straight shaft with key and tap	
Without brake	200 V	1 kW	R88M-G1K020T	R88M-G1K020T-S2
		1.5 kW	R88M-G1K520T	R88M-G1K520T-S2
		2 kW	R88M-G2K020T	R88M-G2K020T-S2
		3 kW	R88M-G3K020T	R88M-G3K020T-S2
		4 kW	R88M-G4K020T	R88M-G4K020T-S2
		5 kW	R88M-G5K020T	R88M-G5K020T-S2
		7.5 kW	R88M-G7K515T	R88M-G7K515T-S2
With brake	200 V	1 kW	R88M-G1K020T-B	R88M-G1K020T-BS2
		1.5 kW	R88M-G1K520T-B	R88M-G1K520T-BS2
		2 kW	R88M-G2K020T-B	R88M-G2K020T-BS2
		3 kW	R88M-G3K020T-B	R88M-G3K020T-BS2
		4 kW	R88M-G4K020T-B	R88M-G4K020T-BS2
		5 kW	R88M-G5K020T-B	R88M-G5K020T-BS2
		7.5 kW	R88M-G7K515T-B	R88M-G7K515T-BS2

Note 1. Models with oil seals are also available.

Note 2. The rated rotation speed for 7.5-kW Servomotors is 1,500 r/min.

■ 1,000-r/min Servomotors

Specifications		Model		
		With absolute encoder		
		Straight shaft without key	Straight shaft with key and tap	
With- out brake	200 V	900 W	R88M-G90010T	R88M-G90010T-S2
		2 kW	R88M-G2K010T	R88M-G2K010T-S2
		3 kW	R88M-G3K010T	R88M-G3K010T-S2
		4.5 kW	R88M-G4K510T	R88M-G4K510T-S2
		6 kW	R88M-G6K010T	R88M-G6K010T-S2
With brake	200 V	900 W	R88M-G90010T-B	R88M-G90010T-BS2
		2 kW	R88M-G2K010T-B	R88M-G2K010T-BS2
		3 kW	R88M-G3K010T-B	R88M-G3K010T-BS2
		4.5 kW	R88M-G4K510T-B	R88M-G4K510T-BS2
		6 kW	R88M-G6K010T-B	R88M-G6K010T-BS2

Note Models with oil seals are also available.

Servo Drive-Servomotor Combinations

The tables in this section show the possible combinations of OMNUC G-Series Servo Drives and Servomotors. The Servomotors and Servo Drives can only be used in the listed combinations. The box (-□) at the end of the model number is for options, such as the shaft type, brake and Decelerators.

■ 3,000-r/min Servomotors and Servo Drives

Voltage	Servomotor			Servo Drive
	Rated output	With incremental encoder	With absolute encoder	
100 V	50 W	R88M-G05030H-□	R88M-G05030T-□	R88D-GNA5L-ML2
	100 W	R88M-G10030L-□	R88M-G10030S-□	R88D-GN01L-ML2
	200 W	R88M-G20030L-□	R88M-G20030S-□	R88D-GN02L-ML2
	400 W	R88M-G40030L-□	R88M-G40030S-□	R88D-GN04L-ML2
Single-phase 200 V	50 W	R88M-G05030H-□	R88M-G05030T-□	R88D-GN01H-ML2
	100 W	R88M-G10030H-□	R88M-G10030T-□	R88D-GN01H-ML2
	200 W	R88M-G20030H-□	R88M-G20030T-□	R88D-GN02H-ML2
	400 W	R88M-G40030H-□	R88M-G40030T-□	R88D-GN04H-ML2
Single-phase/three-phase 200 V	750 W	R88M-G75030H-□	R88M-G75030T-□	R88D-GN08H-ML2
	1 kW	---	R88M-G1K030T-□	R88D-GN15H-ML2
	1.5 kW	---	R88M-G1K530T-□	R88D-GN15H-ML2
Three-phase 200 V	2 kW	---	R88M-G2K030T-□	R88D-GN20H-ML2
	3 kW	---	R88M-G3K030T-□	R88D-GN30H-ML2
	4 kW	---	R88M-G4K030T-□	R88D-GN50H-ML2
	5 kW	---	R88M-G5K030T-□	R88D-GN50H-ML2

■ 3,000-r/min Flat Servomotors and Servo Drives

Voltage	Servomotor			Servo Drive
	Rated output	With incremental encoder	With absolute encoder	
100 V	100 W	R88M-GP10030L-□	R88M-GP10030S-□	R88D-GN01L-ML2
	200 W	R88M-GP20030L-□	R88M-GP20030S-□	R88D-GN02L-ML2
	400 W	R88M-GP40030L-□	R88M-GP40030S-□	R88D-GN04L-ML2
Single-phase 200 V	100 W	R88M-GP10030H-□	R88M-GP10030T-□	R88D-GN01H-ML2
	200 W	R88M-GP20030H-□	R88M-GP20030T-□	R88D-GN02H-ML2
	400 W	R88M-GP40030H-□	R88M-GP40030T-□	R88D-GN04H-ML2

■ 2,000-r/min Servomotors and Servo Drives

Voltage	Servomotor		Servo Drive
	Rated output	With absolute encoder	
Single-phase/three-phase 200 V	1 kW	R88M-G1K020T-□	R88D-GN10H-ML2
	1.5 kW	R88M-G1K520T-□	R88D-GN15H-ML2
Three-phase 200 V	2 kW	R88M-G2K020T-□	R88D-GN20H-ML2
	3 kW	R88M-G3K020T-□	R88D-GN30H-ML2
	4 kW	R88M-G4K020T-□	R88D-GN50H-ML2
	5 kW	R88M-G5K020T-□	R88D-GN50H-ML2
	7.5 kW	R88M-G7K515T-□	R88D-GN75H-ML2

■ 1,000-r/min Servomotors and Servo Drives

Voltage	Servomotor		Servo Drive
	Rated output	With absolute encoder	
Single-phase/three-phase 200 V	900 W	R88M-G90010T-□	R88D-GN15H-ML2
Three-phase 200 V	2 kW	R88M-G2K010T-□	R88D-GN30H-ML2
	3 kW	R88M-G3K010T-□	R88D-GN50H-ML2
	4.5 kW	R88M-G4K510T-□	R88D-GN50H-ML2
	6 kW	R88M-G6K010T-□	R88D-GN75H-ML2

Decelerators

The following types of Decelerators are available for OMNUC G-Series Servomotors. Select a Decelerator based on the Servomotor capacity.

■ Backlash = 3' Max.

Decelerators for 3,000-r/min Servomotors

Specifications		Model
Motor capacity	Gear ratio	
50 W	1/5	R88G-HPG11A05100B□
	1/9	R88G-HPG11A09050B□
	1/21	R88G-HPG14A21100B□
	1/33	R88G-HPG14A33050B□
	1/45	R88G-HPG14A45050B□
100 W	1/5	R88G-HPG11A05100B□
	1/11	R88G-HPG14A11100B□
	1/21	R88G-HPG14A21100B□
	1/33	R88G-HPG20A33100B□
	1/45	R88G-HPG20A45100B□
200 W	1/5	R88G-HPG14A05200B□
	1/11	R88G-HPG14A11200B□
	1/21	R88G-HPG20A21200B□
	1/33	R88G-HPG20A33200B□
	1/45	R88G-HPG20A45200B□
400 W	1/5	R88G-HPG14A05400B□
	1/11	R88G-HPG20A11400B□
	1/21	R88G-HPG20A21400B□
	1/33	R88G-HPG32A33400B□
	1/45	R88G-HPG32A45400B□
750 W	1/5	R88G-HPG20A05750B□
	1/11	R88G-HPG20A11750B□
	1/21	R88G-HPG32A21750B□
	1/33	R88G-HPG32A33750B□
	1/45	R88G-HPG32A45750B□

Specifications		Model
Motor capacity	Gear ratio	
1 kW	1/5	R88G-HPG32A051K0B□
	1/11	R88G-HPG32A111K0B□
	1/21	R88G-HPG32A211K0B□
	1/33	R88G-HPG32A331K0B□
	1/45	R88G-HPG50A451K0B□
1.5 kW	1/5	R88G-HPG32A052K0B□
	1/11	R88G-HPG32A112K0B□
	1/21	R88G-HPG32A211K5B□
	1/33	R88G-HPG50A332K0B□
	1/45	R88G-HPG50A451K5B□
2 kW	1/5	R88G-HPG32A052K0B□
	1/11	R88G-HPG32A112K0B□
	1/21	R88G-HPG50A212K0B□
	1/33	R88G-HPG50A332K0B□
3 kW	1/5	R88G-HPG32A053K0B□
	1/11	R88G-HPG50A113K0B□
	1/21	R88G-HPG50A213K0B□
4 kW	1/5	R88G-HPG32A054K0B□
	1/11	R88G-HPG50A115K0B□
5 kW	1/5	R88G-HPG50A055K0B□
	1/11	R88G-HPG50A115K0B□

Note 1. The standard models have a straight shaft.

Note 2. Models with a key and tap are indicated with "J" at the end of the model number (the suffix shown in the box). (Example: R88G-HPG11A05100BJ)

Decelerators for 2,000-r/min Servomotors

Specifications		Model
Motor capacity	Gear ratio	
1 kW	1/5	R88G-HPG32A053K0B□
	1/11	R88G-HPG32A112K0SB□
	1/21	R88G-HPG32A211K0SB□
	1/33	R88G-HPG50A332K0SB□
	1/45	R88G-HPG50A451K0SB□
1.5 kW	1/5	R88G-HPG32A053K0B□
	1/11	R88G-HPG32A112K0SB□
	1/21	R88G-HPG50A213K0B□
	1/33	R88G-HPG50A332K0SB□
2 kW	1/5	R88G-HPG32A053K0B□
	1/11	R88G-HPG32A112K0SB□
	1/21	R88G-HPG50A213K0B□
	1/33	R88G-HPG50A332K0SB□
3 kW	1/5	R88G-HPG32A054K0B□
	1/11	R88G-HPG50A115K0B□
	1/21	R88G-HPG50A213K0SB□
	1/25	R88G-HPG65A253K0SB□
4 kW	1/5	R88G-HPG50A054K0SB□
	1/11	R88G-HPG50A114K0SB□
	1/20	R88G-HPG65A204K0SB□
	1/25	R88G-HPG65A254K0SB□
5 kW	1/5	R88G-HPG50A055K0SB□
	1/11	R88G-HPG50A115K0SB□
	1/20	R88G-HPG65A205K0SB□
	1/25	R88G-HPG65A255K0SB□
7.5 kW	1/5	R88G-HPG65A057K5SB□
	1/12	R88G-HPG65A127K5SB□

Note 1. The standard models have a straight shaft.

Note 2. Models with a key and tap are indicated with "J" at the end of the model number (the suffix shown in the box). (Example: R88G-HPG32A053K0BJ)

Decelerators for 1,000-r/min Servomotors

Specifications		Model
Motor capacity	Gear ratio	
900 W	1/5	R88G-HPG32A05900TB□
	1/11	R88G-HPG32A11900TB□
	1/21	R88G-HPG50A21900TB□
	1/33	R88G-HPG50A33900TB□
2 kW	1/5	R88G-HPG32A052K0TB□
	1/11	R88G-HPG50A112K0TB□
	1/21	R88G-HPG50A212K0TB□
	1/25	R88G-HPG65A255K0SB□
3 kW	1/5	R88G-HPG50A055K0SB□
	1/11	R88G-HPG50A115K0SB□
	1/20	R88G-HPG65A205K0SB□
	1/25	R88G-HPG65A255K0SB□
4.5 kW	1/5	R88G-HPG50A054K5TB□
	1/12	R88G-HPG65A127K5SB□
	1/20	R88G-HPG65A204K5TB□
6 kW	1/5	R88G-HPG65A057K5SB□
	1/12	R88G-HPG65A127K5SB□

Note 1. The standard models have a straight shaft.

Note 2. Models with a key and tap are indicated with "J" at the end of the model number (the suffix shown in the box). (Example: R88G-HPG32A05900TBJ)

Decelerators for 3,000-r/min Flat Servomotors

Specifications		Model
Motor capacity	Gear ratio	
100 W	1/5	R88G-HPG11A05100PB□
	1/11	R88G-HPG14A11100PB□
	1/21	R88G-HPG14A21100PB□
	1/33	R88G-HPG20A33100PB□
	1/45	R88G-HPG20A45100PB□
200 W	1/5	R88G-HPG14A05200PB□
	1/11	R88G-HPG20A11200PB□
	1/21	R88G-HPG20A21200PB□
	1/33	R88G-HPG20A33200PB□
	1/45	R88G-HPG20A45200PB□
400 W	1/5	R88G-HPG20A05400PB□
	1/11	R88G-HPG20A11400PB□
	1/21	R88G-HPG20A21400PB□
	1/33	R88G-HPG32A33400PB□
	1/45	R88G-HPG32A45400PB□

Note 1. The standard models have a straight shaft.

Note 2. Models with a key and tap are indicated with "J" at the end of the model number (the suffix shown in the box). (Example: R88G-HPG11A05100PBJ)

■ Backlash = 15' Max.

Decelerators for 3,000-r/min Servomotors (Straight Shaft with Key)

Specifications		Model
Motor capacity	Gear ratio	
50 W	1/5	R88G-VRSF05B100CJ
	1/9	R88G-VRSF09B100CJ
	1/15	R88G-VRSF15B100CJ
	1/25	R88G-VRSF25B100CJ
100 W	1/5	R88G-VRSF05B100CJ
	1/9	R88G-VRSF09B100CJ
	1/15	R88G-VRSF15B100CJ
	1/25	R88G-VRSF25B100CJ
200 W	1/5	R88G-VRSF05B200CJ
	1/9	R88G-VRSF09C200CJ
	1/15	R88G-VRSF15C200CJ
	1/25	R88G-VRSF25C200CJ
400 W	1/5	R88G-VRSF05C400CJ
	1/9	R88G-VRSF09C400CJ
	1/15	R88G-VRSF15C400CJ
	1/25	R88G-VRSF25C400CJ
750 W	1/5	R88G-VRSF05C750CJ
	1/9	R88G-VRSF09D750CJ
	1/15	R88G-VRSF15D750CJ
	1/25	R88G-VRSF25D750CJ

Decelerators for 3,000-r/min Flat Servomotors (Straight Shaft with Key)

Specifications		Model
Motor capacity	Gear ratio	
100 W	1/5	R88G-VRSF05B100PCJ
	1/9	R88G-VRSF09B100PCJ
	1/15	R88G-VRSF15B100PCJ
	1/25	R88G-VRSF25B100PCJ
200 W	1/5	R88G-VRSF05B200PCJ
	1/9	R88G-VRSF09C200PCJ
	1/15	R88G-VRSF15C200PCJ
	1/25	R88G-VRSF25C200PCJ
400 W	1/5	R88G-VRSF05C400PCJ
	1/9	R88G-VRSF09C400PCJ
	1/15	R88G-VRSF15C400PCJ
	1/25	R88G-VRSF25C400PCJ

Accessories and Cables

■ Encoder Cables (Standard Cables)

Specifications	Model	
3,000-r/min Servomotors of 50 to 750 W with an absolute encoder, 3,000-r/min Flat Servomotors of 100 to 400 W with an absolute encoder	3 m	R88A-CRGA003C
	5 m	R88A-CRGA005C
	10 m	R88A-CRGA010C
	15 m	R88A-CRGA015C
	20 m	R88A-CRGA020C
	30 m	R88A-CRGA030C
	40 m	R88A-CRGA040C
	50 m	R88A-CRGA050C
3,000-r/min Servomotors of 50 to 750 W with an incremental encoder, 3,000-r/min Flat Servomotors of 100 to 400 W with an incremental encoder	3 m	R88A-CRGB003C
	5 m	R88A-CRGB005C
	10 m	R88A-CRGB010C
	15 m	R88A-CRGB015C
	20 m	R88A-CRGB020C
	30 m	R88A-CRGB030C
	40 m	R88A-CRGB040C
	50 m	R88A-CRGB050C
3,000-r/min Servomotors of 1 to 5 kW, 2,000-r/min Servomotors of 1 to 5 kW, 1,500-r/min Servomotors of 7.5 kW, 1,000-r/min Servomotors of 900 W to 6 kW	3 m	R88A-CRGC003N
	5 m	R88A-CRGC005N
	10 m	R88A-CRGC010N
	15 m	R88A-CRGC015N
	20 m	R88A-CRGC020N
	30 m	R88A-CRGC030N
	40 m	R88A-CRGC040N
	50 m	R88A-CRGC050N

■ Servomotor Power Cables (Standard Cables)

Specifications		Model	
		For Servomotor without brake	For Servomotor with brake
3,000-r/min Servomotors of 50 to 750 W, 3,000-r/min Flat Servomotors of 100 to 400 W	3 m	R88A-CAGA003S	---
	5 m	R88A-CAGA005S	---
	10 m	R88A-CAGA010S	---
	15 m	R88A-CAGA015S	---
	20 m	R88A-CAGA020S	---
	30 m	R88A-CAGA030S	---
	40 m	R88A-CAGA040S	---
	50 m	R88A-CAGA050S	---
3,000-r/min Servomotors of 1 to 1.5 kW, 2,000-r/min Servomotors of 1 to 1.5 kW, 1,000-r/min Servomotors of 900 W	3 m	R88A-CAGB003S	R88A-CAGB003B
	5 m	R88A-CAGB005S	R88A-CAGB005B
	10 m	R88A-CAGB010S	R88A-CAGB010B
	15 m	R88A-CAGB015S	R88A-CAGB015B
	20 m	R88A-CAGB020S	R88A-CAGB020B
	30 m	R88A-CAGB030S	R88A-CAGB030B
	40 m	R88A-CAGB040S	R88A-CAGB040B
	50 m	R88A-CAGB050S	R88A-CAGB050B
3,000-r/min Servomotors of 2 kW, 2,000-r/min Servomotors of 2 kW	3 m	R88A-CAGC003S	R88A-CAGC003B
	5 m	R88A-CAGC005S	R88A-CAGC005B
	10 m	R88A-CAGC010S	R88A-CAGC010B
	15 m	R88A-CAGC015S	R88A-CAGC015B
	20 m	R88A-CAGC020S	R88A-CAGC020B
	30 m	R88A-CAGC030S	R88A-CAGC030B
	40 m	R88A-CAGC040S	R88A-CAGC040B
	50 m	R88A-CAGC050S	R88A-CAGC050B
3,000-r/min Servomotors of 3 to 5 kW, 2,000-r/min Servomotors of 3 to 5 kW, 1,000-r/min Servomotors of 2 to 4.5 kW	3 m	R88A-CAGD003S	R88A-CAGD003B
	5 m	R88A-CAGD005S	R88A-CAGD005B
	10 m	R88A-CAGD010S	R88A-CAGD010B
	15 m	R88A-CAGD015S	R88A-CAGD015B
	20 m	R88A-CAGD020S	R88A-CAGD020B
	30 m	R88A-CAGD030S	R88A-CAGD030B
	40 m	R88A-CAGD040S	R88A-CAGD040B
	50 m	R88A-CAGD050S	R88A-CAGD050B

2

Standard Models and Dimensions

Specifications		Model	
		For Servomotor without brake	For Servomotor with brake
1,500-r/min Servomotors of 7.5 kW, 1,000-r/min Servomotors of 6 kW	3 m	R88A-CAGE003S	---
	5 m	R88A-CAGE005S	---
	10 m	R88A-CAGE010S	---
	15 m	R88A-CAGE015S	---
	20 m	R88A-CAGE020S	---
	30 m	R88A-CAGE030S	---
	40 m	R88A-CAGE040S	---
	50 m	R88A-CAGE050S	---

Note There are separate connectors for power and brakes for 3,000-r/min Servomotors of 50 to 750 W, Flat Servomotors, and Servomotors of 6 kW or higher. Therefore, when a Servomotor with a brake is used, it will require both a Power Cable for a Servomotor without a brake and a Brake Cable.

■ Brake Cables (Standard Cables)

Specifications	Model	
3,000-r/min Servomotors of 50 to 750 W, 3,000-r/min Flat Servomotors of 100 to 400 W	3 m	R88A-CAGA003B
	5 m	R88A-CAGA005B
	10 m	R88A-CAGA010B
	15 m	R88A-CAGA015B
	20 m	R88A-CAGA020B
	30 m	R88A-CAGA030B
	40 m	R88A-CAGA040B
	50 m	R88A-CAGA050B
1,500-r/min Servomotors of 7.5 kW, 1,000-r/min Servomotors of 6 kW	3 m	R88A-CAGE003B
	5 m	R88A-CAGE005B
	10 m	R88A-CAGE010B
	15 m	R88A-CAGE015B
	20 m	R88A-CAGE020B
	30 m	R88A-CAGE030B
	40 m	R88A-CAGE040B
	50 m	R88A-CAGE050B

2

Standard Models and Dimensions

■ Encoder Cables (Robot Cables)

Specifications		Model
3,000-r/min Servomotors of 50 to 750 W with an absolute encoder, 3,000-r/min Flat Servomotors of 100 to 400 W with an absolute encoder	3 m	R88A-CRGA003CR
	5 m	R88A-CRGA005CR
	10 m	R88A-CRGA010CR
	15 m	R88A-CRGA015CR
	20 m	R88A-CRGA020CR
	30 m	R88A-CRGA030CR
	40 m	R88A-CRGA040CR
	50 m	R88A-CRGA050CR
3,000-r/min Servomotors of 50 to 750 W with an incremental encoder, 3,000-r/min Flat Servomotors of 100 to 400 W with an incremental encoder	3 m	R88A-CRGB003CR
	5 m	R88A-CRGB005CR
	10 m	R88A-CRGB010CR
	15 m	R88A-CRGB015CR
	20 m	R88A-CRGB020CR
	30 m	R88A-CRGB030CR
	40 m	R88A-CRGB040CR
	50 m	R88A-CRGB050CR
3,000-r/min Servomotors of 1 to 5 kW, 2,000-r/min Servomotors of 1 to 5 kW, 1,000-r/min Servomotors of 900 W to 4.5 kW	3 m	R88A-CRGC003NR
	5 m	R88A-CRGC005NR
	10 m	R88A-CRGC010NR
	15 m	R88A-CRGC015NR
	20 m	R88A-CRGC020NR
	30 m	R88A-CRGC030NR
	40 m	R88A-CRGC040NR
	50 m	R88A-CRGC050NR

■ Servomotor Power Cables (Robot Cables)

Specifications		Model	
		For Servomotor without brake	For Servomotor with brake
3,000-r/min Servomotors of 50 to 750 W, 3,000-r/min Flat Servomotors of 100 to 400 W	3 m	R88A-CAGA003SR	---
	5 m	R88A-CAGA005SR	---
	10 m	R88A-CAGA010SR	---
	15 m	R88A-CAGA015SR	---
	20 m	R88A-CAGA020SR	---
	30 m	R88A-CAGA030SR	---
	40 m	R88A-CAGA040SR	---
	50 m	R88A-CAGA050SR	---
3,000-r/min Servomotors of 1 to 1.5 kW, 2,000-r/min Servomotors of 1 to 1.5 kW, 1,000-r/min Servomotors of 900 W	3 m	R88A-CAGB003SR	R88A-CAGB003BR
	5 m	R88A-CAGB005SR	R88A-CAGB005BR
	10 m	R88A-CAGB010SR	R88A-CAGB010BR
	15 m	R88A-CAGB015SR	R88A-CAGB015BR
	20 m	R88A-CAGB020SR	R88A-CAGB020BR
	30 m	R88A-CAGB030SR	R88A-CAGB030BR
	40 m	R88A-CAGB040SR	R88A-CAGB040BR
	50 m	R88A-CAGB050SR	R88A-CAGB050BR
3,000-r/min Servomotors of 2 kW, 2,000-r/min Servomotors of 2 kW	3 m	R88A-CAGC003SR	R88A-CAGC003BR
	5 m	R88A-CAGC005SR	R88A-CAGC005BR
	10 m	R88A-CAGC010SR	R88A-CAGC010BR
	15 m	R88A-CAGC015SR	R88A-CAGC015BR
	20 m	R88A-CAGC020SR	R88A-CAGC020BR
	30 m	R88A-CAGC030SR	R88A-CAGC030BR
	40 m	R88A-CAGC040SR	R88A-CAGC040BR
	50 m	R88A-CAGC050SR	R88A-CAGC050BR
3,000-r/min Servomotors of 3 to 5 kW, 2,000-r/min Servomotors of 3 to 5 kW, 1,000-r/min Servomotors of 2 to 4.5 kW	3 m	R88A-CAGD003SR	R88A-CAGD003BR
	5 m	R88A-CAGD005SR	R88A-CAGD005BR
	10 m	R88A-CAGD010SR	R88A-CAGD010BR
	15 m	R88A-CAGD015SR	R88A-CAGD015BR
	20 m	R88A-CAGD020SR	R88A-CAGD020BR
	30 m	R88A-CAGD030SR	R88A-CAGD030BR
	40 m	R88A-CAGD040SR	R88A-CAGD040BR
	50 m	R88A-CAGD050SR	R88A-CAGD050BR

Note There are separate connectors for power and brakes for 3,000-r/min Servomotors of 50 to 750 W and Flat Servomotors.

Therefore, when a Servomotor with a brake is used, it will require a Power Cable for a Servomotor without a brake, as well as a Brake Cable.

■ Brake Cables (Robot Cables)

Specifications		Model
3,000-r/min Servomotors of 50 to 750 W, 3,000-r/min Flat Servomotors of 100 to 400 W	3 m	R88A-CAGA003BR
	5 m	R88A-CAGA005BR
	10 m	R88A-CAGA010BR
	15 m	R88A-CAGA015BR
	20 m	R88A-CAGA020BR
	30 m	R88A-CAGA030BR
	40 m	R88A-CAGA040BR
	50 m	R88A-CAGA050BR

■ Communications Cable

Specifications		Model
RS-232 Communications Cable	2 m	R88A-CCG002P2

■ MECHATROLINK-II Communications Cable

Specifications		Model
MECHATROLINK-II Cable	0.5 m	FNY-W6003-A5
	1 m	FNY-W6003-01
	3 m	FNY-W6003-03
	5 m	FNY-W6003-05
	10 m	FNY-W6003-10
	20 m	FNY-W6003-20
	30 m	FNY-W6003-30
MECHATROLINK-II termination resistor		FNY-W6022

■ Absolute Encoder Battery Cable

Specifications		Model
Absolute Encoder Battery Cable	0.3 m	R88A-CRGD0R3C

■ Connectors

Specifications		Model
Servomotor Connector for Encoder Cable	Absolute Encoder	R88A-CNG01R
	Incremental Encoder	R88A-CNG02R
Control I/O Connector (CN1)		R88A-CNU01C
Encoder Connector (CN2)		R88A-CNW01R
Power Cable Connector (750 W max.)		R88A-CNG01A
Brake Cable Connector (750 W max.)		R88A-CNG01B

■ Control Cables

Specifications		Model
Connector Terminal Block Cables	1 m	XW2Z-100J-B33
	2 m	XW2Z-200J-B33
Connector Terminal Block	M3 screw type	XW2B-20G4
	M3.5 screw type	XW2B-20G5
	M3 screw type	XW2D-20G6

■ External Regeneration Resistors

Specifications	Model
Regeneration capacity: 20 W, 50 Ω (with 150°C thermal switch)	R88A-RR08050S
Regeneration capacity: 20 W, 100 Ω (with 150°C thermal switch)	R88A-RR080100S
Regeneration capacity: 70 W, 47 Ω (with 170°C thermal switch)	R88A-RR22047S
Regeneration capacity: 180 W, 20 Ω (with 200°C thermal switch)	R88A-RR50020S

■ Reactors

Specifications	Model
R88D-GNA5L-ML2/-GN01H-ML2	3G3AX-DL2002
R88D-GN01L-ML2/-GN02H-ML2	3G3AX-DL2004
R88D-GN02L-ML2/-GN04H-ML2	3G3AX-DL2007
R88D-GN04L-ML2/-GN08H-ML2/-GN10H-ML2	3G3AX-DL2015
R88D-GN15H-ML2	3G3AX-DL2022
R88D-GN08H-ML2/-GN10H-ML2/-GN15H-ML2	3G3AX-AL2025
R88D-GN20H-ML2/-GN30H-ML2	3G3AX-AL2055
R88D-GN50H-ML2	3G3AX-AL2110
R88D-GN75H-ML2	3G3AX-AL2220

■ Mounting Brackets (L Brackets for Rack Mounting)

Specifications	Model
R88D-GNA5L-ML2/-GN01L-ML2/-GN01H-ML2/-GN02H-ML2	R88A-TK01G
R88D-GN02L-ML2/-GN04H-ML2	R88A-TK02G
R88D-GN04L-ML2/-GN08H-ML2	R88A-TK03G
R88D-GN10H-ML2/-GN15H-ML2	R88A-TK04G

■ Absolute Encoder Backup Battery

Specifications	Model
2,000 mA·h 3.6 V	R88A-BAT01G

2-2 External and Mounting Hole Dimensions

Servo Drives

- Single-phase 100 VAC: R88D-GNA5L-ML2/-GN01L-ML2 (50 to 100 W)
- Single-phase 200 VAC: R88D-GN01H-ML2/-GN02H-ML2 (50 to 200 W)

Wall Mounting

External Dimensions

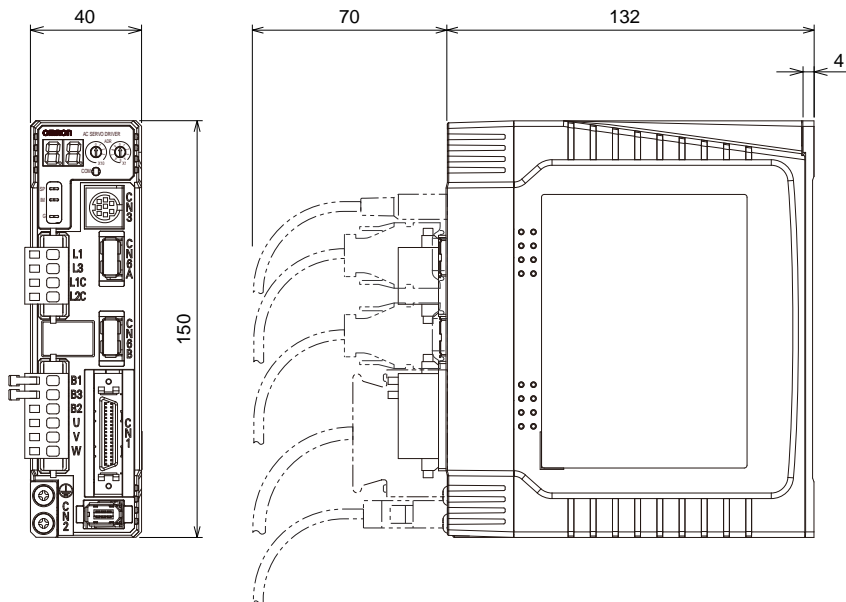

Mounting Hole Dimensions

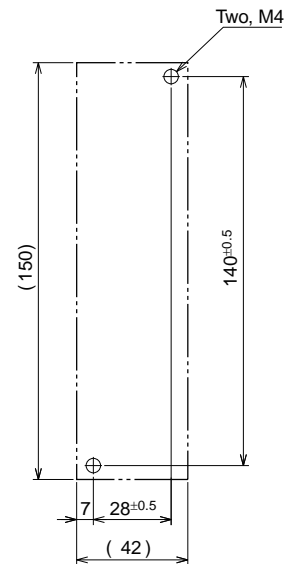

Front Panel Mounting (Using Mounting Brackets)

External Dimensions

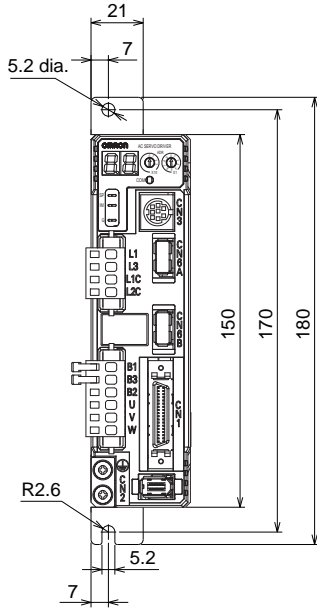

Mounting Hole Dimensions

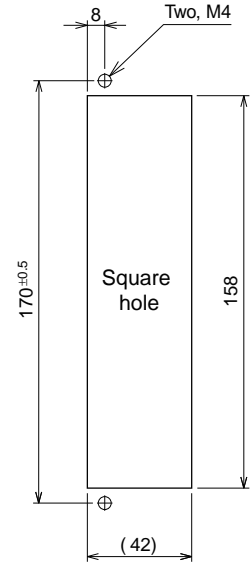
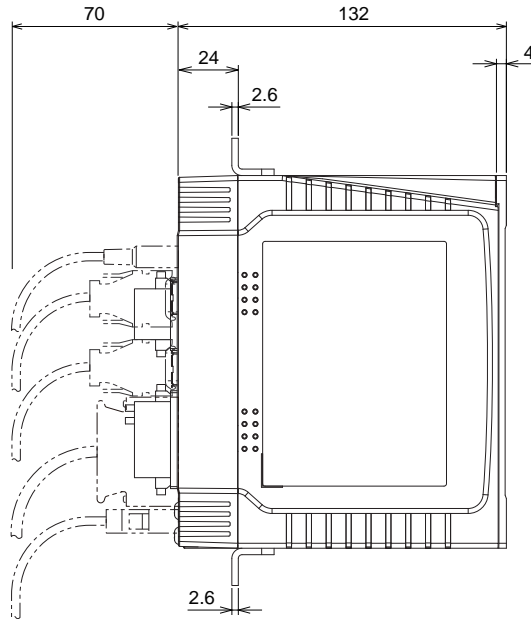

2-2 External and Mounting Hole Dimensions

- Single-phase 100 VAC: R88D-GN02L-ML2 (200 W)
Single-phase 200 VAC: R88D-GN04H-ML2 (400 W)

2

Wall Mounting

External Dimensions

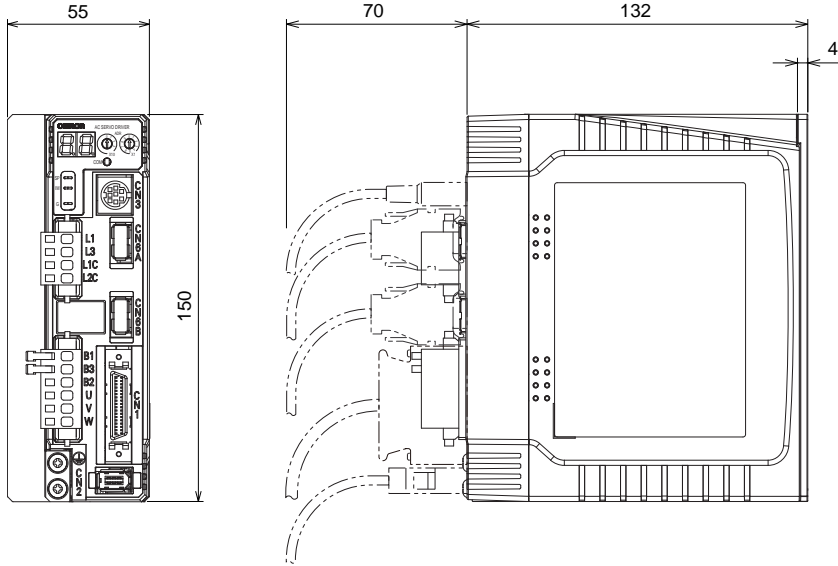

Mounting Hole Dimensions

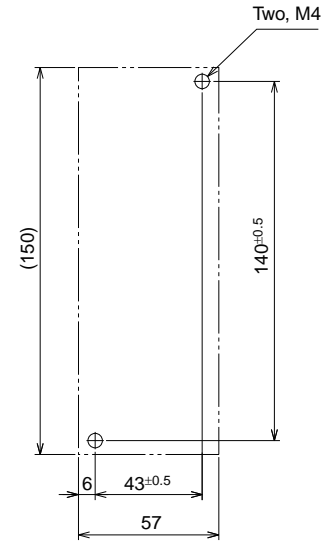

Front Panel Mounting (Using Mounting Brackets)

External Dimensions

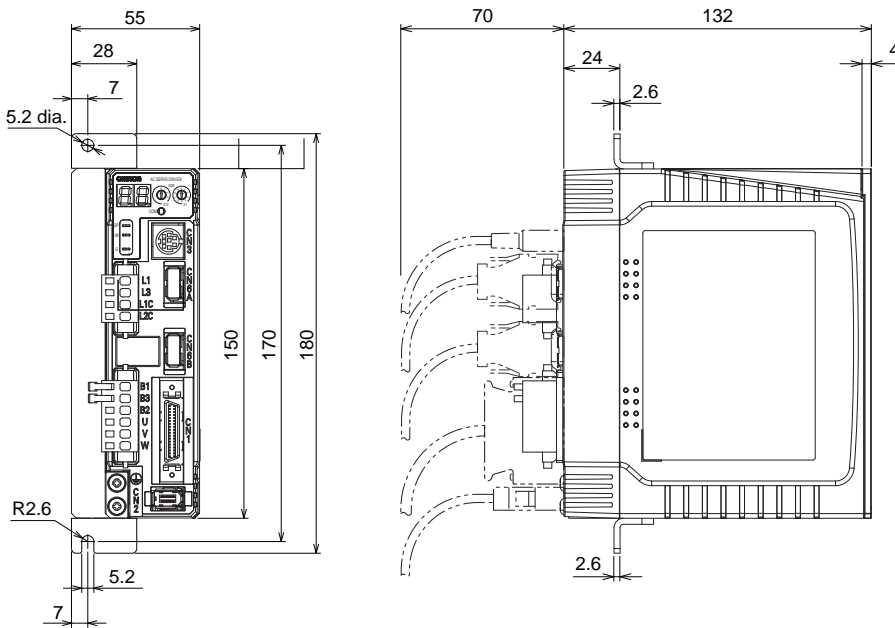

Mounting Hole Dimensions

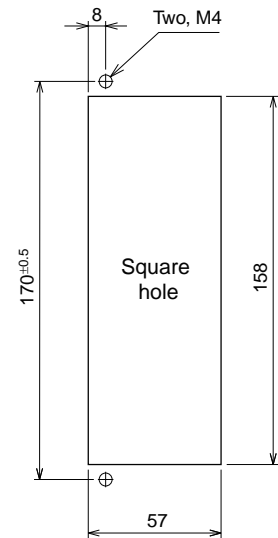

- Single-phase 100 VAC: R88D-GN04L-ML2 (400 W)
Single-phase 200/Three phase VAC: R88D-GN08H-ML2 (750 W)

Wall Mounting

External Dimensions

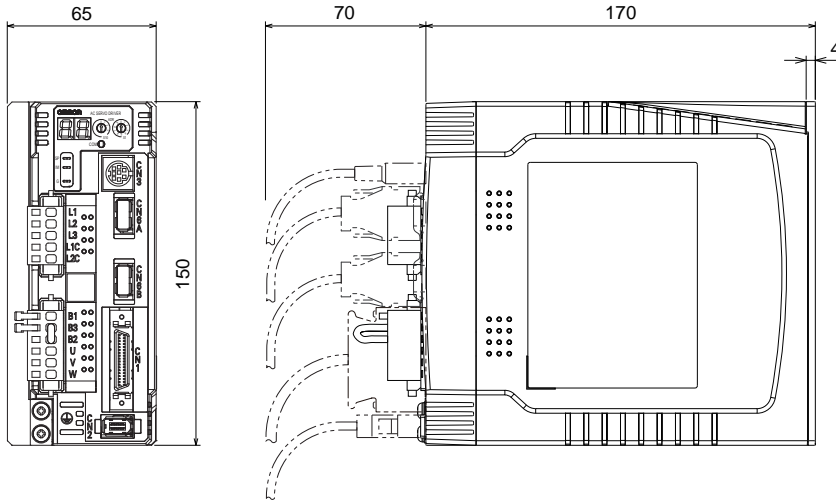

Mounting Hole Dimensions

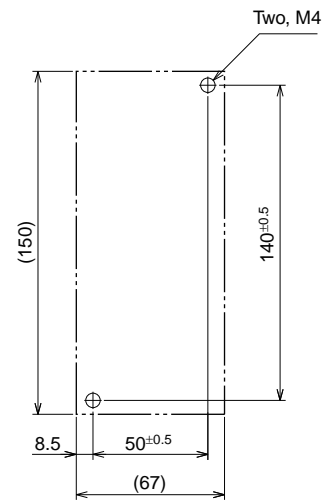

Front Panel Mounting (Using Mounting Brackets)

External Dimensions

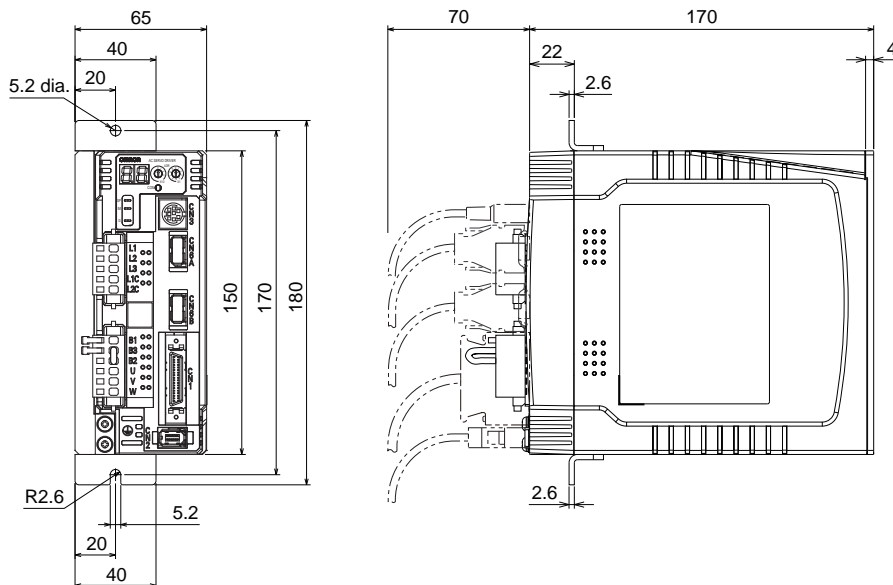

Mounting Hole Dimensions

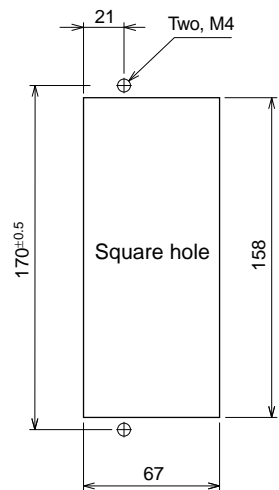

2-2 External and Mounting Hole Dimensions

■ Single-phase/Three-phase 200 VAC: R88D-GN10H-ML2/-GN15H-ML2 (900 W to 1.5 kW)

Wall Mounting

External Dimensions

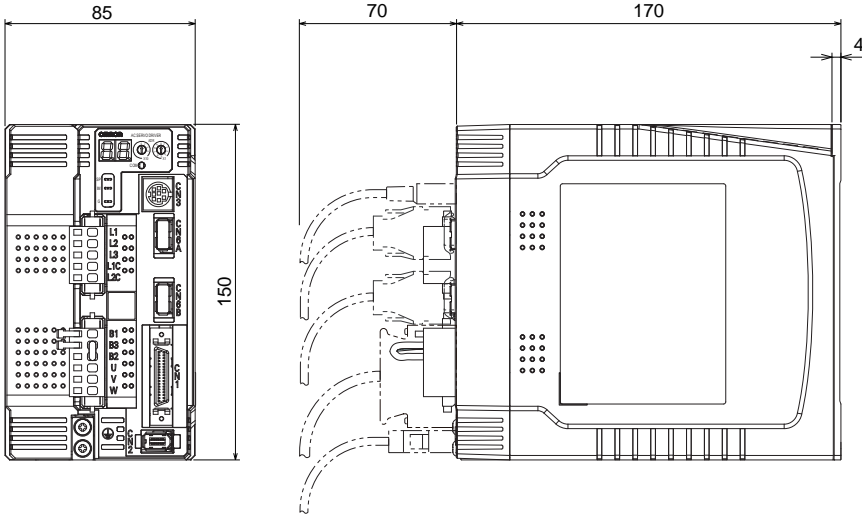

Mounting Hole Dimensions

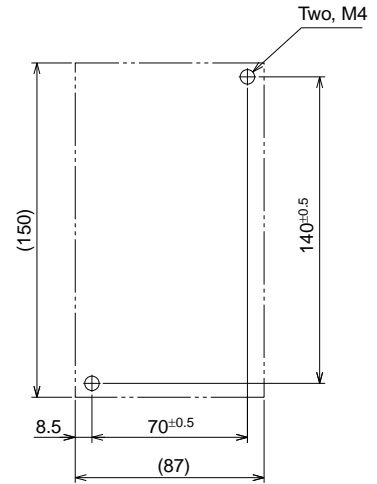

Front Panel Mounting (Using Mounting Brackets)

External Dimensions

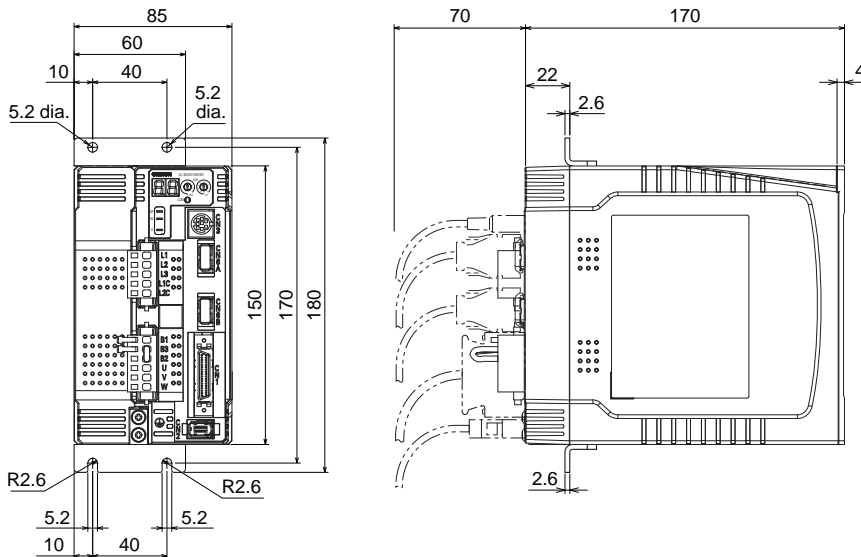

Mounting Hole Dimensions

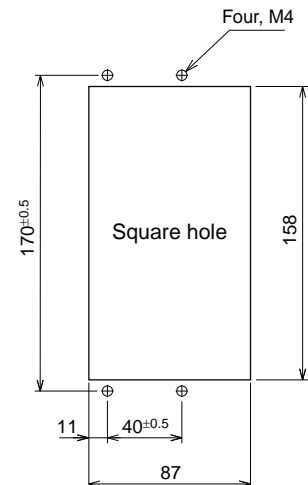

■ Three-phase 200 VAC: R88D-GN20H-ML2 (2 kW)

Wall Mounting

External Dimensions

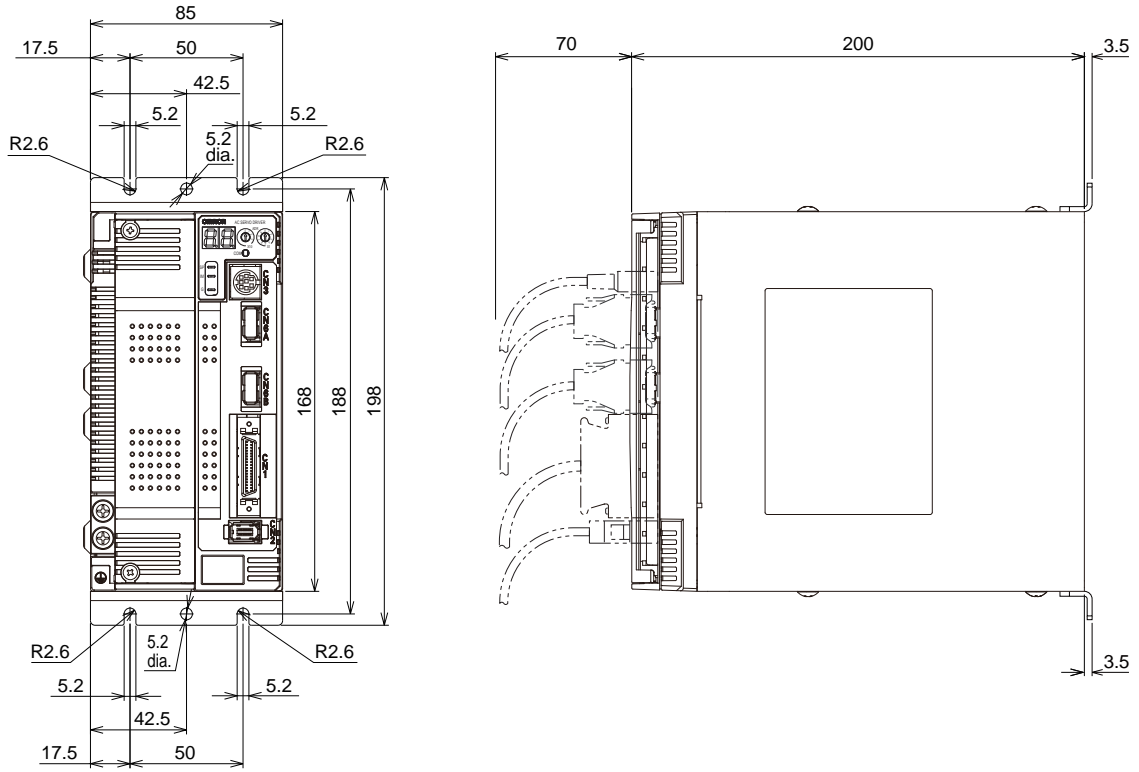

Mounting Hole Dimensions

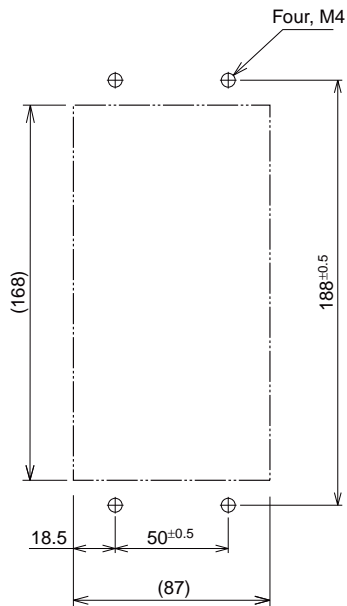

2-2 External and Mounting Hole Dimensions

Front Panel Mounting (Using Mounting Brackets)

External Dimensions

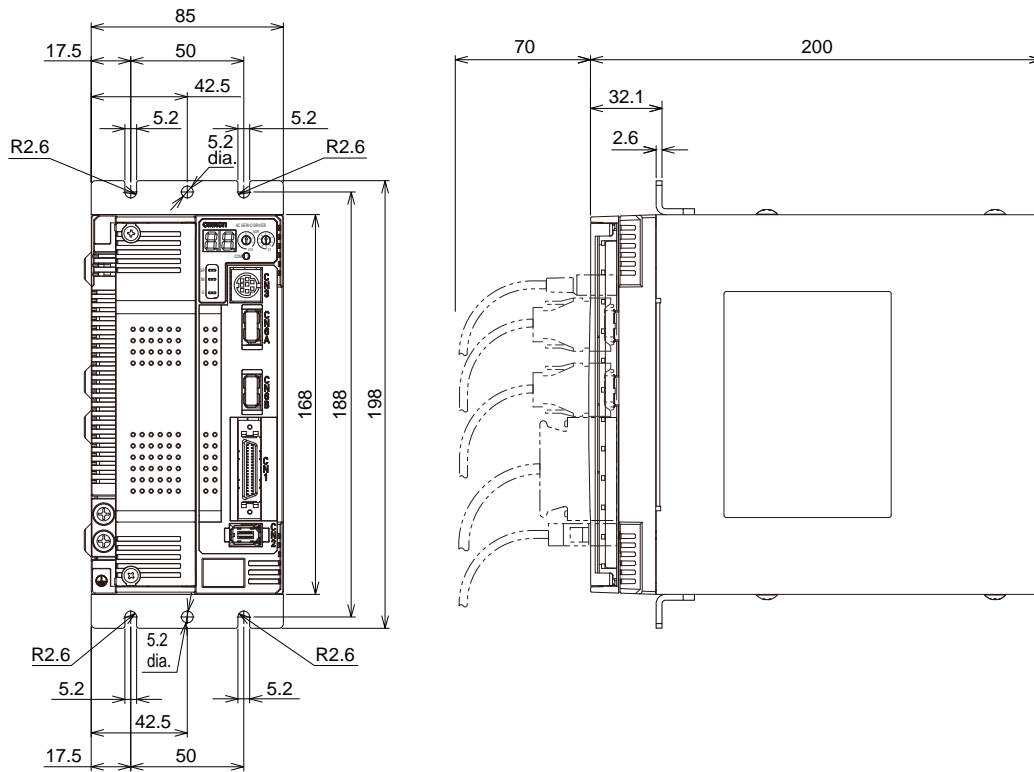

Mounting Hole Dimensions

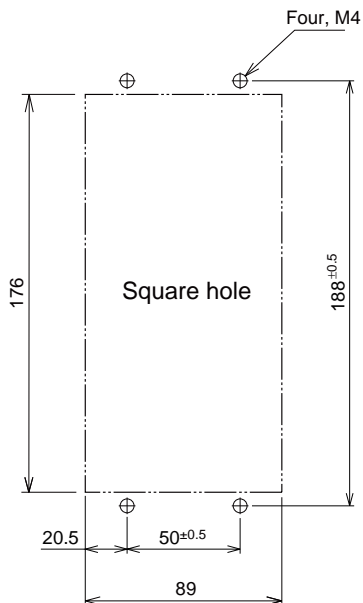

■ Three-phase 200 VAC: R88D-GN30H-ML2/-GN50H-ML2 (2 to 5 kW)

Wall Mounting

External Dimensions

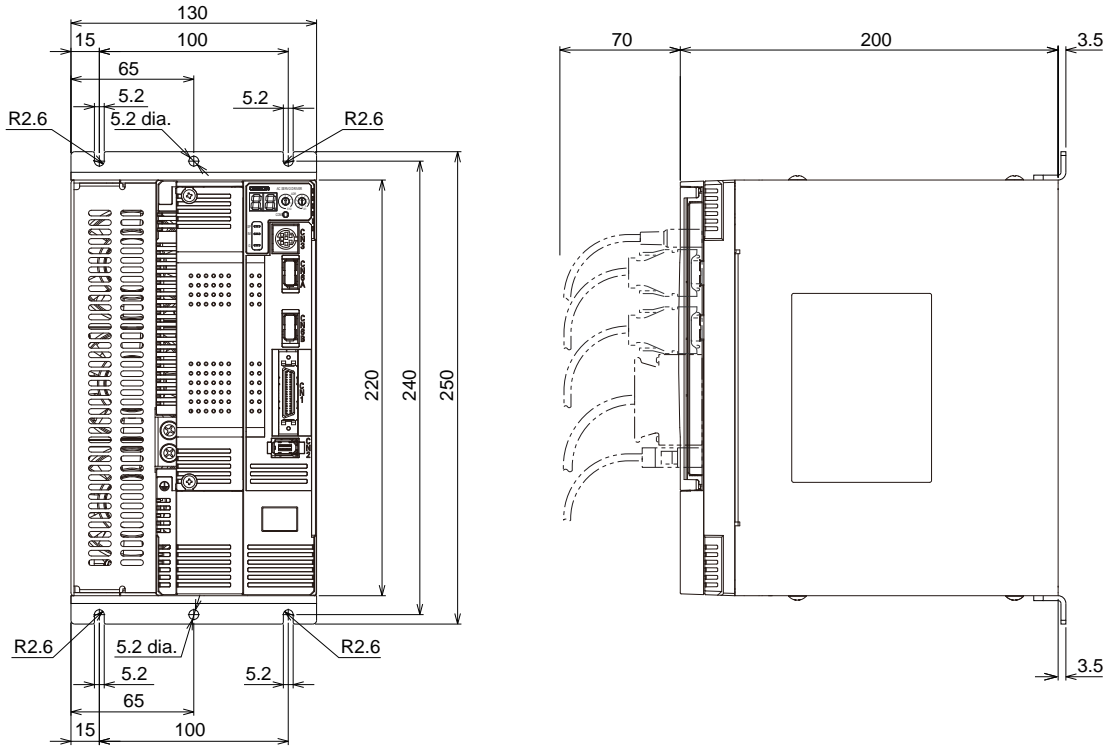

Mounting Hole Dimensions

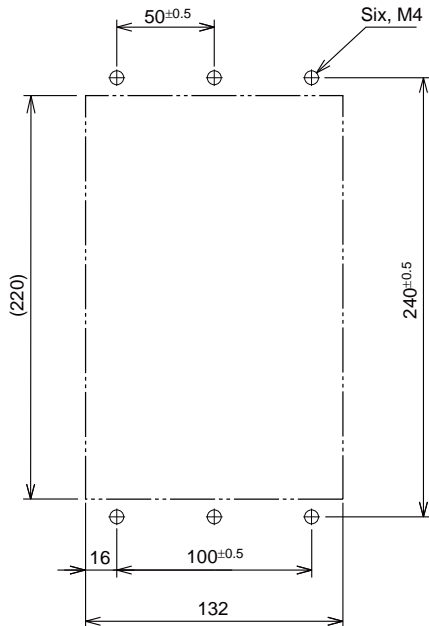

2-2 External and Mounting Hole Dimensions

Front Panel Mounting (Using Mounting Brackets)

External Dimensions

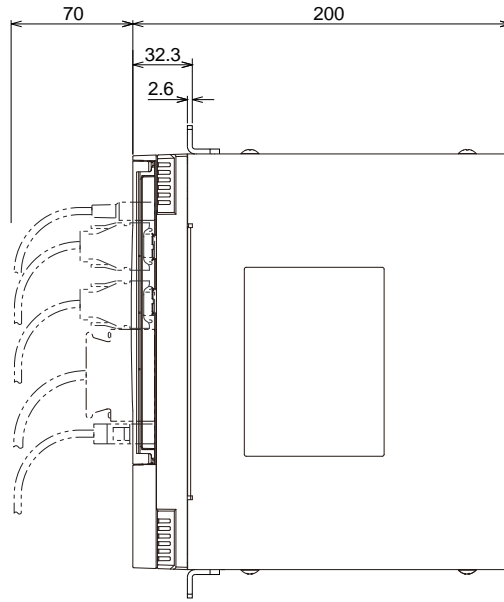
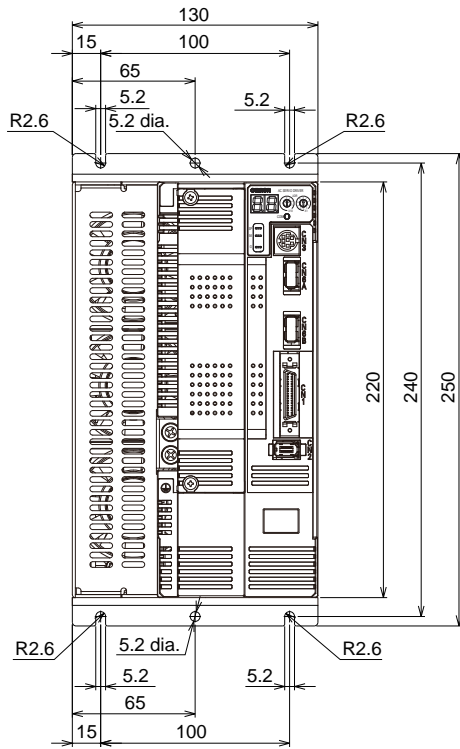

Mounting Hole Dimensions

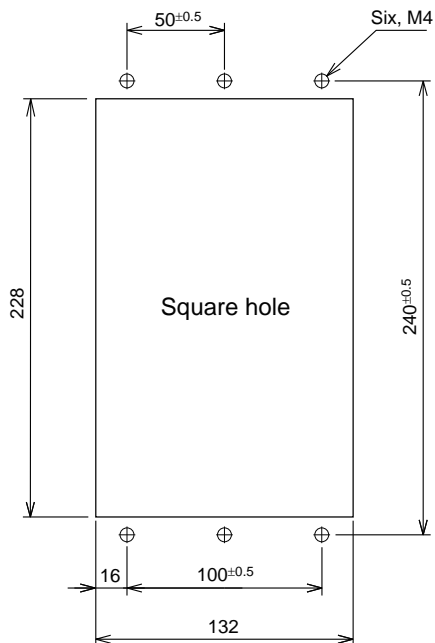

■ Three-phase 200 VAC: R88D-GN75H-ML2 (7.5 kW)

Front Panel Mounting (Using Mounting Brackets)

External Dimensions

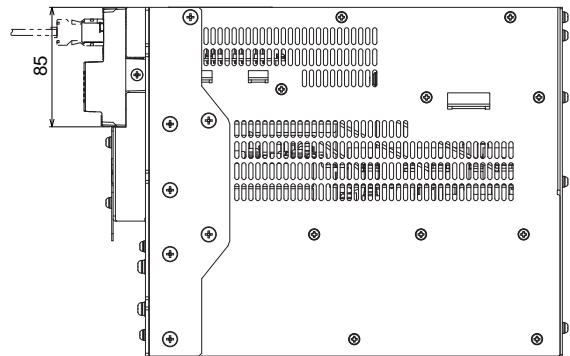
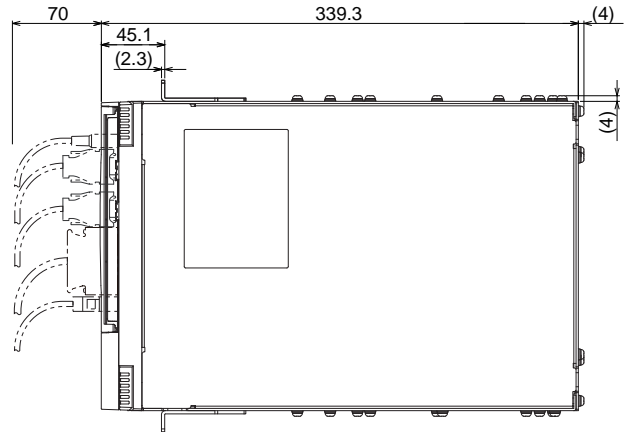
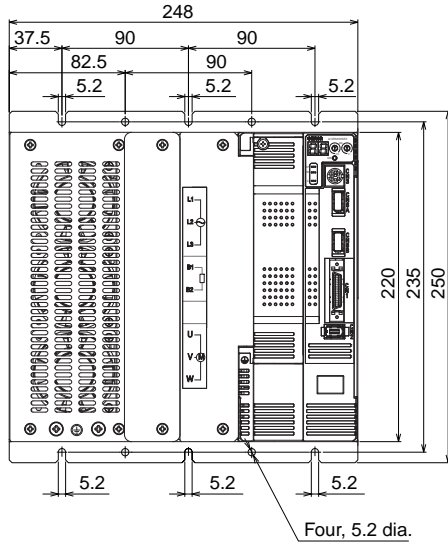

Mounting Hole Dimensions

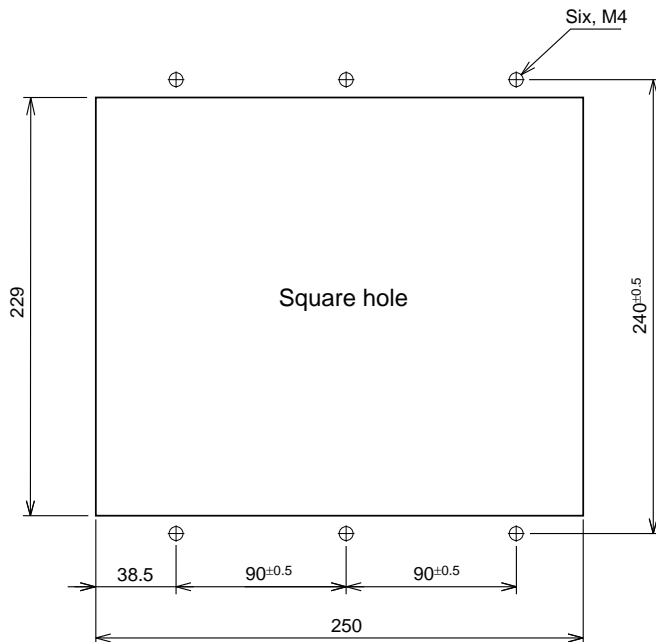

Servomotors

2

■ 3,000-r/min Servomotors

50 W/100 W

R88M-G05030H(-S2)/-G10030L(-S2)/-G10030H(-S2)/-G05030H-B(S2)

/-G10030L-B(S2)/-G10030H-B(S2) **INC**

R88M-G05030T(-S2)/-G10030S(-S2)/-G10030T(-S2)/-G05030T-B(S2)

/-G10030S-B(S2)/-G10030T-B(S2) **ABS**

Standard Models and Dimensions

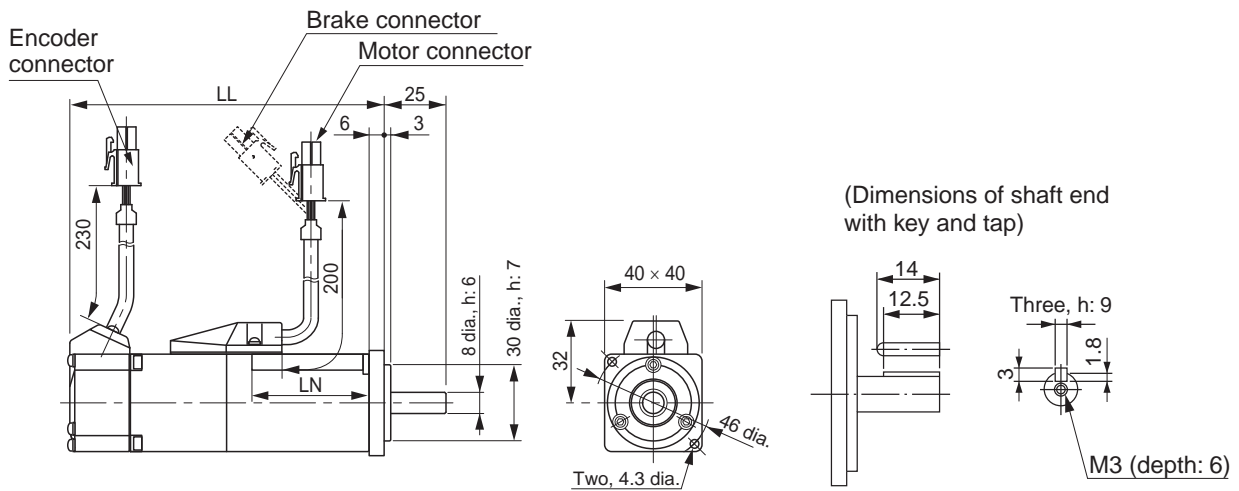

Model	Dimensions (mm)	
	LL	LN
R88M-G05030□	72	26.5
R88M-G10030□	92	46.5
R88M-G05030□-B□	102	26.5
R88M-G10030□-B□	122	46.5

Note The standard models have a straight shaft. Models with a key and tap are indicated with "S2" at the end of the model number.

■ 3,000-r/min Servomotors

200 W/400 W/750 W

- R88M-G20030L(-S2)/-G40030L(-S2)/-G20030H(-S2)/-G40030H(-S2)
- /-G75030H(-S2)/-G20030L-B(S2)/-G40030L-B(S2)
- /-G20030H-B(S2)/-G40030H-B(S2)/-G75030H-B(S2) **INC**
- R88M-G20030S(-S2)/-G40030S(-S2)/-G20030T(-S2)/-G40030T(-S2)
- /-G75030T(-S2)/-G20030S-B(S2)/-G40030S-B(S2)
- /-G20030T-B(S2)/-G40030T-B(S2)/-G75030T-B(S2) **ABS**

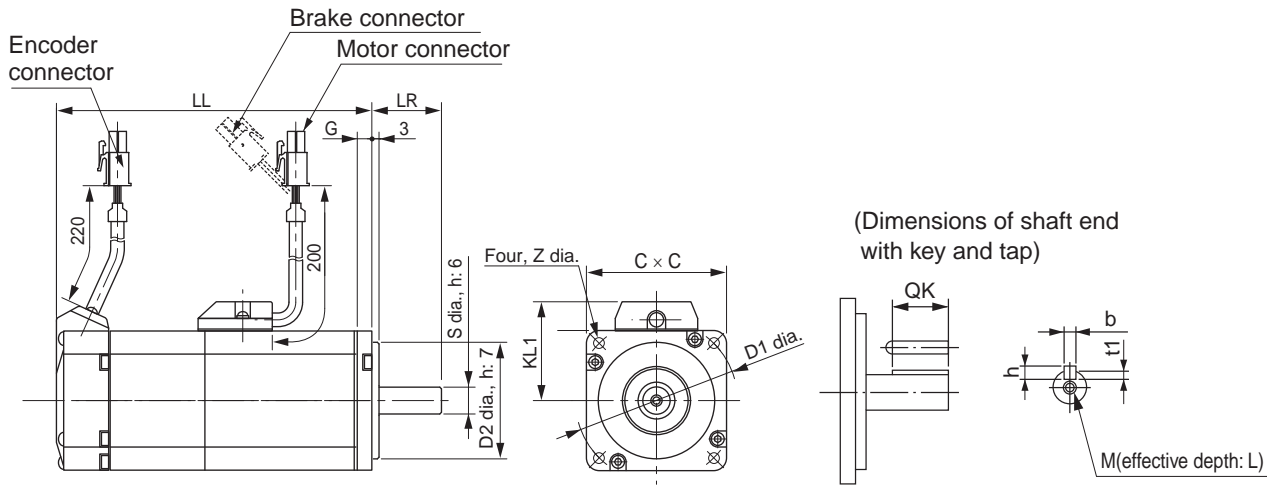

Model	Dimensions (mm)														
	LL	LR	S	D1	D2	C	G	KL1	Z	QK	b	h	M	t1	L
R88M-G20030□	79.5	30	11	70	50	60	6.5	43	4.5	18	4h9	4	M4	2.5	8
R88M-G40030□	99		14							22.5	5h9	5	M5	3	
R88M-G75030□	112.2	35	19	90	70	80	8	53	6	22	6h9	6	M5	3.5	10
R88M-G20030□-B□	116	30	11	70	50	60	6.5	43	4.5	18	4h9	4	M4	2.5	8
R88M-G40030□-B□	135.5		14							22.5	5h9	5	M5	3	
R88M-G75030□-B□	149.2	35	19	90	70	80	8	53	6	22	6h9	6	M5	3.5	10

Note The standard models have a straight shaft. Models with a key and tap are indicated with "S2" at the end of the model number.

2-2 External and Mounting Hole Dimensions

■ 3,000-r/min Servomotors

1 kW/1.5 kW/2 kW

R88M-G1K030T(-S2)/-G1K530T(-S2)/-G2K030T(-S2)/-G1K030T-B(S2)
 /-G1K530T-B(S2)/-G2K030T-B(S2) **ABS**

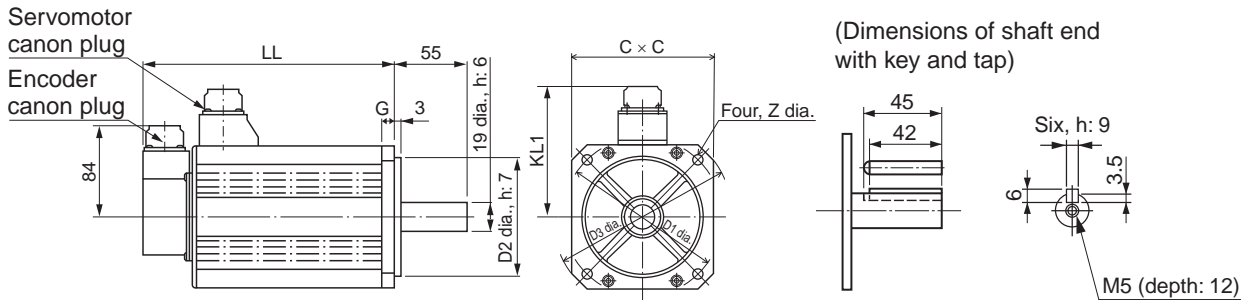

Model	Dimensions (mm)							
	LL	D1	D2	C	D3	G	KL1	Z
R88M-G1K030□	175	100	80	90	120	7	98	6.6
R88M-G1K530□	180	115	95	100	135	10	103	9
R88M-G2K030□	205							
R88M-G1K030□-B□	200	100	80	90	120	7	98	6.6
R88M-G1K530□-B□	205	115	95	100	135	10	103	9
R88M-G2K030□-B□	230							

Note The standard models have a straight shaft. Models with a key and tap are indicated with "S2" at the end of the model number.

■ 3,000-r/min Servomotors

3 kW

R88M-G3K030T(-S2)/-G3K030T-B(S2) **ABS**

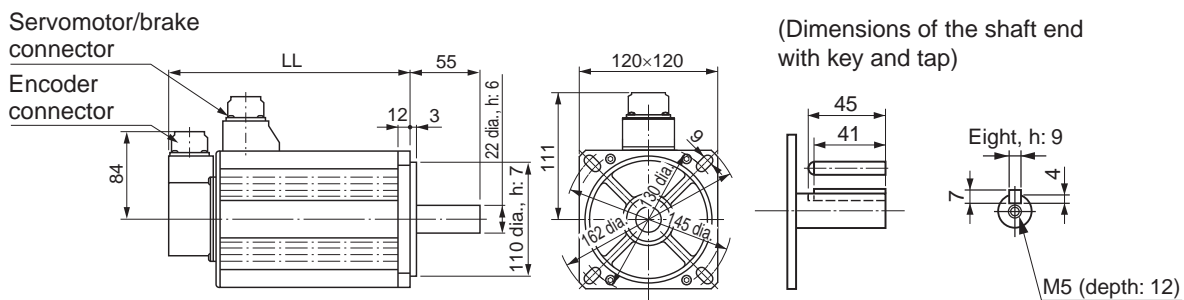

Model	Dimensions (mm)
	LL
R88M-G3K030□	217
R88M-G3K030□-B□	242

Note The standard models have a straight shaft. Models with a key and tap are indicated with "S2" at the end of the model number.

■ 3,000-r/min Servomotors

4 kW/5 kW

R88M-G4K030T(-S2)/-G5K030T(-S2)/-G4K030T-B(S2)/-G5K030T-B(S2) **ABS**

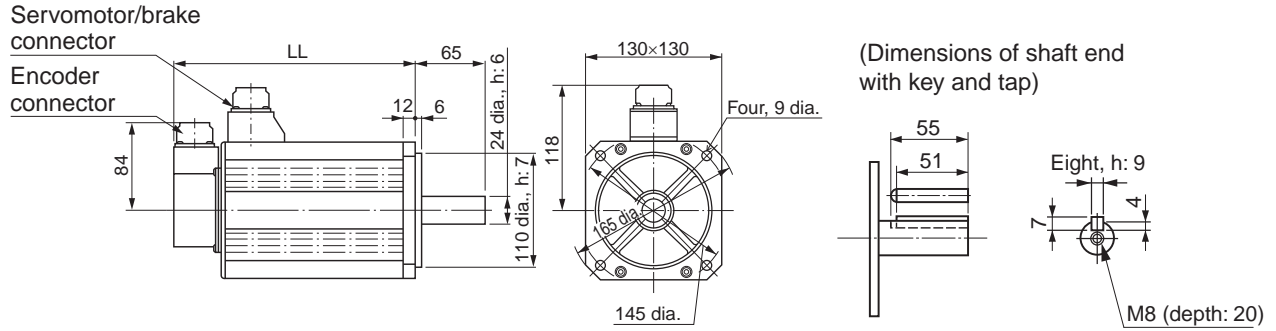

Model	Dimensions (mm)
	LL
R88M-G4K030□	240
R88M-G5K030□	280
R88M-G4K030□-B□	265
R88M-G5K030□-B□	305

Note The standard models have a straight shaft. Models with a key and tap are indicated with "S2" at the end of the model number.

2-2 External and Mounting Hole Dimensions

■ 3,000-r/min Flat Servomotors

100 W/200 W/400 W

R88M-GP10030L(-S2)/-GP20030L(-S2)/-GP40030L(-S2)/-GP10030H(-S2)
 /-GP20030H(-S2)/-GP40030H(-S2)/-GP10030L-B(S2)/-GP20030L-B(S2)
 /-GP40030L-B(S2)/-GP10030H-B(S2)/-GP20030H-B(S2)/-GP40030H-B(S2) **INC**

R88M-GP10030S(-S2)/-GP20030S(-S2)/-GP40030S(-S2)/-GP10030T(-S2)
 /-GP20030T(-S2)/-GP40030T(-S2)/-GP10030S-B(S2)/-GP20030S-B(S2)
 /-GP40030S-B(S2)/-GP10030T-B(S2)/-GP20030T-B(S2)/-GP40030T-B(S2) **ABS**

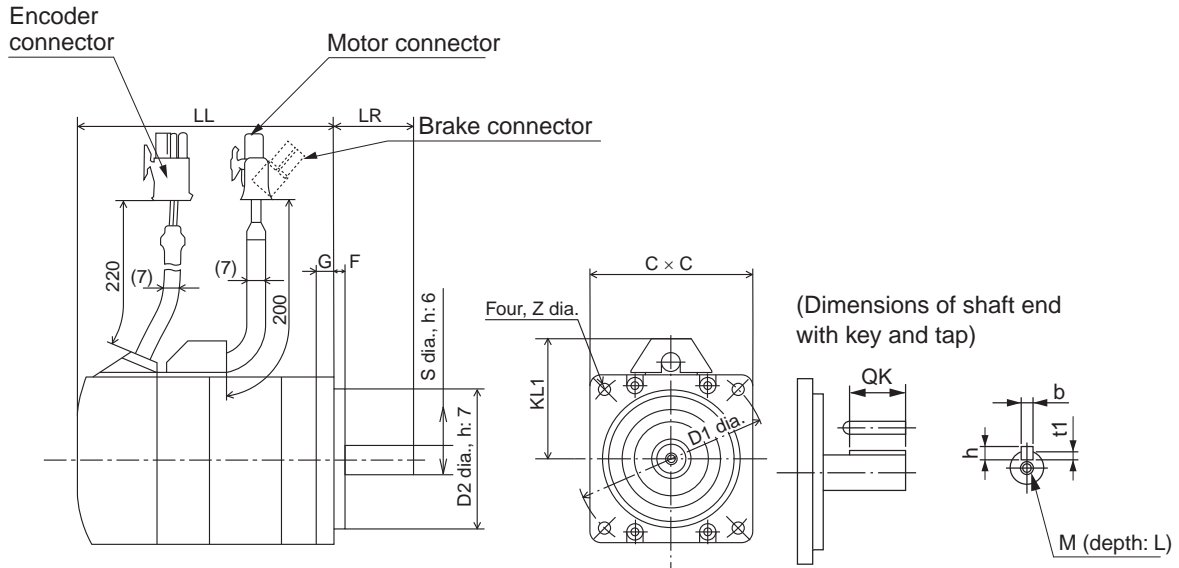

Model	Dimensions (mm)															
	LL	LR	S	D1	D2	C	F	G	KL1	Z	QK	b	h	t1	M	L
R88M-GP10030L	60.5	25	8	70	50	60	3	7	43	4.5	12.5	3h9	3	1.8	M3	6
R88M-GP10030H	87.5															
R88M-GP10030S	87.5	30	11	90	70	80	5	8	53	5.5	18	4h9	4	2.5	M4	8
R88M-GP10030T																
R88M-GP20030L	67.5	30	11	90	70	80	5	8	53	5.5	18	4h9	4	2.5	M4	8
R88M-GP20030H	94.5															
R88M-GP20030S	94.5	30	11	90	70	80	5	8	53	5.5	18	4h9	4	2.5	M4	8
R88M-GP20030T																
R88M-GP40030L	82.5	30	14	90	70	80	5	8	53	5.5	22.5	5h9	5	3	M5	10
R88M-GP40030H	82.5															
R88M-GP40030S	109.5	30	14	90	70	80	5	8	53	5.5	22.5	5h9	5	3	M5	10
R88M-GP40030T																
R88M-GP10030L-B□	84.5	25	8	70	50	60	3	7	43	4.5	12.5	3h9	3	1.8	M3	6
R88M-GP10030H-B□	84.5															
R88M-GP10030S-B□	111.5	30	11	90	70	80	5	8	53	5.5	18	4h9	4	2.5	M4	8
R88M-GP10030T-B□																
R88M-GP20030L-B□	100	30	11	90	70	80	5	8	53	5.5	18	4h9	4	2.5	M4	8
R88M-GP20030H-B□	100															
R88M-GP20030S-B□	127	30	11	90	70	80	5	8	53	5.5	18	4h9	4	2.5	M4	8
R88M-GP20030T-B□																
R88M-GP40030L-B□	115	30	14	90	70	80	5	8	53	5.5	22.5	5h9	5	3	M5	10
R88M-GP40030H-B□																
R88M-GP40030S-B□	142	30	14	90	70	80	5	8	53	5.5	22.5	5h9	5	3	M5	10
R88M-GP40030T-B□																

Note The standard models have a straight shaft. Models with a key and tap are indicated with "S2" at the end of the model number.

■ 2,000-r/min Servomotors

1 kW/1.5 kW

R88M-G1K020T(-S2)/-G1K520T(-S2)/-G1K020T-B(S2)/-G1K520T-B(S2) **ABS**

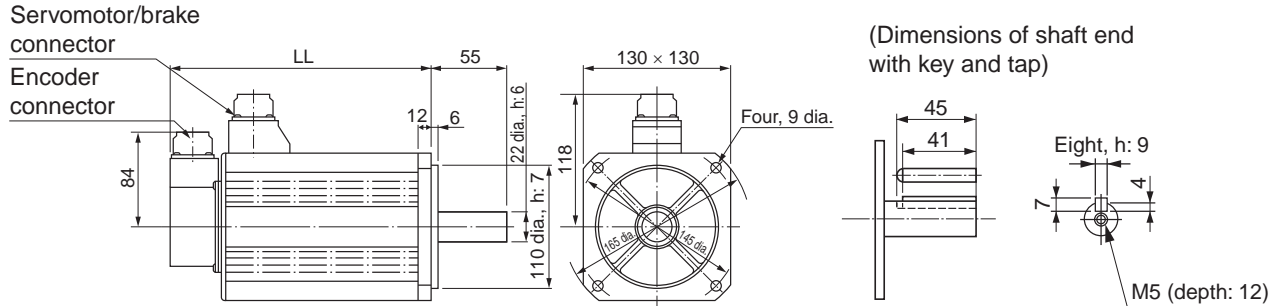

Model	Dimensions (mm)
	LL
R88M-G1K020□	150
R88M-G1K520□	175
R88M-G1K020□-B□	
R88M-G1K520□-B□	200

Note The standard models have a straight shaft. Models with a key and tap are indicated with "S2" at the end of the model number.

■ 2,000-r/min Servomotors

2 kW/3 kW

R88M-G2K020T(-S2)/-G3K020T(-S2)/-G2K020T-B(S2)/-G3K020T-B(S2) **ABS**

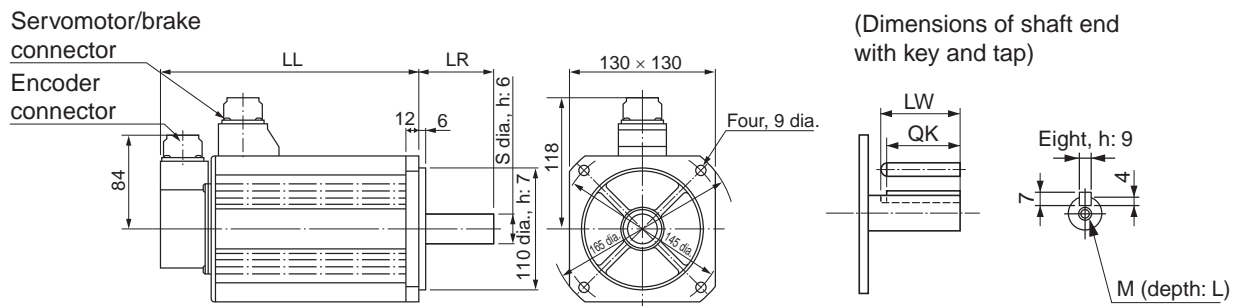

Model	Dimensions (mm)						
	LL	LR	S	LW	QK	M	L
R88M-G2K020□	200	55	22	45	41	M5	12
R88M-G3K020□	250	65	24	55	51	M8	20
R88M-G2K020□-B□	225	55	22	45	41	M5	12
R88M-G3K020□-B□	275	65	24	55	51	M8	20

Note The standard models have a straight shaft. Models with a key and tap are indicated with "S2" at the end of the model number.

2-2 External and Mounting Hole Dimensions

■ 2,000-r/min Servomotors

4 kW/5 kW

R88M-G4K020T(-S2)/-G5K020T(-S2)/-G4K020T-B(S2)/-G5K020T-B(S2) **ABS**

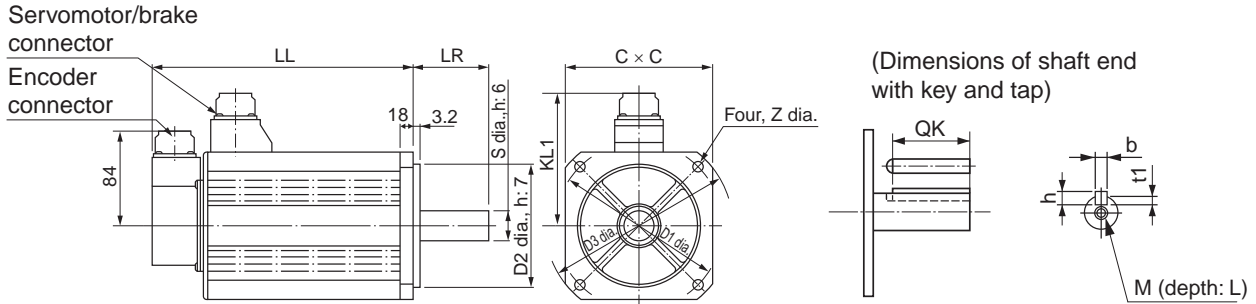

Model	Dimensions (mm)														
	LL	LR	S	D1	D2	C	D3	KL1	Z	QK	b	h	t1	M	L
R88M-G4K020□	242	65	28	165	130	150	190	128	11	51	8h9	7	4	M8	20
R88M-G5K020□	225	70	35	200	114.3	176	233	143	13.5	50	10h9	8	5	M12	25
R88M-G4K020□-B□	267	65	28	165	130	150	190	128	11	51	8h9	7	4	M8	20
R88M-G5K020□-B□	250	70	35	200	114.3	176	233	143	13.5	50	10h9	8	5	M12	25

Note The standard models have a straight shaft. Models with a key and tap are indicated with "S2" at the end of the model number.

■ 1,500-r/min Servomotors

7.5 kW

R88M-G7K515T(-S2)/-G7K515T-B(S2) **ABS**

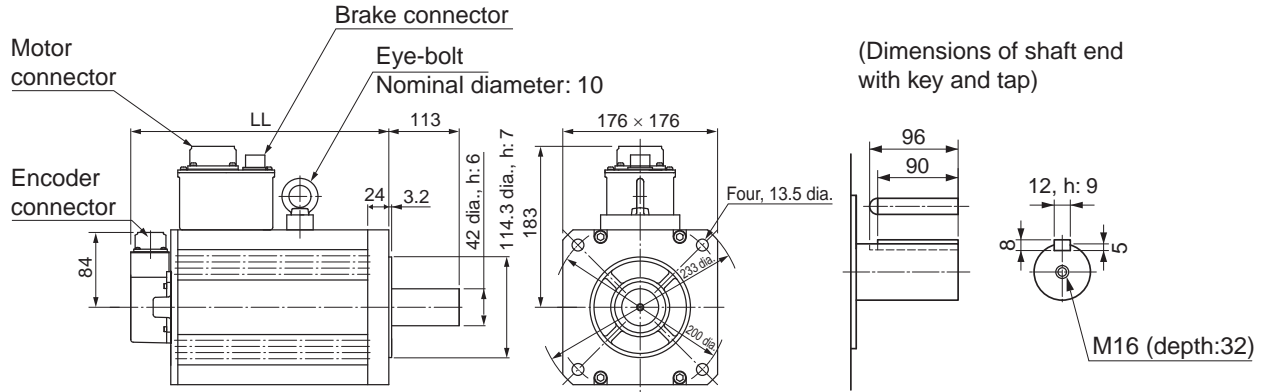

Model	Dimensions (mm)
	LL
R88M-G7K515□	340.5
R88M-G7K515□-B□	380.5

Note The standard models have a straight shaft. Models with a key and tap are indicated with "S2" at the end of the model number.

2-2 External and Mounting Hole Dimensions

■ 1,000-r/min Servomotors

900 W/2 kW

R88M-G90010T(-S2)/-G2K010T(-S2)/-G90010T-B(S2)/-G2K010T-B(S2) **ABS**

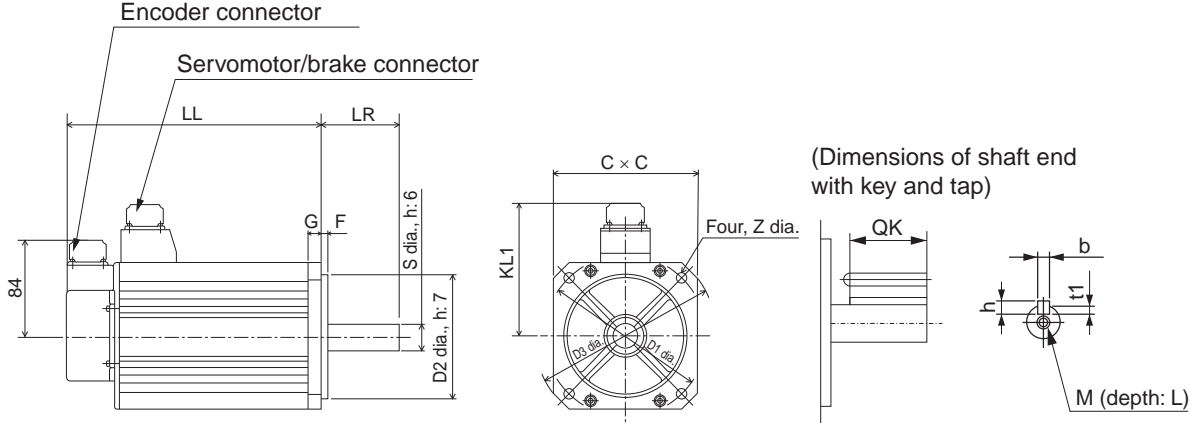

Model	Dimensions (mm)																
	LL	LR	S	D1	D2	C	D3	F	G	KL1	Z	QK	b	h	t1	M	L
R88M-G90010□	175	70	22	145	110	130	165	6	12	118	9	41	8h9	7	4	M5	12
R88M-G2K010□	182	80	35	200	114.3	176	233	3.2	18	143	13.5	50	10h9	8	5	M12	25
R88M-G90010□-B□	200	70	22	145	110	130	165	6	12	118	9	41	8h9	7	4	M5	12
R88M-G2K010□-B□	207	80	35	200	114.3	176	233	3.2	18	143	13.5	50	10h9	8	5	M12	25

Note The standard models have a straight shaft. Models with a key and tap are indicated with "S2" at the end of the model number.

■ 1,000-r/min Servomotors

3 kW

R88M-G3K010T(-S2)/-G3K010T-B(S2) **ABS**

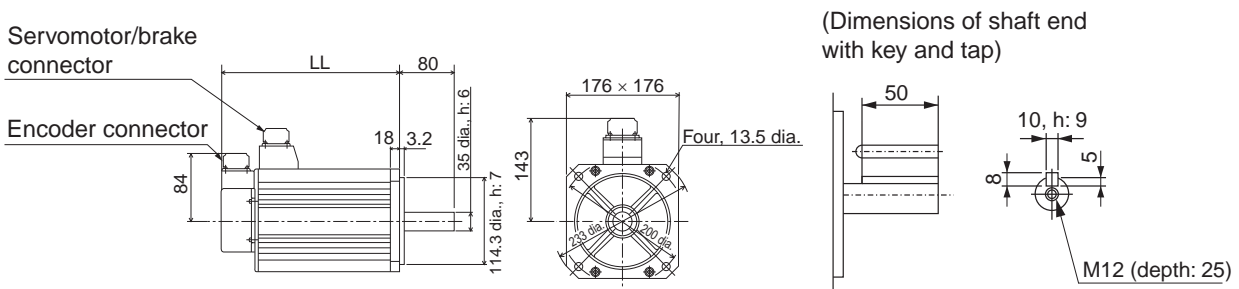

Model	Dimensions (mm)
	LL
R88M-G3K010□	222
R88M-G3K010□-B□	271

Note The standard models have a straight shaft. Models with a key and tap are indicated with "S2" at the end of the model number.

■ 1,000-r/min Servomotors

4.5 kW

R88M-G4K510T(-S2)/-G4K510T-B(S2) **ABS**

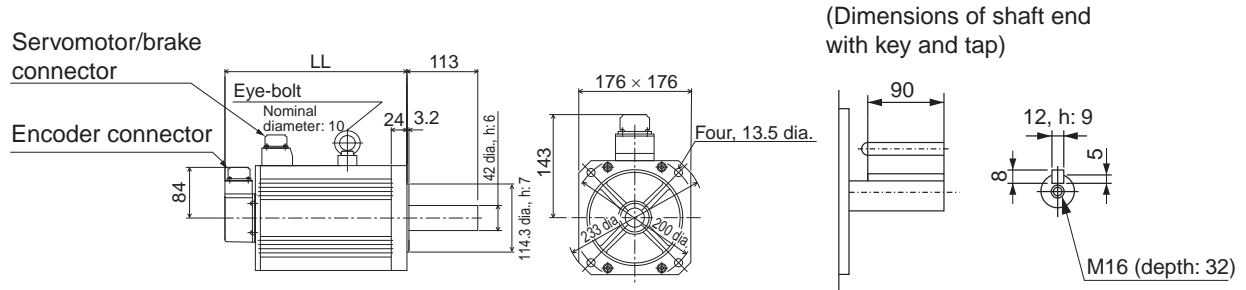

Model	Dimensions (mm)
	LL
R88M-G4K510□	300.5
R88M-G4K510□-B□	337.5

Note The standard models have a straight shaft. Models with a key and tap are indicated with "S2" at the end of the model number.

■ 1,000-r/min Servomotors

6 kW

R88M-G6K010T(-S2)/-G6K010T-B(S2) **ABS**

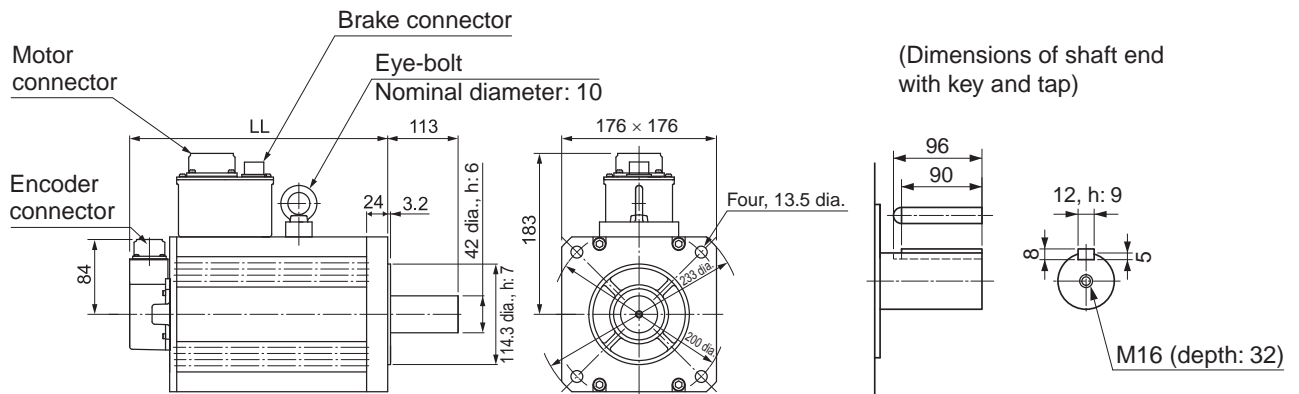

Model	Dimensions (mm)
	LL
R88M-G6K010□	340.5
R88M-G6K010□-B□	380.5

Note The standard models have a straight shaft. Models with a key and tap are indicated with "S2" at the end of the model number.

Parameter Unit Dimensions

2

■ R88A-PR02G Hand-held Parameter Unit

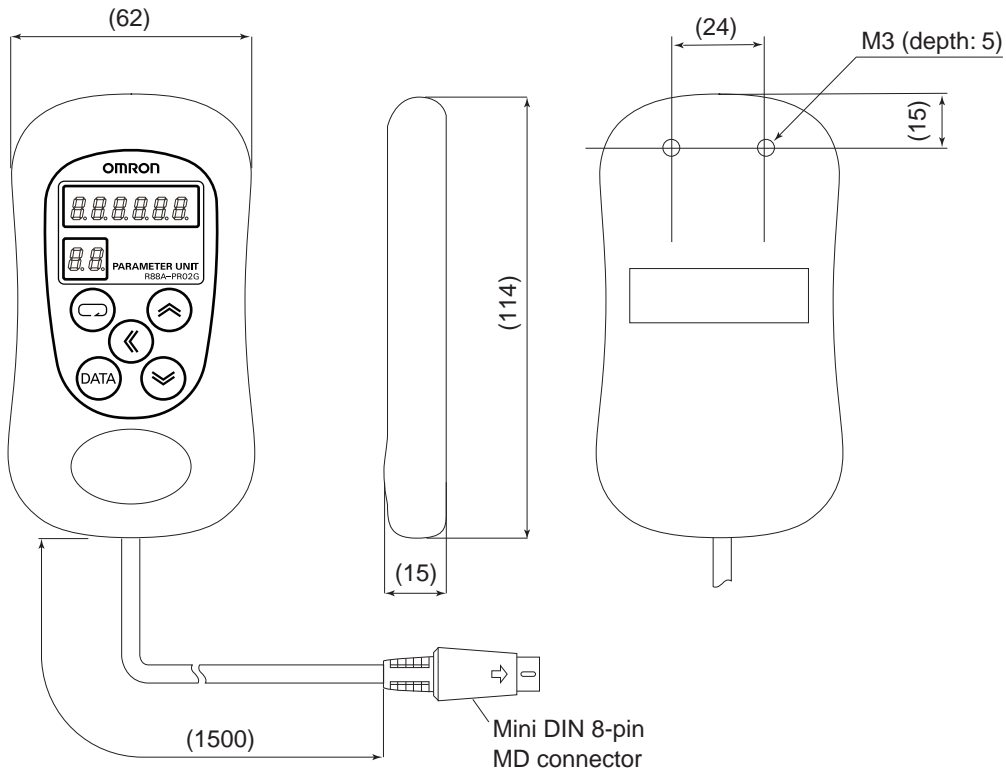

Standard Models and Dimensions

Servomotor and Decelerator Combinations

3,000-r/min Servomotors

Motor model	1/5	1/11 (1/9 for flange size No.11)	1/21	1/33	1/45
R88M-G05030□	R88G-HPG11A05100B□ (Also used with R88M-G10030□)	R88G-HPG11A09050B□ (Gear ratio 1/9)	R88G-HPG14A21100B□ (Also used with R88M-G10030□)	R88G-HPG14A33050B□	R88G-HPG14A45050B□
R88M-G10030□	R88G-HPG11A05100B□	R88G-HPG14A11100B□	R88G-HPG14A21100B□	R88G-HPG20A33100B□	R88G-HPG20A45100B□
R88M-G20030□	R88G-HPG14A05200B□	R88G-HPG14A11200B□	R88G-HPG20A21200B□	R88G-HPG20A33200B□	R88G-HPG20A45200B□
R88M-G40030□	R88G-HPG14A05400B□	R88G-HPG20A11400B□	R88G-HPG20A21400B□	R88G-HPG32A33400B□	R88G-HPG32A45400B□
R88M-G75030□	R88G-HPG20A05750B□	R88G-HPG20A11750B□	R88G-HPG32A21750B□	R88G-HPG32A33750B□	R88G-HPG32A45750B□
R88M-G1K030T	R88G-HPG32A051K0B□	R88G-HPG32A111K0B□	R88G-HPG32A211K0B□	R88G-HPG32A331K0B□	R88G-HPG50A451K0B□
R88M-G1K530T	R88G-HPG32A052K0B□ (Also used with R88M-G2K030T)	R88G-HPG32A112K0B□ (Also used with R88M-G2K030T)	R88G-HPG32A211K5B□	R88G-HPG50A332K0B□ (Also used with R88M-G2K030T)	R88G-HPG50A451K5B□
R88M-G2K030T	R88G-HPG32A052K0B□	R88G-HPG32A112K0B□	R88G-HPG50A212K0B□	R88G-HPG50A332K0B□	---
R88M-G3K030T	R88G-HPG32A053K0B□	R88G-HPG50A113K0B□	R88G-HPG50A213K0B□	---	---
R88M-G4K030T	R88G-HPG32A054K0B□	R88G-HPG50A115K0B□ (Also used with R88M-G5K030T)	---	---	---
R88M-G5K030T	R88G-HPG50A055K0B□	R88G-HPG50A115K0B□	---	---	---

2-2 External and Mounting Hole Dimensions

3,000-r/min Flat Servomotors

Motor model	1/5	1/11	1/21	1/33	1/45
R88M-GP10030□	R88G-HPG11A05100PB□	R88G-HPG14A11100PB□	R88G-HPG14A21100PB□	R88G-HPG20A33100PB□	R88G-HPG20A45100PB□
R88M-GP20030□	R88G-HPG14A05200PB□	R88G-HPG20A11200PB□	R88G-HPG20A21200PB□	R88G-HPG20A33200PB□	R88G-HPG20A45200PB□
R88M-GP40030□	R88G-HPG20A05400PB□	R88G-HPG20A11400PB□	R88G-HPG20A21400PB□	R88G-HPG32A33400PB□	R88G-HPG32A45400PB□

2,000-r/min Servomotors

Motor model	1/5	1/11 (1/12 for flange size No.65)	1/21 (1/20 for flange size No.65)	1/33 (1/25 for flange size No.65)	1/45
R88M-G1K020T	R88G-HPG32A053K0B□ (Also used with R88M-G3K030T)	R88G-HPG32A112K0SB□ (Also used with R88M-G2K020T)	R88G-HPG32A211K0SB□	R88G-HPG50A332K0SB□ (Also used with R88M-G2K020T)	R88G-HPG50A451K0SB□
R88M-G1K520T	R88G-HPG32A053K0B□ (Also used with R88M-G3K030T)	R88G-HPG32A112K0SB□ (Also used with R88M-G2K020T)	R88G-HPG50A213K0B□ (Also used with R88M-G3K030T)	R88G-HPG50A332K0SB□ (Also used with R88M-G2K020T)	---
R88M-G2K020T	R88G-HPG32A053K0B□ (Also used with R88M-G3K030T)	R88G-HPG32A112K0SB□	R88G-HPG50A213K0B□ (Also used with R88M-G3K030T)	R88G-HPG50A332K0SB□	---
R88M-G3K020T	R88G-HPG32A054K0B□ (Also used with R88M-G4K030T)	R88G-HPG50A115K0B□ (Also used with R88M-G5K030T)	R88G-HPG50A213K0SB□	R88G-HPG65A253K0SB□	---
R88M-G4K020T	R88G-HPG50A054K0SB□	R88G-HPG50A114K0SB□	R88G-HPG65A204K0SB□	R88G-HPG65A254K0SB□	---
R88M-G5K020T	R88G-HPG50A055K0SB□	R88G-HPG50A115K0SB□	R88G-HPG65A205K0SB□	R88G-HPG65A255K0SB□	---
R88M-G7K515T	R88G-HPG65A057K5SB□	R88G-HPG65A127K5SB□	---	---	---

1,000-r/min Servomotors

Motor model	1/5	1/11 (1/12 for flange size No.65)	1/21 (1/20 for flange size No.65)	1/33 (1/25 for flange size No.65)
R88M- G90010T	R88G- HPG32A05900TB□	R88G- HPG32A11900TB□	R88G- HPG50A21900TB□	R88G- HPG50A33900TB□
R88M- G2K010T	R88G- HPG32A052K0TB□	R88G- HPG50A112K0TB□	R88G- HPG50A212K0TB□	R88G- HPG65A255K0SB□ (Also used with R88M- G5K020T)
R88M- G3K010T	R88G- HPG50A055K0SB□ (Also used with R88M- G5K020T)	R88G- HPG50A115K0SB□ (Also used with R88M- G5K020T)	R88G- HPG65A205K0SB□ (Also used with R88M- G5K020T)	R88G- HPG65A255K0SB□ (Also used with R88M- G5K020T)
R88M- G4K510T	R88G- HPG50A054K5TB□	R88G- HPG65A127K5SB□ (Also used with R88M- G7K515T)	R88G- HPG65A204K5TB□	---
R88M- G6K010T	R88G- HPG65A057K5SB□ (Also used with R88M- G7K515T)	R88G- HPG65A127K5SB□ (Also used with R88M- G7K515T)	---	---

Decelerator Dimensions

■ Backlash = 3' Max.

Decelerators for 3,000-r/min Servomotors

Model			Dimensions (mm)											
			LM	LR	C1	C2	D1	D2	D3	D4	D5	E	F1	F2
50 W	1/5	R88G-HPG11A05100B□	39.5	42	40	40×40	46	46	40.0	39.5	29	27	2.2	15
	1/9	R88G-HPG11A09050B□	39.5	42	40	40×40	46	46	40.0	39.5	29	27	2.2	15
	1/21	R88G-HPG14A21100B□	64.0	58	60	60×60	70	46	56.0	55.5	40	37	2.5	21
	1/33	R88G-HPG14A33050B□	64.0	58	60	60×60	70	46	56.0	55.5	40	37	2.5	21
	1/45	R88G-HPG14A45050B□	64.0	58	60	60×60	70	46	56.0	55.5	40	37	2.5	21
100 W	1/5	R88G-HPG11A05100B□	39.5	42	40	40×40	46	46	40.0	39.5	29	27	2.2	15
	1/11	R88G-HPG14A11100B□	64.0	58	60	60×60	70	46	56.0	55.5	40	37	2.5	21
	1/21	R88G-HPG14A21100B□	64.0	58	60	60×60	70	46	56.0	55.5	40	37	2.5	21
	1/33	R88G-HPG20A33100B□	66.5	80	90	55 dia.	105	46	85.0	84.0	59	53	7.5	27
	1/45	R88G-HPG20A45100B□	66.5	80	90	55 dia.	105	46	85.0	84.0	59	53	7.5	27
200 W	1/5	R88G-HPG14A05200B□	64.0	58	60	60×60	70	70	56.0	55.5	40	37	2.5	21
	1/11	R88G-HPG14A11200B□	64.0	58	60	60×60	70	70	56.0	55.5	40	37	2.5	21
	1/21	R88G-HPG20A21200B□	71.0	80	90	89 dia.	105	70	85.0	84.0	59	53	7.5	27
	1/33	R88G-HPG20A33200B□	71.0	80	90	89 dia.	105	70	85.0	84.0	59	53	7.5	27
	1/45	R88G-HPG20A45200B□	71.0	80	90	89 dia.	105	70	85.0	84.0	59	53	7.5	27

Model			Dimensions (mm)											
			G	S	T	Z1	Z2	AT ⁺¹	Key dimensions				Tap dimensions	
									QK	b	h	t1	M	L
50 W	1/5	R88G-HPG11A05100B□	5	8	20	3.4	M4×9	M3	15	3	3	1.8	M3	6
	1/9	R88G-HPG11A09050B□	5	8	20	3.4	M4×9	M3	15	3	3	1.8	M3	6
	1/21	R88G-HPG14A21100B□	8	16	28	5.5	M4×10	M3	25	5	5	3	M4	8
	1/33	R88G-HPG14A33050B□	8	16	28	5.5	M4×10	M3	25	5	5	3	M4	8
	1/45	R88G-HPG14A45050B□	8	16	28	5.5	M4×10	M3	25	5	5	3	M4	8
100 W	1/5	R88G-HPG11A05100B□	5	8	20	3.4	M4×9	M3	15	3	3	1.8	M3	6
	1/11	R88G-HPG14A11100B□	8	16	28	5.5	M4×10	M3	25	5	5	3	M4	8
	1/21	R88G-HPG14A21100B□	8	16	28	5.5	M4×10	M3	25	5	5	3	M4	8
	1/33	R88G-HPG20A33100B□	10	25	42	9.0	M4×10	M4	36	8	7	4.0	M6	12
	1/45	R88G-HPG20A45100B□	10	25	42	9.0	M4×10	M4	36	8	7	4.0	M6	12
200 W	1/5	R88G-HPG14A05200B□	8	16	28	5.5	M4×10	M4	25	5	5	3	M4	8
	1/11	R88G-HPG14A11200B□	8	16	28	5.5	M4×10	M4	25	5	5	3	M4	8
	1/21	R88G-HPG20A21200B□	10	25	42	9.0	M4×10	M4	36	8	7	4.0	M6	12
	1/33	R88G-HPG20A33200B□	10	25	42	9.0	M4×10	M4	36	8	7	4.0	M6	12
	1/45	R88G-HPG20A45200B□	10	25	42	9.0	M4×10	M4	36	8	7	4.0	M6	12

Note 1. The standard models have a straight shaft.

Note 2. Models with a key and tap are indicated with "J" at the end of the model number (the suffix shown in the box). (Example: R88G-HPG11A05100BJ)

Model			Dimensions (mm)											
			LM	LR	C1	C2	D1	D2	D3	D4	D5	E	F1	F2
400 W	1/5	R88G-HPG14A05400B□	64.0	58	60	60×60	70	70	56.0	55.5	40	37	2.5	21
	1/11	R88G-HPG20A11400B□	71.0	80	90	89 dia.	105	70	85.0	84.0	59	53	7.5	27
	1/21	R88G-HPG20A21400B□	71.0	80	90	89 dia.	105	70	85.0	84.0	59	53	7.5	27
	1/33	R88G-HPG32A33400B□	104.0	133	120	122 dia.	135	70	115.0	114.0	84	98	12.5	35
	1/45	R88G-HPG32A45400B□	104.0	133	120	122 dia.	135	70	115.0	114.0	84	98	12.5	35
750 W	1/5	R88G-HPG20A05750B□	78.0	80	90	80×80	105	90	85.0	84.0	59	53	7.5	27
	1/11	R88G-HPG20A11750B□	78.0	80	90	80×80	105	90	85.0	84.0	59	53	7.5	27
	1/21	R88G-HPG32A21750B□	104.0	133	120	122 dia.	135	90	115.0	114.0	84	98	12.5	35
	1/33	R88G-HPG32A33750B□	104.0	133	120	122 dia.	135	90	115.0	114.0	84	98	12.5	35
	1/45	R88G-HPG32A45750B□	104.0	133	120	122 dia.	135	90	115.0	114.0	84	98	12.5	35

Model			Dimensions (mm)											
			G	S	T	Z1	Z2	AT*1	Key dimensions				Tap dimensions	
									QK	b	h	t1	M	L
400 W	1/5	R88G-HPG14A05400B□	8	16	28	5.5	M4×10	M4	25	5	5	3	M4	8
	1/11	R88G-HPG20A11400B□	10	25	42	9.0	M4×10	M4	36	8	7	4.0	M6	12
	1/21	R88G-HPG20A21400B□	10	25	42	9.0	M4×10	M4	36	8	7	4.0	M6	12
	1/33	R88G-HPG32A33400B□	13	40	82	11.0	M4×10	M4	70	12	8	5.0	M10	20
	1/45	R88G-HPG32A45400B□	13	40	82	11.0	M4×10	M4	70	12	8	5.0	M10	20
750 W	1/5	R88G-HPG20A05750B□	10	25	42	9.0	M5×12	M4	36	8	7	4.0	M6	12
	1/11	R88G-HPG20A11750B□	10	25	42	9.0	M5×12	M4	36	8	7	4.0	M6	12
	1/21	R88G-HPG32A21750B□	13	40	82	11.0	M5×12	M6	70	12	8	5.0	M10	20
	1/33	R88G-HPG32A33750B□	13	40	82	11.0	M5×12	M6	70	12	8	5.0	M10	20
	1/45	R88G-HPG32A45750B□	13	40	82	11.0	M5×12	M6	70	12	8	5.0	M10	20

*1. This is the set bolt.

Outline Drawings

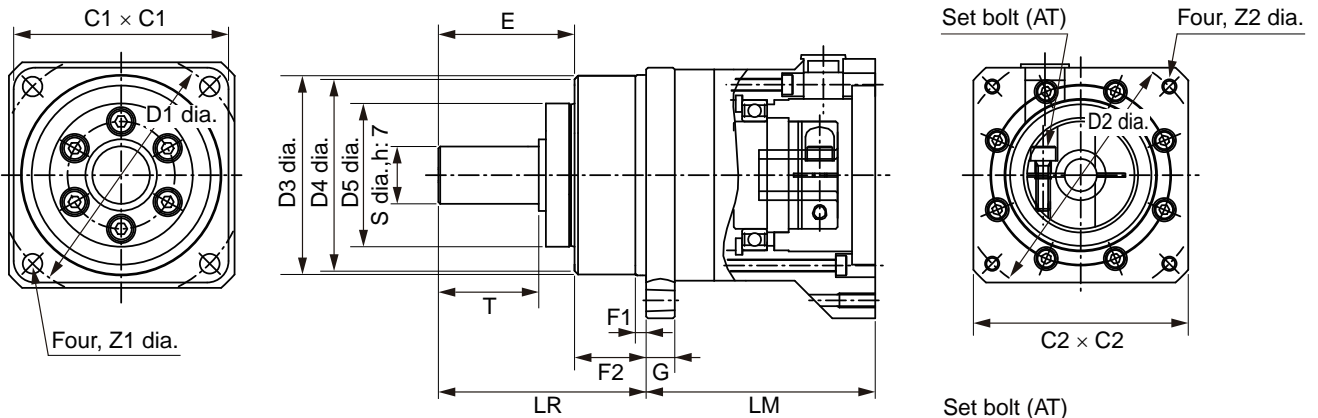

Key and Tap Dimensions

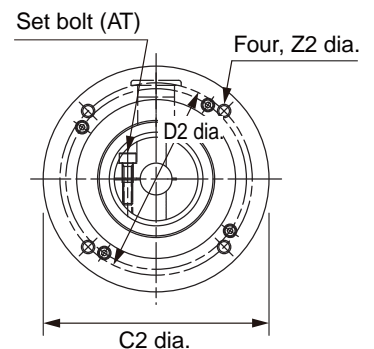
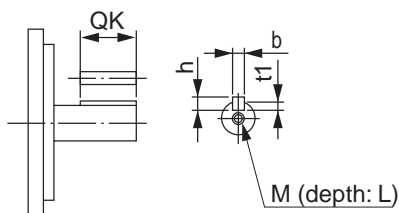

2-2 External and Mounting Hole Dimensions

Model			Dimensions (mm)											
			LM	LR	C1	C2	D1	D2	D3	D4	D5	E	F1	F2
1 kW	1/5	R88G-HPG32A051K0B□	104	133	120	122 dia.	135	100	115	114	84	98	12.5	35
	1/11	R88G-HPG32A111K0B□	104	133	120	122 dia.	135	100	115	114	84	98	12.5	35
	1/21	R88G-HPG32A211K0B□	104	133	120	122 dia.	135	100	115	114	84	98	12.5	35
	1/33	R88G-HPG32A331K0B□	104	133	120	122 dia.	135	100	115	114	84	98	12.5	35
	1/45	R88G-HPG50A451K0B□	123	156	170	170 dia.	190	100	165	163	122	103	12.0	53
1.5 kW	1/5	R88G-HPG32A052K0B□	110	133	120	135 dia.	135	115	115	114	84	98	12.5	35
	1/11	R88G-HPG32A112K0B□	110	133	120	135 dia.	135	115	115	114	84	98	12.5	35
	1/21	R88G-HPG32A211K5B□	110	133	120	135 dia.	135	115	115	114	84	98	12.5	35
	1/33	R88G-HPG50A332K0B□	123	156	170	170 dia.	190	115	165	163	122	103	12.0	53
	1/45	R88G-HPG50A451K5B□	123	156	170	170 dia.	190	115	165	163	122	103	12.0	53
2 kW	1/5	R88G-HPG32A052K0B□	110	133	120	135 dia.	135	115	115	114	84	98	12.5	35
	1/11	R88G-HPG32A112K0B□	110	133	120	135 dia.	135	115	115	114	84	98	12.5	35
	1/21	R88G-HPG50A212K0B□	123	156	170	170 dia.	190	115	165	163	122	103	12.0	53
	1/33	R88G-HPG50A332K0B□	123	156	170	170 dia.	190	115	165	163	122	103	12.0	53
3 kW	1/5	R88G-HPG32A053K0B□	107	133	120	130×130	135	145	115	114	84	98	12.5	35
	1/11	R88G-HPG50A113K0B□	123	156	170	170 dia.	190	145	165	163	122	103	12.0	53
	1/21	R88G-HPG50A213K0B□	123	156	170	170 dia.	190	145	165	163	122	103	12.0	53
4 kW	1/5	R88G-HPG32A054K0B□	129	133	120	130×130	135	145	115	114	84	98	12.5	35
	1/11	R88G-HPG50A115K0B□	149	156	170	130×130	190	145	165	163	122	103	12.0	53
5 kW	1/5	R88G-HPG50A055K0B□	149	156	170	130×130	190	145	165	163	122	103	12.0	53
	1/11	R88G-HPG50A115K0B□	149	156	170	130×130	190	145	165	163	122	103	12.0	53

Note 1. The standard models have a straight shaft.

Note 2. Models with a key and tap are indicated with "J" at the end of the model number (the suffix shown in the box). (Example: R88G-HPG32A051K0BJ)

Model			Dimensions (mm)											
			G	S	T	Z1	Z2	AT*1	Key dimensions				Tap dimensions	
									QK	b	h	t1	M	L
1 kW	1/5	R88G-HPG32A051K0B□	13	40	82	11	M6×12	M6	70	12	8	5.0	M10	20
	1/11	R88G-HPG32A111K0B□	13	40	82	11	M6×12	M6	70	12	8	5.0	M10	20
	1/21	R88G-HPG32A211K0B□	13	40	82	11	M6×12	M6	70	12	8	5.0	M10	20
	1/33	R88G-HPG32A331K0B□	13	40	82	11	M6×12	M6	70	12	8	5.0	M10	20
	1/45	R88G-HPG50A451K0B□	16	50	82	14	M6×10	M6	70	14	9	5.5	M10	20
1.5 kW	1/5	R88G-HPG32A052K0B□	13	40	82	11	M8×10	M6	70	12	8	5.0	M10	20
	1/11	R88G-HPG32A112K0B□	13	40	82	11	M8×10	M6	70	12	8	5.0	M10	20
	1/21	R88G-HPG32A211K5B□	13	40	82	11	M8×10	M6	70	12	8	5.0	M10	20
	1/33	R88G-HPG50A332K0B□	16	50	82	14	M8×10	M6	70	14	9	5.5	M10	20
	1/45	R88G-HPG50A451K5B□	16	50	82	14	M8×10	M6	70	14	9	5.5	M10	20
2 kW	1/5	R88G-HPG32A052K0B□	13	40	82	11	M8×10	M6	70	12	8	5.0	M10	20
	1/11	R88G-HPG32A112K0B□	13	40	82	11	M8×10	M6	70	12	8	5.0	M10	20
	1/21	R88G-HPG50A212K0B□	16	50	82	14	M8×10	M6	70	14	9	5.5	M10	20
	1/33	R88G-HPG50A332K0B□	16	50	82	14	M8×10	M6	70	14	9	5.5	M10	20
3 kW	1/5	R88G-HPG32A053K0B□	13	40	82	11	M8×18	M6	70	12	8	5.0	M10	20
	1/11	R88G-HPG50A113K0B□	16	50	82	14	M8×16	M6	70	14	9	5.5	M10	20
	1/21	R88G-HPG50A213K0B□	16	50	82	14	M8×16	M6	70	14	9	5.5	M10	20
4 kW	1/5	R88G-HPG32A054K0B□	13	40	82	11	M8×25	M6	70	12	8	5.0	M10	20
	1/11	R88G-HPG50A115K0B□	16	50	82	14	M8×25	M6	70	14	9	5.5	M10	20
5 kW	1/5	R88G-HPG50A055K0B□	16	50	82	14	M8×25	M6	70	14	9	5.5	M10	20
	1/11	R88G-HPG50A115K0B□	16	50	82	14	M8×25	M6	70	14	9	5.5	M10	20

*1. This is the set bolt.

Outline Drawings

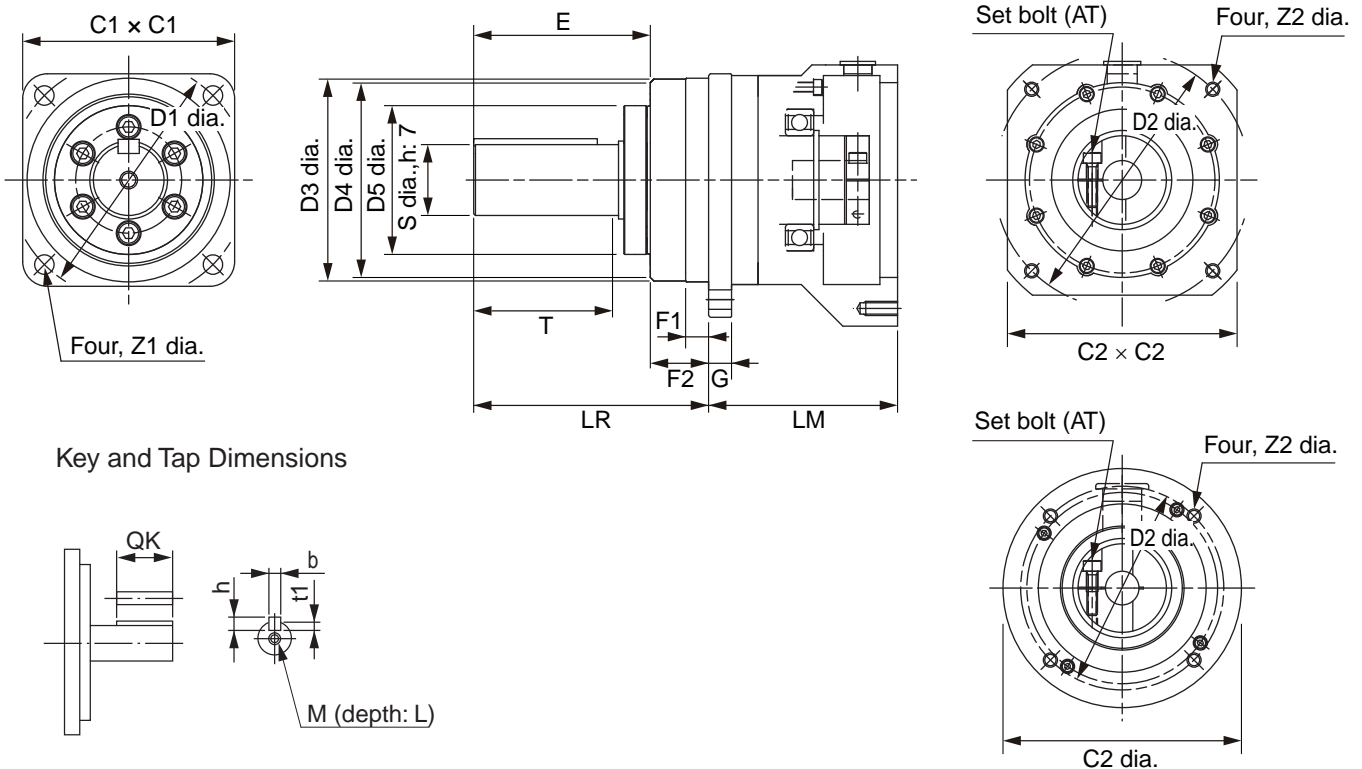

2-2 External and Mounting Hole Dimensions

Decelerators for 2,000-r/min Servomotors

Model			Dimensions (mm)											
			LM	LR	C1	C2	D1	D2	D3	D4	D5	E	F1	F2
1 kW	1/5	R88G-HPG32A053K0B□	107	133	120	130×130	135	145	115	114	84	98	12.5	35
	1/11	R88G-HPG32A112K0SB□	107	133	120	130×130	135	145	115	114	84	98	12.5	35
	1/21	R88G-HPG32A211K0SB□	107	133	120	130×130	135	145	115	114	84	98	12.5	35
	1/33	R88G-HPG50A332K0SB□	123	156	170	170 dia.	190	145	165	163	122	103	12.0	53
	1/45	R88G-HPG50A451K0SB□	123	156	170	170 dia.	190	145	165	163	122	103	12.0	53
1.5 kW	1/5	R88G-HPG32A053K0B□	107	133	120	130×130	135	145	115	114	84	98	12.5	35
	1/11	R88G-HPG32A112K0SB□	107	133	120	130×130	135	145	115	114	84	98	12.5	35
	1/21	R88G-HPG50A213K0B□	123	156	170	170 dia.	190	145	165	163	122	103	12.0	53
	1/33	R88G-HPG50A332K0SB□	123	156	170	170 dia.	190	145	165	163	122	103	12.0	53
2 kW	1/5	R88G-HPG32A053K0B□	107	133	120	130×130	135	145	115	114	84	98	12.5	35
	1/11	R88G-HPG32A112K0SB□	107	133	120	130×130	135	145	115	114	84	98	12.5	35
	1/21	R88G-HPG50A213K0B□	123	156	170	170 dia.	190	145	165	163	122	103	12.0	53
	1/33	R88G-HPG50A332K0SB□	123	156	170	170 dia.	190	145	165	163	122	103	12.0	53
3 kW	1/5	R88G-HPG32A054K0B□	129	133	120	130×130	135	145	115	114	84	98	12.5	35
	1/11	R88G-HPG50A115K0B□	149	156	170	130×130	190	145	165	163	122	103	12.0	53
	1/21	R88G-HPG50A213K0SB□	149	156	170	130×130	190	145	165	163	122	103	12.0	53
	1/25	R88G-HPG65A253K0SB□	231	222	230	130×130	260	145	220	214	168	165	12.0	57

Model			Dimensions (mm)											
			G	S	T	Z1	Z2	AT ¹	Key dimensions				Tap dimensions	
									QK	b	h	t1	M	L
1 kW	1/5	R88G-HPG32A053K0B□	13	40	82	11	M8×18	M6	70	12	8	5.0	M10	20
	1/11	R88G-HPG32A112K0SB□	13	40	82	11	M8×18	M6	70	12	8	5.0	M10	20
	1/21	R88G-HPG32A211K0SB□	13	40	82	11	M8×18	M6	70	12	8	5.0	M10	20
	1/33	R88G-HPG50A332K0SB□	16	50	82	14	M8×16	M6	70	14	9	5.5	M10	20
	1/45	R88G-HPG50A451K0SB□	16	50	82	14	M8×16	M6	70	14	9	5.5	M10	20
1.5 kW	1/5	R88G-HPG32A053K0B□	13	40	82	11	M8×18	M6	70	12	8	5.0	M10	20
	1/11	R88G-HPG32A112K0SB□	13	40	82	11	M8×18	M6	70	12	8	5.0	M10	20
	1/21	R88G-HPG50A213K0B□	16	50	82	14	M8×16	M6	70	14	9	5.5	M10	20
	1/33	R88G-HPG50A332K0SB□	16	50	82	14	M8×16	M6	70	14	9	5.5	M10	20
2 kW	1/5	R88G-HPG32A053K0B□	13	40	82	11	M8×18	M6	70	12	8	5.0	M10	20
	1/11	R88G-HPG32A112K0SB□	13	40	82	11	M8×18	M6	70	12	8	5.0	M10	20
	1/21	R88G-HPG50A213K0B□	16	50	82	14	M8×16	M6	70	14	9	5.5	M10	20
	1/33	R88G-HPG50A332K0SB□	16	50	82	14	M8×16	M6	70	14	9	5.5	M10	20
3 kW	1/5	R88G-HPG32A054K0B□	13	40	82	11	M8×25	M6	70	12	8	5.0	M10	20
	1/11	R88G-HPG50A115K0B□	16	50	82	14	M8×25	M6	70	14	9	5.5	M10	20
	1/21	R88G-HPG50A213K0SB□	16	50	82	14	M8×25	M6	70	14	9	5.5	M10	20
	1/25	R88G-HPG65A253K0SB□	25	80	130	18	M8×25	M8	110	22	14	9.0	M16	35

Note 1. The standard models have a straight shaft.

Note 2. Models with a key and tap are indicated with "J" at the end of the model number (the suffix shown in the box). (Example: R88G-HPG32A053K0BJ)

Model			Dimensions (mm)											
			LM	LR	C1	C2	D1	D2	D3	D4	D5	E	F1	F2
4 kW	1/5	R88G-HPG50A054K0SB□	149	156	170	180×180	190	165	165	163	122	103	12.0	53
	1/11	R88G-HPG50A114K0SB□	149	156	170	180×180	190	165	165	163	122	103	12.0	53
	1/20	R88G-HPG65A204K0SB□	231	222	230	180×180	260	165	220	214	168	165	12.0	57
	1/25	R88G-HPG65A254K0SB□	231	222	230	180×180	260	165	220	214	168	165	12.0	57
5 kW	1/5	R88G-HPG50A055K0SB□	149	156	170	180×180	190	200	165	163	122	103	12.0	53
	1/11	R88G-HPG50A115K0SB□	149	156	170	180×180	190	200	165	163	122	103	12.0	53
	1/20	R88G-HPG65A205K0SB□	231	222	230	180×180	260	200	220	214	168	165	12.0	57
	1/25	R88G-HPG65A255K0SB□	231	222	230	180×180	260	200	220	214	168	165	12.0	57
7.5 kW	1/5	R88G-HPG65A057K5SB□	184.5	222	230	180×180	260	200	220	214	168	165	12.0	57
	1/12	R88G-HPG65A127K5SB□	254.5	222	230	180×180	260	200	220	214	168	165	12.0	57

Model			Dimensions (mm)										Tap dimensions	
			G	S	T	Z1	Z2	AT*1	Key dimensions				M	L
									QK	b	h	t1		
4 kW	1/5	R88G-HPG50A054K0SB□	16	50	82	14	M10×25	M6	70	14	9	5.5	M10	20
	1/11	R88G-HPG50A114K0SB□	16	50	82	14	M10×25	M6	70	14	9	5.5	M10	20
	1/20	R88G-HPG65A204K0SB□	25	80	130	18	M10×25	M8	110	22	14	9.0	M16	35
	1/25	R88G-HPG65A254K0SB□	25	80	130	18	M10×25	M8	110	22	14	9.0	M16	35
5 kW	1/5	R88G-HPG50A055K0SB□	16	50	82	14	M12×25	M6	70	14	9	5.5	M10	20
	1/11	R88G-HPG50A115K0SB□	16	50	82	14	M12×25	M6	70	14	9	5.5	M10	20
	1/20	R88G-HPG65A205K0SB□	25	80	130	18	M12×25	M8	110	22	14	9.0	M16	35
	1/25	R88G-HPG65A255K0SB□	25	80	130	18	M12×25	M8	110	22	14	9.0	M16	35
7.5 kW	1/5	R88G-HPG65A057K5SB□	25	80	130	18	M12×25	M8	110	22	14	9.0	M16	35
	1/12	R88G-HPG65A127K5SB□	25	80	130	18	M12×25	M8	110	22	14	9.0	M16	35

*1. This is the set bolt.

Outline Drawings

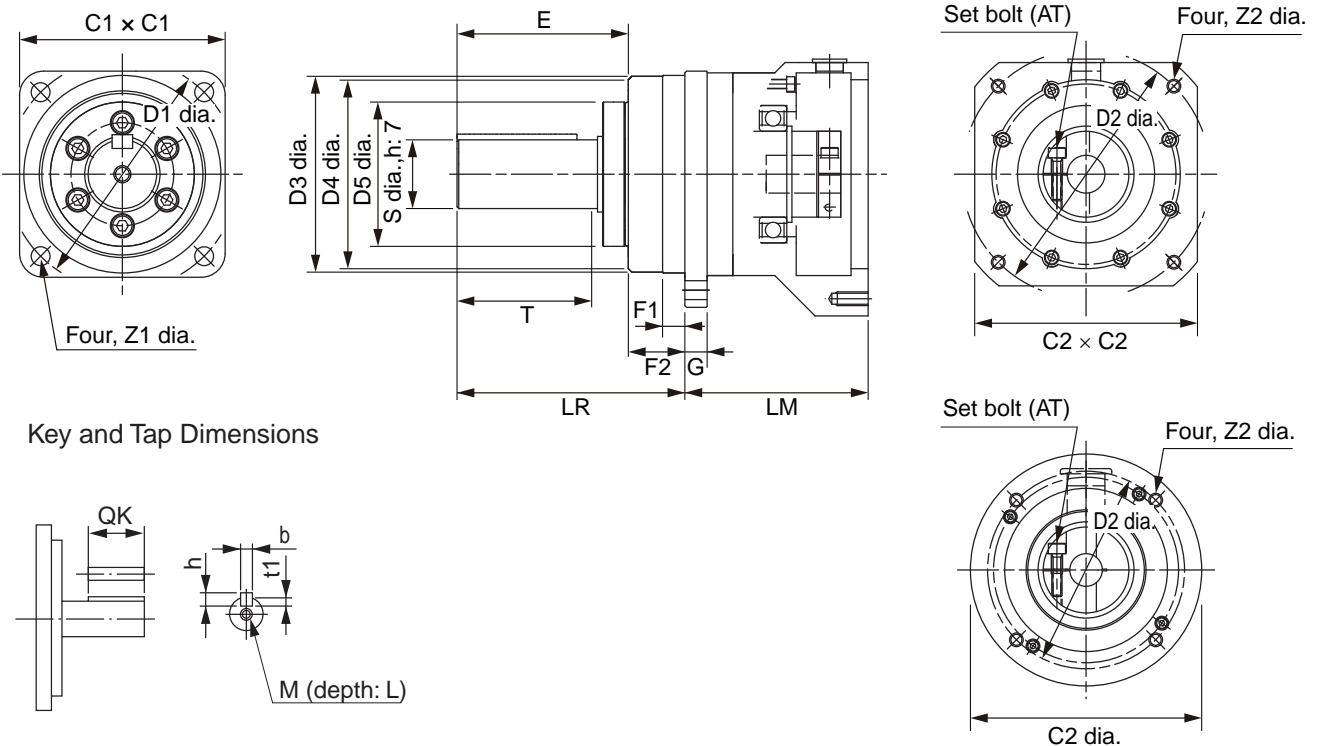

2-2 External and Mounting Hole Dimensions

Decelerators for 1,000-r/min Servomotors

Model		Dimensions (mm)												
		LM	LR	C1	C2	D1	D2	D3	D4	D5	E	F1	F2	
900 W	1/5	R88G-HPG32A05900TB□	129	133	120	130×130	135	145	115	114	84	98	12.5	35
	1/11	R88G-HPG32A11900TB□	129	133	120	130×130	135	145	115	114	84	98	12.5	35
	1/21	R88G-HPG50A21900TB□	149	156	170	130×130	190	145	165	163	122	103	12.0	53
	1/33	R88G-HPG50A33900TB□	149	156	170	130×130	190	145	165	163	122	103	12.0	53
2 kW	1/5	R88G-HPG32A052K0TB□	129	133	120	180×180	135	200	115	114	84	98	12.5	35
	1/11	R88G-HPG50A112K0TB□	149	156	170	180×180	190	200	165	163	122	103	12.0	53
	1/21	R88G-HPG50A212K0TB□	149	156	170	180×180	190	200	165	163	122	103	12.0	53
	1/25	R88G-HPG65A255K0SB□	231	222	230	180×180	260	200	220	214	168	165	12.0	57
3 kW	1/5	R88G-HPG50A055K0SB□	149	156	170	180×180	190	200	165	163	122	103	12.0	53
	1/11	R88G-HPG50A115K0SB□	149	156	170	180×180	190	200	165	163	122	103	12.0	53
	1/20	R88G-HPG65A205K0SB□	231	222	230	180×180	260	200	220	214	168	165	12.0	57
	1/25	R88G-HPG65A255K0SB□	231	222	230	180×180	260	200	220	214	168	165	12.0	57
4.5 kW	1/5	R88G-HPG50A054K5TB□	149	156	170	180×180	190	200	165	163	122	103	12.0	53
	1/12	R88G-HPG65A127K5SB□	254.5	222	230	180×180	260	200	220	214	168	165	12.0	57
	1/20	R88G-HPG65A204K5TB□	254.5	222	230	180×180	260	200	220	214	168	165	12.0	57
6 kW	1/5	R88G-HPG65A057K5SB□	184.5	222	230	180×180	260	200	220	214	168	165	12.0	57
	1/12	R88G-HPG65A127K5SB□	254.5	222	230	180×180	260	200	220	214	168	165	12.0	57

Note 1. The standard models have a straight shaft.

Note 2. Models with a key and tap are indicated with "J" at the end of the model number (the suffix shown in the box). (Example: R88G-HPG32A05900TBJ)

Model			Dimensions (mm)											
			G	S	T	Z1	Z2	AT ^{*1}	Key dimensions				Tap dimensions	
									QK	b	h	t1	M	L
900 W	1/5	R88G-HPG32A05900TB□	13	40	82	11	M8×25	M6	70	12	8	5.0	M10	20
	1/11	R88G-HPG32A11900TB□	13	40	82	11	M8×25	M6	70	12	8	5.0	M10	20
	1/21	R88G-HPG50A21900TB□	16	50	82	14	M8×25	M6	70	14	9	5.5	M10	20
	1/33	R88G-HPG50A33900TB□	16	50	82	14	M8×25	M6	70	14	9	5.5	M10	20
2 kW	1/5	R88G-HPG32A052K0TB□	13	40	82	11	M12×25	M6	70	12	8	5.0	M10	20
	1/11	R88G-HPG50A112K0TB□	16	50	82	14	M12×25	M6	70	14	9	5.5	M10	20
	1/21	R88G-HPG50A212K0TB□	16	50	82	14	M12×25	M6	70	14	9	5.5	M10	20
	1/25	R88G-HPG65A255K0SB□	25	80	130	18	M12×25	M8	110	22	14	9.0	M16	35
3 kW	1/5	R88G-HPG50A055K0SB□	16	50	82	14	M12×25	M6	70	14	9	5.5	M10	20
	1/11	R88G-HPG50A115K0SB□	16	50	82	14	M12×25	M6	70	14	9	5.5	M10	20
	1/20	R88G-HPG65A205K0SB□	25	80	130	18	M12×25	M8	110	22	14	9.0	M16	35
	1/25	R88G-HPG65A255K0SB□	25	80	130	18	M12×25	M8	110	22	14	9.0	M16	35
4.5 kW	1/5	R88G-HPG50A054K5TB□	16	50	82	14	M12×25	M6	70	14	9	5.5	M10	20
	1/12	R88G-HPG65A127K5SB□	25	80	130	18	M12×25	M8	110	22	14	9.0	M16	35
	1/20	R88G-HPG65A204K5TB□	25	80	130	18	M12×25	M8	110	22	14	9.0	M16	35
6 kW	1/5	R88G-HPG65A057K5SB□	25	80	130	18	M12×25	M8	110	22	14	9.0	M16	35
	1/12	R88G-HPG65A127K5SB□	25	80	130	18	M12×25	M8	110	22	14	9.0	M16	35

*1. This is the set bolt.

Outline Drawings

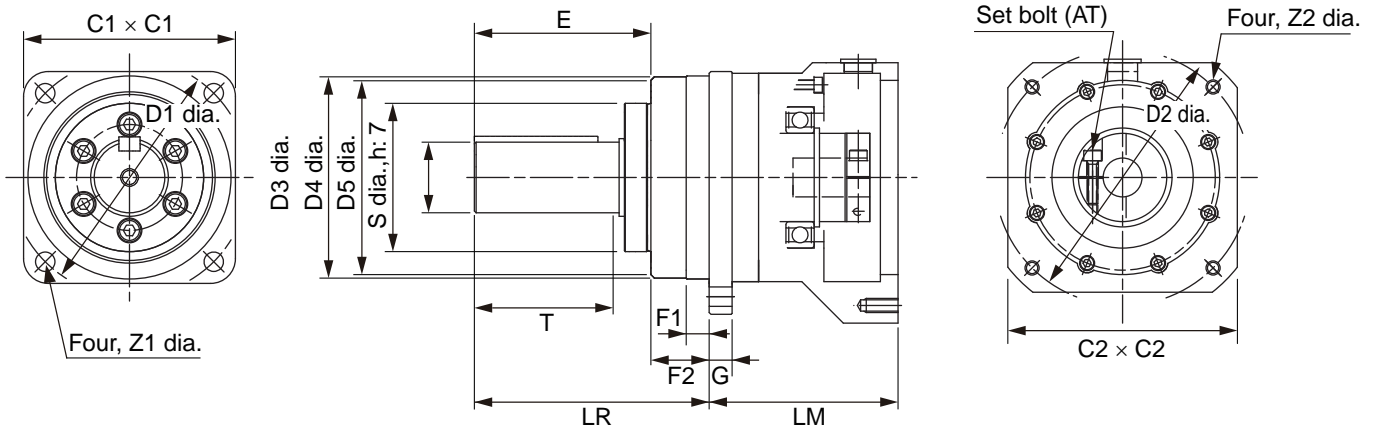

Key and Tap Dimensions

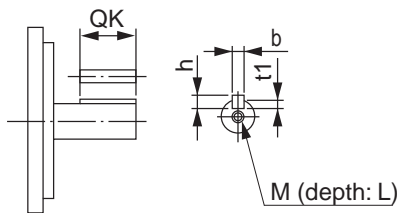

2-2 External and Mounting Hole Dimensions

Decelerators for 3,000-r/min Flat Servomotors

Model			Dimensions (mm)											
			LM	LR	C1	C2	D1	D2	D3	D4	D5	E	F1	F2
100 W	1/5	R88G-HPG11A05100PB□	39.5	42	40	60×60	46	70	40.0	39.5	29	27	2.2	15
	1/11	R88G-HPG14A11100PB□	64.0	58	60	60×60	70	70	56.0	55.5	40	37	2.5	21
	1/21	R88G-HPG14A21100PB□	64.0	58	60	60×60	70	70	56.0	55.5	40	37	2.5	21
	1/33	R88G-HPG20A33100PB□	71.0	80	90	89 dia.	105	70	85.0	84.0	59	53	7.5	27
	1/45	R88G-HPG20A45100PB□	71.0	80	90	89 dia.	105	70	85.0	84.0	59	53	7.5	27

Model			Dimensions (mm)											
			G	S	T	Z1	Z2	AT ^{*1}	Key dimensions				Tap dimensions	
									QK	b	h	t1	M	L
100 W	1/5	R88G-HPG11A05100PB□	5	8	20	3.4	M4×9	M3	15	3	3	1.8	M3	6
	1/11	R88G-HPG14A11100PB□	8	16	28	5.5	M4×10	M3	25	5	5	3.0	M4	8
	1/21	R88G-HPG14A21100PB□	8	16	28	5.5	M4×10	M3	25	5	5	3.0	M4	8
	1/33	R88G-HPG20A33100PB□	10	25	42	9.0	M4×10	M3	36	8	7	4.0	M6	12
	1/45	R88G-HPG20A45100PB□	10	25	42	9.0	M4×10	M3	36	8	7	4.0	M6	12

Model			Dimensions (mm)											
			LM	LR	C1	C2	D1	D2	D3	D4	D5	E	F1	F2
200 W	1/5	R88G-HPG14A05200PB□	65.0	58	60	80×80	70	90	56.0	55.5	40	37	2.5	21
	1/11	R88G-HPG20A11200PB□	78.0	80	90	80×80	105	90	85.0	84.0	59	53	7.5	27
	1/21	R88G-HPG20A21200PB□	78.0	80	90	80×80	105	90	85.0	84.0	59	53	7.5	27
	1/33	R88G-HPG20A33200PB□	78.0	80	90	80×80	105	90	85.0	84.0	59	53	7.5	27
	1/45	R88G-HPG20A45200PB□	78.0	80	90	80×80	105	90	85.0	84.0	59	53	7.5	27

Model			Dimensions (mm)											
			G	S	T	Z1	Z2	AT ^{*1}	Key dimensions				Tap dimensions	
									QK	b	h	t1	M	L
200 W	1/5	R88G-HPG14A05200PB□	8	16	28	5.5	M5×12	M4	25	5	5	3.0	M4	8
	1/11	R88G-HPG20A11200PB□	10	25	42	9.0	M5×12	M4	36	8	7	4.0	M6	12
	1/21	R88G-HPG20A21200PB□	10	25	42	9.0	M5×12	M4	36	8	7	4.0	M6	12
	1/33	R88G-HPG20A33200PB□	10	25	42	9.0	M5×12	M4	36	8	7	4.0	M6	12
	1/45	R88G-HPG20A45200PB□	10	25	42	9.0	M5×12	M4	36	8	7	4.0	M6	12

Note 1. The standard models have a straight shaft.

Note 2. Models with a key and tap are indicated with "J" at the end of the model number (the suffix shown in the box). (Example: R88G-HPG11A05100PB^J)

Model			Dimensions (mm)											
			LM	LR	C1	C2	D1	D2	D3	D4	D5	E	F1	F2
400 W	1/5	R88G-HPG20A05400PB□	78.0	80	90	80×80	105	90	85.0	84.0	59	53	7.5	27
	1/11	R88G-HPG20A11400PB□	78.0	80	90	80×80	105	90	85.0	84.0	59	53	7.5	27
	1/21	R88G-HPG20A21400PB□	78.0	80	90	80×80	105	90	85.0	84.0	59	53	7.5	27
	1/33	R88G-HPG32A33400PB□	104.0	133	120	122 dia.	135	90	115.0	114.0	84	98	12.5	35
	1/45	R88G-HPG32A45400PB□	104.0	133	120	122 dia.	135	90	115.0	114.0	84	98	12.5	35

Model			Dimensions (mm)											
			G	S	T	Z1	Z2	AT ^{*1}	Key dimensions				Tap dimensions	
									QK	b	h	t1	M	L
400 W	1/5	R88G-HPG20A05400PB□	10	25	42	9.0	M5×12	M4	36	8	7	4.0	M6	12
	1/11	R88G-HPG20A11400PB□	10	25	42	9.0	M5×12	M4	36	8	7	4.0	M6	12
	1/21	R88G-HPG20A21400PB□	10	25	42	9.0	M5×12	M4	36	8	7	4.0	M6	12
	1/33	R88G-HPG32A33400PB□	13	40	82	11.0	M5×12	M6	70	12	8	5.0	M10	20
	1/45	R88G-HPG32A45400PB□	13	40	82	11.0	M5×12	M6	70	12	8	5.0	M10	20

*1. This is the set bolt.

Outline Drawings

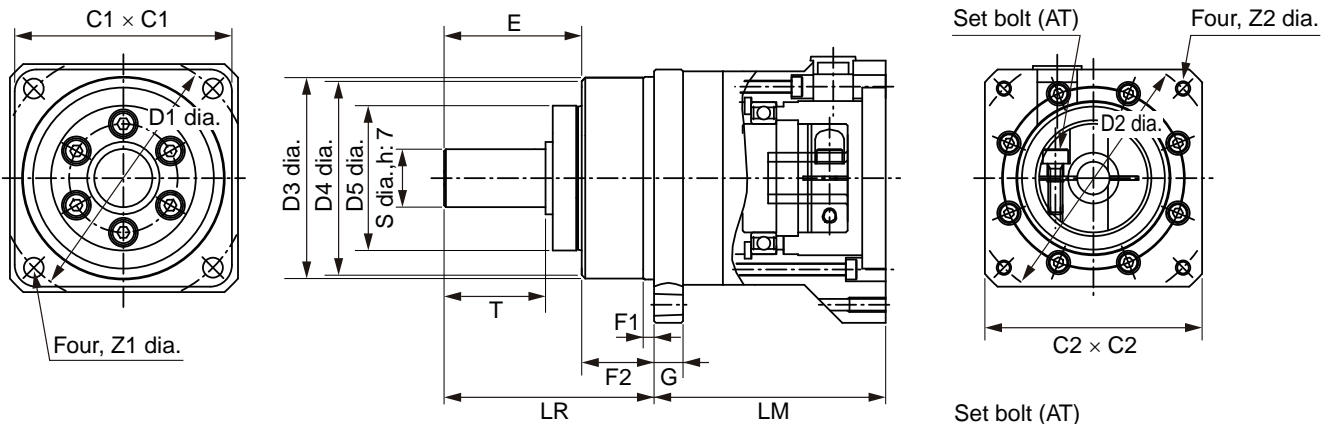

Key and Tap Dimensions

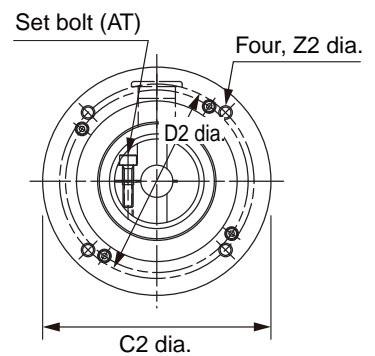
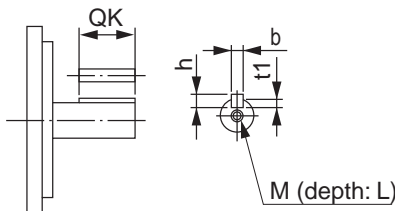

2-2 External and Mounting Hole Dimensions

■ Backlash = 15' Max.

Decelerators for 3,000-r/min Servomotors

Model			Dimensions (mm)										
			LM	LR	C1	C2	D1	D2	D3	D4	E3	F	G
50 W	1/5	R88G-VRSF05B100CJ	67.5	32	40	52	46	60	50	45	10	3	6
	1/9	R88G-VRSF09B100CJ	67.5	32	40	52	46	60	50	45	10	3	6
	1/15	R88G-VRSF15B100CJ	78.0	32	40	52	46	60	50	45	10	3	6
	1/25	R88G-VRSF25B050CJ	78.0	32	40	52	46	60	50	45	10	3	6
100 W	1/5	R88G-VRSF05B100CJ	67.5	32	40	52	46	60	50	45	10	3	6
	1/9	R88G-VRSF09B100CJ	67.5	32	40	52	46	60	50	45	10	3	6
	1/15	R88G-VRSF15B100CJ	78.0	32	40	52	46	60	50	45	10	3	6
	1/25	R88G-VRSF25B100CJ	78.0	32	40	52	46	60	50	45	10	3	6
200 W	1/5	R88G-VRSF05B200CJ	72.5	32	60	52	70	60	50	45	10	3	10
	1/9	R88G-VRSF09C200CJ	89.5	50	60	78	70	90	70	62	17	3	8
	1/15	R88G-VRSF15C200CJ	100.0	50	60	78	70	90	70	62	17	3	8
	1/25	R88G-VRSF25C200CJ	100.0	50	60	78	70	90	70	62	17	3	8
400 W	1/5	R88G-VRSF05C400CJ	89.5	50	60	78	70	90	70	62	17	3	8
	1/9	R88G-VRSF09C400CJ	89.5	50	60	78	70	90	70	62	17	3	8
	1/15	R88G-VRSF15C400CJ	100.0	50	60	78	70	90	70	62	17	3	8
	1/25	R88G-VRSF25C400CJ	100.0	50	60	78	70	90	70	62	17	3	8
750 W	1/5	R88G-VRSF05C750CJ	93.5	50	80	78	90	90	70	62	17	3	10
	1/9	R88G-VRSF09D750CJ	97.5	61	80	98	90	115	90	75	18	5	10
	1/15	R88G-VRSF15D750CJ	110.0	61	80	98	90	115	90	75	18	5	10
	1/25	R88G-VRSF25D750CJ	110.0	61	80	98	90	115	90	75	18	5	10

Note The standard models have a straight shaft with a key.

Outline Drawings

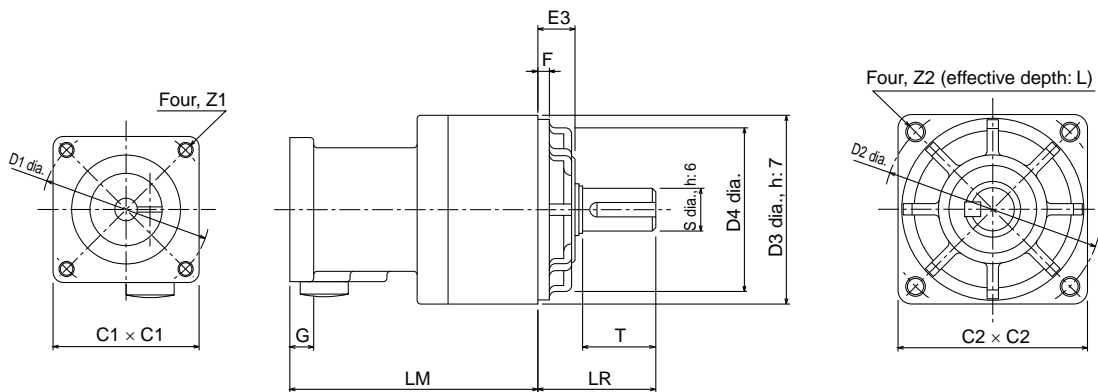

2-2 External and Mounting Hole Dimensions

Model			Dimensions (mm)									
			S	T	Z1	Z2	AT	L	Key dimensions			
									QK	b	h	t1
50 W	1/5	R88G-VRSF05B100CJ	12	20	M4	M5	M3	12	16	4	4	2.5
	1/9	R88G-VRSF09B100CJ	12	20	M4	M5	M3	12	16	4	4	2.5
	1/15	R88G-VRSF15B100CJ	12	20	M4	M5	M3	12	16	4	4	2.5
	1/25	R88G-VRSF25B050CJ	12	20	M4	M5	M3	12	16	4	4	2.5
100 W	1/5	R88G-VRSF05B100CJ	12	20	M4	M5	M3	12	16	4	4	2.5
	1/9	R88G-VRSF09B100CJ	12	20	M4	M5	M3	12	16	4	4	2.5
	1/15	R88G-VRSF15B100CJ	12	20	M4	M5	M3	12	16	4	4	2.5
	1/25	R88G-VRSF25B100CJ	12	20	M4	M5	M3	12	16	4	4	2.5
200 W	1/5	R88G-VRSF05B200CJ	12	20	M4	M5	M4	12	16	4	4	2.5
	1/9	R88G-VRSF09C200CJ	19	30	M4	M6	M4	20	22	6	6	3.5
	1/15	R88G-VRSF15C200CJ	19	30	M4	M6	M4	20	22	6	6	3.5
	1/25	R88G-VRSF25C200CJ	19	30	M4	M6	M4	20	22	6	6	3.5
400 W	1/5	R88G-VRSF05C400CJ	19	30	M4	M6	M4	20	22	6	6	3.5
	1/9	R88G-VRSF09C400CJ	19	30	M4	M6	M4	20	22	6	6	3.5
	1/15	R88G-VRSF15C400CJ	19	30	M4	M6	M4	20	22	6	6	3.5
	1/25	R88G-VRSF25C400CJ	19	30	M4	M6	M4	20	22	6	6	3.5
750 W	1/5	R88G-VRSF05C750CJ	19	30	M5	M6	M4	20	22	6	6	3.5
	1/9	R88G-VRSF09D750CJ	24	40	M5	M8	M4	20	30	8	7	4
	1/15	R88G-VRSF15D750CJ	24	40	M5	M8	M4	20	30	8	7	4
	1/25	R88G-VRSF25D750CJ	24	40	M5	M8	M4	20	30	8	7	4

Outline Drawings

Set bolt (AT)

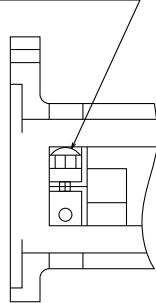

Key Dimensions

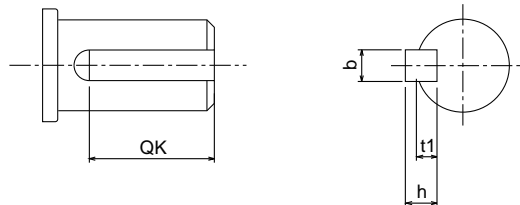

2-2 External and Mounting Hole Dimensions

Decelerators for 3,000-r/min Flat Servomotors

Model			Dimensions (mm)										
			LM	LR	C1	C2	D1	D2	D3	D4	E3	F	G
100 W	1/5	R88G-VRSF05B100PCJ	67.5	32	60	52	70	60	50	45	10	3	8
	1/9	R88G-VRSF09B100PCJ	67.5	32	60	52	70	60	50	45	10	3	8
	1/15	R88G-VRSF15B100PCJ	78.0	32	60	52	70	60	50	45	10	3	8
	1/25	R88G-VRSF25B100PCJ	78.0	32	60	52	70	60	50	45	10	3	8
200 W	1/5	R88G-VRSF05B200PCJ	72.5	32	80	52	90	60	50	45	10	3	12
	1/9	R88G-VRSF09C200PCJ	89.5	50	80	78	90	90	70	62	17	3	12
	1/15	R88G-VRSF15C200PCJ	100.0	50	80	78	90	90	70	62	17	3	12
	1/25	R88G-VRSF25C200PCJ	100.0	50	80	78	90	90	70	62	17	3	12
400 W	1/5	R88G-VRSF05C400PCJ	89.5	50	80	78	90	90	70	62	17	3	12
	1/9	R88G-VRSF09C400PCJ	89.5	50	80	78	90	90	70	62	17	3	12
	1/15	R88G-VRSF15C400PCJ	100.0	50	80	78	90	90	70	62	17	3	12
	1/25	R88G-VRSF25C400PCJ	100.0	50	80	78	90	90	70	62	17	3	12

Note The standard models have a straight shaft with a key.

Outline Drawings

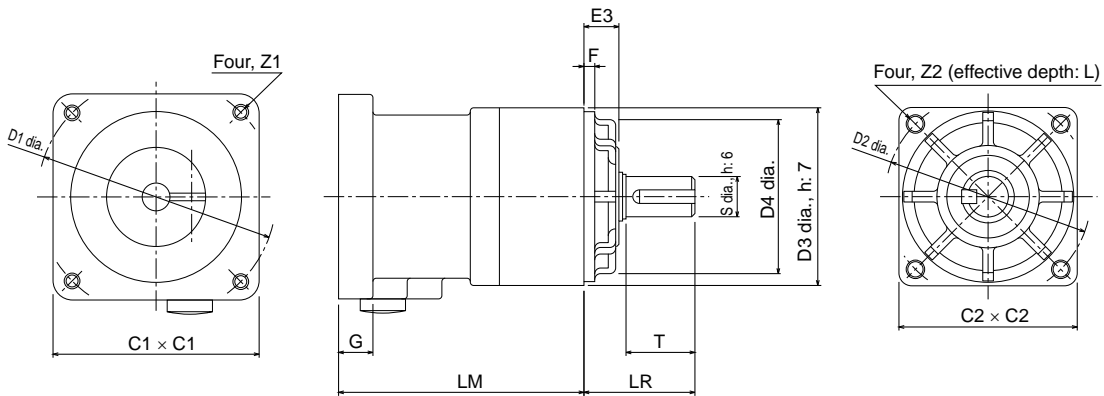

2-2 External and Mounting Hole Dimensions

Model			Dimensions (mm)									
			S	T	Z1	Z2	AT	L	Key dimensions			
									QK	b	h	t1
100 W	1/5	R88G-VRSF05B100PCJ	12	20	M4	M5	M3	12	16	4	4	2.5
	1/9	R88G-VRSF09B100PCJ	12	20	M4	M5	M3	12	16	4	4	2.5
	1/15	R88G-VRSF15B100PCJ	12	20	M4	M5	M3	12	16	4	4	2.5
	1/25	R88G-VRSF25B100PCJ	12	20	M4	M5	M3	12	16	4	4	2.5
200 W	1/5	R88G-VRSF05B200PCJ	12	20	M5	M5	M4	12	16	4	4	2.5
	1/9	R88G-VRSF09C200PCJ	19	30	M5	M6	M4	20	22	6	6	3.5
	1/15	R88G-VRSF15C200PCJ	19	30	M5	M6	M4	20	22	6	6	3.5
400 W	1/25	R88G-VRSF25C200PCJ	19	30	M5	M6	M4	20	22	6	6	3.5
	1/5	R88G-VRSF05C400PCJ	19	30	M5	M6	M4	20	22	6	6	3.5
	1/9	R88G-VRSF09C400PCJ	19	30	M5	M6	M4	20	22	6	6	3.5
	1/15	R88G-VRSF15C400PCJ	19	30	M5	M6	M4	20	22	6	6	3.5
	1/25	R88G-VRSF25C400PCJ	19	30	M5	M6	M4	20	22	6	6	3.5

Outline Drawings

Set bolt (AT)

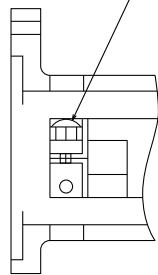

Key Dimensions

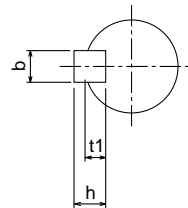
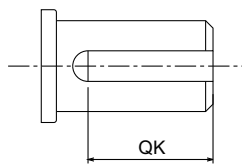

External Regeneration Resistor Dimensions

2

External Regeneration Resistor

R88A-RR08050S/-RR080100S

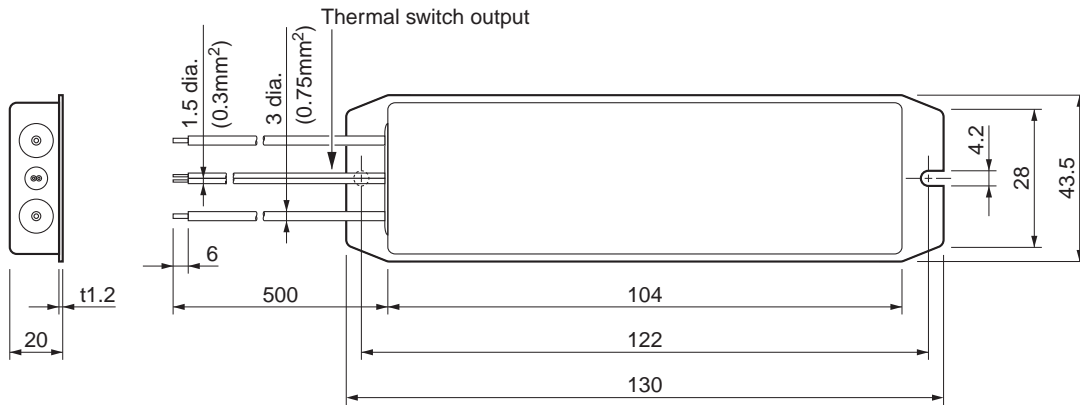

R88A-RR22047S

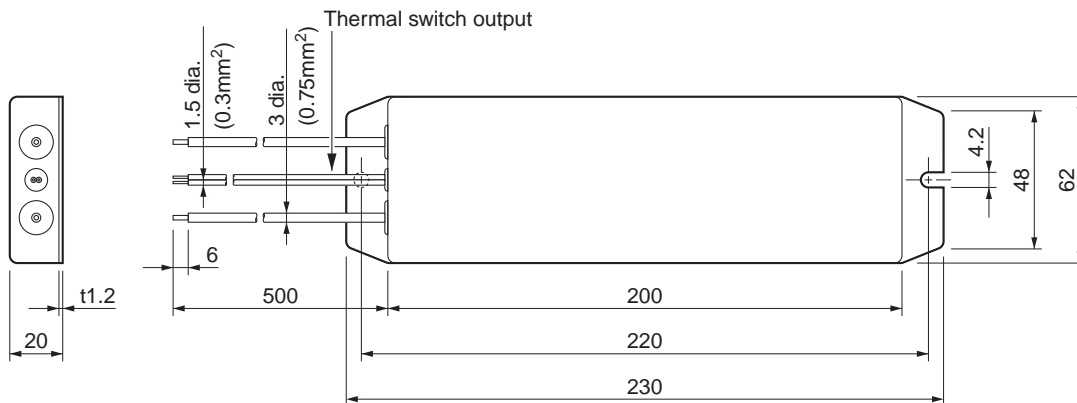

R88A-RR50020S

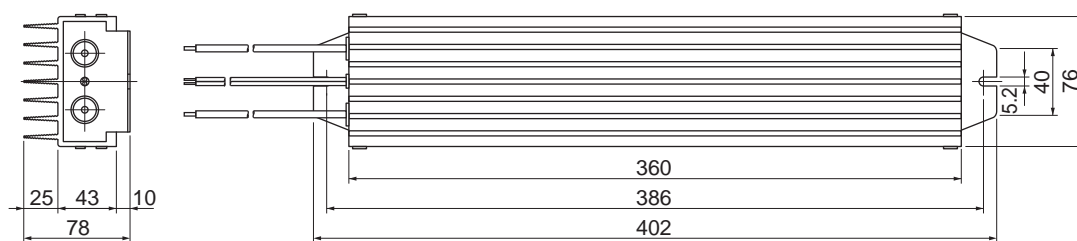

Standard Models and Dimensions

Reactor Dimensions

■ 3G3AX-DL2002

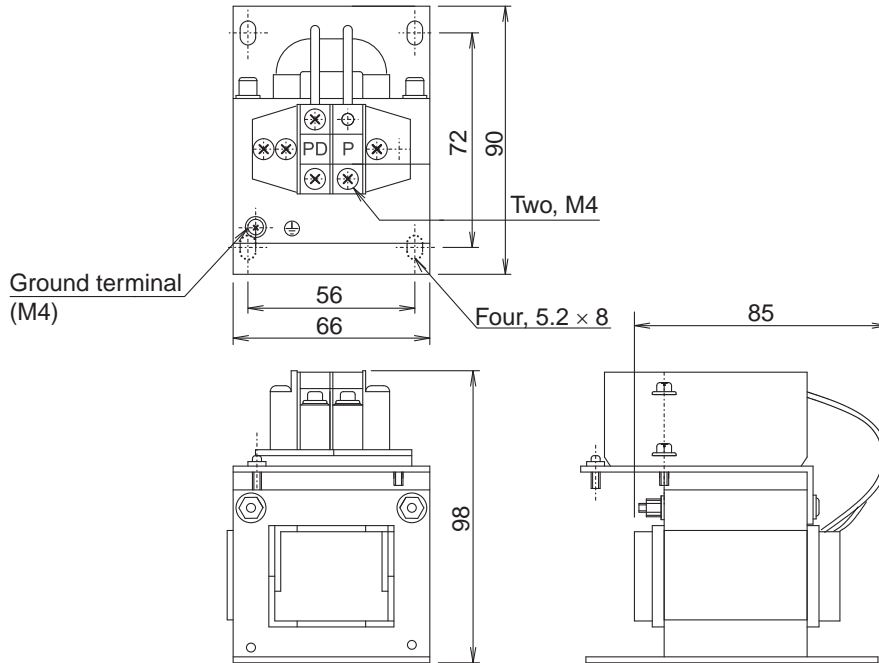

■ 3G3AX-DL2004

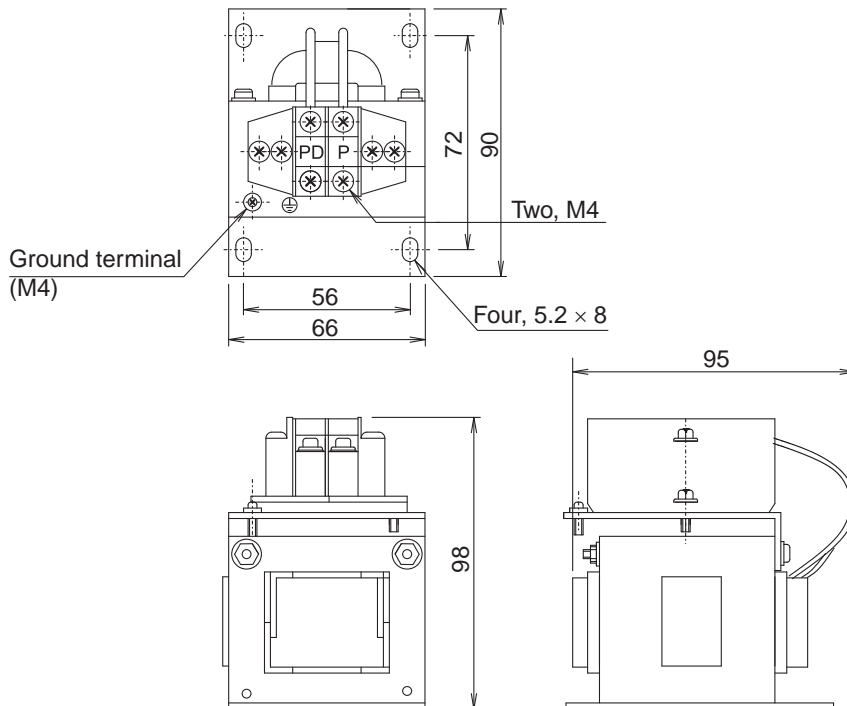

2-2 External and Mounting Hole Dimensions

■ 3G3AX-DL2007

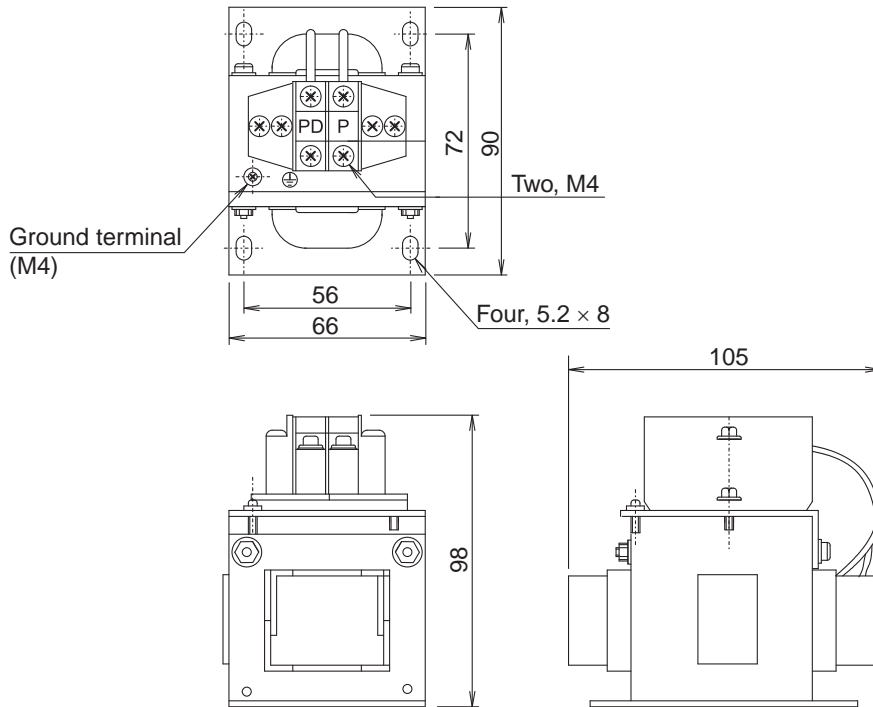

■ 3G3AX-DL2015

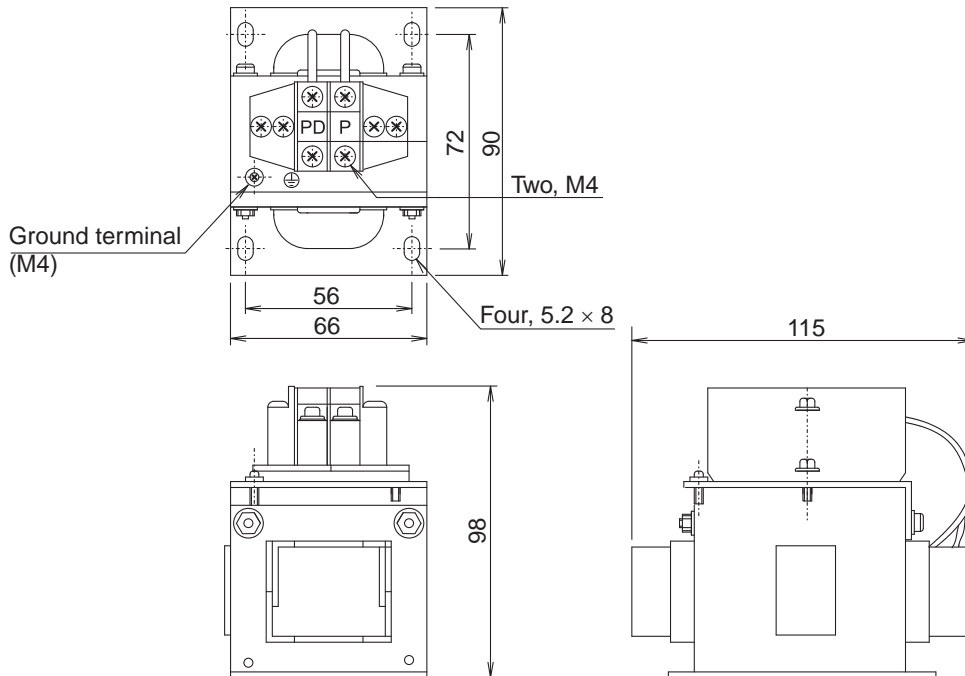

■ 3G3AX-DL2022

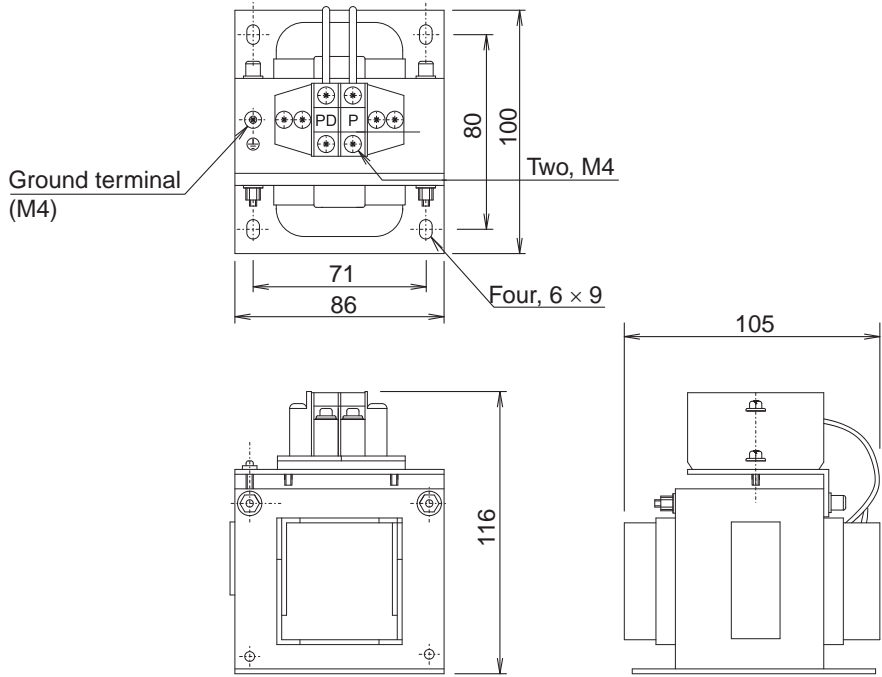

■ 3G3AX-AL2025/-AL2055

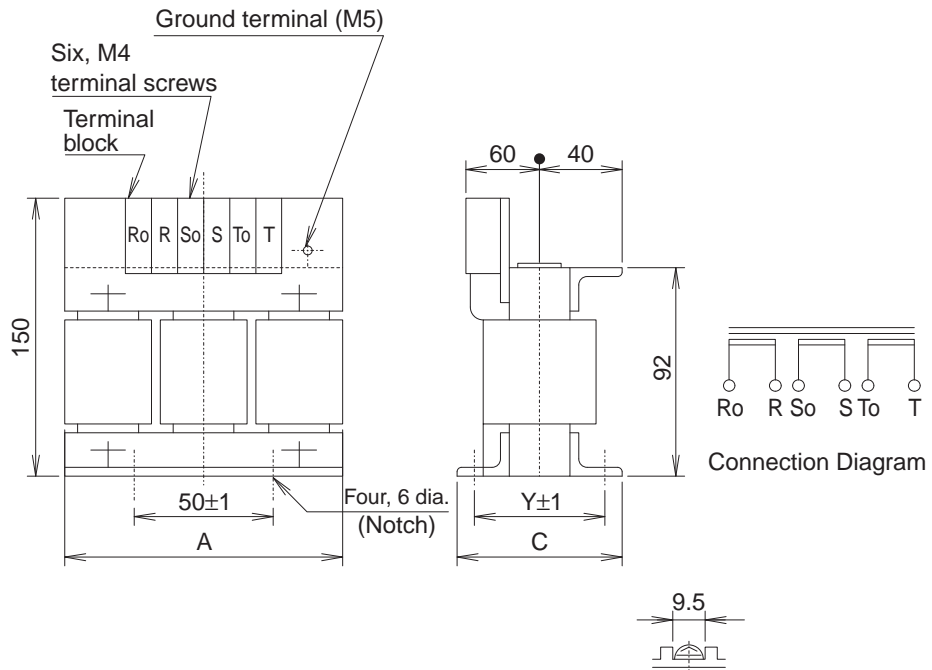

Model	Dimensions (mm)		
	A	C	Y
3G3AX-AL2025	130	82	67
3G3AX-AL2055	140	98	75

2-2 External and Mounting Hole Dimensions

■ 3G3AX-AL2110/-AL2220

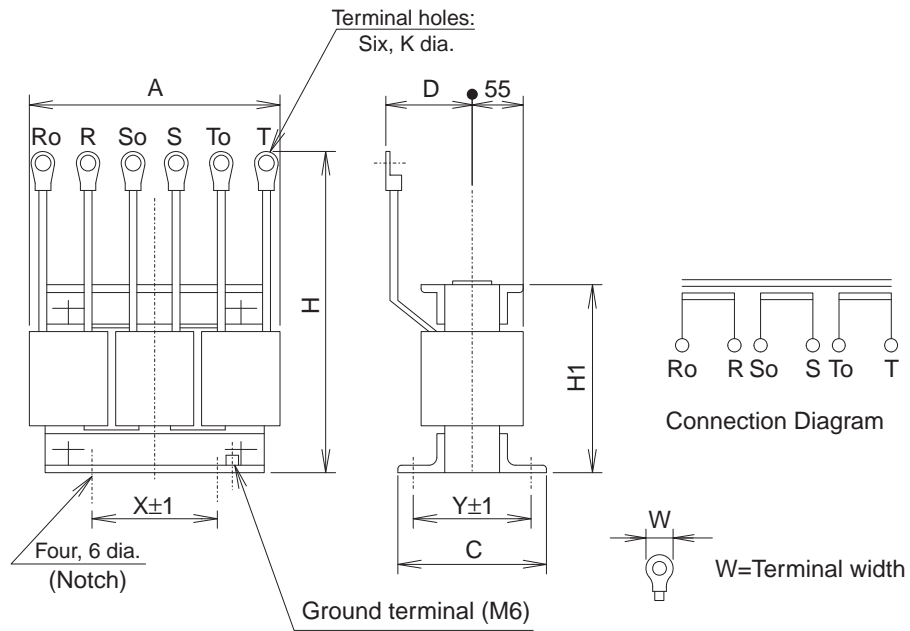

Model	Dimensions (mm)								
	A	C	D	H	H1	X	Y	K	W
3G3AX-AL2110	160	103	70	170	106	60	80	5.3	12
3G3AX-AL2220	180	113	75	190	136	90	90	8.4	16.5

Chapter 3

Specifications

3-1	Servo Drive Specifications	3-1
	General Specifications	3-1
	Characteristics	3-2
	Main Circuit and Servomotor Connector Specifications.....	3-7
	Control I/O Connector Specifications (CN1)	3-10
	Control Input Circuits	3-14
	Control Output Circuits.....	3-14
	Control Sequence Timing	3-15
	Encoder Connector Specifications (CN2)	3-16
	Parameter Unit Connector Specifications (CN3)	3-16
3-2	Servomotor Specifications	3-17
	General Specifications	3-17
	Characteristics	3-18
	Encoder Specifications	3-31
3-3	Decelerator Specifications	3-32
	Standard Models and Specifications.....	3-32
3-4	Cable and Connector Specifications	3-42
	Encoder Cable Specifications	3-42
	Absolute Encoder Battery Cable Specifications.....	3-48
	Servomotor Power Cable Specifications.....	3-49
	Communications Cable Specifications.....	3-67
	Connector Specifications	3-68
	MECHATROLINK-II Communications Cable Specifications.....	3-71
	Control Cable Specifications.....	3-73
3-5	Parameter Unit Specifications	3-78
3-6	External Regeneration Resistor Specifications	3-79
	External Regeneration Resistor Specifications.....	3-79
3-7	Reactor Specifications	3-80

3-1 Servo Drive Specifications

Select the Servo Drive matching the Servomotor to be used. (For details, refer to *Servo Drive-Servomotor Combinations* on page 2-5.)

OMNUC G-series Servo Drives are designed specifically for use with MECHATROLINK-II communication.

General Specifications

Item		Specifications	
Ambient operating temperature and humidity		0 to 55°C, 90% RH max. (with no condensation)	
Ambient storage temperature and humidity		-20 to 65°C, 90% RH max. (with no condensation)	
Operating and storage atmosphere		No corrosive gases	
Vibration resistance		Smaller of either 10 to 60 Hz with double amplitude of 0.1 mm or acceleration of 5.88 m/s ² max. in X, Y, and Z directions.	
Impact resistance		Acceleration of 19.6m/s ² max. 2 times each in X, Y, and Z directions	
Insulation resistance		Between power supply/power line terminals and frame ground: 0.5 MΩ min. (at 500 VDC)	
Dielectric strength		Between power supply/power line terminals and frame ground: 1,500 VAC for 1 min at 50/60 Hz Between each control signal and frame ground: 500 VAC for 1 min	
Protective structure		Built into panel (IP10).	
International standards	EC Directives	EMC Directive	EN 55011 Class A Group 1 EN 61000-6-2, IEC 61000-4-2/-3/-4/-5/-6/-11
		Low Voltage Directive	EN 50178
	UL standards	UL 508C	
	CSA standards	CSA 22.2 No.14	

Note 1. The above items reflect individual evaluation testing. The results may differ under compound conditions.

Note 2. Never perform withstand-voltage or other megameter tests on the Servo Drive. Doing so may damage the internal elements.

Note 3. Depending on the operating conditions, some Servo Drive parts will require maintenance. For details, refer to *Periodic Maintenance* on page 8-21.

Note 4. The service life of the Servo Drive is 28,000 hours at an average ambient temperature of 55°C at 100% of the rated torque.

Characteristics

■ Servo Drives with 100-VAC Input Power

Item			R88D-GNA5L-ML2	R88D-GN01L-ML2	R88D-GN02L-ML2	R88D-GN04L-ML2
Continuous output current (rms)			1.3 A	1.8 A	2.4 A	4.9 A
Momentary maximum output current (rms)			3.9 A	5.4 A	7.2 A	14.7 A
Input power supply	Main circuit	Power supply capacity	0.4 KVA	0.4 KVA	0.5 KVA	0.9 KVA
		Power supply voltage	Single-phase 100 to 115 VAC (85 to 127 V), 50/60 Hz			
		Rated current	1.4 A	2.2 A	3.7 A	6.6 A
	Control circuit	Power supply voltage	Single-phase 100 to 115 VAC (85 to 127 V), 50/60 Hz			
		Rated current	0.09 A	0.09 A	0.09 A	0.09 A
Heat generated	Main circuit		10.1 W	14.4 W	18.4 W	41.4 W
	Control circuit		4.4 W	4.4 W	4.4 W	4.4 W
Control method			All-digital servo			
Inverter method			IGBT-driven PWM method			
PWM frequency			12.0 kHz		6.0 kHz	
Weight			Approx. 0.8 kg	Approx. 0.8 kg	Approx. 1.1 kg	Approx. 1.5 kg
Maximum applicable motor capacity			50 W	100 W	200 W	400 W
Applicable Servomotors	3,000-r/min Servomotors	INC	G05030H	G10030L	G20030L	G40030L
		ABS	G05030T	G10030S	G20030S	G40030S
	3,000-r/min Flat Servomotors	INC	---	GP10030L	GP20030L	GP40030L
		ABS	---	GP10030S	GP20030S	GP40030S
	2,000-r/min Servomotors	ABS	---	---	---	---
	1,000-r/min Servomotors	ABS	---	---	---	---
Performance	Speed control range		1:5000			
	Speed variability: Load characteristic		0.01% or less at 0% to 100% (at rated speed)			
	Speed variability: Voltage characteristic		0% at ±10% of rated voltage (at rated speed)			
	Speed variability: Temperature characteristic		±0.1% or less at 0 to 50°C (at rated speed)			
	Torque control reproducibility		±3% (at 20% to 100% of rated torque)			

3-1 Servo Drive Specifications

■ Servo Drives with Single-phase 200-VAC Input Power

Item			R88D-GN01H-ML2	R88D-GN02H-ML2	R88D-GN04H-ML2	R88D-GN08H-ML2	R88D-GN10H-ML2	R88D-GN15H-ML2	
Continuous output current (rms)			1.16 A	1.6 A	2.7 A	4.0 A	5.9 A	9.8 A	
Momentary maximum output current (rms)			3.5 A	5.3 A	7.1 A	14.1 A	21.2 A	28.3 A	
Input power supply	Main circuit	Power supply capacity	0.5 KVA	0.5 KVA	0.9 KVA	1.3 KVA	1.8 KVA	2.3 KVA	
		Power supply voltage	Single-phase 200 to 240 VAC (170 to 264 V), 50/60 Hz			Single-phase or Three-phase 200 to 240 VAC (170 to 264 V), 50/60 Hz			
		Rated current	1.3 A	2.0 A	3.7 A	5.0/3.3 ^{*1} A	7.5/4.1 ^{*1} A	11/8.0 ^{*1} A	
	Control circuit	Power supply voltage	Single-phase 200 to 240 VAC (170 to 264 V), 50/60 Hz						
		Rated current	0.05 A	0.05 A	0.05 A	0.05 A	0.07 A	0.07 A	
Heat generated	Main circuit		14.3 W	14.8 W	23.6 W	38.7 W	52.9 W	105.9 W	
	Control circuit		4.5 W	4.5 W	4.5 W	4.3 W	6.1 W	6.1 W	
PWM frequency			12.0 kHz			6.0 kHz			
Weight			Approx. 0.8 kg	Approx. 0.8 kg	Approx. 1.1 kg	Approx. 1.5 kg	Approx. 1.7 kg	Approx. 1.7 kg	
Maximum applicable motor capacity			100 W	200 W	400 W	750 W	1 kW	1.5 kW	
Applicable Servomotors	3,000-r/min Servomotors	INC	G05030H G10030H	G20030H	G40030H	G75030H	---	---	
		ABS	G05030T G10030T	G20030T	G40030T	G75030T	---	G1K030T G1K530T	
	3,000-r/min Flat Servomotors	INC	GP10030H	GP20030H	GP40030H	---	---	---	
		ABS	GP10030T	GP20030T	GP40030T	---	---	---	
	2,000-r/min Servomotors	ABS	---	---	---	---	G1K020T	G1K520T	
	1,000-r/min Servomotors	ABS	---	---	---	---	---	G90010T	
	Control method			All-digital servo					
	Inverter method			IGBT-driven PWM method					
Performance	Speed control range		1:5000						
	Speed variability: Load characteristic		0.01% or less at 0% to 100% (at rated speed)						
	Speed variability: Voltage characteristic		0% at ±10% of rated voltage (at rated speed)						
	Speed variability: Temperature characteristic		±0.1% or less at 0 to 50°C (at rated speed)						
	Torque control reproducibility		±3% (at 20% to 100% of rated torque)						

*1. The left value is for single-phase input power and the right value is for three-phase input power.

■ Servo Drives with Three-phase 200-VAC Input Power

Item			R88D-GN20H-ML2	R88D-GN30H-ML2	R88D-GN50H-ML2	R88D-GN75H-ML2	
Continuous output current (rms)			14.3 A	17.4 A	31.0 A	45.4 A	
Momentary maximum output current (rms)			45.3 A	63.6 A	84.8 A	170.0 A	
Input power supply	Main circuit	Power supply capacity	3.3 KVA	4.5 KVA	7.5 KVA	11 KVA	
		Power supply voltage	Three-phase 200 to 230 VAC (170 to 253 V), 50/60 Hz				
		Rated current	10.2 A	15.2 A	23.7 A	35.0 A	
	Control circuit	Power supply voltage	Single-phase 200 to 230 VAC (170 to 253 V), 50/60 Hz				
		Rated current	0.1 A	0.12 A	0.12 A	0.14 A	
Heat generated	Main circuit		112.3 W	219.6 W	391.7 W	376.2 W	
	Control circuit		10.7 W	13.3 W	13.3 W	13.8 W	
PWM frequency			6.0 kHz				
Weight			Approx. 3.2 kg	Approx. 6.0 kg	Approx. 6.0 kg	Approx. 16.4 kg	
Maximum applicable motor capacity			2 kW	3 kW	5 kW	7.5 kW	
Applicable Servomotors	3,000-r/min Servomotors	INC	---	---	---	---	
		ABS	G2K030T	G3K030T	G4K030T G5K030T	---	
	3,000-r/min Flat Servomotors	INC	---	---	---	---	
		ABS	---	---	---	---	
	2,000-r/min Servomotors	ABS	G2K020T	G3K020T	G4K020T G5K020T	G7K515T	
	1,000-r/min Servomotors	ABS	---	G2K010T	G3K010T G4K510T	G6K010T	
	Control method			All-digital servo			
	Inverter method			IGBT-driven PWM method			
Performance	Speed control range		1:5000				
	Speed variability: Load characteristic		0.01% or less at 0% to 100% (at rated speed)				
	Speed variability: Voltage characteristic		0% at ±10% of rated voltage (at rated speed)				
	Speed variability: Temperature characteristic		±0.1% or less at 0 to 50°C (at rated speed)				
	Torque control reproducibility		±3% (at 20% to 100% of rated torque)				

3-1 Servo Drive Specifications

■ Protective Functions

Error detection		Description
Control power supply undervoltage		The voltage between P and N in the control voltage converter has dropped below the specified value.
Overshoot		The voltage between P and N in the converter has exceeded the specified value.
Undervoltage		The main power supply between L1 and L3 was interrupted for longer than the time set in the Momentary Hold Time (Pn06D) when the Undervoltage Alarm Selection (Pn065) was set to 1. Alternatively, the voltage between P and N in the main power supply converter dropped below the specified value while the Servo Drive was ON.
Overcurrent		The current flowing to the converter exceeded the specified value.
Overheating		The temperature of the Servo Drive radiator or power elements exceeded the specified value.
Overload		The torque command value exceeded the level set in the Overload Detection Level Setting (Pn072), resulting in an overload due to the time characteristics.
Regeneration overload		The regenerative energy exceeded the capacity of the regeneration resistor.
Encoder communications error		The disconnection detection function was activated because communications between the encoder and Servo Drive were interrupted for a specified number of times.
Encoder communications data error		There was an error in the communications data from the encoder. (The encoder is connected, but there is an error in the communications data.)
Deviation counter overflow		The number of position deviation pulses exceeded the Deviation Counter Overflow Level (Pn209).
Overspeed		The rotation speed of the Servomotor exceeded the setting of the Overspeed Detection Level Setting (Pn073).
Command error		The operation command ended in an error.
Internal deviation counter overflow		The value of the deviation counter (internal control unit) exceeded 2^{27} (134217728).
Overrun limit error		The allowable range of movement set in the Overrun Limit Setting (Pn026) was exceeded by the Servomotor.
Parameter error		The data in the parameter storage area was corrupted when the data was read from EEPROM at power-ON.
Parameter corruption		The EEPROM write verification data was corrupted when the data was read from EEPROM at power-ON.
Drive prohibit input error		Both the Forward and Reverse Drive Prohibit Inputs were open when the Drive Prohibit Input Selection (Pn004) was set to 0 or either the forward or reverse drive prohibit input was open when the Drive Prohibit Input Selection (Pn004) was set to 2.
Absolute encoder system down error	ABS	The power supply and battery to the absolute encoder went down and the capacitor voltage dropped below the specified value.
Absolute encoder counter overflow error	ABS	The multiturn counter for the absolute encoder has exceeded the specified value.
Absolute encoder overspeed error	ABS	The Servomotor speed exceeded the specified value when the power to the absolute encoder was interrupted and power was supplied only from the battery.
Absolute encoder one-turn counter error	ABS	An error was detected in the one-turn counter for the absolute encoder.
Absolute encoder multi-turn counter error	ABS	An error was detected in the multiturn counter for the absolute encoder.
Absolute encoder status error	ABS	The number of rotations of the encoder exceeded the specified value when the power supply was turned ON.

Error detection	Description
Encoder phase Z error	A phase Z pulse was not detected regularly for the serial encoder.
Encoder PS signal error	A logic error in the PS signal was detected for the serial encoder.
Node address setting error	The rotary switch for setting the node address of the Servo Drive was out of range when the control power was turned ON.
Communications error	The expected data during the MECHATROLINK-II communications cycle was not received continuously, exceeding the number of times set in the Communications Control (Pn005).
Transmission cycle error	While actuating MECHATROLINK-II communications, synchronization frames (SYNC) were not received in accordance with the transmission cycle.
Watchdog data error	The synchronization data exchanged between the master and slave nodes during each MECHATROLINK-II communications cycle resulted in an error.
Emergency stop input error	The emergency stop input circuit opened.
Transmission cycle setting error	The transmission cycle setting is incorrect when receiving the MECHATROLINK-II CONNECT command.
SYNC command error	A SYNC-related command was issued while MECHATROLINK-II was in asynchronous communications mode.
Parameter setting error	The electronic gear ratio is outside the allowable parameter setting range; either it is smaller than 1/100 or larger than 100/1.
Servomotor non-conformity	The Servomotor and Servo Drive do not match.

Main Circuit and Servomotor Connector Specifications

When wiring the main circuit, use proper wire sizes, grounding systems, and anti-noise measures.

- R88D-GNA5L-ML2/-GN01L-ML2/-GN02L-ML2/-GN04L-ML2
R88D-GN01H-ML2/-GN02H-ML2/-GN04H-ML2/-GN08H-ML2/-GN10H-ML2/
-GN15H-ML2

Main Circuit Connector Specifications (CNA)

Symbol	Name	Function
L1	Main circuit power supply input	R88D-GN□L-ML2 (50 to 400 W): Single-phase 100 to 115 VAC (85 to 127 V), 50/60 Hz R88D-GN□H-ML2 (50 W to 1.5 kW): Single-phase 200 to 240 VAC (170 to 264 V), 50/60 Hz (750 W to 1.5 kW): Three-phase 200 to 240 VAC (170 to 264 V), 50/60Hz
L2		
L3		
L1C	Control circuit power supply input	R88D-GN□L-ML2: Single-phase 100 to 115 VAC (85 to 127 V), 50/60 Hz R88D-GN□H-ML2: Single-phase 200 to 240 VAC (170 to 264V), 50/60 Hz
L2C		

Servomotor Connector Specifications (CNB)

Symbol	Name	Function
B1	External Regeneration Resistor connection terminals	50 to 400 W: These terminals normally do not need to be connected. If there is high regenerative energy, connect an External Regeneration Resistor between B1 and B2. 750 W to 1.5 kW: Normally B2 and B3 are connected. If there is high regenerative energy, remove the short-circuit bar between B2 and B3 and connect an External Regeneration Resistor between B1 and B2.
B2		
B3		
U	Servomotor connection terminals	These are the output terminals to the Servomotor. Be sure to wire them correctly.
V		
W		
⊕		
⊕	Frame ground	This is the ground terminal. Ground to 100 Ω or less.

■ R88D-GN20H-ML2/-GN30H-ML2/-GN50H-ML2

Main Circuit Terminal Block Specifications

Symbol	Name	Function	
L1	Main circuit power supply input	R88D-GN□H-ML2 (2 to 5 kW): Three-phase 200 to 230 VAC (170 to 253 V), 50/60Hz	
L2			
L3			
L1C	Control circuit power supply input	R88D-GN□H-ML2: Single-phase 200 to 230 VAC (170 to 253V), 50/60 Hz	
L2C			
B1	External Regeneration Resistor connection terminals	2 to 5 kW: Normally B2 and B3 are connected. If there is high regenerative energy, remove the short-circuit bar between B2 and B3 and connect an External Regeneration Resistor between B1 and B2.	
B2			
B3			
U	Servomotor connection terminals	Red	These are the output terminals to the Servomotor. Be sure to wire them correctly.
V		White	
W		Blue	
⊕		Green/ Yellow	
⊕		Frame ground	



3-1 Servo Drive Specifications

■ R88D-GN75H-ML2

Main Circuit Terminal Block Specifications (TB1)

Symbol	Name	Function	
L1	Main circuit power supply input	R88D-GN75H-ML2 (6 to 7.5 kW): Three-phase 200 to 230 VAC (170 to 253 V), 50/60Hz	
L2			
L3			
B1	External Regeneration Resistor connection terminals	6 to 7.5 kW: A regeneration resistor is not built in. Connect an External Regeneration Resistor between B1 and B2, if necessary.	
B2			
U	Servomotor connection terminals	Red	These are the output terminals to the Servomotor. Be sure to wire them correctly.
V		White	
W		Blue	
⊕		Green/ Yellow	
⊕	Frame ground	This is the ground terminal. Ground to 100 Ω or less.	

Main Circuit Terminal Block Specifications (TB2)

Symbol	Name	Function
NC	---	Do not connect.
L1C	Control circuit power supply input	R88D-GN75H-ML2: Single-phase 200 to 230 VAC (170 to 253 V), 50/60Hz
L2C		
⊕	Frame ground	This is the ground terminal. Ground to 100 Ω or less.
NC	---	Do not connect.
EX1		
EX2		
EX3		
NC		
FN(+)	Fan Stop Output	Outputs a warning signal when the fan inside the Servo Drive stops. (30 VDC, 50 mA max.)
FN(-)		

Control I/O Connector Specifications (CN1)

■ Control I/O Signal Connections and External Signal Processing

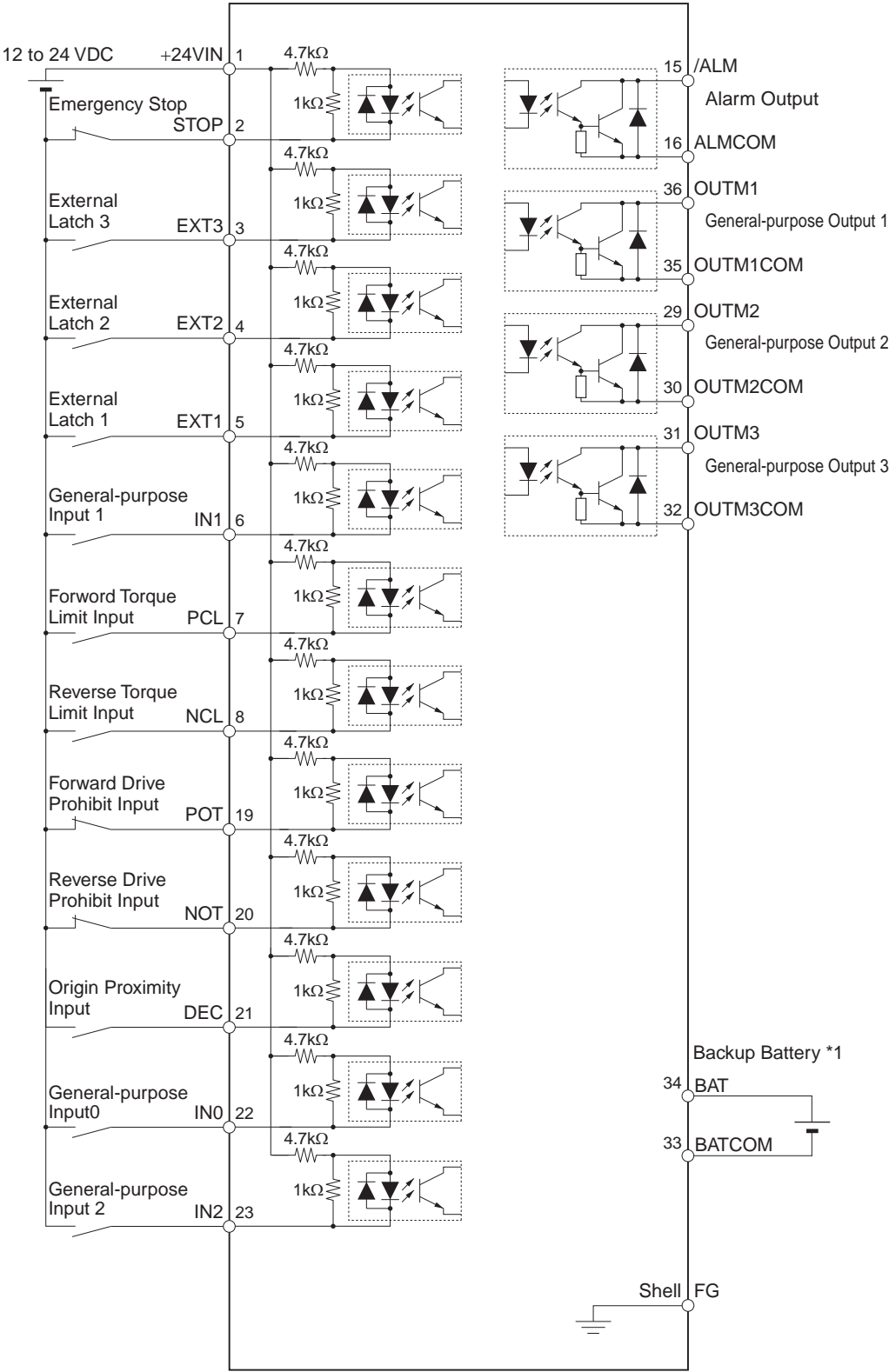

*1. If a backup battery is connected, a cable with a battery is not required.
 *2. Inputs for pins 19 and 20 are determined by parameter settings. The diagram shows the default configuration.

■ Control I/O Signals

CN1 Control Input Signals

Pin No.	Symbol	Name	Function/Interface
1	+24VIN	12 to 24-VDC Power Supply Input	Power supply input terminal (12 to 24 VDC) for sequence inputs.
2	STOP	Emergency Stop Input	Input for emergency stop. When this signal is enabled and pin 1 is not connected to pin 2, an Emergency Stop Input error (alarm code 87) occurs. Set this signal to be enabled or disabled in the Emergency Stop Input Setting (Pn041) (Factory default: Enable).
3	EXT3	External Latch Signal 3	This external signal input latches the current value feedback pulse counter. The position data is obtained the moment the input is turned ON. Minimal signal width must be 1 ms or more.
4	EXT2	External Latch Signal 2	
5	EXT1	External Latch Signal 1	
6	IN1	External general-purpose Input 1	This input is used as external general-purpose input 1.
7	PCL	Forward Torque Limit Input	When the Torque Limit Selection (Pn003) is set to 3 or 5, this signal input selects the torque limit. (For details, refer to the description of the <i>Torque Limit</i> on page 5-16.)
8	NCL	Reverse Torque Limit Input	
19 to 20	POT	Forward Drive Prohibit Input	Forward and reverse rotation overtravel input. Pn004 chooses between enable and disable. Pn044 sets the function assignment for pins 19 and 20. Pn066 selects the operation.
	NOT	Reverse Drive Prohibit Input	
21	DEC	Origin Proximity Input	Connect the origin proximity input signal in the origin search operation. Pn042 changes the logic of the sensor.
22	IN0	External general-purpose Input 0	This input is used as external general-purpose input 0.
23	IN2	External general-purpose Input 2	This input is used as external general-purpose input 2.
11	---	Spare input	Do not connect anything to this input.
12	---	Spare input	Do not connect anything to this input.
13	---	Spare input	Do not connect anything to this input.
14	---	Spare input	Do not connect anything to this input.
9	---	Spare input	Do not connect anything to this input.
10	---	Spare input	Do not connect anything to this input.
27	---	Spare input	Do not connect anything to this input.
28	---	Spare input	Do not connect anything to this input.
34	BAT	Backup Battery Input ABS	Backup battery connection terminals when the absolute encoder's power is interrupted. A cable with a battery is not required if a backup battery is connected to this terminal. (Backup voltage 3.6 V)
33	BATCOM		
17	---	Spare input	Do not connect anything to this input.
24	---	Spare input	Do not connect anything to this input.
25	---	Spare input	Do not connect anything to this input.
26	---	Spare input	Do not connect anything to this input.
18	---	Spare input	Do not connect anything to this input.

CN1 Control Output Signals

Pin No.	Symbol	Name	Function/Interface
15	/ALM	Alarm Output	The output is OFF when an alarm is generated in the Servo Drive.
16	ALMCOM		
29	OUTM2	General-purpose Output 2 (READY)	This is a general-purpose output. The function for this output is selected by changing the parameter. Refer to the <i>Output Signal Assignment Details</i> below.
30	OUTM2COM		
31	OUTM3	General-purpose Output 3 (CLIM)	
32	OUTM3COM		
36	OUTM1	General-purpose Output 1 (BKIR)	
35	OUTM1COM		

Output Signal Assignment Details

Pn112 (General-purpose Output 1 Function Selection) Pn113 (General-purpose Output 2 Function Selection) Pn114 (General-purpose Output 3 Function Selection)	OUTM1 (General-purpose Output 1) OUTM2 (General-purpose Output 2) OUTM3 (General-purpose Output 3)	
0	Not assigned	No output. Always OFF.
1	INP1	Positioning Completed 1 output assignment.
2	VCMP	Speed Conformity Signal output assignment.
3	TGON	Servomotor Rotation Speed Detection output assignment.
4	READY	Servo Ready output assignment.
5	CLIM	Current Limit Detection output assignment.
6	VLIM	Speed Limit Detection output assignment.
7	BKIR	Brake Interlock output assignment.
8	WARN	Warning Signal output assignment.
9	INP2	Positioning Completed 2 output assignment.

3-1 Servo Drive Specifications

■ CN1 Pin Arrangement

2	STOP	Emergency Stop Input	1	+24VIN	12 to 24-VDC Power Supply Input	19	POT	Forward Drive Prohibit Input
4	EXT2	External Latch Signal 2	3	EXT3	External Latch Signal 3	20	NOT	Reverse Drive Prohibit Input
6	IN1	External General-purpose Input 1	5	EXT1	External Latch Signal 1	21	DEC	Origin Proximity Input
8	NCL	Reverse Torque Limit Input	7	PCL	Forward Torque Limit Input	22	IN0	External General-purpose Input 0
10		*	9		*	23	IN2	External General-purpose Input2
12		*	11		*	24		*
14		*	13		*	25		*
16	ALMCOM	Alarm Output	15	/ALM	Alarm Output	26		*
18		*	17		*	27		*
						28		*
						29	OUTM2	General-purpose Output 2
						30	OUTM2COM	General-purpose Output 2
						31	OUTM3	General-purpose Output 3
						32	OUTM3COM	General-purpose Output 3
						33	BATCOM	Backup Battery Input
						34	BAT	Backup Battery Input
						35	OUTM1COM	General-purpose Output1
						36	OUTM1	General-purpose Output 1

Note 1. Do not connect anything to unused pins (*).

Note 2. Inputs for pins 19 and 20 are determined by parameter settings. The diagram shows the default configuration.

■ Connector for CN1 (36 Pins)

Name	Model	Manufacturer
Servo Drive Connector	52986-3679	Molex Japan
Cable Connector	10136-3000PE	Sumitomo 3M
Cable Case (Shell Kit)	10336-52A0-008	

Control Input Circuits

Control Inputs

For the relay contact, use either a switch, or a transistor with an open-collector output.

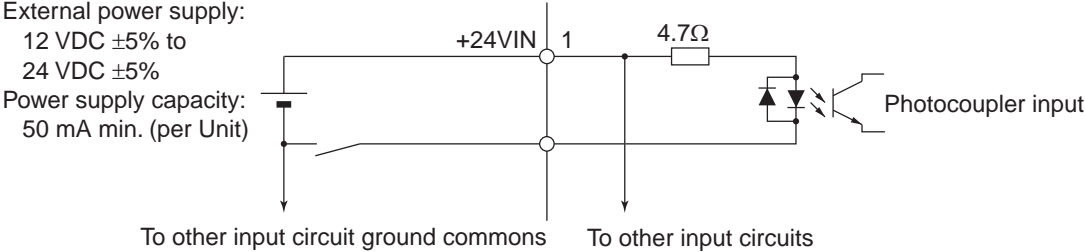

Signal Levels ON level: 10 V min.
 OFF level: 3 V max.

Control Output Circuits

Control Outputs

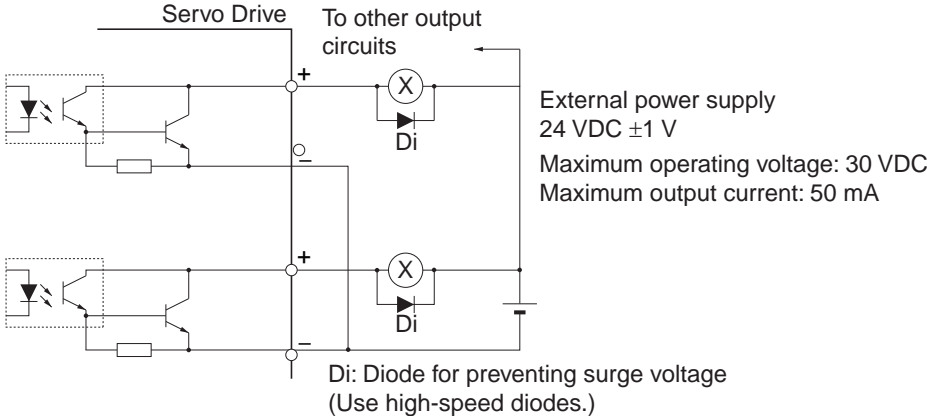

3 Specifications

Control Sequence Timing

■ Power ON operation timing

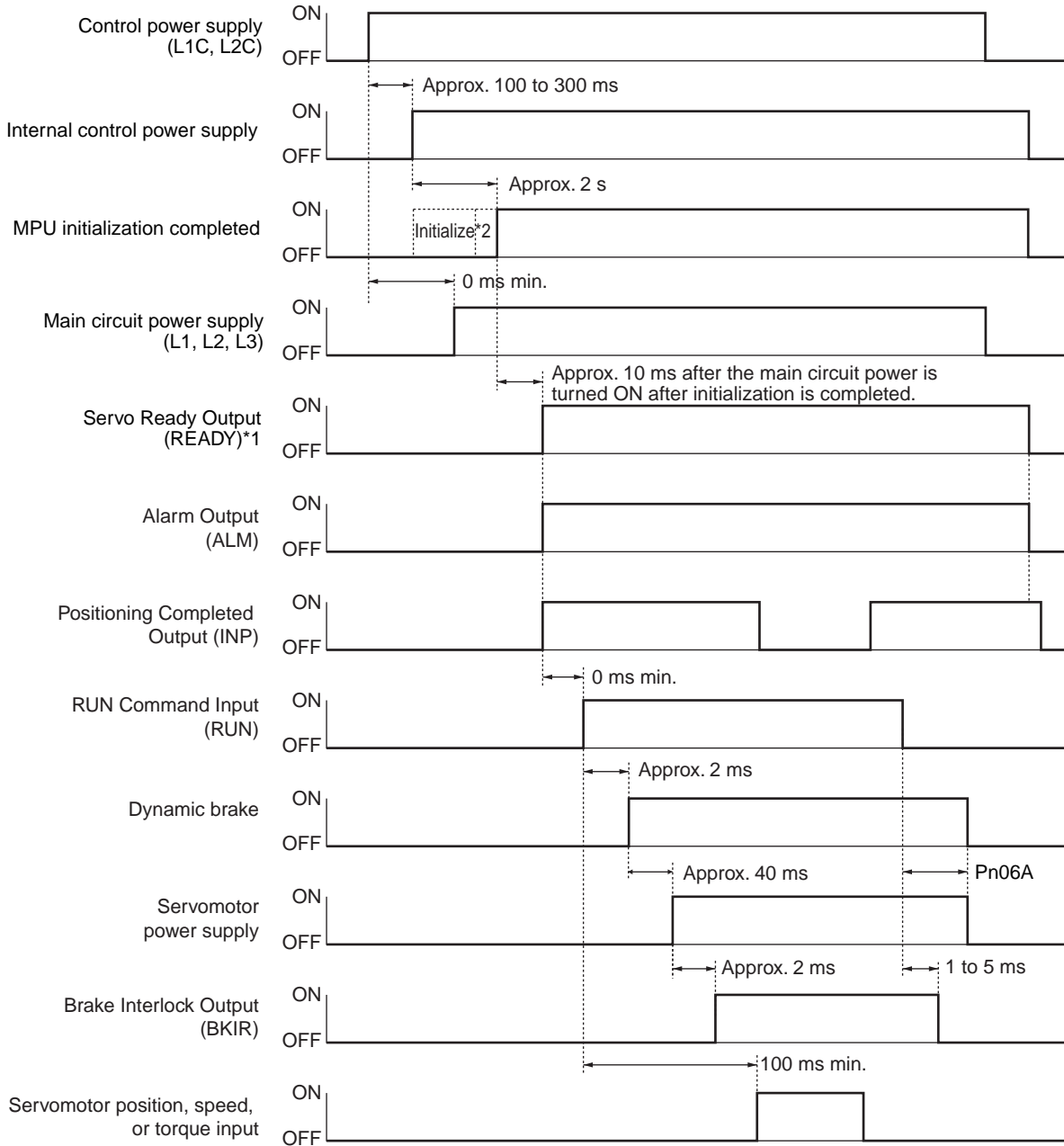

*1. Servo Ready (READY) turns ON and returns a response when these conditions are met: MPU initialization is completed, main power is established, no alarms exist, MECHATROLINK-II communications are established, and the servo is synchronized.

*2. Once the internal control power is established, the protective function starts working about 1.5 s after the CPU starts initializing itself.

Be sure that the input signals, in particular the Emergency Stop (STOP) and Drive Prohibit (POT/NOT) inputs are settled before the protective function starts working.

Encoder Connector Specifications (CN2)

Pin No.	Symbol	Name	Function/Interface
1	E5V	Encoder power supply +5 V	Power supply output for the encoder 5.2 V, 180 mA
2	E0V	Encoder power supply GND	
3	BAT+	Battery +	Backup power supply output for the absolute encoder. 3.6 V, 100 μ A for operation during power interruption, 265 μ A for power interruption timer, and 3.6 μ A when power is supplied to Servo Drive
4	BAT-	Battery -	
5	PS+	Encoder +phase S input	Line-driver input (corresponding with the EIA RS-485 communications method)
6	PS-	Encoder -phase S input	
Shell	FG	Shield ground	Cable shield ground

Connectors for CN2 (6 Pins)

Name	Model	Manufacturer
Servo Drive Connector	53460-0629	Molex Japan
Cable Connector	55100-0670	

Parameter Unit Connector Specifications (CN3)

Pin No.	Symbol	Name	Function/Interface
3	TXD	RS-232 send data	Send data output to the Parameter Unit or personal computer
4	GND	Ground	---
5	RXD	RS-232 receive data	Receive data input from the Parameter Unit or personal computer

Connector for CN3 (8 Pins)

Name	Model	Manufacturer
Connector	MD-S8000-10	J.S.T. Mfg. Co.

3-2 Servomotor Specifications

The following OMNUC G-Series AC Servomotors are available.

- ♦3,000-r/min Servomotors
- ♦3,000-r/min Flat Servomotors
- ♦2,000-r/min Servomotors
- ♦1,000-r/min Servomotors

There are various options available on the Servomotors, such as models with brakes, decelerators, or different shaft types.

Select a Servomotor based on the mechanical system's load conditions and the installation environment.

General Specifications

Item	3,000-r/min Servomotors		3,000-r/min Flat Servomotors	1,000-r/min Servomotors 2,000-r/min Servomotors	
	50 to 750 W	1 to 5 kW	100 to 400 W	900 W to 5 kW	6 to 7.5 kW
Ambient operating temperature and humidity	0 to 40°C, 85% RH max. (with no condensation)				
Ambient storage temperature and humidity	-20 to 65°C, 85% RH max. (with no condensation)	-20 to 80°C, 85% max. (with no condensation)			
Operating and storage atmosphere	No corrosive gases				
Vibration resistance *1	10 to 2,500 Hz Acceleration of 49 m/s ² max. in the X, Y, and Z directions	10 to 2,500 Hz Acceleration of 24.5 m/s ² max. in the X, Y, and Z directions	10 to 2,500 Hz Acceleration of 49 m/s ² max. in the X, Y, and Z directions	10 to 2,500 Hz Acceleration of 24.5 m/s ² max. in the X, Y, and Z directions	
Impact resistance	Acceleration of 98 m/s ² max. 3 times each in the X, Y, and Z directions	Acceleration of 98 m/s ² max. 3 times each in the X, Y, and Z directions	Acceleration of 98 m/s ² max. 3 times each in the X, Y, and Z directions	Acceleration of 98 m/s ² max. 2 times vertically	
Insulation resistance	20 MΩ min. at 500 VDC between the power terminals and FG terminal				
Dielectric strength	1,500 VAC (50 or 60 Hz) for 1 minute between the power terminals and FG terminal				
Operating position	All directions				
Insulation grade	Type B	Type F	Type B	Type F	
Structure	Totally enclosed, self-cooling				
Protective structure	IP65 (excluding the output shaft rotating section and lead wire ends)				
Vibration grade	V-15				
Mounting method	Flange-mounting				
International standards	EC Directives	EMC Directive	EN 55011 Class A Group 1		
		EMC Directive	EN 61000-6-2, IEC 61000-4-2/-3/-4/-5/-6/-11		
	Low-voltage Directive	IEC 60034-1/-5			
	UL standards	UL 1004			UL: pending *2
CSA standards	CSA 22.2 No.100				

*1. The amplitude may be amplified by mechanical resonance. Do not exceed 80% of the specified value for extended periods of time.

*2. UL application pending for motor sizes from 6 to 7.5 kW.

Note 1. Do not use the cable when it is laid in oil or water.

Note 2. Do not expose the cable outlet or connections to stress due to bending or the weight of the cable itself.

Characteristics

■ 3,000-r/min Servomotors

Item		Unit	100 VAC					
			Model (R88M-)		G05030H	G10030L	G20030L	G40030L
			G05030T	G10030S	G20030S	G40030S		
Rated output ^{*1}		W	50	100	200	400		
Rated torque ^{*1}		N·m	0.16	0.32	0.64	1.3		
Rated rotation speed		r/min	3000					
Max. momentary rotation speed		r/min	5000					
Max. momentary torque ^{*1}		N·m	0.45	0.93	1.78	3.6		
Rated current ^{*1}		A (rms)	1.1	1.7	2.5	4.6		
Max. momentary current ^{*1}		A (rms)	3.4	5.1	7.6	13.9		
Rotor inertia		kg·m ² (GD ² /4)	2.5 × 10 ⁻⁶	5.1 × 10 ⁻⁶	1.4 × 10 ⁻⁵	2.6 × 10 ⁻⁵		
Applicable load inertia		---	30 times the rotor inertia max. ^{*2}					
Torque constant ^{*1}		N·m/A	0.14	0.19	0.26	0.28		
Power rate ^{*1}		kW/s	10.4	20.1	30.3	62.5		
Mechanical time constant		ms	1.56	1.11	0.72	0.55		
Electrical time constant		ms	0.7	0.8	2.5	2.9		
Allowable radial load ^{*3}		N	68	68	245	245		
Allowable thrust load ^{*3}		N	58	58	98	98		
Weight	Without brake	kg	Approx. 0.3	Approx. 0.5	Approx. 0.8	Approx. 1.2		
	With brake	kg	Approx. 0.5	Approx. 0.7	Approx. 1.3	Approx. 1.7		
Radiation shield dimensions (material)			100 × 80 × t10 (Al)		130 × 120 × t12 (Al)			
Applicable Servo Drives (R88D-)			GNA5L-ML2	GN01L-ML2	GN02L-ML2	GN04L-ML2		
Brake specifications	Brake inertia	kg·m ² (GD ² /4)	2 × 10 ⁻⁷	2 × 10 ⁻⁷	1.8 × 10 ⁻⁶	1.8 × 10 ⁻⁶		
	Excitation voltage ^{*4}	V	24 VDC ±5%					
	Power consumption (at 20°C)	W	7	7	9	9		
	Current consumption (at 20°C)	A	0.3	0.3	0.36	0.36		
	Static friction torque	N·m	0.29 min.	0.29 min.	1.27 min.	1.27 min.		
	Attraction time ^{*5}	ms	35 max.	35 max.	50 max.	50 max.		
	Release time ^{*5}	ms	20 max.	20 max.	15 max.	15 max.		
	Backlash		1° (reference value)					
	Allowable work per braking	J	39.2	39.2	137	137		
	Allowable total work	J	4.9 × 10 ³	4.9 × 10 ³	44.1 × 10 ³	44.1 × 10 ³		
	Allowable angular acceleration	rad/s ²	30,000 max. (Speed of 2,800 r/min or more must not be changed in less than 10 ms)					
	Brake life	---	10,000,000 operations					
	Rating	---	Continuous					
Insulation grade	---	Type B						

3-2 Servomotor Specifications

Model (R88M-)		200 VAC					
		G05030H	G10030H	G20030H	G40030H	G75030H	
Item	Unit	G05030T	G10030T	G20030T	G40030T	G75030T	
Rated output ^{*1}	W	50	100	200	400	750	
Rated torque ^{*1}	N·m	0.16	0.32	0.64	1.3	2.4	
Rated rotation speed	r/min	3000					
Max. momentary rotation speed	r/min	5000					
Max. momentary torque ^{*1}	N·m	0.45	0.90	1.78	3.67	7.05	
Rated current ^{*1}	A (rms)	1.1	1.1	1.6	2.6	4	
Max. momentary current ^{*1}	A (rms)	3.4	3.4	4.9	7.9	12.1	
Rotor inertia	kg·m ² (GD ² /4)	2.5 × 10 ⁻⁶	5.1 × 10 ⁻⁶	1.4 × 10 ⁻⁵	2.6 × 10 ⁻⁵	8.7 × 10 ⁻⁵	
Applicable load inertia	---	30 times the rotor inertia max. ^{*2}				20 times the rotor inertia max. ^{*2}	
Torque constant ^{*1}	N·m/A	0.14	0.19	0.41	0.51	0.64	
Power rate ^{*1}	kW/s	10.4	20.1	30.3	62.5	66	
Mechanical time constant	ms	1.56	1.1	0.71	0.52	0.45	
Electrical time constant	ms	0.7	0.79	2.6	3	4.6	
Allowable radial load ^{*3}	N	68	68	245	245	392	
Allowable thrust load ^{*3}	N	58	58	98	98	147	
Weight	Without brake	kg	Approx. 0.3	Approx. 0.5	Approx. 0.8	Approx. 1.2	Approx. 2.3
	With brake	kg	Approx. 0.5	Approx. 0.7	Approx. 1.3	Approx. 1.7	Approx. 3.1
Radiation shield dimensions (material)		100 × 80 × t10 (Al)		130 × 120 × t12 (Al)		170 × 160 × t12 (Al)	
Applicable Servo Drives (R88D-)		GN01H-ML2	GN01H-ML2	GN02H-ML2	GN04H-ML2	GN08H-ML2	
Brake specifications	Brake inertia	kg·m ² (GD ² /4)	2 × 10 ⁻⁷	2 × 10 ⁻⁷	1.8 × 10 ⁻⁶	1.8 × 10 ⁻⁶	7.5 × 10 ⁻⁶
	Excitation voltage ^{*4}	V	24 VDC ±5%				
	Power consumption (at 20°C)	W	7	7	9	9	10
	Current consumption (at 20°C)	A	0.3	0.3	0.36	0.36	0.42
	Static friction torque	N·m	0.29 min.	0.29 min.	1.27 min.	1.27 min.	2.45 min.
	Attraction time ^{*5}	ms	35 max.	35 max.	50 max.	50 max.	70 max.
	Release time ^{*5}	ms	20 max.	20 max.	15 max.	15 max.	20 max.
	Backlash		1° (reference value)				
	Allowable work per braking	J	39.2	39.2	137	137	196
	Allowable total work	J	4.9 × 10 ³	4.9 × 10 ³	44.1 × 10 ³	44.1 × 10 ³	147 × 10 ³
	Allowable angular acceleration	rad/s ²	30,000 max. (Speed of 2,800 r/min or more must not be changed in less than 10 ms)				
	Brake life	---	10,000,000 operations				
	Rating	---	Continuous				
	Insulation grade	---	Type B				

Model (R88M-)		200 VAC						
		G1K030T	G1K530T	G2K030T	G3K030T	G4K030T	G5K030T	
Item	Unit							
Rated output ^{*1}	W	1000	1500	2000	3000	4000	5000	
Rated torque ^{*1}	N·m	3.18	4.77	6.36	9.54	12.6	15.8	
Rated rotation speed	r/min	3000						
Max. momentary rotation speed	r/min	5000			4500			
Max. momentary torque ^{*1}	N·m	9.1	12.8	18.4	27.0	36.3	45.1	
Rated current ^{*1}	A (rms)	7.2	9.4	13	18.6	24.7	28.5	
Max. momentary current ^{*1}	A (rms)	21.4	28.5	40	57.1	75	85.7	
Rotor inertia	kg·m ² (GD ² /4)	1.69 × 10 ⁻⁴	2.59 × 10 ⁻⁴	3.46 × 10 ⁻⁴	6.77 × 10 ⁻⁴	1.27 × 10 ⁻³	1.78 × 10 ⁻³	
Applicable load inertia	---	15 times the rotor inertia max. ^{*2}						
Torque constant ^{*1}	N·m/A	0.44	0.51	0.48	0.51	0.51	0.57	
Power rate ^{*1}	kW/s	60	88	117	134	125	140	
Mechanical time constant	ms	0.78	0.54	0.53	0.46	0.51	0.46	
Electrical time constant	ms	6.7	10	10.8	20	20	20	
Allowable radial load ^{*3}	N	392	490	490	490	784	784	
Allowable thrust load ^{*3}	N	147	196	196	196	343	343	
Weight	Without brake	kg	Approx. 4.5	Approx. 5.1	Approx. 6.5	Approx. 9.3	Approx. 12.9	Approx. 17.3
	With brake	kg	Approx. 5.1	Approx. 6.5	Approx. 7.9	Approx. 11	Approx. 14.8	Approx. 19.2
Radiation shield dimensions (material)		170 × 160 × t12 (Al)	320 × 300 × t30 (Al)	320 × 300 × t20 (Al)	380 × 350 × t30 (Al)			
Applicable Servo Drives (R88D-)		GN15H-ML2	GN15H-ML2	GN20H-ML2	GN30H-ML2	GN50H-ML2	GN50H-ML2	
Brake specifications	Brake inertia	kg·m ² (GD ² /4)	2.5 × 10 ⁻⁵	3.3 × 10 ⁻⁵	3.3 × 10 ⁻⁵	3.3 × 10 ⁻⁵	1.35 × 10 ⁻⁴	1.35 × 10 ⁻⁴
	Excitation voltage ^{*4}	V	24 VDC ±10%					
	Power consumption (at 20°C)	W	18	19	19	19	22	22
	Current consumption (at 20°C)	A	0.74	0.81	0.81	0.81	0.9	0.9
	Static friction torque	N·m	4.9 min.	7.8 min.	7.8 min.	11.8 min.	16.1 min.	16.1 min.
	Attraction time ^{*5}	ms	50 max.	50 max.	50 max.	80 max.	110 max.	110 max.
	Release time ^{*5}	ms	15 max.	15 max.	15 max.	15 max.	50 max.	50 max.
	Backlash		1° (reference value)					
	Allowable work per braking	J	392	392	392	392	1470	1470
	Allowable total work	J	2.0 × 10 ⁵	4.9 × 10 ⁵	4.9 × 10 ⁵	4.9 × 10 ⁵	2.2 × 10 ⁶	2.2 × 10 ⁶
	Allowable angular acceleration	rad/s ²	10,000 max. (Speed of 900 r/min or more must not be changed in less than 10 ms)					
	Brake life	---	10,000,000 operations					
	Rating	---	Continuous					
	Insulation grade	---	Type F					

3-2 Servomotor Specifications

- *1. These are the values when the Servomotor is combined with a Servo Drive at room temperature (20°C, 65%). The maximum momentary torque indicates the standard value.
- *2. Applicable Load Inertia
 - ♦ The operable load inertia ratio (load inertia/rotor inertia) depends on the mechanical configuration and its rigidity. For a machine with high rigidity, operation is possible even with high load inertia. Select an appropriate motor and confirm that operation is possible.
 - ♦ If the dynamic brake is activated frequently with high load inertia, the dynamic brake resistor may burn. Do not repeatedly turn the Servomotor ON and OFF while the dynamic brake is enabled.
- *3. The allowable radial and thrust loads are the values determined for a service life of 20,000 hours at normal operating temperatures. The allowable radial loads are applied as shown in the following diagram.

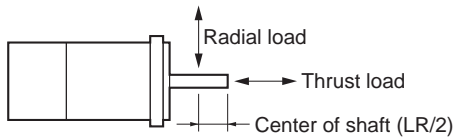

- *4. This is an OFF brake. (It is reset when excitation voltage is applied).
- *5. The operation time is the value (reference value) measured with a surge suppressor (CR50500 manufactured by Okaya Electric Industries Co., Ltd.).

Torque-Rotational Speed Characteristics for 3,000-r/min Servomotors

♦ 3,000-r/min Servomotors with 100-VAC Power Input

The following graphs show the characteristics with a 3-m standard cable and a 100-VAC input.

♦ R88M-G05030H/T (50 W)

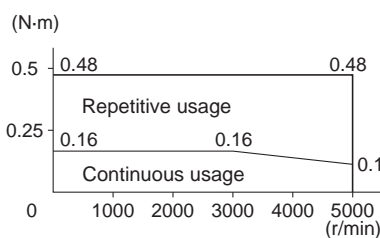

♦ R88M-G10030L/S (100 W)

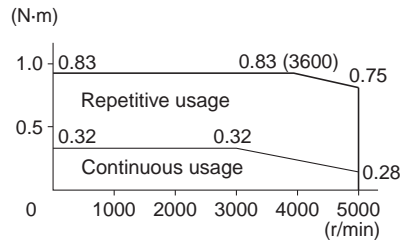

♦ R88M-G20030L/S (200 W)

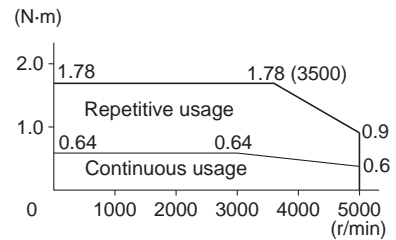

♦ R88M-G40030L/S (400 W)

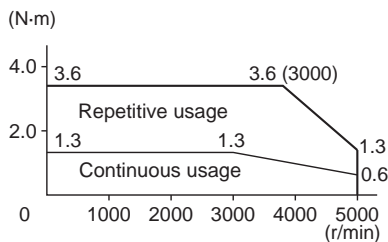

♦ 3,000-r/min Servomotors with 200-VAC Power Input

The following graphs show the characteristics with a 3-m standard cable and a 200-VAC input.

♦ R88M-G05030H/T (50 W)

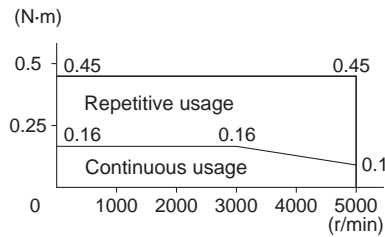

♦ R88M-G10030H/T (100 W)

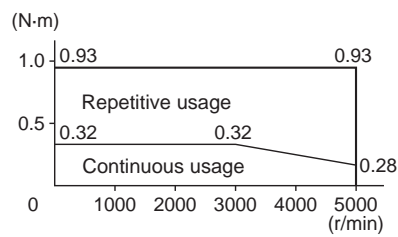

♦ R88M-G20030H/T (200 W)

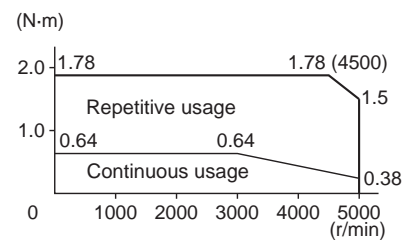

♦ R88M-G40030H/T (400 W)

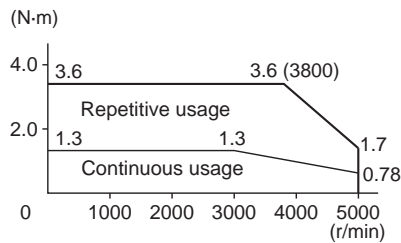

♦ R88M-G75030H/T (750 W)

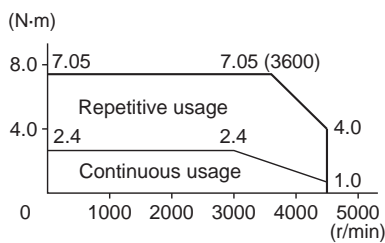

♦ R88M-G1K030T (1 kW)

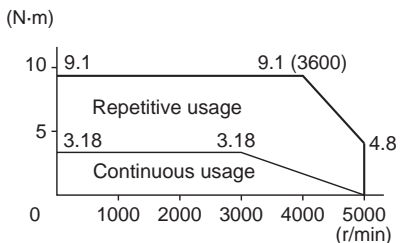

♦ R88M-G1K530T (1.5 kW)

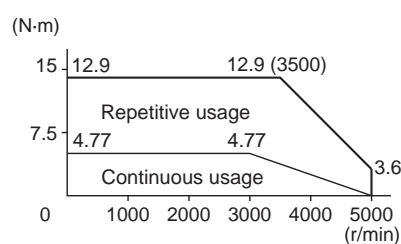

♦ R88M-G2K030T (2 kW)

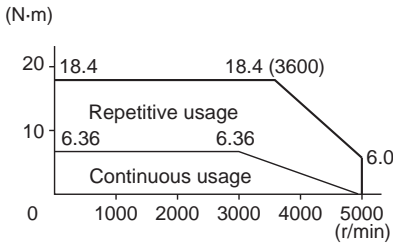

♦ R88M-G3K030T (3 kW)

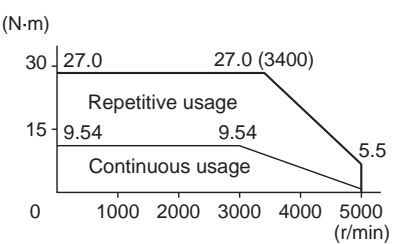

♦ R88M-G4K030T (4 kW)

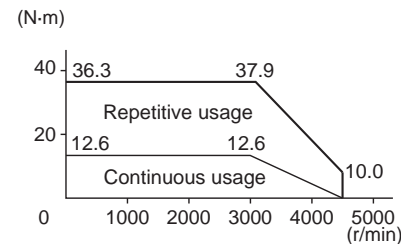

♦ R88M-G5K030T (5 kW)

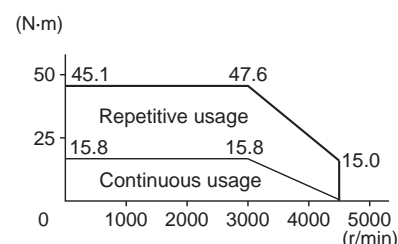

3-2 Servomotor Specifications

Precautions for Correct Use

- Use the following Servomotors in the ranges shown in the graphs below. Using outside of these ranges may cause the Servomotor to generate heat, which could result in encoder malfunction.

- R88M-G05030H/T
50 W (Without Oil Seal)

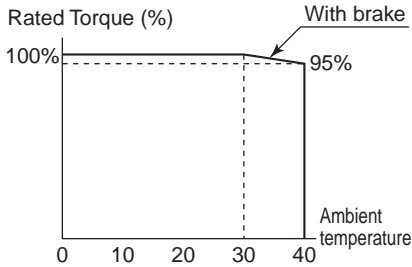

- R88M-G05030H/T
50 W (With Oil Seal)

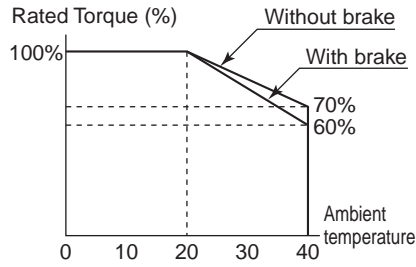

- R88M-G10030H/T
100 W (Without Oil Seal)

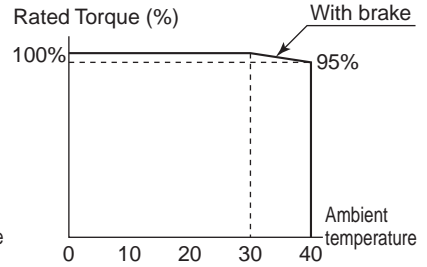

- R88M-G10030H/T
100 W (With Oil Seal)

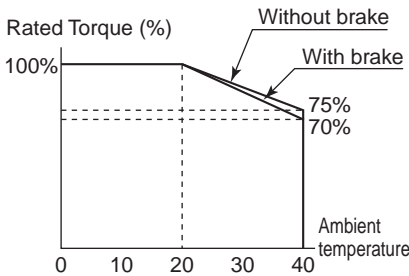

- R88M-G20030H/T
200 W (With Oil Seal)

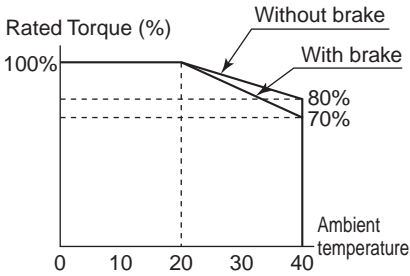

- R88M-G40030H/T
400 W (Without Oil Seal)

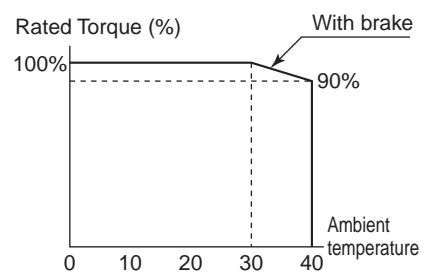

- R88M-G40030H/T
400 W (With Oil Seal)

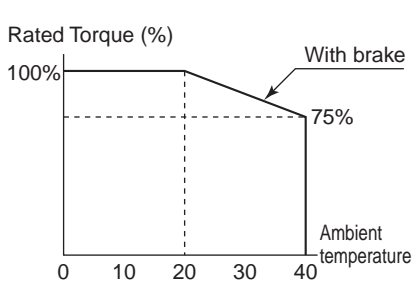

- R88M-G1K530T (1.5 kW)

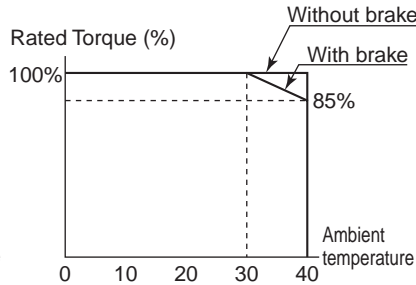

- R88M-G2K030T (2 kW)

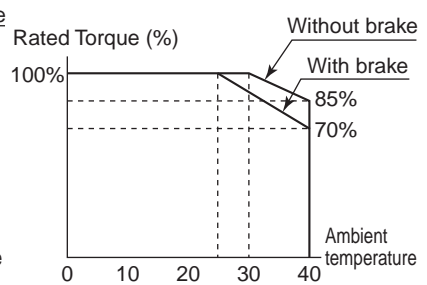

- R88M-G3K030T (3 kW)

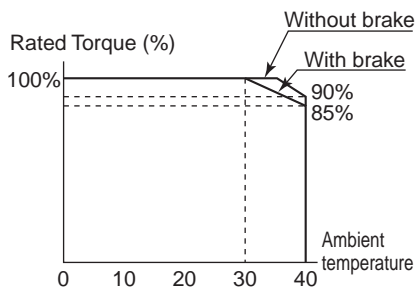

- R88M-G4K030T (4 kW)

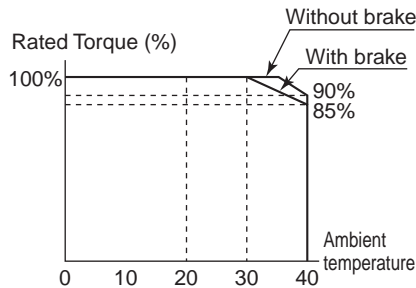

- R88M-G5K030T (5 kW)

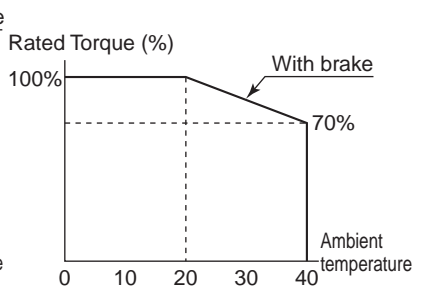

■ 3,000-r/min Flat Servomotors

Model (R88M-)		100 VAC			200 VAC			
		GP10030L	GP20030L	GP40030L	GP10030H	GP20030H	G40030H	
Item	Unit	GP10030S	GP20030S	GP40030S	GP10030T	GP20030T	G40030T	
Rated output ^{*1}	W	100	200	400	100	200	400	
Rated torque ^{*1}	N·m	0.32	0.64	1.3	0.32	0.64	1.3	
Rated rotation speed	r/min	3000			3000			
Max. momentary rotation speed	r/min	5000		4500	5000			
Max. momentary torque ^{*1}	N·m	0.84	1.8	3.6	0.86	1.8	3.65	
Rated current ^{*1}	A (rms)	1.6	2.5	4.4	1	1.6	2.5	
Max. momentary current ^{*1}	A (rms)	4.9	7.5	13.3	3.1	4.9	7.5	
Rotor inertia	kg·m ² (GD ² /4)	1.0 × 10 ⁻⁵	3.5 × 10 ⁻⁵	6.5 × 10 ⁻⁵	1.0 × 10 ⁻⁵	3.5 × 10 ⁻⁵	6.4 × 10 ⁻⁵	
Applicable load inertia	---	20 times the rotor inertia max. ^{*2}						
Torque constant ^{*1}	N·m/A	0.21	0.27	0.3	0.34	0.42	0.54	
Power rate ^{*1}	kW/s	10.2	11.7	26.0	10.2	11.5	25.5	
Mechanical time constant	ms	0.87	0.75	0.55	1.05	0.81	0.59	
Electrical time constant	ms	3.4	6.7	6.7	2.9	5.6	6.6	
Allowable radial load ^{*3}	N	68	245	245	68	245	245	
Allowable thrust load ^{*3}	N	58	98	98	58	98	98	
Weight	Without brake	kg	Approx. 0.7	Approx. 1.3	Approx. 1.8	Approx. 0.7	Approx. 1.3	Approx. 1.8
	With brake	kg	Approx. 0.9	Approx. 2	Approx. 2.5	Approx. 0.9	Approx. 2	Approx. 2.5
Radiation shield dimensions (material)		130 × 120 × t10 (Al)	170 × 160 × t12 (Al)		130 × 120 × t10 (Al)	170 × 160 × t12 (Al)		
Applicable Servo Drives (R88D-)		GN01L-ML2	GN02L-ML2	GN04L-ML2	GN01H-ML2	GN02H-ML2	GN04H-ML2	
Brake specifications	Brake inertia	kg·m ² (GD ² /4)	3 × 10 ⁻⁶	9 × 10 ⁻⁶	9 × 10 ⁻⁶	3 × 10 ⁻⁶	9 × 10 ⁻⁶	9 × 10 ⁻⁶
	Excitation voltage ^{*4}	V	24 VDC ±10%			24 VDC ±10%		
	Power consumption (at 20°C)	W	7	10	10	7	10	10
	Current consumption (at 20°C)	A	0.29	0.41	0.41	0.29	0.41	0.41
	Static friction torque	N·m	0.29 min.	1.27 min.	1.27 min.	0.29 min.	1.27 min.	1.27 min.
	Attraction time ^{*5}	ms	50 max.	60 max.	60 max.	50 max.	60 max.	60 max.
	Release time ^{*5}	ms	15 max.	15 max.	15 max.	15 max.	15 max.	15 max.
	Backlash		1° (reference value)			1° (reference value)		
	Allowable work per braking	J	137	196	196	137	196	196
	Allowable total work	J	44.1 × 10 ³	147 × 10 ³	147 × 10 ³	44.1 × 10 ³	147 × 10 ³	147 × 10 ³
	Allowable angular acceleration	rad/s ²	10,000 max. (Speed of 900 r/min or more must not be changed in less than 10 ms)					
	Brake life	---	10,000,000 operations					
	Rating	---	Continuous			Continuous		
Insulation grade	---	Type B			Type B			

3-2 Servomotor Specifications

- *1. These are the values when the Servomotor is combined with a Servo Drive at room temperature (20°C, 65%). The maximum momentary torque indicates the standard value.
- *2. Applicable Load Inertia
 - ♦ The operable load inertia ratio (load inertia/rotor inertia) depends on the mechanical configuration and its rigidity. For a machine with high rigidity, operation is possible even with high load inertia. Select an appropriate motor and confirm that operation is possible.
 - ♦ If the dynamic brake is activated frequently with high load inertia, the dynamic brake resistor may burn. Do not repeatedly turn the Servomotor ON and OFF while the dynamic brake is enabled.
- *3. The allowable radial and thrust loads are the values determined for a service life of 20,000 hours at normal operating temperatures. The allowable radial loads are applied as shown in the following diagram.

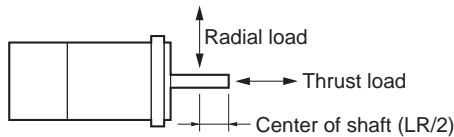

- *4. This is an OFF brake. (It is reset when excitation voltage is applied).
- *5. The operation time is the value (reference value) measured with a surge suppressor (CR50500 manufactured by Okaya Electric Industries Co., Ltd.).

Torque-Rotational Speed Characteristics for 3,000-r/min Flat Servomotors

- ♦ 3,000-r/min Flat Servomotors with 100-VAC Power Input

The following graphs show the characteristics with a 3-m standard cable and a 100-VAC input.

♦R88M-GP10030L/S (100 W)

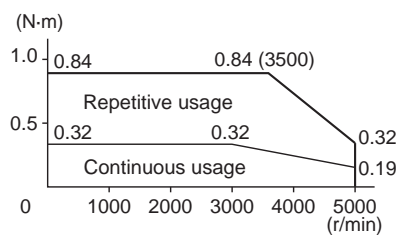

♦R88M-GP20030L/S (200 W)

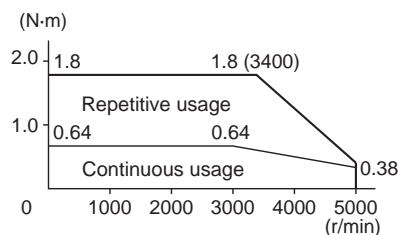

♦R88M-GP40030L/S (400 W)

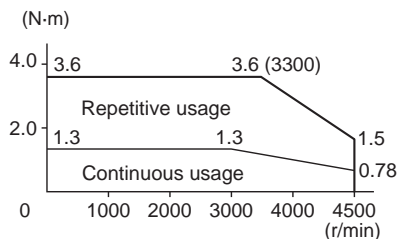

- ♦ 3,000-r/min Flat Servomotors with 200-VAC Power Input

The following graphs show the characteristics with a 3-m standard cable and a 200-VAC input.

♦R88M-GP10030H/T (100 W)

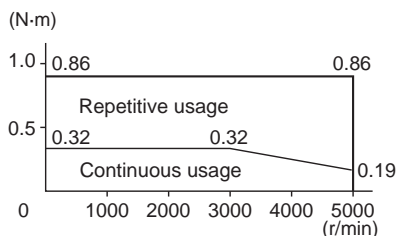

♦R88M-GP20030H/T (200 W)

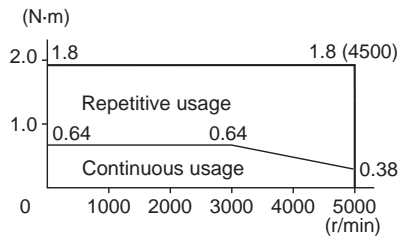

♦R88M-GP40030H/T (400 W)

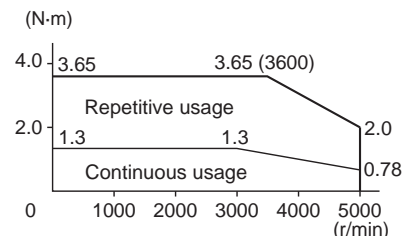

■ 2,000-r/min Servomotors

Model (R88M-)		200 VAC							
		G1K020T	G1K520T	G2K020T	G3K020T	G4K020T	G5K020T	G7K515T	
Item	Unit								
Rated output ^{*1}	W	1000	1500	2000	3000	4000	5000	7500	
Rated torque ^{*1}	N·m	4.8	7.15	9.54	14.3	18.8	23.8	48	
Rated rotation speed	r/min	2000							1500
Max. momentary rotation speed	r/min	3000							2000
Max. momentary torque ^{*1}	N·m	13.5	19.6	26.5	41.2	54.9	70.6	111	
Rated current ^{*1}	A (rms)	5.6	9.4	12.3	17.8	23.4	28	46.6	
Max. momentary current ^{*1}	A (rms)	17.1	28.5	37.1	54.2	71.4	85.7	117.8	
Rotor inertia	kg·m ² (GD ² /4)	6.17 × 10 ⁻⁴	1.12 × 10 ⁻³	1.52 × 10 ⁻³	2.23 × 10 ⁻³	4.25 × 10 ⁻³	6.07 × 10 ⁻³	9.9 × 10 ⁻³	
Applicable load inertia	---	10 times the rotor inertia max. ^{*2}							
Torque constant ^{*1}	N·m/A	0.88	0.76	0.78	0.81	0.81	0.85	1.03	
Power rate ^{*1}	kW/s	37.3	45.8	60	91.6	83.2	93.5	230	
Mechanical time constant	ms	0.7	0.81	0.75	0.72	1	0.9	0.71	
Electrical time constant	ms	18	19	21	20	24	32	34	
Allowable radial load ^{*3}	N	490	490	490	784	784	784	1176	
Allowable thrust load ^{*3}	N	196	196	196	343	343	343	490	
Weight	Without brake	kg	Approx. 6.8	Approx. 8.5	Approx. 10.6	Approx. 14.6	Approx. 18.8	Approx. 25	Approx. 41
	With brake	kg	Approx. 8.7	Approx. 10.1	Approx. 12.5	Approx. 16.5	Approx. 21.3	Approx. 28.5	Approx. 45
Radiation shield dimensions (material)		275 × 260 × t15 (Al)			380 × 350 × t30 (Al)		470 × 440 × t30 (Al)		
Applicable Servo Drives (R88D-)		GN10H-ML2	GN15H-ML2	GN20H-ML2	GN30H-ML2	GN50H-ML2	GN50H-ML2	GN75H-ML2	
Brake specifications	Brake inertia	kg·m ² (GD ² /4)	1.35 × 10 ⁻⁴				4.25 × 10 ⁻⁴	4.7 × 10 ⁻⁴	4.7 × 10 ⁻⁴
	Excitation voltage ^{*4}	V	24 VDC ±10%						
	Power consumption (at 20°C)	W	14	19	19	22	26	31	34
	Current consumption (at 20°C)	A	0.59	0.79	0.79	0.9	1.1	1.3	1.4
	Static friction torque	N·m	4.9 min.	13.7 min.	13.7 min.	16.1 min.	21.5 min.	24.5 min.	58.8 min.
	Attraction time ^{*5}	ms	80 max.	100 max.	100 max.	110 max.	90 max.	80 max.	150 max.
	Release time ^{*5}	ms	70 max.	50 max.	50 max.	50 max.	35 min.	25 min.	50 max.
	Backlash		1° (reference value)						
	Allowable work per braking	J	588	1176	1176	1170	1078	1372	1372
	Allowable total work	J	7.8 × 10 ⁵	1.5 × 10 ⁶	1.5 × 10 ⁶	2.2 × 10 ⁶	2.5 × 10 ⁶	2.9 × 10 ⁶	2.9 × 10 ⁶
	Allowable angular acceleration	rad/s ²	10,000 max. (Speed of 900 r/min or more must not be changed in less than 10 ms)						
	Brake life	---	10,000,000 operations						
	Rating	---	Continuous						
	Insulation grade	---	Type F						

3-2 Servomotor Specifications

- *1. These are the values when the Servomotor is combined with a Servo Drive at room temperature (20°C, 65%). The maximum momentary torque indicates the standard value.
- *2. Applicable Load Inertia
 - ♦ The operable load inertia ratio (load inertia/rotor inertia) depends on the mechanical configuration and its rigidity. For a machine with high rigidity, operation is possible even with high load inertia. Select an appropriate motor and confirm that operation is possible.
 - ♦ If the dynamic brake is activated frequently with high load inertia, the dynamic brake resistor may burn. Do not repeatedly turn the Servomotor ON and OFF while the dynamic brake is enabled.
- *3. The allowable radial and thrust loads are the values determined for a service life of 20,000 hours at normal operating temperatures. The allowable radial loads are applied as shown in the following diagram.

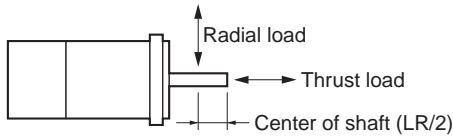

- *4. This is an OFF brake. (It is reset when excitation voltage is applied).
- *5. The operation time is the value (reference value) measured with a surge suppressor (CR50500 manufactured by Okaya Electric Industries Co., Ltd.).

Torque-Rotational Speed Characteristics for 2,000-r/min Servomotors

♦ 2,000-r/min Servomotors with 200-VAC Power Input

The following graphs show the characteristics with a 3-m standard cable and a 200-VAC input.

♦ R88M-G1K020T (1 kW)

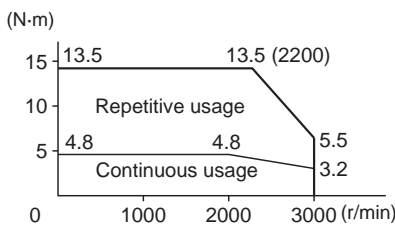

♦ R88M-G1K520T (1.5 kW)

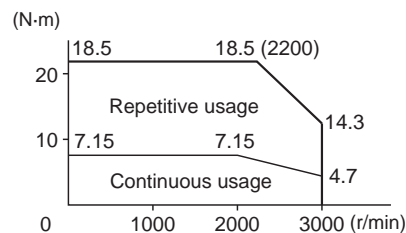

♦ R88M-G2K020T (2 kW)

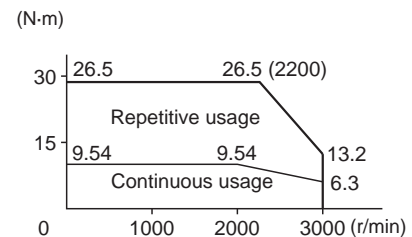

♦ R88M-G3K020T (3 kW)

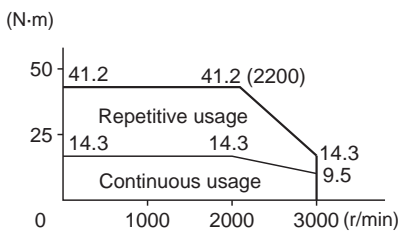

♦ R88M-G4K020T (4 kW)

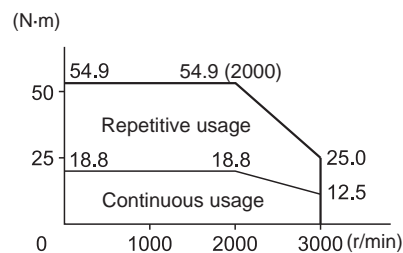

♦ R88M-G5K020T (5 kW)

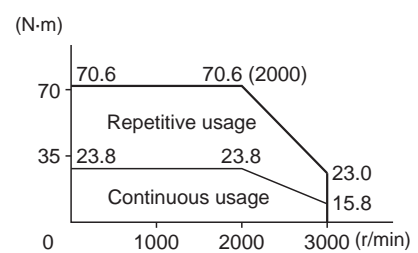

♦ R88M-G7K515T (7.5 kW)

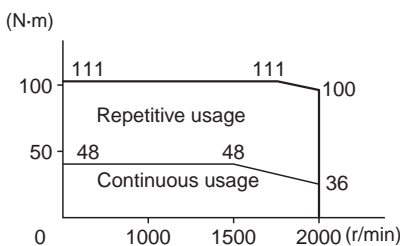

■ 1,000-r/min Servomotors

Item		Model (R88M-)	200 VAC				
			G90010T	G2K010T	G3K010T	G4K510T	G6K010T
Rated output ^{*1}	W		900	2000	3000	4500	6000
Rated torque ^{*1}	N·m		8.62	19.1	28.4	42.9	57.2
Rated rotation speed	r/min		1000				
Max. momentary rotation speed	r/min		2000				
Max. momentary torque ^{*1}	N·m		18.4	41.5	60	101	130
Rated current ^{*1}	A (rms)		7.6	18.5	24	33	57.2
Max. momentary current ^{*1}	A (rms)		17.1	44	57.1	84.2	121.4
Rotor inertia	kg·m ² (GD ² /4)		1.12 × 10 ⁻³	3.55 × 10 ⁻³	5.57 × 10 ⁻³	8.09 × 10 ⁻³	9.9 × 10 ⁻³
Applicable load inertia	---		10 times the rotor inertia max. ^{*2}				
Torque constant ^{*1}	N·m/A		1.13	1	1.1	1.3	1.22
Power rate ^{*1}	kW/s		66.3	103	145	228	331
Mechanical time constant	ms		0.88	0.97	0.74	0.7	0.65
Electrical time constant	ms		20	25	30	31	46.2
Allowable radial load ^{*3}	N		686	1176	1470	1470	1764
Allowable thrust load ^{*3}	N		196	490	490	490	588
Weight	Without brake	kg	Approx. 8.5	Approx. 17.5	Approx. 25	Approx. 34	Approx. 41
	With brake	kg	Approx. 10	Approx. 21	Approx. 28.5	Approx. 39.5	Approx. 45
Radiation shield dimensions (material)			275 × 260 × t15 (Al)	470 × 440 × t30 (Al)			
Applicable Servo Drives (R88D-)			GN15H-ML2	GN30H-ML2	GN50H-ML2	GN50H-ML2	GN75H-ML2
Brake specifications	Brake inertia	kg·m ² (GD ² /4)	1.35 × 10 ⁻⁴	4.7 × 10 ⁻⁴	4.7 × 10 ⁻⁴	4.7 × 10 ⁻⁴	4.7 × 10 ⁻⁴
	Excitation voltage ^{*4}	V	24 VDC ±10%				
	Power consumption (at 20°C)	W	19	31	34	34	34
	Current consumption (at 20°C)	A	0.79	1.3	1.4	1.4	1.4
	Static friction torque	N·m	13.7 min.	24.5 min.	58.8 min.	58.8 min.	58.8 min.
	Attraction time ^{*5}	ms	100 max.	80 max.	150 max.	150 max.	150 max.
	Release time ^{*5}	ms	50 max.	25 max.	50 max.	50 max.	50 max.
	Backlash		1° (reference value)				
	Allowable work per braking	J	1176	1372	1372	1372	1372
	Allowable total work	J	1.6 × 10 ⁶	2.9 × 10 ⁶	2.9 × 10 ⁶	2.9 × 10 ⁶	2.9 × 10 ⁶
	Allowable angular acceleration	rad/s ²	10,000 max. (Speed of 900 r/min or more must not be changed in less than 10 ms)				
	Brake life	---	10,000,000 operations				
	Rating	---	Continuous				
	Insulation grade	---	Type F				

3-2 Servomotor Specifications

- *1. These are the values when the Servomotor is combined with a Servo Drive at room temperature (20°C, 65%). The maximum momentary torque indicates the standard value.
- *2. Applicable Load Inertia
 - ♦ The operable load inertia ratio (load inertia/rotor inertia) depends on the mechanical configuration and its rigidity. For a machine with high rigidity, operation is possible even with high load inertia. Select an appropriate motor and confirm that operation is possible.
 - ♦ If the dynamic brake is activated frequently with high load inertia, the dynamic brake resistor may burn. Do not repeatedly turn the Servomotor ON and OFF while the dynamic brake is enabled.
- *3. The allowable radial and thrust loads are the values determined for a service life of 20,000 hours at normal operating temperatures. The allowable radial loads are applied as shown in the following diagram.

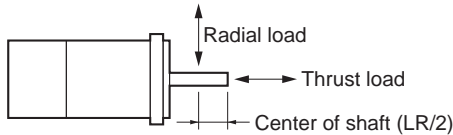

- *4. This is an OFF brake. (It is reset when excitation voltage is applied).
- *5. The operation time is the value (reference value) measured with a surge suppressor (CR50500 manufactured by Okaya Electric Industries Co., Ltd.).

Torque-Rotational Speed Characteristics for 1,000-r/min Servomotors

♦ 1,000-r/min Servomotors with 200-VAC Power Input

The following graphs show the characteristics with a 3-m standard cable and a 200-VAC input.

♦ R88M-G90010T (900 W)

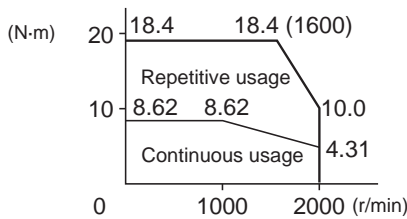

♦ R88M-G2K010T (2 kW)

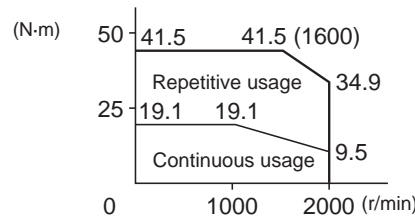

♦ R88M-G3K010T (3 kW)

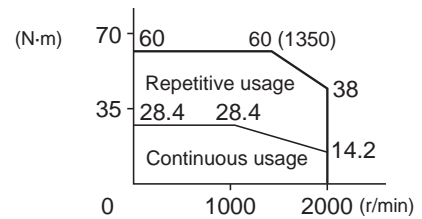

♦ R88M-G4K510 (4.5 kW)

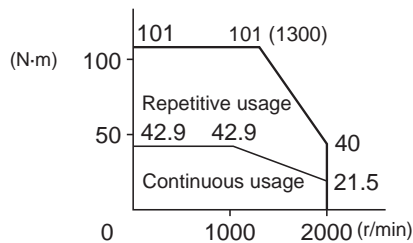

♦ R88M-G6K010T (6 kW)

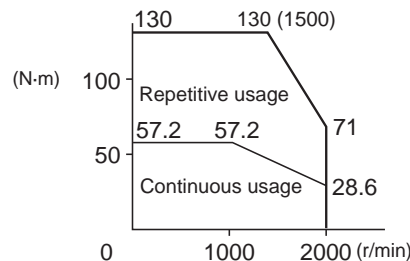

Precautions for Correct Use

- ♦ Use the following Servomotors in the ranges shown in the graphs below. Using outside of these ranges may cause the Servomotor to generate heat, which could result in encoder malfunction.

- ♦ R88M-G4K510
4.5 kW (Without Oil Seal)

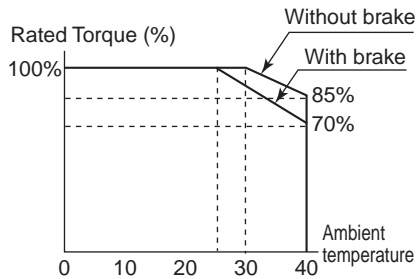

- ♦ R88M-G6K010T
6 kW (With Oil Seal)

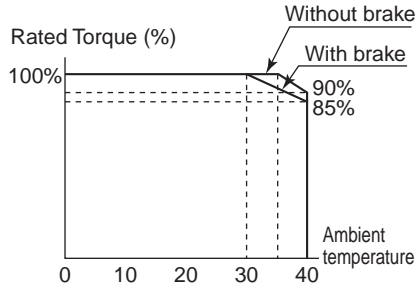

Temperature Characteristics of the Servomotor and Mechanical System

- ♦ OMNUC G-Series AC Servomotors use rare earth magnets (neodymium-iron magnets). The temperature coefficient for these magnets is approximately $-0.13\%/^{\circ}\text{C}$. As the temperature drops, the Servomotor's maximum momentary torque increases, and as the temperature rises, the Servomotor's maximum momentary torque decreases.
- ♦ The maximum momentary torque rises by 4% at a normal temperature of 20°C compared to a temperature of -10°C . Conversely, the maximum momentary torque decreases about 8% when the magnet warms up to 80°C from the normal temperature.
- ♦ Generally, when the temperature drops in a mechanical system, the friction torque and the load torque increase. For that reason, overloading may occur at low temperatures. In particular, in systems that use a Decelerator, the load torque at low temperatures may be nearly twice as much as the load torque at normal temperatures. Check whether overloading may occur at low temperature startup. Also check to see whether abnormal Servomotor overheating or alarms occur at high temperatures.
- ♦ An increase in load friction torque seemingly increases load inertia. Therefore, even if the Servo Drive gains are adjusted at a normal temperature, the Servomotor may not operate properly at low temperatures. Check to see whether there is optimal operation even at low temperatures.

Encoder Specifications

■ Incremental Encoders

Item	Specifications
Encoder system	Optical encoder
No. of output pulses	Phases A and B: 2,500 pulses/rotation Phase Z: 1 pulse/rotation
Power supply voltage	5 VDC \pm 5%
Power supply current	180 mA (max.)
Output signals	+S, -S
Output interface	RS-485 compliance

■ Absolute Encoders

Item	Specifications
Encoder system	Optical encoder
	17 bits
No. of output pulses	Phases A and B: 32,768 pulses/rotation Phase Z: 1 pulse/rotation
Maximum rotations	-32,768 to +32,767 rotations or 0 to 65,534 rotations
Power supply voltage	5 VDC \pm 5%
Power supply current	110 mA (max.)
Applicable battery voltage	3.6 VDC
Current consumption of battery	265 μ A for a maximum of 5 s right after power interruption 100 μ A for operation during power interruption 3.6 μ A when power is supplied to Servo Drive
Output signals	+S, -S
Output interface	RS-485 compliance

3-3 Decelerator Specifications

The following Decelerators are available for use with OMNUC G-Series Servomotors. Select a Decelerator matching the Servomotor capacity.

Standard Models and Specifications

■ Backlash = 3' Max.

Decelerators for 3,000-r/min Servomotors

Model		Rated rotation speed	Rated torque	Efficiency	Maximum momentary rotation speed	Maximum momentary torque	Decelerator inertia	Allowable radial load	Allowable thrust load	Weight	
		r/min	N·m	%	r/min	N·m	kg·m ²	N	N	kg	
50 W	1/5	R88G-HPG11A05100B□	600	0.60	75	1000	1.68	5.00×10^{-7}	135	538	0.29
	1/9	R88G-HPG11A09050B□	333	1.17	81	555	3.29	3.00×10^{-7}	161	642	0.29
	1/21	R88G-HPG14A21100B□	143	2.18	65	238	6.13	5.00×10^{-6}	340	1358	1.04
	1/33	R88G-HPG14A33050B□	91	3.73	71	151	10.5	4.40×10^{-6}	389	1555	1.04
	1/45	R88G-HPG14A45050B□	67	5.09	71	111	14.3	4.40×10^{-6}	427	1707	1.04
100 W	1/5	R88G-HPG11A05100B□	600	1.37	86	1000	3.8	5.00×10^{-7}	135	538	0.29
	1/11	R88G-HPG14A11100B□	273	2.63	75	454	7.39	6.00×10^{-6}	280	1119	1.04
	1/21	R88G-HPG14A21100B□	143	5.40	80	238	15.2	5.00×10^{-6}	340	1358	1.04
	1/33	R88G-HPG20A33100B□	91	6.91	65	151	19.4	6.50×10^{-5}	916	3226	2.4
	1/45	R88G-HPG20A45100B□	67	9.42	65	111	26.5	6.50×10^{-5}	1006	3541	2.4
200 W	1/5	R88G-HPG14A05200B□	600	2.49	78	1000	6.93	2.07×10^{-5}	221	883	1.02
	1/11	R88G-HPG14A11200B□	273	6.01	85	454	16.7	1.93×10^{-5}	280	1119	1.09
	1/21	R88G-HPG20A21200B□	143	10.2	76	238	28.5	4.90×10^{-5}	800	2817	2.9
	1/33	R88G-HPG20A33200B□	91	17.0	81	151	47.4	4.50×10^{-5}	916	3226	2.9
	1/45	R88G-HPG20A45200B□	67	23.2	81	111	64.6	4.50×10^{-5}	1006	3541	2.9

3-3 Decelerator Specifications

Model			Rated rotation speed	Rated torque	Efficiency	Maximum momentary rotation speed	Maximum momentary torque	Decelerator inertia	Allowable radial load	Allowable thrust load	Weight
			r/min	N·m	%	r/min	N·m	kg·m ²	N	N	kg
400 W	1/5	R88G-HPG14A05400B□	600	5.66	87	1000	16.0 (15.7)	2.07×10^{-5}	221	883	1.09
	1/11	R88G-HPG20A11400B□	273	11.7	82	454	33.1 (32.5)	5.70×10^{-5}	659	2320	2.9
	1/21	R88G-HPG20A21400B□	143	23.5	86	238	66.5 (65.2)	4.90×10^{-5}	800	2547	2.9
	1/33	R88G-HPG32A33400B□	91	34.7	81	151	98.2 (96.3)	6.20×10^{-5}	1565	6240	7.5
	1/45	R88G-HPG32A45400B□	67	47.4	81	111	133.9 (131.4)	6.10×10^{-5}	1718	6848	7.5
750 W	1/5	R88G-HPG20A05750B□	600	9.94	83	1000	29.2	6.80×10^{-5}	520	1832	2.9
	1/11	R88G-HPG20A11750B□	273	23.2	88	454	68.1	6.00×10^{-5}	659	2320	3.1
	1/21	R88G-HPG32A21750B□	143	42.3	84	238	124.3	3.00×10^{-4}	1367	5448	7.8
	1/33	R88G-HPG32A33750B□	91	69.7	88	151	204.7	2.70×10^{-4}	1565	6240	7.8
	1/45	R88G-HPG32A45750B□	67	95.0	88	111	279.2	2.70×10^{-4}	1718	6848	7.8
1 kW	1/5	R88G-HPG32A051K0B□	600	11.5	72	1000	32.9	3.90×10^{-4}	889	3542	7.3
	1/11	R88G-HPG32A111K0B□	273	28.9	83	454	82.6	3.40×10^{-4}	1126	4488	7.8
	1/21	R88G-HPG32A211K0B□	143	58.1	87	238	166.1	3.00×10^{-4}	1367	5488	7.8
	1/33	R88G-HPG32A331K0B□	91	94.3	90	151	270.0	2.80×10^{-4}	1565	6240	7.8
	1/45	R88G-HPG50A451K0B□	67	124.2	87	100 ^{*1}	355.4	4.70×10^{-4}	4538	15694	19.0
1.5 kW	1/5	R88G-HPG32A052K0B□	600	19.1	80	1000	51.3	3.90×10^{-4}	889	3542	7.4
	1/11	R88G-HPG32A112K0B□	273	45.7	87	454	122.5	3.40×10^{-4}	1126	4488	7.9
	1/21	R88G-HPG32A211K5B□	143	90.1	90	238	241.9	3.00×10^{-4}	1367	5448	7.9
	1/33	R88G-HPG50A332K0B□	91	141.5	90	136 ^{*1}	379.7	4.80×10^{-4}	4135	14300	19.0
	1/45	R88G-HPG50A451K5B□	67	192.9	90	100 ^{*1}	517.8	4.70×10^{-4}	4538	15694	19.0

Model			Rated rotation speed	Rated torque	Efficiency	Maximum momentary rotation speed	Maximum momentary torque	Decelerator inertia	Allowable radial load	Allowable thrust load	Weight
			r/min	N·m	%	r/min	N·m	kg·m ²	N	N	kg
2 kW	1/5	R88G-HPG32A052K0B□	600	26.7	84	1000	77.4	3.90×10^{-4}	889	3542	7.4
	1/11	R88G-HPG32A112K0B□	273	62.4	89	454	180.7	3.40×10^{-4}	1126	4488	7.9
	1/21	R88G-HPG50A212K0B□	143	118.9	89	214 ^{*1}	343.9	5.80×10^{-4}	3611	12486	19.0
	1/33	R88G-HPG50A332K0B□	91	191.8	91	136 ^{*1}	555.0	4.80×10^{-4}	4135	14300	19.0
3 kW	1/5	R88G-HPG32A053K0B□	600	42.0	88	1000	118.9	3.80×10^{-4}	889	3542	7.3
	1/11	R88G-HPG50A113K0B□	273	92.3	88	409 ^{*1}	261.4	7.70×10^{-4}	2974	10285	19.0
	1/21	R88G-HPG50A213K0B□	143	183.0	91	214 ^{*1}	517.7	5.80×10^{-4}	3611	12486	19.0
4 kW	1/5	R88G-HPG32A054K0B□	600	53.9	90	900 ^{*1}	163.4	3.80×10^{-4}	889	3542	7.9
	1/11	R88G-HPG50A115K0B□	273	124.6	90	409 ^{*1}	359.0	8.80×10^{-4}	2974	10285	19.1
5 kW	1/5	R88G-HPG50A055K0B□	600	69.3	88	900 ^{*1}	197.8	1.20×10^{-3}	2347	8118	18.6
	1/11	R88G-HPG50A115K0B□	273	158.4	91	409 ^{*1}	451.9	8.80×10^{-4}	2974	10285	19.1

*1. Keep the maximum rotation speed at 4,500 r/min or less.

Note 1. The values inside parentheses () are for 100-V Servomotors.

Note 2. The Decelerator inertia is the Servomotor shaft conversion value.

Note 3. The protective structure for Servomotors with Decelerators satisfies IP44.

Note 4. The allowable radial load is the value at the LR/2 position.

Note 5. The standard models have a straight shaft. Models with a key and tap are indicated with "J" at the end of the model number (the suffix in the box).

3-3 Decelerator Specifications

Decelerators for 2,000-r/min Servomotors

Model		Rated rotation speed	Rated torque	Efficiency	Maximum momentary rotation speed	Maximum momentary torque	Decelerator inertia	Allowable radial load	Allowable thrust load	Weight	
		r/min	N·m	%	r/min	N·m	kg·m ²	N	N	kg	
1 kW	1/5	R88G-HPG32A053K0B□	400	20.4	85	600	57.4	3.80×10^{-4}	889	3542	7.3
	1/11	R88G-HPG32A112K0SB□	182	47.3	90	273	133.1	3.40×10^{-4}	1126	4488	7.8
	1/21	R88G-HPG32A211K0SB□	95	92.3	92	143	259.7	2.90×10^{-4}	1367	5448	7.8
	1/33	R88G-HPG50A332K0SB□	60	144.9	92	91	407.6	4.70×10^{-4}	4135	14300	19.0
	1/45	R88G-HPG50A451K0SB□	44	197.7	92	67	555.9	4.70×10^{-4}	4538	15694	19.0
1.5 kW	1/5	R88G-HPG32A053K0B□	400	31.7	89	600	86.8	3.80×10^{-4}	889	3542	7.3
	1/11	R88G-HPG32A112K0SB□	182	72.1	92	273	197.7	3.40×10^{-4}	1126	4488	7.8
	1/21	R88G-HPG50A213K0B□	95	137.5	92	143	377.0	5.80×10^{-4}	3611	12486	19.0
	1/33	R88G-HPG50A332K0SB□	60	219.4	93	91	601.5	4.70×10^{-4}	4135	14300	19.0
2 kW	1/5	R88G-HPG32A053K0B□	400	43.2	91	600	119.9	3.80×10^{-4}	889	3542	7.3
	1/11	R88G-HPG32A112K0SB□	182	97.4	93	273	270.5	3.40×10^{-4}	1126	4488	7.8
	1/21	R88G-HPG50A213K0B□	95	185.6	93	143	515.9	5.80×10^{-4}	3611	12486	19.0
	1/33	R88G-HPG50A332K0SB□	60	270.0*1	93	91	815.0	4.70×10^{-4}	4135	14300	19.0

Model		Rated rotation speed	Rated torque	Efficiency	Maximum momentary rotation speed	Maximum momentary torque	Decelerator inertia	Allowable radial load	Allowable thrust load	Weight	
		r/min	N·m	%	r/min	N·m	kg·m ²	N	N	kg	
3 kW	1/5	R88G-HPG32A054K0B□	400	66.0	92	600	190.1	3.80×10^{-4}	889	3542	7.9
	1/11	R88G-HPG50A115K0B□	182	145.2	92	273	418.3	8.80×10^{-4}	2974	10285	19.1
	1/21	R88G-HPG50A213K0SB□	95	260.0 ^{*1}	93	143	806.4	6.90×10^{-4}	3611	12486	19.1
	1/25	R88G-HPG65A253K0SB□	80	322.9	90	120	930.1	3.00×10^{-3}	7846	28654	52.0
4 kW	1/5	R88G-HPG50A054K0SB□	400	85.8	91	600	250.3	1.20×10^{-3}	2347	8118	18.6
	1/11	R88G-HPG50A114K0SB□	182	192.7	93	273	562.8	8.70×10^{-4}	2974	10285	20.1
	1/20	R88G-HPG65A204K0SB□	100	342.2	91	150	999.2	3.28×10^{-3}	7338	26799	52.0
	1/25	R88G-HPG65A254K0SB□	80	430.9	92	120	1258.6	3.24×10^{-3}	7846	28654	52.0
5 kW	1/5	R88G-HPG50A055K0SB□	400	109.8	92	600	325.5	1.10×10^{-3}	2347	8118	22.0
	1/11	R88G-HPG50A115K0SB□	182	200.0 ^{*1}	93	273	723.8	8.40×10^{-4}	2974	10285	23.5
	1/20	R88G-HPG65A205K0SB□	100	438.2	92	150	1300.5	2.85×10^{-3}	7338	26799	55.4
	1/25	R88G-HPG65A255K0SB□	80	550.9	93	120	1634.4	2.81×10^{-3}	7846	28654	55.4
7.5 kW	1/5	R88G-HPG65A057K5SB□	300	221.1	92	400	511.2	2.07×10^{-2}	4841	17681	48.0
	1/12	R88G-HPG65A127K5SB□	125	540.8	94	166	1250.7	2.02×10^{-2}	6295	22991	52.0

*1."Rated torque" indicates the allowable rated torque for the decelerator. Do not exceed this value.

Note 1. The Decelerator inertia is the Servomotor shaft conversion value.

Note 2. The protective structure for Servomotors with Decelerators satisfies IP44.

Note 3. The allowable radial load is the value at the LR/2 position.

Note 4. The standard models have a straight shaft. Models with a key and tap are indicated with "J" at the end of the model number (the suffix in the box).

3-3 Decelerator Specifications

Decelerators for 1,000-r/min Servomotors

Model		Rated rotation speed	Rated torque	Efficiency	Maximum momentary rotation speed	Maximum momentary torque	Decelerator inertia	Allowable radial load	Allowable thrust load	Weight	
		r/min	N·m	%	r/min	N·m	kg·m ²	N	N	kg	
900 W	1/5	R88G-HPG32A05900TB□	200	39.9	93	400	85.2	3.80×10^{-4}	889	3542	7.9
	1/11	R88G-HPG32A11900TB□	90	89.0	94	182	190.1	3.40×10^{-4}	1126	4488	8.4
	1/21	R88G-HPG50A21900TB□	47	169.8	94	95	362.4	7.00×10^{-4}	3611	12486	19.1
	1/33	R88G-HPG50A33900TB□	30	268.5	94	60	573.2	5.90×10^{-4}	4135	14300	19.1
2 kW	1/5	R88G-HPG32A052K0TB□	200	90.2	95	400	196.1	4.90×10^{-4}	889	3542	8.9
	1/11	R88G-HPG50A112K0TB□	90	198.4	94	182	430.9	8.40×10^{-4}	2974	10285	20.1
	1/21	R88G-HPG50A212K0TB□	47	320.0 ^{*1}	95	95	786.8	6.50×10^{-4}	3611	12486	20.1
	1/25	R88G-HPG65A255K0SB□	40	446.7	94	80	971.1	2.81×10^{-3}	7846	28654	55.4
3 kW	1/5	R88G-HPG50A055K0SB□	200	133.9	94	400	282.9	1.10×10^{-3}	2347	8118	22.0
	1/11	R88G-HPG50A115K0SB□	90	246.0 ^{*1}	95	182	684.0	8.40×10^{-3}	2974	10285	23.5
	1/20	R88G-HPG65A205K0SB□	50	534.7	94	100	1129.2	2.85×10^{-3}	7338	26799	55.4
	1/25	R88G-HPG65A255K0SB□	40	669.9	94	80	1411.5	2.81×10^{-3}	7846	28654	55.4
4.5 kW	1/5	R88G-HPG50A054K5TB□	200	203.5	95	400	479.2	1.20×10^{-3}	2347	8118	22.0
	1/12	R88G-HPG65A127K5SB□	83	485.6	94	166	1142.9	2.02×10^{-2}	6295	22991	52.0
	1/20	R88G-HPG65A204K5TB□	50	813.1	95	100	1915.0	1.92×10^{-2}	7338	26799	52.0
6 kW	1/5	R88G-HPG65A057K5SB□	200	268.1	94	400	609.7	2.07×10^{-2}	4841	17681	48.0
	1/12	R88G-HPG65A127K5SB□	83	650.3	95	166	1477.3	2.02×10^{-2}	6295	22991	52.0

*1. "Rated torque" indicates the allowable rated torque for the decelerator. Do not exceed this value.

Note 1. The Decelerator inertia is the Servomotor shaft conversion value.

Note 2. The protective structure for Servomotors with Decelerators satisfies IP44.

Note 3. The allowable radial load is the value at the LR/2 position.

Note 4. The standard models have a straight shaft. Models with a key and tap are indicated with "J" at the end of the model number (the suffix in the box).

Decelerators for 3,000-r/min Flat Servomotor

Model		Rated rotation speed	Rated torque	Efficiency	Maximum momentary rotation speed	Maximum momentary torque	Decelerator inertia	Allowable radial load	Allowable thrust load	Weight	
		r/min	N·m	%	r/min	N·m	kg·m ²	N	N	kg	
100 W	1/5	R88G-HPG11A05100PB□	600	1.37	85	1000	3.67 (3.59)	5.00×10^{-7}	135	538	0.34
	1/11	R88G-HPG14A11100PB□	273	2.63	75	454	7.06 (6.89)	6.00×10^{-6}	280	1119	1.04
	1/21	R88G-HPG14A21100PB□	143	5.40	80	238	14.5 (14.2)	5.00×10^{-6}	340	1358	1.04
	1/33	R88G-HPG20A33100PB□	91	6.91	65	151	18.6 (18.1)	4.50×10^{-5}	916	3226	2.9
	1/45	R88G-HPG20A45100PB□	67	9.42	65	111	25.3 (24.7)	4.50×10^{-5}	1006	3541	2.9
200 W	1/5	R88G-HPG14A05200PB□	600	2.49	78	1000	7.01	2.07×10^{-5}	221	883	0.99
	1/11	R88G-HPG20A11200PB□	273	4.75	68	454	13.4	5.80×10^{-5}	659	2320	3.1
	1/21	R88G-HPG20A21200PB□	143	10.2	76	238	28.8	4.90×10^{-5}	800	2817	3.1
	1/33	R88G-HPG20A33200PB□	91	17.0	81	151	47.9	4.50×10^{-5}	916	3226	3.1
	1/45	R88G-HPG20A45200PB□	67	23.2	81	111	65.4	4.50×10^{-5}	1006	3541	3.1
400 W	1/5	R88G-HPG20A05400PB□	600	4.67	72	1000 (900)	13.1 (12.9)	7.10×10^{-5}	520	1832	3.1
	1/11	R88G-HPG20A11400PB□	273	11.7	82	454 (409)	32.9 (32.4)	5.80×10^{-5}	659	2320	3.1
	1/21	R88G-HPG20A21400PB□	143	23.5	86	238 (214)	66.2 (65.2)	4.90×10^{-5}	800	2817	3.1
	1/33	R88G-HPG32A33400PB□	91	34.7	81	151 (136)	97.6 (96.2)	2.80×10^{-4}	1565	6240	7.8
	1/45	R88G-HPG32A45400PB□	67	47.4	81	111 (100)	133.0 (131.2)	2.80×10^{-4}	1718	6848	7.8

Note 1. The values inside parentheses () are for 100-V Servomotors.

Note 2. The Decelerator inertia is the Servomotor shaft conversion value.

Note 3. The protective structure for Servomotors with Decelerators satisfies IP44.

Note 4. The allowable radial load is the value at the LR/2 position.

Note 5. The standard models have a straight shaft. Models with a key and tap are indicated with "J" at the end of the model number (the suffix in the box).

3-3 Decelerator Specifications

■ Backlash = 15' Max.

Decelerators for 3,000-r/min Servomotors

Model		Rated rotation speed	Rated torque	Efficiency	Maximum momentary rotation speed	Maximum momentary torque	Decelerator inertia	Allowable radial load	Allowable thrust load	Weight	
		r/min	N·m	%	r/min	N·m	kg·m ²	N	N	kg	
50 W	1/5	R88G-VRSF05B100CJ	600	0.52	65	1000	1.46	4.00×10^{-6}	392	196	0.55
	1/9	R88G-VRSF09B100CJ	333	0.93	65	556	2.63	3.50×10^{-6}	441	220	0.55
	1/15	R88G-VRSF15B100CJ	200	1.67	70	333	4.73	3.50×10^{-6}	588	294	0.70
	1/25	R88G-VRSF25B100CJ	120	2.78	70	200	7.88	3.25×10^{-6}	686	343	0.70
100 W	1/5	R88G-VRSF05B100CJ	600	1.19	75	1000	3.38	4.00×10^{-6}	392	196	0.55
	1/9	R88G-VRSF09B100CJ	333	2.29	80	556	6.48	3.50×10^{-6}	441	220	0.55
	1/15	R88G-VRSF15B100CJ	200	3.81	80	333	10.8	3.50×10^{-6}	588	294	0.70
	1/25	R88G-VRSF25B100CJ	120	6.36	80	200	18.0	3.25×10^{-6}	686	343	0.70
200 W	1/5	R88G-VRSF05B200CJ	600	2.70	85	1000	7.57	1.18×10^{-5}	392	196	0.72
	1/9	R88G-VRSF09C200CJ	333	3.77	66	556	10.6	2.75×10^{-5}	931	465	1.70
	1/15	R88G-VRSF15C200CJ	200	6.29	66	333	17.6	3.00×10^{-5}	1176	588	2.10
	1/25	R88G-VRSF25C200CJ	120	11.1	70	200	31.2	2.88×10^{-5}	1323	661	2.10

Model			Rated rotation speed	Rated torque	Efficiency	Maximum momentary rotation speed	Maximum momentary torque	Decelerator inertia	Allowable radial load	Allowable thrust load	Weight
			r/min	N·m	%	r/min	N·m	kg·m ²	N	N	kg
400 W	1/5	R88G-VRSF05C400CJ	600	5.40	85	1000	15.6 (15.3)	3.63×10^{-5}	784	392	1.70
	1/9	R88G-VRSF09C400CJ	333	9.50	83	556	27.4 (26.8)	2.75×10^{-5}	931	465	1.70
	1/15	R88G-VRSF15C400CJ	200	15.8	83	333	45.7 (44.8)	3.00×10^{-5}	1176	588	2.10
	1/25	R88G-VRSF25C400CJ	120	26.4	83	200	76.1 (74.7)	2.88×10^{-5}	1323	661	2.10
750 W	1/5	R88G-VRSF05C750CJ	600	10.7	90	1000	31.7	7.13×10^{-5}	784	392	2.10
	1/9	R88G-VRSF09D750CJ	333	18.2	85	556	53.9	6.50×10^{-5}	1176	588	3.40
	1/15	R88G-VRSF15D750CJ	200	30.4	85	333	89.9	7.00×10^{-5}	1372	686	3.80
	1/25	R88G-VRSF25D750CJ	120	50.7	85	200	149.8	6.80×10^{-5}	1617	808	3.80

Note 1. The values inside parentheses () are for 100-V Servomotors.

Note 2. The Decelerator inertia is the Servomotor shaft conversion value.

Note 3. The protective structure for Servomotors with Decelerators satisfies IP44.

Note 4. The allowable radial load is the value at the LR/2 position.

Note 5. The standard models have a straight shaft with a key.

3-3 Decelerator Specifications

Decelerators for 3,000-r/min Flat Servomotors

Model		Rated rotation speed	Rated torque	Efficiency	Maximum momentary rotation speed	Maximum momentary torque	Decelerator inertia	Allowable radial load	Allowable thrust load	Weight	
		r/min	N·m	%	r/min	N·m	kg·m ²	N	N	kg	
100 W	1/5	R88G-VRSF05B100PCJ	600	1.19	75	1000	3.15	4.00×10^{-6}	392	196	0.72
	1/9	R88G-VRSF09B100PCJ	333	2.29	80	556	6.048	3.50×10^{-6}	441	220	0.72
	1/15	R88G-VRSF15B100PCJ	200	3.81	80	333	10.08	3.50×10^{-6}	588	294	0.87
	1/25	R88G-VRSF25B100PCJ	120	6.36	80	200	16.8	3.25×10^{-6}	686	343	0.85
200 W	1/5	R88G-VRSF05B200PCJ	600	2.70	85	1000	7.65	1.18×10^{-5}	392	196	0.85
	1/9	R88G-VRSF09C200PCJ	333	3.77	66	556	10.692	2.75×10^{-5}	931	465	1.80
	1/15	R88G-VRSF15C200PCJ	200	6.29	66	333	17.82	3.00×10^{-5}	1176	588	2.20
	1/25	R88G-VRSF25C200PCJ	120	11.1	70	200	31.5	2.88×10^{-5}	1323	661	2.20
400 W	1/5	R88G-VRSF05C400PCJ	600	5.40	85	1000 (900)	15.5 (15.3)	3.63×10^{-5}	784	392	1.80
	1/9	R88G-VRSF09C400PCJ	333	9.50	83	556 (500)	27.3 (26.9)	2.75×10^{-5}	931	465	1.80
	1/15	R88G-VRSF15C400PCJ	200	15.8	83	333 (300)	45.4 (44.8)	3.00×10^{-5}	1176	588	2.20
	1/25	R88G-VRSF25C400PCJ	120	26.4	83	200 (180)	75.7 (74.7)	2.88×10^{-5}	1323	661	2.20

Note 1. The values inside parentheses () are for 100-V Servomotors.

Note 2. The Decelerator inertia is the Servomotor shaft conversion value.

Note 3. The protective structure for Servomotors with Decelerators satisfies IP44.

Note 4. The allowable radial load is the value at the LR/2 position.

Note 5. The standard models have a straight shaft with a key.

3-4 Cable and Connector Specifications

Encoder Cable Specifications

These cables are used to connect the encoder between a Servo Drive and Servomotor. Select the Encoder Cable matching the Servomotor.

Encoder Cables (Standard Cables)

R88A-CRGA□C

Cable Models

For absolute encoders: 3,000-r/min Servomotors of 50 to 750 W and 3,000-r/min Flat Servomotors of 100 to 400 W

Model	Length (L)	Outer diameter of sheath	Weight
R88A-CRGA003C	3 m	6.5 dia.	Approx. 0.2 kg
R88A-CRGA005C	5 m		Approx. 0.3 kg
R88A-CRGA010C	10 m		Approx. 0.6 kg
R88A-CRGA015C	15 m		Approx. 0.9 kg
R88A-CRGA020C	20 m		Approx. 1.2 kg
R88A-CRGA030C	30 m	6.8 dia.	Approx. 2.4 kg
R88A-CRGA040C	40 m		Approx. 3.2 kg
R88A-CRGA050C	50 m		Approx. 4.0 kg

Connection Configuration and Dimensions

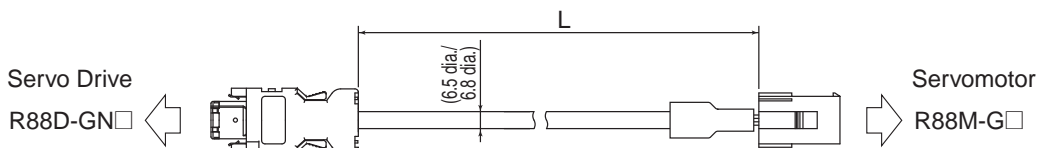

Wiring

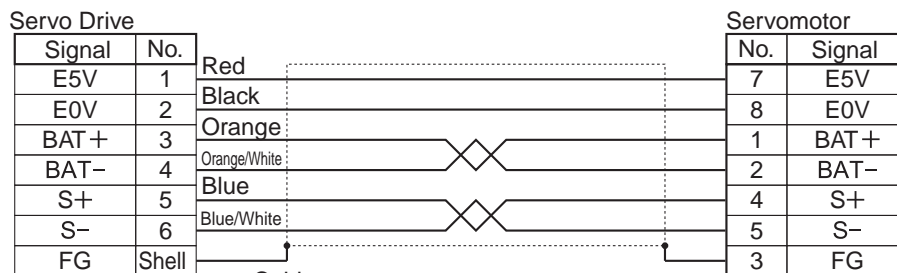

Cable:
 Servo Drive Connector: AWG22×2C + AWG24×2P UL20276 (3 to 20 m)
 Connector: AWG16×2C + AWG26×2P UL20276 (30 to 50 m)

3 to 20 m: Crimp-type I/O Connector (Molex Japan)
 30 to 50 m: 55100-0670 (Molex Japan)

Connector pins:
 50639-8028 (Molex Japan)

Servomotor Connector:
 Connector: 172161-1 (Tyco Electronics AMP KK)

Connector pins:
 170365-1 (Tyco Electronics AMP KK)

171639-1 (Tyco Electronics AMP KK)
 for AWG16

R88A-CRGB□C

Cable Models

For incremental encoders: 3,000-r/min Servomotors of 50 to 750 W and 3,000-r/min Flat Servomotors of 100 to 400 W

Model	Length (L)	Outer diameter of sheath	Weight
R88A-CRGB003C	3 m	6.5 dia.	Approx. 0.2 kg
R88A-CRGB005C	5 m		Approx. 0.3 kg
R88A-CRGB010C	10 m		Approx. 0.6 kg
R88A-CRGB015C	15 m		Approx. 0.9 kg
R88A-CRGB020C	20 m		Approx. 1.2 kg
R88A-CRGB030C	30 m	6.8 dia.	Approx. 2.4 kg
R88A-CRGB040C	40 m		Approx. 3.2 kg
R88A-CRGB050C	50 m		Approx. 4.0 kg

Connection Configuration and Dimensions

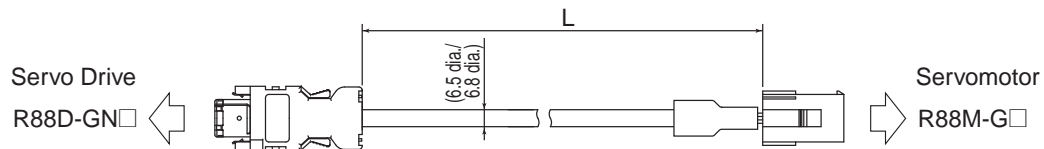

Wiring

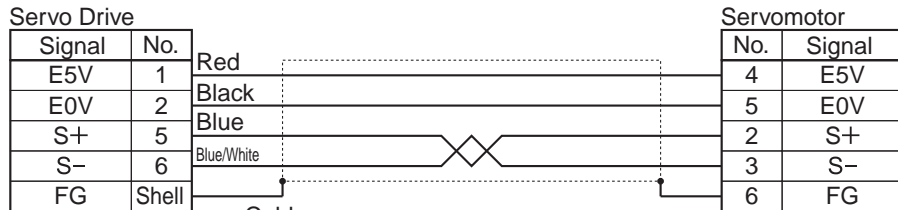

Servo Drive Connector
 Connector: AWG22×2C + AWG24×2P UL20276 (3 to 20 m)
 AWG16×2C + AWG26×2P UL20276 (30 to 50 m)

3 to 20 m: Crimp-type I/O Connector (Molex Japan)
 30 to 50 m: 55100-0670 (Molex Japan)

Connector pins:
 50639-8028 (Molex Japan)

Servomotor Connector
 Connector:

172160-1 (Tyco Electronics AMP KK)

Connector pins:

170365-1 (Tyco Electronics AMP KK)

171639-1 (Tyco Electronics AMP KK)

for AWG16

R88A-CRGC□N

Cable Models

For both absolute encoders and incremental encoders: 3,000-r/min Servomotors of 1 to 5 kW, 2,000-r/min Servomotors of 1 to 5 kW, 1,500-r/min Servomotors of 7.5 kW, and 1,000-r/min Servomotors of 900 W to 6 kW

Model	Length (L)	Outer diameter of sheath	Weight
R88A-CRGC003N	3 m	6.5 dia.	Approx. 0.3 kg
R88A-CRGC005N	5 m		Approx. 0.4 kg
R88A-CRGC010N	10 m		Approx. 0.7 kg
R88A-CRGC015N	15 m		Approx. 1.0 kg
R88A-CRGC020N	20 m		Approx. 1.5 kg
R88A-CRGC030N	30 m	6.8 dia.	Approx. 2.5 kg
R88A-CRGC040N	40 m		Approx. 3.3 kg
R88A-CRGC050N	50 m		Approx. 4.1 kg

Connection Configuration and Dimensions

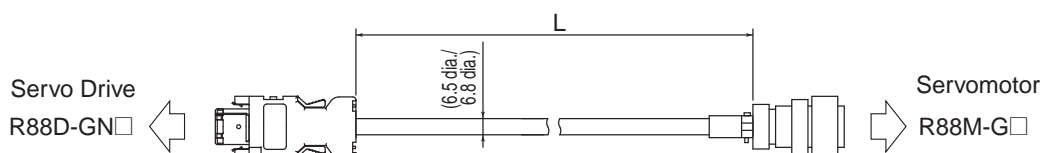

Wiring

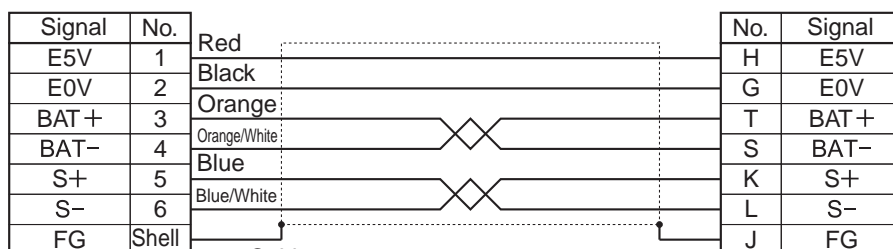

Cable:
 Servo Drive Connector AWG22×2C + AWG24×2P UL20276 (3 to 20 m)
 Connector: AWG16×2C + AWG26×2P UL20276 (30 to 50 m)

3 to 20 m: Crimp-type I/O Connector (Molex Japan)
 30 to 50 m: 55100-0670 (Molex Japan)

Connector pins:
 50639-8028 (Molex Japan)

Servomotor Connector
 Straight plug:
 N/MS3106B20-29S
 (Japan Aviation Electronics)
 Cable clamp:
 N/MS3057-12A
 (Japan Aviation Electronics)

Encoder Cables (Robot Cables)

R88A-CRGA□CR

Cable Models

For absolute encoders: 3,000-r/min Servomotors of 50 to 750 W and 3,000-r/min Flat Servomotors of 100 to 400 W

Model	Length (L)	Outer diameter of sheath	Weight
R88A-CRGA003CR	3 m	7.5 dia.	Approx. 0.2 kg
R88A-CRGA005CR	5 m		Approx. 0.4 kg
R88A-CRGA010CR	10 m		Approx. 0.8 kg
R88A-CRGA015CR	15 m		Approx. 1.1 kg
R88A-CRGA020CR	20 m		Approx. 1.5 kg
R88A-CRGA030CR	30 m	8.2 dia.	Approx. 2.8 kg
R88A-CRGA040CR	40 m		Approx. 3.7 kg
R88A-CRGA050CR	50 m		Approx. 4.6 kg

Connection Configuration and Dimensions

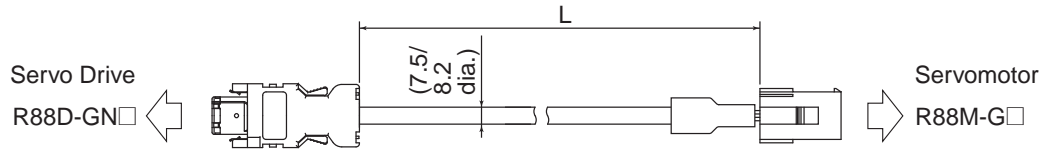

Wiring (3 to 20 m)

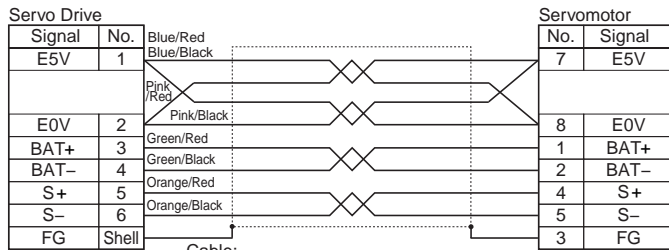

Servo Drive Connector: AWG24x4P UL20276

Connector:

Crimp-type I/O Connector (Molex Japan)

Connector pins:

50639-8028 (Molex Japan)

Servomotor Connector:

Connector:

172161-1 (Tyco Electronics AMP KK)

Connector pins:

170365-1 (Tyco Electronics AMP KK)

Wiring (30 to 50 m)

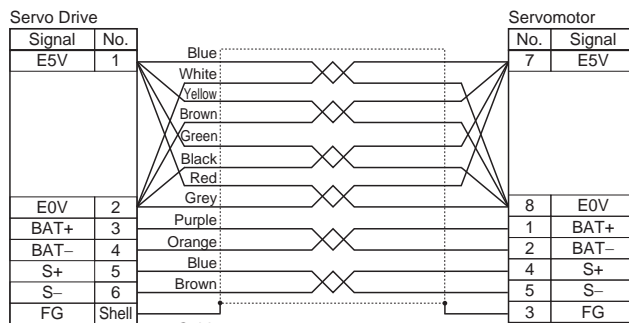

Servo Drive Connector: AWG25 x 6P UL2517

Connector:

Crimp-type I/O Connector (Molex Japan)

Connector pins:

50639-8028 (Molex Japan)

Servomotor Connector:

Connector:

172161-1 (Tyco Electronics AMP KK)

Connector pins:

170365-1 (Tyco Electronics AMP KK)

R88A-CRGB□CR

Cable Models

For incremental encoders: 3,000-r/min Servomotors of 50 to 750 W and 3,000-r/min Flat Servomotors of 100 to 400 W

Model	Length (L)	Outer diameter of sheath	Weight
R88A-CRGB003CR	3 m	7.5 dia.	Approx. 0.2 kg
R88A-CRGB005CR	5 m		Approx. 0.4 kg
R88A-CRGB010CR	10 m		Approx. 0.8 kg
R88A-CRGB015CR	15 m		Approx. 1.1 kg
R88A-CRGB020CR	20 m		Approx. 1.5 kg
R88A-CRGB030CR	30 m	8.2 dia.	Approx. 2.8 kg
R88A-CRGB040CR	40 m		Approx. 3.7 kg
R88A-CRGB050CR	50 m		Approx. 4.6 kg

Connection Configuration and Dimensions

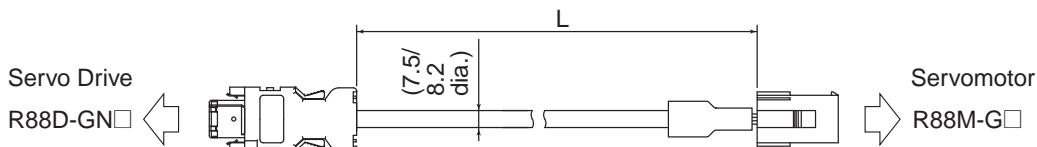

Wiring (3 to 20 m)

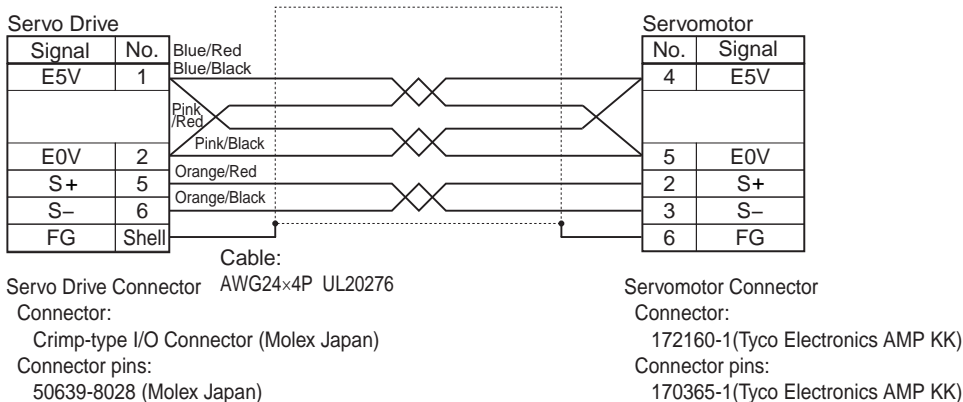

Wiring (30 to 50 m)

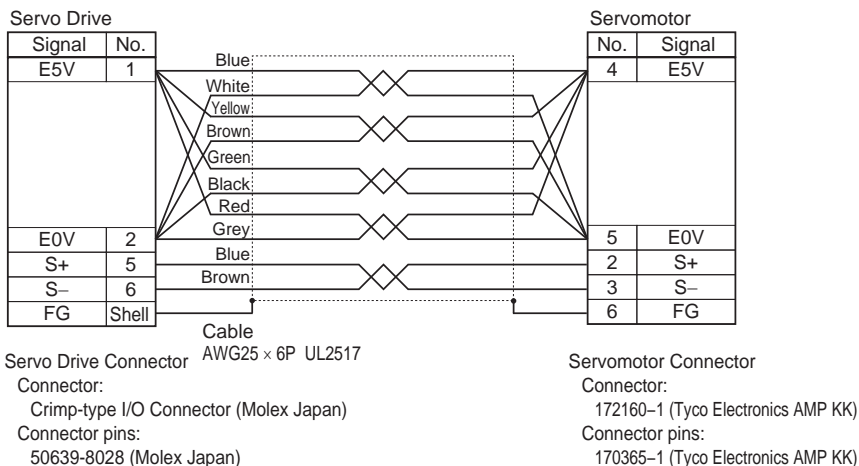

R88A-CRGC□NR

Cable Models

For both absolute encoders and incremental encoders: 3,000-r/min Servomotors of 1 to 5 kW, 2,000-r/min Servomotors of 1 to 5 kW, 1,000-r/min Servomotors of 900 W to 4.5 kW

Model	Length (L)	Outer diameter of sheath	Weight
R88A-CRGC003NR	3 m	7.5 dia.	Approx. 0.4 kg
R88A-CRGC005NR	5 m		Approx. 0.5 kg
R88A-CRGC010NR	10 m		Approx. 0.9 kg
R88A-CRGC015NR	15 m		Approx. 1.3 kg
R88A-CRGC020NR	20 m		Approx. 1.6 kg
R88A-CRGC010NR	30 m	8.2 dia.	Approx. 2.9 kg
R88A-CRGC015NR	40 m		Approx. 3.8 kg
R88A-CRGC020NR	50 m		Approx. 4.7 kg

Connection Configuration and Dimensions

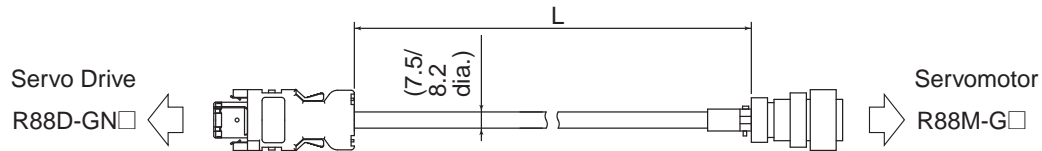

Wiring (3 to 20 m)

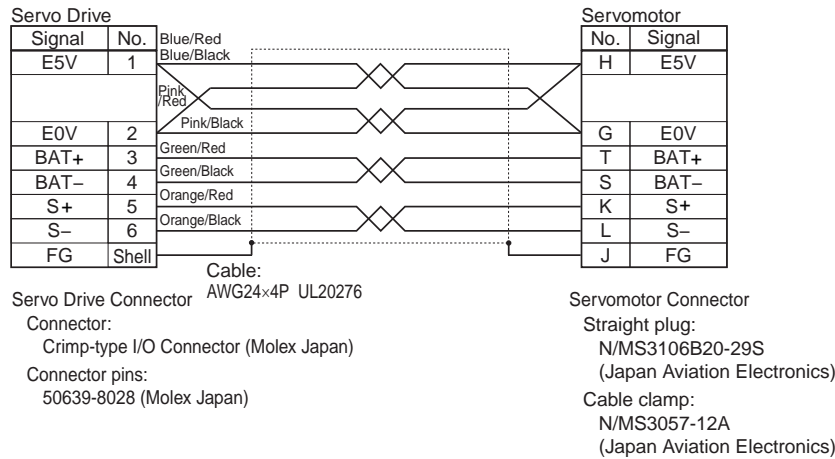

Wiring (30 to 50 m)

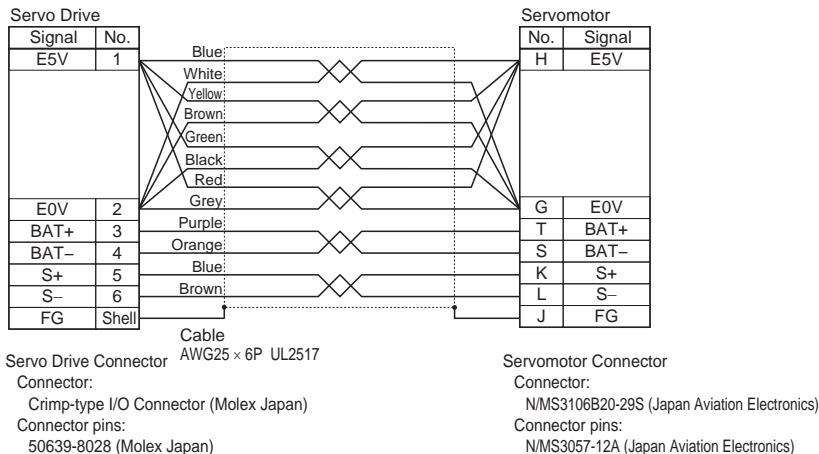

Absolute Encoder Battery Cable Specifications **ABS**

Cable Models

Model	Length (L)
R88A-CRGD0R3C	0.3 m

Connection Configuration and Dimensions

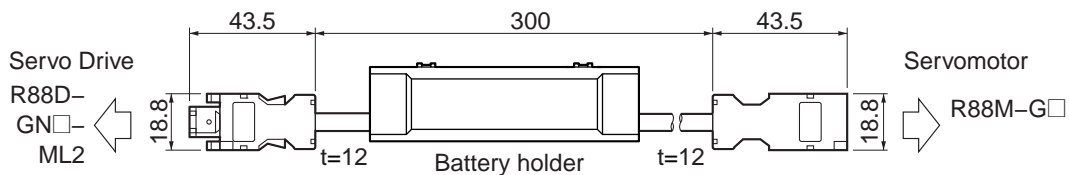

Wiring

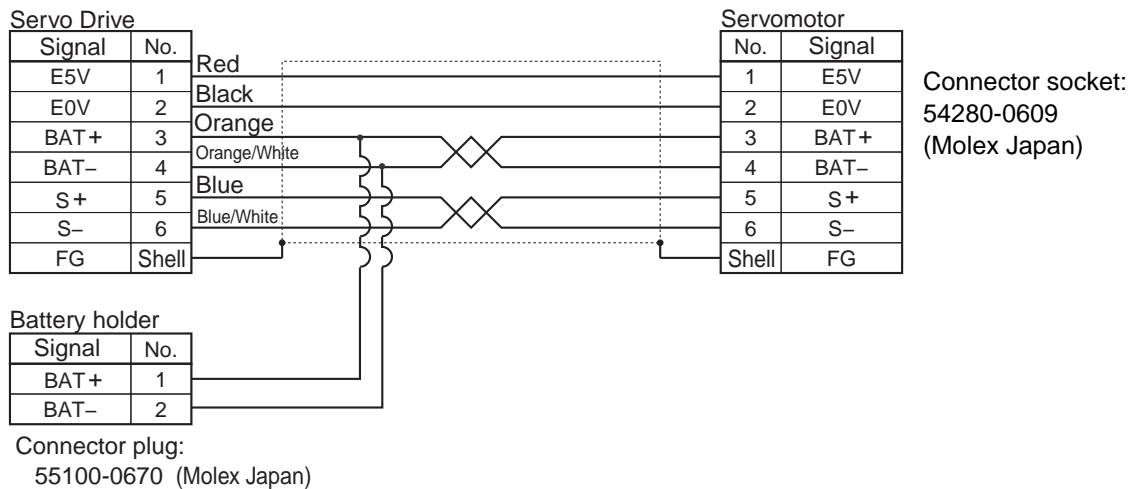

Servomotor Power Cable Specifications

These cables connect the Servo Drive and Servomotor. Select the cable matching the Servomotor.

Precautions for Correct Use

♦ Use a robot cable if the Servomotor is to be used on moving parts.

■ Power Cables for Servomotors without Brakes (Standard Cables)

R88A-CAGA□S

Cable Models

For 3,000-r/min Servomotors of 50 to 750 W and 3,000-r/min Flat Servomotors of 100 to 400 W

Model	Length (L)	Outer diameter of sheath	Weight
R88A-CAGA003S	3 m	6.2 dia.	Approx. 0.2 kg
R88A-CAGA005S	5 m		Approx. 0.3 kg
R88A-CAGA010S	10 m		Approx. 0.6 kg
R88A-CAGA015S	15 m		Approx. 0.9 kg
R88A-CAGA020S	20 m		Approx. 1.2 kg
R88A-CAGA030S	30 m		Approx. 1.8 kg
R88A-CAGA040S	40 m		Approx. 2.4 kg
R88A-CAGA050S	50 m		Approx. 3.0 kg

Connection Configuration and Dimensions

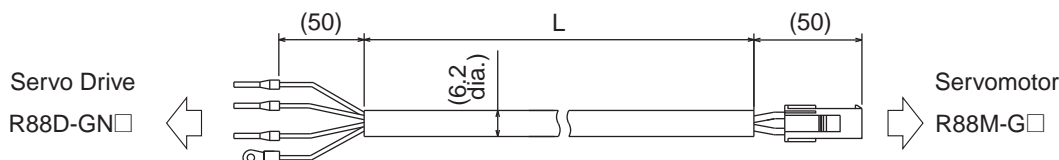

Wiring

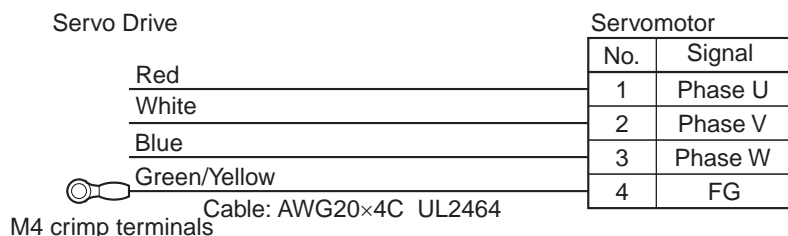

Servomotor Connector

Connector:

172159-1 (Tyco Electronics AMP KK)

Connector pins:

170362-1 (Tyco Electronics AMP KK)

170366-1 (Tyco Electronics AMP KK)

R88A-CAGB□S

Cable Models

For 3,000-r/min Servomotors of 1 to 1.5 kW, 2,000-r/min Servomotors of 1 to 1.5 kW, and 1,000-r/min Servomotors of 900 W

Model	Length (L)	Outer diameter of sheath	Weight
R88A-CAGB003S	3 m	10.4 dia.	Approx. 0.7 kg
R88A-CAGB005S	5 m		Approx. 1.0 kg
R88A-CAGB010S	10 m		Approx. 2.0 kg
R88A-CAGB015S	15 m		Approx. 2.9 kg
R88A-CAGB020S	20 m		Approx. 3.8 kg
R88A-CAGB030S	30 m		Approx. 5.6 kg
R88A-CAGB040S	40 m		Approx. 7.4 kg
R88A-CAGB050S	50 m		Approx. 9.2 kg

Connection Configuration and Dimensions

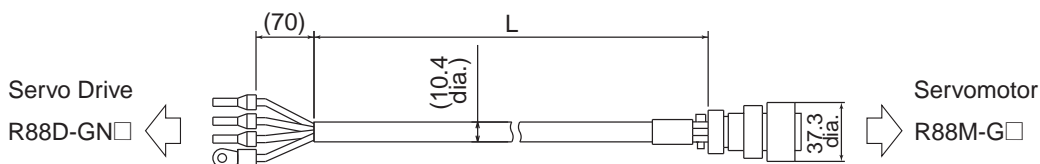

Wiring

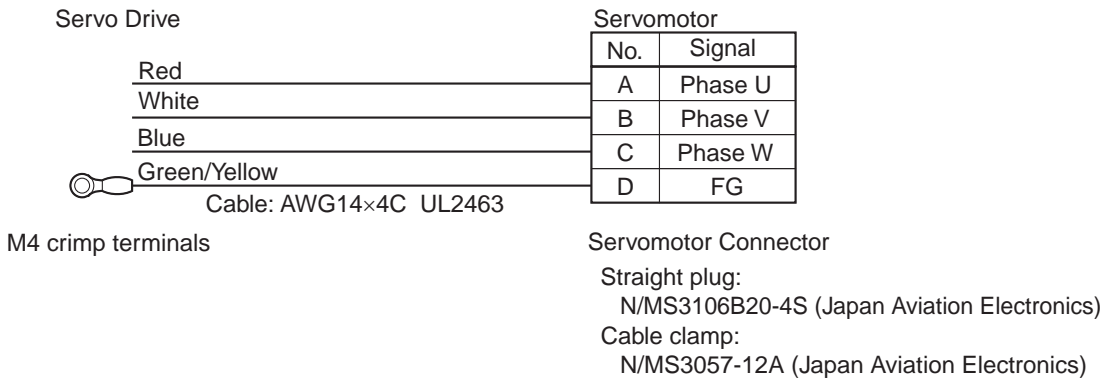

R88A-CAGC□S

Cable Models

For 3,000-r/min Servomotors of 2 kW and 2,000-r/min Servomotors of 2 kW

Model	Length (L)	Outer diameter of sheath	Weight
R88A-CAGC003S	3 m	10.4 dia.	Approx. 0.7 kg
R88A-CAGC005S	5 m		Approx. 1.0 kg
R88A-CAGC010S	10 m		Approx. 2.0 kg
R88A-CAGC015S	15 m		Approx. 2.9 kg
R88A-CAGC020S	20 m		Approx. 3.8 kg
R88A-CAGC030S	30 m		Approx. 5.6 kg
R88A-CAGC040S	40 m		Approx. 7.4 kg
R88A-CAGC050S	50 m		Approx. 9.2 kg

Connection Configuration and Dimensions

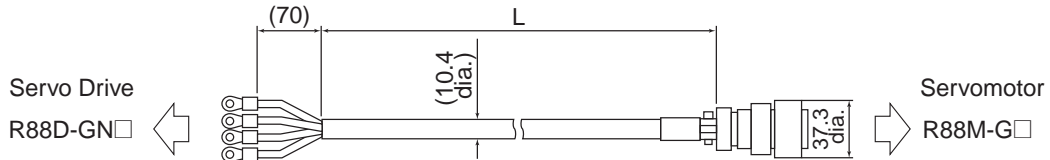

Wiring

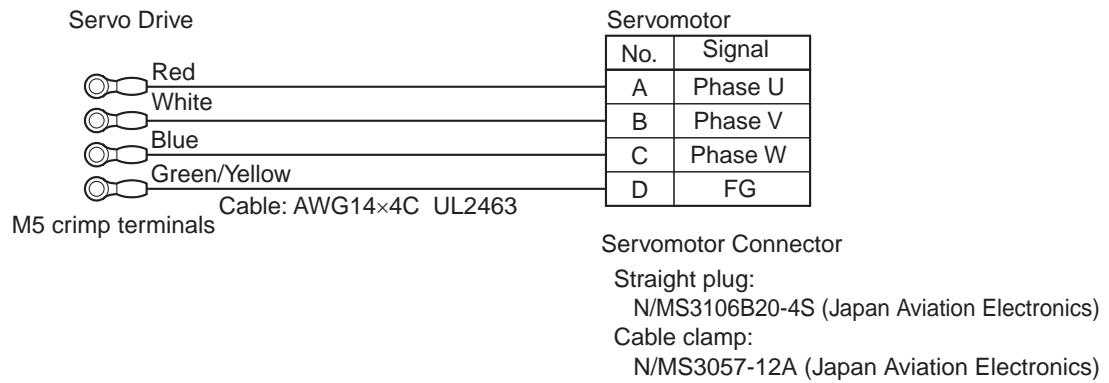

R88A-CAGD□S

Cable Models

For 3,000-r/min Servomotors of 3 to 5 kW, 2,000-r/min Servomotors of 3 to 5 kW, and 1,000-r/min Servomotors of 2 to 4.5 kW

Model	Length (L)	Outer diameter of sheath	Weight
R88A-CAGD003S	3 m	14.7 dia.	Approx. 1.3 kg
R88A-CAGD005S	5 m		Approx. 2.1 kg
R88A-CAGD010S	10 m		Approx. 4.0 kg
R88A-CAGD015S	15 m		Approx. 6.0 kg
R88A-CAGD020S	20 m		Approx. 8.0 kg
R88A-CAGD030S	30 m		Approx. 11.9 kg
R88A-CAGD040S	40 m		Approx. 15.8 kg
R88A-CAGD050S	50 m		Approx. 19.7 kg

Connection Configuration and Dimensions

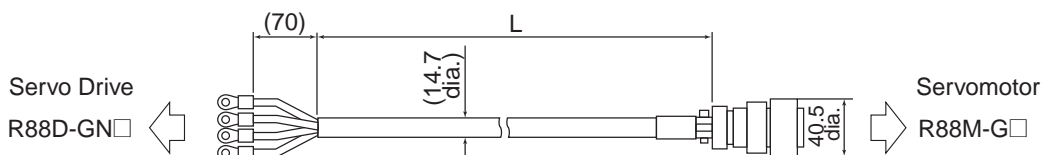

Wiring

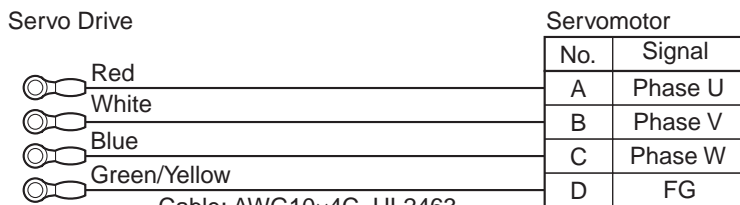

M5 crimp terminals

Servomotor Connector

- Straight plug:
N/MS3106B22-22S (Japan Aviation Electronics)
- Cable clamp:
N/MS3057-12A (Japan Aviation Electronics)

R88A-CAGE□S

Cable Models

For 1,500-r/min Servomotors of 7.5 kW and 1,000-r/min Servomotors of 6 kW

Model	Length (L)	Outer diameter of sheath	Weight
R88A-CAGE003S	3 m	28.5 dia.	Approx. 4.0 kg
R88A-CAGE005S	5 m		Approx. 6.5 kg
R88A-CAGE010S	10 m		Approx. 12.6 kg
R88A-CAGE015S	15 m		Approx. 18.8 kg
R88A-CAGE020S	20 m		Approx. 24.9 kg
R88A-CAGE030S	30 m		Approx. 37.2 kg
R88A-CAGE040S	40 m		Approx. 49.5 kg
R88A-CAGE050S	50 m		Approx. 61.8 kg

Connection Configuration and Dimensions

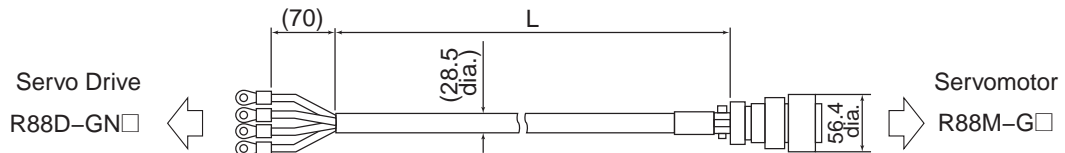

Wiring

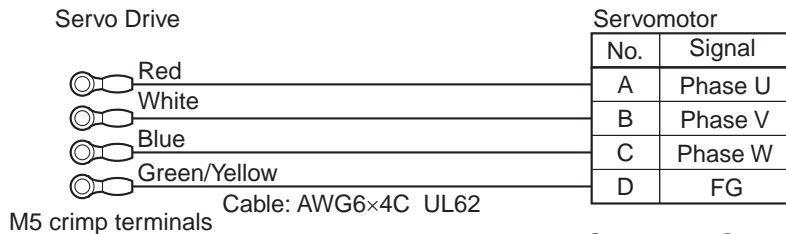

Servomotor Connector

Straight plug:

N/MS3106B32-17S (Japan Aviation Electronics)

Cable clamp:

N/MS3057-20A (Japan Aviation Electronics)

■ Power Cables for Servomotors without Brakes (Robot Cables)

R88A-CAGA□SR

Cable Models

For 3,000-r/min Servomotors of 50 to 750 W and 3,000-r/min Flat Servomotors of 100 to 400 W

Model	Length (L)	Outer diameter of sheath	Weight
R88A-CAGA003SR	3 m	6.9 dia.	Approx. 0.2 kg
R88A-CAGA005SR	5 m		Approx. 0.3 kg
R88A-CAGA010SR	10 m		Approx. 0.7 kg
R88A-CAGA015SR	15 m		Approx. 1.0 kg
R88A-CAGA020SR	20 m		Approx. 1.3 kg
R88A-CAGA030SR	30 m		Approx. 1.9 kg
R88A-CAGA040SR	40 m		Approx. 2.6 kg
R88A-CAGA050SR	50 m		Approx. 3.2 kg

Connection Configuration and Dimensions

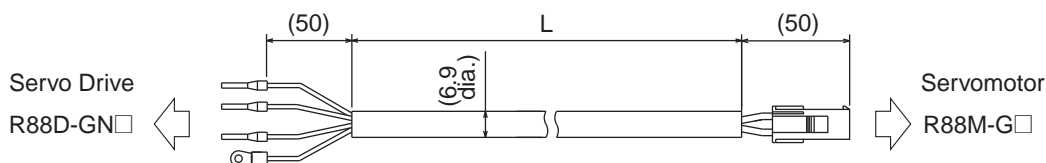

Wiring

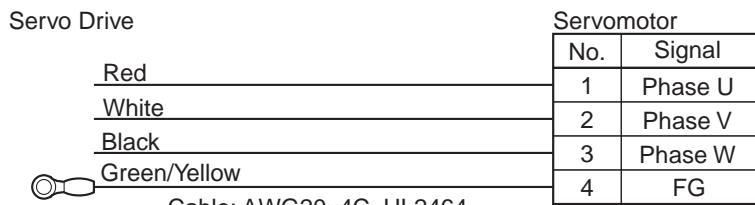

Cable: AWG20×4C UL2464

M4 crimp terminals

Servomotor Connector

Connector:

172159-1(Tyco Electronics AMP KK)

Connector pins:

170362-1(Tyco Electronics AMP KK)

170366-1(Tyco Electronics AMP KK)

3-4 Cable and Connector Specifications

R88A-CAGB□SR

Cable Models

For 3,000-r/min Servomotors of 1 to 1.5 kW, 2,000-r/min Servomotors of 1 to 1.5 kW, and 1,000-r/min Servomotors of 900 W

Model	Length (L)	Outer diameter of sheath	Weight
R88A-CAGB003SR	3 m	12.7 dia.	Approx. 0.8 kg
R88A-CAGB005SR	5 m		Approx. 1.3 kg
R88A-CAGB010SR	10 m		Approx. 2.4 kg
R88A-CAGB015SR	15 m		Approx. 3.5 kg
R88A-CAGB020SR	20 m		Approx. 4.6 kg
R88A-CAGB030SR	30 m		Approx. 6.9 kg
R88A-CAGB040SR	40 m		Approx. 9.2 kg
R88A-CAGB050SR	50 m		Approx. 11.4 kg

Connection Configuration and Dimensions

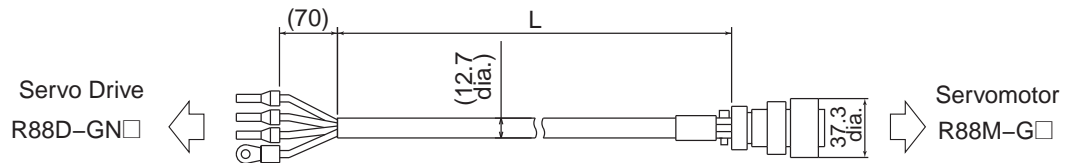

Wiring

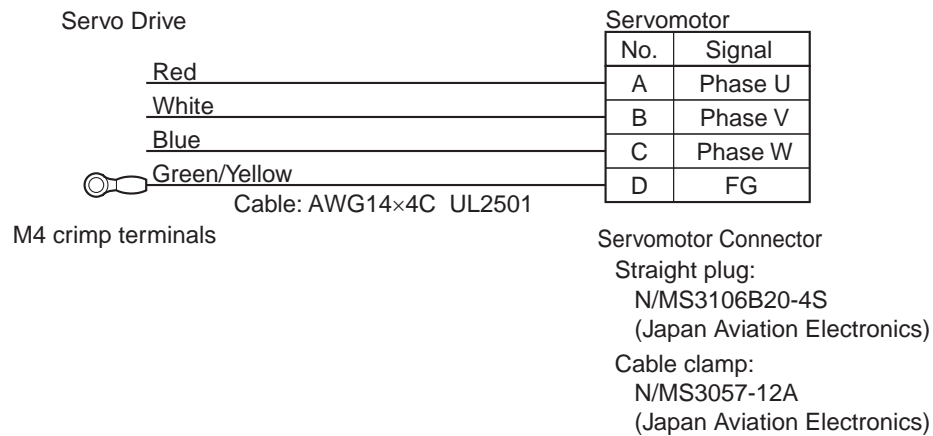

R88A-CAGC□SR

Cable Models

For 3,000-r/min Servomotors of 2 kW and 2,000-r/min Servomotors of 2 kW

Model	Length (L)	Outer diameter of sheath	Weight
R88A-CAGC003SR	3 m	12.7 dia.	Approx. 0.8 kg
R88A-CAGC005SR	5 m		Approx. 1.3 kg
R88A-CAGC010SR	10 m		Approx. 2.4 kg
R88A-CAGC015SR	15 m		Approx. 3.5 kg
R88A-CAGC020SR	20 m		Approx. 4.6 kg
R88A-CAGC030SR	30 m		Approx. 6.9 kg
R88A-CAGC040SR	40 m		Approx. 9.2 kg
R88A-CAGC050SR	50 m		Approx. 11.4 kg

Connection Configuration and Dimensions

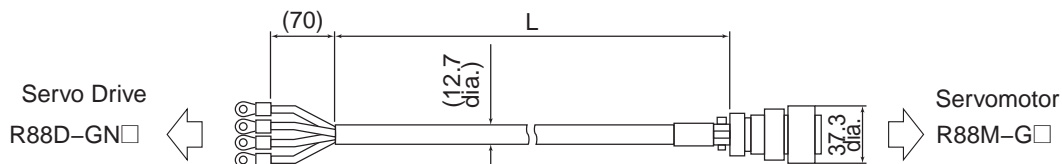

Wiring

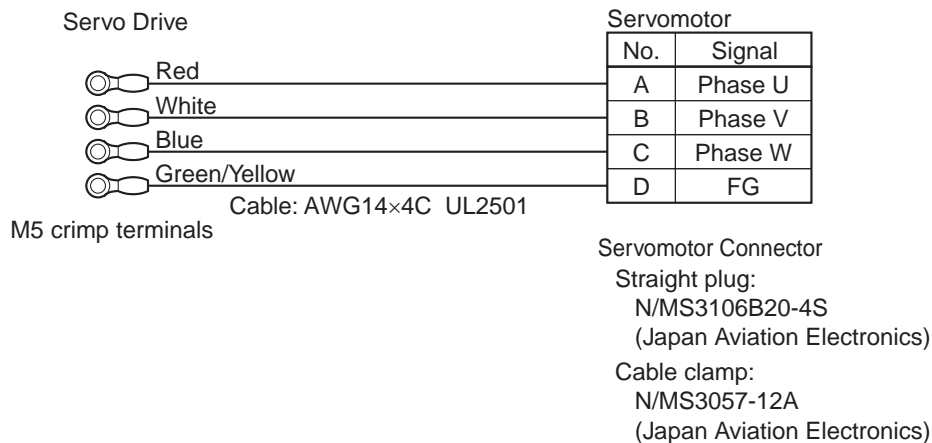

3-4 Cable and Connector Specifications

R88A-CAGD□SR

Cable Models

For 3,000-r/min Servomotors of 3 to 5 kW, 2,000-r/min Servomotors of 3 to 5 kW, and 1,000-r/min Servomotors of 2 to 4.5 kW

Model	Length (L)	Outer diameter of sheath	Weight
R88A-CAGD003SR	3 m	15.6 dia.	Approx. 1.4 kg
R88A-CAGD005SR	5 m		Approx. 2.2 kg
R88A-CAGD010SR	10 m		Approx. 4.2 kg
R88A-CAGD015SR	15 m		Approx. 6.3 kg
R88A-CAGD020SR	20 m		Approx. 8.3 kg
R88A-CAGD030SR	30 m		Approx. 12.4 kg
R88A-CAGD040SR	40 m		Approx. 16.5 kg
R88A-CAGD050SR	50 m		Approx. 20.5 kg

Connection Configuration and Dimensions

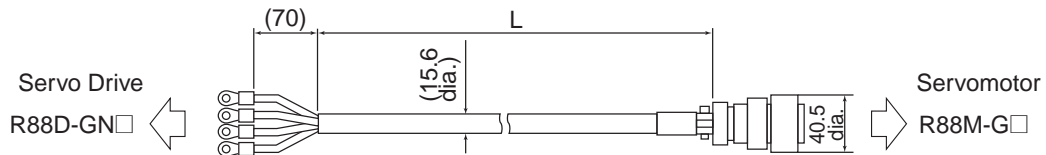

Wiring

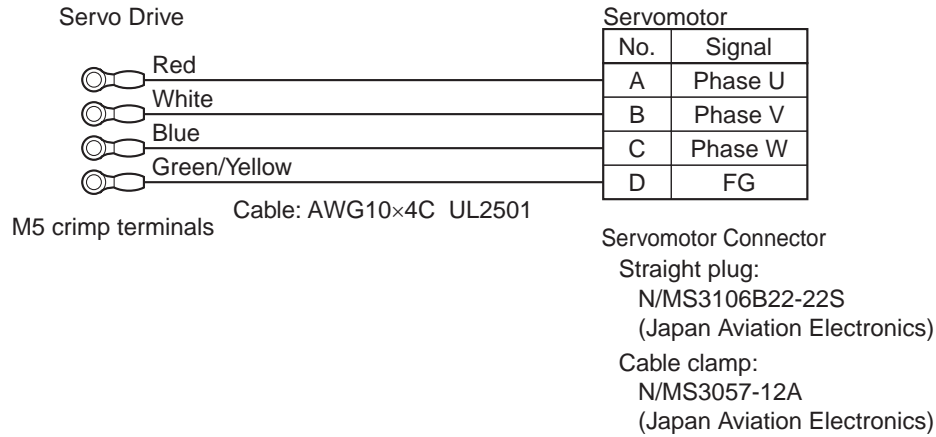

■ Power Cables for Servomotors with Brakes (Standard Cables)

R88A-CAGB□B

Cable Models

For 3,000-r/min Servomotors of 1 to 1.5 kW, 2,000-r/min Servomotors of 1 to 1.5 kW, and 1,000-r/min Servomotors of 900 W

Model	Length (L)	Outer diameter of sheath	Weight
R88A-CAGB003B	3 m	10.4/5.4 dia.	Approx. 0.8 kg
R88A-CAGB005B	5 m		Approx. 1.3 kg
R88A-CAGB010B	10 m		Approx. 2.4 kg
R88A-CAGB015B	15 m		Approx. 3.5 kg
R88A-CAGB020B	20 m		Approx. 4.6 kg
R88A-CAGB030B	30 m		Approx. 6.8 kg
R88A-CAGB040B	40 m		Approx. 9.1 kg
R88A-CAGB050B	50 m		Approx. 11.3 kg

Connection Configuration and Dimensions

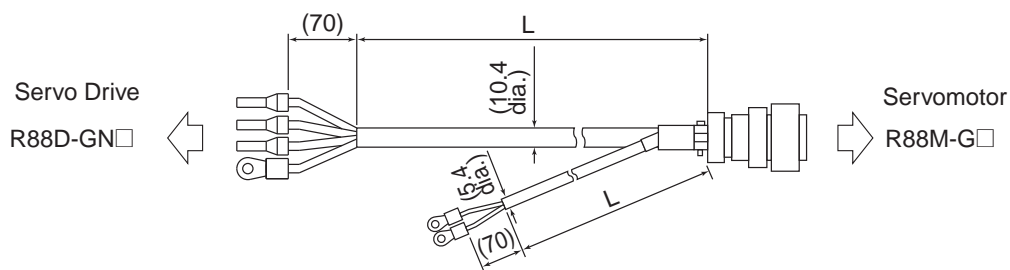

Wiring

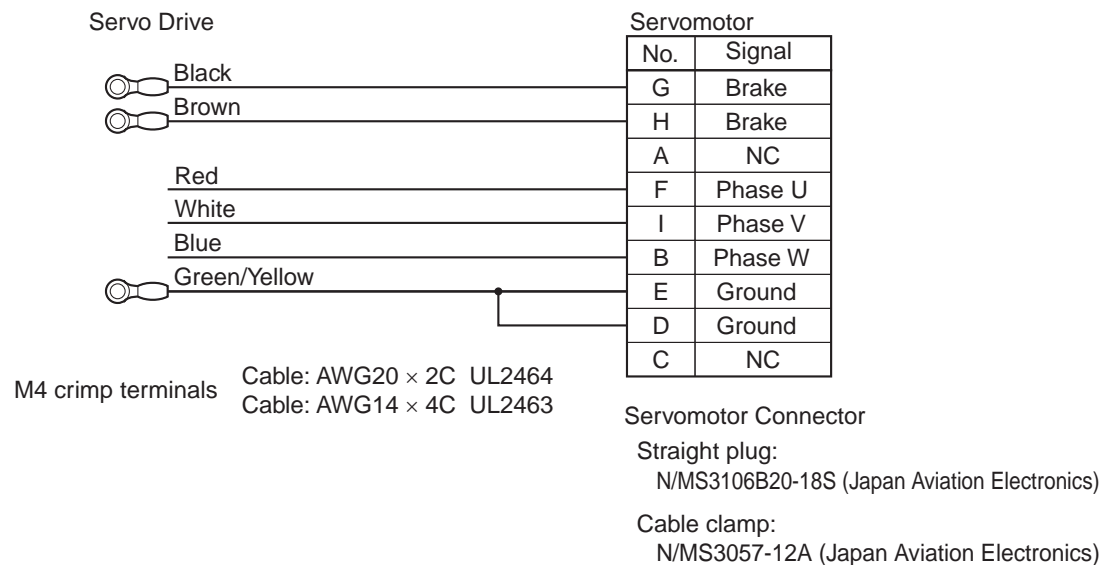

R88A-CAGC□B

Cable Models

For 3,000-r/min Servomotors of 2 kW and 2,000-r/min Servomotors of 2 kW

Model	Length (L)	Outer diameter of sheath	Weight
R88A-CAGC003B	3 m	10.4/5.4 dia.	Approx. 0.8 kg
R88A-CAGC005B	5 m		Approx. 1.3 kg
R88A-CAGC010B	10 m		Approx. 2.4 kg
R88A-CAGC015B	15 m		Approx. 3.5 kg
R88A-CAGC020B	20 m		Approx. 4.6 kg
R88A-CAGC030B	30 m		Approx. 6.8 kg
R88A-CAGC040B	40 m		Approx. 9.1 kg
R88A-CAGC050B	50 m		Approx. 11.3 kg

Connection Configuration and Dimensions

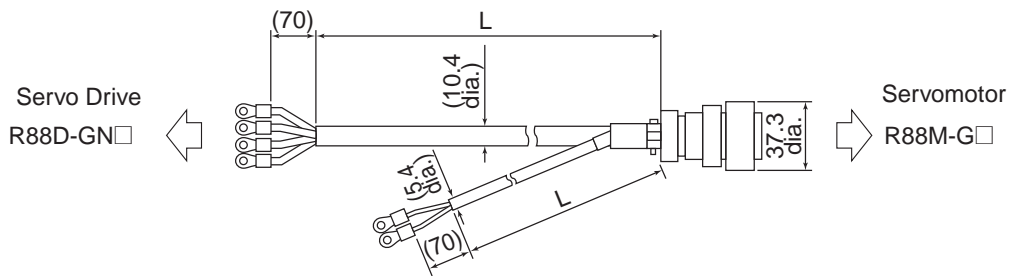

Wiring

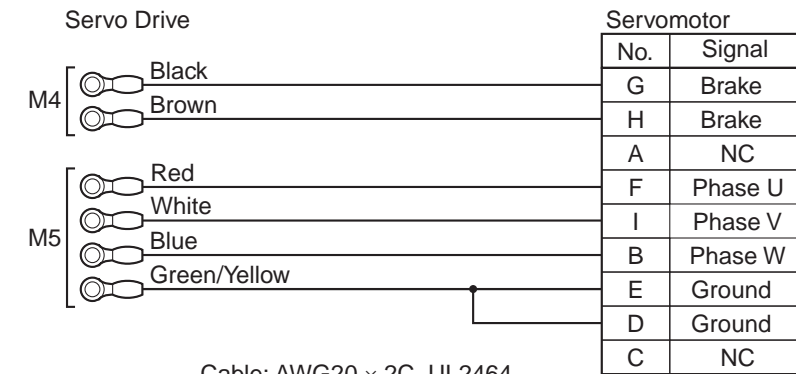

Crimp terminals Cable: AWG20 × 2C UL2464
Cable: AWG14 × 4C UL2463

Servomotor Connector

Straight plug:

N/MS3106B20-18S (Japan Aviation Electronics)

Cable clamp:

N/MS3057-12A (Japan Aviation Electronics)

R88A-CAGD□B

Cable Models

For 3,000-r/min Servomotors of 3 to 5 kW, 2,000-r/min Servomotors of 3 to 5 kW, and 1,000-r/min Servomotors of 2 to 4.5 kW

Model	Length (L)	Outer diameter of sheath	Weight
R88A-CAGD003B	3 m	14.7/5.4 dia.	Approx. 1.5 kg
R88A-CAGD005B	5 m		Approx. 2.4 kg
R88A-CAGD010B	10 m		Approx. 4.5 kg
R88A-CAGD015B	15 m		Approx. 6.7 kg
R88A-CAGD020B	20 m		Approx. 8.8 kg
R88A-CAGD030B	30 m		Approx. 13.1 kg
R88A-CAGD040B	40 m		Approx. 17.4 kg
R88A-CAGD050B	50 m		Approx. 21.8 kg

Connection Configuration and Dimensions

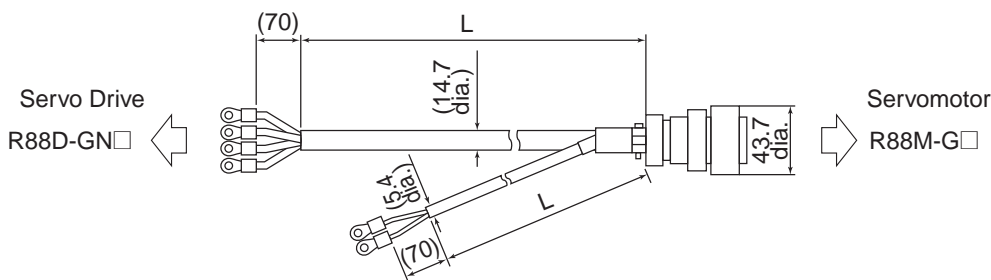

Wiring

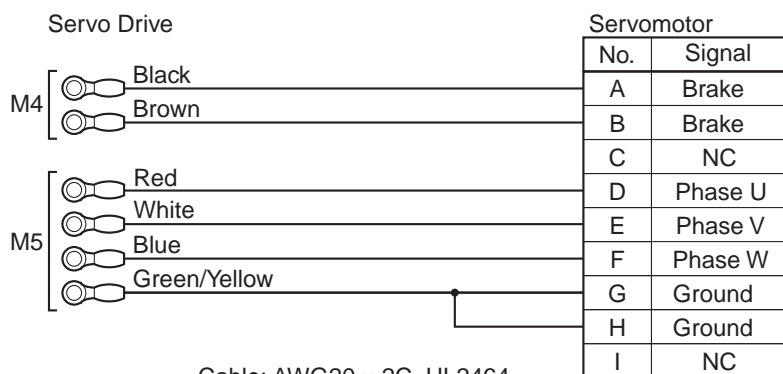

Crimp terminals Cable: AWG20 × 2C UL2464
Cable: AWG10 × 4C UL2463

Servomotor Connector

Straight plug:
N/MS3106B24-11S (Japan Aviation Electronics)
Cable clamp:
N/MS3057-16A (Japan Aviation Electronics)

■ Power Cables for Servomotors with Brakes (Robot Cables)

R88A-CAGB□BR

Cable Models

For 3,000-r/min Servomotors of 1 to 1.5 kW, 2,000-r/min Servomotors of 1 to 1.5 kW, and 1,000-r/min Servomotors of 900 W

Model	Length (L)	Outer diameter of sheath	Weight
R88A-CAGB003BR	3 m	12.7/6.1 dia.	Approx. 0.9 kg
R88A-CAGB005BR	5 m		Approx. 1.5 kg
R88A-CAGB010BR	10 m		Approx. 2.8 kg
R88A-CAGB015BR	15 m		Approx. 4.2 kg
R88A-CAGB020BR	20 m		Approx. 5.5 kg
R88A-CAGB030BR	30 m		Approx. 8.2 kg
R88A-CAGB040BR	40 m		Approx. 10.9 kg
R88A-CAGB050BR	50 m		Approx. 13.6 kg

Connection Configuration and Dimensions

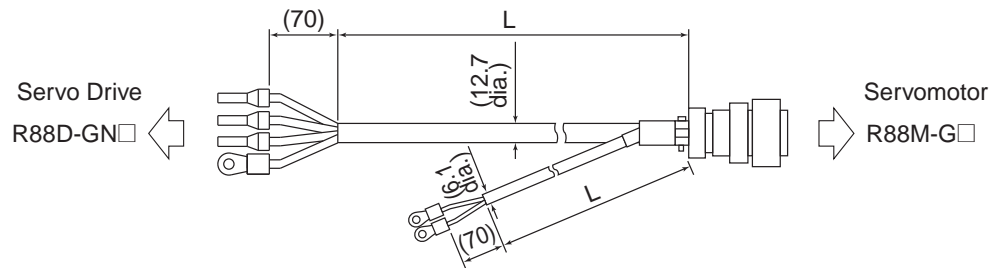

Wiring

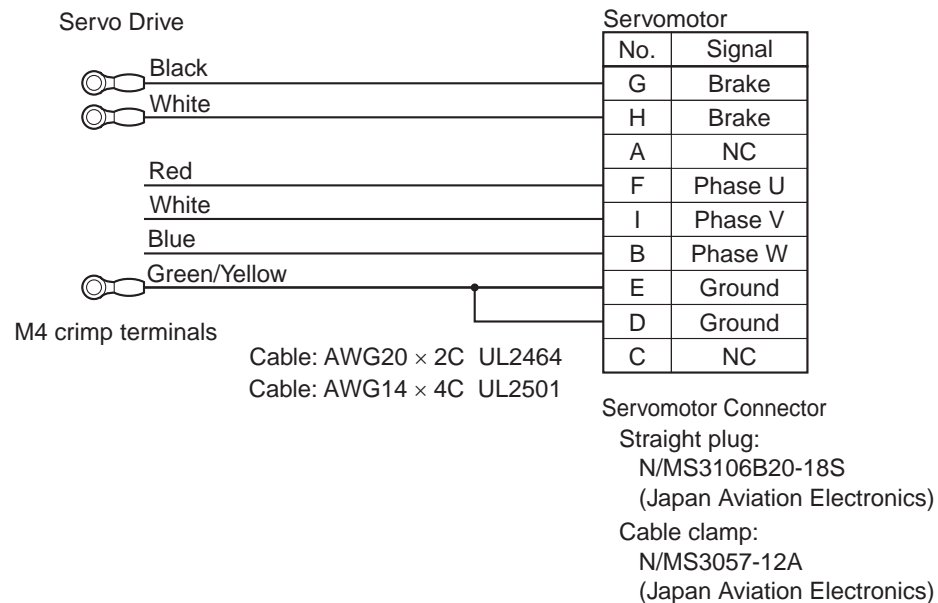

R88A-CAGC□BR

Cable Models

For 3,000-r/min Servomotors of 2 kW and 2,000-r/min Servomotors of 2 kW

Model	Length (L)	Outer diameter of sheath	Weight
R88A-CAGC003BR	3 m	12.7/6.1 dia.	Approx. 0.9 kg
R88A-CAGC005BR	5 m		Approx. 1.5 kg
R88A-CAGC010BR	10 m		Approx. 2.8 kg
R88A-CAGC015BR	15 m		Approx. 4.2 kg
R88A-CAGC020BR	20 m		Approx. 5.5 kg
R88A-CAGC030BR	30 m		Approx. 8.2 kg
R88A-CAGC040BR	40 m		Approx. 10.9 kg
R88A-CAGC050BR	50 m		Approx. 13.6 kg

Connection Configuration and Dimensions

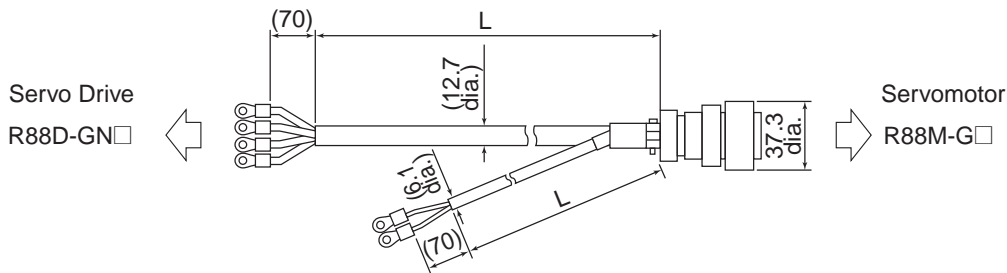

Wiring

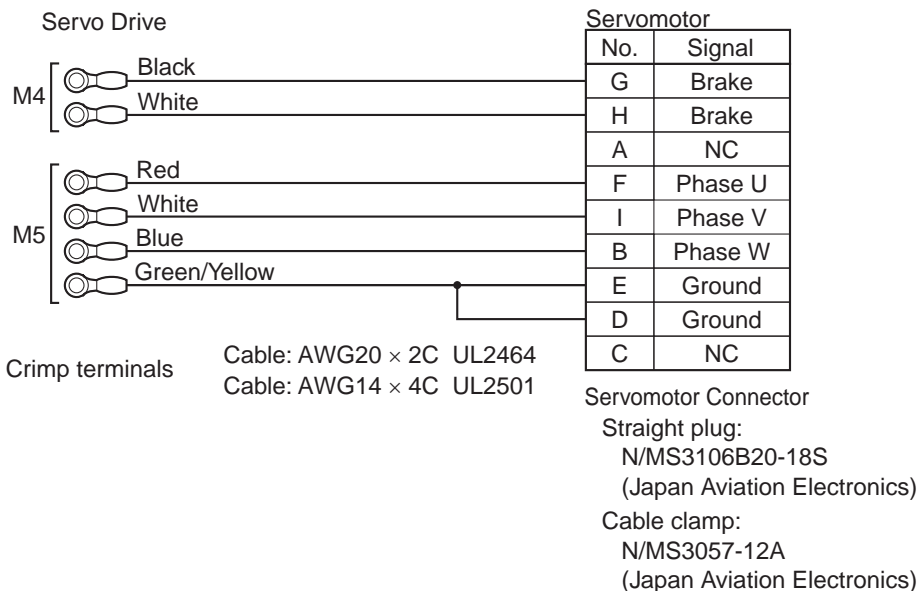

R88A-CAGD□BR

Cable Models

For 3,000-r/min Servomotors of 3 to 5 kW, 2,000-r/min Servomotors of 3 to 5 kW, and 1,000-r/min Servomotors of 2 to 4.5 kW

Model	Length (L)	Outer diameter of sheath	Weight
R88A-CAGD003BR	3 m	15.6/6.1 dia.	Approx. 1.6 kg
R88A-CAGD005BR	5 m		Approx. 2.5 kg
R88A-CAGD010BR	10 m		Approx. 4.7 kg
R88A-CAGD015BR	15 m		Approx. 7.0 kg
R88A-CAGD020BR	20 m		Approx. 9.2 kg
R88A-CAGD030BR	30 m		Approx. 13.7 kg
R88A-CAGD040BR	40 m		Approx. 18.2 kg
R88A-CAGD050BR	50 m		Approx. 22.7 kg

Connection Configuration and Dimensions

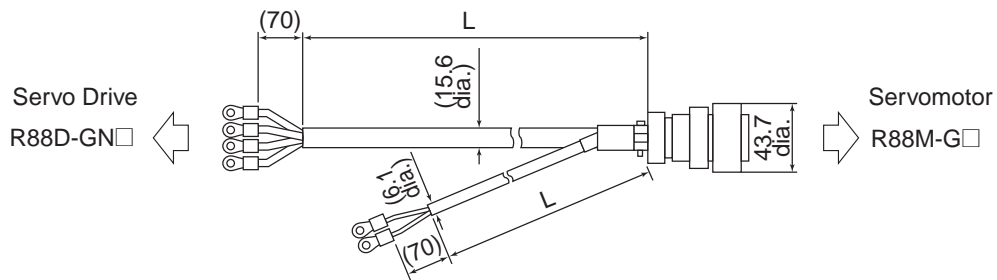

Wiring

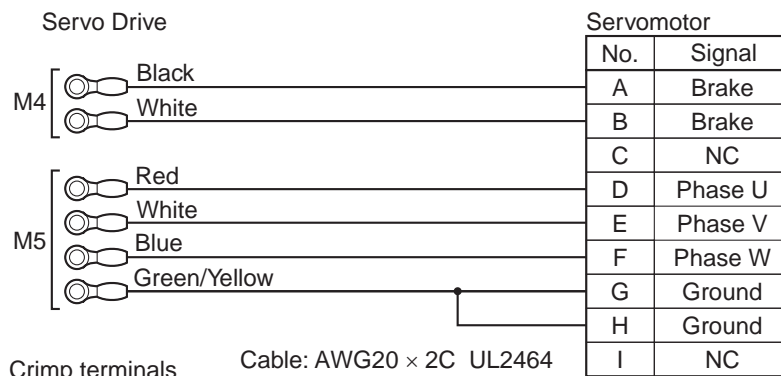

Servomotor Connector

Straight plug:

N/MS3106B24-11S
 (Japan Aviation Electronics)

Cable clamp:

N/MS3057-16A
 (Japan Aviation Electronics)

■ Brake Cables (Standard Cables)

R88A-CAGA□B

Cable Models

For 3,000-r/min Servomotors of 50 to 750 W and 3,000-r/min Flat Servomotors of 100 to 400 W

Model	Length (L)	Outer diameter of sheath	Weight
R88A-CAGA003B	3 m	5.4 dia.	Approx. 0.1 kg
R88A-CAGA005B	5 m		Approx. 0.2 kg
R88A-CAGA010B	10 m		Approx. 0.4 kg
R88A-CAGA015B	15 m		Approx. 0.6 kg
R88A-CAGA020B	20 m		Approx. 0.8 kg
R88A-CAGA030B	30 m		Approx. 1.2 kg
R88A-CAGA040B	40 m		Approx. 1.6 kg
R88A-CAGA050B	50 m		Approx. 2.1 kg

Connection Configuration and Dimensions

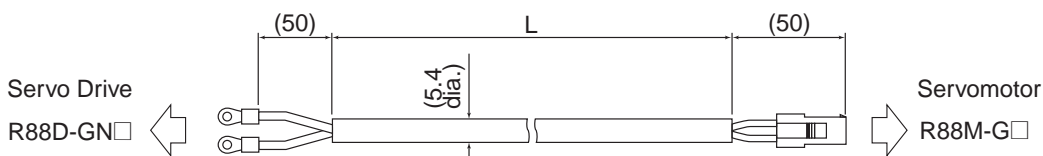

Wiring

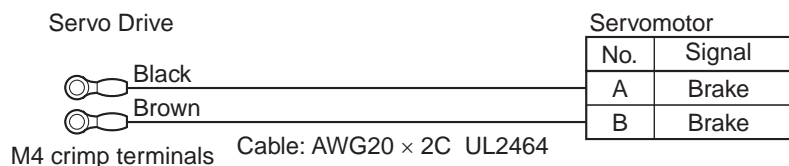

Servomotor Connector

Connector:

172157-1 (Tyco Electronics AMP KK)

Connector pins:

170362-1 (Tyco Electronics AMP KK)

170366-1 (Tyco Electronics AMP KK)

R88A-CAGE□B

Cable Models

For 1,500-r/min Servomotors of 7.5 kW and 1,000-r/min Servomotors of 6 kW

Model	Length (L)	Outer diameter of sheath	Weight
R88A-CAGE003B	3 m	5.4 dia.	Approx. 0.2 kg
R88A-CAGE005B	5 m		Approx. 0.3 kg
R88A-CAGE010B	10 m		Approx. 0.5 kg
R88A-CAGE015B	15 m		Approx. 0.7 kg
R88A-CAGE020B	20 m		Approx. 0.9 kg
R88A-CAGE030B	30 m		Approx. 1.3 kg
R88A-CAGE040B	40 m		Approx. 1.7 kg
R88A-CAGE050B	50 m		Approx. 2.1 kg

Connection Configuration and Dimensions

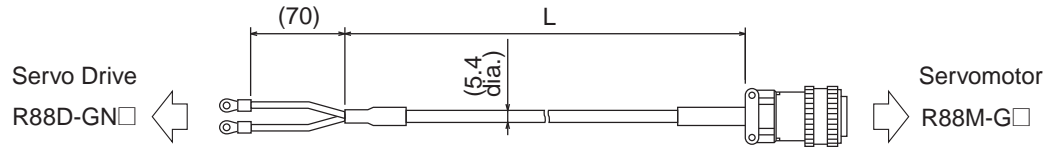

Wiring

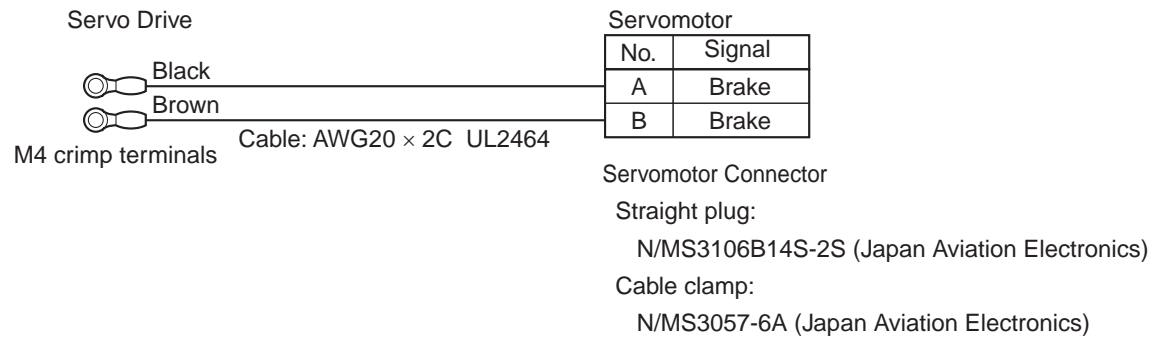

■ Brake Cables (Robot Cables)

R88A-CAGA□BR

Cable Models

For 3,000-r/min Servomotors of 50 to 750 W and 3,000-r/min Flat Servomotors of 100 to 400 W

Model	Length (L)	Outer diameter of sheath	Weight
R88A-CAGA003BR	3 m	6.1 dia.	Approx. 0.1 kg
R88A-CAGA005BR	5 m		Approx. 0.2 kg
R88A-CAGA010BR	10 m		Approx. 0.4 kg
R88A-CAGA015BR	15 m		Approx. 0.7 kg
R88A-CAGA020BR	20 m		Approx. 0.9 kg
R88A-CAGA030BR	30 m		Approx. 1.3 kg
R88A-CAGA040BR	40 m		Approx. 1.8 kg
R88A-CAGA050BR	50 m		Approx. 2.2 kg

Connection Configuration and Dimensions

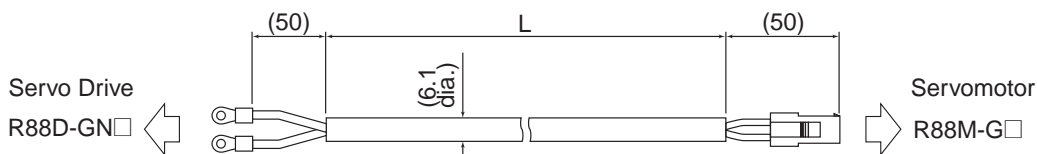

Wiring

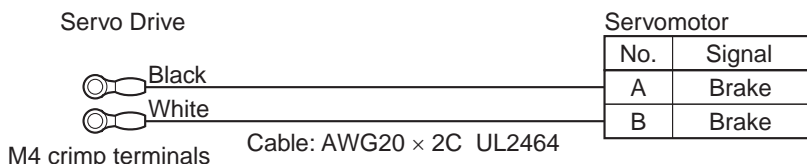

Servomotor Connector
Connector:

172157-1 (Tyco Electronics AMP KK)

Connector pins:

170362-1 (Tyco Electronics AMP KK)

170366-1 (Tyco Electronics AMP KK)

Communications Cable Specifications

■ Computer Monitor Cable

Cable Models

Cables for RS-232 Communications

Model	Length (L)	Outer diameter of sheath	Weight
R88A-CCG002P2	2 m	4.2 dia.	Approx. 0.1 kg

Connection Configuration and Dimensions

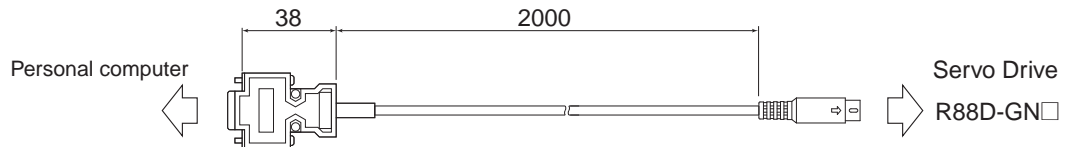

Wiring

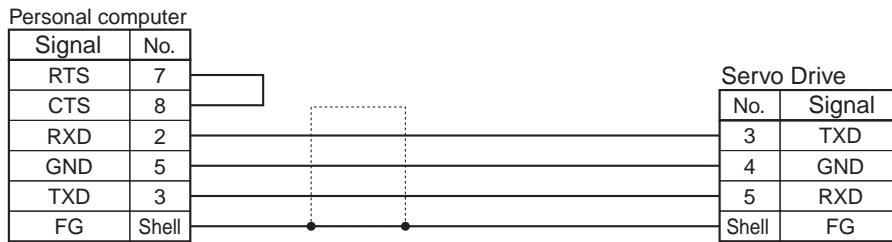

PC Connector

17JE-13090-02 (D8A) (DDK Ltd.)

Precautions for Correct Use

◆ Communications with the Host Device

After confirming the startup of the Servo Drive, initiate communications with the host device.

Note that irregular signals may be received from the host interface during startup. For this reason, take appropriate initialization measures such as clearing the receive buffer.

Connector Specifications

■ Control I/O Connector (R88A-CNU01C)

This connector connects to the control I/O connector (CN1) on the Servo Drive.
Use this connector when preparing a control cable yourself.

Dimensions

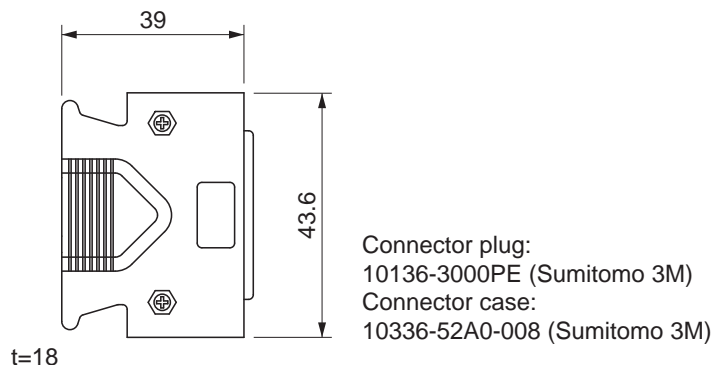

■ Encoder Connectors

These connectors are used for encoder cables.
Use them when preparing an encoder cable yourself.

Dimensions

R88A-CNW01R (for Servo Drive's CN2 Connector)

This connector is a soldering type.
Use the following cable.

- ◆ Applicable wire: AWG16 max.
- ◆ Insulating cover outer diameter: 2.1 mm dia. max.
- ◆ Outer diameter of sheath: 6.7 dia. ± 0.5 mm

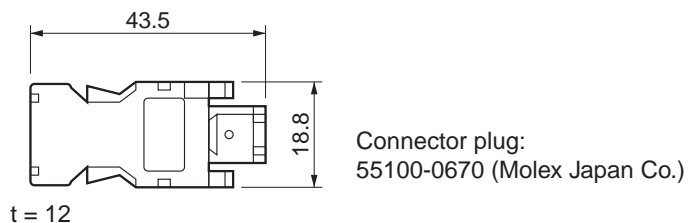

3-4 Cable and Connector Specifications

R88A-CNG01R (for Servomotor Connector) **ABS**

Use the following cable.

- ♦ Applicable wire: AWG22 max.
- ♦ Outer diameter of sheath: 1.75 mm dia. max.

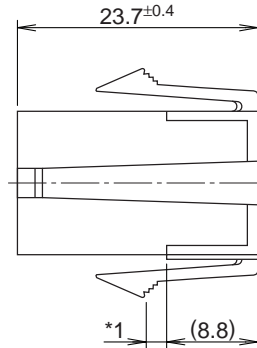
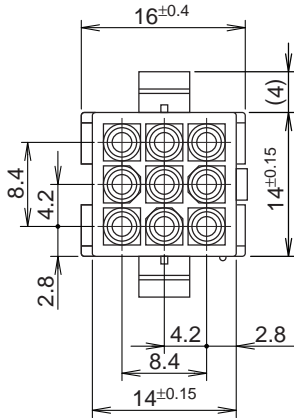

Panel Mounting Hole

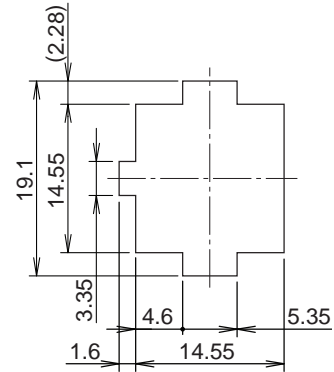

Connector housing:
172161-1 (Tyco Electronics AMP KK)
Contact socket:
170365-1 (Tyco Electronics AMP KK)

*1. Applicable panel thickness:
0.8 to 2.0 mm

R88A-CNG02R (for Servomotor Connector) **INC**

Use the following cable.

- ♦ Applicable wire: AWG22 max.
- ♦ Outer diameter of sheath: 1.75 mm dia. max.

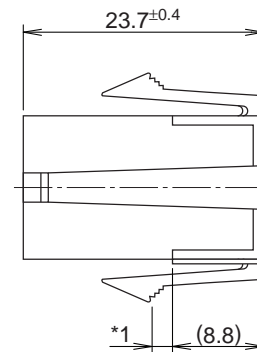
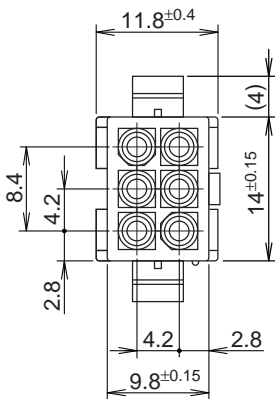

Panel Mounting Hole

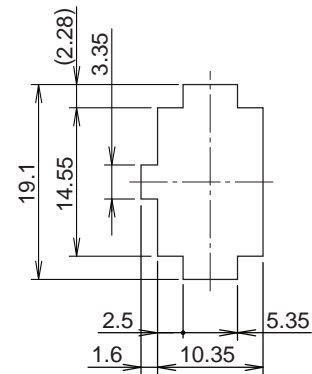

Connector housing:
172160-1 (Tyco Electronics AMP KK)
Contact socket:
170365-1 (Tyco Electronics AMP KK)

*1. Applicable panel thickness:
0.8 to 2.0 mm

■ **Power Cable Connector (R88A-CNG01A)**

This connector is used for power cables.
Use it when preparing a power cable yourself.

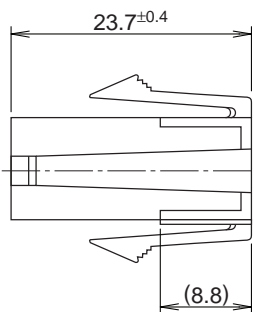
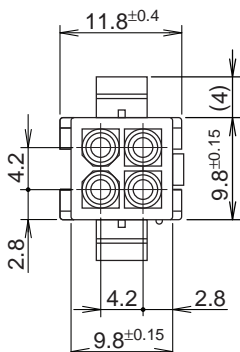

Panel Mounting Hole

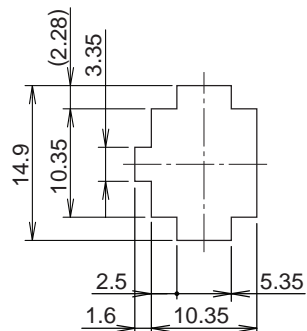

Connector housing:
172159-1 (Tyco Electronics AMP KK)
Contact socket:
170366-1 (Tyco Electronics AMP KK)

Applicable panel thickness:
0.8 to 2.0 mm

■ **Brake Cable Connector (R88A-CNG01B)**

This connector is used for brake cables.
Use it when preparing a brake cable yourself.

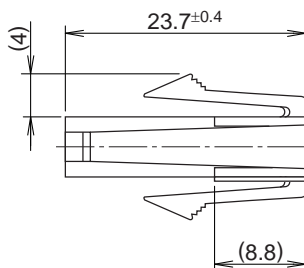
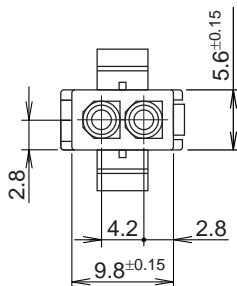

Panel Mounting Hole

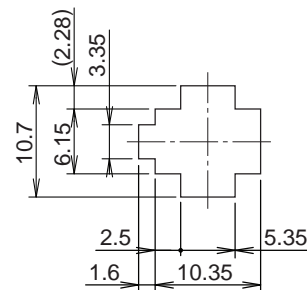

Connector housing:
172157-1 (Tyco Electronics AMP KK)
Contact socket:
170366-1 (Tyco Electronics AMP KK)

Applicable panel thickness:
0.8 to 2.0 mm



MECHATROLINK-II Communications Cable Specifications

- MECHATROLINK Communications Cable (With Connectors and ferrite cores on both ends) (FNY-W6003-□□)

Cable Models

Model	Model	Length (L)
MECHATROLINK-II cable	FNY-W6003-A5	0.5 m
	FNY-W6003-01	1 m
	FNY-W6003-03	3 m
	FNY-W6003-05	5 m
	FNY-W6003-10	10 m
	FNY-W6003-20	20 m
	FNY-W6003-30	30 m
MECHATROLINK-II termination resistor	FNY-W6022	---

Connection Configuration and Dimensions

MECHATROLINK-II Communications Cable



MECHATROLINK-II termination resistor

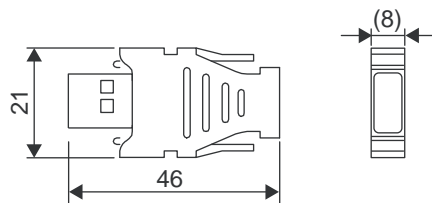

Wiring

The diagram below shows a typical connection between a host device and the Servo Drive using a MECHATROLINK-II communications cable.

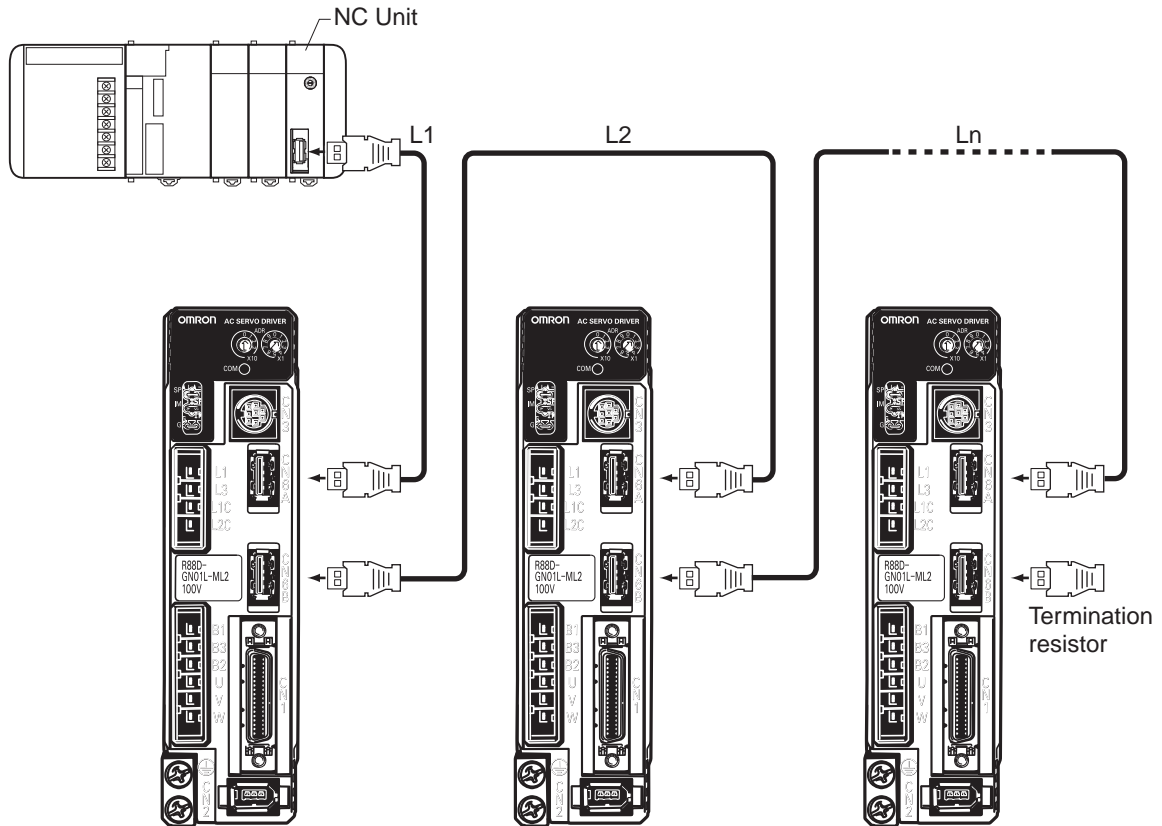

Note 1. Cable length between nodes (L1, L2, ... Ln) should be 0.5 m or longer.

Note 2. Total cable length should be $L1 + L2 + \dots + Ln \leq 50$ m.

Control Cable Specifications

■ Connector Terminal Block Cables (XW2Z-□J-B33)

This is the connector terminal block cable for the G-Series Servo Drive (with built-in MECHATROLINK-II).

Cable Models

Model	Length (L)	Outer diameter of sheath	Weight
XW2Z-100J-B33	1 m	8.0 dia.	Approx. 0.1 kg
XW2Z-200J-B33	2 m		Approx. 0.2 kg

Connection Configuration and Dimensions

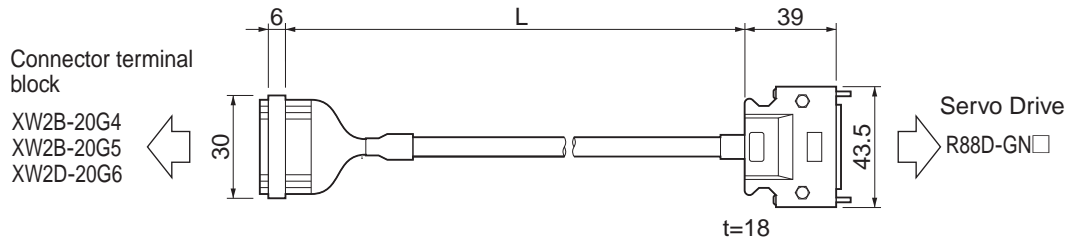

Wiring

Terminal block		Connector		Servo Drive		
Signal	No.	No.		No.	Wire/mark color	Signal
+24VIN	1	1		1	Blue/Red (1)	+24VIN
0V	2	2			Blue/Black (1)	
+24VIN	3	3			Pink/Red (1)	
0V	4	4			Pink/Black (1)	
+24VIN	5	5			Green/Red (1)	
0V	6	6			Green/Black (1)	
STOP	7	7		2	Orange/Red (1)	STOP
DEC	8	8		21	Orange/Black(1)	DEC
POT	9	9		19	Gray/Red (1)	POT
NOT	10	10		20	Gray/Black (1)	NOT
EXT1	11	11		5	Blue/Red (2)	EXT1
EXT2	12	12		4	Blue/Black (2)	EXT2
EXT3	13	13		3	Pink/Red (2)	EXT3
BATCOM	14	14		33	Green/Red (2)	BATCOM
BAT	15	15		34	Green/Black (2)	BAT
OUTM1COM	16	16		35	Orange/Red (2)	OUTM1COM
OUTM1	17	17		36	Orange/Black (2)	OUTM1
ALMCOM	18	18		16	Gray/Red (2)	ALMCOM
/ALM	19	19		15	Gray/Black (2)	/ALM
FG	20	20		Shell		FG

Wires with the same wire color and the same number of marks form a twisted pair.

Example:
A yellow/black (1) wire and pink/black (1) wire form a twisted pair.

Servo Drive Connector
Connector plug:
10136-3000PE (Sumitomo 3M)
Connector case:
10336-52A0-008 (Sumitomo 3M)

Terminal Block Connector
Connector socket: XG4M-2030 (OMRON)
Strain relief: XG4T-2004 (OMRON)

Cable
AWG28x10P UL2464

■ Connector-Terminal Block Conversion Unit

The Connector-Terminal Block Conversion Unit can be used along with a Connector Terminal Block Cable (XW2Z-□J-B33) to convert the Servo Drive's control I/O connector (CN1) to a terminal block.

XW2B-20G4 (M3 screw terminal block)

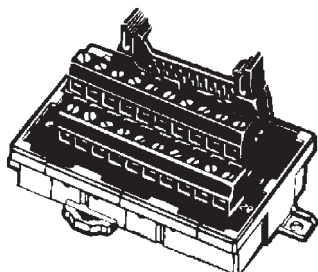

◆ Dimensions

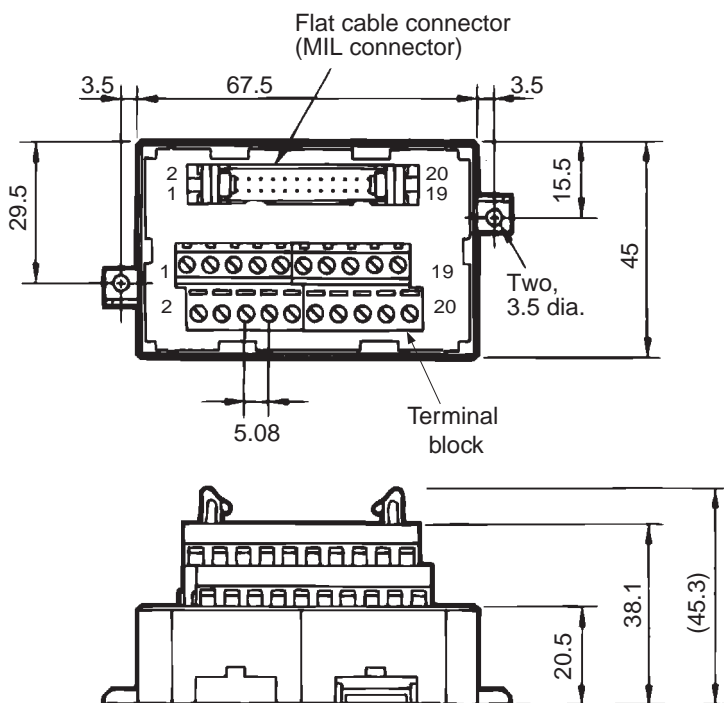

Precautions for Correct Use

- ◆ Use 0.30 to 1.25 mm² wire (AWG22 to AWG16).
- ◆ The wire inlet is 1.8 mm (height) × 2.5 mm (width).
- ◆ Strip the insulation from the end of the wire for 6 mm as shown below.

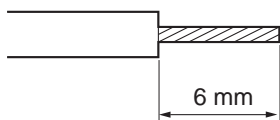

XW2B-20G5 (M3.5 screw terminal block)

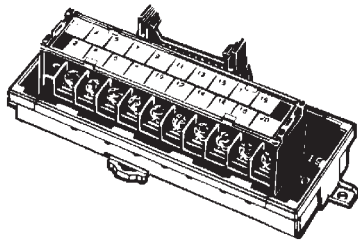

◆ Dimensions

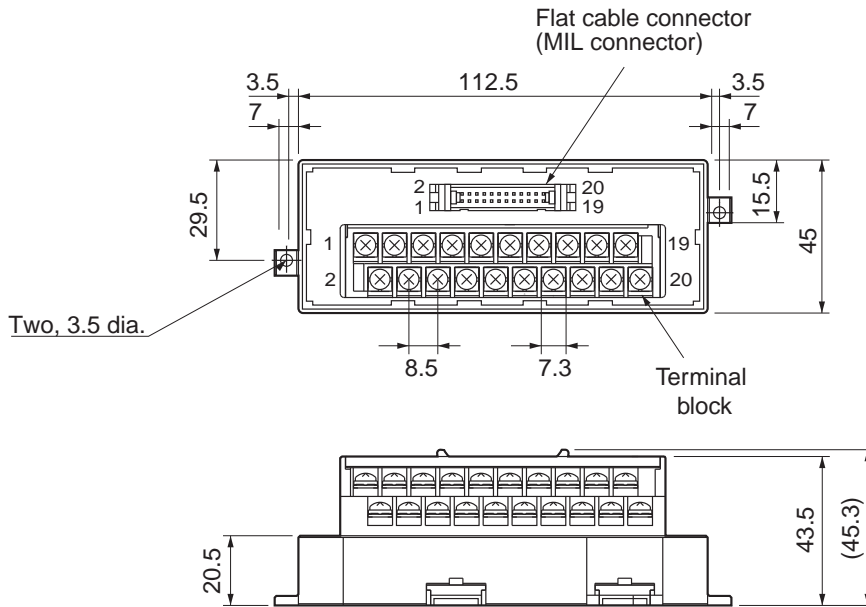

◆ Terminal block pitch: 8.5 mm

Precautions for Correct Use

- ◆ When using crimp terminals, use crimp terminals with the following dimensions.
- ◆ When connecting wires and crimp terminals to a terminal block, tighten them with a tightening torque of 0.59 N·m.

Round Crimp Terminals

Fork Terminals

3.2-mm dia.

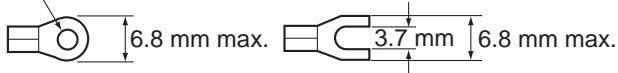

	Applicable Crimp Terminals	Applicable Wires
Round Crimp Terminals	1.25-3	AWG22-16 (0.3 to 1.25 mm ²)
	2-3.5	AWG16-14 (1.25 to 2.0 mm ²)
Fork Terminals	1.25Y-3	AWG22-16 (0.3 to 1.25 mm ²)
	2-3.5	AWG16-14 (1.25 to 2.0 mm ²)

XW2D-20G6 (M3 screw terminal block)

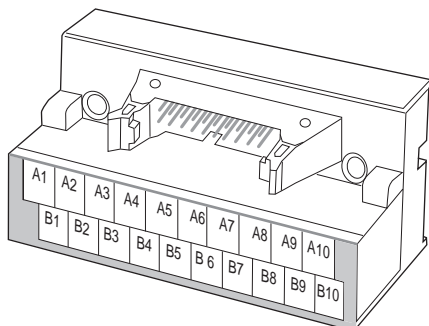

◆ Dimensions

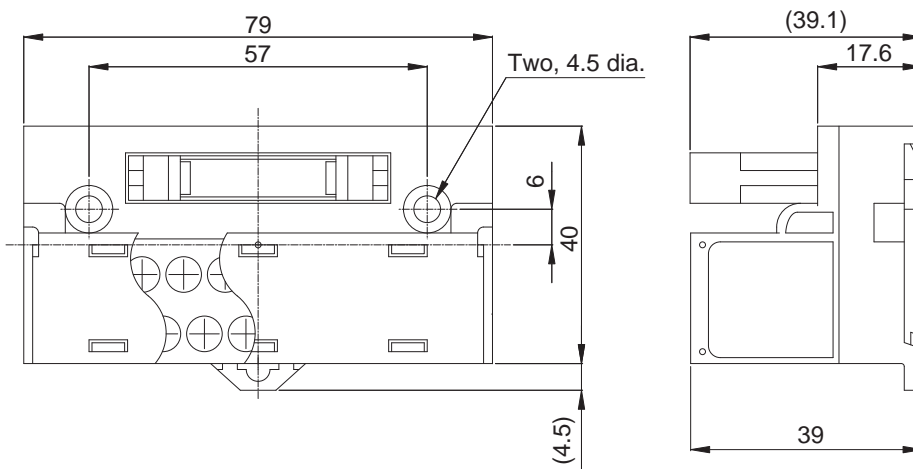

Precautions for Correct Use

- ◆ When using crimp terminals, use crimp terminals with the following dimensions.
- ◆ When connecting wires and crimp terminals to a terminal block, tighten them with a tightening torque of 0.7 N·m.

Round Crimp Terminals

Fork Terminals

3.2-mm dia.

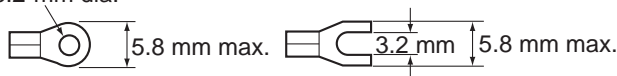

Applicable Crimp Terminals		Applicable Wires
Round Crimp Terminals	1.25-3	AWG22-16 (0.3 to 1.25 mm ²)
Fork Terminals	1.25Y-3	AWG22-16 (0.3 to 1.25 mm ²)

The diagram on the next page shows a typical connection between a host device and the Servo Drive using a MECHATROLINK-II communications cable.



3-4 Cable and Connector Specifications

♦ Terminal Block Wiring Example (common for XW2B-20G4/-20G5, XW2D-20G6)

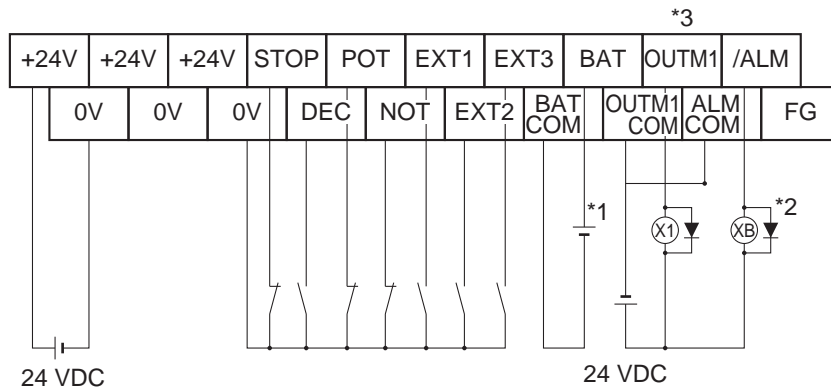

*1. Absolute encoder backup battery 3.6 to 4.5 V

*2. The XB contacts are used to turn ON/OFF the electromagnetic brake.

*3. Assign BKIR (brake interlock) to CN1-36 pin to use.

Note 1. The absolute encoder backup battery is not required when using a Servomotor with an incremental encoder.

Note 2. Connect the absolute encoder backup battery to only one of either the connector terminal block or absolute encoder backup battery cable.

Note 3. Use cable clips with double-sided adhesive tape to secure the absolute encoder backup battery in place.

3-5 Parameter Unit Specifications

■ R88A-PR02G Hand-held Parameter Unit

The Parameter Unit is required to operate the Servo Drive from a distance away from the Servo Drive, or to operate and monitor the Servo Drive from a control panel.
The cable connected to the Parameter Unit is 1.5 m long.

■ General Specifications

Item	Specifications
Ambient operating temperature and humidity	0 to 55°C, 90% RH max. (with no condensation)
Ambient storage temperature and humidity	-20 to 80°C, 90% RH max. (with no condensation)
Operating and storage atmosphere	No corrosive gases
Vibration resistance	5.9 m/s ² max.

■ Performance Specifications

Item	Specifications	
Type	Hand-held	
Cable length	1.5 m	
Connectors	Mini DIN 8-pin MD connector	
Display	Seven-segment LED display	
Outer diameter	62 (W) × 114 (H) × 15 (D) mm	
Weight	Approx. 0.1 kg (including cable)	
Communications specifications	Standard	RS-232
	Communications method	Asynchronous (ASYNC)
	Baud rate	9,600 bps
	Start bits	1 bit
	Data	8 bits
	Parity	No
	Stop bits	1 bit

3-6 External Regeneration Resistor Specifications

External Regeneration Resistor Specifications

■ R88A- RR08050S

Model	Resistance	Nominal capacity	Regeneration absorption for 120°C temperature rise	Heat radiation condition	Thermal switch output specifications
R88A-RR08050S	50 Ω	80 W	20 W	Aluminum, 250 × 250, Thickness: 3.0	Operating temperature: 150°C ±5%, NC contact Rated output: 30 VDC, 50 mA max.

■ R88A-RR080100S

Model	Resistance	Nominal capacity	Regeneration absorption for 120°C temperature rise	Heat radiation condition	Thermal switch output specifications
R88A-RR080100S	100 Ω	80 W	20 W	Aluminum, 250 × 250, Thickness: 3.0	Operating temperature: 150°C ±5%, NC contact Rated output: 30 VDC, 50 mA max.

■ R88A-RR22047S

Model	Resistance	Nominal capacity	Regeneration absorption for 120°C temperature rise	Heat radiation condition	Thermal switch output specifications
R88A-RR22047S	47 Ω	220 W	70 W	Aluminum, 350 × 350, Thickness: 3.0	Operating temperature: 170°C ±7°C, NC contact Rated output: 250 VAC, 0.2 A max.

■ R88A-RR50020S

Model	Resistance	Nominal capacity	Regeneration absorption for 120°C temperature rise	Heat radiation condition	Thermal switch output specifications
R88A-RR50020S	20 Ω	500 W	180 W	Aluminum, 600 × 600, Thickness: 3.0	Operating temperature: 200°C ±7°C, NC contact Rated output: 250 VAC, 0.2 A max. 24 VDC, 0.2 A max.

3-7 Reactor Specifications

Connect a Reactor to the Servo Drive as a harmonic current control measure. Select a model matching the Servo Drive to be used.

■ Specifications

Servo Drive Model	Reactor specifications				Reactor type
	Model	Rated current	Inductance	Weight	
R88D-GNA5L-ML2 R88D-GN01H-ML2	3G3AX-DL2002	1.6 A	21.4 mH	Approx. 0.8 kg	Single-phase
R88D-GN01L-ML2 R88D-GN02H-ML2	3G3AX-DL2004	3.2 A	10.7 mH	Approx. 1.0 kg	Single-phase
R88D-GN02L-ML2 R88D-GN04H-ML2	3G3AX-DL2007	6.1 A	6.75 mH	Approx. 1.3 kg	Single-phase
R88D-GN04L-ML2 R88D-GN08H-ML2 R88D-GN10H-ML2	3G3AX-DL2015	9.3 A	3.51 mH	Approx. 1.6 kg	Single-phase
R88D-GN15H-ML2	3G3AX-DL2022	13.8 A	2.51 mH	Approx. 2.1 kg	Single-phase
R88D-GN08H-ML2 R88D-GN10H-ML2 R88D-GN15H-ML2	3G3AX-AL2025	10.0 A	2.8 mH	Approx. 2.8 kg	Three-phase
R88D-GN20H-ML2 R88D-GN30H-ML2	3G3AX-AL2055	20.0 A	0.88 mH	Approx. 4.0 kg	Three-phase
R88D-GN50H-ML2	3G3AX-AL2110	34.0 A	0.35 mH	Approx. 5.0 kg	Three-phase
R88D-GN75H-ML2	3G3AX-AL2220	67.0 A	0.18 mH	Approx. 10.0 kg	Three-phase

Chapter 4

System Design

4-1	Installation Conditions	4-1
	Servo Drives	4-1
	Servomotors.....	4-3
	Decelerators.....	4-7
4-2	Wiring	4-11
	Connecting Cables.....	4-11
	Selecting Connecting Cables.....	4-12
	Peripheral Device Connection Examples.....	4-16
	Main Circuit and Servomotor Connector Specifications.....	4-20
4-3	Wiring Conforming to EMC Directives.....	4-26
	Wiring Method.....	4-26
	Selecting Connection Components.....	4-31
4-4	Regenerative Energy Absorption	4-44
	Calculating the Regenerative Energy	4-44
	Servo Drive Regenerative Energy Absorption Capacity	4-47
	Absorbing Regenerative Energy with an External Regeneration Resistor	4-48
	Connecting an External Regeneration Resistor.....	4-49

4-1 Installation Conditions

Servo Drives

■ Space around Drives

- ♦ Install Servo Drives according to the dimensions shown in the following illustration to ensure proper heat dispersion and convection inside the panel. If the Servo Drives are to be installed side by side, install a fan for air circulation to prevent uneven temperatures from developing inside the panel.

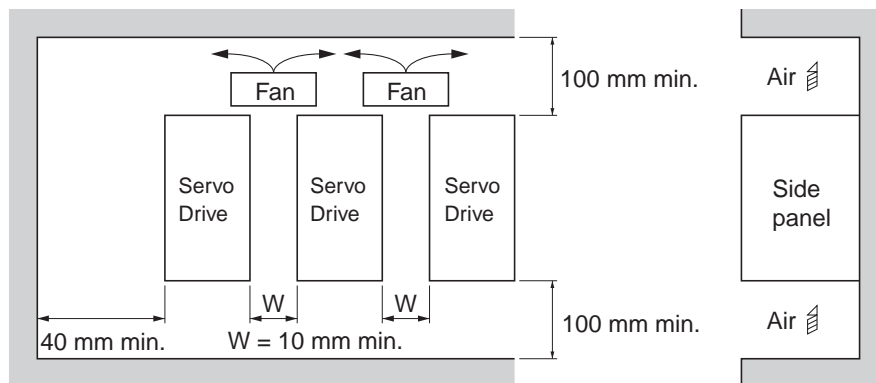

■ Mounting Direction

- ♦ Mount the Servo Drives in a direction (perpendicular) so that the model number can be seen properly.

■ Operating Environment

- ♦ The environment in which Servo Drives are operated must meet the following conditions. Servo Drives may malfunction if operated under any other conditions.
 - Ambient operating temperature: 0 to 55°C (Take into account temperature rises in the individual Servo Drives themselves.)
 - Ambient operating humidity: 90% RH max. (with no condensation)
 - Atmosphere: No corrosive gases.
 - Altitude: 1,000 m max.

■ Ambient Temperature Control

- ♦ Servo Drives should be operated in environments in which there is minimal temperature rise to maintain a high level of reliability.
- ♦ Temperature rise in any Unit installed in a closed space, such as the control box, will cause the Servo Drive's ambient temperature to rise. Use a fan or air conditioner to prevent the Servo Drive's ambient temperature from exceeding 55°C.
- ♦ Servo Drive surface temperatures may rise to as much as 30°C above the ambient temperature. Use heat-resistant materials for wiring, and keep its distance from any devices or wiring that are sensitive to heat.
- ♦ The service life of a Servo Drive is largely determined by the temperature around the internal electrolytic capacitors. The service life of an electrolytic capacitor is affected by a drop in electrostatic capacity and an increase in internal resistance, which can result in overvoltage alarms, malfunctioning due to noise, and damage to individual elements.

- ♦ If a Servo Drive is always operated at the ambient temperature of 55°C and with 100% of the rated torque and rated rotation speed, its service life is expected to be approximately 28,000 hours (excluding the axial-flow fan). A drop of 10°C in the ambient temperature will double the expected service life.

■ Keeping Foreign Objects Out of Units

- ♦ Place a cover over the Units or take other preventative measures to prevent foreign objects, such as drill filings, from getting into the Units during installation. Be sure to remove the cover after installation is complete. If the cover is left on during operation, Servo Drive's heat dissipation is blocked, which may result in malfunction.
- ♦ Take measures during installation and operation to prevent foreign objects such as metal particles, oil, machining oil, dust, or water from getting inside of Servo Drives.

Servomotors

■ Operating Environment

- ♦ The environment in which the Servomotor is operated must meet the following conditions. Operating the Servomotor outside of the following ranges may result in malfunction of the Servomotor.

Ambient operating temperature: 0 to 40°C (See note.)

Ambient operating humidity: 85% RH max. (with no condensation)

Atmosphere: No corrosive gases.

Note The ambient temperature is the temperature at a point 5 cm from the Servomotor.

■ Impact and Load

- ♦ The Servomotor is resistant to impacts of up to 98 m/s². Do not apply heavy impacts or loads during transport, installation, or removal.
- ♦ When transporting, hold the Servomotor body itself, and do not hold the encoder, cable, or connector areas. Doing so may damage the Servomotor.
- ♦ Always use a pulley remover to remove pulleys, couplings, or other objects from the shaft.
- ♦ Secure cables so that there is no impact or load placed on the cable connector areas.

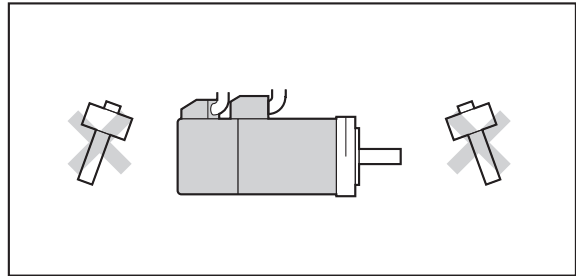

■ Connecting to Mechanical Systems

- ♦ The axial loads for Servomotors are specified in *Characteristics* on page 3-18. If an axial load greater than that specified is applied to a Servomotor, it will reduce the service life of the motor bearings and may break the motor shaft.
- ♦ When connecting to a load, use couplings that can sufficiently absorb mechanical eccentricity and declination.
- ♦ For spur gears, an extremely large radial load may be applied depending on the gear precision. Use spur gears with a high degree of precision (for example, JIS class 2: normal line pitch error of 6 μm max. for a pitch circle diameter of 50 mm).
- ♦ If the gear precision is not adequate, allow backlash to ensure that no radial load is placed on the motor shaft.
- ♦ Bevel gears will cause a load to be applied in the thrust direction depending on the structural precision, the gear precision, and temperature changes. Provide appropriate backlash or take other measures to ensure that a thrust load larger than the specified level is not applied.
- ♦ Do not put rubber packing on the flange surface. If the flange is mounted with rubber packing, the motor flange may crack under the tightening force.

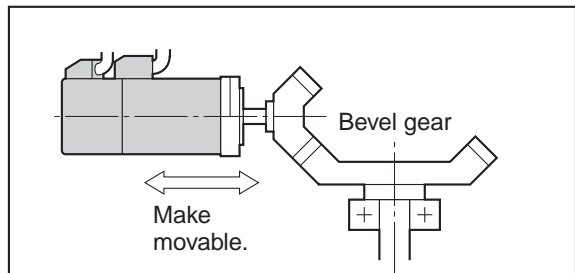
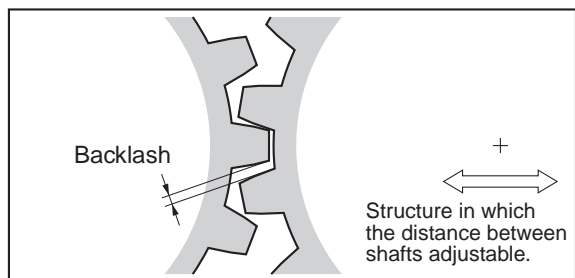
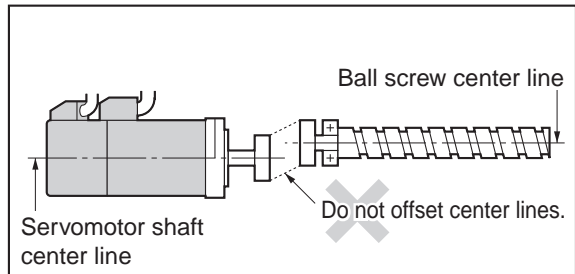

- ♦ When connecting to a V-belt or timing belt, consult the manufacturer for belt selection and tension.
- ♦ A radial load twice the belt tension will be placed on the motor shaft. Do not allow a radial load exceeding specifications to be placed on the motor shaft. If an excessive radial load is applied, the motor shaft and bearings may be damaged.
- ♦ Set up a movable pulley between the motor shaft and the load shaft so that the belt tension can be adjusted.

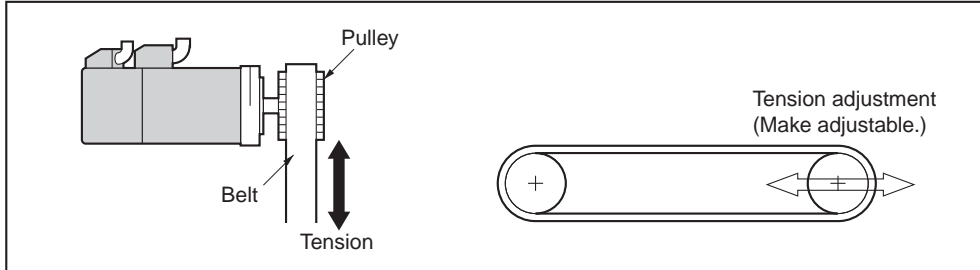

■ Water and Drip Resistance

- ♦ The protective structure for the Servomotors is as follows:
IP65 (except for through-shaft parts and cable outlets)

■ Oil Seal Part Numbers

With OMNUC G-Series Servomotors, an oil seal can be installed afterwards.



Refer to the installation instructions from NOK Corporation for information on installing the oil seal. The following oil seals are not standard NOK products. Check with the manufacturer.

The expected service life of the oil seals is approximately 5,000 hours, but the actual life depends on the application conditions and environment.

Motor model	Shaft diameter (mm)	Outer diameter (mm)	Width (mm)	Material (rubber)	NOK part number (SC type)
R88M-G05030□	8.9	17	4	A435	BC6646-E0
R88M-G10030□	8.9	17	4	A435	BC6646-E0
R88M-G20030□	14	28	4	A435	BC5102-E1
R88M-G40030□	14	28	4	A435	BC5102-E1
R88M-G75030□	19.8	30	4	A435	BC1141-E1
R88M-GP10030□	8.9	22	4	A435	BC5101-E1
R88M-GP20030□	14	28	4	A435	BC5102-E1
R88M-GP40030□	14	28	4	A435	BC5102-E1
R88M-G1K030□	20	35	7	A435	AC1012E2
R88M-G1K530□	20	35	7	A435	AC1012E2
R88M-G2K030□	20	35	7	A435	AC1012E2
R88M-G3K030□	24	38	7	A435	AC1251E1-RA0
R88M-G4K030□	24	38	7	A435	AC1251E1-RA0
R88M-G5K030□	24	38	7	A435	AC1251E1-RA0
R88M-G1K020□	24	38	7	A435	AC1251E1-RA0
R88M-G1K520□	24	38	7	A435	AC1251E1-RA0
R88M-G2K020□	24	38	7	A435	AC1251E1-RA0
R88M-G3K020□	24	38	7	A435	AC1251E1-RA0
R88M-G4K020□	30	45	7	A435	AC1677E1-RA0
R88M-G5K020□	40	58	7	A435	AC2368E2
R88M-G7K515□	45	62	9	A435	AC2651E2
R88M-G90010□	24	38	7	A435	AC1251E1-RA0
R88M-G2K010□	40	58	7	A435	AC2368E2
R88M-G3K010□	40	58	7	A435	AC2368E2
R88M-G4K510□	45	62	9	A435	AC2651E2
R88M-G6K010□	45	62	9	A435	AC2651E2

■ Other Precautions

- ♦ Take measures to protect the shaft from corrosion.
The shafts are coated with anti-corrosion oil when shipped, but anti-corrosion oil or grease should also be applied when connecting the shaft to a load.

 WARNING	
	Do not apply commercial power directly to the Servomotor. Doing so may result in fire.
	Do not dismantle or repair the product. Doing so may result in electric shock or injury.

Decelerators

■ Installing Decelerators

Installing an R88G-HPG□□□ (Backlash = 3' Max.)

Use the following procedure to install the Decelerator on the Servomotor.

1. Turn the input joint and align the head of the bolt that secures the shaft with the rubber cap.
2. Apply sealant to the installation surface on the Servomotor (recommended sealant: Loctite 515).
3. Gently insert the Servomotor into the Decelerator.

As shown in the figures on the next page, stand the Decelerator upright and slide the Servomotor shaft into the input shaft joint while making sure it does not fall over. If the Decelerator cannot be stood upright, tighten each bolt evenly little by little to ensure that the Servomotor is not inserted at a tilt.

4. Bolt together the Servomotor and the Decelerator flanges.

Bolt Tightening Torque for Aluminum

Allen head bolt size	M4	M5	M6	M8	M10	M12
Tightening torque (N-m)	3.2	6.3	10.7	26.1	51.5	89.9

5. Tighten the input joint bolt.

Bolt Tightening Torque for Duralumin

Allen head bolt size	M4	M5	M6	M8	M10	M12
Tightening torque (N-m)	2.0	4.5	15.3	37.2	73.5	128

Note Always use the torque given in the table above. The Servomotor may slip or other problems may occur if the specified torque level is not satisfied.

The R88G-HPG11A□ uses two set screws for the connecting section.

Allen head bolt size	M3
Tightening torque (N-m)	0.69

6. Mount the supplied rubber cap to complete the installation procedure.

(For the R88G-HPG11A□, mount two screws with gaskets.)

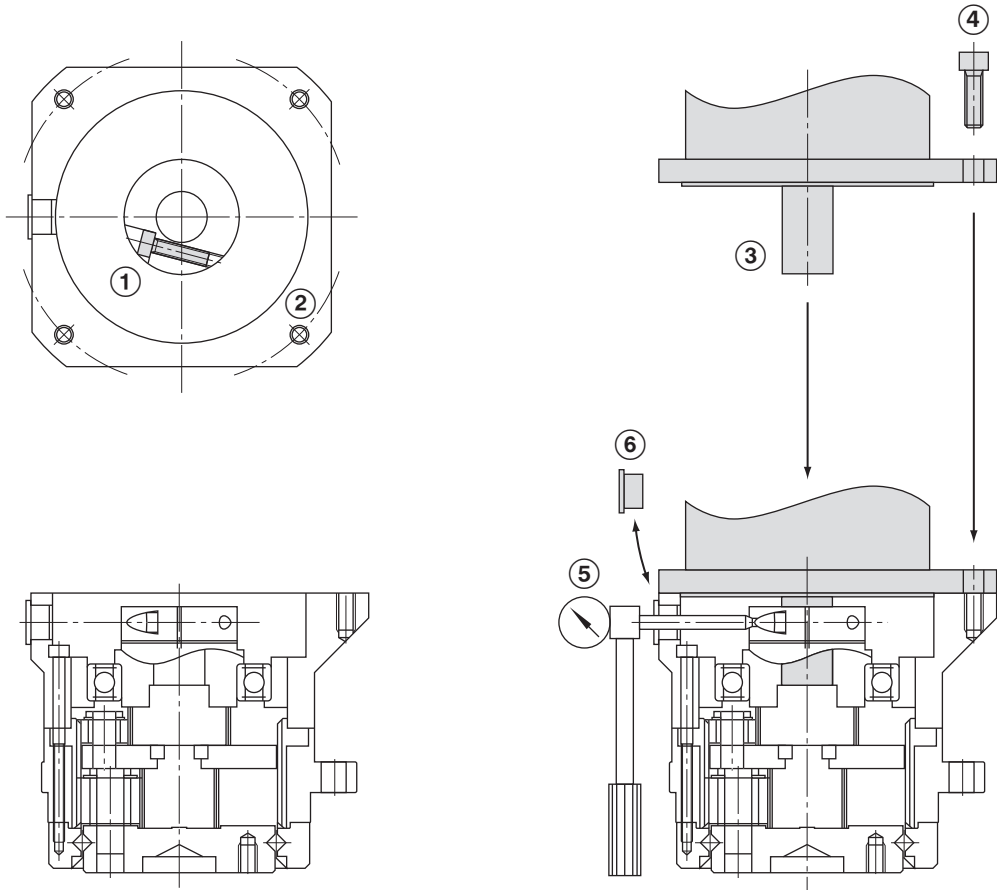

Installing the Decelerator

When installing the R88G-HPG□□□, first make sure that the mounting surface is flat and that there are no burrs on the tap sections, and then bolt on the mounting flanges.

Mounting Flange Bolt Tightening Torque for Aluminum

R88G-HPG	11A	14A	20A	32A	50A	65A
Number of bolts	4	4	4	4	4	4
Bolt size	M3	M5	M8	M10	M12	M16
Mounting PCD (mm)	46	70	105	135	190	260
Tightening torque (N·m)	1.4	6.3	26.1	51.5	103	255

Installing an R88G-VRSF□□□ (Backlash = 15' Max.)

Use the following procedure to install the Decelerator on the Servomotor.

1. Turn the input joint and align the head of the bolt that secures the shaft with the rubber cap.

Make sure the set bolts are loose.

2. Gently insert the Servomotor into the Decelerator.

As shown in the figures below, stand the Decelerator upright and slide the Servomotor shaft into the input shaft joint while making sure it does not fall over. If the Decelerator cannot be stood upright, tighten each bolt evenly little by little to ensure that the Servomotor is not inserted at a tilt.

3. Bolt together the Servomotor and the Decelerator flanges.

Bolt Tightening Torque

Allen head bolt size	M4	M5	M6
Tightening torque (N-m)	3.0	5.8	9.8

4. Tighten the input joint bolt.

Bolt Tightening Torque for Duralumin

Allen head bolt size	M3	M4	M5
Tightening torque (N-m)	1.5	4.5	7.1

Note Always use the torque given in the table above. The Servomotor may slip or other problems may occur if the specified torque level is not satisfied.

5. Mount the supplied rubber cap to complete the installation procedure.

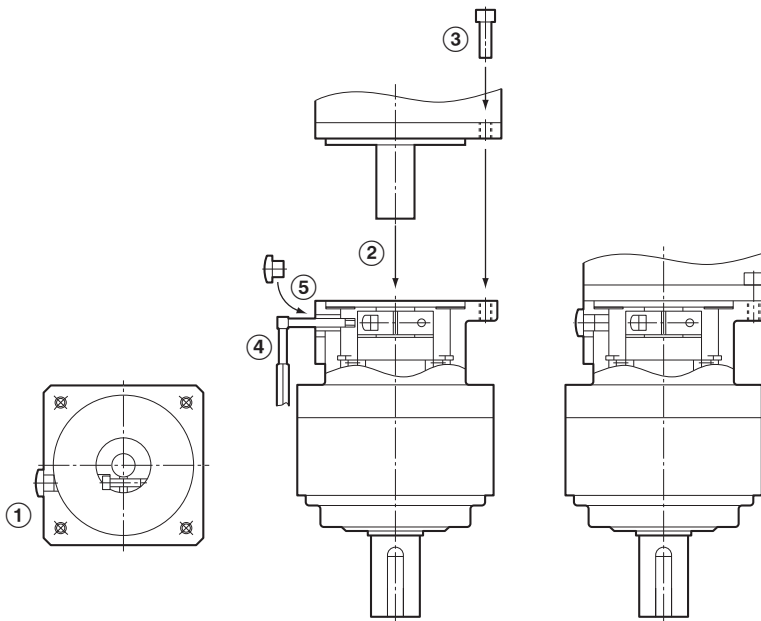

Installing the Decelerator

When installing the R88G-VRSF□□□□, first make sure that the mounting surface is flat and that there are no burrs on the tap sections, and then bolt on the mounting flanges.

Mounting Flange Bolt Tightening Torque for Aluminum

R88G-VRSF	B frame	C frame	D frame
Number of bolts	4	4	4
Bolt size	M5	M6	M8
Mounting PCD (mm)	60	90	115
Tightening torque (N·m)	5.8	9.8	19.6

■ Using Another Company's Decelerator (Reference Information)

If the system configuration requires another company's decelerator to be used in combination with an OMNUC G-Series Servomotor, select the decelerator so that the load on the motor shaft (i.e., both the radial and thrust loads) is within the allowable range.

(Refer to *Characteristics* on page 3-18 for details on the allowable loads for the motors.)

Also, select the decelerator so that the allowable input rotation speed and allowable input torque of the decelerator are not exceeded.

4-2 Wiring

Connecting Cables

This section shows the types of connecting cables used in an OMNUC G-Series servo system.

System Configuration

4

System Design

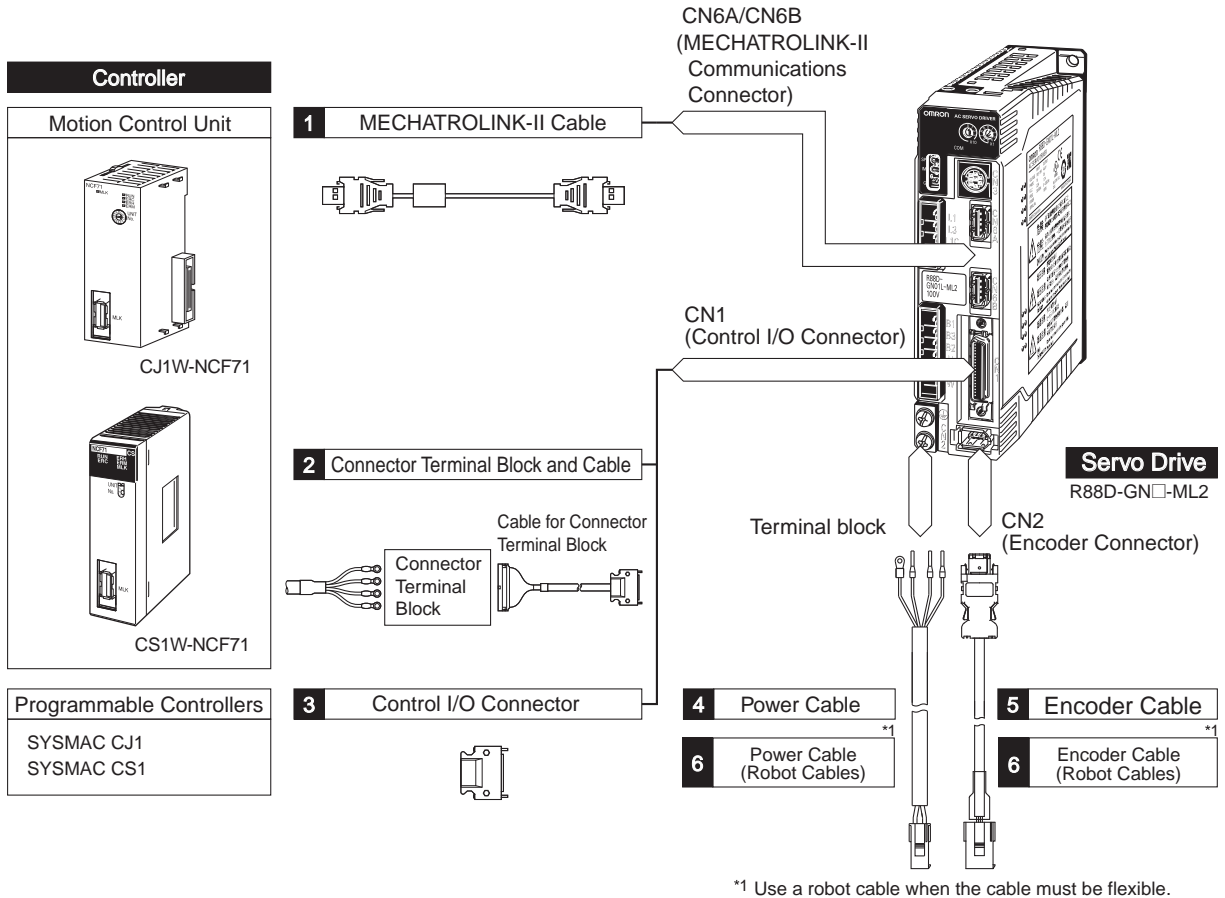

Selecting Connecting Cables

■ Encoder Cables (Standard Cables)

Select an Encoder Cable matching the Servomotor to be used.

Servomotor type		Encoder Cable	Comments
3,000-r/min Servomotors	50 to 750 W ABS	R88A-CRGA□□□C	The □□□ digits in the model number indicate the cable length(3 m, 5 m, 10 m, 15 m, 20 m, 30 m, 40 m, or 50 m). Example model number for a 3-m cable: R88A-CRGA003C
	50 to 750 W INC	R88A-CRGB□□□C	
	1 to 5 kW	R88A-CRGC□□□N	
3,000-r/min Flat Servomotors	100 to 400 W ABS	R88A-CRGA□□□C	
	100 to 400 W INC	R88A-CRGB□□□C	
2,000-r/min Servomotors (1,500-r/min Servomotors)	1 to 7.5 kW	R88A-CRGC□□□N	
1,000-r/min Servomotors	900 W to 6 kW	R88A-CRGC□□□N	

■ Power Cables (Standard Cables)

Select a Power Cable matching the Servomotor to be used.

Servomotor type		Power Cables for Servomotors Without Brakes	Power Cables for Servomotors With Brakes
3,000-r/min Servomotors	50 to 750 W	R88A-CAGA□□□S	R88A-CAGA□□□S (For Power Connector) R88A-CAGA□□□B (For Brake Connector)
	1 to 1.5 kW	R88A-CAGB□□□S	R88A-CAGB□□□B
	2 kW	R88A-CAGC□□□S	R88A-CAGC□□□B
	3 to 5 kW	R88A-CAGD□□□S	R88A-CAGD□□□B
3,000-r/min Flat Servomotors	100 to 400 W	R88A-CAGA□□□S	R88A-CAGA□□□S (For Power Connector) R88A-CAGA□□□B (For Brake Connector)
2,000-r/min Servomotors (1,500-r/min Servomotors)	1 to 1.5 kW	R88A-CAGB□□□S	R88A-CAGB□□□B
	2 kW	R88A-CAGC□□□S	R88A-CAGC□□□B
	3 to 5 kW	R88A-CAGD□□□S	R88A-CAGD□□□B
	7.5 kW	R88A-CAGE□□□S	R88A-CAGE□□□S (For Power Connector) R88A-CAGE□□□B (For Brake Connector)
1,000-r/min Servomotors	900 W	R88A-CAGB□□□S	R88A-CAGB□□□B
	2 to 4.5 kW	R88A-CAGD□□□S	R88A-CAGD□□□B
	6 kW	R88A-CAGE□□□S	R88A-CAGE□□□S (For Power Connector) R88A-CAGE□□□B (For Brake Connector)

Note 1. The □□□ digits in the model number indicate the cable length (3 m, 5 m, 10 m, 15 m, 20 m, 30 m, 40 m, or 50 m). Example model number for a 3-m cable: R88A-CAGA003S

Note 2. For 50 to 750 W (3,000-r/min) Servomotors, Flat Servomotors, and 6-kW and higher Servomotors, there are separate connectors for power and brakes. Therefore, when a Servomotor with a brake is used, it will require both a Power Cable for a Servomotor without a brake and a Brake Cable.

■ Encoder Cables (Robot Cables)

Use a robot cable when the encoder cable must be flexible.

Servomotor type		Encoder Cable	Comments
3,000-r/min Servomotors	50 to 750 W ABS	R88A-CRGA□□□CR	The □□□ digits in the model number indicate the cable length. (3 m, 5 m, 10 m, 15 m, 20 m, 30 m, 40 m, or 50 m). Example model number for a 3-m cable: R88A-CRGA003CR
	50 to 750 W INC	R88A-CRGB□□□CR	
	1 to 5 kW	R88A-CRGC□□□NR	
3,000-r/min Flat Servomotors	100 to 400 W ABS	R88A-CRGA□□□CR	
	100 to 400 W INC	R88A-CRGB□□□CR	
2,000-r/min Servomotors	1 to 5 kW	R88A-CRGC□□□NR	
1,000-r/min Servomotors	900 W to 4.5 kW	R88A-CRGC□□□NR	

■ Power Cables (Robot Cables)

Use a robot cable when the power cable must be flexible.

Servomotor type		Power Cables for Servomotors without Brakes	Power Cables for Servomotors with Brakes
3,000-r/min Servomotors	50 to 750 W	R88A-CAGA□□□SR	R88A-CAGA□□□SR (For Power Connector) R88A-CAGA□□□BR (For Brake Connector)
	1 to 1.5 kW	R88A-CAGB□□□SR	R88A-CAGB□□□BR
	2 kW	R88A-CAGC□□□SR	R88A-CAGC□□□BR
	3 to 5 kW	R88A-CAGD□□□SR	R88A-CAGD□□□BR
3,000-r/min Flat Servomotors	100 to 400 W	R88A-CAGA□□□SR	R88A-CAGA□□□SR (For Power Connector) R88A-CAGA□□□BR (For Brake Connector)
2,000-r/min Servomotors	1 to 1.5 kW	R88A-CAGB□□□SR	R88A-CAGB□□□BR
	2 kW	R88A-CAGC□□□SR	R88A-CAGC□□□BR
	3 to 5 kW	R88A-CAGD□□□SR	R88A-CAGD□□□BR
1,000-r/min Servomotors	900 W	R88A-CAGB□□□SR	R88A-CAGB□□□BR
	2 to 4.5 kW	R88A-CAGD□□□SR	R88A-CAGD□□□BR

Note 1. The □□□ digits in the model number indicate the cable length (3 m, 5 m, 10 m, 15 m, 20 m, 30 m, 40 m, or 50 m). Example model number for a 3-m cable: R88A-CAGA003SR

Note 2. For 50 to 750 W (3,000-r/min) Servomotors and Flat Servomotors, there are separate connectors for power and brakes. Therefore, when a Servomotor with a brake is used, it will require both a Power Cable for a Servomotor without a brake and a Brake Cable.

■ Computer Monitor Cable

A Computer Monitor Cable and the Computer Monitor Software for Servo Drives (CX-Drive) are required to set Servo Drive parameters and perform monitoring with a personal computer.

Name/specifications		Model	Remarks
Computer Monitor Cable	2 m	R88A-CCG002P2	Only a 2-meter cable is available.

■ Control I/O Connector

This connector is used when the cable for the Servo Drive's control I/O connector (CN1) is prepared by the user.

Name	Model	Remarks
Control I/O Connector	R88A-CNU01C	This is the connector for connecting to the Control I/O Connector (CN1). (This item is a connector only.)

■ Connector-Terminal Blocks and Cables

These are used to convert the Servo Drive's control I/O Connector (CN1) signals to a terminal block.

Connector Terminal Block	Cable	Comments
XW2B-20G4 XW2B-20G5 XW2D-20G6	XW2Z-□□□J-B33	The □□□ digits in the model number indicate the cable length (1 m and 2 m). Example model number for a 2-m cable: XW2Z-200J-B33

■ R88D-GN08H-ML2/-GN10H-ML2/-GN15H-ML2

4

System Design

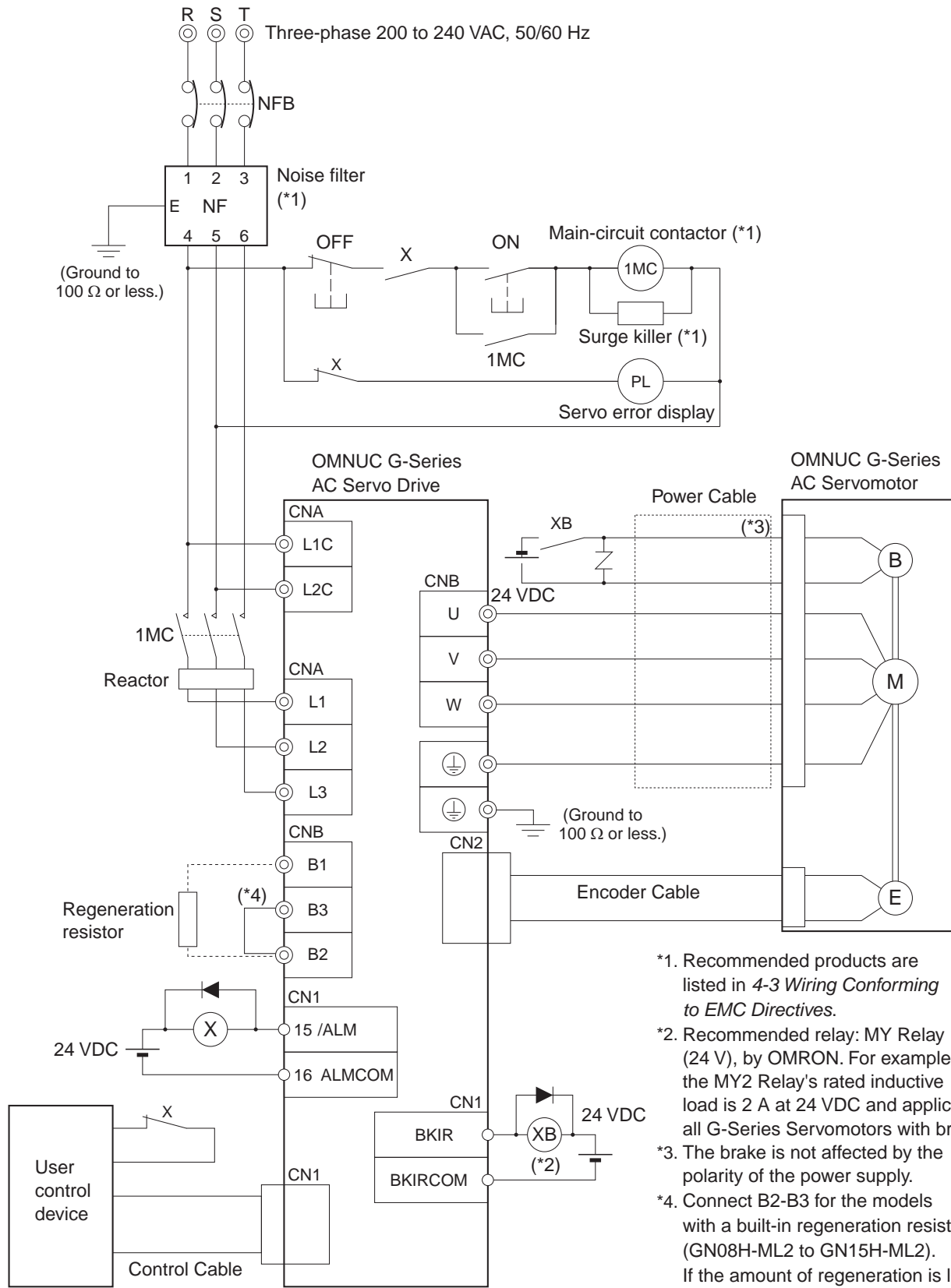

- *1. Recommended products are listed in 4-3 Wiring Conforming to EMC Directives.
- *2. Recommended relay: MY Relay (24 V), by OMRON. For example, the MY2 Relay's rated inductive load is 2 A at 24 VDC and applicable to all G-Series Servomotors with brakes.
- *3. The brake is not affected by the polarity of the power supply.
- *4. Connect B2-B3 for the models with a built-in regeneration resistor (GN08H-ML2 to GN15H-ML2). If the amount of regeneration is large, disconnect B2-B3 and connect an External Regeneration Resistor to B1-B2.

■ R88D-GN20H-ML2/-GN30H-ML2/-GN50H-ML2

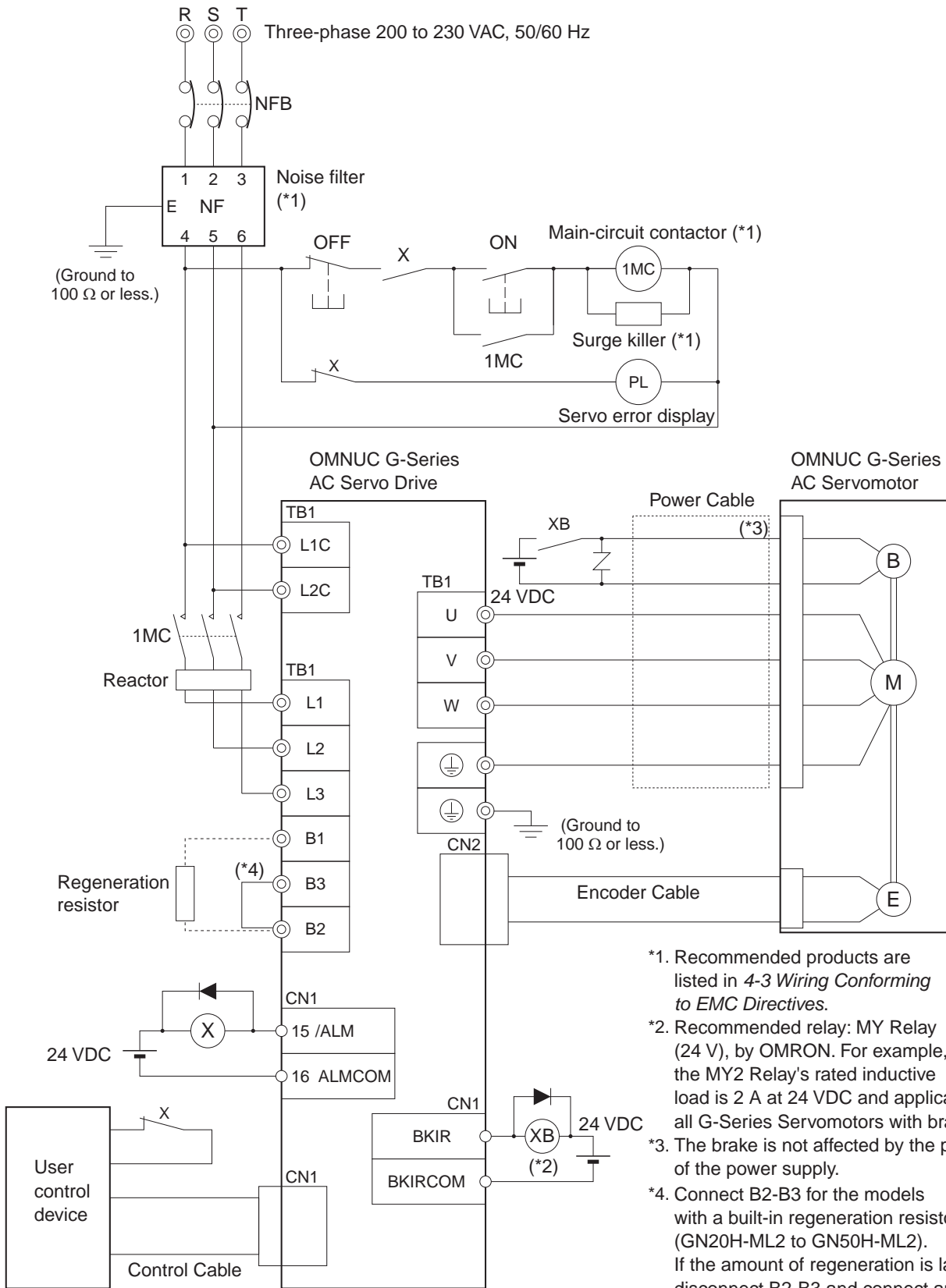

- *1. Recommended products are listed in 4-3 Wiring Conforming to EMC Directives.
- *2. Recommended relay: MY Relay (24 V), by OMRON. For example, the MY2 Relay's rated inductive load is 2 A at 24 VDC and applicable to all G-Series Servomotors with brakes.
- *3. The brake is not affected by the polarity of the power supply.
- *4. Connect B2-B3 for the models with a built-in regeneration resistor (GN20H-ML2 to GN50H-ML2). If the amount of regeneration is large, disconnect B2-B3 and connect an External Regeneration Resistor to B1-B2.

■ R88D-GN75H-ML2

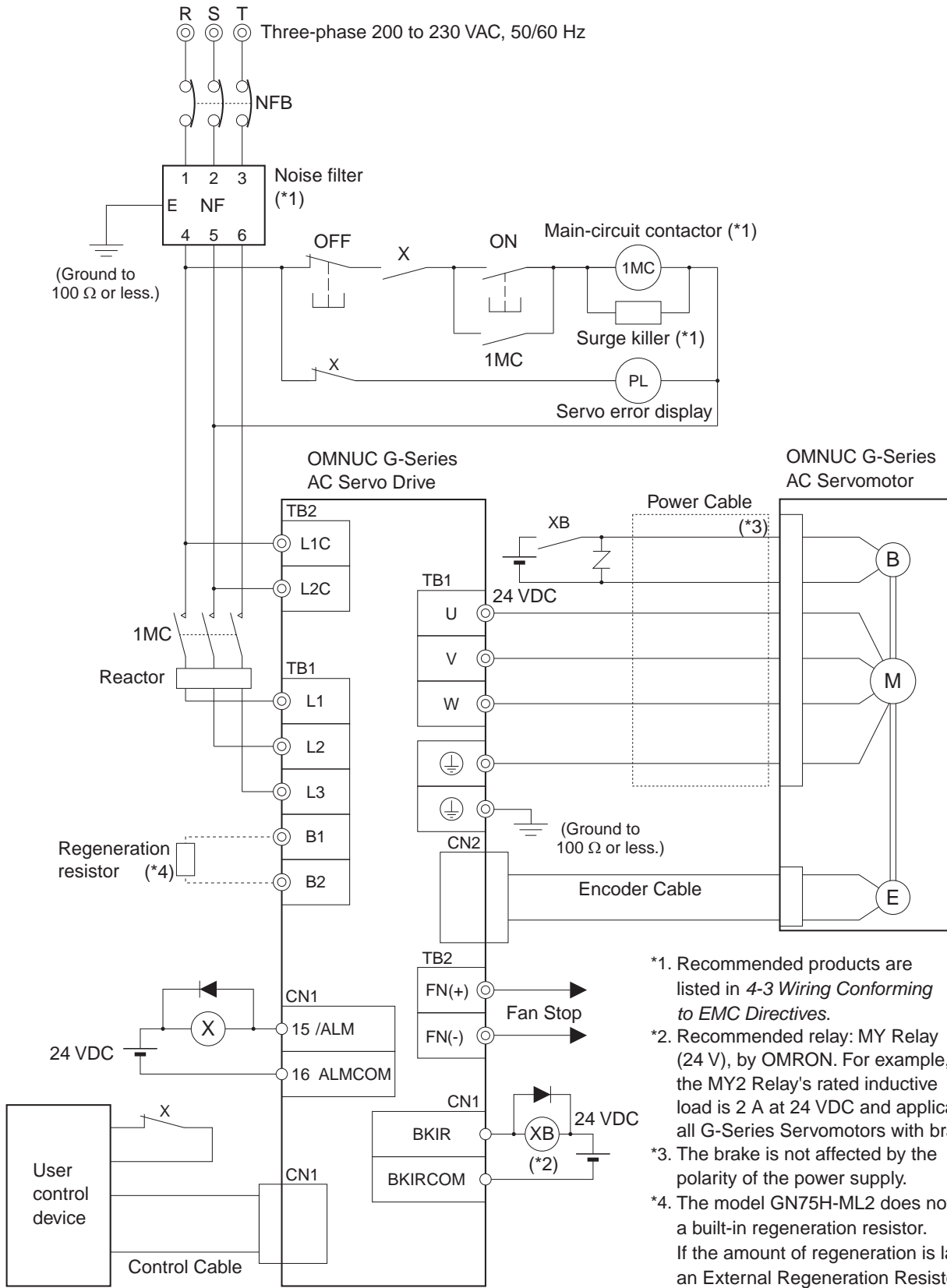

- *1. Recommended products are listed in 4-3 Wiring Conforming to EMC Directives.
- *2. Recommended relay: MY Relay (24 V), by OMRON. For example, the MY2 Relay's rated inductive load is 2 A at 24 VDC and applicable to all G-Series Servomotors with brakes.
- *3. The brake is not affected by the polarity of the power supply.
- *4. The model GN75H-ML2 does not have a built-in regeneration resistor. If the amount of regeneration is large, an External Regeneration Resistor must be connected to B1-B2.

Main Circuit and Servomotor Connector Specifications

When wiring the main circuit, use proper wire sizes, grounding systems, and anti-noise measures.

■ R88D-GNA5L-ML2/-GN01L-ML2/-GN02L-ML2/-GN04L-ML2 R88D-GN01H-ML2/-GN02H-ML2/-GN04H-ML2/-GN08H-ML2/-GN10H-ML2/ -GN15H-ML2

Main Circuit Connector Specifications (CNA)

Symbol	Name	Function
L1	Main circuit power supply input	R88D-GN□L-ML2 (50 to 400 W): Single-phase 100 to 115 VAC (85 to 127 V), 50/60 Hz R88D-GN□H-ML2 (50 W to 1.5 kW): Single-phase 200 to 240 VAC (170 to 264 V), 50/60 Hz (750 W to 1.5 kW): Three-phase 200 to 240 VAC (170 to 264 V), 50/60Hz
L2		
L3		
L1C	Control circuit power supply input	R88D-GN□L-ML2: Single-phase 100 to 115 VAC (85 to 127 V), 50/60 Hz R88D-GN□H-ML2: Single-phase 200 to 240 VAC (170 to 264V), 50/60 Hz
L2C		

Servomotor Connector Specifications (CNB)

Symbol	Name	Function
B1	External Regeneration Resistor connection terminals	50 to 400 W: These terminals normally do not need to be connected. If there is high regenerative energy, connect an External Regeneration Resistor between B1 and B2. 750 W to 1.5 kW: Normally B2 and B3 are connected. If there is high regenerative energy, remove the short-circuit bar between B2 and B3 and connect an External Regeneration Resistor between B1 and B2.
B2		
B3		
U	Servomotor connection terminals	These are the output terminals to the Servomotor. Be sure to wire them correctly.
V		
W		
⊕		
⊕	Frame ground	This is the ground terminal. Ground to 100 Ω or less.

■ R88D-GN20H-ML2/-GN30H-ML2/-GN50H-ML2

Main Circuit Terminal Block Specifications

Symbol	Name	Function	
L1	Main circuit power supply input	R88D-GN□H-ML2 (2 to 5 kW): Three-phase 200 to 230 VAC (170 to 253 V), 50/60Hz	
L2			
L3			
L1C	Control circuit power supply input	R88D-GN□H-ML2 : Single-phase 200 to 230 VAC (170 to 253 V), 50/60 Hz	
L2C			
B1	External Regeneration Resistor connection terminals	2 to 5 kW: Normally B2 and B3 are connected. If there is high regenerative energy, remove the short-circuit bar between B2 and B3 and connect an External Regeneration Resistor between B1 and B2.	
B2			
B3			
U	Servomotor connection terminals	Red	These are the output terminals to the Servomotor. Be sure to wire them correctly.
V		White	
W		Blue	
⊕		Green/ Yellow	
⊕	Frame ground	This is the ground terminal. Ground to 100 Ω or less.	

■ R88D-GN75H-ML2

Main Circuit Terminal Block Specifications (TB1)

Symbol	Name	Function	
L1	Main circuit power supply input	R88D-GN75H-ML2 (6 to 7.5 kW): Three-phase 200 to 230 VAC (170 to 253 V), 50/60Hz	
L2			
L3			
B1	External Regeneration Resistor connection terminals	6 to 7.5 kW: A regeneration resistor is not built in. Connect an External Regeneration Resistor between B1 and B2, if necessary.	
B2			
U	Servomotor connection terminals	Red	These are the output terminals to the Servomotor. Be sure to wire them correctly.
V		White	
W		Blue	
⊕		Green/ Yellow	
⊕	Frame ground	This is the ground terminal. Ground to 100 Ω or less.	

Main Circuit Terminal Block Specifications (TB2)

Symbol	Name	Function
NC	---	Do not connect.
L1C	Control circuit power supply input	R88D-GN75H-ML2: Single-phase 200 to 230 VAC (170 to 253 V), 50/60Hz
L2C		
⊕	Frame ground	This is the ground terminal. Ground to 100 Ω or less.
NC	---	Do not connect.
EX1		
EX2		
EX3		
NC		
FN(+)	Fan Stop Output	Outputs a warning signal when the fan inside the Servo Drive stops. (30 VDC, 50 mA max).
FN(-)		

■ Terminal Block Wire Sizes

100-VAC Input: R88D-GN□□L-ML2

Model (R88D-)		GNA5L-ML2	GN01L-ML2	GN02L-ML2	GN04L-ML2	
Item	Unit					
Power supply capacity	kVA	0.4	0.4	0.5	0.9	
Main circuit power supply input (L1 and L3 or L1, L2, and L3)* ¹	Rated current	A	1.4	2.2	3.7	6.6
	Wire size	---	AWG18			AWG16
Control circuit power supply input (L1C and L2C)	Rated current	A	0.09	0.09	0.09	0.09
	Wire size	---	AWG18			
Servomotor connection terminals (U, V, W, and GR)* ²	Rated current	A	1.2	1.7	2.5	4.6
	Wire size	---	AWG18			
Frame ground (GR)	Wire size	---	AWG14			
	Screw size	---	M4			
	Torque	N·m	1.2			

200-VAC Input: R88D-GN□□H-ML2

Model (R88D-)		GN01H-ML2	GN02H-ML2	GN04H-ML2	GN08H-ML2	GN10H-ML2	
Item	Unit						
Power supply capacity	kVA	0.5	0.5	0.9	1.3	1.8	
Main circuit power supply input (L1 and L3, or L1, L2, and L3)* ¹	Rated current	A	1.3	2.0	3.7	5.0/3.3* ¹	7.5/4.1* ¹
	Wire size	---	AWG18				AWG16
	Screw size	---	---	---	---	---	---
	Torque	N·m	---	---	---	---	---
Control circuit power supply input (L1C and L2C)	Rated current	A	0.05	0.05	0.05	0.05	0.07
	Wire size	---	AWG18				
	Screw size	---	---	---	---	---	---
	Torque	N·m	---	---	---	---	---
Servomotor connection terminals (U, V, W, and GR)* ²	Rated current	A	1.2	1.6	2.6	4.0	5.8
	Wire size	---	AWG18				AWG16
	Screw size	---	---	---	---	---	---
	Torque	N·m	---	---	---	---	---
Frame ground (GR)	Wire size	---	AWG14				
	Screw size	---	M4				
	Torque	N·m	1.2				

Model (R88D-)		GN15H-ML2	GN20H-ML2	GN30H-ML2	GN50H-ML2	GN75H-ML2	
Item	Unit						
Power supply capacity	kVA	2.3	3.3	4.5	7.5	11	
Main circuit power supply input (L1 and L3, or L1, L2, and L3) *1	Rated current	A	11.0/8.0*1	10.2	15.2	23.7	35.0
	Wire size	---	AWG14		AWG12	AWG10	AWG8
	Screw size	---	---	M5			
	Torque	N·m	---	2.0			
Control circuit power supply input (L1C and L2C)	Rated current	A	0.07	0.1	0.12	0.12	0.14
	Wire size	---	AWG18				
	Screw size	---	---	M5			
	Torque	N·m	---	2.0			
Servomotor connection terminals (U, V, W, and GR)*2	Rated current	A	9.4	13.4	18.6	33.0	47.0
	Wire size	---	AWG14		AWG12	AWG8	AWG6
	Screw size	---	---	M5			
	Torque	N·m	---	2.0			
Frame ground (GR)	Wire size	---	AWG14	AWG12		AWG8	
	Screw size	---	M4	M5			
	Torque	N·m	1.2	2.0			

*1. The left value is for single-phase input power, and the right value is for three-phase input power.

*2. Use the same wire sizes for B1 and B2.

*3. Connect an OMRON Servomotor Power Cable to the Servomotor connection terminals.

■ Wire Sizes and Allowable Current (Reference)

The following table shows the allowable current when there are three power supply wires. Use a current below these specified values.

600-V Heat-resistant Vinyl Wire (HIV)

AWG size	Nominal cross-sectional area (mm ²)	Configuration (wires/mm ²)	Conductive resistance (Ω/km)	Allowable current (A) for ambient temperature		
				30°C	40°C	50°C
20	0.5	19/0.18	39.5	6.6	5.6	4.5
---	0.75	30/0.18	26.0	8.8	7.0	5.5
18	0.9	37/0.18	24.4	9.0	7.7	6.0
16	1.25	50/0.18	15.6	12.0	11.0	8.5
14	2.0	7/0.6	9.53	23	20	16
12	3.5	7/0.8	5.41	33	29	24
10	5.5	7/1.0	3.47	43	38	31
8	8.0	7/1.2	2.41	55	49	40
6	14.0	7/1.6	1.35	79	70	57

■ Terminal Block Wiring Procedure

Connector-type Terminal Blocks are used for Servo Drives of 1.5 kW or less (R88D-GNA5L-ML2 to GN15H-ML2).

The procedure for wiring these Terminal Blocks is explained below.

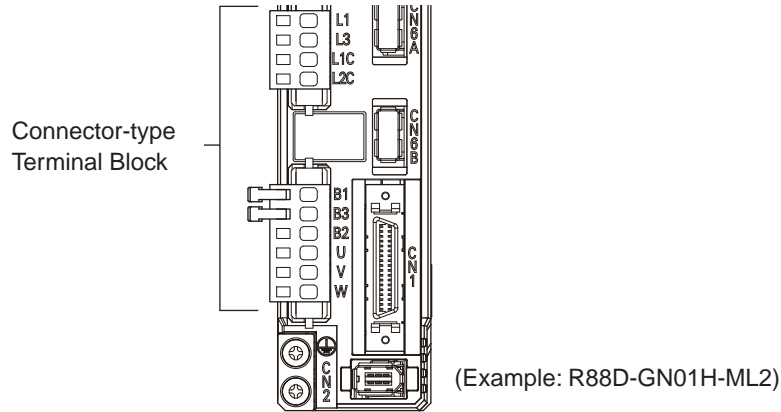

1. Remove the Terminal Block from the Servo Drive before wiring.

The Servo Drive will be damaged if the wiring is performed with the Terminal Block in place.

2. Strip off 8 to 9 mm of the covering from the end of each wire.

Refer to *Terminal Block Wire Sizes* on page 4-23 for applicable wire sizes.

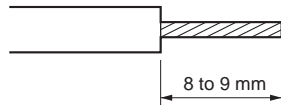

3. Open the wire insertion slots in the Terminal Block.

There are two ways to open the wire insertion slots:

- ♦ Pry the slot open using the lever that comes with the Servo Drive (as in Fig. A).
- ♦ Insert a flat-blade screwdriver (end width: 3.0 to 3.5 mm) into the opening for the screwdriver, and press down firmly to open the slot (as in Fig. B).

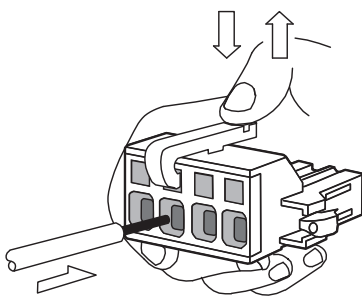

Fig. A

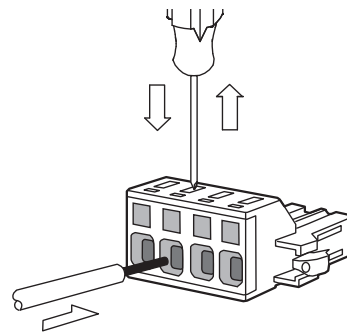

Fig. B

4. With the slot held open, insert the end of the wire.

After inserting the wire, let the slot close by releasing the pressure from the lever or the screwdriver.

5. Mount the Terminal Block to the Servo Drive.

After all of the terminals have been wired, return the Terminal Block to its original position on the Servo Drive.

4-3 Wiring Conforming to EMC Directives

Conformance to the EMC Directives (EN 55011 Class A Group 1 (EMI) and EN 61000-6-2 (EMS)) can be ensured by wiring under the conditions described below.

These conditions are for conformance of OMNUC G-Series products to the EMC Directives. EMC-related performance of these products, however, depends on the configuration, wiring, and other conditions of the equipment in which the products are installed. The EMC conformance of the system as a whole must be confirmed by the customer.

The following are the requirements for EMC Directive conformance.

- ♦ The Servo Drive must be installed in a metal case (control panel). (The Servomotor does not, however, have to be covered with a metal plate.)
- ♦ Noise filters and surge absorbers must be installed on power supply lines.
- ♦ Shielded cables must be used for all I/O signal lines and encoder lines. (Use tin-plated, mild steel wires for the shielding.)
- ♦ All cables, I/O wiring, and power lines connected to the Servo Drive must have clamp filters installed.
- ♦ The shields of all cables must be directly connected to a ground plate.

Wiring Method

R88D-GNA5L-ML2/-GN01L-ML2/-GN02L-ML2/-GN04L-ML2/-GN01H-ML2/-GN02H-ML2/-GN04H-ML2/-GN08H-ML2/-GN10H-ML2/-GN15H-ML2/-GN20H-ML2/-GN30H-ML2/-GN50H-ML2

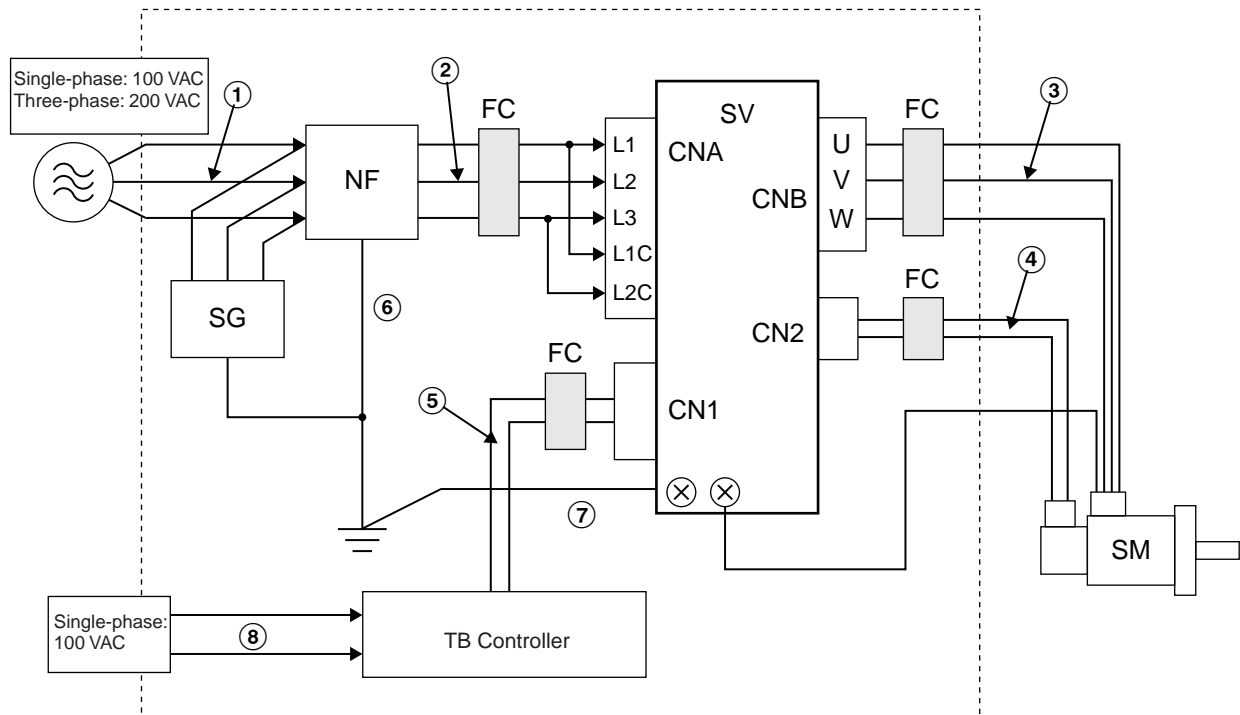

*1. For models with a single-phase power supply input (R88D-GNA5L-ML2/-GN01L-ML2/-GN02L-ML2/-GN04L-ML2/-GN01H-ML2/-GN02H-ML2/-GN04H-ML2/-GN08H-ML2), the main circuit power supply input terminals are L1 and L3.

- ♦ Ground the motor's frame to the machine ground when the motor is on a movable shaft.
- ♦ Use a ground plate for the frame ground for each Unit, as shown in the above diagrams, and ground to a single point.

4-3 Wiring Conforming to EMC Directives

- ♦ Use ground lines with a minimum thickness of 3.5 mm², and arrange the wiring so that the ground lines are as short as possible.
- ♦ No-fuse breakers, surge absorbers, and noise filters should be positioned near the input terminal block (ground plate), and I/O lines should be separated and wired at the shortest distance.

R88D-GN75H-ML2

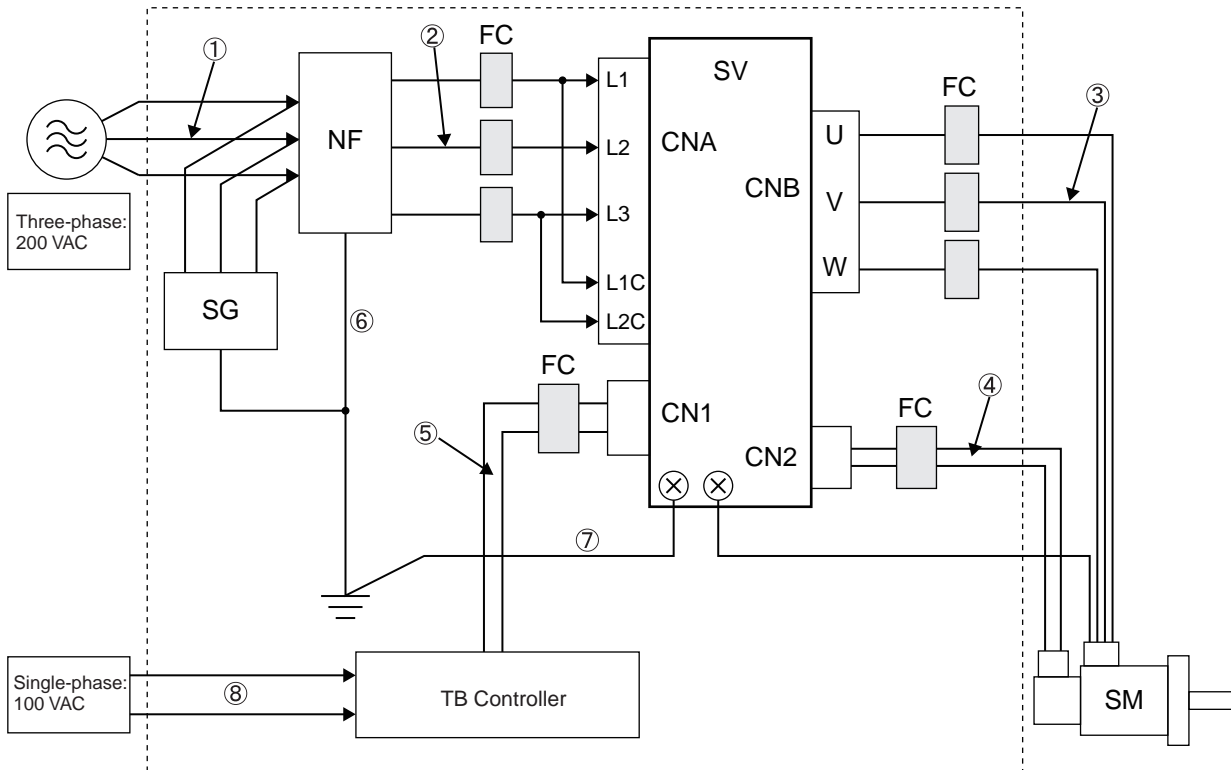

Unit Details

Symbol	Name	Manufacturer	Model	Remarks
SG	Surge absorber	Okaya Electric Industries Co., Ltd.	RAV781BWZ-4	Single-phase 100 VAC
			RAV781BXZ-4	Three-phase 200 VAC
NF	Noise filter	Okaya Electric Industries Co., Ltd.	SUP-EK5-ER-6	Single-phase 100/200 VAC (5 A)
			3SUP-HQ10-ER-6	Three-phase 200 VAC (10A)
			3SUP-HU30-ER-6	Three-phase 200 VAC (30 A)
			3SUP-HL50-ER-6B	Three-phase 200 VAC (50A)
SV	Servo Drive	OMRON	---	*1
SM	Servomotor	OMRON	---	*1
FC	Clamp core	TDK	ZACT305-1330	---
TB	Controller	---	---	Switch box

*1. A specified combination of Servo Drive and Servomotor must be used.

Cable Details

Symbol	Supplies from	Connects to	Cable name	Length	Remarks	Shielded	Ferrite
①	AC power supply	Noise filter	Power supply line	2 m	Three-phase 200 VAC	No	No
②	Noise filter	Servo Drive	Power supply line	2 m	---	No	Yes
③	Servo Drive	Servomotor	Power cable	20 m	---	Yes	Yes
④	Servo Drive	Servomotor	Encoder cable	20 m	---	No	Yes
⑤	Switch box	Servo Drive	I/O cable	2 m	---	No	Yes
⑥	Frame ground	Noise filter	Frame ground line	1.5 m	---	No	No
⑦	Frame ground	Noise filter	Frame ground line	1.5 m	---	No	No
⑧	AC power supply	Switch box	Power supply line	1.5 m	---	No	No

■ Noise Filters for the Power Supply Input

Use the following noise filters for the Servo Drive power supply.

Servo Drive model	Noise Filters for the Power Supply Input				
	Model	Rated current	Phases	Maximum leakage current (60 Hz)	Manufacturer
R88D-GNA5L-ML2	SUP-EK5-ER-6	5 A	Single	1.0 mA (at 250 VAC)	Okaya Electric Industries Co., Ltd.
R88D-GN01L-ML2					
R88D-GN02L-ML2					
R88D-GN04L-ML2	3SUP-HQ10-ER-6	10 A	Three	3.5 mA (at 500 VAC)	
R88D-GN01H-ML2	SUP-EK5-ER-6	5 A	Single	1.0 mA (at 250 VAC)	
R88D-GN02H-ML2					
R88D-GN04H-ML2					
R88D-GN08H-ML2	3SUP-HQ10-ER-6	10 A	Three	3.5 mA (at 500 VAC)	
R88D-GN10H-ML2	3SUP-HU30-ER-6	30 A	Three	3.5 mA (at 500 VAC)	
R88D-GN15H-ML2					
R88D-GN20H-ML2					
R88D-GN30H-ML2	3SUP-HL50-ER-6B	50 A	Three	8.0 mA (at 500 VAC)	
R88D-GN50H-ML2					
R88D-GN75H-ML2					

4-3 Wiring Conforming to EMC Directives

- ♦ If no-fuse breakers are installed at the top and the power supply line is wired from the lower duct, use metal tubes for wiring or make sure that there is adequate distance between the input lines and the internal wiring. If input and output lines are wired together, noise resistance will decrease.
- ♦ Wire the noise filter as shown at the left in the following illustration. The noise filter must be installed as close as possible to the entrance of the control box.

○ Correct: Separate input and output

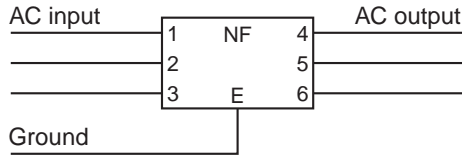

✗ Wrong: Noise not filtered effectively

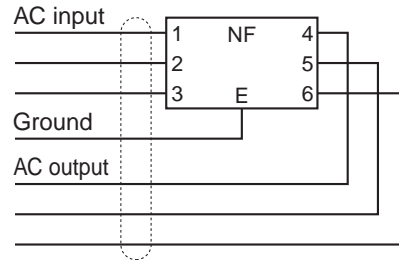

- ♦ Use twisted-pair cables for the power supply cables, or bind the cables.

○ Correct: Properly twisted

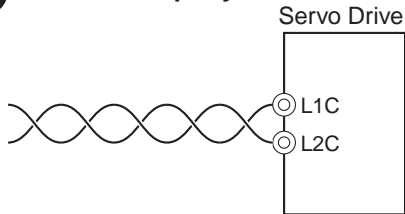

○ Correct: Cables are bound.

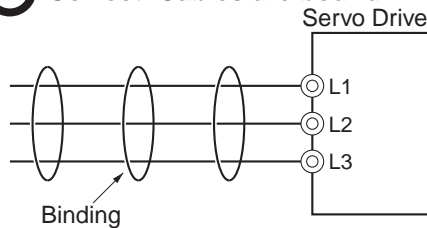

- ♦ Separate power supply cables and signal cables when wiring.

■ Control Panel Structure

Openings in the control panel, such as holes for cables, operating panel mounting holes, and gaps around the door, may allow electromagnetic waves into the panel. To prevent this, observe the recommendations described below when designing or selecting a control panel.

Case Structure

- ♦ Use a metal control panel with welded joints at the top, bottom, and sides so that the surfaces will be electrically conductive.
- ♦ If assembly is required, strip the paint off the joint areas (or mask them during painting), to make them electrically conductive.
- ♦ The panel may warp and gaps may appear when screws are tightened. Be sure that no gaps appear when tightening screws.
- ♦ Do not leave any conductive part unconnected.
- ♦ Ground all Units within the case to the case itself.

Door Structure

- ♦ Use a metal door.
- ♦ Use a water-draining structure where the door and case fit together, and leave no gaps. (Refer to the diagrams on the next page.)
- ♦ Use a conductive gasket between the door and the case. (Refer to the diagrams on the next page.)
- ♦ Strip the paint off the sections of the door and case that will be in contact with the conductive gasket (or mask them during painting), so that they will be electrically conductive.
- ♦ The panel may warp and gaps may appear when screws are tightened. Be sure that no gaps appear when tightening screws.

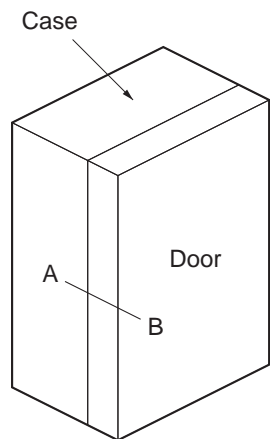

Control panel

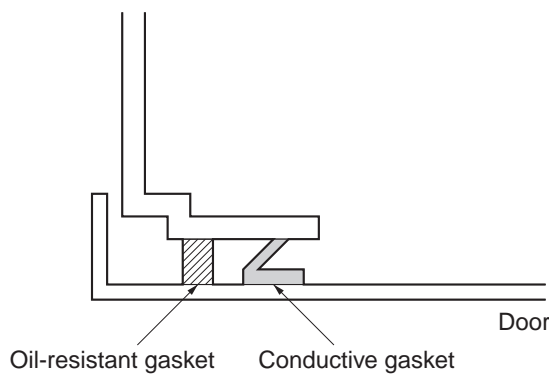

Cross-sectional view of A-B

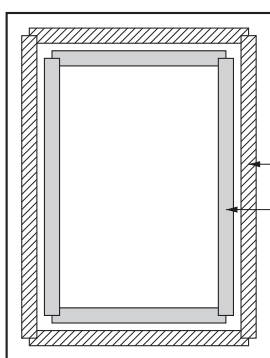

Door (interior view)

Selecting Connection Components

This section explains the criteria for selecting the connection components required to improve noise resistance.

Understand each component's characteristics, such as its capacity, performance, and applicable conditions when selecting the components.

For more details, contact the manufacturers directly.

■ No-fuse Breakers (NFB)

When selecting a no-fuse breaker, consider the maximum input current and the inrush current.

Maximum Input Current:

- ♦ The Servo Drive's maximum momentary output is approximately three times the rated output, and can be output for up to three seconds.
Therefore, select no-fuse breakers with an operating time of at least five seconds at 300% of the rated current. General-purpose and low-speed no-fuse breakers are generally suitable.
- ♦ Select a no-fuse-breaker with a rated current greater than the total effective load current of all the Servomotors. The rated current of the power supply input for each Servomotor is provided in *Main Circuit and Servomotor Connector Specifications* on page 4-20.
- ♦ Add the current consumption of other controllers, and any other components, when selecting the NFB.

Inrush Current:

- ♦ The following table lists the Servo Drive inrush currents.
- ♦ With low-speed no-fuse breakers, an inrush current 10 times the rated current can flow for 0.02 second.
- ♦ When multiple Servo Drives are turned ON simultaneously, select a no-fuse-breaker with a 20-ms allowable current that is greater than the total inrush current, shown in the following table.

Servo Drive model	Inrush current (Ao-p)	
	Main circuit power supply	Control circuit power supply
R88D-GNA5L-ML2	7	14
R88D-GN01L-ML2	7	14
R88D-GN02L-ML2	7	14
R88D-GN04L-ML2	30	14
R88D-GN01H-ML2	14	28
R88D-GN02H-ML2	14	28
R88D-GN04H-ML2	14	28
R88D-GN08H-ML2	60	28
R88D-GN10H-ML2	29	28
R88D-GN15H-ML2	29	28
R88D-GN20H-ML2	29	14
R88D-GN30H-ML2	22	14
R88D-GN50H-ML2	22	14
R88D-GN75H-ML2	88	66

■ Leakage Breakers

- ♦ Select leakage breakers designed for protection against grounding faults.
- ♦ Because switching takes place inside the Servo Drives, high-frequency current leaks from the switching elements of the Servo Drive, the armature of the motor, and the cables.
High-frequency breakers with surge withstand capability do not detect high-frequency current, preventing the breaker from operating with high-frequency leakage current.
When using a general-purpose leakage breaker, use three times the sum of the leakage current given in the following table as a reference value.
- ♦ When selecting leakage breakers, remember to add the leakage current from devices other than the Servomotor, such as machines using a switching power supply, noise filters, inverters, and so on. To prevent malfunction due to inrush current, we recommend using a leakage breaker of ten times the total of all current values.
- ♦ The leakage breaker is activated at 50% of the rated current. Allow leeway when selecting a leakage breaker.
- ♦ For details on leakage breakers, refer to the manufacturer's catalog.
- ♦ The following table shows the Servomotor leakage current for each Servo Drive model.

Servo Drive model	Input power	Leakage current		
		Resistance method Resistor plus capacitor	Clamping method (Measurement filter ON at H10K13283)	
		Motor cable length: 3 m	Motor cable length: 3 m	Per meter of motor cable
R88D-GNA5L-ML2	Single-phase 100 V	0.42 mA	0.33 mA	0.003 mA
R88D-GN01L-ML2	Single-phase 100 V	0.45 mA	0.35 mA	0.002 mA
R88D-GN02L-ML2	Single-phase 100 V	0.46 mA	0.35 mA	0.002 mA
R88D-GN04L-ML2	Single-phase 100 V	0.48 mA	0.35 mA	0.002 mA
R88D-GN01H-ML2	Single-phase 200V	0.92 mA	1.04 mA	0.016 mA
R88D-GN02H-ML2	Single-phase 200V	0.94 mA	1.06 mA	0.013 mA
R88D-GN04H-ML2	Single-phase 200V	1.15 mA	1.13 mA	0.013 mA
R88D-GN08H-ML2	Single-phase 200V	1.27 mA	1.09 mA	0.014 mA
R88D-GN10H-ML2	Single-phase 200V	1.27 mA	1.19 mA	0.015 mA
R88D-GN15H-ML2	Single-phase 200V	1.51 mA	1.20 mA	0.015 mA
R88D-GN08H-ML2	Three-phase 200 V	1.62 mA	0.98 mA	0.009 mA
R88D-GN10H-ML2	Three-phase 200 V	1.77 mA	1.03 mA	0.008 mA
R88D-GN15H-ML2	Three-phase 200 V	2.18 mA	1.04 mA	0.003 mA
R88D-GN20H-ML2	Three-phase 200 V	2.88 mA	1.08 mA	0.008 mA
R88D-GN30H-ML2	Three-phase 200 V	2.83 mA	1.15 mA	0.011 mA
R88D-GN50H-ML2	Three-phase 200 V	3.07 mA	1.14 mA	0.011 mA
R88D-GN75H-ML2	Three-phase 200 V	6.32 mA	1.23 mA	0.013 mA

Note 1. The above leakage current is for cases when Servomotor power cable length is 3 meters or shorter.
(The leakage current depends on the power cable length and the insulation.)

Note 2. The resistor plus capacitor method provides a yardstick to measure the leakage current that may flow through the human body when the Servomotor or Servo Drive is not grounded correctly.
The above leakage current is for normal temperature and humidity. (The leakage current depends on the temperature and humidity.)

■ Surge Absorbers

- ♦ Use surge absorbers to absorb lightning surge voltage and abnormal voltage from power supply input lines.
- ♦ When selecting surge absorbers, take into account the varistor voltage, the allowable surge current and the energy.
- ♦ For 200-VAC systems, use surge absorbers with a varistor voltage of 620 V.
- ♦ The surge absorbers shown in the following table are recommended.

Manufacturer	Model	Surge immunity		Type	Remarks
Okaya Electric Industries Co., Ltd.	R·A·V-781BWZ-4	700 V \pm 20%	2,500 A	Block	Single-phase 100/200 VAC
Okaya Electric Industries Co., Ltd.	R·A·V-781BXZ-4	700 V \pm 20%	2,500 A		Three-phase 200 VAC

Note 1. Refer to the manufacturers' documentation for operating details.

Note 2. The surge immunity is for a standard impulse current of 8/20 μ s. If pulses are wide, either decrease the current or change to a larger-capacity surge absorber.

Dimensions

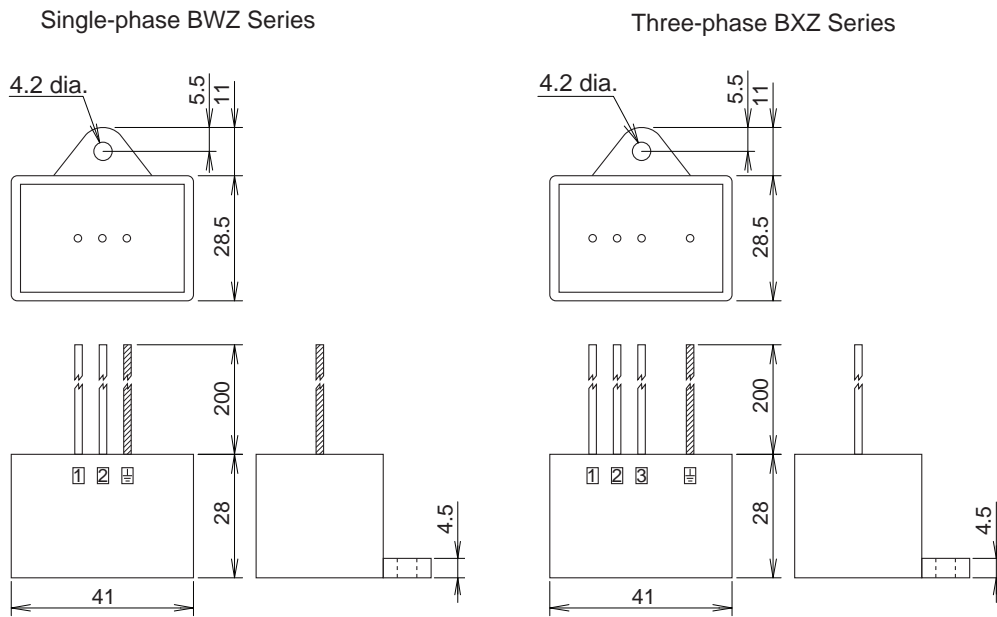

Equalizing Circuits

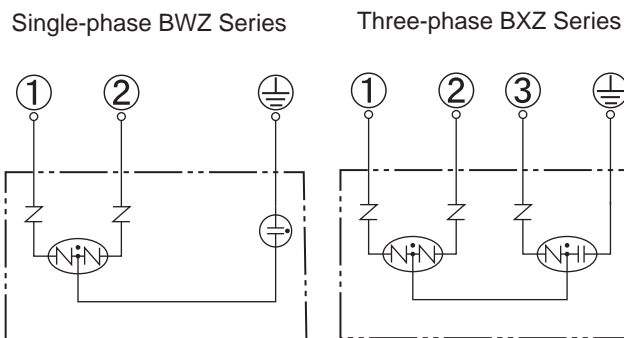

■ Noise Filters for the Power Supply Input

◆ Use the following noise filters for the Servo Drive's power supply.

Servo Drive model	Noise filter for the Power Supply Input			
	Model	Rated current	Max. leakage current (60 Hz)	Manufacturer
R88D-GNA5L-ML2	SUP-EK5-ER-6	5 A	1 mA (at 250 VAC)	Okaya Electric Industries Co., Ltd.
R88D-GN01L-ML2				
R88D-GN02L-ML2				
R88D-GN04L-ML2	3SUP-HQ10-ER-6	10 A	3.5 mA (at 500 VAC)	
R88D-GN01H-ML2	SUP-EK5-ER-6	5 A	1 mA (at 250 VAC)	
R88D-GN02H-ML2				
R88D-GN04H-ML2				
R88D-GN08H-ML2	3SUP-HQ10-ER-6	10 A	3.5 mA (at 500 VAC)	
R88D-GN10H-ML2	3SUP-HU30-ER-6	30 A	3.5 mA (at 500 VAC)	
R88D-GN15H-ML2				
R88D-GN20H-ML2				
R88D-GN30H-ML2	3SUP-HL50-ER-6B	50 A	8 mA (at 500 VAC)	
R88D-GN50H-ML2				
R88D-GN75H-ML2				

Dimensions

SUP-EK5-ER-6

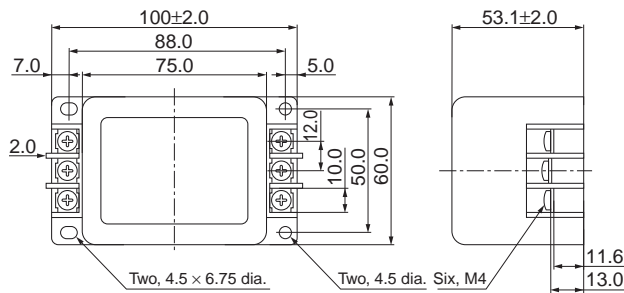

3SUP-HQ10-ER-6

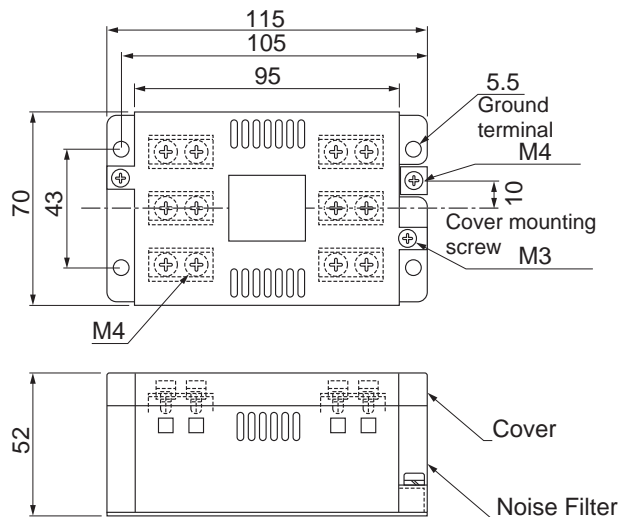

4-3 Wiring Conforming to EMC Directives

3SUP-HU30-ER-6

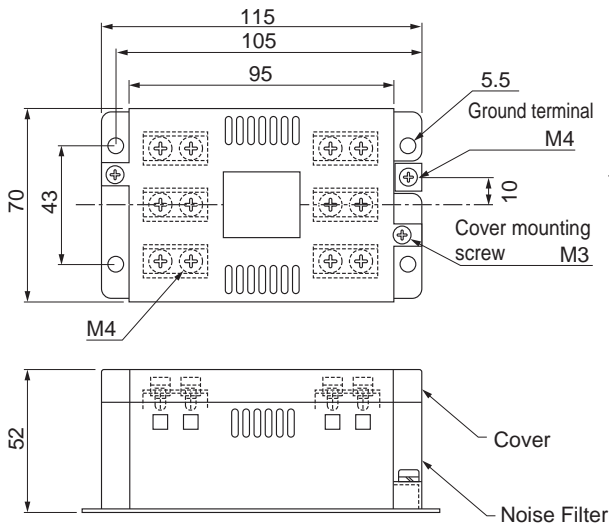

3SUP-HL50-ER-6B

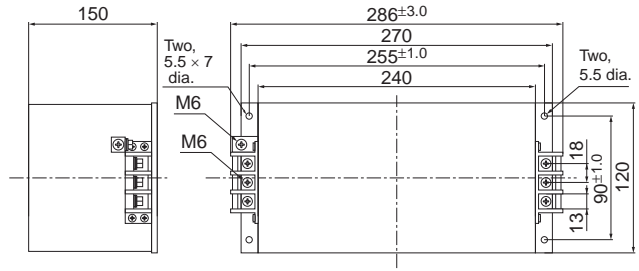

Circuit Diagrams

SUP-EK5-ER-6

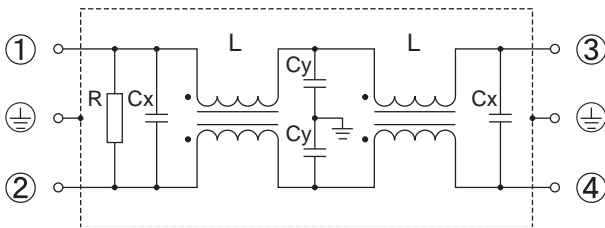

3SUP-HQ10-ER-6

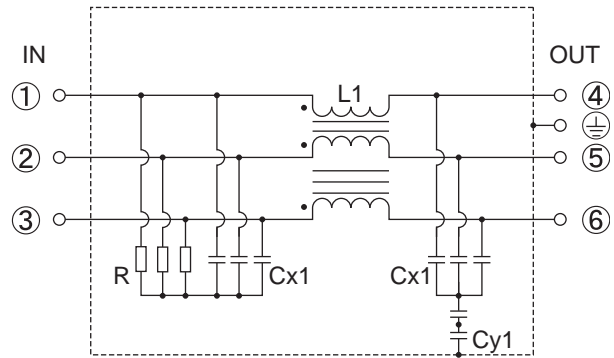

3SUP-HU30-ER-6

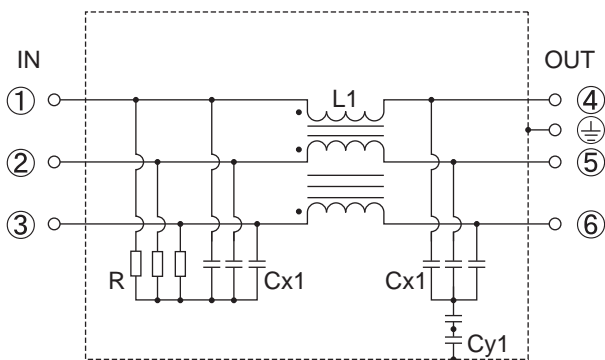

3SUP-HL50-ER-6B

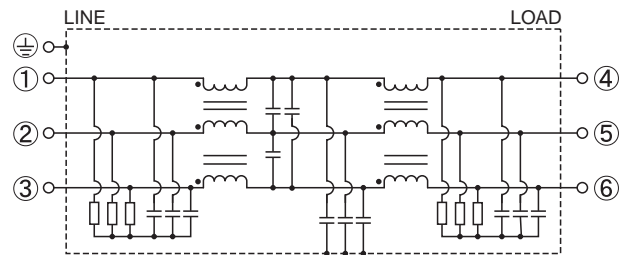

■ Noise Filter for the Brake Power Supply

- ♦ Use the following noise filter for the brake power supply.

Model	Rated current	Rated voltage	Leakage current	Manufacturer
SUP-EK5-ER-6	5 A	250 V	1.0 mA (at 250 Vrms, 60 Hz)	Okaya Electric Industries Co., Ltd.

Note Noise can also be reduced by using 1.5 turns with the ZCAT3035-1330 (TDK) Radio Noise Filter.

■ Radio Noise Filters and Emission Noise Prevention Clamp Cores

Use one of the following filters to prevent switching noise of PWM of the Servo Drive and to prevent noise emitted from the internal oscillation circuit.

Model	Manufacturer	Application
3G3AX-ZCL1 *1	OMRON	Servo Drive output and power cable
3G3AX-ZCL2 *2	OMRON	Servo Drive output and power cable
ESD-R-47B *3	NEC TOKIN	Servo Drive output and power cable
ZCAT3035-1330 *4	TDK	Encoder cable and I/O cable

- *1. Generally used for 1.5 kW or higher.
- *2. Generally used for 1.5 kW or lower. The maximum number of windings is three turns.
- *3. Generally used for 50/100 W. The maximum number of windings is two turns.
- *4. Also used on the Servo Drive output power lines to comply with the EMC Directives. Only a clamp is used. This clamp can also be used to reduce noise current on a frame ground line.

Dimensions

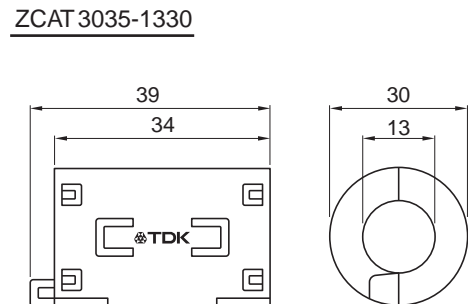
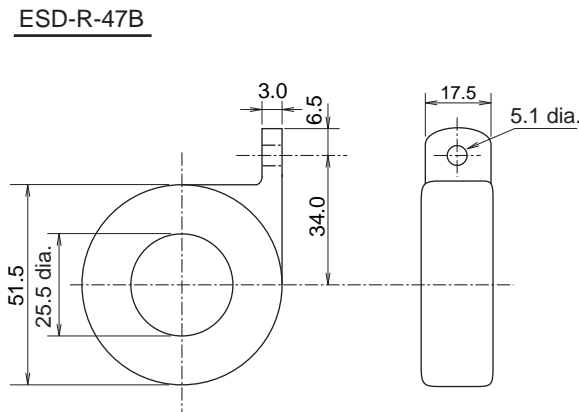
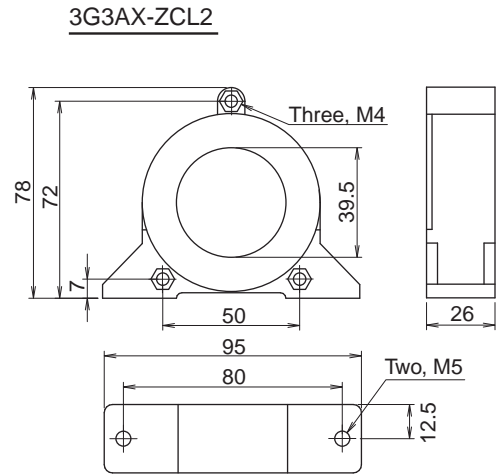
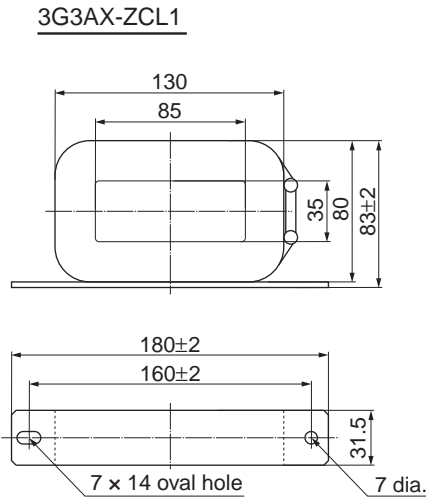

Impedance Characteristics

3G3AX-ZCL1

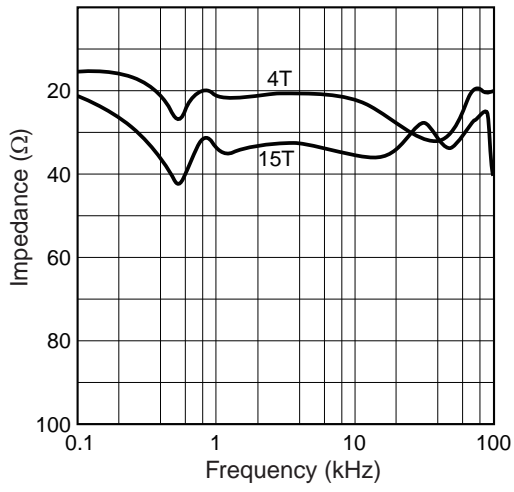

3G3AX-ZCL2

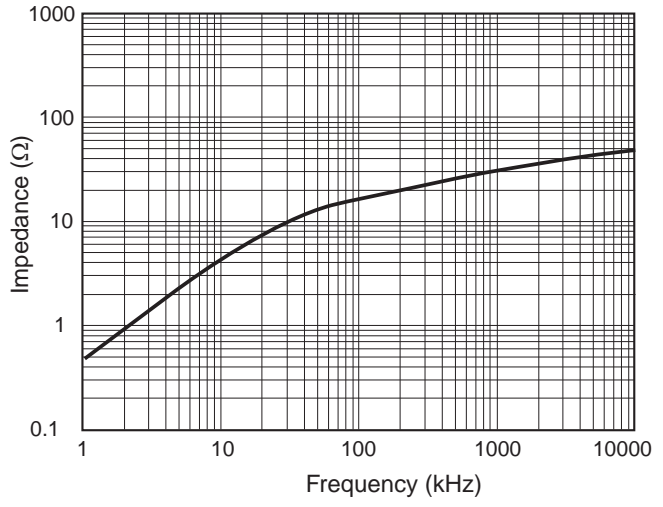

ESD-R-47B

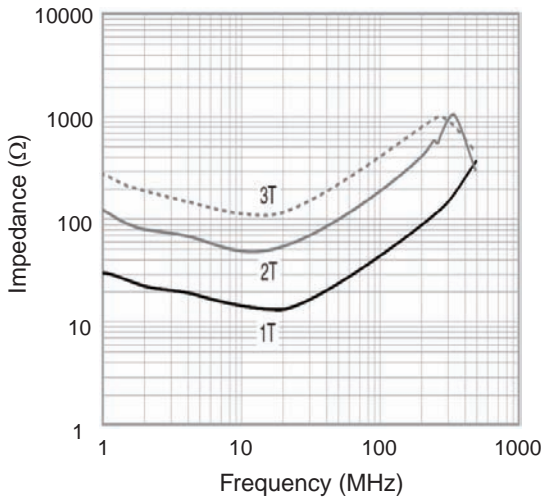

ZCAT 3035-1330

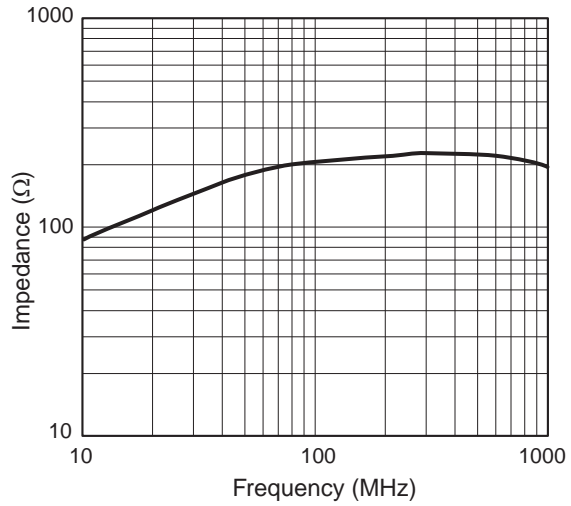

■ Surge Suppressors

- ♦ Install surge suppressors for loads that have induction coils, such as relays, solenoids, brakes, clutches, etc.
- ♦ The following table shows the types of surge suppressors and recommended products.

Type	Features	Recommended products
Diode	Diodes are used for relatively small loads when the reset time is not an issue, such as relays. At power shutoff the surge voltage is the lowest, but the reset time takes longer. Used for 24/48-VDC systems.	Use a fast-recovery diode with a short reverse recovery time (e.g. RU2 of Sanken Electric Co., Ltd.).
Thyristor or varistor	Thyristors and varistors are used for loads with large induction coils, as in electromagnetic brakes, solenoids, etc., and when reset time is an issue. The surge voltage at power shutoff is approximately 1.5 times the varistor voltage.	Select the varistor voltage as follows: 24 VDC system: Varistor V. 39V 100 VDC system: Varistor V. 200 V 100 VAC system: Varistor V. 270 V 200 VAC system: Varistor V. 470 V
Capacitor + resistor	The capacitor plus resistor combination is used to absorb vibration in the surge at power shutoff. The reset time can be shortened by selecting the appropriate capacitance and resistance.	Okaya Electric Industries Co., Ltd. XEB12002 0.2 μ F - 120 Ω XEB12003 0.3 μ F - 120 Ω

- ♦ Thyristors and varistors are made by the following companies. Refer to manufacturers' documentation for details on these components.
Thyristors: Ishizuka Electronics Co.
Varistors: Ishizuka Electronics Co., Matsushita Electric Industrial Co.

■ Contactors

- ♦ Select contactors based on the circuit's inrush current and the maximum momentary phase current.
- ♦ The Servo Drive inrush current is covered in the preceding explanation of no-fuse breaker selection, and the maximum momentary phase current is approximately twice the rated current.
- ♦ The following table shows the recommended contactors.

Manufacturer	Model	Rated current	Coil voltage
OMRON	J7L-09-22200	11 A	200 VAC
	J7L-12-22200	13 A	200 VAC
	J7L-18-22200	18 A	200 VAC
	J7L-32-22200	26 A	200 VAC
	J7L-40-22200	35 A	200 VAC
	J7L-50-22200	50 A	200 VAC
	J7L-65-22200	65 A	200 VAC
	J7L-75-22200	75 A	200 VAC

■ Improving Encoder Cable Noise Resistance

Take the following steps during wiring and installation to improve the encoder's noise resistance.

- ♦ Always use the specified Encoder Cables.
- ♦ If cables are joined midway, be sure to use connectors and do not remove more than 50 mm of the cable insulation. In addition, always use shielded cables.
- ♦ Do not coil cables. If cables are long and are coiled, mutual induction and inductance will increase and cause malfunctions. Always use cables fully extended.
- ♦ When installing noise filters for Encoder Cables, use clamp filters.
- ♦ The following table shows the recommended clamp filters.

Manufacturer	Product name	Model	Specifications
NEC TOKIN	Clamp Filters	ESD-SR-250	For cable diameter up to 13 mm
TDK	Clamp Filters	ZCAT3035-1330	For cable diameter up to 13 mm

- ♦ Do not place the Encoder Cable with the following cables in the same duct:
Control Cables for brakes, solenoids, clutches, and valves.

Dimensions

ESD-SR-250

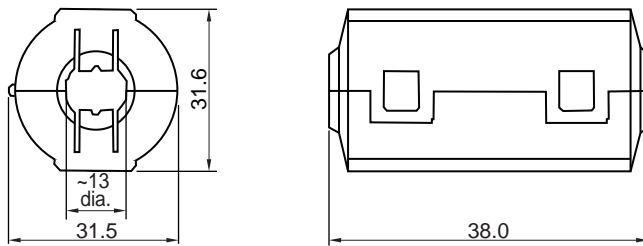

Impedance Characteristics

ESD-SR-250

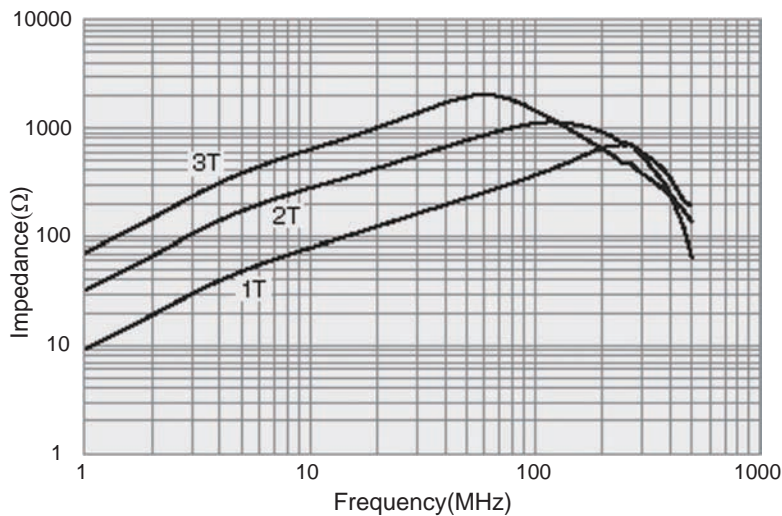

■ Improving Control I/O Signal Noise Resistance

Positioning can be affected and I/O signal errors can occur if control I/O is influenced by noise.

- ♦ Use completely separate power supplies for the control power supply (especially 24 VDC) and the external operation power supply. In particular, do not connect the two power supply ground wires.
- ♦ Install a noise filter on the primary side of the control power supply.
- ♦ If Servomotors with brakes are being used, do not use the same 24-VDC power supply for both the brakes and the control I/O. Additionally, do not connect the ground wires. Connecting the ground wires may cause I/O signal errors.
- ♦ Keep the power supply for pulse commands and deviation counter reset input lines separated from the control power supply as far as possible. In particular, do not connect the two power supply ground wires.
- ♦ We recommend using line drivers for the pulse command and deviation counter reset outputs.
- ♦ Always use twisted-pair shielded cable for the pulse command and deviation counter reset signal lines, and connect both ends of the shield to frame grounds.
- ♦ If the control power supply wiring is long, noise resistance can be improved by adding 1- μ F laminated ceramic capacitors between the control power supply and ground at the Servo Drive input section or the controller output section.
- ♦ For open-collector specifications, keep the length of wires to within two meters.

■ Reactors to Reduce Harmonic Current

Harmonic Current Countermeasures

- ♦ The Reactor is used for suppressing harmonic currents. It suppresses sudden and quick changes in electric currents.
- ♦ "The Guidelines for Suppressing Harmonic Currents in Home Appliances and General Purpose Components" require that manufacturers take appropriate measures to suppress harmonic current emissions onto power supply lines.
- ♦ Select the proper Reactor model according to the Servo Drive to be used.

Servo Drive model	Reactor specifications		
	Model	Rated current	Inductance
R88D-GNA5L-ML2 R88D-GN01H-ML2	3G3AX-DL2002	1.6 A	21.4 mH
R88D-GN01L-ML2 R88D-GN02H-ML2	3G3AX-DL2004	3.2 A	10.7 mH
R88D-GN02L-ML2 R88D-GN04H-ML2	3G3AX-DL2007	6.1 A	6.75 mH
R88D-GN04L-ML2 R88D-GN08H-ML2 R88D-GN10H-ML2	3G3AX-DL2015	9.3 A	3.51 mH
R88D-GN15H-ML2	3G3AX-DL2022	13.8 A	2.51 mH
R88D-GN08H-ML2 R88D-GN10H-ML2 R88D-GN15H-ML2	3G3AX-AL2025	10.0 A	2.8 mH
R88D-GN20H-ML2 R88D-GN30H-ML2	3G3AX-AL2055	20.0 A	0.88 mH
R88D-GN50H-ML2	3G3AX-AL2110	34.0 A	0.35 mH
R88D-GN75H-ML2	3G3AX-AL2220	67.0 A	0.18 mH

■ Selecting Other Parts for Noise Resistance

This section explains the criteria for selecting other connection components required to improve noise resistance.

Understand each component's characteristics, such as its capacity, performance, and applicable conditions when selecting the components.

For more details, contact the manufacturers directly.

Noise Filters for the Power Supply Input

- ♦ Use a noise filter to attenuate external noise and reduce noise emitted from the Servo Drive.
- ♦ Select a noise filter with a rated current that is at least two times greater than the effective load current (the rated current of the main circuit power supply input given in *Main Circuit and Servomotor Connector Specifications* on page 4-20).

Manufacturer	Model	Rated current	Applicable standards	Remarks
NEC TOKIN	GT-2050	5 A	UL, CSA, VDE, TÜV	Single-phase
	GT-2100	10 A		
	GT-2150	15 A		
	GT-2150	20 A		
	HFP-2153	15 A	UL, CSA, TÜV	Three-phase
	HFP-2303	30 A		
Okaya Electric Industries Co., Ltd.	SUP-EK10-ER-6	10 A	UL, cUL, TÜV	Single-phase
	SUP-EK15-ER-6	15 A		
	SUP-EK20-ER-6	20 A		
	SUP-EK30-ER-6	30 A	UL, TÜV	Three-phase
	3SUP-HL10-ER-6	10 A		
	3SUP-HL15-ER-6	15 A		
	3SUP-HL30-ER-6	30 A		
	3SUP-HL75-ER-6	75 A		
	3SUP-HL100-ER-6	100 A		
TDK	ZRCS2006-00S	6 A	UL, CSA, NEMKO	Single-phase
	ZRCS2010-00S	10 A		
	ZRCS2020-00S	20 A		
	ZRCS2030-00S	30 A	UL, CSA, NEMKO	Three-phase
	ZRCT5050-MF	50 A		
	ZRCT5080-MF	80 A		
	ZRCT5100-MF	100 A		

Note 1. To attenuate noise at low frequencies below 200 kHz, use an isolation transformer and a noise filter.

Note 2. To attenuate noise at high frequencies over 30 MHz, use a ferrite core and a high-frequency noise filter with a feed-through capacitor.

Note 3. If multiple Servo Drives are connected to a single noise filter, select a noise filter with a rated current at least two times the total rated current of all the Servo Drives.

Noise Filters for Servomotor Output

- ♦ Use noise filters without built-in capacitors on the Servomotor output lines.
- ♦ Select a noise filter with a rated current at least two times the Servo Drive's continuous output current.
- ♦ The following table shows the noise filters that are recommended for Servomotor output.

Manufacturer	Model	Rated current	Remarks
OMRON	3G3AX-NF001	6 A	For inverter output
	3G3AX-NF002	12 A	
	3G3AX-NF003	25 A	
	3G3AX-NF004	50 A	
	3G3AX-NF005	75 A	
	3G3AX-NF006	100 A	

Note 1. Servomotor output lines cannot use the same noise filters for power supplies.

Note 2. Typical general-purpose noise filters are made for power supply frequencies of 50/60 Hz. If these noise filters are connected to the PWM output of the Servo Drive, a very large (about 100 times larger) leakage current will flow through the noise filter's condenser and the Servo Drive could be damaged.

Dimensions

3G3AX-NF001/-NF002

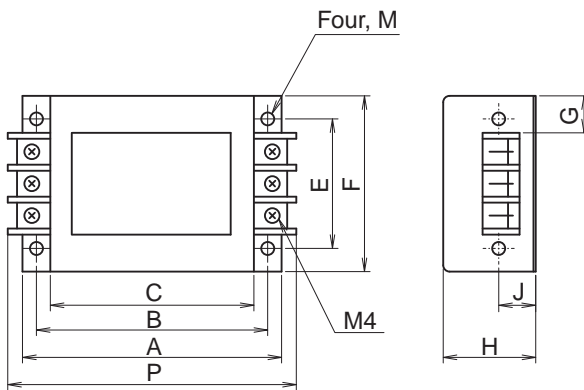

Model	Dimensions (mm)									
	A	B	C	E	F	G	H	J	M	P
3G3AX-NF001	140	125	110	70	95	22	50	20	4.5 dia.	156
3G3AX-NF002	160	145	130	80	110	30	70	25	5.5 dia.	176

4-3 Wiring Conforming to EMC Directives

3G3AX-NF003/-NF004/-NF005/-NF006

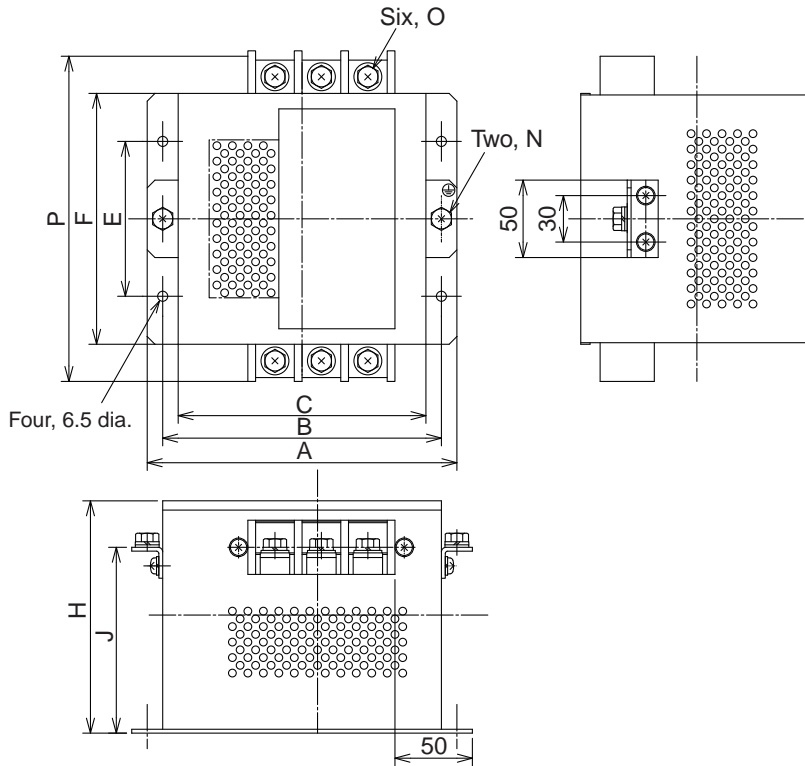

Model	Dimensions (mm)									
	A	B	C	E	F	H	J	N	O	P
3G3AX-NF003	160	145	130	80	112	120	---	---	M4	154
3G3AX-NF004	200	180	160	100	162	150	120	M5	M5	210
3G3AX-NF005	220	200	180	100	182	170	140	M6	M6	230
3G3AX-NF006	220	200	180	100	182	170	140	M8	M8	237

4-4 Regenerative Energy Absorption

The Servo Drives have internal regenerative energy absorption circuitry, which absorbs the regenerative energy produced during Servomotor deceleration and prevents the DC voltage from increasing. An overvoltage error occurs, however, if the amount of regenerative energy from the Servomotor is too large. If this occurs, measures must be taken to reduce the regenerative energy by changing operating patterns, or to increase the regenerative energy absorption capacity by connecting an External Regeneration Resistor.

Calculating the Regenerative Energy

■ Horizontal Axis

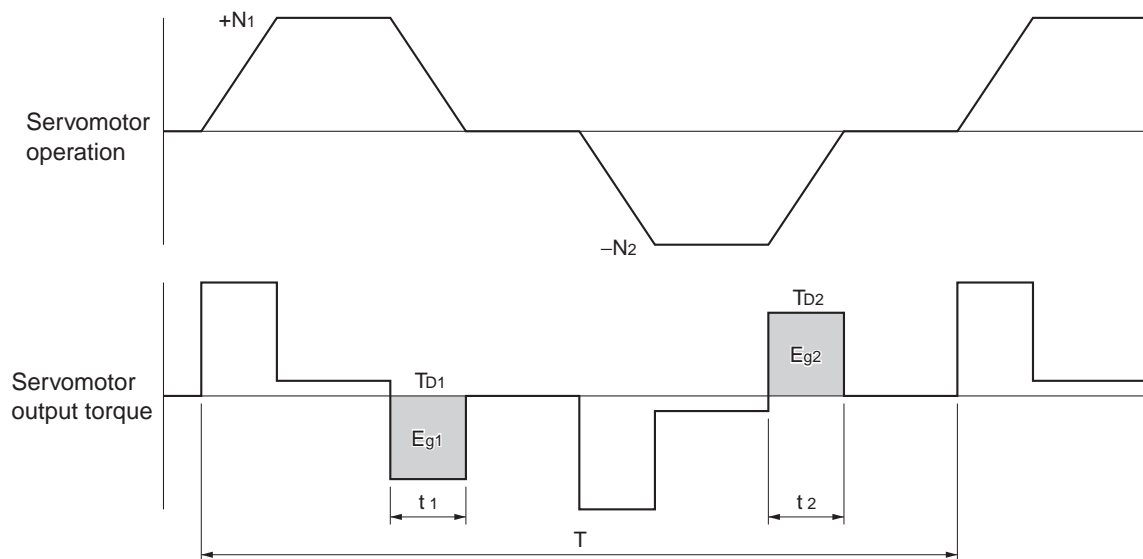

- ♦ In the output torque graph, acceleration in the positive direction is shown as positive, and acceleration in the negative direction is shown as negative.
- ♦ The regenerative energy values for each region can be derived from the following equations.

$$E_{g1} = \frac{1}{2} * \frac{2\pi}{60} * N_1 * T_{D1} * t_1 \text{ [J]}$$

$$E_{g2} = \frac{1}{2} * \frac{2\pi}{60} * N_2 * T_{D2} * t_2 \text{ [J]}$$

N_1, N_2 : Rotation speed at beginning of deceleration [r/min]

T_{D1}, T_{D2} : Deceleration torque [N·m]

t_1, t_2 : Deceleration time [s]

Note Due to the loss of winding resistance and PWM, the actual regenerative energy will be approximately 90% of the values derived from these equations.

4-4 Regenerative Energy Absorption

- ♦ For Servo Drive models with internal capacitors used for absorbing regenerative energy, the values for both E_{g1} or E_{g2} (unit: J) must be lower than the Servo Drive's regenerative energy absorption capacity. (The capacity depends on the model. For details, refer to *Servo Drive Regenerative Energy Absorption Capacity* on page 4-47.)
- ♦ For Servo Drive models with an internal regeneration resistor used for absorbing regenerative energy, the average amount of regeneration P_r (unit: W) must be calculated, and this value must be lower than the Servo Drive's regenerative energy absorption capacity. (The capacity depends on the model. For details, refer to *Servo Drive Regenerative Energy Absorption Capacity* on page 4-47.)

The average regeneration power (P_r) is the regeneration power produced in one cycle of operation [W].

$$P_r = (E_{g1} + E_{g2}) / T \text{ [W]}$$

T: Operation cycle [s]

■ Vertical Axis

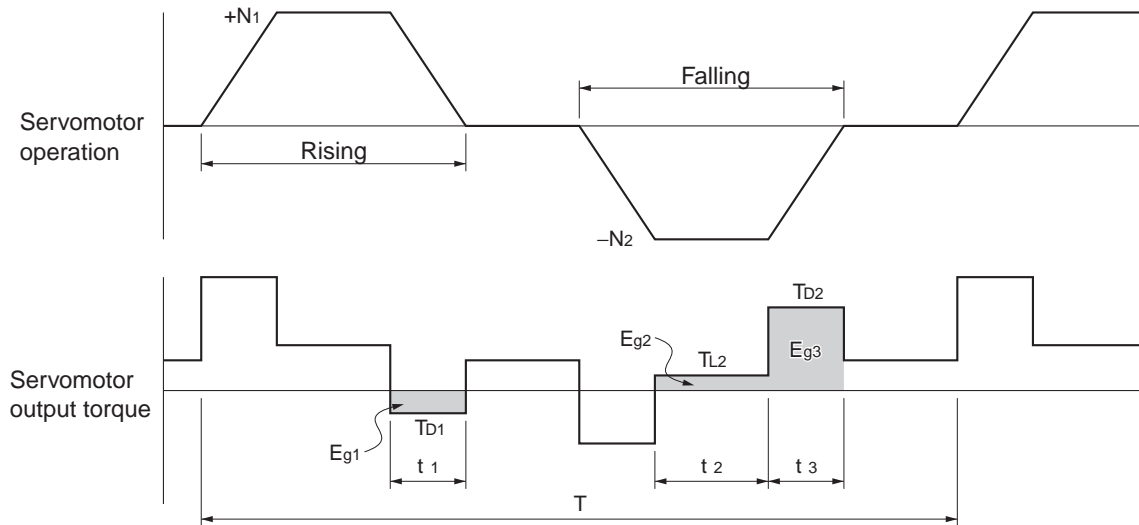

- ♦ In the output torque graph, acceleration in the positive direction (rising) is shown as positive, and acceleration in the negative direction (falling) is shown as negative.
- ♦ The regenerative energy values for each region can be derived from the following equations.

$$E_{g1} = \frac{1}{2} * \frac{2\pi}{60} * N_1 * T_{D1} * t_1 \text{ [J]}$$

$$E_{g2} = \frac{2\pi}{60} * N_2 * T_{L2} * t_2 \text{ [J]}$$

$$E_{g3} = \frac{1}{2} * \frac{2\pi}{60} * N_2 * T_{D2} * t_3 \text{ [J]}$$

- N1, N2: Rotation speed at beginning of deceleration [r/min]
- T_{D1}, T_{D2}: Deceleration torque [N·m]
- T_{L2}: Torque when falling [N·m]
- t1, t3: Deceleration time [s]
- t2: Constant-velocity travel time when falling [s]

Note Due to the loss of winding resistance, the actual regenerative energy will be approximately 90% of the values derived from these equations.

- ♦ For Servo Drive models with internal capacitors used for absorbing regenerative energy, the values for both E_{g1} or E_{g2} + E_{g3} (unit: J) must be lower than the Servo Drive's regenerative energy absorption capacity. (The capacity depends on the model. For details, refer to *Servo Drive Regenerative Energy Absorption Capacity* on page 4-47.)
- ♦ For Servo Drive models with an internal regeneration resistor used for absorbing regenerative energy, the average amount of regeneration Pr (unit: W) must be calculated, and this value must be lower than the Servo Drive's regenerative energy absorption capacity. (The capacity depends on the model. For details, refer to *Servo Drive Regenerative Energy Absorption Capacity* on page 4-47.)

The average regeneration power (Pr) is the regeneration power produced in one cycle of operation [W].

$$P_r = (E_{g1} + E_{g2} + E_{g3}) / T \text{ [W]}$$

T: Operation cycle [s]

Servo Drive Regenerative Energy Absorption Capacity

■ Amount of Internal Regeneration Absorption in Servo Drives

The OMNUC G-Series Servo Drives absorb regenerative energy internally with built-in capacitors. If the regenerative energy is too large to be processed internally, an overvoltage error occurs and operation cannot continue.

The following table shows the regenerative energy (and amount of regeneration) that each Servo Drive can absorb. If these values are exceeded, take the following measures.

- ♦ Connect an External Regeneration Resistor (to improve the regeneration processing capacity).
- ♦ Reduce the operating rotation speed. (The amount of regeneration is proportional to the square of the rotation speed.)
- ♦ Extend the deceleration time (to decrease the regenerative energy produced per time unit).
- ♦ Extend the operation cycle, i.e., the cycle time (to decrease the average regeneration power).

Servo Drive model	Regenerative energy (J) that can be absorbed by internal capacitor	Internal regeneration resistance		Minimum value of regeneration resistance (Ω)
		Average amount of regeneration that can be absorbed (W)	Resistance (Ω)	
R88D-GNA5L-ML2	12	---	---	18
R88D-GN01L-ML2	12	---	---	18
R88D-GN02L-ML2	18	---	---	18
R88D-GN04L-ML2	27	12	50	13
R88D-GN01H-ML2	16	---	---	35
R88D-GN02H-ML2	16	---	---	35
R88D-GN04H-ML2	25	---	---	35
R88D-GN08H-ML2	43	12	100	27
R88D-GN10H-ML2	70	20	30	27
R88D-GN15H-ML2	70	20	30	18
R88D-GN20H-ML2	70	40	15	11
R88D-GN30H-ML2	70	40	15	11
R88D-GN50H-ML2	105	80	10	7
R88D-GN75H-ML2	250	---	---	4

Note These are the values at 100 VAC for 100-VAC models, and at 200 VAC for 200-VAC models.

Absorbing Regenerative Energy with an External Regeneration Resistor

If the regenerative energy exceeds the absorption capacity of the Servo Drive, connect an External Regeneration Resistor.

Connect the External Regeneration Resistor between B1 and B2 terminals on the Servo Drive. Double-check the terminal names when connecting the resistor because the Servo Drive may be damaged by burning if connected to the wrong terminals.

The External Regeneration Resistor will heat up to approximately 120°C. Do not place it near equipment and wiring that is easily affected by heat. Attach radiator plates suitable for the heat radiation conditions.

■ External Regeneration Resistor

Performance Specifications

Model	Resistance	Nominal capacity	Regeneration absorption at 120°C	Heat radiation condition	Thermal switch output specifications
R88A-RR08050S	50 Ω	80 W	20 W	Aluminum, 250 × 250, Thickness: 3.0	Operating temperature: 150°C ±5% NC contact Rated output: 30 VDC, 50 mA max.
R88A-RR080100S	100 Ω	80 W	20 W	Aluminum, 250 × 250, Thickness: 3.0	Operating temperature: 150°C ±5% NC contact Rated output: 30 VDC, 50 mA max.
R88A-RR22047S	47 Ω	220 W	70 W	Aluminum, 350 × 350, Thickness: 3.0	Operating temperature: 170°C ±7°C NC contact Rated output: 250 VAC, 0.2 A max.
R88A-RR50020S	20 Ω	500 W	180 W	Aluminum, 600 × 600, Thickness: 3.0	Operating temperature: 200°C ±7°C NC contact Rated output: 250 VAC, 0.2 A max. 24 VDC, 0.2 A max.

Connecting an External Regeneration Resistor

■ R88D-GNA5L-ML2/-GN01L-ML2/-GN02L-ML2/-GN01H-ML2/-GN02H-ML2/-GN04H-ML2

If an External Regeneration Resistor is necessary, connect it between B1 and B2 as shown in the diagram below.

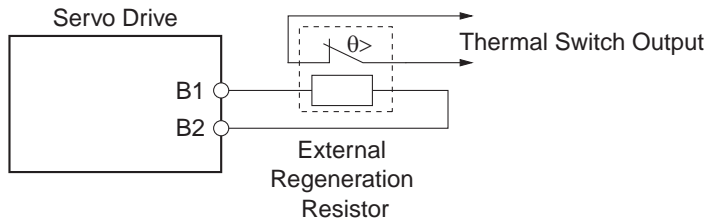

Precautions for Correct Use

- ◆ Connect the thermal switch output so that the main circuit power supply is shut OFF when the contacts open. The resistor may be damaged by burning, or cause fire if it is used without setting up a power supply shutoff sequence using the output from the thermal switch.

■ R88D-GN04L-ML2/-GN08H-ML2/-GN10H-ML2/-GN15H-ML2/-GN20H-ML2/-GN30H-ML2/-GN50H-ML2

If an External Regeneration Resistor is necessary, remove the short-circuit bar between B2 and B3, and then connect the External Regeneration Resistor between B1 and B2 as shown in the diagram below.

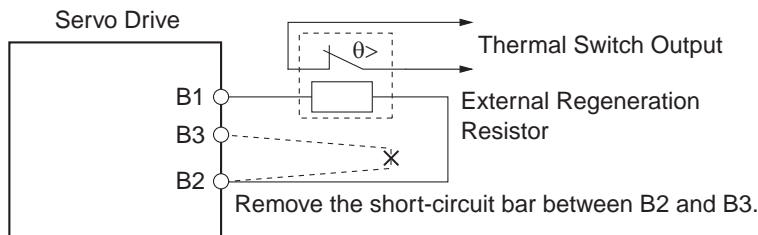

Precautions for Correct Use

- ◆ Connect the thermal switch output so that the main circuit power supply is shut OFF when the contacts open.
- When using multiple External Regeneration Resistors, connect each thermal switch in series.
- The resistor may be damaged by burning, or cause fire if it is used without setting up a power supply shutoff sequence using the output from the thermal switch.

■ R88D-GN75H-ML2

If an External Regeneration Resistor is necessary, connect it between B1 and B2 as shown in the diagram below.

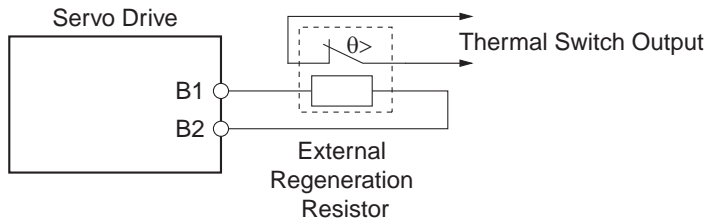



Precautions for Correct Use

- ◆ Connect the thermal switch output so that the main circuit power supply is shut OFF when the contacts open.
- When using multiple External Regeneration Resistors, connect each thermal switch in series.
- The resistor may be damaged by burning, or cause fire if it is used without setting up a power supply shutoff sequence using the output from the thermal switch.

4-4 Regenerative Energy Absorption

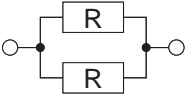
Combining External Regeneration Resistors

Regeneration absorption capacity ^{*1}	20 W	40 W	70 W	140 W
Model	R88A-RR08050S R88A-RR080100S	R88A-RR08050S R88A-RR080100S	R88A-RR22047S	R88A-RR22047S
Resistance ^{*2}	50 Ω / 100 Ω	25 Ω / 50 Ω	47 Ω	94 Ω
Connection method				

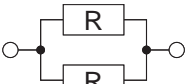
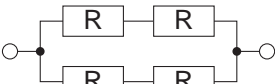
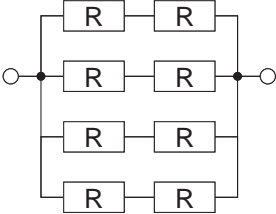
Regeneration absorption capacity ^{*1}	140 W	280 W	560 W
Model	R88A-RR22047S	R88A-RR22047S	R88A-RR22047S
Resistance ^{*2}	23.5 Ω	47 Ω	23.5 Ω
Connection method			

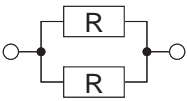
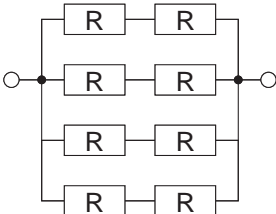
Regeneration absorption capacity ^{*1}	180 W	360 W	1440 W
Model	R88A-RR50020S	R88A-RR50020S	R88A-RR50020S
Resistance ^{*2}	20 Ω	10 Ω	10 Ω
Connection method			

*1. Select a combination that has an absorption capacity greater than the average regeneration power (Pr).

*2. Do not use a combination with resistance values lower than the minimum external regeneration resistance of each Servo Drive. For information on the minimum external regeneration resistance, refer to *Servo Drive Regenerative Energy Absorption Capacity* on page 4-47.

Precautions for Correct Use

- ◆ Surface temperatures on regeneration resistors can reach 200°C. Do not place objects that tend to catch fire near the resistors. To prevent people from touching them, install a type of cover that enables heat dissipation.

Chapter 5

Operating Functions

5-1	Position Control	5-1
5-2	Speed Control	5-4
5-3	Torque Control	5-7
5-4	Forward and Reverse Drive Prohibit	5-10
5-5	Brake Interlock	5-11
5-6	Torque Limit	5-16
5-7	Soft Start	5-18
5-8	Acceleration/Deceleration Time Settings	5-19
5-9	Moving Average Time	5-20
5-10	Electronic Gear	5-21
5-11	Speed Limit	5-22
5-12	Sequence Input Signals	5-23
5-13	Sequence Output Signals	5-25
5-14	Backlash Compensation	5-27
5-15	Overrun Protection	5-29
5-16	Gain Switching	5-31
5-17	Speed Feed-forward	5-38
5-18	Torque Feed-forward	5-39
5-19	Speed Feedback Filter Selection	5-40
5-20	P Control Switching	5-41
5-21	Torque Command Filter Time Constant	5-42
5-22	Notch Filter	5-43
5-23	Adaptive Filter	5-45
5-24	Instantaneous Speed Observer	5-48
5-25	Damping Control	5-50
5-26	User Parameters	5-55
	Setting and Checking Parameters	5-55
	Parameter Tables	5-61
5-27	Details on Important Parameters	5-86

5-1 Position Control

Function

Performs position control using commands from the Position Control Units for MECHATROLINK-II, CJ1W-NCF71/CS1W-NCF71.

The Servomotor rotates using the value of the position command (position command units) multiplied by the Electronic Gear Ratio (Pn205/Pn206).

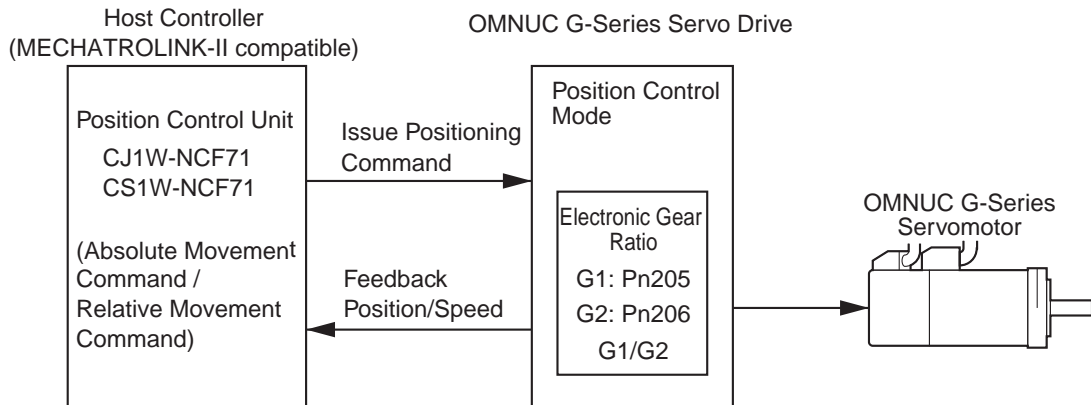

Parameters Requiring Settings

Parameter No.	Parameter name	Explanation	Reference page
Pn205 Pn206	Electronic Gear Ratio 1 (Numerator) Electronic Gear Ratio 2 (Denominator)	Sets the electronic gear ratio (G1/G2).	5-85 5-85
Pn107	Linear Acceleration Constant	Sets the angular acceleration (command units/s ²) for positioning operations.	5-82
Pn10A	Linear Deceleration Constant	Sets the angular deceleration (command units/s ²) for positioning operations.	5-82
Pn10E	Moving Average Time	Sets the moving average time for the position command. Reduces the angular acceleration when starting and stopping, and when approaching and leaving target speed.	5-82
Pn209	Deviation Counter Overflow Level	Sets the level to detect the deviation counter overflow in command units. Setting is based on the encoder to be used and the electronic gear ratio.	5-85
Pn101	Backlash Compensation	Sets the mechanical backlash in command units.	5-81

Related Functions

♦ The main functions related to position control are as follows:

Function	Explanation	Reference page
Speed Feed-forward	This function issues direct speed commands without going through the deviation counter. Sets the speed command ratio (%).	5-38
Damping Control	Sets the vibration frequencies 1, 2 and vibration filters 1,2 for damping control.	5-50
Moving Average Time	Sets the moving average time for the position command. Reduces the acceleration when starting and stopping, and when approaching and leaving target speed.	5-20
Soft Limit	Sets the maximum position command and position feedback current value during position control.	5-81
Backlash Compensation	Sets the mechanical backlash in command units.	5-27

Parameter Block Diagram for Position Control Mode

5

Operating Functions

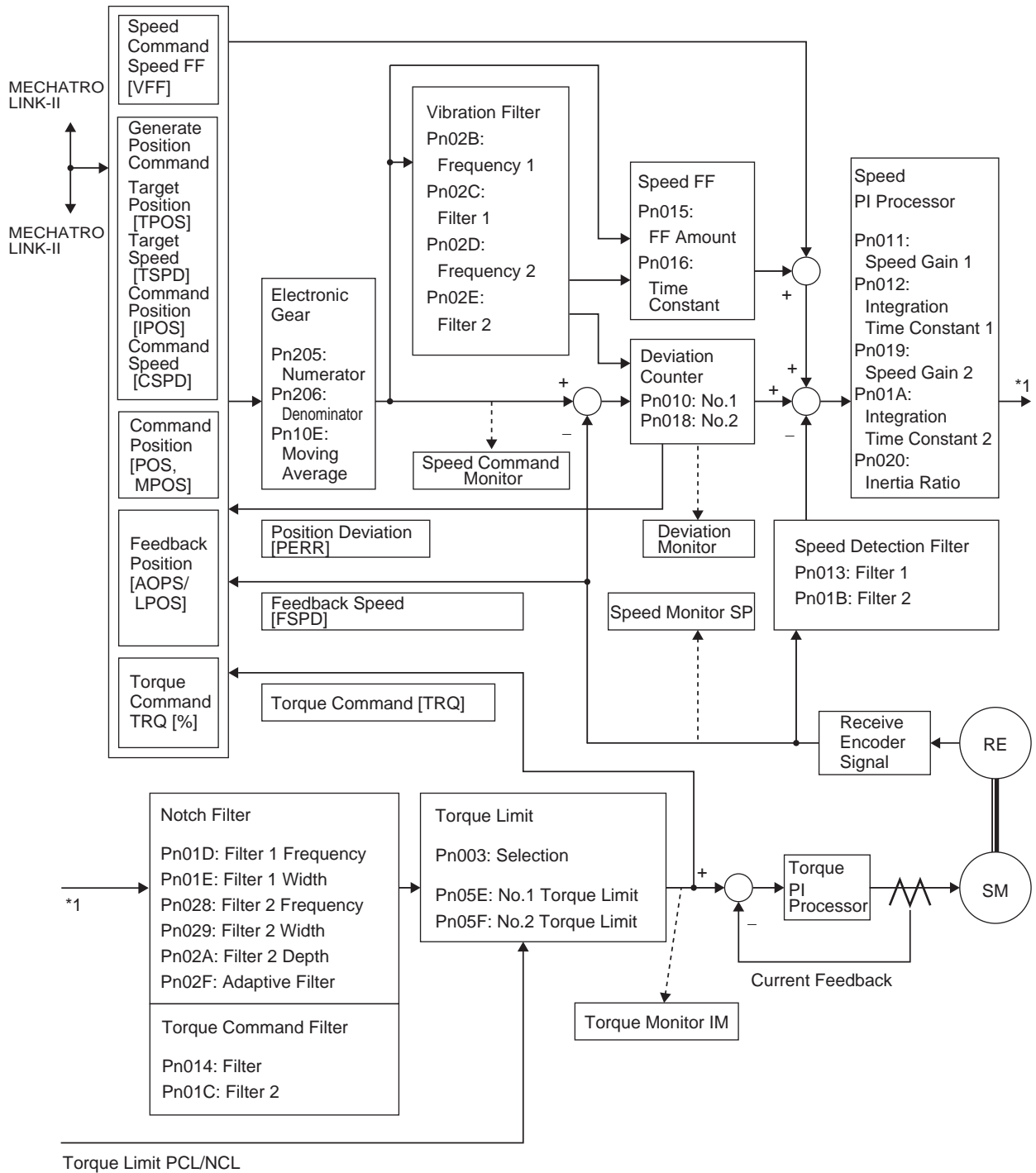

5-2 Speed Control

Function

- Performs speed control using commands from the Position Control Units for MECHATROLINK-II, CJ1W-NCF71/CS1W-NCF71. The Servomotor rotates at the command speed.
- The current feedback value is divided by the Electronic Gear Ratio (Pn205/Pn206) and expressed in the commanded units.

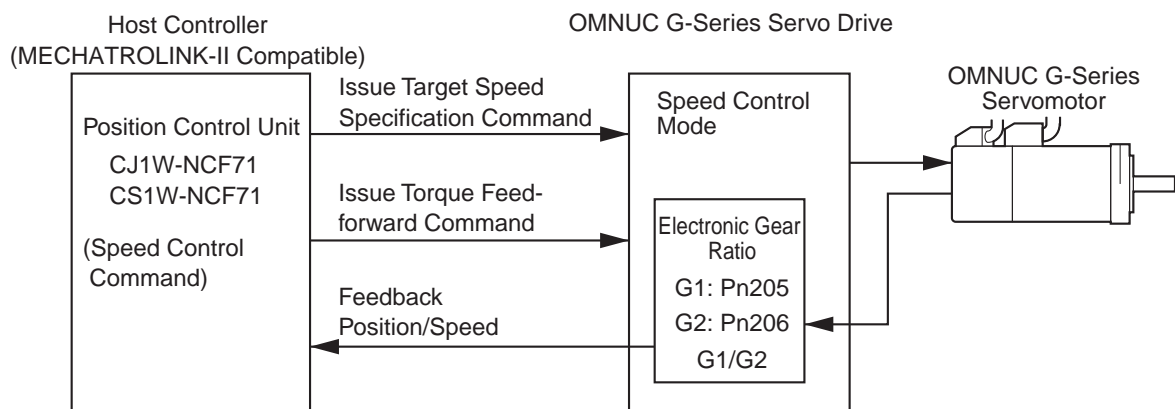

Parameters Requiring Settings

Parameter No.	Parameter name	Explanation	Reference page
Pn205 Pn206	Electronic Gear Ratio 1(Numerator) Electronic Gear Ratio 2 (Denominator)	Sets the electronic gear ratio (G1/G2).	5-85 5-85
Pn058	Soft Start Acceleration Time	Sets the time for the Servomotor to accelerate from 0 to maximum speed [r/min].	5-74
Pn059	Soft Start Deceleration Time	Sets the time for the Servomotor to decelerate from maximum speed to 0 r/min.	5-74
Pn061	Speed Conformity Signal Output Width	Sets the detection width for the speed conformity output width (VCMP).	5-75
Pn062	Rotation Speed for Motor Rotation Detection	Sets the rotations for the motor rotation detection output (TGON) signal.	5-75
Pn011 Pn019	Speed Loop Gain 1, 2	Adjusts the speed loop responsiveness. The larger the value, the faster the response is.	5-67
Pn012 Pn01A	Speed Loop Integration Time Constant 1, 2	Sets the speed loop integration time constant. Adjusts according to the inertia of the load.	5-67
Pn020	Inertia Ratio	Sets the load inertia. The speed loop responsiveness is the value multiplied by the speed loop gain.	5-68
Pn013 Pn01B	Speed Feedback Filter Time Constant 1, 2	Sets the speed feedback time constant. Normally, use a setting of 0.	5-67

Related Functions

♦ The main functions related to speed control are as follows:

Function	Explanation	Reference page
Torque Feed-forward	This function issues direct torque commands without performing speed PI calculations. Sets the torque command ratio (%).	5-39
Soft Start	Sets the soft acceleration and deceleration for the speed command.	5-18
Torque Limit	Limits the output torque.	5-16
P Control Switching	Switches from PI control to P control.	5-41
Speed Feedback Filter Selection	Changes the time constant of the detection filter for the feedback speed to reduce resonance of the load.	5-40

Parameter Block Diagram for Speed Control Mode

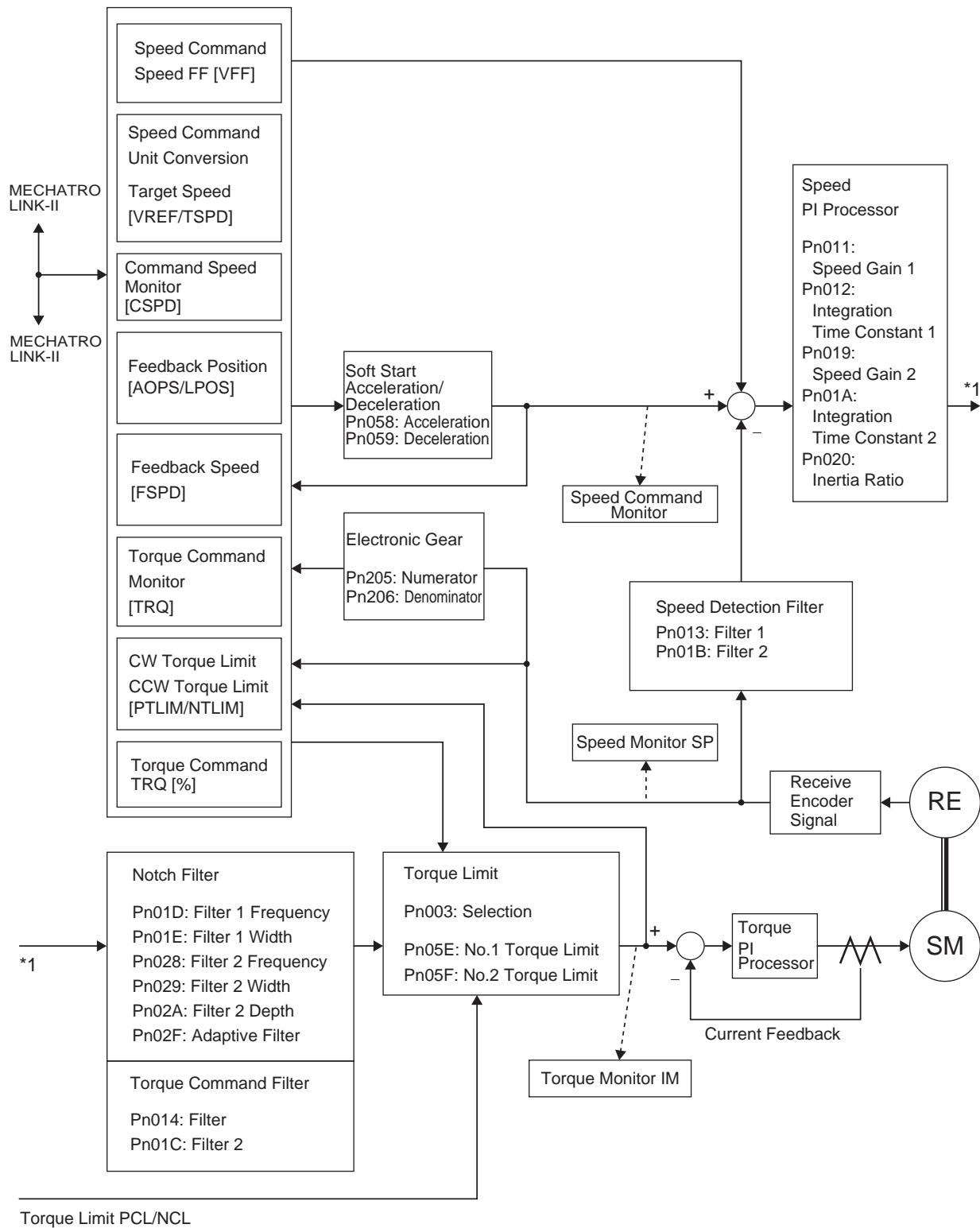

5-3 Torque Control

Function

- Performs torque control using commands from the Position Control Units for MECHATROLINK-II, CJ1W-NCF71/CS1W-NCF71. The Servomotor operates with the commanded torque output. The current feedback value is divided by the Electronic Gear Ratio (Pn205/Pn206) and expressed in the commanded units.

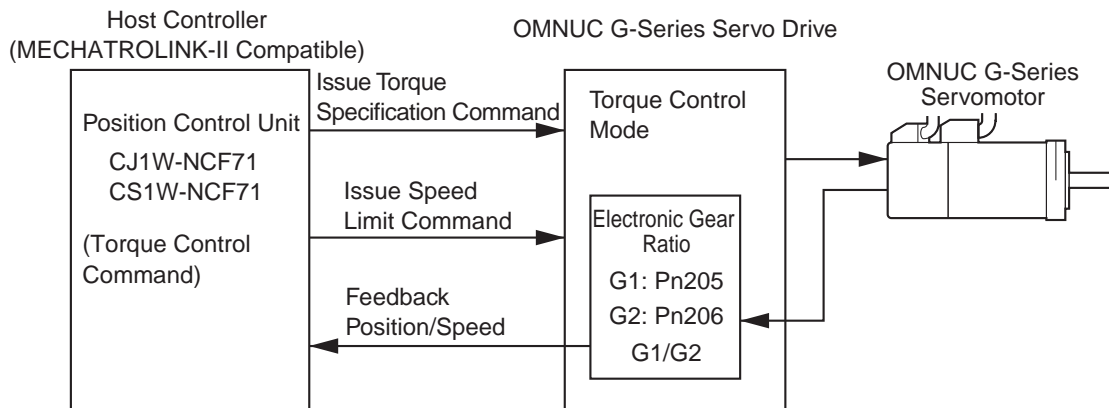

Parameters Requiring Settings

Parameter No.	Parameter name	Explanation	Reference page
Pn205 Pn206	Electronic Gear Ratio 1 (Numerator) Electronic Gear Ratio 2 (Denominator)	Sets the electronic gear ratio (G1/G2).	5-85 5-85
Pn053	Speed Limit	Limits the speed during torque control.	5-74
Pn05B	Speed Limit Selection	Selects speed limit control from the network or through internal parameter Pn053.	5-74
Pn003	Torque Limit Selection	Selects torque limit from the network or through parameter settings.	5-87
Pn05E	No. 1 Torque Limit	Sets the No. 1 Servomotor output torque limit.	5-75
Pn05F	No. 2 Torque Limit	Sets the No. 2 Servomotor output torque limit.	5-75
Pn01D	Notch Filter 1 Frequency	Sets the notch filter 1 frequency for the torque command.	5-68
Pn028	Notch Filter 2 Frequency	Sets the notch filter 2 frequency for the torque command.	5-71

Related Functions

Functions related to torque control are as follows:

Function	Explanation	Reference page
Torque Command Filter Time Constant	Increase to decrease machine resonance.	5-42
Notch Filter	Sets the machine specific resonance frequency.	5-43
Speed Limit	Limits the Servomotor speed during torque control.	5-22
Torque Limit	Limits the maximum output torque during torque control.	5-16
Speed Feedback Filter Selection	Selects the speed detection filter.	5-40

Parameter Block Diagram for Torque Control Mode

5

Operating Functions

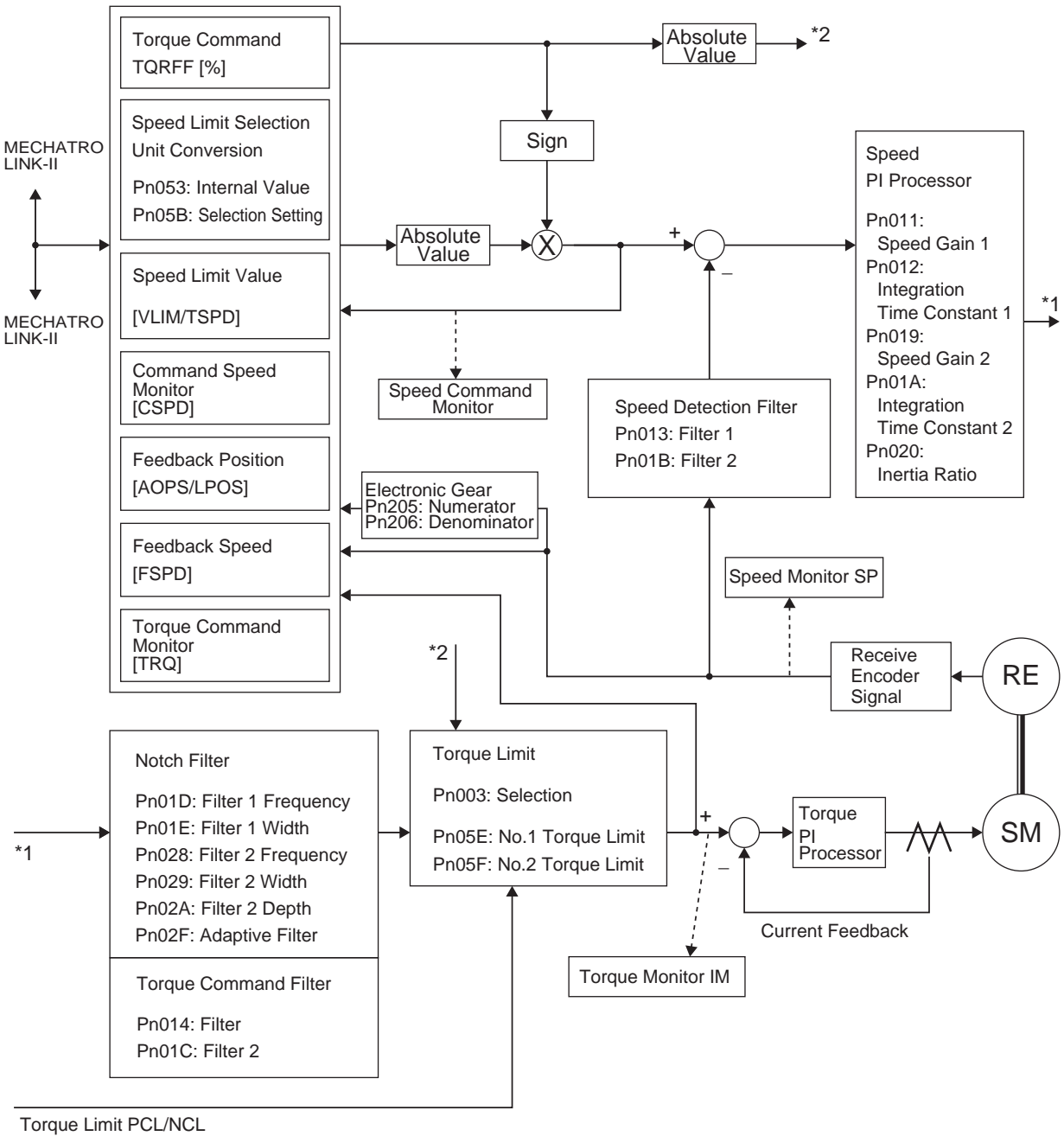

5-4 Forward and Reverse Drive Prohibit

Function

- This function sets the Forward Drive Prohibit Input (POT) and Reverse Drive Prohibit Input (NOT) operation at the control I/O connector CN1 on the Servo Drive.
- You can stop the Servomotor from rotating beyond the machine's operating range with the drive prohibition inputs.

Parameters Requiring Settings

Parameter No.	Parameter name	Explanation	Reference page
Pn004	Drive Prohibit Input Selection	Chooses whether to enable or disable this function when POT/NOT turns OFF.	5-88
Pn044	Input Signal Selection	Sets the POT/NOT assignment. By default, CN1 pin 19 is set to POT, and CN1 pin 20 is set to NOT.	5-74
Pn066	Stop Selection for Drive Prohibition Input	Sets the deceleration stopping method when POT/NOT turns OFF.	5-95

Operation

[Stopping method when Pn004=0 and either POT or NOT turns OFF]

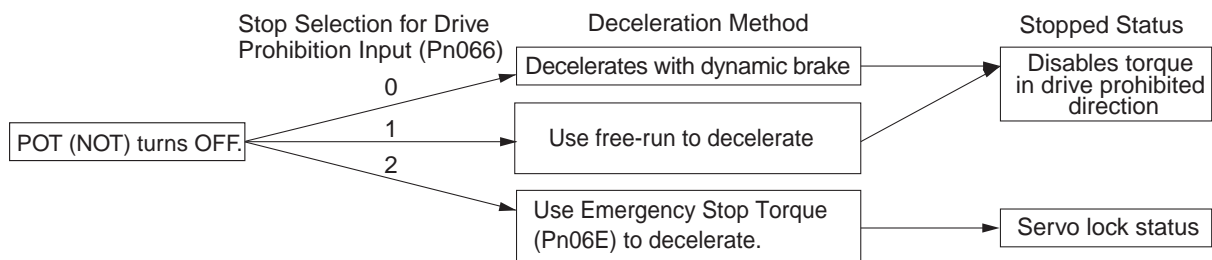

- Drive Prohibit Input Error (alarm code 38) occurs when Pn004=0 and both Forward Drive Prohibit and Reverse Drive Prohibit inputs turn OFF.
- When Pn004=1, the inputs for both Forward Drive Prohibit and Reverse Drive Prohibit are disabled.
- Drive Prohibit Input Error (alarm code 38) occurs when Pn004=2, and either Forward Drive Prohibit input or Reverse Drive Prohibit input turns OFF.
- After stopping, a command in the direction of the drive prohibit input will cause a command warning.

5-5 Brake Interlock

Function

- ◆ This function sets the output timing of the Brake Interlock (BKIR) signal used to activate the holding brake during servo ON, alarms, and servo OFF.

Parameters Requiring Settings

Parameter No.	Parameter name	Explanation	Reference page
Pn06A	Brake Timing when Stopped	Sets the delay time from the Servo OFF command to the Brake Interlock (BKIR) signal OFF and power stoppage during a servo lock stop.	5-78
Pn06B	Brake Timing during Operation	Sets the delay time from the Servo OFF command to the Brake Interlock (BKIR) signal OFF and power stoppage while the Servomotor is operating. BKIR turns OFF if the speed drops below 30 r/min before the set time.	5-78

Precautions on the holding brake

- ◆ The brake on a Servomotor with a brake is a nonexcitation brake designed for holding during stops.
Set the time so that the brake is activated after the Servomotor is stopped.
- ◆ If the brake is applied while the Servomotor is rotating, the brake disk may be damaged or wear out, and cause damage to the Servomotor bearings and encoder.

■ Operation timing during Servo ON or OFF (when Servomotor is stopped)

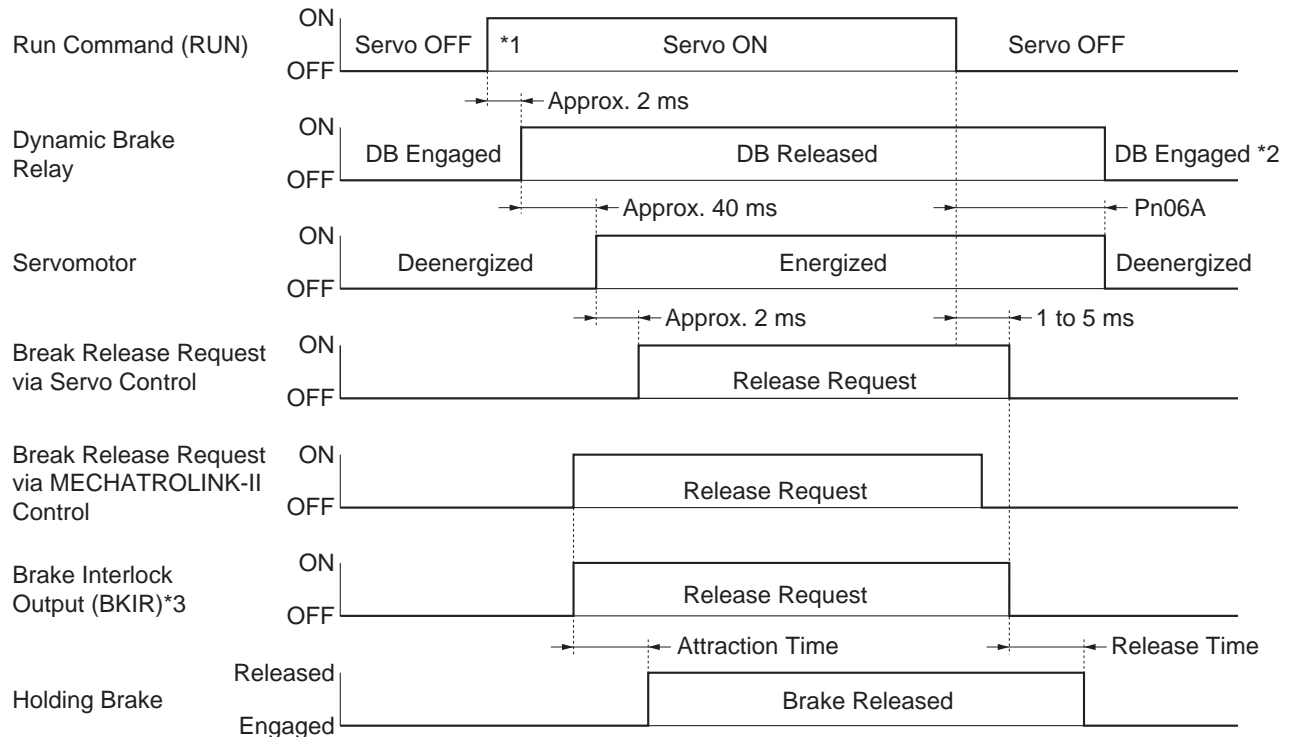

*1. The Servo ON status will not occur until the Servomotor speed drops below approximately 30 r/min.
 *2. The operation of the dynamic brake during Servo OFF depends on the Stop Selection with Servo OFF (Pn069).
 *3. The Brake Interlock (BKIR) signal is output on the release request command that comes first, either from the Servo Controller or the MECHATROLINK-II. The BKIR signal is used by assigning it to the general purpose outputs on CN1.

Note The brake attraction and release time varies depending on the brake on the Servomotor. For details, refer to 3-2 *Servomotor Specifications* on page 3-17.

■ Operation timing during Servo ON or OFF (when Servomotor is rotating)

Regenerative energy occurs when the Servomotor is stopped on an alarm under this operation timing.

For this reason, the operation cannot be repeated. Wait at least 10 minutes before the Servomotor cools down.

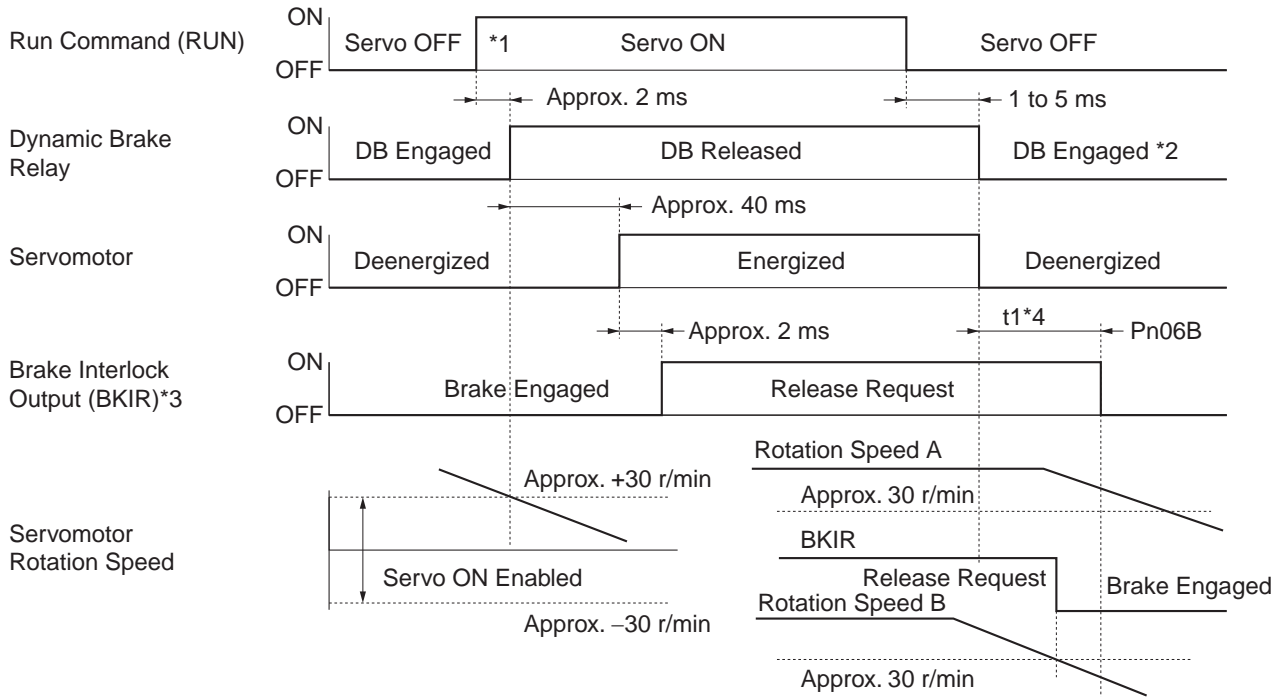

*1. The Servo ON status will not occur until the Servomotor speed drops below approximately 30 r/min.

*2. The operation of the dynamic brake during Servo OFF depends on the Stop Selection with Servo OFF (Pn069).

*3. The Brake Interlock (BKIR) signal is output on the release request command that comes first, either from the Servo Controller or the MECHATROLINK-II. The BKIR signal is used by assigning it to the general purpose outputs on CN1.

In the example above, a release request was not issued from the network.

*4. $t1$ is either the Brake Timing during Operation (Pn06B) setting or the time for the Servomotor speed to drop below approximately 30 r/min, whichever occurs first.

Note The Servomotor will not change to Servo ON until it stops even if the Servo ON input is turned ON while it is decelerating.

■ Operation timing during alarms (during Servo ON)

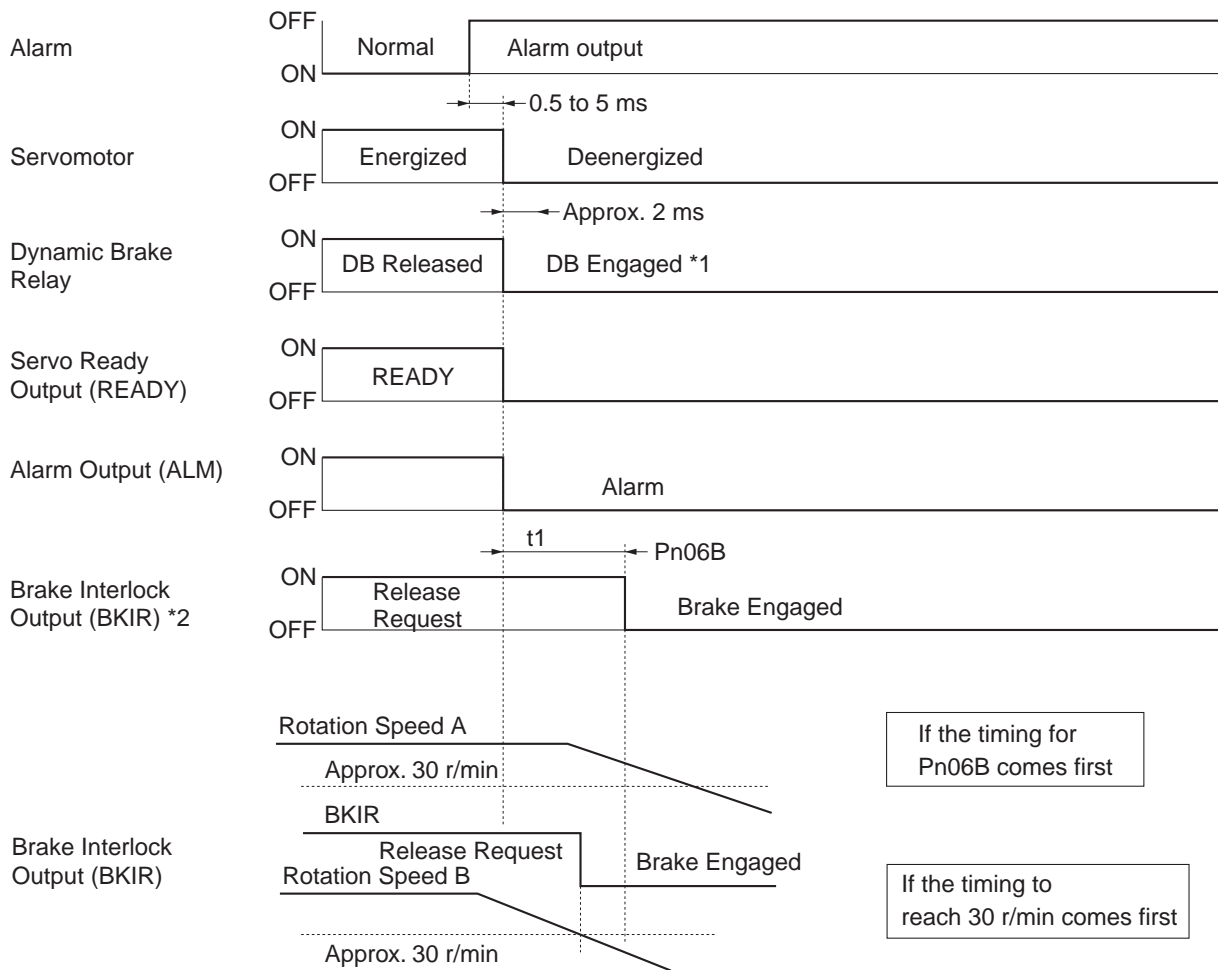

*1. The operation of the dynamic brake during alarms depends on the Stop Selection with Servo OFF (Pn069).

*2. t_1 is either the Brake Time during Operation (Pn06B) setting or the time for the Servomotor speed to drop below approximately 30 r/min, whichever occurs first. t_1 becomes 0 when an alarm occurs while the motor is stopped.

Note 1. The Servomotor will not change to Servo ON until it stops even if the Servo ON input is turned ON while it is decelerating. The Brake Interlock (BKIR) signal is used by assigning it to the general purpose outputs on CN1.

Note 2. The above operation timing is applied because of the Missing Phase alarm and Main Circuit Low Voltage alarm when the power is turned OFF while the Servomotor is rotating.

■ Operation timing at alarm reset

Perform an alarm reset from CX-Drive, host controller via MECHATROLINK-II, or the Parameter Unit. (Alarms can also be reset by recycling the power.)

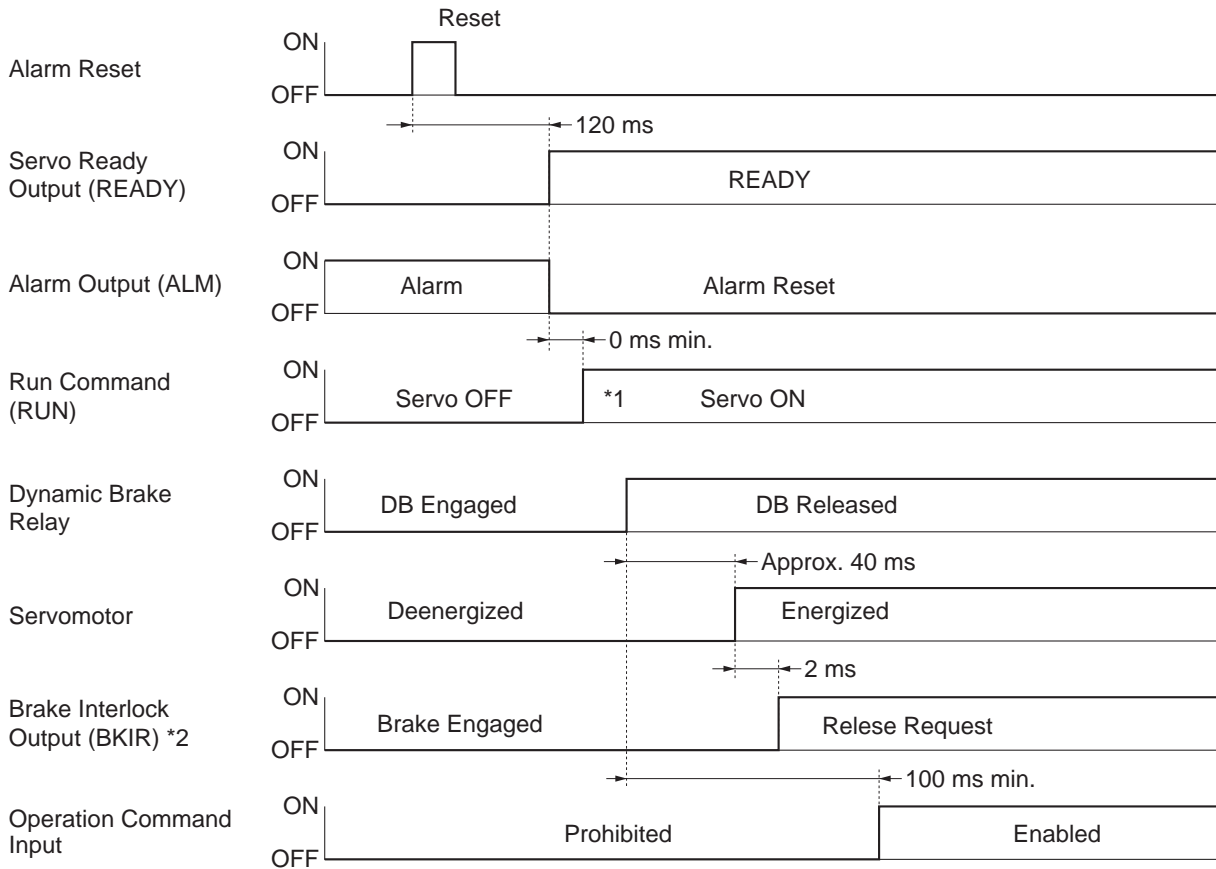

*1. Servo ON status will not occur until the Servomotor speed drops below approximately 30 r/min.

*2. The Brake Interlock (BKIR) signal is output on the release request command that comes first, either from the Servo Controller or the MECHATROLINK-II. The BKIR signal is used by assigning it to the general purpose outputs on CN1.

Note Servo OFF status occurs (Servomotor is de-energized) after the alarm reset. To go to Servo ON status, issue the Servo ON command again after the alarm reset according to the operation timing shown above.

5-6 Torque Limit

Function

- ♦ This function limits the torque output by the Servomotor.
- ♦ The function can be used for:
 - pressing in press machine applications
 - protecting a mechanical system by suppressing torque at start-up and deceleration
- ♦ There are several methods to choose at the Torque Limit Selection (Pn003).

Parameters Requiring Settings

Parameter No.	Parameter name	Explanation	Reference page
Pn003	Torque Limit Selection	Selects the torque limit by various parameters and from the network.	5-87
Pn05E	No. 1 Torque Limit	Sets the No.1 Servomotor output torque limit.	5-75
Pn05F	No. 2 Torque Limit	Sets the No. 2 Servomotor output torque limit.	5-75

■ Torque limit settings for each Servomotor

- ♦ The setting range for the torque limit is 0 to 300% and the standard default setting is 300% except for the following combinations of Servo Drives and Servomotors.

Servo Drive	Applicable Servomotor	Maximum torque limit [%]
R88D-GN15H-ML2	R88M-G90010T	225
R88D-GN30H-ML2	R88M-G2K010T	230
R88D-GN50H-ML2	R88M-G3K010T	235
	R88M-G4K510T	255
R88D-GN75H-ML2	R88M-G6K010T	256
	R88M-G7K515T	250

■ Torque limit during position and speed control

Pn003 Settings	Explanation
1	Set the limit values for forward and reverse operations in Pn05E.
2	Forward: Use Pn05E. Reverse: Use Pn05F.
3	Switch limits by torque limit values and input signals from the network. Limit in forward direction: PCL is OFF = Pn05E, PCL is ON = Pn05F Limit in reverse direction: NCL is OFF = Pn05E, NCL is ON = Pn05F
4	Forward: Use Pn05E as limit. Reverse: Use Pn05F as limit. Only in speed control, torque limits can be switched by torque limit values from the network as below. Limit in forward direction: Use Pn05E or MECHATROLINK-II command option command value 1, whichever is smaller. Limit in reverse direction: Use Pn05F or MECHATROLINK-II command option command value 2, whichever is smaller.
5	Forward: Use Pn05E as limit. Reverse: Use Pn05F as limit. Only in speed control, torque limits can be switched by torque limit values and input signals from the network as below. Limit in forward direction: PCL is OFF = Pn05E, PCL is ON = Pn05E or MECHATROLINK-II command option command value 1, whichever is smaller. Limit in reverse direction: NCL is OFF = Pn05F, NCL is ON = Pn05F or MECHATROLINK-II command option command value 2, whichever is smaller.

- ♦ Always select the No. 1 Torque Limit (Pn05E) as the torque limit when using torque control.
- ♦ For the torque limit when Torque Feed-forward is selected, settings of 1 to 3 are enabled only in speed control. These settings are disabled if not in speed control.
Settings of 4 to 5 are always disabled.

Note PCL ON: When either Forward Torque Limit (CN1 PCL: pin 7) or MECHATROLINK-II Communications Option Field (P-CL) is ON.
PCL OFF: When both Forward Torque Limit (CN1 PCL: pin 7) and MECHATROLINK-II Communications Option Field (P-CL) are OFF.

5-7 Soft Start

Function

- ♦ Set the acceleration and deceleration time for speed command values from the host controller.
- ♦ Set the acceleration and deceleration time for the maximum rotation speed of each Servomotor.

Parameters Requiring Settings

Parameter No.	Parameter name	Explanation	Reference page
Pn058	Soft Start Acceleration Time	Sets the acceleration time for the speed command. Set the time it takes to accelerate from 0 r/min to the Servomotor's maximum speed multiplied by 500.	5-74
Pn059	Soft Start Deceleration Time	Sets the deceleration time for the speed command. Set the time it takes to decelerate from the Servomotor's maximum speed to 0 r/min multiplied by 500.	5-74

- ♦ If the soft start function is not used, set this parameter to 0 (default setting).

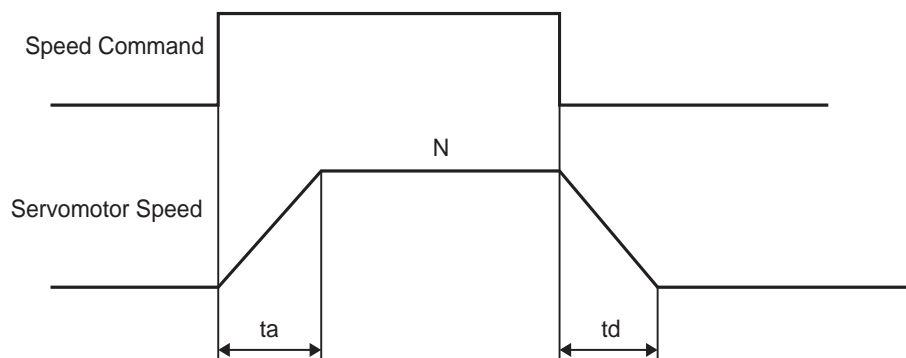

$$\text{Acceleration time } t_a \text{ [s]} = \text{Pn058} \times 0.002 \times \frac{\text{Speed command rotation speed}}{\text{Max. rotation speed}}$$

$$\text{Deceleration time } t_d \text{ [s]} = \text{Pn059} \times 0.002 \times \frac{\text{Speed command rotation speed}}{\text{Max. rotation speed}}$$

5-8 Acceleration/Deceleration Time Settings

Function

- ♦ Set the angular acceleration to reach the target speed and angular deceleration to stop for position commands.
- ♦ Units of setting is $\times 10,000$ [command units/s²].

Parameters Requiring Settings

Parameter No.	Parameter name	Explanation	Reference page
Pn107	Linear Acceleration Constant	Sets the acceleration speed for positioning moves. (Units: $\times 10,000$ [command units/s ²])	5-82
Pn10A	Linear Deceleration Constant	Sets the deceleration speed for positioning moves. (Units: $\times 10,000$ [command units/s ²])	5-82

Note 1. The factory default setting for this parameter:

Linear Acceleration Constant = Linear Deceleration Constant = $100 \times 10,000$ [command units/s²].

Note 2. The setting will be handled after conversion to an un-signed 16-bit data (0 to 65535).

Example: $-32768 \rightarrow 8000h = 32768$

$-1 \rightarrow FFFFh = 65535$

Setting example (using a 2,500-p/r Incremental Encoder)

When the setting is $100 \times 10,000$ [command units/s²], target speed is 2,400 r/min, and the electronic gear ratio of G1/G2 is 2/1, the acceleration and deceleration time is as follows:

$2,400/60 = 40$ r/s The position units for one turn is 5,000 [command units].

The rotation speed units for 2,400 r/min is $40 \times 5,000 = 200,000$ [command units/s].

The linear acceleration and deceleration time to reach 2,400 r/min is $200,000/1,000,000 = 0.2$ s.

Increasing the electronic gear ratio degrades the distribution accuracy of the linear acceleration and deceleration time.

The setting must be increased in order to reduce the acceleration time.

Setting example (using a 17-bit Absolute Encoder)

When the setting is $100 \times 10,000$ [command units/s²], target speed is 2,400 r/min, and the electronic gear ratio of G1/G2 is 64/1, the acceleration and deceleration time is as follows:

$2,400/60 = 40$ r/s The position units for one turn is 8,192 [command units].

The rotation speed units for 2,400 r/min is $40 \times 8,192 = 327,680$ [command units/s].

The linear acceleration and deceleration time to reach 2,400 r/min is $327,680/1,000,000 = 0.32768$ s.

Increasing the electronic gear ratio degrades the distribution accuracy of the linear acceleration and deceleration time.

The setting must be decreased in order to reduce the acceleration time.

In this example, set 328 for an acceleration time of 0.1 s.

5-9 Moving Average Time

Function

- ♦ This function applies the Moving Average Filter (FIR) to the linear acceleration and deceleration time for position commands.
- ♦ This function can reduce vibration and impact during acceleration and deceleration.
- ♦ Time setting range: 0 to 510 ms.

Parameters Requiring Settings

Parameter No.	Parameter name	Explanation	Reference page
Pn10E	Moving Average Time	Sets the moving average time for the position command. Note If the Moving Average Time is set, speed commands may not be executed seamlessly when switching the control modes, and when switching between interpolation feed motions and positioning motions (motions wherein the command waveforms are generated inside the Servo Drive).	5-82

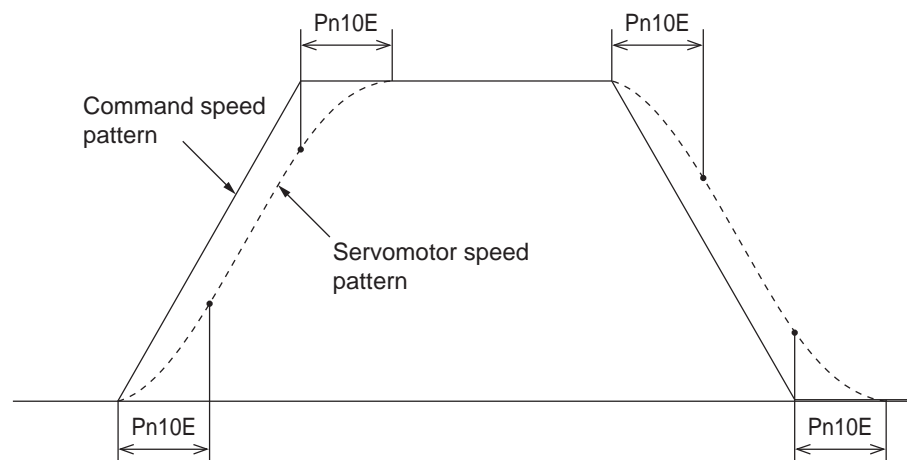

5-10 Electronic Gear

Function

- ♦ The Servomotor rotates at the value (the number of pulses) of the position command multiplied by the electronic gear ratio.
- ♦ During speed and torque control, the pulses from the Servomotor encoder are divided by the electronic gear ratio and converted into command units before being fed back.

Parameters Requiring Settings

Parameter No.	Parameter name	Explanation	Reference page
Pn205	Electronic Gear Ratio 1 (Numerator)	Sets the numerator for the electronic gear ratio. Setting this parameter to 0 automatically sets the encoder resolution as the numerator. (131,072 for a 17-bit absolute encoder, and 10,000 for a 2,500-p/r incremental encoder). The electronic gear ratio can be set to 1/100 to 100 times. A parameter setting alarm (alarm code 93) will occur if the ratio is set outside this range.	5-85
Pn206	Electronic Gear Ratio 2 (Denominator)	Sets the denominator for the electronic gear ratio. A parameter setting alarm (alarm code 93) will occur if the ratio is set outside this range.	5-85

The factory default setting for this parameter is Electronic Gear ratio 1 = Electronic Gear ratio 2 = 1.

Setting example (using a 2,500-p/r Incremental Encoder)

- ♦ To make one turn using a setting unit of 5,000

$$\frac{Pn205}{Pn206} = \frac{10000}{5000} = \frac{2}{1}$$

Setting example (using a 17-bit Absolute Encoder)

- ♦ To make one turn using a setting unit of 10,000

$$\frac{Pn205}{Pn206} = \frac{131072}{10000} = \frac{8192}{625}$$

5-11 Speed Limit

Function

- ♦ Set the Servomotor rotation speed limit when using torque control.
- ♦ The speed limit value can be set by the internal parameter (Pn053) or from a host controller.

Parameters Requiring Settings

Parameter No.	Parameter name	Explanation	Reference page
Pn053	Speed Limit	Sets the speed limit when torque control is used. This value is the same for both forward and reverse directions. The setting must be less than the maximum rotation speed of the Servomotor.	5-74
Pn05B	Speed Limit Selection	Select to perform speed limit by the Speed Limit (Pn053), or the smaller value of either the speed limit from MECHA-TROLINK-II or the Speed Limit (Pn053).	5-74

5-12 Sequence Input Signals

Function

- ◆ Input signals for controlling the Servo Drive operation. Enable or disable the connections and functions as necessary.

Parameters Requiring Settings

Parameter No.	Parameter name	Explanation	Reference page
Pn041	Emergency Stop Input Setting	Enables or disables the emergency stop input. The default setting is "enabled".	5-73
Pn003	Torque Limit Selection	Sets whether to select torque limit using the Forward Torque Limit (PCL) or Reverse Torque Limit (NCL).	5-87
Pn004	Drive Prohibit Input Selection	Sets whether to enable or disable the Forward Drive Prohibit Input (POT) or Reverse Drive Prohibit Input (NOT) function.	5-88
Pn066	Stop Selection for Drive Prohibition Input	Selects the stopping method when the Forward Drive Prohibit Input (POT) or Reverse Drive Prohibit Input (NOT) is input.	5-95
Pn042	Origin Proximity Input Logic Setting	Sets the input logic for the Origin Proximity Input (DEC).	5-73

■ CN1 Control Input Signals

Pin No.	Symbol	Name	Function/Interface
1	+24VIN	12 to 24-VDC Power Supply Input	Power supply input terminal (12 to 24 VDC) for sequence inputs.
2	STOP	Emergency Stop Input	Input for emergency stop. When this signal is enabled and pin 1 is not connected to pin 2, an Emergency Stop Input error (alarm code 87) occurs. Set this signal to be enabled or disabled in the Emergency Stop Input Setting (Pn041). (Factory default: Enable)
3	EXT3	External Latch Signal 3	This external signal input latches the current value feedback pulse counter.
4	EXT2	External Latch Signal 2	The position data is obtained the moment the input is turned ON.
5	EXT1	External Latch Signal 1	Minimal signal width must be 1 ms or more.
6	IN1	External General-purpose Input 1	This input is used as external general-purpose input 1.
7	PCL	Forward Torque Limit Input	When the Torque Limit Selection (Pn003) is set to 3 or 5, this signal input selects the torque limit. (For details, refer to the description of the <i>5-6 Torque Limit</i> on page 5-16.)
8	NCL	Reverse Torque Limit Input	
19 to 20	POT	Forward Drive Prohibit Input	Forward, reverse drive rotation overtravel Input. Pn004 chooses between enable and disable. Pn044 sets the function assignment for pins 19 and 20. Pn066 selects the operation.
	NOT	Reverse Drive Prohibit Input	
21	DEC	Origin Proximity Input	Connect the origin proximity input signal in the origin search operation. Pn042 changes the logic of the sensor.
22	IN0	External General-purpose Input 0	This input is used as external general-purpose input 0.
23	IN2	External General-purpose Input 2	This input is used as external general-purpose input 2.

■ CN1 Control Input Signal Connection Diagram

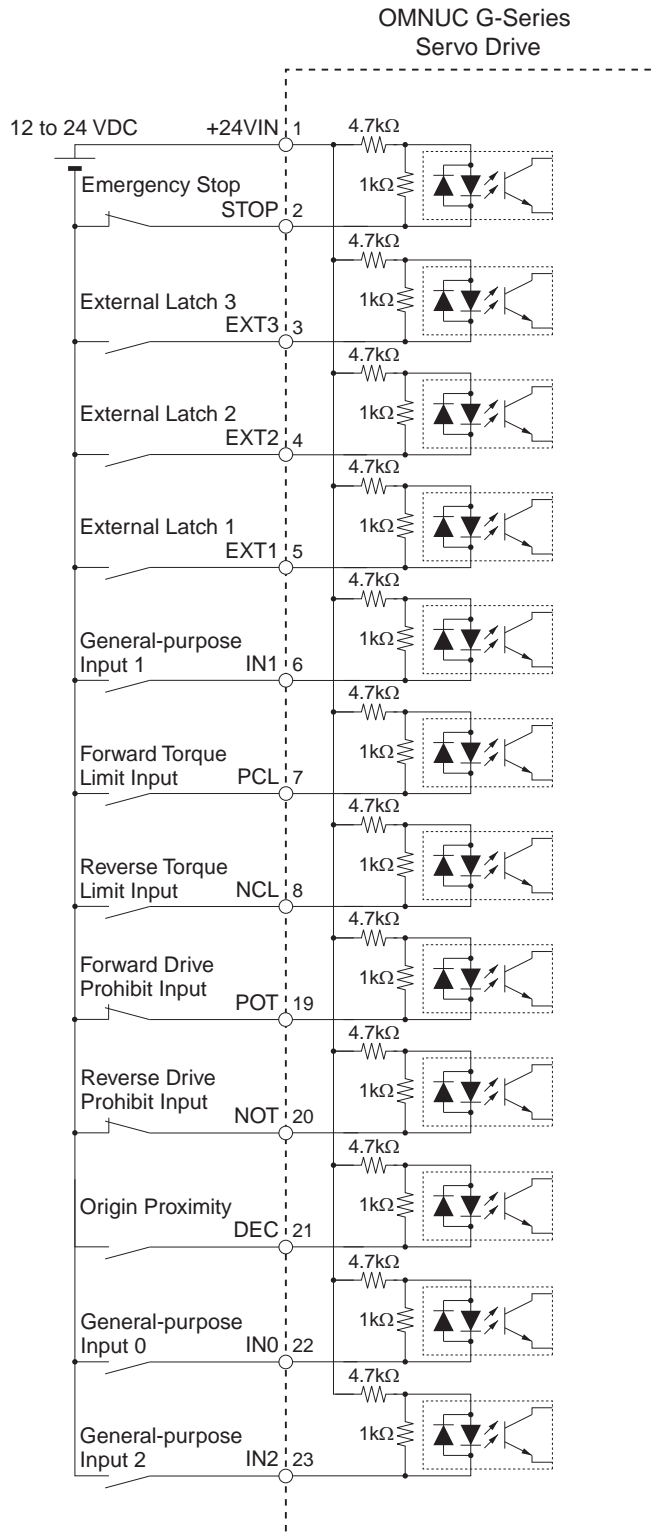

Note Inputs for pins 19 and 20 are determined by parameter settings. The diagram shows the default configuration.

5-13 Sequence Output Signals

Function

- ♦ Sequence output signals that output the Servo Drive status.

Parameters Requiring Settings

Parameter No.	Parameter name	Explanation	Reference page
Pn112	General-purpose Output 1 Function Selection	Selects the function for general-purpose output 1 (OUTM1).	5-83
Pn113	General-purpose Output 2 Function Selection	Selects the function for general-purpose output 2 (OUTM2).	5-83
Pn114	General-purpose Output 3 Function Selection	Selects the function for general-purpose output 3 (OUTM3).	5-83

■ CN1 Control Output Signals

Pin No.	Symbol	Name	Function/Interface
15	/ALM	Alarm Output	The output is OFF when an alarm is generated in the Servo Drive.
16	ALMCOM		
29	OUTM2	General-purpose Output 2 (READY)	This is a general-purpose output. The function for this output is selected by changing the parameter. Refer to <i>Output Signal Assignment Details</i> on the next page.
30	OUTM2COM		
31	OUTM3	General-purpose Output 3 (CLIM)	
32	OUTM3COM		
36	OUTM1	General-purpose Output 1 (BKIR)	
35	OUTM1COM		

Output Signal Assignment Details

Pn112 (General-purpose Output 1 Function Selection) Pn113 (General-purpose Output 2 Function Selection) Pn114 (General-purpose Output 3 Function Selection)		OUTM1 (General-purpose Output 1) OUTM2 (General-purpose Output 2) OUTM3 (General-purpose Output 3)
0	Not assigned	No output. Always OFF.
1	INP1	Positioning Completed 1 output assignment.
2	VCMP	Speed Conformity Signal output assignment.
3	TGON	Servomotor Rotation Speed Detection output assignment.
4	READY	Servo Ready output assignment.
5	CLIM	Current Limit Detection output assignment.
6	VLIM	Speed Limit Detection output assignment.
7	BKIR	Brake Interlock output assignment.
8	WARN	Warning Signal output assignment.
9	INP2	Positioning Completed 2 output assignment.

■ CN1 Control Output Signal Connection Diagram

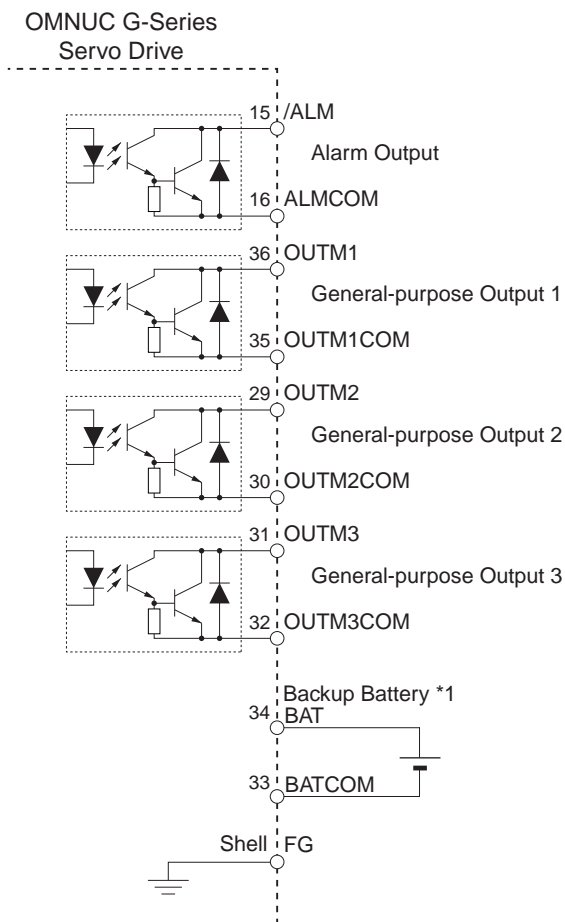

*1. If a backup battery is connected, a cable with a battery is not required.

5-14 Backlash Compensation

Function

- ♦ Compensates the position error caused by backlash in the machine.
- ♦ The specified amount of command units is compensated when the operation direction changes.

Note 1. The backlash compensation status will be retained when you switch from position control to speed control or torque control. Backlash compensation will resume with the status retained during the previous position control.

Note 2. To determine the actual position of the Servomotor, offset the backlash compensation amount from the Servomotor position data acquired via the network.

Note 3. Position data acquired via RS-232 is the value after the backlash compensation.

Note 4. After the Servo ON, compensation will be performed on the first position command for operation in the set direction. Compensation will not be performed for prior reverse operations.

Compensation will, however, be performed on the first reverse operation after the initial backlash compensation.

Once backlash compensation has been performed, it will not be performed again as long as operation continues in the same direction.

Note 5. When the Servo OFF status occurs while backlash compensation is performed, the backlash compensation amount will be cleared by presetting the position command data within the Servo Drive with Servomotor position data including the backlash compensation amount. When the Servo ON occurs again, backlash compensation will be performed as described above.

Parameters Requiring Settings

Parameter No.	Parameter name	Explanation	Reference page
Pn100	Backlash Compensation Selection	Enables or disables backlash compensation and sets the direction for compensation.	5-81
Pn101	Backlash Compensation	Sets the backlash compensation amount in command units.	5-81
Pn102	Backlash Compensation Time Constant	Sets the time to apply backlash compensation. The value dividing the compensation amount by the time constant is the speed.	5-81

■ Compensation in the forward direction

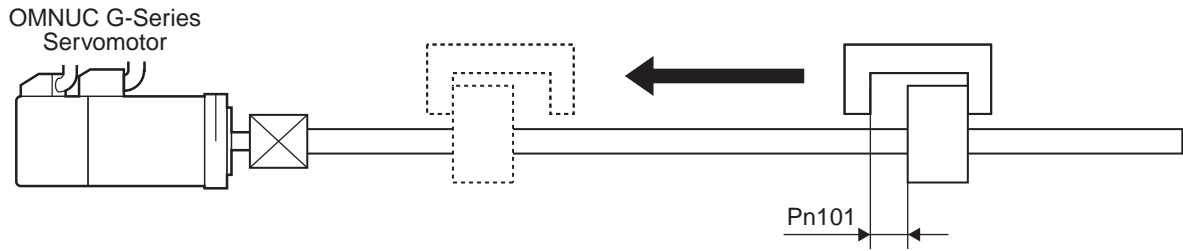

■ Compensation in the reverse direction

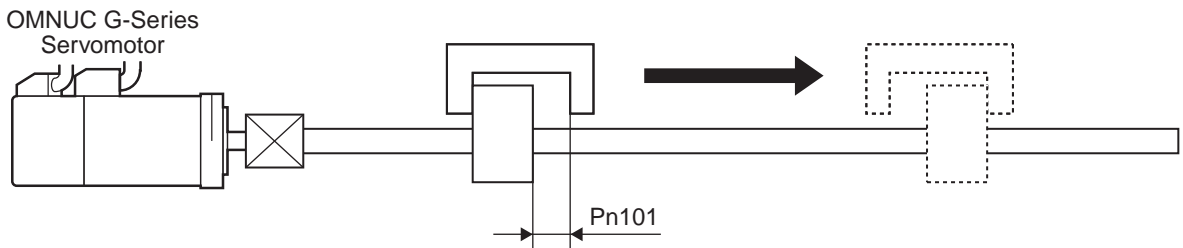

5-15 Overrun Protection

Function

- ♦ The Servomotor can be stopped with an alarm for an overrun limit error (alarm code 34) if the Servomotor exceeds the allowable operating range set in the Overrun Limit Setting (Pn026) with respect to the position command input.
- ♦ This can be used to prevent impact on the edges of the machine because of Servomotor oscillation.

Parameters Requiring Settings

Parameter No.	Parameter name	Explanation	Reference page
Pn026	Overrun Limit Setting	Sets the Servomotor's allowable operating range for the position command input range. (Setting range: 0 to 100 rotations) An overrun limit error (alarm code 34) will occur if the set value is exceeded.	5-70

Operating Conditions

- ♦ The overrun limit will operate under the following conditions.

	Conditions under which the overrun limit will operate
Operating mode	Position Control Mode is used.
Others	<ol style="list-style-type: none"> 1. The servo is ON. 2. The Overrun Limit Setting (Pn026) is not 0. 3. The allowable operating range for both forward and reverse is within 2,147,483,647 after the position command input range is cleared to zero. If the condition 1 above is not met, the Overrun Limit Setting will be disabled until the conditions for clearing the position command input range are satisfied, as described below. If the conditions 1 and 2 above are not met, the position command input range will be cleared to zero.

Conditions for Clearing the Position Command Input Range

The position command input range will be cleared to zero under the following conditions.

- ♦ The power supply is turned ON.
- ♦ The position deviation is cleared. (The deviation counter clearing is enabled and drive prohibit input is enabled by setting the Stop Selection for Drive Prohibition Input (Pn066) to 2.)
- ♦ Normal mode autotuning starts or ends.
- ♦ The position data is initialized (such as during component setup request, origin return, coordinate system setup, or adjustment commands)

Precautions for Correct Use

- ♦ Note this function is not intended to protect against abnormal position commands.
- ♦ When the overrun limit error occurs, the Servomotor is decelerated and stopped according to the Stop Selection for Alarm Generation (Pn068). Set Pn026 to a range taking into account the deceleration operation. Otherwise, the loads may hit and cause damage to the machine ends during deceleration.

Operating Examples

■ No Position Command Input (Servo ON)

No position command is input, and so the Servomotor's allowable operating range for both sides will be the range of the travel distance set in Pn026. An overrun limit error will occur if the load enters the range for generating alarm code 34 (range of slanted lines) due to oscillation.

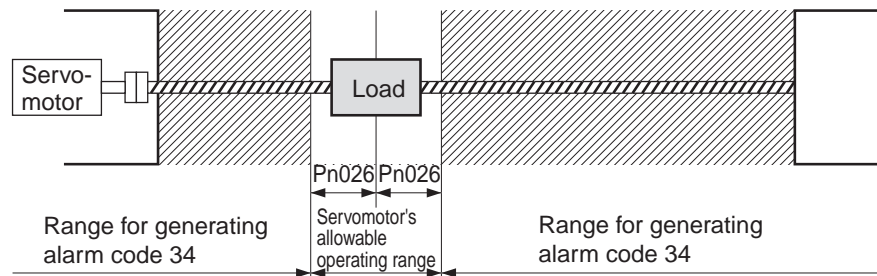

■ Right Side Operation (Servo ON)

When the position command to the right is input, the Servomotor's allowable operating range will increase by the input position command and the range of rotations set in Pn026 will be added to both sides of the position command input range.

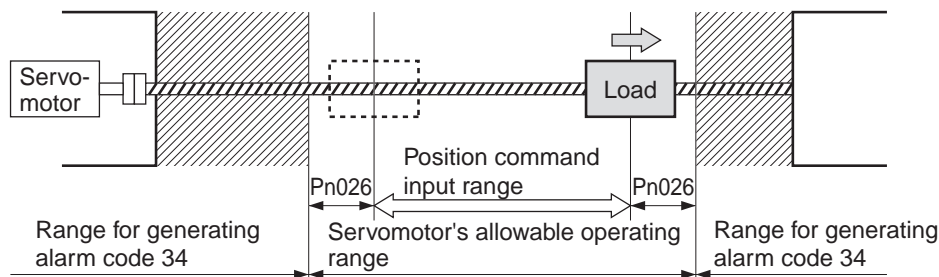

■ Left Side Operation (Servo ON)

When the position command to the left is input, the position command input range will further increase.

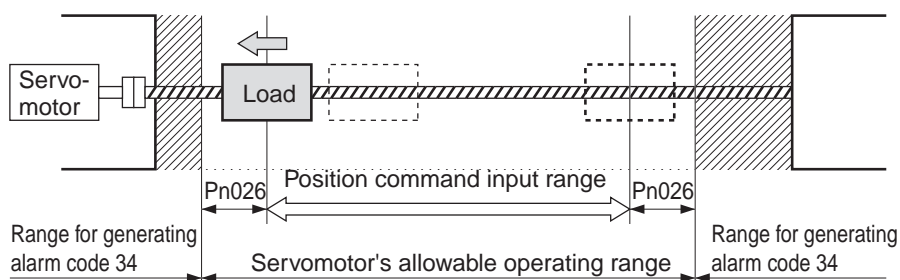

5-16 Gain Switching

Function

- ♦ This function switches the position loop and speed loop gain.
- ♦ Select between enable or disable with the Gain Switching Operating Mode Selection (Pn030). Set the switching conditions with the Gain Switch Setting (Pn031).
- ♦ The control can be optimized by switching gain settings when the load inertia changes, or the responsiveness at stops and during operation needs to be changed.
- ♦ Gain switching is used when realtime autotuning does not work effectively in such cases as follows:
 - When the load inertia fluctuates in 200 ms or less.
 - When the Servomotor rotation speed does not exceed 500 r/min., or the load torque does not exceed 50% of the rated torque.
 - When external force is constantly applied, as with a vertical axis.

Note When gain 2 has been selected, realtime autotuning will not operate normally. If using the gain switching, set the Realtime Autotuning Mode Selection (Pn021) to 0 (disabled).

Parameters Requiring Settings

Parameter No.	Parameter name	Explanation	Reference page
Pn030	Gain Switching Operating Mode Selection	Enable or disable gain switching.	5-72
Pn031	Gain Switch Setting	Sets the condition for switching between gain 1 and gain 2. The conditions depend on the control mode.	5-72
Pn010	Position Loop Gain	Sets position loop responsiveness.	5-67
Pn011	Speed Loop Gain	Sets speed loop responsiveness.	5-67
Pn012	Speed Loop Integration Time Constant	Adjusts the speed loop integration time constant.	5-67
Pn013	Speed Feedback Filter Time Constant	Selects the speed detection filter time constant.	5-67
Pn014	Torque Command Filter Time Constant	Sets the time constant for the torque command filter.	5-68
Pn018	Position Loop Gain 2	Sets the 2nd position loop responsiveness.	5-68
Pn019	Speed Loop Gain 2	Sets the 2nd speed loop responsiveness.	5-68
Pn01A	Speed Loop Integration Time Constant 2	Adjusts the speed loop integration time constant 2.	5-68
Pn01B	Speed Feedback Filter Time Constant 2	Selects the speed detection filter time constant.	5-68
Pn01C	Torque Command Filter Time Constant 2	Sets the time constant for the 2nd torque command filter.	5-68
Pn032	Gain Switch Time	Sets the time to return from gain 2 to gain 1. (Units: 166 μ s)	5-72
Pn033	Gain Switch Level Setting	Sets the judgment level for switching between gain 1 and gain 2.	5-72
Pn034	Gain Switch Hysteresis Setting	Sets the hysteresis width for the judgment level set in the Gain Switch Level setting (Pn033).	5-73
Pn035	Position Loop Gain Switching Time	Sets the number of steps to switch from low gain to high gain. (Units: 166 μ s)	5-73

■ **Timings for Gain Switch Setting (Pn031)**

Switching between gain 1 and gain 2 will be performed as illustrated below.
 Note that Position Loop Gain will be switched according to the setting for Pn035.

Gain Switch Setting (Pn031) = 2: Switching from Network

Gain switches instantly when commanded from the network.

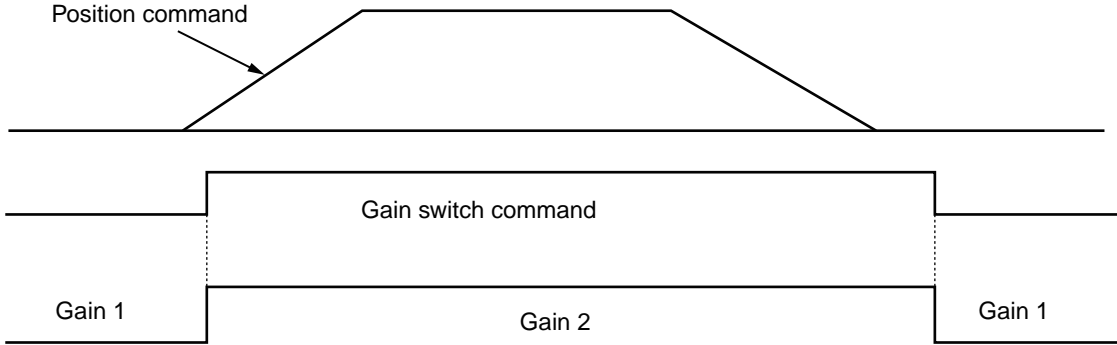

Gain Switch Setting (Pn031) = 3: Switching by an amount of change in torque command

The torque command change amount (angular acceleration and deceleration speed command) is set in units of 0.05%/166 μs.
 Gain Switch is canceled if the change amount vibrates and fails to meet the switching time.
 The change amount is approximately 6 units when switching 4% in 2 ms. (0.33% change in 166 μs)

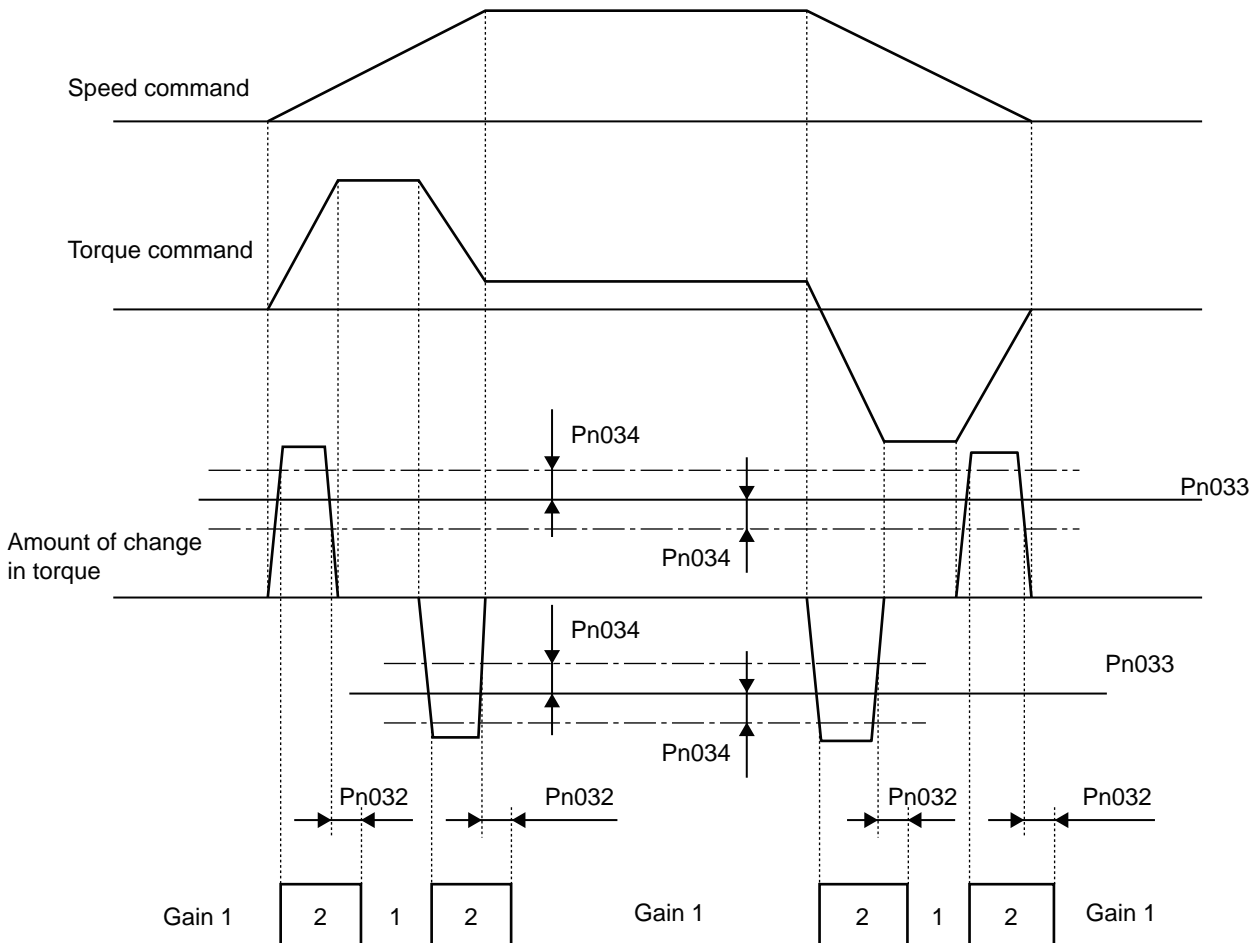

Gain Switch Setting (Pn031) = 5, 9: Switching by the Speed Command or Actual Servomotor Speed

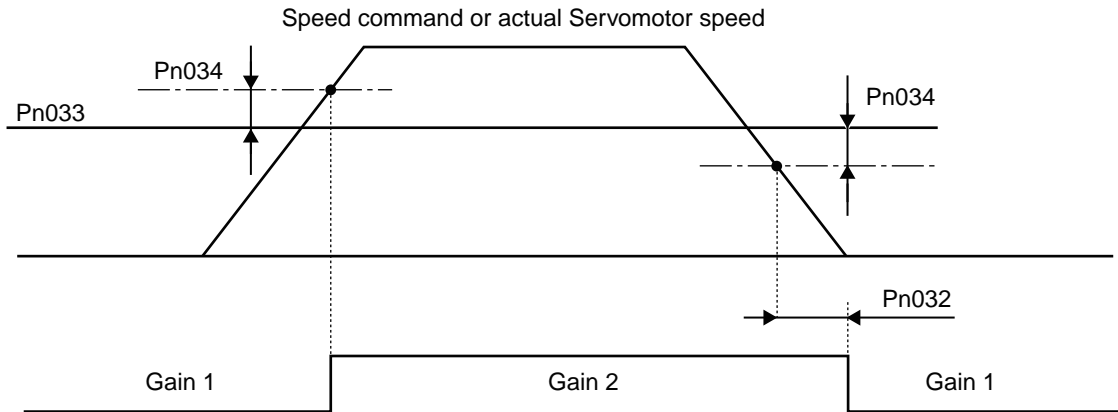

Gain Switch Setting (Pn031) = 6: Switching by the Position Deviation

Switches the gain based on the accumulated value in the deviation counter.

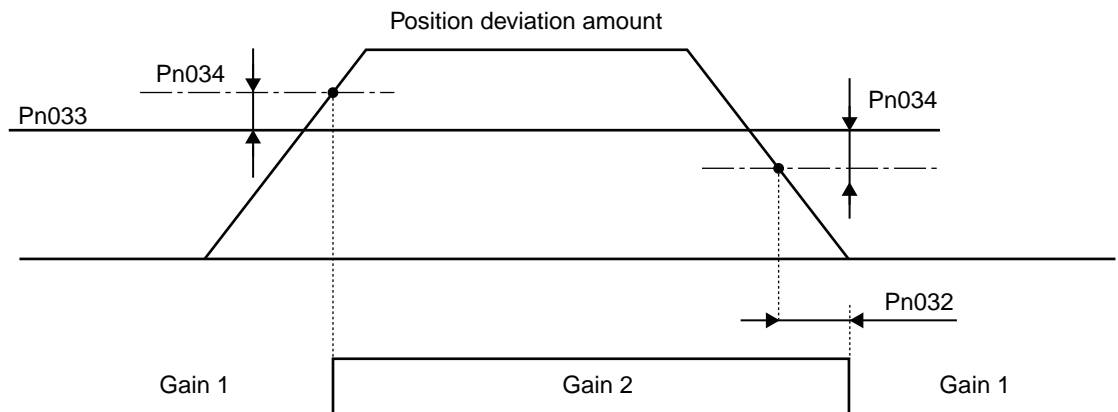

Gain Switch Setting (Pn031) = 7: Switching based on position command pulses received

Switches the gain when one or more position command pulse exists.

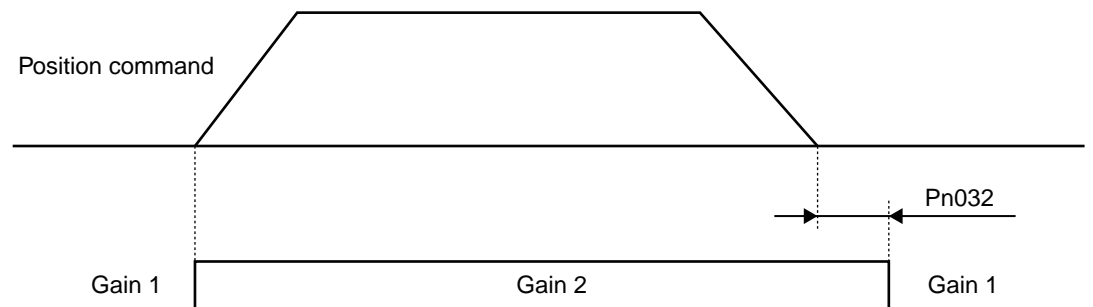

Gain Switch Setting (Pn031) = 8: Switching when the positioning completed signal turns OFF

Switches to gain 2 when the accumulated pulses in the deviation counter exceed Positioning Completion Range 1 (Pn060).

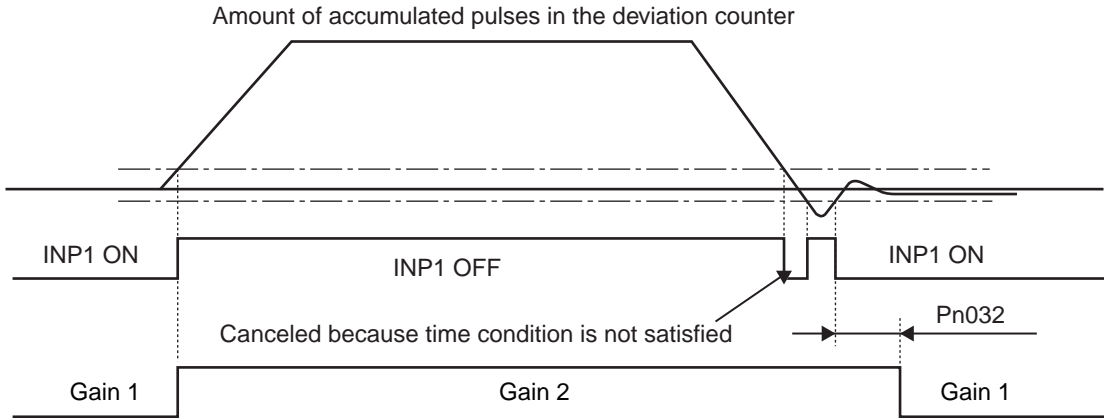

Gain Switch Setting (Pn031) = 10: Switching by the combination of position command pulses received and speed

Switches to gain 2 when there are position command pulses received.
Switches to gain 1 when there are no position commands for the time specified in the Gain Switch Time (Pn032), and when the speed is equal to or less than the Gain Switch Level Setting (Pn033) – the Gain Switch Hysteresis Setting (Pn034) [r/min].

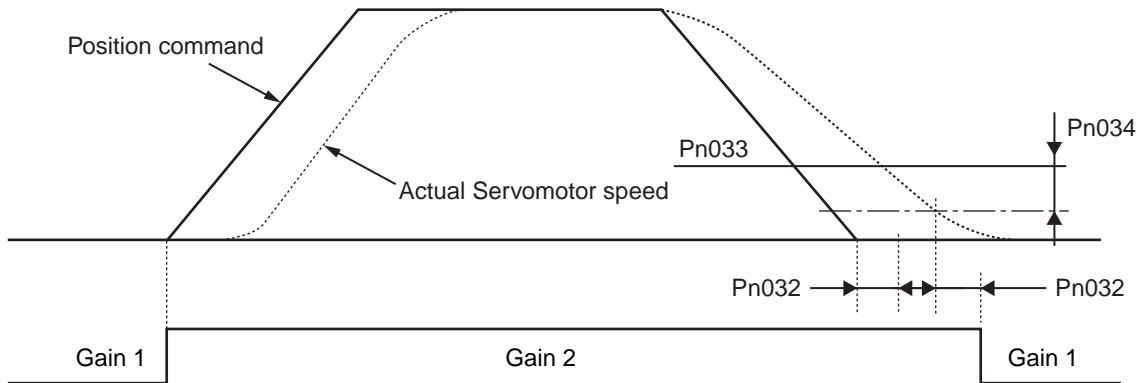

Timing for Position Loop Gain Switching Time (Pn035)

When switching the gain, the speed loop gain, speed loop integration time constant, torque command filter time constant, and speed detection filter will change at the same time, but switching is made by the time set to reduce vibration or resonance in the machine caused by changing gain from low to high.

The switching time is in units of 166 μs of the internal cycle. If the position loop gain is increased from 30 [1/s] to 50 [1/s] and Pn035 is set to 20, the gain moves up a step every 166 μs. (3.32 ms) Conversely, the gain goes down immediately when reducing the position loop gain from 50 [1/s] to 30 [1/s].

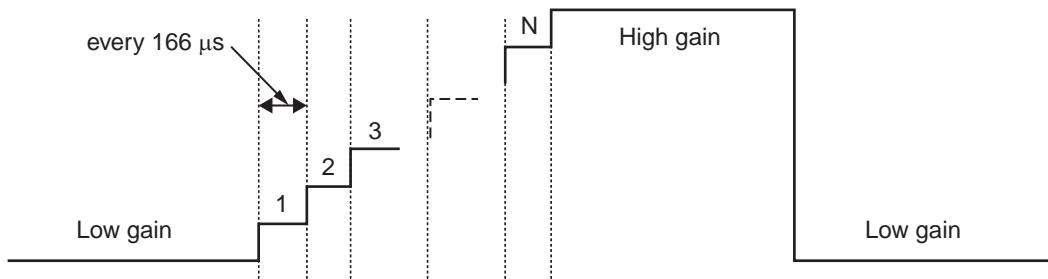

■ Gain switching in position control mode

In position control mode the Gain Switch Setting (Pn031) changes as follows.

(O: Supported, x: Not supported)

Pn031 setting	Switching condition	Gain Switch Time (Pn032)	Gain Switch Level Setting (Pn033)	Gain Switch Hysteresis Setting (Pn034)	Position Loop Gain Switching Time (Pn035)
0	Always Gain 1	x	x	x	x
1	Always Gain 2	x	x	x	x
2	Switching from the network	x	x	x	O
3	Amount of change in torque command	O	O (× 0.05%)	O (× 0.05%)	O
4	Always Gain 1	x	x	x	x
5	Speed command	O	O (r/min)	O (r/min)	O
6	Amount of position deviation	O	O (pulse)	O (pulse)	O
7	Position command pulses received	O	x	x	O
8	Positioning Completed Signal (INP1) OFF	O	x	x	O
9	Actual Servomotor speed	O	O (r/min)	O (r/min)	O
10	Combination of position command pulses received and speed	O	O	O	O

■ Gain switching in speed control mode

In speed control mode the Gain Switch Setting (Pn031) changes as follows.

(O: Supported, x: Not supported)

Pn031 setting	Switching condition	Gain Switch Time (Pn032)	Gain Switch Level Setting (Pn033)	Gain Switch Hysteresis Setting (Pn034)
0	Always Gain 1	x	x	x
1	Always Gain 2	x	x	x
2	Switching from network	x	x	x
3	Amount of change in torque command	O	O (× 0.05%)	O (× 0.05%)
4	Always Gain 1	x	x	x
5	Speed command	O	O (r/min)	O (r/min)

5-16 Gain Switching

■ Gain switching in torque control mode

In torque control mode the Gain Switch Setting (Pn031) changes as follows.

(O: Supported, x: Not supported)

Pn031 setting	Switching condition	Gain Switch Time (Pn032)	Gain Switch Level Setting (Pn033)	Gain Switch Hysteresis Setting (Pn034)
0	Always Gain 1	x	x	x
1	Always Gain 2	x	x	x
2	Switching from network	x	x	x
3	Amount of change in torque command	O	O (× 0.05%)	O (× 0.05%)

5-17 Speed Feed-forward

Function

This function shortens positioning time by adding the amount of change in position command value directly to the speed loop without passing it through the deviation counter.

Performing feed-forward compensation effectively increases the position loop gain and improves responsiveness.

However, this function is not so effective in a system where the position loop gain is already sufficiently high.

Parameters Requiring Settings

Parameter No.	Parameter name	Explanation	Reference page
Pn015	Speed Feed-forward Amount	Sets the speed feed-forward amount from the position command. (Setting range: 0 to 100%)	5-68
Pn016	Feed-forward Filter Time Constant	Sets the time constant for the speed feed-forward first-order lag filter. (Setting range: 0 to 64 ms)	5-68

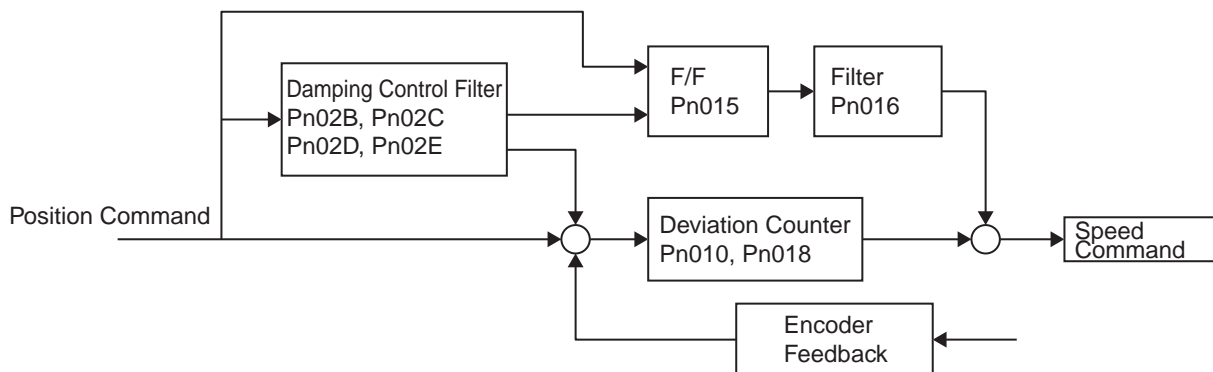

Adjust the feed-forward after completing the gain adjustment.

The Servomotor will overshoot if the feed-forward amount is too large. Increase the feed-forward amount, but not so much that it causes overshooting.

The feed-forward filter is the first-order lag filter. Set this filter according to the acceleration and deceleration time.

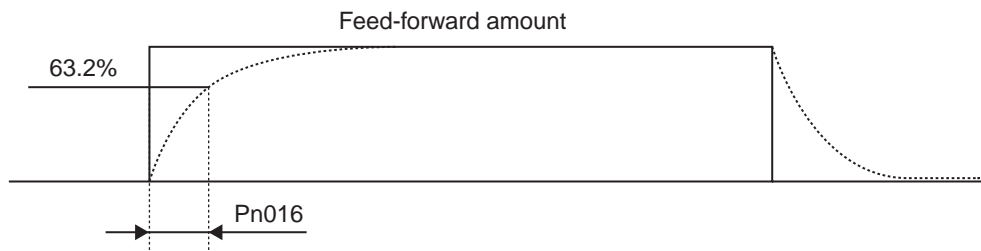

The figure above shows step response, but the positioning time will be delayed accordingly if acceleration or deceleration occurs.

5-18 Torque Feed-forward

Function

In speed commanded control, using the torque feed-forward command reduces the delay caused by the speed loop integration time and thereby makes acceleration and deceleration faster. For a vertical axis, torque feed-forward can compensate heavy loads to eliminate the difference (up and down) in the torque command amount by the speed command calculation.

Parameters Requiring Settings

There are no parameters to set. This is set by command from the network.

To control during acceleration and deceleration, differential operations will be required for the speed command via the host controller.

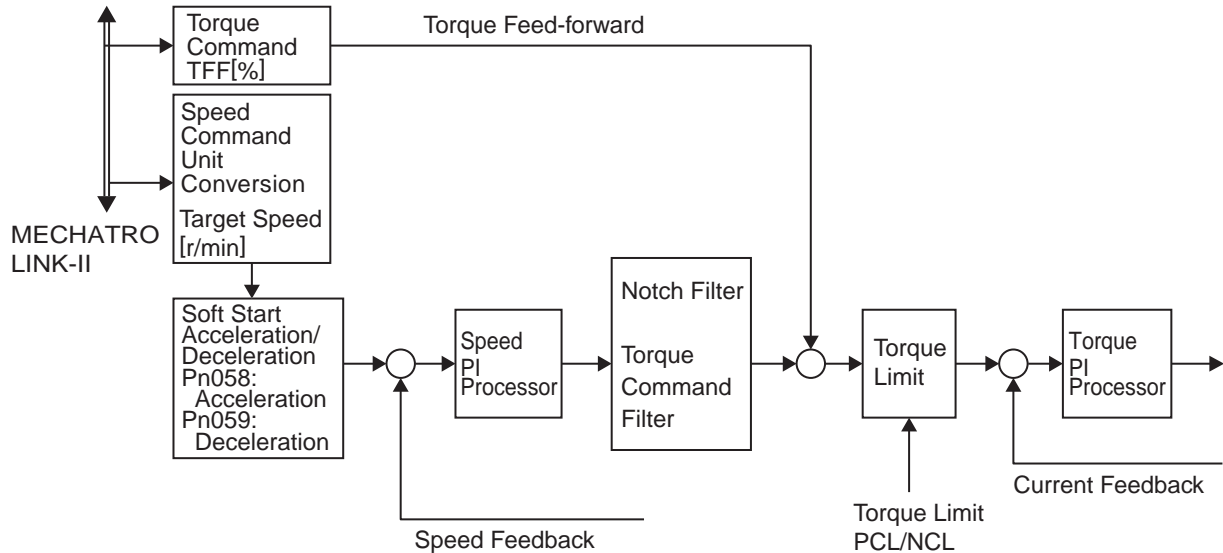

5-19 Speed Feedback Filter Selection

Function

Selects the speed feedback filter. Normally, use a setting of 0.

This is used when the speed loop gain cannot be raised any more due to vibration in the machine. Increasing the value reduces the noise of the Servomotor but also reduces its responsiveness. (first-order lag filter)

When the Instantaneous Speed Observer Setting is enabled (Pn027 = 1), Pn013 and Pn01B are disabled and processed as 0.

Parameters Requiring Settings

Parameter No.	Parameter name	Explanation	Reference page
Pn013	Speed Feedback Filter Time Constant	Selects the speed detection filter time constant. Normally, use a setting of 0. (Setting range: 0 to 5)	5-67
Pn01B	Speed Feedback Filter Time Constant 2	Selects the 2nd speed detection filter time constant. Normally, use a setting of 0. (Setting range: 0 to 5)	5-68

The settings and cut-off frequencies of Pn013 and Pn01B are as follows.

Setting	Frequency (Hz)
0	---
1	1820
2	1120
3	740
4	680
5	330

5-20 P Control Switching

Function

This function switches speed loop control from PI control to P control.
Switching to P control reduces the servo rigidity and eliminates vibration.
The absence of the integration time results in greater speed and position deviations due to external forces and load torques.

5

Parameters Requiring Settings

There are no parameters to set. This is set by command from the network.

5-21 Torque Command Filter Time Constant

Function

Set the primary filter applied to the torque command. The 1st and 2nd filter is switched by gain switching.

The torque command filter can suppress machine vibration that occurs when a servo loop is configured.

Adjusting the time constant of the torque command filter may be able to suppress vibration.

Responsiveness worsens by increasing the time constant. Overshoots may occur as the servo rigidity decreases. Depending on the machine, optimize the setting for this filter as well as the notch filter explained in the next section.

Parameters Requiring Settings

Parameter No.	Parameter name	Explanation	Reference page
Pn014	Torque Command Filter Time Constant	Sets the time constant for the torque command filter. (Setting range: 0 to 25 ms, units: 0.01 ms)	5-68
Pn01C	Torque Command Filter Time Constant 2	Sets the 2nd time constant for the torque command filter. (Setting range: 0 to 25 ms, units: 0.01 ms)	5-68

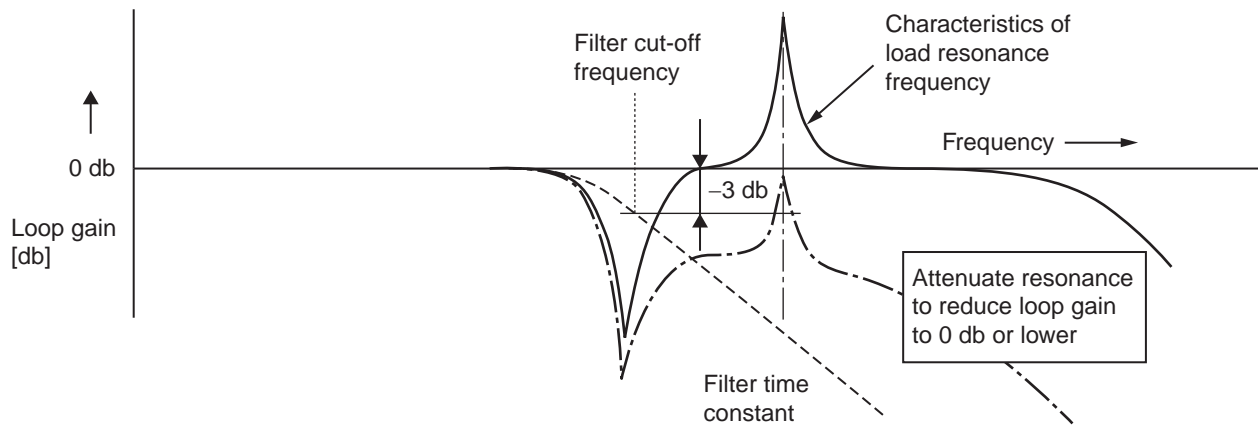

5-22 Notch Filter

Function

Two notch filters can be set for torque commands.

When resonance occurs at a ball screw or a specific location, set the resonance frequency to eliminate the resonance.

Parameters Requiring Settings

Parameter No.	Parameter name	Explanation	Reference page
Pn01D	Notch Filter 1 Frequency	Sets the frequency of notch filter 1. Enabled from 100 to 1499 Hz, disabled at 1500 Hz.	5-68
Pn01E	Notch Filter 1 Width	Selects the width of the frequency of notch filter 1. The notch width becomes wider by increasing this value. (Setting range: 0 to 4, normally use a setting of 2.)	5-68
Pn028	Notch Filter 2 Frequency	Sets the frequency of notch filter 2. Enabled from 100 to 1499 Hz, disabled at 1500 Hz.	5-71
Pn029	Notch Filter 2 Width	Selects the width of the frequency of notch filter 2. The notch width becomes wider by increasing this value. (Setting range: 0 to 4, normally use a setting of 2.)	5-71
Pn02A	Notch Filter 2 Depth	Selects the depth of the frequency of notch filter 2. Increasing this value decreases the notch depth and reduces the phase lag. (Setting range: 0 to 99, normally use a setting of 2.)	5-71

Notch filter width settings and depths

Setting	Depth = F_c/f_w	Width at 500 Hz
0	0.41	408 to 613 Hz
1	0.56	380 to 659 Hz
2	0.71	354 to 707 Hz
3	0.86	330 to 758 Hz
4	1.01	308 to 811 Hz

Notch filter depths and attenuation

Depth	Output/Input (%)
0	0 (cut-off)
30	15% (-16.5 db)
50	50% (-6 db)
99	99% (pass through)

A notch filter is a filter that eliminates a designated component of a frequency.

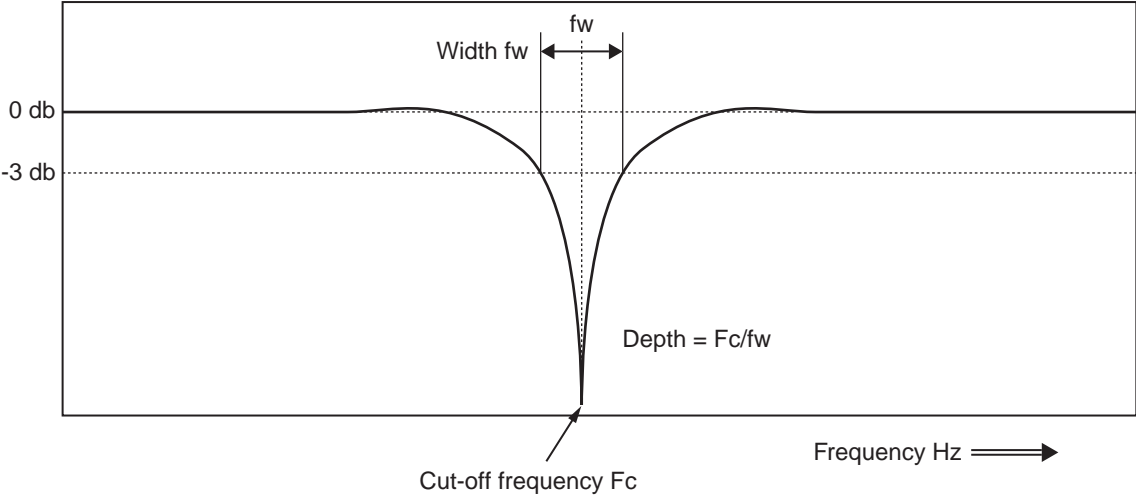

A notch filter is used to eliminate resonance occurring in a machine.

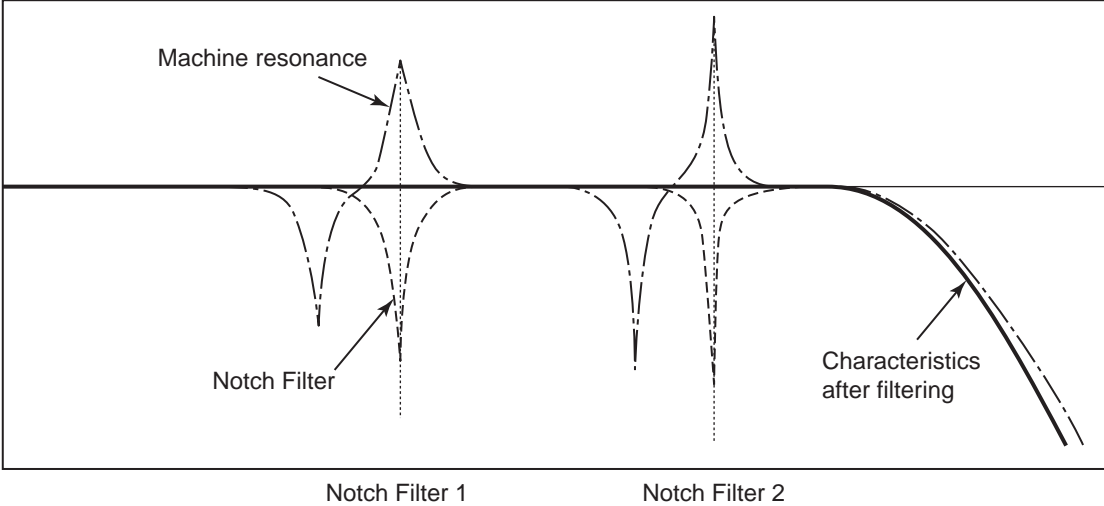

5-23 Adaptive Filter

Function

The adaptive filter reduces resonance point vibration by estimating the resonance frequency from the vibration component that appears in the Servomotor speed during actual operation and automatically sets the frequency of the notch filter, which removes the resonance component from the torque command.

The automatically set notch filter frequency is set in the Adaptive Filter Table Number Display (Pn02F).

The resonance filter frequency can be obtained by specifying the Pn02F table No.

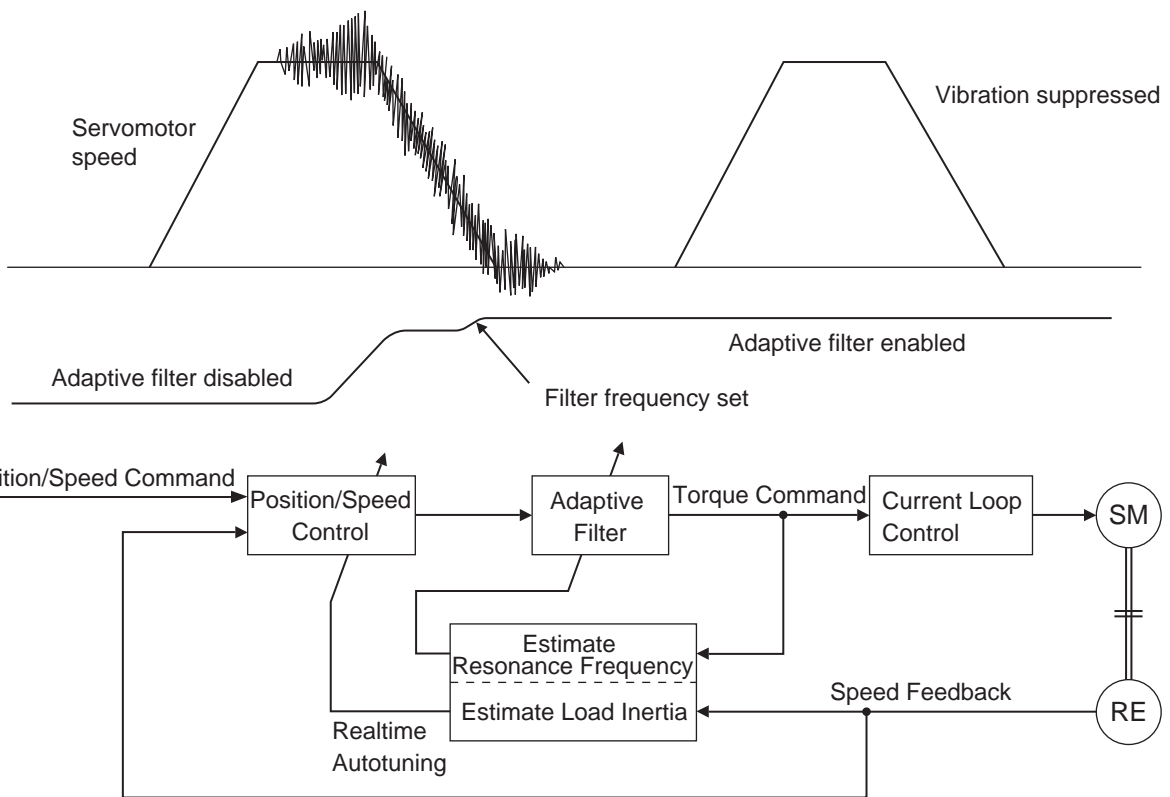

Parameters Requiring Settings

Parameter No.	Parameter name	Setting	Explanation		Reference page
Pn023	Adaptive Filter Selection		Adaptive filter	Adaptive operation	5-92
		0	Disabled	---	
		1	Enabled	Yes	
		2		No (retained)	

If the Adaptive Filter Table Number Display (Pn02F) has stopped changing (completed), a setting of 2 will be retained, assuming that the resonance point does not change.

Write the data to the EEPROM if the results are to be saved.

**Precautions
for Correct Use**

- ♦ The adaptive filter may not function properly under the following conditions.

	Conditions under which the adaptive filter does not function properly
Control Mode	♦ In Torque Control Mode. (Operates in position and speed control modes)
Resonating load status	<ul style="list-style-type: none"> ♦ If the resonance frequency is 300 Hz or lower. ♦ If there are multiple points of resonance. ♦ If the resonance peak or control gain is low, and the Servomotor speed is not affected by it.
Load status	♦ If the Servomotor speed with high-frequency components changes due to backlash or other non-linear elements (play).
Command pattern	♦ If the acceleration/deceleration suddenly changes, i.e. 3,000 r/min or more in 0.1 s.

**Precautions
for Correct Use**

- ♦ Unusual noise or vibration may occur until the adaptive filter stabilizes after startup, immediately after the first servo ON, or when the Realtime Autotuning Machine Rigidity Selection (Pn022) is increased, but this is not a problem if it disappears right away. If the unusual noise or vibration, however, continues for three or more reciprocating operations, take the following measures in any order you can.
 - ♦ Write the parameters used during normal operation to the EEPROM.
 - ♦ Lower the Realtime Autotuning Machine Rigidity Selection (Pn022).
 - ♦ Disable the adaptive filter by setting the Adaptive Filter Selection (Pn023) to 0. (Reset the inertia estimate and adaptive operation)
 - ♦ Set the notch filter manually.
- ♦ Once unusual noise or vibration occurs, the Inertia Ratio (Pn020) may have changed to an extreme value. In this case, also take the measures described above.
- ♦ The Adaptive Filter Table Number Display (Pn02F) is written to the EEPROM every 30 minutes, and when the power supply is turned OFF and turned ON again, this data is used as the initial values for the adaptive operation.

Disabling the Adaptive Filter

The adaptive filter function, which performs automatic tracking in response to the load resonance, can be disabled by setting the Adaptive Filter Selection (Pn023) to 0. If the adaptive filter is disabled when it is operating correctly, the resonance that has been suppressed will reappear, and noise or vibration may occur.

Therefore, before disabling the adaptive filter, perform copying function to the Notch Filter 1 Frequency (Pn01D) of the Adaptive Filter Table Number Display (Pn02F) or manually set the Notch Filter 1 Frequency (Pn01D) based on the Adaptive Filter Table Number Display (Pn02F) in the following tables.

Pn02F	Notch Filter 1 Frequency	Pn02F	Notch Filter 1 Frequency	Pn02F	Notch Filter 1 Frequency
0	(Disabled)	22	766	44	326
1	(Disabled)	23	737	45	314
2	(Disabled)	24	709	46	302
3	(Disabled)	25	682	47	290
4	(Disabled)	26	656	48	279
5	1482	27	631	49	269 (Disabled when Pn022 ≥ F)
6	1426	28	607	50	258 (Disabled when Pn022 ≥ F)
7	1372	29	584	51	248 (Disabled when Pn022 ≥ F)
8	1319	30	562	52	239 (Disabled when Pn022 ≥ F)
9	1269	31	540	53	230 (Disabled when Pn022 ≥ F)
10	1221	32	520	54	221 (Disabled when Pn022 ≥ E)
11	1174	33	500	55	213 (Disabled when Pn022 ≥ E)
12	1130	34	481	56	205 (Disabled when Pn022 ≥ E)
13	1087	35	462	57	197 (Disabled when Pn022 ≥ E)
14	1045	36	445	58	189 (Disabled when Pn022 ≥ E)
15	1005	37	428	59	182 (Disabled when Pn022 ≥ D)
16	967	38	412	60	(Disabled)
17	930	39	396	61	(Disabled)
18	895	40	381	62	(Disabled)
19	861	41	366	63	(Disabled)
20	828	42	352	64	(Disabled)
21	796	43	339		

Set the Notch Filter 1 Frequency (Pn01D) to 1,500 when disabling the adaptive filter using the above table.

5-24 Instantaneous Speed Observer

Function

The instantaneous speed observer improves speed detection accuracy, increases responsiveness, and reduces vibration at stopping by estimating the speed of the Servomotor using a load model (load inertia).

This function does not work for machines with resonance or insufficient rigidity.

This function can be used in the position and speed control modes.

This function is available for Servomotors with only a high speed resolution absolute encoder.

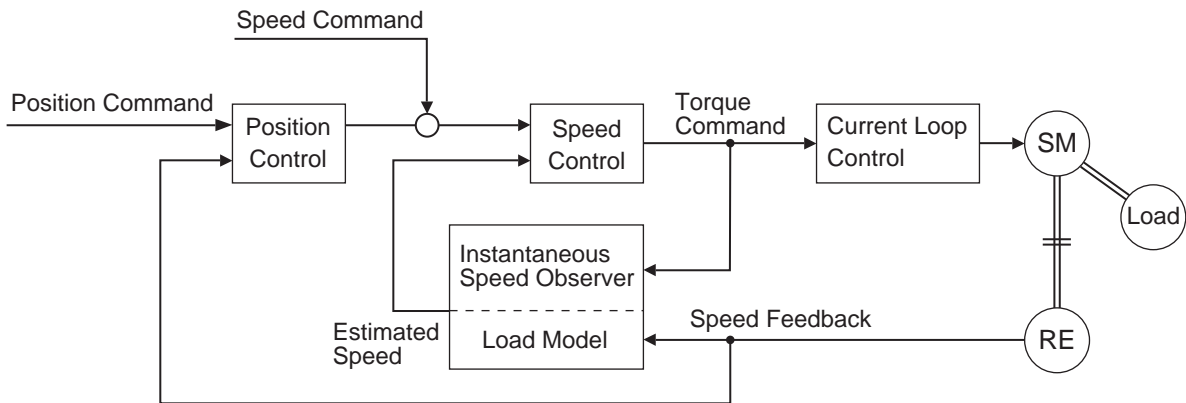

Parameters Requiring Settings

Parameter No.	Parameter name	Setting	Explanation	Reference page
Pn020	Inertia Ratio		Sets the load inertia ratio as accurately as possible.	5-68
Pn027	Instantaneous Speed Observer Setting	0	Instantaneous Speed Observer disabled	5-71
		1	Instantaneous Speed Observer enabled	
Pn060	Positioning Completion Range 1		Set this parameter when using an absolute encoder.	5-75

Precautions for Correct Use

- ♦ The instantaneous speed observer may not function properly or may not be effective under the following conditions.

	Conditions under which the instantaneous speed observer does not function properly
Control Mode	♦ In Torque Control Mode. (Operates in position and speed control modes)
Resonating load status	♦ If there's a large resonance point at the frequency of 300 Hz or lower. ♦ If there are multiple resonance frequencies. ♦ If the resonance peak or control gain is low, and the Servomotor speed is not affected by it.
Load status	♦ If the Servomotor speed with high-frequency components changes due to backlash or other non-linear elements (play). ♦ If a large disturbance torque with high-frequency components is applied. ♦ If the load inertia changes.
Encoder	♦ If a 2,500-p/r incremental encoder is used.

Operating Procedure

1. Set the Inertia Ratio (Pn020).

- Set the inertia ratio as accurately as possible.
- Input the calculated inertia ratio if it has already been calculated when selecting a Servomotor.
- If the inertia ratio is not known, perform normal mode autotuning and set the inertia ratio.
- Use the Pn020 setting if the Inertia Ratio (Pn020) is obtained using realtime autotuning that can be used in normal position control.

2. Adjust the gain for the position loop and speed loop.

Adjust the Position Loop Gain (Pn010), Speed Loop Gain (Pn011), Speed Loop Integration Time Constant (Pn012), and Torque Command Filter Time Constant (Pn014).

Use normal mode autotuning and realtime autotuning if there are no problems in doing so.

3. Set the Instantaneous Speed Observer Setting (Pn027).

- Set the Instantaneous Speed Observer Setting (Pn027) to 1. The speed detection method will switch to the Instantaneous Speed Observer.
- If the machine operating noise or vibration becomes louder, or the torque monitor waveform fluctuates significantly, return the setting to 0 and make sure the inertia ratio and adjustment parameters are correct.
- If improvements are seen, such as a quieter operation, less vibration, or less fluctuation in the torque monitor waveform, make fine adjustments in the Inertia Ratio (Pn020) to find the setting that makes the least fluctuation while monitoring the position deviation waveform and the actual speed waveform.
If changes are made to the Position Loop Gain (Pn010), Speed Loop Gain (Pn011), or Speed Loop Integration Time Constant (Pn012), the optimum value for the Inertia Ratio (Pn020) may have changed. Readjust the value in the Inertia Ratio (Pn020) so that the fluctuation will be minimal.

5-25 Damping Control

Function

Damping control is used to reduce vibration when the end of the machine exhibits vibration. This function is effective on vibration in machines with low rigidity. The normal type is suitable for frequencies from 10 to 200 Hz, the low-pass type is for 1 to 200 Hz. The adaptive filter (300 Hz or more) can be used for the normal type, but not for the low-pass type. Damping control works with position commands and thus cannot be used for speed and torque control.

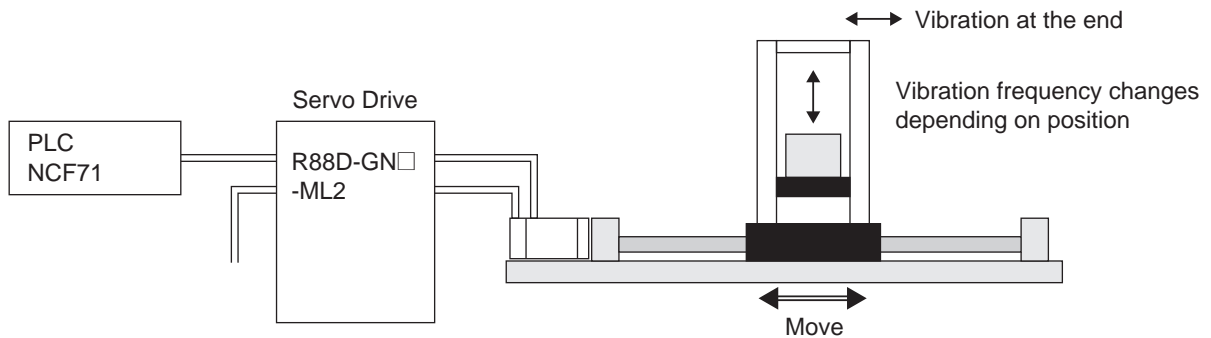

The control block diagram for Damping Control is shown below.

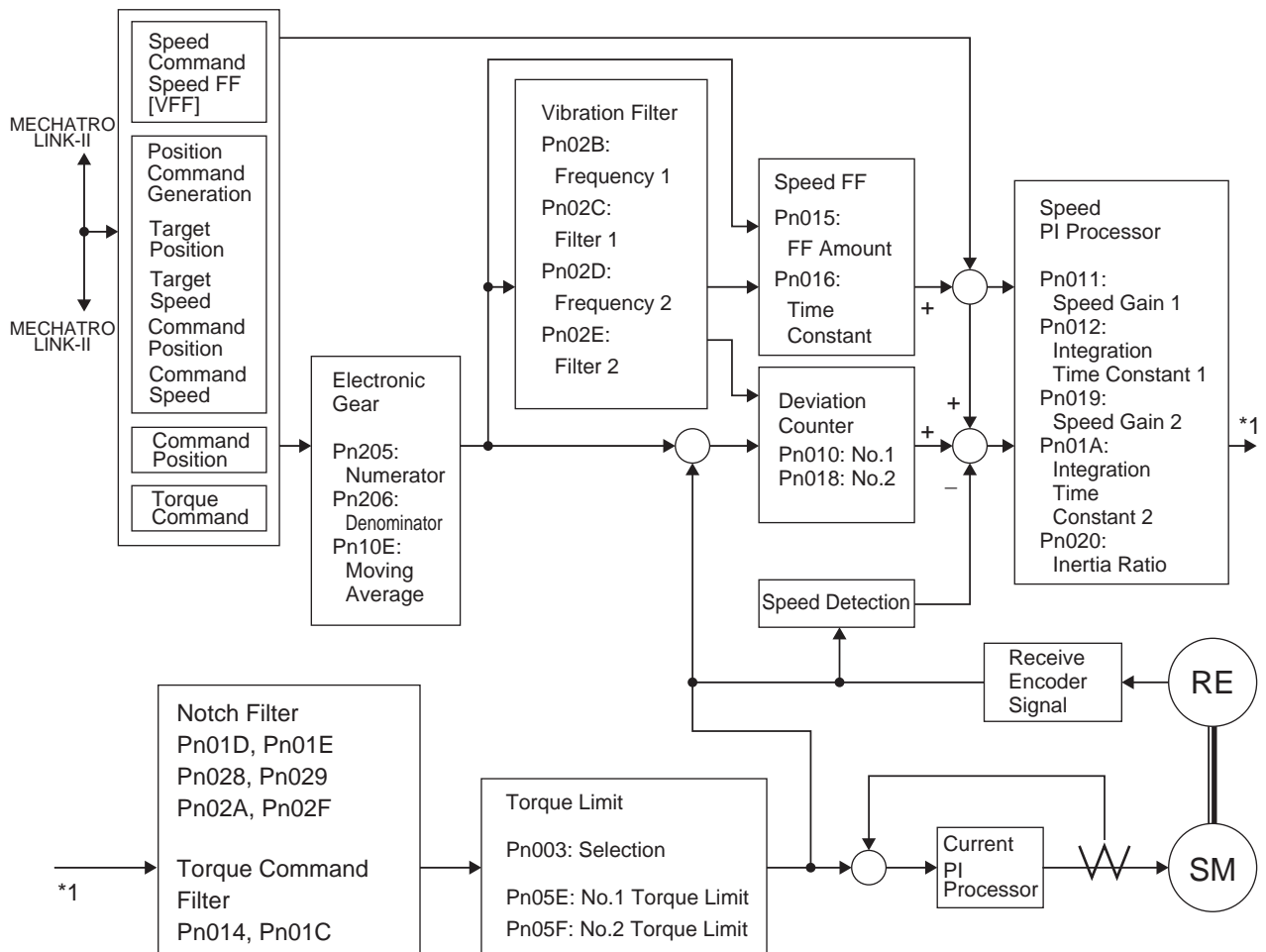

Parameters Requiring Settings

Parameter No.	Parameter name	Setting	Explanation	Reference page	
Pn024	Vibration Filter Selection		Selects the vibration filter type and switching mode based on the status of the equipment. (See Note 1)	5-92	
			Filter type		Switching mode
		0	Normal type		No switching (Both 1 and 2 are enabled)
		1			Switching with command direction
		2			
		3	Low-pass type		No switching (Both 1 and 2 are enabled)
		4			Switching with command direction
5					
Pn02B	Vibration Frequency 1		Sets the Vibration Frequency 1 for damping control to suppress vibration at the end of the load. The setting frequency range and adaptive filter operation depend on the filter type selected with the Vibration Filter Selection (Pn024). Set to 0 if the damping control is not used. (See Note 1)	5-71	
Pn02C	Vibration Filter 1 Setting		Decrease this setting if torque saturation occurs when setting the Vibration Frequency 1 (Pn02B). Increase it to make the operation faster. Normally, use a setting of 0. The setting range depends on the filter type selected with the Vibration Filter Selection (Pn024), as shown below if Vibration Filter 1 is enabled. Note This parameter is disabled when Vibration Filter 1 is disabled. ♦ Normal type (Setting range: -200 to 2000) Setting range: $100 \leq \text{Pn02B} + \text{Pn02C} \leq \text{Pn02B} \times 2$ or 2000 ♦ Low-pass type (Setting range: -200 to 2000) Setting range: $10 \leq \text{Pn02B} + \text{Pn02C} \leq \text{Pn02B} \times 6$	5-71	
Pn02D	Vibration Frequency 2		Same function as Pn02B.	5-71	
Pn02E	Vibration Filter 2 Setting		Same function as Pn02C.	5-72	

Note Details on the vibration filter settings are as follows.

Vibration Filter Selection	Mode Selection	Description of setting
Filter type selection	Normal type	Vibration frequency setting range 10.0 to 200.0 Hz (Disabled when set to 0 to 99) Adaptive filter can be used
	Low-pass type	Vibration frequency setting range 1.0 to 200.0 Hz (Disabled when set to 0 to 9) Adaptive filter cannot be used (forcibly set to disabled)
Switching mode selection	No switching	Both Vibration Frequency 1 and 2 are enabled.
	Switching with command direction	Selects Vibration Frequency 1 in forward direction (Pn02B, Pn02C) Selects Vibration Frequency 2 in reverse direction (Pn02D, Pn02E)

Precautions for Correct Use

- ♦ The damping control may not function properly or may not be effective under the following conditions.

	Conditions under which damping control does not function properly
Control Mode	♦ In speed and torque control modes.
Load status	♦ If forces other than position commands, such as external forces, cause vibration. ♦ If the vibration frequency is outside the range of 1 to 200 Hz. ♦ If the ratio of the resonance frequency to anti-resonance frequency is large. ♦ If the vibration frequency is greater than the response frequency in position control (the value of position loop gain [1/s] divided by 2π (6.28)). (10 Hz when the position loop gain is 63 [1/s].)

Operating Procedure

1. Adjust the gain for the position loop and speed loop.

Adjust the Position Loop Gain (Pn010), Speed Loop Gain (Pn011), Speed Loop Integration Time Constant (Pn012), and Torque Command Filter Time Constant (Pn014).

Use normal mode autotuning and realtime autotuning if there are no problems in doing so.

2. Measure the vibration frequency at the end of the machine system.

Vibration frequency is measured using a laser displacement meter, servo acceleration meter, or acceleration pick-up.

Set the measured vibration frequency to the Vibration Frequency 1 (Pn02B) and Vibration Frequency 2 (Pn02D) according to the motion.

Set the filter type and switching mode with the Vibration Filter Setting (Pn024).

If no measurement device is available, use the CX-Drive data tracing function, and read the residual vibration frequency (Hz) from the position deviation waveform as shown in the following figure.

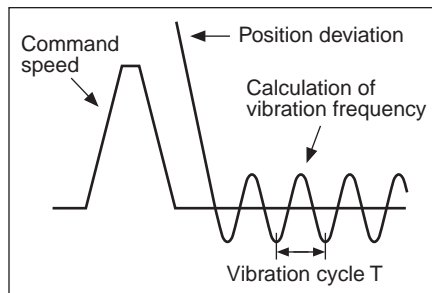

- The following gives the vibration frequency in the figure.

$$f \text{ (Hz)} = \frac{1}{T \text{ (s)}}$$

Since the unit for the parameter is 0.1Hz:
(Pn02B, Pn02D) = 10 × f

- Example:
When the vibration cycle is 100 ms and 20 ms, the vibration frequency is 10 Hz and 40 Hz, therefore set Pn02B = 100, Pn02D = 400.

If the vibration does not disappear with the frequency setting, raise or lower the resonance frequency to find the frequency that can reduce vibration.

3. Set the Vibration Filter.

Set Vibration Filter 1 (Pn02C) and Vibration Filter 2 (Pn02E).

First, set to 0.

The stabilization time can be reduced by setting a large value; however, torque ripple will increase at the command change point as shown in the following figure. Set a range that will not cause torque saturation under actual operation conditions. The effects of vibration suppression will be lost if torque saturation occurs.

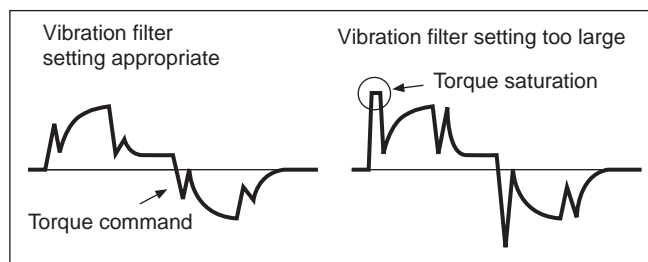

Decrease this setting if torque saturation occurs when setting the Vibration Frequency 1 (Pn02B).

Increase it to make the movement faster. Normally, use a setting of 0.

The setting range depends on the filter type selected with the Vibration Filter Selection (Pn024), as shown below if Vibration Filter 1 is enabled.

- Normal type (Setting range: -200 to 2000)
Setting range: $100 \leq \text{Pn02B} + \text{Pn02C} \leq \text{Pn02B} \times 2$ or 2000
- Low-pass type (Setting range: -200 to 2000)
Setting range: $10 \leq \text{Pn02B} + \text{Pn02C} \leq \text{Pn02B} \times 6$

Note This parameter is disabled when Vibration Filter 1 is disabled.

4. Set the Vibration Filter Selection (Pn024).

Select the vibration filter type and vibration filter switching mode depending on the status of the machine.

Setting	Filter type	Switching mode
0	Normal type	No switching (Both filter 1 and filter 2 are enabled)
1		
2		Switching with command direction
3	Low-pass type	No switching (Both filter 1 and filter 2 are enabled)
4		
5		Switching with command direction

The Vibration Filter Selection (Pn024) parameter is enabled at power-ON. Turn OFF the control power and turn it ON again after setting this parameter.

If the low-pass type filter is selected, the Adaptive Filter Selection (Pn023) is forcibly set to 0 and cannot be used.

If the low-pass type filter is selected when the adaptive filter is operating correctly, the resonance that has been suppressed will reappear, and noise or vibration may occur.

5-26 User Parameters

Set and check the user parameters in Parameter Setting Mode.













Fully understand what the parameters mean and the setting procedures, and set the parameters according to the system.

Some parameters are enabled by turning the power OFF and then ON again. After changing these parameters, turn OFF the power, confirm that the power indicator has gone OFF, and then turn ON the power again.

Setting and Checking Parameters







■ Overview

Use the following procedure to set or check parameters.

- Go to Parameter Setting Mode. Press the  key, and then press the  key once.
- Select the Parameter Type --- , 
- Switch to the Parameter Setting Display --- 
- Set the parameter number (Pn□□) --- , 
- Display the parameter setting --- 
- Change the parameter setting --- , , 
- Save the changed setting to memory and return to Parameter Setting Mode --- 

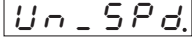
■ Operating Procedures for 16-bit Positioning Parameters

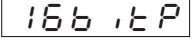

1. Displaying Parameter Setting Mode

Key operation	Display example	Explanation
		The default display is displayed.
		Press the  key to display Monitor Mode.
		Press the  key to display Parameter Setting Mode.

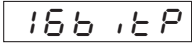

2. Selecting the Parameter Type

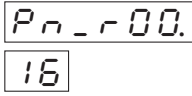
Key operation	Display example	Explanation
		Confirm that 16-bit Parameter is selected.



3. Switching to the Parameter Setting Display

Key operation	Display example	Explanation
		Press the  key to go to the Parameter Setting Display. Press the  key to return to the Parameter Type Selection Display.

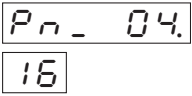
4. Setting the Parameter Number



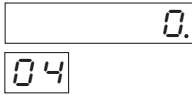





Key operation	Display example	Explanation
  		Set the number of the parameter to be set or checked.

5. Displaying the Parameter Setting

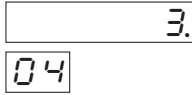
Key operation	Display example	Explanation
		Press the  key to display the setting. The selected parameter number appears in the sub window.

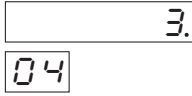

6. Changing the Parameter Setting

♦ The following operation is not required if you are only checking a parameter setting.

Key operation	Display example	Explanation
  		Use the    keys to change the setting. The decimal point will flash for the digit that can be set.
		Press the  key to save the new setting.



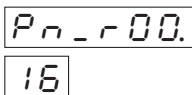



7. Returning to Parameter Setting Mode

♦ The following operation is not required if you are only checking a parameter setting.

Key operation	Display example	Explanation
		Press the  key to return to Parameter Setting Mode.

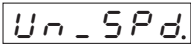
■ Operating Procedures for 32-bit Positioning Parameters





1. Displaying Parameter Setting Mode

Key operation	Display example	Explanation
		The default display is displayed.
		Press the  key to display Monitor Mode.
		Press the  key to display Parameter Setting Mode.





2. Selecting the Parameter Type

Key operation	Display example	Explanation
		Press the   keys to select 32-bit parameters.





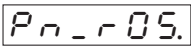



3. Switching to the Parameter Setting Display

Key operation	Display example	Explanation
	 	Press the  key to go to the Parameter Setting Display. Press the  key to return to the Parameter Type Selection Display.

4. Setting the Parameter Number







Key operation	Display example	Explanation
 	 	Set the number of the parameter to be set or checked.

5. Displaying the Parameter Setting

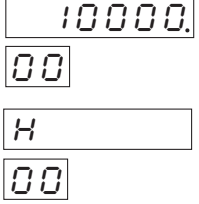
Key operation	Display example	Explanation
	 	Press the  key to display the setting. The selected parameter number appears in the sub window.
	 	32-bit parameters have many digits and thus displayed on two displays. Press the  key to change the display. Negative values of the parameter are indicated with a dot.

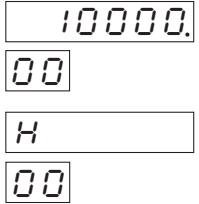

6. Changing the Parameter Setting

♦ The following operation is not required if you are only checking a parameter setting.

Key operation	Display example	Explanation
		Use the    keys to change the setting. The decimal point will flash for the digit that can be set.
		Press the  key to save the new setting.

7. Returning to Parameter Setting Mode

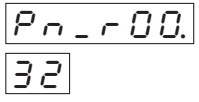
♦ The following operation is not required if you are only checking a parameter setting.

Key operation	Display example	Explanation
		Press the  key to return to Parameter Setting Mode.

■ Operating Procedures for Servo Parameters

1. Displaying Parameter Setting Mode

Key operation	Display example	Explanation
		The default display is displayed.
		Press the key to display Monitor Mode.
		Press the key to display Parameter Setting Mode.

2. Selecting the Parameter Type

Key operation	Display example	Explanation
		Press the keys to select the servo parameter.

3. Switching to the Parameter Setting Display

Key operation	Display example	Explanation
		Press the key to go to the Parameter Setting Display. Press the key to return to the Parameter Type Selection Display.

4. Setting the Parameter Number

Key operation	Display example	Explanation
		Set the number of the parameter to be set or checked.







5. Displaying the Parameter Setting

Key operation	Display example	Explanation
		Press the key to display the setting. The selected parameter number appears in the sub window.

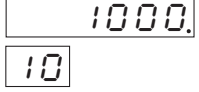
5
Operating Functions



6. Changing the Parameter Setting

♦ The following operation is not required if you are only checking a parameter setting.

Key operation	Display example	Explanation
		Use the    keys to change the setting. The decimal point will flash for the digit that can be set.
		Press the  key to save the new setting.

7. Returning to Parameter Setting Mode

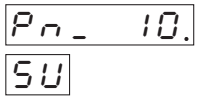
♦ The following operation is not required if you are only checking a parameter setting.

Key operation	Display example	Explanation
		Press the  key to return to Parameter Setting Mode.

Parameter Tables

The Servo Drive has various parameters for setting the characteristics and functions of the Servomotor.

The function and purpose of each parameter is explained here.

Understand the parameters to optimize the Servomotor to your operating conditions.

Servo Drive parameters are categorized by function as follows.

1. Servo Parameters

These parameters are mainly for Servomotor control such as function selection, operation settings, and gain adjustments.

2. Positioning Parameters

These parameters are for acceleration and deceleration settings and function selection related to positioning commands started by MECHATROLINK-II communications.

The parameters are categorized for 16-bit positioning and 32-bit positioning depending on the setting range.

3. Reserved Parameters

Parameters listed as [Reserved] or unlisted parameter numbers cannot be used.

Do not change the default settings of these parameters.

4. Attributes

The attribute indicates when the changed setting for the parameter will be enabled.

A	Always enabled after change
B	Change prohibited during Servomotor operation and command issuance. (It is not known when changes made during Servomotor operation and command issuance will be enabled.)
C	Enabled when the control power is reset, or when a CONFIG command is executed via the network (MECHATROLINK-II communications).
R	Read-only and cannot be changed.

Note 1. Parameters marked with "(RT)" are automatically set during realtime autotuning. To set these parameters manually, disable realtime autotuning by setting the Realtime Autotuning Mode Selection (Pn021) to 0 before changing the parameter.

Note 2. Parameter No. is the number for MECHATROLINK-II communications and CX-Drive.

The Parameter Unit shows only the last two digits.

Parameter numbers in the 100s specify 16-bit parameters, and numbers in the 200s specify 32-bit parameters.

MECHATROLINK-II Communications Parameter No.	Category
0□□h	Servo parameter numbers
1□□h	16-bit positioning parameters
2□□h	32-bit positioning parameters

Note 3. A command refers to data sent from the host controller to the Servo Drive via the network (MECHATROLINK-II communications).

A response refers to data sent from the Servo Drive to the host controller via the network (MECHATROLINK-II communications).

User parameters are set and checked on CX-Drive or the Parameter Unit (R88A-PR02G).

■ Parameter Tables

Pn No.	Parameter name	Setting	Explanation	Default setting	Unit	Setting range	Attribute
000	Reserved	Do not change.		1	---	---	---
001	Default Display	Selects the data to be displayed on the 7-segment LED display on the front panel.		0	---	0 to 4	A
		0	Normal status ("-" Servo OFF, "00" Servo ON)				
		1	Indicates the machine angle from 0 to FF hex. 0 is the zero position of the encoder. The angle increases when the Servomotor turns forward. The count continues from "0" after exceeding "FF". When using an incremental encoder, the display shows "nF" (not Fixed) until detecting the zero position on the encoder after the control power is turned ON.				
		2	Indicates the electrical angle from 0 to FF hex. 0 is the position where the inductive voltage on the U phase reaches the position peak. The angle increases when the Servomotor turns forward. The count continues from "0" after exceeding "FF".				
		3	Indicates the number (total) of MECHATROLINK-II communications errors from 0 to FF hex. The communications error count (total) saturates at the maximum of FFFFh. "h" appears only for the lowest byte. The count continues from "00" after exceeding "FF". Note The communications error count (total) is cleared by turning OFF the control power.				
		4	Indicates the setting on the rotary switch (node address value) loaded at startup, in decimal. This value does not change even if the rotary switch is turned after startup.				
		5 to 32767	Reserved (Do not set.)				
002	Reserved	Do not change.		0	---	---	---

Pn No.	Parameter name	Setting	Explanation	Default setting	Unit	Setting range	Attribute
003	Torque Limit Selection		Selects the torque limit function, or the torque feed-forward function during speed control.	1	---	1 to 5	B
			<p>■ Torque Limit Selection</p> <p>For torque control, always select Pn05E.</p> <p>For position control and speed control, select the torque limit as follows.</p>				
		1	Use Pn05E as the limit value for forward and reverse operations.				
		2	Forward: Use Pn05E. Reverse: Use Pn05F.				
		3	Switch limits by torque limit values and input signals from the network. Limit in forward direction: PCL is OFF = Pn05E, PCL is ON = Pn05F Limit in reverse direction: NCL is OFF = Pn05E, NCL is ON = Pn05F				
		4	Forward: Use Pn05E as limit. Reverse: Use Pn05F as limit. Only in speed control, torque limits can be switched by torque limit values from the network as follows: Limit in forward direction: Use Pn05E or MECHATROLINK-II command option command value 1, whichever is smaller. Limit in reverse direction: Use Pn05F or MECHATROLINK-II command option command value 2, whichever is smaller.				
		5	Forward: Use Pn05E as limit. Reverse: Use Pn05F as limit. Only in speed control, torque limits can be switched by torque limit values and input signals from the network as follows: Limit in forward direction: PCL is OFF = Pn05E, PCL is ON = Pn05E or MECHATROLINK-II command option command value 1, whichever is smaller. Limit in reverse direction: NCL is OFF = Pn05F, NCL is ON = Pn05F or MECHATROLINK-II command option command value 2, whichever is smaller.				
			<p>Note PCL ON: When either Forward Torque Limit (CN1 PCL: pin 7) or MECHATROLINK-II Communications Option Field (P-CL) is ON.</p> <p>PCL OFF: When both Forward Torque Limit (CN1 PCL: pin 7) and MECHATROLINK-II Communications Option Field (P-CL) are OFF.</p>				
			<p>■ Torque Feed-forward Function Selection</p>				
		1 to 3	Enabled only during speed control. Disabled if not using speed control.				
4 to 5	Always disabled						

Pn No.	Parameter name	Setting	Explanation	Default setting	Unit	Setting range	Attribute
004	Drive Prohibit Input Selection		Sets the function for the Forward and Reverse Drive Prohibit Inputs (CN1 POT: pin 19, NOT: pin 20)	0	---	0 to 2	C
		0	Decelerates and stops according to the sequence set in the Stop Selection for Drive Prohibition Input (Pn066) when both POT and NOT inputs are enabled. When both POT and NOT inputs are OPEN, the Drive Prohibit Input Error (alarm code 38) will occur.				
		1	Both POT and NOT inputs disabled.				
		2	When either POT or NOT input becomes OPEN, the Drive Prohibit Input Error (alarm code 38) will occur.				

Pn No.	Parameter name	Setting	Explanation	Default setting	Unit	Setting range	Attribute		
005	Communications Control		<p>Controls errors and warnings for MECHATROLINK-II communications.</p> <p>Note Use with this parameter set to 0. Program to stop immediately if using a value other than 0.</p> <p>Set the Consecutive Communications Error Detection Count in COM_ERR (bit 8 to 11). The communications error (alarm code 83) will occur when a communications error, which is assessed at every MECHATROLINK-II communications cycle, occurs consecutively for the number of the Consecutive Communications Error Detection Count. The error and warning can be masked for debug purposes.</p>	0	---	0 to 3955	C		
		bits 15-12	bits 11-8					bits 7-4	bits 3-0
		---	COM_ERR					MSK COM WARNG	MSK COM ALM
			<p>♦ [bits 8-11] COM_ERR (Consecutive Communications Error Detection Count) Setting range: 0 to 15. Consecutive Communications Error Detection Count = COM_ERR + 2</p> <p>Note These bits are debug functions. Set to enable (0) when not debugging.</p> <p>♦ [bits 0-3] MECHATROLINK-II Communications Alarms Mask (MSK COM ALM) [bit0] 0: Communications error (alarm code 83) enabled 1: Communications error (alarm code 83) disabled [bit1] 0: Watchdog data error (alarm code 86) enabled 1: Watchdog data error (alarm code 86) disabled</p> <p>♦ [bits 4-7] MECHATROLINK-II Communications Warnings Mask (MSK COM WARNG) [bit4] 0: Data setting warning (warning code 94h) enabled 1: Data setting warning (warning code 94h) disabled [bit5] 0: Command warning (warning code 95h) enabled 1: Command warning (warning code 95h) disabled [bit6] 0: ML-II communications warning (warning code 96h) enabled 1: ML-II communications warning (warning code 96h) disabled</p>						
006	Power ON Address Display Duration Setting		<p>Sets the duration to display the node address when the control power is turned ON.</p> <p>Note The node address display has priority even if there are alarms or warnings at power ON.</p>	30	ms	0 to 1000	C		
		0 to 6	600 ms						
		7 to 1000	set value × 100 ms						

Pn No.	Parameter name	Setting	Explanation	Default setting	Unit	Setting range	Attribute
007	Speed monitor (SP) Selection		Selects the output to the Analog Speed Monitor (SP on the front panel). Note This monitor output has a delay due to filtering. The Operating Direction Setting (Pn043) does not affect this monitor output. Thus, forward rotation is always positive (+), and reverse rotation is always negative (-).	3	---	0 to 11	A
		0	Actual Servomotor speed: 47 r/min/6 V				
		1	Actual Servomotor speed: 188 r/min/6 V				
		2	Actual Servomotor speed: 750 r/min/6 V				
		3	Actual Servomotor speed: 3000 r/min/6 V				
		4	Actual Servomotor speed: 12000 r/min/6 V				
		5	Command speed: 47 r/min/6 V				
		6	Command speed: 188 r/min/6 V				
		7	Command speed: 750 r/min/6 V				
		8	Command speed: 3000 r/min/6 V				
		9	Command speed: 12000 r/min/6 V				
		10	Outputs the Issuance Completion Status (DEN). 0V: Issuing 5V: Issuance complete				
11	Outputs the Gain Selection Status. 0V: Gain 2 5V: Gain 1						
008	Torque Monitor (IM) Selection		Selects the output to the Analog Torque Monitor (IM on the front panel) Note This monitor output has a delay due to filtering. The Operating Direction Setting (Pn043) does not affect this monitor output. Thus, forward rotation is always positive (+), and reverse rotation is always negative (-).	0	---	0 to 14	A
		0	Torque command: 100%/3 V				
		1	Position deviation: 31 pulses/3 V				
		2	Position deviation: 125 pulses/3 V				
		3	Position deviation: 500 pulses/3 V				
		4	Position deviation: 2000 pulses/3 V				
		5	Position deviation: 8000 pulses/3 V				
		6 to 10	Reserved				
		11	Torque command: 200%/3 V				
		12	Torque command: 400%/3 V				
		13	Outputs the Issuance Completion Status (DEN). 0V: Issuing 5V: Issuance complete				
		14	Outputs the Gain Selection Status. 0V: Gain 2 5V: Gain 1				
009	Reserved	Do not change.	0	---	---	---	

5-26 User Parameters

Pn No.	Parameter name	Setting	Explanation	Default setting	Unit	Setting range	Attribute
00A	Prohibit Parameter Changes via Network		Allows/prohibits parameter changes via the network.	0	---	0 to 1	A
		0	Allows parameter changes from the host controller via the network.				
		1	Prohibits parameter changes from the host controller via the network. Attempting to change a parameter via the network when prohibited triggers the Command Warning (warning code 95h).				
00B	Operation Switch When Using Absolute Encoder		Selects how the an absolute encoder is used. This parameter is disabled when using an incremental encoder.	0	---	0 to 2	C
		0	Use as an absolute encoder.				
		1	Use an absolute encoder as an incremental encoder.				
		2	Use as an absolute encoder but ignore absolute multi-turn counter overflow alarm (alarm code 41).				
00C	RS-232 Baud Rate Setting		Sets the baud rate for RS-232 communications.	2	---	0 to 5	C
		0	2,400 bps				
		1	4,800 bps				
		2	9,600 bps				
		3	19,200 bps				
		4	38,400 bps				
		5	57,600 bps				
00D	Reserved		Do not change.	0	---	---	---
00E	Reserved		Do not change.	0	---	---	---
00F	Reserved		Do not change.	0	---	---	---
010	Position Loop Gain (RT)		Sets the position loop responsiveness. Increasing the gain increases position control responsiveness and shortens stabilization time. Oscillation or overshoot will occur if set too high. Adjust for optimum responsiveness.	400	×0.1 [1/s]	0 to 30000	B
011	Speed Loop Gain (RT)		Sets the speed loop responsiveness. If the Inertia Ratio (Pn020) is set correctly, this parameter is set to the Servomotor response frequency. Increasing the gain increases the speed control responsiveness, but too much gain may cause oscillating. Small gain may cause overshoot in the speed response. Adjust for optimum responsiveness.	500	×0.1 Hz	1 to 30000	B
012	Speed Loop Integration Time Constant (RT)		Adjusts the speed loop integration time constant. Set a large value for large load inertia. Decrease the setting for fast response with small inertia. Set 9999 to stop integration operation while retaining the integration value. A setting of 10000 disables integration.	200	×0.1 ms	1 to 10000	B
013	Speed Feedback Filter Time Constant (RT)		Sets the type of speed detection filter time constant. Normally, use a setting of 0. Increasing the value reduces the noise of the Servomotor but also reduces its responsiveness. This parameter is disabled if the Instantaneous Speed Observer Setting (Pn027) is enabled.	0	---	0 to 5	B

Pn No.	Parameter name	Setting	Explanation	Default setting	Unit	Setting range	Attribute
014	Torque Command Filter Time Constant (RT)		Adjusts the first-order lag filter time constant for the torque command section. The torque filter setting may reduce machine vibration.	80	×0.01 ms	0 to 2500	B
015	Speed Feed-forward Amount (RT)		Sets the speed feed-forward amount. This parameter is particularly useful when fast response is required.	300	×0.1 %	0 to 1000	B
016	Feed-forward Filter Time Constant (RT)		Sets the time constant for the speed feed-forward first-order lag filter.	100	×0.01 ms	0 to 6400	B
017	Reserved		Do not change.	0	---	---	---
018	Position Loop Gain 2 (RT)		Sets the position loop gain when using gain 2 switching. Same function as Pn010.	200	×0.1 [1/s]	0 to 30000	B
019	Speed Loop Gain 2 (RT)		Sets the speed loop gain when using gain 2 switching. Same function as Pn011.	800	×0.1 Hz	1 to 30000	B
01A	Speed Loop Integration Time Constant 2 (RT)		Sets the speed loop integration time constant when using gain 2 switching. Same function as Pn012. Set 9999 to stop integration operation while retaining the integration value. Setting 10000 disables integration.	500	×0.1 ms	1 to 10000	B
01B	Speed Feedback Filter Time Constant 2 (RT)		Sets the speed detection filter when using gain 2 switching. Same function as Pn013. Normally, use a setting of 0. When Instantaneous Speed Observer Setting (Pn027) is enabled, this parameter will be disabled.	0	---	0 to 5	B
01C	Torque Command Filter Time Constant 2 (RT)		Sets the first-order lag filter time constant for the torque command section when using gain 2 switching. Same function as Pn014.	100	×0.01 ms	0 to 2500	B
01D	Notch Filter 1 Frequency		Sets the notch frequency of notch filter 1 for resonance suppression. This filter must be matched with the resonance frequency of the load.	1500	Hz	100 to 1500	B
		100 to 1499	Filter enabled				
		1500	Filter disabled				
01E	Notch Filter 1 Width		Selects the notch width of notch filter 1 for resonance suppression. Normally, use a setting of 2.	2	---	0 to 4	B
01F	Reserved		Do not change.	0	---	---	---
020	Inertia Ratio (RT)		Sets the load inertia as a percentage of the Servomotor rotor inertia. Setting [%] = (Load inertia / Rotor inertia) × 100 The inertia ratio estimated during realtime autotuning is stored in the EEPROM every 30 minutes.	300	%	0 to 10000	B

Pn No.	Parameter name	Setting	Explanation	Default setting	Unit	Setting range	Attribute	
021	Realtime Autotuning Mode Selection		Sets the operating mode for realtime autotuning. A setting of 3 or 6 will provide faster response to changes in inertia during operation. Operation, however, may be unstable depending on the operating pattern. Normally, use a setting of 1 or 4. Set to 4 to 6 when the Servomotor is used as a vertical axis. Gain switching is enabled at set values 1 to 6. Use a setting of 7 if operation changes caused by gain switching are a problem.	0	---	0 to 7	B	
			Realtime Autotuning					Degree of change in load inertia
		0	Disabled					---
		1	Horizontal axis mode					Almost no change
		2						Gradual changes
		3						Sudden changes
		4	Vertical axis mode					Almost no change
		5						Gradual changes
6	Sudden changes							
7	Gain switching disable mode	Almost no change						
022	Realtime Autotuning Machine Rigidity Selection		Sets the machine rigidity for realtime autotuning. Increasing this value increases the responsiveness. If the value is changed suddenly by a large amount, the gain will change rapidly, subjecting the machine to shock. Always start by making small changes in the value, and gradually increase the value while monitoring machine operation. Cannot be set to 0 when using the Parameter Unit.	2	---	0 to F	B	
023	Adaptive Filter Selection		Enables or disables the adaptive filter. The Adaptive Filter Table Number Display (Pn02F) will be reset to 0 when disabled. Note When the Vibration Filter Selection (Pn024) is set to a low-pass filter type (Pn024 = 3 to 5), the adaptive filter is forcibly set to disabled (Pn023 = 0).	0	---	0 to 2	B	
		0	Adaptive filter disabled.					
		1	Adaptive filter enabled. Adaptive operation performed.					
		2	Adaptive filter enabled. Adaptive operation will not be performed (i.e., retained).					

Pn No.	Parameter name	Setting	Explanation	Default setting	Unit	Setting range	Attribute	
024	Vibration Filter Selection	Selects the vibration filter type and switching mode. ■ Filter type selection ♦ Normal type: Vibration frequency setting range 10.0 to 200.0 Hz ♦ Low-pass type: Vibration frequency setting range 1.0 to 200.0 Hz ■ Switching mode selection ♦ No switching: Both 1 and 2 are enabled ♦ Switching with command direction: Selects Vibration Frequency 1 in forward direction (Pn02B, Pn02C) Selects Vibration Frequency 2 in reverse direction (Pn02D, Pn02E)			0	---	0 to 5	C
			Filter type	Switching mode				
		0	Normal type	No switching				
		1		Switching with command direction				
		2		Switching with command direction				
		3	Low-pass type	No switching				
		4		Switching with command direction				
5	Switching with command direction							
025	Normal Mode Autotuning Operation Setting	Sets the operating pattern for normal mode autotuning.			0	---	0 to 7	B
			Number of rotations	Rotation direction				
		0	Repeat cycles of 2 rotations	Forward and Reverse (Alternating)				
		1		Reverse and Forward (Alternating)				
		2		Forward only				
		3		Reverse only				
		4	Repeat cycles of single rotation	Forward and Reverse (Alternating)				
		5		Reverse and Forward (Alternating)				
		6		Forward only				
7	Reverse only							
026	Overrun Limit Setting	Sets the Servomotor's allowable operating range for the position command input range. Set to 0 to disable the overrun protective function. For details, refer to 5-15 <i>Overrun Protection</i> on page 5-29.			10	×0.1 rotation	0 to 1000	A

5-26 User Parameters

Pn No.	Parameter name	Setting	Explanation	Default setting	Unit	Setting range	Attribute
027	Instantaneous Speed Observer Setting (RT)		The Instantaneous Speed Observer improves speed detection accuracy, thereby improving responsiveness and reducing vibration when stopping. When the instantaneous speed observer is enabled, both Speed Feedback Filter Time Constant (Pn013) and Speed Feedback Filter Time Constant 2 (Pn01B) are disabled. This feature cannot be used with realtime autotuning. For details, refer to 5-24 <i>Instantaneous Speed Observer</i> on page 5-48.	0	---	0 to 1	B
		0	Disabled				
		1	Enabled				
028	Notch Filter 2 Frequency		Sets the notch frequency of notch filter 2 for resonance suppression. This parameter must be matched with the resonance frequency of the load.	1500	Hz	100 to 1500	B
		100 to 1499	Filter enabled				
		1500	Filter disabled				
029	Notch Filter 2 Width		Selects the notch width of notch filter 2 for resonance suppression. Increasing the value increases the notch width.	2	---	0 to 4	B
02A	Notch Filter 2 Depth		Selects the notch depth of notch filter 2 for resonance suppression. Increasing this value decreases the notch depth, thereby reducing the phase lag.	0	---	0 to 99	B
02B	Vibration Frequency 1		Sets the vibration frequency 1 for damping control to suppress vibration at the end of the load. Measure and set the frequency of the vibration. The frequency setting range depends on the filter type selected in the Vibration Filter Selection (Pn024). ♦ Normal type Setting frequency range: 10.0 to 200.0 Hz (Disabled when set to 0 to 99) ♦ Low-pass type Setting frequency range: 1.0 to 200.0 Hz (Disabled when set to 0 to 9) For details, refer to 5-25 <i>Damping Control</i> on page 5-50.	0	×0.1 Hz	0 to 2000	B
02C	Vibration Filter 1 Setting		When setting Vibration Frequency 1 (Pn02B), reduce this setting if torque saturation occurs, or increase it to make the movement faster. Normally, use a setting of 0. The setting range depends on the filter type selected in the Vibration Filter Selection (Pn024), and if Vibration Filter 1 is enabled, the ranges are as follows: Note This parameter is disabled when Vibration Filter 1 is disabled. ♦ Normal type Setting range: $100 \leq Pn02B + Pn02C \leq Pn02B \times 2$ or 2000 ♦ Low-pass type Setting range: $10 \leq Pn02B + Pn02C \leq Pn02B \times 6$	0	×0.1 Hz	-200 to 2000	B
02D	Vibration Frequency 2		Same function as Pn02B.	0	×0.1 Hz	0 to 2000	B

Pn No.	Parameter name	Setting	Explanation	Default setting	Unit	Setting range	Attribute
02E	Vibration Filter 2 Setting		Same function as Pn02C.	0	×0.1 Hz	-200 to 2000	B
02F	Adaptive Filter Table Number Display		Displays the table entry number corresponding to the frequency of the adaptive filter. This parameter is set automatically when the adaptive filter is enabled (i.e., when the Adaptive Filter Selection (Pn023) is set to a value other than 0), and cannot be changed. When the adaptive filter is enabled, this parameter will be saved in EEPROM approximately every 30 min. If the adaptive filter is enabled the next time the power supply is turned ON, adaptive operation will start with the data saved in EEPROM as the default value. To clear this parameter and reset the adaptive operation, disable the adaptive filter by setting the Adaptive Filter Selection (Pn023) to 0, and then enable it again.	0	---	0 to 64	R
		0 to 4	Filter disabled				
		5 to 48	Filter enabled				
		49 to 64	Enable or disable the filter with Pn022				
030	Gain Switching Operating Mode Selection (RT)		Enables or disables gain switching.	1	---	0 to 1	B
		0	Disabled. Uses Gain 1 (Pn010 to Pn014). PI/P operation is switched from MECHATROLINK-II.				
		1	The gain is switched between Gain 1 (Pn010 to Pn014) and Gain 2 (Pn018 to Pn01C). For details, refer to 5-16 Gain Switching on page 5-31.				
031	Gain Switch Setting (RT)		Sets the trigger for gain switching. The details depend on the control mode. For details, refer to 5-16 Gain Switching on page 5-31.	2	---	0 to 10	B
		0	Always Gain 1				
		1	Always Gain 2				
		2	Switching from the network				
		3	Amount of change in torque command				
		4	Always Gain 1				
		5	Speed command				
		6	Amount of position deviation				
		7	Position command pulses received				
		8	Positioning Completed Signal (INP) OFF				
		9	Actual Servomotor speed				
10	Combination of position command pulses received and speed						
032	Gain Switch Time (RT)		Enabled when the Gain Switch Setting (Pn031) is set to 3, or 5 to 10. Sets the lag time from the trigger detection to actual gain switching when switching from gain 2 to gain 1.	30	×166 μs	0 to 10000	B
033	Gain Switch Level Setting (RT)		Sets the judgment level to switch between Gain 1 and Gain 2 when the Gain Switch Setting (Pn031) is set to 3, 5, 6, 9, or 10. The unit for the setting depends on the condition set in the Gain Switch Setting (Pn031).	600	---	0 to 20000	B

5-26 User Parameters

Pn No.	Parameter name	Setting	Explanation	Default setting	Unit	Setting range	Attribute
034	Gain Switch Hysteresis Setting (RT)		Sets the hysteresis of the judgment level for the Gain Switch Level Setting (Pn033) when the Gain Switch Setting (Pn031) is set to 3, 5, 6, 9, or 10. The unit for the setting depends on the condition set in the Gain Switch Setting (Pn031).	50	---	0 to 20000	B
035	Position Loop Gain Switching Time (RT)		This parameter can prevent the position loop gain from increasing suddenly when the position loop gain and position loop gain 2 differ by a large amount. When the position loop gain increases, it takes the duration of (set value + 1) × 166 μs.	20	×166 μs	0 to 10000	B
036	Reserved		Do not change.	0	---	---	---
037	Reserved		Do not change.	0	---	---	---
038	Reserved		Do not change.	0	---	---	---
039	Reserved		Do not change.	0	---	---	---
03A	Reserved		Do not change.	0	---	---	---
03B	Reserved		Do not change.	0	---	---	---
03C	Reserved		Do not change.	0	---	---	---
03D	Jog Speed		Sets the jog operation speed with the Parameter Unit or CX-Drive. Note Jog operation is only available when the network is not established. Do not try to establish the network while using jog operation. Otherwise, command alarm (alarm code 27) will occur.	200	r/min	0 to 500	B
03E	Reserved		Do not change.	0	---	---	---
03F	Reserved		Do not change.	0	---	---	---
040	Reserved		Do not change.	0	---	---	---
041	Emergency Stop Input Setting		Enables the Emergency Stop Input (STOP). Note If this function is disabled, the response status will always be 0 (disabled).	1	---	0 to 1	C
		0	Disabled.				
		1	Enabled (alarm code 87 issued on OPEN)				
042	Origin Proximity Input Logic Setting		Sets the logic for the Origin Proximity Input (DEC).	1	---	0 to 1	C
		0	N.C contact (origin proximity detected on OPEN)				
		1	N.O contact (origin proximity detected on CLOSE)				
043	Operating Direction Setting		Sets the relationship between polarity of operation data sent over the network and the direction of Servomotor rotation. Note In RS-232C communications and on the analog monitor (SP, IM) on the front panel, forward direction is always positive (+), and reverse rotation is always negative (-).	1	---	0 to 1	C
		0	Sets the reverse direction as the positive direction (+).				
		1	Sets the forward direction as the positive direction (+).				

Pn No.	Parameter name	Setting	Explanation	Default setting	Unit	Setting range	Attribute
044	Input Signal Selection	Sets the terminal assignment for Drive Prohibit Input.		0	---	0 to 1	C
		0	Sets CN1 pin 19 to POT, CN1 pin 20 to NOT.				
		1	Sets CN1 pin 19 to NOT, CN1 pin 20 to POT.				
045	Reserved	Do not change.		0	---	---	---
046	Reserved	Do not change.		0	---	---	---
047	Reserved	Do not change.		0	---	---	---
048	Reserved	Do not change.		0	---	---	---
049	Reserved	Do not change.		0	---	---	---
04A	Reserved	Do not change.		0	---	---	---
04B	Reserved	Do not change.		0	---	---	---
04C	Reserved	Do not change.		0	---	---	---
04D	Reserved	Do not change.		0	---	---	---
04E	Reserved	Do not change.		0	---	---	---
04F	Reserved	Do not change.		0	---	---	---
050	Reserved	Do not change.		0	---	---	---
051	Reserved	Do not change.		0	---	---	---
052	Reserved	Do not change.		0	---	---	---
053	Speed Limit	Sets the speed limit for torque control mode. (The value is an absolute value) This parameter is limited by the Overspeed Detection Level Setting (Pn073).		50	r/min	-20000 to 20000	B
054	Reserved	Do not change.		0	---	---	---
055	Reserved	Do not change.		0	---	---	---
056	Reserved	Do not change.		0	---	---	---
057	Reserved	Do not change.		0	---	---	---
058	Soft Start Acceleration Time	Sets the acceleration time for speed control mode. Acceleration time [s] from 0 r/min to maximum speed [r/min] = Set value × 2 ms		0	×2 ms	0 to 5000	B
059	Soft Start Deceleration Time	Sets the deceleration time for speed control mode. Deceleration time [s] from maximum speed [r/min] to 0 r/min = Set value × 2 ms		0	×2 ms	0 to 5000	B
05A	Reserved	Do not change.		0	---	---	---
05B	Speed Limit Selection	Selects the speed limit for torque control mode.		0	---	0 to 1	B
		0	Use the Speed Limit (Pn053)				
		1	Use the speed limit value via MECHATROLINK-II or the Speed Limit (Pn053), whichever is smaller.				
05C	Reserved	Do not change.		0	---	---	---
05D	Reserved	Do not change.		0	---	---	---

5-26 User Parameters

Pn No.	Parameter name	Setting	Explanation	Default setting	Unit	Setting range	Attribute
05E	No. 1 Torque Limit		Sets the No. 1 Torque Limit for the Servomotor output torque. Refer to information on the Torque Limit Selection (Pn003) to select the torque limit. The maximum value of the setting range depends on the applicable Servomotor.	300	%	0 to 500	B
05F	No. 2 Torque Limit		Sets the No. 2 torque limit for the Servomotor output torque. Refer to information on the Torque Limit Selection (Pn003) to select the torque limit. The maximum value of the setting range depends on the applicable Servomotor.	100	%	0 to 500	B
060	Positioning Completion Range 1		Sets the positioning completion range when Positioning Completion 1 (INP1) Output is selected. Positioning is complete when all positioning command pulses are exhausted, and the absolute value of the position deviation converted into command units is less than this setting.	25	Command units	0 to 10000	A
061	Speed Conformity Signal Output Width		Sets the detection width for the speed conformity detection (VCMP) signal. Speed conformity is achieved when the absolute value of the difference between the internal speed command (before acceleration and deceleration limits are applied) and the Servomotor speed is less than the set speed. Note This setting has a hysteresis of 10 r/min.	20	r/min	10 to 20000	A
062	Rotation Speed for Motor Rotation Detection		Sets the threshold level for the speed reached (TGON) signal. Speed reached is determined when the absolute value of the Servomotor speed is greater than the setting speed. Note Speed reached detection has a hysteresis of 10 r/min.	50	r/min	10 to 20000	A
063	Positioning Completion Range 2		Sets the positioning completion range when Positioning Completion 2 (INP2) is selected. Positioning is complete when the absolute value of the position deviation converted into command units is less than this setting, regardless of whether position command pulses are still being processed.	100	Command units	0 to 10000	A
064	Motor Phase Current Offset Re-adjustment Setting		Enables or disables the offset component readjustment function of the Motor Phase Current Detector (CT) for Servo ON command inputs. The readjustment is made when control power is turned ON. Note This adjustment is inaccurate if the offset is measured while the Servomotor is rotating. To enable this function, do not rotate the Servomotor when inputting the Servo ON command.	0	---	0 to 1	A
		0	Disabled (only when turning ON control power)				
		1	Enabled (when turning ON control power, or at Servo ON)				

Pn No.	Parameter name	Setting	Explanation	Default setting	Unit	Setting range	Attribute
065	Undervoltage Alarm Selection		Selects whether to activate the main power supply undervoltage function (alarm code 13) when the main power supply is interrupted for the duration of the Momentary Hold Time (Pn06D) during Servo ON.	1	---	0 to 1	B
		0	Turns the Servo OFF according to the setting for the Stop Selection with Main Power OFF (Pn067), interrupting the positioning command generation process (positioning operation) within the Servo Drive. When the main power supply is turned back ON, Servo ON will resume. Restart the positioning operation after performing the positioning operation and recovering from Servo OFF.				
		1	Causes an error due to main power supply undervoltage (alarm code 13). This parameter is disabled if Pn06D = 1,000. If Pn06D is set too long and the voltage between P and N in the main power supply converter drops below the specified value before a main power supply interruption is detected, a main power supply undervoltage (alarm code 13) will occur.				

Pn No.	Parameter name	Setting	Explanation		Default setting	Unit	Setting range	Attribute	
066	Stop Selection for Drive Prohibition Input		Sets the deceleration stop operation to be performed after the Forward Drive Prohibit Input (POT) or Reverse Drive Prohibit Input (NOT) is enabled.		0	---	0 to 2	C	
			During deceleration	After stopping (30 r/min or less)					Deviation counter
		0	Dynamic brake	Disables torque command in drive prohibited direction					Cleared while decelerating with dynamic brake. Retained after stopping.
		1	Disables torque	Disables torque command in drive prohibited direction					Cleared while decelerating. Retained after stopping.
		2	Emergency Stop Torque (Pn06E)	Servo locked					Retained while decelerating, cleared upon completion of deceleration, and retained after stopping.
		<p>Note 1. The positioning command generation process (positioning operation) within the Servo Drive will be forcibly stopped once it enters the deceleration mode. Also, when the deceleration mode is activated during speed control or torque control, it will switch to position control. If a positioning operation command is received during deceleration, the internal positioning command generation process will be retained, and after deceleration is complete, positioning operation will be activated.</p> <p>Note 2. When the Servomotor rotation speed is 30 r/min or less (stopped), the deceleration mode will not be activated even if the drive prohibit input is enabled.</p> <p>Note 3. When the parameter is set to 2 and an operation command in the drive prohibited direction is received after stopping, a command warning (warning code 95h) will be issued. When the parameter is set to 0 or 1, the operation command in the prohibited direction after stopping will be accepted, but the Servomotor will not operate and the position deviation will accumulate because the torque command is 0. Take measures such as issuing a command in the reverse direction from the host controller.</p> <p>Note 4. When the parameter is set to 2, MECHATROLINK-II communications are interrupted, and either Forward or Reverse Drive Prohibit Input (POT or NOT) is turned ON, receiving an operation command (jog operation or normal mode autotuning) via RS232 will cause a Drive Prohibit Input Error (alarm code 38). A Drive Prohibit Input Error (alarm code 38) will also occur if either POT or NOT is turned ON while operating on an operation command received via RS232.</p>							

Pn No.	Parameter name	Setting	Explanation	Default setting	Unit	Setting range	Attribute
067	Stop Selection with Main Power OFF		Sets the operation to be performed during deceleration and after stopping after the main power supply is turned OFF with the Undervoltage Alarm Selection (Pn065) set to 0. The deviation counter will be reset when the power OFF is detected.	0	---	0 to 7	B
		0 and 4	Use dynamic brake to decelerate and remain stopped with dynamic brake.				
		1 and 5	Use free-run to decelerate and remain stopped with dynamic brake.				
		2 and 6	Use dynamic brake to decelerate, but free the motor when stopped.				
		3 and 7	Use free-run to decelerate, and free the motor when stopped.				
068	Stop Selection for Alarm Generation		Sets the deceleration process and stop status after an alarm is issued by the protective function. The deviation counter will be reset when an alarm is issued.	0	---	0 to 3	B
		0	Use dynamic brake to decelerate and remain stopped with dynamic brake.				
		1	Use free-run to decelerate and remain stopped with dynamic brake.				
		2	Use dynamic brake to decelerate, but free the motor when stopped.				
		3	Use free-run to decelerate, and free the motor when stopped.				
069	Stop Selection with Servo OFF		Sets the operational conditions to apply during deceleration and after stopping when the Servo is turned OFF. The relationship between set values, operation, and deviation counter processing for this parameter is the same as for the Stop Selection with Main Power OFF (Pn067).	0	---	0 to 7	B
06A	Brake Timing When Stopped		Sets the duration from when the Brake Interlock (BKIR) signal turns OFF to when the Servomotor is de-energized when the RUN command is turned OFF with the Servomotor stopped. Note The brake interlock signal is the logical OR of the brake release request from the network and the release request from the Servo controller. Note, the brake release request from the network is OFF (operation request is ON) at power ON.	10	2 ms	0 to 1000	B
06B	Brake Timing during Operation		When the run command (RUN) is turned OFF during the Servomotor rotation, the Servomotor will decelerate reducing the rotation speed and the Brake Interlock Signal (BKIR) will turn OFF after the time set by this parameter has elapsed. BKIR turns OFF if the Servomotor speed drops below 30 r/min before the set time. Note The brake interlock signal is the logical OR of the brake release request from the network and the release request from the Servo controller. Note, the brake release request from the network is OFF (operation request is ON) at power ON.	50	2 ms	0 to 1000	B

5-26 User Parameters

Pn No.	Parameter name	Setting	Explanation	Default setting	Unit	Setting range	Attribute
06C	Regeneration Resistor Selection		Sets the regeneration resistor operation and the regeneration overload (alarm code 18) operation. Set this parameter to 0 if using the built-in regeneration resistor. If using an external regeneration resistor, be sure to turn OFF the main power when the built-in thermal switch is activated.	0	---	0 to 3	C
		0	Sets the regeneration overload to match the built-in regeneration resistor. (regeneration load ratio below 1%)				
		1	The regeneration overload (alarm code 18) occurs when the load ratio of the external regeneration resistor exceeds 10%.				
		2	The regeneration processing circuit by the external regeneration resistor is activated, but the regeneration overload (alarm code 18) does not occur.				
		3	The regeneration processing circuit is not activated. All regenerative energy is absorbed by the built-in capacitor.				
06D	Momentary Hold Time		Sets the amount of time required to detect shutoff when the main power supply continues to shut off. The main power OFF detection will be disabled if this parameter is set to 1000.	35	2 ms	35 to 1000	C
06E	Emergency Stop Torque		Sets the torque limit during deceleration because of the Drive Prohibition Input when the Stop Selection for Drive Prohibition Input (Pn066) is set to 2. When this parameter is set to 0, the normal torque limit will be set. The maximum value of the setting range depends on the Servomotor.	0	%	0 to 300	B
06F	Reserved		Do not change.	0	---	---	---
070	Reserved		Do not change.	0	---	---	---
071	Reserved		Do not change.	0	---	---	---
072	Overload Detection Level Setting		Sets the overload detection level. The overload detection level will be set at 115% if this parameter is set to 0. Normally, use a setting of 0, and set the level only when reducing the overload detection level.	0	%	0 to 500	A
073	Overspeed Detection Level Setting		Sets the overspeed detection level. The overspeed detection level is 1.2 times the maximum Servomotor rotation speed when the parameter is set to 0. Normally, use a setting of 0, and set the level only when reducing the overspeed detection level. Note The detection margin of error for the setting is ± 3 r/min for a 7-core absolute encoder and ± 36 r/min for a 5-core incremental encoder.	0	r/min	0 to 20000	A
074	Reserved		Do not change.	0	---	---	---
075	Reserved		Do not change.	0	---	---	---
076	Reserved		Do not change.	0	---	---	---
077	Reserved		Do not change.	0	---	---	---

5-79

Pn No.	Parameter name	Setting	Explanation	Default setting	Unit	Setting range	Attribute
078	Reserved	Do not change.		0	---	---	---
079	Reserved	Do not change.		0	---	---	---
07A	Reserved	Do not change.		0	---	---	---
07B	Reserved	Do not change.		0	---	---	---
07C	Reserved	Do not change.		0	---	---	---
07D	Reserved	Do not change.		0	---	---	---
07E	Reserved	Do not change.		0	---	---	---
07F	Reserved	Do not change.		0	---	---	---

■ 16-bit Positioning Parameters: Parameter No. 100 to 13F

Pn No.	Parameter name	Setting	Explanation		Default setting	Unit	Setting range	Attribute
100	Backlash Compensation Selection		Enables or disables the backlash compensation for position control, and sets the compensation direction.		0	---	0 to 2	C
		0	Disabled					
		1	Compensates in the initial positive direction after the Servo ON.					
		2	Compensates in the initial negative direction after the Servo ON.					
101	Backlash Compensation		Sets the backlash compensation amount for position control.		0	Command units	-32768 to 32767	B
102	Backlash Compensation Time Constant		Sets the backlash compensation time constant for position control.		0	0.01 ms	0 to 6400	B
		Value of Pn100	Pn101 = Positive number	Pn101 = Negative number				
		1	Compensates in positive direction during rotation in positive direction	Compensates in negative direction during rotation in positive direction				
		2	Compensates in positive direction during rotation in negative direction	Compensates in negative direction during rotation in negative direction				
103	Reserved		Do not change.		0	---	---	---
104	Soft Limit		Enables or disables the soft limit. When enabled, the soft limit values are set in Forward Software Limit (Pn201) and Reverse Software Limit (Pn202). Note The response value for limit signals disabled by this setting will be set to 0. The response value for limit signals is also set to 0 when the Servomotor does not complete its return to origin.		0	---	0 to 3	A
		0	Enable both the Forward / Reverse Software Limits (Pn201 and Pn202)					
		1	Disable the Forward Software Limit (Pn201), enable the Reverse Software Limit (Pn202)					
		2	Enable the Forward Software Limit (Pn201), disable the Reverse Software Limit (Pn202)					
		3	Disable both the Forward / Reverse Software Limits (Pn201 and Pn202)					
105	Origin Range		Sets the threshold for detecting the origin (ZPOINT) in absolute values. ZPOINT = 1 when the return to origin completes (coordinate system setup is complete) and the feedback position is within the setting range of this parameter.		10	Command units	0 to 250	A
106	Reserved		Do not change.		0	---	---	---

5

Operating Functions

Pn No.	Parameter name	Setting	Explanation	Default setting	Unit	Setting range	Attribute
107	Linear Acceleration Constant		Sets the acceleration for positioning operations. A setting of "0" is regarded as "1". The setting will be handled after conversion to an unsigned 16-bit data (0 to 65535). Example: -32768 → 8000h = 32768 -1 → FFFFh = 65535	100	× 10000 [command units/s ²]	-32768 to 32767	B
108	Reserved		Do not change.	0	---	---	---
109	Reserved		Do not change.	0	---	---	---
10A	Linear Deceleration Constant		Sets the deceleration for positioning operations. A setting of "0" is regarded as "1". The setting will be handled after conversion to an unsigned 16-bit data (0 to 65535). Example: -32768 → 8000h = 32768 -1 → FFFFh = 65535	100	× 10000 [command units/s ²]	-32768 to 32767	B
10B	Reserved		Do not change.	0	---	---	---
10C	Reserved		Do not change.	0	---	---	---
10D	Reserved		Do not change.	0	---	---	---
10E	Moving Average Time		Sets the moving average time for position commands. Note If the Moving Average Time is set, commands may not be executed seamlessly when switching the control mode, and when switching between interpolation feed motions and positioning motions (motions wherein the command waveforms are generated inside the Servo Drive).	0	×0.1 ms	0 to 5100	B
10F	Origin Return Mode Settings		Sets the direction for origin return.	0	---	0 to 1	B
		0	Positive direction				
		1	Negative direction				
110	Origin Return Approach Speed 1		Sets the operating speed for origin return from when the origin proximity signal is turned ON, to when it is turned OFF and the latch signal is detected. This parameter can be set to a maximum value of 32767, but internally the speed is limited to the Servomotor's maximum speed.	50	100 [command units/s]	1 to 32767	B
111	Origin Return Approach Speed 2		Sets the operating speed for origin return, from when the point after the latch signal is detected to when the Origin Return Final Distance (Pn204) is reached. This parameter can be set to a maximum value of 32767, but internally the speed is limited to the Servomotor's maximum speed.	5	100 [command units/s]	1 to 32767	B

Pn No.	Parameter name	Setting	Explanation	Default setting	Unit	Setting range	Attribute
112	General-purpose Output 1 Function Selection		Selects the function for general-purpose output 1 (OUTM1).	7	---	0 to 9	C
		0	Always OFF				
		1	INP1 output. Turn ON when position deviation is equal to or less than Pn060 for position control. Undefined when not using position control.				
		2	VCMP output. Turn ON when the deviation between the Servomotor speed and commanded speed is within the range set by Pn061 for speed control. Undefined when not using speed control.				
		3	TGON output. Turn ON when the absolute value of the Servomotor speed exceeds Pn062 setting in all control modes.				
		4	READY output. Turn ON when the main power is supplied, there is no alarm, and Servo SYNC with a host controller is established in all control modes.				
		5	CLIM output. Turn ON when torque limit is activated in all control modes.				
		6	VLIM output. Turn ON when the Servomotor speed reaches the speed limit for torque control. Undefined when not using torque control.				
		7	BKIR output. Turn ON with the release timing of the brake release signal in all control modes.				
		8	WARN output. Turn ON when a warning is issued in all control modes.				
	9	INP2 output. Turn ON when the position deviation is equal to or less than the Positioning Completion Range 2 (Pn063) for position control. Undefined when not using position control.					
113	General-purpose Output 2 Function Selection		Selects the function for general-purpose output 2 (OUTM2). The set values and the functions are the same as for general-purpose output 1 (OUTM1).	0	---	0 to 9	C
114	General-purpose Output 3 Function Selection		Selects the function for general-purpose output 3 (OUTM3). The set values and the functions are the same as for general-purpose output 1 (OUTM1).	0	---	0 to 9	C
115 to 13F	Reserved		Do not change.	0	---	---	---

■ 32-bit Positioning Parameters: Parameter No. 200 to 21F

Pn No.	Parameter name	Setting	Explanation	Default setting	Unit	Setting range	Attribute	
200	Absolute Origin Offset		Sets the offset amount for the encoder position and the mechanical coordinate system position when using an absolute encoder.	0	Command units	-1073741823 to 1073741823	C	
201	Forward Software Limit		Sets the soft limit in the forward direction. If the Servomotor exceeds the limit, the network response status (PSOT) will turn ON (=1). Note 1. Be sure to set the limits so that Forward Software Limit > Reverse Software Limit. Note 2. PSOT is not turned ON when origin return is incomplete.	500000	Command units	-1073741823 to 1073741823	A	
202	Reverse Software Limit		Sets the soft limit for the reverse direction. If the Servomotor exceeds the limit, the network response status (NSOT) will turn ON (=1). Note 1. Be sure to set the limits so that Forward Software Limit > Reverse Software Limit. Note 2. NSOT is not turned ON when origin return is incomplete.	-500000	Command units	-1073741823 to 1073741823	A	
203	Final Distance for External Input Positioning	Sets the distance to travel after detecting the latch signal input position when performing external input positioning. The operation after detecting the latch signal input position will be determined by the external input positioning direction and this parameter as follows.		100	Command units	-1073741823 to 1073741823	B	
		External input positioning direction	Sign					
			Positive					Negative
		Positive direction	Moves in the positive direction and stops* ¹					Decelerates to a stop, reverses, then moves in the negative direction and stops
		Negative direction	Decelerates to a stop, reverses, then moves in the positive direction and stops					Moves in the negative direction and stops* ¹
		*1. Reverses after decelerating to a stop if the final distance for external input positioning is short in comparison to the deceleration distance.						

5-26 User Parameters

Pn No.	Parameter name	Setting	Explanation	Default setting	Unit	Setting range	Attribute	
204	Origin Return Final Distance		Sets the distance from the latch signal input position to the origin when performing origin return. The operation after detecting the latch signal input position will be determined by the origin return direction and this parameter as follows.	100	Command units	-1073741823 to 1073741823	B	
		Origin return direction	Sign					
			Positive					Negative
		Positive direction	Moves in the positive direction and stops *1					Decelerates to a stop, reverses, then moves in the negative direction and stops
		Negative direction	Moves in the negative direction and stops *1					Decelerates to a stop, reverses, then moves in the positive direction and stops
*1. Reverses after decelerating to a stop if the final travel distance for origin return is short in comparison to the deceleration distance.								
205	Electronic Gear Ratio 1 (Numerator)		Sets the numerator for the electronic gear ratio. Setting this parameter to 0 automatically sets the encoder resolution as the numerator. (131072 for a 17-bit absolute encoder, or 10000 for a 2,500-p/r incremental encoder). Note Set the electronic gear ratio within the range of 1/100 to 100 times. A parameter setting alarm (alarm code 93) will occur if the ratio is set outside of this range.	1	---	0 to 131072	C	
206	Electronic Gear Ratio 2 (Denominator)		Sets the denominator for the electronic gear ratio. Note Set the electronic gear ratio within the range of 1/100 to 100 times. A parameter setting alarm (Alarm code 93) will occur if the ratio is set outside of this range.	1	---	1 to 65535	C	
207	Reserved		Do not change.	0	---	---	---	
208	Reserved		Do not change.	0	---	---	---	
209	Deviation Counter Overflow Level		Sets the deviation counter overflow level. The value will become saturated at 134217728 (= 2 ²⁷) pulses after multiplying with the electronic gear ratio. Setting this parameter to 0 will disable deviation counter overflow.	20000	Command units	0 to 2147483647	A	
20A to 21F	Reserved		Do not change.	0	---	---	---	

5-27 Details on Important Parameters

- ♦ This section provides an explanation for the particularly important parameters. Be sure to fully understand the meanings of these parameters before making changes to the parameter settings.
- ♦ Do not set or change the default values for user parameters listed as "Reserved".
- ♦ The attribute indicates when the changed setting for the parameter will be enabled.

Attribute	Timing when changes will be enabled
A	Always enabled after change
B	Change prohibited during Servomotor operation and command issuance. (It is not known when changes made during Servomotor operation and command issuance will be enabled.)
C	Enabled when the control power is reset, or when CONFIG command is executed via the network (MECHATROLINK-II communications).
R	Read-only and cannot be changed.

5-27 Details on Important Parameters

Pn No.	Parameter name	Setting range	Unit	Default setting	Attribute
Pn003	Torque Limit Selection	1 to 5	---	1	B

♦ Selects torque limit function, or torque feed-forward function during speed control.

Torque Limit Selection

Select the torque limit for position control or speed control as follows.

Setting	Explanation
1	Use Pn05E as the limit value for forward and reverse operations.
2	Forward: Use Pn05E as limit. Reverse: Use Pn05F as limit.
3	Switch limits by torque limit values and input signals from the network. Limit in forward direction: PCL is OFF = Pn05E, PCL is ON = Pn05F Limit in reverse direction: NCL is OFF = Pn05E, NCL is ON = Pn05F
4	Forward: Use Pn05E as limit. Reverse: Use Pn05F as limit. Only in speed control, torque limits can be switched by torque limit values from the network as follows: Limit in forward direction: Use Pn05E or MECHATROLINK-II command option command value 1, whichever is smaller. Limit in reverse direction: Use Pn05F or MECHATROLINK-II command option command value 2, whichever is smaller.
5	Forward: Use Pn05E as limit. Reverse: Use Pn05F as limit. Only in speed control, torque limits can be switched by torque limit values and input signals from the network as follows: Limit in forward direction: PCL is OFF = Pn05E, PCL is ON = Pn05E or MECHATROLINK-II command option command value 1, whichever is smaller. Limit in reverse direction: NCL is OFF = Pn05F, NCL is ON = Pn05F or MECHATROLINK-II command option command value 2, whichever is smaller.

Note 1. PCL ON: When either Forward Torque Limit (CN1 PCL: pin 7) or MECHATROLINK-II Communications Option Field (P-CL) is ON.

PCL OFF: When both Forward Torque Limit (CN1 PCL: pin 7) and MECHATROLINK-II Communications Option Field (P-CL) are OFF.

Note 2. For torque control, always select Pn05E.

Torque Feed-forward Function Selection

Setting	Explanation
1 to 3	Enabled only during speed control. Disabled if not using speed control.
4 to 5	Always disabled.

Pn No.	Parameter name	Setting range	Unit	Default setting	Attribute
Pn004	Drive Prohibit Input Selection	0 to 2	---	0	C

Sets the function for the Forward and Reverse Drive Prohibit Inputs (CN1 POT: pin 19, NOT: pin 20).

Setting	Explanation
0	Decelerates and stops according to the sequence set in the Stop Selection for Drive Prohibition Input (Pn066) when both POT and NOT inputs are enabled. When both POT and NOT inputs are OPEN, the Drive Prohibit Input Error (alarm code 38) will occur.
1	Both POT and NOT inputs disabled.
2	When either POT or NOT input becomes OPEN, the Drive Prohibit Input Error (alarm code 38) will occur.

Pn No.	Parameter name	Setting range	Unit	Default setting	Attribute
Pn005	Communications Control	0 to 3955	---	0	C

Controls errors and warnings for MECHATROLINK-II communications.

Note Use with this parameter set to 0.
Program to stop immediately if using a value other than 0.

Set the Consecutive Communications Error Detection Count in COM_ERR (bit 8 to 11). The communications error (alarm code 83) will occur when a communications error, which is assessed at every MECHATROLINK-II communications cycle, occurs consecutively for the number of the Consecutive Communications Error Detection Count. The error and warning can be masked for debug purposes.

bit	15	14	13	12	11	10	9	8	7	6	5	4	3	2	1	0
Setting	0	0	0	0	X	X	X	X	0	X	X	X	0	0	X	X
Content	---				COM_ERR				MSK COM WARNG				MSK COM ALM			

[bits 8-11]COM_ERR (Consecutive Communications Error Detection Count)
Setting range: 0 to 15
Consecutive Communications Error Detection Count = COM_ERR + 2

Note These bits are debug functions. Set to enable (0) when not debugging.

[bits 0-3] MECHATROLINK-II Communications Alarms Mask (MSK COM ALM)
[bit 0] 0: Communications error (alarm code 83) enabled
1: Communications error (alarm code 83) disabled
[bit1] 0: Watchdog data error (alarm code 86) enabled
1: Watchdog data error (alarm code 86) disabled

[bits 4-7] MECHATROLINK-II Communications Warnings Mask (MSK COM WARNG)
[bit4] 0: Data setting warning (warning code 94h) enabled
1: Data setting warning (warning code 94h) disabled
[bit5] 0: Command warning (warning code 95h) enabled
1: Command warning (warning code 95h) disabled
[bit6] 0: ML-II communications warning (warning code 96h) enabled
1: ML-II communications warning (warning code 96h) disabled

5-27 Details on Important Parameters

Pn No.	Parameter name	Setting range	Unit	Default setting	Attribute
Pn021	Realtime Autotuning Mode Selection	0 to 7	---	0	B

Sets the operating mode for realtime autotuning.

A setting of 3 or 6 will provide faster response to changes in inertia during operation. Operation, however, may be unstable depending on the operating pattern.

Normally, set the parameter to 1 or 4.

Set to 4 to 6 when the Servomotor is used as a vertical axis.

Gain switching is enabled at set values 1 to 6.

Use a setting of 7 if operation changes caused by gain switching are a problem.

Setting	Realtime Autotuning	Degree of change in load inertia
0	Disabled	---
1	Horizontal axis mode	Almost no change
2		Gradual changes
3		Sudden changes
4	Vertical axis mode	Almost no change
5		Gradual changes
6		Sudden changes
7	Gain switching disable mode	Almost no change

Precautions for Correct Use

- ◆ In realtime autotuning, responses to inertia changes are derived from the changes in approximately 10 s. Realtime autotuning may not be able to follow sharp changes in inertia. In this case, the vibrations may occur in the operation. Disable realtime autotuning by setting 0 when the operation has become normal.

Pn No.	Parameter name	Setting range	Unit	Default setting	Attribute
Pn022	Realtime Autotuning Machine Rigidity Selection	0 to F	---	2	B

Sets the machine rigidity for realtime autotuning.

When realtime autotuning is enabled, each parameter in the table is automatically set to the machine rigidity values in "Realtime Autotuning (RTAT) Parameter Tables" on the next page. Autotuning adjusts the response by estimating the load inertia based on these values.

Thus, if the value is too large and not suitable for the load, vibration or resonance may occur. If this occurs, lower the setting.

Realtime Autotuning (RTAT) Parameter Tables

Parameter No.	Parameter name	AT Mode Selection (Pn021)	AT Machine Rigidity Selection (Pn022)							
			0	1	2	3	4	5	6	7
Pn010	Position Loop Gain	---	120	320	390	480	630	720	900	1080
Pn011	Speed Loop Gain	---	90	180	220	270	350	400	500	600
Pn012	Speed Loop Integration Time Constant	---	620	310	250	210	160	140	120	110
Pn013	Speed Feedback Filter Time Constant	---	0	0	0	0	0	0	0	0
Pn014	Torque Command Filter Time Constant ^{*1}	---	253	126	103	84	65	57	45	38
Pn015	Speed Feed-forward Amount	---	300	300	300	300	300	300	300	300
Pn016	Feed-forward Filter Time Constant	---	50	50	50	50	50	50	50	50
Pn017	Reserved	---	0	0	0	0	0	0	0	0
Pn018	Position Loop Gain 2	---	190	380	460	570	730	840	1050	1260
Pn019	Speed Loop Gain 2	---	90	180	220	270	350	400	500	600
Pn01A	Speed Loop Integration Time Constant 2	1, 2, 3, 7	10000	10000	10000	10000	10000	10000	10000	10000
		4, 5, 6	9999	9999	9999	9999	9999	9999	9999	9999
Pn01B	Speed Feedback Filter Time Constant 2	---	0	0	0	0	0	0	0	0
Pn01C	Torque Command Filter Time Constant 2 ^{*1}	---	253	126	103	84	65	57	45	38
Pn020	Inertia Ratio	---	Estimated load inertia ratio							
Pn027	Instantaneous Speed Observer Setting	---	0	0	0	0	0	0	0	0
Pn030	Gain Switching Operating Mode Selection	---	1	1	1	1	1	1	1	1
Pn031	Gain Switch Setting ^{*3}	1 to 6	10	10	10	10	10	10	10	10
		7	0	0	0	0	0	0	0	0
Pn032	Gain Switch Time	---	30	30	30	30	30	30	30	30
Pn033	Gain Switch Level Setting	---	50	50	50	50	50	50	50	50
Pn034	Gain Switch Hysteresis Setting	---	33	33	33	33	33	33	33	33
Pn035	Position Loop Gain Switching Time	---	20	20	20	20	20	20	20	20

5-27 Details on Important Parameters

Parameter No.	Parameter name	AT Mode Selection (Pn021)	AT Machine Rigidity Selection (Pn022)							
			8	9	A	B	C	D	E	F
Pn010	Position Loop Gain	---	1350	1620	2060	2510	3050	3770	4490	5570
Pn011	Speed Loop Gain	---	750	900	1150	1400	1700	2100	2500	3100
Pn012	Speed Loop Integration Time Constant	---	90	80	70	60	50	40	40	30
Pn013	Speed Feedback Filter Time Constant	---	0	0	0	0	0	0	0	0
Pn014	Torque Command Filter Time Constant* ¹	---	30	25	20 ^{*2}	16 ^{*2}	13 ^{*2}	11 ^{*2}	10 ^{*2}	10 ^{*2}
Pn015	Speed Feed-forward Amount	---	300	300	300	300	300	300	300	300
Pn016	Feed-forward Filter Time Constant	---	50	50	50	50	50	50	50	50
Pn017	Reserved	---	0	0	0	0	0	0	0	0
Pn018	Position Loop Gain 2	---	1570	1820	2410	2930	3560	4400	5240	6490
Pn019	Speed Loop Gain 2	---	750	900	1150	1400	1700	2100	2100	3100
Pn01A	Speed Loop Integration Time Constant 2	1, 2, 3, 7	10000	10000	10000	10000	10000	10000	10000	10000
		4, 5, 6	9999	9999	9999	9999	9999	9999	9999	9999
Pn01B	Speed Feedback Filter Time Constant 2	---	0	0	0	0	0	0	0	0
Pn01C	Torque Command Filter Time Constant 2* ¹	---	30	25	20 ^{*2}	16 ^{*2}	13 ^{*2}	11 ^{*2}	10 ^{*2}	10 ^{*2}
Pn020	Inertia Ratio	---	Estimated load inertia ratio							
Pn027	Instantaneous Speed Observer Setting	---	0	0	0	0	0	0	0	0
Pn030	Gain Switching Operating Mode Selection	---	1	1	1	1	1	1	1	1
Pn031	Gain Switch Setting* ³	1 to 6	10	10	10	10	10	10	10	10
		7	0	0	0	0	0	0	0	0
Pn032	Gain Switch Time	---	30	30	30	30	30	30	30	30
Pn033	Gain Switch Level Setting	---	50	50	50	50	50	50	50	50
Pn034	Gain Switch Hysteresis Setting	---	33	33	33	33	33	33	33	33
Pn035	Position Loop Gain Switching Time	---	20	20	20	20	20	20	20	20

♦ Parameters Pn015, 016, 01A, 030, and 032 to 035 are set to fixed values. The Servo Drive is set to rigidity No.2 as the default value.

*1. The lower limit is set to 10 when using a 17-bit encoder and 25 when using a 2,500-p/r encoder.

*2. The value for a 17-bit absolute encoder. The value for a 2,500-p/r incremental encoder is 25.

*3. The default setting for the Servo Drive is 2 (switching from the network).

Pn No.	Parameter name	Setting range	Unit	Default setting	Attribute
Pn023	Adaptive Filter Selection	0 to 2	---	0	B

Enables or disables the adaptive filter.

The adaptive filter is enabled during realtime autotuning and manual tuning.

The adaptive filter reduces resonance point vibration in the Servomotor response by estimating the resonance frequency from the vibration component that appears in the Servomotor speed, and automatically sets the frequency of the notch filter which removes the resonance component from the torque command.

The adaptive filter can only be used with position and speed control modes. It is not available for torque control mode.

The adaptive filter may not operate properly under the following conditions.

	Conditions under which the adaptive filter does not function properly
Resonance points	<ul style="list-style-type: none"> ♦ If the resonance frequency is 300 Hz or lower. ♦ If there are multiple points of resonance. ♦ If the resonance peak or control gain is low, and the Servomotor speed is not affected by it.
Load	<ul style="list-style-type: none"> ♦ If the Servomotor speed with high-frequency components changes due to backlash or other non-linear elements.
Command pattern	<ul style="list-style-type: none"> ♦ If the acceleration/deceleration suddenly changes, i.e. 3,000 r/min or more in 0.1 s.

If the adaptive filter does not function properly, correct by setting the Notch Filter 1 Frequency (Pn01D) and Notch Filter 1 Width (Pn01E).

Setting the Vibration Filter Selection (Pn024) to low-pass type 3 to 5 disables (= 0) the adaptive filter.

Setting	Explanation
0	Adaptive filter disabled
1	Adaptive filter enabled, adaptive operation ON
2	Adaptive filter retained (retains the adaptive filter frequency when set to 2)

Pn No.	Parameter name	Setting range	Unit	Default setting	Attribute
Pn024	Vibration Filter Selection	0 to 5	---	0	C

Selects the vibration filter type and switching mode.

Filter type

- ♦ Normal type: Vibration frequency setting range 10.0 to 200.0 Hz
Adaptive filter can be used.
- ♦ Low-pass type: Vibration frequency setting range 1.0 to 200.0 Hz
Adaptive filter cannot be used (forcibly set to disabled).

Switching mode selection

- ♦ No switching: Both 1 and 2 are enabled
- ♦ Switch with command direction:
 Selects Vibration Frequency 1 in forward direction (Pn02B, Pn02C)
 Selects Vibration Frequency 2 in reverse direction (Pn02D, Pn02E)

Setting	Filter type	Switching mode
0	Normal type	No switching (Both filter 1 and filter 2 are enabled.)
1		
2		Switching with command direction
3	Low-pass type	No switching (Both filter 1 and filter 2 are enabled.)
4		
5		Switching with command direction

Pn No.	Parameter name	Setting range	Unit	Default setting	Attribute
Pn025	Normal Mode Autotuning Operation Setting	0 to 7	---	0	B

Normal mode autotuning operates on condition that the network is not established.

If the network is established while normal mode autotuning is in operation, the command error (alarm code 27) will occur.

Normal mode autotuning will not operate properly unless the Torque Limit Selection (Pn003) is set to 1, (Pn05E is the torque limit value), and the Drive Prohibit Input Selection (Pn004) is set to 1 (disabled).

Setting	Number of rotations	Rotation Direction
0	Repeat cycles of 2 rotations	Forward and Reverse (Alternating)
1		Reverse and Forward (Alternating)
2		Forward only
3		Reverse only
4	Repeat cycles of single rotation	Forward and Reverse (Alternating)
5		Reverse and Forward (Alternating)
6		Forward only
7		Reverse only

Pn No.	Parameter name	Setting range	Unit	Default setting	Attribute
Pn02F	Adaptive Filter Table Number Display	0 to 64	---	0	R

The number corresponding to the resonance frequency detected by the adaptive filter is entered. If the adaptive filter is not used, set the Adaptive Filter Selection (Pn023) to 0 and set the number in this parameter to the notch filter. Or set the Adaptive Filter Selection (Pn023) to 2 to retain the Adaptive Filter Table Number.

The Adaptive Filter Table is shown on the next page.

Adaptive Filter Table

Pn02F	Notch Filter 1 Frequency	Pn02F	Notch Filter 1 Frequency	Pn02F	Notch Filter 1 Frequency
0	(Disabled)	22	766	44	326
1	(Disabled)	23	737	45	314
2	(Disabled)	24	709	46	302
3	(Disabled)	25	682	47	290
4	(Disabled)	26	656	48	279
5	1482	27	631	49	269 (Disabled when Pn022 ≥ F)
6	1426	28	607	50	258 (Disabled when Pn022 ≥ F)
7	1372	29	584	51	248 (Disabled when Pn022 ≥ F)
8	1319	30	562	52	239 (Disabled when Pn022 ≥ F)
9	1269	31	540	53	230 (Disabled when Pn022 ≥ F)
10	1221	32	520	54	221 (Disabled when Pn022 ≥ E)
11	1174	33	500	55	213 (Disabled when Pn022 ≥ E)
12	1130	34	481	56	205 (Disabled when Pn022 ≥ E)
13	1087	35	462	57	197 (Disabled when Pn022 ≥ E)
14	1045	36	445	58	189 (Disabled when Pn022 ≥ E)
15	1005	37	428	59	182 (Disabled when Pn022 ≥ D)
16	967	38	412	60	(Disabled)
17	930	39	396	61	(Disabled)
18	895	40	381	62	(Disabled)
19	861	41	366	63	(Disabled)
20	828	42	352	64	(Disabled)
21	796	43	339		

- ♦ The table number corresponding to the frequency for the adaptive filter is displayed.
- ♦ This parameter is set automatically and cannot be changed when the adaptive filter is enabled (when the Adaptive Filter Selection (Pn023) is 1 or 2).
- ♦ When the adaptive filter is enabled, data will be saved in EEPROM every 30 min. If the adaptive filter is enabled the next time the power supply is turned ON, adaptive operation will start with the data saved in EEPROM as the default value.
- ♦ To clear this parameter and reset the adaptive operation, disable the adaptive filter by setting the Adaptive Filter Selection (Pn023) to 0, and then enable it again.

5-27 Details on Important Parameters

Pn No.	Parameter name	Setting range	Unit	Default setting	Attribute
Pn066	Stop Selection for Drive Prohibition Input	0 to 2	---	0	C

Sets the deceleration stop operation to be performed after the Forward Drive Prohibit Input (POT) or Reverse Drive Prohibit Input (NOT) is enabled.

Setting	During deceleration	After stopping (30 r/min or less)	Deviation counter
0	Dynamic brake	Disables torque command in drive prohibited direction	Cleared while decelerating with dynamic brake. Retained after stopping.
1	Disables torque	Disables torque command in drive prohibited direction	Cleared while decelerating. Retained after stopping.
2	Emergency Stop Torque (Pn06E)	Servo locked	Retained while decelerating, cleared upon completion of deceleration, and retained after stopping.

Note 1. The positioning command generation process (positioning operation) within the Servo Drive will be forcibly stopped once it enters the deceleration mode. Also, when the deceleration mode is activated during speed control or torque control, it will switch to position control. If a positioning operation command is received during deceleration, the internal positioning command generation process will be retained, and after deceleration is complete, positioning operation will be activated.

Note 2. When the Servomotor rotation speed is 30 r/min or less (stopped), the deceleration mode will not be activated even if the drive prohibit input is enabled.

Note 3. When the parameter is set to 2 and an operation command in the drive prohibited direction is received after stopping, a command warning (warning code 95h) will be issued. When the parameter is set to 0 or 1, the operation command in the prohibited direction after stopping will be accepted, but the Servomotor will not operate and the position deviation will accumulate because the torque command is 0. Take measures such as issuing a command in the reverse direction from the host controller.

Note 4. When the parameter is set to 2, MECHATROLINK-II communications are interrupted, and either Forward or Reverse Drive Prohibit Input (POT or NOT) is turned ON, receiving an operation command (jog operation or normal mode autotuning) via RS232 will cause a Drive Prohibit Input Error (alarm code 38). A Drive Prohibit Input Error (alarm code 38) will also occur if either POT or NOT is turned ON while operating on an operation command received via RS232.

Pn No.	Parameter name	Setting range	Unit	Default setting	Attribute
Pn067	Stop Selection with Main Power OFF	0 to 7	---	0	B

Sets the operational conditions during deceleration and after stopping after the main power supply is turned OFF with the Undervoltage Alarm Selection (Pn065) set to 0. The deviation counter will be reset when the power OFF is detected.

Setting	Explanation
0 and 4	Use dynamic brake to decelerate and remain stopped with dynamic brake.
1 and 5	Use free-run to decelerate and remain stopped with dynamic brake.
2 and 6	Use dynamic brake to decelerate, but free the motor when stopped.
3 and 7	Use free-run to decelerate, and free the motor when stopped.

Pn No.	Parameter name	Setting range	Unit	Default setting	Attribute
Pn068	Stop Selection for Alarm Generation	0 to 3	---	0	B

Sets the deceleration process and stop status after an alarm is issued by the protective function. The deviation counter will be reset when an alarm is issued.

Setting	Explanation
0	Use dynamic brake to decelerate and remain stopped with dynamic brake.
1	Use free-run to decelerate and remain stopped with dynamic brake.
2	Use dynamic brake to decelerate, but free the motor when stopped.
3	Use free-run to decelerate, and free the motor when stopped.

Pn No.	Parameter name	Setting range	Unit	Default setting	Attribute
Pn069	Stop Selection with Servo OFF	0 to 7	---	0	B

Sets the operational conditions to apply during deceleration and after stopping when the Servo is turned OFF.

Setting	Explanation
0 and 4	Use dynamic brake to decelerate and remain stopped with dynamic brake.
1 and 5	Use free-run to decelerate and remain stopped with dynamic brake.
2 and 6	Use dynamic brake to decelerate, but free the motor when stopped.
3 and 7	Use free-run to decelerate, and free the motor when stopped.

Pn No.	Parameter name	Setting range	Unit	Default setting	Attribute
Pn06C	Regeneration Resistor Selection	0 to 3	---	0	C

Sets the regeneration resistor operation and the regeneration overload (alarm code 18) operation. Set this parameter to 0 if using the built-in regeneration resistor.

If using an external regeneration resistor, be sure to turn OFF the main power when the built-in thermal switch is activated.

Setting	Explanation
0	Sets the regeneration overload to match the built-in regeneration resistor. (regeneration load ratio below 1%)
1	The regeneration overload (alarm code 18) occurs when the load ratio of the external regeneration resistor exceeds 10%.
2	The regeneration processing circuit by the external regeneration resistor is activated, but the regeneration overload does not occur.
3	The regeneration processing circuit is not activated. All regenerative energy is absorbed by the built-in capacitor.

Chapter 6

Operation

6-1	Operational Procedure	6-1
6-2	Preparing for Operation.....	6-2
	Items to Check Before Turning ON the Power.....	6-2
	Turning ON Power	6-4
	Checking the Displays	6-5
	Absolute Encoder Setup	6-6
6-3	Using the Parameter Unit.....	6-8
	Names of Parts and Functions.....	6-8
6-4	Setting the Mode	6-9
	Changing the Mode.....	6-9
	Monitor Mode	6-10
	Parameter Setting Mode	6-17
	Parameter Write Mode	6-23
	Normal Mode Autotuning	6-24
	Auxiliary Function Mode.....	6-25
	Copy Mode.....	6-28
6-5	Trial Operation	6-31
	Preparation for Trial Operation	6-31
	Trial Operation with CX-Drive	6-31

6-1 Operational Procedure

After mounting and wiring, connect a power supply, and check the operation of the Servomotor and Servo Drive individually.

Then make the function settings as required according to the use of the Servomotor and Servo Drive. If the parameters are set incorrectly, there is a risk of an unpredictable Servomotor operation. Set the parameters according to the instructions in this manual.

Item	Contents	Reference
Mounting and installation	Install the Servomotor and Servo Drive according to the installation conditions. (Do not connect the Servomotor to the mechanical system before checking the no-load operation.)	4-1 <i>Installation Conditions</i>
Wiring and connections	Connect the Servomotor and Servo Drive to the power supply and peripheral devices. · Specified installation and wiring requirements must be satisfied, particularly if conforming to the EC Directives.	4-2 <i>Wiring</i>
Preparation for operation	Check the necessary items and then turn ON the power supply. Check the display to see whether there are any internal errors in the Servo Drive. If using a Servomotor with an absolute encoder, first set up the absolute encoder.	6-2 <i>Preparing for Operation</i>
Setting functions	By means of the user parameters, set the functions according to the operating conditions.	5-26 <i>User Parameters</i>
Trial operation	First, test operation without a load connected to the motor. Then turn the power OFF and connect the mechanical system to the motor. If using a Servomotor with an absolute encoder, set up the absolute encoder and set the Motion Control Unit's initial parameters. Turn ON the power, and check to see whether protective functions, such as the emergency stop and operational limits, work properly. Check operation at both low speed and high speed using the system without a workpiece, or with dummy workpieces.	6-5 <i>Trial Operation</i>
Adjustments	Manually adjust the gain if necessary. Further adjust the various functions to improve the control performance.	Chapter 7 <i>Adjustment Functions</i>
Operation	Operation can now be started. If any problems should occur, refer to <i>Chapter 8 Troubleshooting</i> .	Chapter 8 <i>Troubleshooting</i>

6-2 Preparing for Operation

This section explains the procedure for preparing the mechanical system for operation following installation and wiring of the Servomotor and Servo Drive. It explains what you need to check both before and after turning ON the power.

It also explains the setup procedure required for using a Servomotor with an absolute encoder.

Items to Check Before Turning ON the Power

■ Checking Power Supply Voltage

- ♦ Check to be sure that the power supply voltage is within the ranges shown below.
R88D-GT□L-ML2 (single-phase 100 VAC input)
Main circuit power supply: Single-phase, 100 to 115 VAC (85 to 127 V), 50/60 Hz
Control circuit power supply: Single-phase, 100 to 115 VAC (85 to 127 V), 50/60 Hz

- R88D-GN01H-ML2/02H-ML2/04H-ML2/08H-ML2/10H-ML2/15H-ML2
(Single-phase or single/three-phase 200 VAC input)
Main circuit power supply: Single-phase or single/three-phase, 200 to 240 VAC (170 to 264 V), 50/60 Hz
Control circuit power supply: Single-phase or single/three-phase, 200 to 240 VAC (170 to 264 V), 50/60 Hz

- R88D-GN20H-ML2/30H-ML2/50H-ML2/75H-ML2 (three-phase 200VAC input)
Main circuit power supply: Three-phase, 200 to 230 VAC (170 to 253 V), 50/60 Hz
Control circuit power supply: Single-phase, 200 to 230 VAC (170 to 253 V), 50/60 Hz

■ Checking Terminal Block Wiring

- ♦ The main circuit power supply inputs (L1/L3 or L1/L2/L3) must be properly connected to the terminal block.
- ♦ The control circuit power supply inputs (L1C/L2C) must be properly connected to the terminal block.
- ♦ The Servomotor's red (U), white (V), and blue (W) power lines and the green/yellow ground wire (⊕) must be properly connected to the terminal block.

■ Checking the Servomotor

- ♦ There should be no load on the Servomotor. (Do not connect the mechanical system.)
- ♦ The Servomotor's power lines and the power cables must be connected securely.

■ Checking the Encoder Connectors

- ♦ The Encoder Cable must be connected securely to the Encoder Connector (CN2) at the Servo Drive.
- ♦ The Encoder Cable must be connected securely to the Encoder Connector at the Servomotor.

■ Checking the Control I/O Connectors

- ♦ The Control Cable must be connected securely to the Control I/O Connector (CN1).
- ♦ The RUN command (RUN) must be OFF.

■ Checking Parameter Unit Connections

- ♦ When using the Parameter Unit (R88A-PR02G), the enclosed cable must be connected securely to the CN3 connector.

■ Servo Drive Display and Settings

The display for the Servo Driver R88D-GN□ is illustrated below.

The display shows the node address setting for MECHATROLINK-II, alarm display for the Servo Drive, and the communications status.

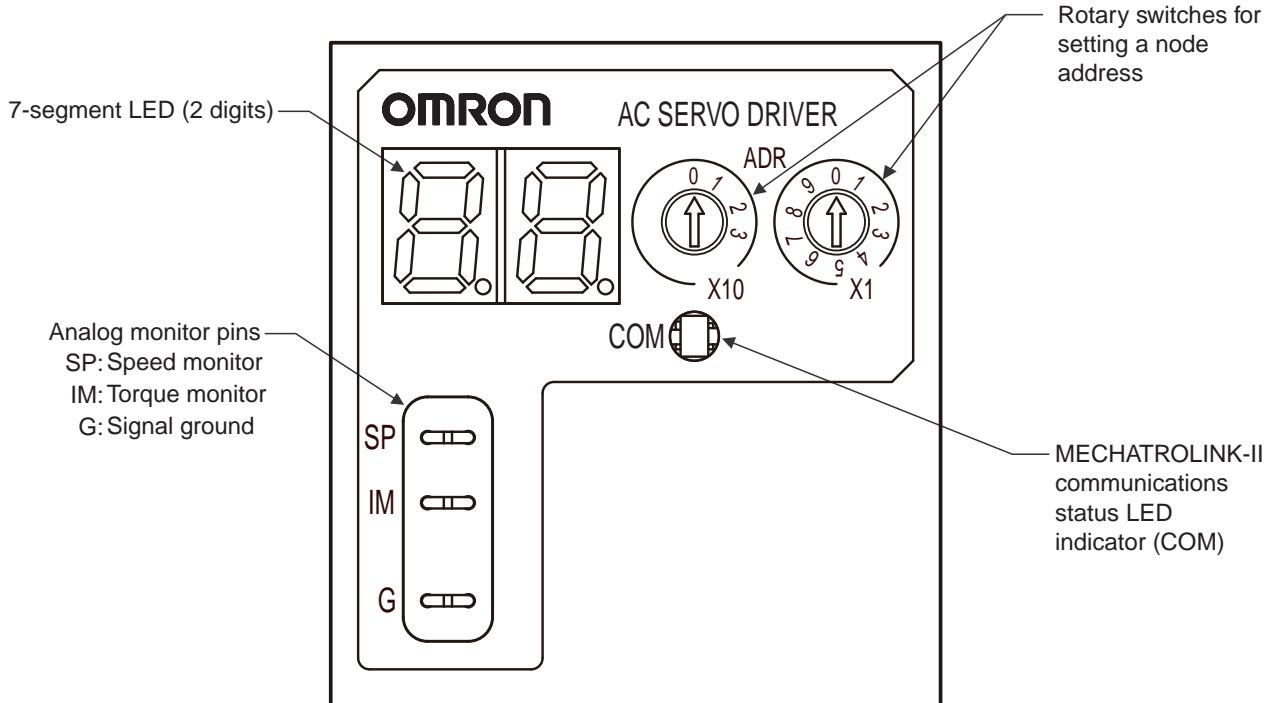

Note 1. The node address is only loaded once when the control power supply is turned ON. Changes made after turning the power ON will not be applied until the power is turned ON next time.

Do not change the rotary switch setting after turning the power ON.

Note 2. The setting range for the node address setting rotary switch is 1 to 31.

The actual node address used on the network will be the sum of the rotary switch setting and the offset value of 40h.

If the rotary switch setting is not between 1 and 31, a node address setting error (alarm code 82) will occur.

Rotary Switch Set Value	Description
1 to 31	Node address = Set value + 40h (41h ≤ Node address ≤ 5Fh)
Others	Alarm code 82 occurs.

■ MECHATROLINK-II Status LED Indicator

The display status of the MECHATROLINK-II status LED indicator (COM) is described below.

LED Display	Description
OFF	No communications
Flashing green	Asynchronous communications established
Lit green	Synchronous communications established
Flashing red	Recoverable MECHATROLINK-II communications alarm <ul style="list-style-type: none"> ♦ Communications error (alarm code 83) ♦ Transmission cycle error (alarm code 84) ♦ Watchdog data error (alarm code 86) ♦ Transmission cycle setting error (alarm code 90) ♦ SYNC command error (alarm code 91)
Lit red	Irrecoverable MECHATROLINK-II communications alarm <ul style="list-style-type: none"> ♦ Node address setting error (alarm code 82)

Note If a communications error occurs at the same time as a non-communications error, the MECHATROLINK-II status LED indicator (COM) will still follow the above rule.

Turning ON Power

- ♦ First carry out the preliminary checks, and then turn ON the control-circuit power supply. It makes no difference whether or not the main-circuit power supply is turned ON.
- ♦ The alarm (/ALM) output will take approximately 2 seconds to turn ON after the power has been turned ON. Do not attempt to detect an alarm using the Host Controller during this time (if power is turned ON while the Host Controller is connected).

Checking the Displays

■ 7-segment LED

The display of the 7-segment LED on the front panel is shown below.

When the power is turned ON, the node address set with the rotary switch is displayed, followed by the display content set by the Default Display (Pn001) parameter.

When an alarm occurs, the alarm code will be displayed. When a warning occurs, the warning code will be displayed.

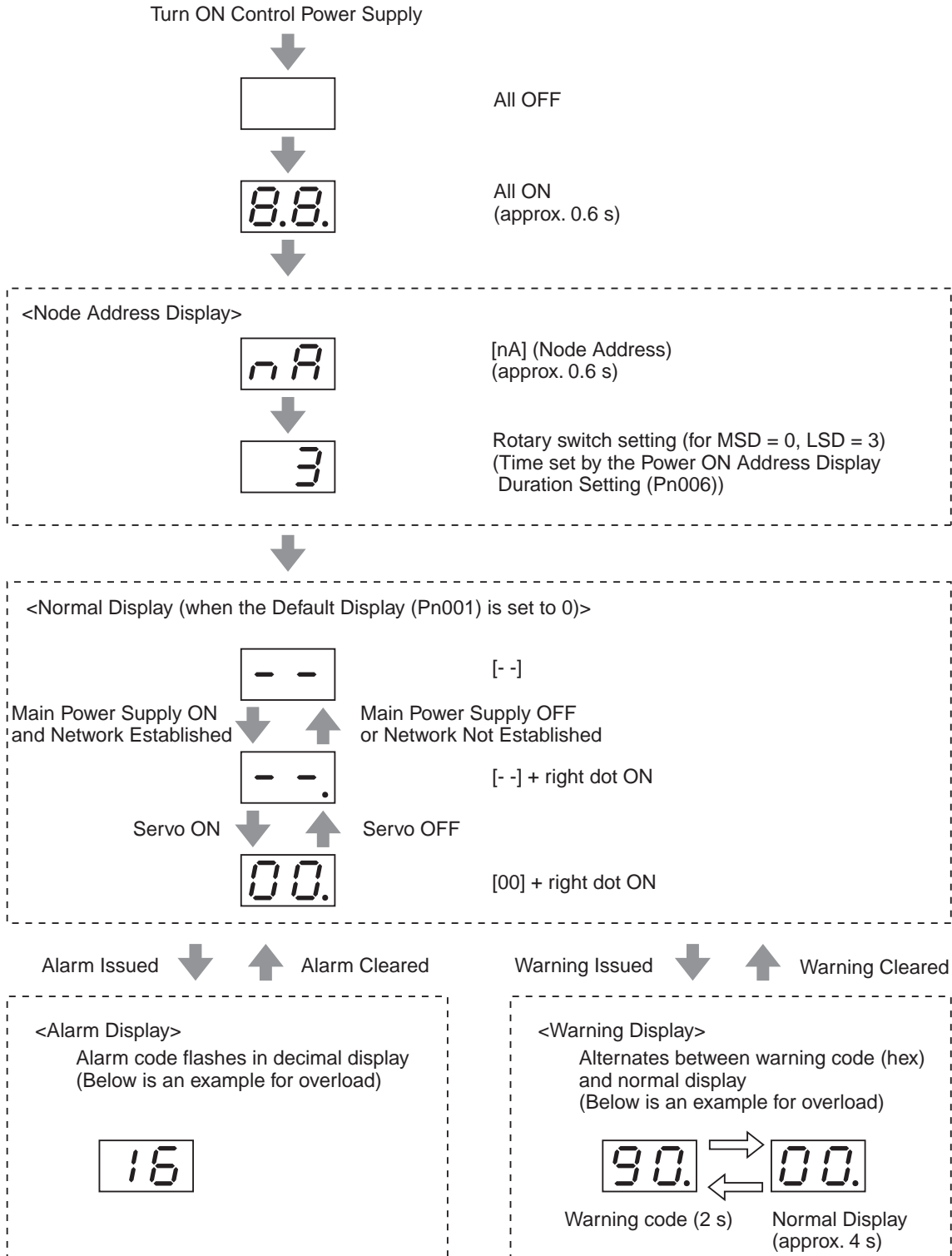

Absolute Encoder Setup **ABS**

When the power is turned OFF, multi-turn data for the absolute value data will be retained using the battery for the absolute encoder. Hence, when turning ON the machine for the first time after loading the battery, you will need to clear the encoder at the origin and set the multi-turn data to 0. To clear the encoder, use the Parameter Unit, CX-Drive or via MECHATROLINK-II.

Note Be sure to turn OFF and turn ON the control power supply again after clearing the absolute value data. A command error (alarm code 27) will occur when the absolute encoder is cleared from the Parameter Unit or CX-Drive. This is for safety purposes, not an indication of failure. Note that the one-turn data cannot be cleared.

■ Absolute Encoder Setup Procedure (for the Parameter Unit)

1. Turn ON the power supply and align to the origin.

Turn ON the power supply, perform the origin alignment operation, and move the machine to the origin position.

2. Go to Auxiliary Function Mode.

Press **DATA** and **←** on the Parameter Unit to display Auxiliary Function Mode.

3. Go to Absolute Encoder Clear Mode.

Press **DATA** again. Absolute Encoder Clear Mode will be displayed.

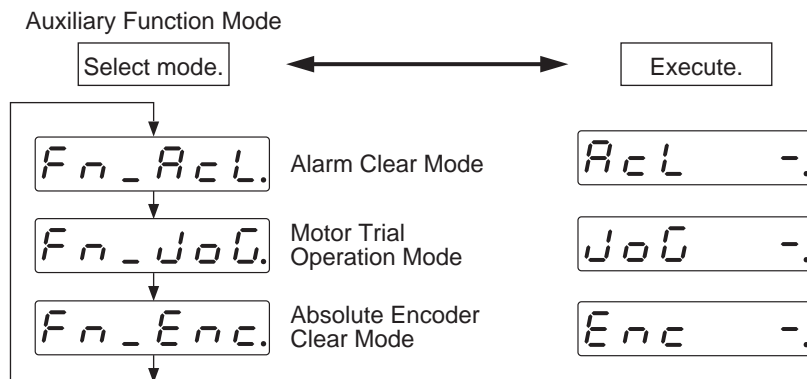

6-2 Preparing for Operation

4. Start clearing the absolute encoder.

Hold down . Clearing the absolute encoder will be started.

Hold down the Increment key for approx. 3 seconds. The number of dashes on the display will increase.

Enc -.

Enc --.

-----.

Clearing the absolute encoder will be started.

StArt

Clearing will be finished almost immediately.

FinIsh.

Error.

Note: If you attempt to clear an incremental encoder, "Error" will be displayed.

5. Restart the Servo Drive.

Turn OFF the control power supply to the Servo Drive, and then turn it back ON.

6-3 Using the Parameter Unit

Names of Parts and Functions

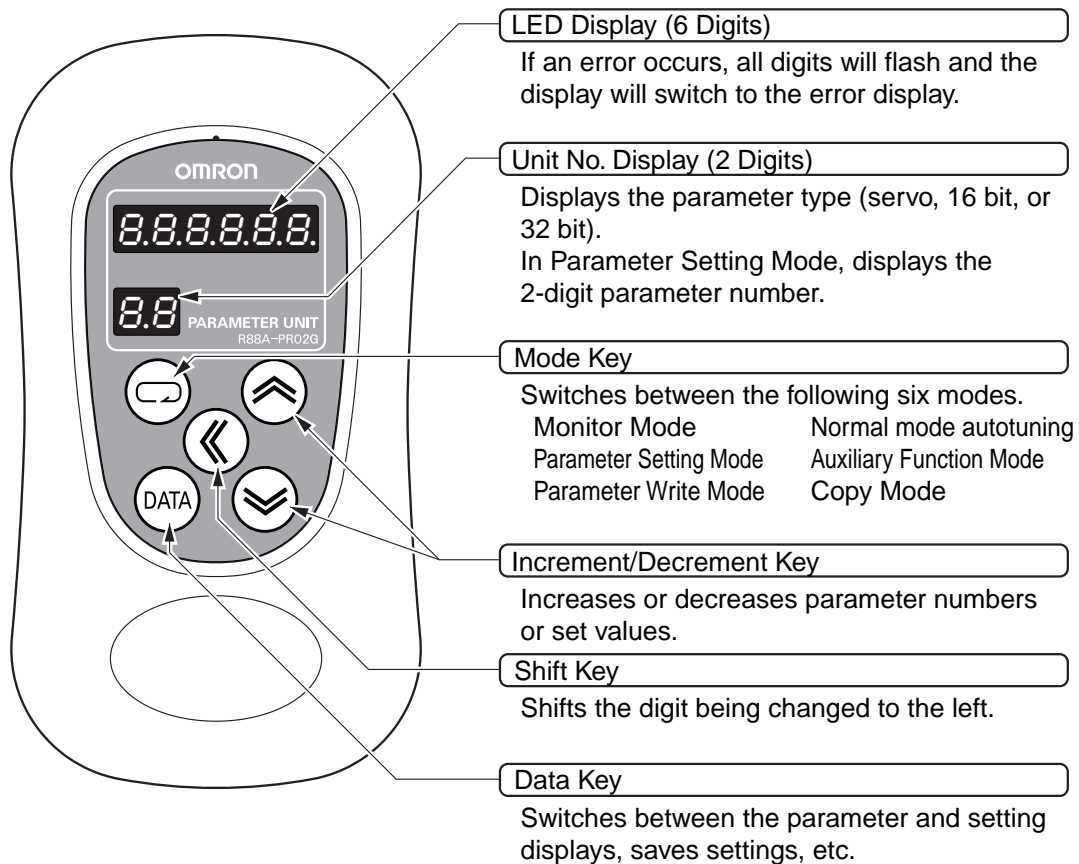
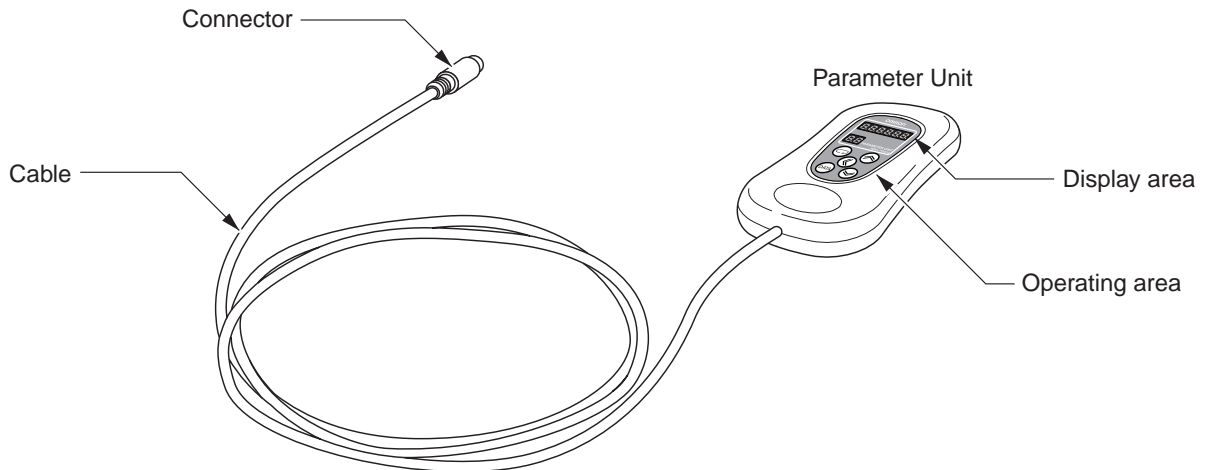

6-4 Setting the Mode

Changing the Mode

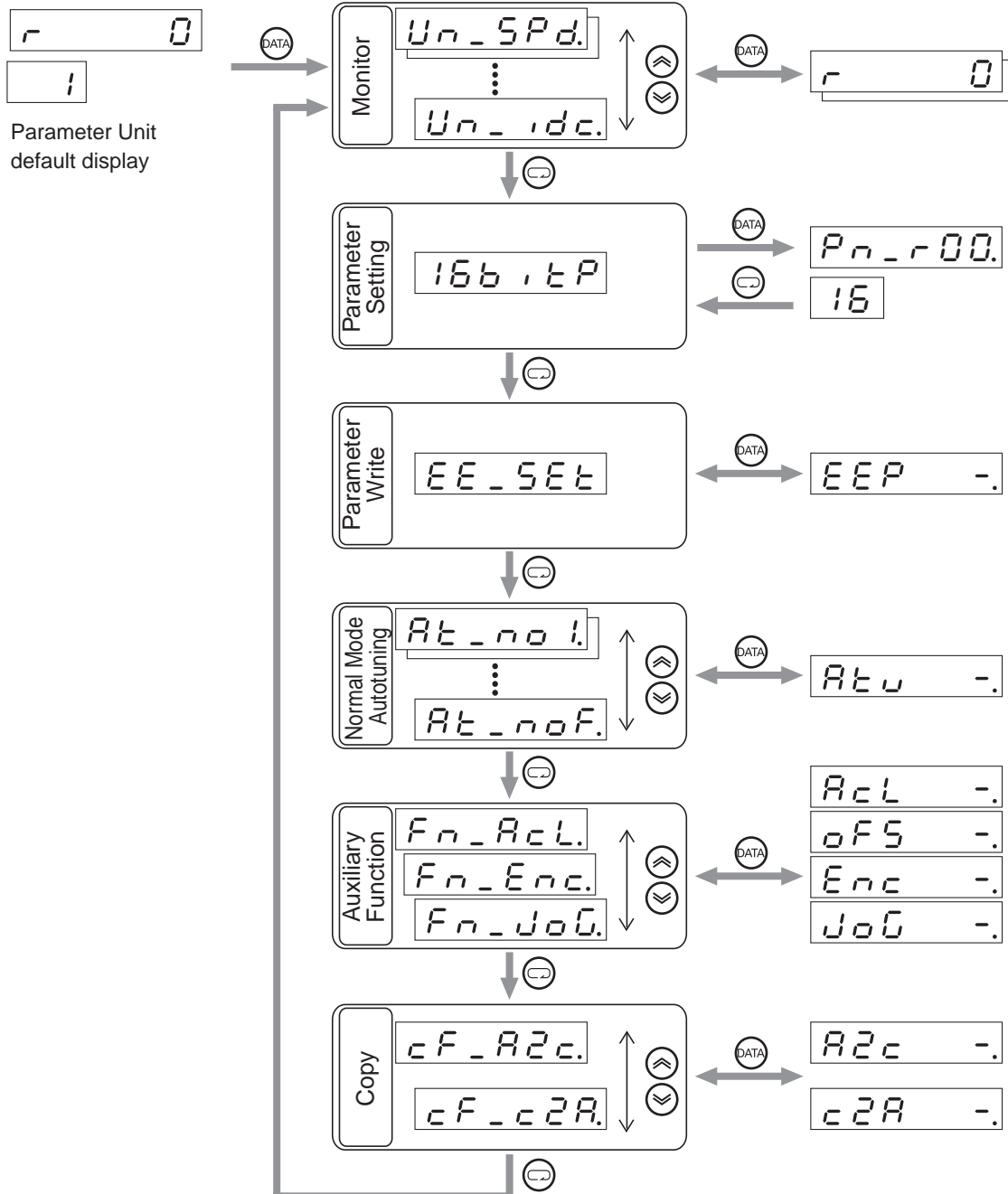

Monitor Mode

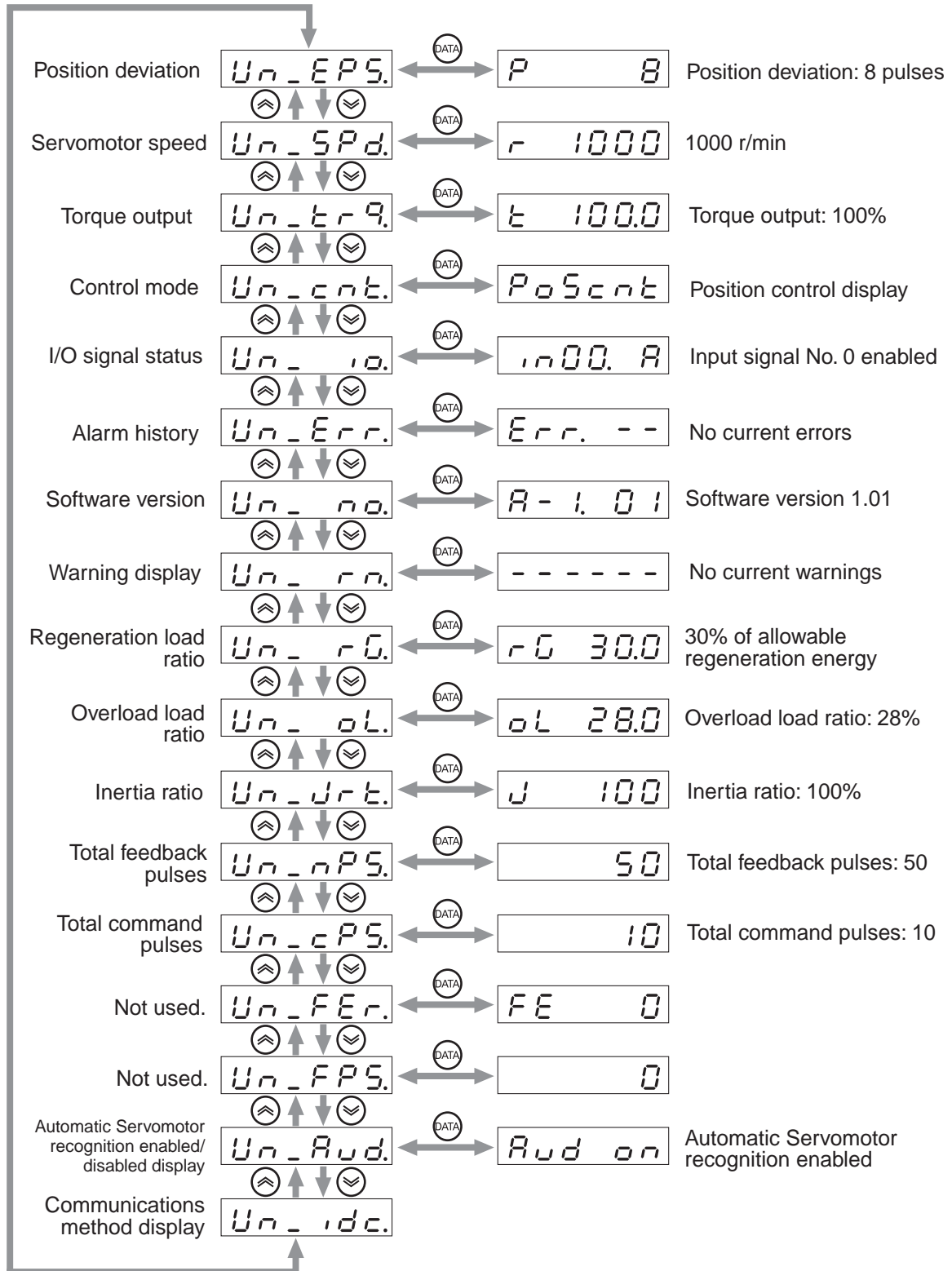

6-4 Setting the Mode

- ♦ The Servomotor speed will be displayed the first time the power is turned ON after purchase. To change the initial display when the power is turned ON, change the setting for the Default Display (Pn001). For details, refer to *Default Display* on page 5-62.

■ Position Deviation

P 8

- ♦ Displays the number of accumulated pulses in the deviation counter (unit: pulse).
- ♦ Accumulated pulses in reverse rotation are displayed with “-”.

■ Servomotor Speed

r 1000

- ♦ Displays the Servomotor speed (unit: r/min).
- ♦ Speeds in reverse rotation are displayed with “-”.

■ Torque Output

t 100.0

- ♦ Displays the percentage of Servomotor torque output.
- ♦ When the rated torque output for the Servomotor is used, “100%” is displayed.
- ♦ Torque outputs in reverse rotation are displayed with “-”.

■ Control Mode

Poscnt Position Control Mode

SPdcnt Speed Control Mode

tr9cnt Torque Control Mode

- ♦ Displays which of position control, speed control, and torque control is being used.

■ I/O Signal Status

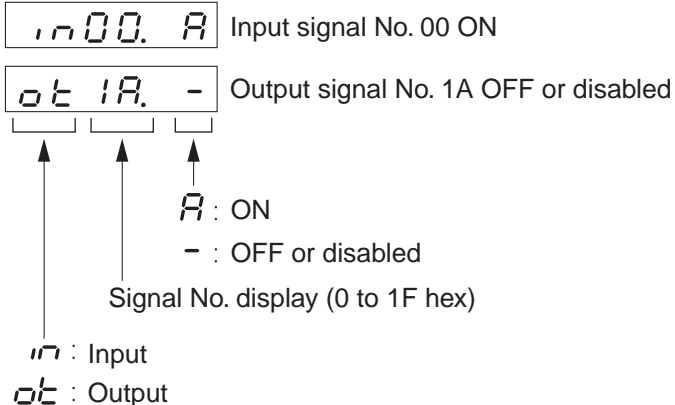

◆ Displays the status of the control input and output signals connected to CN1.

Input Signals

CN1			
Signal No.	Abbreviation	Name	Pin No.
00	POT	Forward Drive Prohibit Input	19
01	NOT	Reverse Drive Prohibit Input	20
02	DEC	Origin Proximity Input	21
06	EXT1	External Latch Signal 1	5
07	EXT2	External Latch Signal 2	4
08	EXT3	External Latch Signal 3	3
0A	STOP	Emergency Stop input	2
0B	IN2	External General-purpose Input 2	23
0C	PCL	Forward Torque Limit Input	7
0D	NCL	Reverse Torque Limit Input	8
0E	IN0	External General-purpose Input 0	22
0F	IN1	External General-purpose Input 1	6

Output Signals

CN1			
Signal No.	Abbreviation	Name	Pin No.
00	READY	Servo Ready	---
01	/ALM	Alarm Output	15
02	INP1	Positioning Completed 1 Output	---
03	BKIR	Brake Interlock	---
04	ZSPD	Zero Speed Detection	---
05	TLIM	Torque Limiting	---
06	VCMP	Speed Conformity	---
09	TGON	Servomotor Rotation Speed Detection	---
0F	INP2	Positioning Completed 2 Output	---

Switching between Input and Output Signals

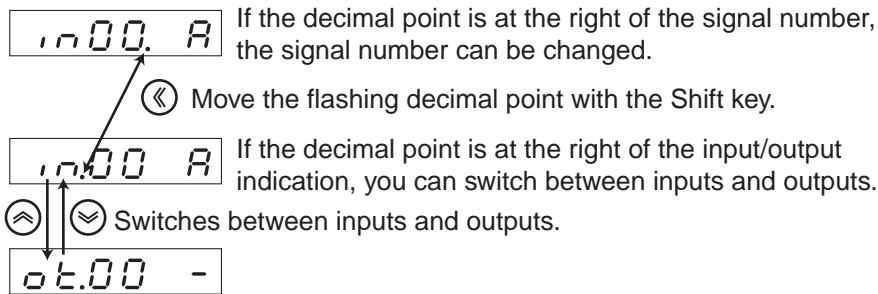

The following procedure can also be used to switch between inputs and outputs.

Press the Increment or Decrement key to select the signal number to be monitored.

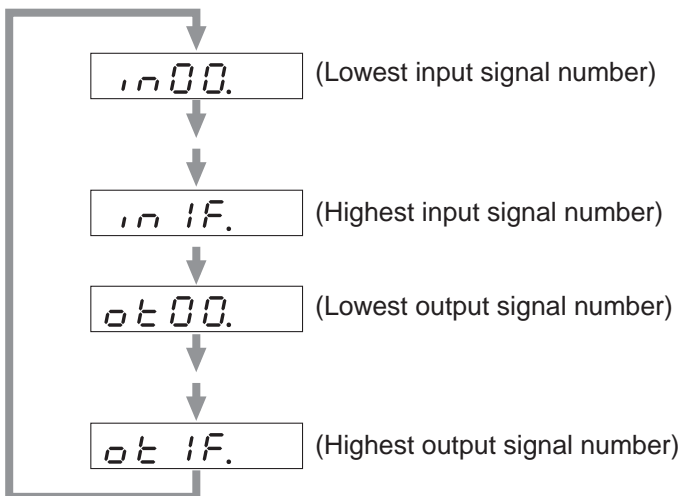

■ Alarm History

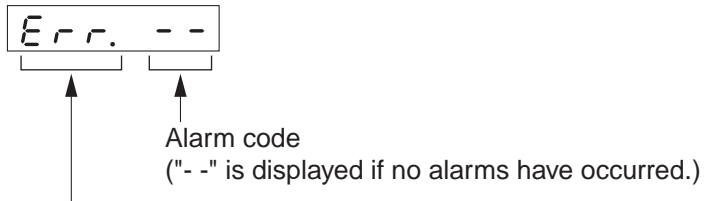

E r r . : Current alarm

E - 0 . : Alarm 0 (newest alarm)

E 13 . : Alarm 13 (oldest alarm)

- ♦ Up to the most recent 14 alarms, including the current one, can be viewed in the alarm history.
- ♦ The display will flash when an alarm occurs.
- ♦ If an alarm that is recorded in the history occurs, the alarm code for the current alarm and for alarm 0 will be the same.

Alarm Codes and Meanings

Alarm Codes	Meaning	Alarm Codes	Meaning
11	Control power supply undervoltage	40	Absolute encoder system down error ABS
12	Overvoltage	41	Absolute encoder counter overflow error ABS
13	Main power supply undervoltage	42	Absolute encoder overspeed error ABS
14	Overcurrent	44	Absolute encoder one-turn counter error ABS
15	Servo Drive overheat	45	Absolute encoder multi-turn counter error ABS
16	Overload	47	Absolute encoder status error ABS
18	Regeneration overload	48	Encoder phase Z error
21	Encoder communications error	49	Encoder PS signal error
23	Encoder communications data error	82	Node address setting error
24	Deviation counter overflow	83	Communications error
26	Overspeed	84	Transmission cycle error
27	Command error	86	Watchdog data error
29	Internal deviation counter overflow	87	Emergency stop input error
34	Overrun limit error	90	Transmission cycle setting error
36	Parameter error	91	SYNC command error
37	Parameter corruption	93	Parameter setting error
38	Drive prohibit input error	95	Servomotor non-conformity
		Others	Other errors

Note The following alarms are not recorded in the history.

- 11: Control power supply undervoltage
- 13: Main power supply undervoltage
- 36: Parameter error
- 37: Parameter corruption
- 38: Drive prohibit input error
- 87: Emergency stop input error
- 95: Servomotor non-conformity

■ Software Version

A-1.01

◆ Displays the software version of the Servo Drive.

■ Warning Display

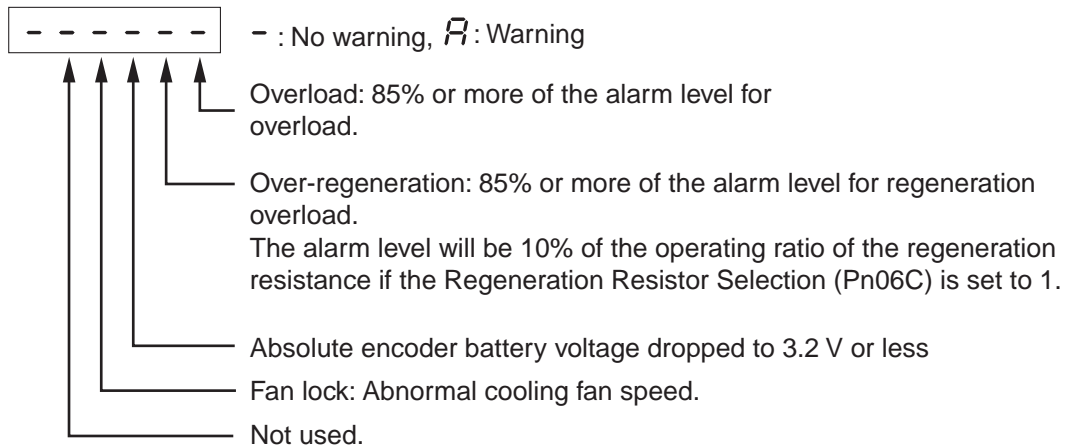

■ Regeneration Load Ratio



◆ Displays the regeneration resistance load ratio as a percentage of the detection level for the regeneration load.

■ Overload Load Ratio



◆ Displays the load ratio as a percentage of the rated load.

■ Inertia Ratio



Displays the inertia ratio as a percentage.

■ Total Feedback Pulses and Total Command Pulses



◆ Displays the total number of pulses after the power supply is turned ON.
◆ The display will overflow as shown in the following figure.

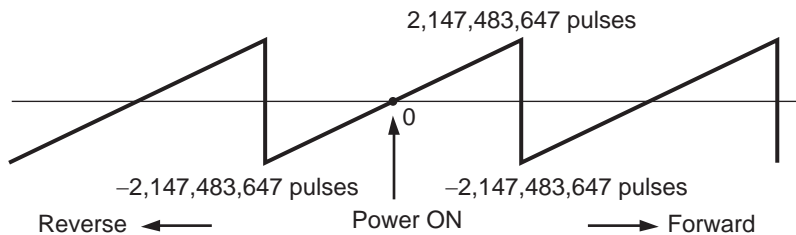

◆ Use the \llcorner key to switch the display between the upper and lower digits of the total number of pulses.



Hold down the DATA key for 5 s or longer to reset the total pulses to 0.

■ Automatic Servomotor Recognition









Automatic recognition enabled (Always this indication is displayed.)

Parameter Setting Mode

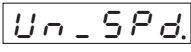
■ 16-bit Positioning Parameters

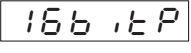

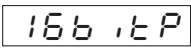

1. Displaying Parameter Setting Mode

Key operation	Display example	Explanation
		The item set for the Default Display (Pn001) is displayed.
		Press the  key to display Monitor Mode.
		Press the  key to display Parameter Setting Mode.



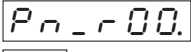





2. Selecting the Parameter Type

Key operation	Display example	Explanation
		Confirm that 16-bit Parameter is selected.



3. Switching to the Parameter Setting Display

Key operation	Display example	Explanation
	 	Press the  key to go to the Parameter Setting Display. Press the  key to return to the Parameter Type Selection Display.





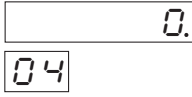

4. Setting the Parameter Number

Key operation	Display example	Explanation
  	 	Use the  ,  , and  keys to set the parameter number. If the parameter number is large, the setting can be made more quickly by using the  key to change the digit that is being set. The decimal point will flash for the digit that can be set.

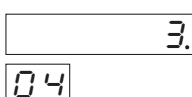

5. Displaying the Parameter Setting

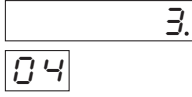
Key operation	Display example	Explanation
		Press the  key to display the setting. The selected parameter number appears in the sub window.

6. Changing the Parameter Setting

Key operation	Display example	Explanation
		Use the  ,  , and  keys to change the setting. The decimal point will flash for the digit that can be set.
		Press the  key to save the new setting.

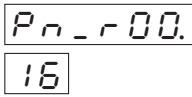
7. Returning to Parameter Setting Mode

Key operation	Display example	Explanation
		Press the  key to return to Parameter Setting Mode.

Precautions for Correct Use

- Some parameters will be displayed with an "r" before the number when the display returns to Parameter Setting Mode. To enable the settings that have been changed for these parameters, you must turn the power supply OFF and ON after saving the parameters to the EEPROM.
- When the setting for a parameter is saved, the new setting will be used for control. Make gradual rather than large changes when changing values for parameters that affect the motor operation significantly. This is particularly true for the speed loop gain and position loop gain.
- For details on parameters, refer to *Parameter Tables* on page 5-61.

6-4 Setting the Mode

■ 32-bit Positioning Parameters

1. Displaying Parameter Setting Mode

Key operation	Display example	Explanation
		The item set for the Default Display (Pn001) is displayed.
		Press the key to display Monitor Mode.
		Press the key to display Parameter Setting Mode.

2. Selecting the Parameter Type

Key operation	Display example	Explanation
		Press the and keys to select 32-bit parameters.





3. Switching to the Parameter Setting Display

Key operation	Display example	Explanation
	 	Press the key to go to the Parameter Setting Display. Press the key to return to the Parameter Type Selection Display.



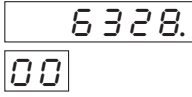

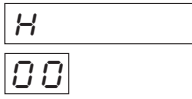

4. Setting the Parameter Number

Key operation	Display example	Explanation
 	 	Use the , , and keys to set the parameter number. If the parameter number is large, the setting can be made more quickly by using the key to change the digit that is being set. The decimal point will flash for the digit that can be set.

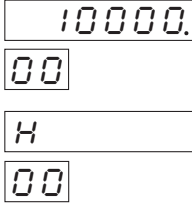

5. Displaying the Parameter Setting

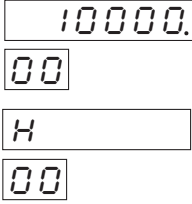
Key operation	Display example	Explanation
		Press the  key to display the setting. The selected parameter number appears in the sub window.
		32-bit parameters have many digits and thus displayed on two displays. Press the  key to change the display. Negative values of the parameter are indicated with a dot.

6. Changing the Parameter Setting

Key operation	Display example	Explanation
		Use the  ,  , and  keys to change the setting. The decimal point will flash for the digit that can be set.
		Press the  key to save the new setting.

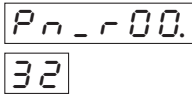
7. Returning to Parameter Setting Mode

Key operation	Display example	Explanation
		Press the  key to return to Parameter Setting Mode.

Precautions for Correct Use

- Some parameters will be displayed with an "r" before the number when the display returns to Parameter Setting Mode. To enable the settings that have been changed for these parameters, you must turn the power supply OFF and ON after saving the parameters to the EEPROM.
- When the setting for a parameter is saved, the new setting will be used for control. Make gradual rather than large changes when changing values for parameters that affect the motor operation significantly. This is particularly true for the speed loop gain and position loop gain.
- For details on parameters, refer to *Parameter Tables* on page 5-61.

6-4 Setting the Mode

■ Servo Parameters

1. Displaying Parameter Setting Mode

Key operation	Display example	Explanation
		The item set for the Default Display (Pn001) is displayed.
		Press the key to display Monitor Mode.
		Press the key to display Parameter Setting Mode.

2. Selecting the Parameter Type

Key operation	Display example	Explanation
		Press the and keys to select the servo parameter.



3. Switching to the Parameter Setting Display

Key operation	Display example	Explanation
	 	Press the key to go to the Parameter Setting Display. Press the key to return to the Parameter Type Selection Display.





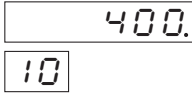

4. Setting the Parameter Number

Key operation	Display example	Explanation
 	 	Use the , , and keys to set the parameter number. If the parameter number is large, the setting can be made more quickly by using the key to change the digit that is being set. The decimal point will flash for the digit that can be set.

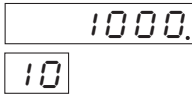

5. Displaying the Parameter Setting

Key operation	Display example	Explanation
		Press the  key to display the setting. The selected parameter number appears in the sub window.

6. Changing the Parameter Setting

Key operation	Display example	Explanation
		Use the  ,  , and  keys to change the setting. The decimal point will flash for the digit that can be set.
		Press the  key to save the new setting.

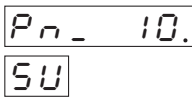
7. Returning to Parameter Setting Mode

Key operation	Display example	Explanation
		Press the  key to return to Parameter Setting Mode.







Precautions for Correct Use

- ♦ Some parameters will be displayed with an "r" before the number when the display returns to Parameter Setting Mode. To enable the settings that have been changed for these parameters, you must turn the power supply OFF and ON after saving the parameters to the EEPROM.
- ♦ When the setting for a parameter is saved, the new setting will be used for control. Make gradual rather than large changes when changing values for parameters that affect the motor operation significantly. This is particularly true for the speed loop gain and position loop gain.
- ♦ For details on parameters, refer to *Parameter Tables* on page 5-61.



Parameter Write Mode

Settings changed in the Parameter Setting Mode must be saved to the EEPROM. To do so, the following procedure must be performed.

1. Saving Changed Settings

Key operation	Display example	Explanation
	<code>EE_SEt</code>	Press the  key to display Parameter Write Mode.
	<code>EEP -.</code>	Press the  key to switch to Parameter Write Mode.
	<code>EEP --.</code>	Press the  key for 5 s or longer.
	<code>-----.</code>	The bar indicator will increase.
	<code>StArt</code>	Writing will start. (This display will appear only momentarily.)
	<code>FinIsh.</code>	This display indicates a normal completion. In addition to the <code>FinIsh.</code> , either <code>rESEt.</code> or <code>ErRor.</code> may be displayed. If <code>rESEt.</code> is displayed, writing has been completed normally, but some of the changed parameters will be enabled only after the power has been turned OFF and ON again. Turn OFF the Servo Drive power supply and then turn it ON again. <code>ErRor.</code> is displayed if there is a writing error. Write the data again.

2. Returning to Parameter Write Mode

Key operation	Display example	Explanation
	<code>EE_SEt</code>	Press the  key to return to the Parameter Write Mode Display.







Precautions for Correct Use

- ♦ If a write error occurs, write the data again. If write errors continue to occur, there may be a fault in the Servo Drive.
- ♦ Do not turn OFF the power supply while writing to EEPROM. Incorrect data may be written if the power supply is turned OFF. If the power supply is turned OFF, perform the settings again for all parameters, and write the data again.
- ♦ Do not disconnect the Parameter Unit from the Servo Drive during the time from writing start (`StArt`) to writing completion (`FinIsh.` or `rESEt.`). If the Parameter Unit is disconnected, repeat the procedure from the beginning.

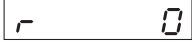





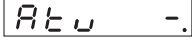

Normal Mode Autotuning

For details on normal mode autotuning, refer to 7-3 *Normal Mode Autotuning* on page 7-9. This section describes the operating procedure only.



1. Displaying Normal Mode Autotuning

Key operation	Display example	Explanation
		The item set for the Default Display (Pn001) is displayed.
		Press the  key to display Monitor Mode.
		Press the  key three times to display Normal Mode Autotuning.

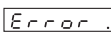
2. Executing Normal Mode Autotuning

Key operation	Display example	Explanation
		Press the  key to switch to Normal Mode Autotuning.
		Press and hold the  key until  is displayed. The bar indicator will increase when the key is pressed for 5 s or longer.
		The bar indicator will increase.
		The Servomotor will start, and normal mode autotuning will begin.
		This display indicates a normal completion.  will be displayed if a tuning error has occurred.

3. Returning to Normal Mode Autotuning

Key operation	Display example	Explanation
		Press the  key to return to Normal Mode Autotuning.

Precautions for Correct Use

- ♦ For details on normal mode autotuning, refer to 7-3 *Normal Mode Autotuning* on page 7-9. This section describes the operating procedure only.
- ♦ Always save each gain value changed with normal mode autotuning in the EEPROM so that the data is not lost when the power is turned OFF or for some other reason.
- ♦ If a normal mode autotuning error occurs, the values for each gain will return to the value before executing normal mode autotuning.

Auxiliary Function Mode

Auxiliary Function Mode includes alarm reset, absolute encoder reset, and jog operation.

Displaying Auxiliary Function Mode

Key operation	Display example	Explanation
		The item set for the Default Display (Pn001) is displayed.
		Press the key to display Monitor Mode.
		Press the key four times to display Auxiliary Function Mode.

■ Alarm Reset

1. Executing Alarm Reset









Key operation	Display example	Explanation
		Press the key to switch to Alarm Reset Mode.
		Press and hold the key until is displayed. The bar indicator will increase when the key is pressed for 5 s or longer.
		The bar indicator will increase.
		Alarm reset will start.
		This display indicates a normal completion. will be displayed if the alarm could not be reset. Reset the power supply to clear the error.

2. Returning to Auxiliary Function Mode

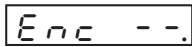

Key operation	Display example	Explanation
		Press the key to return to Auxiliary Function Mode.

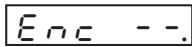
■ Absolute Encoder Reset **ABS**

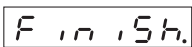
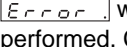
1. Executing Absolute Encoder Reset

Key operation	Display example	Explanation
		Press the  key to switch to Absolute Encoder Reset Mode.
		Press and hold the  key until  is displayed. The bar indicator will increase when the key is pressed for 5 s or longer.
		The bar indicator will increase.
		Absolute encoder reset will start.
		This display indicates a normal completion.  will be displayed if the absolute encoder reset could not be performed. Check whether an unsupported encoder is connected, and then perform the procedure again.

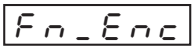
2. Returning to Auxiliary Function Mode













Key operation	Display example	Explanation
		Press the  key to return to Auxiliary Function Mode.

Precautions for Correct Use



- ♦ The absolute encoder can be reset only for systems that use an absolute encoder.
- ♦ Do not disconnect the Parameter Unit from the Servo Drive until resetting the absolute encoder has completed. If the Parameter Unit is disconnected, reconnect it and make the settings from the beginning.

■ Jog Operation

1. Executing Jog Operation

Key operation	Display example	Explanation
	<code>Fn_JoG.</code>	Press the  key to display Jog Operation Mode from the alarm reset display in Auxiliary Function Mode.
	<code>JoG -.</code>	Press the  key to switch to Jog Operation Mode.
	<code>JoG --.</code>	Press and hold the  key until "Ready" is displayed. The bar indicator will increase when the key is pressed for 5 s or longer.
	<code>- - - - -.</code>	The bar indicator will increase.
	<code>r.ERdy</code>	This completes preparations for jog operation.
	<code>r.ERdy.</code>	Press and hold the  key until "Sev_on" is displayed. The decimal point will move to the left when the key is pressed for 3 s or longer.
	<code>r.ERdy</code>	
	<code>SrU_on</code>	The Servo will turn ON.
 	<code>SrU_on</code>	Forward operation will be performed while the  key is pressed, and reverse operation will be performed while the  key is pressed. The Servomotor will stop when the key is released. The speed set for the Jog Speed (Pn03D) will be used for jogging.

2. Returning to Auxiliary Function Mode







Key operation	Display example	Explanation
	<code>Fn_JoG.</code>	Press the  key to return to Auxiliary Function Mode. The Servo lock will be released.

Copy Mode



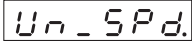

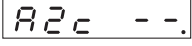

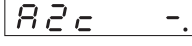

In Copy Mode, user parameters set in the Servo Drive can be copied to the Parameter Unit, and user parameters stored in the Parameter Unit can be copied to the Servo Drive. This function can be used to easily set the same user parameters for more than one Servo Drive. All parameters (Servo, 16-bit, and 32-bit) will be copied collectively.

■ Copying from the Servo Drive to the Parameter Unit

1. Displaying Copy Mode

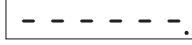
Key operation	Display example	Explanation
		The item set for the Default Display (Pn001) is displayed.
		Press the  key to display Monitor Mode.
		Press the  key five times to display Copy Mode.

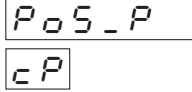
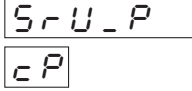
2. Executing Copying

Key operation	Display example	Explanation
		Press the  key to switch to Copy Mode.
		Press and hold the  key until "EEPCLR" is displayed. The bar indicator will increase when the key is pressed for 3 s or longer.
		The indicator bar will increase.
		Initialization of the EEPROM in the Parameter Unit will start.
		The positioning parameters are copied.
		The Servo parameters and the model code are copied.
		This display indicates a normal completion.

3. Returning to Copy Mode

Key operation	Display example	Explanation
		Press the key to return to Copy Mode.

Precautions for Correct Use

- ♦ If is displayed before completion, repeat the procedure from the beginning. Press the key to clear the error.
- ♦ Do not disconnect the Parameter Unit from the Servo Drive while copying is being performed. If the Parameter Unit is disconnected, connect it and then repeat the procedure from the beginning.
- ♦ If errors are repeatedly displayed, the following may be the cause: cable disconnection, connector contact failure, incorrect operation due to noise, or EEPROM fault in the Parameter Unit.

■ Copying from the Parameter Unit to the Servo Drive



1. Displaying Copy Mode

Key operation	Display example	Explanation
		The item set for the Default Display (Pn001) is displayed.
		Press the key to display Monitor Mode.
		Press the key five times to display Copy Mode.
		Press the key to switch to the copy display for copying from the Parameter Unit to the Servo Drive.

2. Checking the Servo Drive Model Code

Key operation	Display example	Explanation
		Press the key to switch to Copy Mode.
		Press and hold the key until "EEP_CH" is displayed. If the model codes do not match, "DIFFER" will be displayed. The bar indicator will increase when the key is pressed for 3 s or longer.
		The bar indicator will increase. The Servo Drive model code is being checked. If a different model code has been entered, refer to 3. <i>Different Model Codes</i> on the next page to perform the procedure. If the model codes match, the display will proceed to the display in 4. <i>Executing Copying</i> .



3. Different Model Codes

Key operation	Display example	Explanation
	<code>d . F F E r .</code>	The decimal point will move to the left when the  key is pressed for 3 s or longer.
	<code>d . F F E . r</code>	The model codes are being matched.
	<code>d . F F E r</code>	Press the  key to cancel copying before completion.

4. Executing Copying

Key operation	Display example	Explanation
	<code>EEP_ch</code> <code>--</code>	Writing user parameters to the EEPROM of the Servo Drive will start.
	<code>POS_P</code> <code>CP</code>	The positioning parameters are copied.
	<code>Srv_P</code> <code>CP</code>	The Servo parameters are copied.
	<code>Finish.</code>	This display indicates a normal completion.

5. Returning to Copy Mode

Key operation	Display example	Explanation
	<code>CF_c2A.</code>	Press the  key to return to Copy Mode.

Precautions for Correct Use

- ♦ If `Error` is displayed before completion, repeat the procedure from the beginning.
- ♦ Press the  key to clear the error.
- ♦ If errors are repeatedly displayed, the following may be the cause: cable disconnection, connector contact failure, incorrect operation due to noise, or EEPROM fault in the Parameter Unit.
- ♦ Do not disconnect the Parameter Unit from the Servo Drive while copying is being performed. If the Parameter Unit is disconnected, incorrect data may be written and the data may be corrupted. Copy the user parameters again from the source Servo Drive to the Parameter Unit, and then copy the user parameters from the Parameter Unit to the other Servo Drive.

6-5 Trial Operation

When you have finished installation, wiring, and switch settings and have confirmed that status is normal after turning ON the power supply, perform trial operation. The main purpose of trial operation is to confirm that the servo system is electrically correct.

If an error occurs during the trial operation, refer to *Chapter 8 Troubleshooting* to eliminate the cause. Then check for safety, and then retry the trial operation.

Preparation for Trial Operation

■ Checks before Trial Operation

Check the following items before starting trial operation.

Wiring

- ♦ Make sure that all wiring is correct, especially the power supply input and motor output.
- ♦ Make sure that there are no short-circuits. Check the ground for short-circuits as well.
- ♦ Make sure that there are no loose connections.

Power Supply Voltage

- ♦ Make sure that the voltage corresponds to the rated voltage.

Motor Installation

- ♦ Make sure that the Servomotor has been securely installed.

Disconnection from Mechanical System

- ♦ If necessary, make sure that the Servomotor has been disconnected from the mechanical system.

Brake

- ♦ Make sure that the brake has been released.

Trial Operation with CX-Drive

1. Connect connector CN1.
2. Input power (12 to 24 VDC) for the control signals (+24VIN, COM).
3. Turn ON the power supply to the Servo Drive.
4. Confirm that the parameters are set to the standard settings.
5. Connect the Computer Communications Cable to CN3, and write parameters from CX-Drive.
6. Write the parameters to EEPROM and then turn OFF the power supply and turn it ON again.
7. Turn the status to Servo ON with jog operation via CX-Drive, and Servo lock the motor.
8. Perform low speed jog operation via CX-Drive.
9. Check the Servomotor rotation speed.

Chapter 7

Adjustment Functions

7-1	Gain Adjustment.....	7-1
	Purpose of the Gain Adjustment.....	7-1
	Gain Adjustment Methods.....	7-1
	Gain Adjustment Procedure.....	7-2
7-2	Realtime Autotuning.....	7-3
	Realtime Autotuning Setting Method.....	7-4
	Machine Rigidity Setting Method.....	7-4
7-3	Normal Mode Autotuning.....	7-9
	Setting the Parameters.....	7-9
7-4	Manual Tuning.....	7-14
	Basic Settings.....	7-14

7-1 Gain Adjustment

OMNUC G-Series Servo Drives provide realtime autotuning and normal mode autotuning functions. With these functions, gain adjustments can be made easily even by those who use a servo system for the first time. Use manual tuning if autotuning does not provide the desired response.

Purpose of the Gain Adjustment

The Servomotor must operate in response to commands from the host system with minimal time delay and maximum reliability. The gain is adjusted to bring the actual operation of the Servomotor as close as possible to the operations specified by the commands, and to maximize the performance of the machine.

Example: Ball screw

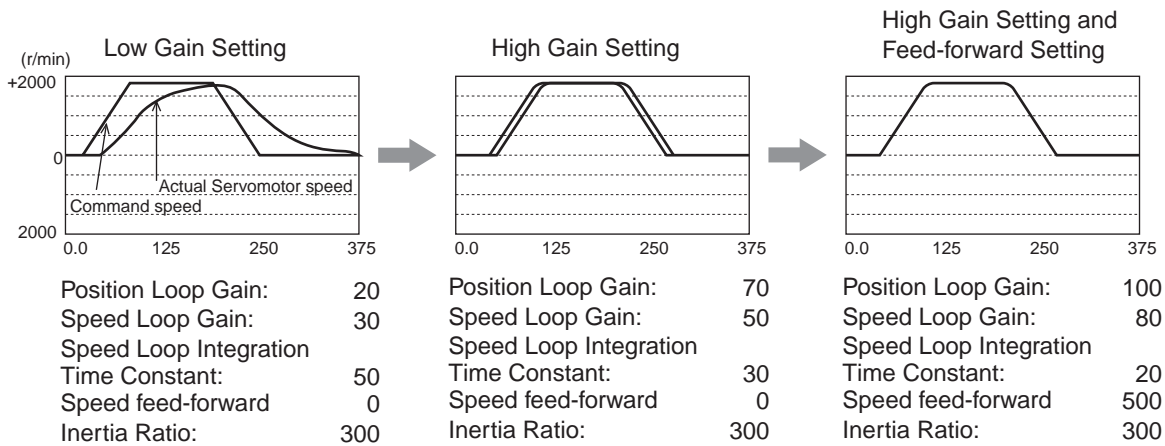

Gain Adjustment Methods

Function		Explanation	Reference page
Automatic adjustment	Realtime autotuning	Realtime autotuning estimates the load inertia of the mechanical system in realtime and automatically sets the optimal gain according to the estimated load inertia.	7-3
	Normal mode autotuning	Normal mode autotuning automatically sets the appropriate gain by operating the Servomotor with the command pattern generated automatically by the Servo Drive and estimating the load inertia from the torque required at that time.	7-9
Manual adjustment	Manual tuning	Manual tuning is performed if autotuning cannot be executed due to restrictions on the control mode or load conditions, or if maximum responsiveness needs to be ensured to match each load.	7-14
	Basic procedure	Position control mode adjustment	7-15
		Speed control mode adjustment	7-16
Torque control mode adjustment		7-21	

Note 1. Take sufficient care for safety.

Note 2. If there is oscillation (e.g., abnormal sound or vibration), immediately turn OFF the power supply or let the servo OFF status occur.

Gain Adjustment Procedure

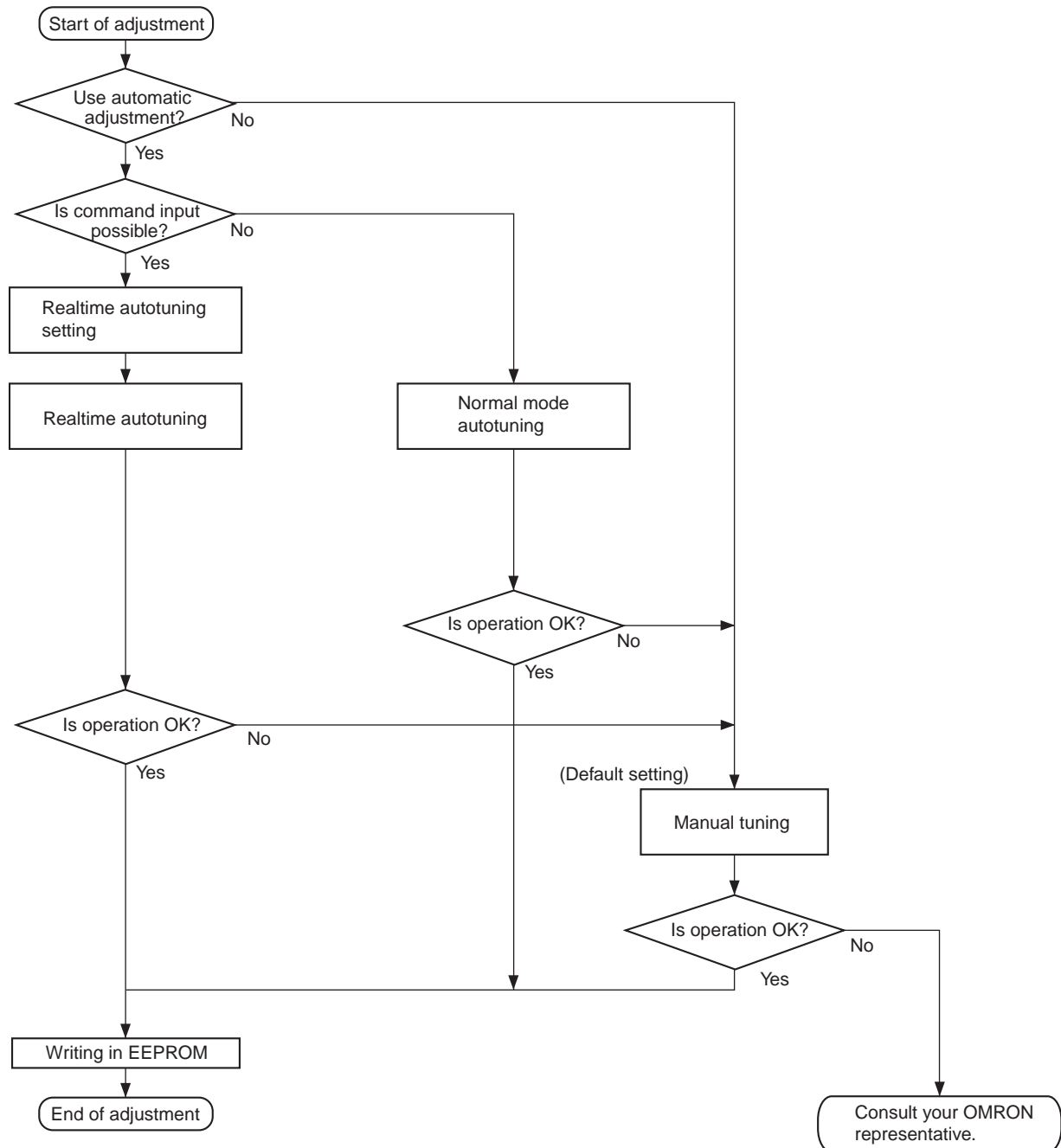

■ Gain Adjustment and Machine Rigidity

Do the following to increase the machine rigidity:

- ◆ Install the machine on a secure base so that it does not wobble.
- ◆ Use couplings that have a high rigidity, and that are designed for servo systems.
- ◆ Use a wide timing belt, and use a tension within the allowable axial load for the Servomotor or decelerator's output.
- ◆ Use gears with small backlash.

The specific vibration (resonance frequency) of the mechanical system has a large impact on gain adjustment. The responsiveness of the servo system cannot be set high for machines with a low resonance frequency (low machine rigidity).

7-2 Realtime Autotuning

Realtime autotuning estimates the load inertia of the mechanical system in realtime and operates the system by automatically setting the gain according to the estimated load inertia. By executing autotuning with the adaptive filter enabled, you can also reduce vibration and resonance. Realtime autotuning adjusts the PI control for the speed loop, and is thus effective for all controls.

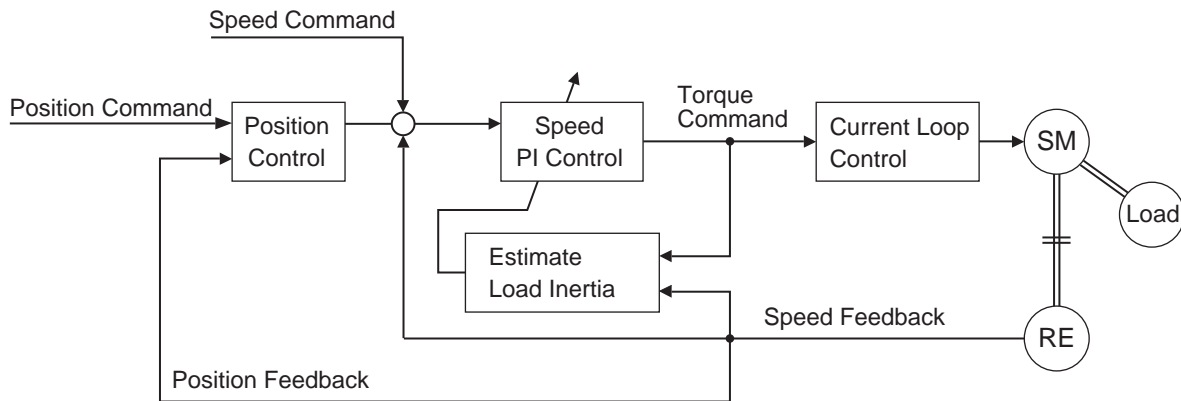

7

Precautions for Correct Use ♦ Realtime autotuning may not function properly under the conditions described in the following table. If realtime autotuning does not function properly, use normal mode autotuning or manual tuning.

	Conditions under which realtime autotuning does not function properly
Load inertia	<ul style="list-style-type: none"> ♦ If the load inertia is too small or too large compared with the rotor inertia (i.e., less than 3 times, more than 20 times, or more than the applicable load inertia ratio). ♦ If the load inertia changes quickly, i.e., in less than 10 seconds.
Load	<ul style="list-style-type: none"> ♦ If the machine rigidity is extremely low. ♦ If there is backlash or play in the system.
Operating pattern	<ul style="list-style-type: none"> ♦ If the speed is continuously run at a low speed below 100 r/min. ♦ If the acceleration/deceleration gradually changes at less than 2,000 r/min in 1 s. ♦ If the acceleration/deceleration torque is too small compared with the unbalanced load and the viscous friction torque. ♦ If a speed of 100 r/min or an acceleration/deceleration of 2,000 r/min/s does not continue for at least 50 ms.

♦ With realtime autotuning, the parameters are fixed to the values in the machine rigidity table when the machine rigidity is set. The operating coefficients for the speed loop gain and the integration time constant are changed by estimating the load inertia based on the operating pattern. Set the estimated values gradually because setting different values for the patterns may cause vibration.

Realtime Autotuning Setting Method

1. Turn the servo OFF before setting realtime autotuning.

2. Set the Realtime Autotuning Mode Selection (Pn021) according to the load.

Setting the parameter to 3 or 6 will allow the system to respond faster to inertia changes during operation. However, it may also cause operation to become unstable depending on the operating pattern. Normally use a setting of 1 or 4.

Use a setting of 4 to 6 when the vertical axis is used.

Gain switching is enabled for a setting of 1 to 6.

If change in operation due to gain switching becomes an issue, use a setting of 7.

Setting	Realtime autotuning	Degree of change in load inertia
0	Disabled (default)	---
1	Horizontal axis mode	Almost no change
2		Gradual changes
3		Sudden changes
4	Vertical axis mode	Almost no change
5		Gradual changes
6		Sudden changes
7	Gain switching disable mode	Almost no change

Machine Rigidity Setting Method

1. Set the Realtime Autotuning Machine Rigidity Selection (Pn022) as shown below.

Machine rigidity 0 cannot be selected for the Parameter Unit and CX-Drive.

Set the machine rigidity starting with a low value and check the operation.

Mechanical Configuration / Drive System	Realtime Autotuning Machine Rigidity Selection (Pn022)
Ball screw direct coupling	6 to C
Ball screw and timing belt	4 to A
Timing belt	2 to 8
Gears, rack and pinion drives	2 to 8
Machines with low rigidity, etc	1 to 4
Stacker crane	Tune manually.

2. Turn the servo ON, and operate the machine with the normal pattern.

To improve the response, increase the machine rigidity number, and then check the response again. If vibration occurs, enable the adaptive filter. If the filter is already enabled, lower the machine rigidity number and make adjustments.

3. If there is no problem with the operation, turn the servo OFF, and disable the Realtime Autotuning Mode Selection (Pn021) by setting it to 0.

The adaptive filter can be left enabled. To disable the adaptive filter, read the frequency on the Adaptive Filter Table Number display, and set the Notch Filter 1 Frequency to the same value.

Precautions for Correct Use

- ♦ Unusual noise or vibration may occur until the load inertia is estimated or the adaptive filter stabilizes after startup, immediately after the first servo ON, or when the Realtime Autotuning Machine Rigidity Selection (Pn022) is increased. This is not a problem if it disappears right away. If the unusual noise or vibration, however, continues for three or more reciprocating operations, take the following measures in any order you can.
 - ♦ Write the parameters used during normal operation to the EEPROM.
 - ♦ Lower the Realtime Autotuning Machine Rigidity Selection (Pn022).
 - ♦ Manually set the notch filter.
 - ♦ Once unusual noise or vibration occurs, the Inertia Ratio (Pn020) may have changed to an extreme value. In this case, also take the measures described above.
 - ♦ Out of the results of realtime autotuning, the Inertia Ratio (Pn020) is automatically saved to the EEPROM every 30 minutes. Realtime autotuning will use this saved data as the default value when the power is turned OFF and turned ON again.
 - ♦ The Instantaneous Speed Observer Setting (Pn027) will automatically be disabled (0) if realtime autotuning is enabled.
-

Operating Procedure

Insert the Parameter Unit connector into CN3 of the Servo Drive and turn ON the Servo Drive power supply.

r 0

Setting Parameter Pn021

Press the  key.

Un_SpD.

Press the  key.

16bitP



Press the  key.

SErUoP

Press the  key.

Pn_00.

SU



Select the number of the parameter to be set by using the  and  keys.
(Pn021 is selected in this example.)

Pn_21.

SU

Press the  key.

0.

Change the value by using the  and  keys.

21

Press the  key.

Pn_21.

SU

Setting Parameter Pn022

Select Pn022 by using the  key.

Pn_22.

SU

Press the  key.

2.

Increase the value by using the  key.

22

(Default setting)

Decrease the value by using the  key.

Press the  key.

Writing to EEPROM

Press the  key.

EE_Set.

Press the  key.

EEP -.

The bars as shown in the figure on the right will increase when the  key is pressed down for approx. 5 s.

EEP --.

-----.

Writing will start (momentary display).

StArT

End

FinIsh.

rESEt.

Error.

Writing completed.

Writing error occurred.

7-2 Realtime Autotuning

Realtime Autotuning (RTAT) Parameter Tables

Parameter No.	Parameter name	AT Mode Selection (Pn021)	AT Machine Rigidity Selection (Pn022)							
			0	1	2	3	4	5	6	7
Pn010	Position Loop Gain	---	120	320	390	480	630	720	900	1080
Pn011	Speed Loop Gain	---	90	180	220	270	350	400	500	600
Pn012	Speed Loop Integration Time Constant	---	620	310	250	210	160	140	120	110
Pn013	Speed Feedback Filter Time Constant	---	0	0	0	0	0	0	0	0
Pn014	Torque Command Filter Time Constant* ¹	---	253	126	103	84	65	57	45	38
Pn015	Speed Feed-forward Amount	---	300	300	300	300	300	300	300	300
Pn016	Feed-forward Filter Time Constant	---	50	50	50	50	50	50	50	50
Pn017	Reserved	---	0	0	0	0	0	0	0	0
Pn018	Position Loop Gain 2	---	190	380	460	570	730	840	1050	1260
Pn019	Speed Loop Gain 2	---	90	180	220	270	350	400	500	600
Pn01A	Speed Loop Integration Time Constant 2	1, 2, 3, 7	10000	10000	10000	10000	10000	10000	10000	10000
		4, 5, 6	9999	9999	9999	9999	9999	9999	9999	9999
Pn01B	Speed Feedback Filter Time Constant 2	---	0	0	0	0	0	0	0	0
Pn01C	Torque Command Filter Time Constant 2* ¹	---	253	126	103	84	65	57	45	38
Pn020	Inertia Ratio	---	Estimated load inertia ratio							
Pn027	Instantaneous Speed Observer Setting	---	0	0	0	0	0	0	0	0
Pn030	Gain Switching Operating Mode Selection	---	1	1	1	1	1	1	1	1
Pn031	Gain Switch Setting* ³	1 to 6	10	10	10	10	10	10	10	10
		7	0	0	0	0	0	0	0	0
Pn032	Gain Switch Time	---	30	30	30	30	30	30	30	30
Pn033	Gain Switch Level Setting	---	50	50	50	50	50	50	50	50
Pn034	Gain Switch Hysteresis Setting	---	33	33	33	33	33	33	33	33
Pn035	Position Loop Gain Switching Time	---	20	20	20	20	20	20	20	20

Parameter No.	Parameter name	AT Mode Selection (Pn021)	AT Machine Rigidity Selection (Pn022)							
			8	9	A	B	C	D	E	F
Pn010	Position Loop Gain	---	1350	1620	2060	2510	3050	3770	4490	5570
Pn011	Speed Loop Gain	---	750	900	1150	1400	1700	2100	2500	3100
Pn012	Speed Loop Integration Time Constant	---	90	80	70	60	50	40	40	30
Pn013	Speed Feedback Filter Time Constant	---	0	0	0	0	0	0	0	0
Pn014	Torque Command Filter Time Constant ^{*1}	---	30	25	20 ^{*2}	16 ^{*2}	13 ^{*2}	11 ^{*2}	10 ^{*2}	10 ^{*2}
Pn015	Speed Feed-forward Amount	---	300	300	300	300	300	300	300	300
Pn016	Feed-forward Filter Time Constant	---	50	50	50	50	50	50	50	50
Pn017	Reserved	---	0	0	0	0	0	0	0	0
Pn018	Position Loop Gain 2	---	1570	1820	2410	2930	3560	4400	5240	6490
Pn019	Speed Loop Gain 2	---	750	900	1150	1400	1700	2100	2100	3100
Pn01A	Speed Loop Integration Time Constant 2	1, 2, 3, 7	10000	10000	10000	10000	10000	10000	10000	10000
		4, 5, 6	9999	9999	9999	9999	9999	9999	9999	9999
Pn01B	Speed Feedback Filter Time Constant 2	---	0	0	0	0	0	0	0	0
Pn01C	Torque Command Filter Time Constant 2 ^{*2}	---	30	25	20 ^{*2}	16 ^{*2}	13 ^{*2}	11 ^{*2}	10 ^{*2}	10 ^{*2}
Pn020	Inertia Ratio	---	Estimated load inertia ratio							
Pn027	Instantaneous Speed Observer Setting	---	0	0	0	0	0	0	0	0
Pn030	Gain Switching Operating Mode Selection	---	1	1	1	1	1	1	1	1
Pn031	Gain Switch Setting ^{*3}	1 to 6	10	10	10	10	10	10	10	10
		7	0	0	0	0	0	0	0	0
Pn032	Gain Switch Time	---	30	30	30	30	30	30	30	30
Pn033	Gain Switch Level Setting	---	50	50	50	50	50	50	50	50
Pn034	Gain Switch Hysteresis Setting	---	33	33	33	33	33	33	33	33
Pn035	Position Loop Gain Switching Time	---	20	20	20	20	20	20	20	20

♦ Parameters Pn015, 016, 01A, 030, and 032 to 035 are set to fixed values. The Servo Drive is set to rigidity No.2 as the default value.

*1. The lower limit is set to 10 when using a 17-bit encoder and 25 when using a 2,500-p/r encoder.

*2. The value for a 17-bit absolute encoder. The value for a 2500-p/r incremental encoder is 25.

*3. The default setting for the Servo Drive is 2 (switching from the network).

7-3 Normal Mode Autotuning

Normal mode autotuning is used to estimate the load inertia of the machine. Position data generated within the Servo Drive is used to operate the machine for the estimation, thereby achieving greater accuracy in estimating the load inertia. Normal mode autotuning can be used from the Parameter Unit or CX-Drive.

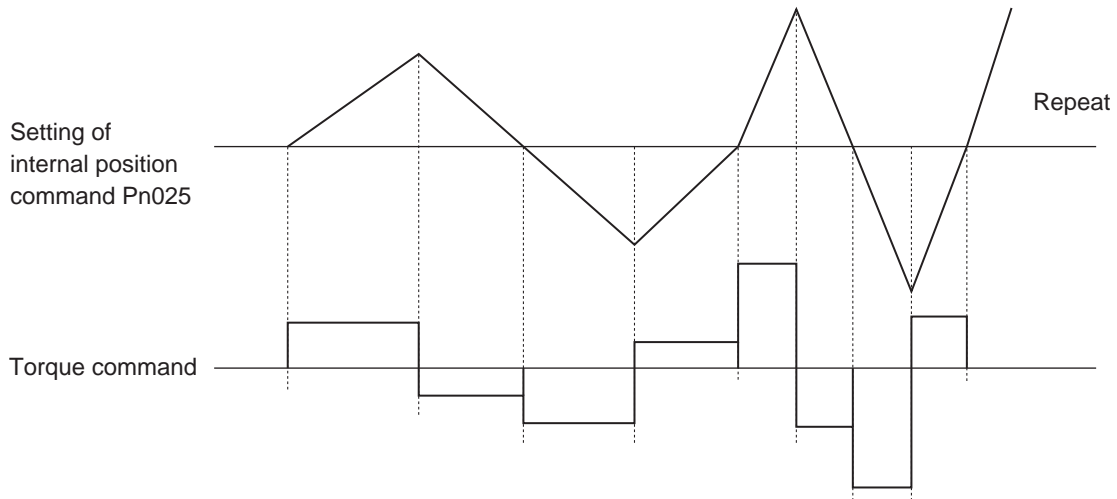
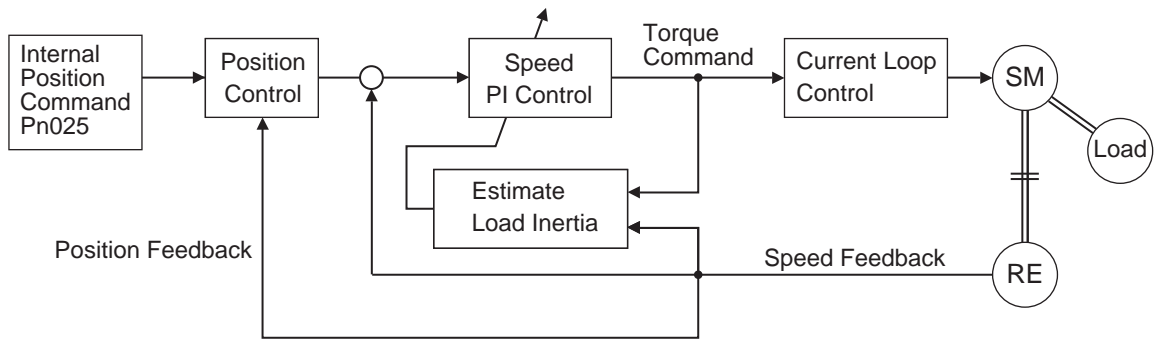

7 Adjustment Functions

Setting the Parameters

1. Set the operating pattern.

Set the operating pattern using the Normal Mode Autotuning Operation Setting (Pn025).

Setting	Number of rotations	Direction of rotation
0	Two rotations Repeat Multiple Times	Forward and Reverse (Alternating)
1		Reverse and Forward (Alternating)
2		Forward only
3		Reverse only
4	One rotation Repeat Multiple Times	Forward and Reverse (Alternating)
5		Reverse and Forward (Alternating)
6		Forward only
7		Reverse only

The following graph shows the speed operating pattern when the set value is 0.

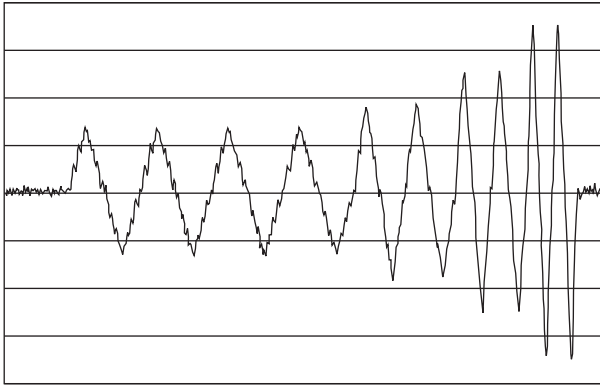

The operating pattern starts with 3 or 4 reciprocating operations, followed by up to 3 cycles of 2 reciprocations, with each cycle accelerated twice as much as the previous cycle. The acceleration will stop changing, as it is limited by the No. 1 Torque Limit (Pn05E). This is not an indication of failure.

2. Select the machine rigidity.

Set the machine rigidity number according to the rigidity of the machine. Refer to the following table for the machine rigidity values.

Machine rigidity 0 cannot be selected for the Parameter Unit and CX-Drive. Set the machine rigidity starting with a low value and check the operation.

Mechanical Configuration / Drive System	Machine Rigidity
Ball screw direct coupling	6 to C
Ball screw and timing belt	4 to A
Timing belt	2 to 8
Gears, rack and pinion drives	2 to 8
Machines with low rigidity, etc.	1 to 4
Stacker crane	Tune manually.

To improve the response, increase the machine rigidity number, and then check the response again. If vibration occurs, lower the machine rigidity number and make adjustments. The setting parameters are the same as in *Realtime Autotuning (RTAT) Parameter Tables* on page 7-7.

3. Execute normal mode autotuning.

Move the load to a position where it will not interfere with the operation performed according to the operation pattern. For reciprocating movement, ± 1 or ± 2 rotations will be made. For one-way movement, about 20 rotations will be made.

■ Operating with the Parameter Unit

1. Switch to the Normal Mode Autotuning display.

Servo lock is performed automatically.

For details on switching to the Normal Mode Autotuning display, refer to *Normal Mode Autotuning* on page 6-24.

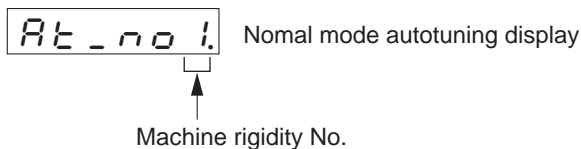

2. Select the machine rigidity.

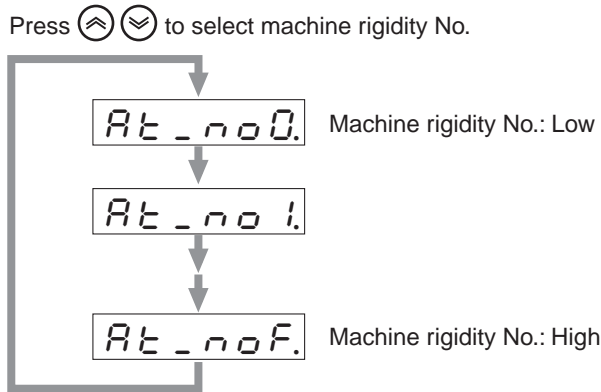

3. Switch to Normal Mode Autotuning.

After selecting the machine rigidity number, press the  key to switch to Normal Mode Autotuning. (For details on the operation, refer to *Normal Mode Autotuning* on page 6-24.)

 Normal mode autotuning

4. Execute normal mode autotuning.

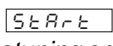
Press and hold the  key until the display changes to .

(For details on the operation, refer to *Normal Mode Autotuning* on page 6-24.)

The Servomotor rotates, and normal mode autotuning begins. The operating pattern will differ depending on the Normal Mode Autotuning Operation Setting (Pn025). If Pn025 is set to 0, the Servomotor will rotate twice in the forward/reverse directions for about 15 seconds. This cycle is repeated up to 5 times. There is no problem if operation ends before 5 cycles are completed. Repeat "Step 2 (Select the machine rigidity)" to "Step 4 (Execute normal mode autotuning)" until the satisfying response can be obtained.

5. Save the gain adjustment value.

Once the satisfying response is obtained, switch to Parameter Write Mode and save the gain values to the EEPROM. (For details on the operation, refer to *Parameter Write Mode* on page 6-23.)

To save the adjustment results, switch to Parameter Write Mode, and save the parameters to the EEPROM.

Precautions for Correct Use

- ♦ When using normal mode autotuning with a Servomotor with a brake, connect the brake interlock (BKIR) output signal to allow the brake to be released.
- ♦ If the Positioning Completion Range 1 (Pn060) is too narrow, it will cause an error. By default, the parameter is set to 25 for an incremental encoder. When using an absolute encoder, set the parameter to 250 (ten times larger).
- ♦ If the Deviation Counter Overflow Level (Pn209) is too small, it will cause a deviation counter overflow. When using an absolute encoder, increase the setting from 20,000 pulses (default) to 200,000 pulses.
- ♦ Set the Torque Limit Selection (Pn003) to 1. If the setting is too small, it will cause an error.
- ♦ The maximum motor output during normal mode autotuning will be limited by the No. 1 Torque Limit (Pn05E). If the value is too small, there may be problems with the operation.
- ♦ Actuating the network during normal mode autotuning will cause a command error (alarm code 27). Do not actuate the network while executing normal mode autotuning.
- ♦ The position data is initialized after normal mode autotuning.
- ♦ If the load inertia is less than 3 times the rotor inertia or greater than the applicable load inertia (20 to 30 times greater), there may be problems with the operation.
- ♦ If the machine rigidity is extremely low, or if the backlash is extremely large, estimation cannot be performed.
- ♦ If an error occurs or a drive prohibition input is received during normal mode autotuning, a tuning error will occur.
- ♦ If normal mode autotuning is executed and the load inertia cannot be estimated, the load inertia will remain the same as it was before normal mode autotuning.
- ♦ Executing normal mode autotuning may not cause an error but result in vibration. Use caution to ensure safety, and promptly turn OFF the power supply if anything unusual happens.

7-3 Normal Mode Autotuning

Normal Mode Autotuning (AT) Parameter Tables

Parameter No.	Parameter name	AT Machine Rigidity Selection (Pn022)															
		0	1	2	3	4	5	6	7	8	9	A	B	C	D	E	F
Pn010	Position Loop Gain	120	320	390	480	630	720	900	1080	1350	1620	2060	2510	3050	3770	4490	5570
Pn011	Speed Loop Gain	90	180	220	270	350	400	500	600	750	900	1150	1400	1700	2100	2500	3100
Pn012	Speed Loop Integration Time Constant	620	310	250	210	160	140	120	110	90	80	70	60	50	40	40	30
Pn013	Speed Feed-back Filter Time Constant	0	0	0	0	0	0	0	0	0	0	0	0	0	0	0	0
Pn014	Torque Command Filter Time Constant ^{*1}	253	126	103	84	65	57	45	38	30	25	20 ^{*2}	16 ^{*2}	13 ^{*2}	11 ^{*2}	10 ^{*2}	10 ^{*2}
Pn015	Speed Feed-forward Amount	300	300	300	300	300	300	300	300	300	300	300	300	300	300	300	300
Pn016	Feed-forward Filter Time Constant	50	50	50	50	50	50	50	50	50	50	50	50	50	50	50	50
Pn018	Position Loop Gain 2	190	380	460	570	730	840	1050	1260	1570	1820	2410	2930	3560	4400	5240	6490
Pn019	Speed Loop Gain 2	90	180	220	270	350	400	500	600	750	900	1150	1400	1700	2100	2100	3100
Pn01A	Speed Loop Integration Time Constant 2	9999	9999	9999	9999	9999	9999	9999	9999	9999	9999	9999	9999	9999	9999	9999	9999
Pn01B	Speed Feed-back Filter Time Constant 2	0	0	0	0	0	0	0	0	0	0	0	0	0	0	0	0
Pn01C	Torque Command Filter Time Constant 2 ^{*1}	253	126	103	84	65	57	45	38	30	25	20 ^{*2}	16 ^{*2}	13 ^{*2}	11 ^{*2}	10 ^{*2}	10 ^{*2}
Pn020	Inertia Ratio	Estimated load inertia ratio															
Pn027	Instantaneous Speed Observer Setting	0	0	0	0	0	0	0	0	0	0	0	0	0	0	0	0
Pn030	Gain Switching Operating Mode Selection	1	1	1	1	1	1	1	1	1	1	1	1	1	1	1	1
Pn031	Gain Switch Setting	10	10	10	10	10	10	10	10	10	10	10	10	10	10	10	10
Pn032	Gain Switch Time	30	30	30	30	30	30	30	30	30	30	30	30	30	30	30	30
Pn033	Gain Switch Level Setting	50	50	50	50	50	50	50	50	50	50	50	50	50	50	50	50
Pn034	Gain Switch Hysteresis Setting	33	33	33	33	33	33	33	33	33	33	33	33	33	33	33	33
Pn035	Position Loop Gain Switching Time	20	20	20	20	20	20	20	20	20	20	20	20	20	20	20	20

*1. The lower limit is set to 10 when using a 17-bit encoder and 25 when using a 2,500-p/r encoder.

*2. The value for a 17-bit absolute encoder. The value for a 2500-p/r incremental encoder is 25.

7-4 Manual Tuning

Basic Settings

As described before, the OMNUC G-Series Servo Drives have an autotuning function. Depending on load conditions or other restrictions, however, readjustment may be required if the gain cannot be properly adjusted when normal mode autotuning is performed or the optimum responsiveness or stability is required to match each load. This section describes how to perform manual tuning for each control mode and function.

■ Before Manual Setting

The Parameter Unit can be used to adjust the Servomotor (machine) while monitoring the operation or noise, but more reliable adjustment can be performed quickly by using waveform monitoring with the data tracing function of CX-Drive or by measuring the analog voltage waveform with the monitor function.

Analog Monitor Output

The actual Servomotor speed, command speed, torque, and number of accumulated pulses can be measured in the analog voltage level using an oscilloscope or other device. Set the type of signal to be output and the output voltage level by setting the Speed Monitor (SP) Selection (Pn007) and Torque Monitor (IM) Selection (Pn008). For details, refer to *Parameter Tables* on page 5-61.

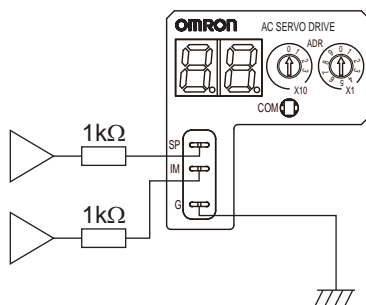

CX-Drive Data Tracing

Commands to the Servomotor and Servomotor operation (e.g., speed, torque commands, and position deviation) can be displayed on a computer as waveforms. Refer to the *CX-Drive Operation Manual* (Cat. No. W453).

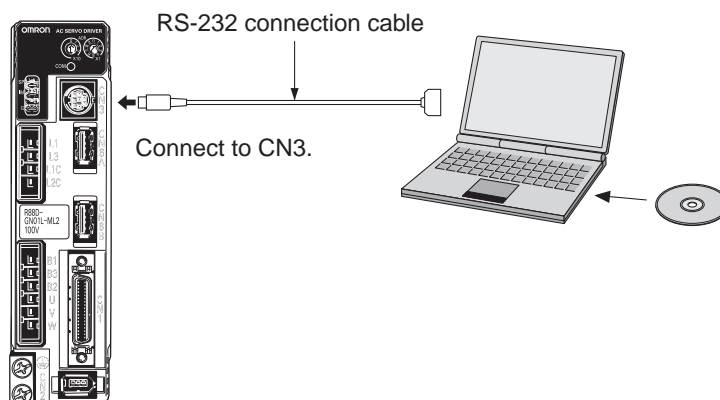

■ Position Control Mode Adjustment

Use the following procedure to make adjustments in position control for the OMNUC G Series.

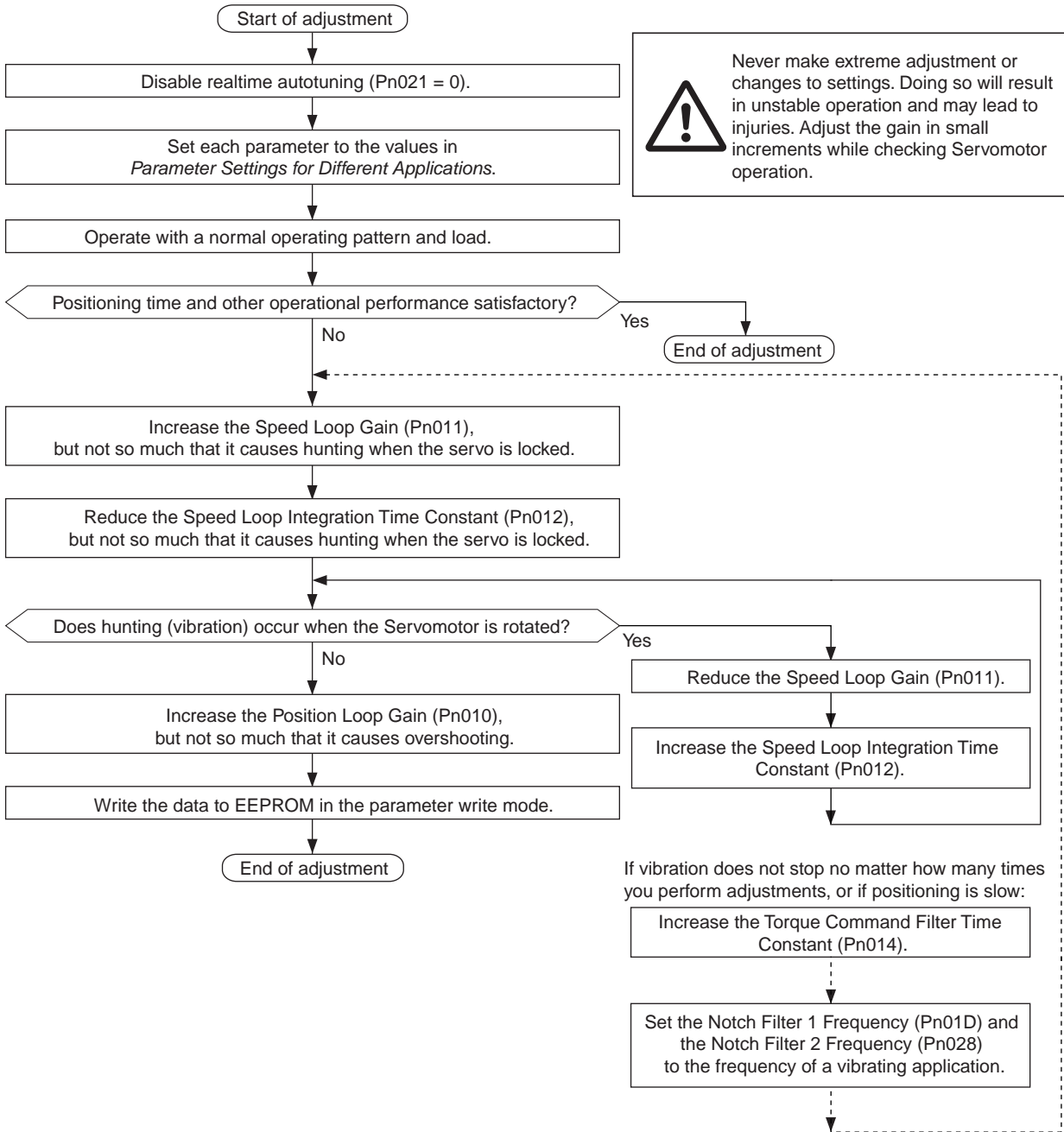

7

Adjustment Functions

■ Speed Control Mode Adjustment

With the OMNUC G Series, adjustments for speed control are almost the same as adjustments for the position control mode. Use the following procedure to adjust parameters.

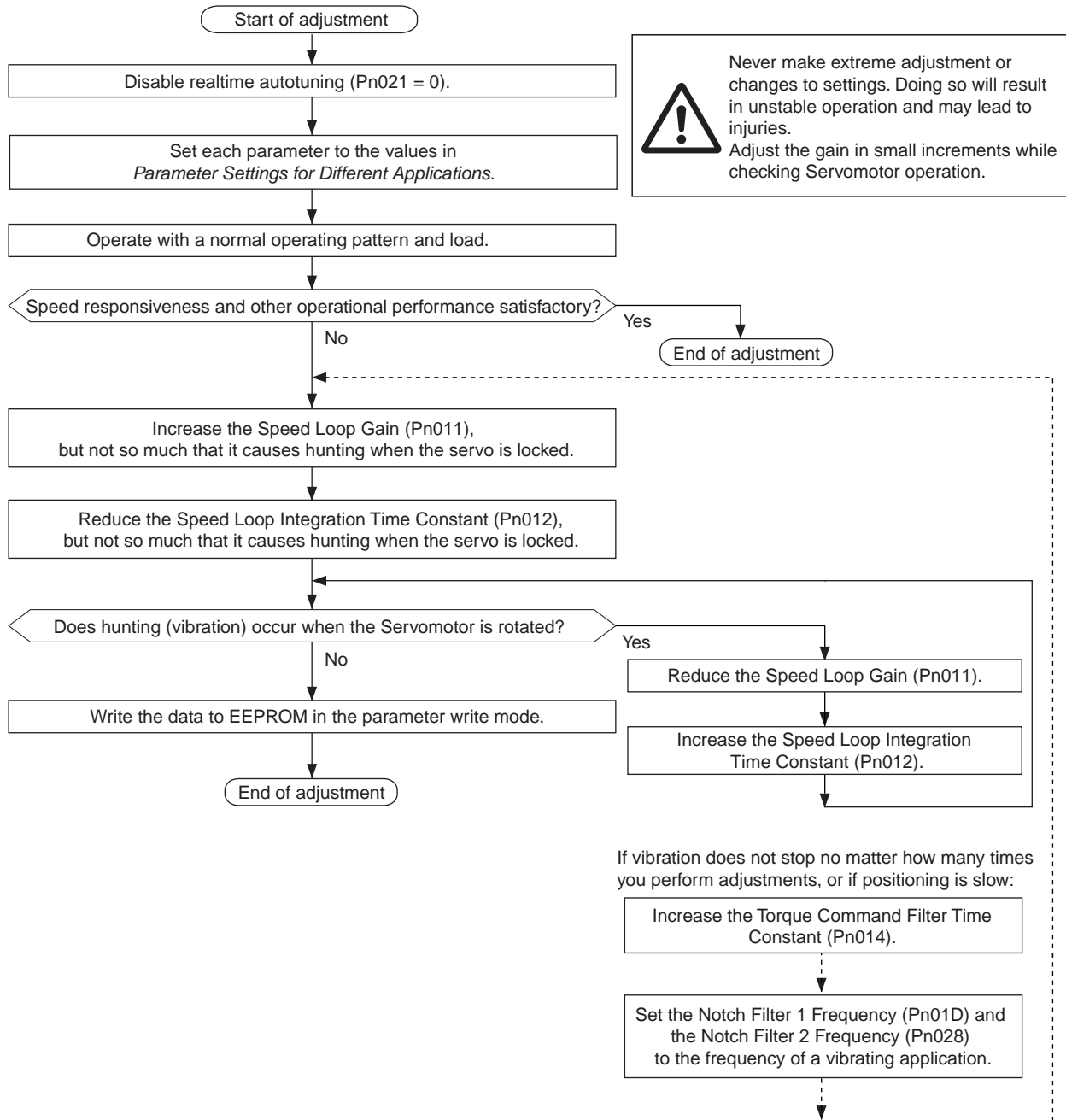

■ Servo Drive Manual Tuning Procedure

There are four basic adjustment parameters for the Servo Drive. If the desired operating characteristics can be achieved by adjusting the following four parameters, you do not need to adjust any other parameter.

Parameter No.	Parameter Name	Default Value	2nd Parameter No.
Pn010	Position Loop Gain	40.0[1/s]	Pn018
Pn011	Speed Loop Gain	50.0Hz	Pn019
Pn012	Speed Loop Integration Time Constant	20.0ms	Pn01A
Pn014	Torque Command Filter Time Constant	0.80ms	Pn01C

■ About Parameter Adjustments

There are three Servo Drive control loops: the outermost Position Loop, the Speed Loop, and the innermost Current Loop. The inner loop is affected by the outer loop and vice versa. Set the initial values according to the configuration and rigidity of the machine, inertia ratio, and other factors.

Referential parameter settings for different applications are provided below.

Parameter Settings for Different Applications

Application	Inertia	Rigidity	Position Loop Gain [1/s]	Speed Loop Gain [Hz]	Speed Loop Integration Time Constant	Torque Command Filter Time Constant [× 0.01 ms]
Ball screw, horizontal	Large	Low	20	140	35	160
Ball screw, horizontal	Medium	Medium	40	80	20	100
Ball screw, horizontal	Small	High	80	60	15	80
Ball screw, vertical	Large	Low	20	160	45	160
Ball screw, vertical	Medium	Medium	40	80	30	120
Ball screw, vertical	Small	High	60	60	20	100
Ball screw, nut rotation, horizontal	Large	Low	20	140	40	160
Ball screw, nut rotation, horizontal	Medium	Medium	40	100	30	120
Ball screw, nut rotation, vertical	Large	Low	20	160	45	160
Ball screw, nut rotation, vertical	Medium	Medium	40	120	25	120
Timing belt	Large	Low	20	160	60	160
Timing belt	Medium	Medium	30	120	40	120
Rack & pinion	Large	Low	20	160	60	160
Rack & pinion	Large	Medium	30	120	40	120
Rack & pinion	Medium	Medium	40	100	20	100
Index table	Large	Medium	40	120	25	120
Index table	Small	High	80	120	20	100
Robot arm, cylindrical	Large	Low	15	160	60	160
Robot arm, cylindrical	Medium	Medium	25	120	40	120
General purpose	Medium	Medium	30	100	30	150

♦ The Inertial Ratio (Pn020) is fixed at 300%.

Inertial Estimations

Small inertia	5 times the rotor inertia or less
Medium inertia	5 to 10 times the rotor inertia or less
Large inertial	10 to 20 times the rotor inertia or less

Pn010, Pn018 Position Loop Gain

This loop controls the pulse count from the encoder so that the count will become a specified value. When the deviation counter's pulse count drops below the specified value, positioning is completed and a signal is output. The ratio of the maximum speed to the deviation counter is the Position Loop Gain.

$$\text{Position Loop Gain [1/s]} = \frac{\text{Command maximum speed [pps]}}{\text{Number of accumulated pulses in the deviation counter (P)}}$$

The reciprocal of the Speed Loop Integration Time Constant (Pn012) should be used as a reference for setting the Position Loop Gain.

For example, if Pn012 is set to 100 ms, set the Position Loop Gain to 10 [1/s].

There will be no overshooting with these settings. To speed up the positioning process, increase the Position Loop Gain. If the Position Loop Gain is too large, overshooting or vibrations may occur. In this case, reduce the Position Loop Gain.

If the vibration is occurring in the Speed Loop or the Current Loop, adjusting the Position Loop does not stop the vibration.

The response to Position Loop Gain adjustment is shown below.

- ♦ High Position Loop Gain causes overshooting.

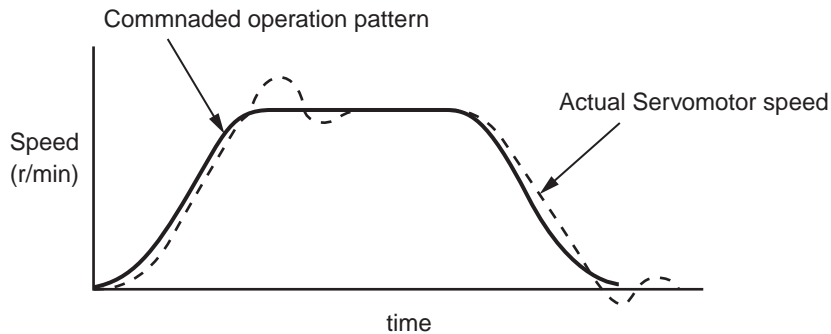

- ♦ Low Position Loop Gain slows down the positioning process.

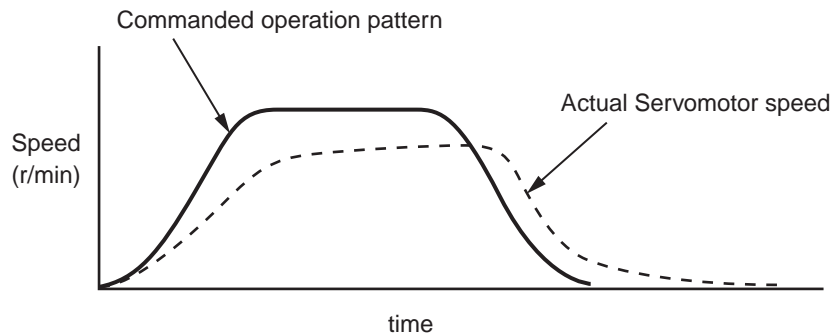

Pn011, Pn019 Speed Loop Gain

The Speed Loop Gain determines the responsiveness of the Servo Drive.

If the Inertia Ratio (Pn020) is set correctly, this setting will be used as the response frequency.

Increasing the Speed Loop Gain will improve the response and speed up the positioning process, but will also increase the likelihood of vibration. Increase the Speed Loop Gain, but not so much that it causes vibrations.

Since the Speed Loop Gain is related to the Speed Loop Integration Time Constant (Pn012), increasing the Integration Time Constant can also increase the Speed Loop Gain.

- ♦ Low Speed Loop Gain causes a slower response and large overshooting.
→ Increase the Speed Loop Gain.

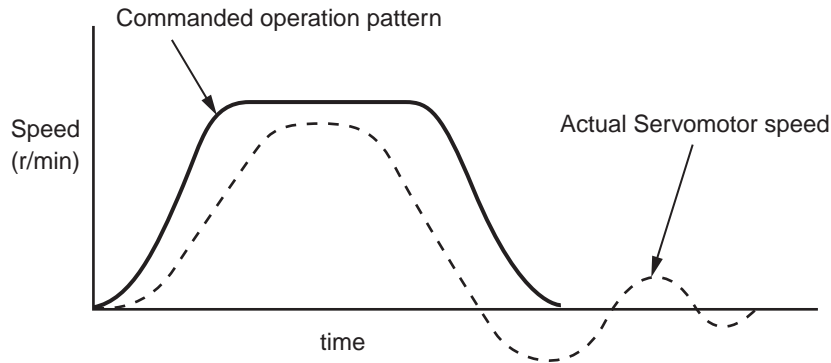

- ♦ High Speed Loop Gain increases the likelihood of vibration. Vibration and resonance may not disappear in some cases. → Decrease the Speed Loop Gain.

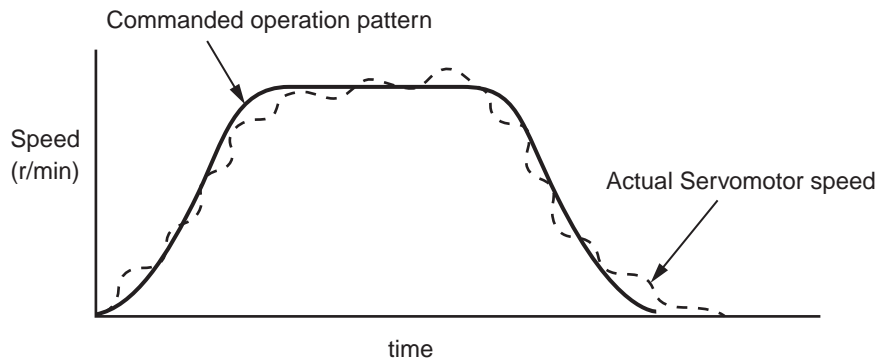

Pn012, Pn01A Speed Loop Integration Time Constant

The Speed Loop Integration Time Constant also determines the responsiveness of the Servo Drive.

- ♦ Low Speed Loop Integration Time Constant causes vibration and resonance.
→ Increase the Speed Loop Integration Time Constant.

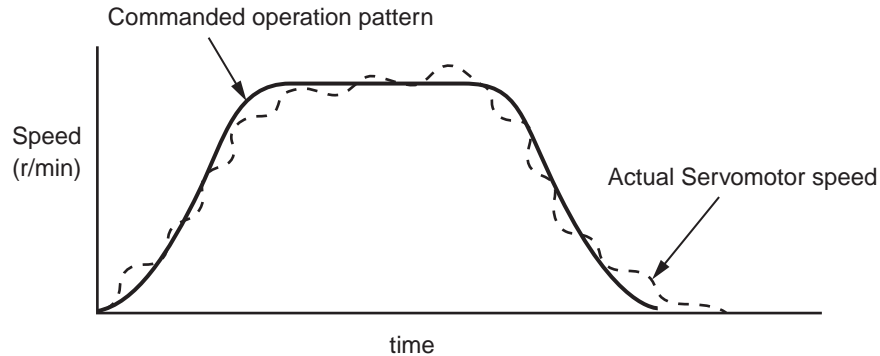

- ♦ High Speed Loop Integration Time Constant causes a slower response and decreased Servo Drive rigidity.
→ Decrease the Speed Loop Integration Time Constant.

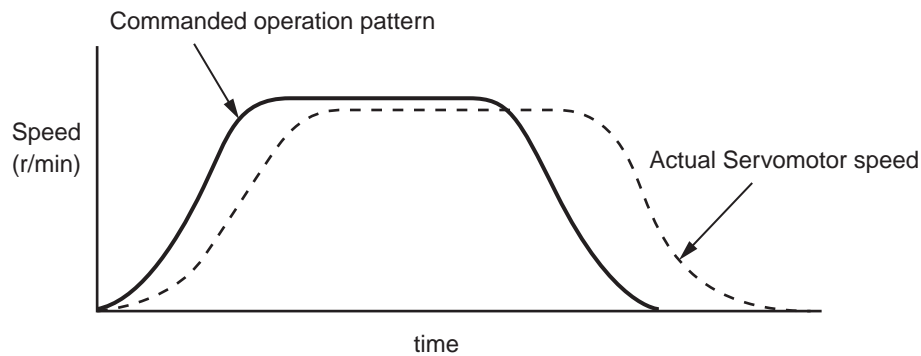

Pn014, Pn01C Torque Command Filter Time Constant (Input Adjustment for the Current Loop)

The Torque Command Filter applies a filter to smoothen the current commands from the Speed Loop. This provides a smoother current flow, thus reducing the amount of vibration.

The default value of the Filter Time Constant is 80 (0.8 ms).

Increase the value to reduce vibration. An increase in value, however, will cause a slower response.

Use 1/25 of the Speed Loop Integration Time Constant (Pn012) as a reference for setting.

The Torque Command Filter also reduces vibration due to machine rigidity.

The Torque Command Filter Time Constant is related to the Speed Loop Gain (Pn011). If Pn011 is set too large, vibration cannot be reduced by increasing the Torque Command Filter Time Constant.

If there is machine resonance, for example from a ball screw, use the notch filter (Pn01D and Pn01E) to reduce vibration, or enable the adaptive filter.

Other Adjustments

If the Torque Loop is saturated because of short acceleration time, large load torque, or other causes, overshooting occurs in the speed response. In such a case, increase the acceleration time to prevent torque saturation.

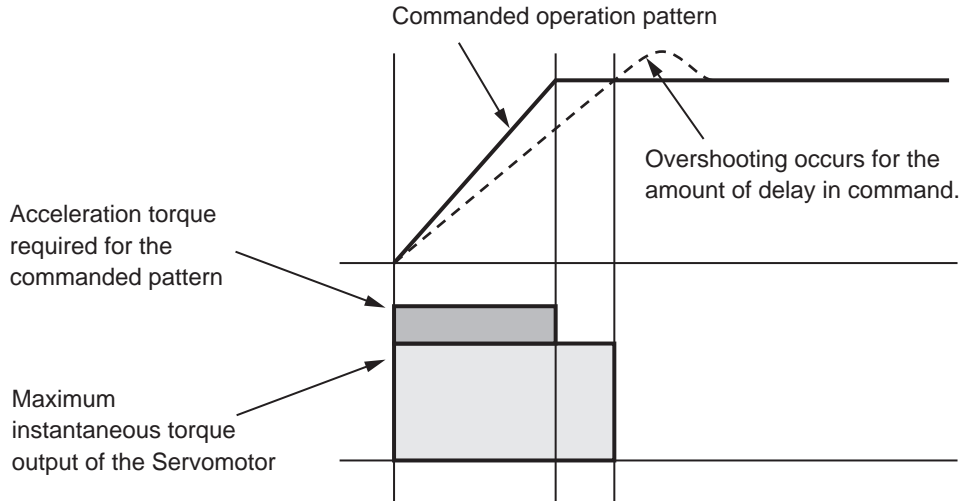

■ Torque Control Mode Adjustment

The torque control is based on the speed control loop using the Speed Limit (Pn053) or the speed limit value from MECHATROLINK-II as the speed limit. This section explains how to set the speed limit value.

Setting Speed Limit Values

- ◆ If the Speed Limit Selection (Pn05B) is set to 0, the setting for the Speed Limit (Pn053) will be used as the speed limit value. If the Speed Limit Selection (Pn05B) is set to 1, the smaller of either the Speed Limit (Pn053) or the MECHATROLINK-II speed limit value will be used.
- ◆ When the Servomotor speed approaches the speed limit value, the control method will switch from torque control using torque commands from MECHATROLINK-II, to speed control using the speed limit value determined via MECHATROLINK-II or the Speed Limit (Pn053).
- ◆ To ensure the stable operation during the speed limit, parameters need to be adjusted according to *Speed Control Mode Adjustment* on page 7-16.
- ◆ If the Speed Limit (Pn053) or the speed limit value from MECHATROLINK-II is too low, the Speed Loop Gain is too low, or the Speed Loop Integration Time Constant is set to 10000 (disable), the input to the torque limiter will be small and the torque commanded via MECHATROLINK-II may not be achieved.

Chapter 8

Troubleshooting

8-1	Error Processing	8-1
	Preliminary Checks When a Problem Occurs	8-1
	Precautions When Troubleshooting	8-2
	Replacing the Servomotor and Servo Drive	8-2
8-2	Alarm Table	8-3
8-3	Troubleshooting	8-7
	Error Diagnosis Using the Displayed Alarm Codes	8-7
	Error Diagnosis Using the Displayed Warning Codes	8-14
	Error Diagnosis Using the Operating Status	8-15
8-4	Overload Characteristics (Electronic Thermal Function)	8-20
	Overload Characteristics Graphs	8-20
8-5	Periodic Maintenance	8-21
	Servomotor Service Life	8-21
	Servo Drive Service Life	8-22
	Replacing the Absolute Encoder Battery	8-23

8-1 Error Processing

Preliminary Checks When a Problem Occurs

This section explains the preliminary checks and analytical tools required to determine the cause of a problem.

■ Checking the Power Supply Voltage

- ♦ Check the voltage at the power supply input terminals.

Main Circuit Power Supply Input Terminals (L1, L3)

R88D-GN□L-ML2 (50 W to 400 W): Single-phase, 100 to 115 VAC (85 to 127 V), 50/60 Hz

R88D-GN□H-ML2 (100 W to 1.5 kW): Single-phase, 200 to 240 VAC (170 to 264 V), 50/60 Hz

Main Circuit Power Supply Input Terminals (L1, L2, L3)

R88D-GN□H-ML2 (750 W to 7.5 kW): Three-phase, 200 to 240 VAC (170 to 264 V), 50/60 Hz

Control Circuit Power Supply Input Terminals (L1C, L2C)

R88D-GN□L-ML2: Single-phase, 100 to 115 VAC (85 to 127 V), 50/60 Hz

R88D-GN□H-ML2: Single-phase, 200 to 240 VAC (170 to 264 V), 50/60 Hz

If the voltage is outside of this range, there is a risk of operation failure, so be sure that the power supply is correct.

- ♦ Check the voltage of the sequence input power supply. (+24 VIN Terminal (CN1 pin 1))

Within the range of 11 to 25 VDC

If the voltage is outside of this range, there is a risk of operation failure, so be sure that the power supply is correct.

■ Checking Whether an Alarm Has Occurred

- ♦ Evaluate the problem using the 7-segment LED display on the front panel.
You can also evaluate the problem by using the R88A-PR02G Parameter Unit.
- ♦ CX-Drive can also be used for the display. The operation status can also be monitored.
Check the load status, including data trace.
- ♦ When an alarm has occurred:
Check the alarm code that is displayed (□□) and evaluate the problem based on the alarm that is indicated.
- ♦ When an alarm has not occurred:
Make an analysis according to the problem.

Precautions When Troubleshooting

When checking and verifying I/O after a problem has occurred, the Servo Drive may suddenly start to operate or suddenly stop, so always take the following precautions.

You should assume that anything not described in this manual is not possible with this product.

■ Precautions

- ♦ Disconnect the cable before checking for wire breakage. Even if you test conduction with the cable connected, test results may not be accurate due to conduction via bypassing circuit.
- ♦ If the encoder signal is lost, the Servomotor may run away, or an error may occur. Be sure to disconnect the Servomotor from the mechanical system before checking the encoder signal.
- ♦ When performing tests, first check that there are no persons in the vicinity of the equipment, and that the equipment will not be damaged even if the Servomotor runs away. Before performing the tests, verify that you can immediately stop the machine using an emergency stop even if the Servomotor runs away.

Replacing the Servomotor and Servo Drive

Use the following procedure to replace the Servomotor or Servo Drive.

■ Replacing the Servomotor

1. Replace the Servomotor.

2. Perform origin position alignment (for position control).

- ♦ When the Servomotor is replaced, the Servomotor's origin position (phase Z) may deviate, so origin alignment must be performed.
- ♦ Refer to the Position Controller's manual for details on performing origin alignment.

3. Set up the absolute encoder.

- ♦ If a Servomotor with an absolute encoder is used, the absolute value data in the absolute encoder will be cleared when the Servomotor is replaced, so setup is again required. The rotation data will be different from before the Servomotor was replaced, so reset the initial Motion Control Unit parameters.
- ♦ For details, refer to *Absolute Encoder Setup* on page 6-6.

■ Replacing the Servo Drive

1. Copy the parameters.

Use the Parameter Unit or CX-Drive to write down all the parameter settings or save them.

2. Replace the Servo Drive.

3. Set the parameters.

Use the Parameter Unit or CX-Drive to set all the parameters.

4. Set up the absolute encoder.

- ♦ If a Servomotor with an absolute encoder is used, the absolute value data in the absolute encoder will be cleared when the Servo Drive is replaced, so setup is again required. The rotation data will be different from before the Servo Drive was replaced, so reset the initial Motion Control Unit parameters.
- ♦ For details, refer to *Absolute Encoder Setup* on page 6-6.

8-2 Alarm Table

■ Protective Functions

The Servo Drive has built-in protective functions. When a protective function is activated, the Servo Drive turns OFF the alarm output signal (ALM) and switches to the Servo OFF status. The alarm code will be displayed on the front panel.

Alarm type	Description
---	Protective function that allows the alarm to be reset, and leaves record in the alarm history.
PR	Protective function that does not allow the alarm to be reset, and requires the control power supply to be turned OFF and turned ON again after resolving the problem.
X	Protective function that does not leave record in the alarm history.

Precautions for Correct Use

- ♦ Alarms can be reset via the network, CX-Drive or the Parameter Unit.
- ♦ Overload (alarm code 16) cannot be reset for approximately 10 s after its occurrence.
- ♦ If "HH", "hh", or "yy" is displayed on the Alarm Number display, the built-in MPU is malfunctioning. Turn OFF the power supply.

■ Warning Function

The Servo Drive issues a warning before a protective function is activated, allowing you to check overload and other status in advance. A warning is also issued for a network error, allowing you to check the network status.

■ Alarms

Alarm Display	Alarm Type	Error Detection Function	Detection Details and Cause of Error
11	X	Control power supply undervoltage	The DC voltage of the main circuit has dropped below the specified value.
12	---	Overvoltage	The DC voltage of the main circuit is abnormally high.
13	X	Main power supply undervoltage	The DC voltage of the main circuit is low.
14	PR	Overcurrent	Overcurrent flowed to the IGBT. Servomotor power line ground fault or short circuit.
15	PR	Servo Drive overheat	The temperature of the Servo Drive radiator exceeded the specified value.
16	---	Overload	Operation was performed with torque significantly exceeding the rating for several seconds to several tens of seconds.
18	PR	Regeneration overload	The regenerative energy exceeded the processing capacity of the regeneration resistor.
21	PR	Encoder communications error	Communications between the encoder and the Servo Drive failed for a specified number of times, thereby activating the error detection function.
23	PR	Encoder communications data error	Communications error occurred for the data from the encoder.
24	---	Deviation counter overflow	The number of position deviation pulses exceeded the Deviation Counter Overflow Level (Pn209).
26	---	Overspeed	The rotation speed of the Servomotor exceeded the setting of the Overspeed Detection Level Setting (Pn073).
27	PR	Command error	The operation command resulted in an error.
29	---	Internal deviation counter overflow	The value of the internal deviation counter (internal control unit) exceeded 2^{27} (134217728).
34	---	Overrun limit error	The Servomotor exceeded the allowable operating range set in the Overrun Limit Setting (Pn026) with respect to the position command input.
36	PR X	Parameter error	Data in the parameter save area was corrupted when the data was read from the EEPROM at power-ON.
37	PR X	Parameter corruption	The EEPROM write verification data was corrupted when the data was read from the EEPROM at power-ON.
38	X	Drive prohibit input error	Forward and Reverse Drive Prohibit Inputs (NOT and POT) both became OPEN.
40	PR	Absolute encoder system down error	ABS The voltage supplied to the absolute encoder dropped below the specified value.
41	PR	Absolute encoder counter overflow error	ABS The multi-turn counter of the absolute encoder exceeded the specified value.
42	PR	Absolute encoder overspeed error	ABS The Servomotor rotation speed exceeded the specified value when power to the absolute encoder is supplied by the battery only.
44	PR	Absolute encoder one-turn counter error	ABS A one-turn counter error was detected.
45	PR	Absolute encoder multi-turn counter error	ABS A multi-turn counter error or phase-AB signal error was detected.
47	---	Absolute encoder status error	ABS The rotation of the absolute encoder is higher than the specified value.

8-2 Alarm Table

Alarm Display	Alarm Type	Error Detection Function	Detection Details and Cause of Error
48	R	Encoder phase Z error	A phase-Z pulse was not detected regularly.
49	R	Encoder PS signal error	A logic error was detected in the PS signal.
82	R	Node address setting error	The rotary switch for setting the node address of the Servo Drive was set out of range.
83	---	Communications error	Data received during each MECHATROLINK-II communications cycle repeatedly failed, exceeding the number of times set in the Communications Control (Pn005).
84	---	Transmission cycle error	While actuating MECHATROLINK-II communications, synchronization frames (SYNC) were not received according to the transmission cycle.
86	---	Watchdog data error	Synchronization data exchanged between the master and slave nodes during each MECHATROLINK-II communications cycle resulted in an error.
87	X	Emergency stop input error	The emergency stop input became OPEN.
90	---	Transmission cycle setting error	The transmission cycle setting error when the MECHATROLINK-II CONNECT command is received.
91	---	SYNC command error	A SYNC-related command was issued while MECHATROLINK-II was in asynchronous communications mode.
93	R	Parameter setting error	Parameter setting exceeded the allowable range.
95	R X	Servomotor non-conformity	The combination of the Servomotor and Servo Drive is not appropriate.
Others	R	Other errors	The control circuit malfunctioned due to excessive noise. An error occurred within the Servo Drive due to the activation of its self-diagnosis function.

■ Warnings

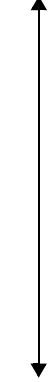
Priority	Warning Code	Warning Detection Function	Warning Details
High  Low	94h (148)	Data setting warning	<ul style="list-style-type: none"> Command argument setting is out of the range. Parameter write failure. Command settings are wrong, and others.
	95h (149)	Command warning	<ul style="list-style-type: none"> Command output conditions are not satisfied. Received unsupported command. Subcommand output conditions are not satisfied.
	96h (150)	ML-II communications warning	One or more MECHATROLINK-II communications error occurred.
	90h (144)	Overload warning	85% of the overload alarm trigger level has been exceeded.
	91h (145)	Regeneration overload warning	85% of the regeneration overload alarm trigger level has been exceeded.
	92h (146)	Battery warning	Voltage of absolute encoder battery has dropped below 3.2 V.
	93h (147)	Fan lock warning	The built-in cooling fan stopped, or rotated abnormally.

Note 1. All warnings are retained. After resolving the problem, clear the alarms and the warnings.

Note 2. When multiple warnings occur, the warning codes are displayed on the front panel in the order of their priority (shown above).

Note 3. Values in parenthesis indicate warning codes read from the host controller.

Example: When a battery warning is issued, the display on a G-Series front panel will alternate between "92" and "00". The warning code read by the host position control unit (CJ1W-NCF71 or CS1W-NCF71) will be "4146".

8-3 Troubleshooting

If an error occurs in the machine, determine the error conditions from the alarm indicator and operating status, identify the cause of the error, and take appropriate countermeasures.

Error Diagnosis Using the Displayed Alarm Codes

Alarm code	Alarm Name	Cause	Countermeasure
11	Control power supply undervoltage	<p>The voltage between P and N in the control voltage converter has dropped below the specified value.</p> <ol style="list-style-type: none"> 1 The power supply voltage is low. A momentary power failure occurred. 2 The power supply capacity is insufficient. The inrush current at power-ON caused the power supply voltage to drop. 3 The Servo Drive has failed. 	<p>Measure the line voltage between control power supply L1C and L2C.</p> <ol style="list-style-type: none"> 1 Resolve the cause of the power supply voltage drop and/or momentary power failure. 2 Increase the power supply capacity. 3 Replace the Servo Drive.
12	Overvoltage	<p>The voltage between P and N in the main circuit has exceeded the specified value. The power supply voltage is too high. Phase advance capacitor and/or UPS (uninterruptible power supply) is causing a jump in voltage.</p> <ol style="list-style-type: none"> 1 Regenerative energy cannot be absorbed due to a disconnection of the regeneration resistor. 2 Regenerative energy cannot be absorbed due to the use of an inappropriate external regeneration resistor. 3 The Servo Drive has failed. 	<p>Measure and check the line voltages between L1, L2, and L3 of the main power supply. Input a correct voltage. Remove the phase advance capacitor.</p> <ol style="list-style-type: none"> 1 Measure the resistance for the external regeneration resistor between terminals B1 and B2 of the Servo Drive, and check that the reading is normal. Replace it if disconnected. 2 Provide the necessary regeneration resistance and wattage. 3 Replace the Servo Drive.
13	Main power supply undervoltage	<p>With the Undervoltage Alarm Selection (Pn065) set to 1, the main power supply between L1 and L3 was interrupted for longer than the time set by Momentary Hold Time (Pn06D). Alternatively, the voltage between P and N in the main circuit dropped below the specified value while the Servo Drive was ON.</p> <ol style="list-style-type: none"> 1 The power supply voltage is low. 2 A momentary power failure occurred. 3 The power supply capacity is insufficient - The inrush current at power-ON caused the power supply voltage to drop. 4 Missing phase - A single-phase power supply was used for a three-phase Servo Drive. 5 The Servo Drive has failed. 	<p>Measure and check the line voltages between L1, L2, and L3 of the main power supply.</p> <ol style="list-style-type: none"> 1 Resolve the cause of the power supply voltage drop and/or momentary power failure. 2 Check the setting for the Momentary Hold Time (Pn06D). 3 Increase the power supply capacity. Refer to the Servo Drive specifications for the power supply capacity. 4 Correctly connect the phases (L1, L2, and L3) of the power supply. Connect single-phase 100 V and single-phase 200 V to L1 and L3. 5 Replace the Servo Drive.

Alarm code	Alarm Name	Cause	Countermeasure
14	Overcurrent	<p>The current on the inverter circuit exceeded the specified value.</p> <ol style="list-style-type: none"> 1 The Servo Drive has failed. (Failure of circuit, IGBT parts, etc.) 2 Short circuit on Servomotor lines U, V, and W. 3 Ground fault on the Servomotor lines. 4 Servomotor burnout. 5 Contact failure on the Servomotor lines. 6 The dynamic brake relay has been consequently welded. 7 The Servomotor is not compatible with the Servo Drive. 8 The operation command input is received simultaneously with or before Servo-ON. 	<ol style="list-style-type: none"> 1 If the alarm is triggered immediately when the Servo Drive is turned ON with the Servomotor lines disconnected, replace the Servo Drive. 2 Check for short circuit in the Servomotor lines U, V, and W. Connect the Servomotor lines correctly. 3 Check the insulation resistance between Servomotor lines U, V, W and the ground line. If there is insulation failure, replace the Servomotor. 4 Measure the interphase resistances of the Servomotor. If they are unbalanced, replace the Servomotor. 5 Check the connector pins for connections U, V, and W of the Servomotor. If they are loose or have come off, securely fix them. 6 Replace the Servo Drive. 7 Check and match the capacity of the Servomotor and the Servo Drive. 8 After the Servo ON, wait for at least 100 ms before inputting an operation command.
15	Servo Drive overheat	<p>The temperature of the Servo Drive radiator or power elements exceeded the specified value.</p> <ol style="list-style-type: none"> 1 The Servo Drive's ambient temperature has exceeded the specified value. Radiation performance has dropped. 2 There is excessive load. 	<ol style="list-style-type: none"> 1 Reduce the Servo Drive's ambient temperature, and improve the cooling conditions. 2 Increase the capacity of the Servomotor. Reduce the effective load ratio, for example with a longer acceleration / deceleration time.
16	Overload	<p>The effective values of the torque commands have exceeded the overload level set by the Overload Detection Level Setting (Pn072). Operation is performed with reverse time characteristics.</p> <ol style="list-style-type: none"> 1 The load is excessive, and the effective torque has exceeded the set level and operation has been performed for a long time. 2 Oscillation, hunching, and vibration are occurring due to improper gain adjustment. 3 Servomotor phases are incorrectly wired and/or are disconnected. 4 The mechanical load is increasing. There is a problem with the mechanics. 5 The holding brake is ON. 6 The Servomotor lines are incorrectly wired between multiple axes. 	<p>Check that the torque (current) waveform is not oscillating, and that it is not fluctuating significantly in the vertical direction. Check the overload warning display and the load ratio.</p> <ol style="list-style-type: none"> 1 Increase the capacity of the Servo Drive and Servomotor, or reduce the load. Or increase the acceleration / deceleration time to reduce the effective torque. 2 Readjust the gain to stop oscillation and hunching. 3 Connect the Servomotor lines as specified in the wiring diagram. Replace the cables. 4 Check that the mechanics operate smoothly. 5 Measure the voltage at the brake terminal. Turn OFF the brake. <p>Note You cannot reset the warning for at least 10 seconds after it occurred.</p>

8-3 Troubleshooting

Alarm code	Alarm Name	Cause	Countermeasure
18	Regeneration overload	<p>The regenerative energy exceeded the capacity of the regeneration resistor.</p> <ol style="list-style-type: none"> 1 The converter voltage was increased by regenerative energy during deceleration due to a large load inertia. The voltage was further increased due to insufficient energy absorption of the regeneration resistance. 2 Because the Servomotor's rotation speed is too high, regenerative energy cannot be fully absorbed within the specified deceleration time. 3 The operating limit of the External Regeneration Resistor is limited to 10%. 	<p>Check the regeneration resistance load ratio. Continuous regenerative braking is not acceptable.</p> <ol style="list-style-type: none"> 1 Check the operation pattern (speed monitor). Check the regeneration resistance load ratio and the over-regeneration warning display. Increase the capacity of the Servomotor and the Servo Drive to slow down the deceleration time. Use an External Regeneration Resistor. 2 Check the operation pattern (speed monitor). Check the regeneration resistance load ratio and the over-regeneration warning display. Increase the capacity of the Servomotor and the Servo Drive to slow down the deceleration time. Lower the Servomotor rotation speed. Use an External Regeneration Resistor. 3 Set Pn06C to 2.
21	Encoder communications error	<p>Communications between the encoder and the Servo Drive failed for a specified number of times, thereby activating the error detection function. (No response to request from the Servo Drive.)</p>	<p>Check that the encoder line is properly connected.</p> <p>Check that there is no damage to the encoder due to incorrect connections. Replace the Servomotor and check again.</p>
23	Encoder communications data error	<p>Communications error occurred for the data from the encoder. Mainly a data error due to noise. The encoder line is connected, but the communications data is erroneous.</p>	<ul style="list-style-type: none"> • Check that the encoder power supply voltage is within the range of 4.75 to 5.25 VDC. (If the encoder line is long.) • If the Servomotor line and the encoder line are bound together, separate them. • Check that the shield is connected to FG (frame ground), and that FG is grounded. • Attach a ferrite core to the encoder cable. Attach a radio noise filter to the power cable.
24	Deviation counter overflow	<p>The number of position deviation pulses exceeded the Deviation Counter Overflow Level (Pn209).</p> <ol style="list-style-type: none"> 1 The Servomotor operation is not following the commands. 2 The Deviation Counter Overflow Level (Pn209) is set too low. Calculate the deviation counter value based on the command speed and the position loop gain. 	<ol style="list-style-type: none"> 1 Use the speed monitor and torque monitor to check that the Servomotor is operating as commanded. Check that torque is not saturated. Check that the No. 1 Torque Limit (Pn05E) and the No. 2 Torque Limit (Pn05F) are not too small. Check by readjusting the gain, increasing the acceleration / deceleration times, and lowering the speed with the reduced load. 2 Increase the setting for Pn209.

Alarm code	Alarm Name	Cause	Countermeasure
26	Overspeed	The rotation speed of the Servomotor exceeded the setting of the Overspeed Detection Level Setting (Pn073).	<ul style="list-style-type: none"> ♦ Check that excessive speed commands have not been issued. ♦ If overshoot is occurring due to improper gain adjustment, adjust the gain for the position loop and the speed loop.
27	Command error	<p>The operation command resulted in an error.</p> <ol style="list-style-type: none"> 1 Incorrect value in position command. <ul style="list-style-type: none"> · The amount of change in the position command (value calculated with the electronic gear ratio) exceeded the specified value. · The travel distance required for acceleration / deceleration, calculated when starting positioning, exceeded the specified value. 2 A MECHATROLINK-II link was established with the host while executing a standalone operation (normal mode autotuning, and jog operation). <p>Note If the alarms are cleared immediately after actuating communications, this alarm may be cleared immediately after it has been issued, and cannot be read.</p> 3 Multi-turn data on the absolute encoder was cleared via RS-232 communications after actuating the MECHATROLINK-II link. 	<ul style="list-style-type: none"> ♦ Check that the operation commands are correct. <ol style="list-style-type: none"> 1 Review the operation commands and settings. Check the settings. For example, check that the amount of change for the position command is not too large (i.e. interpolation function), the backlash compensation amount is not too large, the backlash compensation time constant is not too small, the electronic gear ratio is not too large, and the acceleration/deceleration is not too small. 2 Do not actuate the network while executing normal mode autotuning and jog operation. 3 Alarm code 27 is issued when clearing the multi-turn data on the absolute encoder via RS-232 communications. This is for safety purposes, not an error. When executing the multi-turn clear command via the network, an alarm will not be issued, but be sure to reset the control power supply.
29	Internal deviation counter overflow	The value of the internal deviation counter (internal control unit) exceeded 2^{27} (134217728).	<p>Check that the speed monitor and torque monitor values are indicated as commanded by the Servo Drive. Check that torque is not saturated. Check that the No. 1 Torque Limit (Pn05E) and the No. 2 Torque Limit (Pn05F) are not too small.</p> <p>Check by readjusting the gain, increasing the acceleration / deceleration times, and lowering the speed with the reduced load.</p>
34	Overrun limit error	<p>The Servomotor exceeded the allowable operating range set by the Overrun Limit Setting (Pn026) with respect to the position command input.</p> <ol style="list-style-type: none"> 1 The gain is not appropriate for the load. 2 The setting for Pn026 is too small. 	<ol style="list-style-type: none"> 1 Check the position loop gain, speed loop gain, integration time constant, and inertia ratio. 2 Increase the setting for Pn026. Set Pn026 to 0 to disable the protective function.
36	Parameter error	Data in the parameter save area was corrupted when the data was read from the EEPROM at power-ON.	<p>If the warning continues to occur even after retransferring all parameters, the Servo Drive may have failed. Replace the Servo Drive.</p>

8-3 Troubleshooting

Alarm code	Alarm Name	Cause	Countermeasure
37	Parameter corruption	The EEPROM write verification data was corrupted when the data was read from the EEPROM at power-ON.	If the warning continues to occur even after retransferring all parameters, the Servo Drive may have failed. Replace the Servo Drive.
38	Drive prohibit input error	<ol style="list-style-type: none"> 1 The Drive Prohibit Input Selection (Pn004) is set to 0, and both Forward and Reverse Drive Prohibit Inputs (POT and NOT) became OPEN. 2 The Drive Prohibit Input Selection (Pn004) is set to 2, and either Forward or Reverse Drive Prohibit Input (POT or NOT) became OPEN. 3 With the Drive Prohibit Input Selection (Pn004) set to 0, MECHATROLINK-II communications interrupted, and either Forward or Reverse Drive Prohibit Input (POT or NOT) turned ON, an operation command (jog operation or normal mode autotuning) was received via RS232. Or, either POT or NOT turned ON while operating on an operation command received via RS232. 	<p>Check the sensors, power supply, and wiring for the Forward and Reverse Drive Prohibit Inputs.</p> <p>Also check that the response of the power supply (12 to 24 VDC) is not too slow.</p> <p>Check that there is no command input in the direction of the Drive Prohibit Input.</p>
40	Absolute encoder system down error ABS	The power supply and battery voltage to the encoder dropped, and the capacitor voltage dropped below the specified value. (3.0 V or less)	Connect the power supply for the battery, and clear the absolute encoder. Refer to <i>Absolute Encoder Setup</i> on page 6-6. Initial setup of the absolute encoder must be performed to clear the alarm.
41	Absolute encoder counter overflow error ABS	The multi-turn counter of the encoder exceeded the specified value.	Check the setting for the Operation Switch When Using Absolute Encoder (Pn00B). Set the travel distance from the mechanical origin within 32767 rotations. Initial setup of the absolute encoder must be performed to clear the alarm.
42	Absolute encoder overspeed error ABS	The Servomotor rotation speed exceeded the specified value when power to the absolute encoder is supplied by the battery only during a power outage.	Check the power supply voltage on the encoder side (5 V ± 5%). Check the connection of the CN2 connector. Initial setup of the absolute encoder must be performed to clear the alarm.
44	Absolute encoder one-turn counter error ABS	An error was detected in the one-turn counter for the encoder.	Replace the Servomotor. Check for malfunction due to noise. Also take EMC measures. Initial setup of the absolute encoder must be performed to clear the alarm.
45	Absolute encoder multi-turn counter error ABS	An error was detected in the multi-turn counter for the encoder.	Replace the Servomotor. Check for malfunction due to noise. Also take EMC measures. Initial setup of the absolute encoder must be performed to clear the alarm.

Alarm code	Alarm Name	Cause	Countermeasure
47	Absolute encoder status error ABS	The encoder's detection values were higher than the specified value at power-ON.	Do not rotate the Servomotor when the power is turned ON.
48	Encoder phase Z error	A phase-Z pulse of the 2500 p/r 5-line serial encoder was not detected regularly. The encoder has failed.	Replace the Servomotor. Check for malfunction due to noise. Also take EMC measures.
49	Encoder PS signal error	Logic error was detected in the PS signal (magnetic pole) of the 2500 p/r 5-line serial encoder. The encoder has failed.	Replace the Servomotor.
82	Node address setting error	The rotary switch for setting the node address of the Servo Drive was set out of range. (Value is read at power-ON)	Check the value of the rotary switch for setting the node address. Set the rotary switch correctly (set to 1 to 31), and then turn OFF the control power supply for the Servo Drive and turn it ON again.
83	Communications error	Data received during each MECHATROLINK-II communications cycle repeatedly failed, exceeding the number of times set by the Communications Control (Pn005).	Check that commands are being sent from the master node to the slave node. Check the MECHATROLINK-II communications cable for disconnection or wiring problem. Check the connection of the terminator (termination resistor). Check the MECHATROLINK-II communications cable for excessive noise, and that the cable is laid properly. Also check the FG wiring for the Servo Drive. Increase the consecutive communications error detection count in the Communications Control (Pn005).
84	Transmission cycle error	While actuating MECHATROLINK-II communications, synchronization frames (SYNC) were not received according to the transmission cycle. ♦ The synchronization frames themselves were faulty. ♦ The transmission cycle of the synchronization frames was not as specified. (Includes dropped frames).	♦ Check the transmission cycle of the synchronization frames sent from the master node, and ensure that it does not fluctuate and is as specified. ♦ Check the communications cable for disconnection or wiring problem. ♦ Check for excessive noise on the communications cable. ♦ Check the connection of the terminator (termination resistor). ♦ Check the laying of the communications cable and the FG wiring.
86	Watchdog data error	Synchronization data exchanged between the master and slave nodes during each MECHATROLINK-II communications cycle resulted in an error.	♦ Check the update process for the watchdog data (MN) on the master node.

8-3 Troubleshooting

Alarm code	Alarm Name	Cause	Countermeasure
87	Emergency stop input error	<ul style="list-style-type: none"> The emergency stop input became OPEN. 	<ul style="list-style-type: none"> Check the power supply and wiring connected to the emergency stop input. Check that the emergency stop input is ON. Check that the response of the control signal power supply (12 to 24 VDC) at power-ON is not too slow in comparison to the startup of the Servo Drive.
90	Transmission cycle setting error	<ul style="list-style-type: none"> The transmission cycle setting for receiving the MECHATROLINK-II CONNECT command is incorrect. 	<ul style="list-style-type: none"> Check the transmission cycle settings, and resend the CONNECT command.
91	SYNC command error	<ul style="list-style-type: none"> A SYNC-related command was issued while MECHATROLINK-II was in asynchronous communications mode. 	<ul style="list-style-type: none"> Check the command sent from the master node.
93	Parameter setting error	<ul style="list-style-type: none"> The electronic gear ratio parameter is set outside the allowable setting range. (Less than 1/100 or greater than 100/1) 	<ul style="list-style-type: none"> Check the parameter setting.
95	Servomotor non-conformity	<ul style="list-style-type: none"> The combination of the Servomotor and Servo Drive is not appropriate. 	<ul style="list-style-type: none"> Use the Servomotor and Servo Drive in the correct combination.
Others	Other errors	<p>The control circuit malfunctioned due to excessive noise. An error occurred within the Servo Drive due to the activation of its self-diagnosis function.</p>	<p>Turn OFF the power supply, and then turn it back ON. If the error continues to occur, there may be a failure. Stop the operation, and replace the Servomotor and Servo Drive.</p>

Error Diagnosis Using the Displayed Warning Codes

Warning Code	Error	Cause	Countermeasure
148 (94h)	Data setting warning	<ul style="list-style-type: none"> ♦ Command argument setting is out of the range. ♦ Parameter write failure. ♦ Command settings are wrong, and others. 	<ul style="list-style-type: none"> ♦ Check the setting range. ♦ Check the control power supply voltage. ♦ Check the command settings.
149 (95h)	Command warning	<ul style="list-style-type: none"> ♦ Command output conditions are not satisfied. ♦ Received unsupported command. ♦ Subcommand output conditions are not satisfied. ♦ Operation command in the drive prohibited direction was issued after being stopped by a POT/NOT input. 	<ul style="list-style-type: none"> ♦ Send the command after the command output conditions are satisfied. ♦ Do not send unsupported commands. ♦ Follow the subcommand output conditions and send. ♦ Check the status of POT/NOT input and operation command.
150 (96h)	ML-II communications warning	<ul style="list-style-type: none"> ♦ One or more MECHATROLINK-II communications error occurred. 	<ul style="list-style-type: none"> ♦ Refer to the countermeasures for <i>Communications error</i> on page 8-12 (alarm code 83).
144 (90h)	Overload warning	<ul style="list-style-type: none"> ♦ 85% of the overload alarm trigger level has been exceeded. 	Refer to <i>Overload</i> on page 8-8.
145 (91h)	Regeneration overload	<ul style="list-style-type: none"> ♦ 85% of the regeneration overload alarm trigger level has been exceeded. 	Refer to <i>Regeneration overload</i> on page 8-9.
146 (92h)	Battery warning	<ul style="list-style-type: none"> ♦ Voltage of absolute encoder battery has dropped below 3.2 V. 	Replace the absolute encoder battery while the control power supply is being input.
147 (93h)	Fan lock warning	<ul style="list-style-type: none"> ♦ The built-in cooling fan stopped, or rotated abnormally. ♦ Models with a built-in fan R88D- GN10H-ML2/ GN20H-ML2/ GN30H-ML2/-GN40H-ML2/-GN50H-ML2/-GN75H-ML2 	<p>If the warning continues to occur, the fan may have failed.</p> <p>If so, the internal temperature of the Servo Drive will rise, causing a failure. Replace the fan.</p>

Error Diagnosis Using the Operating Status

Symptom	Probable cause	Items to check	Countermeasure
7-segment LED is not lit.	No control power supply.	Check that the control power supply voltage is within the specified range.	Ensure that power is supplied properly.
		Check that the power supply input is wired correctly.	Wire correctly.
LED (COM) is not lit.	MECHATROLINK-II communications not actuated.	Check that the network cable is connected correctly.	Check that the host controller is running.
		Check that the terminator is connected.	Check the connector and connection.
LED (COM) is flashing in green.	Asynchronous communications on the MECHATROLINK-II communications actuated.	Can be controlled from the host controller (Normal status).	Normal status.
LED (COM) is lit in green.	Synchronous communications on the MECHATROLINK-II communications actuated.	Controllable status (Normal status).	Normal status.
LED (COM) is flashing in red.	Recoverable alarm related to MECHATROLINK-II communications.	<ul style="list-style-type: none"> ♦ Reset and actuate the network again from the host controller. ♦ Check the network wiring. 	Check the wiring and noise.
LED (COM) is lit in red.	Irrecoverable alarm related to MECHATROLINK-II communications.	Check that there is no overlap of node address on the network, and that the number of connected Servo Drives is less than 17.	Correct the network address.
An alarm has occurred.	Read the alarm code and the alarm history.	Check details of alarm by referring to <i>Error Diagnosis Using the Displayed Alarm Codes</i> on page 8-7.	Take countermeasures by referring to <i>Error Diagnosis Using the Displayed Alarm Codes</i> on page 8-7.

Symptom	Probable cause	Items to check	Countermeasure
Does not Servo lock.	Not Servo locked.	Check the response of the NCF71 Servo lock bit.	Set the Servo lock command bit on the host controller again.
	The power cable is not properly connected.	Check the wiring of the Servomotor power cable.	Wire the Servomotor power cable correctly.
	Servomotor power is not ON.	Check the wiring of the main circuit, and the voltage of the power supply.	Input the main circuit power supply and voltage correctly.
	The Forward and Reverse Drive Prohibit Inputs (POT and NOT) are OFF.	<ul style="list-style-type: none"> ♦ Check that the inputs for POT and NOT are not OFF. ♦ Check the +24 VIN input for CN1. 	Turn ON POT and NOT, and input +24 VIN correctly.
	Torque limit is 0.	Check that torque limits Pn05E and Pn05F are not set to 0.	Set the maximum torque to be used for each.
	Torque control is used for the control from the host controller, and the torque command value is set to 0.	Check the control mode and the torque command value for the host controller.	Set the control mode for the host controller to position control mode, and check Servo lock.
	Servo Drive failure.	---	Replace the Servo Drive.
Servo lock is ON, but Servomotor does not rotate.	No command is sent from the host controller.	For position commands, check that speed and position are not set to 0.	Input the position and speed data to start the Servomotor.
	Cannot tell whether the Servomotor is rotating.	Check that the speed command from the host controller is not too slow.	Check the speed command from the host controller.
	The holding brake is working.	Check the brake interlock (BKIR) signal and the +24 VDC power supply.	For a Servomotor with brake, check that its holding brake is released by Servo lock.
	The No.1 and No. 2 Torque Limits (Pn05E, Pn05F) are too small.	Check that the torque limits Pn05E and Pn05F are not set to a value close to 0.	Set the maximum torque to be used for each.
	Torque control is used for the control from the host controller, and the torque command value is too small.	Check the control mode and the torque command value for the host controller.	Set the control mode for the host controller to position control mode, and check Servo lock.
	The Speed Limit (Pn053) is set to 0 for torque control mode.	Check the Speed Limit (Pn053) value.	Increase the value for the Speed Limit (Pn053).
	Servo Drive failure.	---	Replace the Servo Drive.
The Servomotor operates momentarily, but it does not operate after that.	The Servomotor Power Cable is wired incorrectly.	Check the wiring of the Servomotor Power Cable phases U, V, and W.	Correctly wire the Servomotor Power Cable phases U, V, and W.
	Not enough position command data.	Check the position data, electronic gear, and others for NCF71.	Set the correct data.

8-3 Troubleshooting

Symptom	Probable cause	Items to check	Countermeasure
The Servomotor rotates without a command.	There is a small input for speed command mode.	Check that there is no input for speed command mode.	Set the speed command to 0, or switch to position control mode.
	There is a small input for torque command mode.	Check that there is no input for torque command mode.	Switch from torque control mode to position control mode.
The Servomotor rotates in the direction opposite to the command.	The Operating Direction Setting (Pn043) setting is incorrect.	Check the Operating Direction Setting (Pn043) value.	Change the Operating Direction Setting (Pn043) value.
	NCF71 command is incorrect.	<ul style="list-style-type: none"> ♦ Set values are inappropriate for an absolute command. ♦ The polarity is incorrect for an incremental command. 	<ul style="list-style-type: none"> ♦ Check the current and target values. ♦ Check the rotation direction.
The holding brake does not work.	Power is supplied to the holding brake.	Check whether power is supplied to the holding brake.	<ul style="list-style-type: none"> ♦ Check the brake interlock (BKIR) signal and the relay circuit. ♦ Check that the holding brake is not worn down.
The Servomotor is overheating.	The load is too large.	Measure the torque using the front panel IM or a tool.	<ul style="list-style-type: none"> ♦ Slow down the acceleration/deceleration. ♦ Lower the speed and measure the load.
	The heat radiation conditions for the Servomotor have worsened.	<ul style="list-style-type: none"> ♦ Check that the specified heat radiation conditions are satisfied. ♦ For a Servomotor with a brake, check the load ratio. 	<ul style="list-style-type: none"> ♦ Improve the heat radiation conditions. ♦ Reduce the load. ♦ Improve ventilation.
	The ambient temperature is too high.	Check that the ambient temperature has not exceeded 40 °C.	<ul style="list-style-type: none"> ♦ Radiate heat and cool. ♦ Reduce the load ratio.
The Servomotor rotation is unstable.	Load and gain do not match.	Check the response waveforms for speed and torque.	Adjust the speed loop gain so that the rotation is stabilized.
	Load inertia exceeds the specified range.	Calculate the load inertia.	<ul style="list-style-type: none"> ♦ Check if the adjustments can be made via manual tuning. ♦ Increase the capacity of the Servomotor.
	Low rigidity is resulting in vibration.	Measure the vibration frequency of the load.	Enable damping control, and set the vibration filter frequencies.
	Loose coupling with the machine, and/or large gaps.	Check coupling with the machine.	Tighten the coupling with the machine.

Symptom	Probable cause	Items to check	Countermeasure
Machine position is misaligned.	Problem with the coupling between the Servomotor axis and the machine.	Check that the coupling of the Servomotor and the machine is not misaligned.	<ul style="list-style-type: none"> ♦ Re-tighten the coupling. ♦ Replace with a tight coupling.
	Deceleration stop command is received from the host controller.	Check the control ladder on the host controller.	Review the control on the host controller.
The Servomotor is slow to stop even if the RUN command is turned OFF while the Servomotor is rotating.	Load inertia is too large.	<ul style="list-style-type: none"> ♦ Check the load inertia. ♦ Dynamic brake resistor is disconnected. 	<ul style="list-style-type: none"> ♦ Review the load inertia. ♦ Replace the Servomotor and Servo Drive with appropriate models.
	Dynamic brake is disabled.	Check if the dynamic brake is disabled or has failed.	<ul style="list-style-type: none"> ♦ If disabled, enable it. ♦ If there is a failure, or disconnection of the resistor, replace the Servomotor.
Overshoots when starting or stopping.	The Position Loop Gain (Pn010) is too large.	Review the Position Loop Gain (Pn010).	Adjust the gain to avoid overshooting.
	Poor balance between the Speed Loop Integration Time Constant (Pn012) and the Speed Loop Gain (Pn011).	Review the Speed Loop Integration Time Constant (Pn012) and the Speed Loop Gain (Pn011).	Use CX-Drive and analog monitors (SP, IM) to measure the response and adjust the gain.
	Inappropriate machine rigidity setting by realtime autotuning.	Review the machine rigidity setting.	Match the machine rigidity setting to the load rigidity.
	Inertial ratio setting differs from the load.	Review the Inertial Ratio (Pn020).	Match the Inertia Ratio (Pn020) to the load.

8-3 Troubleshooting

Symptom	Probable cause	Items to check	Countermeasure
Unusual noise and vibration occurs from the Servomotor or the load.	The Torque Command Filter Time Constant (Pn014) does not match the load.	Review the Torque Command Filter Time Constant (Pn014).	Increase the Torque Command Filter Time Constant (Pn014) to stop the vibration.
	Vibration occurs due to machine resonance.	Check if the resonance frequency is high or low.	If the resonance frequency is high, set an adaptive filter to stop the resonance, or measure the resonance frequency and set Notch Filters 1 and 2.
	<ul style="list-style-type: none"> ♦ The Position Loop Gain (Pn010) is too large. ♦ Poor balance between the Speed Loop Integration Time Constant (Pn012) and the Speed Loop Gain (Pn011). 	Review the Position Loop Gain (Pn010), Speed Loop Integration Time Constant (Pn012), and the Speed Loop Gain (Pn011).	Use CX-Drive and analog monitors (SP, IM) to measure the response and adjust the gain.
	The Speed Feedback Filter Time Constant (Pn013) does not match the load.	Check the Speed Feedback Filter Time Constant (Pn013). The parameter is usually set to 0.	Increase the Speed Feedback Filter Time Constant (Pn013) and operate.
	Vibration occurs due to low mechanical rigidity.	Check whether the vibration frequency is 100 Hz or below.	If the vibration frequency is 100 Hz or below, stop the vibration by setting the vibration frequency for the vibration filter.
	Vibration occurs due to mechanical installation.	Check whether the coupling with the load is unbalanced.	Make adjustments to balance the rotation.
		Check for eccentricity of the load.	Eliminate eccentricity. Eccentricity of the load results in noise due to fluctuation of torque.
Check for noise from within the decelerator.		Check the decelerator specifications and perform an inspection.	

8-4 Overload Characteristics (Electronic Thermal Function)

An overload protection (electronic thermal) function is built into the Servo Drive to protect the Servo Drive and Servomotor from overloading.

If an overload does occur, first eliminate the cause of the error and then wait at least one minute for the Servomotor temperature to drop before turning on the power again.

If the power is turned ON again repeatedly at short intervals, the Servomotor windings may burn out.

Overload Characteristics Graphs

The following graphs show the characteristics of the load ratio and the electronic thermal function's operation time.

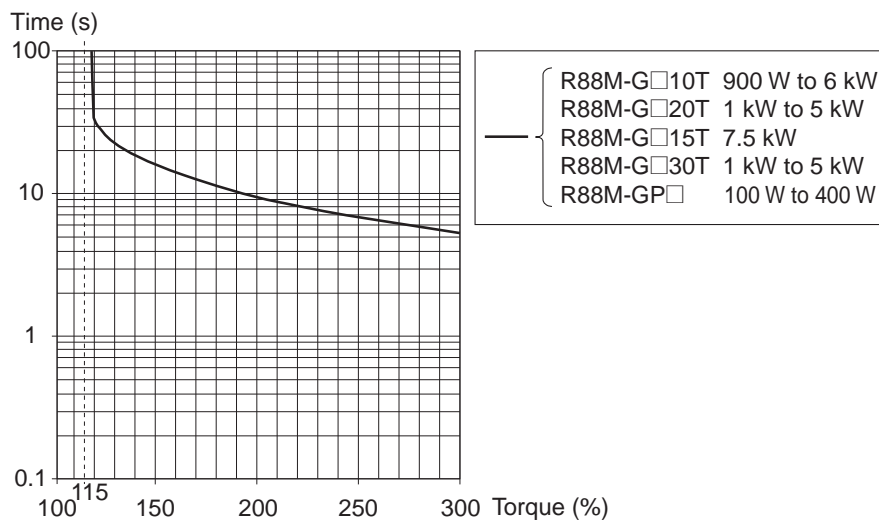
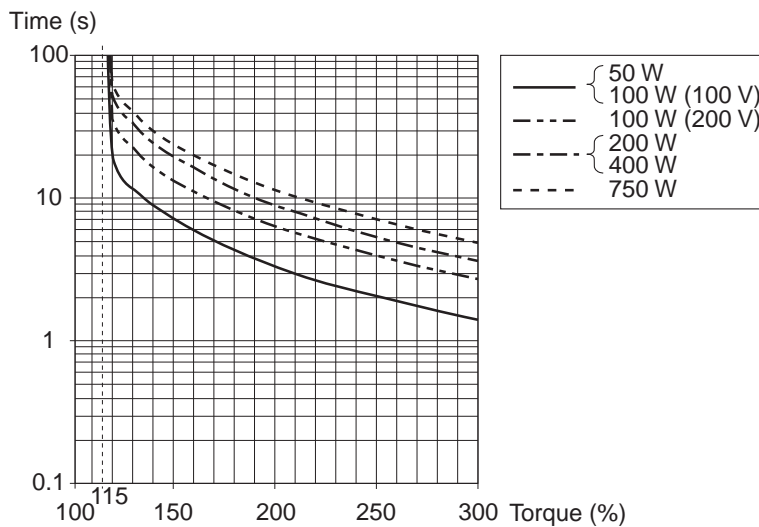

When the torque command = 0, and a constant torque command is continuously applied after three or more times the overload time constant has elapsed, the overload time t [s] will be:

$$t \text{ [s]} = - \text{Overload time constant [s]} \times \log_e (1 - \text{Overload level [\%]} / \text{Torque command [\%]})^2$$

(The overload time constant [s] depends on the Servomotor. The standard overload level is 115%.)

Precautions for Correct Use

- Overload (alarm code 16) cannot be reset for approximately 10 seconds after its occurrence.

8-5 Periodic Maintenance



Caution



Resume operation only after transferring to the new Unit the contents of the data required for operation. Not doing so may result in equipment damage.



Do not attempt to disassemble or repair any of the products. Any attempt to do so may result in electric shock or injury.

Servomotors and Servo Drives contain many components and will operate properly only when each of the individual components is operating properly.

Some of the electrical and mechanical components require maintenance depending on application conditions. Periodic inspection and part replacement are necessary to ensure proper long-term operation of Servomotors and Servo Drives. (quotes from "The Recommendation for Periodic Maintenance of a General-purpose Inverter" published by JEMA)

The periodic maintenance cycle depends on the installation environment and application conditions of the Servomotor or Servo Drive.

Recommended maintenance times are listed below for Servomotors and Servo Drives. Use these for reference in determining actual maintenance schedules.

Servomotor Service Life

- ♦ The service life for components is listed below.

Bearings: 20,000 hours

Decelerator: 20,000 hours

Oil seal: 5,000 hours

Encoder: 30,000 hours

These values presume an ambient Servomotor operating temperature of 40°C, shaft loads within the allowable range, rated operation (rated torque and rated r/min), and proper installation as described in this manual.

The oil seal can be replaced.

- ♦ The radial loads during operation (rotation) on timing pulleys and other components contacting belts is twice the still load. Consult with the belt and pulley manufacturers and adjust designs and system settings so that the allowable shaft load is not exceeded even during operation. If a Servomotor is used under a shaft load exceeding the allowable limit, the Servomotor shaft can break, the bearings can burn out, and other problems can occur.

Servo Drive Service Life

- ♦ Details on the service life of the Servo Drive are provided below.
 - Aluminum electrolytic capacitors: 28,000 hours
(at an ambient Servo Drive operating temperature of 55°C, the rated operation output (rated torque), installed as described in this manual.)
 - Axial fan: 10,000 to 30,000 hours
 - Inrush current prevention relay: Approx. 20,000 operations (The service life depends on the operating conditions.)
- ♦ When using the Servo Drive in continuous operation, use fans or air conditioners to maintain an ambient operating temperature below 40°C.
- ♦ We recommend that ambient operating temperature and the power ON time be reduced as much as possible to lengthen the service life of the Servo Drive.
- ♦ The life of aluminum electrolytic capacitors is greatly affected by the ambient operating temperature. Generally speaking, an increase of 10°C in the ambient operating temperature will reduce capacitor life by 50%.
- ♦ The aluminum electrolytic capacitors deteriorate even when the Servo Drive is stored with no power supplied. If the Servo Drive is not used for a long time, we recommend a periodic inspection and part replacement schedule of five years.
- ♦ If the Servomotor or Servo Drive is not to be used for a long time, or if they are to be used under conditions worse than those described above, a periodic inspection schedule of five years is recommended.
- ♦ Upon request, OMRON will examine the Servo Drive and Servomotor and determine if a replacement is required.

Replacing the Absolute Encoder Battery **ABS**

Replace the Absolute Encoder Backup Battery if it has been used for more than three years or if an absolute encoder system down error (alarm code 40) has occurred.

■ Replacement Battery Model and Specifications

Item	Specifications
Name	Absolute Encoder Backup Battery
Model	R88A-BAT01G
Battery model	ER6V (Toshiba)
Battery voltage	3.6 V
Current capacity	2000 mA·h

■ Mounting the Backup Battery

Mounting the Battery for the First Time

Connect the absolute encoder battery to the Servomotor, and then set up the absolute encoder. Refer to *Absolute Encoder Setup* on page 6-6.

Once the absolute encoder battery is attached, it is recommended that the control power supply be turned ON and OFF once a day to refresh the battery.

If you neglect to refresh the battery, battery errors may occur due to voltage delay in the battery.

Replacing the Battery

If a battery alarm occurs, the absolute encoder battery must be replaced.

Replace the battery with the control power supply to the Servo Drive ON. If the battery is replaced with the control power supply to the Servo Drive OFF, data held in the encoder will be lost.

Once the absolute encoder battery has been replaced, clear the battery alarm. For details on clearing the alarm, refer to *Alarm Reset* on page 6-25.

Note If the absolute encoder is cleared, or the absolute values are cleared using communications, all error and rotation data will be lost and the absolute encoder must be set up again. For details, refer to *Absolute Encoder Setup* on page 6-6.

Battery Mounting Procedure

1. Prepare the R88A-BAT01G replacement battery.

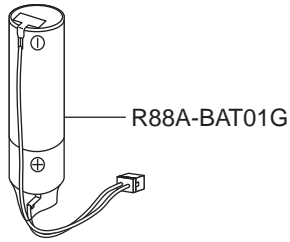

2. Remove the battery box cover.

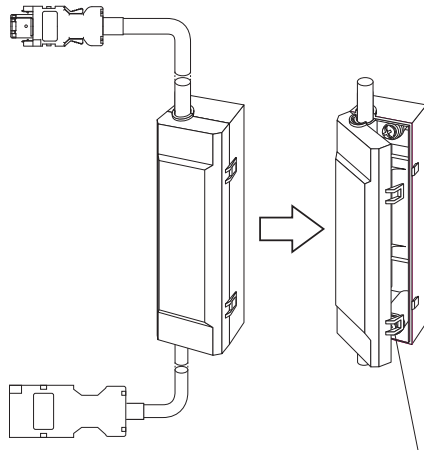

Raise the hooks to remove the cover.

3. Put the battery into the battery box.

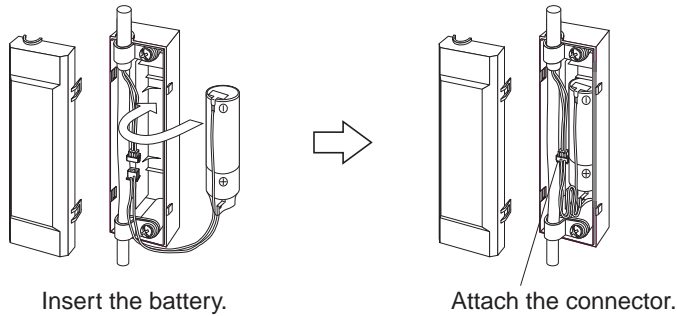

4. Close the cover to the battery box.

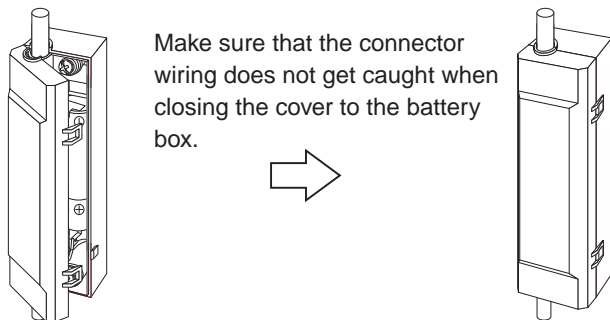

Chapter 9

Appendix

9-1	Parameter Tables.....	9-1
-----	-----------------------	-----

9-1 Parameter Tables

The attribute indicates when the changed setting for the parameter will be enabled.

A	Always enabled after change
B	Change prohibited during Servomotor operation and command issuance. (It is not known when changes made during Servomotor operation and command issuance will be enabled.)
C	Enabled when the control power supply is reset, or when a CONFIG command is executed via the network (MECHATROLINK-II communications).
R	Read-only and cannot be changed.

Note 1. Parameters marked with "(RT)" are automatically set during realtime autotuning. To set these parameters manually, disable realtime autotuning by setting the Realtime Autotuning Mode Selection (Pn021) to 0 before changing the parameter.

Note 2. Parameter No. is the number for MECHATROLINK-II communications and CX-Drive. The Parameter Unit shows only the last two digits. Parameter numbers in the 100s specify 16-bit parameters, and numbers in the 200s specify 32-bit parameters.

User parameters are set and checked on CX-Drive or the Parameter Unit (R88A-PR02G).

■ Parameter Tables

Pn No.	Parameter name	Setting	Explanation	Default Setting	Unit	Setting Range	Attribute	Set value
000	Reserved	Do not change.		1	---	---	---	
001	Default Display	Selects the data to be displayed on the 7-segment LED display on the front panel.		0	---	0 to 4	A	
		0	Normal status ("--" Servo OFF, "00" Servo ON)					
		1	Mechanical angle (0 to FF hex)					
		2	Electrical angle (0 to FF hex)					
		3	Cumulative count for MECHATROLINK-II communication errors (0 to FF hex)					
		4	Rotary switch setting (node address) loaded at startup, in decimal					
5 to 32767	Reserved (Do not set.)							
002	Reserved	Do not change.		0	---	---	---	

9-1 Parameter Tables

Pn No.	Parameter name	Setting	Explanation	Default Setting	Unit	Setting Range	Attribute	Set value
003	Torque Limit Selection		Selects the torque limit function, or the torque feed-forward function during speed control.	1	---	1 to 5	B	
			<p>■ Torque Limit Selection</p> <p>For torque control, always select Pn05E.</p> <p>For position control and speed control, select the torque limit as follows.</p>					
		1	Use Pn05E as limit value for forward and reverse operations.					
		2	Forward: Use Pn05E. Reverse: Use Pn05F.					
		3	Switch limits by torque limit values and input signals from the network. Limit in forward direction: PCL is OFF = Pn05E, PCL is ON = Pn05F Limit in reverse direction: NCL is OFF = Pn05E, NCL is ON = Pn05F					
		4	Forward: Use Pn05E as limit Reverse: Use Pn05F as limit Only in speed control, limits can be switched by torque limit values from the network as follows: Limit in forward direction: Use Pn05E or MECHATROLINK-II command option command value 1, whichever is smaller. Limit in reverse direction: Use Pn05F or MECHATROLINK-II command option command value 2, whichever is smaller.					
		5	Forward: Use Pn05E as limit Reverse: Use Pn05F as limit Only in speed control, torque limits can be switched by torque limit values and input signals from the network as follows. Limit in forward direction: PCL is OFF = Pn05E, PCL is ON = Pn05E or MECHATROLINK-II command option command value 1, whichever is smaller. Limit in reverse direction: NCL is OFF = Pn05F, NCL is ON = Pn05F or MECHATROLINK-II command option command value 2, whichever is smaller.					
			<p>Note PCL ON: When either Forward Torque Limit (CN1 PCL: pin 7) or MECHATROLINK-II Communications Option Field (P-CL) is ON.</p> <p>PCL OFF: When both Forward Torque Limit (CN1 PCL: pin 7) and MECHATROLINK-II Communications Option Field (P-CL) are OFF.</p>					
			<p>■ Torque Feed-forward Function Selection</p>					
		1 to 3	Enabled only during speed control. Disabled if not using speed control.					
4 to 5	Always disabled							

Pn No.	Parameter name	Setting	Explanation	Default Setting	Unit	Setting Range	Attribute	Set value
004	Drive Prohibit Input Selection		Selects the function for the Forward and Reverse Drive Prohibit Inputs (CN1 POT: pin 19, NOT: pin 20).	0	---	0 to 2	C	
		0	Decelerates and stops according to the sequence set in the Stop Selection for Drive Prohibition Input (Pn066) when both POT and NOT inputs are enabled. When both POT and NOT inputs are OPEN, the Drive Prohibit Input Error (alarm code 38) will occur.					
		1	Both POT and NOT inputs disabled.					
		2	When either POT or NOT input becomes OPEN, the Drive Prohibit Input Error (alarm code 38) will occur.					
005	Communications Control		Controls errors and warnings for MECHATROLINK-II communications.	0	---	0 to 3955	C	
006	Power ON Address Display Duration Setting		Sets the duration to display the node address when the control power is turned ON.	30	ms	0 to 1000	C	
		0 to 6	600ms					
		7 to 1000	set value × 100 ms					
007	Speed Monitor (SP) Selection		Selects the output to the Analog Speed Monitor (SP on the front panel). Forward rotation is always positive (+), and reverse rotation is always negative (-).	3	---	0 to 11	A	---
		0	Actual Servomotor speed: 47 r/min/6 V					
		1	Actual Servomotor speed: 188 r/min/6 V					
		2	Actual Servomotor speed: 750 r/min/6 V					
		3	Actual Servomotor speed: 3000 r/min/6 V					
		4	Actual Servomotor speed: 12000 r/min/6 V					
		5	Command speed: 47 r/min/6 V					
		6	Command speed: 188 r/min/6 V					
		7	Command speed: 750 r/min/6 V					
		8	Command speed: 3000 r/min/6 V					
		9	Command speed: 12000 r/min/6 V					
		10	Outputs the Issuance Completion Status (DEN). 0 V: Issuing 5 V: Issuance complete					
11	Outputs the Gain Selection Status. 0 V: Gain 2 5 V: Gain 1							

9-1 Parameter Tables

Pn No.	Parameter name	Setting	Explanation	Default Setting	Unit	Setting Range	Attribute	Set value
008	Torque Monitor (IM) Selection		Selects the output to the Analog Torque Monitor (IM on the front panel). Forward rotation is always positive (+), and reverse rotation is always negative (-).	0	---	0 to 14	A	
		0	Torque command: 100%/3 V					
		1	Position deviation: 31 pulses/3 V					
		2	Position deviation: 125 pulses/3 V					
		3	Position deviation: 500 pulses/3 V					
		4	Position deviation: 2000 pulses/3 V					
		5	Position deviation: 8000 pulses/3 V					
		6 to 10	Reserved					
		11	Torque command: 200%/3 V					
		12	Torque command: 400%/3 V					
		13	Outputs the Issuance Completion Status (DEN). 0 V: Issuing 5 V: Issuance complete					
14	Outputs the Gain Selection Status. 0 V: Gain 2 5 V: Gain 1							
009	Reserved	Do not change.	0	---	---	---		
00A	Prohibit Parameter Changes via Network		Allows/prohibits parameter changes via the network.	0	---	0 to 1	A	
		0	Allows parameter changes from the host controller via the network.					
	1	Prohibits parameter changes from the host controller via the network. Attempting to change a parameter via the network when prohibited triggers the Command Warning (warning code 95h).						
00B	Operation Switch When Using Absolute Encoder		Selects how the absolute encoder is used. This parameter is disabled when using an incremental encoder.	0	---	0 to 2	C	
		0	Use as an absolute encoder.					
		1	Use an absolute encoder as incremental encoder.					
	2	Use as an absolute encoder, but ignore absolute multi-turn counter overflow error (alarm code 41).						
00C	RS-232 Baud Rate Setting		Sets the baud rate for RS-232 communications.	2	---	0 to 5	C	
		0	2,400 bps					
		1	4,800 bps					
		2	9,600 bps					
		3	19,200 bps					
		4	38,400 bps					
5	57,600 bps							
00D	Reserved	Do not change.	0	---	---	---		
00E	Reserved	Do not change.	0	---	---	---		
00F	Reserved	Do not change.	0	---	---	---		
010	Position Loop Gain (RT)		Sets the position loop responsiveness.	400	×0.1 [1/s]	0 to 30000	B	

Pn No.	Parameter name	Setting	Explanation	Default Setting	Unit	Setting Range	Attribute	Set value
011	Speed Loop Gain (RT)		Sets the speed loop responsiveness. If the Inertia Ratio (Pn020) is set correctly, this parameter is set to the Servomotor response frequency.	500	×0.1 Hz	1 to 30000	B	
012	Speed Loop Integration Time Constant (RT)		Adjusts the speed loop integration time constant. Set 9999 to stop integration operation while retaining the integration value. A Setting of 10000 disables integration.	200	×0.1 ms	1 to 10000	B	
013	Speed Feedback Filter Time Constant (RT)		Sets the type of speed detection filter time constant. Normally, use a setting of 0.	0	---	0 to 5	B	
014	Torque Command Filter Time Constant (RT)		Adjusts the first-order lag filter time constant for the torque command section. The torque filter setting may reduce machine vibration.	80	×0.01 ms	0 to 2500	B	
015	Speed Feed-forward Amount (RT)		Sets the speed feed-forward amount. This parameter is particularly useful when fast response is required.	300	×0.1 %	0 to 1000	B	
016	Feed-forward Filter Time Constant (RT)		Sets the time constant for the speed feed-forward first-order lag filter.	100	×0.01 ms	0 to 6400	B	
017	Reserved		Do not change.	0	---	---	---	
018	Position Loop Gain 2 (RT)		Sets the position loop gain when using gain 2 switching.	200	×0.1 [1/s]	0 to 30000	B	
019	Speed Loop Gain 2 (RT)		Sets the speed loop gain when using gain 2 switching.	800	×0.1 Hz	1 to 30000	B	
01A	Speed Loop Integration Time Constant 2 (RT)		Sets the speed loop integration time constant when using gain 2 switching. Same function as Pn012. Set 9999 to stop integration operation while retaining the integration value. Setting 10000 disables integration.	500	×0.1 ms	1 to 10000	B	
01B	Speed Feedback Filter Time Constant 2 (RT)		Sets the speed detection filter when using gain 2 switching. Normally, use a setting of 0. When Instantaneous Speed Observer Setting (Pn027) is enabled, this parameter will be disabled.	0	---	0 to 5	B	
01C	Torque Command Filter Time Constant 2 (RT)		Sets the first-order lag filter time constant for the torque command section when using gain 2 switching.	100	×0.01 ms	0 to 2500	B	
01D	Notch Filter 1 Frequency		Sets the notch frequency of notch filter 1 for resonance suppression.	1500	Hz	100 to 1500	B	
		100 to 1499	Filter enabled					
		1500	Filter disabled					
01E	Notch Filter 1 Width		Selects the notch width of notch filter 1 for resonance suppression. Normally, use a setting of 2.	2	---	0 to 4	B	
01F	Reserved		Do not change.	0	---	---	---	
020	Inertia Ratio (RT)		Selects the load inertia as a percentage of the Servomotor rotor inertia.	300	%	0 to 10000	B	

9-1 Parameter Tables

Pn No.	Parameter name	Setting	Explanation	Default Setting	Unit	Setting Range	Attribute	Set value	
021	Realtime Autotuning Mode Selection	Sets the operating mode for realtime autotuning.		0	---	0 to 7	B		
			Realtime Autotuning						Degree of change in load inertia
		0	Disabled						---
		1	Horizontal axis mode						Almost no change
		2							Gradual changes
		3							Sudden changes
		4	Vertical axis mode						Almost no change
		5							Gradual changes
		6							Sudden changes
7	Gain switching disable mode	Almost no change							
022	Realtime Autotuning Machine Rigidity Selection	Sets the machine rigidity for realtime autotuning. Cannot be set to 0 when using the Parameter Unit.		2	---	0 to F	B		
023	Adaptive Filter Selection	Enables or disables the adaptive filter.		0	---	0 to 2	B		
		0	Adaptive filter disabled.						
		1	Adaptive filter enabled. Adaptive operation performed.						
		2	Adaptive filter enabled. Adaptive operation will not be performed (i.e. retained).						
024	Vibration Filter Selection	Selects the vibration filter type and the switching mode.		0	---	0 to 5	C		
		<ul style="list-style-type: none"> ■ Filter type selection ♦ Normal type: <ul style="list-style-type: none"> Vibration frequency setting range: 10.0 to 200.0 Hz ♦ Low-pass type: <ul style="list-style-type: none"> Vibration frequency setting range: 1.0 to 200.0 Hz ■ Switching mode selection ♦ No switching: Both 1 and 2 are enabled ♦ Switching with command direction: <ul style="list-style-type: none"> Selects Vibration Frequency 1 in forward direction (Pn02B, Pn02C) Selects Vibration Frequency 2 in reverse direction (Pn02D, Pn02E) 							
			Filter Type						Switching mode
		0	Normal type						No switching
		1							Switching with command direction
		2							
		3	Low-pass type						No switching
		4							Switching with command direction
		5							

Pn No.	Parameter name	Setting	Explanation	Default Setting	Unit	Setting Range	Attribute	Set value	
025	Normal Mode Autotuning Operation Setting	Sets the operating pattern for normal mode autotuning.		0	---	0 to 7	B		
			Number of rotations						Rotation direction
		0	Repeat cycles of 2 rotations						Forward and Reverse (Alternating)
		1							Reverse and Forward (Alternating)
		2							Forward only
		3	Reverse only						
		4	Repeat cycles of single rotation						Forward and Reverse (Alternating)
		5							Reverse and Forward (Alternating)
		6							Forward only
7	Reverse only								
026	Overrun Limit Setting	Sets the Servomotor's allowable operating range for the position command input range. Set to 0 to disable overrun protective function.		10	×0.1 rotation	0 to 1000	A		
027	Instantaneous Speed Observer Setting (RT)	The Instantaneous Speed Observer improves speed detection accuracy, thereby improving responsiveness and reducing vibration when stopping.		0	---	0 to 1	B		
		0	Disabled						
		1	Enabled						
028	Notch Filter 2 Frequency	Sets the notch frequency of notch filter 2 for resonance suppression. This parameter must be matched with the resonance frequency of the load.		1500	Hz	100 to 1500	B		
029	Notch Filter 2 Width	Selects the notch width of notch filter 2 for resonance suppression. Increasing the value increases the notch width.		2	---	0 to 4	B		
02A	Notch Filter 2 Depth	Selects the notch depth of notch filter 2 for resonance suppression. Increasing the value decreases the notch depth, thereby reducing the phase lag.		0	---	0 to 99	B		
02B	Vibration Frequency 1	Sets the vibration frequency 1 for damping control to suppress vibration at the end of the load. Measure and set the frequency of the vibration.		0	×0.1 Hz	0 to 2000	B		
02C	Vibration Filter 1 Setting	When setting Vibration Frequency 1 (Pn02B), reduce this setting if torque saturation occurs, or increase it to make the movement faster. Normally, use a setting of 0.		0	×0.1 Hz	-200 to 2000	B		
02D	Vibration Frequency 2	Sets the vibration frequency 2 for damping control to suppress vibration at the end of the load.		0	×0.1 Hz	0 to 2000	B		
02E	Vibration Filter 2 Setting	Sets vibration filter 2 for damping control to suppress vibration at the end of the load.		0	×0.1 Hz	-200 to 2000	B		
02F	Adaptive Filter Table Number Display	Displays the table entry number corresponding to the frequency of the adaptive filter. This parameter is set automatically when the adaptive filter is enabled (i.e. when the Adaptive Filter Selection (Pn023) is set to a value other than 0), and cannot be changed.		0	---	0 to 64	R		
		0 to 4	Filter disabled						
		5 to 48	Filter enabled						
		49 to 64	Enable or disable the filter with Pn022						

9-1 Parameter Tables

Pn No.	Parameter name	Setting	Explanation	Default Setting	Unit	Setting Range	Attribute	Set value
030	Gain Switching Operating Mode Selection (RT)		Enables or disables gain switching. When enabled, the setting of the Gain Switch Setting (Pn031) is used as the condition for switching between gain 1 and gain 2.	1	---	0 to 1	B	
		0	Disabled. Uses Gain 1 (Pn010 to Pn014). PI/P operation is switched from MECHATROLINK-II.					
		1	The gain is switched between Gain 1 (Pn010 to Pn014) and Gain 2 (Pn018 to Pn01C).					
031	Gain Switch Setting (RT)		Sets the trigger for gain switching. The details depend on the control mode.	2	---	0 to 10	B	
		0	Always Gain 1					
		1	Always Gain 2					
		2	Switching from the network					
		3	Degree of change in torque command					
		4	Always Gain 1					
		5	Speed command					
		6	Amount of position deviation					
		7	Position command pulses received					
		8	Positioning Completed Signal (INP) OFF					
		9	Actual Servomotor speed					
10	Combination of position command pulses received and speed							
032	Gain Switch Time (RT)		Enabled when the Gain Switch Setting (Pn031) is set to 3, or 5 to 10. Sets the lag time from the trigger detection to actual gain switching when switching from gain 2 to gain 1.	30	×166 μs	0 to 10000	B	
033	Gain Switch Level Setting (RT)		Sets the judgment level to switch between Gain 1 and Gain 2 when the Gain Switch Setting (Pn031) is set to 3, 5, 6, 9, or 10. The unit for the setting depends on the condition set in the Gain Switch Setting (Pn031).	600	---	0 to 20000	B	
034	Gain Switch Hysteresis Setting (RT)		Sets the hysteresis of the judgment level for the Gain Switch Level Setting (Pn033) when the Gain Switch Setting (Pn031) is set to 3, 5, 6, 9, or 10. The unit for the setting depends on the condition set for the Gain Switch Setting (Pn031).	50	---	0 to 20000	B	
035	Position Loop Gain Switching Time (RT)		This parameter can prevent the position loop gain from increasing suddenly when the position loop gain and position loop gain 2 differ by a large amount. When the position loop gain increases, it takes the duration of (set value + 1) × 166 μs.	20	×166 μs	0 to 10000	B	
036	Reserved		Do not change.	0	---	---	---	
037	Reserved		Do not change.	0	---	---	---	
038	Reserved		Do not change.	0	---	---	---	
039	Reserved		Do not change.	0	---	---	---	
03A	Reserved		Do not change.	0	---	---	---	
03B	Reserved		Do not change.	0	---	---	---	
03C	Reserved		Do not change.	0	---	---	---	
03D	Jog Speed		Sets the jog operation speed with the Parameter Unit or CX-Drive.	200	r/min	0 to 500	---	
03E	Reserved		Do not change.	0	---	---	---	
03F	Reserved		Do not change.	0	---	---	---	

Pn No.	Parameter name	Setting	Explanation	Default Setting	Unit	Setting Range	Attribute	Set value
040	Reserved	Do not change.		0	---	---	---	
041	Emergency Stop Input Setting	Enables the Emergency Stop Input (STOP).		1	---	0 to 1	C	
		0	Disabled					
		1	Enabled (alarm code 87 issued on OPEN)					
042	Origin Proximity Input Logic Setting	Sets the logic for the Origin Proximity Input (DEC).		1	---	0 to 1	C	
		0	N.C contact (origin proximity detected on OPEN)					
		1	N.O contact (origin proximity detected on CLOSE)					
043	Operating Direction Setting	Sets the relationship between polarity of operation data sent over the network and the direction of Servomotor rotation.		1	---	0 to 1	C	
		0	Sets the reverse direction as the positive direction (+).					
		1	Sets the forward direction as the positive direction (+).					
044	Input Signal Selection	Sets the terminal assignment for Drive Prohibit Input.		0	---	0 to 1	C	
		0	Sets CN1 pin 19 to POT, CN1 pin 20 to NOT.					
		1	Sets CN1 pin 19 to NOT, CN1 pin 20 to POT.					
045	Reserved	Do not change.		0	---	---	---	
046	Reserved	Do not change.		0	---	---	---	
047	Reserved	Do not change.		0	---	---	---	
048	Reserved	Do not change.		0	---	---	---	
049	Reserved	Do not change.		0	---	---	---	
04A	Reserved	Do not change.		0	---	---	---	
04B	Reserved	Do not change.		0	---	---	---	
04C	Reserved	Do not change.		0	---	---	---	
04D	Reserved	Do not change.		0	---	---	---	
04E	Reserved	Do not change.		0	---	---	---	
04F	Reserved	Do not change.		0	---	---	---	
050	Reserved	Do not change.		0	---	---	---	
051	Reserved	Do not change.		0	---	---	---	
052	Reserved	Do not change.		0	---	---	---	
053	Speed Limit	Sets the speed limit for torque control mode. (The value is an absolute value) This parameter is limited by the Overspeed Detection Level Setting (Pn073).		50	r/min	-20000 to 20000	B	
054	Reserved	Do not change.		0	---	---	---	
055	Reserved	Do not change.		0	---	---	---	
056	Reserved	Do not change.		0	---	---	---	
057	Reserved	Do not change.		0	---	---	---	
058	Soft Start Acceleration Time	Sets the acceleration time for speed control mode. Acceleration time [s] from 0 r/min to maximum speed [r/min] = Set value × 2 ms		0	×2 ms	0 to 5000	B	
059	Soft Start Deceleration Time	Sets the deceleration time for speed control mode. Deceleration time [s] from maximum speed [r/min] to 0 r/min = Set value × 2 ms		0	×2 ms	0 to 5000	B	
05A	Reserved	Do not change.		0	---	---	---	

9-1 Parameter Tables

Pn No.	Parameter name	Setting	Explanation	Default Setting	Unit	Setting Range	Attribute	Set value
05B	Speed Limit Selection		Sets the speed limit for torque control mode.	0	---	0 to 1	B	
		0	Use the Speed Limit (Pn053)					
		1	Use the speed limit value via MECHATROLINK-II or the Speed Limit (Pn053), whichever is smaller.					
05C	Reserved	Do not change.	0	---	---	---		
05D	Reserved	Do not change.	0	---	---	---		
05E	No.1 Torque Limit	Sets the No.1 Torque Limit for the Servomotor output torque.	300	%	0 to 500	B		
05F	No.2 Torque Limit	Sets the No.2 Torque Limit for the Servomotor output torque.	100	%	0 to 500	B		
060	Positioning Completion Range 1	Sets the positioning completion range when Positioning Completion 1 (INP1) Output is selected.	25	Command units	0 to 10000	A		
061	Speed Conformity Signal Output Width	Sets the detection width for the speed conformity detection (VCMP) signal.	20	r/min	10 to 20000	A		
062	Rotation Speed for Motor Rotation Detection	Sets the threshold level for the speed reached (TGON) signal.	50	r/min	10 to 20000	A		
063	Positioning Completion Range 2	Sets the positioning completion range when Positioning Completion 2 (INP2) is selected.	100	Command units	0 to 10000	A		
064	Motor Phase Current Offset Re-adjustment Setting		Enables or disables the offset component readjustment function of the Motor Phase Current Detector (CT) for Servo ON command inputs. The readjustment is made when control power is turned ON.	0	---	0 to 1	A	
		0	Disabled (only when turning ON control power)					
		1	Enabled (when turning ON control power, or at Servo ON)					
065	Undervoltage Alarm Selection		Selects whether to activate the main power supply undervoltage function (alarm code 13) when the main power supply is interrupted for the duration of the Momentary Hold Time (Pn06D) during Servo ON.	1	---	0 to 1	B	
		0	Turns the Servo OFF according to the setting for the Stop Selection with Main Power OFF (Pn067), interrupting the positioning command generation process (positioning operation) within the Servo Drive. When the main power supply is turned back ON, Servo ON will resume. Restart the positioning operation after performing the positioning operation and recovering from Servo OFF.					
		1	Causes an error due to main power supply undervoltage (alarm code 13).					

Pn No.	Parameter name	Setting	Explanation		Default Setting	Unit	Setting Range	Attribute	Set value	
066	Stop Selection for Drive Prohibition Input	Sets the deceleration stop operation to be performed after the Forward Drive Prohibit Input (POT) or Reverse Drive Prohibit Input (NOT) is enabled.			0	---	0 to 2	C		
			During deceleration	After stopping (30 r/min or less)						Deviation counter
		0	Dynamic brake	Disables torque in drive prohibited direction						Cleared while decelerating with dynamic brake. Retained after stopping.
		1	Disables torque	Disables torque in drive prohibited direction						Cleared while decelerating. Retained after stopping.
		2	Emergency Stop Torque (Pn06E)	Servo locked						Retained while decelerating, cleared upon completion of deceleration, and retained after stopping.
067	Stop Selection with Main Power OFF	Sets the operation to be performed during deceleration and after stopping after the main power supply is turned OFF with the Undervoltage Alarm Selection (Pn065) set to 0. The deviation counter will be reset when the power OFF is detected.			0	---	0 to 7	B		
		0 and 4	Use dynamic brake to decelerate and remain stopped with dynamic brake.							
		1 and 5	Use free-run to decelerate and remain stopped with dynamic brake.							
		2 and 6	Use dynamic brake to decelerate, but free the motor when stopped.							
		3 and 7	Use free-run to decelerate, and free the motor when stopped.							
068	Stop Selection for Alarm Generation	Sets the deceleration process and stop status after an alarm is issued by the protective function. The deviation counter will be reset when an alarm is issued.			0	---	0 to 3	B		
		0	Use dynamic brake to decelerate and remain stopped with dynamic brake.							
		1	Use free-run to decelerate and remain stopped with dynamic brake.							
		2	Use dynamic brake to decelerate, but free the motor when stopped.							
		3	Use free-run to decelerate, and free the motor when stopped.							
069	Stop Selection with Servo OFF	Sets the operation after a Servo OFF. The relationship between set values, operation, and deviation counter processing for this parameter is the same as for the Stop Selection with Main Power OFF (Pn067).			0	---	0 to 7	B		
06A	Brake Timing when Stopped	Sets the duration from Brake Interlock (BKIR) signal detection to Servo OFF.			10	2 ms	0 to 1000	B		

9-1 Parameter Tables

Pn No.	Parameter name	Setting	Explanation	Default Setting	Unit	Setting Range	Attribute	Set value
06B	Brake Timing during Operation		Sets the duration from Servo OFF to when the Brake Interlock (BKIR) signal is turned OFF. BKIR is also turned OFF when the speed drops to 30 r/min or less before the set time elapses.	50	2 ms	0 to 1000	B	
06C	Regeneration Resistor Selection		Sets the regeneration resistor operation and the regeneration overload (alarm code 18) operation. Set this parameter to 0 if using the built-in regeneration resistor. If using an external regeneration resistor, be sure to turn OFF the main power when the built-in thermal switch is activated.	0	---	0 to 3	C	
		0	Sets the regeneration overload to match the built-in regeneration resistor. (regeneration load ratio below 1%)					
		1	The regeneration overload (alarm code 18) occurs when the load ratio of the external regeneration resistor exceeds 10%.					
		2	The regeneration processing circuit by the external regeneration resistor is activated, but the regeneration overload (alarm code 18) does not occur.					
		3	The regeneration processing circuit is not activated. All regenerative energy is absorbed by the built-in capacitor.					
06D	Momentary Hold Time		Sets the amount of time required to detect shutoff when the main power supply continues to shut off. The main power OFF detection will be disabled if this parameter is set to 1000.	35	2 ms	35 to 1000	C	
06E	Emergency Stop Torque		Sets the torque limit during deceleration because of the Drive Prohibition Input when the Stop Selection for Drive Prohibition Input (Pn066) is set to 2. When this parameter is set to 0, the normal torque limit will be set. The maximum value of the setting range depends on the Servomotor.	0	%	0 to 300	B	
06F	Reserved		Do not change.	0	---	---	---	
070	Reserved		Do not change.	0	---	---	---	
071	Reserved		Do not change.	0	---	---	---	
072	Overload Detection Level Setting		Sets the overload detection level. The overload detection level will be set at 115% if this parameter is set to 0. Normally, use a setting of 0, and set the level only when reducing the overload detection level.	0	%	0 to 500	A	
073	Overspeed Detection Level Setting		Sets the overspeed detection level. The overspeed detection level is 1.2 times the maximum Servomotor rotation speed when the parameter is set to 0.	0	r/min	0 to 20000	A	
074	Reserved		Do not change.	0	---	---	---	
075	Reserved		Do not change.	0	---	---	---	
076	Reserved		Do not change.	0	---	---	---	
077	Reserved		Do not change.	0	---	---	---	
078	Reserved		Do not change.	0	---	---	---	
079	Reserved		Do not change.	0	---	---	---	
07A	Reserved		Do not change.	0	---	---	---	
07B	Reserved		Do not change.	0	---	---	---	
07C	Reserved		Do not change.	0	---	---	---	

Pn No.	Parameter name	Setting	Explanation	Default Setting	Unit	Setting Range	Attribute	Set value
07D	Reserved	Do not change.		0	---	---	---	
07E	Reserved	Do not change.		0	---	---	---	
07F	Reserved	Do not change.		0	---	---	---	

■ 16-bit Positioning Parameters: Parameter Numbers 100 to 13F

Pn No.	Parameter name	Setting	Explanation	Default Setting	Unit	Setting Range	Attribute	Set value
100	Backlash Compensation Selection		Enables or disables the backlash compensation for position control, and sets the compensation direction.	0	---	0 to 2	C	
		0	Disabled					
		1	Compensates in the initial forward direction after the Servo ON.					
		2	Compensates in the initial forward direction after the Servo ON.					
101	Backlash Compensation		Sets the backlash compensation amount for position control.	0	Command units	-32768 to 32767	B	
102	Backlash Compensation Time Constant		Sets the backlash compensation time constant for position control.	0	0.01 ms	0 to 6400	B	
103	Reserved		Do not change.	0	---	---	---	
104	Soft Limit		Enables or disables the soft limit.	0	---	0 to 3	A	
		0	Enable both the Forward / Reverse Software Limits (Pn201 and Pn202)					
		1	Disable the Forward Software Limit (Pn201), enable the Reverse Software Limit (Pn202)					
		2	Enable the Forward Software Limit (Pn201), disable the Reverse Software Limit (Pn202)					
105	Origin Range		Sets the threshold for detecting the origin (ZPOINT) in absolute values. ZPOINT = 1 when the return to origin completes (coordinate system setup is complete) and the feedback position is within the setting range of this parameter.	10	Command units	0 to 250	A	
		3	Disable both the Forward / Reverse Software Limits (Pn201 and Pn202)					
106	Reserved		Do not change.	0	---	---	---	
107	Linear Acceleration Constant		Sets the acceleration for positioning operations. A setting of "0" is regarded as "1". The setting will be handled after conversion to an unsigned 16-bit data (0 to 65535). Example: -32768 → 8000h = 32768 -1 → FFFFh = 65535	100	× 10000 [Command units/s ²]	-32768 to 32767	B	
108	Reserved		Do not change.	0	---	---	---	
109	Reserved		Do not change.	0	---	---	---	

Pn No.	Parameter name	Setting	Explanation	Default Setting	Unit	Setting Range	Attribute	Set value
10A	Linear Deceleration Constant		Sets the deceleration for positioning operations. A setting of "0" is regarded as "1". The setting will be handled after conversion to an unsigned 16-bit data (0 to 65535). Example: -32768 → 8000h = 32768 -1 → FFFFh = 65535	100	× 10000 [Command units/s ²]	-32768 to 32767	B	
10B	Reserved		Do not change.	0	---	---	---	
10C	Reserved		Do not change.	0	---	---	---	
10D	Reserved		Do not change.	0	---	---	---	
10E	Moving Average Time		Sets the moving average time for position commands.	0	×0.1 ms	0 to 5100	B	
10F	Origin Return Mode Settings		Sets the direction for origin return.	0	---	0 to 1	B	
		0	Positive direction					
		1	Negative direction					
110	Origin Return Approach Speed 1		Sets the operating speed for origin return, from when the origin proximity signal is turned ON, to when it is turned OFF and the latch signal is detected.	50	×100 [Command units/s]	1 to 32767	B	
111	Origin Return Approach Speed 2		Sets the operating speed for origin return, from when the latch signal is detected, to when the Origin Return Final Distance (Pn204) is reached.	5	×100 [Command units/s]	1 to 32767	B	

9-1 Parameter Tables

Pn No.	Parameter name	Setting	Explanation	Default Setting	Unit	Setting Range	Attribute	Set value
112	General-purpose Output 1 Function Selection		Selects the function for general-purpose output 1 (OUTM1).	7	---	0 to 9	C	
		0	Always OFF					
		1	INP1 output. Turn ON when position deviation is equal to or less than Pn060 for position control.					
		2	VCMP output. Turn ON when the deviation between Servomotor speed and commanded speed is within the range set by Pn061 for speed control.					
		3	TGON output. Turn ON when the absolute value of the Servomotor speed exceeds Pn062 settings in all control modes.					
		4	READY output. Turn ON when the main power is supplied, there is no alarm, and Servo SYNC with a host controller is established in all control modes.					
		5	CLIM output. Turn ON when torque limit is activated in all control modes.					
		6	VLIM output. Turn ON when the Servomotor speed reaches the speed limit for torque control.					
		7	BKIR output. Turn ON with the release timing of the brake release signal in all control modes.					
		8	WARN output. Turn ON when a warning is issued in all control modes.					
		9	INP2 output. Turn ON when the position deviation is equal to or less than the Positioning Completion Range 2 (Pn063) for position control.					
113	General-purpose Output 2 Function Selection		Selects the function for general-purpose output 2 (OUTM2). The set values and the functions are the same as for general-purpose output 1 (OUTM1).	0	---	0 to 9	C	
114	General-purpose Output 3 Function Selection		Selects the function for general-purpose output 3 (OUTM3). The set values and the functions are the same as for general-purpose output 1 (OUTM1).	0	---	0 to 9	C	
115 to 13F	Reserved		Do not change.	0	---	---	---	

■ 32-bit Positioning Parameters: Parameter Numbers 200 to 21F

Pn No.	Parameter name	Setting	Description	Default Setting	Unit	Setting Range	Attribute	Set value	
200	Absolute Origin Offset		Sets the offset amount for the encoder position and the mechanical coordinate system position when using an absolute encoder.	0	Command units	-1073741823 to 1073741823	C		
201	Forward Software Limit		Sets the soft limit in the forward direction. If the Servomotor exceeds the limit, the network response status (PSOT) will turn ON (=1). Note 1. Be sure to set the limits so that Forward Software Limit > Reverse Software Limit. Note 2. PSOT is not turned ON when origin return is incomplete.	500000	Command units	-1073741823 to 1073741823	A		
202	Reverse Software Limit		Sets the soft limit for the reverse direction. If the Servomotor exceeds the limit, the network response status (NSOT) will turn ON (=1). Note 1. Be sure to set the limits so that Forward Software Limit > Reverse Software Limit. Note 2. NSOT is not turned ON when origin return is incomplete.	-500000	Command units	-1073741823 to 1073741823	A		
203	Final Distance for External Input Positioning	Sets the distance to travel after detecting the latch signal input position when performing external input positioning. The operation after detecting the latch signal input position will be determined by the external input positioning direction and this parameter as follows.		100	Command units	-1073741823 to 1073741823	B		
		External input positioning direction	Sign						
			Positive						Negative
		Positive direction	Moves in the positive direction and stops *1						Decelerates to a stop, reverses, then moves in the negative direction and stops
Negative direction	Decelerates to a stop, reverses, then moves in the positive direction and stops	Moves in the negative direction and stops *1							
*1. Reverses after decelerating to a stop if the final distance for external input positioning is short in comparison to the deceleration distance.									

9-1 Parameter Tables

Pn No.	Parameter name	Setting	Description	Default Setting	Unit	Setting Range	Attribute	Set value	
204	Origin Return Final Distance		Sets the distance from the latch signal input position to the origin when performing origin return. The operation after detecting the latch signal input position will be determined by the origin return direction and this parameter as follows.	100	Command units	-1073741823 to 1073741823	B		
		Origin return direction	Sign						
			Positive						Negative
		Positive direction	Moves in the positive direction and stops *1						Decelerates to a stop, reverses, then moves in the negative direction and stops
		Negative direction	Moves in the negative direction and stops *1						Decelerates to a stop, reverses, then moves in the positive direction and stops
	*1. Reverses after decelerating to a stop if the final distance for origin return is short in comparison to the deceleration distance.								
205	Electronic Gear Ratio 1 (Numerator)		Sets the numerator for the electronic gear ratio. Setting this parameter to 0 automatically sets the encoder resolution as the numerator. (131072 for a 17-bit absolute encoder, or 10000 for a 2,500-p/r incremental encoder). Note Set the electronic gear ratio within the range of 1/100 to 100 times. A parameter setting alarm (alarm code 93) will occur if the ratio is set outside of this range.	1	---	0 to 131072	C		
206	Electronic Gear Ratio 2 (Denominator)		Sets the denominator for the electronic gear ratio. Note Set the electronic gear ratio within the range of 1/100 to 100 times. A parameter setting alarm (alarm code 93) will occur if the ratio is set outside of this range.	1	---	1 to 65535	C		
207	Reserved		Do not change.	0	---	---	---		
208	Reserved		Do not change.	0	---	---	---		
209	Deviation Counter Overflow Level		Sets the deviation counter overflow level. The value will become saturated at 134217728 (= 2 ²⁷) pulse after multiplying with the electronic gear ratio. Setting this parameter to 0 will disable deviation counter overflow.	20000	Command units	0 to 2147483647	A		
20A to 21F	Reserved		Do not change.	---	---	---	---		

Index

Numerics

1,000-r/min Servomotors	2-4, 3-28
12 to 24-VDC Power Supply Input (+24VIN)	3-11
16-bit Positioning Parameters	5-81, 9-15
2,000-r/min Servomotors	2-3, 3-26
3,000-r/min Flat Servomotors	2-3, 3-24
3,000-r/min Servomotors	2-2, 3-18
32-bit Positioning Parameters	5-84, 9-18

A

Absolute Encoder Battery Cable	3-48, 2-20
Absolute Encoders	3-31
Absolute Origin Position Offset (Pn200)	5-84
AC Reactors	4-40
Adaptive Filter	5-45
Adaptive Filter Selection (Pn023)	5-69, 5-92
Adaptive Filter Table Number Display (Pn02F)	5-72, 5-93
Address Display Time at Power Up (Pn006)	5-65
Alarm Output (/ALM)	3-12, 5-25
Alarm Reset	6-25
alarms table	8-4
allowable current	4-24
applicable standards	1-10

B

Backlash Compensation	5-27
Backlash Compensation (Pn101)	5-81
Backlash Compensation Selection (Pn100)	5-81
Backlash Compensation Time Constant (Pn102)	5-81
Backup Battery Input (BAT)	3-11
Brake Cables (Robot Cables)	2-20, 3-66
Brake Cables (Standard Cables)	2-17, 3-64
Brake Interlock	5-11
Brake Timing during Operation (Pn06B)	5-78
Brake Timing When Stopped (Pn06A)	5-78

C

Check Pins	1-4
Clamp Cores	4-36
Communications Cables	2-20, 3-67
Communications Control (Pn005)	5-65, 5-88
Computer Monitor Cable	3-67, 4-14
Connecting cables	4-11
connector specifications	3-42
Connector Terminal Block Cables	2-21, 3-73
Connector Terminal Blocks	2-21
Connectors	2-21
Connector-Terminal Block Conversion Unit	3-74
Connector-Terminal Blocks and Cables	4-15
Contactors	4-38
Control Cables	2-21, 3-42
Control I/O connector specifications	3-10
Control I/O Connector	3-68, 4-14
Control Input Circuits	3-14
Control input signals	3-11
Control inputs	3-14
Control Output Circuits	3-14
Control Outputs	3-14
Control Sequence Timing	3-15

Copy Mode	6-28
-----------------	------

D

Damping Control	5-50
Decelerator dimensions	2-47
Decelerator installation conditions	4-7
Decelerator specifications	3-32
Decelerators	2-7
Decelerators for 1,000-r/min Servomotors (Backlash = 3' Max.)	2-53, 3-37
Decelerators for 2,000-r/min Servomotors (Backlash = 3' Max.)	2-51, 3-35
Decelerators for 3,000-r/min Flat Servomotors (Backlash = 15' Max.)	2-59, 3-41
Decelerators for 3,000-r/min Flat Servomotors (Backlash = 3' Max.)	2-55, 3-38
Decelerators for 3,000-r/min Servomotors (Backlash = 15' Max.)	2-57, 3-39
Decelerators for 3,000-r/min Servomotors (Backlash = 3' Max.)	2-47, 3-32
Default Display (Pn001)	5-62
Deviation Counter Overflow Level (Pn209)	5-85
disabling adaptive filter	5-47
Drive Prohibit Input Selection (Pn004)	5-64, 5-88
Dynamic brake	5-95, 5-96

E

EC Directives	1-10
Electronic Gear	5-21
Electronic Gear Ratio 1 (Numerator) (Pn205)	5-85
Electronic Gear Ratio 2 (Denominator) (Pn206)	5-85
Electronic Thermal Function	8-20
Emergency Stop Input (STOP)	3-11, 5-23
Emergency Stop Input Setting (Pn041)	5-73
Emergency Stop Torque (Pn06E)	5-79
Encoder cable	3-42
Encoder cable noise resistance	4-39
Encoder Cables (Robot Cables)	2-18, 3-45, 4-13
Encoder Cables (Standard Cables)	2-14, 3-42, 4-12
Encoder connector specifications (CN2)	3-16
Encoder connectors	3-68
Encoder Dividing	5-10
Encoder specifications	3-31
Error Diagnosis Using the Displayed Alarm Codes	8-7
Error Diagnosis Using the Displayed Warning Codes	8-14
Error Diagnosis Using the Operating Status	8-15
Error Processing	8-1
External dimensions	2-23
External General-purpose Input 0 (IN0)	3-11, 5-23
External General-purpose Input 1 (IN1)	3-11, 5-23
External General-purpose Input 2 (IN2)	3-11, 5-23
External latch signal 1 (EXT1)	3-11, 5-23
External latch signal 2 (EXT2)	3-11, 5-23
External latch signal 3 (EXT3)	3-11, 5-23
External Regeneration Resistor dimensions	2-61
External Regeneration Resistor specifications	3-79
External Regeneration Resistors	2-21

Index-1

F

Feed-forward Filter Time Constant (Pn016)	5-68
Final Distance for External Input Positioning (Pn203)	5-84
Forward Drive Prohibit	5-10
Forward Drive Prohibit Input (POT)	3-11, 5-23
Forward Software Limit (Pn201)	5-84
Forward Torque Limit Input (PCL)	3-11, 5-23

G

gain adjustment	7-1
Gain Switch Hysteresis Setting (Pn034)	5-73
Gain Switch Level Setting (Pn033)	5-72
Gain Switch Setting (Pn031)	5-72
Gain Switch Time (Pn032)	5-72
Gain Switching	5-31
Gain Switching Operating Mode Selection (Pn030)	5-72
General-purpose Output 1 (OUTM1)	3-12, 5-25
General-purpose Output 1 Function Selection (Pn112)	5-83
General-purpose Output 2 (OUTM2)	3-12, 5-25
General-purpose Output 2 Function Selection (Pn113)	5-83
General-purpose Output 3 (OUTM3)	3-12, 5-25
General-purpose Output 3 Function Selection (Pn114)	5-83

H

harmonic current countermeasures	4-40
--	------

I

Incremental Encoders	3-31
Inertia Ratio (Pn020)	5-68
Input Signal Selection (Pn044)	5-74
Instantaneous Speed Observer	5-48
Instantaneous Speed Observer Setting (Pn027)	5-71

J

Jog Operation	6-27
Jog Speed (Pn03D)	5-73

L

Leakage Breakers	4-32
Linear Acceleration Constant (Pn107)	5-82
Linear Deceleration Constant (Pn10A)	5-82

M

Main Circuit Connector Specifications (CNA)	3-7, 4-20
Main Circuit Terminal Block Specifications	3-8, 3-9, 4-21, 4-22
Manual Tuning	7-14
MECHATROLINK-II Communications Cable	2-20, 3-71
mode setup	6-9
Momentary Hold Time (Pn06D)	5-79
Monitor Mode	6-10
Motor Phase Current Offset Re-adjustment Setting (Pn064)	5-75

Mounting Brackets (L brackets for rack mounting)	2-22
mounting hole dimensions	2-23
Moving Average Time	5-20
Moving Average Time (Pn10E)	5-82

N

no-fuse breakers	4-31
Noise filter	4-34, 4-35, 4-36, 4-42
noise filters for brake power supply	4-35
noise filters for Servomotor output	4-42
noise filters for the power supply input	4-34
Normal Mode Autotuning	6-24, 7-9
Normal Mode Autotuning Operation Setting (Pn025)	5-70, 5-93
Notch Filter	5-43
Notch Filter 1 Frequency (Pn01D)	5-68
Notch Filter 1 Width (Pn01E)	5-68
Notch Filter 2 Depth (Pn02A)	5-71
Notch Filter 2 Frequency (Pn028)	5-71
Notch Filter 2 Width (Pn029)	5-71
No. 1 Torque Limit (Pn05E)	5-75
No. 2 Torque Limit (Pn05F)	5-75

O

oil seal	4-5
Operating Direction Setting (Pn043)	5-73
Operation Switch When Using Absolute Encoder (Pn00B)	5-67
Origin Proximity Input (DEC)	3-11, 5-23
Origin Proximity Input Logic Setting (Pn042)	5-73
Origin Range (Pn105)	5-81
Origin Return Approach Speed 1 (Pn110)	5-82
Origin Return Approach Speed 2 (Pn111)	5-82
Origin Return Final Distance (Pn204)	5-85
Origin Return Mode Settings (Pn10F)	5-82
Overload Characteristics	8-20
Overload Detection Level Setting (Pn072)	5-79
Overrun Limit Setting (Pn026)	5-70
Overrun Protection	5-29
Overspeed Detection Level Setting (Pn073)	5-79

P

P Control Switching	5-41
Parameter Details	5-86
Parameter Setting Mode	6-17
Parameter Tables	5-61, 9-1
Parameter Unit Connector Specifications (CN3)	3-16
Parameter Unit dimensions	2-43
Parameter Unit specifications	3-78
Parameter Write Mode	6-23
Periodic Maintenance	8-21
pin arrangement	3-13
Position Control	5-1
Position Control Mode	7-15
Position Loop Gain (Pn010)	5-67
Position Loop Gain 2 (Pn018)	5-68
Position Loop Gain Switching Time (Pn035)	5-73
Positioning Completion Range 1 (Pn060)	5-75
Positioning Completion Range 2 (Pn063)	5-75
Power Cables (Robot Cables)	4-14

Index

Power Cables (Standard Cables)	4-13
Power Cables for Servomotors with Brakes (Robot Cables)	3-61
Power Cables for Servomotors with Brakes (Standard Cables)	3-58
Power Cables for Servomotors without Brakes (Robot Cables)	3-54
Power Cables for Servomotors without Brakes (Standard Cables)	3-49
Prohibit Parameter Changes via Network (Pn00A)	5-67
Protective Functions	3-5

R

radio noise filters	4-36
Reactor dimensions	2-62
Reactors	2-21, 3-80, 4-40
Realtime Autotuning	7-3
Realtime Autotuning Machine Rigidity Selection (Pn022)	5-69, 5-89
Realtime Autotuning Mode Selection (Pn021)	5-69, 5-89
Regeneration Resistor Selection (Pn06C)....	5-79, 5-96
regenerative energy.....	4-44
regenerative energy (External Regeneration Resistors)	4-48
regenerative energy absorption.....	4-47
Replacing the Absolute Encoder Battery.....	8-23
replacing the Servo Drive	8-2
replacing the Servomotor	8-2
Reverse Drive Prohibit.....	5-10
Reverse Drive Prohibit Input (NOT).....	3-11, 5-23
Reverse Software Limit (Pn202).....	5-84
Reverse Torque Limit Input (NCL).....	3-11, 5-23
Rotation Speed for Motor Rotation Detection (Pn062).....	5-75
rotational speed characteristics for 1,000-r/min Servomotors	3-29
rotational speed characteristics for 2,000-r/min Servomotors	3-27
rotational speed characteristics for 3,000-r/min Flat Servomotors	3-25
rotational speed characteristics for 3,000-r/min Servomotors	3-21
RS-232 Baud Rate Setting (Pn00C).....	5-67

S

Sequence Input Signals.....	5-23
Sequence Output Signals.....	5-25
Servo Drive characteristics.....	3-2
Servo Drive dimensions.....	2-23
Servo Drive functions	1-4
Servo Drive General Specifications.....	3-1
Servo Drive installation conditions.....	4-1
Servo Drive models	2-1
Servo Drive part names.....	1-3
Servo Drive service life.....	8-22
Servo Drive-Servomotor combinations.....	2-5
Servomotor and Decelerator Combinations	2-44
Servomotor characteristics.....	3-18
Servomotor connector specifications (CNB)...	3-7, 4-20
Servomotor general specifications	3-17

Servomotor installation conditions.....	4-3
Servomotor models	2-2
Servomotor power cable.....	3-49
Servomotor Power Cables (Robot Cables)	2-19
Servomotor Power Cables (Standard Cables)	2-15
Servomotor service life	8-21
Soft Limit (Pn104).....	5-81
Soft Start.....	5-18
Soft Start Acceleration Time (Pn058)	5-74
Soft Start Deceleration Time (Pn059).....	5-74
Speed Conformity Signal Output Width (Pn061)	5-75
Speed Control.....	5-4
speed control mode adjustment	7-16
Speed Feedback Filter Selection.....	5-40
Speed Feedback Filter Time Constant (Pn013)	5-67
Speed Feedback Filter Time Constant 2 (Pn01B)..	5-68
Speed Feed-forward.....	5-38
Speed Feed-forward Amount (Pn015).....	5-68
Speed Limit.....	5-22
Speed Limit (Pn053).....	5-74
Speed Limit Selection (Pn05B).....	5-74
speed limit values	7-21
Speed Loop Gain (Pn011).....	5-67
Speed Loop Gain 2 (Pn019).....	5-68
Speed Loop Integration Time Constant (Pn012)	5-67
Speed Loop Integration Time Constant 2 (Pn01A)	5-68
Speed monitor (SP) Selection (Pn007)	5-66
Stop Selection for Alarm Generation (Pn068)	5-78, 5-96
Stop Selection for Drive Prohibition Input (Pn066)	5-77, 5-95
Stop Selection with Main Power OFF (Pn067)	5-78, 5-95
Stop Selection with Servo OFF (Pn069).....	5-78, 5-96
surge absorbers.....	4-33
surge suppressors	4-38
system block diagrams	1-5
system configuration.....	1-2

T

Terminal Block Wire Sizes.....	4-23
Terminal Block Wiring.....	4-25
Torque Command Filter Time Constant	5-42
Torque Command Filter Time Constant (Pn014) ...	5-68
Torque Command Filter Time Constant 2 (Pn01C)	5-68
Torque Control.....	5-7
torque control mode adjustment	7-21
Torque Feed-forward.....	5-39
Torque Limit.....	5-16, 5-19
Torque Limit Selection (Pn003).....	5-63, 5-87
Torque Monitor (IM) Selection (Pn008)	5-66
Trial Operation.....	6-31
troubleshooting.....	8-7

U

UL and CSA standards.....	1-10
Undervoltage Alarm Selection (Pn065)	5-76
user parameters	5-55
using the parameter unit.....	6-8

Index-3

V

Vibration Filter 1 Setting (Pn02C).....	5-71
Vibration Filter 2 Setting (Pn02E).....	5-72
Vibration Filter Selection (Pn024).....	5-70, 5-92
Vibration Frequency 1 (Pn02B).....	5-71
Vibration Frequency 2 (Pn02D).....	5-71

W

Wire Sizes	4-24
wiring conforming to EMC Directives.....	4-26

Revision History

A manual revision code appears as a suffix to the catalog number on the front and back covers of the manual.

Cat. No. I566-E1-01



Revision code

The following table outlines the changes made to the manual during each revision. Page numbers refer to the previous version.

Revision code	Date	Revised content and pages
01	July 2008	Original production

OMRON Corporation
Industrial Automation Company
Control Devices Division H.Q.
Motion Control Department

Shiokoji Horikawa, Shimogyo-ku,
Kyoto, 600-8530 Japan
Tel: (81) 75-344-7173/Fax: (81) 75-344-7149
2-2-1 Nishikusatsu, Kusatsu-shi,
Shiga, 525-0035 Japan
Tel: (81) 77-565-5223/Fax: (81) 77-565-5568

Regional Headquarters

OMRON EUROPE B.V.

Wegalaan 67-69-2132 JD Hoofddorp
The Netherlands
Tel: (31)2356-81-300/Fax: (31)2356-81-388

OMRON Industrial Automation Global: www.ia.omron.com

OMRON ELECTRONICS LLC

One Commerce Drive Schaumburg,
IL 60173-5302 U.S.A.
Tel: (1) 847-843-7900/Fax: (1) 847-843-7787

OMRON ASIA PACIFIC PTE. LTD.

No. 438A Alexandra Road # 05-05/08 (Lobby 2),
Alexandra Technopark, Singapore 119967
Tel: (65) 6835-3011/Fax: (65) 6835-2711

OMRON (CHINA) CO., LTD.

Room 2211, Bank of China Tower,
200 Yin Cheng Zhong Road,
PuDong New Area, Shanghai, 200120, China
Tel: (86) 21-5037-2222/Fax: (86) 21-5037-2200

Authorized Distributor:

© OMRON Corporation 2008 All Rights Reserved.
In the interest of product improvement,
specifications are subject to change without notice.

Cat. No. I566-E1-01