

Preface

The temperature controller E5EN allows the user to carry out the following:

- Select from many types of temperature, non-contact temperature sensor and analog input
- Select heating and cooling control in addition to standard control
- Select AT (auto-tuning) and ST (self-tuning) as tuning functions
- Use multi-SP and the run/stop function according to event input (for units equipped with the event input function)
- Use the HBA (heater burnout alarm) function (for units equipped with the heater burnout alarm function)
- Use the communications function (for units equipped with the communications function)
- Calibrate sensor input
- The E5EN features a watertight construction (NEMA4 : equivalent to IP66).
- The E5EN conforms to UL/CSA/IEC safety standards and EMC standards.

* This User's Manual describes how to use the E5EN.

Before using your E5EN, thoroughly read and understand this manual in order to ensure correct use.

Also, store this manual in a safe place so that it can be retrieved whenever necessary.

* For an additional description of the communications function, also refer to the E5EN/CN/GN Temperature Controller, Communications Function User's Manuals (Cat. No. H111-E1-1).

E OMRON, 1999

All rights reserved. No part of this publication may be reproduced, stored in a retrieval system or transmitted, in any form, or by any means, mechanical, electronic, photocopying, recording, or otherwise, without the prior written permission of OMRON.

No patent liability is assumed with respect to the use of the information contained herein. Moreover, because OMRON is constantly striving to improve its high-quality products, the information contained in this manual is subject to change without notice. Every precaution has been taken in the preparation of this manual. Nevertheless, OMRON assumes no responsibility for errors or omissions. Neither is any liability assumed for damages resulting from the use of the information contained in this publication.

PRECAUTIONS

When the product is used under the circumstances or environment described in this manual, always adhere to the limitations of the rating and functions. Also, for safety, take countermeasures such as fitting fail safe installations.

DO NOT USE :

- In circumstances or environments that have not been described below in this manual.
- For control in nuclear power, railway, aircraft, vehicle, incinerator, medical, entertainment, or safety applications.
- Where death or serious property damage may occur, or where extensive safety precautions are required.

SAFETY PRECAUTIONS

J Safety Signal Words

This manual uses the following signal words to mark safety precautions for the E5EN. These precautions provide important information for the safe application of the product. You must be sure to follow the instructions provided in all safety precautions.

 WARNING	Indicates information that, if not heeded, could possibly result in loss of life or serious injury.
--	---

 CAUTION	Indicates information that, if not heeded, could result in relatively serious or minor injury, damage to the product, or faulty operation.
--	--

J Safety Precautions

 CAUTION
F Electric Shock Warning Do not touch the terminals while the power is ON. Doing so may cause an electric shock.
Do not allow metal fragments or lead wire scraps to fall inside this product. These may cause electric shock, fire or malfunction.
Never disassemble, repair or modify the product. Doing so may cause electric shock, fire or malfunction.
Do not operate this product in flammable and explosive gas atmospheres.
The life expectancy of the output relays varies greatly with the switching capacity and other switching conditions. Always use the output relays within their rated load and electrical life expectancy. If an output relay is used beyond its life expectancy, its contacts may become fused or burned.
Use this product within the rated load. Not doing so may cause damage or fire.
Use this product within the rated supply voltage. Not doing so may cause damage or fire.
Tighten the terminal screws to a torque of 0.74 to 0.90 N _l m Loose screws may cause malfunction.
Set all settings according to the control target of the product. If the settings are not appropriate for the control target, the product may operate in an unexpected manner, resulting in damage to the product or resulting in accidents.
To maintain safety in the event of a product malfunction, always take appropriate safety measures, such as installing an alarm on a separate line to prevent excessive temperature rise. If a malfunction prevents proper control, a major accident may result.

NOTICE

Be sure to observe these precautions to ensure safe use.

- (1) Do not wire unused terminals.
- (2) Be sure to wire properly with correct polarity of terminals.
- (3) To reduce induction noise, separate the high-voltage or large-current power lines from other lines, and avoid parallel or common wiring with the power lines when you are wiring to the terminals. We recommend using separating pipes, ducts, or shielded lines.
- (4) Do not use this product in the following places:
 - Places subject to dust or corrosive gases (in particular, sulfide gas and ammonia gas)
 - Places subject to high humidity, condensation or freezing
 - Places subject to direct sunlight
 - Places subject to vibration and large shocks
 - Places subject to splashing liquid or oily atmosphere
 - Places directly subject to heat radiated from heating equipment
 - Places subject to intense temperature changes
- (5) To allow heat to escape, do not block the area around the product. (Ensure that enough space is left for the heat to escape.)
 - Do not block the ventilation holes on the casing.
- (6) When you draw out or draw in the internal mechanism or the terminal unit from the housing, never touch electrical components inside or subject the internal mechanism to shock.
- (7) Cleaning: Do not use paint thinner or the equivalent. Use standard grade alcohol to clean the product.
- (8) Use specified size (M3.5, width 7.2 mm or less) crimped terminals for wiring.
- (9) Allow as much space as possible between the E5EN and devices that generate powerful high-frequency noise (e.g. high-frequency welders, high-frequency sewing machines) or surges.
- (10) When executing self-tuning, turn the load (e.g. heater) ON simultaneously or before you turn the the main unit ON. If you turn the the main unit ON before turning the load ON, correct self-tuning results and optimum control may no longer be obtained.
- (11) Use a 100 to 240 VAC (50/60 Hz), 24 VAC (50/60 Hz) or 24 VDC power supply matched to the power specifications of the E5EN. Also, make sure that rated voltage is attained within two seconds of turning the power ON.
- (12) Attach a surge suppressor or noise filter to peripheral devices that generate noise (in particular, motors, transformers, solenoids, magnetic coils or other equipment that have an inductance component).
- (13) When mounting a noise filter on the power supply, be sure to first check the filter's voltage and current capacity, and then mount the filter as close as possible to the E5EN.
- (14) Use within the following temperature and humidity ranges:
 - Temperature: -10 to 55_C, Humidity: 25 to 85% (with no icing or condensation)
If the E5EN is installed inside a control board, the ambient temperature must be kept to under 55_C, including the temperature around the E5EN.
If the E5EN is subjected to heat radiation, use a fan to cool the surface of the E5EN to under 55_C.
- (15) Store within the following temperature and humidity ranges:
 - Temperature: -25 to 65_C, Humidity: 25 to 85% (with no icing or condensation)
- (16) Never place heavy objects on, or apply pressure to the E5EN as it may cause it to deform and deteriorate during use or storage.
- (17) Avoid using the E5EN in places near a radio, television set, or wireless installation. These devices can cause radio disturbances which adversely affect the performance of the E5EN.

Conventions Used in This Manual

J Meanings of Abbreviations

The following abbreviations are used in parameter names, figures and in text explanations. These abbreviations mean the following:

Symbol	Term
PV	Process value
SV	Set value
SP	Set point
AT	Auto-tuning
ST	Self-tuning
EU	Engineering unit *1

*1 _C, m, g and other units are indicated for scaled data. However, "EU" is used as the minimum unit for the data. For example, for "50.02 (m)", 1 EU is taken as the minimum unit 0.01 (m).

J How to Read Display Symbols

The following tables show the correspondence between the symbols displayed on the displays and alphabet characters.

A	b	C	d	E	F	G	H	I	J	K	L	M
A	B	C	D	E	F	G	H	I	J	K	L	M

n	o	P	q	r	S	t	U	v	w	x	y	z
N	O	P	Q	R	S	T	U	V	W	X	Y	Z

J How This Manual is Organized

Purpose	Related title	Description
D Learning about the E5EN	Chapter 1 INTRODUCTION	This chapter describes the features, names of parts and typical functions.
D Setting up the E5EN	Chapter 2 PREPARATIONS	This chapter describes installation and wiring.
D Basic operations	Chapter 3 BASIC OPERATION and Chapter 5 PARAMETERS	These chapters describe basic control examples.
D Applied operations	Chapter 4 APPLIED OPERATION and Chapter 5 PARAMETERS	These chapters describe advanced functions to fully use E5EN.
D Calibration	Chapter 6 CALIBRATION	This chapter describes calibration method.
D Appendix		This chapter describes the unit specifications. There is also a parameter operations list to be used as a backup guide to the parameter settings.

Table of Contents

Preface	I
Precautions	II
Safety Precautions	III
Notice	IV
Conventions Used in This Manual	V

CHAPTER 1 INTRODUCTION	1-1
1.1 Names of Parts	1-2
Front panel	1-2
Display	1-2
How to use keys	1-3
1.2 I/O Configuration and Main Functions	1-4
I/O configuration	1-4
Main functions	1-5
1.3 How Setup Levels Are Configured and Operating the Keys on the Front Panel	1-6
Selecting parameters	1-8
Fixing settings	1-8
1.4 Communications Function	1-9
CHAPTER 2 PREPARATIONS	2-1
2.1 Installation	2-2
Dimensions	2-2
Panel cutout	2-2
Mounting	2-3
Draw out	2-4
2.2 Wiring Terminals	2-5
Terminal arrangement	2-5
Precautions when wiring	2-5
Wiring	2-5
CHAPTER 3 BASIC OPERATION	3-1
3.1 Initial Setup Examples	3-2
3.2 Setting the Input Type	3-4
Input type	3-4
3.3 Selecting _C/_F	3-5
Temperature unit	3-5
3.4 Selecting PID Control or ON/OFF Control	3-6
3.5 Setting Output Specifications	3-7
Control period	3-7
Direct/reverse operation	3-7
3.6 Setting the SP	3-9
Changing the SP	3-9
3.7 Executing ON/OFF Control	3-10
ON/OFF Control	3-10
Setup	3-11

3.8	Determining PID Constants (AT, ST, manual setup)	3-12
	AT.(auto-tuning)	3-12
	ST (self-tuning)	3-13
	ST start conditions	3-14
	ST stable range	3-14
	Manual setup	3-15
3.9	Alarm Outputs	3-17
	Alarm type	3-17
	Alarm value	3-18
3.10	Heater Burnout Alarm (HBA)	3-19
	HBA detection	3-19
	Operating conditions	3-19
	Setup	3-20
	How to calculate detection current values	3-21
	Example	3-21
CHAPTER 4 APPLIED OPERATION		4-1
4.1	Shifting Input Values	4-2
	Shifting input	4-2
	How to calculate input shift values (2-point shift)	4-3
	1-point shift method	4-4
	2-point shift method	4-4
	Example of 2-point temperature input shift	4-5
4.2	Alarm Hysteresis	4-6
	Standby sequence	4-6
	Close in alarm/open in alarm	4-7
4.3	Setting Scaling Upper and Lower Limits (analog input)	4-8
	Analog input	4-8
4.4	Executing Heating and Cooling Control	4-10
	Heating and cooling control	4-10
	Setup	4-11
4.5	Externally Setting the SP	4-12
	Setting event input	4-12
	How to use multi-SP	4-12
	Setting by key operation	4-13
	Setup	4-13
	Executing run/stop control	4-14
4.6	Setting the SP Upper and Lower Limit Values	4-15
	Set point limiter	4-15
	Setup	4-16
4.7	Executing the SP Ramp Function (limiting the SP change rate)	4-17
	SP ramp	4-17
4.8	To Move to the Advanced Function Setting Level	4-19
4.9	Using the Key Protect Level	4-20
	Key protect	4-20

CHAPTER 5 PARAMETERS	5-1
Conventions Used in this Chapter	5-2
Protect Level	5-3
Operation Level	5-4
Adjustment Level	5-11
Initial Setting Level	5-19
Advanced Function Setting Level	5-27
Communications Setting Level	5-40
 CHAPTER 6 CALIBRATION	 6-1
6.1 Parameter Structure	6-2
6.2 User Calibration	6-3
6.3 Calibrating Thermocouples	6-4
6.4 Calibrating Analog Input	6-7
6.5 Calibrating Platinum Resistance Thermometers	6-8
6.6 Checking Indication Accuracy	6-9
 APPENDIX	 A-1
SPECIFICATIONS	A-2
Ratings	A-2
Characteristics	A-3
CURRENT TRANSFORMER (CT)	A-4
ERROR DISPLAY	A-5
PARAMETER OPERATIONS LIST	A-7
SENSOR INPUT SETTING AND INDICATION RANGES	A-10
SETUP LEVELS DIAGRAM	A-11
PARAMETER FLOW	A-12

INDEX

CHAPTER 1

INTRODUCTION

1.1	Names of Parts	1-2
	Front panel	1-2
	Display	1-2
	How to use keys	1-3
1.2	I/O Configuration and Main Functions ...	1-4
	I/O configuration	1-4
	Main functions	1-5
1.3	How Setup Levels Are Configured and Operating the Keys on the Front Panel ...	1-6
	Selecting parameters	1-8
	Fixing settings	1-8
1.4	Communications Function	1-9

1.1 Names of Parts

J Front panel

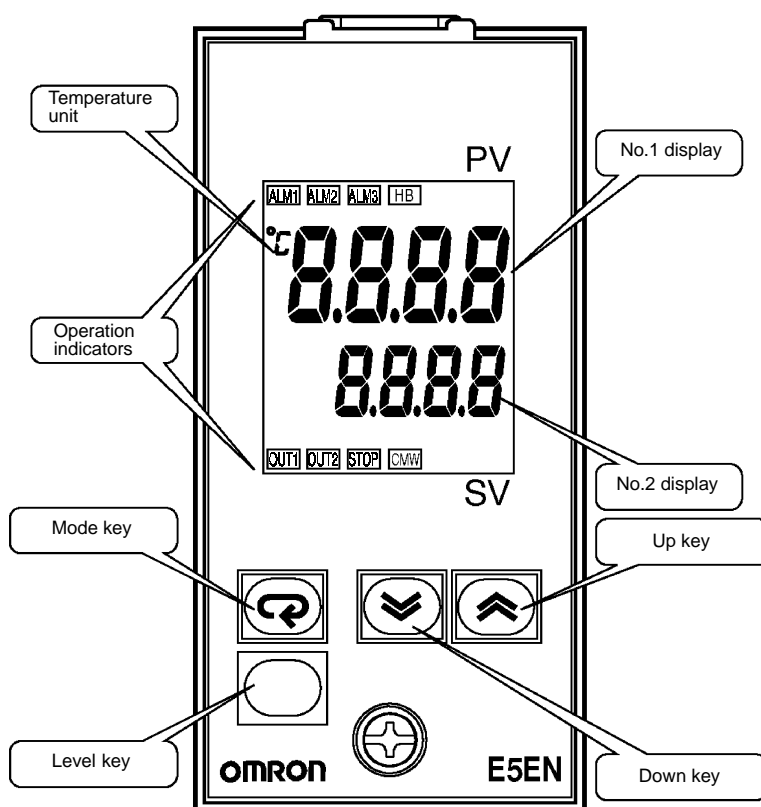

J Display

F No.1 display

Displays the process value or parameter type.
Lights for approximately one second during startup.

F No.2 display

Displays the set point, parameter operation read value or the manipulated variable.

F Operation indicators

Lights for approximately one second during startup.

- (1) ALM1 (alarm 1)
Lights when alarm 1 is ON.
- ALM2 (alarm 2)
Lights when alarm 2 is ON.
- ALM3 (alarm 3)
Lights when alarm 3 is ON.
- (2) HB (heater burnout alarm display)
Lights when a heater burnout is detected.
- (3) OUT1, OUT2 (control output 1, control output 2)
Lights when control output 1 and/or control output 2 are ON. However, whenever control output 1 is the current output, OUT1 stays off.
- (4) STOP (stop)
Lights when operation is stopped.
During operation, this indicator lights when an event or the run/stop function is stopped. Otherwise, this indicator stays off.
- (5) CMW (communications writing control)
Lights when communications writing is "enabled" and is out when it is "disabled."

F Temperature unit The temperature unit is displayed when the display unit parameter is set to a temperature. Indication is determined by the currently selected “temperature unit” parameter set value. When this parameter is set to “_C”, “**℃**” is displayed, and when set to “_F”, “**℉**” is displayed.
Flashes during ST operation.



J How to use keys The following describes the basic functions of the front panel keys.

F  (level) key Press this key to select the setting levels. The setting level is selected in order “operation level” ↔ “adjustment level”, “initial setting level” ↔ “communications setting level”.

F  (mode) key Press this key to select parameters within each level.

F  (up) key Each press of this key increases values displayed on the No.2 display. Holding down this key speeds up the incrementation.

F  (down) key Each press of this key decreases values displayed on the No.2 display. Holding down this key speeds up the decrementation.

F  +  key combination This key combination sets the E5EN to the “protect level.” For details on the protect level, see Chapter 5 Parameters.

1.2 I/O Configuration and Main Functions

J I/O configuration

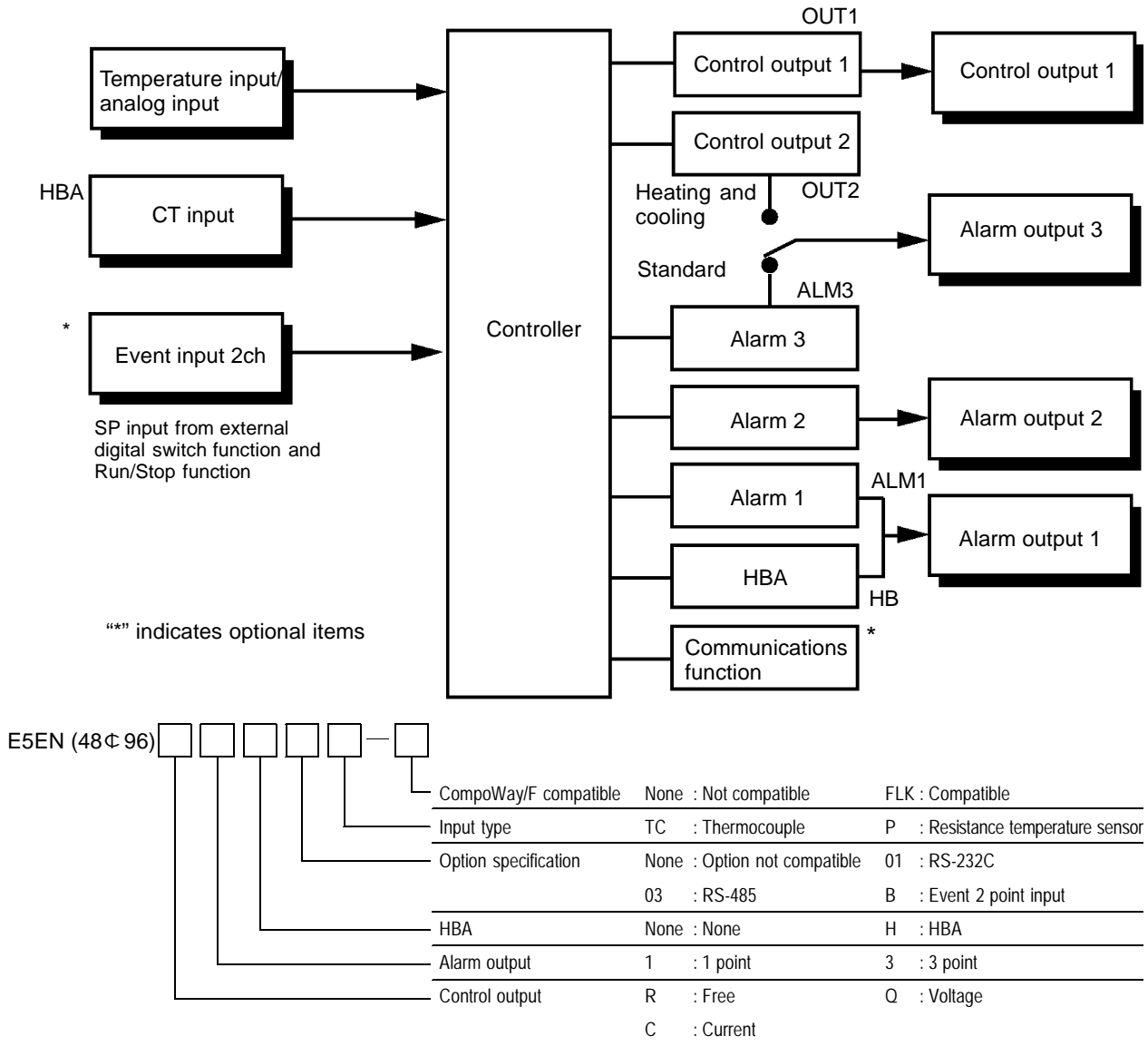

Function availability varies according to the selection and grouping of units. Refer to the product catalogue for further information.

Example

- RS-232C communication function (HBA equipped) : E5EN-V3H01V
- Alarm output (3 point, HBA, event input equipped) : E5EN-V3HBV

1.3 How Setup Levels Are Configured and Operating the Keys on the Front Panel

Parameters are divided into groups, each called a “level”. Each of the set values (setup items) in these levels are called a “parameter.” The parameters on the E5EN are divided into the following seven levels:

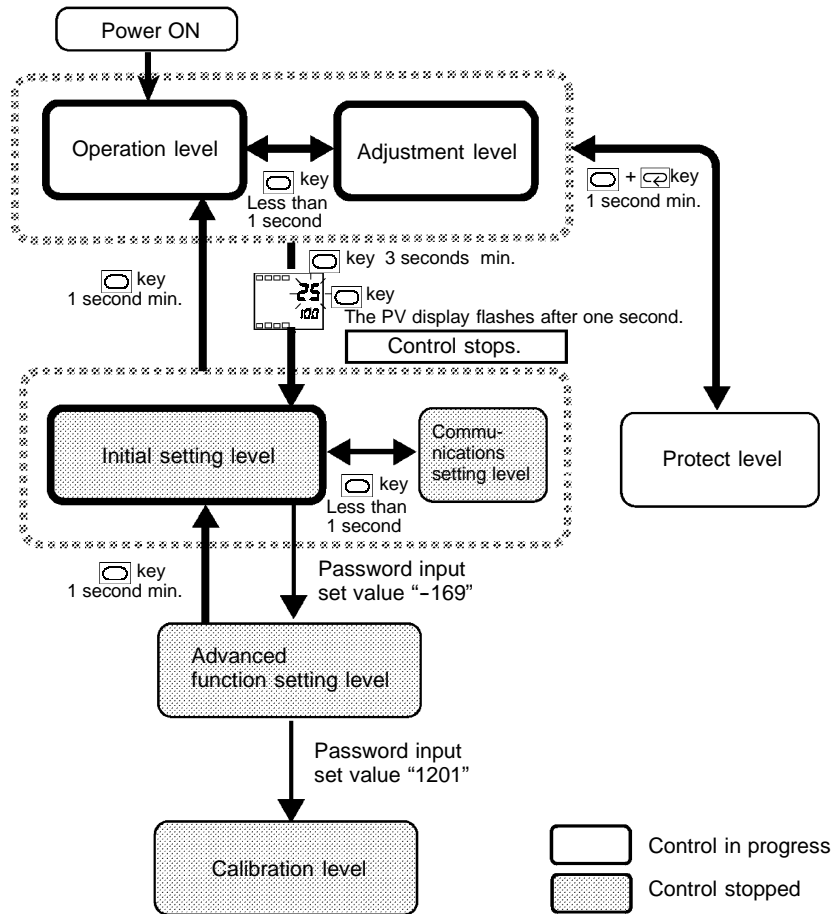







	Control in Progress	Control Stopped
Protect level	f	-
Operation level	f	-
Adjustment level	f	-
Initial setting level	-	f
* Advanced function setting level	-	f
Calibration level	-	f
Communications setting level	-	f



* : To activate the advanced function setting level, set the “Protect level” of the “Initial/Communications protect” to “0”.

f : Indicates items that can be set.

Of these levels, the initial setting level, communications setting level, advanced function setting level and calibration level can be used only when control has stopped. Note that controller outputs are stopped when any of these four levels are selected.





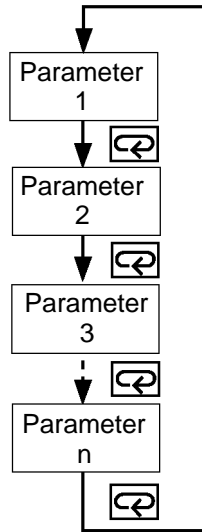

- F Protect level**
- To select this level, simultaneously press the  and  keys for at least one second. This level is for preventing unwanted or accidental modification of parameters. Protected levels will not be displayed, and so the parameters in that level cannot be modified.
- F Operation level**
- This level is displayed when turning the power ON. It can be moved to the protect level, initial setting level and adjustment level from this level.
 - Normally, select this level during operation. During operation, the process value and manipulated variable can be monitored, and the set point, alarm value and upper- and lower-limit alarms can be monitored and modified.
- F Adjustment level**
- To select this level, press the  key for less than one second.
 - This level is for entering set values and offset values for control. This level contains parameters for setting the set point, AT (auto-tuning), communications writing enable/disable, hysteresis, multi-SP, input shift values, heater burnout alarm (HBA) and PID constants. It can be moved to the top parameter of the initial setting level, protect level and operation level from here.
- F Initial setting level**
- To select this level, press the  key for at least three seconds in the operation level. The PV display flashes after one second. This level is for specifying the input type, selecting the control method, control period, setting direct/reverse action and alarm type. It can be moved to the advanced function setting level or communications setting level from this level. To return to the operation level, press the  key for at least one second. To move to the communications setup level, press the  key for less than one second.
- F Advanced function setting level**
- To activate the advanced function setting level, after setting the “Protect level” of the “Initial/Communications protect” to “0”, input the password (“-169”) in the initial setting level.
 - It can be moved to the calibration level or initial level from this level.
 - This level is for setting the automatic return of display mode, MV limiter, event input assignment, standby sequence, alarm hysteresis, ST (self-tuning) and for moving to the user calibration level.
- F Communications setting level**
- To select this level, press the  key for less than one second in the initial setting level. When the communications function is used, set the communications conditions in this level. Communicating with a personal computer (host computer) allows set points to be read and written, and manipulated variables to be monitored.
- F Calibration level**
- To select this level, enter the password in the advanced function setting level. This level is for offsetting deviation in the input circuit.
 - It cannot be moved to other levels by operating the keys on the front panel from the calibration level. To cancel this level, turn the power OFF then back ON again.

J Selecting parameters

- To select parameters in each level, press the  key. Each press of the  key advances to the next parameter. For details on each parameter, see Chapter 5.







J Fixing settings

- If the  key is pressed at the final parameter, the display returns to the top parameter for the current level.
- To change parameter settings or setup, specify the setting using the  or  keys, and either leave the setting for at least two seconds or press the  key. This fixes the setting.
- When another level is selected, the parameter and setting on the display are fixed.
- When the power is turned OFF, fix first the settings or parameter setup (by pressing the  key). The settings and parameter setup are sometimes not changed by merely pressing the  or  keys.

1.4 Communications Function

The E5EN can be provided with a communications function that allows you to check and set controller parameters on a host computer. If the communications function is required, mount the option unit (E5EN–VVV01V or E5EN–VVV03V) in the E5EN. For details on the communications function, see the separate “Communications Functions User’s Manual.”

Follow the procedure below to move to the communications setting level.

- (1) Press the  key for at least three seconds in the “operation level”. The level moves to the “initial setting level”.
- (2) Press the  key for less than one second. The “initial setting level” moves to the “communications setting level”.
- (3) Pressing the  key advances the parameters as shown in the following figure.
- (4) Press the  or  keys to change the parameter setups.

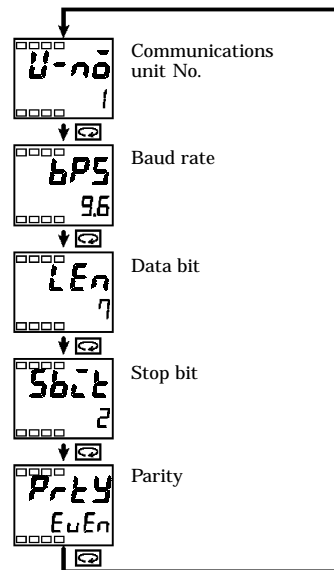

F Setting up communications data

Set the E5EN communications specifications so that they match the communications setup of the host computer. In a multidrop 1:N configuration, match the setting data except the communications unit No. on all units. Unique communications unit Nos. must be set to each unit.

Parameter	Displayed Characters	Set (monitor) Value	Settings	Default	Unit
Communications unit No.	U-nō	0 to 99		1	None
Baud rate	bPS	1.2, 2.4, 4.8, 9.6, 19.2	1.2, 2.4, 4.8, 9.6, 19.2	9.6	kbps
Data bit	LEn	7, 8		7	bit
Stop bit	SbLt	1, 2		2	bit
Parity	PrLy	None, even, odd	nōnE, EwEn, ōdd	Even	None

CHAPTER 2

PREPARATIONS

2.1	Installation	2-2
	Dimensions	2-2
	Panel cutout	2-2
	Mounting	2-3
	Draw out	2-4
2.2	Wiring Terminals	2-5
	Terminal arrangement	2-5
	Precautions when wiring	2-5
	Wiring	2-5

2.1 Installation

J Dimensions

(Unit: mm)

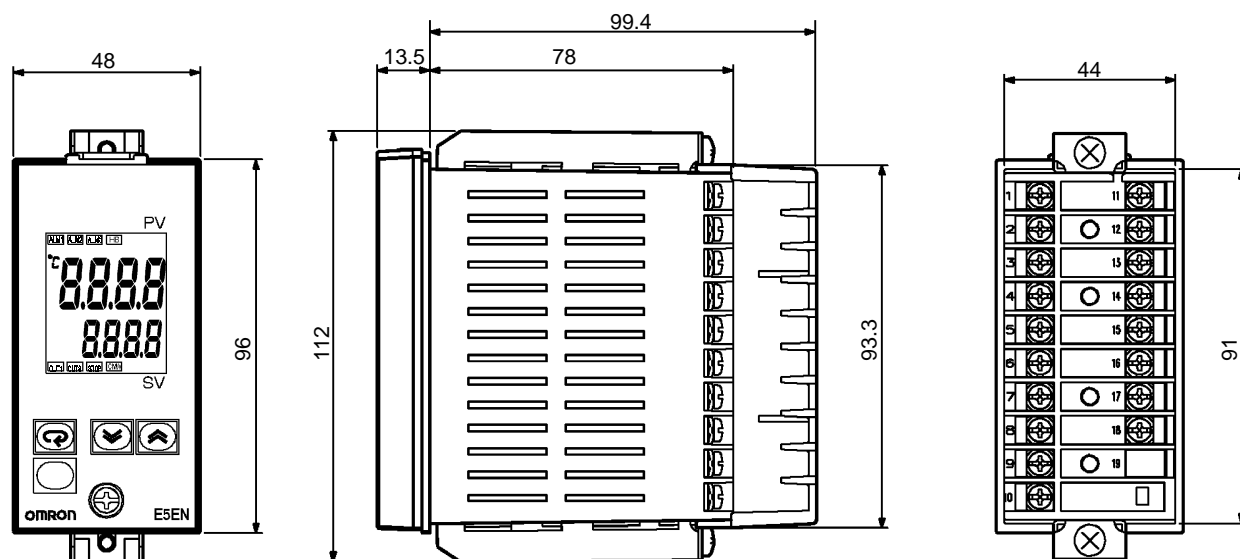

J Panel cutout Unit: mm

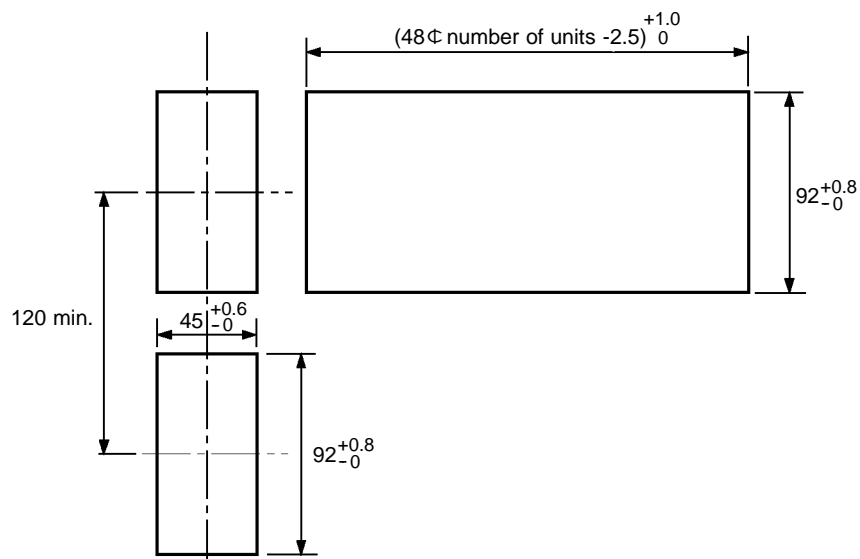

- Several units cannot be group mounted close together vertically. (Observe the recommended mounting space limits.)
- When group mounting several controllers, ensure that the surrounding temperature does not exceed the allowable operating temperature listed in the specifications.
- The recommended panel thickness is 1 to 8 mm.
- To ensure waterproofing, enclose the unit in the waterproof packing prior to mounting. Waterproofing is not possible when group mounting several units.

J Mounting

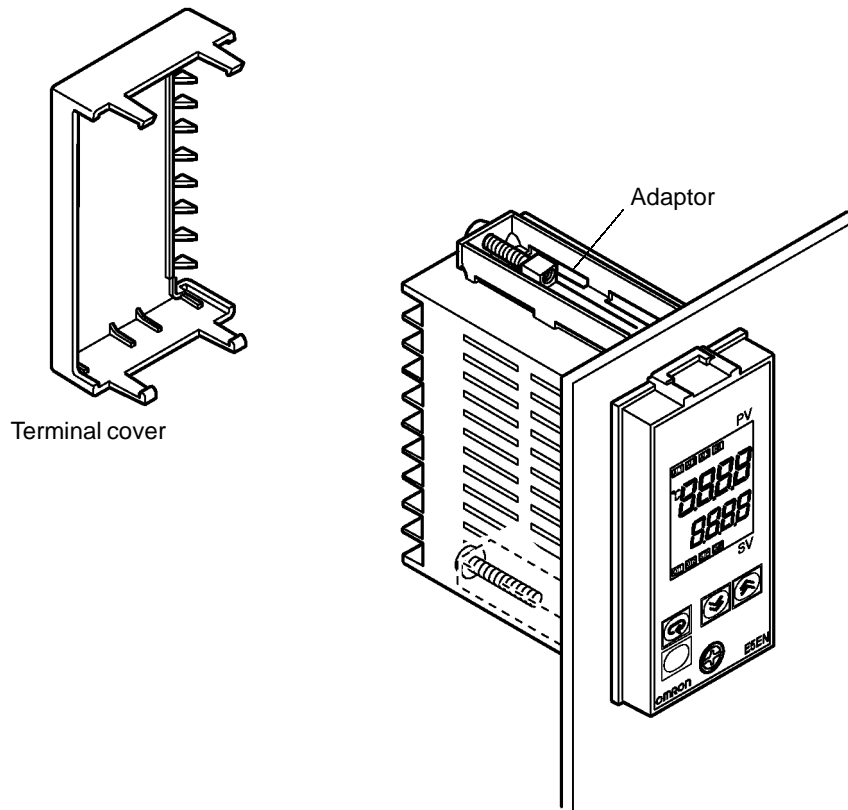

F How to attach the E5EN on the panel

- (1) Insert the main unit through the mounting hole in the panel (1-8 mm thickness). Pull the adaptor along the body of the main unit from rear case up to the panel and fasten temporarily.
- (2) Tighten the upper and lower screws alternately with only one turn of the screwdriver at a time to maintain an even torque balance.

F How to attach the terminal cover

Confirm that the “E53-COV03” alphanumeric characters on the cover are right-side up and align the upper and lower hooks of the cover.

J Draw out

The main unit can be drawn out to perform maintenance without removing the terminal compartment.

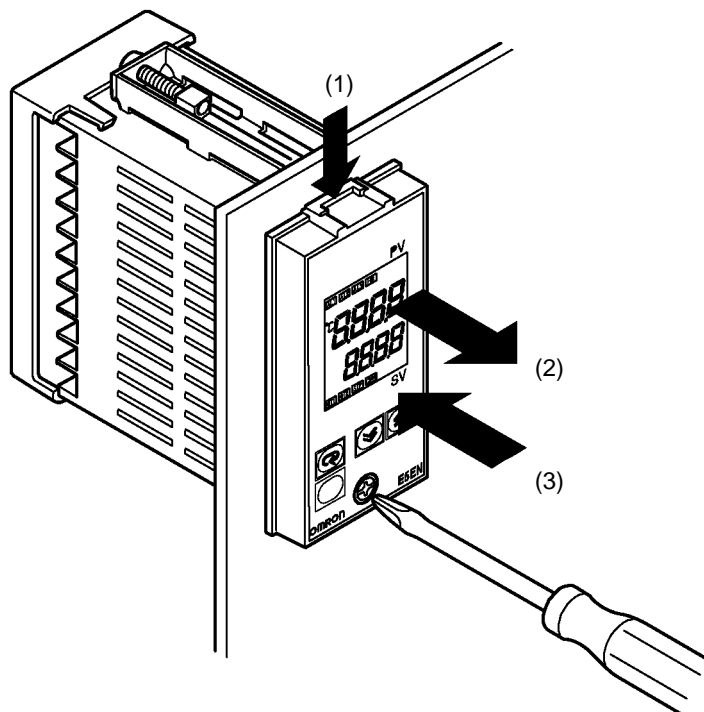

Prepare a screwdriver that can be used on the lower front screw of the unit.

- (1) Loosen the lower front screw with a screwdriver (turning left) while pushing the hook on the upper surface of the front panel.
- (2) Grasp both sides of the front panel and draw (pull) it out.
- (3) Ensure that the waterproof packing is in place before drawing in the unit. Re-tighten the lower front screw with a screwdriver (turning right) to a torque of 0.3 to 0.5 N_m while pushing the hook on the upper surface of the front panel.

2.2 Wiring Terminals

J Terminal arrangement

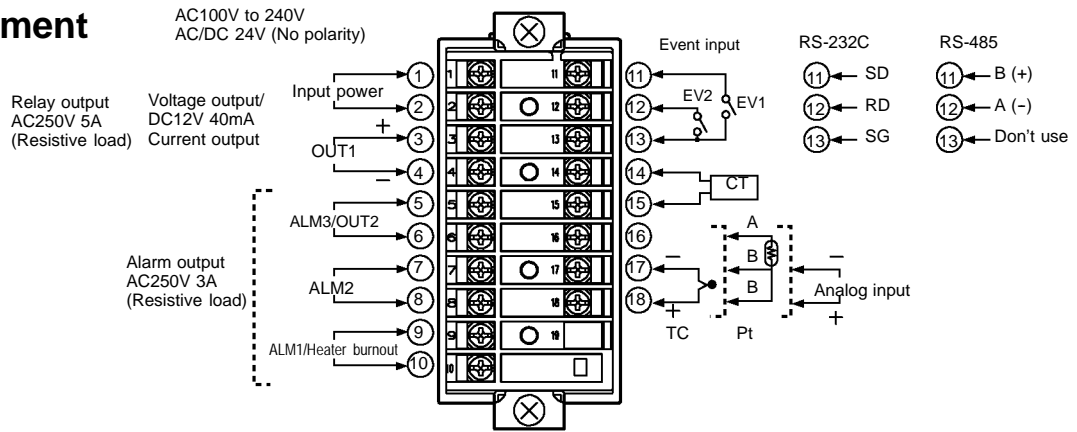

J Precautions when wiring

- Separate input leads and power lines in order to protect the E5EN and its lines from external noise.
- Use AWG28 or larger twisted pair cable.

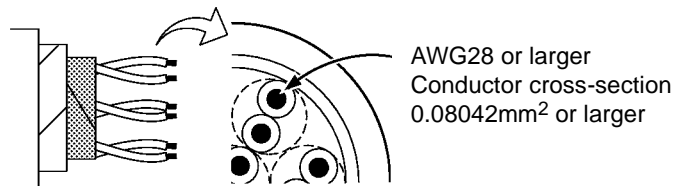

- It's recommended to use solderless terminals when wiring the E5EN.
- Tighten the terminal screws using a torque no greater than 0.74 N_m.
- Use the following type of solderless terminals for M3.5 screws.

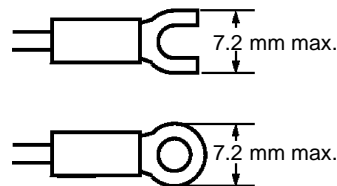

J Wiring

F Power supply

- Connect to terminal Nos. 9 and 10. The following table shows the specifications.

Input power supply	E5EN
100 to 240 VAC, 50/60 Hz	9VA
24 VAC, 50/60 Hz	5VA
24 VDC (no polarity)	4W

- Standard insulation is applied to the power supply I/O sections. If reinforced insulation is required, connect the input and output terminals to a device without any exposed current-carrying parts or to a device with standard insulation suitable for the maximum operating voltage of the power supply I/O section.

F Input

- Connect to terminal Nos.16 to 18 as follows according to the input type.

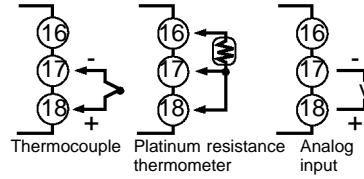

F Control output 1

- Terminal Nos. 3 to 4 are for control output. The following diagrams show the available outputs and their internal equalizing circuits.

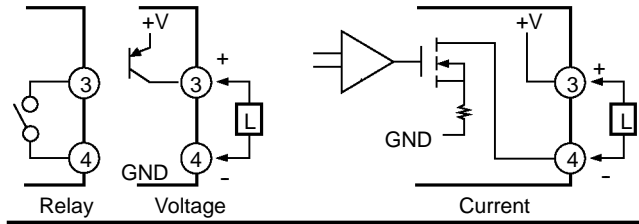

- The following table shows the specifications for each output type.

Output type	Specifications
Relay	250 VAC, 5A (resistive load) electrical life : 100,000 operations
Voltage (PNP) (with short-circuit protection)	DC12V \pm 15%FS 21mA min.
	DC12V $\begin{matrix} +15\% \\ -20\% \end{matrix}$ FS 40mA min.
Current	DC4-20mA load : 600 Ω min. resolution : approx. 2600

- The voltage output (control output) is not electrically insulated from the internal circuits. When using a grounding thermocouple, do not connect the control output terminals to the ground. If the control output terminals are connected to the ground, errors will occur in the measured temperature values as a result of leakage current.

F Alarm output/Control output 2

- On the E5EN-V3VVV, alarm output 1 (ALM1) is between terminal Nos. 9 and 10, alarm output 2 (ALM2) is between terminal Nos. 7 and 8 and alarm output 3 (ALM3) is between terminal Nos. 5 and 6. When utilizing heating and cooling control, alarm output 2 becomes alarm output 3 and alarm output 3 is not available.
- When the option unit E5EN-j j Hj j is mounted on the E5EN, an OR of alarm output 1 and the heater burnout alarm will be output. To disable alarm output 1 and output only the heater burnout alarm on terminals 7 and 8, set the mode of the alarm output 1 to 0.
- The interior equivalent circuits of alarm output 1, 2 and 3 are shown in the following diagram.

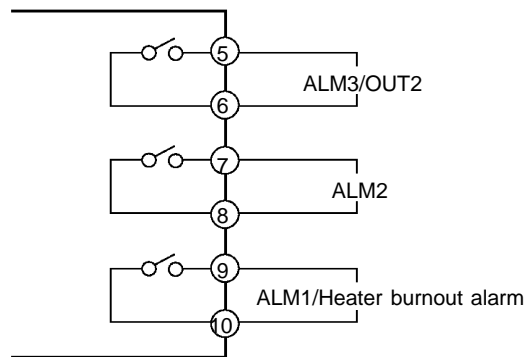

- Relay specifications are as follows:
SPST-NO : 3A250VAC

F CT input

- When the option unit E5EN-j j Hj j is mounted on the E5EN and the heater burnout function is used, connect a current transformer (CT) across terminal Nos. 14 and 15.

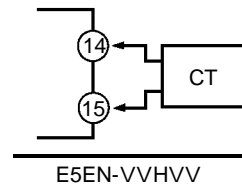

F Event input

- When the option event input unit E5EN-VVVBV is mounted on the E5EN and event input is used, connect to terminal Nos. 11 to 13.

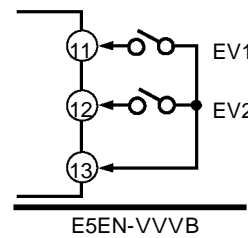

- Use event inputs under the following conditions:

Contact input	ON: 1 kΩ max., OFF: 100kΩ min.
No-contact input	ON: residual voltage 1.5 V max., OFF: leakage current 0.1 mA max.

Polarities during no-contact input are as follows:

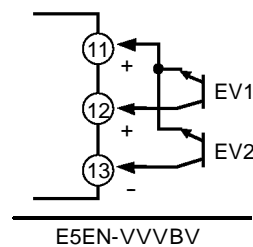

F Communications

- When the option communications unit E5EN-VVV01V is mounted in the E5EN for communications connect the communications cable to terminal Nos. 11, 12 and 13.

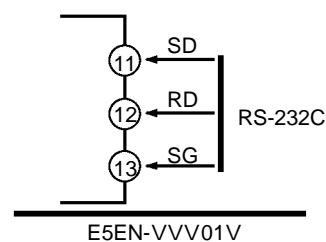

Communications unit connection diagram

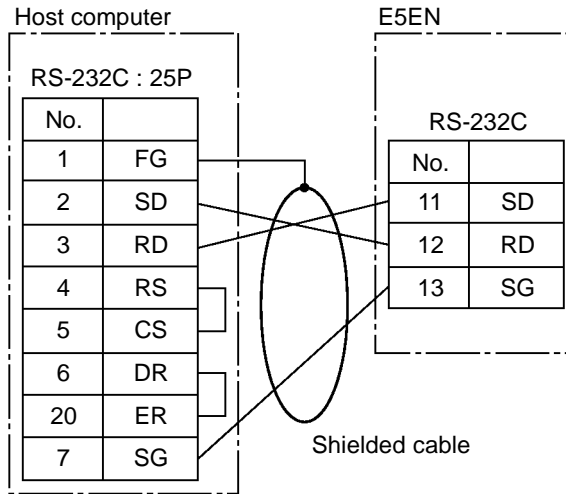

- The RS-232C connection is 1:1
- The maximum cable length is 15m. Use the RS-232C optical interface cable (Z3RN) as an extension cable if necessary.
- Use shielded, twisted pair cable (AWG28 min.).
- When the E5EN-VVV03V is mounted in the E5EN for communications, connect the communications cable to terminal Nos. 11 and 12.

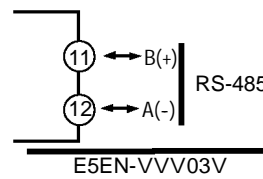

Communications unit connection diagram

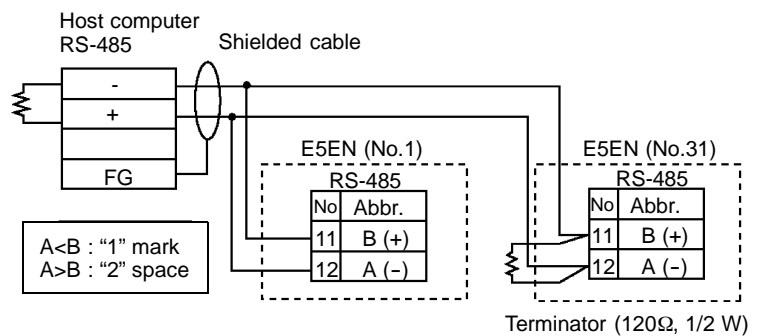

- The RS-485 connection can either be 1:1 or 1:N. Up to 32 units including the host computer can be connected 1:N. Use shielded, twisted pair cable (AWG28 min.) and keep the total cable length to within 500m.

Cable reference diagram

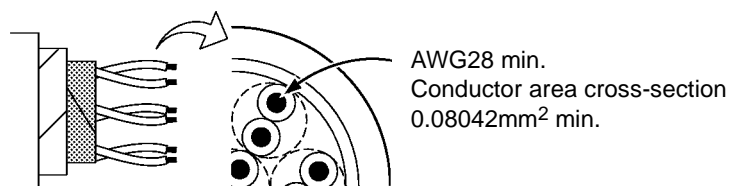



CHAPTER 3

BASIC OPERATION

3.1	Initial Setup Examples	3-2
3.2	Setting the Input Type	3-4
	Input type	3-4
3.3	Selecting _C/_F	3-5
	Temperature unit	3-5
3.4	Selecting PID Control or ON/OFF Control	3-6
3.5	Setting Output Specifications	3-7
	Control period	3-7
	Direct/reverse operation	3-7
3.6	Setting the SP	3-9
	Changing the SP	3-9
3.7	Executing ON/OFF Control	3-10
	ON/OFF Control	3-10
	Setup	3-11
3.8	Determining PID Constants	
	(AT, ST, manual setup)	3-12
	AT.(auto-tuning)	3-12
	ST (self-tuning)	3-13
	ST start conditions	3-14
	ST stable range	3-14
	Manual setup	3-15
3.9	Alarm Outputs	3-17
	Alarm type	3-17
	Alarm value	3-18
3.10	Heater Burnout Alarm (HBA)	3-19
	HBA detection	3-19
	Operating conditions	3-19
	Setup	3-20
	How to calculate detection	
	current values	3-21
	Example	3-21

3.1 Initial Setup Examples

On previous controllers, sensor input type, alarm type and control period were set by the DIP switches. These hardware settings are now set in parameters in setup menus. The  and  keys are used to switch between setup menus, and the amount of time that you hold the keys down for determines which setup menu you move to. This section describes two typical examples.

F Typical example 1

Input type	: 0 K thermocouple -200 to 1300_C
Control method	: ON/OFF control
Alarm type	: 2 upper limit
Alarm value 1	: 20_C (deviation)
Set point	: 100_C

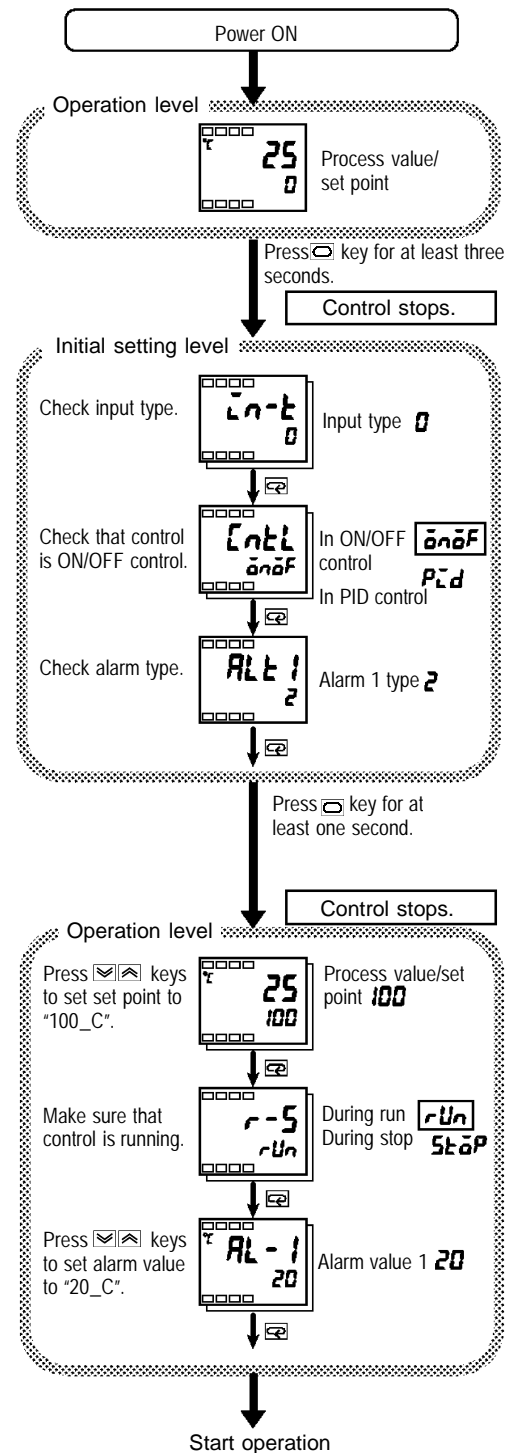
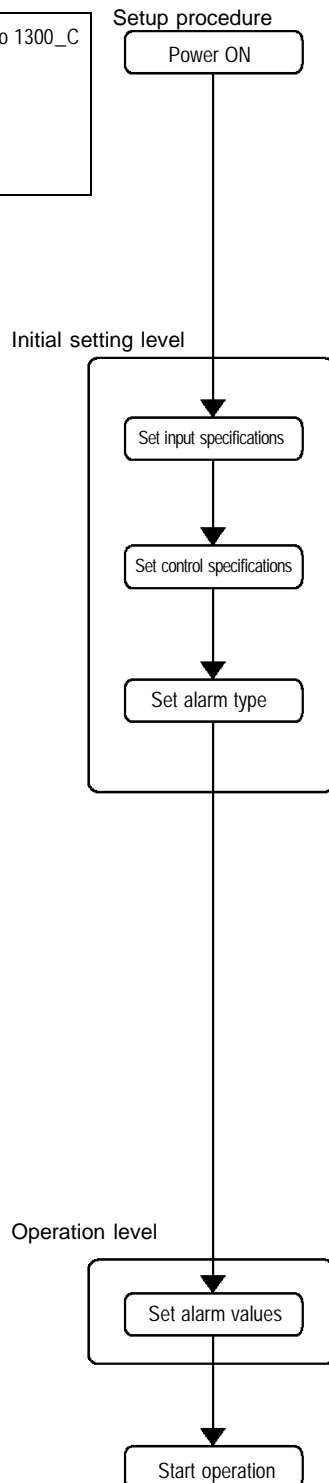

F Typical example 2

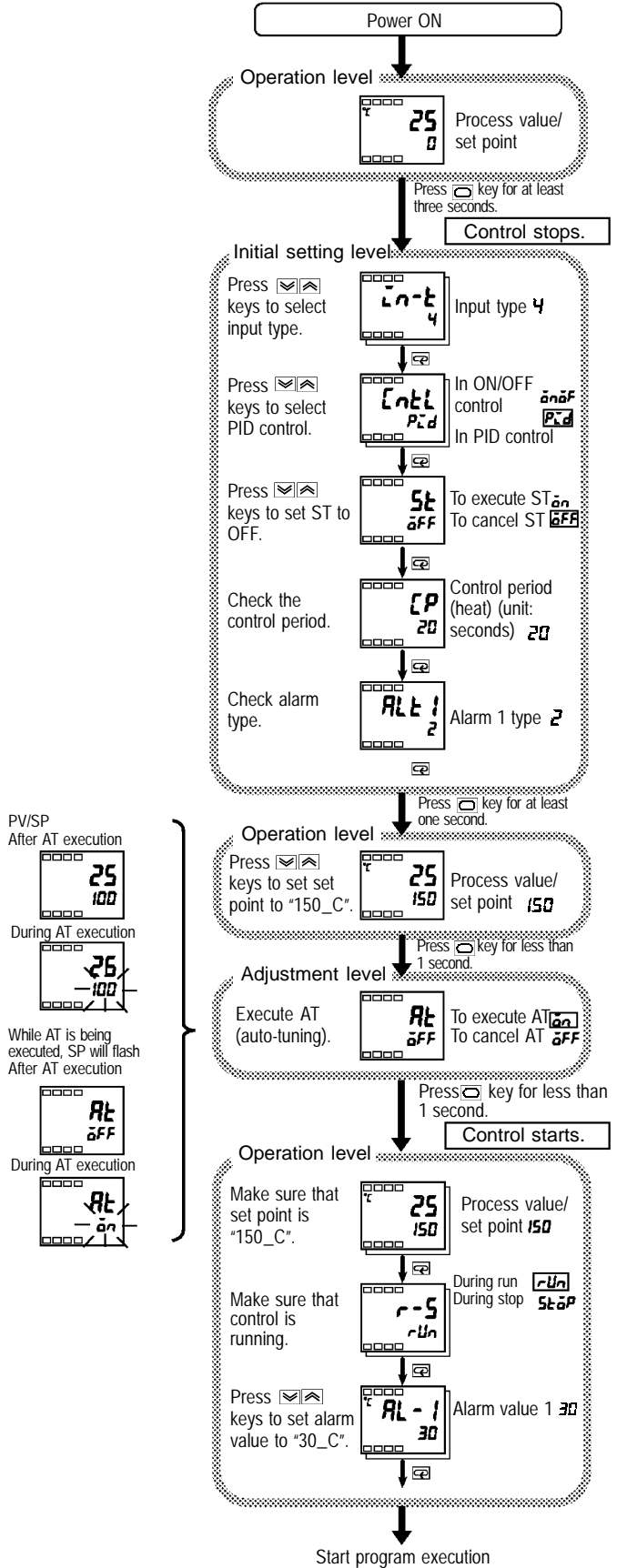
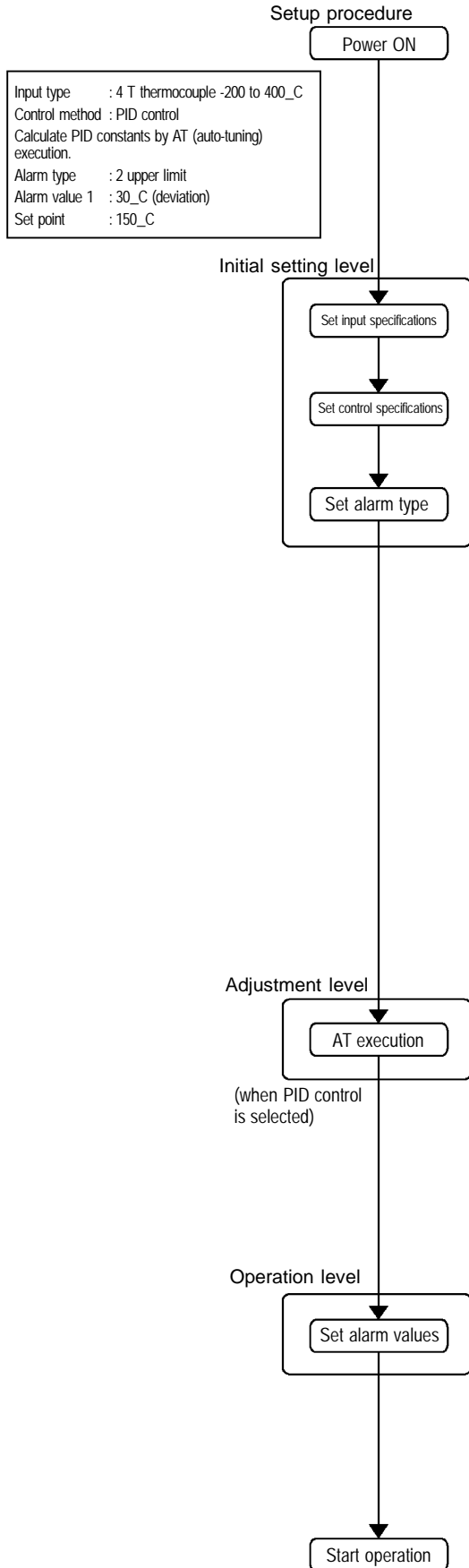

3.2 Setting the Input Type

The E5EN supports four input types: platinum resistance thermometer, thermocouple, non-contact temperature sensor and analog inputs. Set the input type matched to the sensor used in the “input type” parameter. The E5EN specifications support two types of inputs, platinum resistance thermometer input types and thermocouple input type, whose set values differ. Check the type of E5EN at purchase.

J Input type

Operation Procedure

Setting the input type “thermocouple K-20.0 to 500.0_C”.

Operation level

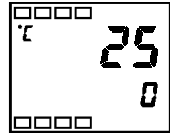

Initial setting level

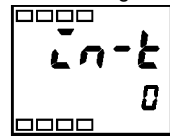

Input type

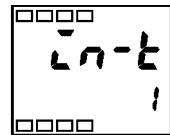

(1) Press the key for at least three seconds to move from the “operation level” to the “initial setting level”.

(2) Press the key to enter the set value of the desired sensor. When using K thermocouple (-20.0 to 500.0_C), enter “1” as the set value.

Hint: The set value is fixed if you do not operate the keys on the front panel for two seconds after changing the parameter, or by pressing the or keys.

List of Input Types

	Input type	Name	Set Value	Input Temperature Setup Range
Platinum resistance thermometer input type	Platinum resistance thermometer	Pt100	0	-200 to 850 (_C) / -300 to 1500 (_F)
			1	-199.9 to 500.0 (_C) / -199.9 to 900.0 (_F)
		JPt100	2	0.0 to 100.0 (_C) / 0.0 to 210.0 (_F)
			3	-199.9 to 500.0 (_C) / -199.9 to 900.0 (_F)
		4	0.0 to 100.0 (_C) / 0.0 to 210.0 (_F)	

	Input type	Name	Set Value	Input Temperature Setup Range	
Thermocouple input type	Thermocouple	K	0	-200 to 1300 (_C) / -300 to 2300 (_F)	
			1	-20.0 to 500.0 (_C) / 0.0 to 900.0 (_F)	
		J	2	-100 to 850 (_C) / -100 to 1500 (_F)	
			3	-20 to 400.0 (_C) / 0.0 to 750.0 (_F)	
		T	4	-200 to 400 (_C) / -300 to 700 (_F)	
		E	5	0 to 600 (_C) / 0 to 1100 (_F)	
		L	6	-100 to 850 (_C) / -100 to 1500 (_F)	
		U	7	-200 to 400 (_C) / -300 to 700 (_F)	
		N	8	-200 to 1300 (_C) / -300 to 2300 (_F)	
		R	9	0 to 1700 (_C) / 0 to 3000 (_F)	
		S	10	0 to 1700 (_C) / 0 to 3000 (_F)	
	B	11	100 to 1800 (_C) / 300 to 3200 (_F)		
	Non-contact temperature sensor ES1A		K10 to 70_C	12	0 to 90 (_C) / 0 to 190 (_F)
			K60 to 120_C	13	0 to 120 (_C) / 0 to 240 (_F)
			K115 to 165_C	14	0 to 165 (_C) / 0 to 320 (_F)
			K160 to 260_C	15	0 to 260 (_C) / 0 to 500 (_F)
Analog input		0 to 50mV	16	For scaling use ranges from -1999 to 9999 or -199.9 to 999.9.	

Shaded ranges indicate default settings.

3.3 Selecting _C/_F

J Temperature unit

- Select either “_C” or “_F” as the temperature unit.
- Set the temperature unit in the “temperature unit” parameter of “initial setting level”. Default is “**C** : _C”.

Operation Procedure

Operation level

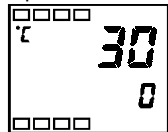

Initial setting level





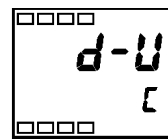

Input type



Temperature unit

Select “_C”.

- (1) Press the  key for at least three seconds to move from the “operation level” to the “initial setting level”.
- (2) Select the “temperature unit” parameter by pressing the  key. Press the  or  keys to select either “_C” or “_F”.
C : _C **F** : _F
- (3) To return to the “operation level” press the  key for at least one second.

3.4 Selecting PID Control or ON/OFF Control

The E5EN supports two control methods, 2-PID control and ON/OFF control. The control method is selected by the “PID / ON/OFF” parameter in the “initial setting level”. When this parameter is set to **PID**, 2-PID control is set, and when set to **ONOFF**, ON/OFF control is set (default).

F 2-PID control

PID control is set by AT (auto-tuning), ST (self-tuning) or manual setup. For PID control, set the PID constants in the “proportional band (P)”, “integral time (I)” and “derivative time (D)” parameters.

F ON/OFF control

In “ON/OFF” control, the control output is turned ON when the process value is lower than the current set point, and the control output is turned OFF when the process value is higher than the current set point (reverse operation).

3.5 Setting Output Specifications

J Control period



- Set the output period (control period). Though a shorter period provides better control performance, it is recommended to set the control period to 20 seconds or more taking the life expectancy in the case of relay output into consideration. If necessary, readjust the control period by trial operation, for example, when the control period parameters are set to their defaults.
- Set the control period in the “control period (heat)” and “control period (cool)” parameters (initial setting level). Default is “20 seconds”.
- Whenever control output 1 is the current output, “control period (heat)” cannot be used.
- The “control period (cool)” parameter can be used only in heating and cooling control.

J Direct/reverse operation



- “Direct operation” refers to control where the manipulated variable is increased according to the increase in the process value. Alternatively, “Reverse operation” refers to control where the manipulated variable is decreased according to the increase in the process value.

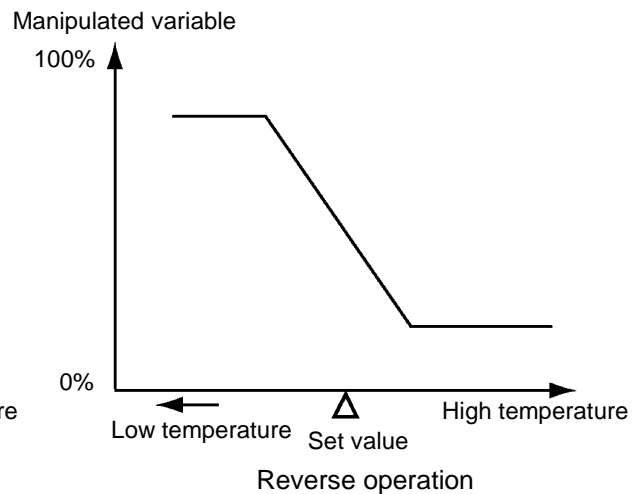
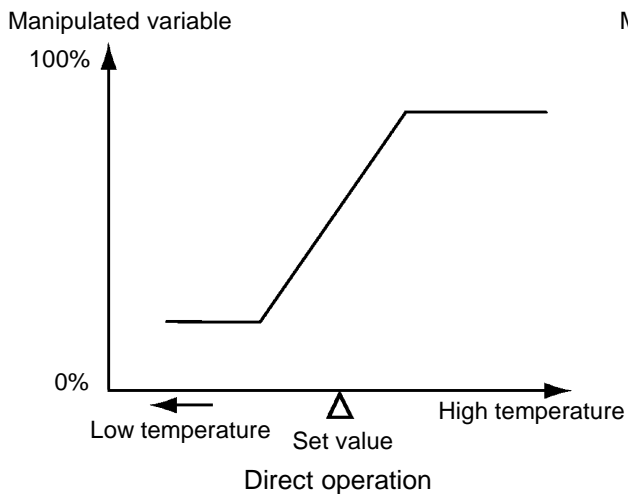

For example, when the process value (PV) (temperature) is lower than the set point (SP) (temperature) in a heating control system, the manipulated variable increases by the difference between the PV and SP values.

Accordingly, this becomes “reverse operation” in a heating control system, or alternatively, “direct operation” in a cooling control system.

- Direct/reverse operation is set in the “direct/reverse operation” parameter (initial setting level). The “direct/reverse operation” parameter default is “reverse operation”.

Operation Procedure

In this example, monitor the “input type”, “temperature unit”, “direct/reverse operation” and “control period (heat)” parameters.

“input type” = “0”: K thermocouple

“temperature unit” = “C”: _C

“direct/reverse operation” = “o-r-r”: reverse operation

“control period (heat)” = “20 (secs)”

Operation level

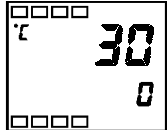

Initial setting level



Input type

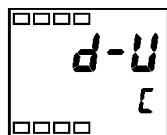

Temperature unit

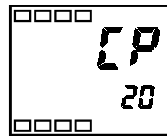

Control period (heat)



Direct/reverse operation

Operation level

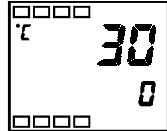

PV/SP

- (1) Press the key for at least three seconds to move from the “operation level” to the “initial setting level”.
- (2) The input type is displayed. When you are setting the input type for the first time, “0”: K thermocouple is set. (“0” is set in the case of a platinum resistance thermometer.) To select a different sensor, press the or keys.
- (3) Select the “temperature unit” parameter by pressing the key. Default is “C”: _C. To select “F”: _F, press the key.
- (4) Select the “control period (heat)” parameter by pressing the key. Default is “20”.
- (5) Select the “direct/reverse operation” parameter by pressing the key. Default is “o-r-r”: reverse operation. To select “o-r-d”: direct operation, press the key.
- (6) To return to the “operation level” press the key for at least one second.



3.6 Setting the SP

Operation level



J Changing the SP

The “operation level” is displayed when the E5EN is turned ON. The upper display (No.1 display) displays the process value, and the lower display (No.2 display) displays the set point.



- The set point cannot be changed when the “operation/adjustment protection” parameter is set to “3”. For details, see “4.9 Using the Key Protect Levels.”
- To change the set point, press the  or  keys in the “PV/SP” parameter (operation level), and set the desired set value. The new set point is selected two seconds after you have specified the new value.

Operation Procedure

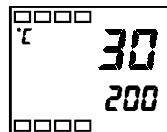
Operation level



In this example, change the set point from “0_C” to “200_C”.

- (1) Normally, the “PV/SP” parameter is displayed. The set point is “0_C”.
- (2) Use the   keys to set the set point to “200_C”.

3.7 Executing ON/OFF Control

J ON/OFF Control

F Hysteresis

F 3-position control

In “ON/OFF” control, the control output turns OFF when the currently controlled temperature reaches a preset set point. When the manipulated variable turns OFF, the temperature begins to fall and the control turns ON again. This operation is repeated at a certain point. At this time, how much the temperature must fall before control turns ON again is determined by the “hysteresis (heat)” parameter. Also, how much the manipulated variable must be adjusted in response in the increase or decrease in the process value is determined by “direct/reverse operation” parameter.

- Switching between 2-PID control and ON/OFF control is carried out by the “PID / ON/OFF” parameter (initial setting level). When this parameter is set to “PId”, 2-PID control is selected, and when set to “OnOff”, ON/OFF control, is selected. Default is “OnOff”.
- In ON/OFF control the hysteresis is used as a differential for switching the output ON when the temperature moves away from the required set point, and is used give stability around the set point. The control output (heat) and control output (cool) functions are set in the hysteresis (heat) and hysteresis (cool) functions respectively.
- In standard control (heating or cooling control), the “hysteresis (heat)” setting is used as the hysteresis setting in the adjustment level regardless of the control type, heating control or cooling control.

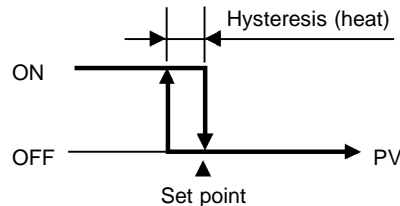

- In heating and cooling control, a dead band (an area where both control outputs are “0”) can be set to either the heating or cooling side. So, 3-position control is made possible.

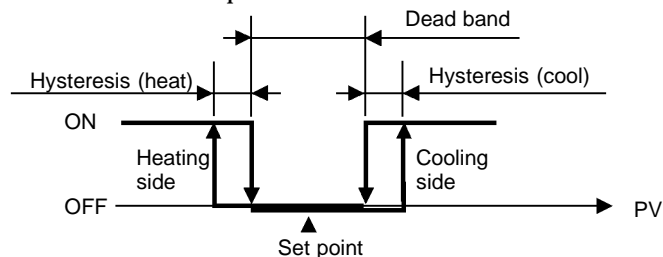

Parameters

Symbol	Parameter Name: Level	Description
S-HC	Standard/heating and cooling: Initial setting level	For specifying control method
[nL]	PID / ON/OFF: Initial setting level	For specifying control method
oEv	Direct/reverse operation: Initial setting level	For specifying control method
[-db	Dead band: Adjustment level	Heating and cooling control
[-sc	Cooling coefficient: Adjustment level	Heating and cooling control
HYS	Hysteresis (heat): Adjustment level	ON/OFF control
[HYS	Hysteresis (cool): Adjustment level	ON/OFF control

J Setup

To execute ON/OFF control, set the “set point,” “PID / ON/OFF” and “hysteresis” parameters.

- Setting the PID / ON/OFF parameter

Operation Procedure

In this example, check first that the “PID / ON/OFF” parameter is set to “**ōōōF**” in the “initial setting level”.

Operation level

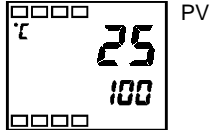

PV

Initial setting level



Input type



PID / ON/OFF

- (1) Press the key for at least three seconds to move from the “operation level” to the “initial setting level”.
- (2) Display the “input type” parameter in the initial setting level.
- (3) Select the “PID / ON/OFF” parameter by pressing the key.
- (4) Check that the set value is “**ōōōF**” (default).

Set the following set point value.

- Setting the SP

Operation Procedure

In this example, set the set point value (200). The lower display (No.2 display) shows the set value (SP value).

Operation level

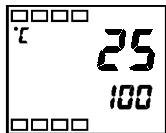

PV/SP

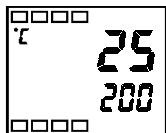

- (1) Select “PV/SP” at the operation level.
- (2) Use the keys to set the SP value. (For example, 200) To set the value either press the key or wait more than two seconds.

3.8 Determining PID Constants (AT, ST, manual setup)

J AT. (auto-tuning)



- When you execute auto-tuning, the optimum PID constants for the set point during program execution are automatically set by forcibly changing the manipulated variable to calculate the characteristics (called the “limit cycle method”) of the control target.
- To execute AT (auto-tuning), specify “**ōn**: AT execute”, and to cancel AT (auto-tuning), specify “**ōff**: AT cancel”.
- AT (auto-tuning) cannot be executed during ON/OFF control.
- The result of AT (auto-tuning) is mirrored in the “proportional band (P),” “integral time (I)” and “derivative time (D)” parameters in the “adjustment level”.

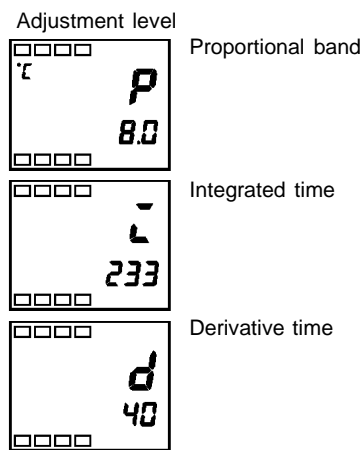

F Description

AT (auto-tuning) is started when the “AT execute/cancel” parameter is set to “ON”. During execution of AT, the No.1 display for the “AT execute/cancel” parameter blinks. When AT ends, the “AT execute/cancel” parameter turns OFF, and the No.1 display stops blinking.

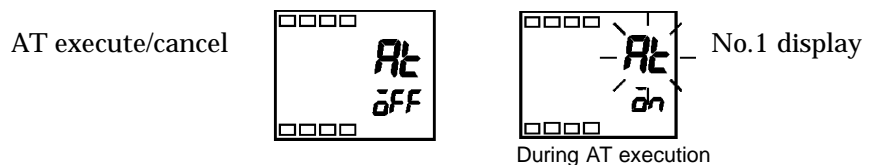

If you move to the “operation level” during AT execution, the No.2 display blinks to indicate that AT is being executed.

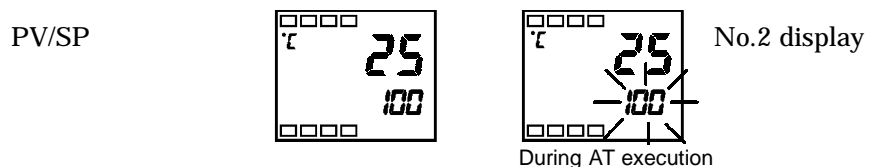

Only the “communications writing”, “run/stop” and “AT execution/cancel” parameters can be changed during AT execution. Other parameters cannot be changed.

Operation Procedure

Adjustment Level

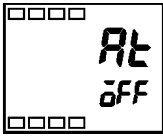

AT execute/
cancel

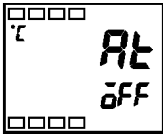

Operation level

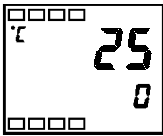

PV

J ST (self-tuning)



Execute auto-tuning (AT).

- (1) Press the key for less than one second to move from the “operation level” to the “adjustment level”.
- (2) Press the key to start execution of AT (auto-tuning). “ON” is displayed during AT execution.
- (3) “OFF” is displayed when AT ends.
- (4) To return to the “operation level,” press the key.

The ST (self-tuning) function executes tuning from the start of program execution to calculate PID constants matched to the control target. Once the PID constants have been calculated, ST is not executed when the next control operation is started as long as the set point remains unchanged.

Operation Procedure

Initial setting level

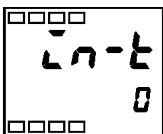

Input type



ST

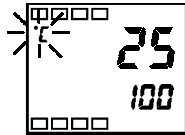

ST

ST (self-tuning) is executed when the “ST” parameter is set to “ON” in the “initial setting level”.

When the ST function is in operation, be sure to turn the power supply of the load connected to the control output ON simultaneously with or before starting operation of the E5EN.

Execute self-tuning (ST).

- (1) Press the key for at least three seconds to move from the “operation level” to the “initial setting level”.
- (2) Select the “ST” parameter by pressing the key.
- (3) Press the key to select “ON” (default).
- (4) To return to the “operation level,” press the key. The temperature display blinks during self-tuning (ST) execution.



About PID parameters

When control characteristics are already known, the PID parameters can be directly to adjust control.

PID parameters are set in the “proportional band” (P), “integrated time” (I) a “derivative time” (D) parameters in the “adjustment level”.

J ST start conditions

Self-tuning by step response tuning (SRT) is started when the following conditions are met after program execution is started and the set point is changed.

At Start of Program Execution	When Set Point Is Changed
1. The set point is different from the set point (see Note) used when the previous SRT was executed. 2. The temperature at the start of program execution is smaller than the set point during reverse operation and is larger than the set point during direct operation. 3. No reset from input error (Note) The "set point used when the previous SRT was executed" refers to the set point used to calculate the PID constants by the previous SRT operation.	1. The new set point differs from the set point (see Note) used when the previous SRT was executed. 2. During reverse operation, the value obtained by subtracting the set point before the change from the new set point is larger than the ST stable range. During direct operation, the value obtained by subtracting the new set point from the set point before the change is larger than the ST stable range. 3. The set point change width is larger than the "current proportional band x 1.27 + 4".

PID constants are not set for the currently preset set point by self-tuning (ST) in the following instances :

- (1) When the PID constants have been changed manually.
- (2) When auto-tuning (AT) has been executed.



J ST stable range

The ST stable range is a condition for determining the conditions under which ST (self-tuning) functions. In this example, let's set the ST stable range to 20_C.

Operation Procedure

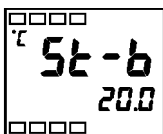
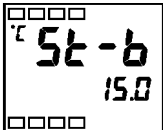
Advanced function setting level
 ST stable range



- (1) Select the "ST stable range" parameter by pressing the  key in the "advanced function setting level".
- (2) Set to 20_C (deviation) using the   keys.

J Manual setup

Operation Procedure

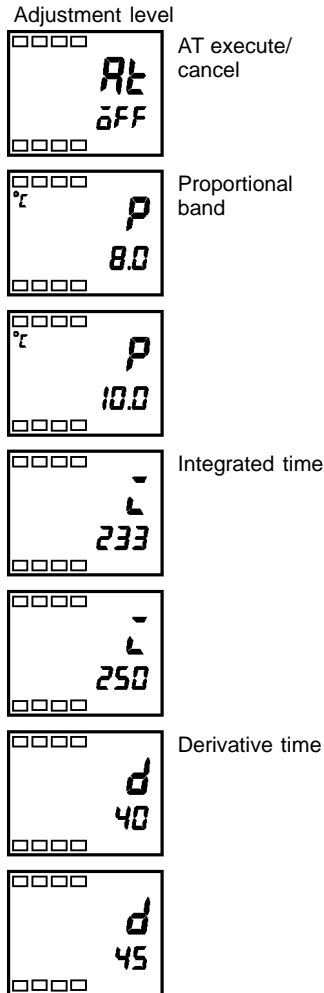

The individual PID constants can be manually set in the “Proportional band”, “integral time”, and “Derivative time” parameters in the “adjustment level”.

In this example, set the “proportional band” parameter to “10.0”, the “integrated time” parameter to “250” and the “derivative time” parameter to “45”.

- (1) Press the key to move from the “operation level” to the “adjustment level”.
- (2) Select “proportional band” by pressing the key.
- (3) Use the keys to set the parameter to “10.0”.
- (4) Select “integrated time” by pressing the key.
- (5) Use the keys to set the parameter to “250”.
- (6) Select “derivative time” by pressing the key.
- (7) Use the keys to set the parameter to “45”.
- (8) To return to the “operation level,” press the key.



Proportional Operation

When PID constants I (integral time) and D (derivative time) are set to “0”, control is executed according to proportional operation. The default set point becomes the center value of the proportional band.

Related parameter

“manual reset value” (adjustment level)

• When P (proportional band) is adjusted

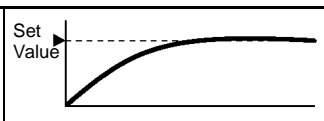
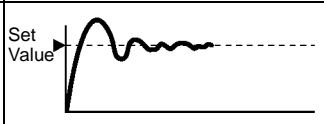
When P is increased	 <p>The graph shows a smooth curve starting from the origin and rising gradually to a horizontal dashed line labeled 'Set Value'. The curve has a concave-down shape, indicating a long stable time and no overshoot.</p>	The curve rises gradually, and a long stable time is achieved, preventing overshoot.
When P is decreased	 <p>The graph shows a curve that rises quickly, overshoots the 'Set Value' line, and then oscillates around it with decreasing amplitude before stabilizing.</p>	Overshoot and hunting occur, however the set point is quickly reached after which the curve stabilizes.

• When I (integral time) is adjusted

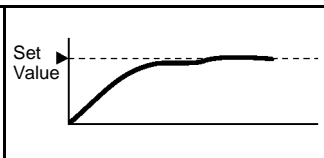
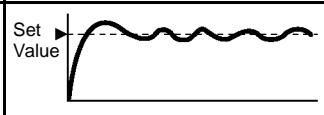
When I is increased	 <p>The graph shows a curve that rises slowly and smoothly to a horizontal dashed line labeled 'Set Value'. The curve has a concave-down shape, indicating a long time to reach the set point but little overshoot.</p>	It takes a long time for the process value to reach the set point. It takes time to achieve a stable state, however there is little overshoot/undershoot and hunting.
When I is decreased	 <p>The graph shows a curve that rises quickly, overshoots the 'Set Value' line, and then oscillates around it with decreasing amplitude before stabilizing.</p>	Overshoot/undershoot and hunting occur, and the curve rises quickly.

• When D (derivative time) is adjusted

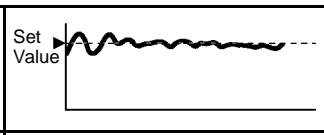
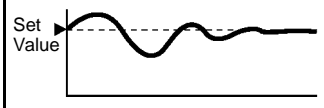
When D is increased	 <p>The graph shows a curve that rises quickly, overshoots the 'Set Value' line, and then oscillates around it with very small amplitude, indicating fine hunting.</p>	Overshoot/undershoot and stable time are reduced, however, fine hunting occurs on changes in the curve itself.
When D is decreased	 <p>The graph shows a curve that rises quickly, overshoots the 'Set Value' line, and then oscillates around it with large amplitude, indicating significant overshoot and hunting.</p>	Overshoot/undershoot increase, and it takes time for the process value to reach the set point.

3.9 Alarm Outputs

- The following describes the “alarm type”, “alarm value”, “upper-limit alarm” and “lower-limit alarm” parameters.

J Alarm type

Set Value	Alarm Type	Alarm Output Operation	
		When alarm value X is positive	When alarm value X is negative
0	Alarm function OFF	Output OFF	
*1 1	Upper- and lower-limit (deviation)		*2
2	Upper-limit (deviation)		
3	Lower-limit (deviation)		
*1 4	Upper- and lower-limit range (deviation)		*3
*1 5	Upper- and lower-limit alarm with standby sequence (deviation)		*4
6	Upper-limit alarm with standby sequence (deviation)		
7	Lower-limit alarm with standby sequence (deviation)		
8	Absolute-value upper-limit		
9	Absolute-value lower-limit		
10	Absolute-value upper-limit with standby sequence		
11	Absolute-value lower-limit with standby sequence		

*1 : The upper- and lower-limit values, expressed as “L” and “H”, can be set independently for each alarm point with set values 1, 4 and 5.

*2 : Set value : 1 Upper- and lower-limit alarm

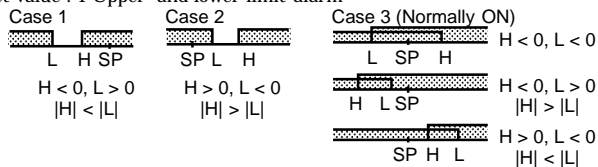

*3 : Set value : 4 Upper- and lower-limit range

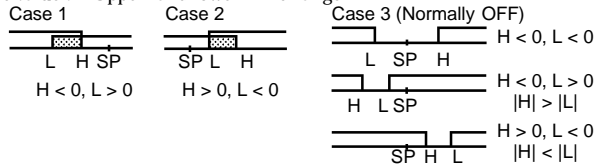

*4 : Set value : 5 Upper- and lower-limit alarm with standby sequence

*For the above upper- and lower-limit alarm

- In cases 1 and 2, the alarm is normally OFF if upper- and lower-limit values of hysteresis overlap.
- In case 3, the alarm is normally OFF.

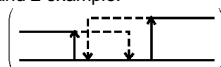

- Alarm types are set independently for each “Alarm type 1 to 3” (initial setting level). The default value is “2 : Upper-limit alarm”.

J Alarm value

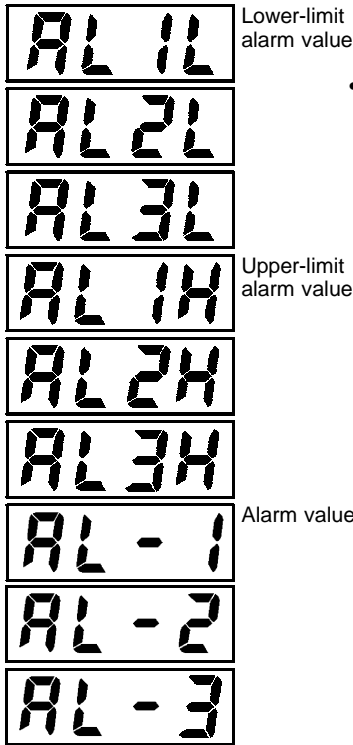

- Alarm values are indicated by “X” in the table on the previous page. When the upper and lower limits are set independently, “H” is displayed for upper limit values, and “L” is displayed for lower limit values.
- To set the upper- and lower-limit alarm values for deviation, set the upper and lower limits in each of the “alarm upper limit 1 to 3”, and “alarm lower limit 1 to 3” parameters (operation level).

Operation Procedure

Set “alarm 1” to the upper-limit alarm. The following shows related parameters and setups. In this example, the alarm output is active when the set point is exceeded by “10_C”. (The temperature unit in this example is “_C”.)

“alarm 1 type” = “2: upper-limit alarm (deviation)”
 “alarm value 1” = “10”

Initial setting level

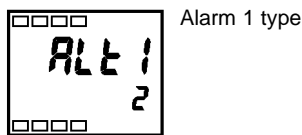
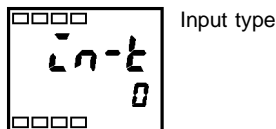

Operation level

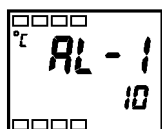
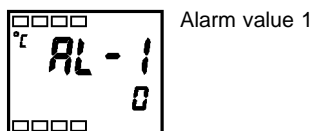
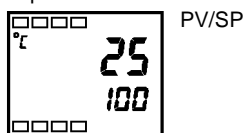

- (1) Press the key for at least three seconds to move from the “operation level” to the “initial setting level”.
- (2) Select the “alarm 1 type” parameter by pressing the key. Check that the “alarm type” parameter is set to “2” (default, upper-limit alarm).
- (3) To return to the “operation level” press the key for at least one second.
- (4) Select “alarm value 1” by pressing .
- (5) Use the keys to set the parameter to “10”.

3.10 Heater Burnout Alarm (HBA)

J HBA detection

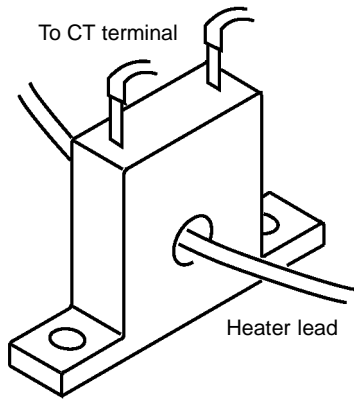

- Heater burnout detection works as follows.
 - (1) Connect the current transformer (CT) to terminal Nos. 14 and 15, and insert the heater lead through the CT hole. For specifications, models and external dimensions of current transformers that can be used on this controller, see “Appendix, About Current Transformer (CT).”
 - (2) When current flows through this lead, the current transformer generates AC current proportional to the current value. The E5EN measures this AC current to calculate the current flowing to the heater.
 - (3) If the heater is burned out, the current measured at the current transformer decreases. This value is compared with the value set as the “heater burnout set value”, and the output becomes active as the heater burnout alarm.
- Set the heater burnout set value in the “heater burnout detection” parameter (adjustment level). To monitor the current value of the current transformer, use the “heater current monitor” parameter.
- When HBA function, is not used set the “heater burnout” parameter (advanced function setting level) to “OFF”.

J Operating conditions

- The HBA function can be used when the option unit E5EN-VVHV is mounted on the E5EN. Be sure to connect the CT to the E5EN, and pass the heater lead through the CT hole.
- Turn the heater ON at the same time as or before turning the E5EN ON. If the heater is turned ON after turning the E5EN ON, the heater burnout alarm will activate.
- Control is continued even if the heater burnout alarm is active. (That is, the E5EN attempts to control the heater on which the heater burnout alarm has not occurred.)
- The heater burnout alarm is detected when the control output is continuously ON for 190 ms or more.
- The rated current value may sometimes differ slightly from the actual current flowing to the heater. Check the current value in an actual operating state in the “heater current monitor” parameter.
- If there is little difference between the current in a normal state and the current in the burnout state, detection may become unstable. On a heater of current 10.0 A or less, maintain a difference of 1.0 A or more. On a heater of current 10.0 A or more, maintain a difference of 2.5 A or more.
- The HBA function cannot be used when the heater is controlled by a phase control system or cycle control system. Also, 3-phase heaters cannot be used.

When heater burnout is detected on a 3-phase heater, use the K2CU-Fj j A-j GS (with gate input terminal). See the respective data sheet for details.

J Setup

To activate the heater burnout alarm, set the “HBA used” parameter (advanced function setting level) to “ON” and the heater burnout set value in the “heater burnout detection” parameter (adjustment level).

Operation Procedure

In this example, set the “heater burnout detection” parameter to “2.5”.

- Moving to the advanced function setting level

Operation level

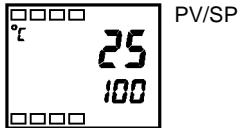

Initial setting level

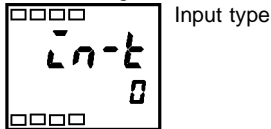

Move to advanced function setting level



Advanced function setting level



HBA used



The default of the “heater burnout” parameter is already “ON”, so set the “heater burnout detection” parameter.

- (1) Move to the advanced function setting level.
Press the key for at least three seconds to move from the “operation level” to the “initial setting level”.
- (2) Then move to “advanced function setting level” by pressing the key.
- (3) Use the keys to input the password (“-169”), and move from the “initial setting level” to the “advanced function setting level”. The top parameter in the “advanced function setting level” is displayed.
- (4) Select the “HBA used” parameter by pressing the key. Make sure that this parameter is set to “ON” (default). Next, set the “heater current value monitor” parameter.

- Setting heater burnout detection

Operation level

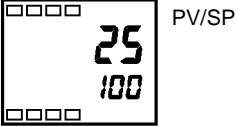

Adjustment level

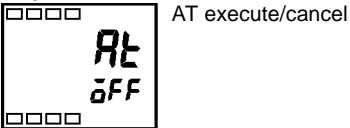

Heater current value monitor



Heater burnout detection



- (5) Press the key for at least one second to move from the “advanced function setting level” to the “initial setting level” and then to the “operation level”.
- (6) Press the key for less than one second to move from the “operation level” to the “adjustment level”.
- (7) Select the “heater current value monitor” parameter by pressing the key. Check the current value. Next, set the “heater burnout detection” parameter.
- (8) Select the “heater burnout detection” parameter by pressing the key. Set the current value as a reference value. Set this set value so that there is a large difference between the current flowing to the heater lead when heater operation is normal and the current flowing when a heater burnout occurs.
- (9) For example, set “2.5”. To return to the “operation level”, press the key for less than one second.

J How to calculate detection current values

- Calculate the set value by the following equation:

$$\text{Set value} = \frac{(\text{current value at normal operation} + \text{current value at heater burnout})}{2}$$
- To set the value of the heater burnout when two or more heaters are connected through the CT, use the current value of the smallest heater connected. OR the current value when one of the heaters burns out if all the heaters have the same current value.
- Make sure that the following conditions are satisfied:
 Heater of current 10.0 A or less:
 Current value at normal operation - current value at heater burnout ≥ 1 A
 (When the resultant current is less than 1 A, detection is unstable.)
 Heater of current 10.0 A or more:
 Current value at normal operation - current value at heater burnout ≥ 2.5 A
 (When the resultant current is less than 2.5 A, detection is unstable.)
- The setting range is 0.1 to 49.9 A. Heater burnout is not detected when the set value is "0.0" or "50.0". When the set value is "0.0", the heater burnout alarm is set to "OFF", and if the set value is "50.0", the heater burnout alarm is set to "ON".
- Set the total current value at normal heater operation to 50 A or less. When set to "55.0 A", "FFFF" is displayed in the "heater current monitor" parameter.

J Example

Example 1 When using a 200 VAC, 1 kW heater

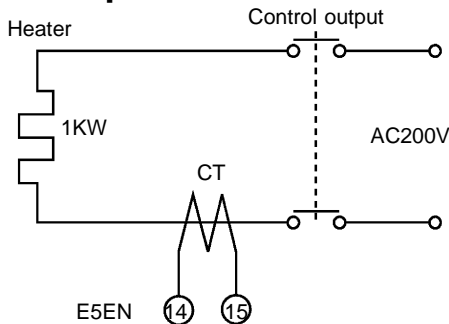

Current during normal operation = $\frac{1000}{200} = 5\text{A} (< 10\text{A})$
 Current at heater burnout = 0A
 Set value = $\frac{5 + 0}{2} = 2.5\text{A}$
 (current at normal operation - current at heater burnout) = $5 - 0 = 5\text{A} (\geq 1\text{A})$

Example 2 When using three 200 VAC, 1 kW heaters

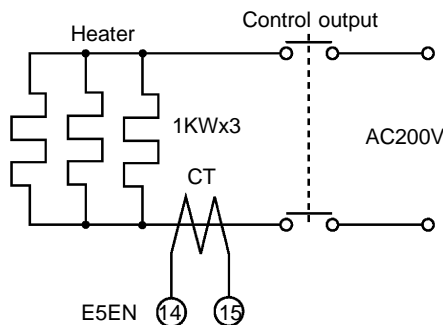

Current at normal operation = $\frac{1000}{200} \times 3 = 15\text{A} (\geq 10\text{A})$
 Current at burnout of one heater = $\frac{1000}{200} \times 2 = 10\text{A}$
 Set value = $\frac{15 + 10}{2} = 12.5\text{A}$
 (current at normal operation - current at heater burnout) = $15 - 10 = 5\text{A} (\geq 2.5\text{A})$

Parameters

Symbol	Parameter : Level	Description
CT	Heater current value monitor: Adjustment level	For heater current value monitor
HB	Heater burnout detection: Adjustment level	For HBA detection
HBH	Heater burnout hysteresis: Advanced function setting level	For HBA detection
HL	Heater burnout latch: Advanced function setting level	For HBA detection

CHAPTER 4

APPLIED OPERATION

4.1	Shifting Input Values	4-2
	Shifting input	4-2
	How to calculate input shift values (2-point shift)	4-3
	1-point shift method	4-4
	2-point shift method	4-4
	Example of 2-point temperature input shift	4-5
4.2	Alarm Hysteresis	4-6
	Standby sequence	4-6
	Close in alarm/open in alarm	4-7
4.3	Setting Scaling Upper and Lower Limits (analog input)	4-8
	Analog input	4-8
4.4	Executing Heating and Cooling Control ..	4-10
	Heating and cooling control	4-10
	Setup	4-11
4.5	Externally Setting the SP	4-12
	Setting event input	4-12
	How to use multi-SP	4-12
	Setting by key operation	4-13
	Setup	4-13
	Executing run/stop control	4-14
4.6	Setting the SP Upper and Lower Limit Values	4-15
	Set point limiter	4-15
	Setup	4-16
4.7	Executing the SP Ramp Function (limiting the SP change rate)	4-17
	SP ramp	4-17
4.8	To Move to the Advanced Function Setting Level	4-19
4.9	Using the Key Protect Level	4-20
	Key protect	4-20

4.1 Shifting Input Values

J Shifting input

F 1-point shift



- The input shift type matched to the sensor currently selected in the “input type” parameter is displayed.
- 2-point shift is applied only for non-contact temperature sensors.
- With 1-point shift, only the value set to the “Temperature input shift” parameter (adjustment level) is applied to the entire temperature input range. For example, if the input shift value is set to “1.2_C”, the process value is treated as “201.2_C” after input shift is applied when the process value is 200_C.

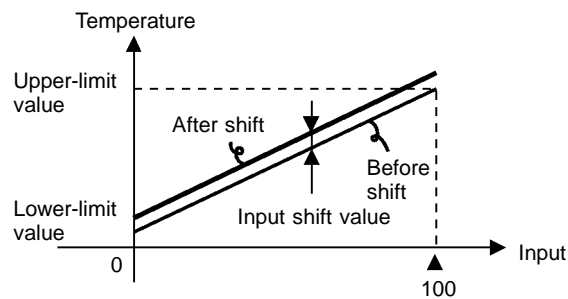

Operation Procedure

In this example, shift the input of the K sensor by “1_C” by 1-point input shift.

Operation level

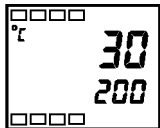

Adjustment level

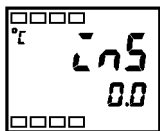

Temperature input shift

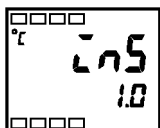

Operation level

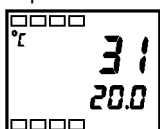

Operation level

- (1) Press the key to move from the “operation level” to the “adjustment level”.
- (2) Select the “temperature input shift” parameter by pressing the key.
- (3) Use the keys to set “1”.
- (4) To return to the “operation level,” press the key. The process value is 1_C larger than before shift is applied.

F 2-point shift

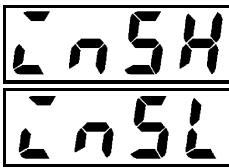

Upper-limit
temperature
input shift
value

Lower-limit
temperature
input shift
value

- The input temperature range of non-contact temperature sensors can be shifted by setting an individual value for the upper and lower points of the sensor range. This means that the shift can be applied equally across the range with separate values for each end of the range. For example, if the upper-limit value is set to “2_C” and the lower-limit value is set to “1_C”, the sensor range is shifted by an average of 1.5_C at 50% input.
- Set the upper-limit value in the “upper-limit temperature input shift value” parameter and the lower-limit value in the “lower-limit temperature input shift value” parameter.

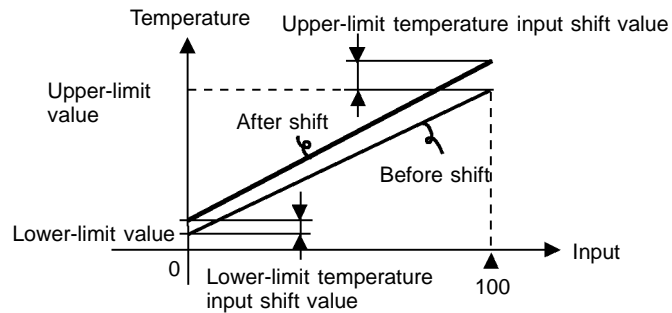

J How to calculate input shift values (2-point shift)

When the non-contact temperature sensor model ES1A is connected to the E5EN, an offset of several to several tens of a degree can occur.

For this reason, offset the readout value by 1-point or 2-point shift as described in this item. This offset occurs as a bias current for detecting controller sensor error flows to the output impedance of the non-contact temperature sensor. 2-point shift can be carried out only on non-contact temperature sensors, and cannot be set for other input types.

[Preparations]

- (1) Set to the temperature range matching the input specifications of the non-contact temperature sensor. (ES1A is supported only in thermocouple input types on the E5EN.)
- (2) Prepare a thermometer capable of measuring the temperature of the control target as shown in Figure 1 so that 1-point shift or 2-point shift can be carried out.

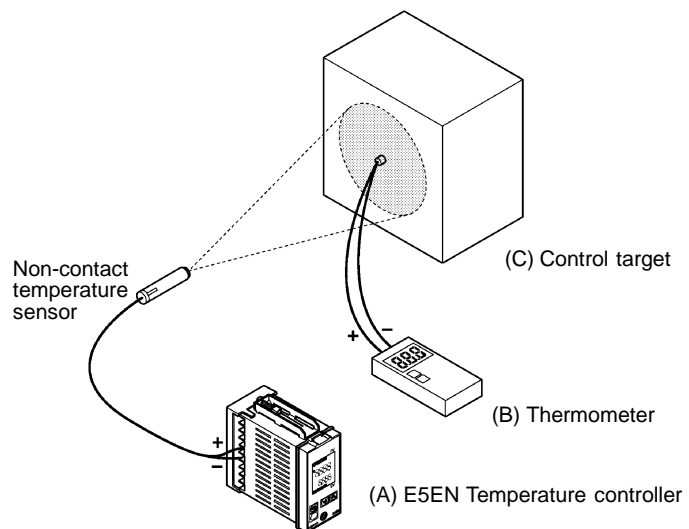
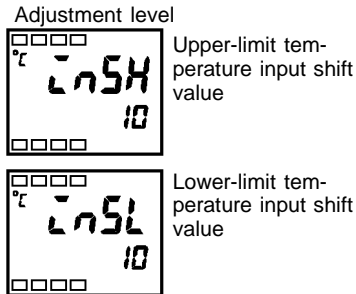

Figure 1 Configuration When Compensating a Non-contact Temperature Sensor

J 1-point shift method



- (1) In the configuration shown in Figure 1, bring the set point to near the value at which the temperature of the control target is to be controlled. Assume that the control target temperature (C) and the control target temperature (B) are matching.
- (2) Check the control target temperature (B) and the controller readout (A). Take the following value as the input shift value, and set the same numerical values to "10SL" and "10SH".

$$\text{control target temperature (B) - controller readout (A)}$$

Figure 2 shows the effect of 1-point temperature input shift.

- (3) After setting the input shift values, check controller readout (A) and control target temperature (B). If they are almost the same, this completes temperature input shift.

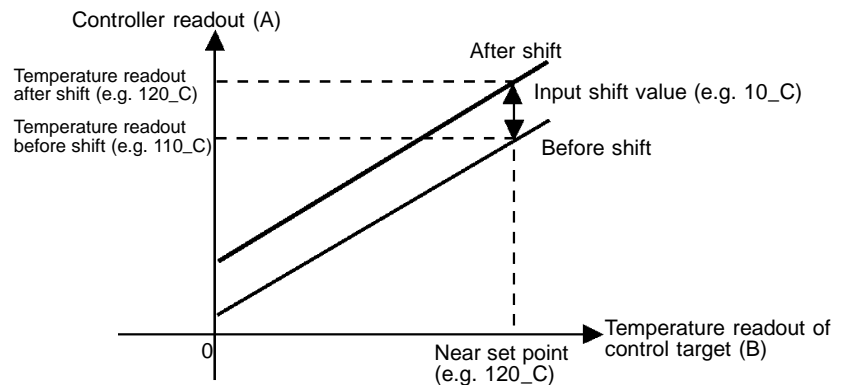

Figure2 1-point Temperature Input Shift

J 2-point shift method

Use 2-point input shift if you want to increase the accuracy of the readout values across the range of the sensor.

- (1) Shift the controller readout by two points, near room temperature and near the value at which the temperature of the control target is to be controlled. For this reason, bring the control target temperature to near room temperature and to near the set point, and check control target temperature (B) and controller readout (A).
- (2) Using equations (1) and (2) calculate the upper- and lower-limit temperature input shift values from the readout and temperature to be shifted that you obtained in step 1.

Figure 3 shows the effect of shift by 2-point temperature input shift.

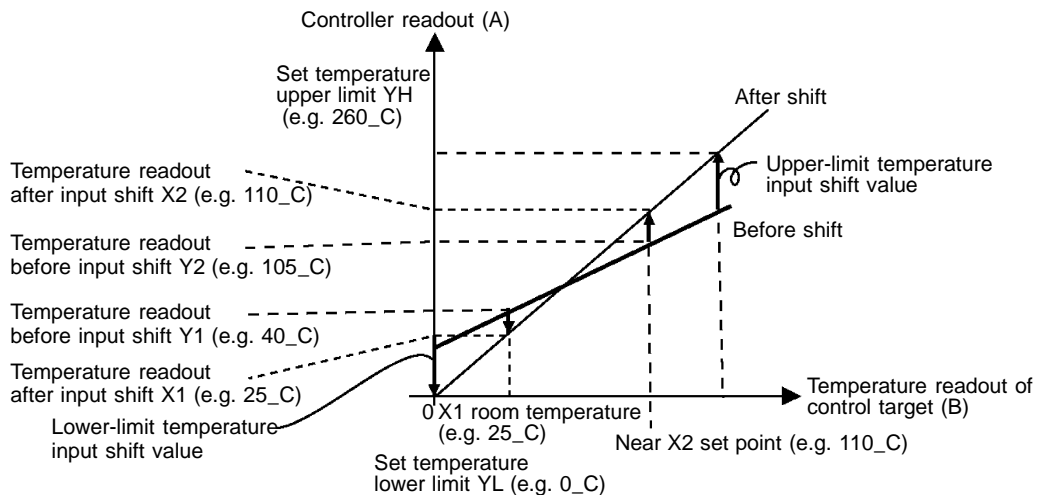

Figure3 2-point Temperature Input Shift

- Use the following equation to calculate the lower-limit temperature input shift value.

$$\Delta T_{SL} = \frac{Y_L - Y_1}{Y_2 - Y_1} \times \{(X_2 - Y_2) - (X_1 - Y_1)\} + (X_1 - Y_1) \dots \text{equation 1}$$

- Use the following equation to calculate the upper-limit temperature input shift value.

$$\Delta T_{SH} = \frac{Y_H - Y_1}{Y_2 - Y_1} \times \{(X_2 - Y_2) - (X_1 - Y_1)\} + (X_1 - Y_1) \dots \text{equation 2}$$

- (3) After setting the calculated values to “ ΔT_{SL} ” and “ ΔT_{SH} ”, check controller readout (A) and control target temperature (B).
- (4) Although the input shift was carried out at two points, close to room temperature (ambient temperature), and near to the set point, select points close to each end of the sensor range to improve accuracy across the full range of the sensor measurement range.

J Example of 2-point temperature input shift

In this example, we use the ES1A K 0 to 260_C specification.

YL and YH in equations 1 and 2 are set temperature lower limit YL is 0_C and set temperature upper limit YH is 260_C. Check the temperature of the control target.

When the room temperature X1 is 25_C, the readout on the controller Y1 is 40_C, and when the temperature near the set point X2 is 110_C, the readout on the controller Y2 becomes 105_C.

Adjustment level

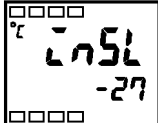

Lower-limit temperature input shift value

Lower-limit temperature input shift value

$$\Delta T_{SL} = \frac{0 - 40}{105 - 40} \times \{(110 - 105) - (25 - 40)\} + (25 - 40) = -27.3(^{\circ}\text{C})$$

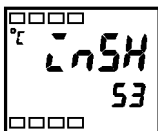

Upper-limit temperature input shift value

Upper-limit temperature input shift value

$$\Delta T_{SH} = \frac{260 - 40}{105 - 40} \times \{(110 - 105) - (25 - 40)\} + (25 - 40) = 52.7(^{\circ}\text{C})$$

4.2 Alarm Hysteresis

- The hysteresis of alarm outputs when alarms are switched ON/OFF can be set as follows:



- Alarm hysteresis is set independently for each alarm in the “alarm hysteresis 1 to 3” parameters (advanced function setting level). Default is “0.2EU”.

J Standby sequence

- “Standby sequence” is a function which allows the alarm outputs to be temporarily disabled while the first alarm condition occurs. From here on, the alarm output is active for future alarm conditions.
- For example, in a standard heating application, if you used the standard “low alarm”, the alarm would be active from switching the controller ON. However, with “Standby Sequence”, the alarm output is disabled during the first warmup, and the temperature has to rise above the alarm set point before the alarm can become active. Then, if the temperature falls below the alarm set point, the output is active.

F Restart

- The standby sequence is canceled when an alarm is output. It is, however, restarted later by the “standby sequence” parameter (advanced function setting level). For details, see the “standby sequence” parameter in “Chapter 5, Parameters.”

**J Close in alarm/
open in alarm**

- When the E5EN is set to “close in alarm,” the status of the alarm output is normally open. When set to “open in alarm,” the status of the alarm output is output inverted or normally closed.
- Alarm type and close in alarm (normally open)/open in alarm (normally closed) can be set independently for each alarm.
- Close in alarm/open in alarm is set in the “alarm 1 to 3 open in alarm” parameters (advanced function setting level). Default is “n-0: close in alarm”.

	Alarm Output Function	Output	Alarm LCD
Close in alarm	ON	ON	Lit
	OFF	OFF	Out
Open in alarm	ON	OFF	Lit
	OFF	ON	Out

**F Summary of
alarm operations**

The figure below visually summarizes the above description of alarm operations (when alarm type is set to “lower-limit alarm with standby sequence” and E5EN is set to “close in alarm”).

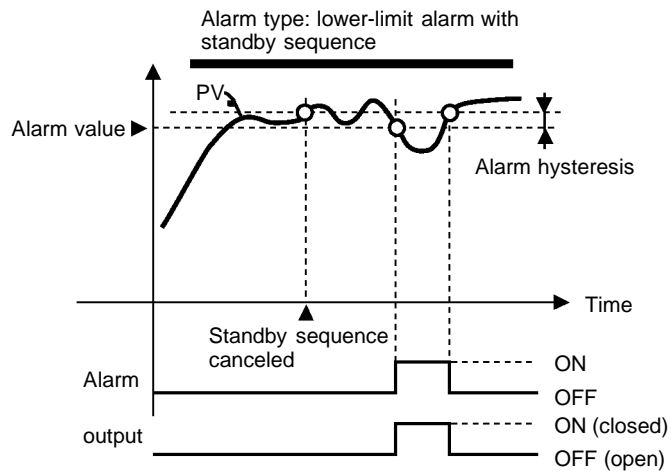

Parameters

Symbol	Parameter : Level	Description
ALH V	Alarm 1 to 3 hysteresis: Advanced function setting level	Alarm
rE5t	Standby sequence reset method: Advanced function setting level	Alarm
ALV n	Alarm 1 to 3 open in alarm: Advanced function setting level	Alarm

V : 1, 2, or 3

4.3 Setting Scaling Upper and Lower Limits (analog input)

J Analog input

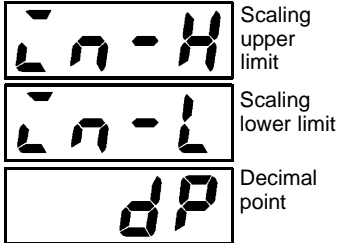

- When an analog input (voltage input) is selected, scaling matched to the control is possible.
- Scaling is set in the “scaling upper limit”, “scaling lower limit” and “decimal point” parameters (initial setting level). These parameters cannot be used when temperature input type is selected.
- The “scaling upper limit” parameter sets the physical quantity to be expressed by the upper limit value of input, and the “scaling lower limit” parameter sets the physical quantity to be expressed by the lower-limit value of input. The “decimal point” parameter specifies the number of digits past the decimal point.
- The following figure shows a scaling example of 0 to 5 mV input. After scaling, the humidity can be directly read.

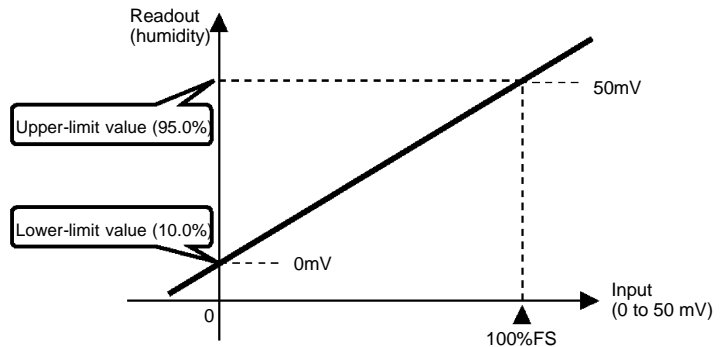

Operation Procedure

In this example, let's set the scaling upper- and lower-limits so that inputs 0 to 50 mV become 10.0% to 95.0%.

Initial setting level

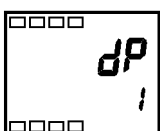
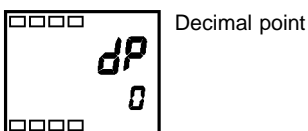
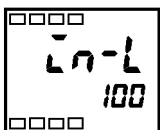
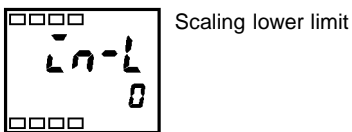
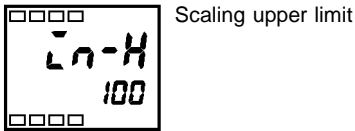
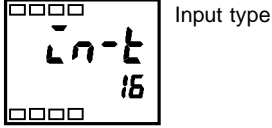

- (1) Press the key for at least three seconds to move from the “operation level” to the “initial setting level”.
- (2) Select “scaling upper limit” by pressing .
- (3) Use the keys to set the parameter to “950”.
- (4) Select “scaling lower limit” by pressing .
- (5) Use the keys to set the parameter to “100”.
- (6) Select the decimal point position by pressing .
- (7) Use the keys to set the parameter to “1”.
- (8) To return to the “operation level” press the key for at least one second.

4.4 Executing Heating and Cooling Control

J Heating and cooling control

Heating and cooling control can be used on E5EN-j 3j j j controllers. Heating and cooling control operates when “H-C : heating and cooling” is selected in the “standard/heating and cooling” parameter. Select the standard heating control or cooling control according to the following table:

Control Method	Control Output	Alarm 2 output	Direct/reverse operation
Heating control (standard)	Control output (heat)	-	Reverse operation
Cooling control (standard)	Control output (cool)	-	Direct operation
Heating and cooling control	Control output (heat)	Control output (cool)	Reverse operation

(The parameter default is heating control (standard).)

- When heating and cooling control is selected, the “dead band” and “cooling coefficient” parameters can be used.

F Dead band

The dead band is set with the set point as its center on the E5EN-j 2j j . The dead band width is the set value of the “dead band” parameter (adjustment level). Setting a negative value produces an overlap band. Default is “0.0%EU.”

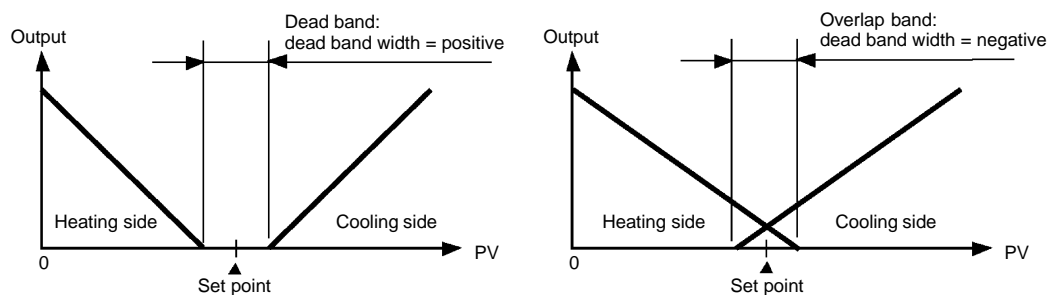

F Cooling coefficient

If the heating and cooling characteristics of the control target greatly differ, preventing satisfactory control characteristics from being obtained by the same PID constants, adjust the proportional band (P) at the cooling side using the cooling coefficient to balance control between the heating and cooling sides. In heating and cooling control, P at the heating or cooling side is calculated by the following formula:

Heating side $P = P$

Cooling side $P = P \times \text{cooling coefficient}$

The cooling coefficient is applied to heating side P to obtain control whose characteristics (cooling side P) differ from those on the heating side.

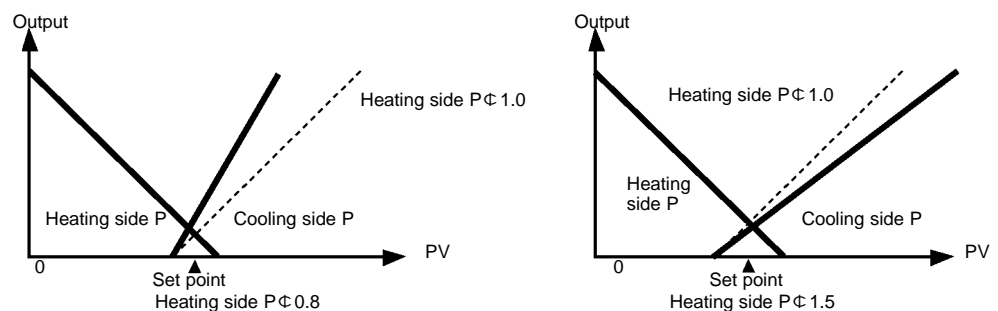

J Setup

To set heating and cooling control, set the “standard/heating and cooling”, “dead band” and “cooling coefficient” parameters.

- Setting heating and cooling control

Operation Procedure

“standard/heating and cooling” = “heating and cooling”

Initial setting level



Standard/heating and cooling

- (1) Press the key for at least three seconds to move from the “operation level” to the “initial setting level”.
- (2) Select “standard heating and cooling control” in the “initial setting level”.

Std: Standard control

H-C : Heating and cooling control

- Setting dead band

Operation Procedure

“Dead band” = “5”

Adjustment level



Dead band

- (1) Select “dead band” in the “adjustment level”.
- (2) Use the keys to set the parameter to “5.0”.
The setting range is -199.9 to 999.9.



- Setting cooling coefficient

Operation Procedure

Cooling coefficient = 10

Adjustment level

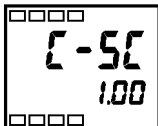

Cooling coefficient

- (1) Select “cooling coefficient” in the “adjustment level”.
In this example, set the parameter to “10”.
- (2) Use the keys to set the parameter to “10.00”.
The setting range is 0.01 to 99.99.

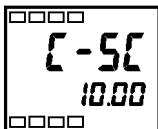

4.5 Externally Setting the SP

J Setting event input

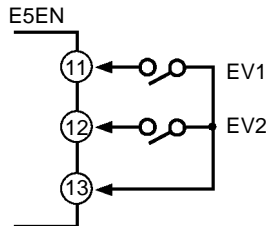

Run/stop control is executed by event input assignments 1 and 2.

The following table shows the “number of multi-SP uses” displays which functions are assigned to event inputs 1 and 2.

The “number of multi-SP uses” parameter is used when the number of preset set points is 2 or 4. This parameter determines display or non-display of the “event input assignment 1” and “event input assignment 2” parameters.

Number of Multi-SP Uses	Event Input 1 Function	Event Input 2 Function
0	Set in “event input assignment 1”	Set in “event input assignment 2”
1	Multi-SP (SP 0/1 selectable)	Set in “event input assignment 2”
2	Multi-SP (SP 0/1/2/3 selectable)	

When you are setting two external input set points, set in the “number of multi-SP uses” parameter.

- To select set points (0/1)

Two set points can be selected when the “number of multi-SP uses” is set to “1” (default). This setting need not be changed. Set point 0 or 1 is specified by the ON/OFF state of event input 1.

J How to use multi-SP

“Multi-SP” is a function for setting set points 0 to 3 in advance, and selecting these set points by a combination of event inputs 1 and 2.

F When multi-SP is used by event input

Multi-SP can be used when the option event input unit E5EN-VVVBV is mounted on the E5EN and “number of multi-SP uses” is set to “1” or “2”.

- When “number of multi-SP uses” is set to “1”

Event input 1	Selected Set Point
OFF	Set point 0
ON	Set point 1

- When “number of multi-SP uses” is set to “2”

Event input 1	Event input 2	Selected Set Point
OFF	OFF	Set point 0
ON	OFF	Set point 1
OFF	ON	Set point 2
ON	ON	Set point 3

* Event input can be used when the option event input unit E5EN-VVVBV is mounted in the E5EN. Select event input ON/OFF while the E5EN is turned ON. Judgment of event input ON/OFF is carried out on event inputs of 50 ms or more.

J Setting by key operation

Set points 0 to 3 can be selected by changing the set value of the “multi-SP” parameter. The “multi-SP” display conditions are as follows:

- When the option event input unit E53-CNHB is not mounted in the E5EN, and “multi-SP” is set to “ON”
- When the option event input unit E53-CNHB is mounted in the E5EN, the “number of multi-SP uses” is set to “0” and “multi-SP” is set to “ON”

The following table shows the relationship between the “multi SP” parameter set value and the selected set point.

Multi-SP	Selected Set Point
0	Set point 0
1	Set point 1
2	Set point 2
3	Set point 3

J Setup

- To select set points (0/1/2/3)

Operation Procedure

Before setting the “number of multi SP uses,” cancel protection and move to the “advanced function setting level”. For details on how to cancel protection, see “4.9 Using the Key Protect Level”.

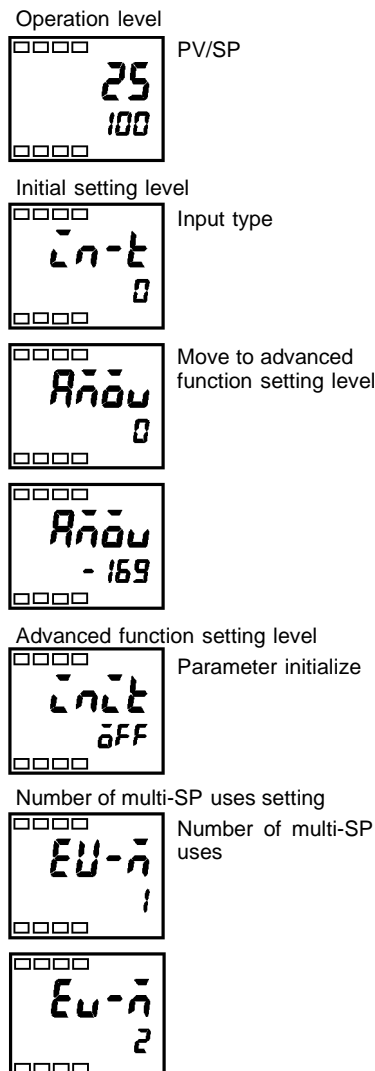

- (1) Press the key for at least three seconds to move from the “operation level” to the “initial setting level”.
- (2) Select “Move to advanced function setting level” by pressing the key.
- (3) Use the key to enter “-169” (password).
It can be moved to the “advanced function setting level” by pressing the key or leaving the setting for at least two seconds.
- (4) Select “Number of multi-SP uses” by pressing the key.
- (5) Use the key to set the parameter to “2”.
- (6) To return to the “initial setting level” press the key for at least one second.
- (7) To return to the “operation level” press the key for at least one second.

Set points 0, 1, 2 and 3 are set according to the ON/OFF states of event inputs 1 and 2.

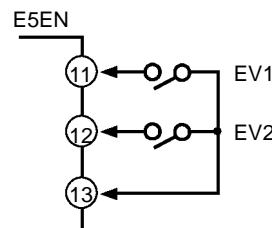

J Executing run/stop control

When “event input assignment 1” or “event input assignment 2” is set to “run/stop”, control is started when event input 1 or 2 becomes “OFF”. Control is stopped when this becomes “ON”.

While control is stopped, STOP lights.

Setting	Input Contact	State
Event input 1 or 2	ON	STOP
Event input 1 or 2	OFF	RUN

Note: When “number of multi-SP uses” is set to “0” or “1” that is not the set point setting, run/stop control is possible according to event inputs.

Event input assignments 1 and 2 are as follows according to the “number of multi-SP uses” setting.

Parameter Name	Setting		
	0	1	2
Event input assignment 1	None or Run/stop	Not displayed (none)	Not displayed (none)
Event input assignment 2	None or Run/stop	None or Run/stop	Not displayed (none)

- When the number of multi-SP uses is set to either 1 or 2, and event input assignment 1 or 2 is set to “not displayed,” the setting automatically becomes “none.”
- When the “number of multi-SP uses” is set to “0”, and both input assignments 1 and 2 can be set, RUN/STOP is assigned to only one event assignment. The other event assignment is automatically set to OFF.

Parameters

Symbol	Parameters : Level	Description
E_{u-1}	Event input 1 assignment: Advanced function setting level	For event input function
E_{u-2}	Event input 2 assignment: Advanced function setting level	
E_{u-n}	Number of multi-SP uses: Advanced function setting level	

4.6 Setting the SP Upper and Lower Limit Values

J Set point limiter

The setting range of the set point is limited by the set point limiter. The set point limiter is used to prevent the control target from reaching abnormal temperatures. The upper- and lower-limit values of this set point limiter are set by the “set point upper limit” and “set point lower limit” parameters in the “initial setting level”, respectively. However, note that when the set point limiter is reset, the set point is forcibly changed to the upper- or lower-limit value of the set point limiter if the set point is out of the limiter range. Also, when the input type and temperature unit are changed, the set point limiter is forcibly reset to the sensor setting range.

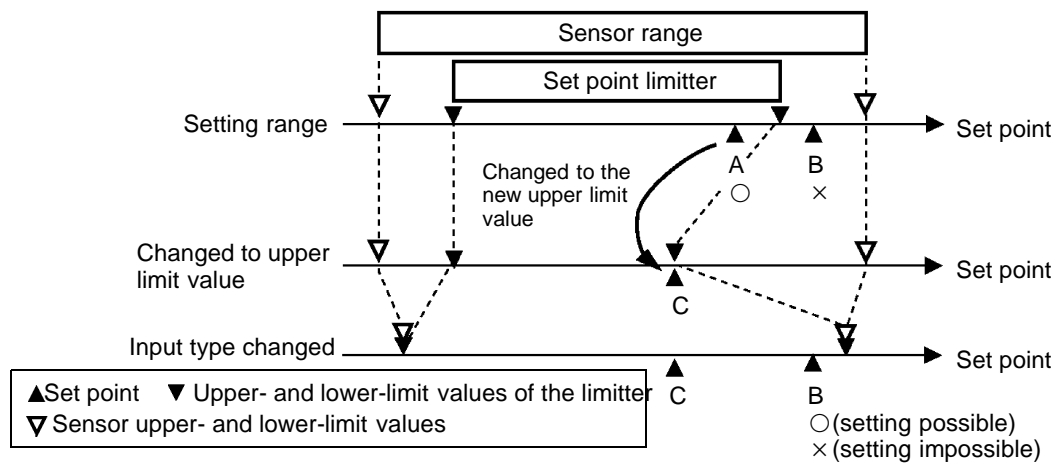

Parameters

Symbol	Parameters : Level	Description
SL-H	Set point upper limit : Initial setting level	For limiting SP setting
SL-L	Set point lower limit : Initial setting level	For limiting SP setting

J Setup

To set the set point upper and lower limits, set in the “set point upper limit” and “set point lower limit” parameters in the “initial setting level”. This example describes how to set the set point limiter “-200 to 1300_C” to input type K thermocouple.

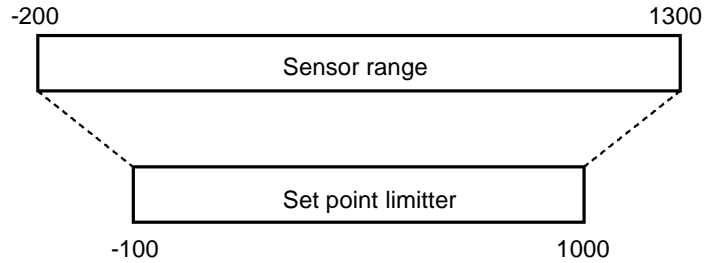

- Setting the set point upper limit

Operation Procedure

Set the “set point upper limit” parameter to “1000”.

Initial setting level

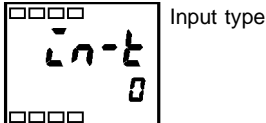

- (1) Press the key for at least three seconds to move from the “operation level” to the “initial setting level”.
- (2) Select “set point upper limit”.
- (3) Use the keys to set the parameter to “1000”.

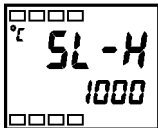
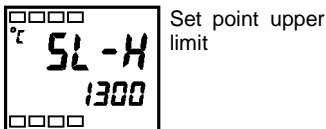

- Setting the set point lower limit

Operation Procedure

Set the “set point lower limit” parameter to “-100”.

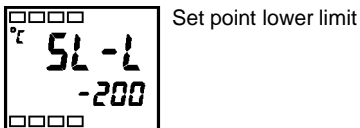

- (1) Select “set point lower limit” in the “initial setting level”.
- (2) Use the keys to set the parameter to “-100”.

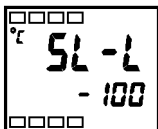

4.7 Executing the SP Ramp Function (limiting the SP change rate)

J SP ramp

With the SP ramp function, the controller operates according to the value (set point during SP ramp) limited by a change rate. The interval in which the set point during SP ramp is limited is referred to as the “SP ramp”.

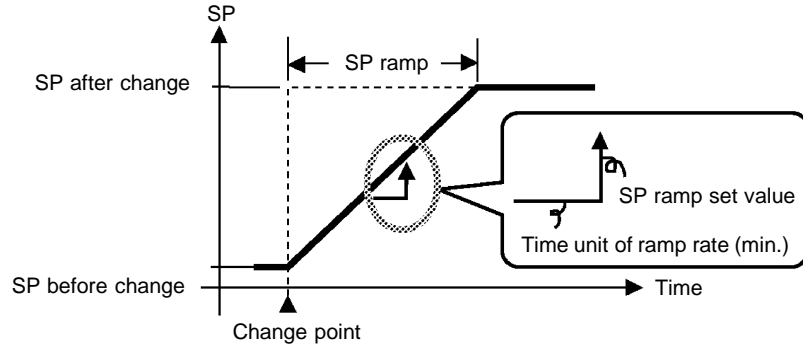

The change rate during SP ramp is specified by the “SP ramp set value” parameter. The “SP ramp set value” default is “OFF”, and the SP ramp function is disabled.

Changing of the ramp set point can be monitored in the “set point during SP ramp” parameter (operation level). Use this parameter during monitoring of the SP ramp.

Parameters

Symbol	Parameters : Level	Description
$\bar{O}L-H$	MV upper limit : Advanced function setting level	For limiting manipulated variable
$\bar{O}L-L$	MV lower limit : Advanced function setting level	For limiting manipulated variable
$SL-H$	Set point upper limit: Initial setting level	For limiting SP setting
$SL-L$	Set point lower limit: Initial setting level	For limiting SP setting
$SP-r$	SP ramp set value: Advanced function setting level	For limiting SP change rate

F Operation at start

If the SP ramp function is enabled when the E5EN is turned ON, and when “run” is switched to from “stop,” the process value may reach the set point after SP ramp in the same way as when the set point is changed. In this case, operation is carried out with the process value regarded as the set point before the change was made.

The direction of the SP ramp changes according to the relationship between the process value and the set point.

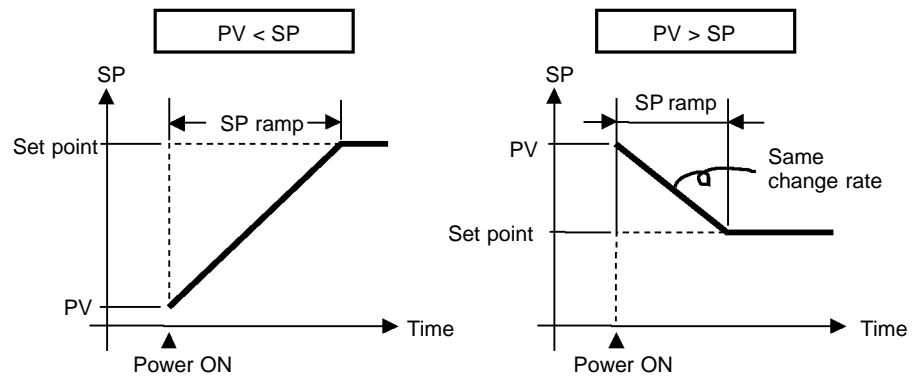



F Restrictions during SP ramp operation

- Execution of auto-tuning starts after the end of SP ramp.
- When control is stopped or an error occurs, the SP ramp function is disabled.

4.8 To Move to the Advanced Function Setting Level

In the default setting, the advanced function setting level is protected and it can not be moved to this setting level. To move to this setting level, cancel first the protection applied by the “protect level.” See “4.9 Using the Key Protect Level”.

- (1) Press the  and  keys simultaneously for at least one second in the “operation level.”



“operation/adjustment protection”

- (2) The controller moves to the protect level, and “operation/adjustment protection” is displayed.



“initial setting/communications protection”



- (3) Press the  key once to move to “initial setting/communications protection.”

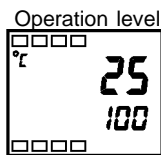

- (4) Set the set value to “0”



PV/SP

- (5) Press the  and  keys simultaneously to return to the “operation level.”

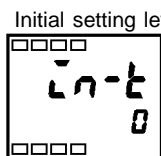

Input type

- (6) Press the  key for at least three seconds to move to the “initial setting level” from the “operation level.”



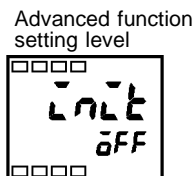

Move to advanced function setting level

- (7) Select the “Move to advanced function setting level” parameter by pressing the  key.





Advanced function setting level

- (8) Use the   keys to input the password (“-169”), and either press the  key or leave the setting for at least two seconds to move to the “advanced function setting level” from the “initial setting level.”

4.9 Using the Key Protect Level

J Key protect

- To move to the protect level, press the  and  keys simultaneously for at least one second.
- The protect level protects parameters that are not changed during controller operation until operation is started to prevent them from being modified unintentionally.
- The protect level setting restricts the range of parameters that can be used.

F Operation/adjustment protection



The following table shows the relationship between set values and the range of protection.

Level		Set value			
		0	1	2	3
Operation level	PV	f	f	f	f
	PV/SP	⊙	⊙	⊙	f
	Other	⊙	⊙	⊘	⊘
Adjustment level		⊙	⊘	⊘	⊘

- ⊙ : Can be displayed and changed
- f : Can be displayed
- ⊘ : Cannot be displayed and move to other levels not possible

- When this parameter is set to “0”, parameters are not protected.
- Default is “0”.

F Initial setting/communications protection



This protect level restricts movement to the initial setting level, communications setting level and advanced function setting level.

Set value	Initial setting level	Communications setting level	Advanced function setting level
0	f	f	f
1	f	f	⊘
2	⊘	⊘	⊘

- f : Move to other levels possible
- ⊘ : Move to other levels not possible

- Default is “1”.

F Setting change protection

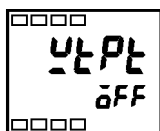

This protect level protects setup from being changed by operating the keys on the front panel.

Set value	Description
OFF	Setup can be changed by key operation.
ON	Setup cannot be changed by key operation. (The protect level can be changed.)

- Default is “OFF”.

CHAPTER 5

PARAMETERS

Conventions Used in this Chapter	5-2
Protect Level	5-3
Operation Level	5-4
Adjustment Level	5-11
Initial Setting Level	5-19
Advanced Function Setting Level	5-27
Communications Setting Level	5-40



Conventions Used in this Chapter

J Meanings of icons used in this chapter



Function

Describes the functions of the parameter.



Setting

Describes the setting range and defaults of the parameter.



Monitor

Describes the monitor range.



Example of use

Describes the parameter operations.



See

Describes related parameters and items.

J About parameter display

Parameters are displayed only when the “Conditions of Use” on the right of the parameter heading are satisfied. However, note that the settings of protected parameters are still valid, and are not displayed regardless of the conditions of use.

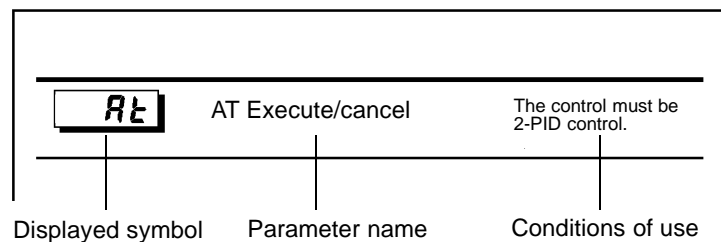

J About the Order in Which Parameters Are Described in This Chapter

Parameters are described level by level.

The first page of each level lists the parameters available in that level. The parameter names in this list are listed in the order that they are displayed on the E5EN.

Protect Level

Three levels of protection are provided on the E5EN, “operation/adjustment protection”, “initial setting/communications protection” and “setting change protection.” These protect levels prevent unwanted operation of the keys on the front panel in varying degrees.

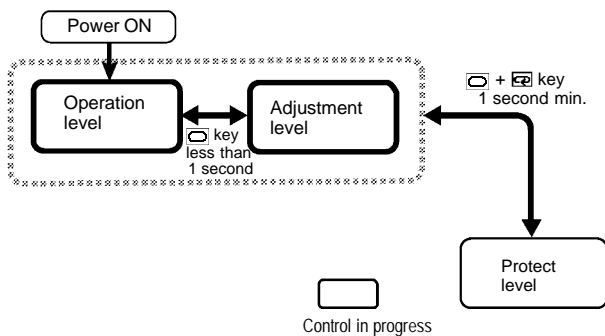

To move from the operation Level to the protect level, press the and keys for at least one second.

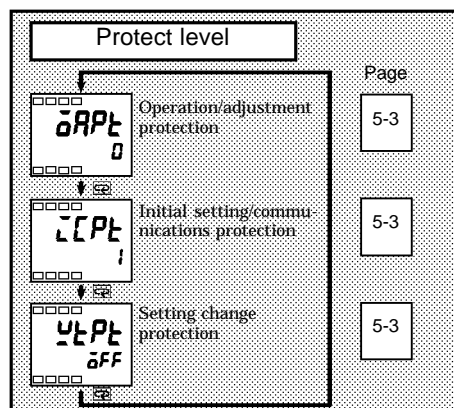

The settings of protected parameters are not displayed and so cannot be modified.

Operation/adjustment protection

Initial setting/communications protection

Setting change protection

This parameter specifies the range of parameters to be protected. indicates the default.



Function



Setting

F Operation/adjustment protection

The following table shows the relationship between set values and the range of protection.

Level		Set value			
		0	1	2	3
Operation level	PV	f	f	f	f
	PV/SP	⊙	⊙	⊙	f
	Other	⊙	⊙	⊘	⊘
Adjustment level		⊙	⊘	⊘	⊘

- ⊙ : Can be displayed and changed
- f : Can be displayed
- ⊘ : Cannot be displayed and move to other levels not possible

- Parameter items are not protected when the set value is set to “0”.

F Initial setting/communications protection

Move to the “initial setting level,” “communications setting level” and “advanced function setting level” is restricted.

Set value	Initial setting level	Communications setting level	Advanced function setting level
0	f	f	f
1	f	f	⊘
2	⊘	⊘	⊘

- f : Move to other levels possible
- ⊘ : Move to other levels not possible

F Setting change protection

Changes to setups by key operation are restricted.

Set value	Description
OFF	Setup can be changed by key operation.
ON	Setup cannot be changed by key operation. (The protect level can be changed.)

Operation Level

Display this level when you are to carry out control operations on the E5EN. You can set alarm values or monitor the manipulated variable in this level.

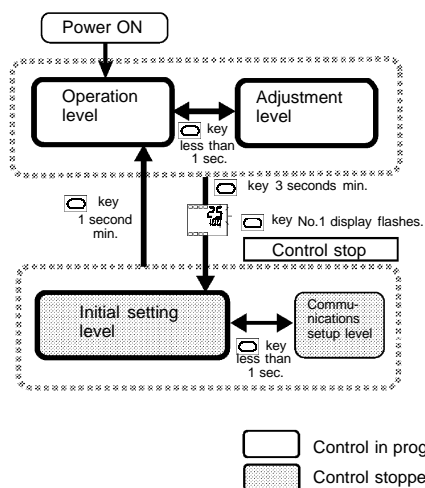

This level is automatically displayed immediately after the E5EN is turned ON. To move to other levels, press the key or the and keys.

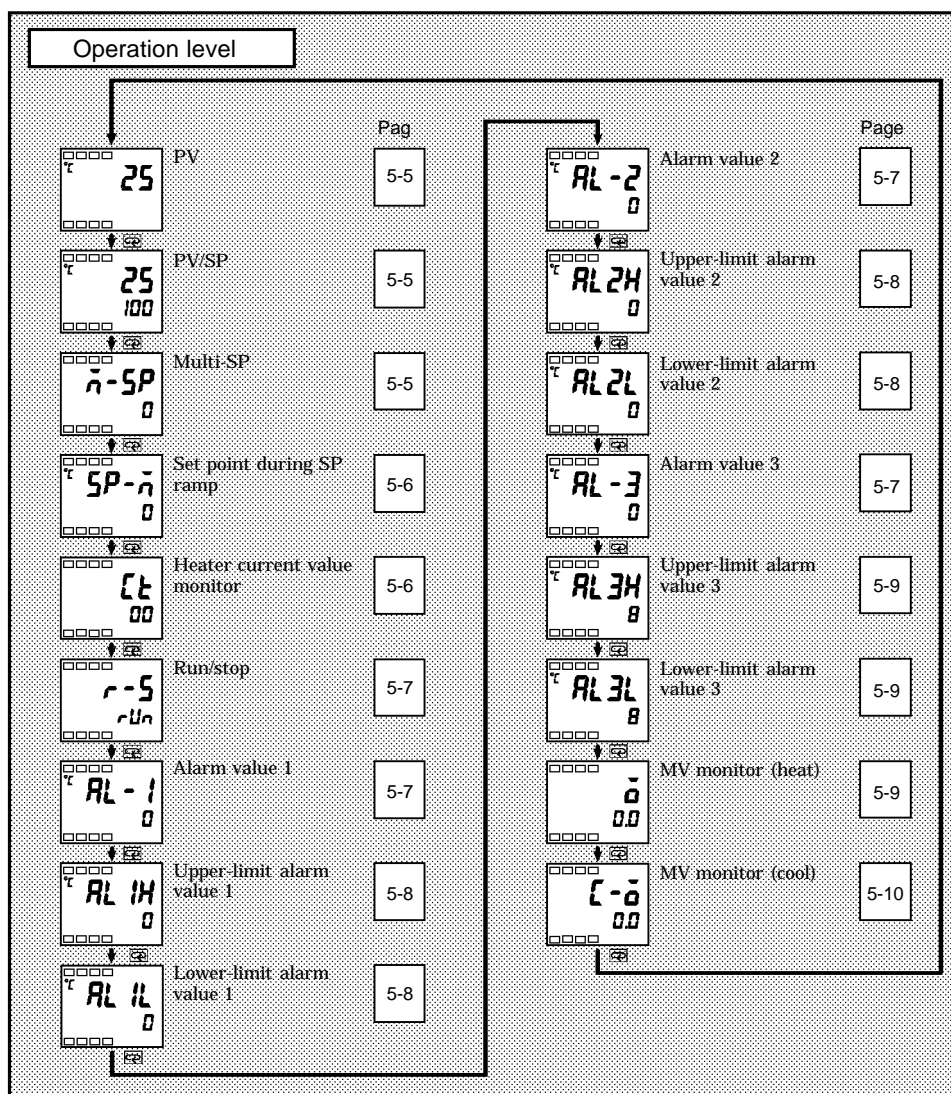

Operation Level

PV

The “additional PV display” parameter must be set to “ON”.



Function



Monitor

The process value is displayed on the No.1 display, and nothing is displayed (blank) on the No.2 display.

	Monitor Range	Unit
Process Value	Input indication range (See page A-10.)	EU

The decimal point position is dependent on the selected sensor.



See

F Related parameters

“Input type” (initial setting level) (p. 5-20)

“Set point upper limit” “Set point lower limit” (initial setting level)

PV/SP



Function

The process value is displayed on the No.1 display, and the set point is displayed on the No.2 display.

	Monitor Range	Unit
Process Value	Input indication range (See page A-10.)	EU

	Setting Range	Unit
Set Point	Set point lower limit to set point upper limit	EU

The decimal point position is dependent on the selected sensor.



See

Refer to the PV parameter

Multi-SP

Multi-SP (set point 0 to 3)

The “multi-SP uses” parameter must be set to “ON”.



Function

Multi-SP allows you to set up to four set points (SP0 to 3) in adjustment level. These can be switched by operating the keys on the front panel or by external input signals (event input assignments). In the parameter, enter set points 0 to 3.



See

- When the option event input unit E53-CNHB is not mounted in the E5EN, the set point can be selected when “number of multi-SP uses” is set to “0” and “multi-SP function” is set to “ON”.
- Multi-SP can also be selected by communications when the optional communications unit E53-CNH03 is mounted.

Operation Level

SP-r

Set point during SP ramp

The "SP ramp set value" parameter must not be set to "OFF".

This parameter monitors the set point during SP ramp.



Function

"Ramp" is a function for restricting the change width of the set point as a change rate. The set value is displayed when "SP ramp set value" parameter (advanced function setting level) is set.

When the set point is out of the preset ramp, the set point is matched to the set point set in the "PV/SP" parameter.



Monitor

Monitor Range	Unit
SP: Set point lower limit to set point upper limit	EU



See

F Related parameters

"PV/SP" (operation level) (p. 5-5)

"SP ramp set value" (advanced function setting level) (p. 5-30)

"Set point upper limit" "Set point lower limit" (initial setting level) (p. 5-22)

CT

Heater current value monitor

The "heater burnout" parameter must be set to "ON".

This parameter measures the heater current value from the CT input used for detecting heater burnout.



Function

Measures and displays the heater current value.



Monitor

Monitor Range	Unit
0.0 to 55.0	A

- When the current exceeds 55.0A, **FFFFF** is displayed.



See

F Related parameter

"Heater burnout detection" (adjustment level) (p. 5-13)

Operation Level

r - 5

Run/Stop

The run/stop function must not be set to event input assignments 1 and 2.

This parameter specifies run and stop.



Function

When “**rUn** : run” is selected, control is running. When “**StoP** : stop” is selected, control is stopped. When control is stopped, the STOP display lights. Default is “**rUn**”.



See

When the run/stop function is being controlled by event input, the run/stop function cannot be set by operating the keys on the front panel.

AL - 1

Alarm value 1

AL - 2

Alarm value 2

AL - 3

Alarm value 3

The alarm type must be set to either no alarm or a setting other than the upper- and lower-limit alarm.

This parameter sets the input value “X” in the alarm type list.



Function

- This parameter is used for setting the alarm values of alarm outputs 1, 2 to 3.
- During temperature input, the decimal point position is dependent on the currently selected sensor, and during analog input it is dependent on the “decimal point” parameter setting.



Setting

Setting Range	Unit	Default
-1999 to 9999	EU	0



See

The alarm type must be set to other than upper and lower limit alarm.

F Related parameters

“Input type” (p. 5-20) “Scaling upper limit” “Scaling lower limit” “Decimal point” (initial setting level) (p. 5-21)

“Alarm 1 to 3 type” (initial setting level) (p. 5-25)

“Alarm 1 to 3 open in alarm” “Alarm 1 to 3 hysteresis” “Standby sequence reset method” (p. 5-31) (advanced function setting level)

Operation Level

AL 1H

Upper-limit alarm value 1

AL 1L

Lower-limit alarm value 1

Alarm 1 type must be set to upper and lower limits, upper and lower limit range or upper- and lower-limit alarm with standby sequence.

This parameter independently sets the upper- and lower-limit alarm values when the mode for setting the upper and lower limits is selected for alarm 1 type (initial setting level).



Function

- This parameter sets the upper and lower limit values of alarm 1.
- During temperature input, the decimal point position is dependent on the currently selected sensor, and during analog input it is dependent on the “decimal point” parameter setting.



Setting

Setting Range	Unit	Default
-1999 to 9999	EU	0



See

F Related parameters

“Alarm 1 type” (initial setting level) (p. 5-25)

“Standby sequence reset method” (p. 5-31) “Alarm 1 open in alarm” (p. 5-32) “Alarm 1 hysteresis” (p. 5-32) (advanced function setting level)

AL 2H

Upper-limit alarm value 2

AL 2L

Lower-limit alarm value 2

Alarm 2 type must be set to upper and lower limits, upper and lower limit range or upper- and lower-limit alarm with standby sequence.

This parameter independently sets the upper- and lower-limit alarm values when the mode for setting the upper and lower limits is selected for alarm 2 type (initial setting level).



Function

- This parameter sets the upper and lower limit values of alarm 2.
- The decimal point position is dependent on the currently selected sensor.



Setting

Setting Range	Unit	Default
-1999 to 9999	EU	0



See

F Related parameters

“Alarm 2 type” (initial setting level) (p. 5-25)

“Standby sequence reset method” (p. 5-31) “Alarm 2 open in alarm” “Alarm 2 hysteresis” (p. 5-33) (advanced function setting level)

Operation Level

AL3H

Upper-limit alarm value 3

AL3L

Lower-limit alarm value 3

The control must be standard control. Alarm 3 type must be set to upper and lower limits, upper and lower limit range or upper- and lower-limit alarm with standby sequence.

This parameter independently sets the upper- and lower-limit alarm values when the mode for setting the upper and lower limits is selected for alarm 3 type (initial setting level).



Function

- This parameter sets the upper and lower limit values of alarm 3.
- The decimal point position is dependent on the currently selected sensor.



Setting

Setting Range	Unit	Default
-1999 to 9999	EU	0



See

F Related Parameters

“Alarm 1 type” (initial setting level) (p. 5-25)

“Standby sequence reset method” (p. 5-31) “Alarm 3 open in alarm” “Alarm 3 hysteresis” (p. 5-34) (advanced function setting level)

0

MV monitor (heat)

Manipulated variable display must be set to “ON”.

This parameter is for monitoring the manipulated variable on the heating side during operation.



Function

- During standard control, the manipulated variable is monitored, and during heating and cooling control, the manipulated variable on the heating side is monitored.
- Default is “OFF” and the manipulated variable is not displayed.



Monitor

Control	Monitor Range	Unit
Standard	-5.0 to 105.0	%
Heating and cooling	0.0 to 105.0	%



See

F Related parameter

“Manipulated variable display” (advanced function setting level) (p. 5-39)

Operation Level



MV monitor (cool)

The control must be heating and cooling control.
 Manipulated variable display must be set to "ON".

This parameter is for monitoring the manipulated variable on the cooling side during operation.



Function

- During heating and cooling control, the manipulated variable on the cooling side ("OUT 2" terminal output) is monitored.



Monitor

Control	Monitor Range	Unit
Heating and cooling	0.0 to 105.0	%



See

- F Related parameters
- "Standard/heating and cooling" (initial setting level) (p. 5-23)
 - "Manipulated variable display" (advanced function setting level) (p. 5-39)

Adjustment Level

This level is for executing AT (auto-tuning) or setting up the control.

This level provides you with basic controller setup parameters for PID (proportional band, integral time, derivative time) and heating and cooling control.

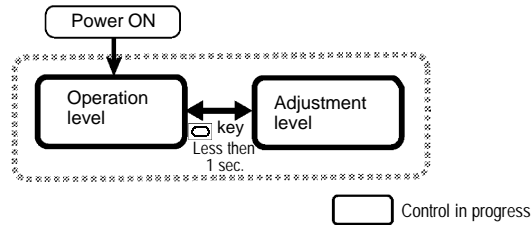

To move to the adjustment level from the operation level, press the key for less than one second.

- The set points 0 to 3 in the adjustment level are set values for switching the set point during multi-SP input.
- Heater current value monitor and HBA detection are displayed when option unit E5EN-VVHV is mounted on the E5EN.
- You can change adjustment level parameters by setting Operation/adjustment protection to “0”. If the protect level is set to “1” to “3”, adjustment level parameters cannot be displayed.

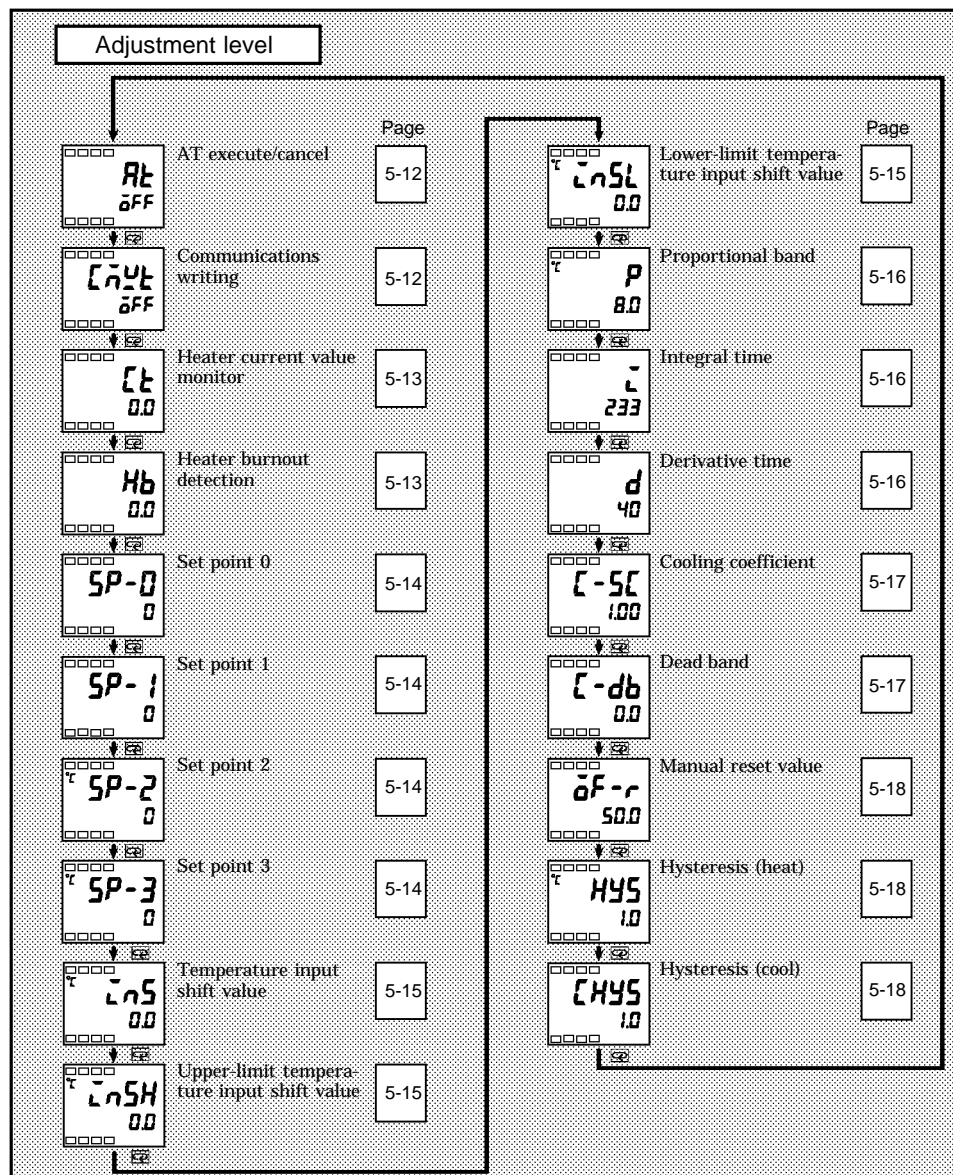

Adjustment Level

AT

AT execute/cancel

The E5EN must be in operation, and control must be 2-PID control.

This parameter executes AT (auto-tuning).





Function

- When auto-tuning is executed the optimum PID parameters “proportional band,” “integral time” and “derivative time” for the set point during program execution are automatically set by forcibly changing the manipulated variable to calculate the characteristics of the control target.



Example of use

- Normally, this parameter is set to “OFF”. If you press the  or  keys, the parameter is turned ON and AT is executed.
AT cannot be executed when control has stopped or during ON/OFF control.
- When AT execution ends, the parameter setting automatically returns to “OFF”.



See

F Related parameters

“Proportional band” “Integral time” “Derivative time” (adjustment level) (p. 5-16)
“PID / ON/OFF” (initial setting level) (p. 5-23)

CAUTION

Communications writing

The communication unit must be mounted on the E5EN.



Function

This parameter enables/disables writing of parameters to the E5EN from the host (personal computer) by communications.



Setting

ON : Writing enabled
OFF : Writing disabled



See

F Related parameters

“Communication unit No.” “Baud rate” “Data bit” “Parity” “Stop bit” (communications setting level) (p. 5-40)

Adjustment Level

ct

Heater current value monitor

The "HBA used" parameter must be set to "ON".

This parameter measures the current value of the heater from current transformer (CT) input to detect heater burnout.



Function

This parameter measures and displays the current value of the heater.



Monitor

Monitor Range	Unit
0.0 to 55.0	A

- "FFFF" is displayed when 55.0A is exceeded.



See

F Related parameters

"Heater burnout detection" (adjustment level) (p. 5-13)

"HBA used" (advanced function setting level) (p. 5-35)

Hb

Heater burnout detection

The "HBA used" parameter must be set to "ON".

This parameter sets the current value for the heater burnout alarm output to become active.



Function

- This parameter outputs the heater burnout alarm when the heater current value falls below this parameter setting.
- When the set value is "0.0", the heater burnout alarm is "OFF". When the set value is "50.0", the heater burnout alarm is "ON".



Setting

Setting Range	Unit	Default
0.0 to 50.0	A	0.0



See

F Related parameters

"HBA used" (advanced function setting level) (p. 5-35)

"Heater current value monitor" (adjustment level) (p. 5-13)

"Heater burnout latch" (advanced function setting level) (p. 5-35)

"Heater burnout hysteresis" (advanced function setting level) (p. 5-35)

Adjustment Level

SP-0 Set point 0

SP-1 Set point 1

SP-2 Set point 2

SP-3 Set point 3

The “number of multi-SP uses” parameter must be set to either “1” or “2”, and the “multi-SP uses” parameter must be set to “ON”.

These parameters set the set points when the multi-SP function is used.

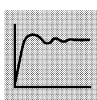

Function

The values set in these parameters can be selected by operating the keys on the front panel or by event input.

- When the set point has been changed, the set value of these parameters currently set by multi-SP is linked and changed.
- During temperature input, the decimal point position is dependent on the selected sensor.

During analog input, the decimal point position is dependent on the setting of the “decimal point position” parameter.



Setting

Setting Range	Unit	Default
Set point lower limit to set point upper limit	EU	0



See

F Related parameters

- “Number of multi-SP uses” (advanced function setting level) (p. 5-28)
- “Event input assignment 1” (advanced function setting level) (p. 5-29)
- “Event input assignment 2” (advanced function setting level) (p. 5-29)
- “Multi-SP uses” (advanced function setting level) (p. 5-30)
- “PV/SP” (operation level) “Input type” (initial setting level) (p. 5-5)
- “Input type” (initial setting level) (p. 5-20)

Adjustment Level

Ln5

Temperature input shift

The “input type” parameter must be set to temperature input excluding a non-contact temperature sensor.

Sometimes an error between the set point and the actual temperature occurs. To offset this, a value obtained by adding an input shift value to the input is displayed as the measurement value and used for control.



Function

The entire input range is shifted by a fixed rate (1-point shift). If the input shift value is set to “-1.0_C”, the set point is controlled to a value obtained by subtracting 1.0_C from the actual temperature.



Setting

Setting Range	Unit	Default
-199.9 to 999.9	_C or _F	0.0



See

F Related parameter

“Input type” (initial setting level) (p. 5-20)

Ln5H

Upper-limit temperature input shift value

The “input type” parameter must be set to only the non-contact temperature sensor.

Ln5L

Lower-limit temperature input shift value

Whereas the entire input range is shifted by a fixed rate (1-point shift) in the “temperature input shift” parameter, the input range is shifted by two points (2-point shift) at the upper and lower limits. 2-point shift enables more accurate offset of the input range compared with 1-point shift, if the input shift values at the upper and lower limits differ.



Function

This parameter sets input shift values for each of the upper and lower limits (2-point shift) of the input range.



Setting

Setting Range	Unit	Default
-199.9 to 999.9	_C or _F	0.0



See

F Related parameter

“Input type” (initial setting level) (p. 5-20)

Adjustment Level

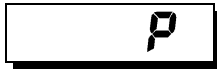

Proportional band

The control must be 2-PID control.

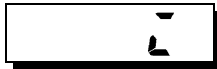

Integral time



Derivative time

This parameter sets the PID parameters. Note that PID is automatically set when AT and ST are executed.

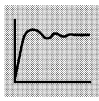

Function

Proportional action : P refers to control in which the MV is proportional to the deviation (control error).

Integral action : I gives a control action that is proportional to the time integral of the control error. With proportional control, there is normally an offset (control error). So, proportional action is used in combination with integral action. As time passes, this control error disappears, and the set point comes to agree with the control temperature (process value).

Derivative action : D gives a control action that is proportional to the time derivative of the control error. As proportional control and integral control correct for errors in the control result, the control system will be late in responding to sudden changes in temperature. Derivative action enables control that is proportional to a predicted process output to correct for future error.

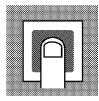

Setting

Parameter	Setting Range	Unit	Default
Proportional band	0.1 to 999.9	EU	8.0
Integral time	0 to 3999	Second	233
Derivative time	0 to 3999	Second	40

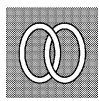

See

F Related parameter

“AT execute/cancel” (adjustment level) (p. 5-12)

Adjustment Level

C-5C

Cooling coefficient

The control must be either heating and cooling control and 2-PID control.

If the heating and cooling characteristics of the control target greatly differ, preventing satisfactory control characteristics from being obtained by the same PID parameters, adjust the proportional band (P) at the cooling side by adding the cooling coefficient to balance control between the heating and cooling sides.



Function

In heating and cooling control, cooling side P is calculated by the following formula to set the cooling coefficient:

$$\text{Cooling side P} = \text{Cooling coefficient} \Phi \text{ P (proportional operation)}$$



Setting

Setting Range	Unit	Default
0.01 to 99.99	None	1.00



See

F Related parameter

“Proportional band” (adjustment level) (p. 5-16)

C-db

Dead band

The control system must be heating and cooling control.

This parameter sets the output dead band width in a heating and cooling control system. A negative setting sets an overlap band.



Function

This parameter sets an area in which the control output is “0” centering around the set point in a heating and cooling control system.



Setting

Setting Range	Unit	Default
-199.9 to 999.9	EU	0.0

Adjustment Level

OF-r

Manual reset value

The control must be standard control and 2-PID control. The “integral time” parameter must be set to “0”.



Function

- This parameter sets the required manipulated variable to remove offset during stabilization of P or PD control.



Setting

Setting Range	Unit	Default
0.0 to 100.0	%	50.0



See

F Related parameters

- “PID / ON/OFF” (initial setting level) (p. 5-23)
- “Integral time” (adjustment level) (p. 5-16)

HYS

Hysteresis (heat)

The control must be ON/OFF control.

[HYS

Hysteresis (cool)

This parameter sets the hysteresis for ensuring stable operation at ON/OFF switching.



Function

- In a standard control, use the “hysteresis (heat)” parameter. The “hysteresis (cool)” parameter cannot be used.
- In a heating and cooling control, the hysteresis can be set independently for heating and cooling. Use the “hysteresis (heat)” parameter to set the heating side hysteresis, and use the “hysteresis (cool)” parameter to set the cooling side hysteresis.



Setting

Setting Range	Unit	Default
0.1 to 999.9	EU	1.0



See

F Related parameter

- “PID / ON/OFF” (initial setting level) (p. 5-23)

Initial Setting Level

This level is for setting up the basic specifications of the E5EN. In this level, you can set the “input type” parameter for selecting the sensor input to be connected to the E5EN, limit the setting range of set points or set the alarm mode.

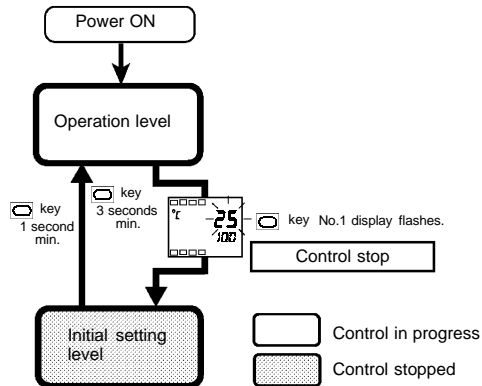

To move from the operation level to the initial setting level, press key for three seconds or more.

- The initial setting level is not displayed when “initial/communications protection” is set to “2”. This initial setting level can be used when “initial setting/communications protection” is set to “0” or “1”.
- The “scaling upper limit”, “scaling lower limit” and “decimal point” parameters are displayed when analog input is selected as the input type.

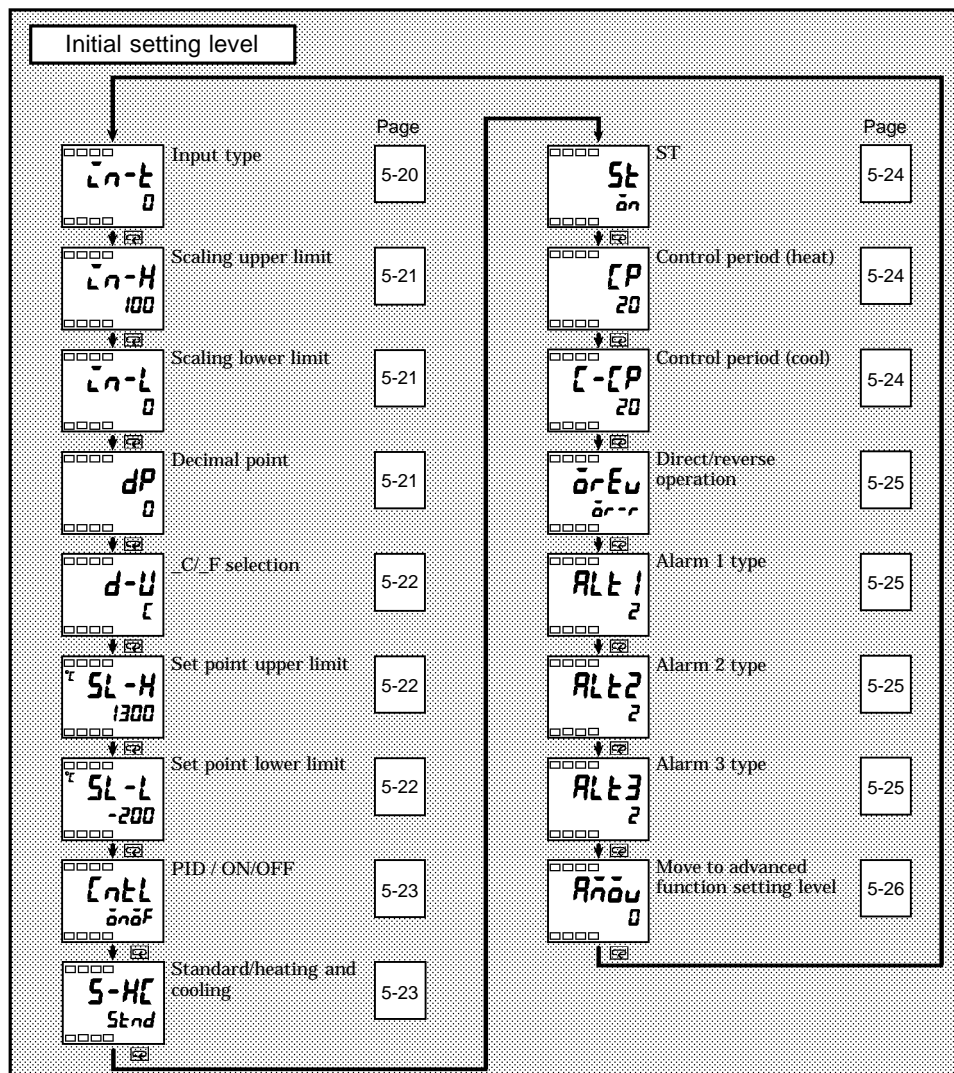

Initial Setting Level

Input type



Function

- This parameter sets the sensor type by a corresponding code.
- When this parameter is changed, the set point upper limit is changed to the default. If the set point limits must be changed, set the “set point upper limit” and “set point lower limit” parameters (initial setting level).



Setting

- Set the code according to the following table. Shaded ranges indicate default settings.
Platinum resistance thermometer : “0”: platinum resistance thermometer pt100
Thermocouple : “0”: K thermocouple

	Input type	Name	Set Value	Input Temperature Range
Platinum resistance thermometer	Platinum resistance thermometer	Pt100	0	-200 to 850 (_C) / -300 to 1500 (_F)
			1	-199.9 to 500.0 (_C) / -199.9 to 900.0 (_F)
			2	0.0 to 100.0 (_C) / 0.0 to 210.0 (_F)
		JPt100	3	-199.9 to 500.0 (_C) / -199.9 to 900.0 (_F)
			4	0.0 to 100.0 (_C) / 0.0 to 210.0 (_F)

	Input type	Name	Set Value	Input Temperature Range
Thermocouple input type	Thermocouple	K	0	-200 to 1300 (_C) / -300 to 2300 (_F)
			1	-20.0 to 500.0 (_C) / 0.0 to 900.0 (_F)
		J	2	-100 to 850 (_C) / -100 to 1500 (_F)
			3	-20 to 400.0 (_C) / 0.0 to 750.0 (_F)
			4	-200 to 400 (_C) / -300 to 700 (_F)
		E	5	0 to 600 (_C) / 0 to 1100 (_F)
		L	6	-100 to 850 (_C) / -100 to 1500 (_F)
		U	7	-200 to 400 (_C) / -300 to 700 (_F)
		N	8	-200 to 1300 (_C) / -300 to 2300 (_F)
		R	9	0 to 1700 (_C) / 0 to 3000 (_F)
		S	10	0 to 1700 (_C) / 0 to 3000 (_F)
	B	11	100 to 1800 (_C) / 300 to 3200 (_F)	
	Non-contact temperature sensor ES1A	K10 to 70_C	12	0 to 90 (_C) / 0 to 190 (_F)
		K60 to 120_C	13	0 to 120 (_C) / 0 to 240 (_F)
		K115 to 165_C	14	0 to 165 (_C) / 0 to 320 (_F)
		K160 to 260_C	15	0 to 260 (_C) / 0 to 500 (_F)
Analog input	0 to 50mV	16	One of following ranges depending on the results of scaling: -1999 to 9999, -199.9 to 999.9,	



See

F Related parameters

“_C/_F selection” “Set point upper limit” “Set point lower limit” (initial setting level) (p. 5-22)

Initial Setting Level

Ln-H

Scaling upper limit

The input type must be set to analog input.

Ln-L

Scaling lower limit

dP

Decimal point



Function

- These parameters can be used when voltage input is selected as the input type.
- When voltage input is selected as the input type, scaling is carried out. Set the upper limit in the “scaling upper limit” parameter and the lower limit in the “scaling lower limit” parameter.
- The “decimal point” parameter specifies the decimal point position of parameters (set point, etc.) whose unit is set to EU.



Setting

- Scaling upper limit, Scaling lower limit

Parameter	Setting Range	Unit	Default
Scaling upper limit	Scaling lower limit +1 to 9999	None	100
Scaling lower limit	-1999 to scaling upper limit -1	None	0

- Decimal point: Default is “0: 0 digits past decimal point”

Set value	Setting	Example
0	0 digits past decimal point	1234
1	1 digit past decimal point	123.4



See

F Related parameter

“Input type” (initial setting level) (p. 5-20)

Initial Setting Level

d-U

_C/_F selection

The input type must be set to temperature input.



Function

- Set the temperature input unit to either of “_C” or “_F”.



Setting

Setting Range	Default
Ⓛ : _C / Ⓧ : _F	Ⓛ



See

- F Related parameter
 “Input type” (initial setting level) (p. 5-20)

SL-H

Set point upper limit

SL-L

Set point lower limit



Function

- This parameter limits the upper and lower limits when the SP is set. The SP can be set within the range defined by the upper and lower limit set values in the “set point upper limit” and “set point lower limit” parameters. The existing SP settings that are out of the range are forcibly changed to one of the upper or lower limit values (whichever is closest).
- When the temperature input type and temperature unit have been changed, the set point upper limit and set point lower limit are forcibly changed to the upper and lower limits of the sensor.
- During temperature input, the decimal point position is dependent on the currently selected sensor. During analog input, it is dependent on the “decimal point” parameter setting.



Setting

Parameter	Setting Range	Unit	Default
Set point upper limit	Set point lower limit +1 to sensor range upper limit	EU	1300
	Platinum resistance thermometer	EU	850
Set point lower limit	Sensor range lower limit to set point upper limit -1	EU	-200



See

- F Related parameters
 “Input type” (p. 5-20) “_C/_F selection” (initial setting level) (p. 5-22)

Initial Setting Level

EntL

PID / ON/OFF



Function

- This parameter selects 2-PID control or ON/OFF control.
- The AT and ST tuning functions can be used in 2-PID control.



Setting

Setting Range	Default
$P\bar{L}d$: 2-PID / $\bar{O}n\bar{O}F$: ON/OFF	$\bar{O}n\bar{O}F$



See

F Related parameters

- “AT execute/cancel” (p. 5-12) “Manual reset” “Hysteresis (heat)” “Hysteresis (cool)” (adjustment level) (p. 5-18)
- “ST stable range” (advanced function setting level) (p. 5-36)

S-HC

Standard/heating and cooling

The E5EN must support alarm 3 output.



Function

- This parameter selects standard control or heating and cooling control.
- When heating and cooling control is selected, the alarm 3 output terminal “ALM3” is used for cooling side output. Therefore, alarm 3 cannot be used.



Setting

Setting Range	Default
$S\bar{t}nd$: Standard / $H-C$: Heating and cooling	$S\bar{t}nd$



See

F Related parameters

- “MV monitor (heat)” “MV monitor (cool)” (operation level) (p. 5-9, 10)
- “Alarm value” (p. 5-7) “Upper-limit alarm value 3” “Lower-limit alarm value 3” (operation level) (p. 5-9)
- “Hysteresis (cool)” (p. 5-18) “Cooling coefficient” “Dead band” (p. 5-17) (adjustment level)
- “Control period (cool)” (initial setting level) (p. 5-24)
- “Alarm 3 type” (initial setting level) (p. 5-25)
- “Alarm 3 hysteresis” (p. 5-34) “Alarm 3 open in alarm” (p. 5-34) (advanced function setting level)

Initial Setting Level

St

ST self-tuning

The control must be set to temperature input, standard control and 2-PID control.



Function

- The ST (self-tuning) function executes tuning from the start of program execution to calculate PID constants matched to the control target. When the ST function is in operation, be sure to turn the power supply of the load connected to the control output ON simultaneously with or before starting operation of the E5EN.



Setting

Parameter	Setting Range	Unit	Default
ST	$\bar{0}FF$: ST function OFF / $\bar{0}n$: ST function ON	None	$\bar{0}FF$



See

F Related parameters

“ST stable range” (advanced function setting level) (p. 5-36)

“Input type” (p. 5-20) “PID / ON/OFF” (p. 5-23) (initial setting level)

CP

Control period (heat)

The control must be set to 2-PID control.

C-CP

Control period (cool)



Function

- This parameter sets the output period. Set the control period taking the control characteristics and the electrical life expectancy of the relay into consideration.
- In a standard control system, use the “control period (heat)” parameter. The “control period (cool)” parameter cannot be used.
- Whenever control output 1 is the current output, “control period (heat)” cannot be used.
- In a heating and cooling control system, the control period can be set independently for heating and cooling. Use the “control period (heat)” parameter to set the heating side control period, and use the “control period (cool)” parameter to set the cooling side control period.



Setting

Parameter	Setting Range	Unit	Default
Control period (heat)	1 to 99	Second	20
Control period (cool)	1 to 99	Second	20



See

F Related parameter

“PID / ON/OFF” (initial setting level) (p. 5-23)

Initial Setting Level

0rEw

Direct/reverse operation



Function

- “Direct operation” refers to control where the manipulated variable is increased according to the increase in the process value. Alternatively, “reverse operation” refers to control where the manipulated variable is increased according to the decrease in the process value.



Setting

Setting Range	Default
0r-r : Reverse operation/0r-d : Direct operation	0r-r

ALt1

Alarm 1 type

The alarm 1 type must be supported.



Function

- Select one of the following alarm 1 types:
Deviation/Deviation range/Absolute value



Setting

Refer to the alarm 2, 3 type list on the following page.



See

F Related parameters

- “Alarm value 1” (operation level) (p. 5-7)
- “Upper-limit alarm value 1” “Lower-limit alarm value 1” (operation level) (p. 5-8)
- “Standby sequence reset method” (p. 5-31) “Alarm 1 open in alarm” “Alarm 1 hysteresis” (p. 5-32) (advanced function setting level)

ALt2

Alarm 2 type

The alarm 2, 3 type must be supported.
The control must be set to standard control.

ALt3

Alarm 3 type



Function

- Select one of the following alarm 2, 3 types:
Deviation/Deviation range/Absolute value

Initial Setting Level



Set Value	Alarm Type	Alarm Output Operation	
		When X is positive	When X is negative
0	Alarm function OFF	Output OFF	
*1 1	Upper- and lower-limit (deviation)	ON OFF	*2
2	Upper-limit (deviation)	ON OFF	ON OFF
3	Lower-limit (deviation)	ON OFF	ON OFF
*1 4	Upper- and lower-limit range (deviation)	ON OFF	*3
*1 5	Upper- and lower-limit with standby sequence (deviation)	ON OFF	*4
6	Upper-limit with standby sequence (deviation)	ON OFF	ON OFF
7	Lower-limit with standby sequence (deviation)	ON OFF	ON OFF
8	Absolute-value upper-limit	ON OFF	ON OFF
9	Absolute-value lower-limit	ON OFF	ON OFF
10	Absolute-value upper-limit with standby sequence	ON OFF	ON OFF
11	Absolute-value lower-limit with standby sequence	ON OFF	ON OFF

*1 : The upper- and lower-limit values, expressed as "L" and "H", can be set independently for each alarm point with set values 1, 4 and 5.

*2 : Set value : 1 Upper- and lower-limit alarm

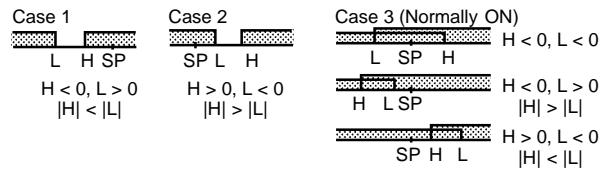

*3 : Set value : 4 Upper- and lower-limit range

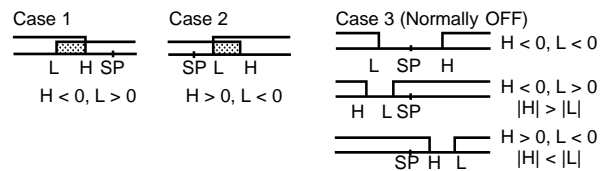

*4 : Set value : 5 Upper- and lower-limit alarm with standby sequence

- *For the above upper- and lower-limit alarm
- In cases 1 and 2, the alarm is normally OFF if upper- and lower-limit values of hysteresis overlap.
- In case 3, the alarm is normally OFF.

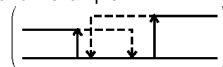

- Alarm types are set independently for each alarm in the "alarm 1 to 3 type" parameters (initial setting level). Default is "2: Upper-limit alarm".



See

F Related parameters

"Alarm value 2, 3" (operation level) (p. 5-7)

"Upper-limit alarm value 2, 3" "Lower-limit alarm value 2, 3" (operation level) (p. 5-8, 9)

"Standby sequence reset method" (p. 5-31) "Alarm 2, 3 open in alarm" "Alarm 2, 3 hysteresis" (p. 5-33, 34) (advanced function setting level)

Advanced Function Setting Level

This level is for using the E5EN to its maximum. To move to this level, input the password (“-169”) in the “initial setting level”.

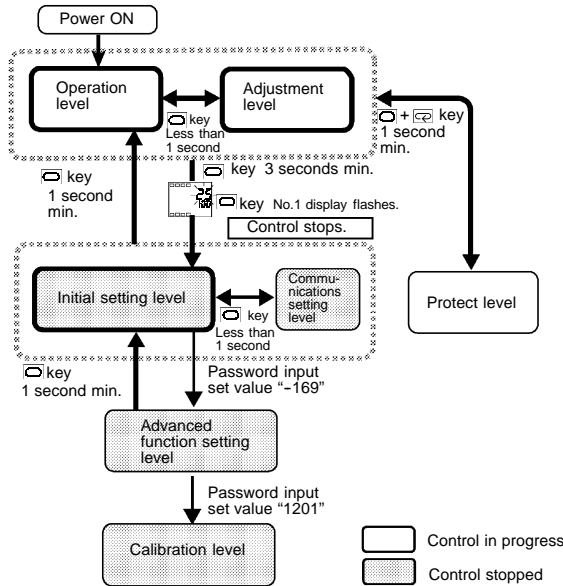

- The parameters in this level can be used when “initial setting/communications protection” is set to “0”.
- The “move to calibration level” can be moved to by entering the password (“1201”).

Advanced function setting level		Page	Advanced function setting level		Page	Advanced function setting level		Page
Parameter initialize	[Display]	5-28	Alarm 2 open in alarm	[Display]	5-33	Alarm 2 hysteresis	[Display]	5-33
Number of multi-SP uses	[Display]	5-28	Alarm 2 hysteresis	[Display]	5-33	Alarm 3 open in alarm	[Display]	5-34
Event input assignment 1	[Display]	5-29	Alarm 3 open in alarm	[Display]	5-34	Alarm 3 hysteresis	[Display]	5-34
Event input assignment 2	[Display]	5-29	Alarm 3 hysteresis	[Display]	5-34	HBA used	[Display]	5-35
Multi-SP uses	[Display]	5-30	HBA used	[Display]	5-35	Heater burnout latch	[Display]	5-35
SP ramp set value	[Display]	5-30	Heater burnout latch	[Display]	5-35	Heater burnout hysteresis	[Display]	5-35
Standby sequence reset method	[Display]	5-31	Heater burnout hysteresis	[Display]	5-35	ST stable range	[Display]	5-36
Alarm 1 open in alarm	[Display]	5-32	ST stable range	[Display]	5-36	Move to calibration level	[Display]	6-2
Alarm 1 hysteresis	[Display]	5-32						
			Alarm 2 open in alarm	[Display]	5-33	MV upper limit	[Display]	5-37
			Alarm 2 hysteresis	[Display]	5-33	MV lower limit	[Display]	5-37
			Alarm 3 open in alarm	[Display]	5-34	Input digital filter	[Display]	5-38
			Alarm 3 hysteresis	[Display]	5-34	Additional PV display	[Display]	5-38
			HBA used	[Display]	5-35	Manipulated variable display	[Display]	5-39
			Heater burnout latch	[Display]	5-35	Automatic return of display mode	[Display]	5-39
			Heater burnout hysteresis	[Display]	5-35			
			ST stable range	[Display]	5-36			

Advanced Function Setting Level

E5EN

Parameter initialize



Function

This parameter returns parameter settings to their defaults.



Setting

ON : Initializes all parameters.

OFF : Turns the E5EN OFF after returning parameter settings to their defaults.

E5EN

Number of Multi-SP

The option event input unit must be mounted in the E5EN.

Uses



Function

“Multi-SP” is a function for setting set points 0 to 3 in advance, and selecting these set points by a combination of event inputs 1 and 2.

The “number of multi-SP uses” parameter is used when the number of preset set points is 2 or 4. This parameter determines display or non-display of the “event input assignment 1” and “event input assignment 2” parameters.



Setting

The “number of multi-SP uses” displays which functions are assigned to event inputs 1 and 2.

Number of Multi-SP Uses	Event Input 1 Function	Event Input 2 Function
0	Set in “event input assignment 1”	Set in “event input assignment 2”
1	Multi-SP (SP 0/1 selectable)	Set in “event input assignment 2”
2	Multi-SP (SP 0/1/2/3 selectable)	

- Default : 1

Multi-SP can be used when the option event input unit is mounted on the E5EN, and the “number of multi-SP uses” is set to “1” or “2”.

- When the number of multi-SP uses is set to “1”

Event input 1	Selected Set Point
OFF	Set point 0
ON	Set point 1

Advanced Function Setting Level

- When the number of multi-SP uses is set to “2”

Event input 1	Event input 2	Selected Set Point
OFF	OFF	Set point 0
ON	OFF	Set point 1
OFF	ON	Set point 2
ON	ON	Set point 3

- * Event input can be used when the option event input unit E5EN-VV/VHB is mounted in the E5EN. Select event input ON/OFF while the E5EN is turned ON. Judgment of event input ON/OFF is carried out on event inputs of 50 ms or more.



See

F Related parameters

- “Event input assignment 1” (advanced function setting level) (p. 5-29)
- “Event input assignment 2” (advanced function setting level) (p. 5-29)
- “Multi-SP uses” (advanced function setting level) (p. 5-30)
- “Set point 0 to 3” (adjustment level) (p. 5-14)

E_U-1

Event input assignment 1

The number of multi-SP uses must be set to “0” or “1”.

E_U-2

Event input assignment 2



Function

- The following functions are assigned as event input 1 or event input 2:
“Run/stop”



Setting

Settings	Function
nōnE	None
StōP	RUN/STOP

- Default is “nōnE” for event input assignment 1 and “StōP” for event input assignment 2.



See

F Related parameters

- “Set point 0 to 3” (adjustment level) (p. 5-14)
- “Number of multi-SP uses” (advanced function setting level) (p. 5-28)

Advanced Function Setting Level



Multi-SP uses

The “number of multi-SP uses” parameter must be set to “0” on models on which the option event input unit is not mounted.



Function

When the “multi-SP uses” parameter is set to “ON”, you can select set points 0 to 3 by operating the keys on the front panel of the controller.

When the option event input unit E53-CNHB is mounted on the E5GN, this parameter can be used when the “number of multi-SP uses” parameter is set to “0” and “multi-SP uses” is set to ON.



Setting

$\bar{0}n$: Set points 0 to 3 can be selected.

$\bar{0}FF$: Set points 0 to 3 can be not selected.

- Default : OFF



See

F Related parameters

“Multi-SP” (operation level) (p. 5-5)

“Number of Multi-SP uses” (advanced function setting level) (p. 5-28)



SP ramp set value

ST (self-tuning) must be set to “OFF”.



Function

- This parameter specifies the change rate during SP ramp operation. Set the maximum permissible change width per unit of time (minute) as the “SP ramp set value”. However, note, that when the “SP ramp set value” is set to “OFF”, the SP ramp function is disabled.

- During temperature input, the decimal point position of the SP ramp set value is dependent on the currently selected sensor, and during analog input it is dependent on scaling.



Setting

Parameter	Setting Range	Unit	Default
SP ramp set value	OFF, 1 to 9999	EU	OFF



See

F Related parameters

“Input type” (p. 5-20) “Scaling upper limit” “Scaling lower limit” (p. 5-21) “Decimal point” “ST” (p. 5-24) (initial setting level)

Advanced Function Setting Level



Standby sequence reset method

The alarm 1 to 3 type must be set to “with standby sequence.”

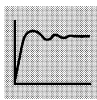

Function

- This parameter selects the conditions for enabling reset after the standby sequence of the alarm has been canceled.
- Condition A:
Control started (including power ON), and set point, alarm value (upper/lower-limit alarm value) or input shift value (upper/lower-limit temperature input shift value) changed
- Condition B:
Power ON
- The following example shows the reset action when the alarm type is lower-limit alarm with standby sequence.

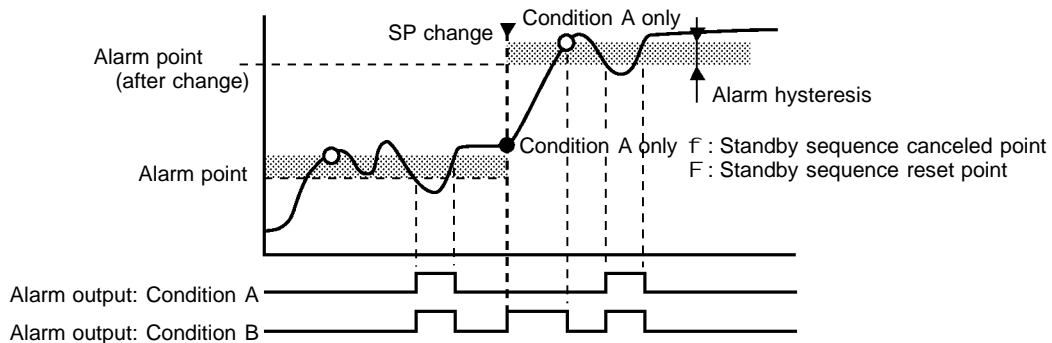

Setting

Setting Range	Default
A : Condition A / b : Condition B	A



See

F Related parameters

“Alarm 1 to 3 type” (initial setting level) (p. 5-25)

Advanced Function Setting Level

AL In

Alarm 1 open in alarm

Alarm 1 function must be supported.

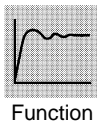

- This parameter sets the output states of alarm 1.
- When the E5EN is set to “close in alarm,” the status of the alarm output function is normally open. When set to “open in alarm,” the status of the alarm output is output inverted normally, or closed. The following table shows the relationship between alarm output functions, alarm output and output LCDs.



	Alarm Output Function	Alarm Output	Output LCDs
Close in alarm	ON	ON	Lit
	OFF	OFF	Out
Open in alarm	ON	OFF	Lit
	OFF	ON	Out

Setting Range	Default
$n-\bar{0}$: Close in alarm / $n-\bar{1}$: Open in alarm	$n-\bar{0}$



- F Related parameters
- “Alarm value 1” (p. 5-7) “Upper-limit alarm value 1” “Lower-limit alarm value 1” (p. 5-8)(operation level)
 - “Alarm 1 type” (p. 5-25) “Standard/heating and cooling” (p. 5-23) (initial setting level)
 - “Alarm 1 hysteresis” (p. 5-32) “Standby sequence reset method” (p. 5-31) (advanced function setting level)

ALH 1

Alarm 1 hysteresis

Alarm 1 function must be supported.

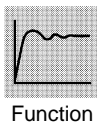

- This parameter sets the hysteresis of alarm output 1.



Setting Range	Unit	Default
0.1 to 999.9	EU	0.2



- F Related parameters
- “Alarm value 1” (p. 5-7) “Upper-limit alarm value 1” “Lower-limit alarm value 1” (p. 5-8) (operation level)
 - “Alarm 1 type” (p. 5-25) “Standard/heating and cooling” (p. 5-23) (initial setting level)
 - “Alarm 1 open in alarm” (p. 5-32) “Standby sequence reset method” (p. 5-31) (advanced function setting level)

Advanced Function Setting Level

AL2n

Alarm 2 open in alarm

Alarm 2 function must be supported.

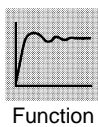

- This parameter sets the output states of alarm 2.
- When the E5EN is set to “close in alarm,” the status of the alarm output function is normally open. When set to “open in alarm,” the status of the alarm output function is output inverted normally closed. The following table shows the relationship between alarm output functions, alarm output and output LCDs.



	Alarm Output Function	Alarm Output	Output LCDs
Close in alarm	ON	ON	Lit
	OFF	OFF	Out
Open in alarm	ON	OFF	Lit
	OFF	ON	Out

Setting Range	Default
n-0 : Displayed / n-1 : Not displayed	n-0

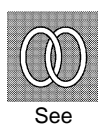

F Related parameters

“Alarm value 2” (p. 5-7) “Upper-limit alarm value 2” “Lower-limit alarm value 2” (p. 5-8) (operation level)

“Alarm 2 type” (initial setting level) (p. 5-25)

“Alarm 2 hysteresis” (p. 5-33) “Standby sequence reset method” (p. 5-31) (advanced function setting level)

ALH2

Alarm 2 hysteresis

Alarm 2 function must be supported.

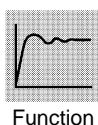

- This parameter sets the hysteresis of alarm output 2.



Setting Range	Unit	Default
0.1 to 999.9	EU	0.2

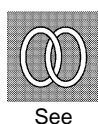

F Related parameters

“Alarm value 2” (operation level) (p. 5-7)

“Upper-limit alarm value 2” “Lower-limit alarm value 2” (operation level) (p. 5-8)

“Alarm 2 type” (p. 5-25) (initial setting level)

“Alarm 2 open in alarm” (p. 5-33) “Standby sequence reset method” (p. 5-31) (advanced function setting level)

Advanced Function Setting Level

AL3n

Alarm 3 open in alarm

Alarm 3 function must be supported.
Control must be set to standard control.

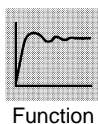

- This parameter sets the output states of alarm 3.
- When the E5EN is set to “close in alarm,” the status of the alarm output function is normally open. When set to “open in alarm,” the status of the alarm output is output inverted normally, or closed. The following table shows the relationship between alarm output functions, alarm output and output LCDs.



	Alarm Output Function	Alarm Output	Output LCDs
Close in alarm	ON	ON	Lit
	OFF	OFF	Out
Open in alarm	ON	OFF	Lit
	OFF	ON	Out

Setting Range	Default
n-0 : Close in alarm / n-1 : Open in alarm	n-0

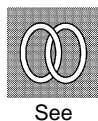

- F Related parameters
- “Alarm value 3” (p. 5-7) “Upper-limit alarm value 3” “Lower-limit alarm value 3” (p. 5-9)(operation level)
 - “Alarm 3 type” (p. 5-25) “Standard/heating and cooling” (p. 5-23) (initial setting level)
 - “Alarm 3 hysteresis” (p. 5-34) “Standby sequence reset method” (p. 5-31) (advanced function setting level)

ALH3

Alarm 3 hysteresis

Alarm 3 function must be supported.
Control must be set to standard control.

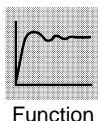

- This parameter sets the hysteresis of alarm output 3.



Setting Range	Unit	Default
0.1 to 999.9	EU	0.2

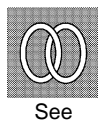

- F Related parameters
- “Alarm value 3” (operation level) (p. 5-7)
 - “Upper-limit alarm value 3” “Lower-limit alarm value 3” (operation level) (p. 5-9)
 - “Alarm 3 type” (p. 5-25) (initial setting level) (p.5-23)
 - “Alarm 3 open in alarm” (p. 5-34) “Standby sequence reset method” (p. 5-31) (advanced function setting level)

Advanced Function Setting Level

HbU

HBA used

The option input unit E5EN-VVHVV must be mounted on the E5EN.



Function

- This parameter sets use of the heater burnout alarm.
- This parameter can be used when option input unit E5EN-VVHVV is mounted on the E5EN.



Setting

Setting Range	Default
$\bar{0}n$: Enabled / $\bar{0}FF$: Disabled	$\bar{0}n$

HbL

Heater burnout latch

The “HBA used” parameter must be set to “ON”.



Function

- When this parameter is set to ON, the heater burnout alarm is held until either of the following conditions is satisfied:
 - Heater burnout detection is set to “0.0A”.
 - The power is turned OFF then back ON again (power is reset).



Setting

Setting Range	Default
$\bar{0}n$: Enabled / $\bar{0}FF$: Disabled	$\bar{0}FF$



See

- F Related parameter
 “HBA used” (advanced function setting level) (p. 5-35)

HbH

Heater burnout hysteresis

The “heater burnout latch” parameter must be set to OFF.



Function

- This parameter sets the hysteresis when HBA is detected.



Setting

Setting Range	Unit	Default
0.1 to 50.0	A	0.1



See

- F Related parameter
 “HBA used” (advanced function setting level) (p. 5-35)

Advanced Function Setting Level

St-6

ST stable range

The control must be set to temperature input, standard control, PID control, and ST set to "ON".



Function

- This parameter sets the set value for determining the conditions under which ST (self-tuning) occurs. This parameter cannot be used when the "ST" parameter is set to "OFF".



Setting

Setting Range	Unit	Default
0.1 to 999.9	_C or _F	15.0



See

F Related parameters

"PID / ON/OFF" (initial setting level) (p. 5-23)

"Input type" (initial setting level) (p. 5-20)

"ST" (initial setting level) (p. 5-24)

ALFA

α

The control must be 2-PID control, and the "ST" parameter must be set to "OFF".



Function

- Normally, use this parameter at its default.
- This parameter sets 2-PID-constant α .



Setting

Setting Range	Unit	Default
0.00 to 1.00	None	0.65



See

F Related parameters

"PID / ON/OFF" (initial setting level) (p. 5-23)

"ST" (initial setting level) (p. 5-24)

Advanced Function Setting Level

OL-H

MV upper limit

The control must be 2-PID control, and the "ST" parameter must be set to "OFF".

OL-L

MV lower limit

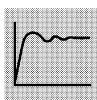

Function

- The "MV upper limit" and "MV lower limit" parameters set the upper and lower limits of the manipulated variable. When the manipulated variable calculated by the E5EN exceeds the upper or lower limit value, the upper or lower limit set becomes the output level.

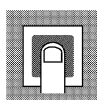

Setting

- MV upper limit
The setting ranges during standard control and heating and cooling control are different.
The manipulated variable at the cooling side during heating and cooling control is expressed as a negative value.

Control Method	Setting Range	Unit	Default
Standard	MV lower limit +0.1 to 105.0	%	105.0
Heating and cooling	0.0 to 105.0	%	105.0

- MV lower limit
The setting ranges during standard control and heating and cooling control are different.
The manipulated variable at the cooling side during heating and cooling control is expressed as a negative value.

Control Method	Setting Range	Unit	Default
Standard	-5.0 to MV upper limit -0.1	%	-5.0
Heating and cooling	-105.0 to 0.0	%	-105.0



See

- F Related parameters
- "PID / ON/OFF" (initial setting level) (p. 5-23)
 - "ST" (initial setting level) (p. 5-24)

Advanced Function Setting Level

INF

Input digital filter



Function

- Sets the time constant of the input digital filter. The following figure shows the effect on data after passing through the digital filter:

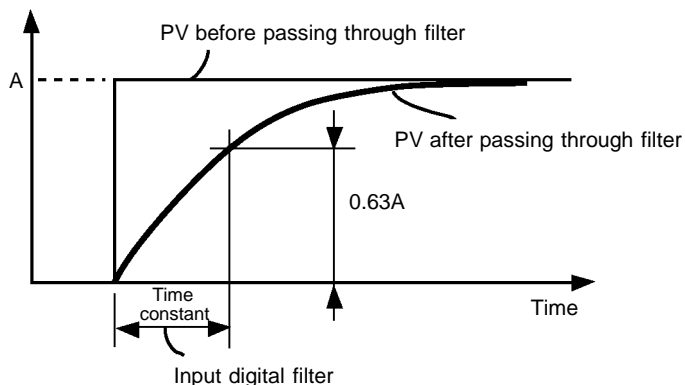

Setting

Setting Range	Unit	Default
0.0 to 999.9	Second	0.0

PvPd

Additional PV display



Function

- This parameter adds the facility of displaying only the PV. It is added to the top of the operation level. It is used to give the option of displaying the PV and SP or just the PV only.



Setting

Setting Range	Default
$\bar{0}n$: Displayed / $\bar{0}FF$: Not displayed	OFF

Advanced Function Setting Level

̄-dP

Manipulated variable display



Function

This parameter displays the manipulated variable.

The manipulated variable is displayed when the “manipulated variable monitor (heat and cool)” parameters are set to “ON”, and not displayed when these parameters are set to “OFF”.



Setting

Setting Range	Default
̄on : Displayed / ̄FF : Not displayed	OFF

rEt

Automatic return of display mode



Function

- If any of the keys on the front panel for the time set by this parameter in the “operation level” and “adjustment level” are not operated, the display automatically returns to the PV/SP display.
- This function is disabled (display does not change automatically) when this parameter is set to “OFF”.



Setting

Setting Range	Unit	Default
OFF, 1 to 99	Second	OFF

Communications Setting Level

U-nō

Communications unit No.

Communications function must be supported.

bPS

Baud rate

LEn

Communications data length

Sbĭt

Communications stop bit

P-rĭy

Communications parity

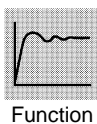

- Each parameter is enabled when the power is reset.
- Match the communications specifications of the E5EN and the host computer. If a 1 : N connection is being used, ensure that the communications specifications for all devices in the system (except “Communications unit No.”) are the same.



Parameter	Displayed Characters	Set Value	Setting Range
Communications unit No.	U-nō	0, 1 to 99	0 to 99
Baud rate	bPS	1.2 / 2.4 / 4.8 / 9.6 / 19.2 (kbps)	1.2 / 2.4 / 4.8 / 9.6 / 19.2 (kbps)
Communications data length	LEn	7 / 8 (bit)	7 / 8 (bit)
Communications stop bit	Sbĭt	1 / 2	1 / 2
Communications parity	P-rĭy	none / even / odd	None / even / odd

Highlighted characters indicate defaults.



F Related parameters

“Communications writing” (adjustment level) (p. 5-12)

CHAPTER 6

CALIBRATION

6.1	Parameter Structure	6-2
6.2	User Calibration	6-3
6.3	Calibrating Thermocouples	6-4
6.4	Calibrating Analog Input	6-7
6.5	Calibrating Platinum Resistance Thermometers	6-8
6.6	Checking Indication Accuracy	6-9

6.1 Parameter Structure

- To calibrate the E5EN, enter the password “1201” at the “move to calibration level” parameter in the “advanced function setting level”. “Ad” is displayed.
- However, note that the “move to calibration level” parameter might not be displayed when, for example, the user is calibrating the E5EN for the first time. If this happens, set the “initial/communications protection” parameter in the protect level to “0” before moving to the “advanced function setting level”.
- The parameters in the calibration level are structured as follows:

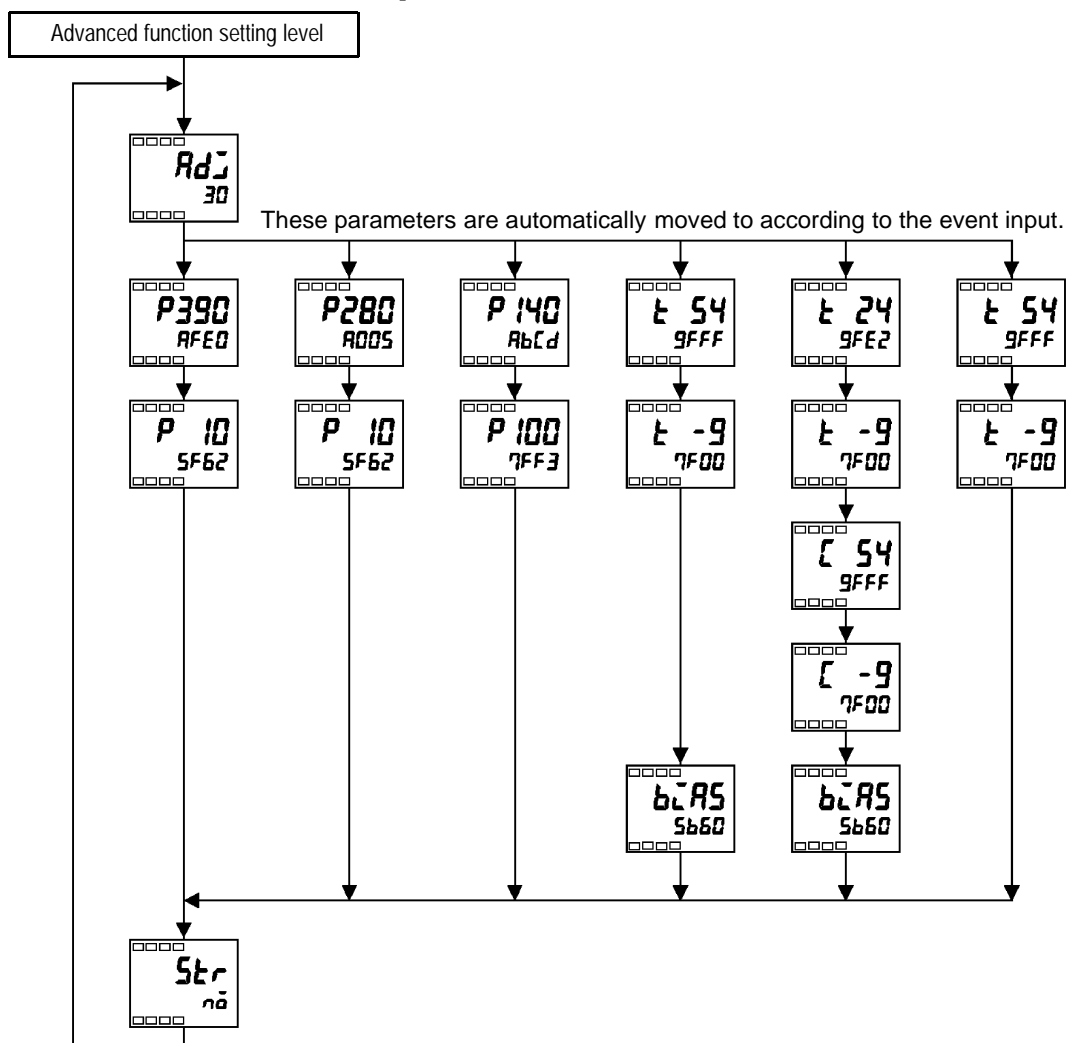

Once the user has calibrated the E5EN, a dot will be displayed when the calibration level is moved to, to indicate that the E5EN has already been calibrated by the user.

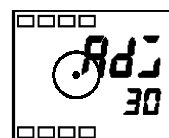

Dot is displayed.

6.2 User Calibration

The E5EN is correctly calibrated before it is shipped from the factory, and normally need not be calibrated by the user.

If, however, it must be calibrated by the user, use the parameters for calibrating temperature input and analog input.

However, note that OMRON cannot ensure the results of calibration by the user.

Also, calibration data is overwritten with the latest settings. The default calibration settings cannot be returned to after user calibration.

F Calibrating input

When the user calibrates the E5EN, the input type currently selected in parameters is calibrated. The following 22 input types can be calibrated.

- Thermocouple : 12 types
- Non-contact temperature sensor : 4 type
- Analog input : 1 type
- Platinum resistance thermometer : 5 types

F Registering calibration data

The new calibration data for each item is temporarily registered. It can be officially registered as calibration data only when all items have been calibrated to new values. Therefore, be sure to temporarily register all items when you calibrate the E5EN.

When calibration data is registered, it is registered regardless of whether or not the E5EN has been calibrated by the user.

Prepare separate measuring devices and equipment for calibration. For details on how to handle measuring devices and equipment, refer to the respective instruction manuals.

6.3 Calibrating Thermocouples

- Calibrate according to the type of thermocouple, thermocouple 1 group (input types 0, 2, 5, 6, 8) and thermocouple 2 group (input types 1, 3, 4, 7, 9, 10, 11, 12, 13, 14, 15).
- When calibrating, do not cover the bottom of the E5EN. Also, do not touch the input terminals (Nos. 17 and 18) or compensating conductor on the E5EN.

F Preparations

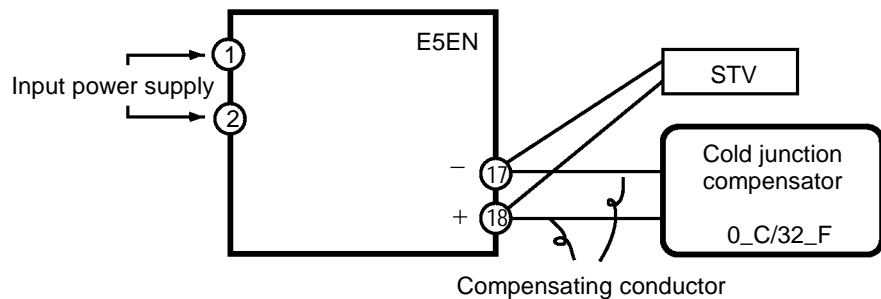

- Set the cold junction compensator designed for compensation of internal thermocouples to 0_C. However, make sure that internal thermocouples are disabled (tips are open).
- In the above figure, STV refers to a standard DC current/voltage source.
- Use the compensating conductor designed for the selected thermocouple. However, note that when thermocouples R, S, E, B or a non-contact temperature sensor is used, the cold junction compensator and the compensating conductor can be substituted with the cold junction compensator and the compensating conductor for thermocouple K.



Connecting the Cold Junction Compensator

Correct process values cannot be obtained if you touch the contact ends of the compensating conductor during calibration of a thermocouple. Accordingly, short-circuit (enable) or open (disable) the tip of the thermocouple inside the cold junction compensator as shown in the figure below to create a contact or non-contact state for the cold junction compensator.

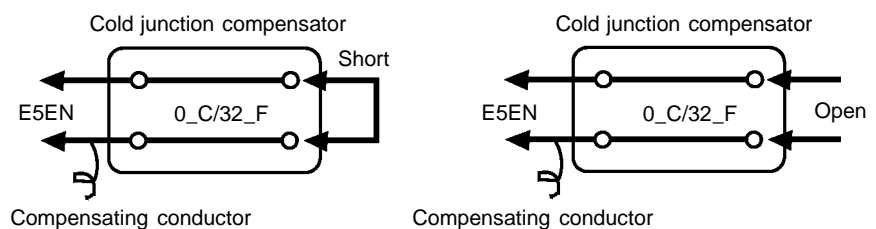

This example describes how to calibrate the E5EN when thermocouple input is currently selected on an E5EN supporting thermocouple input.

- (1) Connect the power supply.
- (2) Connect a standard DC current/voltage source (STV), precision digital multimeter (DMM) and contact junction compensator (e.g. zero controller as in figure) to the thermocouple input terminals, as shown in the figure below.

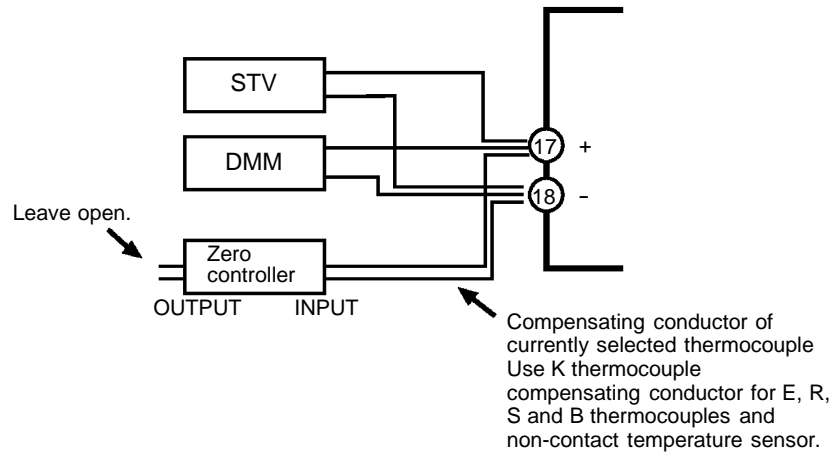

- (3) Turn the power ON.
- (4) Move to the calibration level.

This starts the 30-minute aging timer. This timer provides an approximate timer for aging. After 30 minutes, the No.2 display changes to "0". You can advance to the next step in this procedure even if "0" is not displayed.

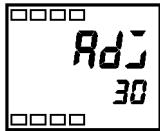

Input type 0, 2, 5, 6, 8

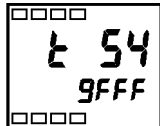

Input type, 1, 3, 4, 7, 9, 10, 11, 12, 13, 14, 15

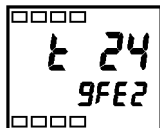

- (5) Press the key to set the E5EN to the state on the left.

The No.2 display at this time displays the currently entered count value entered in Hexadecimal. Set the STV as follows:

- Input types 0, 2, 5, 6, 8 : Set to "54 mV".
- Input types 1, 3, 4, 7, 9, 10, 11, 12, 13, 14, 15: Set to "24 mV".

Allow the count value on the No.2 display to fully stabilize, then press the key to temporarily register the calibration setup.

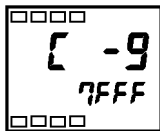
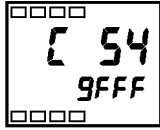
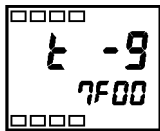

- (6) Press the key to set the E5EN to the state on the left. Set STV to “-9mV”. Allow the count value on the No.2 display to fully stabilize, then press the key to temporarily register the calibration setup.
- (7) Press the key. The No.2 display changes to the state on the left when the input type is 1, 3, 4, 7, 9, 10, 11, 12, 13, 14 or 15.
- (8) Set STV to “54mV”. Allow the count value on the No.2 display to fully stabilize, then press the key to temporarily register the calibration setup.
- (9) Press the key. The No.2 display changes to the state on the left when the input type is 1, 3, 4, 7, 9, 10, 11, 12, 13, 14 or 15. Set STV to “-9mV”.
- (10) Allow the count value on the No.2 display to fully stabilize, then press the key to temporarily register the calibration setup.
- (11) Press the key to set the E5EN to the state on the left.
- (12) Change the wiring as follows:

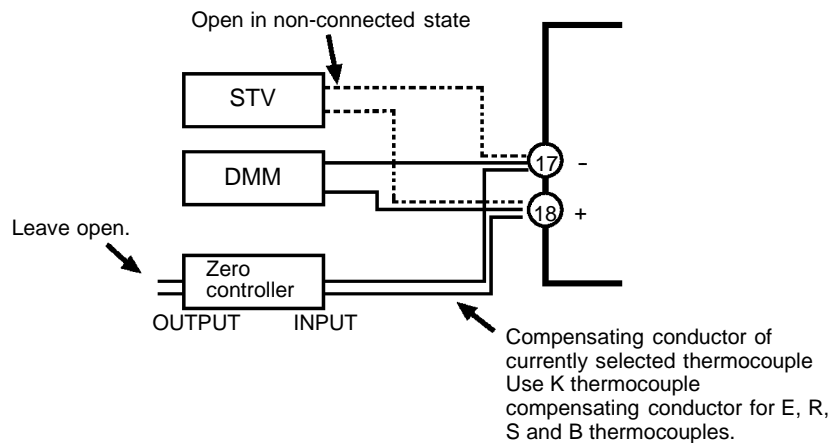

Disconnect the STV to enable the thermocouple of the cold junction compensator. When doing this, be sure to disconnect the wiring on the STV side.

- (13) Allow the count value on the No.2 display to fully stabilize, then press the key to temporarily register the calibration setup.
- (14) Press the key. The No.2 display changes to the state on the left. Note that the data to be temporarily registered is not displayed when it is not entirely prepared. Press the key. The No.2 display changes to “YES”. Release the key and wait two seconds or press the key. This stores the temporarily registered calibration data to EEPROM. Data will not be stored to memory if you press the key with “no” displayed on the No.2 display.
- (15) The calibration mode is quit by turning the power OFF.

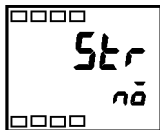

6.4 Calibrating Analog Input

This example describes how to calibrate when 0 to 50 mV input (input type 16) is currently selected on an E5EN supporting thermocouple input.

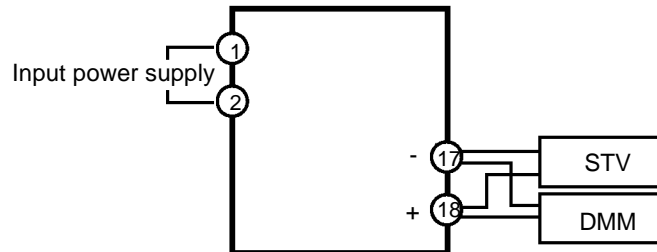

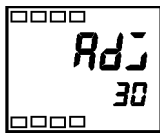

- (1) Connect the power supply.
- (2) Connect an STV and DMM to the analog input terminals, as shown in the figure above.
- (3) Turn the power ON.
- (4) Move to the calibration level.



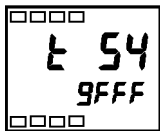

This starts the 30-minute aging timer. This timer provides an approximate timer for aging. After 30 minutes, the No.2 display changes to "0". It can be advanced to the next step in this procedure even if "0" is not displayed.



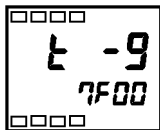



- (5) Press the  key to set the E5EN to the state on the left. The No.2 display at this time displays the currently entered count value entered in Hexadecimal. Set the STV to "54mV".
- (6) Allow the count value on the No.2 display to fully stabilize, then press the  key to temporarily register the calibration setup.



- (7) Press the  key to set the E5EN to the state on the left. Set STV to "-9mV".
- (8) Allow the count value on the No.2 display to fully stabilize, then press the  key to temporarily register the calibration setup.



- (9) Press the  key. The No.2 display changes to the state on the left. Note that the data to be temporarily registered is not displayed when it is not entirely prepared. Press the  key. The No.2 display changes to "YES". Release the key and wait two seconds or press the  key. This stores the temporarily registered calibration data to EEPROM. Data will not be stored to memory if you press the  key with "no" displayed on the No.2 display.

- (10) The calibration mode is quit by turning the power OFF.

6.5 Calibrating Platinum Resistance Thermometers

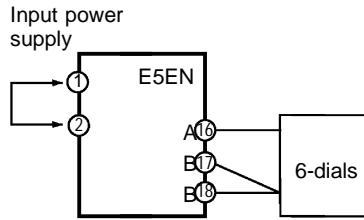

This example describes how to calibrate the E5EN when it is connected to a platinum resistance thermometer.

When calibrating a platinum resistance thermometer use wires of the same thickness as those used to connect the E5EN.

- (1) Connect the power supply.
- (2) Connect a precision resistance box (called “6-dial” in this manual) to the platinum resistance thermometer input terminals.
- (3) Turn the power ON.
- (4) Move to the calibration level. This starts the 30-minute aging timer. This timer provides an approximate timer for aging. After 30 minutes, the No.2 display changes to “0”. You can advance to the next step in this procedure even if “0” is not displayed.
- (5) Press the key to display the count value for each input type. The No.2 display at this time displays the currently entered count value entered in Hexadecimal. Set the 6-dial as follows:
 - Input type 0: 390 Ω
 - Input type 1 or 3: 280 Ω
 - Input type 2 or 4: 140 Ω
- (6) Allow the count value on the No.2 display to fully stabilize, then press the key to temporarily register the calibration setup.
- (7) Press the key to set the E5EN to the state on the left. Set the 6-dial as follows:
 - Input type 0: 10 Ω
 - Input type 1 or 3: 10 Ω
 - Input type 2 or 4: 100 Ω
- (8) Allow the count value on the No.2 display to fully stabilize, then press the key to temporarily register the calibration setup.
- (9) Press the key. The No.2 display changes to the state on the left. Note that the data to be temporarily registered is not displayed when it is not entirely prepared. Press the key. The No.2 display changes to “YES”. Release the key and wait two seconds or press the key. This stores the temporarily registered calibration data to EEPROM. Data will not be stored to memory if you press the key with “no” displayed on the No.2 display.
- (10) The calibration mode is quit by turning the power OFF.

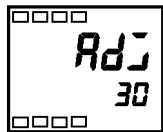

Input type 0



Input types 1, 3



Input types 2, 4

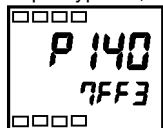

Input type 0

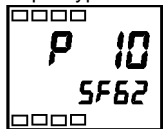

Input types 1, 3

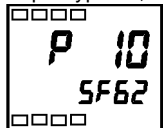

Input types 2, 4

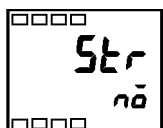

6.6 Checking Indication Accuracy

- After calibrating input, be sure to check indication accuracy to make sure that the E5EN has been correctly calibrated.
- Operate the E5EN in the PV/SP monitor mode.
- Check the indication accuracy at the upper and lower limits and mid-point.

F Thermocouple or non-contact temperature sensor

• Preparation

The following figure shows the required device connection. Make sure that the E5EN and cold junction compensator are connected by a compensating conductor for the thermocouple that is to be used during actual operation. For the non-contact temperature sensor, connect a K thermocouple, and set the input type to the K thermocouple.

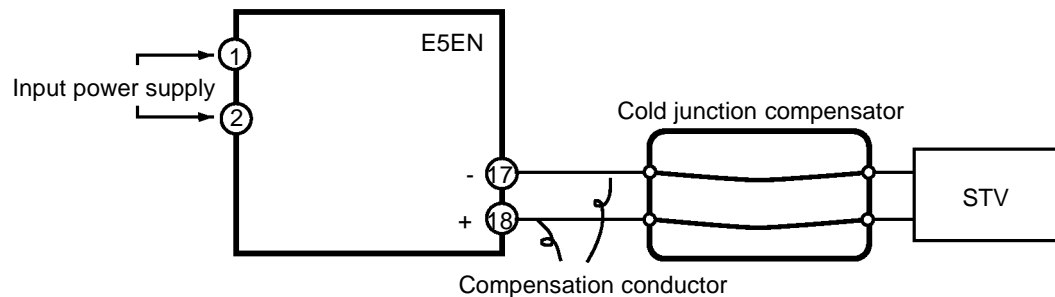

• Operation

Make sure that the cold junction compensator is at 0_C, and set STV output to the voltage equivalent to the starting power of the check value.

F Analog input

• Preparation

The following figure shows the required device connection:

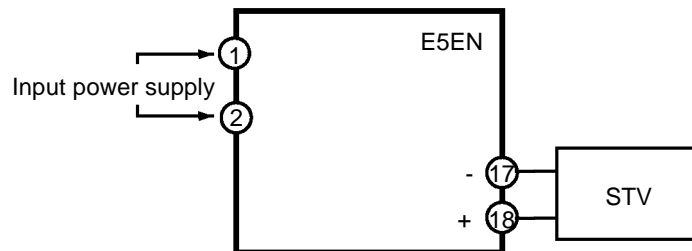

• Operation

Set the STV to the voltage equivalent to the check value.

F Platinum resistance thermometer

• Preparation

The following figure shows the required device connection:

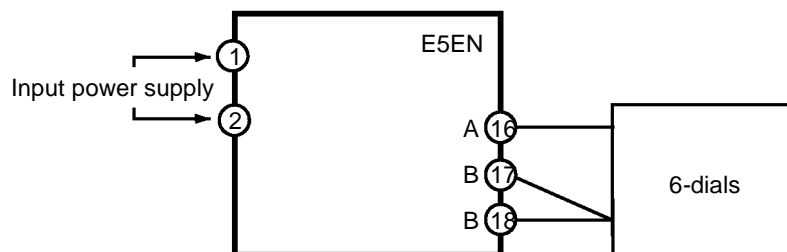

• Operation

Set the 6-dial to the resistance equivalent to the check value.

APPENDIX

SPECIFICATIONS	A-2
Ratings	A-2
Characteristics	A-3
CURRENT TRANSFORMER (CT)	A-4
ERROR DISPLAY	A-5
PARAMETER OPERATIONS LIST	A-7
SENSOR INPUT SETTING AND INDICATION RANGES	A-10
SETUP LEVELS DIAGRAM	A-11
PARAMETER FLOW	A-12

SPECIFICATIONS

J Ratings

Supply voltage	100 to 240 VAC, 50/60 Hz	24 VAC, 50/60 Hz/24 VDC
Operating voltage range	85 to 110% of rated supply voltage	
Power consumption	9VA	5VA/4W
Sensor input	Thermocouple : K, J, T, E, L, U, N, R, S, B Platinum resistance thermometer: Pt100, JPt100 Non-contact temperature sensor : K10 to 70_C, K60 to 120_C, K115 to 165_C, K160 to 260_C Voltage input: 0 to 50 mV	
Control output	Relay output	1a AC 250V 5A (resistive load), electrical life : 100,000 operations
	Voltage output (PNP)	DC 12V $\pm 15\%$ FS, max. load current 21mA DC 12V $\pm 20\%$ FS, max. load current 40mA With short circuit protection circuit.
	Current output	DC 4-20mA load 600 Ω max. resolution approx.2,600
Alarm output	SPST-NO, 250 VAC, 3A (resistive load), electrical life: 100,000 operations	
Control method	2-PID or ON/OFF control	
Setting method	Digital setting using front panel keys	
Indication method	7-segment digital display and single-lighting indicator	
Other functions	According to controller model	
Ambient temperature	-10 to 55_C (with no condensation or icing)	
Ambient humidity	Relative humidity 25 to 85%	
Storage temperature	-25 to 65_C (with no condensation or icing)	

* For the setting ranges for each sensor input, see page A-10.

F HBA

Max. heater current	Single-phase AC 50 A
Input current readout accuracy	$\pm 5\%$ FS ± 1 digit max.
Heater burnout alarm setting range	0.1 to 49.9 A (0.1 A units) 0.0 A : Heater burnout alarm output turns OFF. 50.0 A : Heater burnout alarm output turns ON.
Min. detection ON time	190ms

*1 When the control output ON time is less than 190 ms, heater burnout detection and heater current measurement are not carried out.

J Characteristics

Indication accuracy	Thermocouple: ($\pm 0.5\%$ of indication value or $\pm 1_{\text{C}}$, whichever is greater) ± 1 digit max. (*1) Platinum resistance thermometer: ($\pm 0.5\%$ of indication value or $\pm 1_{\text{C}}$, whichever is greater) ± 1 digit max. Analog input: $\pm 5\%FS \pm 1$ digit max. CT input: $\pm 5\%FS \pm 1$ digit max.	
Hysteresis	0.1 to 999.9EU (in units of 0.1EU)	
Proportional band (P)	0.1 to 999.9EU (in units of 0.1EU)	
Integral time (I)	0 to 3999 (in units of 1 second)	
Derivative time (D)	0 to 3999 (in units of 1 second)	
Control period	1 to 99 (in units of 1 second)	
Manual reset value	0.0 to 100.0% (in units of 0.1%)	
Alarm setting range	-1999 to 9999 (decimal point position dependent on input type)	
Sampling period	500 ms	
Insulation resistance	20 M Ω min. (by 500 VDC megger)	
Dielectric strength	2000 VAC 50 or 60 Hz 1min	
Vibration resistance	10 to 55 Hz, 1.0 G for 10 min. each in X, Y and Z directions	
Shock resistance	Max. 30.6 G, 3 times each in 3 axes, 6 directions (relay: 10.2 G)	
Weight	Approx. 260 g	Adapter: approx. 100g, Terminal cover : approx. 20g
Protective structure	Front panel: NEMA4 for indoor use (equivalent to IP66), Rear case: IP20, terminals: IP00	
Memory protection	EEPROM (non-volatile memory) (number of writes: 100,000)	

*1 The indication of K thermocouples in the -200 to 1300 $_{\text{C}}$ range, T and N thermocouples at a temperature of -100 $_{\text{C}}$ or less, and U and L thermocouples at any temperature is $\pm 2_{\text{C}} \pm 1$ digit maximum. The indication of B thermocouples at a temperature of 400 $_{\text{C}}$ or less is unrestricted.
The indication of R and S thermocouples at a temperature of 200 $_{\text{C}}$ or less is $\pm 3_{\text{C}} \pm 1$ digit maximum.

CURRENT TRANSFORMER (CT)

F Specifications

Item	Specifications	
Model	E54-CT1	E54-CT3
Max. continuous current	50A	120A (*1)
Dielectric strength	1000 VAC (1 minute)	
Vibration resistance	50 Hz 98m/S ²	
Weight	Approx. 11.5 g	Approx. 50 g
Accessory	None	Armature (2) Plug (2)

*1 The maximum continuous current of the E5EN is 50 A.

F External dimensions

E54-CT1

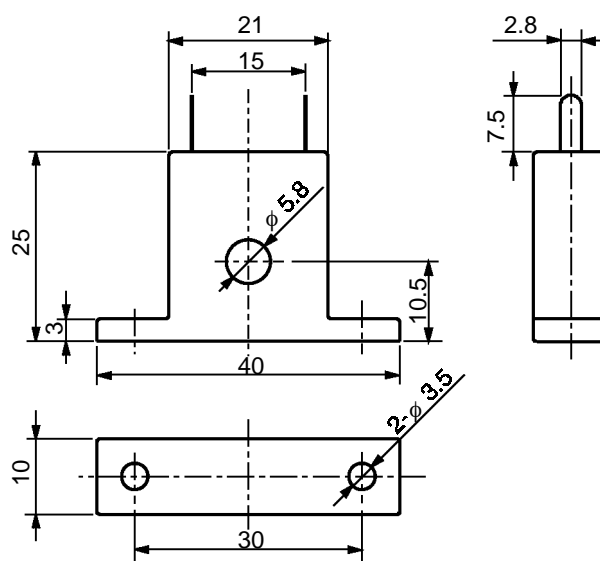

E54-CT3

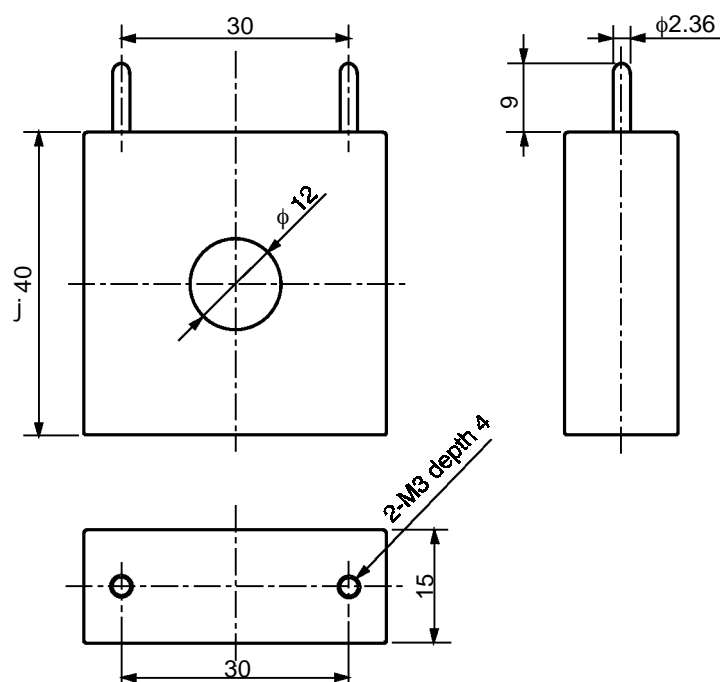

**HB error****F Meaning**

Internal circuits are in error.

F Action



First, turn the power OFF then back ON again. If the display remains the same, the E5EN must be replaced. If the display is restored, then a probable cause can be electrical noise affecting the control system. Check for electrical noise.

F Operation at error

Control output functions turn OFF. An error message is displayed when “process value” or “PV/SP” are displayed.

**Display range over****F Meaning**

Though this is not an error, this is displayed when the process value exceeds the display range when the control range is larger than the display range (-1999 (-199.9) to 9999 (999.9)).

- When less than “-1999 (-199.9)” 
- When larger than “9999 (999.9)” 

F Action

Control continues, allowing normal operation. An error message is displayed when “process value” or “PV/SP” are displayed.

**Current value exceeds****F Meaning**

This error is displayed when the heater current value exceeds “55.0A”.

F Action

Control continues, allowing normal operation. An error message is displayed when “heater current value monitor” is displayed.

PARAMETER OPERATIONS LIST

Operation level

Parameter Name	Symbol	Setting (monitor) Value	Display	Default	Unit	Set Value
PV		Sensor input indication range			EU	
PV/SP		SP lower limit to SP upper limit		0	EU	
Multi-SP	$\bar{n}-SP$	0 to 3		0	None	
Set point during SP ramp	$SP-\bar{n}$	SP lower limit to SP upper limit			EU	
Heater current value monitor	ζt	0.0 to 55.0			A	
Run/stop	$r-s$	Run/stop	$rUn, StOP$	Run	None	
Alarm value 1	$AL-1$	-1999 to 9999		0	EU	
Upper-limit alarm value 1	$AL1H$	-1999 to 9999		0	EU	
Lower-limit alarm value 1	$AL1L$	-1999 to 9999		0	EU	
Alarm value 2	$AL-2$	-1999 to 9999		0	EU	
Upper-limit alarm value 2	$AL2H$	-1999 to 9999		0	EU	
Lower-limit alarm value 2	$AL2L$	-1999 to 9999		0	EU	
Alarm value 3	$AL-3$	-1999 to 9999		0	EU	
Upper-limit alarm value 3	$AL3H$	-1999 to 9999		0	EU	
Lower-limit alarm value 3	$AL3L$	-1999 to 9999		0	EU	
MV monitor (heat)	δ	-5.0 to 105.0 (standard) 0.0 to 105.0 (heating and cooling)			%	
MV monitor (cool)	$\zeta-\delta$	0.0 to 105.0			%	

Adjustment level

Parameter Name	Symbol	Setting (monitor) Value	Display	Default	Unit	Set Value
AT execute/cancel	At	ON, OFF	\bar{on}, \bar{OFF}	\bar{OFF}	None	
Communications writing	ζnYt	ON, OFF	\bar{on}, \bar{OFF}	\bar{OFF}	None	
Heater current value monitor	ζt	0.0 to 55.0			A	
Heater burnout detection	Hb	0.0 to 50.0		0	A	
Set point 0	$SP-0$	SP lower limit to upper limit		0	EU	
Set point 1	$SP-1$	SP lower limit to upper limit		0	EU	
Set point 2	$SP-2$	SP lower limit to upper limit		0	EU	
Set point 3	$SP-3$	SP lower limit to upper limit		0	EU	
Temperature input shift	ζnS	-199.9 to 999.9		0.0	_C or _F	
Upper-limit temperature input shift value	ζnSH	-199.9 to 999.9		0.0	_C or _F	
Lower-limit temperature input shift value	ζnSL	-199.9 to 999.9		0.0	_C or _F	
Proportional band	P	0.1 to 999.9		8.0	EU	
Integral time	ζ	0 to 3999		233	Second	
Derivative time	d	0 to 3999		40	Second	
Cooling coefficient	$\zeta-S\zeta$	0.01 to 99.99		1.00	None	
Dead band	$\zeta-db$	-199.9 to 999.9		0.0	EU	
Manual reset value	$\bar{OF}-r$	0.0 to 100.0		50.0	%	
Hysteresis (heat)	HYS	0.1 to 999.9		1.0	EU	
Hysteresis (cool)	ζHYS	0.1 to 999.9		1.0	EU	

Initial Setting Level

Parameter Name	Symbol	Setting (monitor) Value	Display	Default	Unit	Set Value	
Input type *	I n - t	Platinum resistance thermometer 0 : Pt100 1 : Pt100 2 : Pt100 3 : JPt100 4 : JPt100		0	None		
		Thermocouple 0 : K 1 : K 2 : J 3 : J 4 : T 5 : E 6 : L 7 : U 8 : N 9 : R 10 : S 11 : B		0	None		
		Non-contact temperature sensor 12 : K10 to 70_C 13 : K60 to 120_C 14 : K115 to 165_C 15 : K160 to 260_C					
		Analog input 16 : 0 to 50mA					
Scaling upper limit	I n - H	Scaling lower limit +1 to 9999		100	None		
Scaling lower limit	I n - L	-1999 to scaling upper limit -1		0	None		
Decimal point	d P	0,1		0	None		
Temperature unit	d - U	_C, _F	C , F	_C	None		
Set point upper limit	S L - H	SP lower limit +1 to input range lower value (temperature)		1300	EU		
		SP lower limit +1 to scaling upper limit (analog)		1300	EU		
Set point lower limit	S L - L	Input range lower limit to SP upper limit -1 (temperature)		-200	EU		
		Scaling lower limit to SP upper limit -1 (analog)		-200	EU		
PID / ON/OFF	I n t l	2-PID, ON/OFF	P i d , o n o f f	ON/OFF	None		
Standard/heating and cooling	S - H C	Standard, heating and cooling	S t a n d , H - C	Standard	None		
ST	S t	ON, OFF	o n , o f f	ON	None		
Control period (heat)	C P	1 to 99		20	Second		
Control period (cool)	C - C P	1 to 99		20	Second		
Direct/reverse operation	o r e u	Direct operation, reverse operation	o r - d , o r - r	Reverse operation	None		
Alarm 1 type	A L t 1	0: Alarm function OFF 1: Upper- and lower-limit alarm 2: Upper-limit alarm 3: Lower-limit alarm 4: Upper- and lower-limit range 5: Upper- and lower-limit alarm with standby sequence 6: Upper-limit alarm with standby sequence 7: Lower-limit alarm with standby sequence 8: Absolute-value upper-limit alarm 9: Absolute-value lower-limit alarm 10: Absolute-value upper-limit alarm with standby sequence 11: Absolute-value lower-limit alarm with standby sequence		2	None		
Alarm 2 type	A L t 2	Same as alarm 1 type		2	None		
Alarm 3 type	A L t 3	Same as alarm 1 type		2	None		
Move to advanced function setting level	A n o u	-1999 to 9999		0	None		

Advanced function setting level

Parameter Name	Symbol	Setting (monitor) Value	Display	Default	Unit	Set Value
Parameter initialize	$\bar{c}n\bar{c}t$	ON, OFF	$\bar{o}n, \bar{o}ff$	OFF	None	
Number of multi-SP uses	$\bar{E}u-\bar{n}$	0 to 2		1	None	
Event input assignment 1	$\bar{E}u-1$	None, run/stop	$n\bar{o}nE, St\bar{o}P$	None	None	
Event input assignment 2	$\bar{E}u-2$	None, run/stop	$n\bar{o}nE, St\bar{o}P$	RUN/STOP	None	
Multi-SP uses	$\bar{n}SPU$	ON, OFF	$\bar{o}n, \bar{o}ff$	OFF	None	
SP ramp set value	$SPr\bar{t}$	OFF, 1 to 9999	$\bar{o}ff, 1$ to 9999	OFF	EU	
Standby sequence reset method	$rESt$	Condition A, Condition B	A, b	Condition A	None	
Alarm 1 open in alarm	$ALIn$	Open in alarm/Close in alarm	$n-\bar{o}, n-\bar{c}$	Open in alarm	None	
Alarm 1 hysteresis	$ALH1$	0.1 to 999.9		0.2	EU	
Alarm 2 open in alarm	$AL2n$	Open in alarm/Close in alarm	$n-\bar{o}, n-\bar{c}$	Open in alarm	None	
Alarm 2 hysteresis	$ALH2$	0.1 to 999.9		0.2	EU	
Alarm 3 open in alarm	$AL3n$	Open in alarm/Close in alarm	$n-\bar{o}, n-\bar{c}$	Open in alarm	None	
Alarm 3 hysteresis	$ALH3$	0.1 to 999.9		0.2	EU	
HBA used	HbU	ON, OFF	$\bar{o}n, \bar{o}ff$	ON	None	
Heater burnout latch	HbL	ON, OFF	$\bar{o}n, \bar{o}ff$	OFF	None	
Heater burnout hysteresis	HbH	0.1 to 50.0		0.1	A	
ST stable range	$St-b$	0.1 to 999.9		15.0	_C or _F	
α	$ALFA$	0.00 to 1.00		0.65	None	
MV upper limit	$\bar{o}L-H$	MV lower limit +0.1 to 105.0 (standard) 0.0 to 105.0 (heating and cooling)		105.0 105.0	% %	
MV lower limit	$\bar{o}L-L$	-5.0 to MV upper limit -0.1 (standard) -105.0 to 0.0 (heating and cooling)		-5.0 -105.0	% %	
Input digital filter	$\bar{c}nF$	0.1 to 999.9		0.0	Second	
Additional PV display	$PURd$	ON, OFF	$\bar{o}n, \bar{o}ff$	OFF	None	
Manipulated variable display	$\bar{o}-dP$	ON, OFF	$\bar{o}n, \bar{o}ff$	OFF	None	
Automatic return of display mode	rEt	OFF, 1 to 9999	$\bar{o}ff, 1$ to 9999	OFF	Second	
Move to calibration level	$\bar{c}\bar{n}\bar{o}u$	-1999 to 9999		0	None	

Protect level

Parameter Name	Symbol	Setting (monitor) Value	Display	Default	Unit	Set Value
Operation/adjustment protection	$\bar{o}RPt$	0 to 3		0	None	
Initial setting/communications protection	$\bar{c}LPt$	0 to 2		1	None	
Setup change protection	$yLPt$	ON, OFF	$\bar{o}n, \bar{o}ff$	OFF	None	

Communications Setting Level

Parameter Name	Symbol	Setting (monitor) Value	Display	Default	Unit	Set Value
Communication unit No.	$U-n\bar{o}$	0 to 99		1	None	
Baud rate	bPS	1.2, 2.4, 4.8, 9.6, 19.2	$1.2, 2.4, 4.8, 9.6, 19.2$	9.6	kbps	
Data bit	LEn	7, 8		7	bit	
Stop bit	$Sb\bar{c}t$	1, 2		2	bit	
Parity	$Pr\bar{t}y$	None, Even, Odd	$n\bar{o}nE, E, O, odd$	Even	None	

SENSOR INPUT SETTING AND INDICATION RANGES

	Input type	Specifications	Set Value	Input Temperature Range	Input Indication Range
Platinum resistance thermometer input type	Platinum resistance thermometer	Pt100	0	-200 to 850 (°C) / -300 to 1500 (°F)	-200 to 870 (°C) / -340 to 1540 (°F)
			1	-199.9 to 500.0 (°C) / -199.9 to 900.0 (°F)	-199.9 to 520 (°C) / -199.9 to 940 (°F)
			2	0.0 to 100.0 (°C) / 0.0 to 210.0 (°F)	-20 to 120 (°C) / -40 to 250 (°F)
		JPt100	3	-199.9 to 500.0 (°C) / -199.9 to 900.0 (°F)	-199.9 to 520 (°C) / -199.9 to 940 (°F)
			4	0.0 to 100.0 (°C) / 0.0 to 210.0 (°F)	-20 to 120 (°C) / -40 to 250 (°F)

	Input type	Specifications	Set Value	Input Temperature Range	Input Indication Range
Thermocouple input type	Thermocouple	K	0	-200 to 1300 (°C) / -300 to 2300 (°F)	-220 to 1320 (°C) / -340 to 2340 (°F)
			1	-20.0 to 500.0 (°C) / 0.0 to 900.0 (°F)	-40 to 520 (°C) / -40 to 940 (°F)
		J	2	-100 to 850 (°C) / -100 to 1500 (°F)	-120 to 870 (°C) / -140 to 1540 (°F)
			3	-20.0 to 400.0 (°C) / 0.0 to 750.0 (°F)	-40 to 420 (°C) / -40 to 790 (°F)
		T	4	-200 to 400 (°C) / -300 to 700 (°F)	-220 to 420 (°C) / -340 to 740 (°F)
		E	5	0 to 600 (°C) / 0 to 1100 (°F)	-20 to 620 (°C) / -40 to 1140 (°F)
		L	6	-100 to 850 (°C) / -100 to 1500 (°F)	-120 to 870 (°C) / -140 to 1540 (°F)
		U	7	-200 to 400 (°C) / -300 to 700 (°F)	-220 to 420 (°C) / -340 to 740 (°F)
		N	8	-200 to 1300 (°C) / -300 to 2300 (°F)	-220 to 1320 (°C) / -340 to 2340 (°F)
		R	9	0 to 1700 (°C) / 0 to 3000 (°F)	-20 to 1720 (°C) / -40 to 3040 (°F)
		S	10	0 to 1700 (°C) / 0 to 3000 (°F)	-20 to 1720 (°C) / -40 to 3040 (°F)
	B	11	100 to 1800 (°C) / 300 to 3200 (°F)	0 to 1820 (°C) / 0 to 3240 (°F)	
	Non-contact temperature sensor ES1A	K10 to 70_°C	12	0 to 90 (°C) / 0 to 190 (°F)	-20 to 130 (°C) / -40 to 270 (°F)
		K60 to 120_°C	13	0 to 120 (°C) / 0 to 240 (°F)	-20 to 160 (°C) / -40 to 320 (°F)
		K115 to 165_°C	14	0 to 165 (°C) / 0 to 320 (°F)	-20 to 205 (°C) / -40 to 400 (°F)
		K160 to 260_°C	15	0 to 260 (°C) / 0 to 500 (°F)	-20 to 300 (°C) / -40 to 580 (°F)
Analog input	0 to 50mV	16	One of following ranges depending on the results of scaling: -1999 to 9999, -199.9 to 999.9	-5 to 105% of the setting range (However, -1999 to 9999 or -199.9 to 999.9 is displayed)	

- “O” is the default for both input types.
- The applicable standards for each of the above input ranges are as follows:
 - K, J, T, E, N, R, S, B : JIS C1602-1995, IEC 584-1
 - L : Fe-CuNi, DIN 43710-1985
 - U : Cu-CuNi, DIN 43710-1985
 - JPt100 : JIS C 1604-1989, JIS C 1606-1989
 - Pt100 : JIS C 1604-1997 IEC 751

SETUP LEVELS DIAGRAM

The following diagram shows an overview of the setup levels on the E5EN. To move to the advanced function setting level and calibration level, you must enter passwords. Some parameters are not displayed depending on the protect level setting and the conditions of use. Control stops when you move from the operation level to the initial setting level.

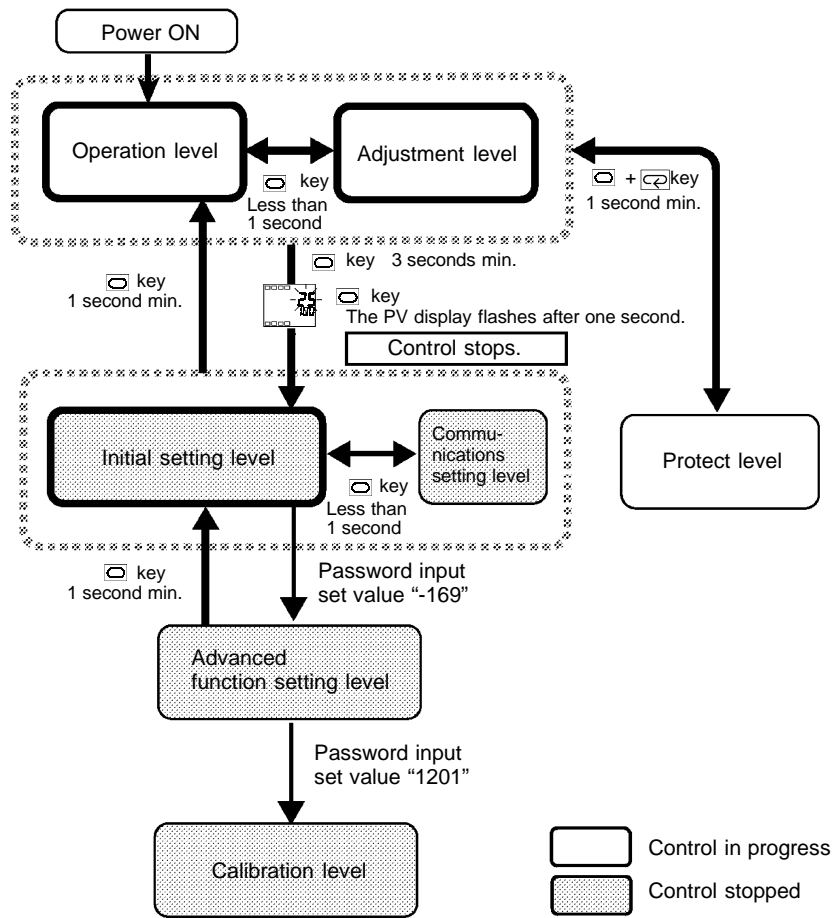

PARAMETER FLOW

- If you press the mode key at the last parameter in each level, you return to the top parameter in that level.

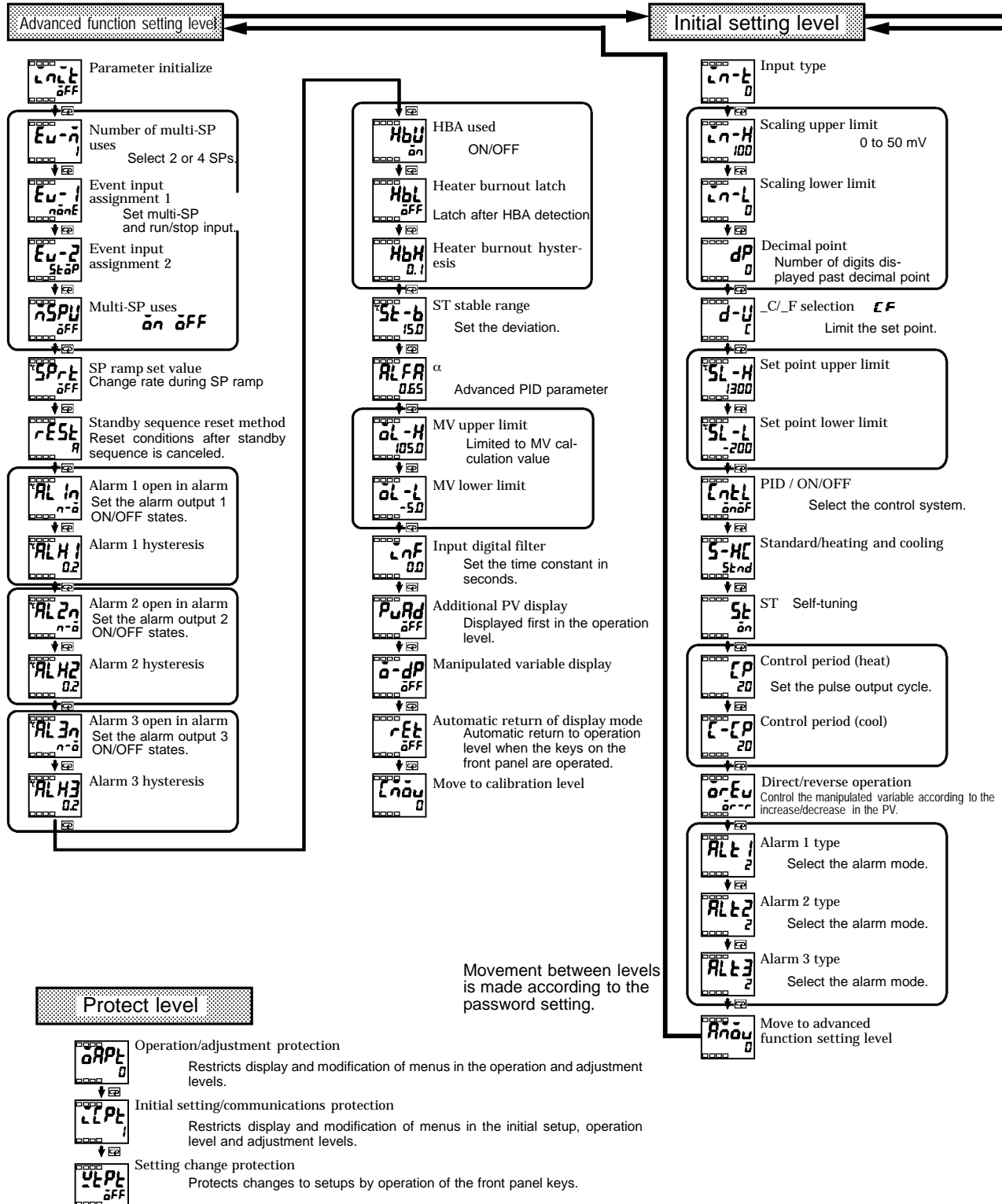

Power ON

Operation level



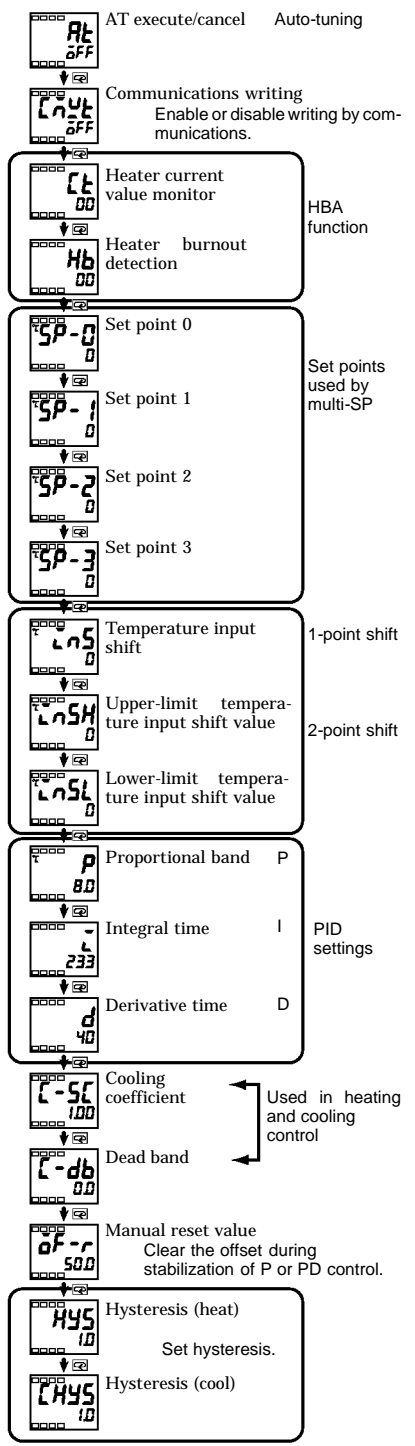
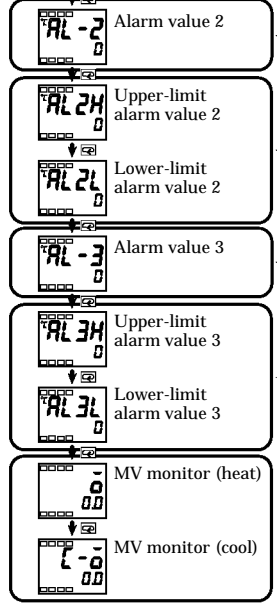
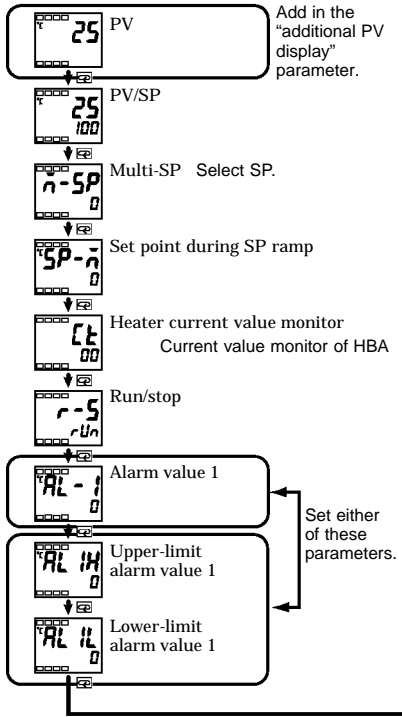

Adjustment level

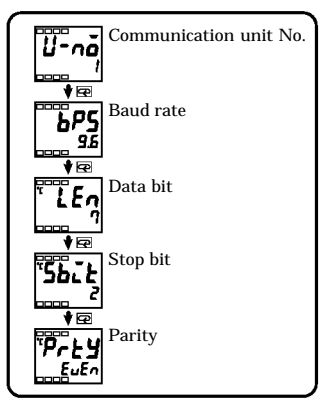

Communications setting level

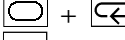

Communications setup on other party personal computer is different.

	(down) key	1-3
	(level) key	1-3
	+ (mode) key combination	1-3
	(mode) key	1-3
	(up) key	1-3

Numbers

1-point shift	4-2
1-point shift method	4-4
2-PID control	3-6, 3-10
2-point shift	4-3
2-point shift method	4-4
3-position control	3-10

A

α	5-36
A.T. (Auto-tuning)	3-12
Additional PV display	5-38
Adjustment level	1-7, 5-11, A-7
Advanced function setting level	1-7, 5-27, A-9
Alarm 1 hysteresis	5-32
Alarm 1 open in alarm	5-32
Alarm 1 type	5-8, 5-25, 5-31
Alarm 2 hysteresis	5-33
Alarm 2 open in alarm	5-33
Alarm 2 type	5-25
Alarm 3 hysteresis	5-34
Alarm 3 open in alarm	5-34
Alarm 3 type	5-25
Alarm hysteresis	4-6
Alarm output/Control output 2	2-6
Alarm outputs	3-17
Alarm type	3-17
Alarm value	3-18
Alarm value 1	5-7
Alarm value 2	5-7
Alarm value 3	5-7
Analog input	1-5, 4-8, 6-9
Analog input (voltage input)	4-8, 5-21
AT (Auto-tuning)	5-11
AT execute/cancel	3-12
Automatic return of display mode	5-39

C

Calibrating analog input	6-7
Calibrating input	6-3
Calibrating platinum resistance thermometer	6-8
Calibrating thermocouples	6-4
Calibration level	1-7
Changing the SP	3-9

Characteristics	A-3
Checking indication accuracy	6-9
Close in alarm/open in alarm	4-7
Communications	2-7
Communications data length	5-40
Communications function	1-5, 1-9
Communications parity	5-40
Communications setting level	1-7, 5-40, A-9
Communications stop bit	5-40
Communications unit No.	5-40
Connecting the cold junction compensator	6-4
Control adjustment	1-5
Control output	1-5
Control output 1	2-6
Control period	3-7
Control period (cool)	3-7
Control period (heat)	3-7
Cooling coefficient	4-10, 4-11, 5-17
CT input	2-7
Current transformer (CT)	A-4

D

Dead band	4-10, 4-11, 5-17
Decimal point	5-5, 5-7, 5-8, 5-14, 5-19, 5-21, 5-22, 5-30
Derivative time	3-12, 3-15, 5-11, 5-12, 5-16
Description	3-12
Determining PID constants (AT, ST, manual setup)	3-12
Dimensions	2-2
Direct/reverse operation	3-7, 5-25
Display	1-2
Draw out	2-4

E

Error display	A-5
Event input	1-5, 2-7, 4-12, 5-5, 5-7, 5-28
Example of 2-point temperature input shift	4-5
Executing ON/OFF control	3-10
Executing run/ stop control	4-14
Executing the SP ramp function (limiting the SP change rate)	4-17
External dimensions	A-4
Externally setting the SP	4-12

F

Fixing settings	1-8
Front panel	1-2

H

HBA	1-5, A-2
HBA detection	3-19
Heater burnout alarm (HBA)	3-19
Heater burnout detection	3-20, 5-13
Heater burnout latch	5-35

- Heater current value monitor 5-13
 - Heating and cooling control 4-10
 - How setup levels are configured and operating the keys on the front panel 1-6
 - How to calculate detection current values 3-21
 - How to calculate input shift values (2-point shift) 4-3
 - How to use keys 1-3
 - Hysteresis 3-10
 - Hysteresis (cool) 5-18
 - Hysteresis (heat) 5-18
- I**
- I/O configuration 1-4
 - Initial setting level 1-7, 5-19, A-8
 - Initial setting/ communications protection 4-20
 - Initial setup examples 3-2
 - Initial/communications protection 5-19
 - Input digital filter 5-38
 - Input error A-5
 - Input sensor types 1-5
 - Input type 3-4, 5-19, 5-20, 5-21, A-10
 - Installation 2-2
 - Integral time 3-12
- K**
- Key protect 4-20
- L**
- Lower-limit temperature input shift value 5-15
- M**
- Manipulated variable display 5-39
 - Manual reset value 5-18
 - Manual setup 3-15
 - Mounting 2-3
 - Multi-SP 4-12
 - Multi-SP (set point 0 to 3) 5-5
 - MV lower limit 5-37
 - MV monitor (cool) 5-10
 - MV monitor (heat) 5-9
 - MV upper limit 5-37
- N**
- Names of parts 1-2
 - No.1 display 1-2
 - No.2 display 1-2
 - Number of multi-SP uses ... 4-12, 4-13, 5-28
- O**
- ON/OFF control 3-6, 3-10, 3-11
 - Operation indicators 1-2
 - Operation level 1-7, 3-9, 3-11, 5-4, 5-11, 5-19, A-7
 - Operation/adjustment protection 4-20
- P**
- Panel cutout 2-2
 - Parameter flow A-12
 - Parameter initialize 5-28
 - Parameter operation list A-7
 - PID / ON/OFF 5-23
 - PID constants 3-12
 - Power supply 2-5
 - Precautions when wiring 2-5
 - Proportional band 3-12, 5-11, 5-12, 5-16
 - Proportional operation 3-15
 - Protect level 1-7, 5-3, A-9
 - PV/SP 3-9, 5-5, 5-6, 5-39
- R**
- Ratings A-2
 - Registering calibration data 6-3
 - Restrictions during SP ramp operation 4-18
 - RS-485 2-8
 - Run/Stop 5-7
- S**
- Scaling 5-21
 - Scaling lower limit 5-19, 5-21
 - Scaling upper limit 5-19, 5-21
 - Selecting _C/_F 3-5
 - Selecting parameters 1-8
 - Selecting PID control or ON/OFF control 3-6
 - Sensor input setting and indication ranges A-10
 - Set point 3-9
 - Set point 0 5-14
 - Set point 1 5-14
 - Set point 2 5-14
 - Set point 3 5-14
 - Set point during SP ramp 4-17, 5-6
 - Set point limiter 4-15
 - Setting change protection 4-20
 - Setting heating and cooling control 4-11
 - Setting output specifications 3-7
 - Setting scaling upper and lower limits (analog input) 4-8
 - Setting the input type 3-4
 - Setting the PID / ON/OFF parameter .. 3-11
 - Setting the set point lower limit 4-16
 - Setting the set point upper limit 4-16
 - Setting the SP 3-9
 - Setting the SP upper and lower limit values 4-15

Setting the upper and lower limits 5-8
Setting up communications data 1-9
Setup levels diagram A-11
Shifting input values 4-2
SP ramp 4-17
SP ramp set value 5-30
Specifications A-2, A-4
ST (self-tuning) 3-13, 5-24, 5-36
ST stable range 3-14, 5-36
ST start conditions 3-14
Standby sequence 4-6, 5-31
Standby sequence reset method 5-31
Stop 5-7
Summary of alarm operations 4-7

T

Temperature input 1-5
Temperature input shift 4-5, 5-15
Temperature unit 1-3, 3-5
Terminal arrangement 2-5
To select set points (0/1/2/3) 4-13

U

Upper-limit temperature
input shift value 5-15
User calibration 6-3

W

Wiring 2-5

Revision History

A manual revision code appears as a suffix to the catalog number on the front cover of the manual.

Cat. No. H111-E1-1



Revision code

The following table outlines the changes made to the manual during each revision. Page numbers refer to previous version.

Revision code	Date	Revised content
1	March 1999	Original production