

**SYSMAC
WS02-NCTC1-E
CX-Position**

OPERATION MANUAL

OMRON

OMRON

Authorized Distributor:

WS02-NCTC1-E CX-Position



Operation Manual

Produced July 2001

Notice:

OMRON products are manufactured for use according to proper procedures by a qualified operator and only for the purposes described in this manual.

The following conventions are used to indicate and classify precautions in this manual. Always heed the information provided with them. Failure to heed precautions can result in injury to people or damage to property.

-  **DANGER** Indicates an imminently hazardous situation which, if not avoided, will result in death or serious injury.
-  **WARNING** Indicates a potentially hazardous situation which, if not avoided, could result in death or serious injury.
-  **Caution** Indicates a potentially hazardous situation which, if not avoided, may result in minor or moderate injury, or property damage.

OMRON Product References

All OMRON products are capitalized in this manual. The word “Unit” is also capitalized when it refers to an OMRON product, regardless of whether or not it appears in the proper name of the product.

The abbreviation “Ch,” which appears in some displays and on some OMRON products, often means “word” and is abbreviated “Wd” in documentation in this sense.

The abbreviation “PC” means Programmable Controller and it is not used as the abbreviation for anything else.

Visual Aids

The following headings appear in the left column of the manual to help you locate different types of information.

Note Indicates information of particular interest for efficient and convenient operation of the product.

1,2,3... 1. Indicates lists of one sort or another, such as procedures, checklists, etc.

Notation

In this manual, the following conventions are used to describe screen messages and mouse/keyboard operations.

Names of menus and menu items are indicated in bold italic, e.g., the ***File*** Menu.

Names of keys and buttons are indicated in bold (usually followed by “Key” or “Button”), e.g., **Tab** Key and **OK** Button.

Dialog box and window names are indicated with capitalization, e.g., the Search Dialog Box.

The levels of items in menu hierarchies are distinguished with back-slashes. For example, “Select ***File/ New***” tells the reader to select ***New*** from the ***File*** Menu.

The “+” sign is used to indicate that keys are pressed simultaneously. For example, “Press the **Ctrl+S** Keys” tells the reader to press the **S** Key while holding down the **Ctrl** Key.

Copyrights

Windows is a registered trademark of the Microsoft Corporation. VS-FlexGrid Pro is a product of Bunka Orient. Co., Ltd. (©Copyright VideoSoft Corporation, 2000). Other system and product names used in this manual are the trademarks or registered trademark of the respective companies.

© OMRON, 2001

All rights reserved. No part of this publication may be reproduced, stored in a retrieval system, or transmitted, in any form, or by any means, mechanical, electronic, photocopying, recording, or otherwise, without the prior written permission of OMRON.

No patent liability is assumed with respect to the use of the information contained herein. Moreover, because OMRON is constantly striving to improve its high-quality products, the information contained in this manual is subject to change without notice. Every precaution has been taken in the preparation of this manual. Nevertheless, OMRON assumes no responsibility for errors or omissions. Neither is any liability assumed for damages resulting from the use of the information contained in this publication.

TABLE OF CONTENTS

PRECAUTIONS	xi
1 Intended Audience	xii
2 General Precautions	xii
3 Safety Precautions	xii
4 Application Precautions	xiii
5 Operating Environment Precautions	xiv
SECTION 1	
Overview	1
1-1 Introduction	2
1-2 System Configuration	5
1-3 List of Functions	6
1-4 Comparison with SYSMAC-NCT	6
1-5 Basic Operating Procedure	7
SECTION 2	
Setup and Basic Procedures	9
2-1 Installation	10
2-2 Connecting to a PC	13
2-3 Basic Operations	18
SECTION 3	
Creating New Projects	37
3-1 Creating New Projects	38
3-2 Adding and Deleting PCs	39
3-3 Adding and Deleting NC Units	41
3-4 Automatic NC Unit Search	42
SECTION 4	
Editing Settings	43
4-1 Overview	44
4-2 Setting Editing Screens	47
4-3 Editing Parameter Settings	55
4-4 Editing Sequence Settings	56
4-5 Editing Speed Settings	58
4-6 Editing Acceleration/Deceleration Time Settings	59
4-7 Editing Dwell Time Settings	60
4-8 Editing Zone Settings	61

TABLE OF CONTENTS

SECTION 5

Saving and Reading Projects 63

5-1 Saving Projects 64

5-2 Reading Projects 65

SECTION 6

Online Connection Default Configurations. 67

6-1 Default Configurations for Connecting Online. 68

6-2 FinsGateway Configuration and Startup. 68

SECTION 7

Transferring and Verifying Data 73

7-1 Downloading Data 74

7-2 Uploading Data 75

7-3 Verifying Data 77

7-4 Writing Data to Flash Memory 78

SECTION 8

Monitoring NCs 81

8-1 Monitoring NCs 82

8-2 Multiple Unit Monitoring 82

8-3 Operating Memory Area Monitoring 83

8-4 Operating Data Area Monitoring 84

SECTION 9

Printing Data. 87

9-1 Printing Data 88

SECTION 10

Error Logs and Troubleshooting 91

10-1 NC Unit Error Logs. 92

10-2 Troubleshooting 108

Revision History 111

About this Manual:

This manual describes the specifications and operation of the WS02-NCTC1-E CX-Position software and includes the sections described below. The CX-Position runs on Windows 95, 98, 2000, or NT operating systems and is used to create data for and monitor the operation of the CS1W-NC□□□ and CJ1W-NC□□□ Position Control Units (referred to as NC Units in this manual).

Please read this manual carefully and be sure you understand the information provided before attempting to install and operate CX-Position. Please read the following manuals carefully and be sure you understand the information provided before using a Position Control Unit.

NC Unit model number	Manual name	Cat. No.
CS1W-NC113/213/413/133/233/433	CS1W-NC113/213/413/133/233/433 Position Control Units Operation Manual	W376
CJ1W-NC113/213/413/133/233/433	CJ1W-NC113/213/413/133/233/433 Position Control Units Operation Manual	W397

Section 1 provides an overview of CX-Position, its functions, and the system configuration in which it is used.

Section 2 provides information about CX-Position installation, connecting to the PC, and basic operating procedures

Section 3 describes the procedures for creating new projects, as well as those for adding and deleting Programmable Controllers (PCs) and Position Control Units (NCs).

Section 4 describes the procedures used to edit settings

Section 5 provides information about saving and reading files.

Section 6 provides information on default configurations for connecting online.

Section 7 provides information on data transfer and verification operations between the CX-Position and NC Units, and about operations for writing data transferred to NC Units into the NC Unit flash memory.

Section 8 provides information about monitoring NC Units. The NC Unit's current positions, error codes, and status are displayed on the NC Monitor. Monitor Units are also available, displaying sequence numbers and current positions for up to four Units simultaneously. Operating memory area monitoring, operating data area monitoring, and NC Unit error logs can also be displayed. For details on NC error log display, refer to *10-1 NC Unit Error Logs*.

Section 9 provides information about printing data.

Section 10 provides information about NC Unit error log displays and troubleshooting.



WARNING Failure to read and understand the information provided in this manual may result in personal injury or death, damage to the product, or product failure. Please read each section in its entirety and be sure you understand the information provided in the section and related sections before attempting any of the procedures or operations given.

PRECAUTIONS

This section provides general precautions for using CX-Position and related devices.

The information contained in this section is important for the safe and reliable application of CX-Position. You must read this section and understand the information contained before attempting to set up or operate the CX-Position.

1	Intended Audience	xii
2	General Precautions	xii
3	Safety Precautions.....	xii
4	Application Precautions	xiii
5	Operating Environment Precautions	xiv

1 Intended Audience

This manual is intended for the following personnel, who must also have knowledge of electrical systems (an electrical engineer or the equivalent).

- Personnel in charge of installing FA systems.
- Personnel in charge of designing FA systems.
- Personnel in charge of managing FA systems and facilities.

2 General Precautions

The user must operate the product according to the performance specifications described in the operation manuals.

Before using the product under conditions which are not described in the manual or applying the product to nuclear control systems, railroad systems, aviation systems, vehicles, combustion systems, medical equipment, amusement machines, safety equipment, and other systems, machines, and equipment that may have a serious influence on lives and property if used improperly, consult your OMRON representative.

Make sure that the ratings and performance characteristics of the product are sufficient for the systems, machines, and equipment, and be sure to provide the systems, machines, and equipment with double safety mechanisms.

This manual provides information for using CX-Position. Be sure to read this manual before attempting to use CX-Position and keep this manual close at hand for reference during operation.

 **WARNING** It is extremely important that CX-Position and related devices be used for the specified purpose and under the specified conditions, especially in applications that can directly or indirectly affect human life. You must consult with your OMRON representative before applying CX-Position and related devices to the above mentioned applications.

3 Safety Precautions

 **WARNING** Never attempt to disassemble any Units while power is being supplied. Doing so may result in serious electric shock.

 **WARNING** Never touch any of the terminals while power is being supplied. Doing so may result in serious electric shock.

 **Caution** Save parameters and other data to flash memory after transferring them to the Position Control Unit (referred to as NC Units in this manual). If parameters and other data are not saved to flash memory, data will return to their previous values the next time power is turned ON, possibly resulting in Unit malfunction.

 **Caution** Confirm the safety of the destination node before transferring parameters or other data to the node. Transferring parameters or other data without confirming safety may result in injury.

 **Caution** Do not save data to flash memory during memory operation or while the motor is running. Doing so may result in unexpected operation.

4 Application Precautions

 **Caution** Observe the following precautions when using CX-Position.

- Confirm the unit number before transferring parameters and other data to an NC Unit.
- Confirm that set parameters and data operate properly before using in actual operation.
- When the settings of the following parameters have been changed, they must be transferred to the NC Unit and written to flash memory, and then the NC Unit must be turned OFF and back ON, or restarted as a Special I/O Unit, to enable using the new settings.
 - Output pulse selection
 - Limit input signal type
 - Origin proximity input signal type
 - Origin input signal type
 - Emergency stop input function
 - No-origin specification
 - Operating mode selection
 - Origin search operation
 - Origin detection method
 - Origin search direction
- Do not turn OFF the power to an NC Unit while writing to flash memory. Doing so may damage flash memory.
- Confirm that no adverse effect will occur in the system before attempting any of the following. Not doing so may result in unexpected operation.
 - Changing the operating mode of the PC.
 - Changing the present value of any word or any set value in memory.
 - Force-setting/force-resetting any bit in memory.
- Do not turn OFF the power to the computer while installing or uninstalling CX-Position. Doing so may corrupt computer data.

5 Operating Environment Precautions

 **Caution** Perform installation properly, according to the procedures described in this manual.

 **Caution** Do not install in the following locations:

- Locations subject to direct sunlight.
- Locations subject to temperatures or humidity outside the range specified in the specifications.
- Locations subject to condensation as the result of severe changes in temperature.
- Locations subject to corrosive or flammable gases.
- Locations subject to dust (especially iron dust) or salts.
- Locations subject to exposure to water, oil, or chemicals.
- Locations subject to shock or vibration.

 **Caution** Take appropriate and sufficient countermeasures when installing in the following locations:

- Locations subject to static electricity or other forms of noise.
- Locations subject to strong electromagnetic fields.
- Locations subject to possible exposure to radioactivity.
- Locations close to power supplies.

SECTION 1

Overview

This section provides an overview of CX-Position, its functions, and the system configuration in which it is used.

1-1	Introduction	2
1-1-1	What Is CX-Position?	2
1-1-2	Applicable NC Units	2
1-1-3	Features	2
1-1-4	Applicable Computers	3
1-1-5	CX-Position Data	3
1-1-6	Software Structure	3
1-1-7	Checking the Package	4
1-2	System Configuration	5
1-3	List of Functions	6
1-4	Comparison with SYSMAC-NCT	6
1-5	Basic Operating Procedure	7

1-1 Introduction

1-1-1 What Is CX-Position?

The CX-Position is a software package that enables the setting, transfer, storage, and printing of data used with Position Control Units (referred to as NC Units in this manual), as well as monitoring of NC Unit operating status.

The CX-Position runs on a Windows 95, 98, 2000, or NT operating system.

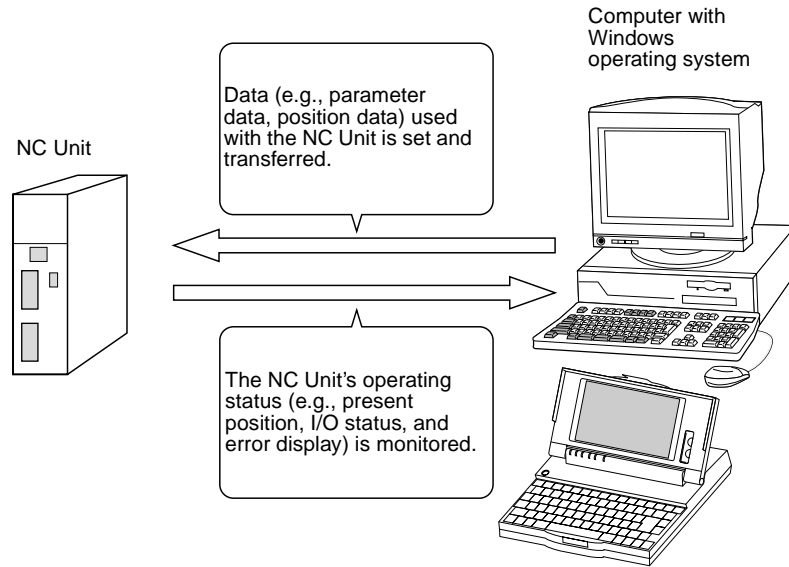

1-1-2 Applicable NC Units

CX-Position can be used with the following NC Units.

NC Unit model number	PC series
CS1W-NC113/133/213/233/413/433	CS Series
CS1W-NC113/133/213/233/413/433	CJ Series

Note For details on the system configuration, refer to 1-2 System Configuration.

1-1-3 Features

Data Management and Editing in Project Units

The CX-Position enables data for several NC Units (96 NC Units max. per PC) on several PCs (1,000 max.) to be handled as 1 project. Data is displayed in tree format with parameter data, sequence data, speed data, acceleration/deceleration data, dwell times, and zone data displayed under the corresponding NC Unit, NC Units displayed under the corresponding PC, and PCs displayed under the corresponding project.



The communications method (i.e., the type of network) depends on the FinsGateway driver used. For example, to connect using Host Link (SYSWAY-CV) via the RS-232C port, use the FinsGateway Serial Unit driver.

CX-Position	
FinsGateway	
Serial Unit driver	ETN_UNIT driver
Host Link (SYSWAY-CV) (peripheral port or RS-232C port)	Ethernet

Note The CX-Position can be used with a Serial Unit driver or via Ethernet only.

1-1-7 Checking the Package

After purchase, confirm that the contents of the package are as described below.

Model Number

Confirm that the following details are correct.

Product name	Model number	Setup disk
CX-Position	WS02-NCTC1-E	CD-ROM

CX-Position Package

The CX-Position software package consists of the following items. Confirm that accessories are provided.

Setup disk (CD-ROM)	1
Operation manual (this manual)	1
Software Licence Agreement/User Registration Card	1
Address label	1

1-2 System Configuration

The system configuration for the NC Units is given below with the CS1W-NC413/433 used as a representative example. The CS1W-NC213/233 and CS1W-NC113/133 are used for control of 2 axes and 1 axis respectively.

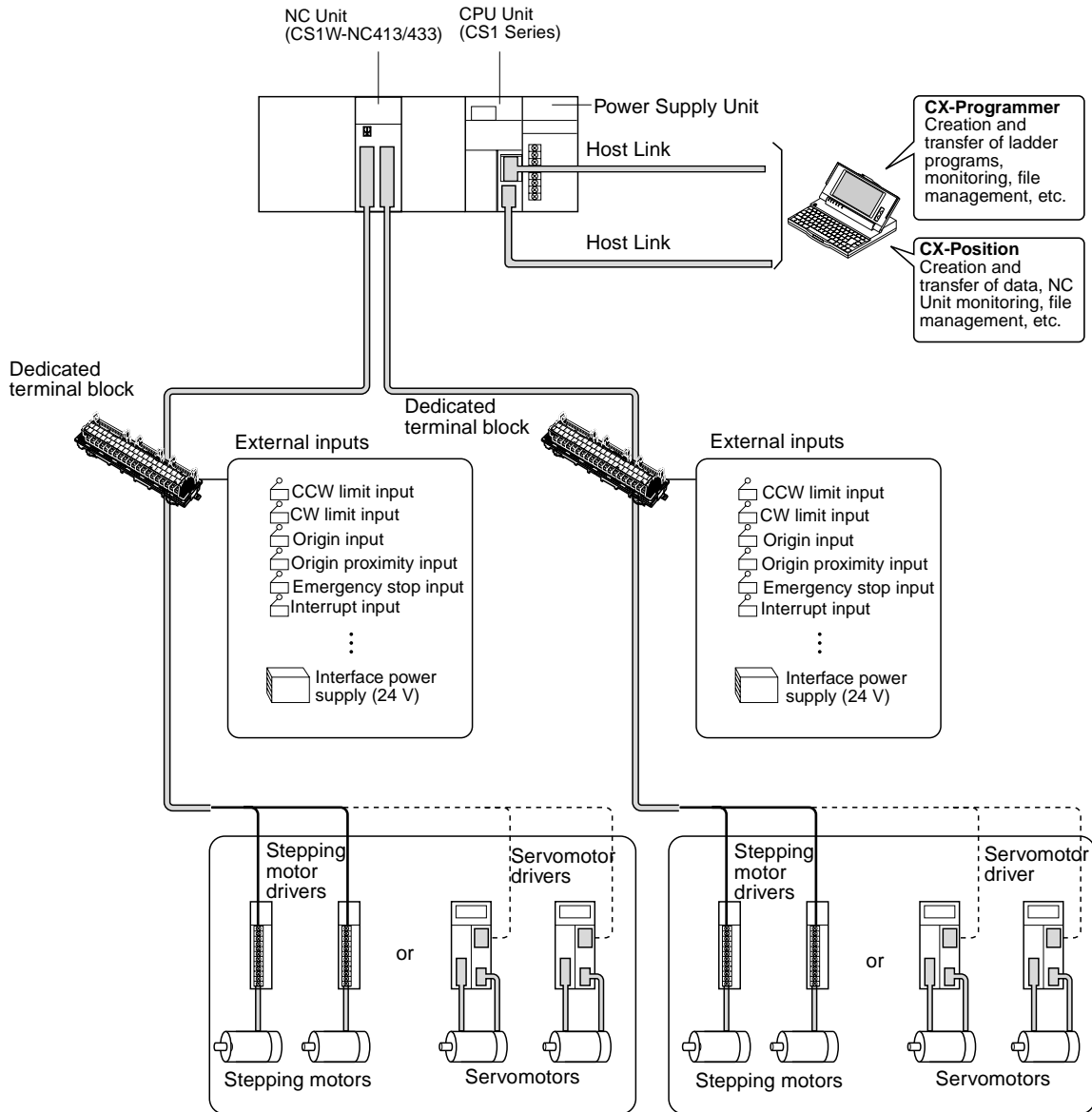

- Note**
1. Special cables are available to connect OMRON U-series Drivers, W-series Drivers, or Smart Step A-series Drivers. Cables made by the user can also be used.
 2. Special cables are available for connections to special terminal blocks. Cables made by the user can also be used.
 3. A battery for data backup is required when using an absolute encoder.

1-3 List of Functions

Group	Function	Details	Page	
Editing projects	Create project	Used to create project files (".nci").	page 38	
	Create PC	Used to specify a PC model and add PC data to a project.	page 39	
	Create NC Unit	Used to specify an NC Unit model and add NC Unit data to a PC in a project.	page 41	
	Edit PC/NC Unit	Used to perform editing for a project, such as making property settings for or deleting PCs or NC Units, cutting, copying, or pasting NC Units, pasting NC Unit data, and drag-and-drop.	page 41	
Editing NC Unit data	Edit	Used to edit the NC Unit data shown on the right.	Parameter data	page 55
		Sequence data	page 56	
		Speed data	page 58	
		Acceleration/deceleration time data	page 59	
		Dwell time data	page 60	
		Zone data	page 61	
Saving and loading project files	Save	Used to save all the data in a project as a project file (".nci").	page 64	
	Load	Used to read a project file (".nci") to a project.	page 65	
Importing NCT data files	Import	Used to import data files created with SYSMAC-NCT to CX-Position projects.	page 65	
Online	Download/upload/verify	Used to download, upload, or verify data.	page 74, page 75, page 77	
	Flash memory write	Used to write data to flash memory.	page 78	
	Monitor	Used to display the sequence number, present position, I/O status, and error code for an NC Unit.	page 82	
	Monitor Units	Used to display the sequence numbers, present positions, I/O statuses, and error codes for 4 NC Units.	page 82	
	Automatic project setting	Used to read information about the NC Units mounted on a specified PC connected online, and creates a project tree based on this. If the data upload check box is turned ON, the data for all NC Units on the specified PC is read and included in the project.	page 42, page 76	
	Operating memory area monitor	Used to monitor the CPU Unit's operating memory area.	page 83	
	Operating data area monitor	Used to monitor the CPU Unit's operating data area.	page 84	
	NC Unit error log monitor	Used to monitor items (20 max. per NC Unit) in NC Unit error logs.	page 92	

1-4 Comparison with SYSMAC-NCT

Item	CX-Position	SYSMAC-NCT
NC Unit	CS1W-NC□□□□ CJ1W-NC□□□□	C200HW-NC□□□□ C500-NC□□□□
Created files	Project files (".nci") created with the data from more than 1 NC Unit mounted on more than 1 PC (1,000 max.)	Data files (C200HW-NC: ".ncm"; C500-NC: ".nci") created with the data from 1 NC Unit
Managing and editing using projects	Supported Within a project, data can be moved or copied (see note) in units of NC Units using "drag-and-drop" and "copy-and-paste" operations. (Data can be moved or copied within the same PC or between PCs.) Note The data at the NC Unit to which data is copied is overwritten. Icons are not copied along with the data.	Not supported All data is handled together. (Moving and copying in units of NC Units is not possible.)

Item	CX-Position	SYSMAC-NCT
Method for connecting to PC	<ul style="list-style-type: none"> • Connected to the RS-232C port on the CPU Unit or a Serial Communications Board/Unit using an RS-232C cable. • Connected to the peripheral port on the CPU Unit using a peripheral cable, or via Ethernet. 	Connected to the RS-232C port on the CPU Unit using an RS-232C cable.
Networks for connection to PC	Select from the following using the FinsGateway driver: <ul style="list-style-type: none"> • Host Link (SYSWAY-CV or RS-232C) • Ethernet (via an Ethernet board) 	Host Link (RS-232C) only
Decimal/binary display selection	Supported.	Not supported (decimal only).
Changing display font size	Supported.	Not supported.
NC Unit error log display	Supported.	Not supported.

1-5 Basic Operating Procedure

A basic outline of the procedures required to install the CX-Position and FinsGateway, create data, transfer it to the NC Units, and use in actual operation is given below.

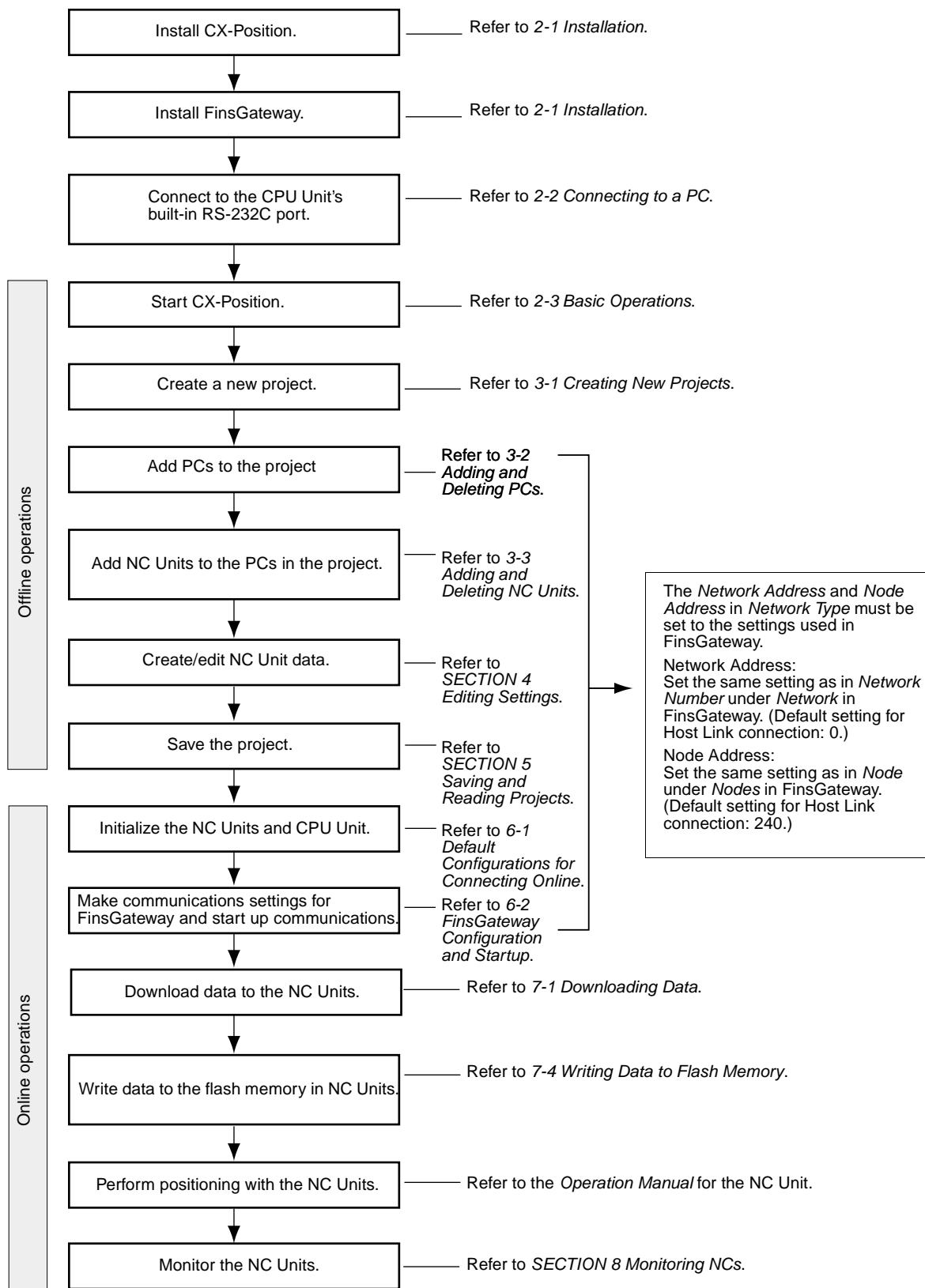

SECTION 2

Setup and Basic Procedures

This section provides information about CX-Position installation, connecting to the PC, and basic operating procedures.

2-1	Installation	10
2-1-1	Installing CX-Position and FinsGateway	10
2-1-2	Uninstalling CX-Position or FinsGateway	13
2-2	Connecting to a PC	13
2-2-1	Connecting via Host Link (SYSWAY-CV)	14
2-2-2	Connecting via Ethernet	18
2-3	Basic Operations	18
2-3-1	Starting	18
2-3-2	Quitting	19
2-3-3	Basic Window	20
2-3-4	Displaying Menus	21
2-3-5	Moving and Copying NC Unit Data	22
2-3-6	Main Menus	24
2-3-7	Main Menu Items	25
2-3-8	Operations Listed by Purpose	28
2-3-9	Toolbar	31
2-3-10	Status Bar	31
2-3-11	Option Settings	31
2-3-12	View Settings	32
2-3-13	Setting the Network Type	33
2-3-14	Help	33

2-1 Installation

To use the CX-Position, the following software must be installed on the same computer.

- CX-Position
- FinsGateway Version 3 Embedded Edition

- Note**
1. FinsGateway Version 3 Embedded Edition is included with the CX-Position package.
 2. If FinsGateway Version 3 Embedded Edition is not installed, CX-Position can be started up, but online operations are not possible. Only offline operations can be performed.
 3. CX-Position can also be used with FinsGateway Version 2.
 4. For details on preparation required before installing FinsGateway, refer to the *FinsGateway User's Manual* (PDF data).

2-1-1 Installing CX-Position and FinsGateway

Use the following procedure to install CX-Position, FinsGateway, and the Serial Unit driver or Ethernet driver.

- 1,2,3...**
1. Insert the CD-ROM into the computer's CD-ROM drive.
After a dialog box indicating that setup preparation is taking place has been displayed, the following window will be displayed.

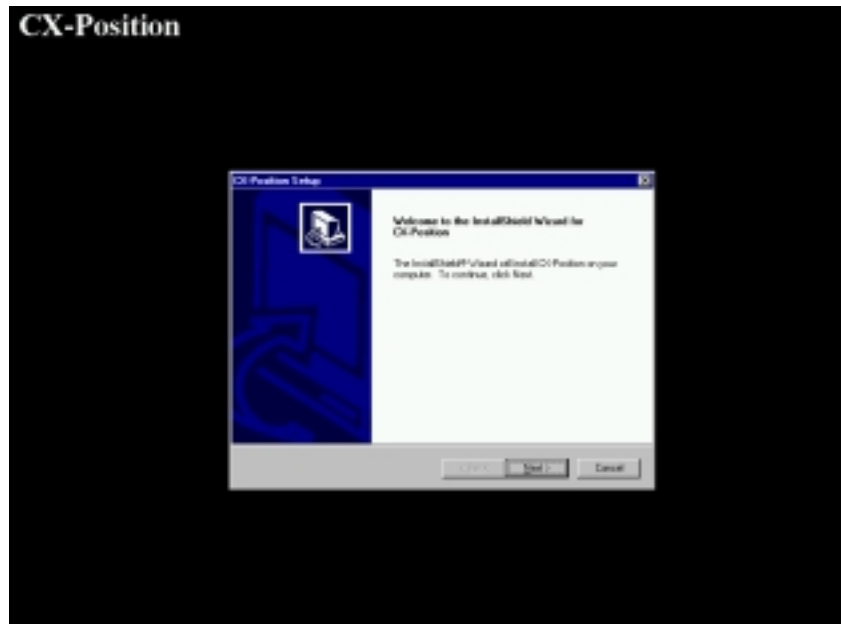

2. Click **Next**. The Software Licence Agreement Dialog Box will be displayed.
3. Click **Next** and input the licence number (as printed on the Software Licence Agreement/User Registration Card). The Destination Location Dia-

log Box will be displayed.

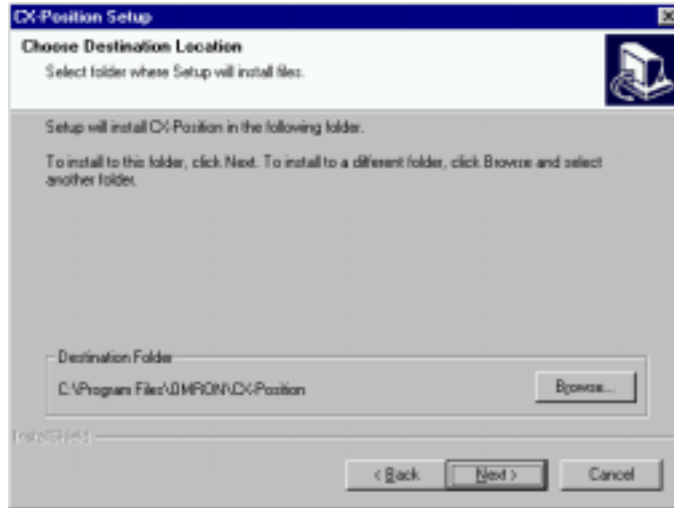

4. Specify the drive and folder to which CX-Position is to be installed. The default destination is C:\Program Files\OMRON\CX-Position. No changes are required to install in the folder that is displayed. To install in a different folder, click **Browse** and select the desired drive and folder.
5. Click **Next**. The Program Folder Dialog Box will be displayed. Select the desired program folder. The default program folder is CX-Position.
6. Click **Next**. The CX-Position Setup Dialog Box will be displayed and installation will start.

Next, the following dialog box will be displayed to confirm whether FinsGateway installation is necessary.

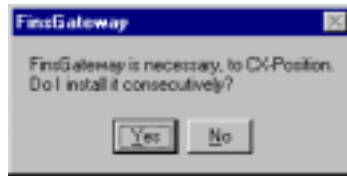

7. Click **Yes**. (If FinsGateway is already installed, click **No**.) The FinsGateway and Serial Unit Driver Installation Window will be displayed.

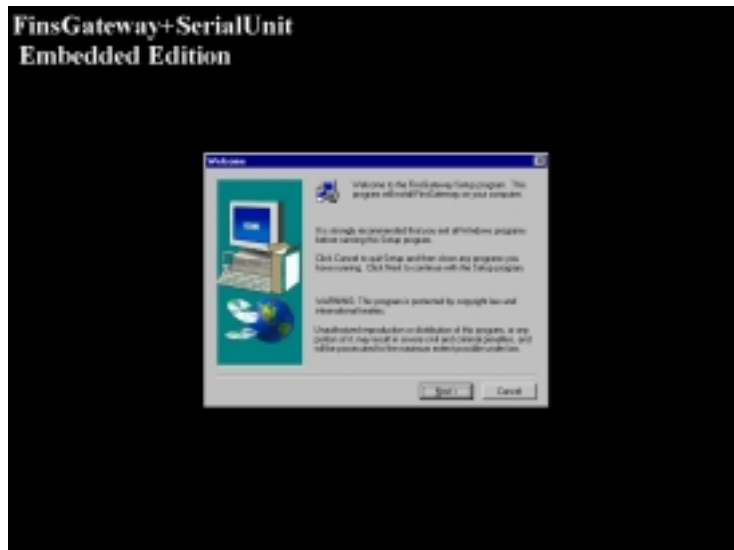

8. Click **Next**. The FinsGateway and ETN_UNIT Driver Installation Window will be displayed.
9. Click **Next**. The User Registration Dialog Box will be displayed.

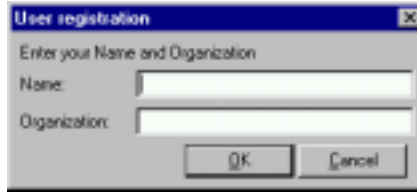

10. Enter your name and organization, and click **OK**. A confirmation will be displayed.
11. Click **Next**. The Destination Location Dialog Box will be displayed.

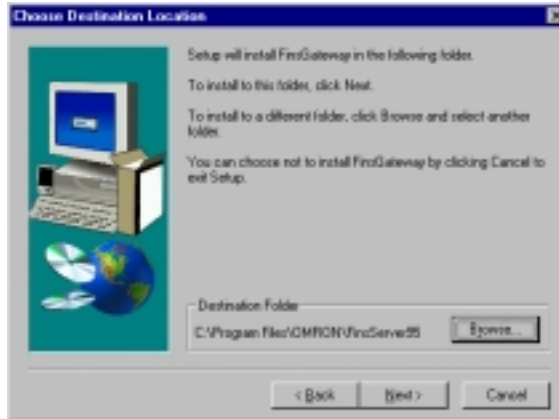

12. Specify the drive and folder to which FinsGateway is to be installed. The default destination is C:\Program Files\OMRON\FinsServer95. No changes are required to install in the folder that is displayed. To install in a different folder, click **Browse** and select the desired drive and folder.
13. Click **Next**. The Program Folder Dialog Box will be displayed. Select the desired program folder. The default program folder is FinsGateway. No changes are required to install in the folder that is displayed. To install in a different folder, click **Browse** and select the desired drive and folder.
14. Click **Next**. FinsGateway has been installed.

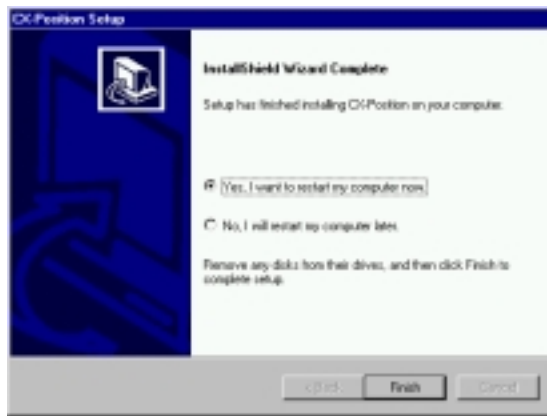

15. Click **Finish**.

Note Do not turn OFF or reset the power to the computer during installation. Computer data may be damaged.

2-1-2 Uninstalling CX-Position or FinsGateway

Uninstalling CX-Position Use the following procedure to remove CX-Position from the computer.

- 1,2,3...**
1. Click **Start** on the task bar and move the cursor to **Settings**.
 2. Select **Control Panel**.
 3. Double-click the Add/Remove Programs Icon.
 4. The Add/Remove Programs Properties Dialog Box will be displayed. Select **CX-Position** from the Install/Uninstall List and click the **Add/Remove** Button.
 5. Click **OK** in the confirmation dialog box. CX-Position will be removed from the computer.

Uninstalling FinsGateway Use the following procedure to remove FinsGateway from the computer.

- 1,2,3...**
1. Click the **Start** on the task bar and move the cursor to **Settings**.
 2. Select **Control Panel**.
 3. Double-click the Add/Remove Programs Icon.
 4. The Add/Remove Programs Properties Dialog Box will be displayed. Select **OMRON FinsGateway + SerialUnit Embedded Edition** from the Install/Uninstall List and click the **Add/Remove** Button.
 5. Click **OK** in the confirmation dialog box. FinsGateway will be removed from the computer.

Note Do not attempt to uninstall CX-Position or FinsGateway Version 3 when they are running. The uninstall operation may not be completed successfully.

2-2 Connecting to a PC

Note If OMRON Support Software that communicates using CX-Server (e.g., CX-Programmer, CX-Protocol, or CX-Motion) or an application that uses a special serial driver is connected online, it is not possible to perform online operations from CX-Position using the same COM port. Quit online connection for the OMRON Support Software that communicates using CX-Server (e.g., CX-Programmer, CX-Protocol, or CX-Motion) or the application that uses a special serial driver, and then re-attempt online operations from CX-Position after starting up FinsGateway's Serial Unit servicing.

CX-Position can be connected to the PC using any of the following methods.

Network type	Computer port	FinsGateway communications driver
Host Link (SYSWAY-CV) (See note.)	RS-232C port	Serial Unit driver
Ethernet	Ethernet port (or built-in port)	Ethernet driver

Note Connection is also possible to PCs on Controller Link, SYSMAC LINK, or Ethernet networks via Host Link (using the PC's gateway functions).

Any FinsGateway Version 2 driver can be used.

FinsGateway Version 3 Embedded Edition is included with CX-Position. The following explanation is for when FinsGateway Version 3 Embedded Edition is used.

Use the following procedure to start up the FinsGateway communications driver. For details, refer to 6-2 *FinsGateway Configuration and Startup*.

- 1,2,3...
1. Select **Programs/FinsGateway/FinsGateway Settings** from the **Start** Menu.
 2. Select the desired communications driver under **Driver** under **Network** on the **Basic** Tab Page, click **Properties**, and make the required settings (COM port used, communications protocol (see note), communications conditions, etc.).
Note For example, select **SYSWAY-CV** to connect via Host Link (SYSWAY-CV).
 3. Select the desired communications driver (service) under **Services** on the **Basic** Tab Page, and click the **Start** Button.

2-2-1 Connecting via Host Link (SYSWAY-CV)

To connect via Host Link, use FinsGateway Version 3's Serial Unit driver. Use Host Link (SYSWAY-CV) to connect to the PC's peripheral port or RS-232C port.

Connection Method

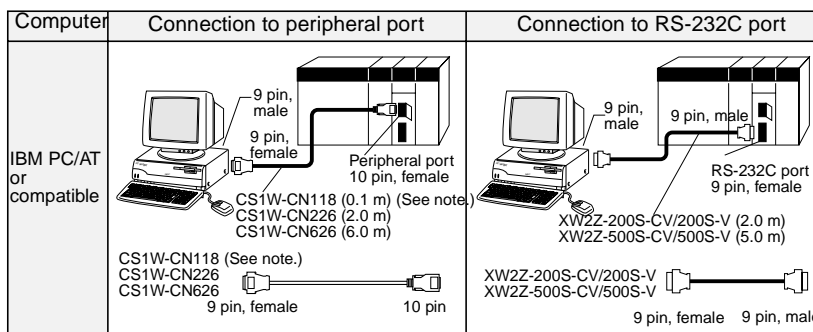

Note Use the CS1W-CN118 to connect to the peripheral port of the CPU Unit using one of the RS-232C cables shown on the right (XW2Z-□□□□-□□) in the way shown below.

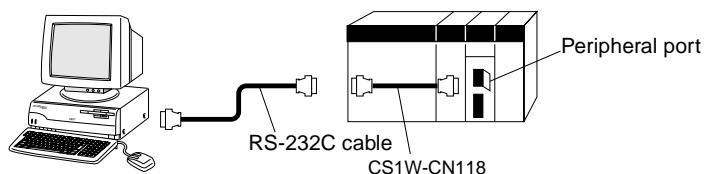

Note With CS/CJ-series PCs, it is also possible to connect to ports on Serial Communications Units/Boards. In this case, connection can be made by Host Link only.

Connecting Cables

Unit	Port on Unit	Computer	Port on computer	FinsGateway communications driver	Protocol (serial communications mode)	Model number	Length	Remarks
CPU Unit	Built-in peripheral port	IBM PC/AT or compatible	D-SUB, 9-pin, male	Serial Unit	SYSWAY-CV	CS1W-CN226	2.0 m	---
						CS1W-CN626	6.0 m	
	Built-in RS-232C port (D-SUB, 9-pin, female)					XW2Z-200S-CV	2 m	Uses anti-static connector
	XW2Z-500S-CV					5 m		
Serial Communications Board/Unit	RS-232C port (D-SUB, 9-pin, female)					XW2Z-200S-CV	2 m	Uses anti-static connector
						XW2Z-500S-CV	5 m	

Note When connecting the connectors of the above cables to the PC's RS-232C port, discharge any static build-up (e.g., by touching a grounded metal object) before touching the connectors. Although XW2Z-□□□S-CV Cables use the anti-static XM2S-0911-E Connector Hood (thus reducing the possibility of static build-up), be sure to discharge any static as a safety precaution.

Other Connection Methods

Connecting RS-232C Cable to Peripheral Port

The following connection methods can be used when connecting an RS-232C cable to the peripheral port.

Unit	Port on Unit	Computer	Port on computer	FinsGateway communications driver	Protocol (serial communications mode)	Model number	Length	Remarks
CPU Unit	Built-in peripheral port	IBM PC/AT or compatible	D-Sub, 9-pin, male	Serial Unit	SYSWAY-CV	CS1W-CN118 + XW2Z-200S-CV/500-CV	0.1 m (2 m or 5 m)	The XW2Z-□□□S-CV uses an anti-static connector.
						CS1W-CN118 + XW2Z-200S-V/500-V		---

Connecting CQM1-CIF01/02 to Peripheral Port

The following connection method can be used when connecting the conventional CQM1-CIF01/02 Cable to the peripheral port.

Unit	Port on Unit	Computer	Port on computer	FinsGateway communications driver	Protocol (serial communications mode)	Model number	Length	Remarks
CPU Unit	Built-in peripheral port	IBM PC/AT or compatible	D-Sub, 9-pin, male	Serial Unit	SYSWAY-CV	CS1W-CN114 + CQM1-CIF02	0.5 m + 3.3 m	---

Connecting a Computer with an RS-232C Cable

The following connection method can be used when connecting an IBM PC/AT or compatible computer using an RS-232C cable.

Unit	Port on Unit	Computer	Port on computer	FinsGateway communications driver	Protocol (serial communications mode)	Model number	Length	Remarks
CPU Unit	Built-in RS-232C port (D-SUB, 9-pin, female)	IBM PC/AT or compatible	D-SUB, 9-pin, male	Serial Unit	SYSWAY-CV	XW2Z-200S-V	2 m	---
						XW2Z-500S-V	5 m	
Serial Communications Board/Unit	RS-232C port (D-SUB, 9-pin, male)					XW2Z-200S-V	2 m	
						XW2Z-500S-V	5 m	

Making an RS-232C Cable

For connections with an RS-232C cable, either purchase one of the cables listed above, or make a cable using the connection method and components given below.

Connector Pin Arrangement

The pin arrangement for the CPU Unit connector is shown below.

Pin number	Signal abbreviation	Signal name	Signal direction
1	FG	Frame ground	---
2	SD (TXD)	Send data	Output
3	RD (RXD)	Receive data	Input
4	RS (RTS)	Request to send	Output
5	CS (CTS)	Clear to send	Input
6	5V	Power supply	---
7	DR (DSR)	Data set ready	Input
8	ER (DTR)	Data terminal ready	Output
9	SG (0V)	Signal ground	---
Metal cap	FG	Frame ground	---

CS-series Pin Arrangement

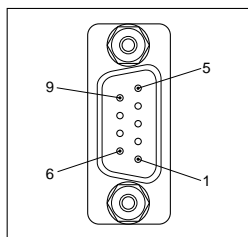

CJ-series Pin Arrangement

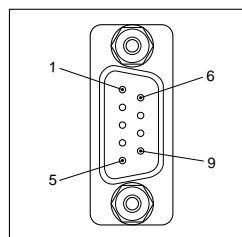

Connection Method

Either of the following configurations can be used for connection via Host Link.

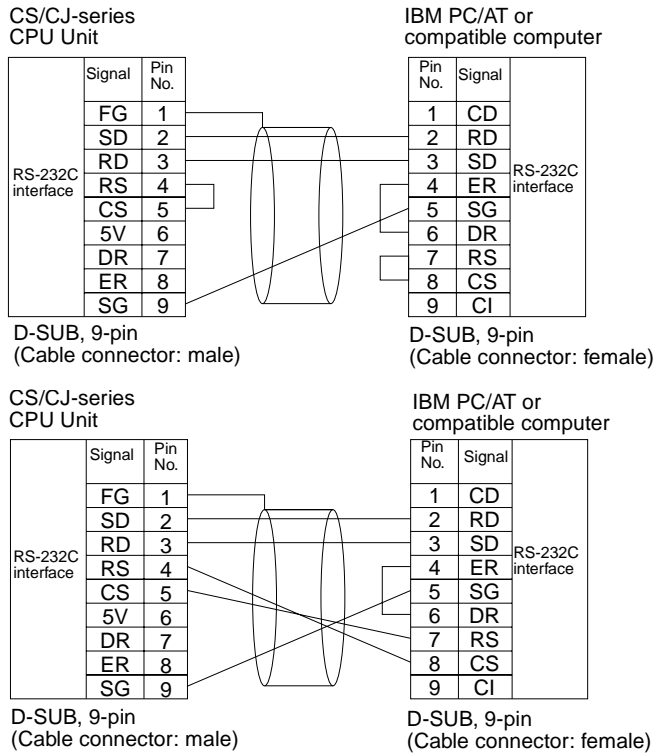

Applicable Connectors

Use the following connector at the CPU Unit end.

Product name	Model number	Specifications
Plug	XM2A-0901	9-pin, male
Hood	XM2S-0911-E	For 9-pin, metric screws Anti-static

Use together.
(1 is provided with CPU Units as a standard accessory.)

Use the following connector at the computer end (IBM PC/AT or compatible).

Product name	Model number	Specifications
Plug	XM2D-0901	9-pin, female
Hood	XM2S-0913	For 9-pin, Imperial screws

Use together.

Connect to an IBM PC/AT compatible computer using the following configuration.

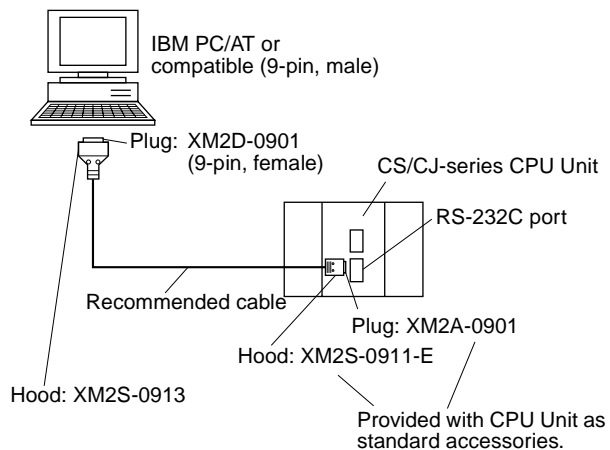

Recommended Cables

Fujikura Ltd.

UL2464 AWG28 × 5P IFS-RVV-SB (UL item)
 AWG28 × 5P IFVV-SB (non-UL item)

Hitachi Cable, Ltd.

UL2464-SB (MA) 5P × 28AWG (7/0.127) (UL item)
 CO-MA-VV-SB 5P × 28AWG (7/0.127) (non-UL item)

2-2-2 Connecting via Ethernet

Use FinsGateway Version 3's Ethernet driver to connect to the PC via Ethernet.

Support Software
 (on IBM PC/AT or compatible computer)

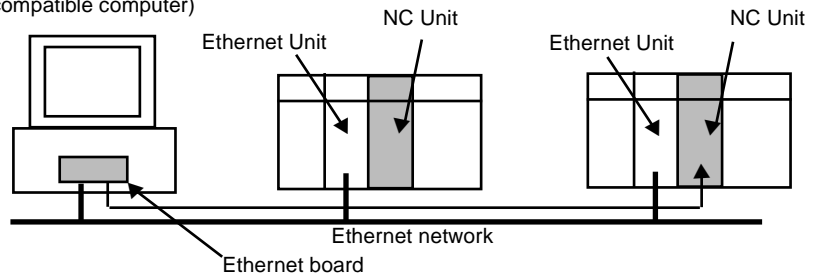

Note Connection via Ethernet is not possible if the Ethernet driver for FinsGateway Version 3 is not installed.

Ethernet Units

Use one of the following Ethernet Units.

Model number	Applicable PC	Unit classification	Communications path	FinsGateway communications driver
CS1W-ETN01	CS Series	CPU Bus Unit	Ethernet 10BASE-5	Ethernet driver
CS1W-ETN11			Ethernet 10BASE-T	
CJ1W-ETN11	CJ Series			

2-3 Basic Operations

Descriptions of CX-Position's basic operations is given below.

2-3-1 Starting

- 1,2,3... 1. Click **Start**, and move the cursor to **Program/OMRON/CX-Position**.
 2. Click **CX-Position**.

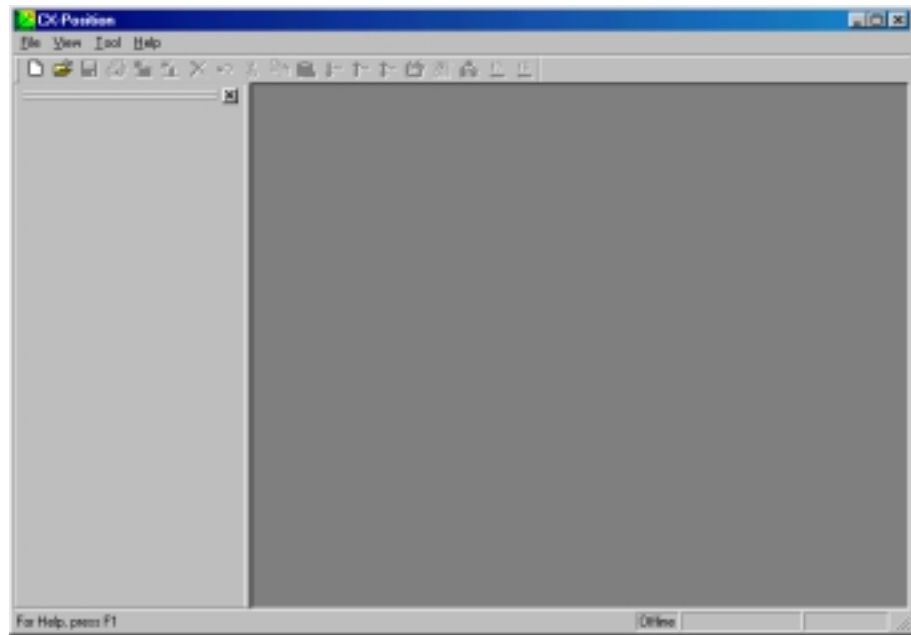

2-3-2 Quitting

- 1,2,3...
1. Select **File/Exit** or click the **Close** Button at the top right corner of the window. After editing a project, if the project has not been saved, the following dialog box will be displayed.

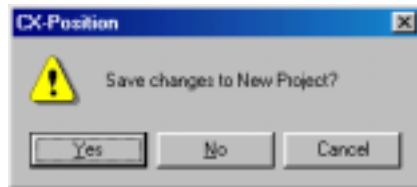

2. Click **Yes** to save the changes made. Click **No** if it is not necessary to save the changes. Click **Cancel** to return to the Project Editing Window without quitting CX-Position. Refer to 5-1 Saving Projects.

2-3-3 Basic Window

CX-Position's Basic Window is shown below.

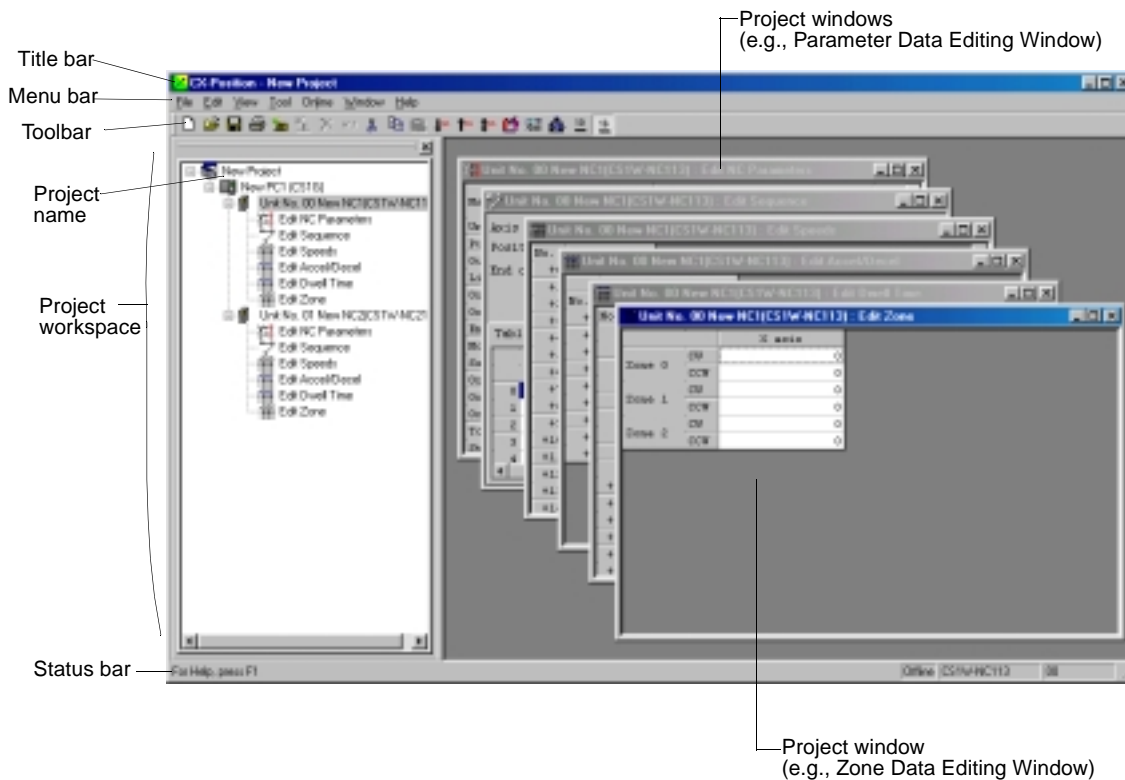

The Basic Window is split into 2 sections.

- The data hierarchy is displayed in tree format in the section on the left. This section is called the project workspace.
- The section on the right contains project windows, which are displayed when data icons in the project workspace are selected, when new data is created, and when online operations are performed.

The menus that can be used with CX-Position are displayed on the menu bar. The functions that can be used with CX-Position are displayed as icons on the toolbar.

Windows

Project Workspace

Data is displayed in the hierarchy shown below.

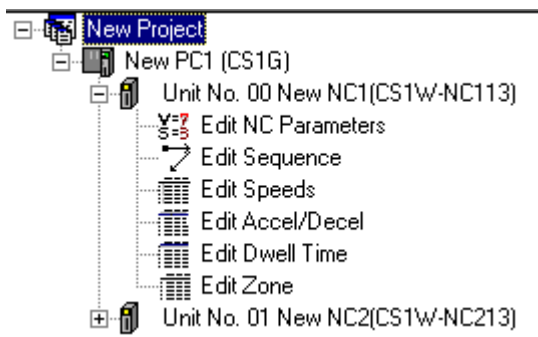

A Minus Icon appears next to data for which the lower level is displayed. A Plus Icon appears next to data for which the lower level is not displayed.

If there is more than one PC or NC Unit, then the corresponding number of icons is displayed. One of each type of data file (e.g., parameters and speeds) is registered for each NC Unit.

The Plus and Minus Icons can be used to display/hide sub-hierarchies. The Plus Icon next to a data icon indicates that there is a hidden sub-hierarchy for that data. Click the Plus Icon to display the sub-hierarchy. The Minus Icon next to a data icon indicates that the sub-hierarchy for that data is displayed. Click the Minus Icon to hide the sub-hierarchy.

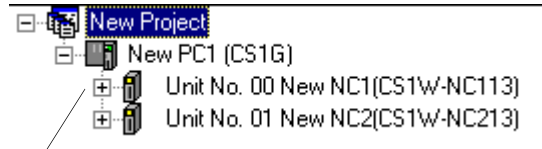

Click the Plus Icon.

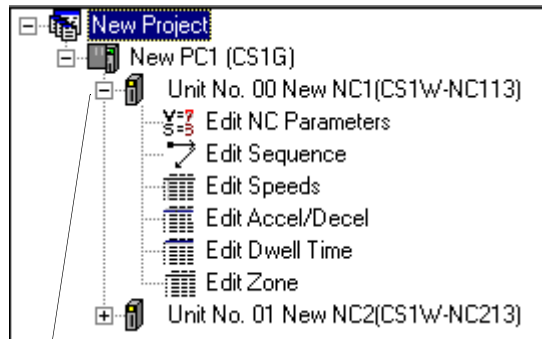

The Plus Icon changes to a Minus Icon and the sub-hierarchy is displayed.

The cursor can be moved up and down inside the project workspace when it is active using the **Up** and **Down** Keys. If the **Right** Key is pressed when the cursor is at a Plus Icon, the corresponding sub-hierarchy will be displayed. If the **Left** Key is pressed when the cursor is at a Minus Icon, the cursor will move to the next level up in the hierarchy.

Project Windows

Project windows are displayed for data files selected from the project workspace by double-clicking, and for online operations, such as transferring data and monitoring NC Unit operation. The project workspace or project windows can be made active simply by clicking on the required window. Project windows can also be made active by selecting **Window/Project** from the menu bar.

2-3-4 Displaying Menus

If, for example, you click **File**, or press the **Alt+F** Keys, a menu will be displayed. Select functions from the menu by clicking on the desired item.

Example: The following menu is displayed if you click **File**.



Shortcut keys are allocated to some functions. These allocations are displayed on the right side of the menu. For example, **New** can be selected by pressing the **Ctrl+N** Keys (i.e., by pressing the **N** Key while holding down the **Ctrl** Key).

If the menu is displayed, **New** can also be selected by pressing the **N** Key (i.e., the underlined letter).

2-3-5 Moving and Copying NC Unit Data

NC Unit data, such as parameters, sequences, and speeds, can be moved to other NC Units in the same project in units of NC Units either using drag-and-drop or by using the **Cut** and **Paste** commands. Data can also be copied using the **Copy** and **Paste** commands.

Moving NC Unit Data

NC Unit data can be moved between CPU Units of the same series. The following example shows how to move the data for NC2 on PC1 to PC2.



Either of the following 2 methods can be used.

■ Drag and Drop

- 1,2,3...**
1. Click NC2, and move the cursor across to PC 2 with the (left) mouse button held down. When the NC Unit Icon appears, release the mouse button.
The NC Unit Icon appears only if the data can be moved. If the data cannot be moved, the Operation Prohibited Icon will be displayed.

■ Cut and Paste

- 1,2,3...**
1. Click NC2 and execute the **Cut** command using any of the following methods:
 - Right-click and select **Cut** from the pop-up menu.
 - Select **Edit/Cut** from the menu bar.
 - Click the Cut Icon in the toolbar.
 2. Click PC 2 and paste the data using any of the following methods:
 - Right-click and select **Paste** from the pop-up menu.
 - Select **Edit/Paste** from the menu bar.
 - Click the Paste Icon in the toolbar.

If there is an NC Unit with the same unit number at the PC to which NC2 is copied, the dialog box below will be displayed. Set a new unit number (i.e., a unit number that is not used at that PC). Changing this setting will change the unit number of the NC Unit itself. The dialog box below indicates that the unit number of NC2 is already used for another NC Unit.

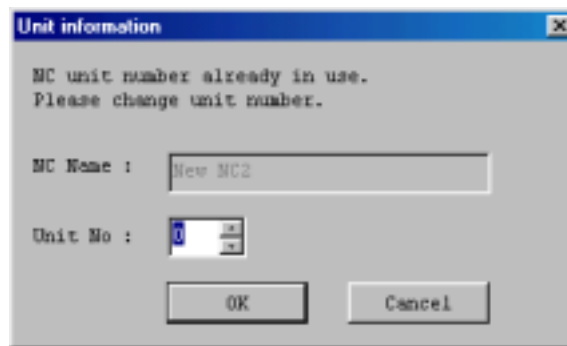

Copying NC Unit Data

When data is copied from one NC Unit to another, the data at the destination NC Unit is overwritten.

NC Unit data can be copied between CPU Units of the same series.

If data is copied to an NC Unit that controls a higher number of axes, only the data corresponding to the axes controlled by the source NC Unit is overwritten.

- 1,2,3...**
1. Click the icon of the source NC Unit.
 2. Copy the data using any of the following methods:
 - Right-click and select **Copy** from the pop-up menu.
 - Press the **Ctrl+C** Keys.
 - Select **Edit/Copy** from the menu bar.
 - Click the Copy Icon in the toolbar.
 3. Click the icon of the destination NC Unit and paste the data using any of the following methods:
 - Right-click and select **Paste** from the pop-up menu.
 - Press the **Ctrl+V** Keys.

- Select **Edit/Paste** from the menu bar.
- Click the Paste Icon in the toolbar.

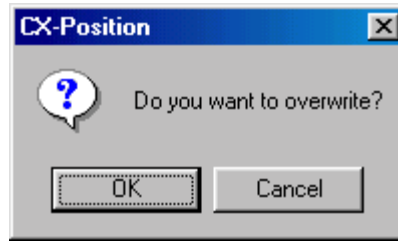

4. Click **OK**.

2-3-6 Main Menus

Main menu	Contents	Keyboard shortcut
<u>E</u> ile	Used to create, save, and print new projects.	Alt+F
<u>E</u> dit	Used to add or remove PCs and NC Units to/from projects, and edit NC Unit data.	Alt+E
<u>V</u> iew	Used to display or hide project trees, the toolbar, and the scroll bar, and to switch between decimal and hexadecimal display of NC Unit data.	Alt+V
<u>T</u> ool	Used to make optional settings (font, number of files displayed on the recently used file list, default display format (decimal/hexadecimal)).	Alt+T
<u>O</u> nline	Used for performing online operations, such as downloading, uploading, comparison, and monitoring.	Alt+L
<u>W</u> indow	Used to change the display method for the currently displayed editing window. It is also used to move the focus from the data editing window to the project tree.	Alt+W
<u>H</u> elp	Used to display help and version information.	Alt+H

2-3-7 Main Menu Items











The names and functions for all of the menus are given in the table below. When an item is selected, the dialog box for that function is displayed. Follow the instructions in the dialog box.

Main menu	Item	Contents	Keyboard shortcut
File	New	Creates a new project file.	Ctrl+N
	Open	Opens an existing project file.	Ctrl+O
	Close Project	Closes the active project.	---
	Close	Closes the active data editing window.	---
	Save Project	Saves the active project (overwrites the previous data).	Ctrl+S
	Save Project As	Saves the active project with a new name.	Ctrl+A
	Import	Imports data created for the C200HW-NC□13 with the SYSMAC-NT.	---
	Print	Prints all NC Unit data or specified data.	Ctrl+P
	Properties	Displays the properties for a project, PC, or NC Unit.	---
	Exit	Quits CX-Position.	---
Edit	New PC	Creates a new PC for a project.	---
	New NC	Creates a new NC Unit for a PC.	---
	Remove	Removes a specified PC or NC Unit from a project.	Del
	Undo	Undoes the previous operation.	Ctrl+Z
	Cut	<ul style="list-style-type: none"> Used to move a specified NC Unit in the project tree to another PC. Used to move data in specified range (other than parameter editing windows). 	Ctrl+X
	Copy	<ul style="list-style-type: none"> Used to copy data from a specified NC Unit in the project tree to another PC's NC Unit. Used to copy specified data in a data editing window. 	Ctrl+C
	Paste	Copies the data copied to the clipboard using Cut or Copy to a specified position.	Ctrl+V
	Display All	Displays all the data editing windows to a specified NC Unit. If there are already windows displayed, the remaining windows are displayed. Up to 90 windows can open at the same time. This command cannot be used if there are 90 or more windows open.	---
	Default Clear/Clear	<ul style="list-style-type: none"> The command Default Clear is displayed in parameter editing windows. It returns the parameter settings for a specified axis to their default values. The command Clear is displayed in other windows. This command clears specified data to 0. 	---
Copy Axis	Copies data in axis units.	---	

Main menu	Item	Contents	Keyboard shortcut
View	Project	Displays/hides project tree.	---
	Toolbar	Displays/hides toolbar.	---
	Status Bar	Displays/hides status bar.	---
	Change Display	Hexa-decimal	Changes the display format for the active data editing window and the input range display for the status bar to hexa-decimal.
Decimal		Changes the display format for the active data editing window and the input range display for the status bar to decimal.	---
Tool	Option	Displays the option dialog box. Used to perform the following settings. <ul style="list-style-type: none"> • Font name and size • Default display format (decimal/hexa-decimal) for data editing windows • Number of files displayed on the recently used files list (16 max.) 	---
Online	Download to NC	Transfers specified data or all data to a specified NC Unit.	---
	Upload from NC	Transfers specified data or all data from a specified NC Unit to a project.	---
	Verify	Compares editing data with the data of a specified NC Unit.	---
	Write Flash Memory	Writes NC Unit data to flash memory.	---
	Monitor	Monitors NC Unit operating status.	---
	Monitor Units (F)	Simultaneously monitors the operating status for 4 NC Units.	---
	Automatic NC Search	Reads information about the NC Units mounted to the PC connected online, and automatically creates a project based on this information. If the <i>Upload Data</i> check box is enabled, all data for the NC Units mounted to the specified PC is read and included in the project.	---
	Monitor NC Operating Memory Area	Monitors the commands, NC Unit status, I/O status, and error codes allocated to the operating memory area.	---
	Monitor NC Operating Data Area	Monitors the positions, speeds, acceleration/deceleration times, sequence numbers, and present positions specified in the operating data area.	---
View NC Error Log	Displays the error log for a specified NC Unit.	---	

Main menu	Item	Contents	Keyboard shortcut
Window	Display All (W)	Displays all the data editing windows that are represented as icons.	---
	Icon All	Displays all data editing windows as icons.	---
	Cascade	Displays editing windows on top of each other.	---
	Tile Horizontally	Displays editing windows arranged horizontally.	---
	Tile Vertically	Displays editing windows arranged vertically.	---
	Arrange Icons	Aligns editing windows represented as icons.	---
	Close All	Closes all open editing windows.	---
	Project	Moves the focus to the project tree.	---
Help	Contents	Displays the table of contents for help.	---
	Search	Displays the search window for help.	---
	Unit Error	Displays help for Unit errors.	---
	Version (A)	Displays the version information for CX-Position.	---

2-3-8 Operations Listed by Purpose

	Purpose	Operation	Keyboard shortcut	Toolbar icon	Reference section
Project	Creating a new project	File – New	Ctrl+N		3-1
	Opening a project	File – Open	Ctrl+O		5-2-1
	Closing a project	File – Close Project	---	---	2-3-2
	Saving (overwriting)	File – Save Project	Ctrl+S		5-1-1
	Saving with a different name	File – Save Project AS	Ctrl+A	---	5-1-1
	Importing	File – Import	---	---	5-2-2
	Printing	File – Print	Ctrl+P		9-1
	Creating a new PC	Edit – New PC or Right click – New PC	---		3-2-1
	Creating a new NC Unit	Select a PC – Edit/New NC or Select a PC – Right click – New NC	---		3-3-1
	Displaying the properties for a project, PC, or NC Unit	Select a PC or NC Unit – File – Properties or Select a PC – Right click – Properties	---	---	3-1
	Removing a PC or NC Unit	Select a PC or NC Unit – Edit – Remove or Select a PC or NC Unit – Right click – Remove	DEL		3-2-2, 3-3-2
	Cutting an NC Unit	Select an NC Unit – Edit – Cut or Select an NC Unit – Right click – Cut	Ctrl+X		2-3-5
	Copying NC Unit data	Select an NC Unit – Edit – Copy	Ctrl+C		2-3-5
	Pasting an NC Unit	Select a PC – Edit – Paste or Select a PC – Right click – Paste	Ctrl+V		2-3-5
	Pasting NC Unit data	Select an NC Unit – Edit – Paste or Select an NC Unit – Right click – Paste	Ctrl+V		2-3-5
	Moving NC Unit data	Drag the NC Unit using the mouse and drop it at the desired PC.	---	---	2-3-5

Purpose		Operation	Keyboard shortcut	Toolbar icon	Reference section
Display settings	Displaying/hiding a project	View – Project	---	---	2-3-12
	Displaying/hiding the toolbar	View – Toolbar	---	---	2-3-12
	Displaying/hiding the status bar	View – Status Bar	---	---	2-3-12
	Switching between decimal and hexadecimal display	<ul style="list-style-type: none"> • View – Change Display – Decimal or Hexadecimal • Right click in editing window – Decimal or Hexadecimal 	---	 	2-3-12, 4-2-3
	Opening all editing windows	<ul style="list-style-type: none"> • Select an NC Unit in a project – Edit – Display All • Select an NC Unit in a project – Right click – Display All • During data editing – Edit – Display All 	---	---	4-2-1
Editing data	Editing parameter data	<ul style="list-style-type: none"> • Select Edit NC Parameters in a project and double-click. • Select Edit NC Parameters in a project and press Enter. 	---	---	4-3-2
	Editing sequence data	<ul style="list-style-type: none"> • Select Edit Sequence in a project and double-click. • Select Edit Sequence in a project and press Enter. 	---	---	4-4
	Editing speed data	<ul style="list-style-type: none"> • Select Edit Speeds in a project and double-click. • Select Edit Speeds in a project and press Enter. 	---	---	4-5
	Editing acceleration/deceleration data	<ul style="list-style-type: none"> • Select Edit Accel/Decel in a project and double-click. • Select Edit Accel/Decel in a project and press Enter. 	---	---	4-6
	Editing dwell time data	<ul style="list-style-type: none"> • Select Edit Dwell Time in a project and double-click. • Select Edit Dwell Time in a project and press Enter. 	---	---	4-7
	Editing zone data	<ul style="list-style-type: none"> • Select Edit Zone in a project and double-click. • Select Edit Zone in a project and press Enter. 	---	---	4-8
	Initializing the data in a specified range	Edit – Cut	Ctrl+X		---

Purpose	Operation	Keyboard shortcut	Toolbar icon	Reference section	
Copying the data in a specified range	Edit – Copy	Ctrl+C		---	
Pasting the data in a specified range	Edit – Paste	Ctrl+V		---	
Undoing the last operation	Edit – Undo	Ctrl+Z		---	
Returning parameter data to default settings	Edit – Default Clear or In an editing window – Right click – Default Clear (Parameter editing windows only)	---	---	4-2-4	
Clearing data in a specified range to 0	Edit – Clear or In an editing window – Right click – Clear (Windows other than parameter editing windows)	---	---	4-2-4	
Copying data to another axis	Edit – Copy Axis	---	---	4-2-5	
Online operations	Downloading	Online – Download to NC	---		7-1
	Uploading	Online – Upload from NC	---		7-2
	Verification	Online – Verify	---		7-3
	Writing to flash memory	Online – Write Flash Memory	---		7-4
	Monitoring an NC Unit	Online – Monitor	---		8-1
	Monitor Units	Online – Monitor Units [F]	---		8-2
	Automatic setting of project	Online – Automatic NC Search	---	---	7-2-2
	Monitoring operating memory area	Online – Monitor NC Operating Memory Area	---	---	8-3
	Monitoring operating data area	Online – Monitor NC Operating Memory Area	---	---	8-4
	Displaying an error log	Online – View NC Error Log	---	---	10-1-2
Option settings	Making font settings	Tool – Option – Font	---	---	2-3-11
	Setting the default display format	Tool – Option – Default Display Format	---	---	2-3-11
	Setting the number of files displayed in the recently used files list	Tool – Option – Number of recent used files	---	---	2-3-11
Displaying help	Displaying help table of contents	Help – Contents	---	---	2-3-14
	Searching for help topics	Help – Search	---	---	2-3-14
	Displaying help for Unit errors	Help – Unit Error	---	---	2-3-14
	Displaying CX-Position version information	Help – Version (A)	---	---	2-3-14

2-3-9 Toolbar

Functions can be executed directly by clicking on the appropriate icon on the toolbar. The functions that can be executed from the toolbar are given below.



Number	Function	Number	Function
1	Creates a new project.	11	Inserts the clipboard contents at the insertion point.
2	Opens an existing project.	12	Download
3	Saves the active project.	13	Upload
4	Print	14	Verify
5	Adds a new PC.	15	Writes to flash memory
6	Adds a new NC Unit.	16	Monitors NC Unit operating status.
7	Delete	17	Monitors operating status for 4 NC Units.
8	Undo	18	Changes display format to decimal.
9	Cuts the selection and moves it to the clipboard.	19	Changes display format to hexadecimal.
10	Copies the selection and moves it to the clipboard.		

2-3-10 Status Bar

The following information is displayed on the status bar.



- Network information or the NC Unit's unit number
- PC or NC Unit model
- Communications mode (offline/online)
- When inputting data, the range that can be input is displayed here. Help is displayed at other times.

2-3-11 Option Settings

The following settings can be made as option settings.

- Name and size of font for data editing windows
- Default display format for data editing windows
- Number of files displayed in the recently used files list

Setting the Font Name and Size

- 1,2,3... 1. Click **Tool/Option**. The Option Dialog Box is displayed.

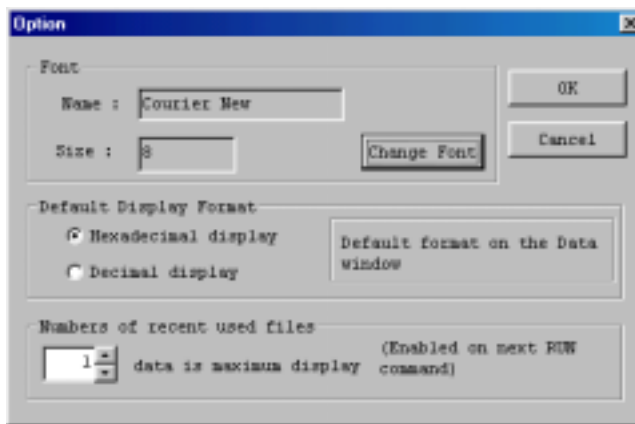

2. Click **Change Font**. The Change Font Dialog Box will be displayed.

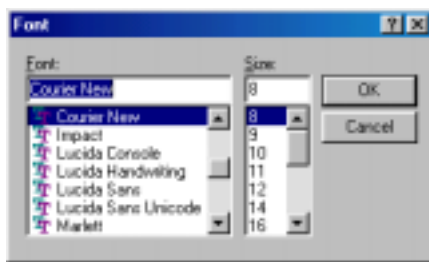

3. After selecting the desired font name and size from the drop-down lists, click **OK**.

Setting the Default (Startup) Display Format

1,2,3...

1. Click **Tool/Option**. The Option Dialog Box will be displayed.
2. Under **Default Display Format**, select either **Hexadecimal display** or **Decimal display**.

Setting the Number of Files Displayed in the Recently Used Files List

1,2,3...

1. Click **Tool/Option**. The Option Dialog Box will be displayed.
2. Under **Numbers of recent used files**, either enter a number directly or select a number from the drop-down list.

2-3-12 View Settings

The view settings can be used to display or hide the project tree, the toolbar, or the status bar, or change the display format (decimal/hexadecimal) for the active data editing window.

Display/Hide Settings

1,2,3...

1. Click **View**.

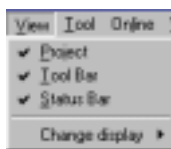

2. If a check appears next to **Project**, **Toolbar**, or **Status Bar**, the corresponding item is displayed. To hide any of these, click **Project**, **Toolbar**, or **Status Bar** to remove the check.

Setting the Display Format

Data in the active data editing window can be displayed in either decimal or hexadecimal. The default display format is set in the option settings.

1,2,3...

1. Select the data for which the display format is to be changed, and either right click, or click **View/Change display**.



2. Click either **Hexadecimal** or **Decimal** as desired.

Note

1. The display format can also be changed by right clicking in the editing window, and selecting either **Decimal** or **Hexadecimal** from the pop-up menu.
2. Hexadecimal cannot be used if the unit setting is either millimeter or inch. Use decimal display.

2-3-13 Setting the Network Type

Set the network type for online connection to the PC with FinsGateway. For details, refer to 6-2 *FinsGateway Configuration and Startup*.

2-3-14 Help**Displaying the Help Contents**

1,2,3...

1. Click **Help/Contents**. The table of contents for help will be displayed.

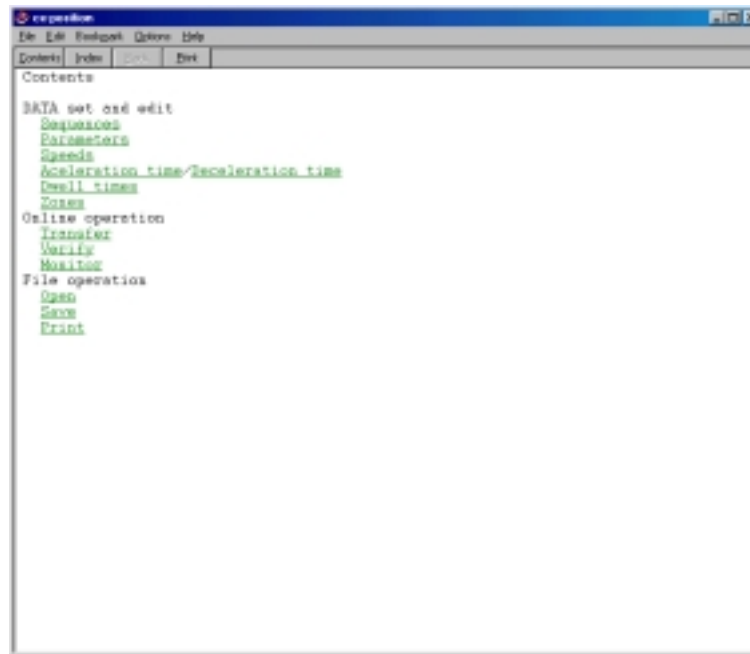

2. Click an item to display information relating to that item.

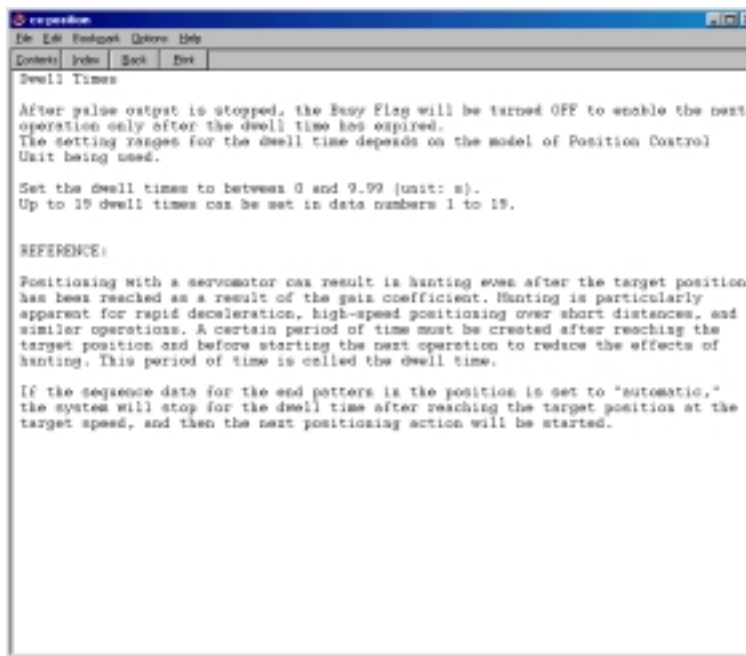

Searching by Key Word

- 1,2,3... 1. Click **Help/Search**. The Help Topics Dialog Box will be displayed.

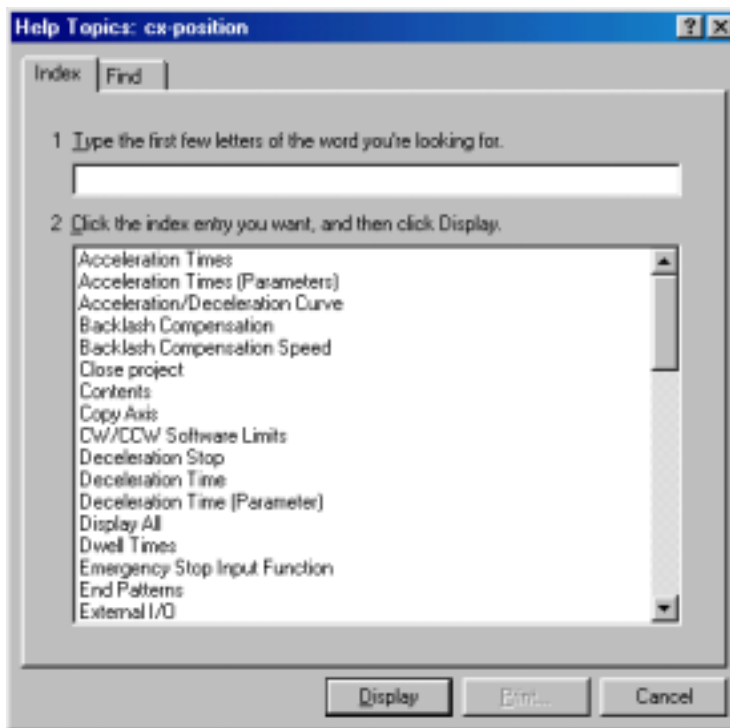

2. Enter the first few letters of the word to be searched for and press **Enter**. If a matching word is found, it is displayed in reverse video. Click **Display** or double-click to display the information for that word.

It is also possible to click directly on a key word (index entry) and then click **Display** or double-click to display the information for that word.

Some parameters are common to all axes and some are set individually for each axis. The parameters are given in the following table. The parameters for the axes are handled as parameter data for the CX-Position.

Parameter	Setting Range	Default
Unit Setting	False, mm, inch	False
Pulse Rate	0.0001 to 1	5
Output Pulse Selection	CW/CCW, Pulse direction	CW/CCW
Limit Input Signal Type	M.C. constant, N.C. constant	M.C.
CCW Software Limit	-1,073,741,823 to +1,073,741,823	-1,073,741,823
CW Software Limit	-1,073,741,823 to +1,073,741,823	+1,073,741,823
Blank Compensation	0 to 9999	0
Blank Compensation Speed	1 to 50000	0
Set Operation Mode	Mode 0 to Mode 3	Mode 0
Origin Search Operation	Reverse Mode 1, Reverse Mode 2, One-dir Mode	Reverse Mode 1
Origin Search Method	Method 0, Method 1, Method 2, Method 3	Method 0
Origin Search Direction	CW, CCW	CW
Origin Proximity Signal Type	M.C. constant, N.C. constant	N.C. constant
Origin Signal Type	M.C. constant, N.C. constant	N.C. constant
Origin Compensation	-1,073,741,823 to +1,073,741,823	0
Top Speed	1 to 50000	50000
Initial Speed	0 to 50000	0
Origin Search High Speed	1 to 50000	2500
Origin Search Proximity Speed	1 to 10000	2500
Acceleration/Deceleration Curve	Trapezoid, S-curve	Trapezoid
Acceleration Time	0 to 250000	100
Deceleration Time	0 to 250000	100

Displaying Unit Errors

Use the following procedure to display help for NC Unit errors.

1,2,3...

1. Click **Help/Unit Error**. The Error Code Help Dialog Box will be displayed.

NC Error Code Lists

- Error Code: 0001
- Error Code: 0002
- Error Code: 0003
- Error Code: 0010
- Error Code: 0011
- Error Code: 0012
- Error Code: 0014
- Error Code: 0020
- Error Code: 1000
- Error Code: 1001
- Error Code: 1010
- Error Code: 1010
- Error Code: 1011 to 1013
- Error Code: 1020
- Error Code: 1021 to 1029
- Error Code: 1030
- Error Code: 1032
- Error Code: 1000 to 1039
- Error Code: 1600
- Error Code: 1601
- Error Code: 1602
- Error Code: 1603
- Error Code: 1604
- Error Code: 1605
- Error Code: 1606
- Error Code: 1607
- Error Code: 1700
- Error Code: 1710

2. Click the relevant error code. Information about that error code will be displayed.



Displaying CX-Position Version Information

- 1,2,3...**
1. Click **Help/Version**. The CX-Position version information will be displayed.

SECTION 3

Creating New Projects

This section describes the procedures for creating new projects, as well as those for adding and deleting Programmable Controllers (PCs) and Position Control Units (NC Units).

3-1	Creating New Projects	38
3-2	Adding and Deleting PCs	39
3-2-1	Adding a PC	39
3-2-2	Deleting a PC	40
3-3	Adding and Deleting NC Units	41
3-3-1	Adding an NC Unit	41
3-3-2	Deleting an NC Unit	41
3-4	Automatic NC Unit Search	42

3-1 Creating New Projects

Use the following procedure to create a new project.

- 1,2,3... 1. Select **File/New**, press the **Ctrl+N** Keys, or select the *New Project* Icon from the toolbar.

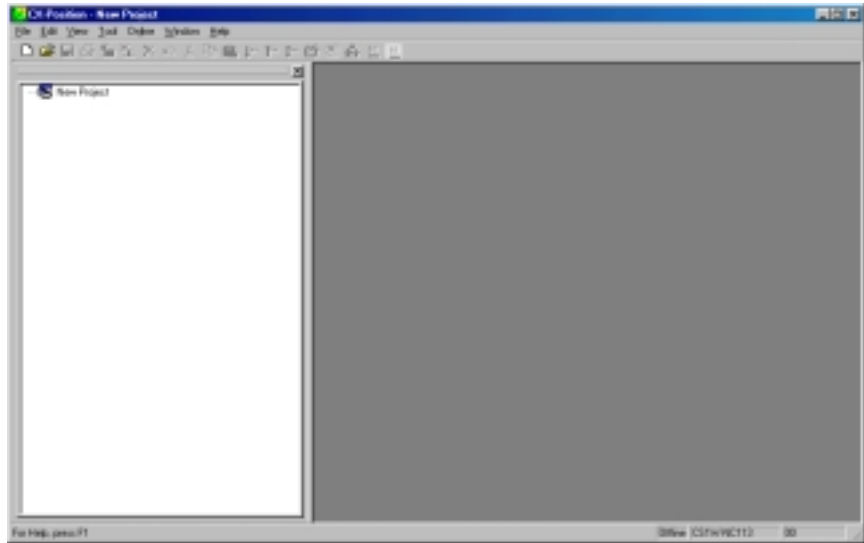

2. To change the project name, highlight the project and either select **File/Properties**, or right-click and select **Properties** from the pop-up menu.

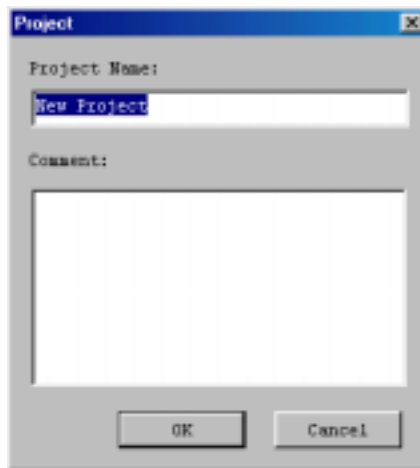

New Project is the default project name.

3. Enter the project name and click the **OK** Button. Comments can also be entered.

3-2 Adding and Deleting PCs

3-2-1 Adding a PC

Use the following procedure to add a PC to a new or existing project.

- 1,2,3... 1. Select the project from the project tree, and either select **Edit/New PC** or right-click and select **New PC** from the pop-up menu.



2. Enter the *Device Name*. *New PC*□ (where □ = 1, 2 etc.) is the default name.
3. Set the *PC Device Type* by clicking on the *PC Device Type* drop-down list and selecting the device type.
4. Set the *Network Address*, *Node Address*, and *Unit No.* under *Network Type* for the applicable PC on the FINS network.

Before making the above settings, however, the FinsGateway settings must be made. Match the *Network Type* settings to the FinsGateway settings.

Use the following settings when connecting using Host Link (SYSWAY-CV) and the default FinsGateway Serial Unit driver settings:

- Network Address: 0
- Node Address: 240 (default setting is 240, not 0)
- Unit No.: 0 (fixed setting)

Refer to 6-2 *FinsGateway Configuration and Startup* for information on FinsGateway settings.

Note When connecting using Host Link (SYSWAY-CV), the FinsGateway Serial Unit driver node number setting shown in the following window must match the *Node Address* set under the *Network Type*. The *Node Address* must be set to 240 to enable going online. Even if the protocol is correctly set to SYSWAY-CV, online access will not be possible with any other address because the FinsGateway Serial Unit driver default node number setting (shown in the following window) is 240. If CX-Position online operations are started with any oth-

er node address, a dialog box will be displayed saying that the selected PC is different from the connected PC.

The *Node Address* in the *Network Type* field must be set to this value (default setting for *Node Address*: 240).

(For FinsGateway, any setting can be used for the node number as long as it has not been used for another FINS Network node.

Default Setting for *Node #*: 240).

*1: This is the setting for the Host Link unit number (used to differentiate slaves). The setting remains 0 when connecting 1:1.

*2: Always use SYSWAY-CV for this setting

*3: Any setting may be used, including the default C200H

5. Enter a comment if required.
6. Click the **OK** Button to add the PC to the project.

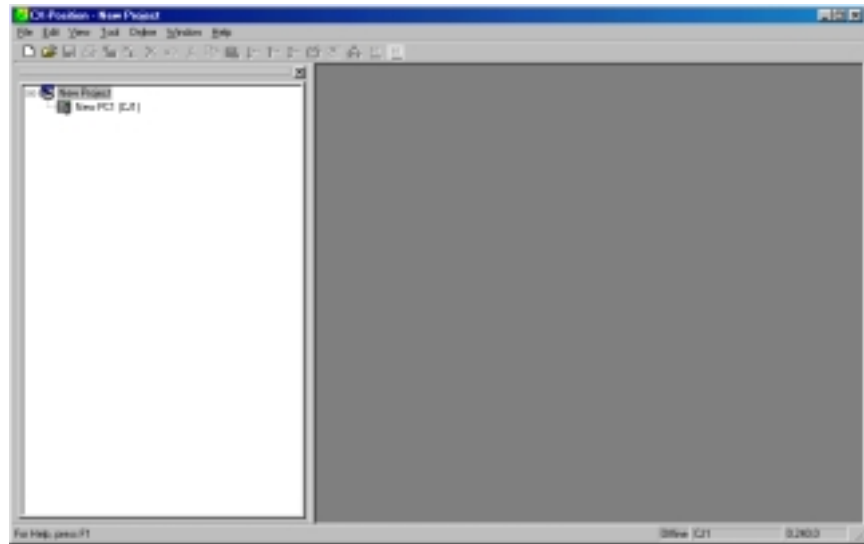

3-2-2 Deleting a PC

- 1,2,3... 1. Select the PC to be deleted from the project tree, and select **Edit/Remove DEL**, press the **DEL** Key, or right-click and select **Remove/DEL** from the pop-up menu.
2. A dialog box will be displayed asking “Do you want to delete?” Click the **OK** Button.

3-3 Adding and Deleting NC Units

3-3-1 Adding an NC Unit

Use the following procedure to add an NC Unit to a PC.

- 1,2,3... 1. Select the PC to be added to from the project tree.
2. Either select **Edit/New NC (M)**, or right-click and select **New NC (M)** from the pop-up menu.

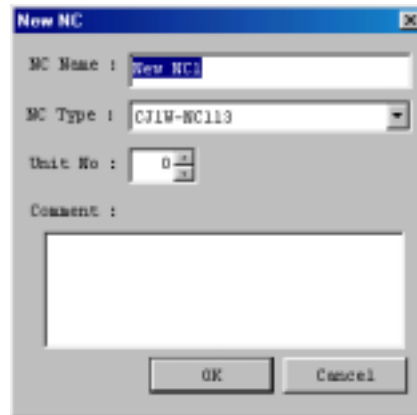

3. Enter the *NC Name*. *New NC* \square (where \square = 1, 2 etc.) is the default name.
4. Set the *NC Type* by clicking on the *NC Type* drop-down list and selecting.
5. Select the *Unit No.* allocated to the NC Unit (as a Special I/O Unit)
6. Enter a comment if required.
7. Click the **OK** Button to add the NC Unit to the project.

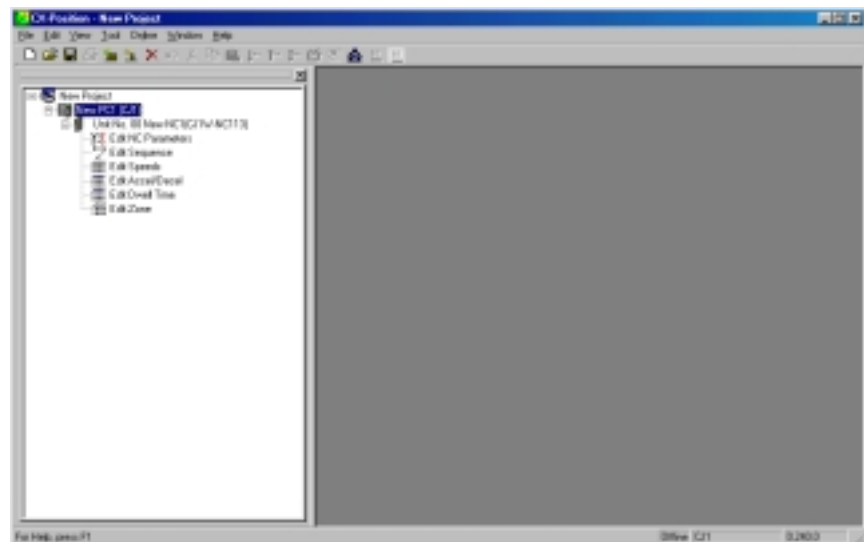

3-3-2 Deleting an NC Unit

- 1,2,3... 1. Select the NC Unit to be deleted from the project tree, and select **Edit/Remove DEL**, press the **DEL** Key, or right-click and select **Remove/DEL** from the pop-up menu.
2. A dialog box will be displayed asking "Do you want to delete?" Click the **OK** Button.

3-4 Automatic NC Unit Search

When online, data from all the NC Units mounted in the online PC can be read to automatically create NCs within a specified PC. At the same time, all the data read from the NC Units of the specified PC can be added as project data.

- 1,2,3...
1. Create a PC by either select **Edit/New PC**, or right-click and select **New PC** from the pop-up menu.
 2. Select the PC from the project tree and then select **Online/Automatic NC Search**.

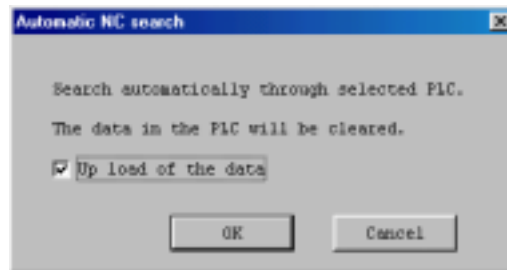

The Automatic NC Search Dialog Box, shown above, will be displayed.

3. Click the data upload checkbox to read all the data from the NC Units.
4. Click the **OK** Button to create NCs automatically. If there is data to be uploaded, the following window will appear.

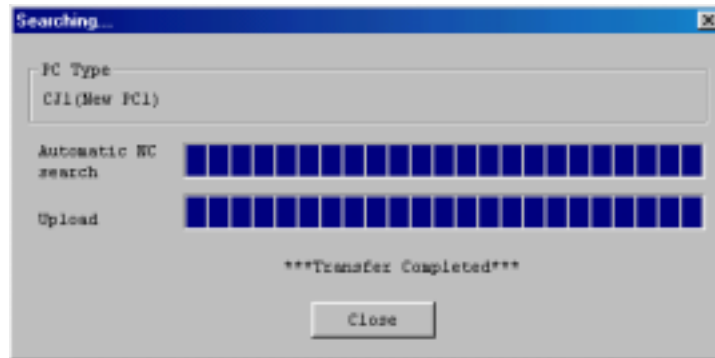

If there is no data to be uploaded, the following window will appear.

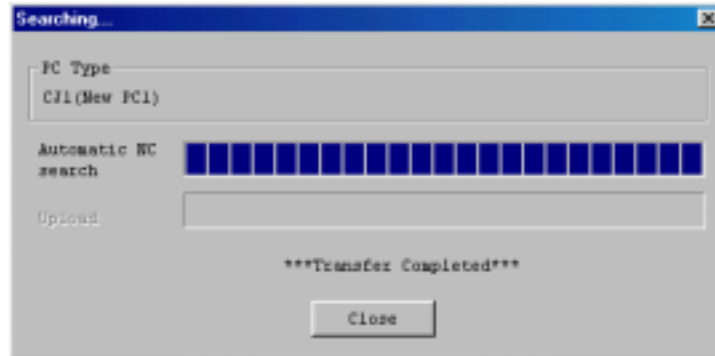

SECTION 4

Editing Settings

This section describes the procedures used to edit settings. This manual describes on the possible range of settings and setting procedures. Refer to the *Operation Manuals* for individual NC Units for details on the settings.

4-1	Overview	44
4-2	Setting Editing Screens	47
4-2-1	Displaying Setting Editing Screens	47
4-2-2	Editing Settings	52
4-2-3	Switching Setting Display Formats	53
4-2-4	Clearing Settings	53
4-2-5	Copying Axis Settings	54
4-3	Editing Parameter Settings	55
4-3-1	Parameter Setting Editing Screen	55
4-3-2	Editing Parameter Settings	55
4-4	Editing Sequence Settings	56
4-4-1	Sequence Editing Screen	56
4-4-2	Editing Sequence Settings	56
4-5	Editing Speed Settings	58
4-5-1	Speed Setting Editing Screen	58
4-5-2	Editing Speed Settings	58
4-6	Editing Acceleration/Deceleration Time Settings	59
4-6-1	Acceleration/Deceleration Time Setting Screen	59
4-6-2	Editing Acceleration/Deceleration Time Settings	59
4-7	Editing Dwell Time Settings	60
4-7-1	Dwell Time Setting Screen	60
4-7-2	Editing Dwell Time Settings	60
4-8	Editing Zone Settings	61
4-8-1	Zone Setting Screen	61
4-8-2	Editing Zone Settings	61

4-1 Overview

There are 6 types of settings used in CS1W-NC□□3/CJ1W-NC□□3 NC Units. Setting items, setting ranges and start values are shown in the following table.

Refer to the following operation manuals for details on specific settings.

Reference Manuals:

- SYSMAC CS1W-NC113/133/213/233/413/433 Position Control Units Operation Manual (W376)
- SYSMAC CJ1W-NC113/133/213/233/413/433 Position Control Units Operation Manual (W397)

Parameters

Item	Setting range	Default setting
Unit set (unit setting)	Pulse, mm, or inches	Pulse
Pulse rate	0.0001 to 1.0000 (See note 1.)	1.0000
Output pulse	CW/CCW output or pulse/direction output	CW/CCW output
Limit input sig type (limit input signal type)	N.C. or N.O.	N.C.
Ori prox sig type (origin proximity signal type)	N.C. or N.O.	N.O.
Ori sig type (origin signal type)	N.C. or N.O.	N.O.
Emerg stop fun (emergency stop function)	Only pulse output or error counter reset	Only pulse output
Non-origin setting (no origin setting)	Retain prior status or forcibly change to origin undefined status	Retain prior status
Set operation mode (operating mode setting)	Mode 0, Mode 1, Mode 2, or Mode 3	Mode 0
Ori search operation (origin search operation)	Reverse mode 1, Reverse mode 2, or Single-direction mode	Reverse mode 1
Ori search method	Method 0, Method 1, Method 2, or Method 3	Method 0
Ori search dir (origin search direction)	Clockwise (CW) or counterclockwise (CCW)	CW
Top speed (See notes 2 and 3.)	00000001 to 0007A120 Hex (1 to 500,000 pps)	0007A120 (500,000)
Start speed (See notes 2 and 3.)	00000000 to 0007A120 Hex (0 to 500,000 pps)	00000000 (0)
Ori search high speed (See notes 2 and 3.)	00000001 to 0007A120 Hex (1 to 500,000 pps)	000061A8 (25,000)
Ori search low speed (See notes 2 and 3.)	00000001 to 0007A120 Hex (1 to 500,000 pps)	000009C4 (2,500)
Ori compensation value (origin compensation value) (See notes 2 and 3.)	C0000001 to 3FFFFFFF Hex ($\pm 1,073,741,823$ pulses)	00000000 (0)
Backlash comp (backlash compensation) (See notes 2 and 3.)	0000 to 270F Hex (0 to 9,999 pulses)	0000 (0)
Backlash speed (See notes 2 and 3.)	00000000 to 0007A120 Hex (0 to 500,000 pps)	00000000 (0)
Acc/Dec curve (acceleration/deceleration curve)	Trapezoid or S-curve	Trapezoid
Acc time (See note 2.) (acceleration time)	00000000 to 0003D090 Hex (0 to 250,000 ms)	00000064 (100)
Dec time (deceleration time) (See note 2.)	00000000 to 0003D090 Hex (0 to 250,000 ms)	00000064 (100)
Positioning mon time (positioning monitor time) (See note 2.)	0000 to 270F Hex (0 to 9,999 pulses) (See note 4.)	270F (9,999)
CCW limit (See notes 2 and 3.)	C0000001 to 3FFFFFFF Hex ($\pm 1,073,741,823$ pulses)	C0000001 (-1,073,741,823)

Item	Setting range	Default setting
CW limit (See notes 2 and 3.)	C0000001 to 3FFFFFFF Hex ($\pm 1,073,741,823$ pulses)	3FFFFFFF (+1,073,741,823)
Initial pulse specification	250 pps or top speed	250 pps

- Notes**
- Always 1 if the unit is set to *Pulse*.
 - Settings can be entered and displayed in either hexadecimal or decimal format depending on the setting of the display format.
 - Ranges given in the table are for when the displayed value's unit is set to *Pulse*. When the set unit is millimeters or inches and the pulse rate is set to a value other than 1, the values displayed will change to the specified set value \times the pulse rate. The following settings are also affected:
 - Position
 - Zone
 - Speed
 - The position monitoring time must be set only when the operating mode is set to Mode 2 or Mode 3.

Sequences (X/Y/Z/U Axes: #0 to #99)

Only the X-axis settings are used for the CS1W-NC113/133 and CJ1W-NC113/133, and only the X- and Y-axis settings are used for the CS1W-NC213/233 and CJ1W-NC213/233. Settings can be entered in either hexadecimal or decimal format depending on display setting.

Item	Setting range
Position data	C0000001 to 3FFFFFFF Hex ($\pm 1,073,741,823$ pulses)
Axis set	X/Y/Z/U
Output code (See note 1.)	00 to 0F Hex (0 to 15)
Position designation	0 (absolute position) or 1 (relative position)
End code (completion code) (See note 1.)	00 to 06 Hex (0 to 6)
Dwell # (See note 1.)	00 to 13 Hex (0 to 19)
Accel. # (See note 1.)	0 to 9 Hex (0 to 9)
Decel. # (See note 1.)	0 to 9 Hex (0 to 9)
Start speed (See note 1.)	00 to 63 Hex (0 to 99)
Target speed (See note 1.)	00 to 63 Hex (0 to 99)

- Notes**
- These values can be entered and displayed in either hexadecimal or decimal format by setting the display format.
 - Ranges given in the table are for when the displayed value's unit is set to *Pulse*. When the set unit is millimeters or inches and the pulse rate is set to a value other than 1, the values displayed will change to the specified set value \times the pulse rate.

Speeds (X/Y/Z/U Axes: #0 to #99)

Only the X-axis settings are used for the CS1W-NC113/133 and CJ1W-NC113/133, and only the X- and Y-axis settings are used for the CS1W-NC213/233 and CJ1W-NC213/233. Settings can be entered and displayed in

either hexadecimal or decimal format depending on the setting of the display format.

Item	Setting range
Speed (See notes 1 and 2.)	00000000 to 000F4240 Hex (0 to 1,000,000) (pps)

- Notes**
- Settings can be entered and displayed in either hexadecimal or decimal format depending on the setting of the display format.
 - When the displayed value's set unit is *Pulse*. When the set unit is *mm* or *inches* and the pulse rate is set to other than 1, the value displayed will change.
 - The speeds set above can be set as interpolation speeds. However, make sure that the maximum speed of individual axes does not exceed 500,000 (pps) or the maximum speed set in the parameter settings.

Acceleration/Deceleration (X/Y/Z/U Axes: #1 to #9)

Only the X-axis settings are used for the CS1W-NC113/133 and CJ1W-NC113/133, and only the X- and Y-axis settings are used for the CS1W-NC213/233 and CJ1W-NC213/233. Settings can be entered and displayed in either hexadecimal or decimal format depending on the setting of the display format.

Item	Setting range
Acceleration (See note.)	00000000 to 0003D090 Hex (0 to 250,000) (ms)
Deceleration (See note.)	00000000 to 0003D090 Hex (0 to 250,000) (ms)

- Note** Settings can be entered and displayed in either hexadecimal or decimal format depending on the setting of the display format.

Dwell Time (X/Y/Z/U Axes: #1 to #19)

Only the X-axis settings are used for the CS1W-NC113/133 and CJ1W-NC113/133, and only the X- and Y-axis settings are used for the CS1W-NC213/233 and CJ1W-NC213/233. Settings can be entered and displayed in either hexadecimal or decimal format depending on the setting of the display format.

Item	Setting range
Dwell time (See note.)	0000 to 03E7 Hex (0.00 to 9.99) (s)

- Note** Settings can be entered and displayed in either hexadecimal or decimal format depending on the setting of the display format.

Zone (X/Y/Z/U Axes: Zone 0 to Zone 2)

Only the X-axis settings are used for the CS1W-NC113/133 and CJ1W-NC113/133, and only the X- and Y-axis settings are used for the CS1W-NC213/233 and CJ1W-NC213/233. Settings can be entered and displayed in either hexadecimal or decimal format depending on the setting of the display format.

Item	Setting range
Zone (See notes 1 and 2.)	C0000001 to 3FFFFFFF Hex ($\pm 1,073,741,823$) (pulses)

- Note**
- Settings can be entered and displayed in either hexadecimal or decimal format depending on the setting of the display format.
 - When the displayed value's set unit is *Pulse*. When the set unit is *mm* or *inches* and the pulse rate is set to other than 1, the value displayed will change to specified set value \times *Pulse Rate*.

4-2 Setting Editing Screens

Use the following procedures to display the screen shown below.

To create a new project:

- Select **File(F)/New**, or
- Press the **Ctrl+N** Keys; or
- Select the **New Project** Icon from the toolbar.

To select an existing project:

- Select **File(F)/Open**; or
- Press the **Ctrl+O** Keys; or
- Select the **Open** Icon from the toolbar.

Note Refer to *SECTION 5 Saving and Reading Projects* for information on opening an existing project

Example: The following screen will be displayed after creating a new project

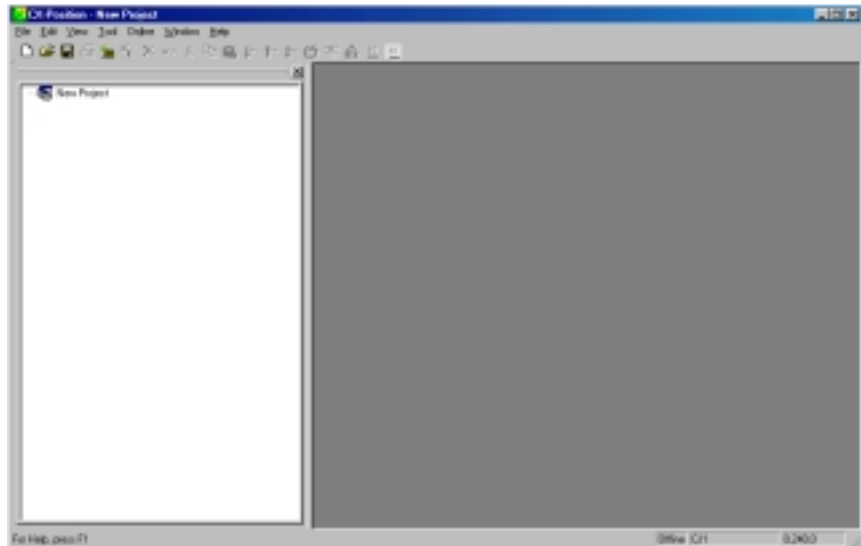

4-2-1 Displaying Setting Editing Screens

Use the following procedures to display individual Setting Editing Screens in project window.

To Display Individual Setting Editing Screens

With the project tree displayed, select the settings to be displayed for the specified NC, and either double-click or press the **Enter** Key.

X- and Y-axis editing screens will be displayed for 2-axis NC Units; X-, Y-, Z- and U-axis editing screens will be displayed for 4-axis NC Units

To Display the Parameter Editing Screen

- 1,2,3...
1. Under the NC on the project tree, either double-click **Edit NC Parameters**, or select it and press the **Enter** Key.

- The following screen will be displayed.

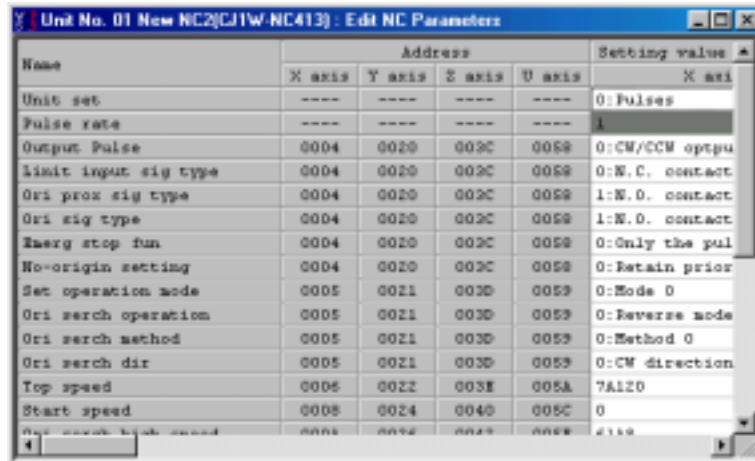

To Display the Sequence Editing Screen

- 1,2,3... 1. Under the NC on the project tree, either double-click *Edit Sequence*, or select it and press the **Enter** Key
2. The following screen will be displayed.

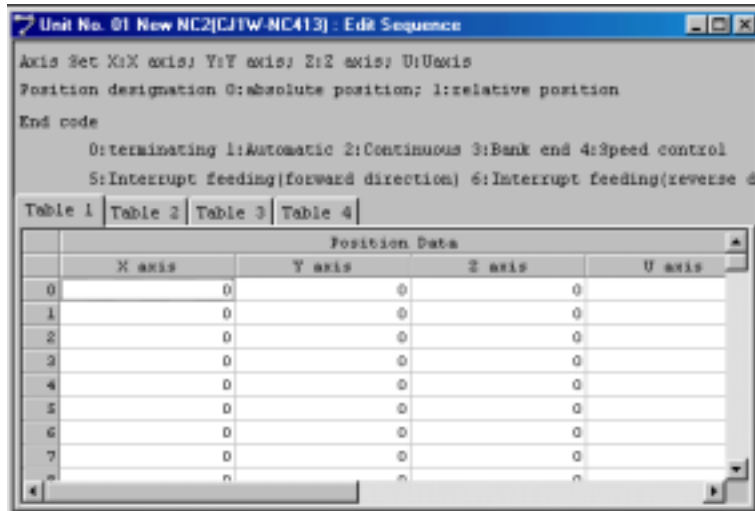

To Display the Speed Editing Screen

- 1,2,3... 1. Under the NC on the project tree, either double-click *Edit Speeds*, or select it and press the **Enter** Key.

- The following screen will be displayed.

No.	X axis	Y axis	Z axis	U axis
+0	0	0	0	0
+1	0	0	0	0
+2	0	0	0	0
+3	0	0	0	0
+4	0	0	0	0
+5	0	0	0	0
+6	0	0	0	0
+7	0	0	0	0
+8	0	0	0	0
+9	0	0	0	0
+10	0	0	0	0
+11	0	0	0	0
+12	0	0	0	0
+13	0	0	0	0
+14	0	0	0	0
+15	0	0	0	0
+16	0	0	0	0
+17	0	0	0	0
+18	0	0	0	0

To Display the Acceleration/Deceleration Editing Screen

- 1,2,3... 1. Under the NC on the project tree, either double-click *Edit Accel/Decel*, or select it and press the **Enter** Key
2. The following screen will be displayed.

No.	X axis		Y axis		Z axis		U axis
	Accel	Decel	Accel	Decel	Accel	Decel	Accel
+1	0	0	0	0	0	0	0
+2	0	0	0	0	0	0	0
+3	0	0	0	0	0	0	0
+4	0	0	0	0	0	0	0
+5	0	0	0	0	0	0	0
+6	0	0	0	0	0	0	0
+7	0	0	0	0	0	0	0
+8	0	0	0	0	0	0	0
+9	0	0	0	0	0	0	0

To Display the Dwell Time Editing Screen

- 1,2,3... 1. Under the NC on the project tree, either double-click *Edit Dwell Time*, or select it and press the **Enter** Key

2. The following screen will be displayed.

Mo.	X axis	Y axis	Z axis	U axis
+1	0	0	0	0
+2	0	0	0	0
+3	0	0	0	0
+4	0	0	0	0
+5	0	0	0	0
+6	0	0	0	0
+7	0	0	0	0
+8	0	0	0	0
+9	0	0	0	0
+10	0	0	0	0
+11	0	0	0	0
+12	0	0	0	0
+13	0	0	0	0
+14	0	0	0	0
+15	0	0	0	0
+16	0	0	0	0
+17	0	0	0	0
+18	0	0	0	0

To Display the Zone Editing Screen

- 1,2,3... 1. Under the NC on the project tree, either double-click *Edit Zone*, or select it and press the **Enter** Key
2. The following screen will be displayed.

		X axis	Y axis	Z axis	U axis
Zone 0	CW	0	0	0	0
	CCW	0	0	0	0
Zone 1	CW	0	0	0	0
	CCW	0	0	0	0
Zone 2	CW	0	0	0	0
	CCW	0	0	0	0

To Display All Editing Screens

To display all editing screens, select the NC and select **Edit/Display All**. Example: The following screen will be displayed after selecting **Edit/Display All**.

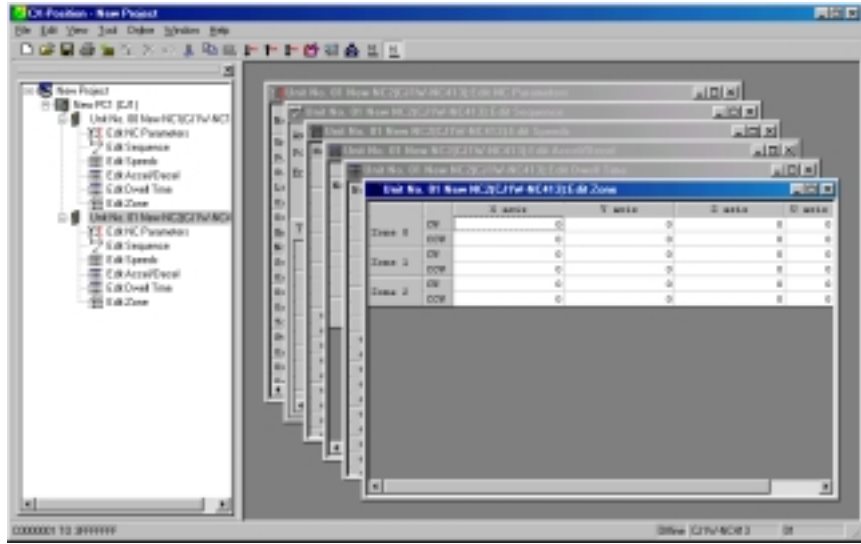

If multiple setting screens are displayed, select the screen to be edited to activate it, and edit individual settings.

To Use Each Editing Screen Window

Use the **Window** Menu to select various screen displays, minimize, and close screens, and arrange their contents.

Main menu	Command	Function
Window (W)	Display All	Displays all minimized screens.
	Icon All	Minimizes all screens.
	Cascade	Cascades screens.
	Tile Horizontally	Tiles screens horizontally.
	Tile Vertically	Tiles screens vertically.
	Arrange Icons	Arranges iconized screens within the window.
	Close All	Closes all screens.
	Project	Selects the project tree.

Screens can also be displayed and minimized by clicking directly on the upper-right screen buttons.

Click a minimized screen or on the left side of any screen's title bar to display the following menus.

Minimized screen

Title bar



Menu items and functions will be as follows.

Menu item	Function
Restore	Restores minimized screens to the project window.
Move	Moves screens.
Size	Sizes screens.
Minimize	Minimizes screens.
Maximize	Maximizes screens.
Close	Closes screens.
Next	Activates next screen.

4-2-2 Editing Settings

All settings can be set by selecting items from the drop-down lists on the Setting Editing Screens or by directly entering item list numbers. Use one of the following procedures to set individual setting types.

To Enter Settings

Selecting Items From Drop-Down Lists

- 1,2,3... 1. On the Setting Editing Screen, select the setting to be made, and either click the drop-down list arrow, or press the **Space Bar**.

Example: The following screen will be displayed when selecting from the drop-down list on the Pulse Rate Screen

Name	Address				Setting value
	X axis	Y axis	Z axis	U axis	X axis
Unit set	----	----	----	----	0:Pulses
Pulse rate	----	----	----	----	0:Pulses
Output Pulse	0004	0020	003C	0058	1:mm
Limit input sig type	0004	0020	003C	0058	2:inch

2. Select an item from the expanded drop-down list either by clicking on it directly, or by using the Up or Down Keys or entering its list number (0, 1, 2 etc.).
3. Press the **Enter** Key to collapse the list and set the settings.

Entering Settings Using List Numbers

- 1,2,3... 1. In the Setting Editing Screen, enter the desired settings directly.
2. Press the **Enter** Key, or use the Up or Down Keys, to set the setting.

- Note** 1. Settings can be displayed in either hexadecimal or decimal format. (Refer to 4-2-3 To Switch Settings Display Formats.)
2. When the Setting Editing Screen is active, the left-hand side of its status bar will display the possible range for entries.



Possible range for entries is displayed

Press the **Backspace** Key before setting an entry to alter it.

- Note** If entering settings directly, decimal values must be entered starting with the leading zero (i.e., 0.□□), not with the decimal point (i.e., .□□).

To Move the Cursor

Move the cursor in individual Setting Editing Screens either by using the Cursor Keys or by clicking in the screen directly.

To Move the Screen

Settings that cannot be displayed in a single screen can be viewed either by pressing the **PageDown** Key or by using the scroll bar on the right-hand side of the screen.

4-2-3 Switching Setting Display Formats

Settings on any Setting Editing Screen can be displayed in either hexadecimal or decimal format.

Switching the Current Settings Display Format

Switch the display format by selecting *Hexadecimal* or *Decimal* under **View/Change Display** on the Setting Editing Screen or by right-clicking and selecting *Hexadecimal* or *Decimal* from the pop-up menu.

Example: The following screens will be displayed for speed settings in hexadecimal (right) and decimal (left) formats

Decimal Notation

No.	X axis	Y axis
+0	500	500
+1	1000	1000
+2	2000	2000
+3	4000	4000
+4	8000	8000

Hexadecimal Notation

No.	X axis	Y axis
+0	1F4	1F4
+1	3E8	3E8
+2	7D0	7D0
+3	FA0	FA0
+4	1F40	1F40

Switching the Settings Display Format on Startup

Set the display format when starting up CX-Position by selecting **Tools/Options/Default Display Format**. Decimal is the default display format. To switch to hexadecimal display, select the *Hexadecimal Display* option.

4-2-4 Clearing Settings

Set parameter settings can be made into default settings and non-parameter setting ranges can be cleared.

To Clear to Default Settings

Use the following procedure to clear axis settings to their default values.

1,2,3...

1. With the Parameter Setting Editing Screen enabled, either select **Edit/Defaults Setting**, or right-click and select **Defaults Setting** from the pop-up menu.

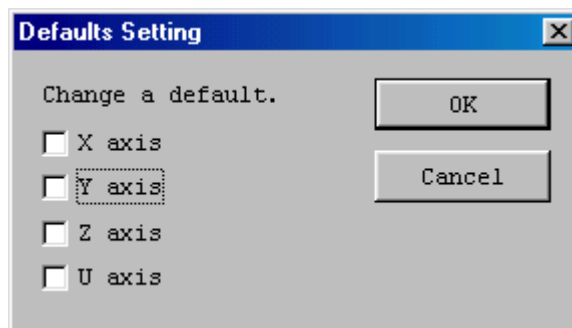

2. Select the axis for which settings are to be cleared to the defaults.
3. Click the **OK** Button.
4. A dialog box will be displayed asking if the settings should be returned to their default values. Click the **OK** Button.

To Clear Setting Ranges

Non-parameter settings can also be cleared.

- 1,2,3... 1. On the (non-parameter) editing screen, select the settings to be cleared, or designate the range by clicking and dragging.

No.	X axis	Y axis
+0	500	500
+1	1000	1000
+2	2000	2000
+3	4000	4000
+4	8000	8000

2. Select **Edit/Clear**, or right-click and select **Clear** from the pop-up menu.

No.	X axis	Y axis
+0	0	0
+1	0	0
+2	0	0
+3	0	0
+4	0	0

Note Under the **Edit** Menu, *Default Clear* is enabled when parameter settings are selected, and *Clear* is enabled when non-parameter settings are active.

4-2-5 Copying Axis Settings

For 2-axis and 4-axis NC Units, data can be copied from one axis to another axis by selecting the source and destination axes.

Applicable NC Units

4-axis NCs: CS1W-NC413/NC433 and CJ1W-NC413/NC433
 2-axis NCs: CS1W-NC213/NC233 and CJ1W-NC213/NC233

Settings That Can Be Copied

The following settings can all be copied using a single procedure.

- Parameters
- Sequences
- Speeds
- Accelerations/Decelerations
- Dwell Times
- Zones

- 1,2,3... 1. Select **Edit/Copy Axis**

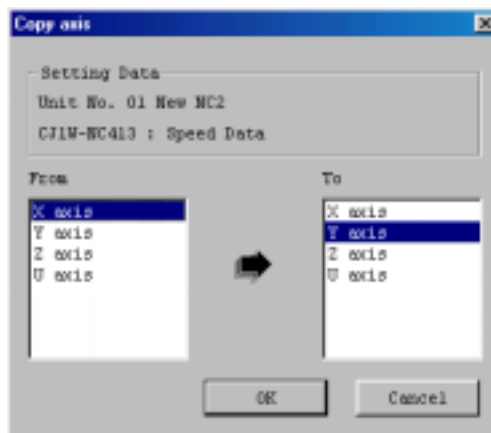

2. Under *From*, select the axis to be copied from. The default settings are from X axis to Y axis. The *From* axis cannot be the same as the *To* axis.

For 4-axis NC Units, if the same axis is clicked for the *To* axis as the one already selected for the *From* axis, the next *To* axis will be selected automatically (in the order Y, Z, U, X).

More than one axis can be selected for the *To* axis (except for the axis already selected as the *From* axis).

For 2-axis NC Units, selecting the Y axis as the *From* axis will automatically make the X axis the *To* axis, and vice-versa.

3. Change the *To* axis by clicking on and selecting a different axis.
4. Verify the *From* and *To* axes, and click the **OK** Button.

4-3 Editing Parameter Settings

4-3-1 Parameter Setting Editing Screen

Select *Parameters* on the project tree, and either double-click or press the **Enter** Key.

Example: The following will be displayed as the 4-axis NC Unit parameter Setting Editing Screen.

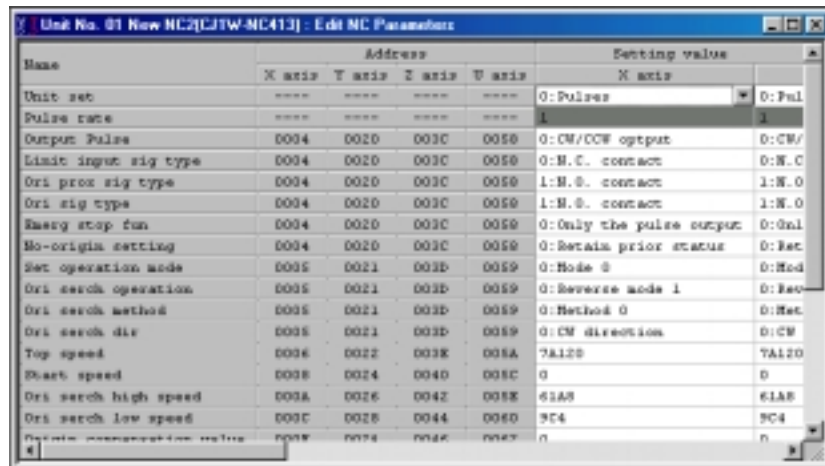

4-3-2 Editing Parameter Settings

Select a setting or enter settings directly. Refer to 4-2-2 *Editing Settings* for editing methods.

To Enter Settings

Selecting Settings From the Drop-down List

- 1,2,3...
1. On the Setting Editing Screen, select the setting to be set, and either click the drop-down list arrow or press the **Space** Bar.
 2. Select an item from the expanded drop-down list either by clicking on it directly, or by using the Up or Down Keys or entering its list number (0, 1, 2 etc.).
 3. Press the **Enter** Key to collapse the list and set the settings.

Entering Settings Using the List Numbers

- 1,2,3...
1. In the Setting Editing Screen, enter directly the setting to be set.
 2. Press the **Enter** Key or use the Up or Down Keys to set the setting.

Clearing to Default Settings

Use the following procedure to clear the axis settings to their default values. (Refer to 4-2-4 *Clearing Settings* for details.)

- 1,2,3...
1. On the Parameter Setting Editing Screen, either select **Edit/Defaults Setting**, or right-click and select **Defaults Setting** from the pop-up menu.
 2. Select the axis whose settings are to be cleared to the default values.
 3. Click the **OK** Button.
 4. A dialog box will be displayed asking if the settings should be returned to their default values. Click the **OK** Button.

To Copy Axes

For 2-axis and 4-axis NC Units, data can be copied from one axis to another axis by selecting the source and destination axes. (Refer to 4-2-5 *Copying Axis Settings* for details.)

- 1,2,3...
1. Select **Edit/Copy Axis**.
 2. Under *From* and *To*, select the axes to be copied from and to respectively.
 3. Click the **OK** Button.

4-4 Editing Sequence Settings

4-4-1 Sequence Editing Screen

On the project tree, either double-click *Edit Sequence*, or select it and press the **Enter** Key.

For single axis NC Units, only the *Table 1* Tab will be displayed; for 2-axis NC Units, only the *Table 1* and *Table 2* Tabs will be displayed.

Example: The following will be displayed as the 4-axis NC Unit sequence Setting Editing Screen.

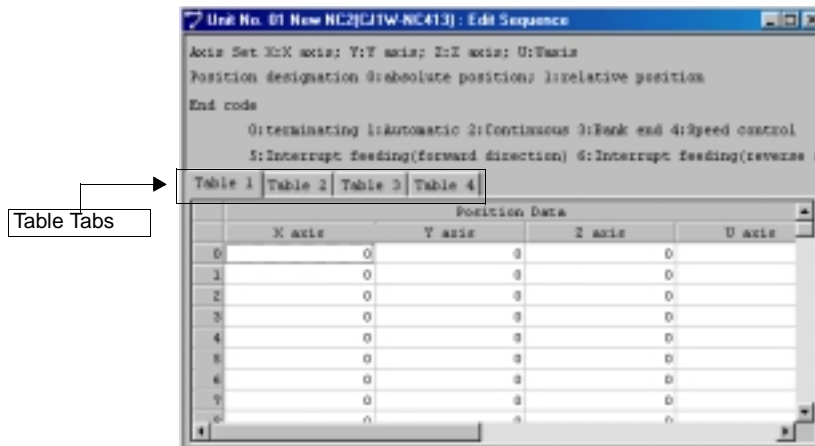

4-4-2 Editing Sequence Settings

Enter each sequence setting in order. Refer to 4-2-2 *Editing Settings* for editing methods

The following items and setting ranges will be displayed.

Item	Setting range
Position data	Pulses: C0000001 to 3FFFFFFF Hex ($\pm 1,073,741,823$) mm or inches: pulse set value \times pulse rate
Axis set	X/Y/Z/U
Output code	00 to 0F Hex (0 to 15)

Item	Setting range
Position designation	0 (absolute position) or 1 (relative position)
End code	00 to 06 Hex (0 to 6) 0 = terminating; 1 = automatic; 2 = continuous; 3 = bank end; 4 = speed control; 5 = interrupt feeding (forward direction); 6 = interrupt feeding (reverse direction)
Dwell #	00 to 13 Hex (0 to 19) (no dwell time for 0)
Accel. #	0 to 9 Hex (0 to 9) (0 = Acceleration time in parameter settings)
Decel. #	0 to 9 Hex (0 to 9) (0 = Deceleration time in parameter settings)
Start speed	00 to 63 Hex (0 to 99)
Target speed	00 to 63 Hex (0 to 99)

No particular axis is allocated to Tables 1 to 4, but between tables the same axis cannot be specified in the same sequence.

Example: The following screen will be displayed after setting sequence Numbers 0 to 3 in Table 1 for a 4-axis NC Unit.

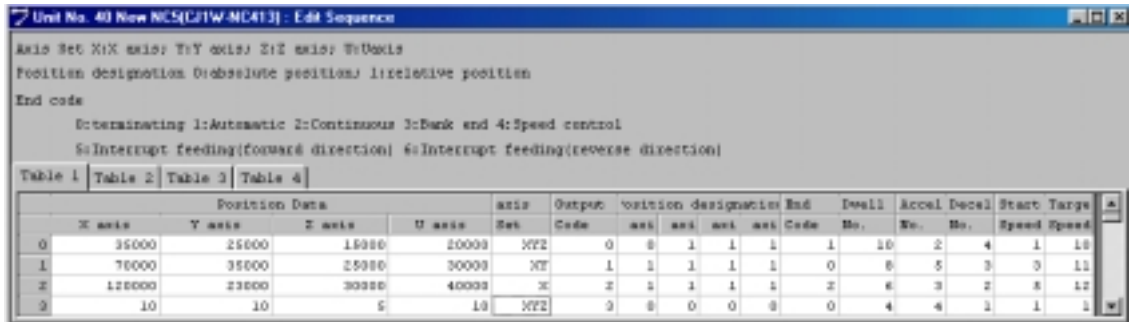

To Clear to Default Settings

Use the following procedure to clear specific settings to their default values. (Refer to 4-2-4 Clearing Settings for details.)

- 1,2,3... 1. On the Sequence Setting Editing Screen, select the settings to be cleared to the default values, or designate the range by clicking and dragging.
2. Select **Edit/Clear**

To Copy Axes

For 2-axis and 4-axis NC Units, data can be copied from one axis to another axis by selecting the source and destination axes. (Refer to 4-2-5 Copying Axis Settings for details.)

- 1,2,3... 1. Select **Edit/Copy Axis**.
2. Under *From* and *To*, select the axes to be copied from and to respectively.
3. Click the OK Button.

4-5 Editing Speed Settings

4-5-1 Speed Setting Editing Screen

On the project tree, either double-click *Edit Speeds*, or select it and press the **Enter** Key.

Example: The following will be displayed as the 4-axis NC Unit speed Setting Editing Screen.

No.	X axis	Y axis	Z axis	W axis
+0	0	0	0	0
+1	0	0	0	0
+2	0	0	0	0
+3	0	0	0	0
+4	0	0	0	0
+5	0	0	0	0
+6	0	0	0	0
+7	0	0	0	0
+8	0	0	0	0
+9	0	0	0	0
+10	0	0	0	0
+11	0	0	0	0
+12	0	0	0	0
+13	0	0	0	0
+14	0	0	0	0
+15	0	0	0	0
+16	0	0	0	0
+17	0	0	0	0
+18	0	0	0	0

4-5-2 Editing Speed Settings

The speed setting range is from 00000000 to 000F4240 Hex (0 to 1,000,000) (pps). If the pulse rate is set to a value other than 1, the value displayed will change to specified set value times the pulse rate. Refer to 4-2-2 *Editing Settings* for editing methods.

Note The speeds set above can be set as interpolation speeds. Make sure, however, that the maximum speed of individual axes does not exceed 500,000 (pps) or the maximum speed set in the parameter settings.

Example: The following will be displayed as the Speed Setting Editing Screen.

No.	X axis	Y axis	Z axis	W axis
+0	1000	1000	1000	1000
+1	2000	2000	2000	2000
+2	3000	3000	3000	3000
+3	4000	4000	4000	4000

To Clear to Default Settings

Use the following procedure to clear specific settings to their default values. (Refer to 4-2-4 *Clearing Settings* for details.)

- 1,2,3... 1. On the speed Setting Editing Screen, select the settings to be cleared to their default values, or designate the range by clicking and dragging.
2. Select **Edit/Clear**

To Copy Axes

For 2-axis and 4-axis NC Units, data can be copied from one axis to another axis by selecting the source and destination axes. (Refer to 4-2-5 *Copying Axis Settings* for details.)

- 1,2,3... 1. Select **Edit/Copy Axis**.
2. Under *From* and *To*, select the axes to be copied from and to respectively.
3. Click the OK Button.

4-6 Editing Acceleration/Deceleration Time Settings

4-6-1 Acceleration/Deceleration Time Setting Screen

On the project tree, either double-click *Edit Accel/Decel*, or select it and press the **Enter** Key.

Example: The following will be displayed as the 4-axis NC Unit Acceleration/Deceleration Time Setting Editing Screen.

No.	X axis		Y axis		Z axis		U axis	
	Accel	Decel	Accel	Decel	Accel	Decel	Accel	Decel
+1	0	0	0	0	0	0	0	0
+2	0	0	0	0	0	0	0	0
+3	0	0	0	0	0	0	0	0
+4	0	0	0	0	0	0	0	0
+5	0	0	0	0	0	0	0	0
+6	0	0	0	0	0	0	0	0
+7	0	0	0	0	0	0	0	0
+8	0	0	0	0	0	0	0	0
+9	0	0	0	0	0	0	0	0
+0	0	0	0	0	0	0	0	0

4-6-2 Editing Acceleration/Deceleration Time Settings

The acceleration/deceleration time setting range is from 00000000 to 0003D090 Hex (0 to 250,000) (ms). After the settings have been entered and the Enter Key pressed, the cursor will move to the next setting.

Example: The following will be displayed as the Acceleration/Deceleration Time Setting Editing Screen.

No.	Y axis		Z axis		U axis	
	Accel	Decel	Accel	Decel	Accel	Decel
+1	1000	2000	300	150	400	200
+2	1000	1000	600	200	800	400
+3	1400	1000	900	300	1200	600

To Clear to Default Settings

Use the following procedure to clear specific settings to their default values. (Refer to 4-2-4 *Clearing Settings* for details.)

- 1,2,3... 1. On the acceleration/deceleration Setting Editing Screen, select the settings to be cleared to their default values, or designate the range by clicking and dragging.
2. Select **Edit/Clear**

To Copy Axes

For 2-axis and 4-axis NC Units, data can be copied from one axis to another axis by selecting the source and destination axes. (Refer to 4-2-5 *Copying Axis Settings* for details.)

- 1,2,3... 1. Select **Edit/Copy Axis**.
2. Under *From* and *To*, select the axes to be copied from and to respectively.
3. Click the OK Button.

4-7 Editing Dwell Time Settings

4-7-1 Dwell Time Setting Screen

On the project tree, either double-click *Edit Dwell Time*, or select it and press the **Enter** Key.

Example: The following will be displayed as the 4-axis NC Unit Dwell Time Setting Editing Screen.

No.	X axis	Y axis	Z axis	U axis
+0	0	0	0	0
+1	0	0	0	0
+2	0	0	0	0
+3	0	0	0	0
+4	0	0	0	0
+5	0	0	0	0
+6	0	0	0	0
+7	0	0	0	0
+8	0	0	0	0
+9	0	0	0	0
+10	0	0	0	0
+11	0	0	0	0
+12	0	0	0	0
+13	0	0	0	0
+14	0	0	0	0
+15	0	0	0	0
+16	0	0	0	0

4-7-2 Editing Dwell Time Settings

The dwell time setting range is from 0000 to 03E7 Hex (0.00 to 0.99) (s). Refer to 4-2-2 *Editing Settings* for editing methods.

Example: The following will be displayed as the Dwell Time Setting Editing Screen.

No.	X axis	Y axis	Z axis	U axis
+0	0.20	0.30	1.00	0.50
+1	0.40	0.20	2.00	1.50
+2	0.60	0.30	3.00	1.50
+3	0.80	0.40	4.00	2.00

To Clear to Default Settings

Use the following procedure to clear specific settings to their default values. (Refer to 4-2-4 *Clearing Settings* for details.)

- 1,2,3... 1. On the dwell time Setting Editing Screen, select the settings to be cleared to their default values, or designate the range by clicking and dragging.
2. Select **Edit/Clear**

To Copy Axes

For 2-axis and 4-axis NC Units, data can be copied from one axis to another axis by selecting the source and destination axes. (Refer to 4-2-5 *Copying Axis Settings* for details.)

- 1,2,3... 1. Select **Edit/Copy Axis**.
2. Under *From* and *To*, select the axes to be copied from and to respectively.
3. Click the OK Button.

4-8 Editing Zone Settings

4-8-1 Zone Setting Screen

On the project tree, either double-click *Edit Zone*, or select it and press the **Enter** Key.

Example: The following will be displayed as the 4-axis NC Unit Zone Setting Editing Screen.

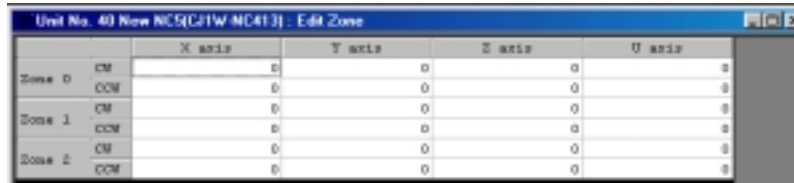

		X axis	Y axis	Z axis	U axis
Zone 0	CW	0	0	0	0
	CCW	0	0	0	0
Zone 1	CW	0	0	0	0
	CCW	0	0	0	0
Zone 2	CW	0	0	0	0
	CCW	0	0	0	0

4-8-2 Editing Zone Settings

The zone setting range is as follows.

Pulse: C0000001 to 3FFFFFFF Hex ($\pm 1,073,741,823$) (pulse)

mm or inches: Above set value \times pulse rate

Example: The following will be displayed as the Zone Setting Editing Screen (hexadecimal display shown).



		X axis	Y axis	Z axis	U axis
Zone 0	CW	1FFFFFFF	FFFFFFF	2FFFFFFF	7FFFFFFF
	CCW	B0000001	F0000001	10000001	F0000001
Zone 1	CW	17FFFFFFF	7FFFFFFF	10000001	6FFFFFFF
	CCW	00000000	00000000	00000001	1FFFFFFF
Zone 2	CW	3FFFFFFF	5FFFFFFF	7FFFFFFF	3FFFFFFF
	CCW	FFC00001	FFA00001	FF000001	FF600001

To Clear to Default Settings

Use the following procedure to clear specific setting to their default values. (Refer to 4-2-4 *Clearing Settings* for details.)

- 1,2,3... 1. On the zone Setting Editing Screen, select the settings to be cleared to their default values, or designate the range by clicking and dragging.
2. Select **Edit/Clear**

To Copy Axes

For 2-axis and 4-axis NC Units, data can be copied from one axis to another axis by selecting the source and destination axes. (Refer to 4-2-5 *Copying Axis Settings* for details.)

- 1,2,3... 1. Select **Edit/Copy Axis**.
2. Under *From* and *To*, select the axes to be copied from and to respectively.
3. Click the **OK** Button.

SECTION 5

Saving and Reading Projects

This section provides information about saving and reading files.

5-1	Saving Projects	64
5-1-1	Saving a Project	64
5-2	Reading Projects	65
5-2-1	Reading a Project	65
5-2-2	Importing C200HW-NC□□□ NC Settings	65

5-1 Saving Projects

5-1-1 Saving a Project

To save a project, select **File/Save Project (Ctrl+S)** to resave an edited project under the same name or **File/Save Project As (Ctrl+A)** to save a new or existing project under a new name.

To Save a Project Under a New Name

- 1,2,3... 1. Select **File/Save Project As** to display the Save As Window.

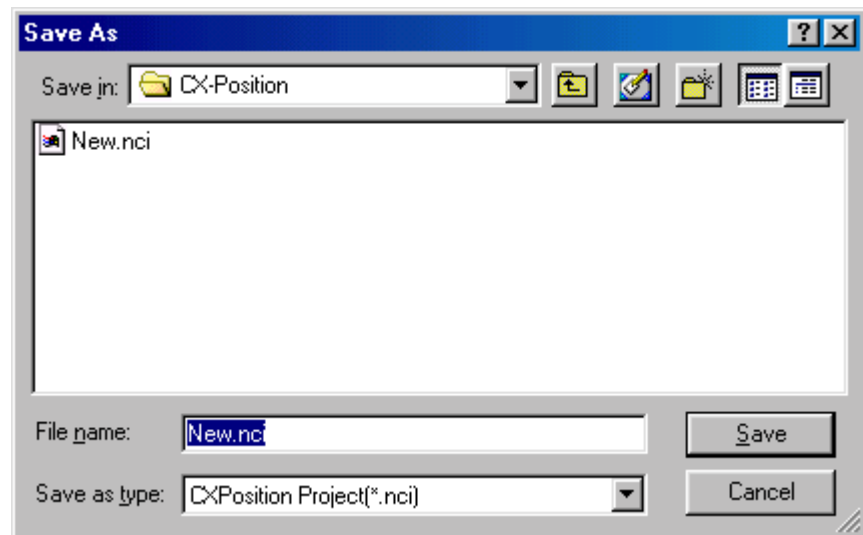

2. Enter the folder to be saved in, or select one by clicking on the arrow to expand the drop-down list. (The folder into which CX-Position was installed will be the default folder.) Enter or select the file name, and the Save as file type (CX-Position default file type: *.nci) and press the **Save** Button.

5-2 Reading Projects

5-2-1 Reading a Project

Select **File/Open** (Ctrl+O) to open a saved project.

- 1,2,3... 1. Select **File/Open**.

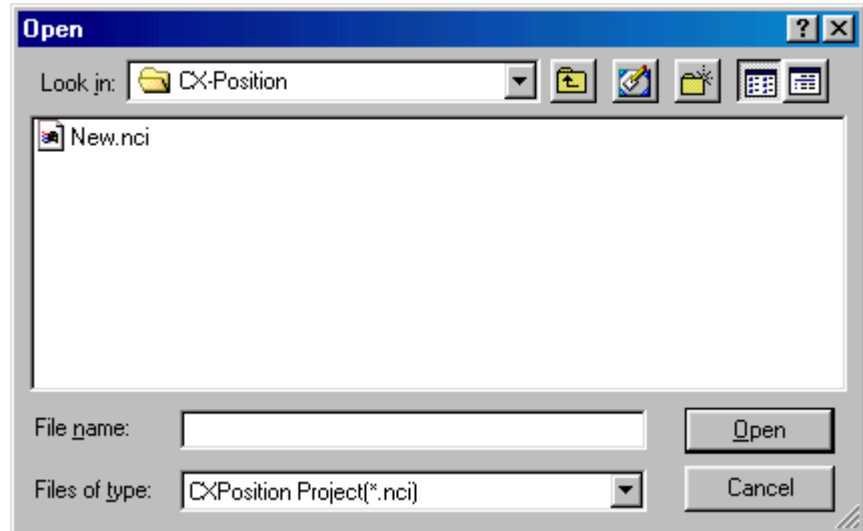

2. From the *Look in* drop-down list, select the drive and folder to which the project was saved.
3. Enter the project name, or select one from the file list. Set the *Files of type:* field to *.nci.
4. Click the **Open** Button.

5-2-2 Importing C200HW-NC@@@ NC Settings

C200HW-NC□□□ data created using the SYSMAC-NCT can be imported as NC project data.

- 1,2,3... 1. Select **File/Import**.



2. From the *Look in* drop-down list, select the drive and folder to which the file to be imported was saved.
3. Enter the file name, or select one from the file list. Set the *Files of type* field to *.ncm.
4. Click the **Open** Button.

SECTION 6

Online Connection Default Configurations

This section provides information on default configurations for connecting online.

If OMRON Support Software that communicates using CX-Server (e.g., CX-Programmer, CX-Protocol, or CX-Motion) or an application that uses a special serial driver is connected online, it is not possible to perform online operations from CX-Position using the same COM port. The reverse is also true.

Quit online connection for the OMRON Support Software that communicates using CX-Server (e.g., CX-Programmer, CX-Protocol, or CX-Motion) or the application that uses a special serial driver, and then re-attempt online operations from CX-Position after starting up FinsGateway's Serial Unit servicing.

6-1	Default Configurations for Connecting Online.	68
6-1-1	Connecting via Host Link (SYSWAY-CV).	68
6-2	FinsGateway Configuration and Startup.	68
6-2-1	Standard Configuration and Startup Procedure	68
6-2-2	Example: Configuration and Startup Procedures via Host Link (SYSWAY-CV).	69

6-1 Default Configurations for Connecting Online

Online connection enables using the following CX-Position software functions.

- Download to NC
- Upload from NC
- Verify
- Write Flash Memory
- Monitor
- Monitor Units
- Monitor NC Operating Memory Area
- Monitor NC Operating Data Area
- View NC Error Log

The following FinsGateway settings are required to connect the CX-Position software online to a PC using serial communications (with the Host Link protocol) and execute the functions in the previous list.

6-1-1 Connecting via Host Link (SYSWAY-CV)

CPU and NC Unit Default Configuration

- 1,2,3...
1. Set the NC Unit's unit number (using the front-panel rotary switches)
 2. Create the I/O tables (using the CX-Programmer or Programming Console)
 3. Set the DIP switch on the CPU Unit's front panel.
 - If using a peripheral port, turn ON pin 4, and set the PC Setup (set Programming Console address 144 to the 0000 Hex default, if not already set to it).
 - If using an RS-232C port, turn OFF pin 5, and set the PC Setup (set Programming Console address 160 to the 0000 Hex default, if not already set to it).

FinsGateway Configuration and Startup

Refer to 6-2 *FinsGateway Configuration and Startup* for details.

6-2 FinsGateway Configuration and Startup

6-2-1 Standard Configuration and Startup Procedure

The following are the standard configuration and startup procedures.

- 1,2,3...
1. From the *Start* Menu, select **Programs/FinsGateway/FinsGateway Configuration**.
 2. Double-click each communications driver under *Networks/Drivers* on the **Basic** Tab Page and set the required configuration (e.g., the COM Port, protocol, communications parameters, and other settings). The following FinsGateway configurations must match the *Network Configuration* configurations set when the PC was added to CX-Position.

FinsGateway	Adding a PC to CX-Position
Network number under the Network Tab's Network	Network Address under Network Settings
Node... in the Nodes Tab.	Node Number under Network Settings

3. Select each communications driver under *Services* on the standard tab page, and click the **Startup** Button.
4. Online operations, such as data transfer, comparison, and NC monitoring, are executed from CX-Position.

6-2-2 Example: Configuration and Startup Procedures via Host Link (SYSWAY-CV)

The following FinsGateway configuration procedures show an example of connecting the CX-Position to a PC via Host Link (SYSWAY-CV).

- Note**
1. The SYSWAY-CV protocol sends FINS commands, together with Host Link headers, terminators and other data, in Host Link protocol, and is different from SYSWAY (which issues C-mode commands). The CX-Position uses the SYSWAY-CV protocol for communications with the NC Unit via a CS- or CV-series CPU Unit. Communications are not possible with SYSWAY (a communications error will occur when an online connection is attempted).
 2. The node number setting on the FinsGateway *Nodes* Tab Page must match the node number set when the PC was added to the project. If not, a dialog box will be displayed saying that the selected PC and connected PC models conflict, and online connection will be disabled.
 3. Refer to FinsGateway online help (under *Programs/FinsGateway/FinsGateway Help*, with FinsGateway installed) for details on configuration methods. Following are the configuration procedures for FinsGateway serial communications (Host Link).

Configuring and Starting FinsGateway

From the **Start** Menu, select **Programs/FinsGateway/FinsGateway Configuration**.

Selecting the Computer COM Port for Connection

FinsGateway Host Link is handled as a network on one of the computer's COM Ports, the COM Port to be used must be set (several ports may be specified).

- 1,2,3...
1. Select the **Drivers** Icon under the **Basic** Tab in the FinsGateway Configuration Screen.
 2. Double-click *SerialUnit* in the *Driver Settings*.
 3. Click the *Lines* Tab, and check the COM Port to be used.

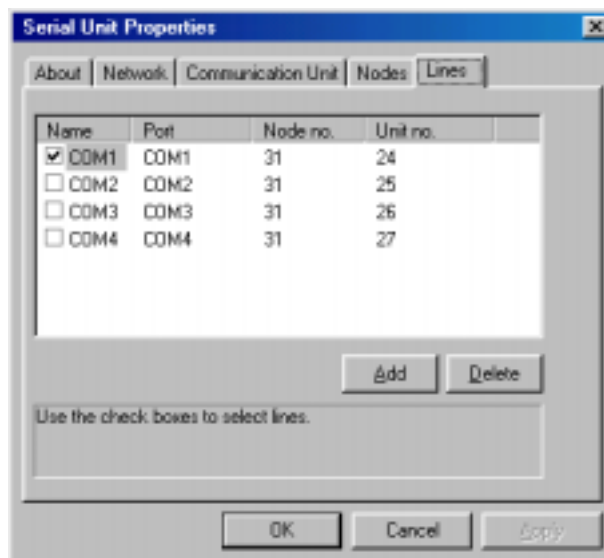

Configuring the Protocol and Node

For Host Link, the protocol must be changed to SYSWAY-CV from the default, (SYSWAY). The node number must match the node number used when the PC was added to CX-Position.

1,2,3...

1. Click the **Nodes** Tab.

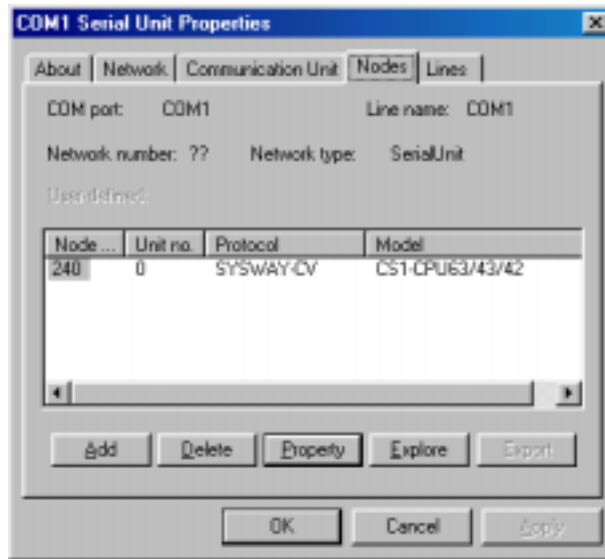

2. Set the node to 240 (shown in reverse video).
3. Click the **Property** Button.



4. Set the following configurations in the Add/Edit Serial Node Window.
 - The node number must match the node number used under *Networks* when the PC was added to CX-Position.

FinsGateway	FinsGateway default setting	Adding PC to CX-Position	PC addition default setting
Node... on the Nodes Tab Page.	240	Node Number under Network Settings	0 Must be set to 240 if FinsGateway is the default.

- The *Type* can be left as C200H.

- Change the protocol to SYSWAY-CV.

FinsGateway	Configuration
Protocol in the Nodes Tab	SYSWAY-CV

- If the *Unit No./Data* for the Host Link of the PC to be connected is 0, the default value is left as 0.

- Note**
1. The protocol cannot be changed once communications have started. Stop and restart Host Link communications.
 2. The node number is the FINS node number for the device (in this case, a PC) to be serially connected. Node number 240 is allocated as the Host Link default to identify the FINS network node as the device to be serially connected. Any value may be used so long as it has not already been allocated as another FINS node number. It must, however, match the *Node Number* of the PC to be added to CX-Position.
 3. For Host Link, the node number is the unit number for the Host Link of the device to be serially connected. It must match the Host Link unit number of the CPU Unit or Serial Communications Unit.

Matching Communications Conditions on the PC for Connection

- 1,2,3...**
1. Click the **Communication Unit** Tab. The default settings are as follows: Baud rate = 9,600 bits/s; Data length = 7 bits; Stop bits = 2 bits; Parity = Even; No. of retries = 0; Timeout = 5,000 ms.
 2. Match these to the communications conditions on the PC for connection.
 3. Click the **Network** Tab. The default settings (with the network number 0 and disabled) are: Local node number = 31; Communications unit number = 24. For Host Link, use the default values as they are.

- Note**
1. Network number is the FINS network number of the SerialUnit (virtual unit). When using on Host Link, 0 is the allocated default (fixed). It must match the network address of the PC to be added to CX-Position.
 2. The local node number is the FINS node number of the SerialUnit (virtual unit). When using on Host Link, 31 is the allocated default, but any value may be used so long as it has not already been allocated as another FINS node number.
 3. The communication unit number is the COM Port FINS Unit No. in the SerialUnit (virtual unit). When using on Host Link, 24 is the allocated default. Any value may be used so long as it has not already been allocated as another FINS Unit No. in the same node number.

Host Link communications can be started once the communications circuit, protocol and conditions have been configured.

Starting Host Link Communications

Communications start once the communications units (services) have been configured. To use FinsGateway to communicate with the device, communications unit services must be started without fail.

- 1,2,3...**
1. Select the **Services** Icon under the **Basic** Tab in the FinsGateway Setting Screen.
 2. Select the **SerialUnit** Icon and then click the **Start** Button inside *Service Setting*.



3. Normally when services are started, the status display changes to *Running*, and at the same time the × mark in the *SerialUnit* icon disappears.

Online Operations from the CX-Position

Online operations, such as data transfers, comparisons, and NC monitoring, are executed from the CX-Position. The following operations can be done later, as and when needed, from the *Service Manager* icon.

1,2,3...

1. FinsGateway settings can be configured by right-clicking on the *Service Manager* icon, and selecting **Setting/Configuration** from the pop-up menu.
2. Services can be ended by right-clicking on the *Service Manager* icon, and selecting **End All Services** from the pop-up menu.

SECTION 7

Transferring and Verifying Data

This section provides information on data transfer and verification operations between the CX-Position and NC Units, and about operations for writing data transferred to NC Units into the NC Unit flash memory.

Connect the computer to the PC with a Connecting Cable and confirm that you are online before attempting to transfer or verify data or write data to the flash memory. (Refer to 2-2 *Connecting to a PC* and 6-2 *FinsGateway Configuration and Startup*.)

If OMRON Support Software that communicates using CX-Server (e.g., CX-Programmer, CX-Protocol, or CX-Motion) or an application that uses a special serial driver is connected online, it is not possible to perform online operations from CX-Position using the same COM port. The reverse is also true.

Quit online connection for the OMRON Support Software that communicates using CX-Server (e.g., CX-Programmer, CX-Protocol, or CX-Motion) or the application that uses a special serial driver, and then re-attempt online operations from CX-Position after starting up FinsGateway's Serial Unit servicing.

7-1	Downloading Data	74
7-2	Uploading Data	75
7-2-1	Uploading Data	75
7-2-2	Automatic NC Searches	76
7-3	Verifying Data	77
7-4	Writing Data to Flash Memory	78

7-1 Downloading Data

Use the following procedure to download edited project data from the (CX-Position) computer to the NC Unit.

- 1,2,3...
1. On the project tree, select the NC Unit to be downloaded to.
 2. Select *Online (L)/Download (D)*.

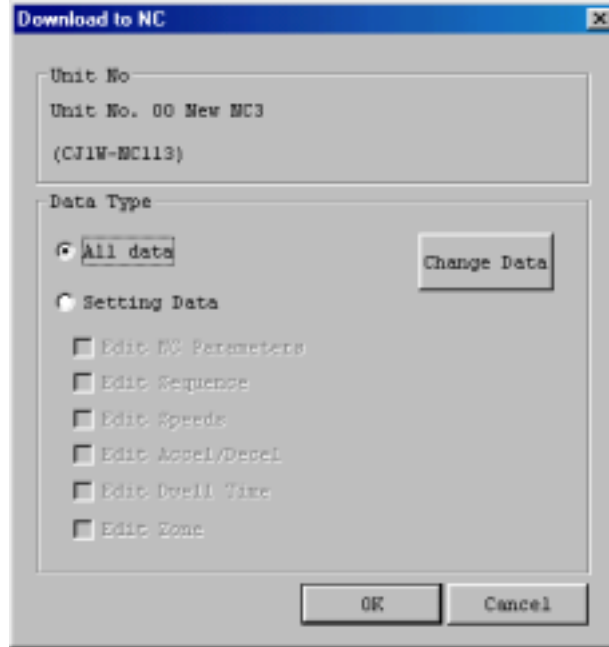

3. Select the data to be downloaded under *Data Type*. To download all data, select *All Data*. To designate specific data to be downloaded, select *Setting Data* and then the specific data. Clicking the **Change Data** Button will select only the data that has been changed.
4. Click the **OK** Button. (Click the **Cancel** Button during data loading to stop the download.)

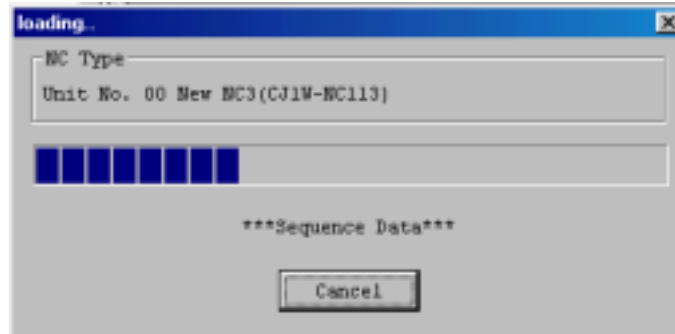

- When download is complete, *Transfer successful; Write flash memory?* will be displayed.

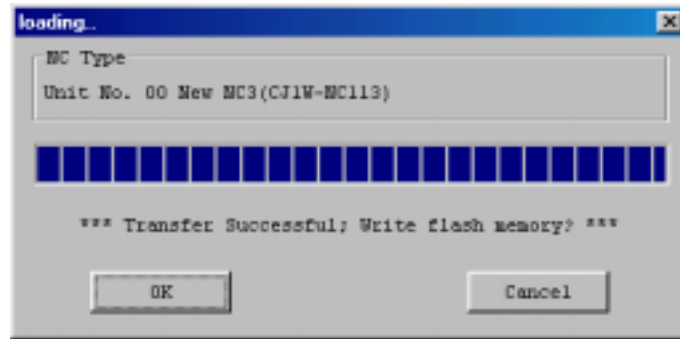

- Click the **OK** Button.

7-2 Uploading Data

7-2-1 Uploading Data

Use the following procedure to upload NC Unit data to the (CX-Position) computer.

- 1,2,3... 1. On the project tree, select the NC Unit to be uploaded from.
2. Select **Online (L)/Upload (U)**.



3. Select the data to be uploaded under *Data Type*. To upload all data, select *All Data*. To designate specific data to be uploaded, select *Setting Data* and then the specific data.

4. Click the **OK** Button.

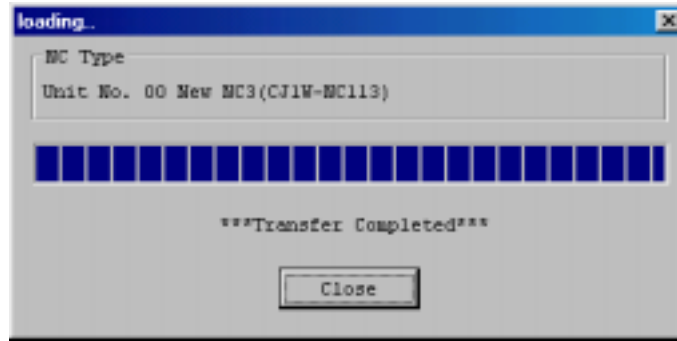

7-2-2 Automatic NC Searches

When online, NC Units under a project's specified PC can be searched for automatically by uploading data from all the NC Units installed on the PC to be connected online. All of the data on all the specified PC's NC Units can also be uploaded to the project.

- 1,2,3... 1. Select **Edit/New PC**, or right click and select **New PC** from the pop-up menu, to create a PC.
2. Select the PC on the project tree and select **Online/Automatic NC Search**.

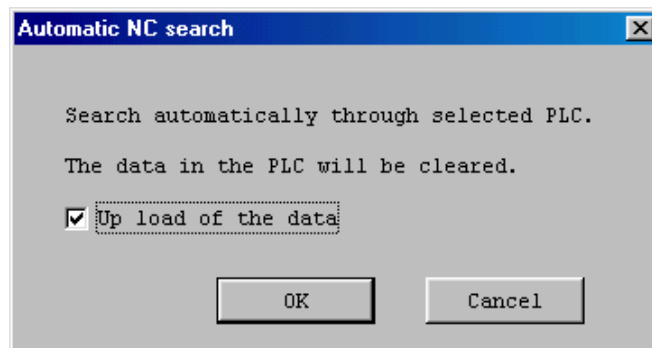

3. To upload all NC Unit data, select the checkbox.
4. Click the **OK** Button. The project will be automatically searched for. The following screen will be displayed if data is uploaded.

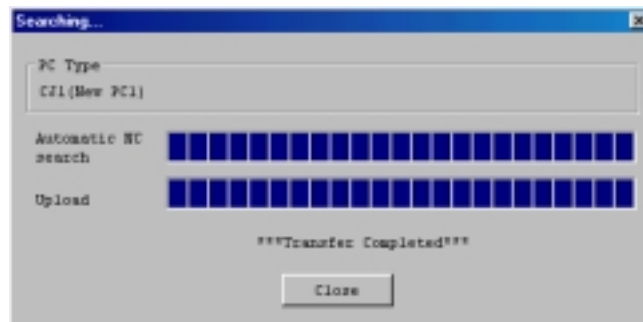

The following screen will be displayed if data is not uploaded.

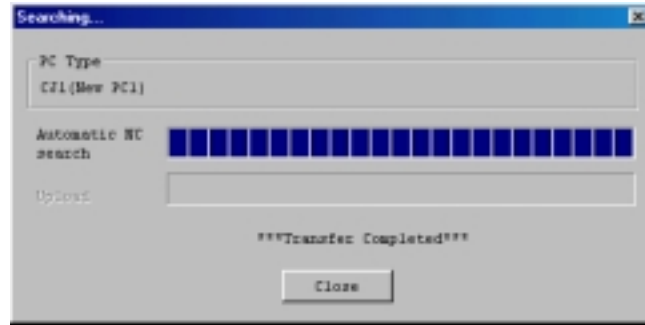

7-3 Verifying Data

Use the following procedure to verify CX-Position data at the computer and NC Unit data.

- 1,2,3... 1. On the project tree, select the NC Unit for verification.
2. Select **Online (L)/Verify (V)**.

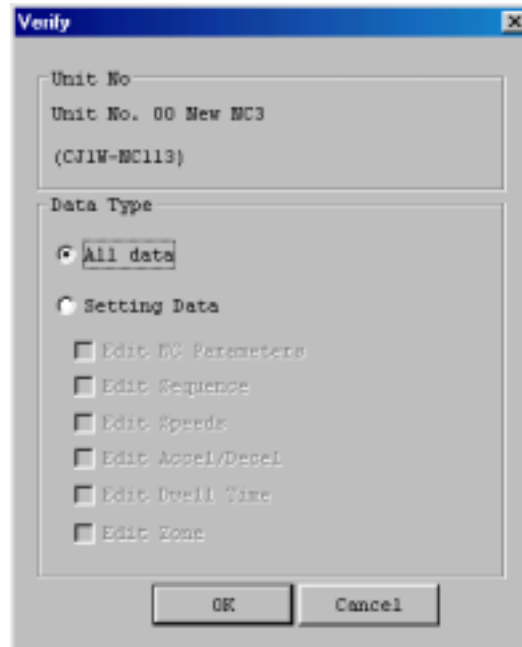

3. Under *Data Type*, select the data to be verified. To verify all data, select *All Data*. To designate specific data to be verified, select *Setting Data*, and then the specific data.
4. Click the **OK** Button. (Click the **Cancel** Button during verification to stop the verification process.)

- The following screen will be displayed when verification has been completed. Click the **Close** Button to end verification.

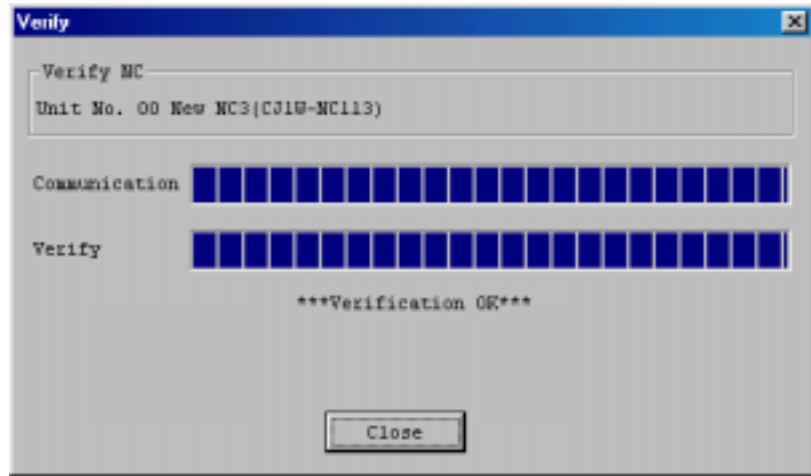

The following screen will be displayed if there is a failure during the verification process. Click the **Close** Button to halt verification.

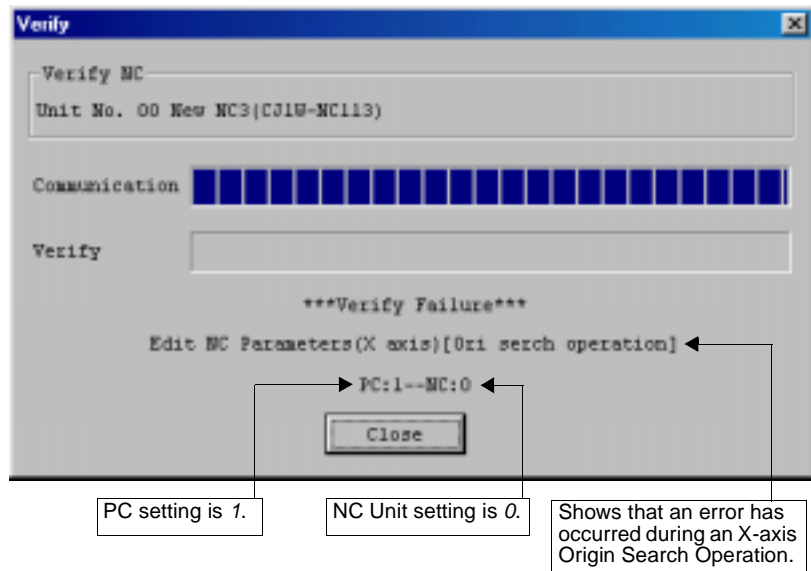

PC setting is 1.

NC Unit setting is 0.

Shows that an error has occurred during an X-axis Origin Search Operation.

7-4 Writing Data to Flash Memory

Use the following procedure to write all, or specified, data in the NC Unit to flash memory.

- Caution** Back up the data to flash memory after transferring parameters or other data to the NC Unit. If parameters and other data are not backed up to flash memory, settings will revert to their previous values the next time power is turned ON, possibility resulting in incorrect operation

- 1,2,3...
1. On the project tree, select the NC Unit for flash memory writing.
 2. Select **Online (L)/Write Flash Memory (R)**.

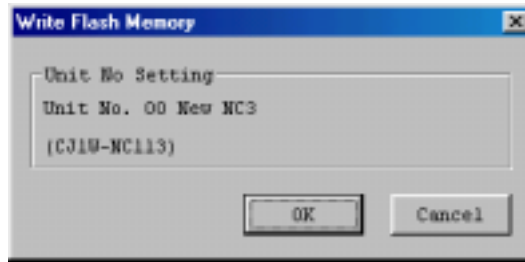

3. Click the **OK** Button.

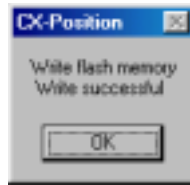

4. Click the **OK** Button.

SECTION 8

Monitoring NCs

This section provides information about monitoring NC Units. The NC Unit's current positions, error codes, and status are displayed on the *NC Monitor*. *Monitor Units* are also available, displaying sequence numbers and current positions for up to four Units simultaneously. Operating memory area monitoring, operating data area monitoring, and NC Unit error logs can also be displayed. For details on NC error log display, refer to *10-1 NC Unit Error Logs*.

Connect the computer to the PC with a Connecting Cable and confirm that you are online before attempting to monitor an NC Unit. (Refer to *2-2 Connecting to a PC* and *6-2 FinsGateway Configuration and Startup*.)

If OMRON Support Software that communicates using CX-Server (e.g., CX-Programmer, CX-Protocol, or CX-Motion) or an application that uses a special serial driver is connected online, it is not possible to perform online operations from CX-Position using the same COM port. The reverse is also true.

Quit online connection for the OMRON Support Software that communicates using CX-Server (e.g., CX-Programmer, CX-Protocol, or CX-Motion) or the application that uses a special serial driver, and then re-attempt online operations from CX-Position after starting up FinsGateway's Serial Unit servicing.

8-1	Monitoring NCs	82
8-2	Multiple Unit Monitoring	82
8-3	Operating Memory Area Monitoring	83
8-4	Operating Data Area Monitoring	84

8-1 Monitoring NCs

Use the following procedure to display NC Unit present positions, error codes, sequence numbers, and I/O status on the *NC Monitor*.

- 1,2,3... 1. On the project tree, select the NC Unit to be monitored and select **Online (L)/Monitor (M)**. If another NC Unit is to be monitored after NC monitoring has been started, select the new NC Unit from the *Unit No.* field.

Example: The following will be displayed as the 4-axis NC Unit Monitoring Screen.

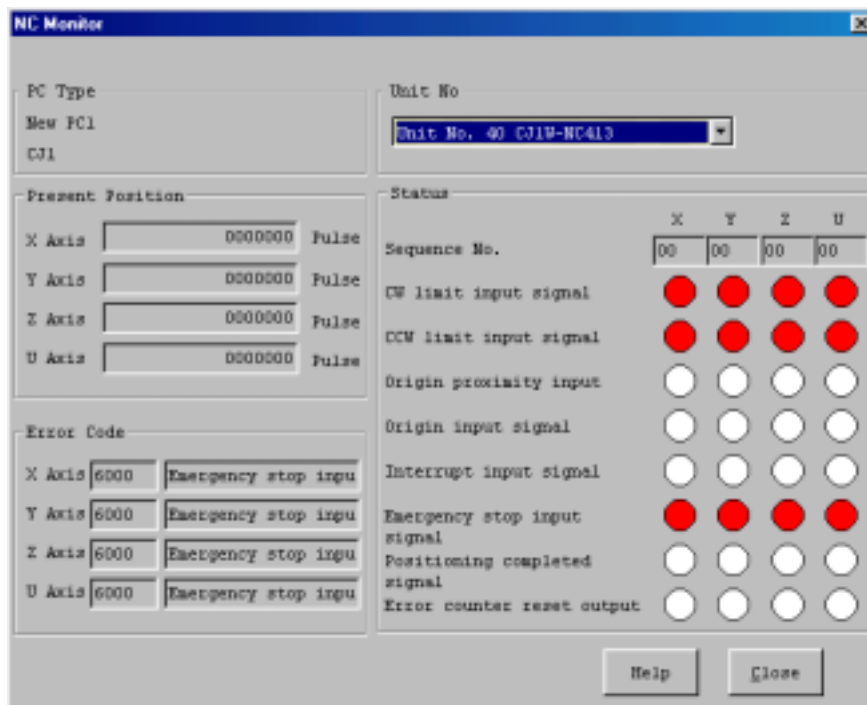

The present position of each axis is shown under *Present Position*; the error code number and description are shown under *Error Code*; and the sequence number and I/O status of each axis are shown under *Status*. A red light indicates that an I/O signal is ON.

For error details, refer to the relevant NC Unit *Operation Manual*, or click the **Help** Button.

8-2 Multiple Unit Monitoring

Use the following procedure to monitor the status of up to four NC Units simultaneously.

- 1,2,3... 1. On the project tree, select an PC or NC, and then select **Online (L)/Monitor Units (F)**. After starting Unit monitoring, the Units selected for monitoring can be changed using the screen's four drop-down lists.

Example: The following will be displayed as the 4-axis NC Unit Monitor Units Screen.

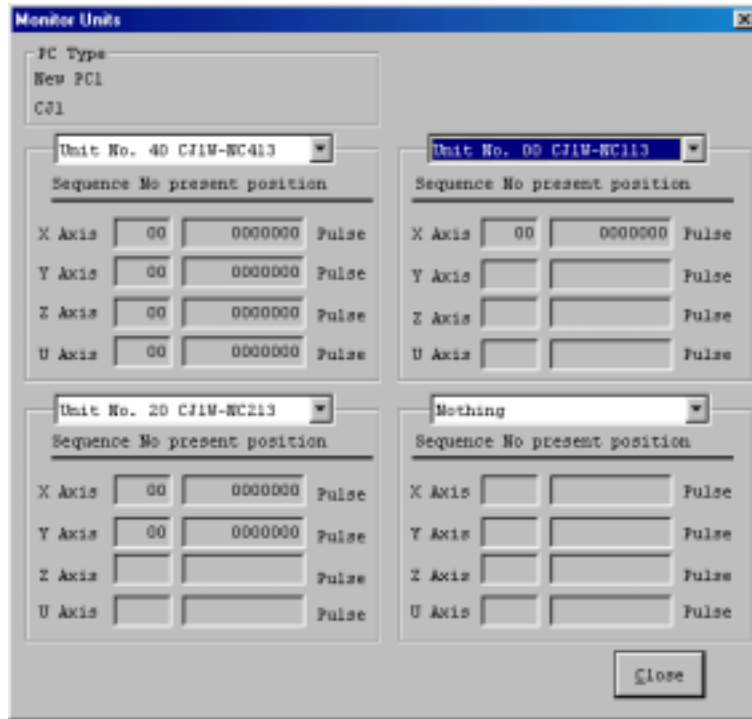

The sequence number and current position for each axis are displayed.

8-3 Operating Memory Area Monitoring

Use the following procedure to monitor the operating memory area (Special I/O Unit words allocated in the CIO Area) allocated to the PC.

- 1,2,3...
1. On the project tree, select the NC Unit for operating memory area monitoring.
 2. Select **Online (L)/Online Monitor NC Operating Memory Area**.
 3. Select either *Automatic* or *Manual* to start monitoring. *Automatic* continues monitoring until the **Stop Monitor** Button is clicked. *Manual* refreshes the monitor screen contents.

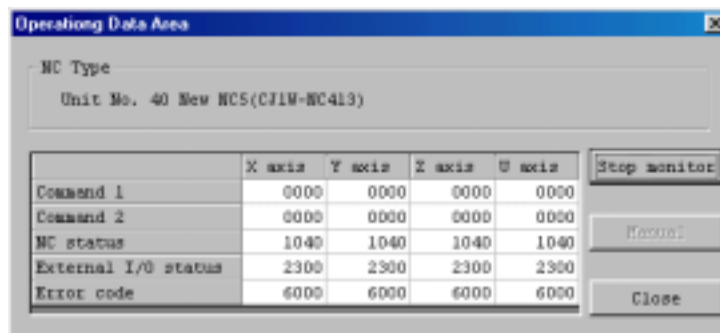

The following table shows the operating memory area words that are displayed.

Data	Allocated words						
	NC1@3	NC2@3		NC4@3			
	X axis	X axis	Y axis	X axis	Y axis	Z axis	U axis
Command 1	n	n	n+2	n	n+2	n+4	n+6
Command 2	n+1	n+1	n+3	n+1	n+3	n+5	n+7
NC status	n+2	n+4	n+7	n+8	n+11	n+14	n+17
External I/O status	n+3	n+5	n+8	n+9	n+12	n+15	n+18
Error codes	n+4	n+6	n+9	n+10	n+13	n+16	n+19

Refer to the *Operation Manual* for the NC Unit for details on bit allocations.

8-4 Operating Data Area Monitoring

Use the following procedure to monitor the operating data area (Special I/O Unit words allocated in the DM Area or custom DM/EM Area) allocated to the PC.

- 1,2,3...**
1. On the project tree, select the NC Unit for operating data area monitoring.
 2. Select **Online (L)/Online Monitor NC Operating Data Area**.

3. Select either *Automatic* or *Manual* to start monitoring. *Automatic* continues monitoring until the **Stop Monitor** Button is clicked. *Manual* refreshes the monitor screen contents.

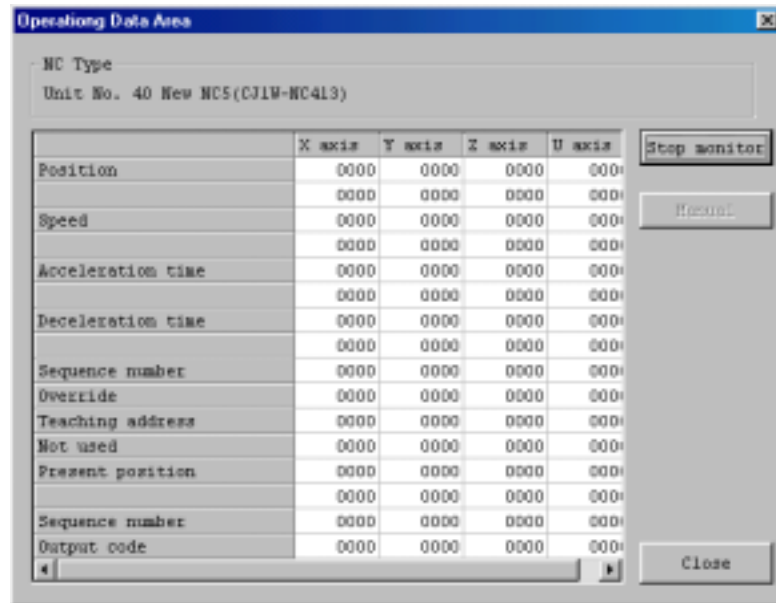

Data	Allocated words (See note 1.)						
	NC1@3	NC2@3		NC4@3			
	X axis	X axis	Y axis	X axis	Y axis	Z axis	U axis
Positions	I+8	I+8	I+20	I+8	I+20	I+32	I+44
	I+9	I+9	I+21	I+9	I+21	I+33	I+45
Speeds	I+10	I+10	I+22	I+10	I+22	I+34	I+46
	I+11	I+11	I+23	I+11	I+23	I+35	I+47
Acceleration times	I+12	I+12	I+24	I+12	I+24	I+36	I+48
	I+13	I+13	I+25	I+13	I+25	I+37	I+49
Deceleration times	I+14	I+14	I+26	I+14	I+26	I+38	I+50
	I+15	I+15	I+27	I+15	I+27	I+39	I+51
Sequence numbers	I+16	I+16	I+28	I+16	I+28	I+40	I+52
Overrides	I+17	I+17	I+29	I+17	I+29	I+41	I+53
Teaching addresses	I+18	I+18	I+30	I+18	I+30	I+42	I+54
Not used	I+19	I+19	I+31	I+19	I+31	I+43	I+55
Present positions	I+20	I+32	I+36	I+56	I+60	I+64	I+68
	I+21	I+33	I+37	I+57	I+61	I+65	I+69
Sequence numbers	I+22	I+34	I+38	I+58	I+62	I+66	I+70
Output codes	I+23	I+35	I+39	I+59	I+63	I+67	I+71

- Note**
1. The first word address depends on the setting in words m and m+1 of the common parameters (where m = D20000 + 100 × unit number) Refer to the *Operation Manual* for the NC Unit for details.
 2. Refer to the *Operation Manual* for the NC Unit for details on operating data area.

SECTION 9

Printing Data

This section provides information about printing data.

9-1 Printing Data	88
-----------------------------	----

9-1 Printing Data

Use the following procedure to print all, or specific, data. For *Edit Sequence*, a specified range of data numbers can be printed.

- 1,2,3...
1. On the project tree, select the data or NC Unit for printing.
 2. Select **File (F)/Print**.

Example: The following screen will be displayed for a 4-axis NC Unit.

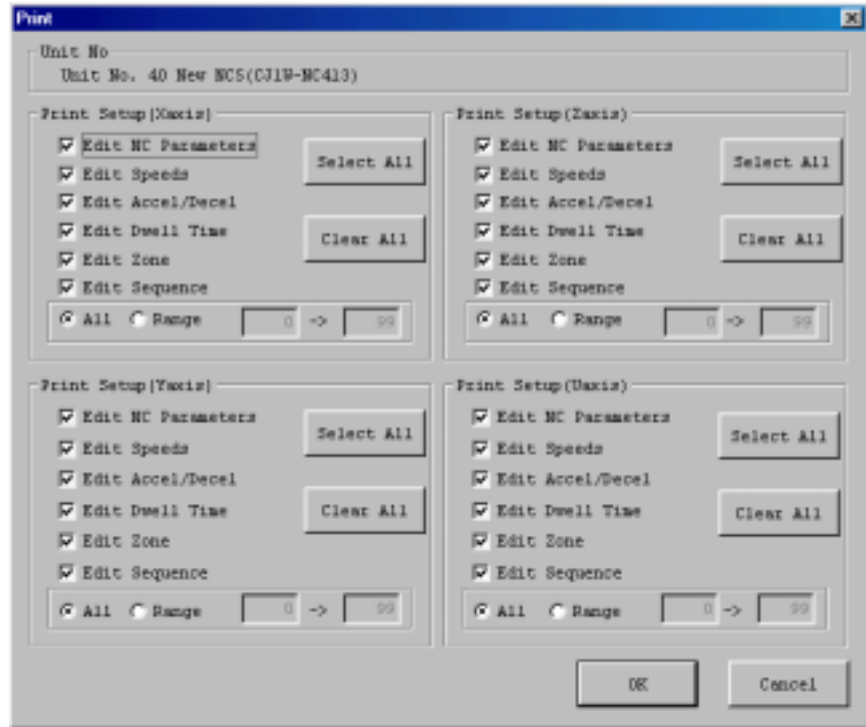

For a 2-axis Unit, the X axis and Y axis will be shown; for a 1-axis Unit, just the X axis will be shown. After selecting the NC Unit, select **Print** to display the screen with all the checkboxes selected. After selecting the data, select **Print** to display the screen with just the specified checkboxes selected.

3. To print all data, click the **Select All** Button. To print specific data, select their checkboxes. *All* is the default selection for the *Edit Sequence* checkbox. To print a specified range, click the *Range* Option and enter the start and end data numbers.

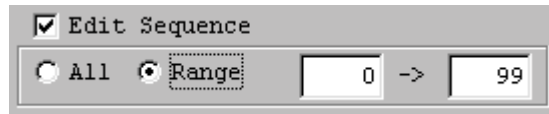

4. Click the **OK** Button.

The following two tables represent print examples.

• Acceleration/Deceleration Data

No.	X axis		Y axis		Z axis		U axis	
	Accel.	Decel.	Accel.	Decel.	Accel.	Decel.	Accel.	Decel.
+1	1000	2000	10000	8000	300	100	400	200
+2	2000	4000	12000	10000	600	200	800	400
+3	3000	6000	14000	12000	900	300	1200	600
+4	4000	8000	16000	14000	1200	400	1600	0
+5	5000	10000	18000	16000	1500	500	2000	0
+6	6000	12000	20000	18000	1800	600	2400	0
+7	7000	14000	22000	20000	2100	700	2800	0
+8	8000	16000	24000	22000	2400	800	3200	0
+9	9000	18000	26000	24000	2700	900	3500	0

• Zone Data

		X axis	Y axis	Z axis	U axis
Zone 0	CW	536870911	268435455	805306367	132417727
Zone 0	CCW	-536870911	-268435455	-805306367	260046849
Zone 1	CW	25165823	8388607	536870911	7340031
Zone 1	CCW	8388608	524288	-536870911	2097151
Zone 2	CW	4194303	6291455	8388607	655359
Zone 2	CCW	-4194303	-6291455	-8388607	-655359

SECTION 10

Error Logs and Troubleshooting

This section provides information about NC Unit error log displays and troubleshooting.

10-1	NC Unit Error Logs	92
10-1-1	Overview	92
10-1-2	To Display NC Unit Error Logs	92
10-1-3	Troubleshooting	92
10-1-4	Command Execution Check	96
10-2	Troubleshooting	108

10-1 NC Unit Error Logs

10-1-1 Overview

A maximum of 20 NC Unit errors can be recorded and displayed. Errors thereafter will replace previous errors, starting with the least recent error.

10-1-2 To Display NC Unit Error Logs

- 1,2,3... 1. On the project tree, select the NC Unit whose error log is to be displayed, and select **Online (L)/View NC Error Log**.

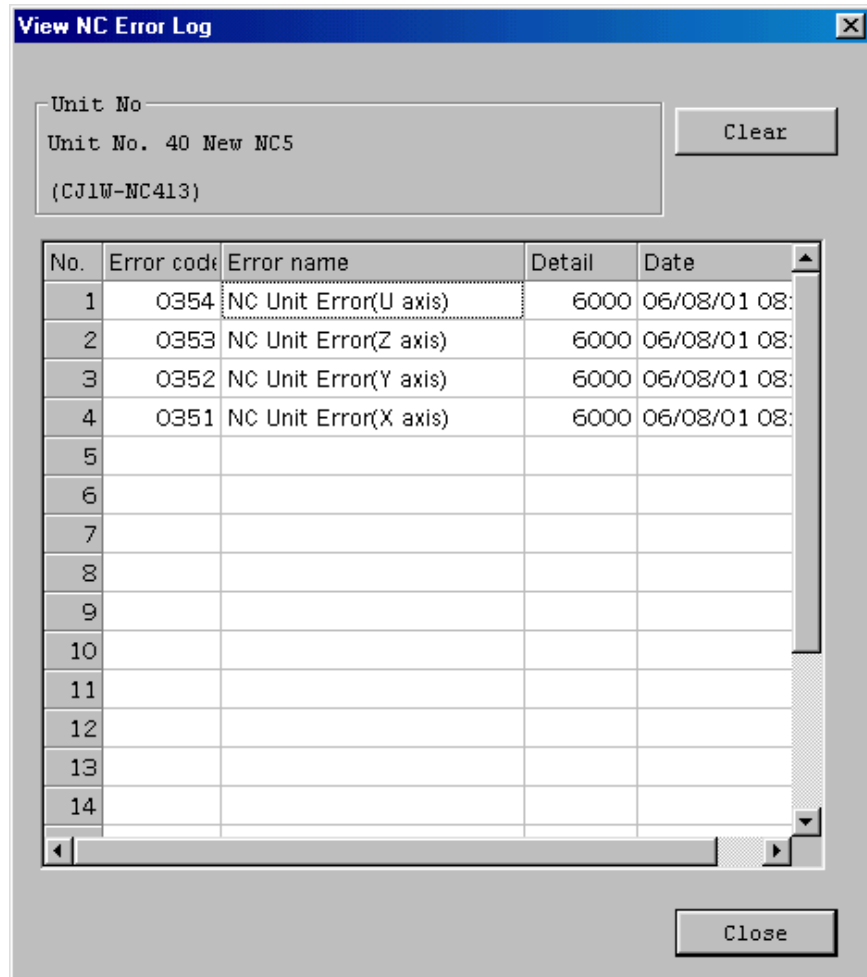

Click on the **Clear** Button to clear the error log.

Note Error codes 0350 to 0354 are NC Unit errors. NC Unit error codes will be displayed for them under *Detail*.

10-1-3 Troubleshooting

For detailed information on error code causes and remedies, see the section on troubleshooting in the *Operation Manual* of the NC Unit, or click on **Help (H) /Unit Errors** and refer to **Unit Error Help**.

Data Check at Startup The following table shows the errors checked when power is turned ON.

Group	Name	Code	Cause	Remedy
Data destruction	Parameters destruction	0001	When using the axis parameters in the NC Unit, the parameters saved in flash memory are lost. It is possible that, while saving to flash memory, the NC Unit's power supply was interrupted, there was noise, or there was an error in flash memory.	In this condition, only the data transfer (read and write) and data save operations can be performed. The NC Unit's axis parameters and data are all returned to their default values. After transferring the parameters and data for all axes, save the parameters and either reset the power supply, or restart the Unit. If the error persists, it is possible that there is a fault in flash memory, and so it may be necessary to replace the NC Unit.
	Data destruction	0002	The following data saved in flash memory will be lost: Zones, positioning sequences, speeds, acceleration/deceleration data, positions, and dwell times. It is possible that, while saving to flash memory, the NC Unit's power supply was interrupted, there was noise, or there was an error in flash memory.	
	F-ROM check data destruction	0003	The flash memory error data saved in flash memory is lost (OMRON maintenance data is lost). It is possible that, while saving to flash memory, the NC Unit's power supply was interrupted, there was noise, or there was an error in flash memory.	
Common parameters	Operating data area designation error	0010	The operating data area designation (m) is incorrect. <ul style="list-style-type: none"> Area designation: Set to a setting other than 00, 0D, or 0E. Bank designation: Set to a setting not in the range 00 to 0C, when 0E is set for the area designation. 	In this condition, only the data save operations can be performed. All of the axes' parameters and all data will be returned to their default values. After correcting the common parameters, (refer to SECTION 4), reset the power supply or restart the NC Unit.
	Operating data area address designation error	0011	The designation of the beginning word of the operating data area's address (m+1) is outside the settable range.	
	Parameter designation error	0013	The axis parameter designation (m+2) is not set to 00 or 01.	
	Axis designation error	0014	The axis parameter designation (m+2) is set to 01, but 1 is set for an axis other than that for a 1-axis, 2-axis or 4-axis Unit.	
Axis parameters	Response timeout	0020	The axis parameters set in the CPU Unit could not be read to the NC Unit.	Increase the cycle monitor time set with CX-Programmer and either reset the power supply or restart the NC Unit. If this error occurs again, despite increasing the cycle monitor time, it is possible that there is a fault in the NC Unit or somewhere in the PC. Either replace the whole PC, or the NC Unit.

Group	Name	Code	Cause	Remedy
Initial speed	Initial speed error	1000	The axis parameters' initial speed setting exceeds the maximum speed setting for an axis.	In this condition, only the data transfer (read or write) and data save operations can be performed. All of the axis parameters will be returned to their default values.
	Initial pulse designation error	1001	The initial pulse designation is not set to 0000 or 0001.	
Maximum speed	Maximum speed error	1010	The axis parameters' maximum speed setting is outside the settable range (1 to 500 kpps).	After correcting the appropriate axis parameters, reset the power supply or restart the NC Unit.
Acceleration/ deceleration data	Acceleration time error	1310	The axis parameters' origin search acceleration time setting is outside the settable range (0 to 250 s).	
	Deceleration time error	1320	The axis parameters' origin search deceleration time setting is outside the settable range (0 to 250 s).	
	Acceleration/deceleration curve error	1330	The axis parameters' acceleration/deceleration curve setting is not 0 or 1.	
	Positioning monitor time error	1332	The axis parameters' positioning monitor time setting is outside the settable range (0 to 9999 ms).	
Origin search	Origin compensation error	1600	The axis parameters' origin compensation setting is outside the settable range (-1,073,741,823 to 1,073,741,823 pulses).	
	Origin search high speed error	1601	The axis parameters' origin search high speed setting exceeds the axis parameters' maximum speed setting.	
	Origin search proximity speed error	1602	The axis parameters' origin search proximity setting exceeds the axis parameters' maximum speed setting.	
	Origin search speed inconsistent	1603	The axis parameters' origin search high speed setting is less than or equal to the origin search proximity speed setting.	
	Operation mode selection error	1604	The axis parameters' origin search operating mode selection setting is not 0, 1, 2, or 3.	
	Origin search operation error	1605	The axis parameters' origin search operation setting is not 0, 1, or 2.	
	Origin search direction error	1606	The axis parameters' origin search direction is not 0 or 1.	
	Origin detection method error	1607	Even though the axis parameters' origin search operation is not set to single-direction mode, the origin detection method setting is not 0, 1, or 2.	

Group	Name	Code	Cause	Remedy
Backlash compensation	Backlash compensation error	1700	The axis parameters' backlash compensation setting is outside the settable range (0 to 9,999 pulses).	In this condition, only the data transfer (read or write) and data save operations can be performed. All of the axis parameters will be returned to their default values. After correcting the appropriate axis parameters, reset the power supply or restart the NC Unit.
	Backlash compensation speed error	1710	The axis parameters' backlash compensation speed setting exceeds the maximum speed setting.	
Software limits	CW software limit error	1800	The axis parameters' CW software limit setting is outside the settable range (-1,073,741,823 to 1,073,741,823).	
	CCW software limit error	1801	The axis parameters' CCW software limit setting is outside the settable range (-1,073,741,823 to 1,073,741,823).	
Sensor inputs	Emergency stop input	6000	An emergency stop signal has been input.	After clearing the emergency stop input, execute RELEASE PROHIBIT/ERROR RESET. For a limit input, execute RELEASE PROHIBIT/ERROR RESET and feed in the opposite direction from the limit stop. Check the axis parameters' signal type setting (N.C. or N.O.).
	CW limit stop	6100	A CW limit input signal has been input.	
	CCW limit stop	6101	A CCW limit input signal has been input.	

10-1-4 Command Execution Check

Data Checks for Data-writing Commands

Item	Name	Code	Cause	Clearing method	Operation after error
Initial speed	Initial speed error	1000	The axis parameters' initial speed setting exceeds the maximum speed designation.	Transfer the data again after checking and correcting it.	When this error occurs during data transfer, all data (including the data with the error) specified for transfer will be lost. All operating axes will be decelerated to a stop.
	Initial pulse designation error	1001	The initial pulse designation is not set to 0000 or 0001.		
Maximum speed	Maximum speed error	1010	The axis parameters' maximum speed setting is outside the settable range (1 to 500 kpps).		
Acceleration/ deceleration data	Acceleration time error	1310	The axis parameters' origin search acceleration time setting is outside the settable range (0 to 250 s).		
	Acceleration time error	1311 to 1319	An acceleration time setting (1 to 9) is outside the settable range (0 to 250 s). (The rightmost digit of the error code indicates the setting with the error.)		
	Deceleration time error	1320	The axis parameters' origin search deceleration time setting is outside the settable range (0 to 250 s).		
	Deceleration time error	1321 to 1329	A deceleration time setting (1 to 9) is outside the settable range (0 to 250 s). (The rightmost digit of the error code indicates the setting with the error.)		
	Acceleration/deceleration curve error	1330	The axis parameters' acceleration/ deceleration curve setting is not 0 or 1.		
	Positioning monitor time error	1332	The axis parameters' positioning monitor time is outside the settable range (0 to 9,999 ms).		
Speed data	Speed error	1500 to 1599	A speed setting is outside the settable range (1 pps to 1,000 kpps). (The last two digits of the code indicate the speed data number where the error occurred.)		
Origin search	Origin compensation error	1600	The axis parameters' origin compensation setting is outside the settable range (-1,073,741,823 to 1,073,741,823 pulses).		
	Origin search high speed error	1601	The axis parameters' origin search high speed setting exceeds the axis parameters' maximum speed setting.		
	Origin search proximity speed error	1602	The axis parameters' origin search proximity setting exceeds the axis parameters' maximum speed setting.		
	Origin search speed inconsistent	1603	The axis parameters' origin search high speed setting is less than or equal to the origin search proximity speed.		

Item	Name	Code	Cause	Clearing method	Operation after error
Origin search (continued)	Origin mode selection error	1604	The axis parameters' origin search operating mode selection setting is not 0, 1, 2, or 3.	Transfer the data again after checking and correcting it.	When this error occurs during data transfer, all data (including the data with the error) specified for transfer will be lost. All operating axes will be decelerated to a stop.
	Origin search operation error	1605	The axis parameters' origin search operation setting is not 0, 1, or 2.		
	Origin search direction error	1606	The axis parameters' origin search direction is not 0 or 1.		
	Origin detection method error	1607	Even though the axis parameters' origin search operation is not set to single-direction mode, the origin detection method setting is not 0, 1, or 2.		
Backlash compensation	Backlash compensation error	1700	The axis parameters' backlash compensation setting is outside the settable range (0 to 9,999pulses).		
	Backlash compensation speed error	1710	The axis parameters' backlash compensation speed setting exceeds the maximum speed setting.		
Software limits	CW software limit error	1800	The axis parameters' CW software limit setting is outside the settable range (-1,073,741,823 to 1,073,741,823).		
	CCW software limit error	1801	The axis parameters' CCW software limit setting is outside the settable range (-1,073,741,823 to 1,073,741,823).		
Zones	Zone 0 CW error	1900	Zone 0's CW data is outside the settable range (-1,073,741,823 to 1,073,741,823).		
	Zone 0 CCW error	1901	Zone 0's CCW data is outside the settable range (-1,073,741,823 to 1,073,741,823).		
	Zone 1 CW error	1910	Zone 1's CW data is outside the settable range (-1,073,741,823 to 1,073,741,823).		
	Zone 1 CCW error	1911	Zone 1's CCW data is outside the settable range (-1,073,741,823 to 1,073,741,823).		
	Zone 2 CW error	1920	Zone 2's CW data is outside the settable range (-1,073,741,823 to 1,073,741,823).		
	Zone 2 CCW error	1921	Zone 2's CCW data is outside the settable range (-1,073,741,823 to 1,073,741,823).		
Position data	Target position error	2000 to 2099	The position data is outside the settable range (-1,073,741,823 to 1,073,741,823). (The last two digits of the code indicate the position data number where the error occurred.)		

Item	Name	Code	Cause	Clearing method	Operation after error
Positioning sequences	Sequence data error	3000 to 3099	<p>One of the following errors occurred in the positioning sequence:</p> <p>The completion code is not in the range 0 to 6.</p> <p>The initial speed number is not in the range 00 to 99.</p> <p>The acceleration time number is not in the range 0 to 9.</p> <p>The deceleration time number is not in the range 0 to 9.</p> <p>The target speed number is not in the range 00 to 99.</p> <p>The dwell time number is not in the range 00 to 19.</p> <p>One of the following errors occurred in the axis designation:</p> <p>The Y, Z, or U axis was specified for a 1-axis NC Unit.</p> <p>The Z or U axis was specified for a 2-axis NC Unit.</p> <p>More than one axis is specified for interrupt feeding or speed control, or all axis designation settings are set to 0.</p> <p>(The last two digits of the code indicate the position data number (00 to 99) where the error occurred.)</p>	Transfer the data again after checking and correcting it.	<p>When this error occurs during data transfer, all data (including the data with the error) specified for transfer will be lost.</p> <p>All operating axes will be decelerated to a stop.</p>
Dwell times	Dwell time error	4001 to 4019	<p>These codes indicate that a dwell time is outside the settable range (0 to 9.99 s).</p> <p>(The last two digits of the code indicate the dwell time number (00 to 19) where the error occurred.)</p>		

Initial Operation Error Checks and Checks During Operation

Group	Name	Code	Cause	Clearing method	Operation after error
Software limits	CW software limit value	5030	<p>If positioning were performed in response to one of the following commands with the specified position data, the CW software limit would be exceeded, so positioning cannot be started.</p> <ul style="list-style-type: none"> • ABSOLUTE MOVEMENT, RELATIVE MOVEMENT, or PRESENT POSITION PRESET • Positioning commands used in memory operation (absolute or relative designation) <p>The software limit was exceeded for interrupt feeding or speed control during memory operation.</p>	Start operation after correcting all of the position data and clearing the pulse output prohibited state.	<p>The current START command will not be executed.</p> <p>Or, the axes for which speed control or interrupt feeding is performed and which exceeded the software limit will decelerate to a stop.</p> <p>Operating axes will not be affected.</p>
	CCW software limit value	5031	<p>If positioning were performed in response to one of the following commands with the specified position data, the CCW software limit would be exceeded, so positioning cannot be started.</p> <ul style="list-style-type: none"> • ABSOLUTE MOVEMENT, RELATIVE MOVEMENT, or PRESENT POSITION PRESET • Positioning commands used in memory operation (absolute or relative designation) <p>The software limit was exceeded for interrupt feeding or speed control during memory operation.</p>		
Origin	Current position unknown	5040	<p>One of the following commands was attempted with an unknown origin.</p> <p>Memory operation with absolute values, ABSOLUTE MOVEMENT direct operation, TEACH, or ORIGIN RETURN</p>	Execute the command again after executing ORIGIN SEARCH or PRESENT POSITION PRESET and establishing the origin.	
Limit stop	Stopped at CW limit	5060	A CW-direction movement command was executed while the CW limit input signal was ON.	Move in the CCW direction.	
	Stopped at CCW limit	5061	A CCW-direction movement command was executed while the CCW limit input signal was ON.	Move in the CW direction.	
Software limits (JOG)	Manual CW software limit	5070	The CW software limit was exceeded during JOG operation.	After executing RELEASE PROHIBIT/ERROR RESET, move in the CCW direction.	<p>The axis that exceeded the software limit will be decelerated to a stop.</p> <p>Other operating axes will not be affected.</p>
	Manual CCW software limit	5071	The CCW software limit was exceeded during JOG operation.	After executing RELEASE PROHIBIT/ERROR RESET, move in the CW direction.	

Group	Name	Code	Cause	Clearing method	Operation after error
Sensor inputs	Emergency stop input	6000	The axis was stopped by an emergency stop signal input.	Start operation again after clearing the emergency stop input and executing RELEASE PROHIBIT/ERROR RESET.	An emergency stop will be performed on the affected axis. Other operating axes will not be affected.
	CW limit stop	6100	The axis was stopped by a CW limit input signal.	Move in the CCW direction after executing RELEASE PROHIBIT/ERROR RESET.	
	CCW limit stop	6101	The axis was stopped by a CCW limit input signal.	Move in the CW direction after executing RELEASE PROHIBIT/ERROR RESET.	
Origin search	No origin proximity input signal	6200	The Unit is set for a proximity input signal, but no origin proximity input signal was received during the origin search.	Perform the origin search again after checking the origin proximity input signal wiring and the origin proximity input signal type (N.C. or N.O.) in the axis parameters' I/O settings. If the signal type is changed, reset the power supply or restart the NC Unit before resuming operation.	Other operating axes will not be affected.
	No origin input signal	6201	There was no origin input signal received during the origin search.	Perform the origin search again after checking the origin input signal wiring and the origin input signal type (N.C. or N.O.) in the axis parameters' I/O settings. If the signal type is changed, reset the power supply or restart the NC Unit before resuming operation.	

Group	Name	Code	Cause	Clearing method	Operation after error
Origin search	Origin input signal error	6202	There was an origin input signal received while decelerating after the origin proximity input signal was received during an origin search in mode 0.	Perform the following adjustments so that the origin signal will turn ON after deceleration is completed. <ul style="list-style-type: none"> • Increase the distance between the sensors used for the origin input signal and the sensor used for the origin proximity input signal. • Decrease the origin search high speed and origin search proximity speed settings. 	The axis where the origin input signal was input will be decelerated to a stop. Other operating axes will not be affected.
	Limit inputs in both directions	6203	Origin search cannot be executed because there are limit signals being input in both directions.	Perform the origin search again after checking the wiring and signal type in the axis parameters' I/O settings (N.C. or N.O.) for both directions. If the signal type is changed, reset the power supply or restart the NC Unit before resuming operation.	The origin search will not be executed, but other operating axes will not be affected.
	Simultaneous origin proximity and limit signals	6204	The origin proximity input and limit signal in the origin search direction were input simultaneously during the origin search.	Perform the origin search again after checking the wiring and signal types in the axis parameters' I/O settings (N.C. or N.O.) for the origin proximity and limit signals. If the signal type is changed, reset the power supply or restart the NC Unit before resuming operation.	An emergency stop will be performed on the axis where the signals were input. Other operating axes will not be affected.

Group	Name	Code	Cause	Clearing method	Operation after error
Origin search	Limit input already being input	6205	<p>There was already a limit signal in the origin search direction during an origin search in a single direction.</p> <p>The origin input signal and limit signal opposite the origin search direction were ON simultaneously or the limit input in the search direction went ON while the origin input signal was reversed during an origin search without proximity input signal.</p>	Perform the origin search again after checking the wiring and signal type in the axis parameters' I/O settings (N.C. or N.O.) for the limit input. If the signal type is changed, reset the power supply or restart the NC Unit before resuming operation.	<p>The current START command will not be executed.</p> <p>Pulse output for the axes for which the limit input signal was input will be stopped immediately.</p> <p>Other operating axes will not be affected.</p>
	Origin proximity/origin reverse error	6206	<p>The limit signal in the origin search direction was input while the origin proximity input signal was reversed during a proximity search with limit input reversal.</p> <p>The limit input signal in the origin search direction was received while the origin input signal was reversed during a proximity search with limit input reversal (not using the origin proximity input signal).</p>	Perform the origin search again after checking the signal types in the axis parameters' I/O settings (N.C. or N.O.) and positions for the limit input signal, origin proximity input signal, and origin input signal inputs. If the signal type is changed, reset the power supply or restart the NC Unit before resuming operation.	An emergency stop will be performed on the axis where the signals were input. Other operating axes will not be affected.
Absolute movement command	Absolute movement position error	7000	The position designation of the ABSOLUTE MOVEMENT command is outside the settable range (-1,073,741,823 to 1,073,741,823 pulses).	Execute the command again after correcting the position or speed designation to a value in the settable range.	The current START command will not be executed, but other operating axes will not be affected.
	Absolute movement speed error	7001	The speed designation for the ABSOLUTE MOVEMENT command is 0 or exceeds the axis parameters' maximum speed.		
	Absolute movement acceleration time error	7002	The acceleration time designation of the ABSOLUTE MOVEMENT command is outside the settable range (0 to 250 ms).		
	Absolute movement deceleration time error	7003	The deceleration time designation of the ABSOLUTE MOVEMENT command is outside the settable range (0 to 250 ms).		

Group	Name	Code	Cause	Clearing method	Operation after error
Relative movement command	Relative movement position error	7100	The position designation of the RELATIVE MOVEMENT command is outside the settable range (-1,073,741,823 to 1,073,741,823 pulses).	Execute the command again after correcting the position or speed designation to a value in the settable range.	The current START command will not be executed, but other operating axes will not be affected.
	Relative movement speed error	7101	The speed designation of the RELATIVE MOVEMENT command is 0 or exceeds the axis parameters' maximum speed.		
	Relative movement acceleration time error	7102	The acceleration time designation of the RELATIVE MOVEMENT command is outside the settable range (0 to 250 ms).		
	Relative movement deceleration time error	7103	The deceleration time designation of the RELATIVE MOVEMENT command is outside the settable range (0 to 250 ms).		
Interrupt feeding	Interrupt feeding position error	7200	The position designation of interrupt feeding is outside the settable range (-1,073,741,823 to 1,073,741,823 pulses).		
	Interrupt feeding speed error	7201	The speed designation of interrupt feeding is 0 or exceeds the axis parameters' maximum speed.		
	Interrupt feeding acceleration time error	7202	The acceleration time designation of interrupt feeding is outside the settable range (0 to 250 ms).		
	Interrupt feeding deceleration time error	7203	The deceleration time designation of interrupt feeding is outside the settable range (0 to 250 ms).		
Origin return	Origin return error	7300	The speed designation of origin return is 0 or exceeds the axis parameters' maximum speed.		
	Origin return acceleration time error	7301	The acceleration time designation of origin return is outside the settable range (0 to 250 s).		
	Origin return deceleration time error	7302	The deceleration time designation of origin return is outside the settable range (0 to 250 s).		
Present position	Present position error	7400	The position specified with present position preset is outside the settable range (-1,073,741,823 to 1,073,741,823).		
JOG	JOG speed error	7500	The JOG speed is 0 or exceeds the axis parameters' maximum speed.		
	JOG acceleration time error	7501	The JOG acceleration time is outside the settable range (0 to 250 s).		
	JOG deceleration time error	7502	The JOG deceleration time is outside the settable range (0 to 250 s).		

Group	Name	Code	Cause	Clearing method	Operation after error
Multiple axis start	Multiple axis start	8000	Two or more of the following commands were executed simultaneously for the same axis: START, INDEPENDENT START, ORIGIN SEARCH, ORIGIN RETURN, PRESENT POSITION PRESET, JOG, TEACH, RELEASE PROHIBIT/ERROR RESET, ABSOLUTE MOVEMENT, RELATIVE MOVEMENT, or INTERRUPT FEEDING	Correct the ladder program so that just one command is executed for each axis at one time and execute the command again.	The command will not be executed. If the last command made before the error was START, INDEPENDENT START, ORIGIN SEARCH, ORIGIN RETURN, JOG, ABSOLUTE MOVEMENT, RELATIVE MOVEMENT, or INTERRUPT FEEDING, the axis with the error will be decelerated to a stop.
			One of the following commands was executed for a busy axis: ORIGIN SEARCH, ORIGIN RETURN, PRESENT POSITION PRESET, JOG, TEACH, RELEASE PROHIBIT/ERROR RESET, ABSOLUTE MOVEMENT, RELATIVE MOVEMENT, or INTERRUPT FEEDING	Correct the ladder program so that a command is not executed for a busy axis and execute the command again.	When interpolation operation is being used, all interpolated axes will be decelerated to a stop.
			A data save operation was executed while one of the following commands was in progress: START, INDEPENDENT START, ORIGIN SEARCH, ORIGIN RETURN, PRESENT POSITION PRESET, JOG, TEACH, RELEASE PROHIBIT/ERROR RESET, ABSOLUTE MOVEMENT, RELATIVE MOVEMENT, or INTERRUPT FEEDING	Correct the ladder program so that the data save operation is executed while none of the axes are busy. Execute the data save operation again.	If the error is generated during data transfer (read or write) or data saving, all axes will be decelerated to a stop. Any operating axes not specified above will not be affected.
			Two or more of the following commands were executed: DATA WRITE, DATA READ, or DATA SAVE	Correct the ladder program so that more than one data transfer (read or write) or data save operation is not executed at the same time. Execute the data transfer or data save operation again.	
			A START or INDEPENDENT START command was executed for a different axis, but a busy axis was specified in the axis designation.	Correct the ladder program so that busy axes are not specified for memory operation and execute the command again.	

Group	Name	Code	Cause	Clearing method	Operation after error
Multiple axis start	Multiple axis start	8000	One of the following commands was executed while the Data Transferring Flag was ON: DATA WRITE, DATA READ, or DATA SAVE	Correct the ladder program so that data transfer (read or write) or data save operation is not executed while the Data Transferring Flag is ON. Execute the data transfer or data save operation again.	<p>The command will not be executed.</p> <p>If the last command made before the error was START, INDEPENDENT START, ORIGIN SEARCH, ORIGIN RETURN, JOG, ABSOLUTE MOVEMENT, RELATIVE MOVEMENT, or INTERRUPT FEEDING, the axis with the error will be decelerated to a stop.</p> <p>When interpolation operation is being used, all interpolated axes will be decelerated to a stop.</p> <p>If the error is generated during data transfer (read or write) or data saving, all axes will be decelerated to a stop.</p> <p>Any operating axes not specified above will not be affected.</p>
Memory operation	Sequence number error	8101	There was a memory operation command and the Sequence Number Enable Bit was ON, but the specified sequence number was outside the settable range (00 to 99).	Execute the command again after checking the sequence number.	The current START command will not be executed, but other operating axes will not be affected.
			The Sequence Number Enable Bit was OFF, or the FORCED INTERRUPT Bit was ON, when memory operation was executed after the power was turned ON or the NC Unit was restarted, or after an origin search, origin return, or present position preset.	Execute the command again after changing the turning ON the Sequence Number Enable Bit. Change the ON timing for the FORCED INTERRUPT Bit.	
			The axis designations for the specified sequence number's sequence data were all set to 0.	Execute the command again after correcting the sequence data.	
			The FORCED INTERRUPT Bit was turned ON after a bank end completion in memory operation.	Change the ON timing for the FORCED INTERRUPT Bit.	
	Speed error	8104	When positioning with memory operation, the speed specified in the sequence data was set to 0.	Execute the command again after checking the speed data and sequence data to make sure that the target speed is not 0.	

Group	Name	Code	Cause	Clearing method	Operation after error
Teaching	Teaching address error	8200	There was a TEACH command, but the teaching position number was not in the range 00 to 99.	Execute the command again after correcting the teaching position number.	The current START command will not be executed, but other operating axes will not be affected.
	Teaching range error	8201	Teaching cannot be performed because the present position is outside the range -1,073,741,823 to 1,073,741,823 pulses.	Change the present position on the axis (e.g., using JOG) and perform teaching again.	
Data transfer	Write transfer: number of words error	8310	The number of write words was set to 0 or exceeded the number of write data words. The parameters for the origin search high speed and the origin search proximity speed were not sent together.	Execute the command again after changing the incorrect setting.	The current START command will not be executed, but other operating axes will not be affected.
	Write transfer: source word error	8311	The write source word or the write source area was outside the settable range.		
	Write transfer: destination address error	8312	The write destination address was outside the settable range.		
	Read transfer: number of words error	8320	The number of read words was set to 0 or exceeded the number of read data words.		
	Read transfer: source address error	8321	The read source address was outside the settable range.		
	Read transfer: destination word error	8322	The read destination word or the read destination area was outside the settable range.		
Error counter reset/ Origin adjustment output	Error counter reset/ Origin adjustment output error	8400	There was an attempt to output a error counter reset/origin adjustment output when the output couldn't be used.	Execute the command again after checking that the output can be used and changing the ladder program if necessary.	The axis will be decelerated to a stop. Other operating axes will not be affected.
Override	Override error	8500	The override setting was outside the settable range (1 to 999%).	Execute the command again after correcting the data.	
Positioning	Positioning timer timeout	8600	The Servo Driver's positioning completed signal did not go ON within the axis parameters' specified time.	Execute the command again after making adjustments such as adjusting the positioning monitor time or the servo system's gain, or checking the wiring for the positioning completed signal and correcting if necessary.	The specified axis will be decelerated to a stop. Other operating axes will not be affected.
	Overflow	8601	The movement distance is too long (greater than 2,147,483,646 pulses, or greater than 2,147,483,520 pulses for linear interpolation) and so operation is not possible.	Execute the command again after reducing the distance to move in one operation (by changing the position data).	The specified axis will be decelerated to a stop. Other operating axes will not be affected.

Group	Name	Code	Cause	Clearing method	Operation after error
Intelligent Read/Write	IORD format error	8700	One of the following errors occurred when the IORD instruction was executed: The NC Unit's address was outside the settable range.	Execute the instruction again after correcting the data.	The current data transfer will not be executed, but other operating axes will not be affected.
	IOWR format error	8701	One of the following errors occurred when the IOWR instruction was executed: The NC Unit's address was outside the settable range. The parameters for the origin search high speed and the origin search proximity speed were not sent together.		
Flash memory	Flash memory error	9300	An attempt was made to save data to flash memory, but the data couldn't be saved because of a problem with the flash memory.	Execute the data save operation again. The error will be cleared if the data is written normally. Replace the Unit if the error occurs again. (In some cases the data save operation can take up to 30 s.)	The current instruction will not be executed. All axes will be decelerated to a stop.

10-2 Troubleshooting

The following flowchart shows the error messages that may occur during CX-Position operation, along with the causes and remedies for each.

Troubleshooting the *The communication error occurred* Online Error Message

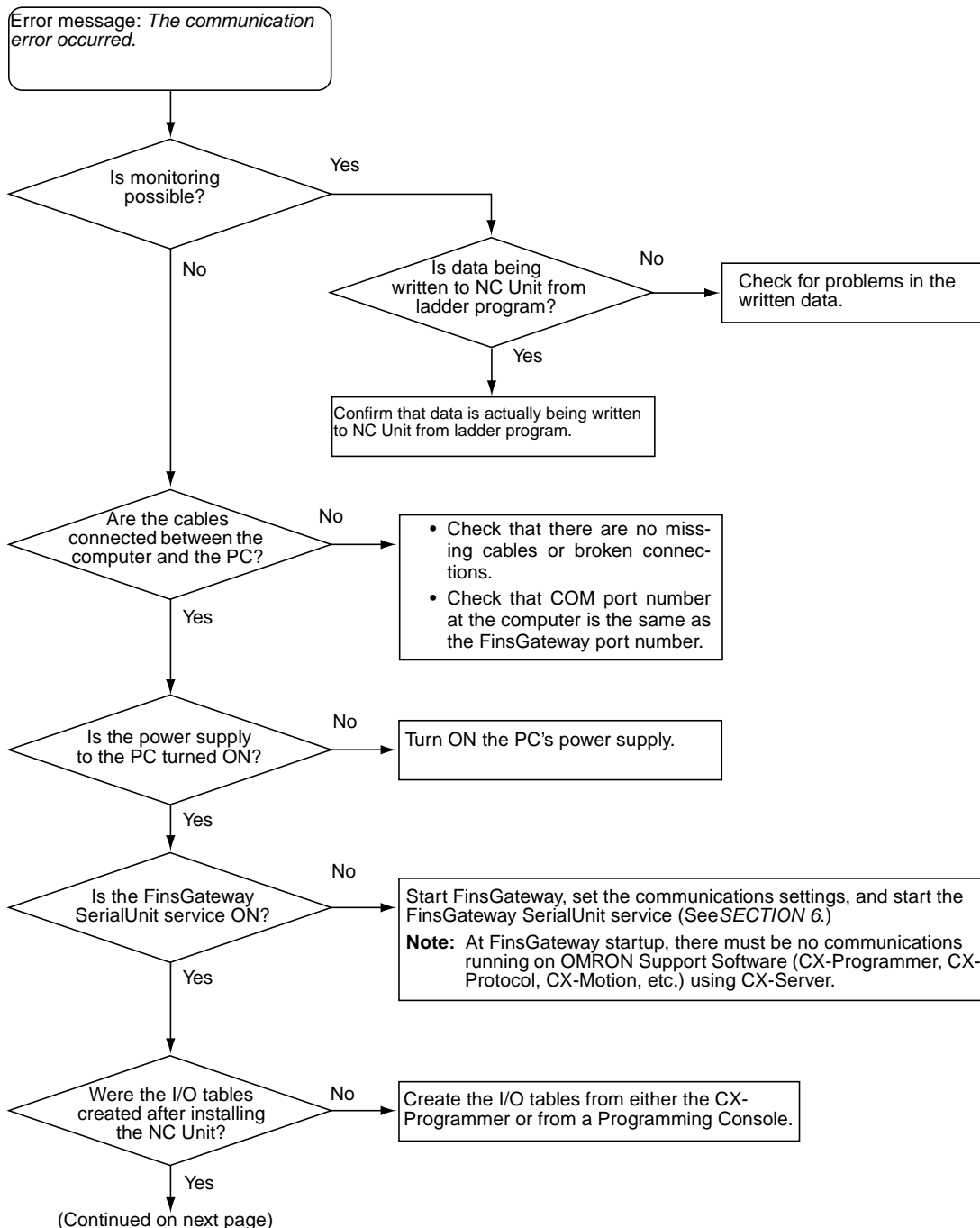

(Continued from previous page)

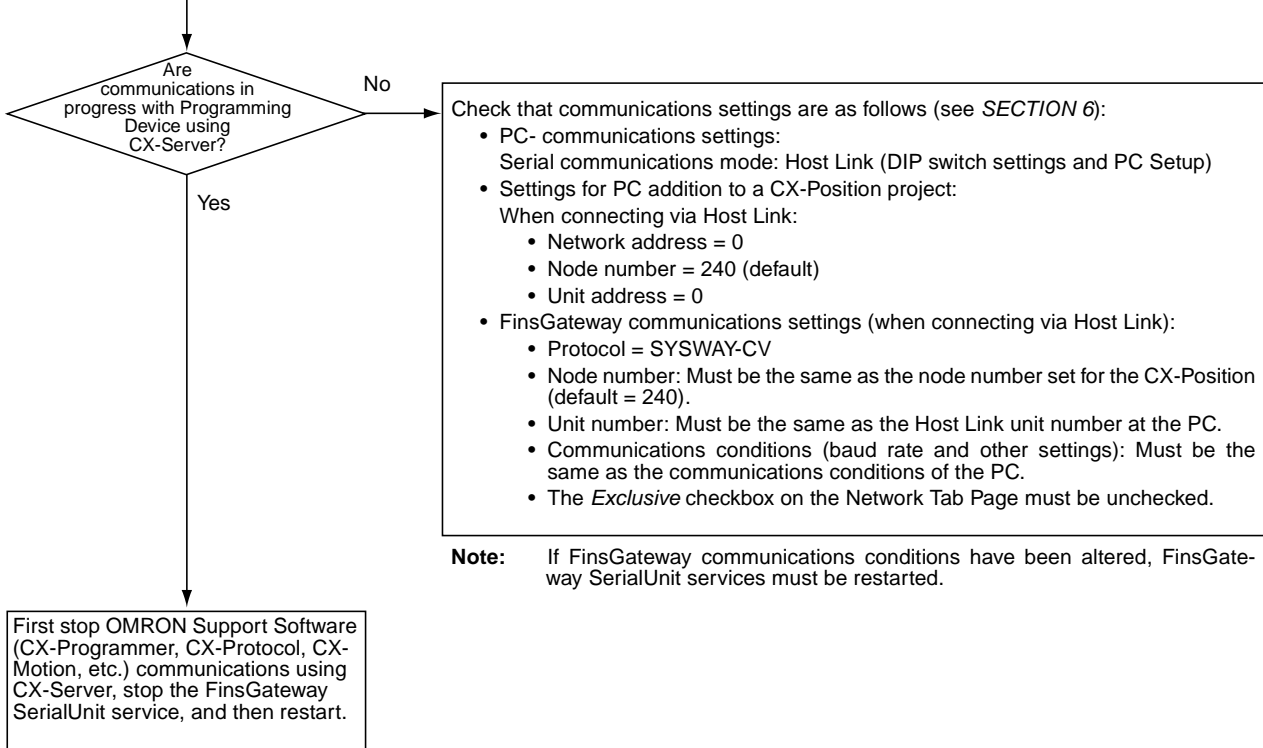

Note Communications cannot be received from the OMRON Support Software using CX-Server when FinsGateway SerialUnit services are ON. Run communications with FinsGateway SerialUnit services OFF.

Troubleshooting the *The connected PC type does not match the chosen PLC type* Online Error Message

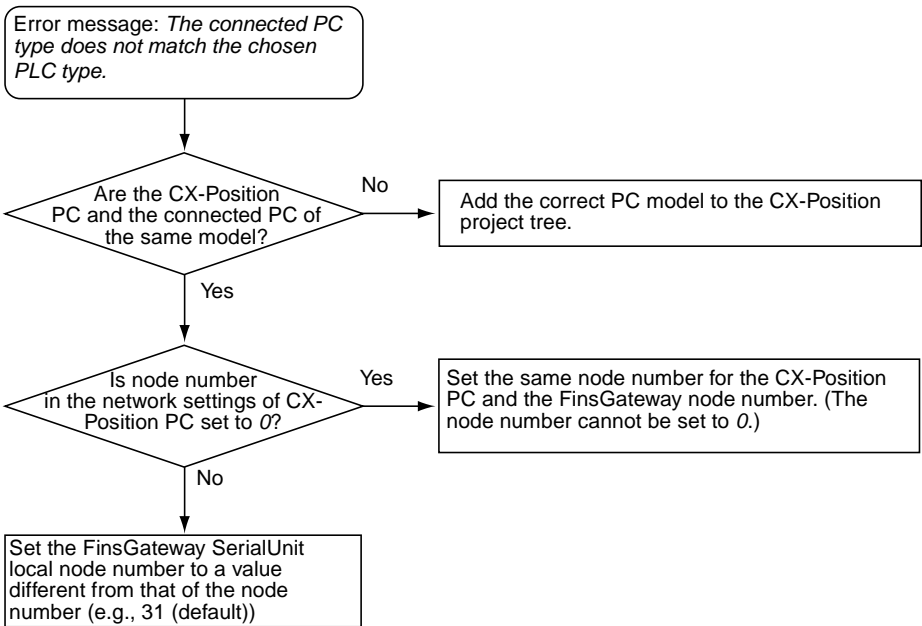

Revision History

A manual revision code appears as a suffix to the catalog number on the front cover of the manual.

Cat. No. W398-E1-1



The following table outlines the changes made to the manual during each revision. Page numbers refer to the previous version.

Revision code	Date	Revised content
1	July 2001	Original production

