

SYSMAC

CPM1/CPM1A/CPM2A/CPM2C/SRM1(-V2)

Programmable Controllers

PROGRAMMING MANUAL

OMRON



OMRON

Authorized Distributor:

Programmable Controllers

Programming Manual

Revised February 2001

OMRON products are manufactured for use according to proper procedures by a qualified operator and only for the purposes described in this manual.

The following conventions are used to indicate and classify precautions in this manual. Always heed the information provided with them. Failure to heed precautions can result in injury to people or damage to property.

DANGER Indicates an imminently hazardous situation which, if not avoided, will result in death or serious injury.

WARNING Indicates a potentially hazardous situation which, if not avoided, could result in death or serious injury.

Caution Indicates a potentially hazardous situation which, if not avoided, may result in minor or moderate injury, or property damage.

OMRON Product References

All OMRON products are capitalized in this manual. The word "Unit" is also capitalized when it refers to an OMRON product, regardless of whether or not it appears in the proper name of the product.

The abbreviation "Ch," which appears in some displays and on some OMRON products, often means "word" and is abbreviated "Wd" in documentation in this sense.

The abbreviation "PC" means Programmable Controller and is not used as an abbreviation for anything else.

Visual Aids

The following headings appear in the left column of the manual to help you locate different types of information.

Note Indicates information of particular interest for efficient and convenient operation of the product.

1, 2, 3... 1. Indicates lists of one sort or another, such as procedures, checklists, etc.

OMRON, 1999

All rights reserved. No part of this publication may be reproduced, stored in a retrieval system, or transmitted, in any form, or by any means, mechanical, electronic, photocopying, recording, or otherwise, without the prior written permission of OMRON.

No patent liability is assumed with respect to the use of the information contained herein. Moreover, because OMRON is constantly striving to improve its high-quality products, the information contained in this manual is subject to change without notice. Every precaution has been taken in the preparation of this manual. Nevertheless, OMRON assumes no responsibility for errors or omissions. Neither is any liability assumed for damages resulting from the use of the information contained in this publication.

PRECAUTIONS	xiii
1 Intended Audience	xiv
2 General Precautions	xiv
3 Safety Precautions	xiv
4 Operating Environment Precautions	xv
5 Application Precautions	xvii
SECTION 1	
PC Setup	1
1-1 PC Setup	2
1-2 Basic PC Operation and I/O Processes	16
1-3 CPM2C Changes in SW2	21
SECTION 2	
Special Features	25
2-1 CPM2A/CPM2C Interrupt Functions	26
2-2 CPM2A/CPM2C High-speed Counters	42
2-3 CPM1/CPM1A Interrupt Functions	73
2-4 SRM1(-V2) Interrupt Functions	91
2-5 CPM2A/CPM2C Pulse Output Functions	94
2-6 CPM1A Pulse Output Functions	128
2-7 Synchronized Pulse Control (CPM2A/CPM2C Only)	131
2-8 Data Computation Standards	143
2-9 Analog I/O Functions (CPM1/CPM1A/CPM2A/CPM2C Only)	144
2-10 Temperature Sensor Input Functions (CPM1A/CPM2A/CPM2C Only)	144
2-11 CompoBus/S I/O Slave Functions (CPM1A/CPM2A/CPM2C Only)	144
2-12 CompoBus/S I/O Master Functions (SRM1(-V2) and CPM2C-S Only)	145
2-13 Analog Controls (CPM1/CPM1A/CPM2A Only)	147
2-14 Quick-response Inputs	149
2-15 Macro Function	154
2-16 Calculating with Signed Binary Data	155
2-17 Differential Monitor	156
2-18 Expansion Instructions (CPM2A/CPM2C/SRM1(-V2) Only)	157
2-19 Using the CPM2A/CPM2C Clock Function	160
SECTION 3	
Using Expansion Units	161
3-1 Analog I/O Units	162
3-2 Temperature Sensor Units	189
3-3 CompoBus/S I/O Link Units	210
3-4 DeviceNet I/O Link Unit	215
SECTION 4	
Communications Functions	221
4-1 Introduction	222
4-2 CPM1/CPM1A Communications Functions	223
4-3 CPM2A/CPM2C Communications Functions	227
4-4 SRM1(-V2) Communications Functions	264
4-5 Host Link Commands	277
SECTION 5	
Memory Areas	303
5-1 Memory Area Functions	304
5-2 I/O Allocation for CPM1/CPM1A/CPM2A PCs	309
5-3 I/O Allocation for CPM2C PCs	319

SECTION 6	
Ladder-diagram Programming	329
6-1 Basic Procedure	330
6-2 Instruction Terminology	330
6-3 Basic Ladder Diagrams	331
6-4 Controlling Bit Status	350
6-5 Work Bits (Internal Relays)	352
6-6 Programming Precautions	354
6-7 Program Execution	356

SECTION 7
Instruction Set **357**

7-1 Notation	360
7-2 Instruction Format	360
7-3 Data Areas, Definer Values, and Flags	360
7-4 Differentiated Instructions	362
7-5 Coding Right-hand Instructions	363
7-6 Instruction Tables	366
7-7 Ladder Diagram Instructions	372
7-8 Bit Control Instructions	373
7-9 NO OPERATION – NOP(00)	377
7-10 END – END(01)	377
7-11 INTERLOCK and INTERLOCK CLEAR – IL(02) and ILC(03)	377
7-12 JUMP and JUMP END – JMP(04) and JME(05)	379
7-13 User Error Instructions: FAILURE ALARM AND RESET – FAL(06) and SEVERE FAILURE ALARM – FALS(07)	381
7-14 Step Instructions: STEP DEFINE and STEP START–STEP(08)/SNXT(09)	381
7-15 Timer and Counter Instructions	384
7-16 Shift Instructions	400
7-17 Data Movement Instructions	407
7-18 Data Control Instructions	417
7-19 Comparison Instructions	428
7-20 Conversion Instructions	435
7-21 BCD Calculation Instructions	453
7-22 Binary Calculation Instructions	463
7-23 Special Math Instructions	467
7-24 Logic Instructions	475
7-25 Increment/Decrement Instructions	479
7-26 Subroutine Instructions	480
7-27 Pulse Output Instructions	483
7-28 Special Instructions	493
7-29 Interrupt Control Instructions	497
7-30 Communications Instructions	501

SECTION 8
PC Operations and Processing Time **507**

8-1 CPM1/CPM1A Cycle Time and I/O Response Time	508
8-2 CPM2A/CPM2C Cycle Time and I/O Response Time	519
8-3 SRM1(-V2) Cycle Time and I/O Response Time	533

SECTION 9	
Troubleshooting	545
9-1 Introduction	546
9-2 Programming Console Operation Errors	546
9-3 Programming Errors	547
9-4 User-defined Errors	548
9-5 Operating Errors	549
9-6 Error Log	551
9-7 Host Link Errors	553
9-8 Troubleshooting Flowcharts	553
Appendices	
A Programming Instructions	555
B Error and Arithmetic Flag Operation	561
C Memory Areas	565
D I/O Assignment Sheet	583
E Program Coding Sheet	585
F List of FAL Numbers	589
G Extended ASCII	591
Index	593
Revision History	599

about this Manual:

This manual provides information on programming the CPM1, CPM1A, CPM2A, CPM2C (including CPM2C-S), and SRM1 (-V2) PCs. The following manuals describe the system configurations and installation of the PCs and provide a basic explanation of operating procedures for the Programming Console. They also introduces the capabilities of the SYSMAC Support Software (SSS) and SYSMAC-CPT Support Software. Read the relevant manual first to acquaint yourself with the PC.

Manual	Catalog No.
CPM1 Operation Manual	W262
CPM1A Operation Manual	W317
CPM2A Operation Manual	W352
CPM2C Operation Manual	W356
CPM2C-S Operation Manual	W377
SRM1(-V2) Operation Manual	W318

- Note**
1. Version 2 (-V2) of the SRM1 is included beginning with following revision of the manual W318-E1-3.
 2. Refer to sections on the CPM2C for information on CPM2C instructions and Expansion Units.

The *SYSMAC Support Software Operation Manuals: Basics and C-series PCs* (W247 and W248) provide descriptions of SSS operations for SYSMAC C-series PCs. The *SYSMAC-CPT Support Software Quick Start Guide* (W332) and *User Manual* (W333), as well as the *CX-Programmer User Manual* (W361) and *CX-Server User Manual* (362) provide descriptions of ladder diagram operations in the Windows environment.

Please read this manual carefully and be sure you understand the information provided before attempting to program or operate the PC.

Section 1 explains the PC Setup. The PC Setup can be used to control the operating parameters.

Section 2 explains special features of the PC.

Section 3 describes how to use the CPM1A-MAD01 and CPM2C-MAD11 Analog I/O Units, the CPM1A-TS□□□ and CPM2C-TS□□□ Temperature Sensor Units, and the CPM1A-SRT21 and CPM2C-SR□□□ CompoBus/S I/O Link Units.

Section 4 describes how to use the communications functions provided in the PCs.

Section 5 describes the structure of the PC memory areas and explains how to use them. Details of memory areas are provided in *Appendix C*.

Section 6 explains the basic steps and concepts involved in writing a basic ladder diagram program. It introduces the instructions that are used to build the basic structure of the ladder diagram and control execution.

Section 7 explains instructions individually and provides the ladder diagram symbol, data areas, and flags used with each.

Section 8 explains the internal PC processing, as well as the time required for processing and execution.

Section 9 describes how to diagnose and correct hardware and software errors that can occur during operation.

Various **Appendices** are also provided for easy reference. Refer to the table of contents for a list of appendices.

 **WARNING** Failure to read and understand the information provided in this manual may result in personal injury or death, damage to the product, or product failure. Please read each section in its entirety and be sure you understand the information provided in the section and related sections before attempting any of the procedures or operations given.

s section provides general precautions for using the Programmable Controller (PC) and related devices.

information contained in this section is important for the safe and reliable application of the Programmable Controller. You must read this section and understand the information contained before attempting to set up or operate the system.

1 Intended Audience	xiv
2 General Precautions	xiv
3 Safety Precautions	xiv
4 Operating Environment Precautions	xv
5 Application Precautions	xvii

This manual is intended for the following personnel, who must also have knowledge of electrical systems (an electrical engineer or the equivalent).

- Personnel in charge of installing FA systems.
- Personnel in charge of designing FA systems.
- Personnel in charge of managing FA systems and facilities.

General Precautions

The user must operate the product according to the performance specifications described in the operation manuals.

Before using the product under conditions which are not described in the manual or applying the product to nuclear control systems, railroad systems, aviation systems, vehicles, combustion systems, medical equipment, amusement machines, safety equipment, and other systems, machines, and equipment, you may have a serious influence on lives and property if used improperly, consult your OMRON representative.

Make sure that the ratings and performance characteristics of the product are sufficient for the systems, machines, and equipment, and be sure to provide safety systems, machines, and equipment with double safety mechanisms.

This manual provides information for programming and operating the Unit. Be sure to read this manual before attempting to use the Unit and keep this manual close at hand for reference during operation.



WARNING It is extremely important that a PC and all PC Units be used for the specified purpose and under the specified conditions, especially in applications that directly or indirectly affect human life. You must consult with your OMRON representative before applying a PC System to the above-mentioned applications.

Safety Precautions



WARNING Do not attempt to take any Unit apart while the power is being supplied. Doing so may result in electric shock.



WARNING Do not attempt to disassemble, repair, or modify any Units. Any attempt to do so may result in malfunction, fire, or electric shock.



WARNING Always turn OFF the power supply to the PC before attempting any of the following. Not turning OFF the power supply may result in malfunction or electric shock.

- Assembling the Units.
- Mounting or dismounting I/O Units, CPU Units, or any other Units.
- Connecting or wiring the cables.
- Connecting or disconnecting the connectors.
- Setting DIP switches.
- Replacing the battery



WARNING Do not touch any of the terminals or terminal blocks while the power is being supplied. Doing so may result in electric shock.

**WARNING**

Provide safety measures in external circuits (i.e., not in the Programmable Controller), including the following items, to ensure safety in the system if an abnormality occurs due to malfunction of the PC or another external factor affecting the PC operation. Not doing so may result in serious accidents.

- Emergency stop circuits, interlock circuits, limit circuits, and similar safety measures must be provided in external control circuits.
- The PC will turn OFF all outputs when its self-diagnosis function detects an error or when a severe failure alarm (FALS) instruction is executed. As a countermeasure for such errors, external safety measures must be provided to ensure safety in the system.
- The PC outputs may remain ON or OFF due to deposition or burning of output relays or destruction of the output transistors. As a countermeasure for such problems, external safety measures must be provided to ensure safety in the system.
- When the 24-VDC output (service power supply to the PC) is overloaded or short-circuited, the voltage may drop and result in the outputs being turned OFF. As a countermeasure for such problems, external safety measures must be provided to ensure safety in the system.

**WARNING**

When handling the Memory Backup Battery, never drop, disassemble, discharge, short-circuit, recharge, heat to a temperature exceeding 100°C, or throw into fire. The Battery may explode, catch fire, or leak fluid if mishandled in any of these ways.

**Caution**

Execute online edit only after confirming that no adverse effects will be caused by extending the cycle time. Otherwise, input signals may not be readable.

**Caution**

When transferring programs to other nodes, or when making changes to memory, confirm the safety of the destination node before transfer. Not doing so may result in injury.

**Caution**

Tighten the screws on the terminal block of the AC Power Supply Unit to the torque specified in the operation manual. The loose screws may result in fire or malfunction.

Operating Environment Precautions

**Caution**

Do not operate the control system in the following places:

- Locations subject to direct sunlight.
- Locations subject to temperatures or humidity outside the range specified in the specifications.
- Locations subject to condensation as the result of severe changes in temperature.
- Locations subject to corrosive or flammable gases.
- Locations subject to dust (especially iron dust) or salts.
- Locations subject to exposure to water, oil, or chemicals.

**Caution**

Take appropriate and sufficient countermeasures when installing systems in the following locations:

- Locations subject to static electricity or other forms of noise.
- Locations subject to strong electromagnetic fields.
- Locations subject to possible exposure to radioactivity.
- Locations close to power supplies.

**Caution**

The operating environment of the PC System can have a large effect on the performance and reliability of the system. Improper operating environments can lead to malfunction, failure, and other unforeseeable problems with the PC System. Ensure that the operating environment is within the specified conditions at installation and remains within the specified conditions during the life of the system.

Observe the following precautions when using the PC System.



Caution

Failure to abide by the following precautions could lead to faulty operation of PC or the system, or could damage the PC or PC Units. Always heed these cautions.

Signing Circuits or Creating Ladder Programs

- Fail-safe measures must be taken by the customer to ensure safety in event of incorrect, missing, or abnormal signals caused by broken signal lines, momentary power interruptions, or other causes.
- Construct a control circuit so that power supply for the I/O circuits does not come ON before power supply for the Unit. If power supply for the I/O circuits comes ON before power supply for the Unit, normal operation may be temporarily interrupted.
- If the operating mode is changed from RUN or MONITOR mode to PROGRAM mode, with the IOM Hold Bit ON, the output will hold the most recent status. In such a case, ensure that the external load does not exceed specification. When operation is stopped because of an operating error, including errors generated by FALS instructions, the values in the internal memory of the CPU Unit will be saved, but the outputs will all turn OFF.)
- For models with only the super-capacitor installed, the contents of the REWRITE enable area of the DM area, HR area, AR area, and CNT data area may be damaged if the power is turned OFF for a long time. To prevent such damage, provide ladder program that will check AR 1314 to ensure proper operation of the system.
- The life of relays largely varies depending on switching conditions. Be sure to test operating conditions using actual Units and use the product within the specified number of switchings so as not to cause any performance problems. Using the product with performance problems may result in defective insulation between circuits or burning of the relays.

Installation

- Install the Units properly as specified in the relevant operation manual(s). Improper installation of the Units may result in malfunction.
- Do not install the PC or PC Units in places where the Units may be affected by excessive noise. Doing so may result in malfunction.
- Install the Units properly so that they will not fall off.
- Be sure that all the mounting screws, terminal screws, and cable connector screws are tightened to the torque specified in the relevant manuals. Incorrect tightening torque may result in malfunction.
- Install the Expansion I/O Unit connector cover to the last Expansion I/O Unit to prevent dust or foreign matter from entering inside the Unit. Not doing so may result in malfunction.
- Be sure that the terminal blocks, expansion cables, and other items with locking devices are properly locked into place. Improper locking may result in malfunction.

Wiring and Connection

- Be sure to use cables as specified in the relevant manual(s).
- Install external breakers and take other safety measures against short-circuiting in external wiring. Insufficient safety measures against short-circuiting may result in burning.
- When wiring signal lines, do not place them in the same duct as high-voltage lines or power lines. Doing so may result in malfunction.

- Leave the labels attached CPM1 or CPM2A Units when wiring to prevent wiring cuttings from entering the Units.
- Attach the labels supplied with CPM1A or CPM2C Units or provide other protective covers when wiring to prevent dust or wiring cuttings from entering Units.
- Remove the labels after the completion of wiring to ensure proper heat dissipation. Leaving the labels attached may result in malfunction.
- Use the connectors and wiring materials specified in the relevant manual.
- Be sure to wire according to the relevant manual(s). Incorrect wiring may result in burning.

Connection and System Startup

- Disconnect the functional ground terminal when performing withstand voltage tests.
- Always use the power supply voltages specified in the operation manual(s). Incorrect voltage may result in malfunction or burning.
- Take appropriate measures to ensure that the specified power with the rated voltage and frequency is supplied. Be particularly careful in places where the power supply is unstable.
- Do not apply voltages to the input terminals in excess of the rated input voltage. Excess voltages may result in burning.
- Do not apply voltages or connect loads to the output terminals in excess of the maximum switching capacity. Excess voltage or loads may result in burning.
- Double-check all wiring and switch settings before turning ON the power supply. Incorrect wiring may result in burning.
- Check the user program for proper execution before actually running it on the Unit. Not checking the program may result in an unexpected operation.

Handling Precautions

- When using, storing, or transporting the product, keep within the specifications listed in the relevant manual(s).
- Confirm that no adverse effect will occur in the system before attempting any of the following. Not doing so may result in an unexpected operation.
 - Changing the operating mode of the PC.
 - Force-setting/force-resetting any bit in memory.
 - Changing the present value of any word or any set value in memory.
- Before touching a Unit, be sure to first touch a grounded metallic object to discharge any static built-up. Not doing so may result in malfunction or damage.
- Do not touch the Expansion I/O Unit Connecting Cable while the power is being supplied to prevent any malfunction due to static electricity.
- Do not pull on the cables or bend the cables beyond their natural limit. Doing either of these may break the cables.
- Do not place objects on top of the cables. Doing so may break the cables.
- When disposing of Units or other products, be sure to do so according to local laws and regulations.
- When using a Temperature Sensor Unit with a thermocouple input (CPM1A-TS001/002, CPM2C-TS001), observe the following precautions:
 - With the CPM1A-TS001/002, do not remove the cold junction compensator attached at the time of delivery. If the cold junction compensator is removed the Unit will not be able to measure temperatures correctly.

the cold junction compensator attached to the Unit. If the Unit is used with the cold junction compensator from other Units, the Unit will not be able to measure temperatures correctly.

- With the CPM1A-TS001/002 or the CPM2C-TS001, do not touch the cold junction compensator. Doing so may result in incorrect temperature measurement.

Maintenance

- When replacing a part, be sure to confirm that the rating of a new part is correct. Not doing so may result in malfunction or burning.
- When the CPU Unit is replaced, resume operation only after transferring to the new CPU Unit the contents of the DM and HR Areas required for operation. Doing so may result in an unexpected operation.

Transportation and Storage

- When transporting the Units, use special packing boxes. Do not subject the Units or other products to excessive vibration or shock during transportation and do not to drop them.
- Store the Units within the following temperature and humidity ranges:
Storage temperature: -25 to 65°C
Storage humidity: 25% to 85% (with no icing or condensation)

This section explains the PC Setup in the CPM1, CPM1A, CPM2A, CPM2C (including the CPM2C-S), and SRM1(-V2). PC Setup can be used to control the operating parameters. To change the PC Setup, refer to the *Operation Manual* for Programming Console procedures.

Refer to the *SSS Operation Manual: C-series PCs* for SSS procedures. Refer to the *SYSMAC-CPT Support Software Quick Start Guide (W332)* and *User Manual (W333)* for SYSMAC-CPT Support Software procedures. Refer to the *CX-Programmer User Manual (W361)* for CX-Programmer procedures.

If you are not familiar with OMRON PCs or ladder diagram program, you can read *1-1 PC Setup* as an overview of the operating parameters available for the CPM1/CPM1A, CPM2A/CPM2C, and SRM1(-V2). You may then want to read *Section 2 Memory Areas*, *Section 6 Ladder-diagram Programming*, and related instructions in *Section 7 Instruction Set* before continuing this section.

1-1	PC Setup	2
1-1-1	Changing the PC Setup	2
1-1-2	CPM1/CPM1A PC Setup Settings	3
1-1-3	CPM2A/CPM2C PC Setup Settings	7
1-1-4	SRM1(-V2) PC Setup Settings	13
1-2	Basic PC Operation and I/O Processes	16
1-2-1	Startup Mode	16
1-2-2	Hold Bit Status	17
1-2-3	Program Memory Write-protection	17
1-2-4	RS-232C Port Servicing Time (CPM2A/CPM2C/SRM1(-V2) Only)	18
1-2-5	Peripheral Port Servicing Time	18
1-2-6	Cycle Monitor Time	18
1-2-7	Minimum Cycle Time	19
1-2-8	Input Time Constants	19
1-2-9	Error Log Settings	21
1-3	CPM2C Changes in SW2	21

The PC Setup comprises various operating parameters that control PC operation. In order to make the maximum use of PC functionality when using inter-process processing and communications functions, the PC Setup may be customized according to operating conditions.

At the time of shipping, the defaults are set for general operating conditions so that the PC can be used without having to change the settings. You are, however, advised to check the default values before operation.

Default Values

The default values for the PC Setup are 0000 for all words (except for the battery error enable in DM 6655 bits 12 to 15 for CPM2A CPU Units). The default values can be reset at any time by turning ON SR 25210 in PROGRAM mode.



Caution

When data memory (DM) is cleared from a Programming Device, the PC Setup settings will also be cleared to all zeros.

I-1 Changing the PC Setup

PC Setup settings are accessed at various times depending on the setting described below.

- DM 6600 to DM 6614: Accessed only when PC's power supply is turned ON.
- DM 6615 to DM 6644: Accessed only when program execution begins.
- DM 6645 to DM 6655: Accessed regularly when the power is ON.

Since changes in the PC Setup become effective only at the times given above, the PC will have to be restarted to make changes in DM 6600 to DM 6614 effective, and program execution will have to be restarted to make changes in DM 6615 to DM 6644 effective.

When DM 6602 bits 00 to 03 are set to protect the program memory, DM 6602 cannot be changed using the PC Setup operation of the Support Software. To change DM 6602, use the I/O Monitor or DM Edit operation.

Making Changes from a Programming Device

The PC Setup can be read, but not overwritten, from the user program. Writing can be done only by using a Programming Device.

Although the PC Setup is stored in DM 6600 to DM 6655, settings can be read and changed only from a Programming Device (e.g., SSS, or Programmer Console). DM 6600 to DM 6644 can be set or changed only while in PROGRAM mode. DM 6645 to DM 6655 can be set or changed while in either PROGRAM mode or MONITOR mode. The cycle time will be rather long when the PC Setup is changed in MONITOR mode.

The following settings can be made in PROGRAM mode from the SSS user menu operations. All other settings must be made using the hexadecimal setting operation.

- Startup Mode (DM 6600)
- I/O Hold Bit Status and Forced Status Hold Bit Status (DM 6601)
- Cycle Monitor Time (DM 6618)
- Cycle Time (DM 6619)
- RS-232C Port Settings (DM 6645 to DM 6649)

Note The RS-232C Port Settings (DM 6645 to DM 6649) are not used on CPM1/CPM1A PCs because these PCs aren't equipped with an RS-232C port.

Errors in the PC Setup

If an incorrect PC Setup setting is accessed, a non-fatal error (error code 9B) will be generated, the corresponding error flag (AR 1300 to AR 1302) will be turned ON, and the default setting will be used instead of the incorrect setting.

The PC Setup is broadly divided into four categories: 1) Settings related to PC operation and I/O processes, 2) Settings related to the cycle time, 3) Settings related to interrupts, and 4) Settings related to communications. This section explains the settings according to these classifications.

The following table shows the settings for CPM1/CPM1A PCs in order. Refer to the page number in the last column for more details on that setting.

Word(s)	Bit(s)	Function	Page
Startup Processing (DM 6600 to DM 6614)			
The following settings are effective after transfer to the PC only after the PC is restarted.			
6600	00 to 07	Startup mode (effective when bits 08 to 15 are set to 02). 00: PROGRAM; 01: MONITOR 02: RUN	16
	08 to 15	Startup mode designation 00: According to communications port setting switch and peripheral port connection (See table at the bottom of this page.) 01: Continue operating mode last used before power was turned OFF. 02: Setting in 00 to 07	
6601	00 to 07	Not used.	17
	08 to 11	IOM Hold Bit (SR 25212) Status at Startup 0: Reset; 1: Maintain (See note 3.)	
	12 to 15	Forced Status Hold Bit (SR 25211) Status at Startup 0: Reset; 1: Maintain (See note 3.)	
6602	00 to 03	Program memory write-protection 0: Program memory unprotected 1: Program memory write-protected (except DM 6602 itself)	17
	04 to 07	Programming Console display language 0: English; 1: Japanese	
	08 to 15	Not used.	
6603	00 to 15	Not used.	
6604	00 to 07	00: If data could not be saved with the built-in capacitor (AR 1314 ON), a memory error will be generated. 01: If data could not be saved with the built-in capacitor (AR 1314 ON), a memory error will be generated.	
	08 to 15	Not used.	
6605 to 6614	00 to 15	Not used.	
Cycle Time Settings (DM 6615 to DM 6619)			
The following settings are effective after transfer to the PC the next time operation is started.			
6615, 6616	00 to 15	Not used.	
6617	00 to 07	Servicing time for peripheral port (effective when bits 08 to 15 are set to 01) 00 to 99 (BCD): Percentage of cycle time used to service peripheral.	18
	08 to 15	Peripheral port servicing setting enable 00: 5% of the cycle time 01: Use time in 00 to 07.	
6618	00 to 07	Cycle monitor time (effective when bits 08 to 15 are set to 01, 02, or 03) 00 to 99 (BCD): Setting (see 08 to 15)	18
	08 to 15	Cycle monitor enable (Setting in 00 to 07 x unit; 99 s max.) 00: 120 ms (setting in bits 00 to 07 disabled) 01: Setting unit: 10 ms 02: Setting unit: 100 ms 03: Setting unit: 1 s	
6619	00 to 15	Cycle time 0000: Variable (no minimum) 0001 to 9999 (BCD): Minimum time in ms	19

Interrupt Processing (DM 6620 to DM 6639)

following settings are effective after transfer to the PC the next time operation is started.

6620	00 to 03	Input constant for IR 00000 to IR 00002 0: 8 ms; 1: 1 ms; 2: 2 ms; 3: 4 ms; 4: 8 ms; 5: 16 ms; 6: 32 ms; 7: 64 ms; 8: 128 ms	19
	04 to 07	Input constant for IR 00003 and IR 00004 (Setting same as bits 00 to 03)	
	08 to 11	Input constant for IR 00005 and IR 00006 (Setting same as bits 00 to 03)	
	12 to 15	Input constant for IR 00007 to IR 00011 (Setting same as bits 00 to 03)	
6621	00 to 07	Input constant for IR 001 00: 8 ms; 01: 1 ms; 02: 2 ms; 03: 4 ms; 04: 8 ms; 05: 16 ms; 06: 32 ms; 07: 64 ms; 08: 128 ms	
	08 to 15	Input constant for IR 002 (Setting same as for IR 001.)	
6622	00 to 07	Input constant for IR 003 (Setting same as for IR 001.)	
	08 to 15	Input constant for IR 004 (Setting same as for IR 001.)	
6623	00 to 07	Input constant for IR 005 (Setting same as for IR 001.)	
	08 to 15	Input constant for IR 006 (Setting same as for IR 001.)	
6624	00 to 07	Input constant for IR 007 (Setting same as for IR 001.)	
	08 to 15	Input constant for IR 008 (Setting same as for IR 001.)	
6625	00 to 07	Input constant for IR 009 (Setting same as for IR 001.)	
	08 to 15	Not used.	
6626 to 6627	00 to 15	Not used.	
6628	00 to 03	Interrupt enable for IR 00003 (0: Normal input; 1: Interrupt input; 2: Quick-response)	75
	04 to 07	Interrupt enable for IR 00004 (0: Normal input; 1: Interrupt input; 2: Quick-response)	
	08 to 11	Interrupt enable for IR 00005 (0: Normal input; 1: Interrupt input; 2: Quick-response)	
	12 to 15	Interrupt enable for IR 00006 (0: Normal input; 1: Interrupt input; 2: Quick-response)	
6629 to 6641	00 to 15	Not used.	

High-speed Counter Settings (DM 6640 to DM 6644)

following settings are effective after transfer to the PC the next time operation is started.

6640 to 6641	00 to 15	Not used.	
6642	00 to 03	High-speed counter mode 0: Up/down counter mode; 4: Incrementing counter mode	83
	04 to 07	High-speed counter reset mode 0: Z phase and software reset; 1: Software reset only	
	08 to 15	High-speed counter enable 00: Don't use high-speed counter; 01: Use high-speed counter with settings in 00 to 07	
6643, 6644	00 to 15	Not used.	

General Port Settings

following settings are effective after transfer to the PC.

6645 to 6649	00 to 15	Not used.	222																																																																
6650	00 to 07	Port settings 00: Standard (1 start bit, 7-bit data, even parity, 2 stop bits, 9,600 bps) 01: Settings in DM 6651 (Other settings will cause a non-fatal error and AR 1302 will turn ON.)																																																																	
	08 to 11	Link area for 1:1 PC Link via peripheral port: 0: LR 00 to LR 15																																																																	
	12 to 15	Communications mode 0: Host Link; 2: 1:1 PC Link Slave; 3: 1:1 PC Link Master; 4: 1:1 NT Link (Other settings will cause a non-fatal error and AR 1302 will turn ON.)																																																																	
6651	00 to 07	Baud rate 00: 1.2K, 01: 2.4K, 02: 4.8K, 03: 9.6K, 04: 19.2K, 05 to 07: Cannot be used (see note 2) (Other settings will cause a non-fatal error and AR 1302 will turn ON.)																																																																	
	08 to 15	Frame format <table border="1" style="width: 100%; border-collapse: collapse;"> <thead> <tr> <th></th> <th>Start</th> <th>Length</th> <th>Stop</th> <th>Parity</th> </tr> </thead> <tbody> <tr><td>00:</td><td>1 bit</td><td>7 bits</td><td>1 bit</td><td>Even</td></tr> <tr><td>01:</td><td>1 bit</td><td>7 bits</td><td>1 bit</td><td>Odd</td></tr> <tr><td>02:</td><td>1 bit</td><td>7 bits</td><td>1 bit</td><td>None</td></tr> <tr><td>03:</td><td>1 bit</td><td>7 bits</td><td>2 bits</td><td>Even</td></tr> <tr><td>04:</td><td>1 bit</td><td>7 bits</td><td>2 bits</td><td>Odd</td></tr> <tr><td>05:</td><td>1 bit</td><td>7 bits</td><td>2 bits</td><td>None</td></tr> <tr><td>06:</td><td>1 bit</td><td>8 bits</td><td>1 bit</td><td>Even</td></tr> <tr><td>07:</td><td>1 bit</td><td>8 bits</td><td>1 bit</td><td>Odd</td></tr> <tr><td>08:</td><td>1 bit</td><td>8 bits</td><td>1 bit</td><td>None</td></tr> <tr><td>09:</td><td>1 bit</td><td>8 bits</td><td>2 bits</td><td>Even</td></tr> <tr><td>10:</td><td>1 bit</td><td>8 bits</td><td>2 bits</td><td>Odd</td></tr> <tr><td>11:</td><td>1 bit</td><td>8 bits</td><td>2 bits</td><td>None</td></tr> </tbody> </table> (Other settings will cause a non-fatal error and AR 1302 will turn ON.)		Start	Length	Stop	Parity	00:	1 bit	7 bits	1 bit	Even	01:	1 bit	7 bits	1 bit	Odd	02:	1 bit	7 bits	1 bit	None	03:	1 bit	7 bits	2 bits	Even	04:	1 bit	7 bits	2 bits	Odd	05:	1 bit	7 bits	2 bits	None	06:	1 bit	8 bits	1 bit	Even	07:	1 bit	8 bits	1 bit	Odd	08:	1 bit	8 bits	1 bit	None	09:	1 bit	8 bits	2 bits	Even	10:	1 bit	8 bits	2 bits	Odd	11:	1 bit	8 bits	2 bits	None
	Start	Length	Stop	Parity																																																															
00:	1 bit	7 bits	1 bit	Even																																																															
01:	1 bit	7 bits	1 bit	Odd																																																															
02:	1 bit	7 bits	1 bit	None																																																															
03:	1 bit	7 bits	2 bits	Even																																																															
04:	1 bit	7 bits	2 bits	Odd																																																															
05:	1 bit	7 bits	2 bits	None																																																															
06:	1 bit	8 bits	1 bit	Even																																																															
07:	1 bit	8 bits	1 bit	Odd																																																															
08:	1 bit	8 bits	1 bit	None																																																															
09:	1 bit	8 bits	2 bits	Even																																																															
10:	1 bit	8 bits	2 bits	Odd																																																															
11:	1 bit	8 bits	2 bits	None																																																															
6652	00 to 15	Transmission delay (Host Link) (See note 4.) 0000 to 9999: In ms. (Other settings will cause a non-fatal error and AR 1302 will turn ON.)																																																																	
6653	00 to 07	Node number (Host Link) 00 to 31 (BCD) (Other settings will cause a non-fatal error and AR 1302 will turn ON.)																																																																	
	08 to 15	Not used.																																																																	
6654	00 to 15	Not used.																																																																	

Log Settings (DM 6655)

following settings are effective after transfer to the PC.

6655	00 to 03	Style 0: Shift after 7 records have been stored 1: Store only first 7 records (no shifting) 2 to F: Do not store records	21
	04 to 07	Not used.	
	08 to 11	Cycle time monitor enable 0: Detect long cycles as non-fatal errors 1: Do not detect long cycles	
	12 to 15	Not used.	

Note 1. When the startup mode is set to continue the operating mode last used before the power was turned off, that operating mode will be retained by built-in capacitor. If the power remains off for longer than the backup time of the capacitor, the data may be lost. (For details on the holding time, refer to the *CPM1A* or *CPM1 Operation Manual*.)

ate properly and the RUN I/O Setup Error flag (MR 1002 ON) will not be ON.

3. Retention of IOM Hold Bit (SR 25212) Status

If the "IOM Hold Bit Status at Startup" (DM 6601, bits 08 to 11) is set to "Maintain" with the IOM Hold Bit (SR 25212) turned ON, operation can be started with the I/O memory (I/O, IR, LR) status just as it was before the power was turned OFF. (The input area is refreshed at startup, however, so it is overwritten by the most recently updated input status.)

Retention of Forced Status Hold Bit (SR 25211) Status

If the "Forced Status Hold Bit Status at Startup" (DM 6601, bits 12 to 15) is set to "Maintain" with the Forced Status Hold Bit (SR 25211) turned ON, operation can be started with the forced set/reset status just as it was before the power was turned OFF. (When starting up in RUN Mode, however, the forced set/reset status is cleared.)

Even if the "IOM Hold Bit Status at Startup" or "Forced Status Hold Bit Status at Startup" is set to "Maintain," the IOM Hold Bit (SR 25212) or Forced Status Hold Bit (SR 25211) status may be cleared if the power remains OFF longer than the backup time of the built-in capacitor. (For details on the holding time, refer to the *CPM1A* or *CPM1 Operation Manual*.) At this time, the I/O memory will also be cleared, so set up the system so that clearing the memory will not cause problems.

4. The transmission delay is the delay between the previous transmission and the next transmission.

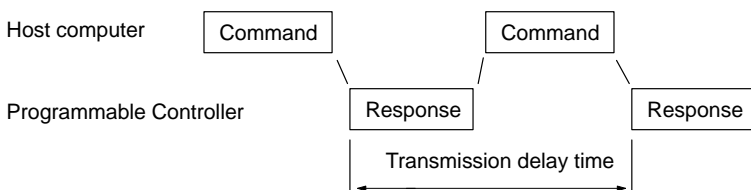

5. If an out-of-range value is set, the following communications conditions result. In that case, reset the value so that it is within the permissible range.

Communications mode: Host Link

Communications format: Standard settings
(1 start bit, 7-bit data; even parity, 2 stop bits)
9,600 bps)

Transmission delay: No

Node number: 00

The PC Setup is broadly divided into four categories: 1) Settings related to PC operation and I/O processes, 2) Settings related to pulse output function, 3) Settings related to interrupts, and 4) Settings related to communications. This section will explain the settings according to these classifications.

The following table shows the setting in order in the DM area. For details, refer to the page numbers shown.

Word(s)	Bit(s)	Function	Page
Startup Processing (DM 6600 to DM 6614)			
The following settings are effective after transfer to the PC only after the PC is restarted.			
6600	00 to 07	Startup mode (effective when bits 08 to 15 are set to 02). 00: PROGRAM; 01: MONITOR; 02: RUN	16
	08 to 15	Startup mode designation 00: Mode set on Programming Console switch if Programming Console is connected. RUN mode if Programming Console is not connected. 01: Continue operating mode last used before power was turned OFF. 02: Setting in 00 to 07 The setting of the switch SW2 will affect the operating mode for all CPM2C CPU Units produced before 1 September 2000. Refer to <i>1-3 Changes in SW2</i> for details.	
6601	00 to 07	Not used.	17
	08 to 11	IOM Hold Bit (SR 25212) Status at Startup 0: Reset to 0; 1: Maintain previous status	
	12 to 15	Forced Status Hold Bit (SR 25211) Status at Startup 0: Reset to 0; 1: Maintain previous status	
6602	00 to 03	Program memory write-protection 0: Program memory unprotected 1: Program memory write-protected (except DM 6602 itself)	17
	04 to 07	Programming Console display language 0: English; 1: Japanese	
	08 to 11	Expansion instruction function code assignments 0: Default settings 1: User assignments	158
	12 to 15	Not used.	
6603	00 to 15	Not used.	
6604	00 to 07	00: A memory error will not be generated if data could not be retained by the battery. 01: A memory error will be generated if data could not be retained by the battery.	
	08 to 15	Not used.	
6605 to 6614	00 to 15	Not used.	

Note For CPM2C PCs with lot number of 31800 or earlier, the startup operating mode will be as shown in the following table if bits 08 to 15 of DM 6600 are set to 02.

Peripheral port connected to	Communications port setting switch	
	SW2 OFF	SW2 ON
Nothing	PROGRAM	RUN
Programming Console	Mode set on Programming Console mode switch	PROGRAM (The CPM2C will not be able to communicate with Programming Console.)
Other Programming Device	PROGRAM (The CPM2C will not be able to communicate with Programming Device.)	PROGRAM

Time Settings (DM 6615 to DM 6619)

following settings are effective after transfer to the PC the next time operation is started.

6615	00 to 15	Not used.	
6616	00 to 07	Servicing time for RS-232C port (Effective when bits 08 to 15 are set to 01.) 00 to 99 (BCD): Percentage of cycle time used to service RS-232C port.	18
	08 to 15	RS-232C port servicing setting enable 00: 5% of the cycle time 01: Use time in bits 00 to 07.	
6617	00 to 07	Servicing time for peripheral port (Effective when bits 08 to 15 are set to 01.) 00 to 99 (BCD): Percentage of cycle time used to service peripheral.	18
	08 to 15	Peripheral port servicing setting enable 00: 5% of the cycle time 01: Use time in bits 00 to 07.	
6618	00 to 07	Cycle monitor time (Effective when bits 08 to 15 are set to 01, 02, or 03.) 00 to 99 (BCD): Setting (See bits 08 to 15, below.) A fatal error will be generated and PC operation will stop if the cycle time exceeds the cycle monitor time set here.	18
	08 to 15	Cycle monitor enable (Setting in 00 to 07 × units; 99 s max.) 00: 120 ms (setting in bits 00 to 07 disabled) 01: Setting units: 10 ms 02: Setting units: 100 ms 03: Setting units: 1 s	
6619	00 to 15	Minimum cycle time 0000: Variable (no minimum) 0001 to 9999 (BCD): Minimum time in ms	19

Interrupt Processing (DM 6620 to DM 6639)

following settings are effective after transfer to the PC the next time operation is started.

6620	00 to 03	Input time constant for IR 00000 to IR 00002 0: 10 ms; 1: 1 ms; 2: 2 ms; 3: 3 ms; 4: 5 ms; 5: 10 ms; 6: 20 ms; 7: 40 ms; 8: 80 ms	19
	04 to 07	Input time constant for IR 00003 and IR 00004 (Setting same as bits 00 to 03)	
	08 to 11	Input time constant for IR 00005 and IR 00006 (Setting same as bits 00 to 03)	
	12 to 15	Input time constant for IR 00007 to IR 00011 (Setting same as bits 00 to 03)	
6621	00 to 07	Input time constant for IR 001 00: 10 ms 01: 1 ms 02: 2 ms 03: 3 ms 04: 5 ms 05: 10 ms 06: 20 ms 07: 40 ms 08: 80 ms	
	08 to 15	Input constant for IR 002 (Setting same as for IR 001.)	
6622	00 to 07	Input constant for IR 003 (Setting same as for IR 001.)	
	08 to 15	Input constant for IR 004 (Setting same as for IR 001.)	
6623	00 to 07	Input constant for IR 005 (Setting same as for IR 001.)	
	08 to 15	Input constant for IR 006 (Setting same as for IR 001.)	
6624	00 to 07	Input constant for IR 007 (Setting same as for IR 001.)	
	08 to 15	Input constant for IR 008 (Setting same as for IR 001.)	
6625	00 to 07	Input constant for IR 009 (Setting same as for IR 001.)	
	08 to 15	Not used.	
6626 to 6627	00 to 15	Not used.	
6628	00 to 03	Interrupt enable for IR 00003 (0: Normal input; 1: Interrupt input; 2: Quick-response)	27
	04 to 07	Interrupt enable for IR 00004 (0: Normal input; 1: Interrupt input; 2: Quick-response)	
	08 to 11	Interrupt enable for IR 00005 (0: Normal input; 1: Interrupt input; 2: Quick-response) (Set to 0 in CPM2C CPU Units with 10 I/O points.)	
	12 to 15	Interrupt enable for IR 00006 (0: Normal input; 1: Interrupt input; 2: Quick-response) (This input does not exist in CPM2C CPU Units with 10 I/O points.)	

6629	00 to 03	PV coordinate system for pulse output 0 0: Relative coordinates; 1: Absolute coordinates	98
	04 to 07	PV coordinate system for pulse output 1 0: Relative coordinates; 1: Absolute coordinates	
	08 to 15	Not used.	
6630 to 6641	00 to 15	Not used.	

High-speed Counter Settings (DM 6640 to DM 6644)

The following settings are effective after transfer to the PC the next time operation is started.

6640 to 6641	00 to 15	Not used.	
6642	00 to 03	High-speed counter mode 0: Differential phase mode (5 kHz) 1: Pulse + direction input mode (20 kHz) 2: Up/down input mode (20 kHz) 4: Increment mode (20 kHz)	44,
	04 to 07	High-speed counter reset mode 0: Z phase and software reset; 1: Software reset only	
	08 to 15	High-speed counter/Synchronized pulse control for IR 00000 to IR 00002 00: Don't use either function. 01: Use as high-speed counters. 02: Use for synchronized pulse control (10 to 500 Hz). 03: Use for synchronized pulse control (20 Hz to 1 kHz). 04: Use for synchronized pulse control (300 Hz to 20 kHz).	
6643, 6644	00 to 15	Not used.	

RS-232C Port Communications Settings

The following settings are effective after transfer to the PC.

If the CPM2A CPU Unit's Communications Switch is ON, communications through the CPM2A's RS-232C port are governed by the default settings (all 0) regardless of the settings in DM 6645 through DM 6649.

If switch 2 of the CPM2C CPU Unit's DIP switch is ON, communications through the CPM2C's RS-232C port are governed by the default settings (all 0) regardless of the settings in DM 6645 through DM 6649.

6645	00 to 03	Port settings 0: Standard (1 start bit, 7 data bits, even parity, 2 stop bits, 9,600 bps), Host Link unit number: 0 1: Settings in DM 6646 (Any other setting will cause a non-fatal error and AR 1302 will turn ON.)	222
	04 to 07	CTS control setting 0: Disable CTS control; 1: Enable CTS control (Any other setting will cause a non-fatal error and AR 1302 will turn ON.)	
	08 to 11	Link words for 1:1 data link 0: LR 00 to LR 15 (Any other settings are ineffective.)	
	12 to 15	Communications mode 0: Host Link; 1: No-protocol; 2: 1:1 PC Link Slave; 3: 1:1 PC Link Master; 4: NT Link (Any other setting causes a non-fatal error and turns ON AR 1302.)	

6646	00 to 07	Baud rate 00: 1,200 bps; 01: 2,400 bps; 02: 4,800 bps; 03: 9,600 bps; 04: 19,200 bps	222																																																																	
	08 to 15	<p>Frame format</p> <table border="1"> <thead> <tr> <th></th> <th>Start bits</th> <th>Data bits</th> <th>Stop bits</th> <th>Parity</th> </tr> </thead> <tbody> <tr><td>00:</td><td>1 bit</td><td>7 bits</td><td>1 bit</td><td>Even</td></tr> <tr><td>01:</td><td>1 bit</td><td>7 bits</td><td>1 bit</td><td>Odd</td></tr> <tr><td>02:</td><td>1 bit</td><td>7 bits</td><td>1 bit</td><td>None</td></tr> <tr><td>03:</td><td>1 bit</td><td>7 bits</td><td>2 bits</td><td>Even</td></tr> <tr><td>04:</td><td>1 bit</td><td>7 bits</td><td>2 bits</td><td>Odd</td></tr> <tr><td>05:</td><td>1 bit</td><td>7 bits</td><td>2 bits</td><td>None</td></tr> <tr><td>06:</td><td>1 bit</td><td>8 bits</td><td>1 bit</td><td>Even</td></tr> <tr><td>07:</td><td>1 bit</td><td>8 bits</td><td>1 bit</td><td>Odd</td></tr> <tr><td>08:</td><td>1 bit</td><td>8 bits</td><td>1 bit</td><td>None</td></tr> <tr><td>09:</td><td>1 bit</td><td>8 bits</td><td>2 bits</td><td>Even</td></tr> <tr><td>10:</td><td>1 bit</td><td>8 bits</td><td>2 bits</td><td>Odd</td></tr> <tr><td>11:</td><td>1 bit</td><td>8 bits</td><td>2 bits</td><td>None</td></tr> </tbody> </table> <p>(Any other setting specifies standard settings (1 start bit, 7 data bits; even parity, 2 stop bits, 9,600 bps), causes a non-fatal error, and turns ON AR 1302.)</p>		Start bits	Data bits	Stop bits	Parity	00:	1 bit	7 bits	1 bit	Even	01:	1 bit	7 bits	1 bit	Odd	02:	1 bit	7 bits	1 bit	None	03:	1 bit	7 bits	2 bits	Even	04:	1 bit	7 bits	2 bits	Odd	05:	1 bit	7 bits	2 bits	None	06:	1 bit	8 bits	1 bit	Even	07:	1 bit	8 bits	1 bit	Odd	08:	1 bit	8 bits	1 bit	None	09:	1 bit	8 bits	2 bits	Even	10:	1 bit	8 bits	2 bits	Odd	11:	1 bit	8 bits	2 bits	None	
	Start bits	Data bits	Stop bits	Parity																																																																
00:	1 bit	7 bits	1 bit	Even																																																																
01:	1 bit	7 bits	1 bit	Odd																																																																
02:	1 bit	7 bits	1 bit	None																																																																
03:	1 bit	7 bits	2 bits	Even																																																																
04:	1 bit	7 bits	2 bits	Odd																																																																
05:	1 bit	7 bits	2 bits	None																																																																
06:	1 bit	8 bits	1 bit	Even																																																																
07:	1 bit	8 bits	1 bit	Odd																																																																
08:	1 bit	8 bits	1 bit	None																																																																
09:	1 bit	8 bits	2 bits	Even																																																																
10:	1 bit	8 bits	2 bits	Odd																																																																
11:	1 bit	8 bits	2 bits	None																																																																
6647	00 to 15	<p>Transmission delay (0000 to 9999 BCD sets a delay of 0 to 99,990 ms.)</p> <p>(Any other setting specifies a delay of 0 ms, causes a non-fatal error, and turns ON AR 1302.)</p>	222																																																																	
6648	00 to 07	<p>Node number (Host Link)</p> <p>00 to 31 (BCD)</p> <p>(Any other setting specifies a node number of 00, causes a non-fatal error, and turns ON AR 1302.)</p>	222																																																																	
	08 to 11	<p>Start code selection for no-protocol communications</p> <p>0: Disables start code; 1: Enables start code in DM 6649</p> <p>(Any other setting disables the start code, causes a non-fatal error, and turns ON AR 1302.)</p>																																																																		
	12 to 15	<p>End code selection for no-protocol communications</p> <p>0: Disables end code; 1: Enables end code in DM 6649; 2: Sets end code of CR, LF.</p> <p>(Any other setting disables the end code, causes a non-fatal error, and turns ON AR 1302.)</p>																																																																		
6649	00 to 07	<p>Start code (00 to FF)</p> <p>(This setting is valid only when bits 8 to 11 of DM 6648 are set to 1.)</p>	222																																																																	
	08 to 15	<p>When bits 12 to 15 of DM 6648 set to 0: Sets the number of bytes to receive. (00: 256 bytes; 01 to FF: 1 to 255 bytes)</p> <p>When bits 12 to 15 of DM 6648 set to 1: Sets the end code. (00 to FF)</p>																																																																		

Peripheral Port Communications Settings

The following settings are effective after transfer to the PC.

The CPM2A CPU Unit's Communications Switch is ON, communications through the peripheral port are governed by the default settings (all 0) regardless of the settings in DM 6650 through DM 6654.

The CPM2A's Communications Switch setting has no effect on communications with a Programming Console connected to the peripheral port or Support Software set for peripheral bus communications. The CPM2A CPU Unit will auto-detect the Programming Device and automatically establish communications.

For the CPM2C CPU Unit must be OFF in order for communications through the CPM2C's peripheral port to be governed by the settings in DM 6650 through DM 6654.

6650	00 to 03	Port settings 00: Standard (1 start bit, 7 data bits, even parity, 2 stop bits, 9,600 bps), Host Link unit number: 0 01: Settings in DM 6651 (Any other setting specifies standard settings, causes a non-fatal error, and turns ON AR 1302.)	222																																																															
	04 to 11	Not used.																																																																
	12 to 15	Communications mode 0: Host Link or peripheral bus; 1: No-protocol (Any other setting specifies Host Link, causes a non-fatal error, and turns ON AR 1302.)																																																																
6651	00 to 07	Baud rate 00: 1,200 bps; 01: 2,400 bps; 02: 4,800 bps; 03: 9,600 bps; 04: 19,200 bps	222																																																															
	08 to 15	Frame format <table border="1"> <thead> <tr> <th></th> <th>Start bits</th> <th>Data bits</th> <th>Stop bits</th> <th>Parity</th> </tr> </thead> <tbody> <tr> <td>00:</td> <td>1 bit</td> <td>7 bits</td> <td>1 bit</td> <td>Even</td> </tr> <tr> <td>01:</td> <td>1 bit</td> <td>7 bits</td> <td>1 bit</td> <td>Odd</td> </tr> <tr> <td>02:</td> <td>1 bit</td> <td>7 bits</td> <td>1 bit</td> <td>None</td> </tr> <tr> <td>03:</td> <td>1 bit</td> <td>7 bits</td> <td>2 bits</td> <td>Even</td> </tr> <tr> <td>04:</td> <td>1 bit</td> <td>7 bits</td> <td>2 bits</td> <td>Odd</td> </tr> <tr> <td>05:</td> <td>1 bit</td> <td>7 bits</td> <td>2 bits</td> <td>None</td> </tr> <tr> <td>06:</td> <td>1 bit</td> <td>8 bits</td> <td>1 bit</td> <td>Even</td> </tr> <tr> <td>07:</td> <td>1 bit</td> <td>8 bits</td> <td>1 bit</td> <td>Odd</td> </tr> <tr> <td>08:</td> <td>1 bit</td> <td>8 bits</td> <td>1 bit</td> <td>None</td> </tr> <tr> <td>09:</td> <td>1 bit</td> <td>8 bits</td> <td>2 bits</td> <td>Even</td> </tr> <tr> <td>10:</td> <td>1 bit</td> <td>8 bits</td> <td>2 bits</td> <td>Odd</td> </tr> <tr> <td>11:</td> <td>1 bit</td> <td>8 bits</td> <td>2 bits</td> <td>None</td> </tr> </tbody> </table> (Any other setting specifies standard settings (1 start bit, 7 data bits; even parity, 2 stop bits, 9,600 bps), causes a non-fatal error, and turns ON AR 1302.)			Start bits	Data bits	Stop bits	Parity	00:	1 bit	7 bits	1 bit	Even	01:	1 bit	7 bits	1 bit	Odd	02:	1 bit	7 bits	1 bit	None	03:	1 bit	7 bits	2 bits	Even	04:	1 bit	7 bits	2 bits	Odd	05:	1 bit	7 bits	2 bits	None	06:	1 bit	8 bits	1 bit	Even	07:	1 bit	8 bits	1 bit	Odd	08:	1 bit	8 bits	1 bit	None	09:	1 bit	8 bits	2 bits	Even	10:	1 bit	8 bits	2 bits	Odd	11:	1 bit	8 bits
	Start bits	Data bits	Stop bits	Parity																																																														
00:	1 bit	7 bits	1 bit	Even																																																														
01:	1 bit	7 bits	1 bit	Odd																																																														
02:	1 bit	7 bits	1 bit	None																																																														
03:	1 bit	7 bits	2 bits	Even																																																														
04:	1 bit	7 bits	2 bits	Odd																																																														
05:	1 bit	7 bits	2 bits	None																																																														
06:	1 bit	8 bits	1 bit	Even																																																														
07:	1 bit	8 bits	1 bit	Odd																																																														
08:	1 bit	8 bits	1 bit	None																																																														
09:	1 bit	8 bits	2 bits	Even																																																														
10:	1 bit	8 bits	2 bits	Odd																																																														
11:	1 bit	8 bits	2 bits	None																																																														
6652	00 to 15	Transmission delay (0000 to 9999 BCD sets a delay of 0 to 99,990 ms.) (Any other setting specifies a delay of 0 ms, causes a non-fatal error, and turns ON AR 1302.)	222																																																															
6653	00 to 07	Node number (Host Link) 00 to 31 (BCD) (Any other setting specifies a node number of 00, causes a non-fatal error, and turns ON AR 1302.)	222																																																															
	08 to 11	Start code selection for no-protocol communications 0: Disables start code; 1: Enables start code in DM 6649 (Any other setting disables the start code, causes a non-fatal error, and turns ON AR 1302.)																																																																
	12 to 15	End code selection for no-protocol communications 0: Disables end code; 1: Enables end code in DM 6649; 2: Sets end code of CR, LF. (Any other setting disables the end code, causes a non-fatal error, and turns ON AR 1302.)																																																																

6654	00 to 07	Start code (00 to FF) (This setting is valid only when bits 8 to 11 of DM 6648 are set to 1.)	222
	08 to 15	When bits 12 to 15 of DM 6648 set to 0: Sets the number of bytes to receive. (00: 256 bytes; 01 to FF: 1 to 255 bytes) When bits 12 to 15 of DM 6648 set to 1: Sets the end code. (00 to FF)	

Log Settings (DM 6655)

The following settings are effective after transfer to the PC.

6655	00 to 03	Style 0: Shift after 7 records have been stored 1: Store only first 7 records (no shifting) 2 to F: Do not store records	21
	04 to 07	Not used.	
	08 to 11	Cycle time monitor enable 0: Generate a non-fatal error for a cycle time that is too long. 1: Do not generate a non-fatal error.	
	12 to 15	Low battery error enable 0: Generate a non-fatal error for low battery voltage. 1: Do not generate a non-fatal error. Low battery error detection is disabled (i.e., set to 1) by default in CPU Units that do not have a clock. If the PC Setup is cleared, the setting will be changed to 0 and a low battery error will occur. Bits 12 to 15 should always be set to 0 when the optional CPM2C-BAT01 is mounted.	

The PC Setup is broadly divided into three categories: 1) Settings related to basic PC operation and I/O processes, 2) Settings related to the cycle time, and 3) Settings related to communications. This section will explain the settings according to these classifications.

The following table shows the settings for SRM1(-V2) PCs in order. Refer to the page number in the last column for more details on that setting.

Word(s)	Bit(s)	Function	Page
Startup Processing (DM 6600 to DM 6614)			
The following settings are effective after transfer to the PC only after the PC is restarted.			
6600	00 to 07	Startup mode (effective when bits 08 to 15 are set to 02). 00: PROGRAM; 01: MONITOR 02: RUN	16
	08 to 15	Startup mode designation 00: Programming Console switch 01: Continue operating mode last used before power was turned off 02: Setting in 00 to 07	
6601	00 to 07	Not used.	17
	08 to 11	IOM Hold Bit (SR 25212) Status 0: Reset; 1: Maintain (See caution on page 17.)	
	12 to 15	Forced Status Hold Bit (SR 25211) Status 0: Reset; 1: Maintain	
6602	00 to 03	Program memory write-protection 0: Program memory unprotected 1: Program memory write-protected (except DM 6602 itself)	17
	04 to 07	Programming Console display language 0: English; 1: Japanese	
	08 to 11	Expansion Instructions 0: Default settings; 1: User settings	
	12 to 15	Not used.	
6603	00 to 03	Maximum number of CompoBus/S devices 0: Max. no. 32 1: Max. no. 16	
	04 to 07	CompoBus/S communications mode setting (V2 only) 0: High-speed communications 1: Long-distance communications	
	08 to 15	Not used.	
6604	00 to 07	00: If data could not be saved for a power interruption (AR 1314 ON), a memory error will not be generated. 01: If data could not be saved for a power interruption (AR 1314 ON), a memory error will be generated.	
	08 to 15	Not used.	
6605 to 6614	00 to 15	Not used.	
Cycle Time Settings (DM 6615 to DM 6619)			
The following settings are effective after transfer to the PC the next time operation is started.			
6615	00 to 15	Not used.	
6616	00 to 07	Servicing time for RS-232C port (effective when bits 08 to 15 are set to 01) 00 to 99 (BCD): Percentage for cycle time used to service peripheral.	18
	08 to 15	RS-232C port servicing enable 00: 5% of the cycle time 01: Use time in 00 to 07.	
6617	00 to 07	Servicing time for peripheral port (effective when bits 08 to 15 are set to 01) 00 to 99 (BCD): Percentage of cycle time used to service peripheral.	18
	08 to 15	Peripheral port servicing setting enable 00: 5% of the cycle time 01: Use time in 00 to 07.	

6618	00 to 07	Cycle monitor time (effective when bits 08 to 15 are set to 01, 02, or 03) 00 to 99 (BCD): Setting (see 08 to 15)	18
	08 to 15	Cycle monitor enable (Setting in 00 to 07 x unit; 99 s max.) 00: 120 ms (setting in bits 00 to 07 disabled) 01: Setting unit: 10 ms 02: Setting unit: 100 ms 03: Setting unit: 1 s	
6619	00 to 15	Cycle time 0000: Variable (no minimum) 0001 to 9999 (BCD): Minimum time in ms	19
6620 to 6644	00 to 15	Not used.	

232C Port Settings

following settings are effective after transfer to the PC.

6645	00 to 03	Port settings 0: Standard (1 start bit, 7-bit data, even parity, 2 stop bits, 9,600 bps) 1: Settings in DM 6646	264																																																																						
	04 to 07	CTS control settings 0: Disable; 1: Set																																																																							
	08 to 11	When using a 1:1 data link: Sets the link area for 1:1 PC Link. 0: LR 00 to LR 15 Not 0: Disable When using a 1:N NT Link: Sets the maximum PT node number. 1 to 7																																																																							
	12 to 15	Communications mode 0: Host Link; 1: No-protocol; 2: 1:1 PC Link Slave; 3: 1:1 PC Link Master; 4: 1:1 NT Link; 5: 1:N NT Link (Any other setting specifies Host Link mode, causes a non-fatal error, and turns ON AR 1302.) The 1:N NT Link is supported by SRM1-C02-V2 only.																																																																							
6646	00 to 07	Baud rate 00: 1.2K, 01: 2.4K, 02: 4.8K, 03: 9.6K, 04: 19.2K																																																																							
	08 to 15	Frame format <table border="1"> <thead> <tr> <th></th> <th>Start</th> <th>Length</th> <th>Stop</th> <th>Parity</th> </tr> </thead> <tbody> <tr> <td>00:</td> <td>1 bit</td> <td>7 bits</td> <td>1 bit</td> <td>Even</td> </tr> <tr> <td>01:</td> <td>1 bit</td> <td>7 bits</td> <td>1 bit</td> <td>Odd</td> </tr> <tr> <td>02:</td> <td>1 bit</td> <td>7 bits</td> <td>1 bit</td> <td>None</td> </tr> <tr> <td>03:</td> <td>1 bit</td> <td>7 bits</td> <td>2 bits</td> <td>Even</td> </tr> <tr> <td>04:</td> <td>1 bit</td> <td>7 bits</td> <td>2 bits</td> <td>Odd</td> </tr> <tr> <td>05:</td> <td>1 bit</td> <td>7 bits</td> <td>2 bits</td> <td>None</td> </tr> <tr> <td>06:</td> <td>1 bit</td> <td>8 bits</td> <td>1 bit</td> <td>Even</td> </tr> <tr> <td>07:</td> <td>1 bit</td> <td>8 bits</td> <td>1 bit</td> <td>Odd</td> </tr> <tr> <td>08:</td> <td>1 bit</td> <td>8 bits</td> <td>1 bit</td> <td>None</td> </tr> <tr> <td>09:</td> <td>1 bit</td> <td>8 bits</td> <td>2 bits</td> <td>Even</td> </tr> <tr> <td>10:</td> <td>1 bit</td> <td>8 bits</td> <td>2 bits</td> <td>Odd</td> </tr> <tr> <td>11:</td> <td>1 bit</td> <td>8 bits</td> <td>2 bits</td> <td>None</td> </tr> <tr> <td>Other:</td> <td>1 bit</td> <td>7 bits</td> <td>2 bits</td> <td>Even</td> </tr> </tbody> </table> AR 1302 will turn ON to indicate a non-fatal system setting error if any value not between 00 and 11 is set.		Start	Length	Stop	Parity	00:	1 bit	7 bits	1 bit	Even	01:	1 bit	7 bits	1 bit	Odd	02:	1 bit	7 bits	1 bit	None	03:	1 bit	7 bits	2 bits	Even	04:	1 bit	7 bits	2 bits	Odd	05:	1 bit	7 bits	2 bits	None	06:	1 bit	8 bits	1 bit	Even	07:	1 bit	8 bits	1 bit	Odd	08:	1 bit	8 bits	1 bit	None	09:	1 bit	8 bits	2 bits	Even	10:	1 bit	8 bits	2 bits	Odd	11:	1 bit	8 bits	2 bits	None	Other:	1 bit	7 bits	2 bits	Even	
	Start	Length	Stop	Parity																																																																					
00:	1 bit	7 bits	1 bit	Even																																																																					
01:	1 bit	7 bits	1 bit	Odd																																																																					
02:	1 bit	7 bits	1 bit	None																																																																					
03:	1 bit	7 bits	2 bits	Even																																																																					
04:	1 bit	7 bits	2 bits	Odd																																																																					
05:	1 bit	7 bits	2 bits	None																																																																					
06:	1 bit	8 bits	1 bit	Even																																																																					
07:	1 bit	8 bits	1 bit	Odd																																																																					
08:	1 bit	8 bits	1 bit	None																																																																					
09:	1 bit	8 bits	2 bits	Even																																																																					
10:	1 bit	8 bits	2 bits	Odd																																																																					
11:	1 bit	8 bits	2 bits	None																																																																					
Other:	1 bit	7 bits	2 bits	Even																																																																					
6647	00 to 15	Transmission delay (Host Link) 0000 to 9999 (BCD): Set in units of 10 ms, e.g., setting of 0001 equals 10 ms																																																																							
6648	00 to 07	Node number (Host Link, effective when bits 12 to 15 of DM 6645 are set to 0.) 00 to 31 (BCD)																																																																							
	08 to 11	Start code enable (RS-232C, effective when bits 12 to 15 of DM 6645 are set to 1.) 0: Disable; 1: Set																																																																							
	12 to 15	End code enable (RS-232C, effective when bits 12 to 15 of DM 6645 are set to 1.) 0: Disable (number of bytes received) 1: Set (specified end code) 2: CR, LF																																																																							

6649	00 to 07	Start code (RS-232C) 00 to FF (binary)	264
	08 to 15	When bits 12 to 15 of DM 6648 are set to 0: Number of bytes received 00: Default setting (256 bytes) 01 to FF: 1 to 255 bytes When bits 12 to 15 of DM 6648 are set to 1: End code (RS-232C) 00 to FF (binary)	

Peripheral Port Settings

The following settings are effective after transfer to the PC.

6650	00 to 03	Port settings 00: Standard (1 start bit, 7-bit data, even parity, 2 stop bits, 9,600 bps) 01: Settings in DM 6651 (Other settings will cause a non-fatal error and AR 1302 will turn ON.)	264																																																																						
	04 to 07	Not used.																																																																							
	08 to 11	Not used.																																																																							
	12 to 15	Communications mode 0: Host Link; 1: No-protocol (Other settings will cause a non-fatal error and AR 1302 will turn ON.)																																																																							
6651	00 to 07	Baud rate 00: 1.2K, 01: 2.4K, 02: 4.8K, 03: 9.6K, 04: 19.2K																																																																							
	08 to 15	Frame format <table border="1"> <thead> <tr> <th></th> <th>Start</th> <th>Length</th> <th>Stop</th> <th>Parity</th> </tr> </thead> <tbody> <tr><td>00:</td><td>1 bit</td><td>7 bits</td><td>1 bit</td><td>Even</td></tr> <tr><td>01:</td><td>1 bit</td><td>7 bits</td><td>1 bit</td><td>Odd</td></tr> <tr><td>02:</td><td>1 bit</td><td>7 bits</td><td>1 bit</td><td>None</td></tr> <tr><td>03:</td><td>1 bit</td><td>7 bits</td><td>2 bits</td><td>Even</td></tr> <tr><td>04:</td><td>1 bit</td><td>7 bits</td><td>2 bits</td><td>Odd</td></tr> <tr><td>05:</td><td>1 bit</td><td>7 bits</td><td>2 bits</td><td>None</td></tr> <tr><td>06:</td><td>1 bit</td><td>8 bits</td><td>1 bit</td><td>Even</td></tr> <tr><td>07:</td><td>1 bit</td><td>8 bits</td><td>1 bit</td><td>Odd</td></tr> <tr><td>08:</td><td>1 bit</td><td>8 bits</td><td>1 bit</td><td>None</td></tr> <tr><td>09:</td><td>1 bit</td><td>8 bits</td><td>2 bits</td><td>Even</td></tr> <tr><td>10:</td><td>1 bit</td><td>8 bits</td><td>2 bits</td><td>Odd</td></tr> <tr><td>11:</td><td>1 bit</td><td>8 bits</td><td>2 bits</td><td>None</td></tr> <tr><td>Other:</td><td>1 bit</td><td>7 bits</td><td>2 bits</td><td>Even</td></tr> </tbody> </table> AR 1302 will turn ON to indicate a non-fatal system setting error if any value not between 00 and 11 is set.		Start	Length	Stop	Parity	00:	1 bit	7 bits	1 bit	Even	01:	1 bit	7 bits	1 bit	Odd	02:	1 bit	7 bits	1 bit	None	03:	1 bit	7 bits	2 bits	Even	04:	1 bit	7 bits	2 bits	Odd	05:	1 bit	7 bits	2 bits	None	06:	1 bit	8 bits	1 bit	Even	07:	1 bit	8 bits	1 bit	Odd	08:	1 bit	8 bits	1 bit	None	09:	1 bit	8 bits	2 bits	Even	10:	1 bit	8 bits	2 bits	Odd	11:	1 bit	8 bits	2 bits	None	Other:	1 bit	7 bits	2 bits	Even	
	Start	Length	Stop	Parity																																																																					
00:	1 bit	7 bits	1 bit	Even																																																																					
01:	1 bit	7 bits	1 bit	Odd																																																																					
02:	1 bit	7 bits	1 bit	None																																																																					
03:	1 bit	7 bits	2 bits	Even																																																																					
04:	1 bit	7 bits	2 bits	Odd																																																																					
05:	1 bit	7 bits	2 bits	None																																																																					
06:	1 bit	8 bits	1 bit	Even																																																																					
07:	1 bit	8 bits	1 bit	Odd																																																																					
08:	1 bit	8 bits	1 bit	None																																																																					
09:	1 bit	8 bits	2 bits	Even																																																																					
10:	1 bit	8 bits	2 bits	Odd																																																																					
11:	1 bit	8 bits	2 bits	None																																																																					
Other:	1 bit	7 bits	2 bits	Even																																																																					
6652	00 to 15	Transmission delay (Host Link) 0000 to 9999 (BCD): Set in units of 10 ms. (Other settings will cause a non-fatal error and AR 1302 will turn ON.)	264																																																																						
6653	00 to 07	Node number (Host Link) 00 to 31 (BCD) (Other settings will cause a non-fatal error and AR 1302 will turn ON.)																																																																							
	08 to 11	Start code enable (RS-232C, effective when bits 12 to 15 of DM6650 are set to 1.) 0: Disable 1: Set																																																																							
	12 to 15	End code enable (RS-232C, effective when bits 12 to 15 of DM6650 are set to 1.) 0: Disable (number of bytes received) 1: Set (specified end code) 2: CR, LF																																																																							

00 to 07	Start code (effective when bits 08 to 11 of DM6650 are set to 1.) 00: 256 bytes 01 to FF: 1 to 255 bytes	264
08 to 15	End code When bits 12 to 15 of DM6653 are set to 0: 00: 256 bytes 01 to FF: 1 to 255 bytes When bits 12 to 15 of DM6653 are set to 1: Setting: 00 to FF (binary)	

Log Settings (DM 6655)

The following settings are effective after transfer to the PC.

00 to 03	Style 0: Shift after 7 records have been stored 1: Store only first 7 records Errors will not be stored if other values are set.	21
04 to 07	Not used.	
08 to 11	Cycle time monitor enable 0: Detect long cycles as non-fatal errors 1: Do not detect long cycles	
12 to 15	Low battery error enable 0: Generate a non-fatal error for low battery voltage. 1: Do not generate a non-fatal error.	

Note If an out-of-range value is set, the following communications conditions will result. In that case, reset the value so that it is within the permissible range.

Communications mode: Host Link
 Communications format: Standard settings
 (1 start bit, 7-bit data; even parity, 2 stop bits, 9,600 bps)
 Transmission delay: No
 Node number: 00

2 Basic PC Operation and I/O Processes

This section explains the PC Setup settings related to basic operation and I/O processes.

2-1 Startup Mode

The operation mode the PC will start in when power is turned on can be set as shown below.

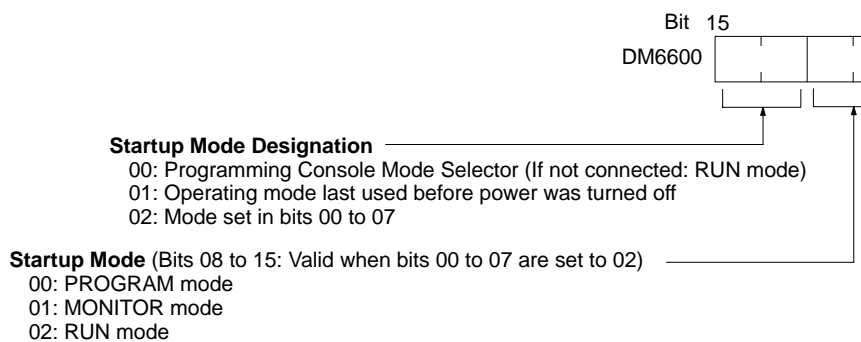

Default: Programming Console Mode Selector or RUN mode when Programming Console is not connected.

Unit's Bit Switch is ON, the CPU MZC will enter ROM mode automatically, regardless of the Programming Console's mode switch setting.

2-2 Hold Bit Status

Make the settings shown below to determine whether, when the power supply is turned on, the Forced Status Hold Bit (SR 25211) and/or IOM Hold Bit (SR 25212) will retain the status that was in effect when the power was turned off, or whether the previous status will be cleared.

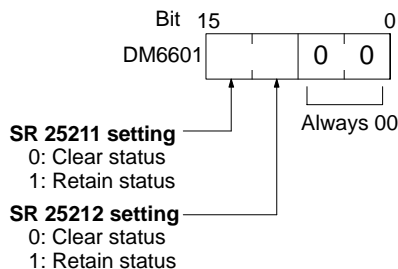

Default: Clear both.

The Forced Status Hold Bit (SR 25211) determines whether or not the forced set/reset status is retained when changing from PROGRAM mode to MONITOR mode.

The IOM Hold Bit (SR 25212) determines whether or not the status of IR bits and LR bits is retained when PC operation is started and stopped.



Caution

In PCs with capacitor backup, do not use the I/O Hold Bit Status and Forced Status Hold Bit Status Bits (DM 6601) when the power to the PC is going to be turned off longer than the memory backup time of the internal capacitor. If the memory backup time is exceeded, memory status will be unstable even if the I/O Hold Bit Status and Forced Status Hold Bit Status Bits are used. Unpredictable results may occur if operation is attempted with unstable memory status.

- Note**
1. The memory backup time of the internal capacitor varies with the ambient temperature, but is 20 days at 25°C. Refer to hardware specifications for more details.
 2. The memory backup time assumes that the internal capacitor is fully charged before power is turned off. Fully charging the capacitor requires that power is supplied to the CPU Unit for at least 15 minutes.

2-3 Program Memory Write-protection

In CPM1, CPM1A, CPM2A, and CPM2C PCs, the program memory can be write-protected by setting bits 00 to 03 of DM 6602 to 1. Bits 04 to 07 determine whether Programming Console messages are displayed in English or Japanese.

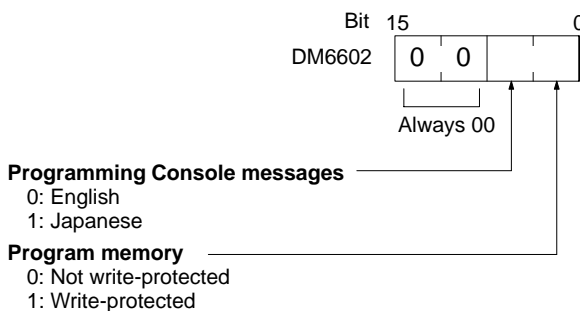

Default: English displays, not write-protected

2-4 RS-232C Port Servicing Time (CPM2A/CPM2C/SRM1(-V2) Only)

The following settings are used to determine the percentage of the cycle devoted to servicing the RS-232C port.

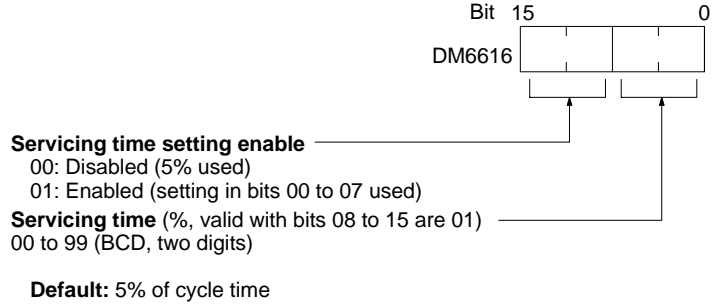

Example: If DM 6616 is set to 0110, the RS-232C port will be serviced for 10% of the cycle time.

The servicing time will be 0.34 ms minimum.

The entire servicing time will not be used unless processing requests exist.

2-5 Peripheral Port Servicing Time

The following settings are used to determine the percentage of the cycle devoted to servicing the peripheral port.

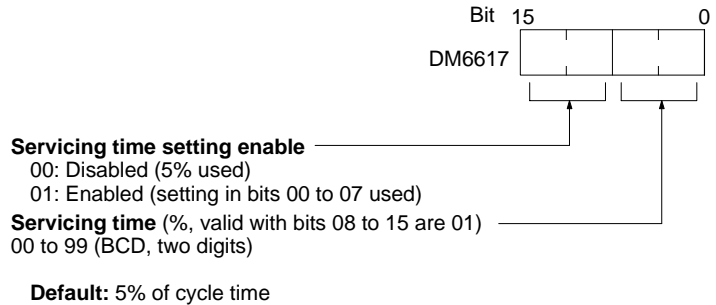

Example: If DM 6617 is set to 0115, the peripheral port will be serviced for 15% of the cycle time.

The servicing time will be 0.34 ms minimum.

The entire servicing time will not be used unless processing requests exist.

2-6 Cycle Monitor Time

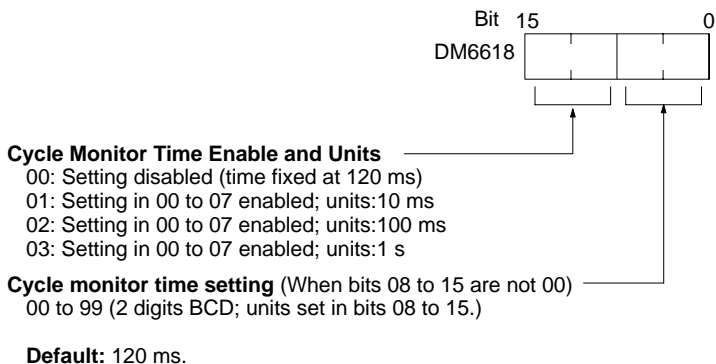

ceeds the cycle monitor setting, a fatal error (FALS 9F) will be generated.

- Note**
1. The units used for the maximum and current cycle times recorded in the AR area (AR 14 and AR 15) are determined by the setting for the cycle monitor time in DM 6618, as shown below.
Bits 08 to 15 set to 01: 0.1 ms
Bits 08 to 15 set to 02: 1 ms
Bits 08 to 15 set to 03: 10 ms
 2. If the cycle time is 1 s or longer, the cycle time read from Programming Devices will be 999.9 ms. The correct maximum and current cycle times will be recorded in the AR area.

Example

If 0230 is set in DM 6618, an FALS 9F error will not occur until the cycle time exceeds 3 s. If the actual cycle time is 2.59 s, the current cycle time stored in the AR area will be 2590 (ms), but the cycle time read from a Programming Device will be 999.9 ms.

A “cycle time over” error (non-fatal) will be generated when the cycle time exceeds 100 ms unless detection of long cycle times is disabled using the setting DM 6655.

2-7 Minimum Cycle Time

Make the settings shown below to standardize the cycle time and to eliminate variations in I/O response time by setting a minimum cycle time.

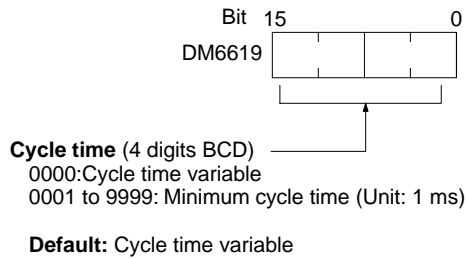

If the actual cycle time is shorter than the minimum cycle time, execution will wait until the minimum time has expired. If the actual cycle time is longer than the minimum cycle time, then operation will proceed according to the actual cycle time. AR 2405 will turn ON if the minimum cycle time is exceeded.

2-8 Input Time Constants

Make the settings shown below to set the time from when the actual inputs to the DC Input Unit are turned ON or OFF until the corresponding input bits are updated (i.e., until their ON/OFF status is changed). Make these settings when you want to adjust the time until inputs stabilize.

Increasing the input time constant can reduce the effects from chattering external noise.

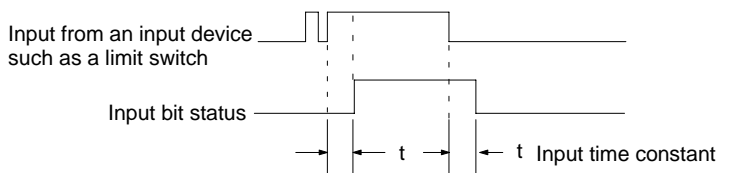

The SRM1(-V2) does not have this setting.

vice.

Input Time Constants for IR 000

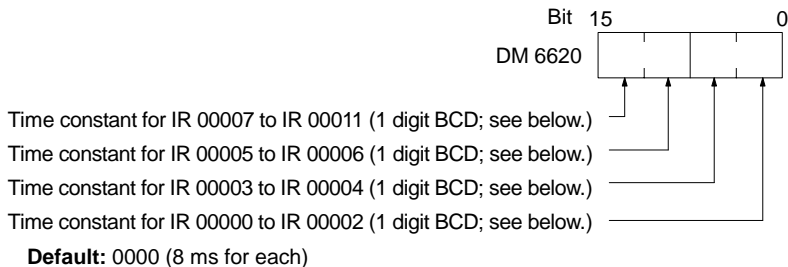

Input Time Constants for IR 001 to IR 009

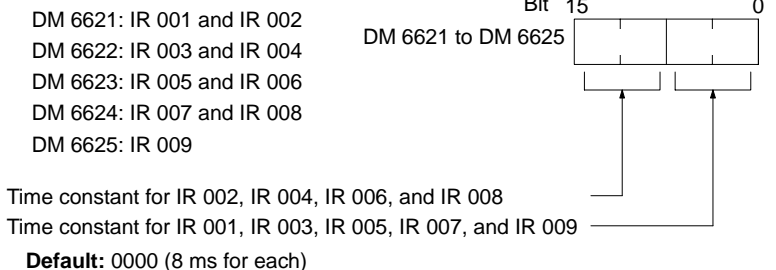

The nine possible settings for the input time constant are shown below. (Set the rightmost digit for each setting for IR 000.)

00: 8 ms	01: 1 ms	02: 2 ms	03: 4 ms	04: 8 ms
05: 16 ms	06: 32 ms	07: 64 ms	08: 128 ms	

The CPM1/CPM1A's I/O response time is the input time constant (1 ms to 128 ms; default is 8 ms) + the cycle time.

Refer to 8-1 CPM1/CPM1A Cycle Time and I/O Response Time for more details.

CPM2A/CPM2C PCs

Set the input time constants for CPM2A/CPM2C inputs from a Programming Device.

Input Time Constants for IR 000

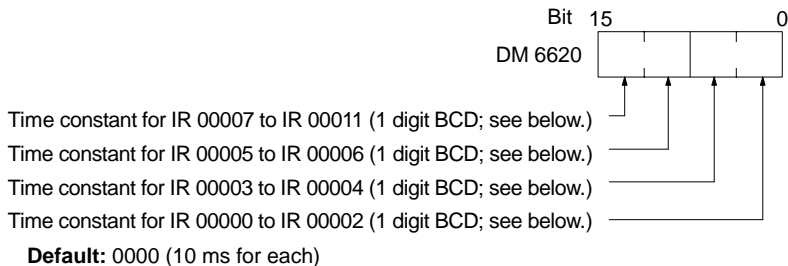

Input Time Constants for IR 001 to IR 009

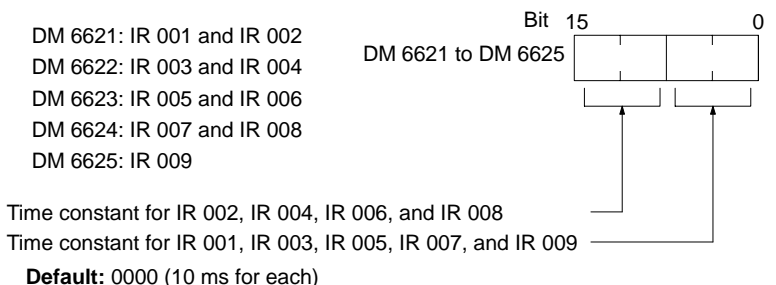

the rightmost digit for IR 665.)
 00: 10 ms 01: 1 ms 02: 2 ms 03: 3 ms 04: 5 ms
 05: 10 ms 06: 20 ms 07: 40 ms 08: 80 ms

2-9 Error Log Settings

Error Detection and Error Log Operation (DM 6655)

Make the settings shown below to determine whether or not a non-fatal error can be generated when the cycle time exceeds 100 ms or when the voltage of the built-in battery drops (CPM2A/CPM2C only), and to set the method for storing error records in the error log when errors occur.

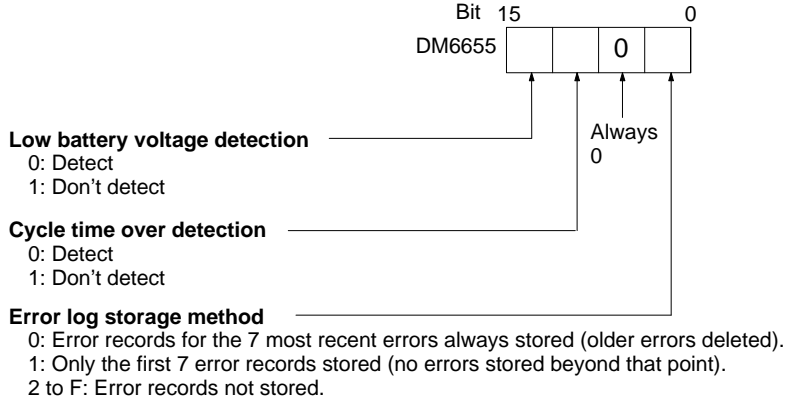

Default: Low battery voltage and cycle time over errors detected, and error records stored for the 7 most recent errors.

Battery errors and cycle time overrun errors are non-fatal errors.

For details on the error log, refer to *Section 9 Troubleshooting*.

Note The low battery error is applicable to CPM2A/CPM2C only. This digit isn't used on CPM1/CPM1A/SRM1(-V2) PCs and CPM2C PCs that aren't equipped with a built-in battery.

3 CPM2C Changes in SW2

The connection of a Programming Console to the peripheral connector is automatically detected for CPM2C CPU Units with lot numbers of 01900 (1 September 2000) or later. This has resulted in a change to the operation of SW2 on the front of the CPU Unit. Check the lot number to confirm the operation of SW2 on any of the following model numbers before attempting operations.

Units with Changed Specifications for SW2

I/O	Units with Relay Outputs and a Terminal Block	Units with Transistor Outputs and a Connector	
		Sinking outputs	Sourcing outputs
10 I/O points	CPM2C-10CDR-D CPM2C-10C1DR-D	CPM2C-10CDTC-D CPM2C-10C1DTC-D	CPM2C-10CDT1C CPM2C-10C1DT1C
20 I/O points	---	CPM2C-20CDTC-D CPM2C-20C1DTC-D	CPM2C-20CDT1C CPM2C-20C1DT1C

Interpreting Lot Numbers

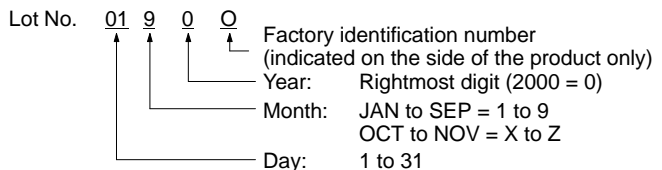

The following instructions apply to CPU Units with lot numbers of 31800 (AUDIN 2000) or earlier.

The previous CPU Units do not detect a Programming Console connected to peripheral port, and SW2 of the DIP switch was used to set either "Programming Console" or "Other device."

SW2 Setting

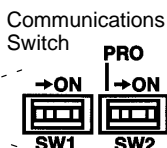

Setting	Meaning
OFF	Programming Console connected to peripheral port.
ON	Device other than Programming Console connected to peripheral port.

SW1 Setting

Setting	Meaning
OFF	Use PC Setup settings for RS-232C port (DM 6645 to DM 6649).
ON	Use default settings for RS-232C port.

The relationship between the PC Setup settings, the setting of SW2, and the startup operating mode for previous CPU Units is shown in the following table.

PC Setup			CPM2C Operating Mode			
Address	Bits	Setting				
16600	08 to 15	00 Hex	According to communications switch SW2 and peripheral port device.			
			Peripheral device	SW2 setting		
				OFF	ON	
			Nothing connected	PROGRAM mode	RUN mode	
	Programming Console	According to Programming Console key switch.	PROGRAM mode (See note.)			
	Other	PROGRAM mode (See note.)	PROGRAM mode			
00 to 07	00 to 07	01 Hex	Mode used immediately before power interruption			
		02 Hex	Mode specified in bits 00 to 07.			
		00 Hex	PROGRAM mode			
	00 to 07	01 Hex	MONITOR mode			
		00 to 07	02 Hex	RUN mode		

- Note**
- The default setting for DM 6600, bits 06 to 15 is 00 Hex, i.e., according to communications switch on the front panel. If SW2 is set for connecting a device other than a Programming Console to the peripheral connector, CPU Unit will start in RUN mode as soon as power is turned ON. Be sure adequate precautions are taken to ensure safety.
 - If SW2 is for connecting a device other than a Programming Console to peripheral connector, the CPU Unit will start in RUN mode as soon as power is turned ON even if a device is connected to the RS-232C port. Be sure adequate precautions are taken to ensure safety.

IBM PC/AT
or compatible

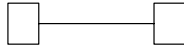

XW2Z-200S-V
XW2Z-500S-V

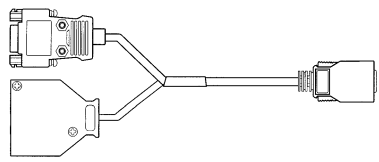
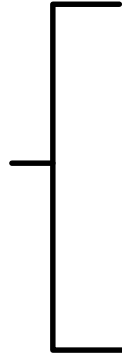

CPM2C-CN111

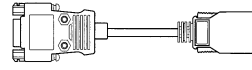

CS1W-CN118

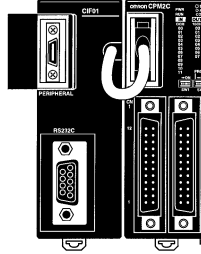
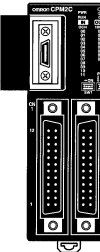

This section explains special features of the CPM1, CPM1A, CPM2A, CPM2C (including the CPM2C-S), and SRM1(-V2).

2-1	CPM2A/CPM2C Interrupt Functions	26
2-1-1	Interrupt Inputs	27
2-1-2	Interval Timer Interrupts	34
2-1-3	Precautions on Programming Interrupts	39
2-2	CPM2A/CPM2C High-speed Counters	42
2-2-1	Using High-speed Counters	44
2-2-2	Input Interrupts In Counter Mode	65
2-3	CPM1/CPM1A Interrupt Functions	73
2-3-1	Types of Interrupts	74
2-3-2	Input Interrupts	75
2-3-3	Masking All Interrupts	80
2-3-4	Interval Timer Interrupts	81
2-3-5	High-speed Counter Interrupts	83
2-3-6	Precautions on Programming Interrupts	91
2-4	SRM1(-V2) Interrupt Functions	91
2-4-1	Types of Interrupts	91
2-4-2	Interval Timer Interrupts	91
2-5	CPM2A/CPM2C Pulse Output Functions	94
2-5-1	Using Single-phase Pulse Outputs Without Acceleration and Deceleration (Fixed Duty Ratio)	98
2-5-2	Using Pulse Outputs With Variable Duty Ratio	108
2-5-3	Using Pulse Outputs With Trapezoidal Acceleration and Deceleration	114
2-6	CPM1A Pulse Output Functions	128
2-6-1	Programming Example in Continuous Mode	129
2-6-2	Programming Example in Independent Mode	129
2-6-3	Using Pulse Output Instructions	129
2-6-4	Changing the Frequency	130
2-6-5	Stopping Pulse Output	130
2-7	Synchronized Pulse Control (CPM2A/CPM2C Only)	131
2-8	Data Computation Standards	143
2-8-1	Pulse Outputs	143
2-8-2	Synchronized Pulse Control	143
2-9	Analog I/O Functions (CPM1/CPM1A/CPM2A/CPM2C Only)	144
2-10	Temperature Sensor Input Functions (CPM1A/CPM2A/CPM2C Only)	144
2-11	CompoBus/S I/O Slave Functions (CPM1A/CPM2A/CPM2C Only)	144
2-12	CompoBus/S I/O Master Functions (SRM1(-V2) and CPM2C-S Only)	145
2-13	Analog Controls (CPM1/CPM1A/CPM2A Only)	147
2-14	Quick-response Inputs	149
2-14-1	CPM1/CPM1A Quick-response Inputs	149
2-14-2	CPM2A/CPM2C Quick-response Inputs	151
2-15	Macro Function	154
2-16	Calculating with Signed Binary Data	155
2-16-1	Definition of Signed Binary Data	156
2-16-2	Arithmetic Flags	156
2-16-3	Inputting Signed Binary Data Using Decimal Values	156
2-17	Differential Monitor	156
2-18	Expansion Instructions (CPM2A/CPM2C/SRM1(-V2) Only)	157
2-18-1	CPM2A/CPM2C/CPM2C-S Expansion Instructions	158
2-18-2	SRM1(-V2) Expansion Instructions	159
2-19	Using the CPM2A/CPM2C Clock Function	160
2-19-1	Data Area Words	160
2-19-2	Setting the Time	160

Types of Interrupts

The CPM2A and CPM2C (including the CPM2C-S) provide the following kinds of interrupt processing. Interrupts may be disabled temporarily when online editing is performed during operation or STUP(—) is executed to change settings.

Note *Input points 00005 and 00006 do not exist in CPM2C CPU Units with only 10 input points or in CPM2C-S CPU Units. In these CPU Units, interrupt subroutine numbers 000 and 001 are allocated to input points 00003 and 00004.

Interrupt Inputs

Interrupt programs are executed when inputs to the CPU Unit's built-in input points (00003 to 00006*) are turned from OFF to ON. Interrupt subroutine numbers 000 to 003* are allocated to input points 00003 to 00006*.

Interval Timer Interrupts

Interval timer interrupt programs are executed with a precision of 0.1 ms. Interrupt subroutine numbers 000 to 049 are allocated by instructions.

Count-up Interrupts Using Interrupt Inputs (Counter Mode)

Input signals to the CPU Unit's built-in input points (00003 to 00006*) are counted at high speed (2 kHz), and the normal program is stopped and an interrupt program is executed. Interrupt subroutine numbers 000 to 003* are allocated to input points 00003 to 00006*.

Count-check Interrupts Using the High-speed Counter

Pulse inputs to the CPU Unit's input points (00000 to 00002) are counted at high speed (20 kHz/5 kHz), and an interrupt program is executed when the present value matches the target value or falls within a given range. Interrupt subroutine numbers 000 to 049 are allocated by instructions.

Note Interrupts will be temporarily disabled if online editing is performed during operation or if the PC Setup is changed during operation (including changes made with STUP(—)).

Writing Interrupt Programs

Interrupt programs are defined as interrupt subroutines within the user program. Just like ordinary subroutines, an interrupt subroutine is defined by SBN(92) and RET(93). It is written at the end of the normal program.

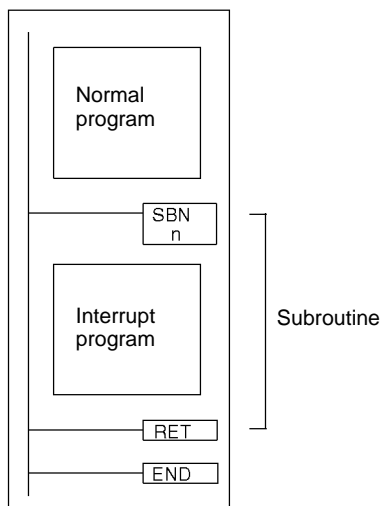

- 1, 2, 3...** 1. A new interrupt can be defined in an interrupt subroutine, and an existing one can be cleared.
2. Within any given interrupt subroutine, it is not possible to write another interrupt subroutine for processing another interrupt. Do not nest another interrupt subroutine between the SBN(92) and RET(93) instructions.

Do not nest an ordinary subroutine program between the SBN(92) and RET(93) instructions.

- It is not possible to write an interrupt subroutine within an ordinary subroutine program. Do not nest an interrupt subroutine between the SBN(92) and RET(93) instructions.

When an interrupt subroutine is defined, an SBS UNDEFD error will be generated during the program check but execution will be normal.



Caution

Although IORF(97) can be used in interrupt subroutines, you must be careful of the interval between IORF(97) executions. If IORF(97) is executed too frequently, a fatal system error may occur (FALS 9F), stopping operation. The interval between executions of IORF(97) should be at least 1.3 ms + total execution of the interrupt subroutine.

Order of Priority for Interrupts

The order of priority for interrupts is as follows:

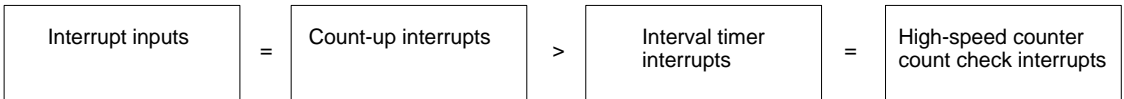

If an interrupt with a higher priority is generated during interrupt program execution, the interrupt that is currently being processed will be stopped and the higher-priority interrupt will be processed first. Then the original interrupt will be resumed after the higher-priority interrupt processing has been completed.

If interrupts of the same priority are generated simultaneously, they will be processed in the following order:

Interrupt input 0 → Interrupt input 1 → Interrupt input 2 → Interrupt input 3 (including count-up mode)

Interval timer interrupt → High-speed counter interrupt

I-1 Interrupt Inputs

By turning the CPU Unit's built-in input points from OFF to ON, the normal program can be stopped and the interrupt program executed. The interrupt inputs are allocated to four points (00003 to 00006, see note).

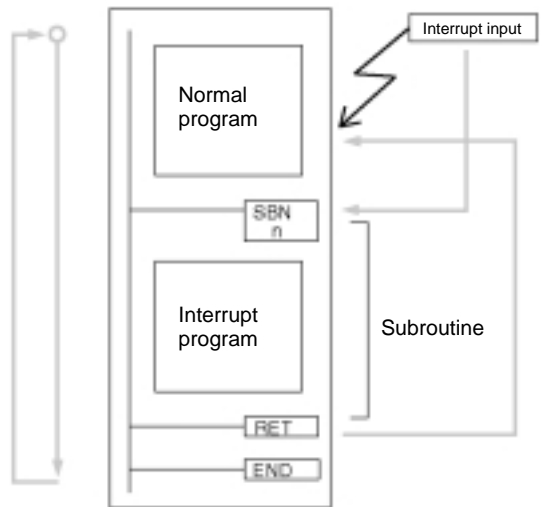
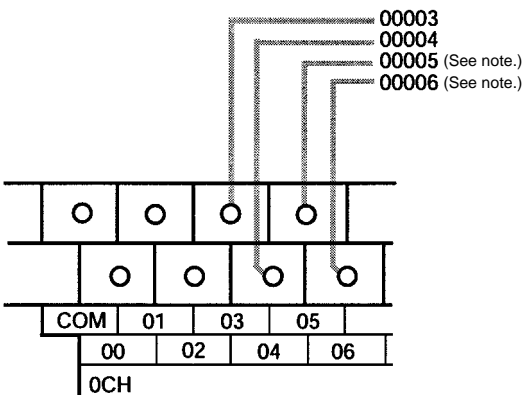

Note Input points 00005 and 00006 do not exist in CPM2C CPU Units with only 10 input points or in CPM2C-S CPU Units.

(Note 1)	number	number (Note 2)	input signal width	response time
00003	0	000	50 μ s	0.3 ms (from when input turns ON until program execution)
00004	1	001		
00005 (See note 3.)	2	002		
00006 (See note 3.)	3	003		

- Note**
1. Input numbers 00003 to 00006 can be used for any of the following functions: interrupt inputs, interrupt inputs (counter mode), or quick-response inputs. When not being used for any of these, they can be used as ordinary inputs.
 2. Subroutine numbers 000 to 003 are the subroutine numbers for interrupt programs started up when interrupt inputs or count-up interrupts for interrupt inputs (counter mode) are generated. When not being used for this purpose, they can be used as ordinary inputs.
 3. Input points 00005 and 00006 do not exist in CPM2C CPU Units with on-board I/O points or in CPM2C-S CPU Units.

The following table shows the relationships between interrupt inputs and CPM2A/CPM2C PC's other functions.

Function	Interrupt inputs (counter mode)
Synchronized pulse control	Can be used simultaneously.
Interrupt inputs	See note 1.
Interval timer interrupts	Can be used simultaneously.
High-speed counters	Can be used simultaneously.
Interrupt inputs (counter mode)	See note 1.
Pulse outputs	Can be used simultaneously.
Quick-response inputs	See note 1.
Input time constant	See note 2.
Clock	Can be used simultaneously.

- Note**
1. The same input number (from 00003 to 00006) cannot be used for more than one of the following functions: interrupt inputs, interrupt inputs (counter mode), or quick-response inputs.
 2. When inputs 00003 to 00006 are set for use as interrupt inputs (counter mode), the input time constants for the relevant inputs are disabled. The input time constants remain in effect, however, for the values for refresh in the relevant input relay area.

Set the interrupt input number.



Wire the inputs.

Input numbers: 00003 to 00006 (See note.)



PC Setup (DM 6628)

Use as interrupt inputs (interrupt input mode or counter mode)



Create a ladder diagram program.

INT(89): For masking and unmasking interrupt inputs.
SBN(92) and RET(93): For creating interrupt subroutines.

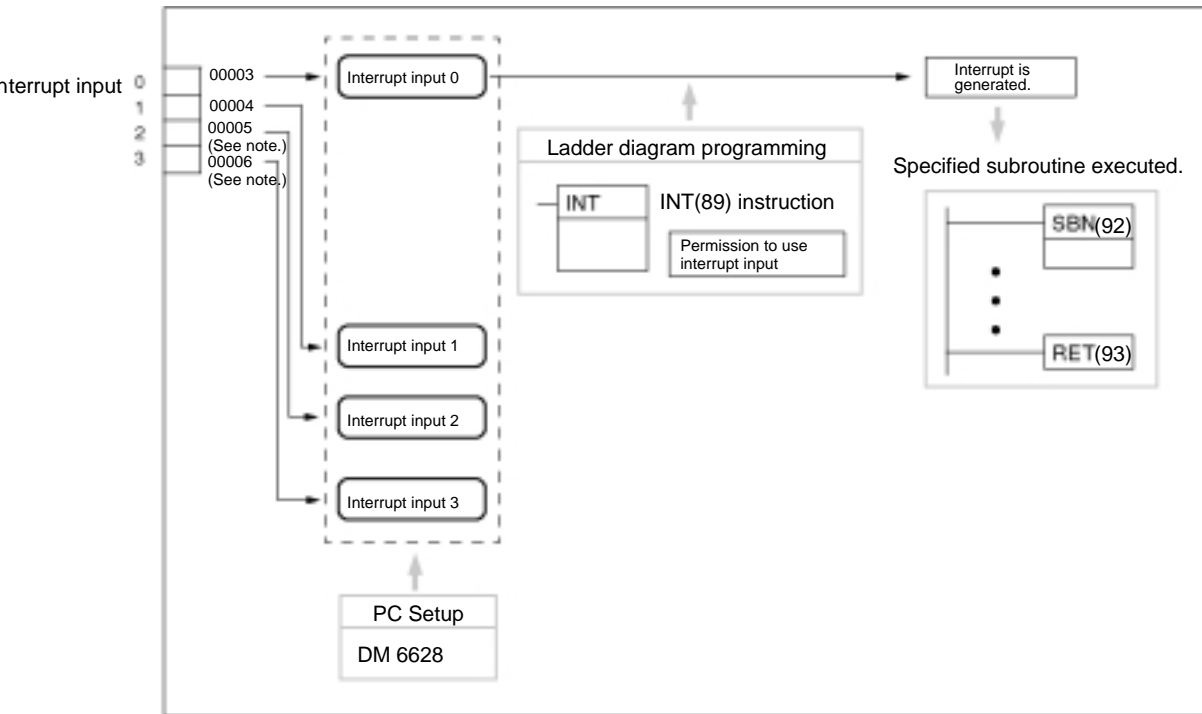

Note Input points 00005 and 00006 do not exist in CPM2C CPU Units with only 10 points or in CPM2C-S CPU Units.

Setting the Interrupt Input Number

With interrupt inputs (interrupt input mode), the subroutine numbers executed for the input numbers are fixed.

Input number	Interrupt number	Subroutine number
00003	0	000
00004	1	001
00005 (See note.)	2	002
00006 (See note.)	3	003

The same input number (from 00003 to 00006) cannot be used for more than one of the following functions: interrupt inputs, interrupt inputs (counter mode) or quick-response inputs.

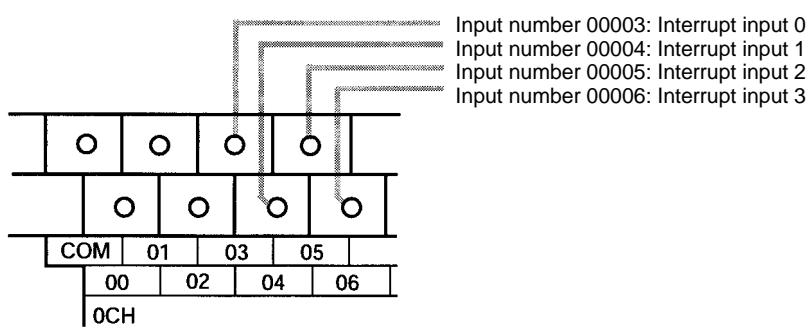

With a CPM2C, wire to the input terminals as shown in the following illustration.

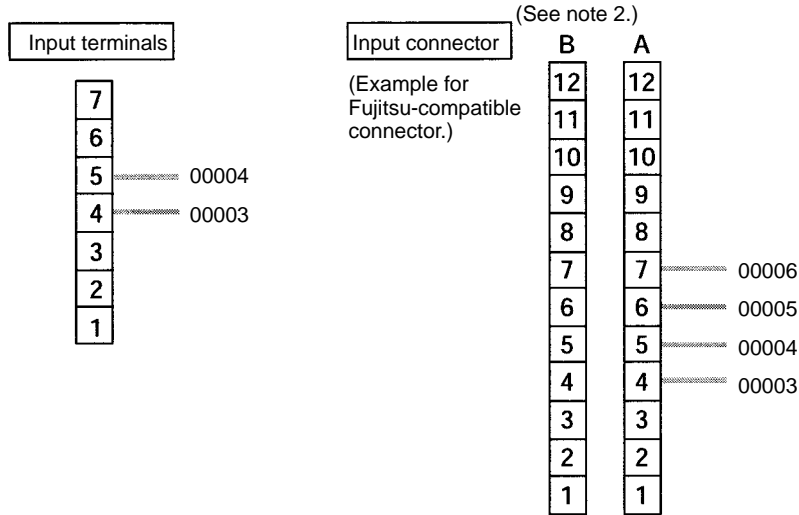

- Note**
1. Refer to the operation manual for your CPU Unit for information on wiring.
 2. Input terminal and pin numbers depend on the model. Refer to the *CPM2C Operation Manual (W356)* for details.

Setup

The following table shows the settings in the PC Setup area related to interrupt input usage.

Word	Bits	Function	Setting	
DM 6628	00 to 03	Interrupt setting for input 00003	0: Normal input 1: Interrupt input (interrupt input mode or counter mode) 2: Quick-response input	1
	04 to 07	Interrupt setting for input 00004		
	08 to 11	Interrupt setting for input 00005*		
	12 to 15	Interrupt setting for input 00006*		

- Note** *Input points 00005 and 00006 do not exist in CPM2C CPU Units with only 10 input points and in CPM2C-S CPU Units.

The settings will go into effect when the mode is changed (from PROGRAM/MONITOR/RUN) or when the power supply is turned ON to the CPM2C.

Wiring Diagram

The following table shows the instruction operations related to interrupt input control.

(@)INT(89)	Mask/unmask interrupt inputs	Prohibits or permits specified interrupts.
	Clear interrupt inputs	Clears the cause of a prohibited interrupt input.
	Read current mask status	Reads the permitted/prohibited status of an interrupt input.
	Mask all interrupts	Prohibits all interrupts, including interrupt inputs, interval timer interrupts, high-speed counters, etc.
	Unmask all interrupts	Permits all interrupts, including interrupt inputs, interval timer interrupts, high-speed counters, etc.

Masking or Unmasking Interrupt Inputs

This function is used to mask or unmask input numbers 00003 to 00006 (interrupt inputs 0 to 3).

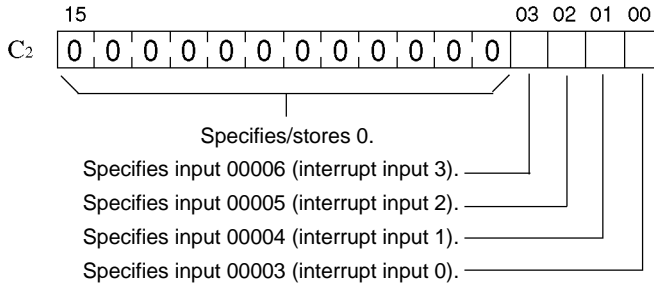
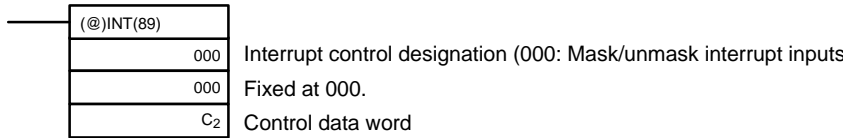

0: Clear mask (interrupt input permitted)
 1: Set mask (interrupt input prohibited).

All interrupt inputs are prohibited at the beginning of operation (in either PROGRAM mode or in RUN/MONITOR mode). To use interrupt inputs, use INT(89) to permit them.

Clearing Interrupt Inputs

This function is used to clear input numbers 00003 to 00006 (interrupt inputs 0 to 3). Since interrupt inputs are recorded, masked interrupts will be serviced when the mask is removed unless they are cleared first. Use INT(89) to clear the cause of the interrupt inputs so that they will not be executed when interrupt inputs are permitted (i.e., when the mask is removed).

001	Interrupt control designation (001: Clear interrupt inputs)
000	Fixed at 000.
C ₂	Control data word

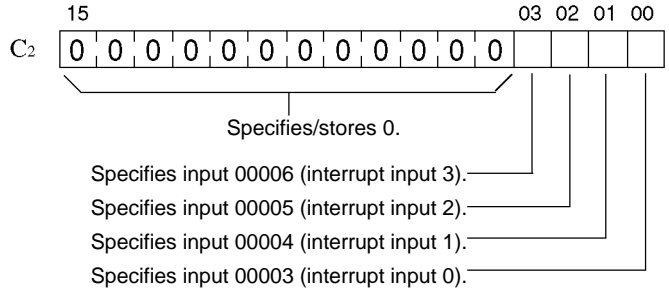

0: Retain cause of interrupt input.
 1: Clear cause of interrupt input.

While interrupt inputs are masked, one cause is recorded for each interrupt input.

Reading Current Mask Status

This function is used to read the current mask status for input numbers 0000000000000006 (interrupt inputs 0 to 3).

(@)INT(89)	
002	Interrupt control designation (002: Read current mask status)
000	Fixed at 000.
C ₂	Control data word

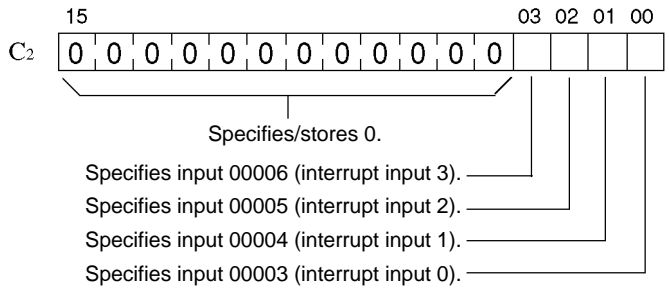

0: Mask is cleared (interrupt inputs permitted).
 1: Mask is set (interrupt inputs prohibited).

Masking or Unmasking All Interrupts

This function is used to mask or unmask all interrupt processing, including interrupt inputs (interrupt input mode and counter mode), interval timer interrupt and high-speed counters. Masked inputs are recorded, but ignored.

Masking All Interrupts

(@)INT(89)	
100	Interrupt control designation (100: Mask all interrupts)
000	Fixed at 000.
000	Fixed at 000.

(@)INT(89)		
200	Interrupt control designation (200: Unmask all interrupts)	
000	Fixed at 000.	
000	Fixed at 000.	

The masking or unmasking all interrupts cannot be executed within an interrupt subroutine.

If causes for interrupts occur while all interrupts are masked, the causes will be recorded for each interrupt but the interrupt processing will not be executed. When "unmask all interrupts" is executed, the processing will then be carried out according to the interrupt mask status at that point in time.

Interrupt masks cannot be cleared simply by executing "unmask all interrupts". Executing "unmask all interrupts" merely restores the status that was in effect prior to the execution of "mask all interrupts."

Note INT(89) must be executed in order, with "mask all interrupts" followed by "unmask all interrupts."

Operation Example

Explanation

In this example, an interrupt subroutine is executed by turning input 00003 OFF to ON. The interrupt subroutine adds 1 to DM 0000.

Wiring

The following diagram shows input wiring in the CPM2A.

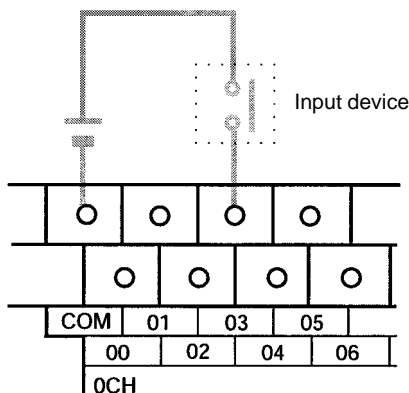

The following diagram shows input wiring in the CPM2C.

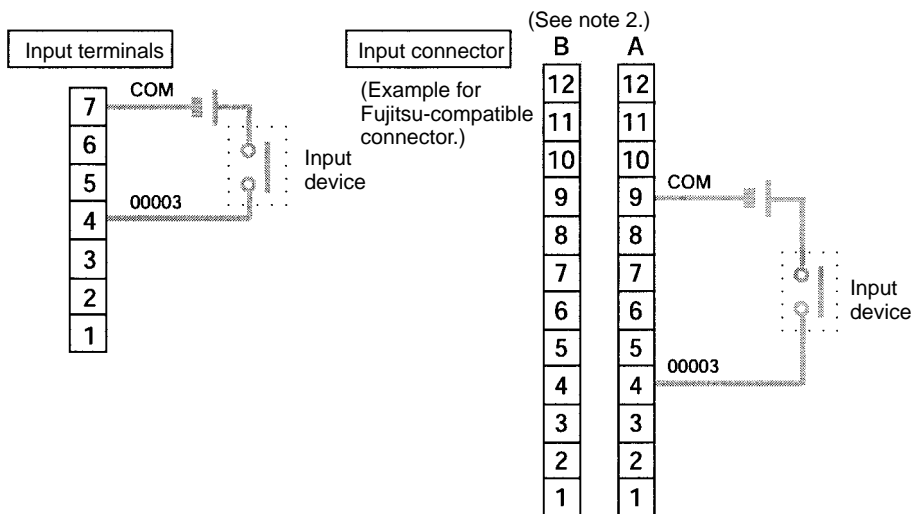

Input 00003 is used as an interrupt input.
(Inputs 00004 to 00006 are used as ordinary inputs.)

Programming

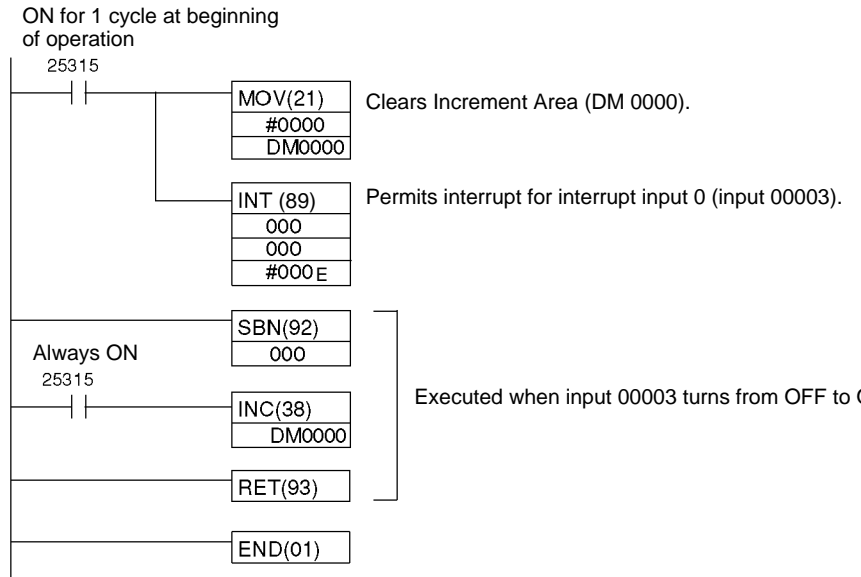

I-2 Interval Timer Interrupts

One interval timer (precision: 0.1 ms) is supported and it can be set from 0.5 to 319,968 ms. There are two interrupt modes: the one-shot mode, in which a single interrupt is executed when the time is up, and the scheduled-interrupt mode, in which interrupts are executed at regular intervals.

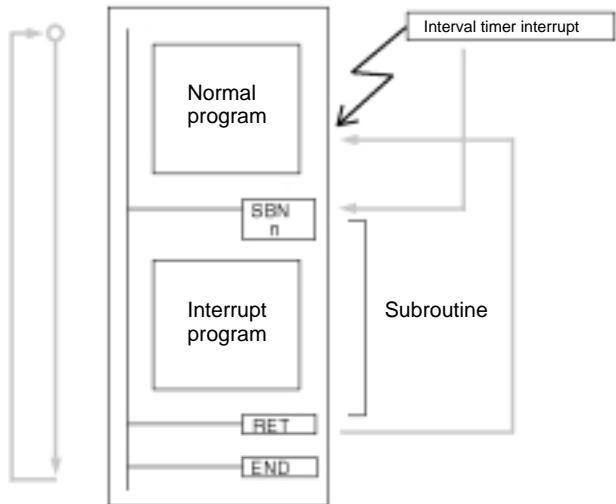

	One-shot mode	Scheduled-interrupt mode
Operation	Interrupt is executed once when time has elapsed.	Interrupts are executed at regular intervals.
Set time	0.5 to 316,968 ms (Unit: 0.1 ms)	
Interrupt response time	0.3 ms (from when time has elapsed until execution of interrupt program)	

	Interval timer interrupts
Synchronized pulse control	Can be used simultaneously.
Interrupt inputs	Can be used simultaneously.
Interval timer interrupts	---
High-speed counters	Can be used simultaneously.
Interrupt inputs (counter mode)	Can be used simultaneously.
Pulse outputs	Can be used simultaneously.
Quick-response inputs	Can be used simultaneously.
Input time constant	Can be used simultaneously.
Clock	Can be used simultaneously.

Procedure for Using Interval Timer Interrupts

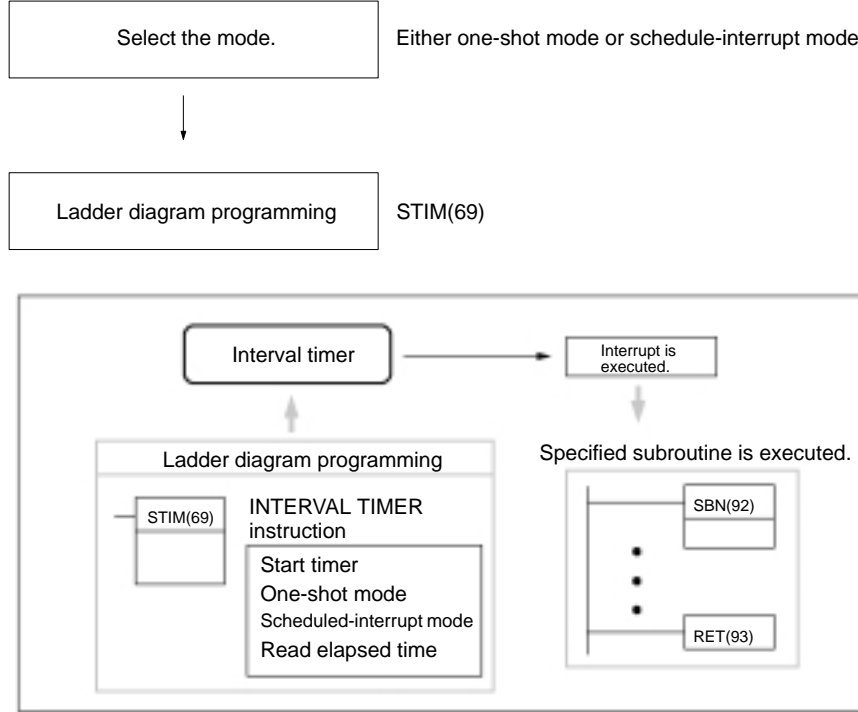

Selecting the Mode

Select either the one-shot mode or the scheduled-interrupt mode.

One-shot Mode

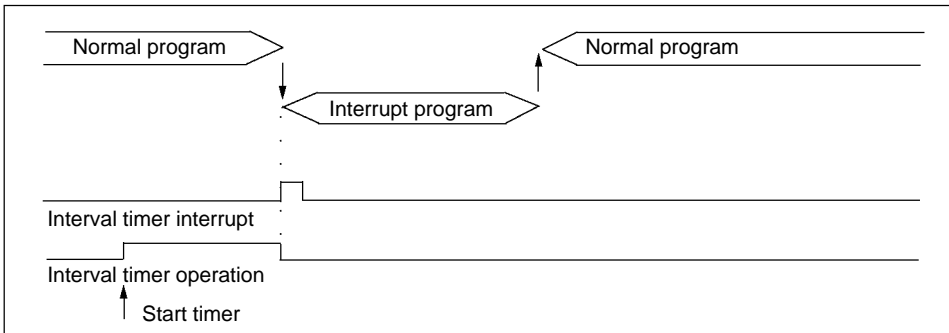

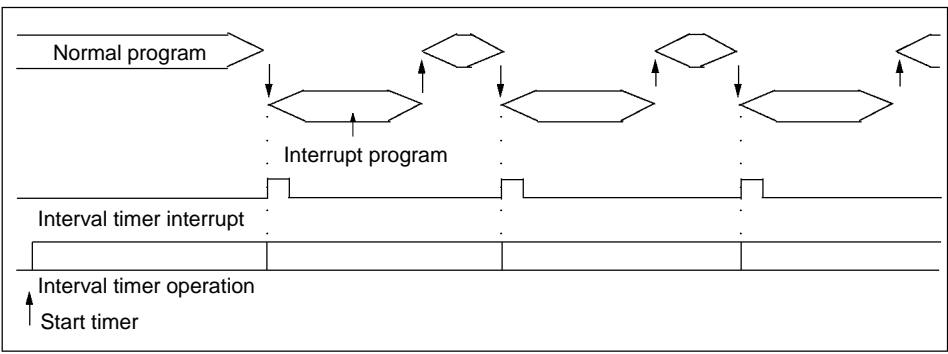

In the scheduled-interrupt mode, the timer is reset each time the interrupt program is called when the set time elapses, and then the interval timer operation starts again.

Be careful with regard to the interrupt program's execution time and the interval timer's set time. If the interrupt program's execution time exceeds the interval timer's set time, scheduled interrupts cannot be executed properly.

Order Diagram programming

The following table shows the instruction operations related to interrupt control.

Instruction	Control	Operation
(@)STIM(69)	Start one-shot timer	Starts interval timer in one-shot mode.
	Start scheduled-interrupt timer	Starts interval timer in scheduled-interrupt mode.
	Read timer PV	Reads the timer PV.
	Stop timer	Stops timer operations.
(@)INT(89)	Mask all interrupts	Prohibits all interrupts, including interrupt inputs, interval timer interrupts, high-speed counters, etc.
	Unmask all interrupts	Permits all interrupts, including interrupt inputs, interval timer interrupts, high-speed counters, etc.

Starting Timers

This function sets the mode (one-shot or scheduled-interrupt) and the timer SV, and starts the interval timer.

One-shot Mode

(@)STIM(69)	
000	Control designation (000: Start one-shot timer)
C ₂	First word of timer SV
C ₃	Subroutine number (4 digits BCD: 0000 to 0049)

Scheduled-interrupt Mode

(@)STIM(69)	
003	Control designation (003: Start scheduled-interrupt timer)
C ₂	First word of timer SV
C ₃	Subroutine number (4 digits BCD): 0000 to 0049

C₂ Decrementing counter initial value (4 digits Hex): 0000 to 9999

C₂+1 Decrementing time interval (4 digits BCD; unit: 0.1 ms): 0005 to 0320 (0.5 to 32 ms)

lated as follows:

$$(\text{Content of word } C_2) \times (\text{Content of words } C_2 + 1) \times 0.1 \text{ ms}$$

(0.5 to 319,968 ms)

When a constant is set for C2, that value will be taken as the decremer counter initial value, and the decrementing time interval will become 10 (1 (The SV is specified just as it is, in units of ms.)

Reading Timer PVs

This function reads interval timer PVs.

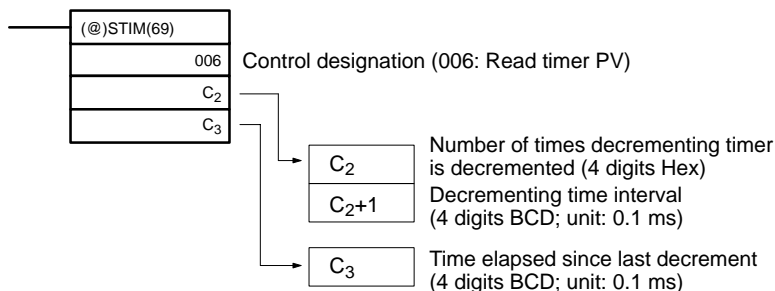

Stopping Timers

This function stops the interval timer.

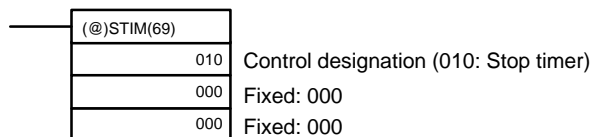

Masking or Unmasking All Interrupts

For details on masking/unmasking all interrupts, refer to *2-1-1 Interrupt In* and *7-29 Interrupt Control Instructions*.

Explanation

In this example, the timer is started when the execution condition (00005) transitions from OFF to ON. When the time (approx. 1 s) has elapsed, the interrupt subroutine is executed one time. When the interrupt subroutine is executed, 1 is added to DM 0000.

Elapsed time: $100 \times 100 \times 0.1 = 1,000 \text{ ms}$

Programming

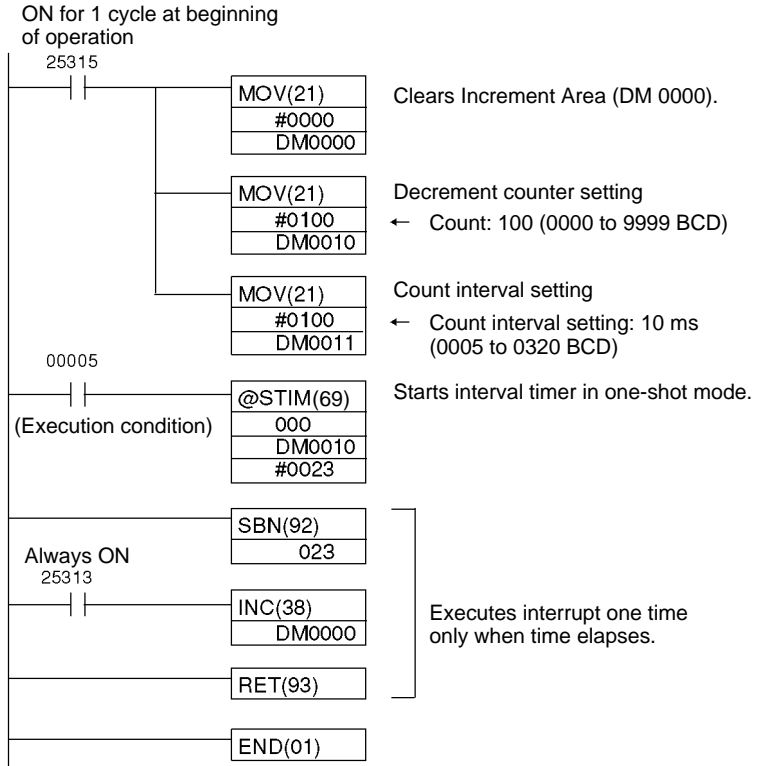

Explanation

In this example, the timer is started when the execution condition (00005) turns from OFF to ON. Then the interrupt subroutine is executed each time that the time (approx. 1 s) elapses. Each time the interrupt subroutine is executed, 1 is added to DM 0000.

Elapsed time: $100 \times 100 \times 0.1 = 1,000$ ms

Programming

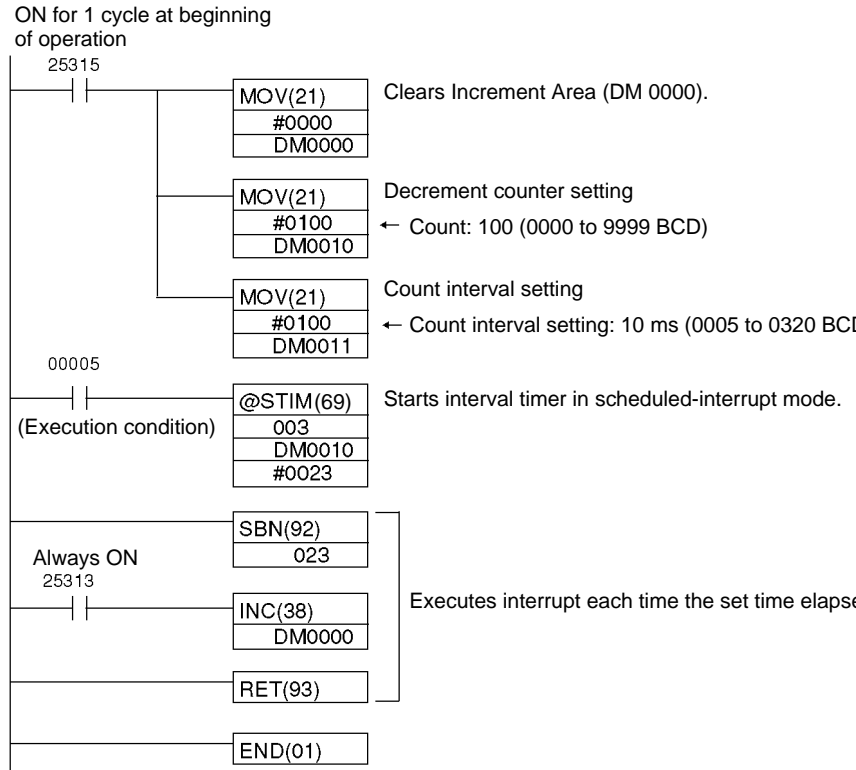

1-3 Precautions on Programming Interrupts

If words in memory are being manipulated both in the main program and in the interrupt program, the interrupts must be masked when the words are being manipulated in the main program.

When an interrupt occurs, any instruction being executed in the main program will be interrupted and processing data will be temporarily stored while the interrupt program is being executed. When execution of the interrupt program has been completed, the original execution status of the main program will be restored and execution will be continued. Thus, if the manipulation of words in the main program is interrupted and the same words are altered in the interrupt program, the words altered in the interrupt program will simply be restored to the status that was in the process of being written in the main program, effectively canceling the result of the interrupt program. If there are instructions that should not be interrupted during processing in the main program, disable interrupts before and after executing them.

There are two cases in which the above problem can occur: When manipulating the contents of one word and when manipulating the contents of multiple words.

MOV instruction then executed in the interrupt program.

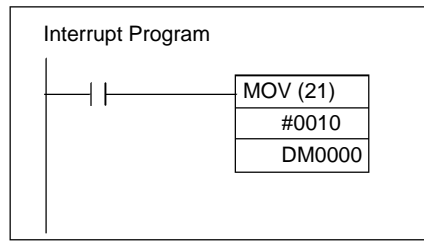
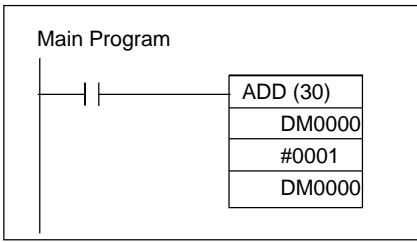

Flow of Processing

The processing that would occur when the ADD instruction above is interrupted is illustrated below.

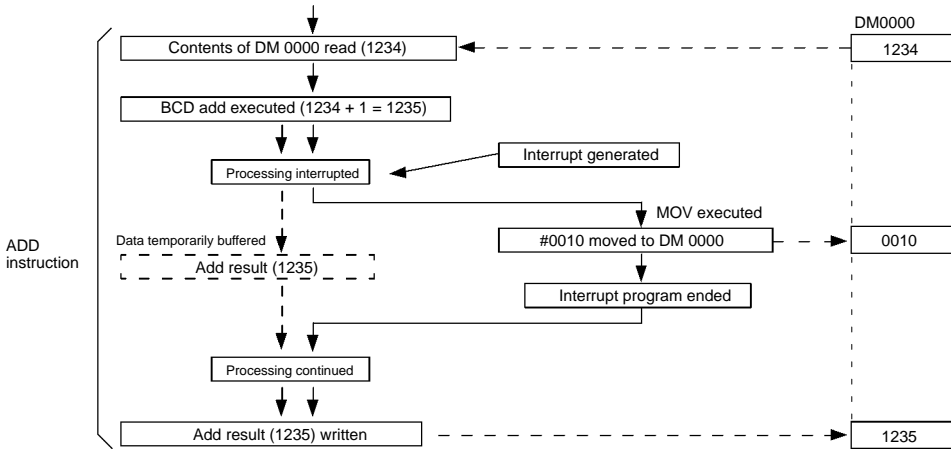

Processing is interrupted before the result of the add operation can be written to DM 0000 and the result is buffered. The interrupt program writes #0010 to DM 0000, but this is immediately overwritten by the result of the add (1235) soon as execution of the interrupt program has been completed. In other words, the result of the interrupt program have been consequently nullified.

Solution

The INT instruction can be used to enable and disable interrupts before and after the add operation as shown below.

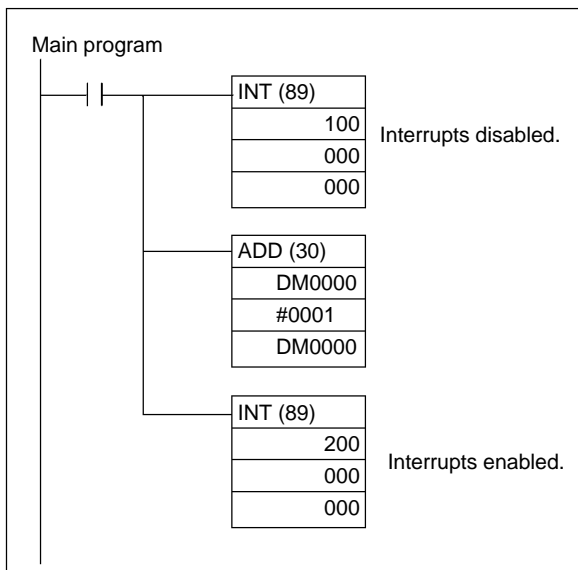

BSET instruction could be used before all of the data for BSET has been written and the CMP instruction then executed in the interrupt program.

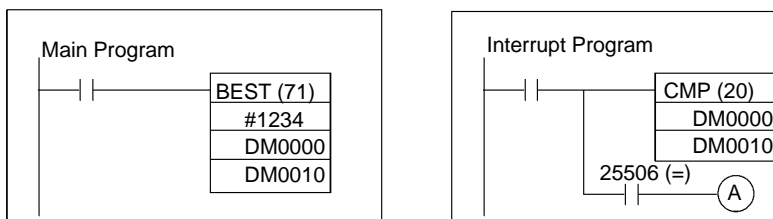

Flow of Processing

The processing that would occur when the BSET instruction above is interrupted is illustrated below.

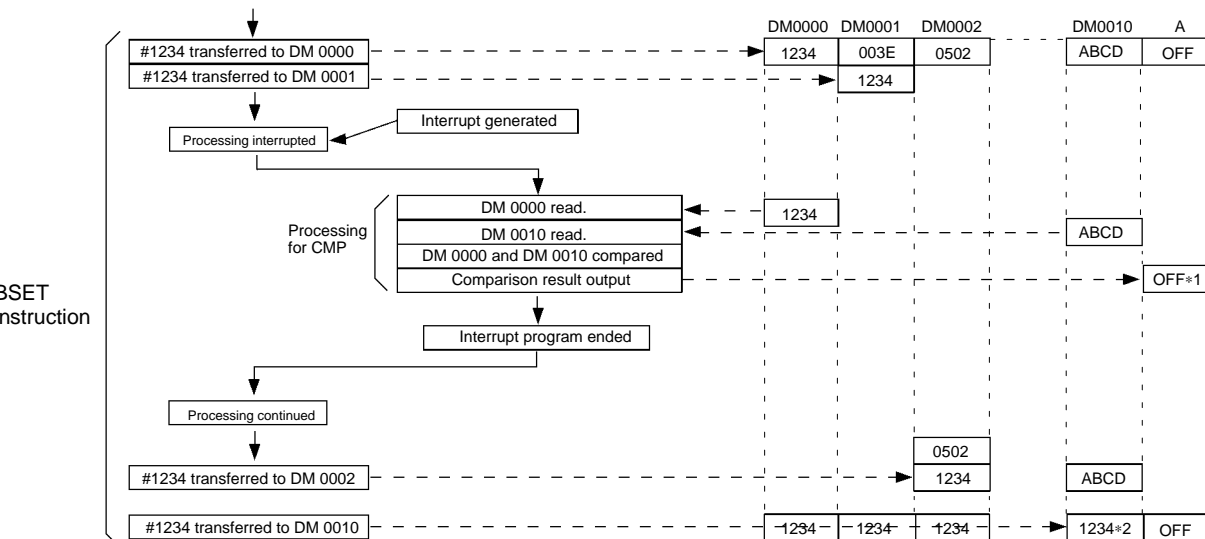

Processing is interrupted before `#1234` can be written to `DM 0010`. Bit `A` in the interrupt program is thus turned `OFF` and will remain `OFF` when execution of the main program is resumed even though the contents of `DM 0000` and `DM 0010` will be the same as soon as the main program is resumed, i.e., the result of the comparison is not correct.

Solution

The `INT` instruction can be used to enable and disable interrupts before and after the `BSET` instruction as shown below.

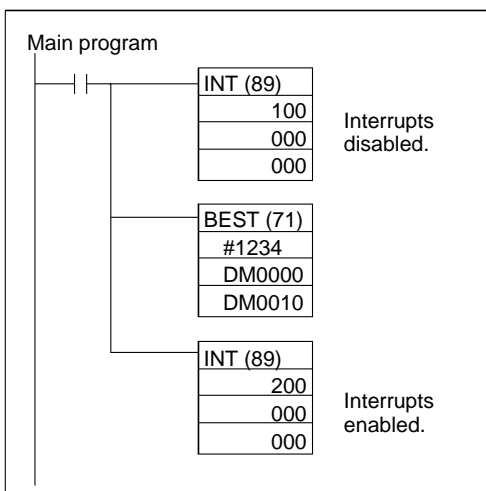

CPM2A CPU Units and most CPM2C CPU Units have five points for high-speed counters: One point for a high-speed counter with a maximum response frequency of 20 kHz, and four points for interrupt inputs (counter mode). CPM2C CPU Units with 10 I/O points have four points for high-speed counter. One point for a high-speed counter with a maximum response frequency of 20 kHz, and three points for interrupt inputs (counter mode).

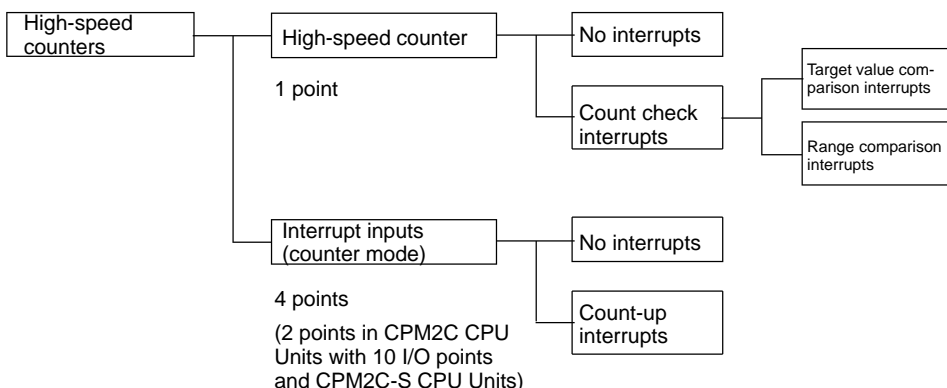

Features of High-speed counters

The CPM2A/CPM2C provides both a built-in high-speed counter and built-in interrupt inputs.

High-speed Counter

The built-in high-speed counter is a counter based on inputs to the CPU Units. The built-in points 00000 to 00002. The high-speed counter itself has one point, and it can provide either an incrementing/decrementing or just an incrementing count depending on the mode setting.

Input No. (See note.)	Response frequency	Input mode (count value)	Control method
00000 00001 00002	5 kHz	Differential phase input mode (-8388608 to 8388607)	Target value comparison interrupt
	20 kHz	Pulse + direction input mode(-8388608 to 8388607) Up/down pulse input mode (-8388608 to 8388607) Increment mode (0 to 16777215)	Range comparison interrupts

Note Input points not used for counter inputs can be used as ordinary inputs.

Interrupt Inputs (Counter Mode)

Interrupt inputs (counter mode) are counters based on inputs to the CPU Units. The built-in points 00003 to 00006 (00003 to 00004 in CPM2C CPU Units with 10 I/O points and in CPM2C-S CPU Units). These counters have four points, and they can provide either an incrementing or decrementing count depending on the mode setting. Since this function utilizes interrupt inputs for counting, it is not possible to use the same inputs for other interrupt inputs.

Input No. (See note.)	Response frequency	Input mode (count value)	Control method
00003	2 kHz	Incrementing counter (0000 to FFFF)	Count-up interrupts
00004			
00005		Decrementing counter (0000 to FFFF)	
00006			

Note 1. Input points not used for counter inputs can be used as ordinary inputs.

h-speed Counter Interrupts

Interrupts by High-speed Counter (Count-check Interrupts)

Target Value Comparison Interrupts

The current count is compared to each target value in the order that they are listed in the table. When the count is the same as the current target value, an interrupt subroutine is executed. Up to 16 target values and interrupt subroutines can be registered in the table in either the incrementing or decrementing direction.

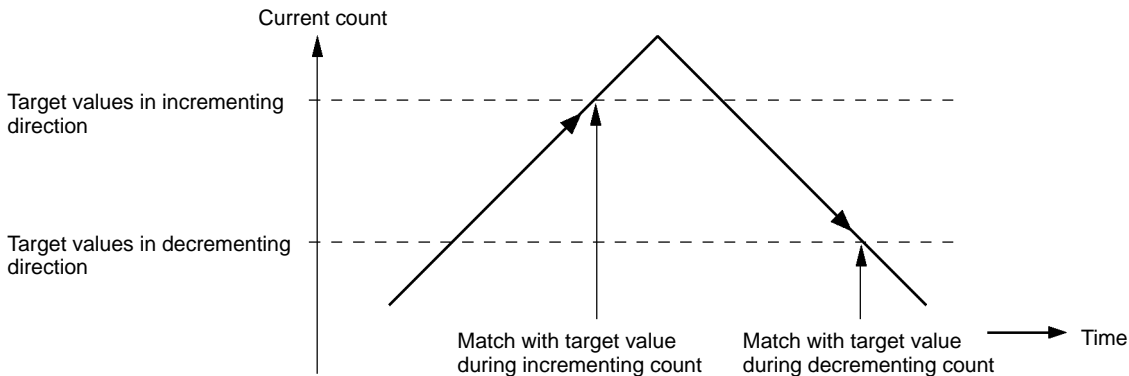

Interrupt processing can be executed when the current count matches a target value in either the incrementing or decrementing direction.

Range Comparison Interrupts

A range comparison table contains up to eight ranges which are each defined by a lower limit and an upper limit, as well as their corresponding subroutine numbers. The corresponding subroutine is called and executed when the current count (the counter PV) falls within a given range.

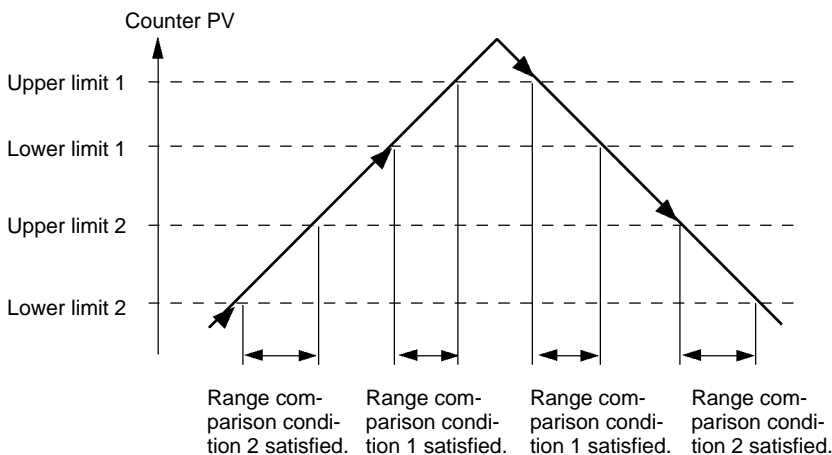

Interrupt processing can be executed when a range comparison condition is satisfied. Furthermore, when the counter PV is within a range between an upper limit and a lower limit, the corresponding bits (from 0 to 7) in AR 11 will turn ON.

Count-up Interrupts by Interrupt Inputs (Counter Mode)

An interrupt subroutine is executed each time the condition is satisfied that the counter PV equals the counter SV (in incrementing mode) or 0 (in decrementing mode).

The CPM2A/CPM2C's CPU Unit has one built-in channel for a high-speed counter that can count inputs at a maximum of 20 kHz. Using this in conjunction with the interrupt function enables target value comparison control or range comparison control to be executed without deviating from the cycle time.

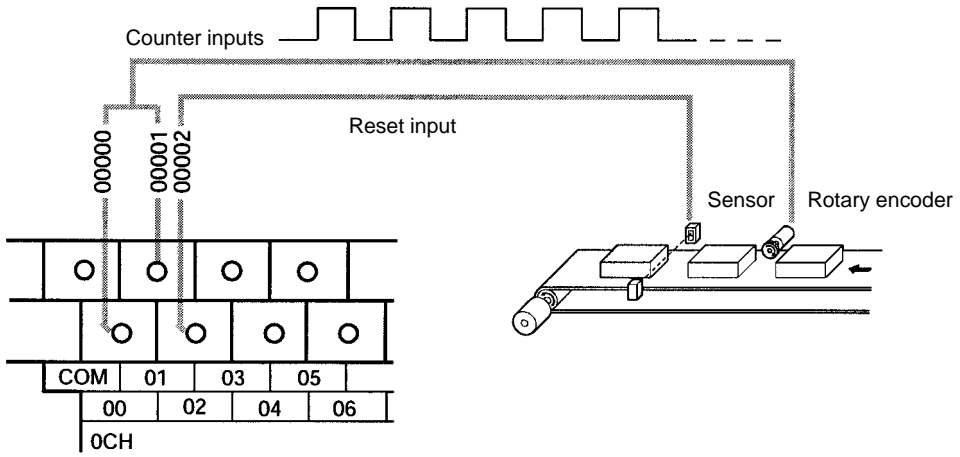

Item		Input mode			
		Differential phase	Pulse + direction	Up/down input	Increment
Input number	00000	Phase-A inputs	Pulse inputs	CW inputs	Pulse inputs
	00001	Phase-B inputs	Direction inputs	CCW inputs	See note 1.
	00002	Phase-Z inputs (Reset inputs) (See note 1.)			
Input method		Differential phase inputs (4X)	Phase inputs	Phase inputs	Phase inputs
Response frequency		5 kHz	20 kHz	20 kHz	20 kHz
Count value		-8388608 to 8388607			0 to 16777215
Counter PV storage destination (See note 2.)		Words SR 248 (rightmost digit) and SR 249 (leftmost digit)			
Interrupts	Target value comparison	Up to 16 target values and interrupt subroutine numbers can be registered in either the incrementing or decrementing direction.			
	Range comparison	Up to eight ranges (with upper and lower limits) and subroutine numbers can be registered.			
Counter reset method		Phase-Z signal + software reset: Counter is reset when IR 00002 turns ON while SR 25200 is ON. Software reset: Counter is reset when SR 25200 turns ON.			

- Note**
1. Input points not used for counter inputs can be used as ordinary input points.
 2. When not used for the counter PV storage destination, these words can be used as ordinary IR words.
 3. SR 25200 is read once each cycle. Up to one cycle may be required for the reset to occur on the leading edge of phase Z.

The following table shows the relationships between the high-speed counter and the CPM2A/CPM2C's other functions.

Synchronized pulse control	Cannot be used simultaneously.
Interrupt inputs	Can be used simultaneously.
Interval timer interrupts	Can be used simultaneously.
High-speed counters	---
Interrupt inputs (counter mode)	Can be used simultaneously.
Pulse outputs	Can be used simultaneously.
Quick-response inputs	Can be used simultaneously.
Input time constant	See note.
Clock	Can be used simultaneously.

Note When inputs 00000 to 00002 are set for use as a high-speed counter, the input time constants for the relevant inputs are disabled. The input time constants remain in effect, however, for the values for refreshing the relevant input number area.

Operation Example

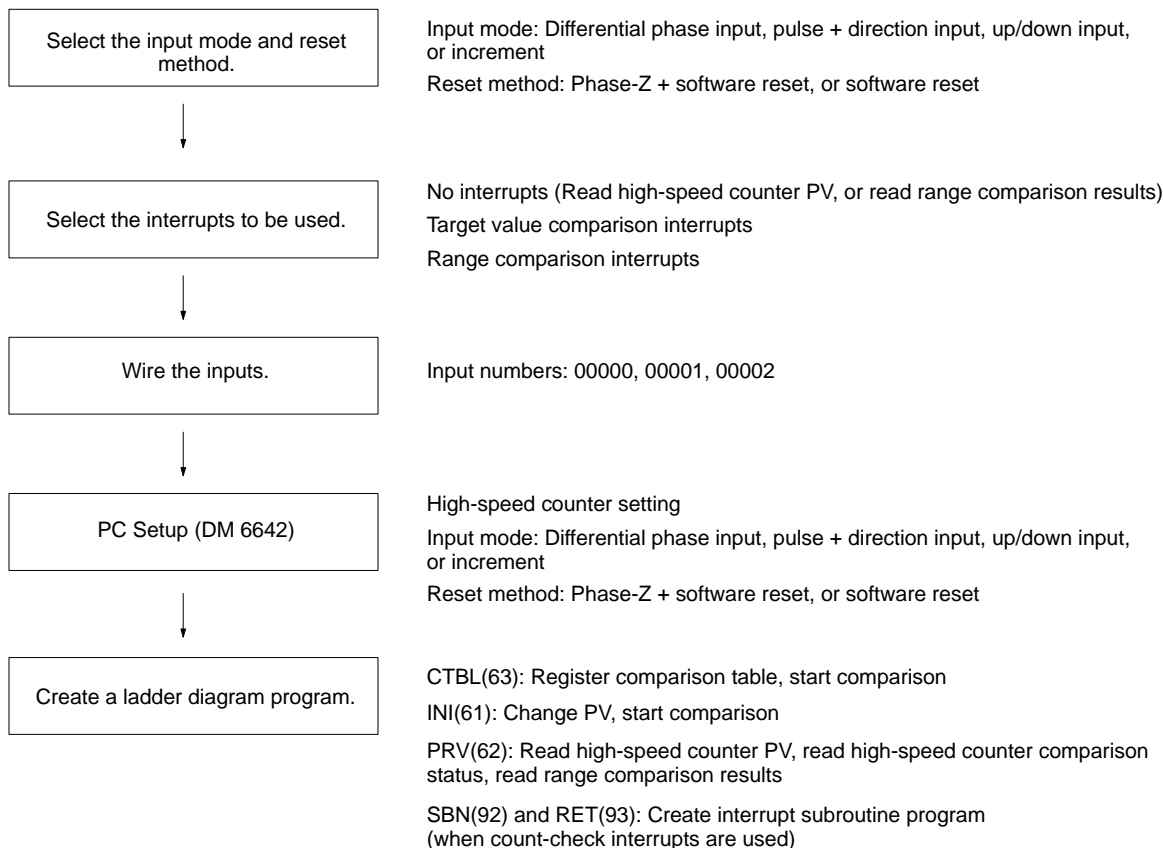

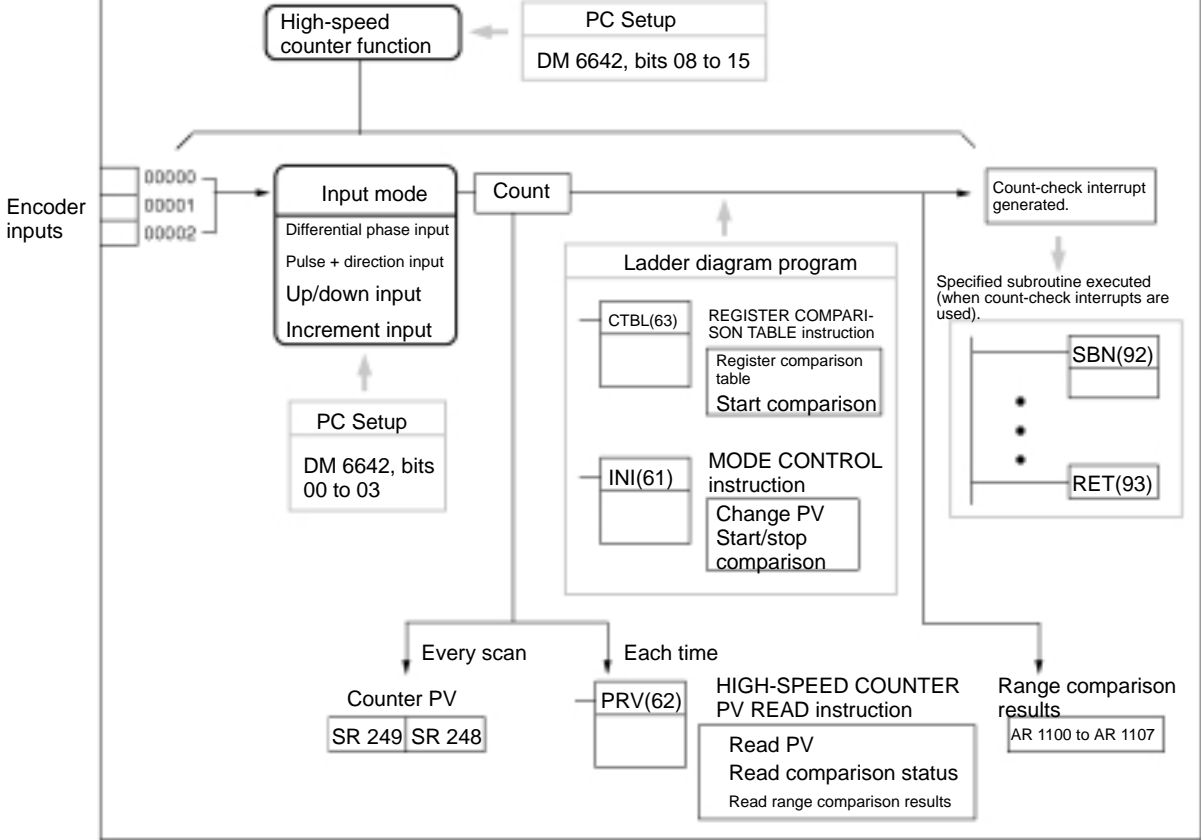

Selecting the Input Mode and Reset Method

Input Mode

Select the input mode for the high-speed counter according to the signal type.

Differential Phase Input Mode

In the differential phase input mode, the count is incremented or decremented according to two differential phase signals with a multiplication of 4 (phase A and phase B).

Maximum frequency: 5 kHz

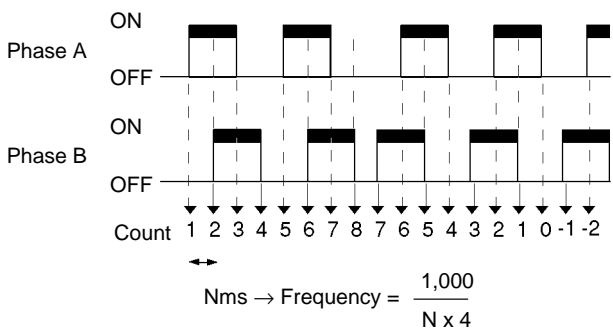

In the pulse + direction input mode, pulse signals and direction signals are input and the count is incremented or decremented according to the direction signal status.

Maximum frequency: 20 kHz

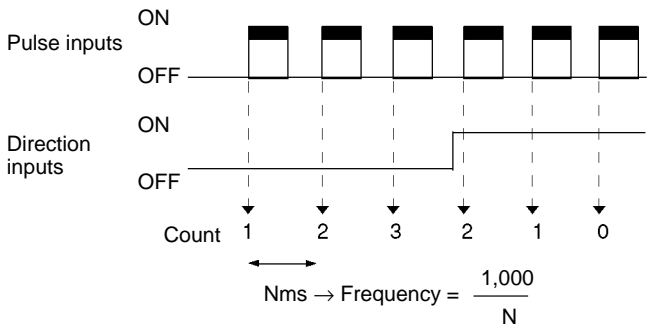

Up/Down Pulse Input Mode

In the up/down pulse input mode, CW signals (up pulses) and CCW signals (down pulses) are input, and the count is incremented or decremented accordingly.

Maximum frequency: 20 kHz

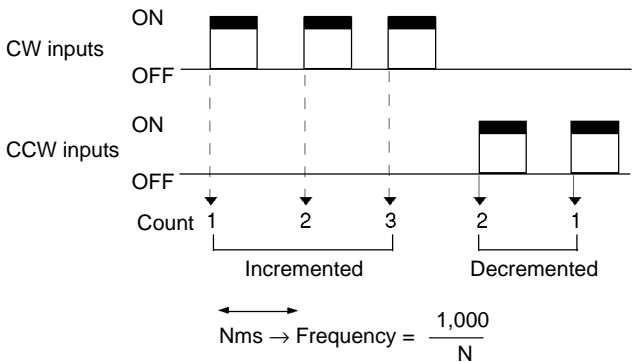

Increment Mode

In the increment mode, pulse signals are input and the count is incremented on each pulse. IR 00001 can be used as an ordinary input.

Maximum frequency: 20 kHz

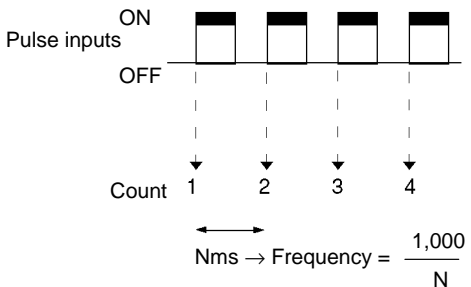

When the differential phase input mode is used, the inputs must be 4X differential phase inputs. When an encoder is connected in this mode, the number of counts per revolution will be four times the encoder resolution. When selecting an encoder take into account the relationship with the number of counts that is possible.

only. If the count is outside of the permissible range, an overflow or underflow result. The PV will become 0FFFFFFF if an overflow occurs, or FFFFFFFF underflow occurs, and the comparison will be stopped.

Differential phase input mode	
Pulse + direction input mode	
Up/down pulse input mode	
Increment mode	

To restart the count following an overflow or underflow, reset the PV. (The PV automatically reset whenever operation is started or stopped.)

Reset Method

Either of the following two methods can be selected for resetting the counter to 0.

Phase-Z Signal (Reset Input) + Software Reset

The PV is reset when a phase-Z signal (i.e., a reset input) turns ON while High-speed Counter Reset Flag (25200) is ON.

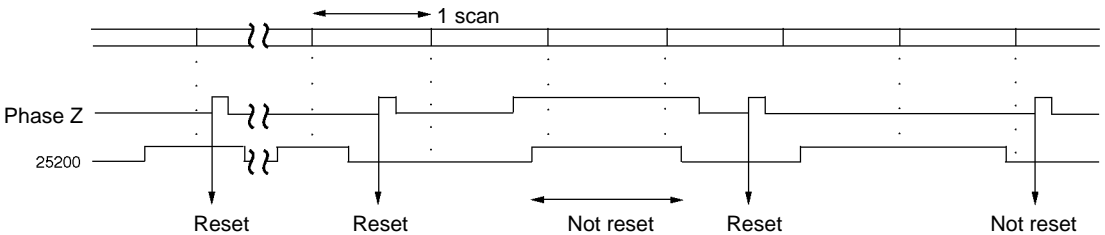

Software Reset

The PV is reset when the High-speed Counter Reset Flag (25200) turns ON.

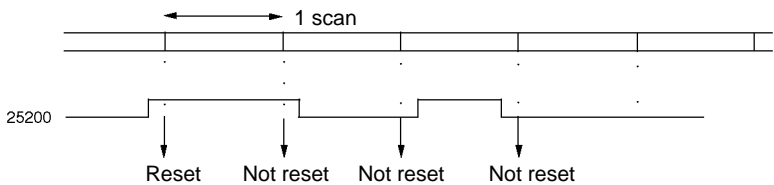

The High-speed Counter Reset Flag (25200) is refreshed with every scan, must remain ON for at least one cycle time to be certain it is read.

Even when the PV is reset, the comparison table registration status, the comparison execution status, and the range comparison results are all retained just as they were before the PV reset. (If a comparison was underway prior to the reset, that comparison will be continued with no change following the reset.)

Following the reset, the High-speed Counter Reset Flag (25200) must be turned OFF in order to be able to execute the next reset. To be certain that it is turned OFF, it must remain OFF for at least one cycle time.

Selecting the Interrupts to be Used

High-speed Counter Interrupts

High-speed counter interrupts use a comparison table and perform a comparison check by either of the methods described below (i.e., target value comparison or range comparison). If the conditions are satisfied, then an interrupt is generated.

under 2-7 interrupts.
 If an interrupt is generated during execution of one of the high-speed counter control instructions, i.e., CTBL(63), INI(61), or PRV(62), these instructions will not be executed within the interrupt program.

Target Value Comparison Interrupts

Up to 16 combinations of comparison conditions (target value and count direction) and interrupt subroutine numbers can be registered in the comparison table. The specified subroutine is executed when the counter PV matches a target value in the comparison table.

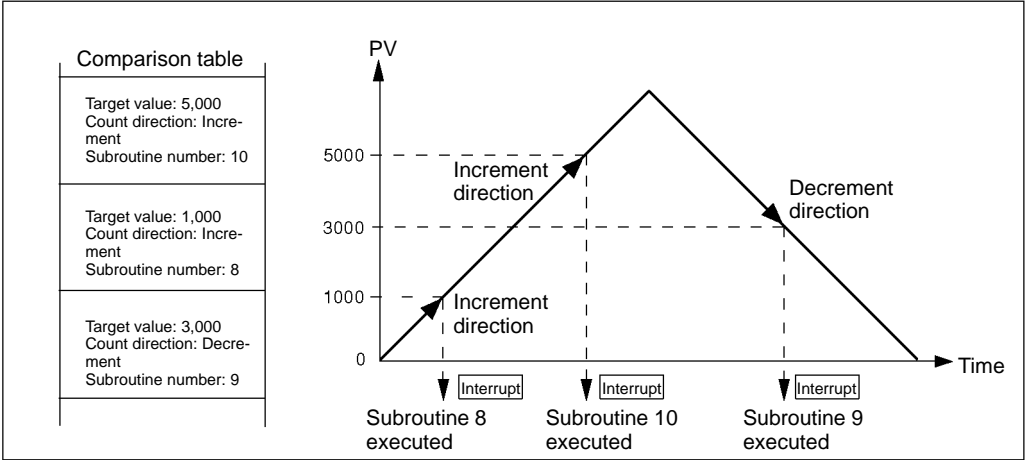

The relationship between the target value comparison count check and the comparison table is different for the CPM1/CPM1A. Refer to the individual manuals for details.

It is not possible to specify more than one comparison direction condition for the same target value in the comparison table.

Either target value comparison or range comparison can be used for high-speed counter interrupts.

Range Comparison Interrupts

Up to eight combinations of comparison conditions (upper limit and lower limit) and interrupt subroutine numbers can be registered in the comparison table. The specified subroutine is executed once when the counter PV is greater than or equal to the lower limit and less than or equal to the upper limit in the comparison table.

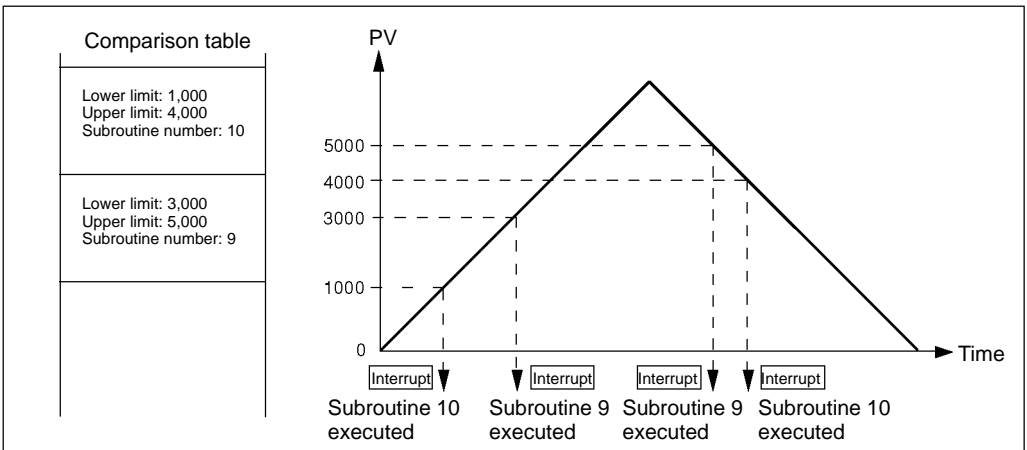

cycle); the interrupt for the condition closest to the beginning of the comparison table will be executed.

Either target value comparison or range comparison can be used for high-speed counter interrupts.

If an interrupt is generated during execution of one of the high-speed counter control instructions, i.e., CTBL(63), INI(61), or PRV(62), these instructions will not be executed within the interrupt program.

If an interrupt is generated while an instruction controlling the high-speed counter is being executed in the normal program area, the CTBL(63), INI(61), PRV(62), instructions will not be executed within the interrupt program. This situation can be avoided by means of the following programming.

Method 1

Prohibit interrupts in the normal program area while executing the instruction.

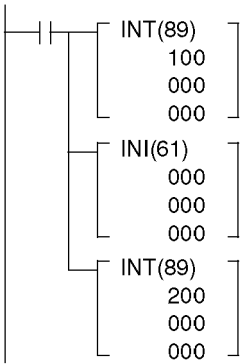

Method 2

In the normal program area, re-execute the instruction that could not be executed.

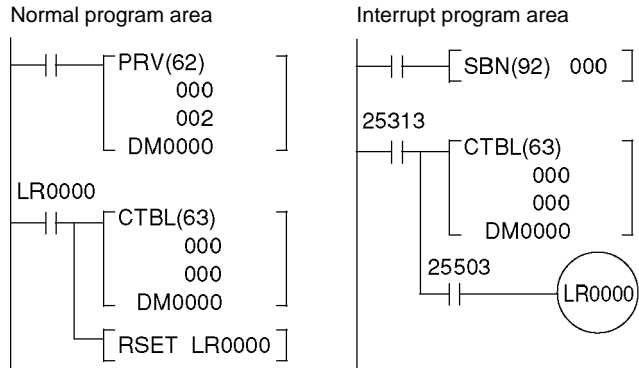

Interrupt processing subroutines are defined by SBN(92) and RET(93), just as ordinary subroutines.

An SBS UNDEFD error will be generated during the program check while an interrupt processing subroutine is being defined, but execution will be normal.

CPM2A Inputs

Differential Phase Input Mode

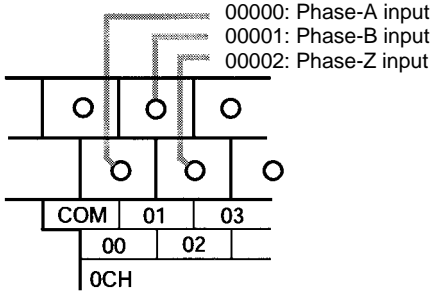

Up/Down Pulse Input Mode

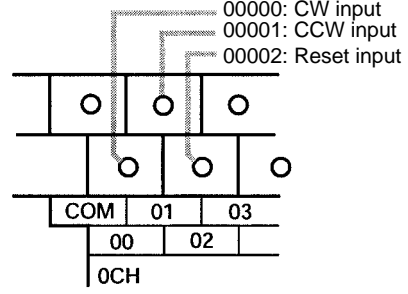

Pulse + Direction Input Mode

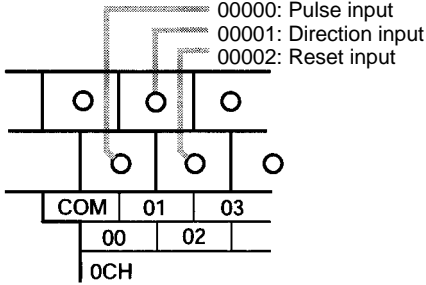

Increment Mode

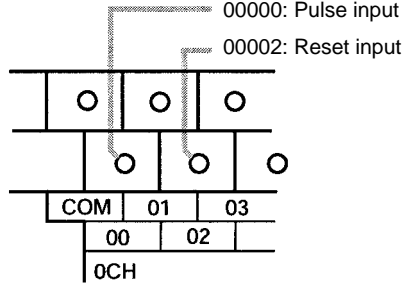

CPM2C Inputs

Note The following examples are for Fujitsu-compatible connectors. Input bit addresses and connector pin numbers depend on the models. Refer to the *CPM2C Operation Manual (W356)* or the *CPM2C-S Operation Manual (W377)* for details.

Differential Phase Input Mode

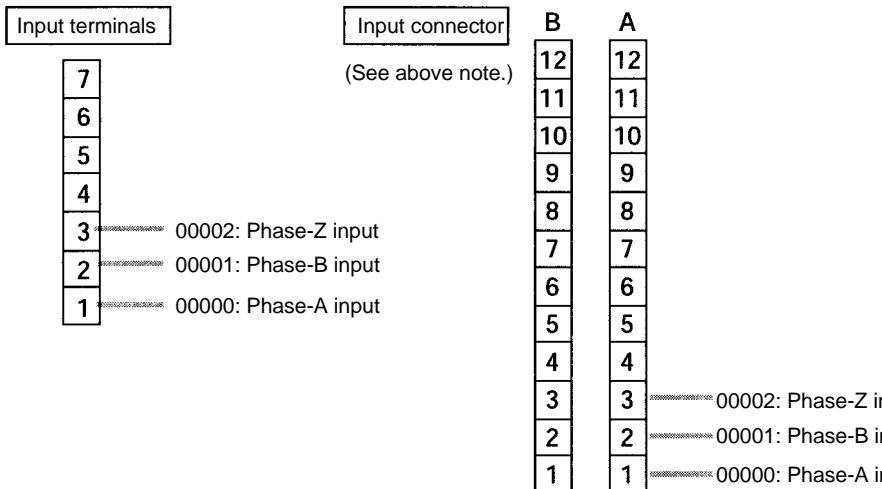

Input terminals

Input connector

(See above note.)

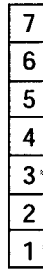

00002: Reset input
 00001: CCW input
 00000: CW input

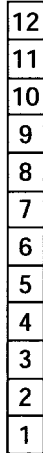
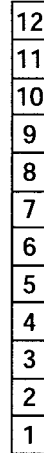

00002: Reset in
 00001: CCW in
 00000: CW in

Pulse + Direction Input Mode

Input terminals

Input connector

(See above note.)

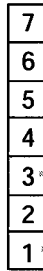

00002: Reset input
 00001: Direction input
 00000: Pulse input

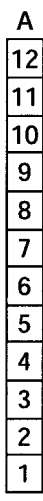

00002: Reset input
 00001: Direction in
 00000: Pulse input

Increment Mode

Input terminals

Input connector

(See above note.)

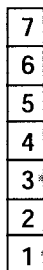

00002: Reset input
 00000: Pulse input

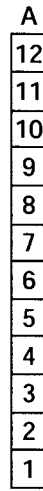
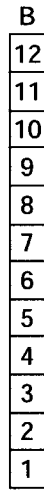

00002: Reset in
 00000: Pulse in

When phase-Z and reset inputs are not used, 00002 can be used as an ordinary input.

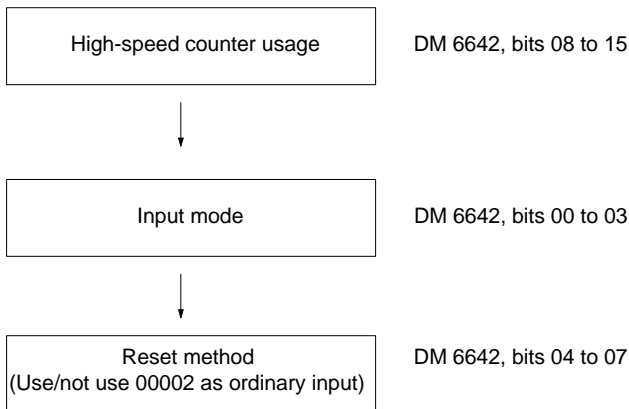

Word	Bits	Function	Setting
DM 6642	00 to 03	High-speed counter input mode setting 0: Differential phase input 5 kHz 1: Pulse + direction input 20 kHz 2: Up/down input 20 kHz 4: Increment 20 kHz	0, 1, 2, 4
	04 to 07	High-speed counter reset method setting 0: Phase-Z signal + software reset 1: Software reset	0 or 1
	08 to 15	High-speed counter usage setting 00: Do not use. 01: Use as high-speed counter 02: Use as pulse synchronization control (10 Hz to 500 Hz) 03: Use as pulse synchronization control (20 Hz to 1 kHz) 04: Use as pulse synchronization control (300 Hz to 20 kHz)	01

The new settings for the System Setup go into effect when operation begins (when PROGRAM mode is changed to MONITOR or RUN mode), or when CPM2A/CPM2C's power is turned ON.

Instruction	Control	Operation
(@)CTBL(63)	Register target value comparison table	Registers target value comparison table.
	Register range comparison table	Registers range comparison table.
	Register target value comparison table and start comparison	Registers target value comparison table and starts comparison.
	Register range comparison table and start comparison	Registers range comparison table and starts comparison.
(@)INI(61)	Start comparison	Starts comparison with registered comparison table.
	Stop comparison	Stops comparison.
	Change PV	Changes the high-speed counter PV.
(@)PRV(62)	Read PV	Reads the high-speed counter PV.
	Read status	Reads the high-speed counter status.
	Read range comparison result	Reads range comparison result.
(@)INT(89)	Mask all interrupts	Prohibits all interrupts, including interrupt inputs, interval timer interrupts, high-speed counters, etc.
	Unmask all interrupts	Permits all interrupts, including interrupt inputs, interval timer interrupts, high-speed counters, etc.

The following table shows the data areas related to high-speed counter control.

Word	Bits	Name	Contents
248 249	00 to 15 00 to 15	High-speed counter PV	Reads high-speed counter PV.
252	00	High-speed counter reset	When this bit turns ON, a software reset is triggered for the high-speed counter.
AR11	00 to 07	High-speed counter range comparison results	ON: Condition satisfied OFF: Condition not satisfied
	08	High-speed counter comparison	ON: Comparison in progress OFF: Comparison stopped
	09	High-speed counter PV overflow/underflow	ON: Overflow/underflow OFF: Normal

Register Target Value Comparison Table

Register Target Value Comparison Table and Start Comparison

These functions register a comparison table to the CPM2A/CPM2C for the purpose of count checking in target value comparison. It is also possible to start comparison along with the registration.

Register Target Value Comparison Table

(@)CTBL(63)	
000	Port specifier (000: High-speed counter)
002	Mode designation (002: Register target value comparison table only)
S	Beginning word of comparison table

(@)CTBL(63)	
000	Port specifier (000: High-speed counter)
000	Mode designation (000: Register target value comparison table and start comparison)
S	Beginning word of comparison table

Target Value Comparison Table

+1	Number of comparisons	Comparison 1 setting	Number of comparisons 0001 to 0016 BCD
+2	Target value 1 (rightmost)		Target value (rightmost, leftmost)
+3	Target value 1 (leftmost)		Register the counter value to be compared. The leftmost digit shows the sign (+/-).
+4	Subroutine number	Comparison 2 setting	Differential phase input mode Pulse + direction input mode Up/down pulse input mode
+5	Target value 2 (rightmost)		When incrementing: F8388607 to 08388607 When decrementing: F8388608 to 08388606
+6	Target value 2 (leftmost)		Increment mode 00000001 to 16777215 The range that can be specified depends on the mode when target comparison interrupts are specified.
	Subroutine number		Subroutine number Register the direction of comparison and the subroutine number to be executed when there is a match. The leftmost digit shows the direction (increment/decrement) Increment direction: 0000 to 0049 Decrement direction: F000 to F049

It is not possible to specify more than one comparison direction condition for the same target value in the comparison table.

Once a comparison table has been registered, it will be saved in the CPM2A/CPM2C as long as no other comparison table is registered and the mode is changed to PROGRAM mode (and as long as the power is not turned OFF).

Register Range Comparison Table

Register Range Comparison Table and Start Comparison

These functions register a comparison table to the CPM2A/CPM2C for the purpose of count checking in range comparison. It is also possible to start the comparison along with the registration.

Register Range Comparison Table

(@)CTBL(63)	
000	Port specifier (000: High-speed counter)
003	Mode designation (003: Register range comparison table only)
S	Beginning word of comparison table

Register Range Comparison Table and Start Comparison

(@)CTBL(63)	
000	Port specifier (000: High-speed counter)
001	Mode designation (001: Register range comparison table and start comparison)
S	Beginning word of comparison table

S	Lower limit 1 (rightmost)	Range comparison condition 1	Eight range comparison conditions consisting of upper and lower limits and subroutine numbers must be set.
S+1	Lower limit 1 (leftmost)		
S+2	Upper limit 1 (rightmost)		
S+3	Upper limit 1 (leftmost)		
S+4	Subroutine number		Upper and lower limits (rightmost, leftmost) Register the upper and lower limits. The leftmost digit shows the sign (+/-). Differential phase input mode Pulse + direction input mode Up/down pulse input mode F8388608 to 08388607 Increment mode 00000000 to 16777215
S+5			Subroutine number Register the subroutine number to be executed when the range comparison condition is satisfied. 0000 to 0049 If the set values do not reach 8, set FFFF.
S+6		Range comparison condition 8	
:	Lower limit 8 (rightmost)		
:	Lower limit 8 (leftmost)		
:	Upper limit 8 (rightmost)		
:	Upper limit 8 (leftmost)		
:	Subroutine number		

If two or more comparison conditions are satisfied simultaneously (in the same cycle), the interrupt for the condition closest to the beginning of the comparison table will be executed.

Once a comparison table has been registered, it will be saved in the CPM2A/CPM2C as long as no other comparison table is registered and the mode is changed to PROGRAM mode (and as long as the power is not turned OFF).

Start/Stop Comparison

The comparison can be started or stopped according to the table that has already been registered to the CPM2A/CPM2C by CTBL(63).

Start Comparison

(@)INI(61)	
000	Port specifier (000: High-speed counter)
000	Control designation (000: Start comparison)
000	Fixed: 000

Stop Comparison

(@)INI(61)	
000	Port specifier (000: High-speed counter)
001	Control designation (001: Stop comparison)
000	Fixed: 000

This function changes the high speed counter PV.

(@)INI(61)	
000	Port specifier (000: High-speed counter)
002	Control designation (002: Change PV)
C ₂	Beginning word of PV data to change

C₂ Rightmost 4 digits

C₂+1 Leftmost 4 digits

PV data to change (Rightmost and leftmost)

Register the PV data to be changed.

The leftmost digit shows the sign (+/-).

Differential phase input mode

Pulse + direction input mode

Up/down pulse input mode

F8388608 to 08388607

Increment mode

00000000 to 16777215

No interrupt will occur during a target value comparison even if the target value registered in the comparison table is changed by INI(61).

Read PV

This function reads the high-speed counter PV.

Using an Instruction

(@)PRV(62)	
000	Port specifier (000: High-speed counter)
002	Control designation (000: Read PV)
C ₂	Beginning word for storing PV

D Rightmost 4 digits

D+1 Leftmost 4 digits

PV (Rightmost and leftmost)

The read PV will be stored here.

The leftmost digit shows the sign (+/-).

Differential phase input mode

Pulse + direction input mode

Up/down pulse input mode

F8388608 to 08388607

Increment mode

00000000 to 16777215

Using Data Areas

The high-speed counter PV is stored in words 248 and 249 as shown below.

SR 248 PV (Rightmost word)

SR 249 PV (Leftmost word)

Words 248 and 249 are refreshed with every scan, so there may be a discrepancy from the exact PV at any given time.

When the high-speed counter is not used, words 248 and 249 can be used as work words.

When the PV is read by executing PRV(62), words 248 and 249 are refreshed with the same timing.

This function reads the high speed counter status, such as whether a comparison operation is in progress or whether an overflow or underflow has occurred.

Using an Instruction

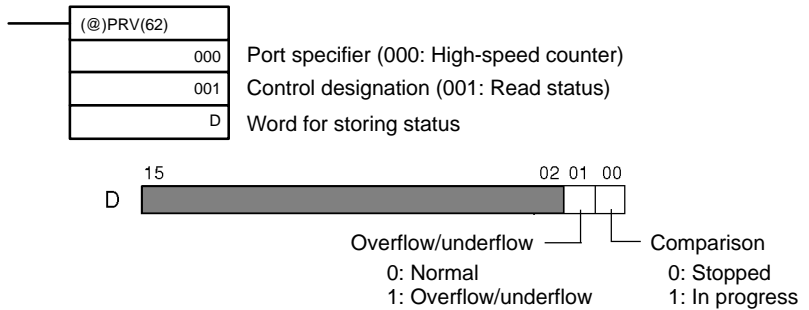

Using Data Areas

The status is stored in AR 1108 and AR 1109 as shown below.

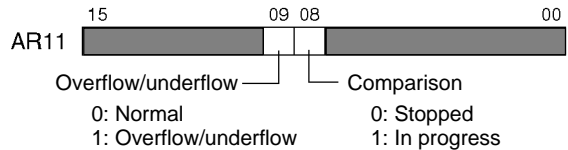

AR 1108 and AR 1109 are refreshed with every scan, so there may be a discrepancy from the exact status at any given time.

When the status is read by executing PRV(62), AR 1108 and AR 1109 are refreshed with the same timing.

Read Range Comparison Result

This function reads the result of a range comparison showing whether or not PV is within a range.

Using an Instruction

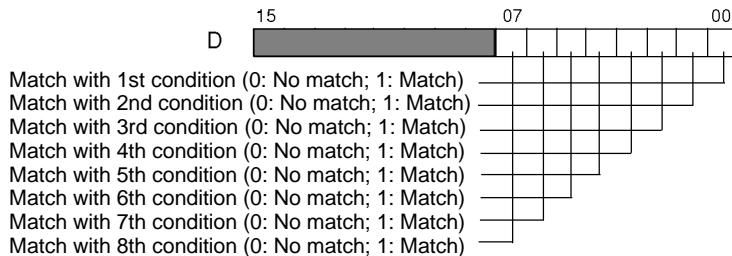
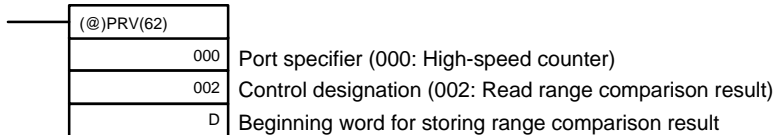

Using Data Areas

The range comparison result is stored in AR 1100 through AR 1107, as shown below.

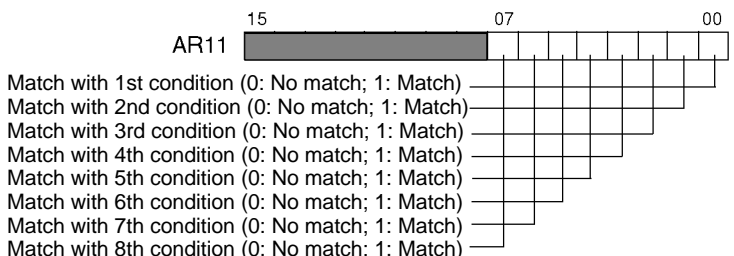

discrepancy from the exact PV range comparison result at any given time.
When the range comparison result is read by executing PRV(62), AR 1 through AR 1107 are refreshed with the same timing.

Mask/Unmask All Interrupts

For details regarding masking and unmasking all interrupts, refer to 2-1-1 *Interrupt Inputs*.

Application Examples

Target Value Comparison

Explanation

In this example, specified interrupt subroutines are executed by matching high-speed counter's PV with five values set as a target value comparison target. With each interrupt, the data in DM 0000 to DM 0004 is incremented by one.

Wiring (CPM2A)

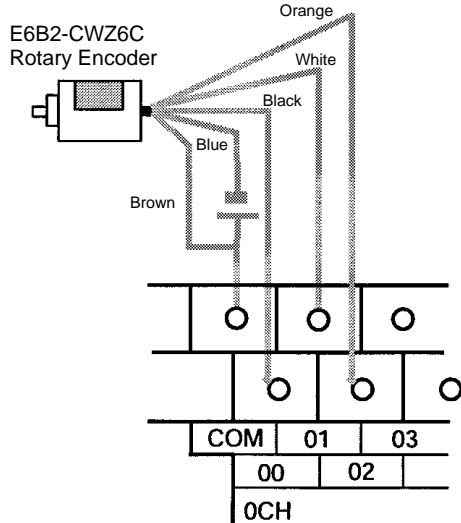

Note The following examples are for Fujitsu-compatible connectors. Input bit addresses and connector pin numbers depend on the models. Refer to the *CPI Operation Manual (W356)* or the *CPM2C-S Operation Manual (W377)* for tails.

Input terminals

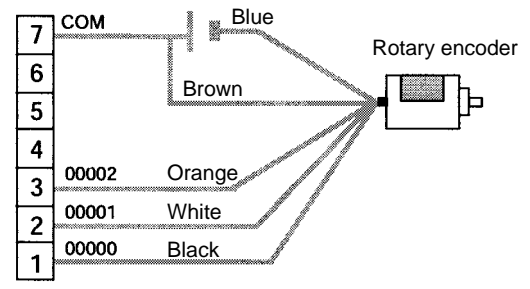

Input connector

(See above note.)

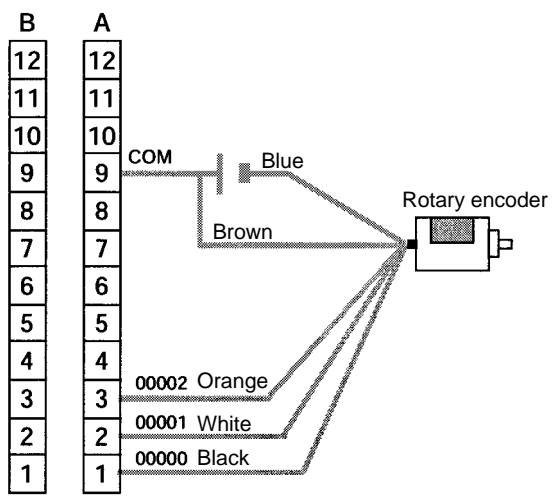

PC Setup

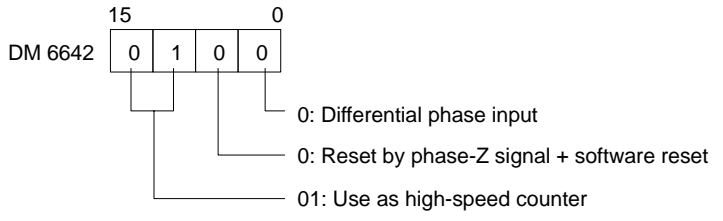

ON for 1 cycle at beginning of operation

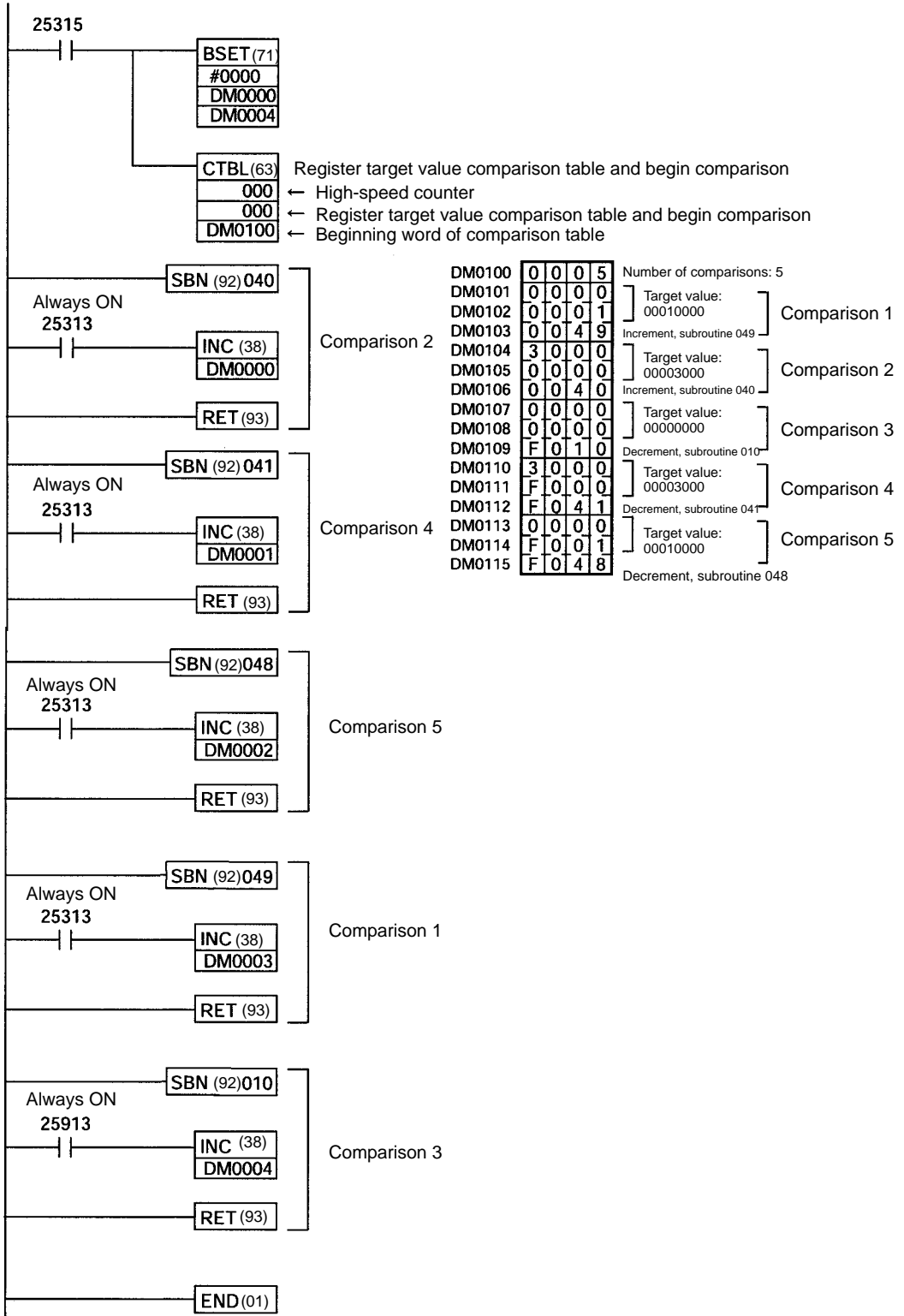

Application:
 In this example, specified interrupt subroutines are executed by matching high-speed counter's PV with five range set as a range comparison table. At each interrupt, the data in DM 0000 to DM 0004 is incremented by one.

Wiring (CPM2A)

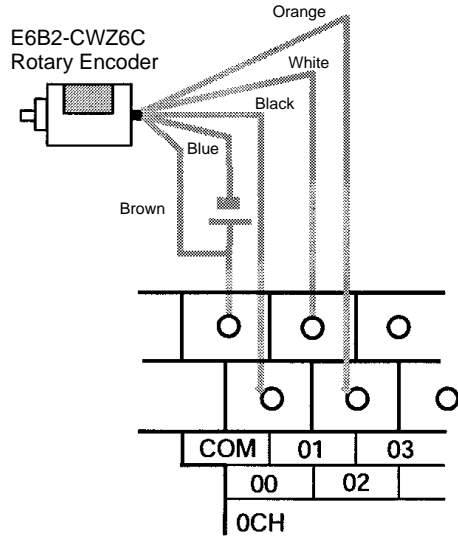

Note The following examples are for Fujitsu-compatible connectors. Input bit addresses and connector pin numbers depend on the models. Refer to the *CPM2C Operation Manual (W356)* or the *CPM2C-S Operation Manual (W377)* for details.

Input terminals

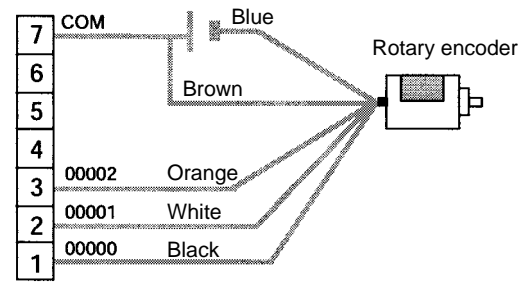

Input connector

(See above note.)

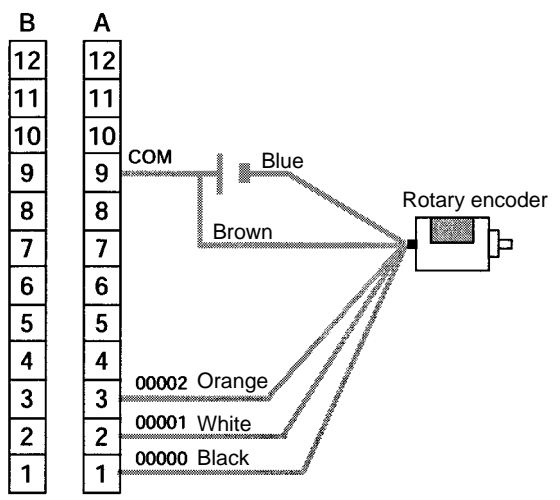

PC Setup

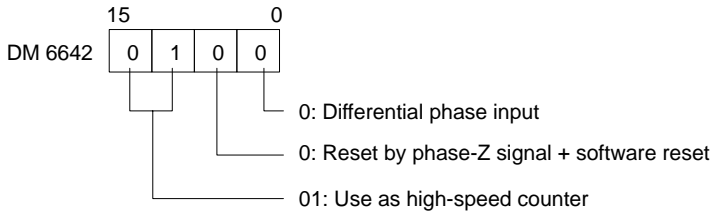

ON for 1 cycle at beginning of operation

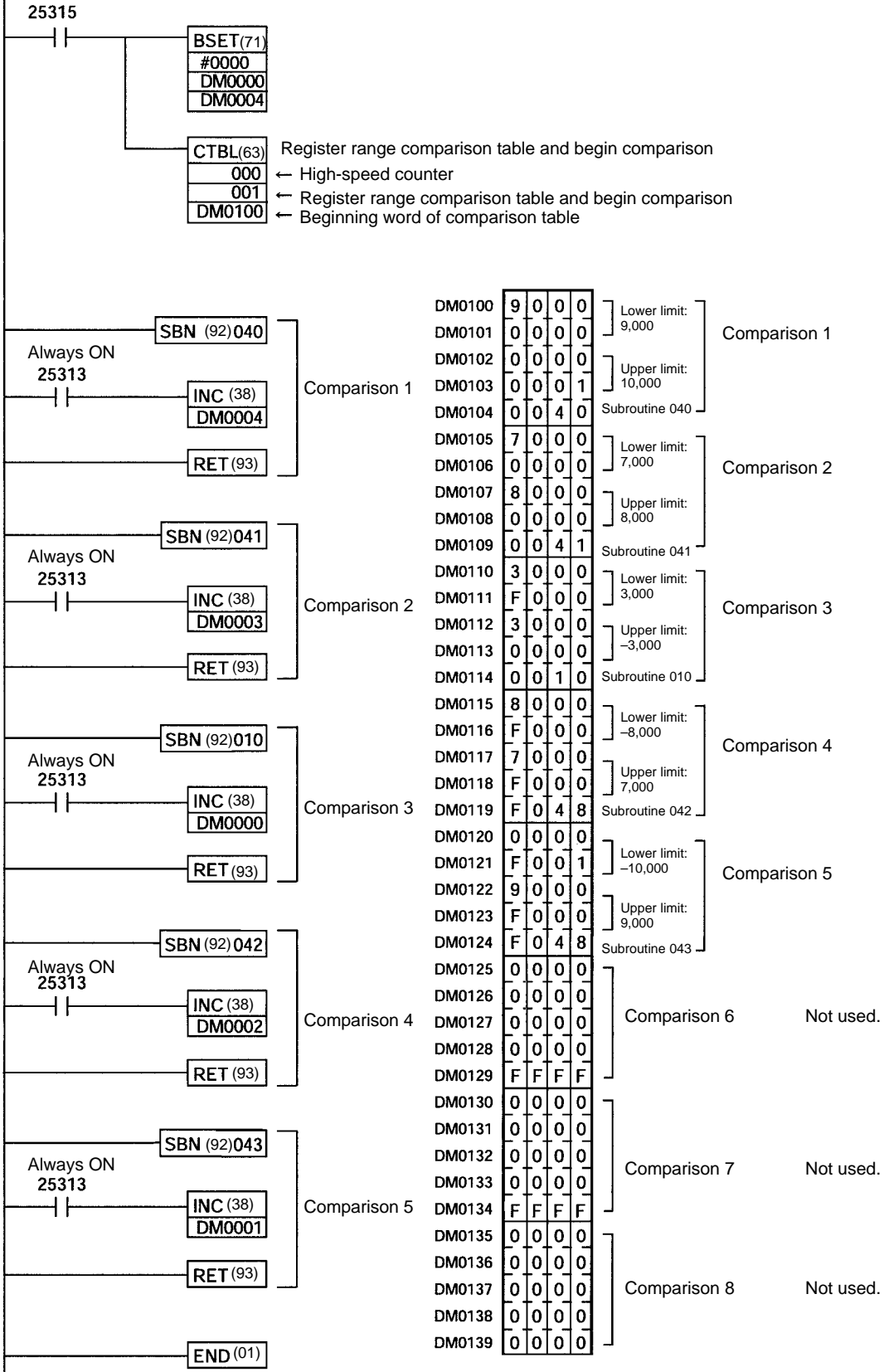

The four built-in interrupt inputs in the CPM2A/CPM2C's CPU Unit can be used in counter mode as inputs of up to 2 kHz. These inputs can be used as either incrementing counters or decrementing counters, triggering an interrupt (when executing an interrupt subroutine) when the count matches the set value.

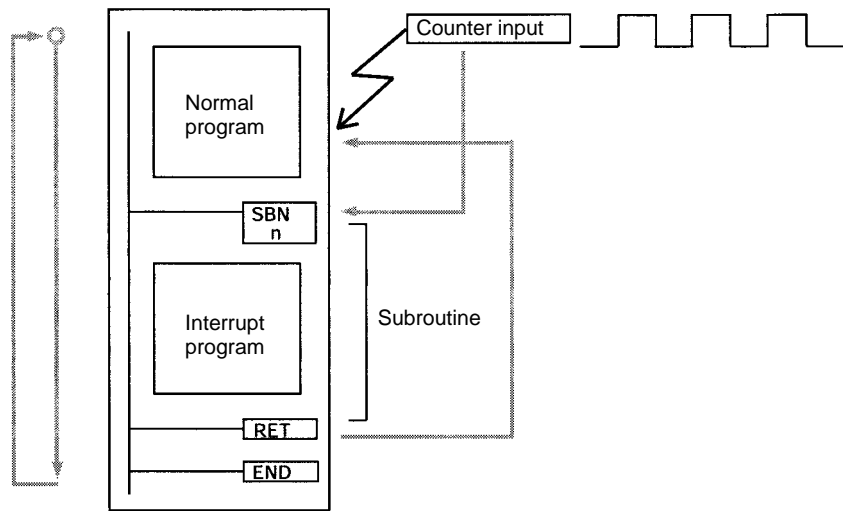
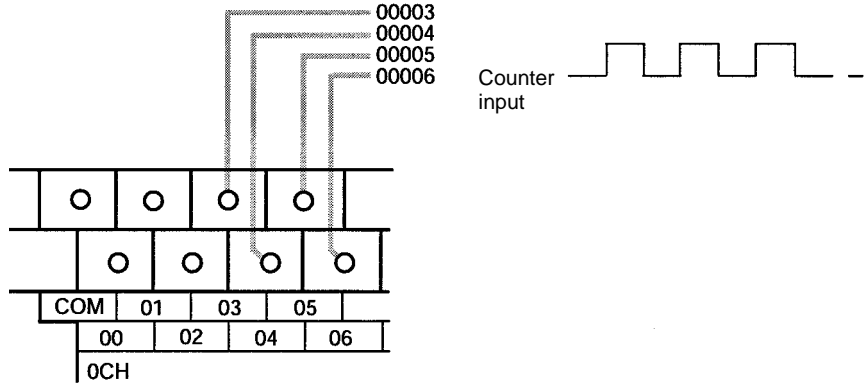

Input number (Note 2)	Count	Interrupt number	Subroutine number (Note 3)	Response frequency
00003	0 to 65535 (0000 to FFFF)	0	000	2 kHz
00004		1	001	
00005		2	002	
00006		3	003	

- Note**
1. Input number 00005 and 00006 cannot be used in CPM2C CPU Units 10 I/O points and CPM2C-S CPU Units.
 2. Input numbers 00003 to 00006 can be used for any of the following functions: interrupt inputs, interrupt inputs (counter mode), or quick-response inputs. When not being used for any of these, they can be used as ordinary inputs.
 3. Subroutine numbers 000 to 003 are the subroutine numbers for interrupt programs started up when interrupt inputs or count-up interrupts for interrupt inputs (counter mode) are generated. When not being used for this purpose, they can be used as ordinary inputs.

the interval between IORF(97) executions. If IORF(97) is executed too frequently, a fatal system error may occur (FALS 9F), stopping operation. The interval between executions of IORF(97) should be at least 1.3 ms + total execution of the interrupt subroutine.

The following table shows the relationships between interrupt inputs (counter mode) and the CPM2A/CPM2C's other functions.

Function	Interrupt inputs (counter mode)
Synchronized pulse control	Can be used simultaneously.
Interrupt inputs	See note 1.
Interval timer interrupts	Can be used simultaneously.
High-speed counters	Can be used simultaneously.
Interrupt inputs (counter mode)	See note 1.
Pulse outputs	Can be used simultaneously.
Quick-response inputs	See note 1.
Input time constant	See note 2.
Clock	Can be used simultaneously.

- Note**
1. The same input number (from 00003 to 00006) cannot be used for more than one of the following functions: interrupt inputs, interrupt inputs (counter mode), or quick-response inputs.
 2. When inputs 00003 to 00006 are set for use as interrupt inputs (counter mode), the input time constants for the relevant inputs are disabled. The input time constants remain in effect, however, for the values for refresh the relevant input relay area.

Procedure for Using Interrupt Inputs in Counter Mode

Set the interrupt input number.



Select either incrementing or decrementing count.



Wire the inputs.

Input numbers: 00003 to 00006 (00003 or 00004 for CPM2C CPU Units with 10 I/O points and CPM2C-S CPU Units.)



PC Setup (DM 6628)

1: Use as interrupt input (interrupt input mode or counter mode)



Create a ladder diagram program.

INI(61): Change counter PV
 INT(89): Refresh counter SV*
 PRV(62): Read counter PV
 SBN(92) and RET(93): For creating interrupt subroutines.*

*Used only for count-up interrupts.

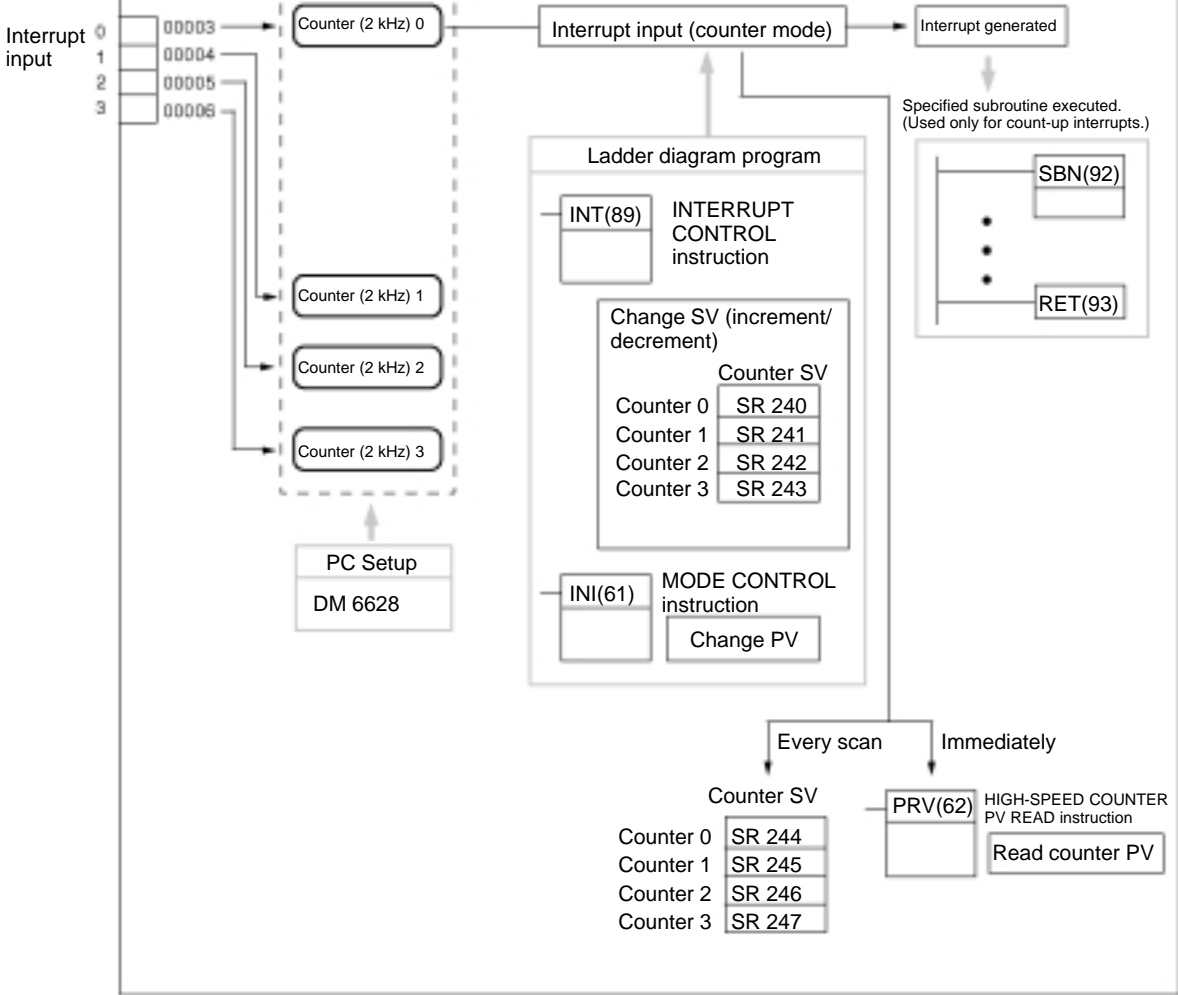

Setting the Interrupt Input Number

With interrupt inputs in counter mode, the subroutine to be executed is determined by the interrupt corresponding to the input number.

Input number	Interrupt number	Subroutine number
00003	0	000
00004	1	001
00005*	2	002
00006*	3	003

Note *Input numbers 00005 and 00006 cannot be used for CPM2C CPU Units with I/O points and for CPM2C-S CPU Units.

The same input number (from 00003 to 00006) cannot be used for more than one of the following functions: interrupt inputs, interrupt inputs (counter mode) or quick-response inputs.

Incrementing Counter Mode

As the set value (SV) is refreshed, the count is incremented from 0, and the interrupt subroutine is executed when the present value (PV) matches the SV.

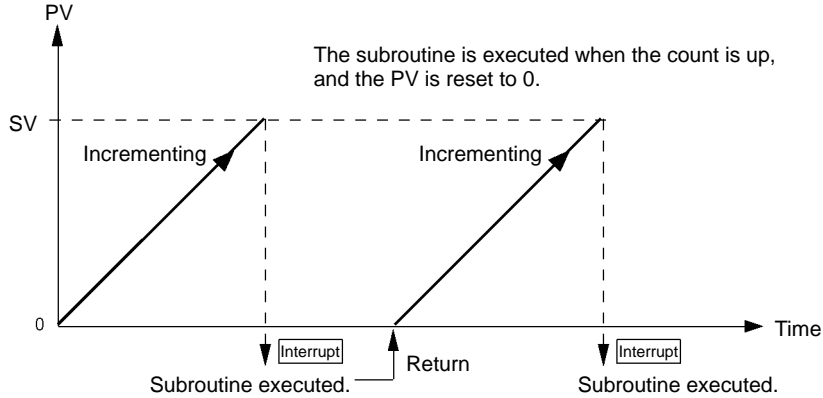

Decrementing Counter Mode

As the set value (SV) is refreshed, the count is decremented toward 0, and the interrupt subroutine is executed when the present value (PV) reaches 0.

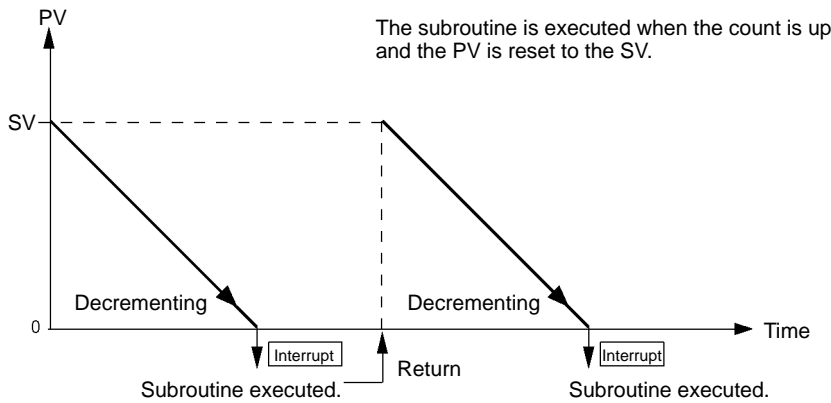

ing the Inputs

With the CPM2A, wire the input terminals as shown in the following illustration

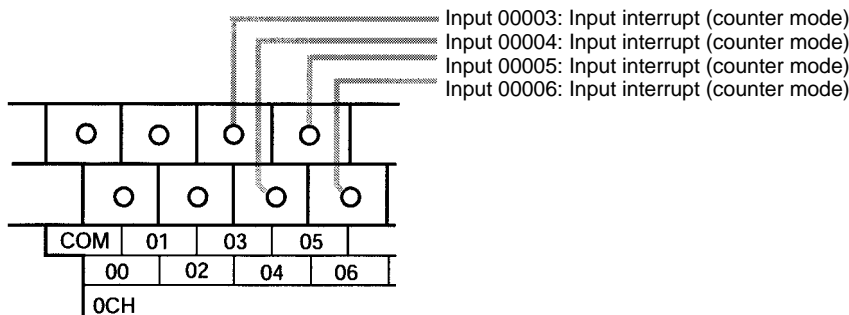

With the CPM2C, wire the input terminals as shown in the following illustration

addresses and connector pin numbers depend on the models. Refer to the CPM2C-S Operation Manual (W356) or the CPM2C-S Operation Manual (W377) for details.

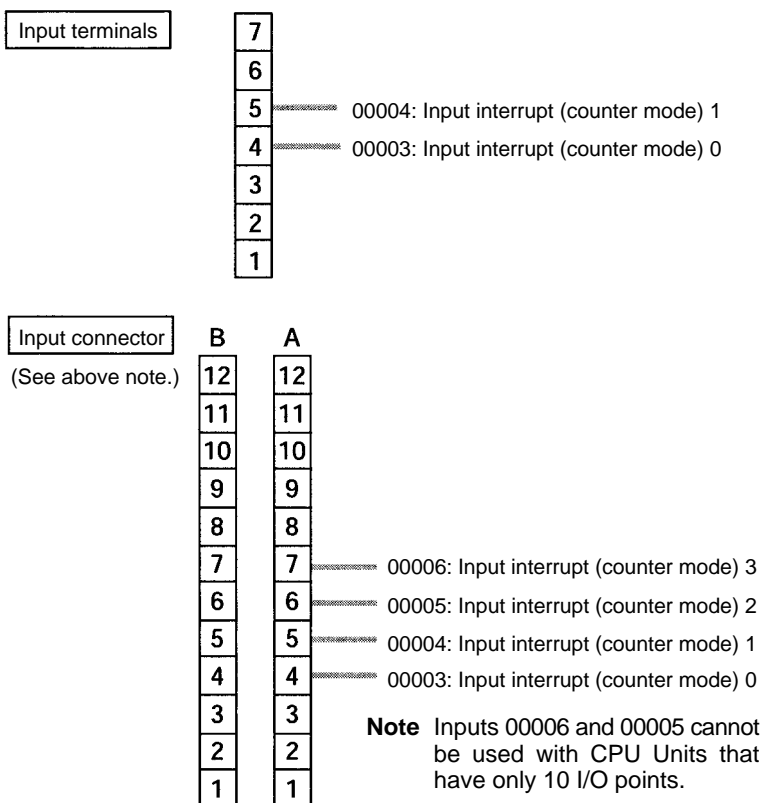

Setup

The following table shows the settings in the PC Setup area related to interrupt input usage.

Word	Bits	Function	Setting
DM 6628	00 to 03	Interrupt setting for input 00003	0: Normal input 1: Interrupt input (interrupt input mode or counter mode) 2: Quick-response input
	04 to 07	Interrupt setting for input 00004	
	08 to 11	Interrupt setting for input 00005*	
	12 to 15	Interrupt setting for input 00006*	

Note *Input number 00005 and 00006 cannot be used in CPM2C CPU Units with 11 I/O points and in CPM2C-S CPU Units.

The setting will go into effect when the mode is changed (from PROGRAM/MONITOR/RUN) or when the power supply is turned ON to the CPM2C.

(counter mode) control.

Instruction	Control	Operation
(@)INT(89)	Refresh incrementing counter SV	Refreshes the counter's SV and starts incrementing count.
	Refresh decrementing counter SV	Refreshes the counter's SV and starts decrementing count.
	Mask all interrupts	Prohibits all interrupts, including interrupt inputs, interval timer interrupts, high-speed counters, etc.
	Unmask all interrupts	Permits all interrupts, including interrupt inputs, interval timer interrupts, high-speed counters, etc.
(@)INI(61)	Change PV	Changes the counter's PV.
(@)PRV(62)	Read PV	Reads the counter's PV.

The functions related to input interrupts (counter mode) are executed according to the data areas shown in the following table.

Word	Bits	Name	Contents
240	00 to 15	SV area for input interrupt (counter mode) 0	Stores the counter's set value (SV).
241	00 to 15	SV area for input interrupt (counter mode) 1	
242	00 to 15	SV area for input interrupt (counter mode) 2	
243	00 to 15	SV area for input interrupt (counter mode) 3	
244	00 to 15	PV area for input interrupt (counter mode) 0	Stores the counter's present value (PV).
245	00 to 15	PV area for input interrupt (counter mode) 1	
246	00 to 15	PV area for input interrupt (counter mode) 2	
247	00 to 15	PV area for input interrupt (counter mode) 3	

Refresh Incrementing Counter SV / Refresh Decrementing Counter SV

These functions store the counter's set values in data areas and refresh them by means of INT(89). In this way, they start the count operation for input interrupt (counter mode) and they permit interrupts.

Storing Set Values in Data Areas

The counter's set values are stored in words 240, 241, 242, and 243.

SR 240	SV for interrupt input (count mode) 0: 0000 to FFFF
SR 241	SV for interrupt input (count mode) 1: 0000 to FFFF
SR 242	SV for interrupt input (count mode) 2: 0000 to FFFF
SR 243	SV for interrupt input (count mode) 3: 0000 to FFFF

Incrementing Counter

(@)INT(89)		
	004	Interrupt control designation (004: Refresh incrementing counter S
	000	Fixed: 000
	C ₂	Control data word

Decrementing Counter

(@)INT(89)		
	003	Interrupt control designation (003: Refresh decrementing counter S
	000	Fixed: 000
	C ₂	Control data word

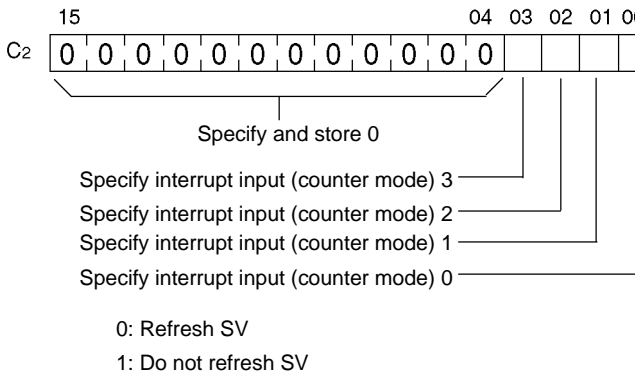

Note When INT(89) is executed to mask interrupts during counter operation (interrupt control designation 000), counter operation will be stopped and the counter will be reset. To use the counter again, start the counter operation again as described above.

Change PV

This function refreshes the counter's present value (PV).

(@)INT(89)		
	P	Port specifier (100, 102, 102, 103: Interrupt inputs (counter mode) 0 to
	002	Control designation (002: Change PV)
	C ₂	Change PV data word

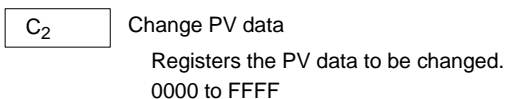

Read PV

This function reads the counter's present value (PV).

Using an Instruction

(@)PRV(62)		
	P	Port specifier (100, 102, 102, 103: Interrupt inputs (counter mode) 0 to
	000	Control designation (000: Read PV)
	D	Word for storing PV

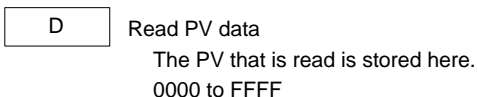

The high speed counter's present value (PV) is stored in words SR 244 to SR 247 as shown below.

SR 244	PV	Interrupt input (counter mode) 0
SR 245	PV	Interrupt input (counter mode) 1
SR 246	PV	Interrupt input (counter mode) 2
SR 247	PV	Interrupt input (counter mode) 3

Words SR 244 to SR 247 are refreshed with every scan, so there may be a discrepancy from the exact PV at any given time.

Words SR 244 to SR 247 cannot be used as work word even when the interrupt inputs (counter mode) are not used.

When the PV is read by executing PRV(62), words 244 to 247 are refreshed at the same timing.

Mask/Unmask All Interrupts

For details regarding masking and unmasking all interrupts, refer to 2-1-1 / Interrupt Inputs.

Application Example

Explanation

In this example, the PV is decremented every time input 00003 is turned ON, DM 0000 is incremented by 1 by an interrupt subroutine every 100 times (Hex) that input 00003 is turned ON.

Wiring

The following diagram shows input wiring in the CPM2A.

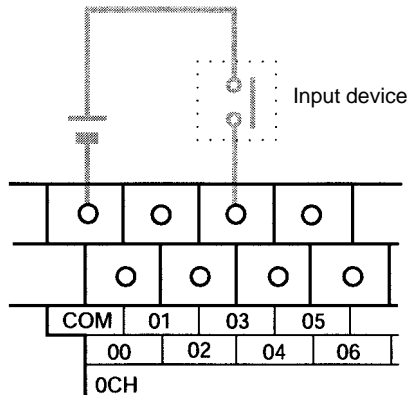

Note The following examples are for Fujitsu-compatible connectors. Input bit addresses and connector pin numbers depend on the models. Refer to the *CPM1 Operation Manual (W356)* or the *CPM2C-S Operation Manual (W377)* for details.

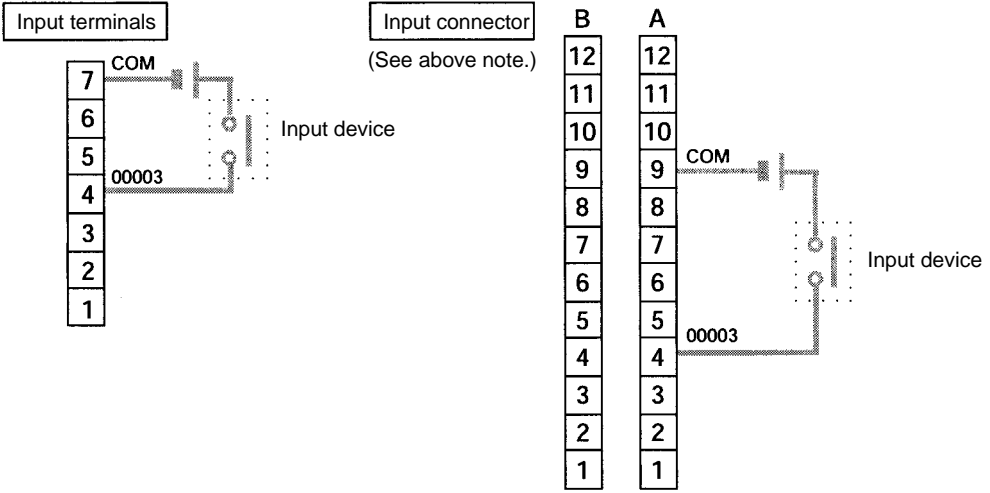

Setup

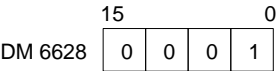

Specifies bit 00003 as an interrupt input (counter mode). Inputs 00004 to 00006 are used as ordinary inputs.

Programming

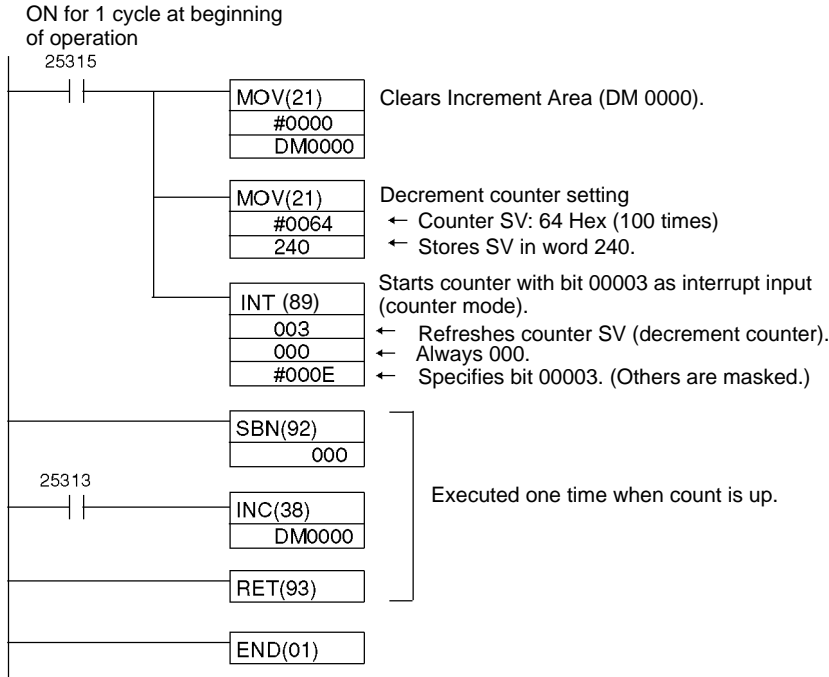

3 CPM1/CPM1A Interrupt Functions

This section explains the settings and methods for using the CPM1/CPM1A interrupt functions.

The CPM1/CPM1A has three types of interrupt processing, as outlined below.

Input Interrupts

CPM1/CPM1A PCs have two or four interrupt inputs. Interrupt processing is executed when one of these inputs is turned ON from an external source.

Interval Timer Interrupts

Interrupt processing is executed by an interval timer with a precision of 0.1 μs.

High-speed Counter Interrupts

The high-speed counter counts pulse inputs to one of CPU bits 00000 to 00003. Interrupt processing is executed when the count reaches the set value of a bit in high-speed counter.

Interrupt Priority

When an interrupt is generated, the specified interrupt processing routine is executed. Interrupts have the following priority ranking.

Input interrupts > Interval interrupts = High-speed counter interrupts

When an interrupt with a higher priority is received during interrupt processing, the current processes will be stopped and the newly received interrupt will be processed instead. After that routine has been completely executed, then processing of the previous interrupt will be resumed.

When an interrupt with a lower or equal priority is received during interrupt processing, then the newly received interrupt will be processed as soon as the routine currently being processed has been completely executed.

When two interrupts with equal priority are received at the same time, they are executed in the following order:

Input interrupt 0 > Input interrupt 1 > Input interrupt 2 > Input interrupt 3

Interval interrupts > High-speed counter interrupts

Interrupt Program Cautions

Observe the following precautions when using interrupt programs:

1, 2, 3...

1. A new interrupt can be defined within an interrupt program. Furthermore, an interrupt can be cleared from within an interrupt program.
2. Another interrupt program cannot be written within an interrupt program.
3. A subroutine program cannot be written within an interrupt program. Do not write a SUBROUTINE DEFINE instruction, SBN(92), within an interrupt program.
4. An interrupt program cannot be written within a subroutine program. Do not write an interrupt program between a SUBROUTINE DEFINE instruction (SBN(92)) and a RETURN instruction (RET(93)).

Inputs used as interrupts cannot be used as regular inputs.

High-speed Counter Instructions and Interrupts

The following instructions cannot be executed in an interrupt subroutine when an instruction that controls high-speed counters is being executed in the interrupt program:

INI(61), PRV(62), or CTBL(63)

The following methods can be used to circumvent this limitation:

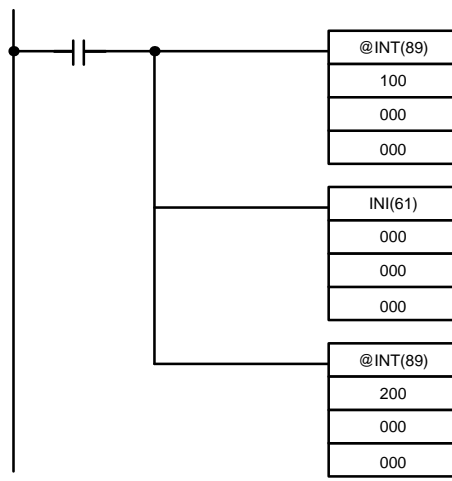

Method 2

Execute the instruction again in the main program.

- 1, 2, 3... 1. This is the program section from the main program:

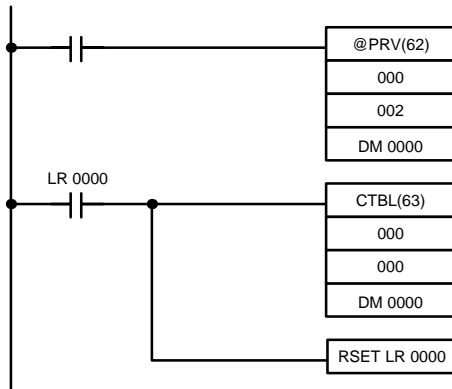

2. This is the program section from the interrupt subroutine:

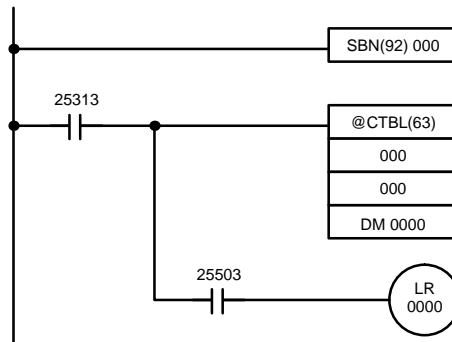

- Note**
1. Define interrupt routines at the end of the main program with SBN(92) RET(93) instructions, just like regular subroutines.
 2. When defining an interrupt routine, a "SBS UNDEFD" error will occur during the program check operation, but the program will be executed normally.

3-2 Input Interrupts

The 10-pt CPU Units (CPM1-10CDR-□ and CPM1A-10CDR-□) have two interrupt inputs (00003 and 00004).

CPM1-30CDR-□(-V1), CPM1A-30CDR-□ and CPM1A-40CDR-□ have four interrupt inputs (00003 to 00006).

There are two modes for input interrupts: input interrupt mode and counter mode.

M1 PCs

10-pt CPU Units
(CPM1-10CDR-□)

20- and 30-pt CPU Units
(CPM1-20CDR-□ and
CPM1-30CDR-□(-V1))

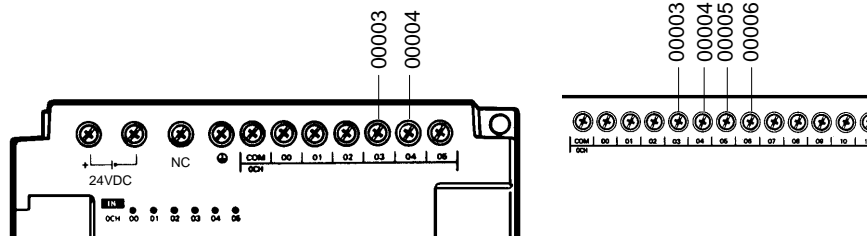

M1A PCs

10-pt CPU Units
(CPM1A-10CDR-□)

20-, 30-, and 40-pt CPU Units
(CPM1A-20CDR-□,
CPM1A-30CDR-□, and
CPM1A-40CDR-□)

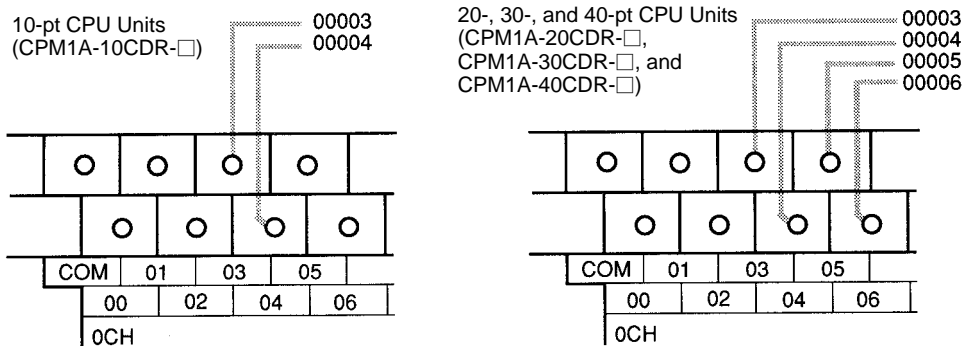

CPU Unit	Input	Interrupt number	Response time	
			Interrupt mode	Counter mode
CPM1-10CDR-□ CPM1A-10CD□-□	00003	00	0.3 ms max. (Time until the interrupt program is executed.)	1 kHz
	00004	01		
CPM1-20CDR-□ CPM1A-20CD□-□	00003	00		
	00004	01		
CPM1-30CDR-□(-V1) CPM1A-30CD□-□	00003	02		
	00004	03		

Note If input interrupts are not used, use inputs 00003 to 00006 as regular inputs.

be used for input interrupts in the DM 6628. Set the corresponding digit if the input is to be used as an interrupt input (input interrupt or counter mode) and set it to 0 if it is to be used as a regular input.

Word	Setting
DM 6628	0: Regular input (default setting) 1: Interrupt input 2: Quick-response input

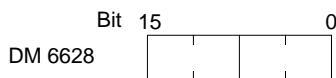

Setting for input 00006: Set to 1

Setting for input 00005: Set to 1

Setting for input 00004: Set to 1

Setting for input 00003: Set to 1

Interrupt Subroutines

Interrupts from inputs 00003 to 00006 are allocated interrupt numbers 00 to 03 and call subroutines 000 to 003. If the input interrupts aren't being used, subroutines 000 to 003 can be used in regular subroutines.

Input number	Interrupt number	Subroutine number
00003	0	000
00004	1	001
00005	2	002
00006	3	003

Input Refreshing

If input refreshing is not used, input signal status within the interrupt routine may not be reliable. Depending on the input time constant, the input signals might go ON even if input refreshing is used. This includes the status of the interrupt input bit that activated the interrupt.

For example, IR 00000 would not be ON in interrupt routine for input interrupt 00000 unless it was refreshed. In this case, use the Always ON Flag, SR 25313 in the interrupt routine instead of IR 00000.

Input Interrupt Mode

When an input interrupt signal is received, the main program is interrupted and the interrupt program is executed immediately, regardless of the point in the cycle in which the interrupt is received. The signal must be ON for 200 μs or more to be detected.

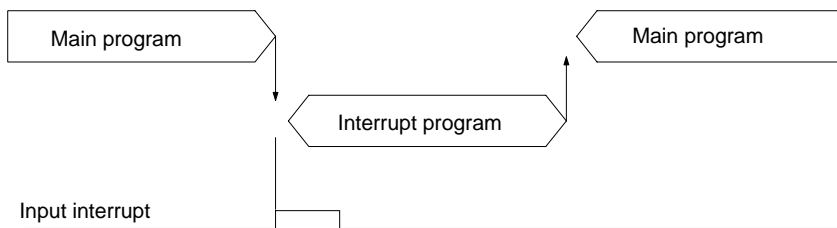

Use the following instructions to program input interrupts using the Input Interrupt Mode.

Masking/Unmasking of Interrupts

With the INT(89) instruction, set or clear input interrupt masks as required.

(@)INT(89)	
	000
	000
	D

Make the settings with word D bits 0 to 3, which correspond to input interrupts 0 to 3.

0: Mask cleared. (Input interrupt enabled.)

1: Mask set. (Input interrupt disabled.)

Input mode is being used, be sure to enable the inputs by executing INT(89) as shown above.

Clearing Masked Interrupts

If the bit corresponding to an input interrupt turns ON while masked, that interrupt will be saved in memory and will be executed as soon as the mask is cleared. In order for that input interrupt not to be executed when the mask is cleared, the interrupt must be cleared from memory.

Only one interrupt signal will be saved in memory for each interrupt number. With the INT(89) instruction, clear the input interrupt from memory.

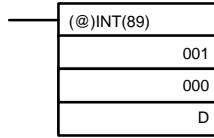

If D bits 0 to 3, which correspond to input interrupts 0 to 3, are set to "1," then the input interrupts will be cleared from memory.
 0: Input interrupt retained.
 1: Input interrupt cleared.

Reading Mask Status

With the INT(89) instruction, read the input interrupt mask status.

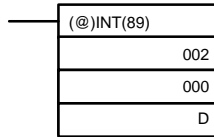

The status of the rightmost digit of the data stored in word D (bits 0 to 3) show the mask status.
 0: Mask cleared. (Input interrupt enabled.)
 1: Mask set. (Input interrupt disabled.)

Program Example

When input 00003 (interrupt no. 0) goes ON, operation moves immediately to the interrupt program with subroutine number 000. Inputs for DM 6628 have been set to 0001.

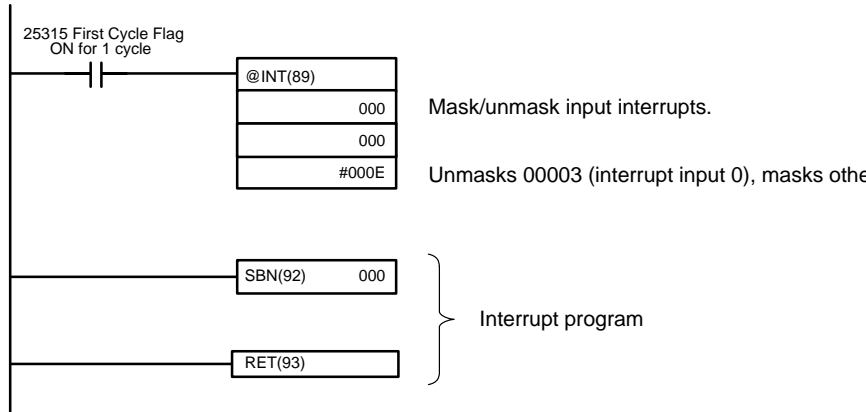

Counter Mode

External signal inputs are counted at high speed and an interrupt is generated when the count reaches the set value. When an interrupt is generated, the main program is interrupted and the interrupt program is executed. Signals up to 1 kHz can be counted.

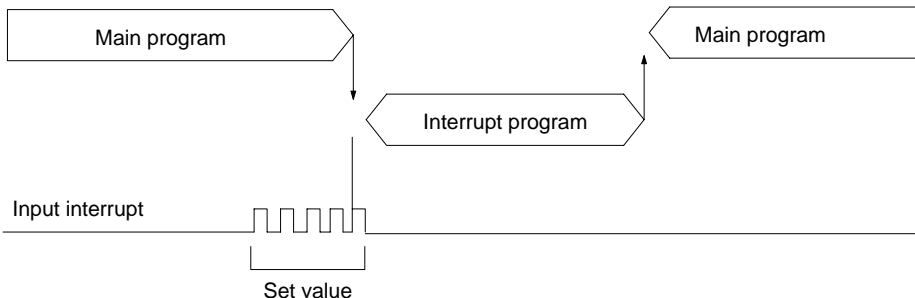

1, 2, 3...

1. Write the set values for counter operation to the SR words shown in the following table. The set values are written between 0000 and FFFF (65,535). A value of 0000 will disable the count operation until a new value is set and step 2, below, is repeated.

Interrupt	Word
Input interrupt 0	SR 240
Input interrupt 1	SR 241
Input interrupt 2	SR 242
Input interrupt 3	SR 243

The SR words used in the Counter Mode (SR 240 to SR 243) contain hexadecimal data, not BCD. If the Counter Mode is not used, these words can be used as work bits.

Note These SR words are cleared at the beginning of operation, and must be written from the program.

2. With the INT(89) instruction, refresh the Counter Mode set value and enable interrupts.

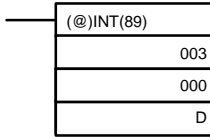

If D bits 0 to 3, which correspond to input interrupts 0 to 3, are set to "0," then the set value will be refreshed and interrupts will be permitted.

- 0: Counter mode set value refreshed and mask cleared.
- 1: Not refreshed.

Be sure to set the corresponding bit to 1 if an input interrupt isn't being controlled.

The input interrupt for which the set value is refreshed will be enabled in Counter Mode. When the counter reaches the set value, an interrupt will occur, the counter will be reset, and counting/interrupts will continue until the counter is stopped.

- Note**
1. If the INT(89) instruction is used during counting, the present value (PV) will return to the set value (SV). You must, therefore, use the differentiated flag of the instruction or an interrupt may never occur.
 2. The set value will be set when the INT(89) instruction is executed. If interrupts are already in operation, then the set value will not be changed just by changing the content of SR 240 to SR 243, i.e., if the contents are changed, the set value must be refreshed by executing the INT(89) instruction again.

Interrupts can be masked using the same process used with the Input Interrupt Mode, but if the masked interrupts are cleared using the same process, the interrupts will operate in Input Interrupt Mode, not Counter Mode.

Interrupt signals received for masked interrupts can also be cleared using the same process as for the Input Interrupt Mode.

Counter PV in Counter Mode

When input interrupts are used in Counter Mode, the counter PV will be stored in the SR word corresponding to input interrupts 0 to 3. Values are 0000 to FFFF (65,534) and will equal the counter PV minus one.

Interrupt	Word
Input interrupt 0	SR 244
Input interrupt 1	SR 245
Input interrupt 2	SR 246
Input interrupt 3	SR 247

Example: The present value for an interrupt whose set value is 000A will be recorded as 0009 immediately after INT(89) is executed.

Note Even if input interrupts are not used in Counter Mode, these SR bits cannot be used as work bits.

When input 00003 (interrupt no. 0) goes ON 10 times, operation moves immediately to the interrupt program with subroutine number 000. The following table shows where the counters' set values and present values -1 are stored. In for DM 6628 have been set to 0001.

Interrupt	Word containing SV	Word containing PV-1
Input 00003 (input interrupt 0)	SR 240	SR 244
Input 00004 (input interrupt 1)	SR 241	SR 245
Input 00005 (input interrupt 2)	SR 242	SR 246
Input 00006 (input interrupt 3)	SR 243	SR 247

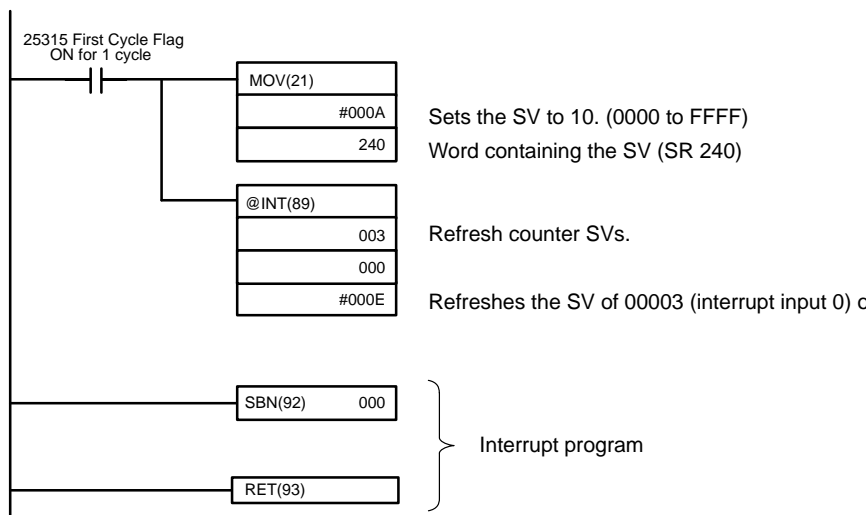

3-3 Masking All Interrupts

All interrupts, including input interrupts, interval timer interrupts, and high-speed counter interrupts, can be masked and unmasked as a group by means of the INT(89) instruction. The mask is in addition to any masks on the individual types of interrupts. Furthermore, clearing the masks for all interrupts does not clear the masks on the individual types of interrupts, but restores them to the mask conditions that existed before INT(89) was executed to mask them as a group.

Do not use INT(89) to mask interrupts unless it is necessary to temporarily mask all interrupts and always use INT(89) instructions in pairs to do so, using the first INT(89) instruction to mask and the second one to unmask interrupts.

INT(89) cannot be used to mask and unmask all interrupts from within interrupt routines.

Masking Interrupts

Use the INT(89) instruction to disable all interrupts.

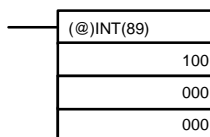

If an interrupt is generated while interrupts are masked, interrupt processing will not be executed but the interrupt will be recorded for the input, interval timer, high-speed counter interrupts. The interrupts will then be serviced as soon as the interrupts are unmasked.

(@)INT(89)
200
000
000

3-4 Interval Timer Interrupts

The CPM1/CPM1A is equipped with one interval timer. When the interval times out, the main program is interrupted and the interrupt program is executed immediately, regardless of the point in the cycle.

There are two modes for interval timer operation, the One-shot Mode, in which only one interrupt will be executed when time expires, and the Scheduled Interrupt Mode in which the interrupt is repeated at a fixed interval.

The interval timer's set value can be set anywhere from 0.5 to 319968 ms in units of 0.1 ms.

eration

Use the following instruction to activate and control the interval timer.

Starting Up in One-Shot Mode

Use the STIM(69) instruction to start the interval timer in the one-shot mode.

(@)STIM(69)
C ₁
C ₂
C ₃

- C₁: Interval timer, one-shot mode (000)
- C₂: Timer set value (first word address)
- C₃: Subroutine no. (4 digits BCD): 0000 to 0049

1, 2, 3...

1. When C₂ is entered as a word address:

C₂: Decrementing counter set value (4 digits BCD): 0000 to 9999

C₂ + 1: Decrementing time interval (4 digits BCD; unit: 0.1 ms): 0005 to 0049 (0.5 ms to 32 ms)

Each time that the interval specified in word C₂ + 1 elapses, the decrementing counter will decrement the present value by one. When the PV reaches 0, the designated subroutine will be called just once and the timer will stop.

The time from when the STIM(69) instruction is executed until time elapses is calculated as follows:

$$(\text{Content of } C_2) \times (\text{Content of } C_2 + 1) \times 0.1 \text{ ms} = (0.5 \text{ to } 319,968 \text{ ms})$$

2. When C₂ is entered as a constant:

The set value of the decrementing counter will equal the specified constant (in ms) and the decrementing time interval will be 10 (1 ms).

Starting Up in Scheduled Interrupt Mode

Use the STIM(69) instruction to start the interval timer in the scheduled interrupt mode.

(@)STIM(69)
C ₁
C ₂
C ₃

- C₁: Interval timer, scheduled interrupt mode (003)
- C₂: Timer set value (leading word no.)
- C₃: Subroutine no. (4 digits BCD): 0000 to 0049

1, 2, 3...

1. When C₂ is entered as a word address:

C₂: Decrementing counter set value (4 digits BCD): 0000 to 9999

C₂ + 1: Decrementing time interval (4 digits BCD; unit: 0.1 ms): 0005 to 0049 (0.5 ms to 32 ms)

The meanings of the settings are the same as for the one-shot mode, but in the scheduled interrupt mode the timer PV will be reset to the set value and decrementing will begin again after the subroutine has been called. In scheduled interrupt mode, interrupts will continue to be repeated at fixed intervals until the operation is stopped.

The settings are the same as for the one-shot mode, but interrupts will continue to be repeated at fixed intervals until the operation is stopped.

Reading the Timer's Elapsed Time

Use the STIM(69) instruction to read the timer's elapsed time.

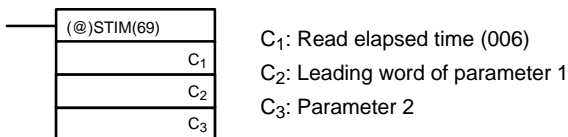

C₂: Number of times the decrementing counter has been decremented (4 digits BCD)

C₂ + 1: Decrementing counter time interval (4 digits BCD; unit: 0.1 ms)

C₃: Elapsed time from previous decrement (4 digits BCD; unit: 0.1 ms)

The time from when the interval timer is started until the execution of this instruction is calculated as follows:

$$\{(\text{Content of } C_2) \times (\text{Content of } C_2+1) + (\text{Content of } C_3)\} \times 0.1 \text{ ms}$$

If the specified interval timer is stopped, then "0000" will be stored.

Stopping the Timer

Use the STIM(69) instruction to stop the interval timer. The interval timer will be stopped.

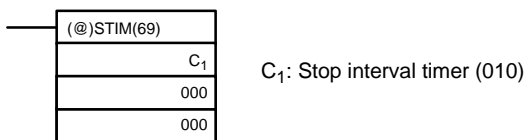

Application Example (One-shot Mode)

In this example, an interrupt is generated 2.4 ms (0.6 ms × 4) after input 00005 goes ON; the interrupt executes interrupt subroutine number 23.

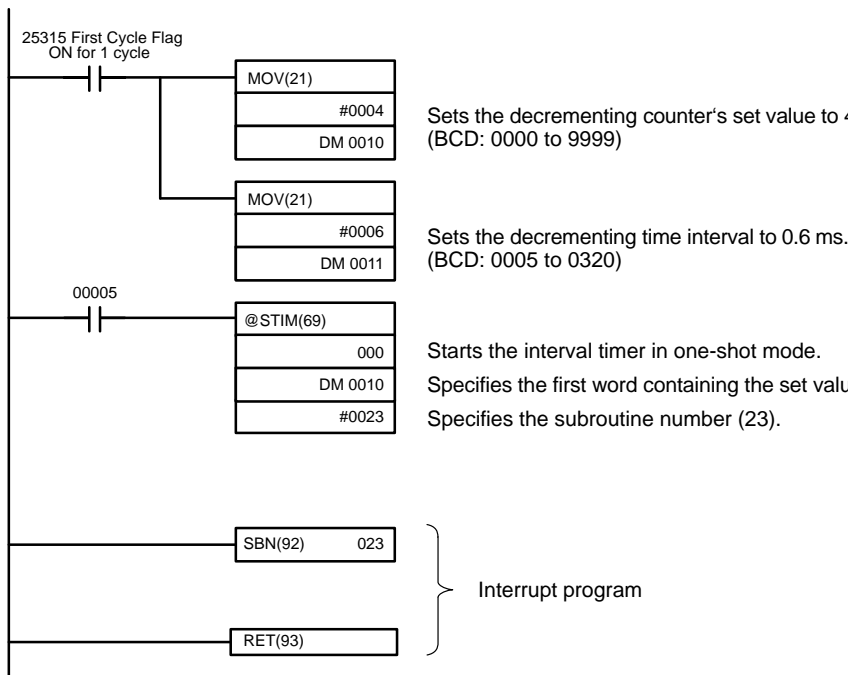

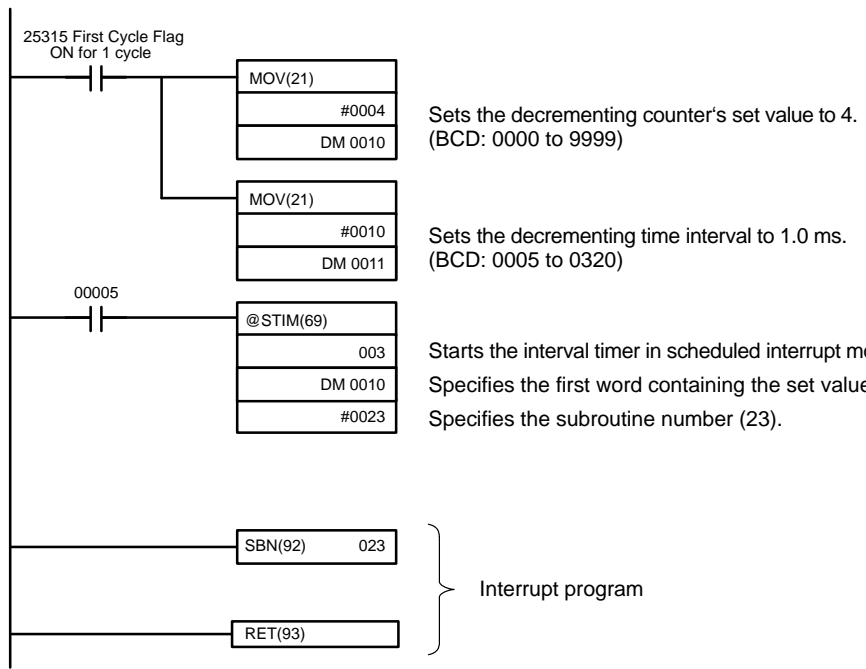

3-5 High-speed Counter Interrupts

CPM1/CPM1A PCs have a high-speed counter function that can be used in decremting mode or up/down mode. The high-speed counter can be combined with input interrupts to perform target value control or zone comparison control that isn't affected by the PC's cycle time.

High-speed counter signals can be input to CPU bits 00000 through 00006

CPM1 PCs

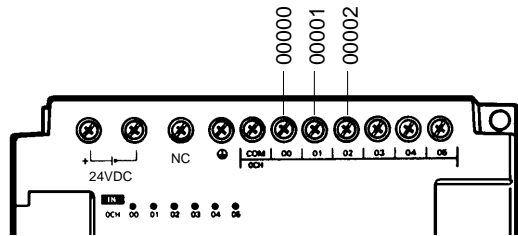

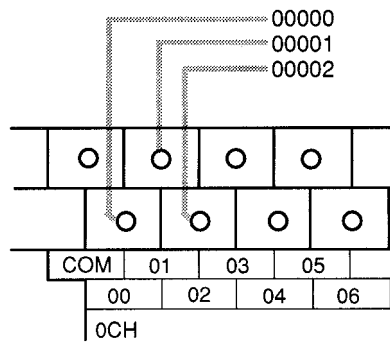

Mode	Input functions	Input method	Count frequency	Count range	Control methods
Up/Down	00000: Phase-A input 00001: Phase-B input 00002: Phase-Z input	Phase-difference, 4x inputs	2.5 kHz max.	-32767 to 32767	Target value control: Up to 16 target values and interrupt subroutine numbers can be registered.
Incrementing	00000: Count input 00001: See note. 00002: Reset input	Individual inputs	5.0 kHz max.	0 to 65535	Zone comparison control: Up to 8 sets of upper limit values, lower limit values, and interrupt subroutine numbers can be registered.

Note In incrementing mode, input 00001 can be used as a regular input. When the reset method is used for the software reset, input 00002 can be used as a regular input. Also, even when used for the phase-Z signal and software reset, the input status is reflected in 00002 of the I/O memory.

High-speed Counter Settings The following settings must be made in DM 6642 when using the CPM1/CPM1A's high-speed counter function.

DM 6642 Bits	Function	Settings		
		Incrementing	Up/Down	Not used
00 to 03	Sets the counter mode: 0: Up/down 4: Incrementing	4	0	0 or 4
04 to 07	Sets the reset method: 0: Phase-Z + software reset 1: Software reset	0 or 1	0 or 1	0 or 1
08 to 15	Sets the counter: 00: Counter not being used. 01: Counter being used.	01	01	00

Count Range The CPM1/CPM1A's high-speed counter uses linear operation and the count value (present value) is stored in SR 248 and SR 249. (The upper four digits are stored in SR 249 and the lower four digits are stored in SR 248.)

Mode	Count range
Up/Down	F003 2767 to 0003 2767 (-32,767 to 32,767) The leftmost digit in SR 248 indicates the sign. F is negative, 0 is positive.
Incrementing	0000 0000 to 0006 5535 (0 to 65,535)

Error	Incrementing	Up/Down	Present value
Overflow	Occurs when the count is incremented from 65,535.	Occurs when the count is incremented from 32,767.	0FFF FF
Underflow	---	Occurs when the count is decremented from -32,767.	FFFF FF

Processing

Two types of signals can be input from a pulse encoder. The count mode used by the high-speed counter will depend on the signal type. The count mode and set mode are set in DM 6642; these settings become effective when the power is turned on or PC operation is started.

Up/Down Mode:

Phase-A difference 4× two-phase signal (phase-A and phase-B) and phase-Z signal are used for inputs. The count is incremented or decremented according to differences in the 2-phase signals.

Incrementing Mode:

One single-phase pulse signal and a count reset signal are used for inputs. The count is incremented according to the single-phase signal.

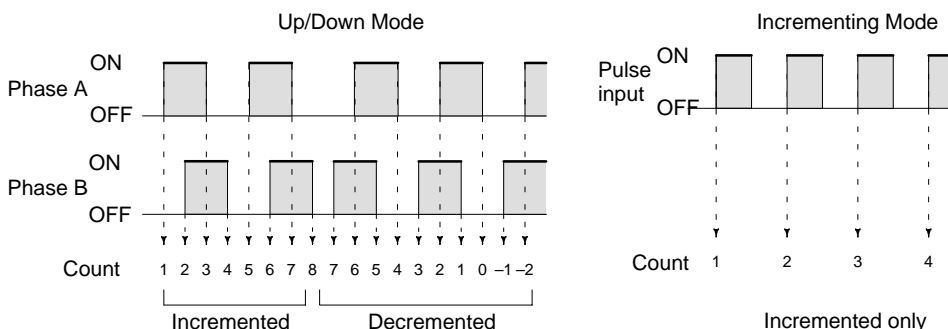

Note One of the reset methods described below should always be used to reset the counter when restarting it. The counter will be automatically reset when program execution is started or stopped.

The following signal transitions are handled as forward (incrementing) pulses: Phase-A leading edge to phase-B leading edge to phase-A trailing edge to phase-B trailing edge. The following signal transitions are handled as reverse (decrementing) pulses: Phase-B leading edge to phase-A leading edge to phase-B trailing edge to phase-A trailing edge.

The Up/Down Mode always uses a 4× phase-difference input. The number of counts for each encoder revolution would be 4 times the resolution of the counter. Select the encoder based on the countable ranges.

Reset Methods

Either of the two methods described below may be selected for resetting the counter of the count (i.e., setting it to 0).

Phase-Z signal + software reset:

The PV is reset when the phase-Z signal (reset input) is turned ON while the High-speed Counter Reset Bit (SR 25200) is ON.

Software reset:

The PV is reset when the High-speed Counter Reset Bit (SR 25200) is turned ON.

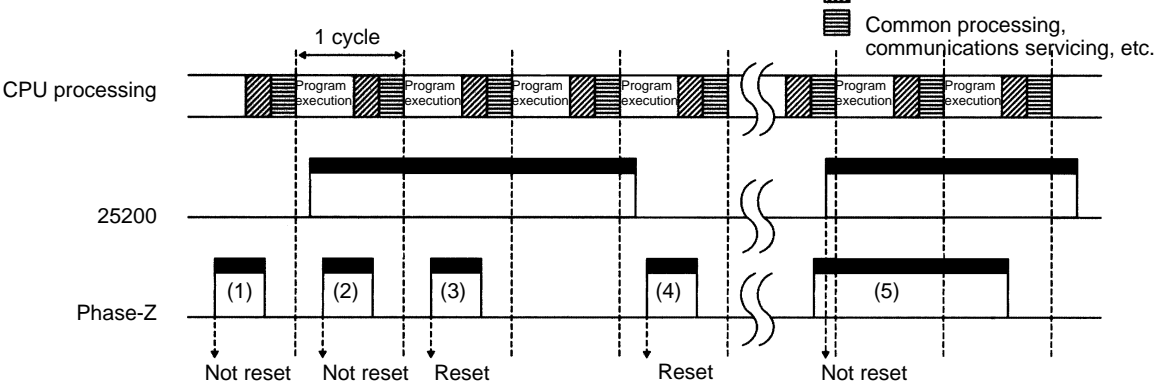

No.	Operation timing	Reset
(1)	Phase-Z signal turns ON when SR 25200 turns OFF.	Not reset.
(2)	Phase-Z signal turns ON within one cycle after SR 25200 turns ON.	Not reset.
(3)	Phase-Z signal turns ON after at least one cycle elapses after SR 25200 turns ON.	Reset with phase-Z leading edge.
(4)	Phase-Z signal turns ON within one cycle after SR 25200 turns OFF.	Reset with phase-Z leading edge.
(5)	SR 25200 turns ON when phase-Z signal is ON.	Not reset.

Note The High-speed Counter Reset Bit (SR 25200) is refreshed once every cycle in order for it to be read reliably it must be ON for at least one cycle.

The “Z” in “phase-Z” is an abbreviation for “Zero.” It is a signal that shows the encoder has completed one cycle.

High-speed Counter Interrupt Count

For high-speed counter 0 interrupts, a comparison table is used instead of “count up.” The count check can be carried out by either of the two methods described below. In the comparison table, comparison conditions (for comparing the PV) and interrupt routine combinations are saved.

Target value:

A maximum of 16 comparison conditions (target values and count directions) and interrupt routine combinations are saved in the comparison table. When the counter PV and the count direction match the comparison conditions, then the specified interrupt routine is executed.

Range (zone) comparison:

Eight comparison conditions (upper and lower limits) and interrupt routine combinations are saved in the comparison table. When the PV is greater than or equal to the lower limit and less than or equal to the upper limit, the specified interrupt routine is executed.

are set in the comparison table and interrupts are generated as the count equals each target value. Once the count has equaled all of the target values in the table, the target value is set to the first target value in the table, which is then compared to the current counted until the two values are equal.

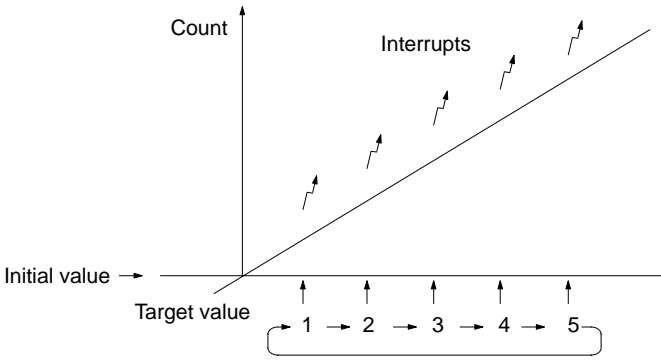

Comparison Table

Target value 1
Target value 2
Target value 3
Target value 4
Target value 5

Range Comparisons

The current count is compared in cyclic fashion to all of the ranges at the same time and interrupts are generated based on the results of the comparisons.

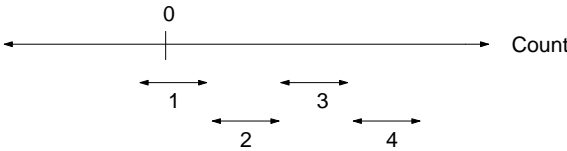

Comparison Table

Range setting 1
Range setting 2
Range setting 3
Range setting 4

Note When performing target value comparisons, do not repeatedly use the IN instruction to change the current value of the count and start the comparison operation. The interrupt operation may not work correctly if the comparison operation is started immediately after changing the current value from the program. (The comparison operation will automatically return to the first target value of the table when an interrupt has been generated for the last target value. Repetitious operation is thus possible merely by changing the current value.)

Programming

Use the following steps to program the high-speed counter.

The high-speed counter begins the counting operation when the proper PC setup settings are made, but comparisons will not be made with the comparison table and interrupts will not be generated unless the CTBL(63) instruction is executed.

The high-speed counter is reset to "0" when power is turned ON and when the counting operation begins.

The present value of high-speed counter is maintained in SR 248 and SR 249.

Controlling High-speed Counter Interrupts

- 1, 2, 3... 1. Use the CTBL(63) instruction to save the comparison table in SR 248 and begin comparisons.

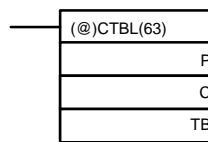

C: (3 digits BCD)

- 000: Target table set and comparison begun
- 001: Range table set and comparison begun
- 002: Target table set only
- 003: Range table set only

TB: Beginning word of comparison table

method, if 001, then they will be made by the range comparison method. The comparison table will be saved, and, when the save operation is complete, then comparisons will begin. While comparisons are being executed, high-speed interrupts will be executed according to the comparison table. For details on the contents of the comparison tables that are saved, refer to the explanation of the CTBL(63) instruction in *Section 7 Instruction Set*.

Note The comparison results are normally stored in AR 1100 through AR 1107 while the range comparison is being executed.

If C is set to 002, then comparisons will be made by the target match method; if 003, then they will be made by the range comparison method. In either of these settings, the comparison table will be saved, but comparisons will not begin, and the INI(61) instruction must be used to begin comparisons.

2. To stop comparisons, execute the INI(61) instruction as shown below.



To start comparisons again, set the second operand to "000" (execute comparison), and execute the INI(61) instruction.

Once a table has been saved, it will be retained in the CPM1/CPM1A during operation (i.e., during program execution) as long as no other table is saved.

Reading the PV

There are two ways to read the PV. The first is to read it from SR 248 and SR 249, and the second to use the PRV(62) instruction.

Reading SR 248 and SR 249

The PV of high-speed counter is stored in SR 248 and SR 249 as shown below. The leftmost bit will be F for negative values.

Leftmost 4 digits	Rightmost 4 digits	Up/Down Mode	Incrementing Mode
SR 249	SR 248	F0032767 to 00032767 (-32767)	00000000 to 00065535

- Note**
1. These words are refreshed only once every cycle, so there may be a difference from the actual PV.
 2. When high-speed counter is not being used, the bits in these words can be used as work bits.

Using the PRV(62) Instruction

Read the PV of the high-speed counter by using the PRV(62) instruction.

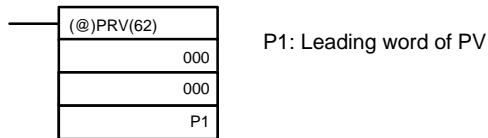

The PV of the high-speed counter is stored as shown below. The leftmost bit will be F for negative values.

Leftmost 4 digits	Rightmost 4 digits	Up/Down Mode	Incrementing Mode
P1+1	P1	F0032767 to 00032767 (-32767)	00000000 to 00065535

Changing the PV

There are two ways to change the PV of high-speed counter. The first way is to reset it by using the reset methods. (In this case the PV is reset to 0.) The second way is to use the INI(61) instruction.

The method using the INI(61) instruction is explained here. For an explanation of the reset method, refer to the beginning of this description of high-speed counter.

Change the timer PV by using the INI(61) instruction as shown below.

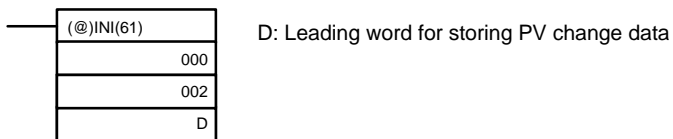

Leftmost 4 digits	Rightmost 4 digits	Up/Down Mode	Incrementing Mode
D+1	D	F0032767 to 00032767	00000000 to 00065535

To specify a negative number in up/down mode, set F in the leftmost digit.

Application Example (Incrementing Mode)

This example shows a program that uses the high-speed counter with single phase inputs in the Incrementing Mode, making comparisons by means of the target matching method.

The comparison conditions (target values and count directions) are stored in the comparison table with the subroutine numbers. Up to 16 target values can be stored. The corresponding subroutine is executed when the counter's value matches the target value.

The following data is stored for the comparison table:

DM 0000	0002	Number of comparison conditions: 2
DM 0001	1000	Target value 1: 1000
DM 0002	0000	
DM 0003	0030	Comparison 1 interrupt subroutine no.: 30
DM 0004	2000	Target value 2: 2000
DM 0005	0000	
DM 0006	0031	Comparison 2 interrupt subroutine no.: 31

The following diagram shows the example ladder program. DM 6642 must be set to 01□4, where □ is the reset method which can be set to 0 or 1.

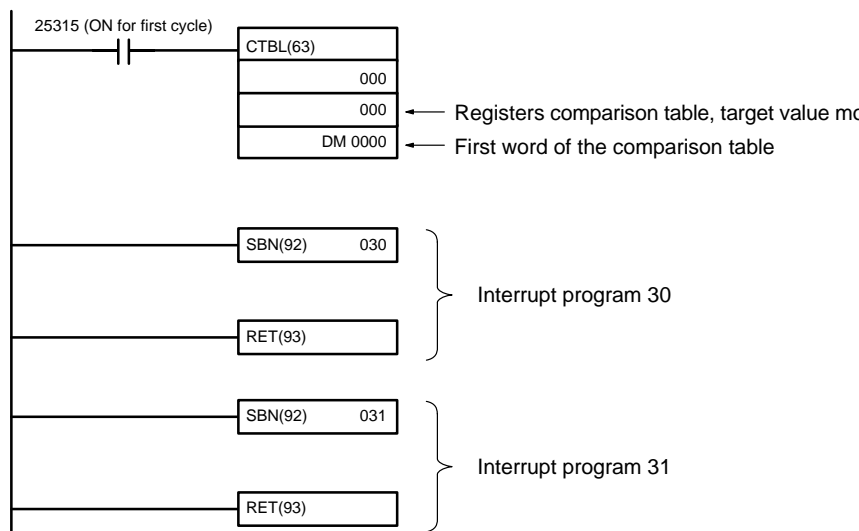

reference inputs in the Up/Down mode, making comparisons by means of a range comparison method.

The comparison conditions (upper/lower limits of the ranges) are stored in a comparison table with the subroutine numbers. Up to 8 separate ranges can be defined. The corresponding subroutine is executed when the counter's P is within the range.

Note Always set 8 ranges. If fewer than 8 ranges are needed, set the remaining routine numbers to FFFF. A value of FFFF indicates that no subroutine is to be executed.

The following data is stored for the comparison table:

DM 0000	1500	
DM 0001	0000	Lower limit 1: 1,500 counts
DM 0002	3000	
DM 0003	0000	Upper limit 1: 3,000 counts
DM 0004	0040	Range 1 interrupt subroutine no.: 40
DM 0005	7500	
DM 0006	0000	Lower limit 2: 7,500 counts
DM 0007	0000	
DM 0008	0001	Upper limit 2: 10,000 counts
DM 0009	0041	Range 2 interrupt subroutine no.: 41
DM 0010	0000	
DM 0011	0000	
DM 0012	0000	
DM 0013	0000	
DM 0014	FFFF	Range 3 interrupt subroutine not executed
.	.	.
.	.	.
.	.	.
.	.	.
.	.	.
DM 0035	0000	
DM 0036	0000	
DM 0037	0000	
DM 0038	0000	
DM 0039	FFFF	Range 8 interrupt subroutine not executed

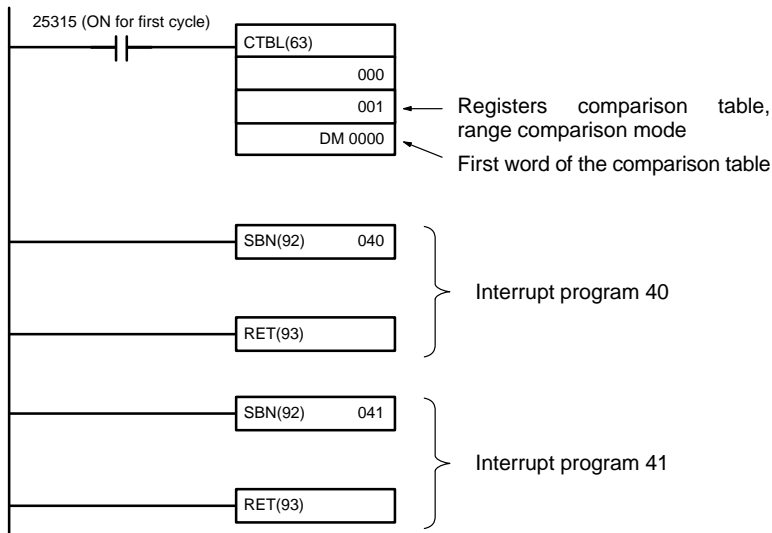

3-6 Precautions on Programming Interrupts

If words in memory are being manipulated both in the main program and in an interrupt program, the interrupts must be masked when the words are being manipulated in the main program. Refer to 2-1-3 *Precautions on Programming Interrupts* for details.

4 SRM1(-V2) Interrupt Functions

This section explains the settings and methods for using the SRM1(-V2) interrupt functions.

4-1 Types of Interrupts

The SRM1(-V2) has only one type of interrupt processing, as outlined below.

Interval Timer Interrupts

Interrupt processing is executed by an interval timer with a precision of 0.1 ms.

4-2 Interval Timer Interrupts

The SRM1(-V2) is equipped with one interval timer. When the interval timer times out, the main program is interrupted and the interrupt program is executed immediately, regardless of the point in the cycle.

There are two modes for interval timer operation, the One-shot Mode, in which only one interrupt will be executed when time expires, and the Scheduled Interrupt Mode in which the interrupt is repeated at a fixed interval.

The interval timer's set value can be set anywhere from 0.5 to 319,968 ms in units of 0.1 ms.

eration

Use the following instruction to activate and control the interval timer.

Starting Up in One-Shot Mode

Use the STIM(69) instruction to start the interval timer in the one-shot mode.

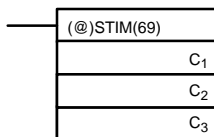

- C₁: Interval timer, one-shot mode (000)
- C₂: Timer set value (first word address)
- C₃: Subroutine no. (4 digits BCD): 0000 to 0049

C₂: Decrementing counter set value (4 digits BCD): 0000 to 9999
 C₂ + 1: Decrementing time interval (4 digits BCD; unit: 0.1 ms): 0005 to 0032 (0.5 ms to 32 ms)

Each time that the interval specified in word C₂ + 1 elapses, the decrementing counter will decrement the present value by one. When the PV reaches 0, the designated subroutine will be called just once and the timer will stop.

The time from when the STIM(69) instruction is executed until time elapses is calculated as follows:

$$(\text{Content of } C_2) \times (\text{Content of } C_2 + 1) \times 0.1 \text{ ms} = (0.5 \text{ to } 319,968 \text{ ms})$$

- When C₂ is entered as a constant:

The set value of the decrementing counter will equal the specified constant (in ms) and the decrementing time interval will be 10 (1 ms).

Starting Up in Scheduled Interrupt Mode

Use the STIM(69) instruction to start the interval timer in the scheduled interrupt mode.

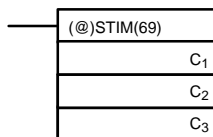

- C₁: Interval timer, scheduled interrupt mode (003)
- C₂: Timer set value (leading word no.)
- C₃: Subroutine no. (4 digits BCD): 0000 to 0049

1, 2, 3...

- When C₂ is entered as a word address:

C₂: Decrementing counter set value (4 digits BCD): 0000 to 9999
 C₂ + 1: Decrementing time interval (4 digits BCD; unit: 0.1 ms): 0005 to 0032 (0.5 ms to 32 ms)

The meanings of the settings are the same as for the one-shot mode, but in the scheduled interrupt mode the timer PV will be reset to the set value and decrementing will begin again after the subroutine has been called. In scheduled interrupt mode, interrupts will continue to be repeated at fixed intervals until the operation is stopped.

- When C₂ is entered as a constant:

The settings are the same as for the one-shot mode, but interrupts will continue to be repeated at fixed intervals until the operation is stopped.

Reading the Timer's Elapsed Time

Use the STIM(69) instruction to read the timer's elapsed time.

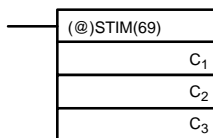

- C₁: Read elapsed time (006)
- C₂: Leading word of parameter 1
- C₃: Parameter 2

C₂: Number of times the decrementing counter has been decremented (4 digits BCD)

C₂ + 1: Decrementing counter time interval (4 digits BCD; unit: 0.1 ms)

C₃: Elapsed time from previous decrement (4 digits BCD; unit: 0.1 ms)

The time from when the interval timer is started until the execution of this instruction is calculated as follows:

$$\{(\text{Content of } C_2) \times (\text{Content of } C_2+1) + (\text{Content of } C_3)\} \times 0.1 \text{ ms}$$

If the specified interval timer is stopped, then "0000" will be stored.

stopped.

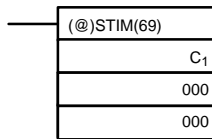

C₁: Stop interval timer (010)

Application Example (One-shot Mode)

In this example, an interrupt is generated 2.4 ms (0.6 ms × 4) after input 00005 goes ON; the interrupt executes interrupt subroutine number 23.

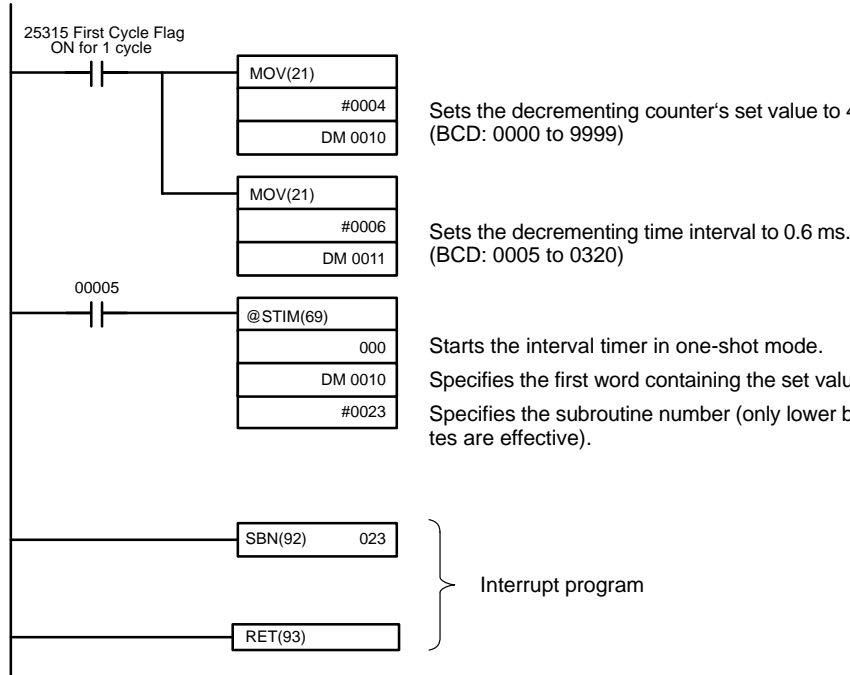

Application Example (Scheduled Interrupt Mode)

In this example, an interrupt is generated every 4.0 ms (1.0 ms × 4) after input 00005 goes ON; the interrupts execute interrupt subroutine number 23.

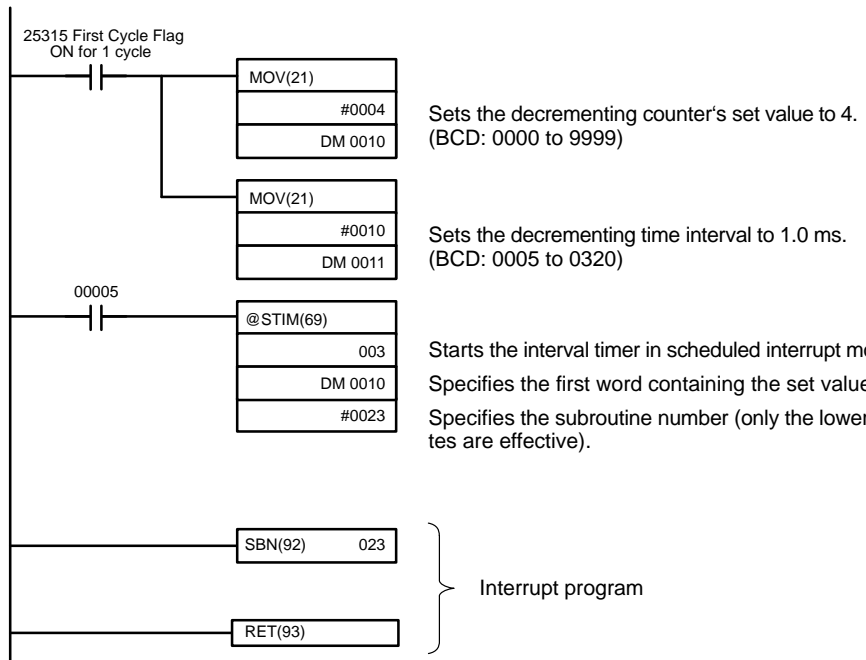

The CPM2A/CPM2C has two pulse outputs. By means of a selection in the Setup, these outputs can be used as two single-phase outputs without acceleration and deceleration, two variable duty ratio pulse outputs, or pulse outputs with trapezoidal acceleration/deceleration (one pulse + direction output and one up/down pulse output). The pulse output PV coordinate system can also be specified in the PC Setup as either relative or absolute.

There are two pulse output modes: Independent mode, in which outputs are stopped at a preset amount of pulses, and continuous mode, in which outputs are stopped by an instruction.

Note To use pulse outputs, it is necessary to use a CPU Unit with transistor outputs, i.e., either a CPM2A-□□CDT-D or CPM2A-□□CDT1-D.

The following diagram shows the configuration for a CPM2A, but the configuration for a CPM2C is identical.

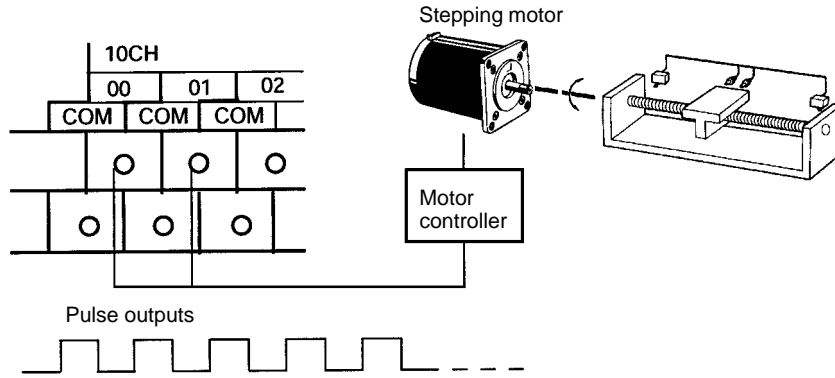

Item		Single-phase pulse outputs without accel/decel	Variable duty ratio pulse outputs	Single-phase pulse outputs with trapezoidal acceleration/deceleration			
				Pulse + direction outputs		Up/down pulse outputs	
Execution instructions		PULS(65) and SPED(64)	PWM(—)	PULS(65) and ACC(—)			
Output number	01000	Pulse output 0 (See note 1.)	Pulse output 0 (See note 1.)	Pulse output 0	Pulse output	Pulse output 0	CW pulse output
	01001	Pulse output 1 (See note 1.)	Pulse output 1 (See note 1.)		Direction output		CCW pulse output
Output frequency range		10 Hz to 10 kHz	0.1 to 999.9 Hz	10 Hz to 10 kHz		10 Hz to 10 kHz	
Pitch		10 Hz	0.1 Hz	10 Hz		10 Hz	
Up/down frequency pitch		---	---	10 Hz (See note 2.)		10 Hz (See note 2.)	
Start speed pitch		---	---	10 Hz		10 Hz	
Output mode		Continuous, Independent	Continuous	Continuous, Independent		Continuous, Independent	
Number of pulses		1 to 16777215	---	±1 to 16777215		±1 to 16777215	
Duty ratio (See note 3.)		50%	0 to 100%	50%		50%	
Control method	Movement specification	Yes	No	Yes		Yes	
	Accel/decel specification	No	No	Yes		Yes	
	Start speed specification	No	No	Yes		Yes	
	Duty specification	No	Yes	No		No	

independently.

2. Pulse outputs can be accelerated or decelerated in units of 10 Hz every ms.

3. Actual pulses are affected by the transistor output's ON response time (40 μs max.) and OFF response time (40 μs max.).

The following table shows the relationships between the high-speed counter and the CPM2A/CPM2C's other functions.

	Interval timer interrupts
Synchronized pulse control	Cannot be used simultaneously.
Interrupt inputs	Can be used simultaneously.
Interval timer interrupts	Can be used simultaneously.
High-speed counters	Can be used simultaneously.
Interrupt inputs (counter mode)	Can be used simultaneously.
Pulse outputs	See note.
Quick-response inputs	Can be used simultaneously.
Input time constant	Can be used simultaneously.
Clock	Can be used simultaneously.

Note The number of simultaneous outputs varies according to the type of pulse output, as shown in the following table.

Combination		Single-phase pulse output		Pulse + direction output	Up/down pulse output
		Fixed duty ratio	Variable duty ratio		
Single-phase pulse output	Fixed duty ratio	Can use two points simultaneously (independently).	Can use one point at a time (independently).	Cannot be used.	Cannot be used.
	Variable duty ratio	Can use one point at a time (independently).	Can use two points simultaneously (independently).	Cannot be used.	Cannot be used.
Pulse + direction output		Cannot be used.	Cannot be used.	Cannot be used.	Cannot be used.
Up/down pulse output		Cannot be used.	Cannot be used.	Cannot be used.	Cannot be used.

Up to two points can be output simultaneously with only single-phase pulse outputs, so two-point output is possible when fixed duty ratio and variable duty ratio are used in combination.

Outputs are possible for only one point at a time with pulse + direction output and up/down pulse outputs, so no other pulses can be output.

Types of Pulse Outputs

There are three types of pulse outputs: Single-phase pulse outputs without acceleration and deceleration, variable duty ratio pulse outputs, and single-phase pulse outputs with trapezoidal acceleration and deceleration.

Single-phase Pulse Outputs Without Acceleration and Deceleration

- Frequency: 10 Hz to 10 kHz (Set in units of 10 Hz.)
- Output destination: Output number 01000 (Word 010, bit 00)
Output number 01001 (Word 010, bit 01)
(Pulses can be output simultaneously and independently from two points.)
- Output mode: Continuous or Independent
- Number of pulses: 1 to 16,777,215

- With PULS(65), the number of pulses is set for each point (in independent mode only).
- With SPED(64), the output mode and target frequency are set for each point, and pulses are output.

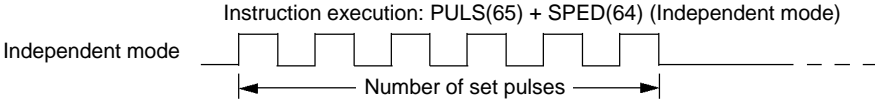

The output is stopped automatically when the set number of pulses has been output.

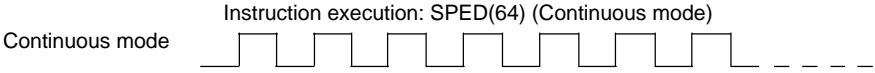

Pulses continue to be output at the set frequency until stopped by the instruction.

Variable Duty Ratio Pulse Outputs

- Duty ratio: 0% to 100% (Set in units of 1%.)
- Frequency: 0.1 to 999.9 Hz (Set in units of 0.1 Hz.)
- Output destination: Output number 01000 (Word 010, bit 00)
Output number 01001 (Word 010, bit 01)
(Pulses can be output simultaneously and independently from two points.)
- Output mode: Continuous
- Instruction: PWM(—)

With PWM(—), pulses are output with a variable duty ratio.

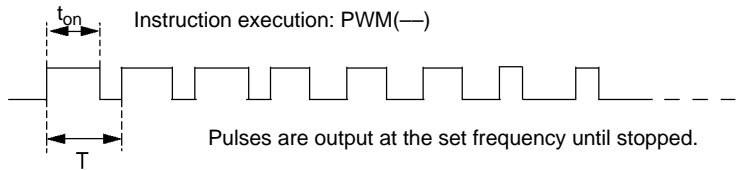

$$\text{Duty ratio (D)} = \frac{t_{on}}{T}$$

Single-phase Pulse Outputs With Trapezoidal Acceleration/Deceleration

- Frequency: 10 Hz to 10 kHz (Set in units of 10 Hz.)
- Acceleration/deceleration rate: 10 Hz/10 ms to 10 kHz/10 ms (Set in units of 10 Hz.)

Pulse + Direction Outputs

- For CW Output:
Output number 01001 (Word 010, bit 01) turned OFF.
Pulses output from output number 01000 (Word 010, bit 00).
- For CCW Output:
Output number 01001 (Word 010, bit 01) turned ON.
Pulses output from output number 01000 (Word 010, bit 00).

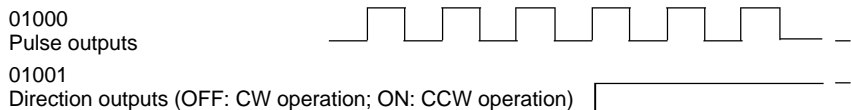

- For CW output:
Pulses output from output number 01000 (Word 010, bit 00).
- For CCW output:
Pulses output from output number 01001 (Word 010, bit 01).

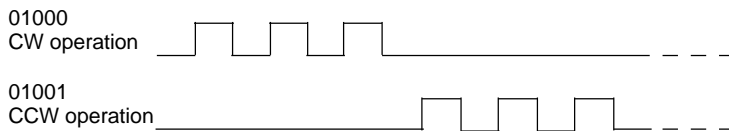

- Output mode: Continuous and Independent
- Number of pulses: 1 to 16,777,215
- Instructions: PULS(65) and ACC(—)
 - With PULS(65), the number of pulses is set (in independent mode only)
 - With ACC(—), the output mode, starting frequency, target frequency, acceleration/deceleration rate are set, and the pulse outputs are started. From when the pulse outputs are started until they are stopped, they are controlled at a constant-ratio frequency change.

Independent Mode

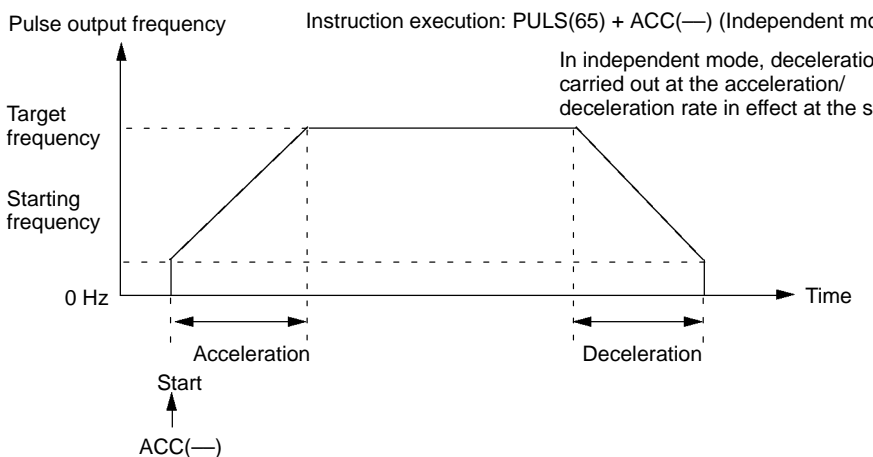

Continuous Mode

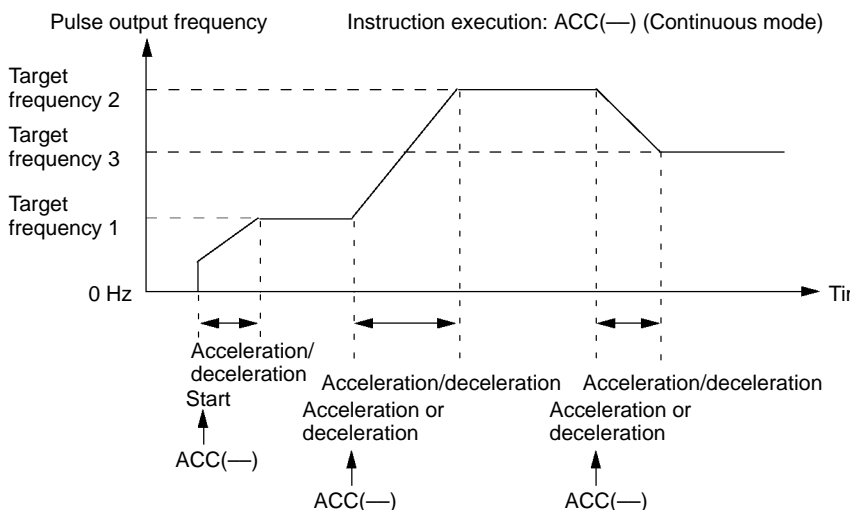

Deceleration (Fixed Duty Ratio)

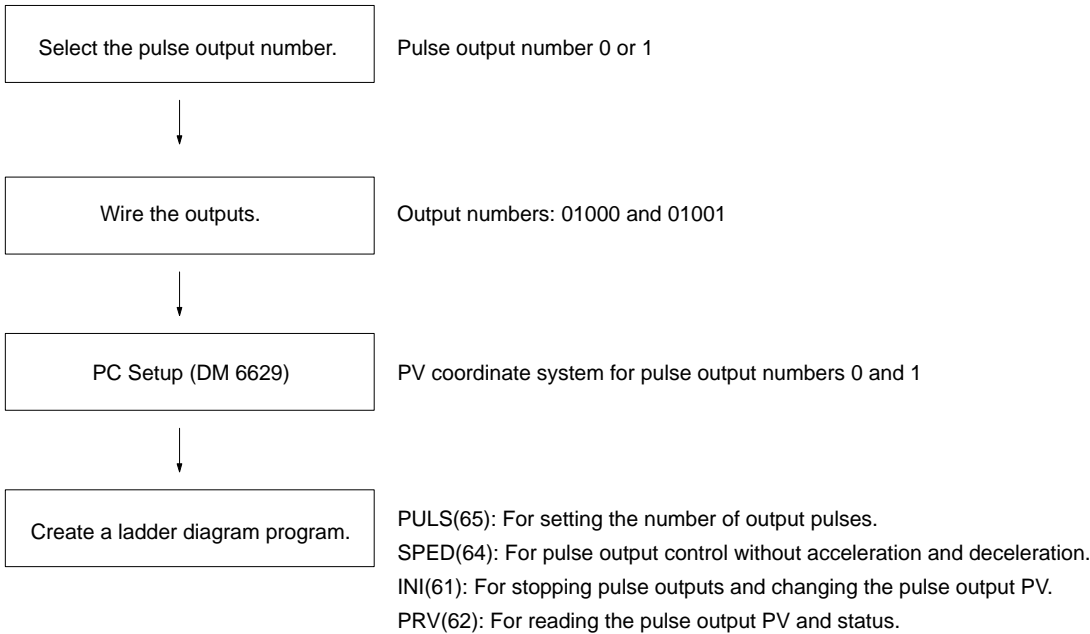

Single-phase Pulse Outputs

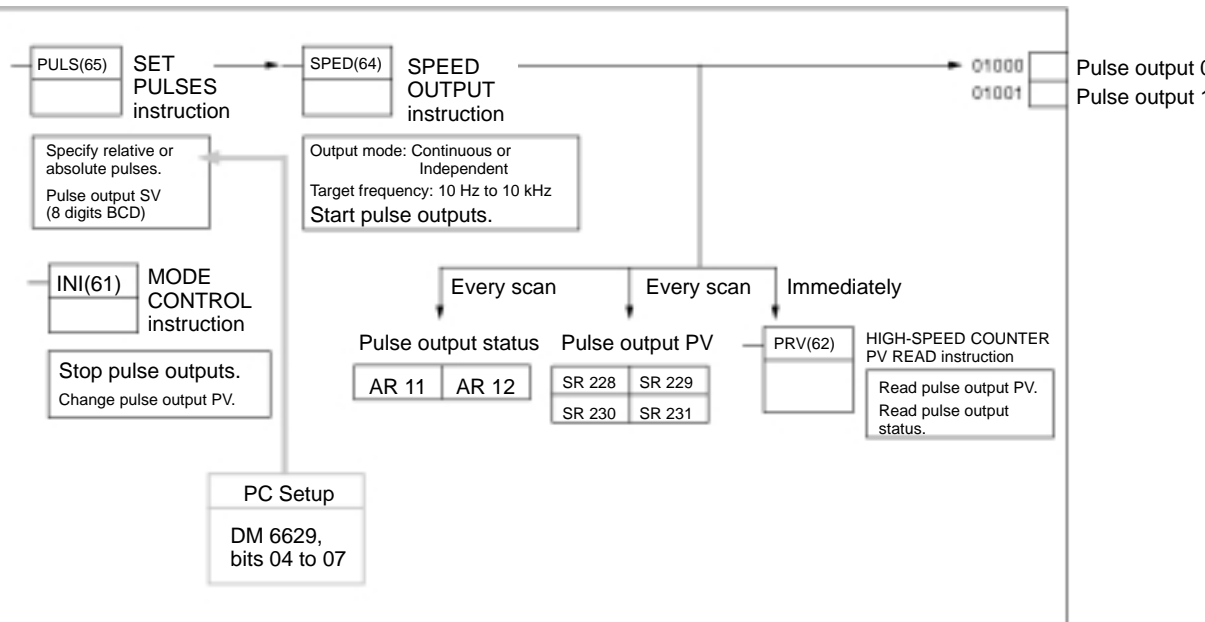

Selecting the Pulse Output Number

Select either pulse number 0 or 1.

Output number	Pulse output number
01000	0
01001	1

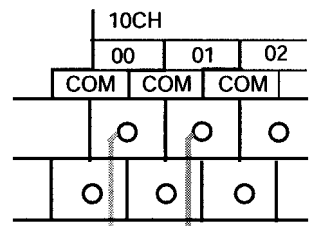

Output 01000: Pulse output 0 (single-phase output)

Output 01001: Pulse output 1 (single-phase output)

Wire the CPM2C outputs as shown in the following illustration. (Pulses can be output independently from pulse outputs 0 and 1.)

Note The following examples are for Fujitsu-compatible connectors. Output bit addresses and connector pin numbers depend on the models. Refer to the *CPM2C Operation Manual (W356)* or the *CPM2C-S Operation Manual (W377)* for details.

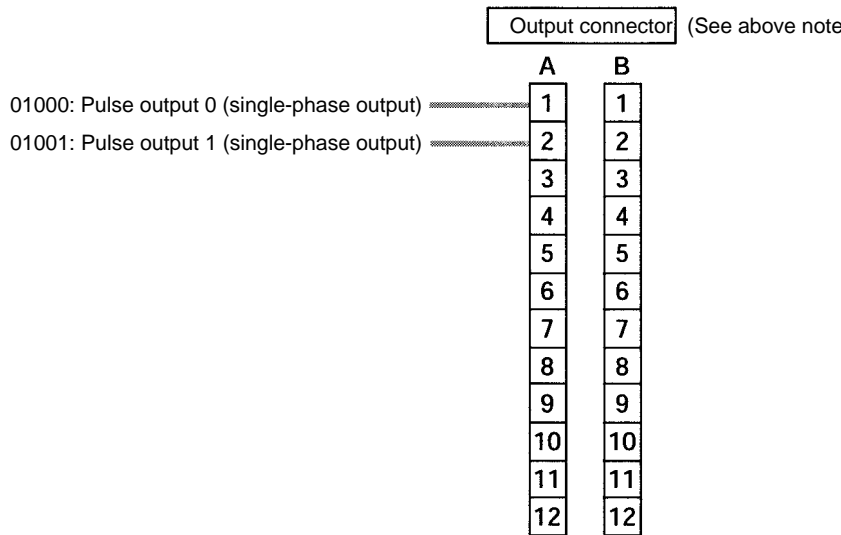

Word	Bits		Function	Setting
DM 6629	00 to 03	Pulse 0 PV coordinate system	0: Relative coordinate system	Either 0 1
	04 to 07	Pulse 1 PV coordinate system	1: Absolute coordinate system	
DM 6642	08 to 15	High-speed counter setting	00: Do not use. 01: Use as high-speed counter 02: Use as synchronized pulse control (10 to 500 Hz). 03: Use as synchronized pulse control (20 Hz to 1 kHz). 04: Use as synchronized pulse control (300 Hz to 20 kHz).	Either 00 01

If absolute pulses are specified with PULS(65), be sure to set the absolute coordinate system (1).

Synchronized pulse control cannot be used simultaneously.

The settings will go into effect when the mode is changed (from PROGRAM/MONITOR/RUN) or when the power supply is turned ON to the PC.

Parameter Diagram Programming

The following table shows the instruction operations related to pulse outputs without acceleration and deceleration (fixed duty ratio).

Instruction	Control	Operation
(@)PULS(65)	Set number of pulses	Sets the number of pulses to be output in independent mode.
(@)SPED(64)	Set frequency and start pulse outputs	Sets the frequency for outputs in the independent mode or continuous mode and starts the pulse outputs.
	Change frequency	Changes the frequency for outputs in the independent mode or continuous mode.
	Stop pulse outputs	Stops the pulse outputs (by changing the speed to a frequency of 0 Hz).
(@)INI(61)	Stop pulse outputs	Stops the pulse outputs.
	Change pulse output PV	Changes the pulse output PV.
(@)PRV(62)	Read pulse output PV	Reads the pulse output PV.
	Read pulse output status	Reads the pulse output status.

The following table shows which instructions can be executed during pulse outputs without acceleration and deceleration.

	PULS(65)	SPED(64)	INI(61)	PRV(62)	ACC(—)	PWM(—)
Continuous mode	No	Yes (See note 2.)	Yes (See note 1.)	Yes	No	No
Independent mode	No	Yes (See note 2.)	Yes (See note 1.)	Yes	No	No

- Note**
- This instruction can be executed only while pulse outputs are stopped. PV cannot be changed while pulses are being output. If the PV needs to be changed, be sure to stop the pulse output first.
 - This instruction can be used only for changing the frequency and stopping the pulse output. It cannot be used for switching between independent mode and continuous mode.

Word	Bits	Name	Contents
228	00 to 15	Pulse output PV 0, rightmost 4 digits	Cannot be used as work bits even when not used as pulse outputs.
229	00 to 15	Pulse output PV 0, leftmost 4 digits	
230	00 to 15	Pulse output PV 1, rightmost 4 digits	
231	00 to 15	Pulse output PV 1, leftmost 4 digits	
252	04	Pulse output 0 PV reset	Clears PV 0 when C
	05	Pulse output 1 PV reset	Clears PV 1 when C
AR 11	12	Pulse output 0 PV overflow/underflow	ON: Occurred OFF: Normal
	13	Number of pulses set for pulse output 0	ON: Set (by PULS(6 OFF: Not set
	14	Pulse output completed for pulse output 0	ON: Completed (by SPED(64)) OFF: Not completed
	15	Pulse output in progress for pulse output 0	ON: In progress (by SPED(64)) OFF: Stopped
AR 12	12	Pulse output 1 PV overflow/underflow	ON: Occurred OFF: Normal
	13	Number of pulses set for pulse output 1	ON: Set (by PULS(6 OFF: Not set
	14	Pulse output completed for pulse output 1	ON: Completed (by SPED(64)) OFF: Not completed
	15	Pulse output in progress for pulse output 0	ON: In progress (by SPED(64)) OFF: Stopped

Set Number of Pulses

Specify the number of pulses to be output in independent mode.

(@)PULS(65)	
P	Port specifier (000: Pulse output 0; 010: Pulse output 1)
D	Type of Pulse Output (000: Relative pulses; 001: Absolute pulses) (See note.)
N	Beginning word of setting for number of pulses

N	Rightmost 4 digits	Number of pulses (Rightmost, leftmost digits)
---	--------------------	---

N+1	Leftmost 4 digits	Register the number of pulses to be set. 96,777,215 to 16,777,215 Negative numbers are expressed by turning ON the leftmost bit.
-----	-------------------	--

Type of Pulse Output

000: Relative pulses (SV for number of pulses = Number of pulses moved)

001: Absolute pulses (SV for number of pulses = The next PV on the absolute coordinate system, i.e., the pulse output PV + number of pulses moved)*

*Absolute pulses can only be specified by PULS(65) when the PV coordinate system in the PC Setup is set for an absolute coordinate system.

Set Frequency and Start Pulse Outputs

Change Frequency

These functions set the pulse output number, the output mode, and the frequency.

pulse outputs are already in progress.

(@)SPED(64)		
	P	Port specifier (000: Pulse output 0; 010: Pulse output 1)
	M	Mode designation (000: Independent; 001: Continuous)
	F	Target frequency data word

F	Target frequency
---	------------------

Register the target frequency data to be set.
 #0001 to #1000 (4 digits BCD): 10 Hz to 10 kHz
 #0000: Pulse output stopped

Change Pulse Output PV

Resetting Pulse Output PV

This function changes the pulse output present value (PV). The PV can also be cleared by using SR 25204 and SR 25205.

(@)INI(61)		
	P	Port specifier (000: Pulse output 0; 010: Pulse output 1)
	004	Control designation (004: Change pulse output PV)
	C ₂	Beginning word for PV change data

C ₂	Rightmost 4 digits	Change PV data (Rightmost, leftmost digits)
----------------	--------------------	---

C ₂ +1	Leftmost 4 digits	Register the PV data to be changed.
-------------------	-------------------	-------------------------------------

96,777,215 to 16,777,215

Negative numbers are expressed by turning ON the leftmost bit.

The pulse output PV can only be changed or reset while pulse outputs stopped. Check to be sure that the Pulse Output In Progress Flags (AR 1115 AR 1215) have been turned OFF.

Stop Pulse Outputs

This function stops the pulse outputs.

Using SPED(64)

(@)SPED(64)		
	P	Port specifier (000: Pulse output 0; 010: Pulse output 1)
	M	Mode designation (000: Independent; 001: Continuous)
	F	Target frequency data word

F	#0000	Specifies a frequency of 0 Hz.
---	-------	--------------------------------

Using INI(61)

(@)INI(61)		
	P	Port specifier (000: Pulse output 0; 010: Pulse output 1)
	003	Control designation (003: Stop pulse outputs)
	000	Fixed: 000

Besides executing the instructions shown above, it is also possible to stop pulse outputs by stopping operation (PROGRAM mode).

Read Pulse Output PV

This function reads the pulse output PV.

(@)PRV(62)	
P	Port specifier (000: Pulse output 0; 010: Pulse output 1)
003	Control designation (003: Read pulse output PV)
D	Beginning word for storing pulse output PV

D	Rightmost 4 digits	Pulse output PV (rightmost, leftmost digits) The PV data that is read is stored here. 96,777,215 to 16,777,215
D+1	Leftmost 4 digits	Negative numbers are expressed by turning ON the leftmost bit.

Using Data Areas

As shown in the following illustration, the pulse output PV for pulse output 0 is stored in words 228 and 229, and the pulse output PV for pulse output 1 is stored in words 230 and 231.

Pulse Output 0		Pulse Output 1	
Word 228	PV (Rightmost)	Word 230	PV (Rightmost)
Word 229	PV (Leftmost)	Word 231	PV (Leftmost)

Words 228 to 231 are refreshed with every scan, so there may be a discrepancy from the exact PV at any given time.

Words 228 to 231 cannot be used as work words even when pulse outputs are not being used.

When the PV is read by executing PRV(62), words 228 to 231 are refreshed at the same timing.

Read Pulse Output Status

This function reads the pulse output status.

Using an Instruction

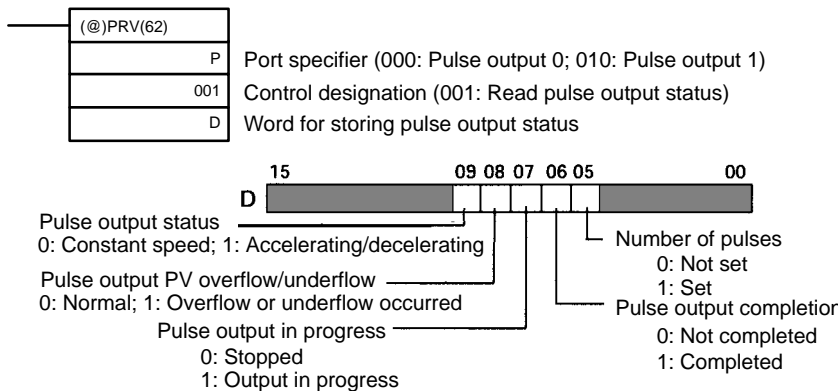

Using Data Areas

As shown in the following illustration, the pulse output status for pulse output 0 is stored in AR 11, and the pulse output status for pulse output 1 is stored in AR 12.

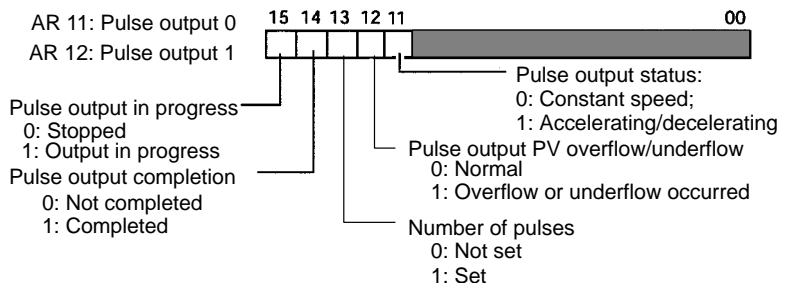

these words may not reflect the actual status during each cycle, but the next
 AR 11 and AR 12 are refreshed when the status is read with PRV(62).

Relationship Between Status and Operation

Independent Mode (Without Acceleration and Deceleration)

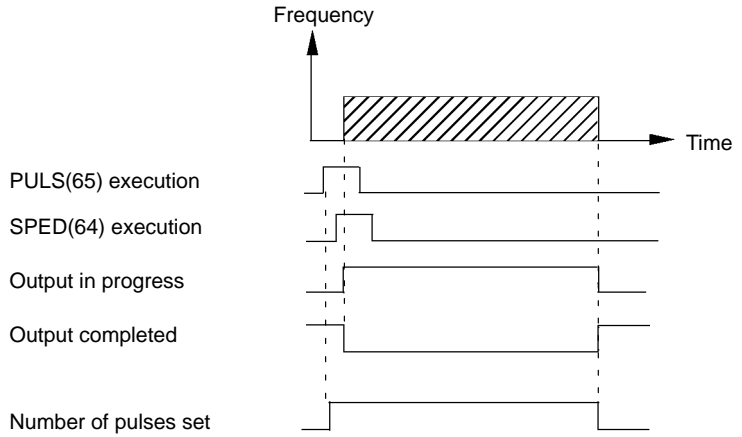

Continuous Mode

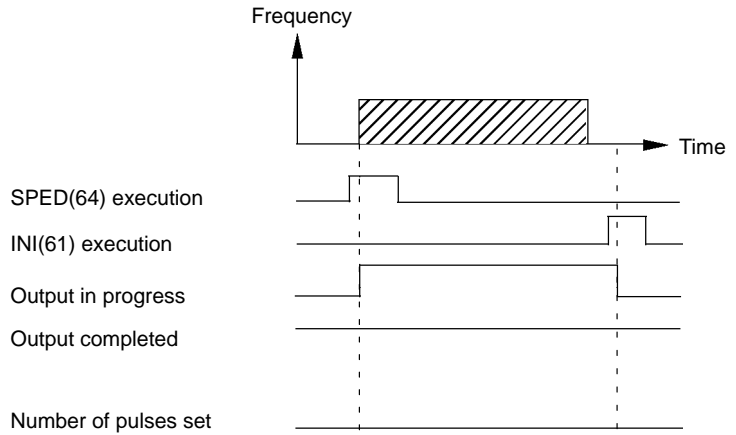

Clipping Output in Independent Mode (Without Acceleration and Deceleration)

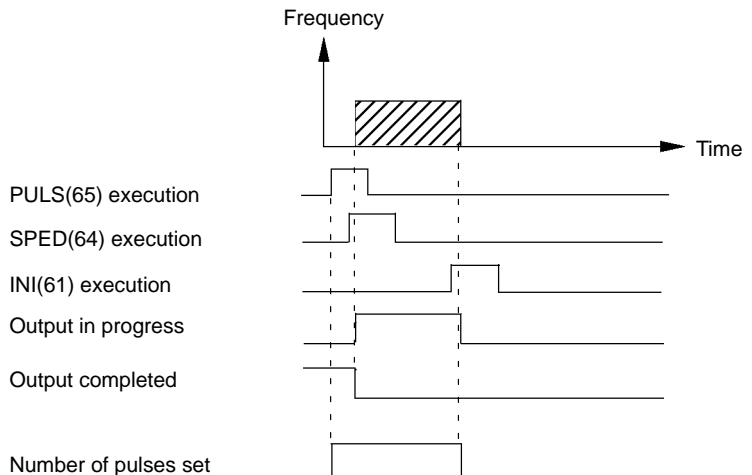

Explanation

In this example, when the execution condition (00005) turns ON, 100 pulses output from output 01000 (pulse output 0) at a frequency of 60 Hz.

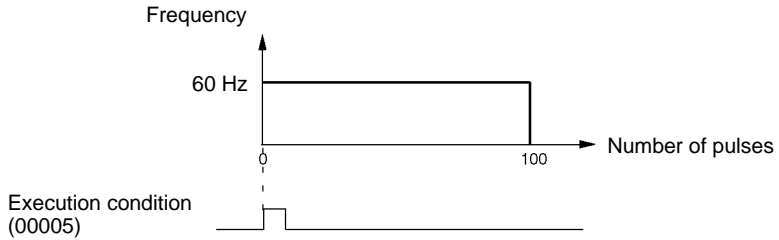

Wiring

Wire the CPM2A to the motor driver as shown in the following illustration.

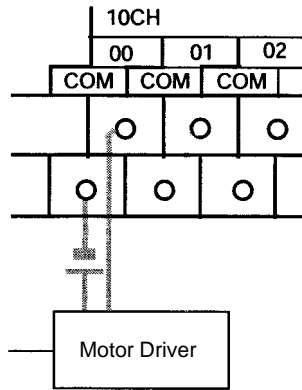

Wire the CPM2C to the motor driver as shown in the following illustration. In case, a CPU Unit with sinking transistor outputs is used.

Note The following examples are for Fujitsu-compatible connectors. Output bit addresses and connector pin numbers depend on the models. Refer to the *CPM2A Operation Manual (W356)* or the *CPM2C-S Operation Manual (W377)* for details.

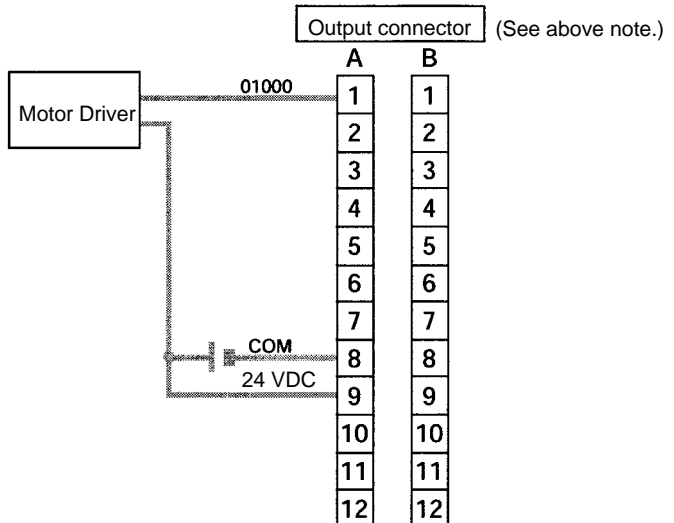

15 0

DM 6629

			0
--	--	--	---

 Sets the coordinate system for pulse output 0 as relative.

DM 6642

0	0		
---	---	--	--

 Set for other than synchronized pulse control.
(Set to 01□□ when using the high-speed counter.)

Programming

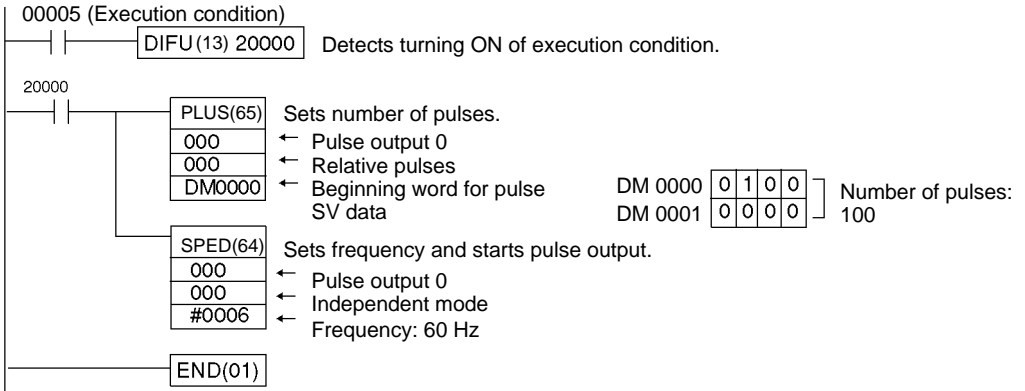

3 Operation

Explanation

In this example, when the execution condition (00005) turns ON, JOG pulses output at a frequency of 100 Hz from either output 01000 (pulse output 0) or output 01001 (pulse output 1). When the execution condition (00005) turns OFF, the output is stopped. Switching between output 01000 (pulse output 0) and output 01001 (pulse output 1) is performed by means of the direction designator (00006).

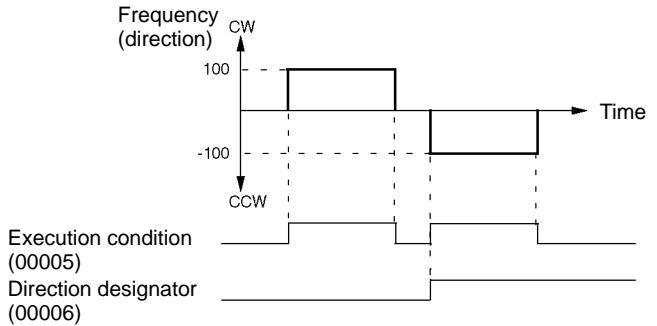

Wiring

Wire the CPM2A to the motor driver as shown in the following illustration.

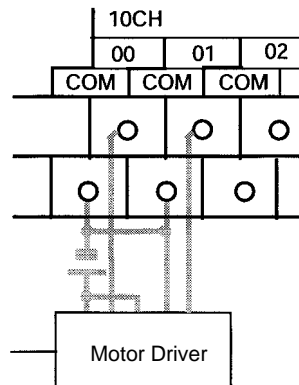

base, a CPU Unit with sinking transistor outputs is used.

Note The following examples are for Fujitsu-compatible connectors. Output bit addresses and connector pin numbers depend on the models. Refer to the *CPM1C Operation Manual (W356)* or the *CPM2C-S Operation Manual (W377)* for details.

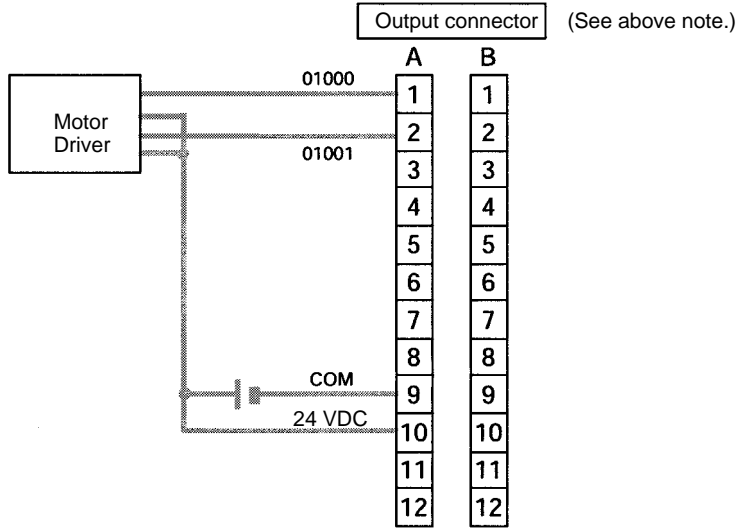

Note Refer to page operation manual for details on wiring outputs.

PC Setup

DM 6629

15			0
		0	0

 Sets the coordinate system for pulse outputs 0 and 1 as relative.

DM 6642

0	0		
---	---	--	--

 Set for other than synchronized pulse control.
(Set to 01□□ when using the high-speed counter.)

Programming

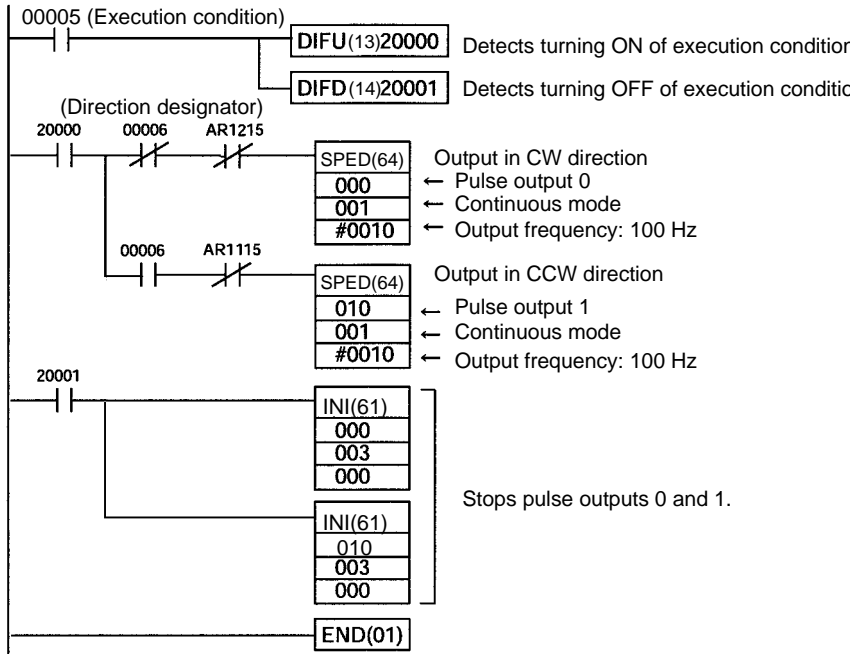

Select the pulse output number.

Pulse output number 0 or 1

Wire the outputs.

Output numbers: 01000 and 01001

Create a ladder diagram program.

PWM(—): For setting the frequency and duty ratio
 INI(61): For stopping pulse outputs.
 PRV(62): For reading the pulse output status.

Pulse Outputs With Variable Duty Ratio

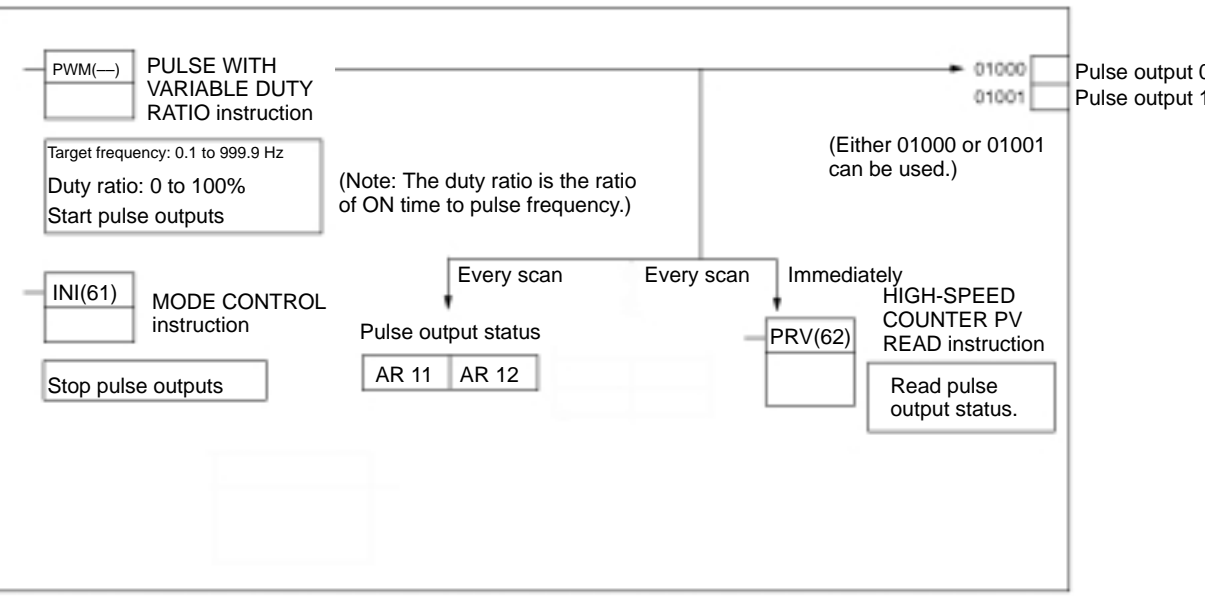

Selecting the Pulse Output Number

Select either pulse output 0 or 1.

Output number	Pulse output number
01000	0
01001	1

Wiring the Outputs

Wire the CPM2A outputs as shown in the following illustration. (Pulses can be output independently from pulse outputs 0 and 1.)

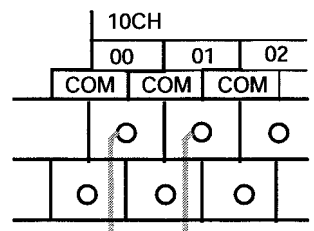

Output 01000: Pulse output 0 (single-phase output)
 Output 01001: Pulse output 1 (single-phase output)

Wire the CPM2C outputs as shown in the following illustration. (Pulses can be output independently from pulse outputs 0 and 1.)

addresses and connector pin numbers depend on the model. Refer to the *CPM2C-S Operation Manual (W356)* or the *CPM2C-S Operation Manual (W377)* for details.

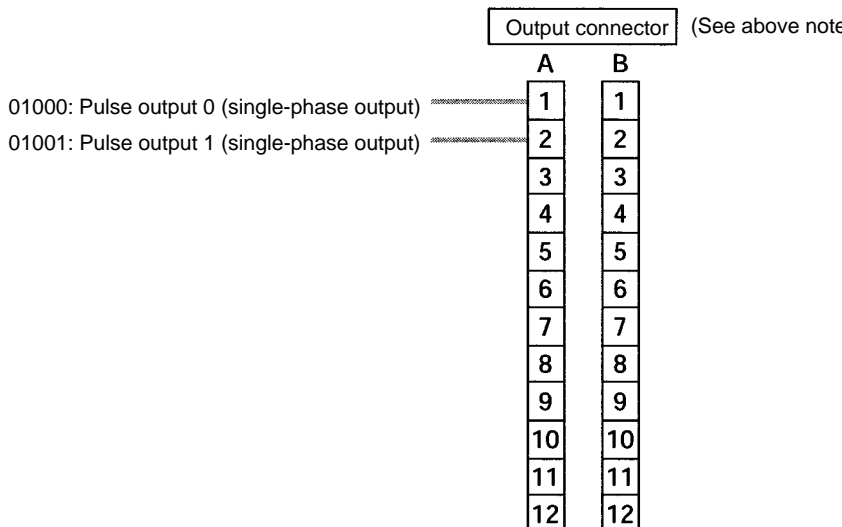

Setup

Make the following settings in the PC Setup.

Word	Bits	Function		Setting
DM 6642	08 to 15	High-speed counter setting	00: Do not use. 01: Use as high-speed counter 02: Use as synchronized pulse control (10 to 500 Hz). 03: Use as synchronized pulse control (20 Hz to 1 kHz). 04: Use as synchronized pulse control (300 Hz to 20 kHz).	Either 00 or 01

Synchronized pulse control cannot be used simultaneously.

The settings will go into effect when the mode is changed (from PROGRAM MONITOR/RUN) or when the power supply is turned ON to the PC.

Parameter Diagram Programming

The following table shows the instruction operations related to pulse outputs with variable duty ratio.

Instruction	Control	Operation
(@)PWM(—)	Pulse output with variable duty ratio	Sets the frequency and duty ratio and starts the pulse outputs.
	Change duty ratio	Changes the duty ratio during pulse outputs while pulse outputs with variable duty ratio are already in progress.
(@)INI(61)	Stop pulse outputs	Stops the pulse outputs.
(@)PRV(62)	Read pulse output status	Reads the pulse output status (during pulse outputs).

The following table shows which instructions can be executed during pulse outputs without acceleration and deceleration.

PULS(65)	SPED(64)	INI(61)	PRV(62)	ACC(—)	PWM(—)
No	No	Yes (See note 1.)	Yes	No	Yes (See note 2.)

- Note**
1. This instruction can be used only for stopping pulse outputs.
 2. This instruction can be used only for changing the duty ratio. The frequency cannot be changed while pulses are being output. If the frequency needs to be changed, be sure to stop the pulse output first.

able duty ratio.

Word	Bit	Name	Contents
AR 11	15	Pulse output in progress for pulse output 0	ON: In progress (by SPED(64), ACC(—), or PWM(—)) OFF: Stopped
AR 12	15	Pulse output in progress for pulse output 1	ON: In progress (by SPED(64), ACC(—), or PWM(—)) OFF: Stopped

Pulse Output With Variable Duty Ratio

Change Duty Ratio

These functions set the position for outputting pulses (01000, 01001), the frequency, and the duty ratio, and start the pulse outputs. By changing the duty setting and executing PWM(—) again, it is also possible to change the duty while pulse outputs with variable duty ratio are already in progress.

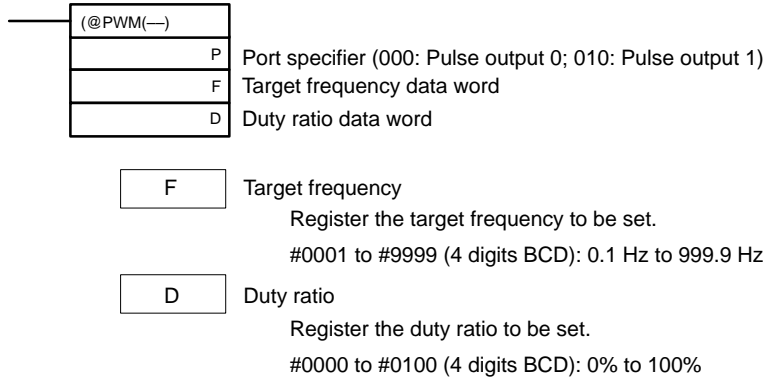

The pulse frequency cannot be changed while pulses are being output.

Stop Pulse Outputs

This function stops pulse outputs.

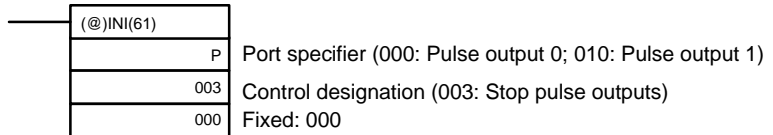

Note The pulse outputs can also be stopped by switching the PC to PROGRAM mode.

Read Pulse Output Status

This function reads the pulse output status.

Using an Instruction

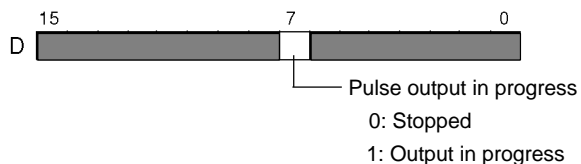
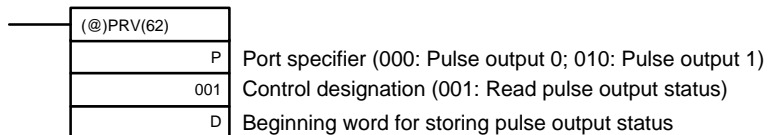

As shown in the following illustration, the pulse output status for pulse output 0 is stored in AR 1115, and the pulse output status for pulse output 1 is stored in AR 1215.

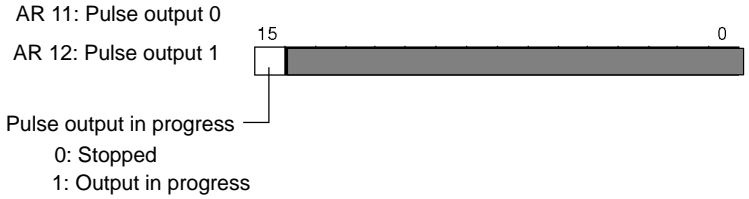

Note AR 1115 and AR 1215 are refreshed once each cycle, so the values in the words may not reflect the actual status during each cycle, but AR 1115 and AR 1215 are refreshed when the status is read with PRV(62).

Relationship Between Status and Operation

Continuous Mode (Pulse Output With Variable Duty Ratio)

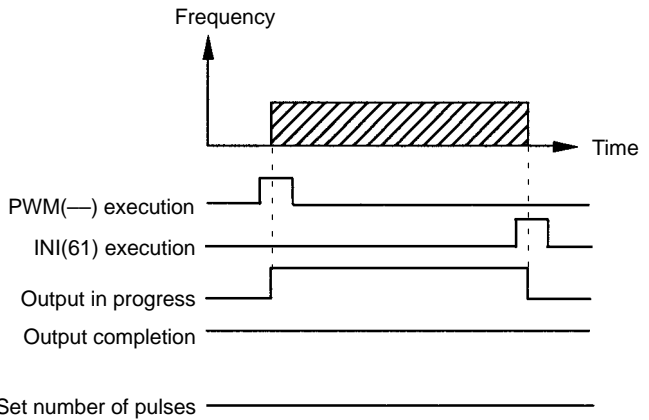

Application Example

Explanation

In this example, when the execution condition (00005) turns ON, variable pulses are output from output 01000 (pulse output 0) at a frequency of 100 Hz. The duty ratio at this time can be changed with the thumbwheel switch 0.

Wiring

Wire the CPM2A to the motor driver and thumbwheel switch as shown in the following illustration.

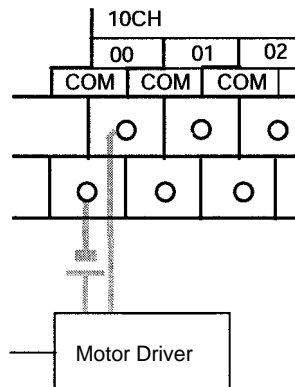

Wire the CPM2C to the motor driver and thumbwheel switch as shown in the following illustration. In this case, a CPU Unit with sinking transistor output is used.

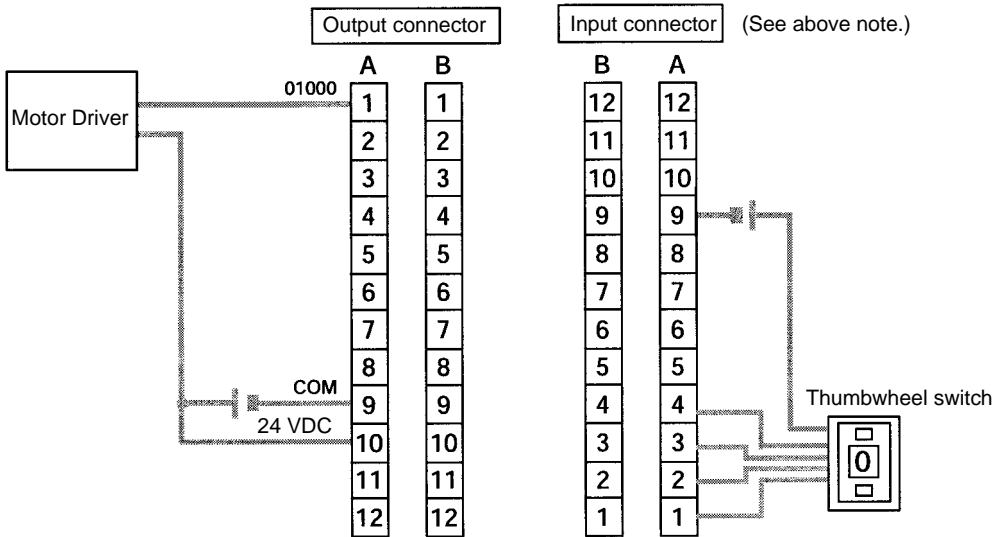

Note Refer to the operation manual for details on wiring.

PC Setup

DM 6642

15	0	0	0
----	---	---	---

 High-speed counter not used.
(Set for other than synchronized pulse control.)

Programming (CPM2A Example)

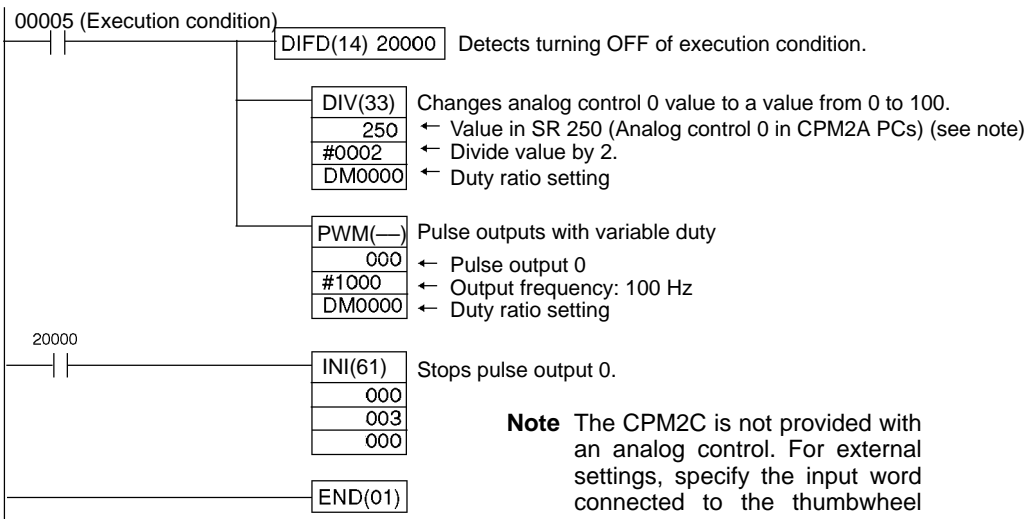

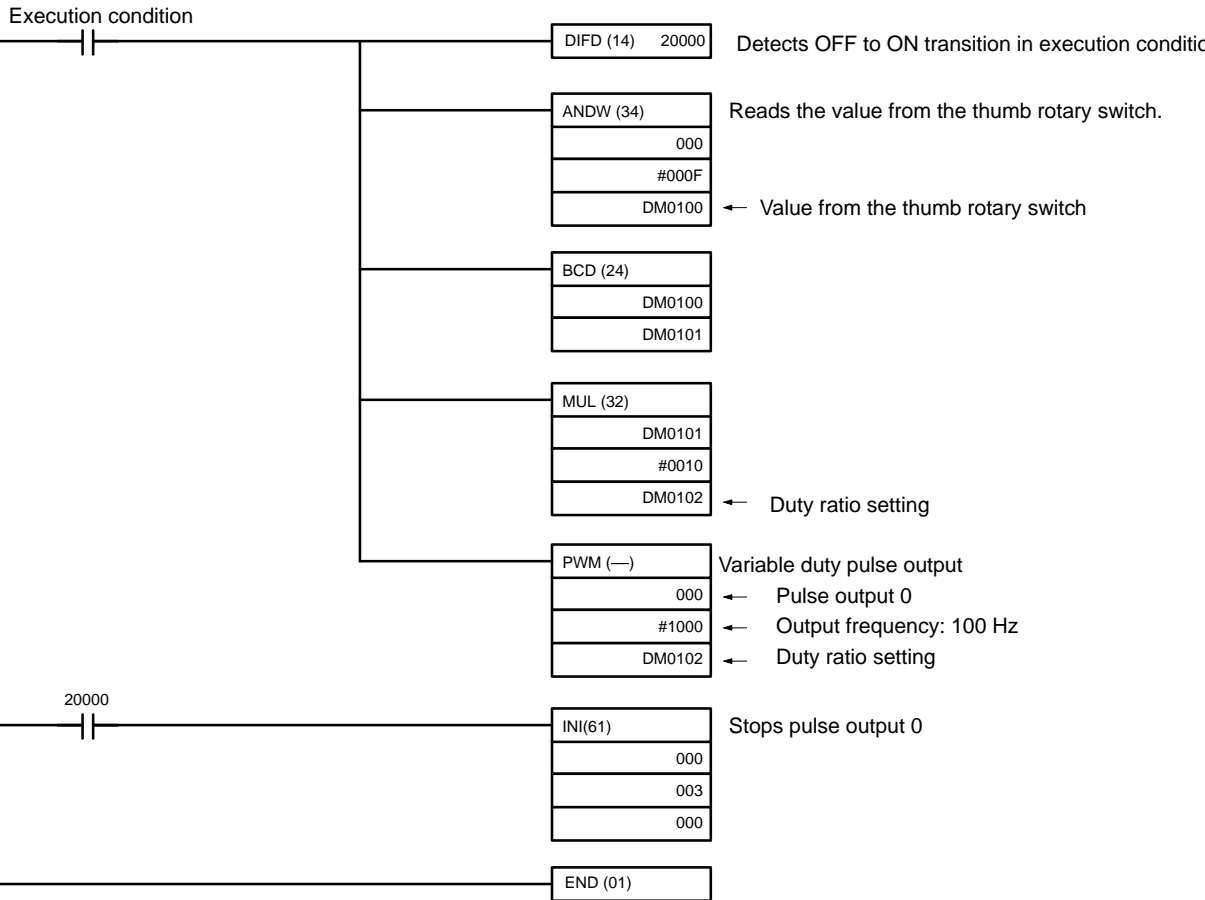

Deceleration

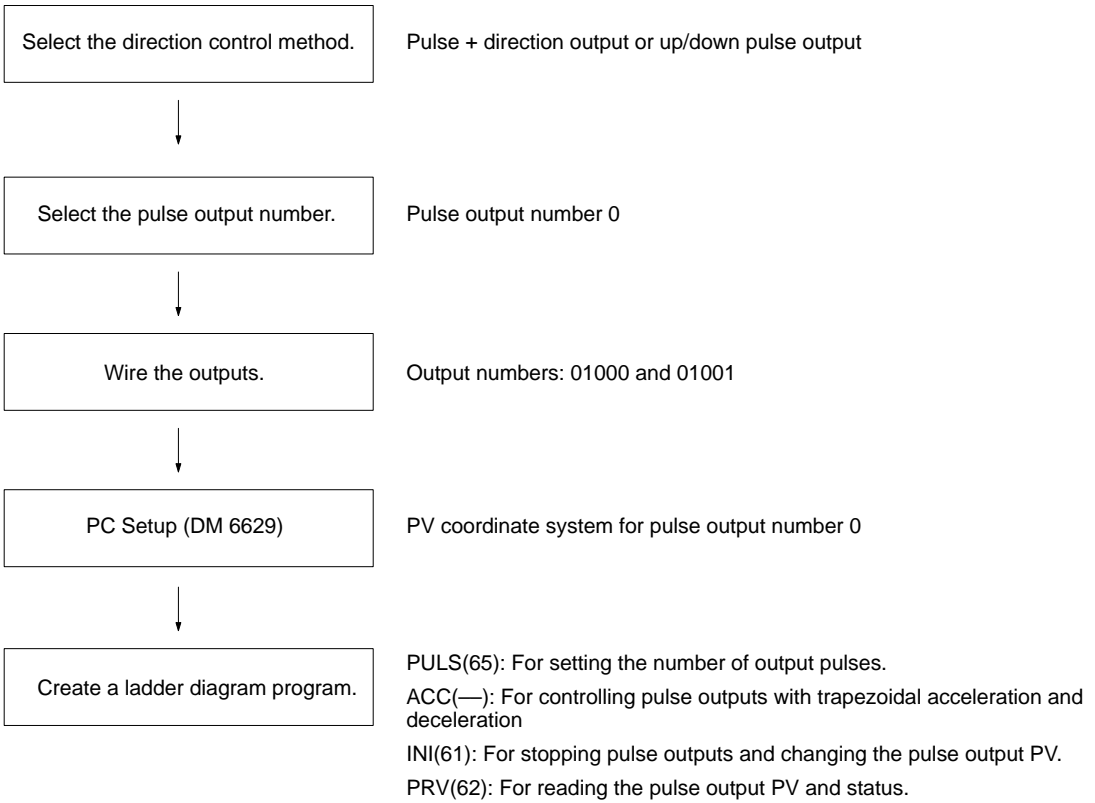

Pulse Outputs With Trapezoidal Acceleration and Deceleration

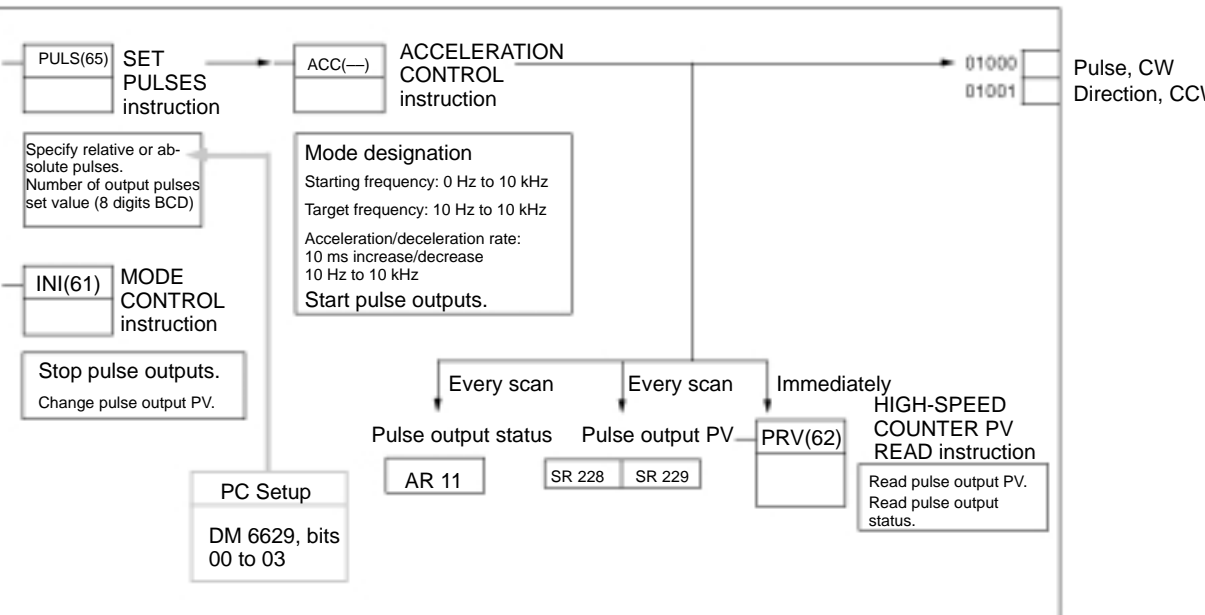

used.

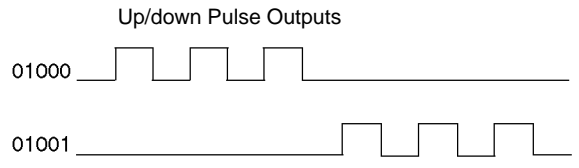
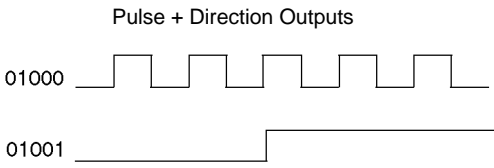

Selecting the Pulse Output Number

Select pulse output 0.

Output number	Pulse output number
01000	0
01001	

Wiring the Outputs

Wire the CPM2A outputs as shown in the following illustration.

Pulse + Direction Outputs

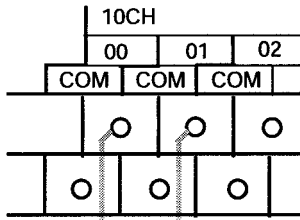

Output 01000: Pulse output
Output 01001: Direction output

Up/down Pulse Outputs

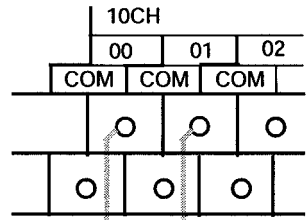

Output 01000: CW output
Output 01001: CCW output

Wire the CPM2C outputs as shown in the following illustration.

Note The following examples are for Fujitsu-compatible connectors. Output bit addresses and connector pin numbers depend on the models. Refer to the *CPM2C Operation Manual (W356)* or the *CPM2C-S Operation Manual (W377)* for details.

Pulse + Direction Outputs (See above note.)

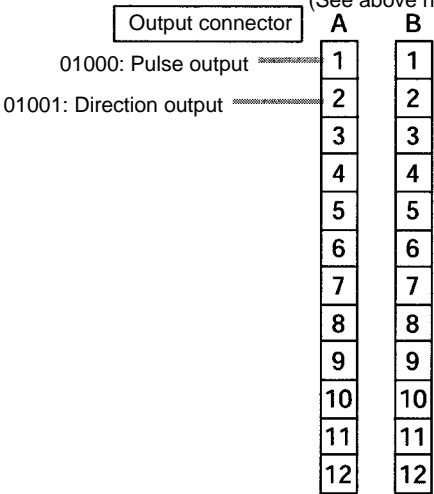

Up/down Pulse Outputs (See above note.)

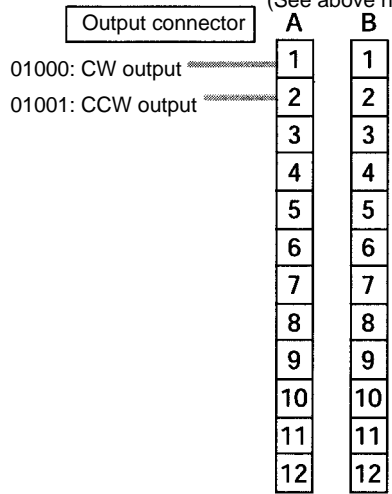

Word	Bits		Function	Setting
DM 6629	00 to 03	Pulse 0 PV coordinate system	0: Relative coordinate system 1: Absolute coordinate system	Either 0 or 1
DM 6642	08 to 15	High-speed counter setting	00: Do not use. 01: Use as high-speed counter 02: Use as synchronized pulse control (10 to 500 Hz). 03: Use as synchronized pulse control (20 Hz to 1 kHz). 04: Use as synchronized pulse control (300 Hz to 20 kHz).	Either 00 or 01

If absolute pulses are specified with PULS(65), be sure to set the absolute coordinate system (1).

Synchronized pulse control cannot be used simultaneously.

The settings will go into effect when the mode is changed (from PROGRAM MONITOR/RUN) or when the power supply is turned ON to the PC.

Parameter Diagram Programming

The following table shows the instruction operations related to pulse outputs with trapezoidal acceleration and deceleration (fixed duty ratio).

Instruction	Control	Operation
(@)PULS(65)	Set number of pulses	Sets the number of pulses to be output in independent mode.
(@)ACC(—)	Set frequency and start pulse outputs	Sets the target frequency, starting frequency, and acceleration/deceleration rate for outputs in independent mode, continuous mode, and starts the pulse outputs.
	Change frequency	Changes the frequency during pulse output in continuous mode by accelerating or decelerating according to the specified acceleration/deceleration rate.
	Stop pulse outputs	Decelerates pulse outputs to a stop according to the specified acceleration/deceleration rate.
(@)INI(61)	Stop (decelerate stop) pulse outputs	Stops the pulse outputs.
	Change pulse output PV	Changes the pulse output PV.
(@)PRV(62)	Read pulse output PV	Reads the pulse output PV.
	Read pulse output status	Reads the pulse output status.

The following table shows which instructions can be executed during pulse outputs with trapezoidal acceleration and deceleration.

	PULS(65)	SPED(64)	INI(61)	PRV(62)	ACC(—)	PWM(—)
Continuous mode	No	No	Yes (See note 1.)	Yes	No	No
Independent mode	No	No	Yes (See note 1.)	Yes	Yes (See note 2.)	No

- Note**
- This instruction can be executed only while pulse outputs are stopped. PV cannot be changed while pulses are being output. If the PV needs to be changed, be sure to stop the pulse output first.
 - This instruction can be used only for changing the frequency and stop the pulse output. It cannot be used for switching between independent mode and continuous mode. Moreover, ACC(—) cannot be received during acceleration or deceleration.

Word	Bits	Name	Contents
228	00 to 15	Pulse output PV 0, rightmost 4 digits	Cannot be used as work bits even when not used as pulse outputs.
229	00 to 15	Pulse output PV 0, leftmost 4 digits	
252	04	Pulse output 0 PV reset	Clears PV 0 when C
AR 11	11	Pulse output status for pulse output 0	ON: Accelerating or decelerating OFF: Constant speed
	12	Pulse output 0 PV overflow/underflow	ON: Occurred OFF: Normal
	13	Number of pulses set for pulse output 0	ON: Set OFF: Not set
	14	Pulse output completed for pulse output 0	ON: Completed OFF: Not completed
	15	Pulse output in progress for pulse output 0	ON: In progress (by SPED(64), ACC(—), or PWM(—)) OFF: Stopped

Set Number of Pulses

Specify the number of pulses to be output in independent mode.

(@)PULS(65)	
000	Fixed at 000: Pulse output 0
D	Type of Pulse Output (000: Relative pulses; 001: Absolute pulses) (See note.)
N	Beginning word of setting for number of pulses

N	Rightmost 4 digits	Number of pulses (Rightmost, leftmost digits)
---	--------------------	---

N+1	Leftmost 4 digits	Register the number of pulses to be set. 96,777,215 to 16,777,215 Negative numbers are expressed by turning ON the leftmost bit.
-----	-------------------	--

Type of Pulse Output

000: Relative pulses (SV for number of pulses = Number of pulses moved)

001: Absolute pulses (SV for number of pulses = The next PV on the absolute coordinate system i.e., the pulse output PV + number of pulses moved)*

*Absolute pulses can only be specified by PULS(65) when the PV coordinate system in the PC Setup is set for an absolute coordinate system.

Change Frequency

These functions set the output mode, the target frequency, the starting frequency, and the acceleration/deceleration rate, and they begin pulse outputs. They can also be used to change the frequency, by accelerating or decelerating at a specified acceleration/deceleration rate, if pulse outputs are already in progress in continuous mode.

Setting the Frequencies, Acceleration/Deceleration, and Starting Pulse Outputs in Independent Mode

(@)ACC(—)	
000	Fixed at 000: Pulse output 0
M	Output mode designation
T	Beginning word of settings table

M Output mode
Specify the output mode.
000: Up/down pulse outputs, independent mode
002: Pulse + direction outputs, independent mode

T Acceleration/deceleration rate (#0001 to #1000 BCD: 10 Hz to 10 kHz)

T+1 Target frequency (#0001 to #1000 BCD: 10 Hz to 10 kHz)

T+2 Starting frequency (#0000 to #1000 BCD: 0 to 10 kHz)

Register the data for each frequency.

The acceleration/deceleration rate is the increase or decrease in the frequency every 10 ms.

Pulse output frequency

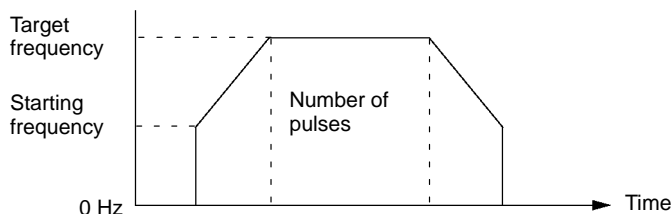

In independent mode, the acceleration and deceleration points are determined from the number of pulses, the acceleration/deceleration rate, the target frequency, and the starting frequency.

(@)ACC(—)	
000	Fixed at 000: Pulse output 0
M	Output mode designation
T	Beginning word of settings table

M Output mode

Specify the output mode.

010: Up/down pulse output, CW, continuous mode

011: Up/down pulse output, CCW, continuous mode

012: Pulse + direction output, CW, continuous mode

013: Pulse + direction output, CCW, continuous mode

T Acceleration/deceleration rate (#0001 to #1000 BCD: 10 Hz to 10 kHz)

T+1 Target frequency (#0001 to #1000 BCD: 10 Hz to 10 kHz)

T+2 Starting frequency (#0000 to #1000 BCD: 0 to 10 kHz)

Register the data for each frequency.

The acceleration/deceleration rate is the increase or decrease in the frequency every 10 ms.

Pulse output frequency

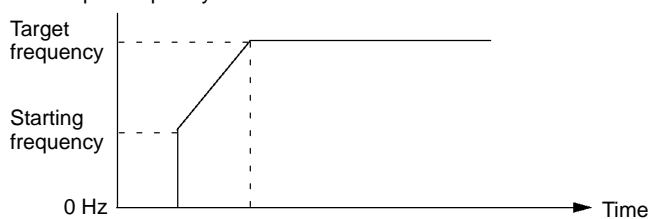

In continuous mode, pulses are output at the target frequency until stopped. The next ACC(—) instruction cannot be received except during acceleration or deceleration.

Change Pulse Output PV

This function changes the pulse output PV.

(@)INI(61)	
000	Fixed at 000: Pulse output 0
004	Control designation (004: Change pulse output PV)
C ₂	Beginning word for PV change data

C₂ Rightmost 4 digits

Change PV data (Rightmost, leftmost digits)

C₂+1 Leftmost 4 digits

Register the PV data to be changed.

96,777,215 to 16,777,215

Negative numbers are expressed by turning ON the leftmost bit.

Note The pulse output PV can be changed only while the pulse output is stopped.

Decelerate and Stop Pulse Outputs

Stop Pulse Outputs

(@)INI(61)		
	000	Fixed at 000: Pulse output 0
	003	Control designation (003: Stop pulse outputs)
	000	Fixed at 000

Decelerate Stop Pulse Outputs

(@)ACC(—)		
	000	Fixed at 000: Port specifier
	000	Mode designation
	T	Beginning word of settings table

T	Acceleration/deceleration rate (#0001 to #1000 BCD: 10 Hz to 10 kHz)
---	--

T+1	Target frequency (#0000 to #1000 BCD: 0 Hz to 10 kHz)
-----	---

T+2	Starting frequency (#0000 to #1000 BCD: 0 to 10 kHz)
-----	--

Register the data for each frequency.

The acceleration/deceleration rate is the increase or decrease in the frequency every 10 ms.

Note The pulse outputs can also be stopped by switching the PC to PROGRAM mode.

Read Pulse Output PV

This function reads the pulse output PV.

Using an Instruction

(@)PRV(62)		
	000	Fixed at 000: Pulse output 0
	003	Control designation (003: Read pulse output PV)
	D	Beginning word for storing pulse output PV

D	Rightmost 4 digits	Pulse output PV (rightmost, leftmost digits)
---	--------------------	--

D+1	Leftmost 4 digits	The PV data that is read is stored here.
-----	-------------------	--

96,777,215 to 16,777,215

Negative numbers are expressed by turning ON the leftmost bit.

Using Data Areas

As shown in the following illustration, the pulse output PV for pulse output 0 is stored in words 228 and 229.

Pulse Output 0

Word 228	PV (Rightmost)
Word 229	PV (Leftmost)

SR 228 and SR 229 are refreshed once each cycle, so the values in these words may not reflect the actual status during each cycle. SR 228 and SR 229 are refreshed immediately when their status is read with PRV(62).

SR 228 to SR 231 are refreshed with every scan, so there may be a discrepancy from the exact PV at any given time.

not being used.

When the PV is read by executing PRV(62), SR 228 to SR 231 are refreshed at the same timing.

Read Pulse Output Status

This function reads the pulse output status.

Using an Instruction

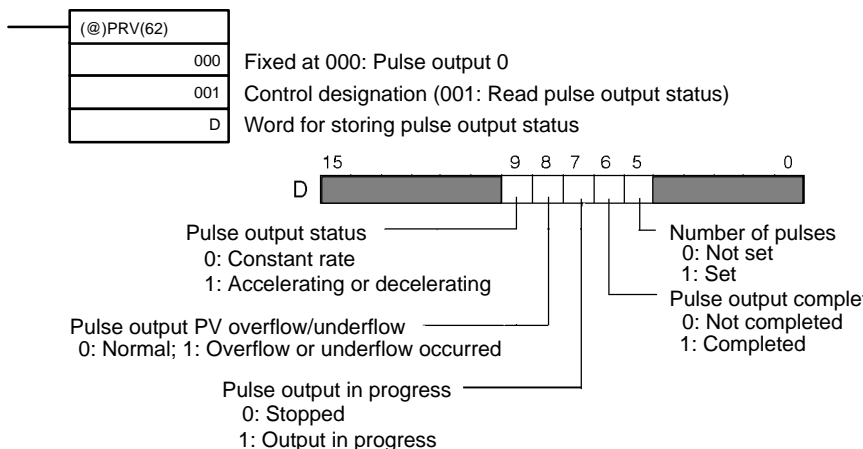

Using Data Areas

As shown in the following illustration, the pulse output status for pulse output 0 is stored in AR 1111 to AR 1115.

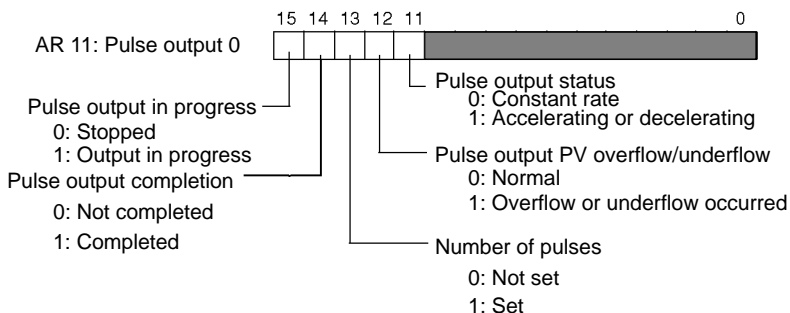

Note AR 1111 through AR 1115 are refreshed once each cycle, so the values of the flags may not reflect the actual status, but these flags are refreshed immediately when their status is read with PRV(62).

Independent Mode with Acceleration and Deceleration 1

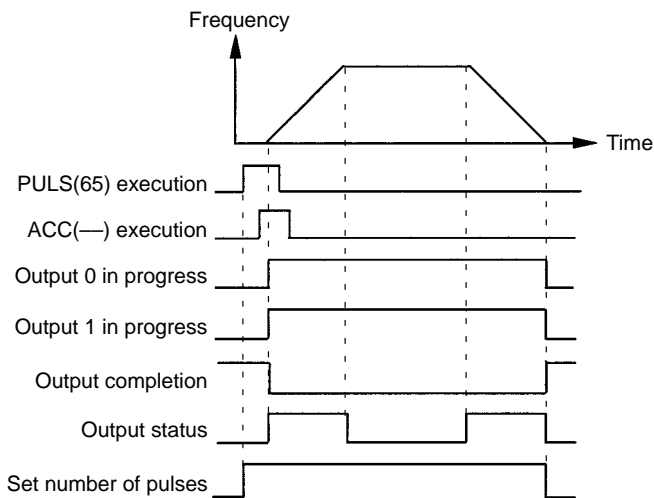

Continuous Mode with Acceleration and Deceleration 1

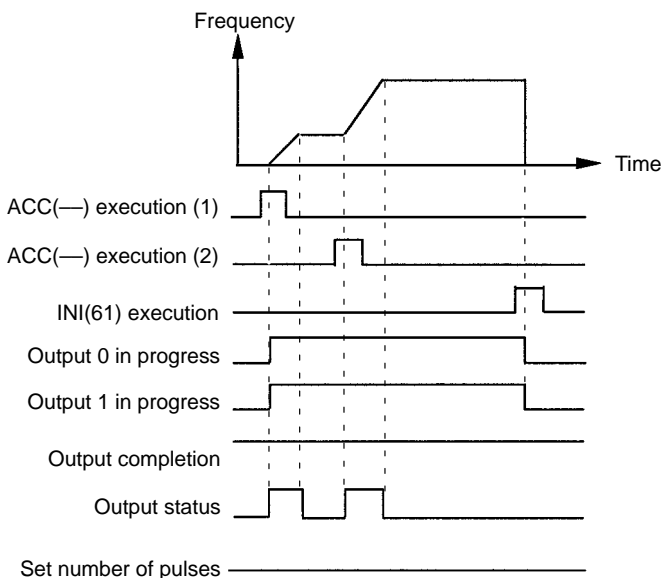

Continuous Mode with Acceleration and Deceleration 2

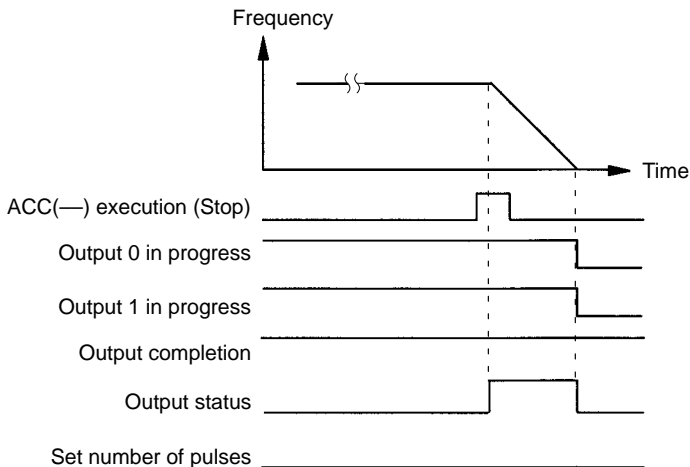

With Acceleration and Deceleration 1

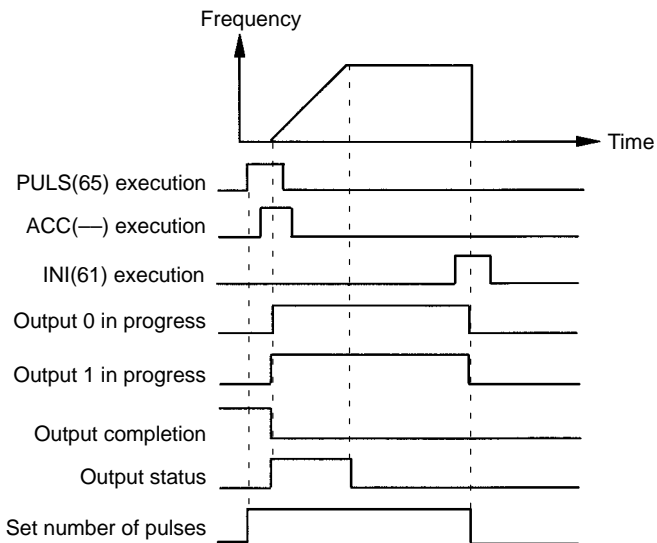

Stopping Outputs in Continuous Mode with Acceleration and Deceleration 2

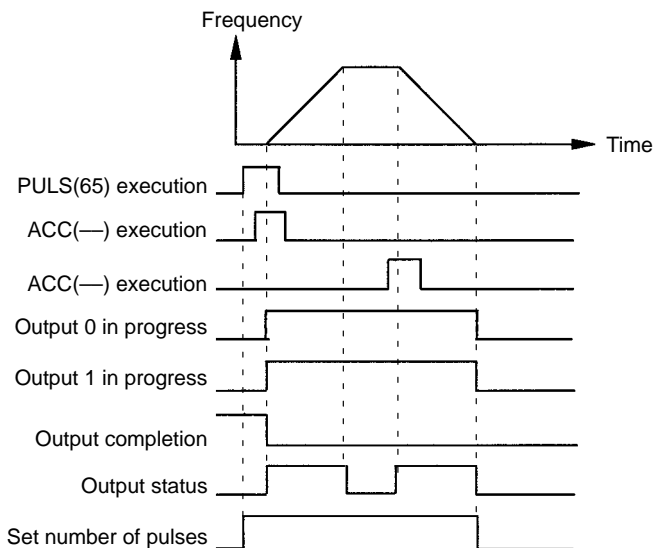

Application Example
Positioning

Explanation

In this example, when the execution condition (00005) turns ON, 1000 pulses are output from output 01000 (pulse output 0) in a trapezoidal acceleration/deceleration pattern as shown in the following diagram.

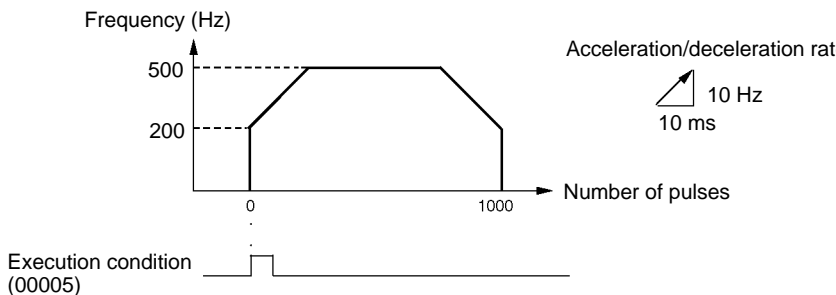

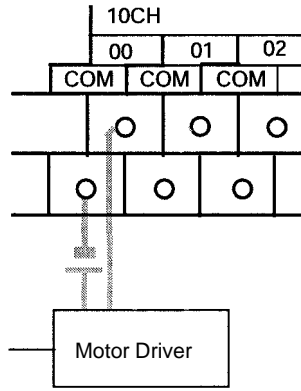

Wire the CPM2C to the motor driver as shown in the following illustration. In this case, a CPU Unit with sinking transistor outputs is used.

Note The following examples are for Fujitsu-compatible connectors. Output bit addresses and connector pin numbers depend on the models. Refer to the *CPM2C Operation Manual (W356)* or the *CPM2C-S Operation Manual (W377)* for details.

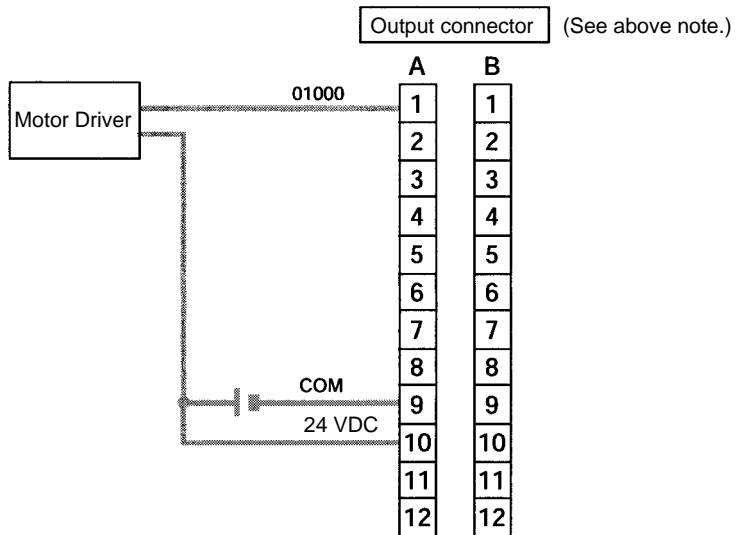

Note Refer to the operation manual for details on wiring.

PC Setup

	15	0							
DM 6629	<input type="checkbox"/>	<input type="checkbox"/>	<input type="checkbox"/>	<input type="checkbox"/>	<input type="checkbox"/>	<input type="checkbox"/>	<input type="checkbox"/>	0	Sets the coordinate system for pulse output 0 as relative.
DM 6642	<input type="checkbox"/>	<input type="checkbox"/>	<input type="checkbox"/>	<input type="checkbox"/>	<input type="checkbox"/>	<input type="checkbox"/>	<input type="checkbox"/>	<input type="checkbox"/>	High-speed counter not used. (Set for other than synchronized pulse control.)

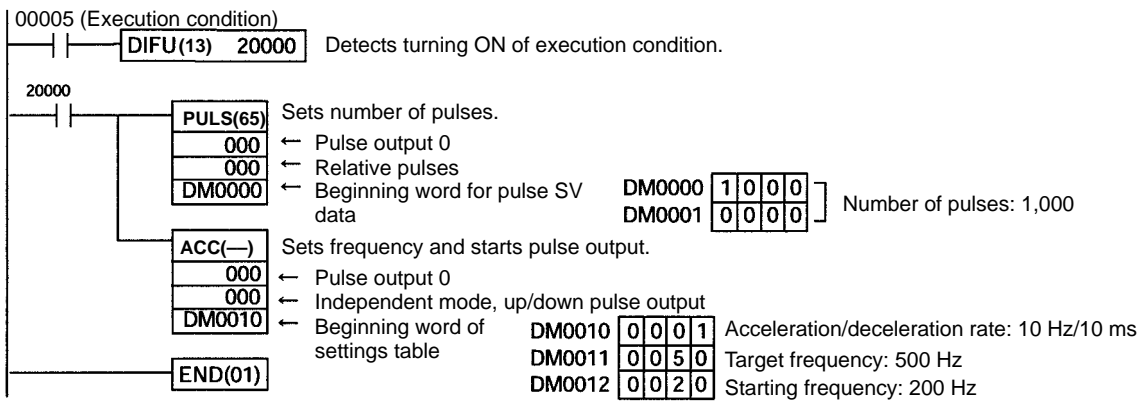

gging

Explanation

In this example, when the execution condition (00005) turns ON, JOG pulses output at a frequency of 100 Hz from either output 01000 (CW direction) or put 01001 (CCW direction). When the execution condition (00005) turns OFF, the output is stopped. As shown in the following diagram, the JOG pulses accelerated and decelerated at the start and stop of the operation. Switching between output 01000 (CW direction) and output 01001 (CCW direction) is formed by means of the direction designer (00006).

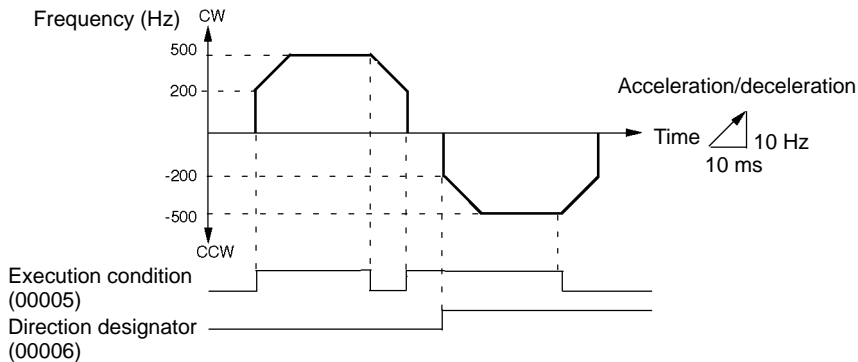

Wiring

Wire the CPM2A to the motor driver as shown in the following illustration.

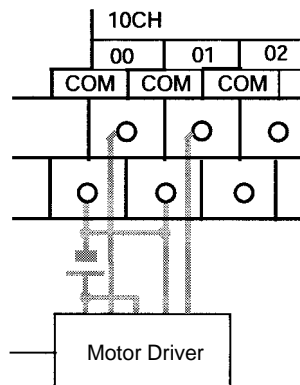

case, a C-U Unit with sinking transistor outputs is used.

Note The following examples are for Fujitsu-compatible connectors. Output bit addresses and connector pin numbers depend on the models. Refer to the *CPM1C Operation Manual (W356)* or the *CPM2C-S Operation Manual (W377)* for details.

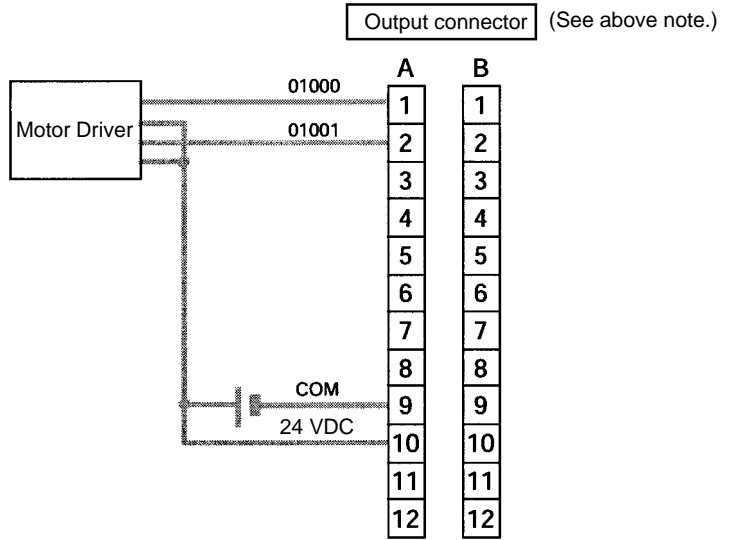

Note Refer to the operation manual for details on wiring.

PC Setup

	15		0	
DM 6629			0	Sets the coordinate system for pulse output 0 as relative.
DM 6642	0	0		High-speed counter not used. (Set for other than synchronized pulse control.)

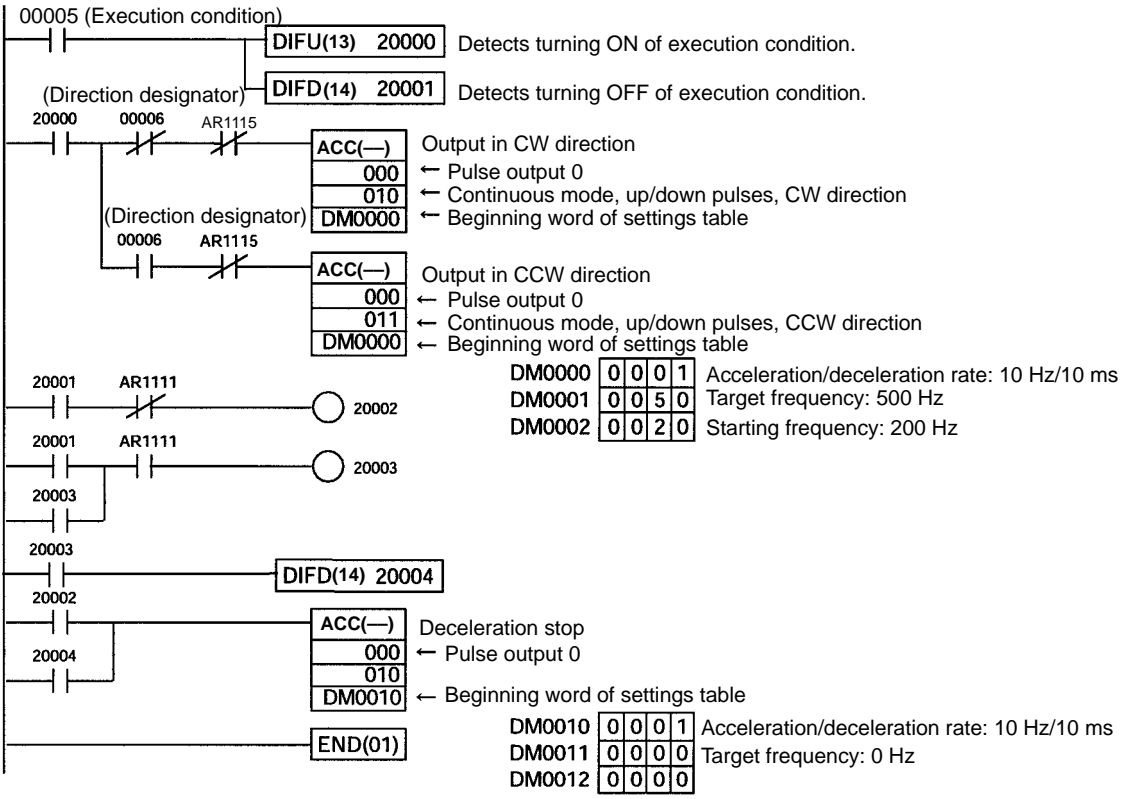

The CPM1A PCs with transistor outputs have a pulse output function capable of outputting a pulse of 20 Hz to 2 kHz (single-phase). Either IR 01000 or IR 01001 can be selected for pulse output, and the pulse output can be set to either continuous mode, under which the output can be stopped by an instruction in the independent mode, under which the output is stopped after a preset number of pulses (1 to 16,777,215).

Refer to the *CPM1A Operation Manual* for details on hardware connection, output points and ports.

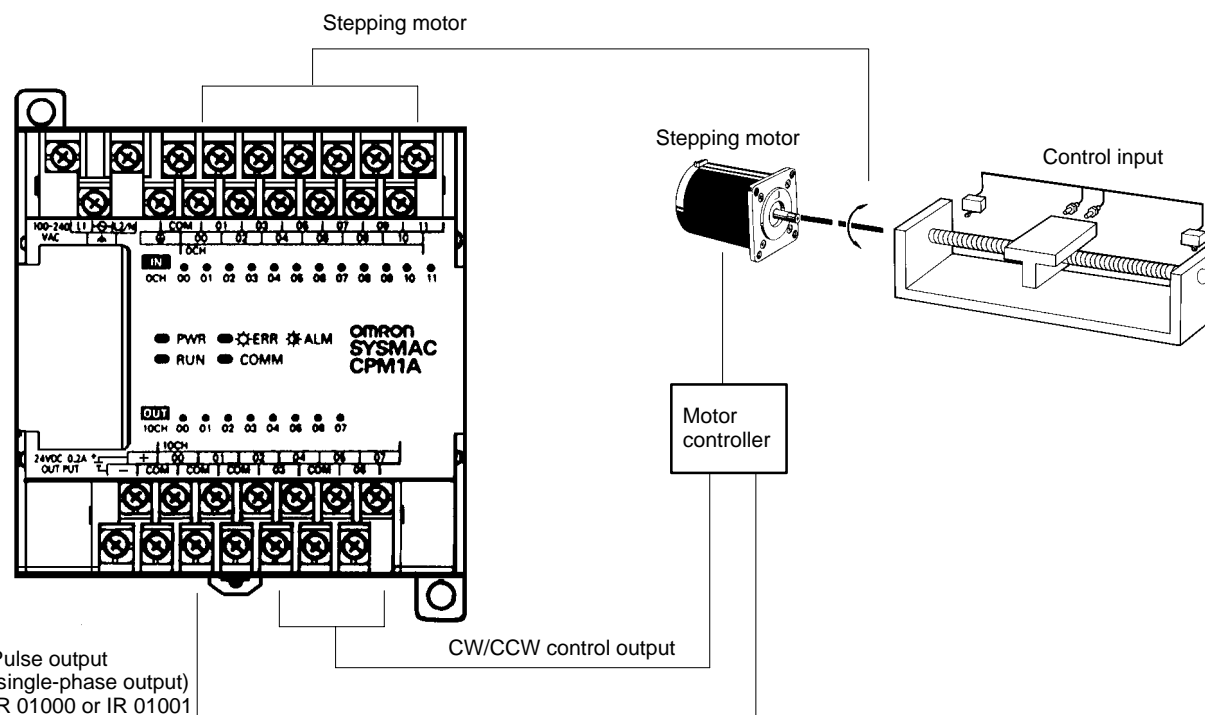
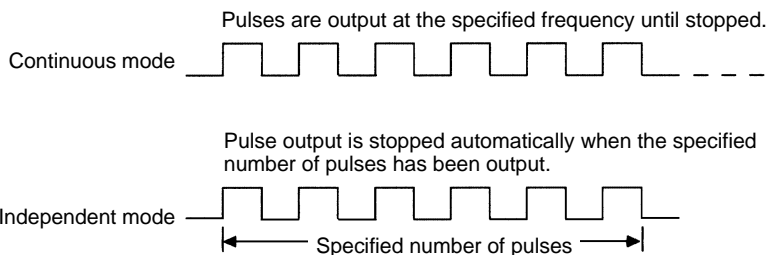

- Note**
1. The CPM1A uses a single-phase pulse output. The control signal for direction of rotation (CW/CCW) for the motor driver must be written in program.
 2. Be sure to use a CPU Unit with transistor outputs.

In this example program, pulse output begins from IR 01000 when IR 00004 turns ON, and is stopped when input IR 00005 turns ON.

SPED(64) can be used to stop pulse output. When using SPED(64) for that purpose, specify #0000 (constant or word contents) as the pulse frequency.

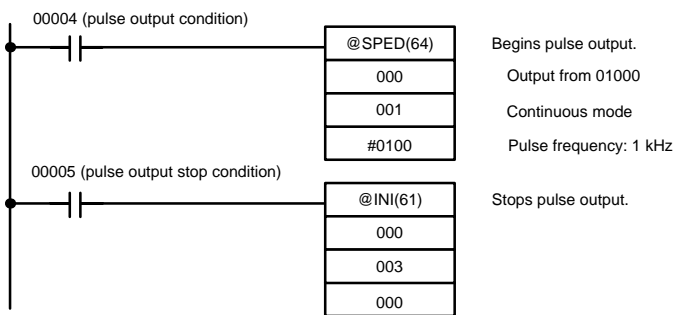

6-2 Programming Example in Independent Mode

In this example program, pulse output begins from IR 01000 when IR 00004 turns ON, and is stopped after the specified number of pulses has been output. The pulse amount is set in DM 0100 and DM 0101.

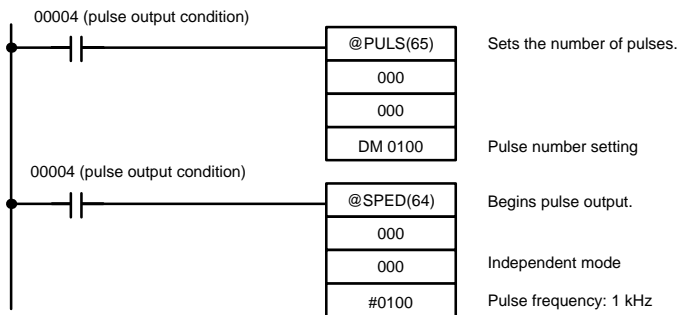

6-3 Using Pulse Output Instructions

Setting the Number of Pulses

Before beginning pulse output using the independent mode use PULS(65) shown below to set the number of pulses to be output. This setting is not required for the continuous mode.

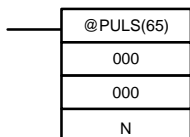

In N, set the beginning word address of the words where the number of pulses is set. Store the number of pulses in words N and N+1, in eight digits BCD, with the leftmost four digits in N+1 and the rightmost four digits in N.

Make the setting within a range of 00000001 to 16777215 (BCD).

pulse output.

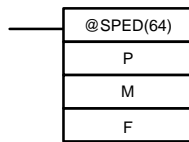

P (3 digits BCD)

000: Outputs to IR 01000

010: Outputs to IR 01001

M (3 digits BCD)

000: Independent mode

001 Continuous mode

F (4 digits BCD)

For the beginning pulse output frequency, specify constant or word contents. The specified value and frequency are as follows:

Specified value: 0002 to 0200

Set frequency: 20 to 2,000 Hz

- Note**
1. Pulses can be output from only one bit at a time.
 2. When pulse output is begun in independent mode, the number of pulses read when SPED(64) is executed. PULS(65) cannot be used to change number of pulses while pulses are being output.

2-6-4 Changing the Frequency

To change the frequency during pulse output, change the frequency setting SPED(64). At that time, set the operands other than the frequency to the same settings as at the beginning of pulse output.

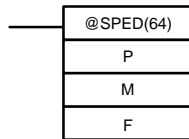

P (3 digits BCD)

Same as at beginning of pulse output.

M (3 digits BCD)

Same as at beginning of pulse output.

F (4 digits BCD)

For the changed pulse output frequency, specify constant or word contents. The specified value and frequency are as follows:

Specified value: 0002 to 0200

Set frequency: 20 to 2,000 Hz

2-6-5 Stopping Pulse Output

When pulses are output in the independent mode, the pulse output will automatically stop after the number of pulses specified with PULS(65) has been output. When pulses are output in the continuous mode, either of the following methods can be used to stop the pulse output.

1. Use SPED(64) to set the frequency to 0.
2. Use INI(61) to stop the pulse output.

ng SPED(64)

The first method is to use SPED(64) to stop the pulse output by setting the frequency to 0. For details, refer to 2-6-4 *Changing the Frequency*.

ng INI(61)

The second method is to use INI(61) to stop the pulse output, as follows:

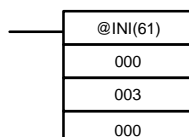

By combining the CPM2A/CPM2C's high-speed counter function with the pulse output function, the output pulse frequency can be controlled as a specified multiple of the input pulse frequency.

Note A CPU Unit with transistor outputs is required in order to use synchronized pulse output control, i.e., either a CPM2A-□□CDT-D or CPM2A-□□CDT1-D.

The following diagram shows the configuration for a CPM2A, but the configuration for a CPM2C is identical.

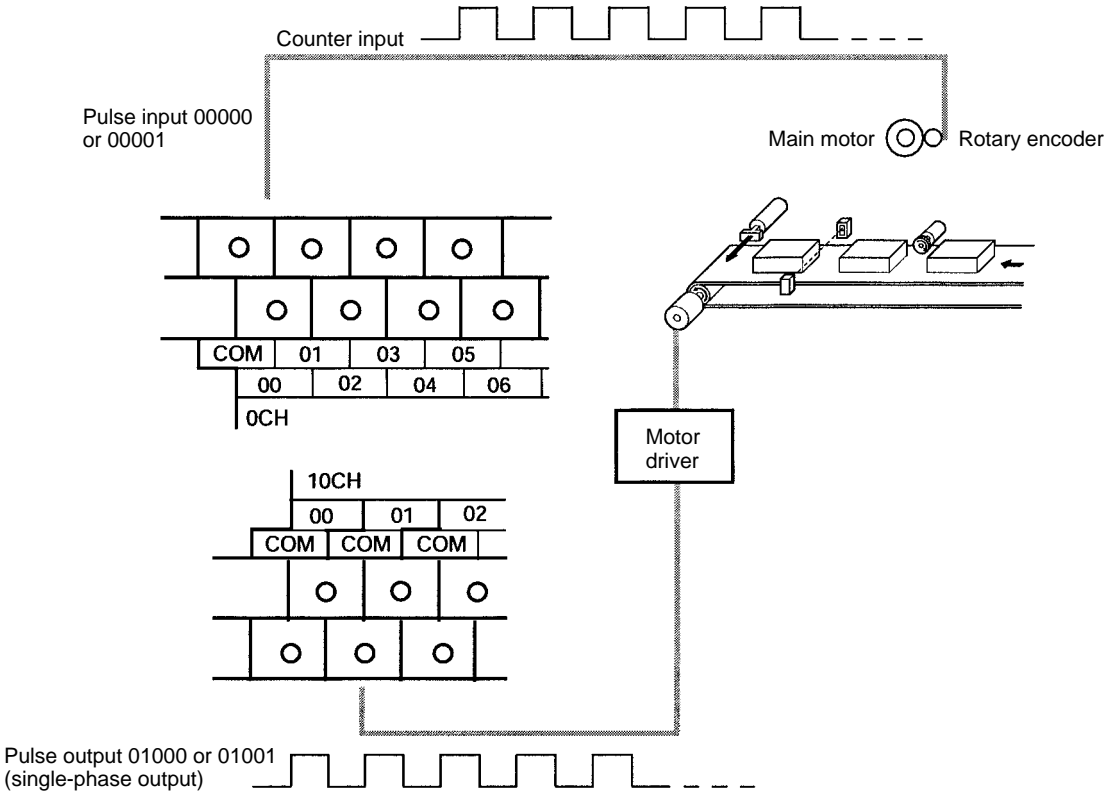

Item		Input mode			
		Differential phase input mode	Pulse + direction input mode	Up/down pulse input mode	Increment mode
Output number	00000	Phase-A input	Count input	CW input	Count input
	00001	Phase-B input	Direction input	CCW input	(See note 1.)
Output method		Differential phase input (4X)	Single-phase input	Single-phase input	Single-phase input
Output frequency range		10 to 500 Hz (accuracy ± 1 Hz) 20 Hz to 1 kHz (accuracy ± 1 Hz) 300 Hz to 20 kHz (accuracy ± 25 Hz) (See note 2.)			
Output number (See note 3.)	01000	Pulse output 0			
	01001	Pulse output 1			
Output method		Single-phase output			
Output frequency range		10 Hz to 10 kHz (accuracy 10 Hz)			
Frequency ratio		1% to 1,000% (Can be specified in units of 1%.)			
Synchronized control cycle		10 ms			

- Note**
1. Can be used as an ordinary input.
 2. When 10 kHz or less, then the accuracy is ± 10 Hz.
 3. Either can be selected as the output number, using SYNC(—).

been input is read, without regard to the direction.
 The following table shows the relationships between synchronized pulse control and the CPM2A's other functions.

Function	Synchronized pulse control
Synchronized pulse control	---
Interrupt inputs	Can be used simultaneously.
Interval timer interrupts	Can be used simultaneously.
High-speed counters	Cannot be used simultaneously.
Interrupt inputs (counter mode)	Can be used simultaneously.
Pulse outputs	Cannot be used simultaneously.
Quick-response inputs	Can be used simultaneously.
Input time constant	See note.
Clock	Can be used simultaneously.

Note When inputs 00000 and 00001 are set for use as synchronized pulse control inputs, the input time constant settings for the affected inputs are disabled. Input time constants remain in effect, however, for the values for refreshing relevant input data area.

The relationship between the pulse input frequency and the pulse output frequency is shown below.

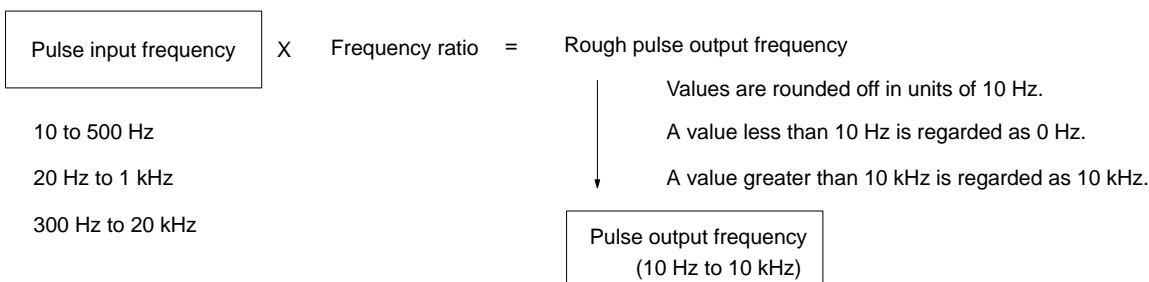

The scaling factor control cycle is 10 ms, and the pulse output frequency is changed at intervals of 10 ms with respect to the pulse input frequency.

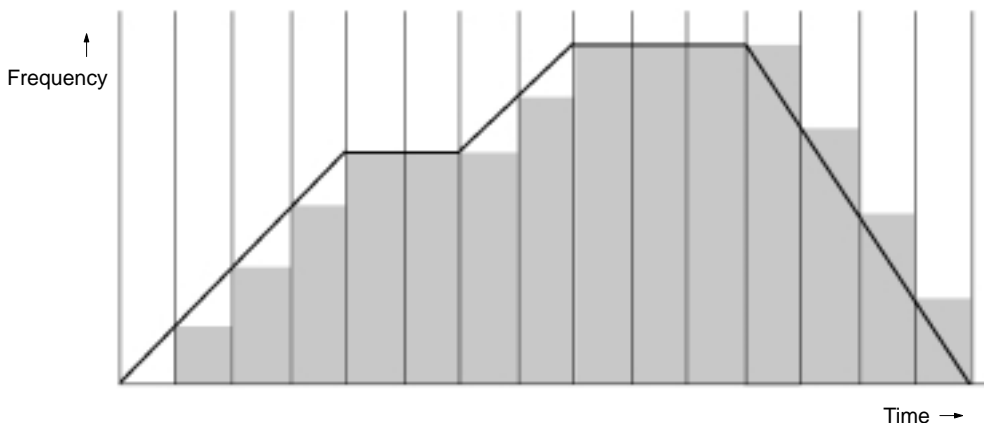

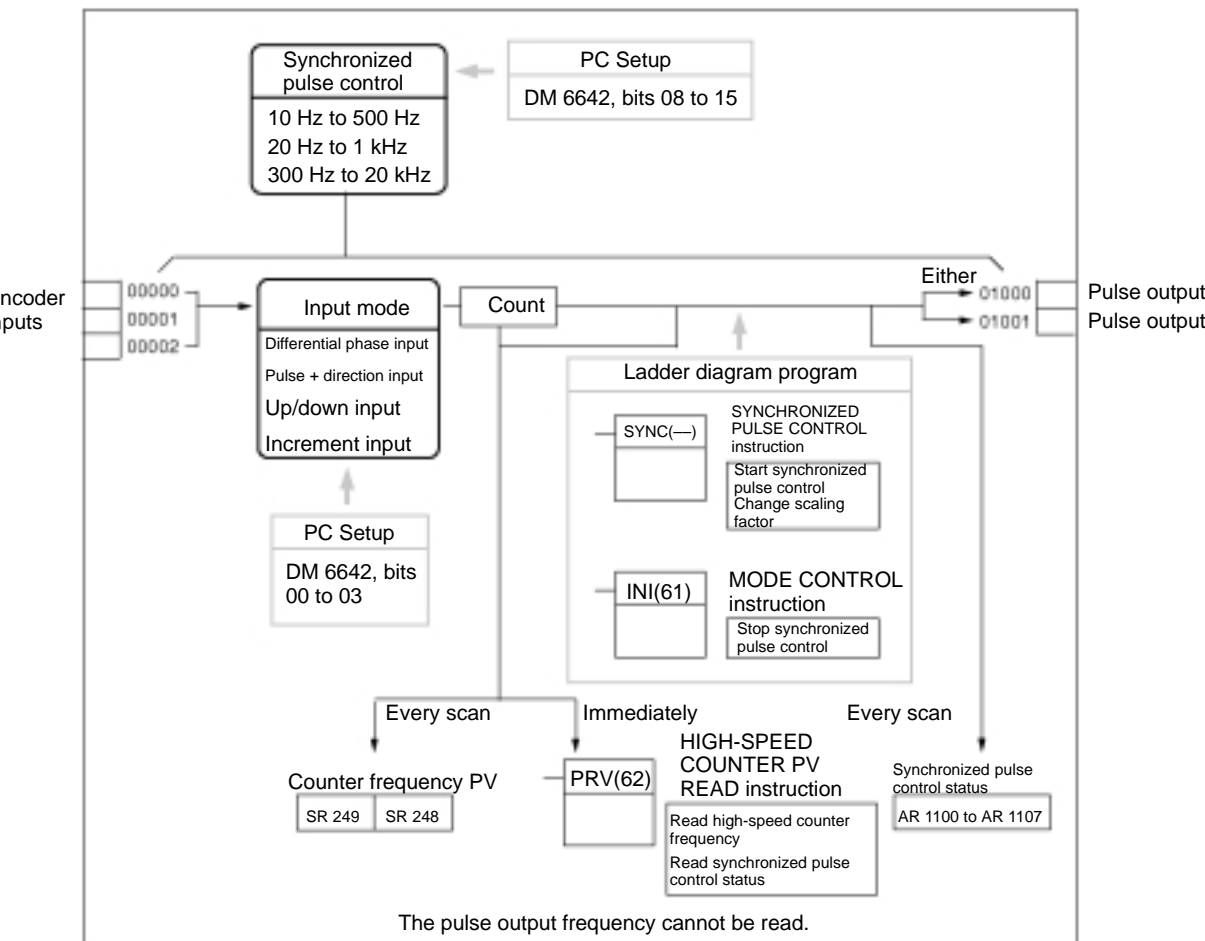
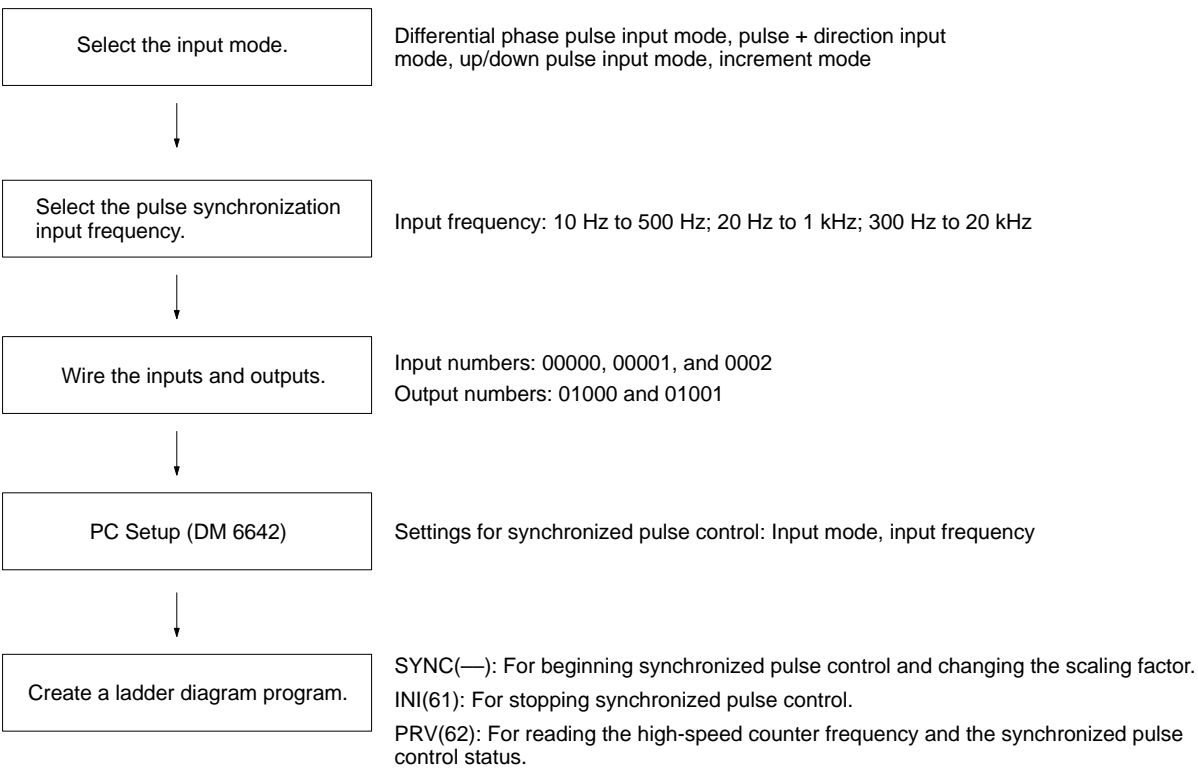

Selecting the Pulse Synchronization Input Frequency

up/down pulse input mode, or the increment mode. These modes are explained below.

Select one of the following as the input frequency range: 10 Hz to 500 Hz, 20 to 1 kHz, or 300 Hz to 20 kHz. For more information on input frequencies, refer to the following diagrams.

Differential Phase Input Mode

In the differential phase input mode, the count is incremented or decremented according to two differential phase signals (phase A and phase B) with a multiplication factor of 4.

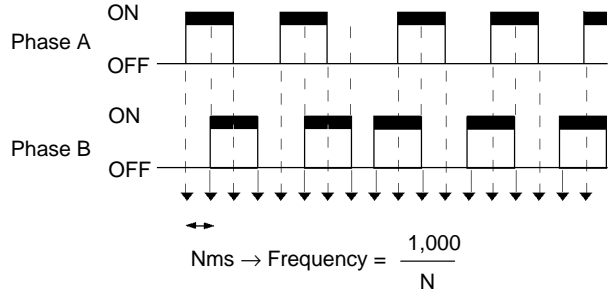

Pulse + Direction Input Mode

In the pulse + direction input mode, pulse signals and direction signals are input, and the count is incremented or decremented according to the direction signal status.

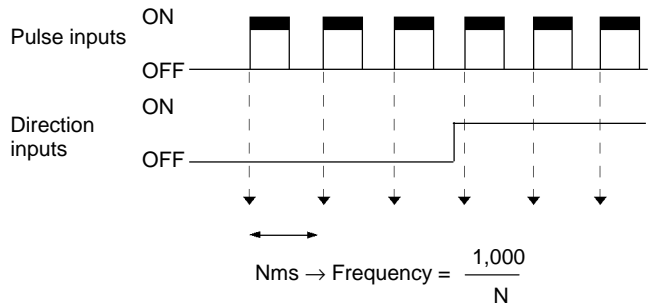

Up/Down Pulse Input Mode

In the up/down pulse input mode, CW signals (up pulses) and CCW signals (down pulses) are input, and the count is incremented or decremented accordingly.

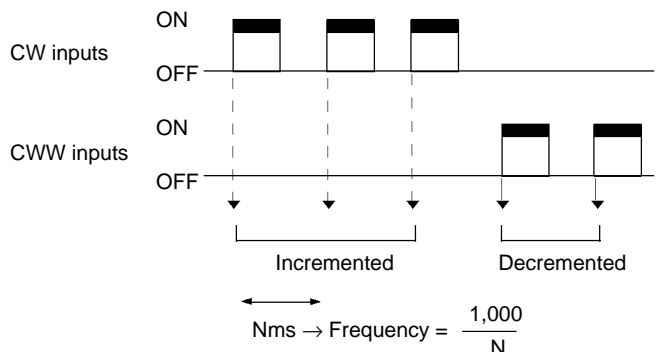

In the increment mode, pulse signals are input and the count is incremented each pulse. Phase-B inputs can be used as ordinary inputs.

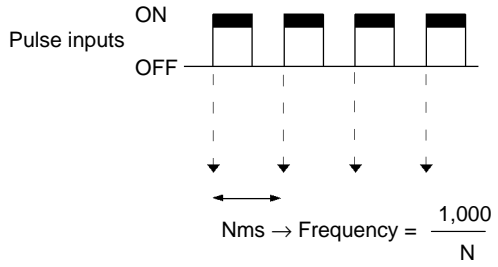

ing the Inputs

Input Wiring

Wire the CPM2A inputs as shown in the following diagram.

Differential Phase Input Mode

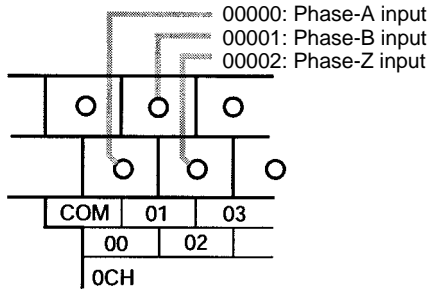

Up/Down Pulse Input Mode

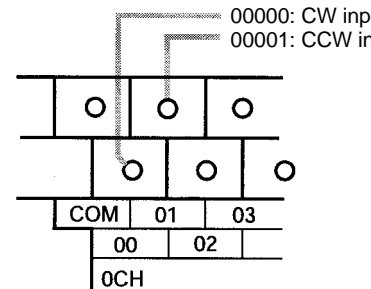

Pulse + Direction Input Mode

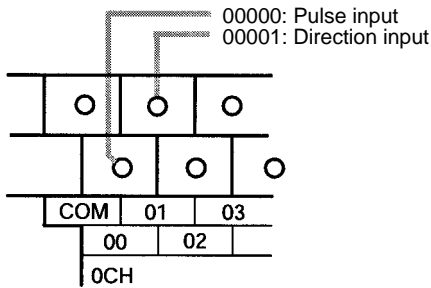

Increment Mode

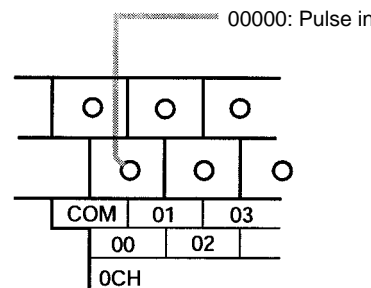

Note The following examples are for Fujitsu-compatible connectors. Input bit addresses and connector pin numbers depend on the models. Refer to the *CPM2C Operation Manual (W356)* or the *CPM2C-S Operation Manual (W377)* for tails.

Differential Phase Input Mode

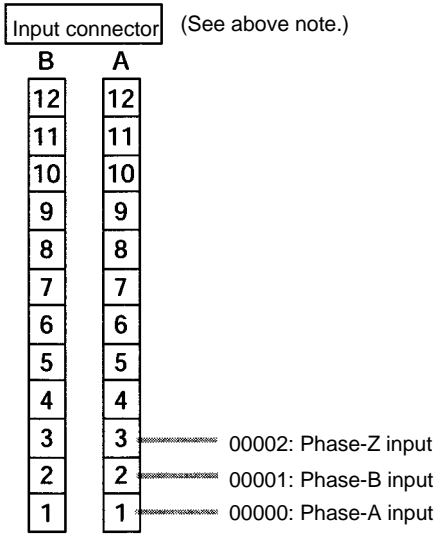

Up/Down Pulse Input Mode

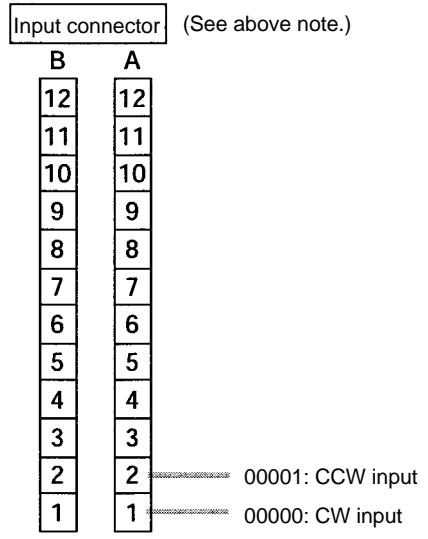

Pulse + Direction Input Mode

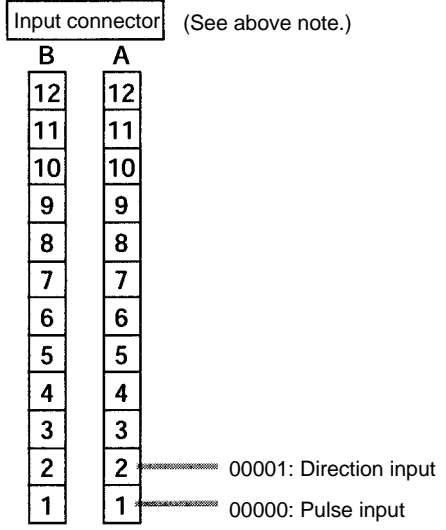

Increment Mode

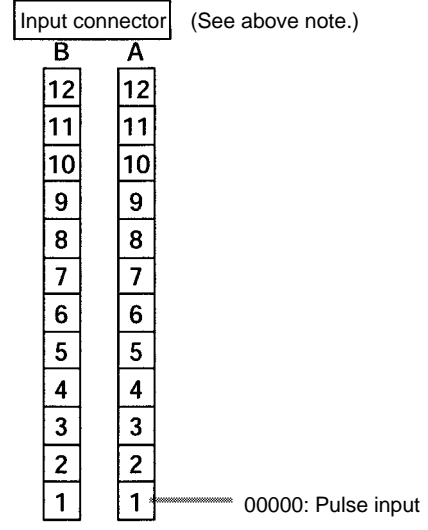

Output Wiring

Wire the CPM2A outputs as shown in the following diagram.

Output Wiring

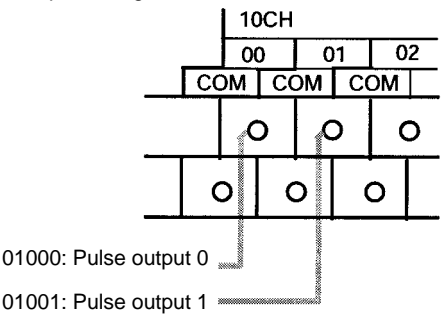

Output connector (See above note.)

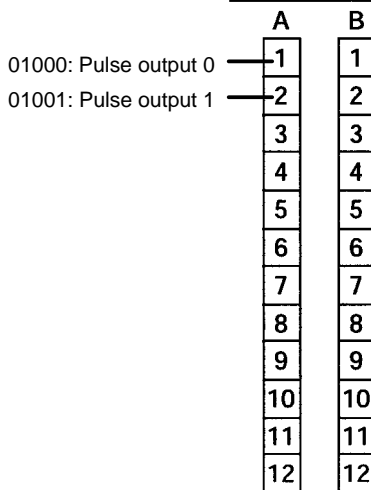

Setup

The settings in the PC Setup related to synchronized pulse control are listed in the following table.

Word	Bits	Function	Setting
DM 6642	00 to 03	High-speed counter input mode setting 0: Differential phase input 5 kHz 1: Pulse + direction input 20 kHz 2: Up/down input 20 kHz 4: Increment 20 kHz	0, 1, 2, 4
	04 to 07	High-speed counter reset method setting 0: Phase-Z signal + software reset 1: Software reset	0 or 1
	08 to 15	High-speed counter setting 00: Do not use. 01: Use as high-speed counter 02: Use as synchronized pulse control (10 Hz to 500 Hz) 03: Use as synchronized pulse control (20 Hz to 1 kHz) 04: Use as synchronized pulse control (300 Hz to 20 kHz)	02, 03,

The settings will go into effect when the mode is changed (from PROGRAM MONITOR/RUN) or when the power supply is turned ON to the PC.

Under Diagram Programming

The following table shows the instruction operations related to synchronized pulse control.

Instruction	Control	Operation
(@)SYNC(—)	Start synchronized control	Specifies the frequency scaling factor and the output port, and outputs pulse.
	Change frequency scaling factor	Changes the frequency scaling factor during pulse output.
(@)INI(61)	Stop synchronized control	Stops the pulse outputs.
(@)PRV(62)	Read input frequency	Reads the input frequency.
	Read synchronized control status	Reads the synchronized control status.

Word	Bits	Name	Contents
248	00 to 15	Input frequency PV, rightmost digits	Reads the input frequency PV.
249	00 to 15	Input frequency PV, leftmost digits	
AR 11	15	Pulse output in progress for pulse output 0	ON: Output in progress OFF: Stopped
AR 12	15	Pulse output in progress for pulse output 1	

Start Frequency Control

This function specifies the bits for pulse outputs (01000, 01001) and the frequency scaling factor (1% to 1,000%), and starts the pulse output.

(@)SYNC(—)		
000	Pulse input port designation (000: High-speed counter)	
P ₂	Pulse output port designation (000: Pulse output 0; 010: Pulse output 1)	
C	Frequency scaling factor setting	

C Frequency scaling factor

Register the frequency scaling factor to be set.

#0001 to #1000 (4 digits BCD): 1 to 1,000%

Note When using SYNC(—) to specify a frequency scaling factor, be careful to keep the pulse output frequency below 10 kHz.

Change Frequency Scaling Factor

This function changes the frequency scaling factor during synchronized control (during pulse output) by specifying the bits for pulse outputs (01000, 01001) the frequency scaling factor (1% to 1,000%) and executing SYNC(—).

Stop Synchronized Control

This function stops the pulse outputs.

(@)INI(61)		
000	Port specifier (000: High-speed counter)	
005	Control designation (005: Stop synchronized control)	
000	Fixed: 000	

Note The pulse output can also be stopped by switching the PC to PROGRAM mode.

Read Input Frequency

This function reads the input frequency PV.

Using an Instruction

(@)PRV(62)		
000	Fixed: 000	
000	Control designation (000: Read high-speed counter input frequency)	
D	Beginning word for storing input frequency PV	

D Rightmost 4 digits
D+1 Leftmost 4 digits
00000000 to 00020000 (8 digits BCD)

Using Data Areas

As shown in the following illustration, the input frequency is stored in words 248 and 249.

Word 248	Input frequency PV (Rightmost)
Word 249	Input frequency PV (Leftmost)

by from the exact PV at any given time.

When the PV is read by executing PRV(62), words 248 and 249 are refreshed with the same timing.

Read Synchronized Control Status

This function reads the synchronized control status.

Using an Instruction

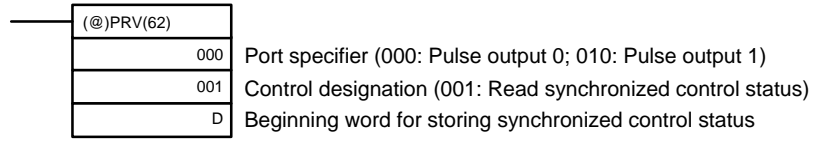

- Port specifier: 000

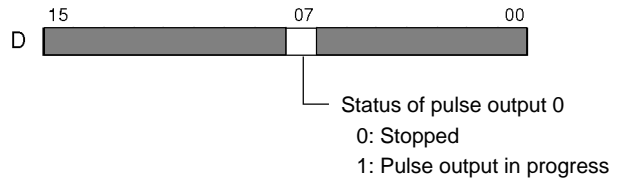

- Port specifier: 010

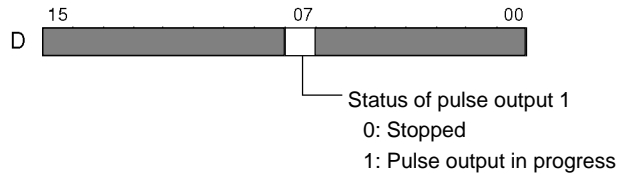

Using Data Areas

As shown in the following illustration, the status of pulse output 0 is stored in AR 1115, and the status of pulse output 1 is stored in AR 1215.

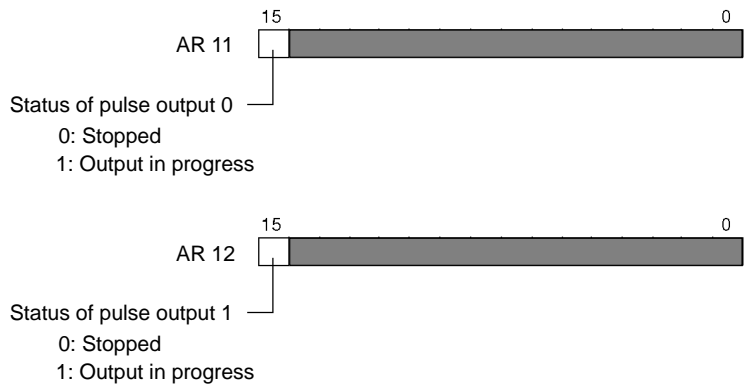

AR 1115 and AR 1215 are refreshed once each cycle, so there may be a discrepancy from the exact PV at any given time.

When the PV is read by executing PRV(62), AR 1112 and AR 1212 are refreshed immediately.

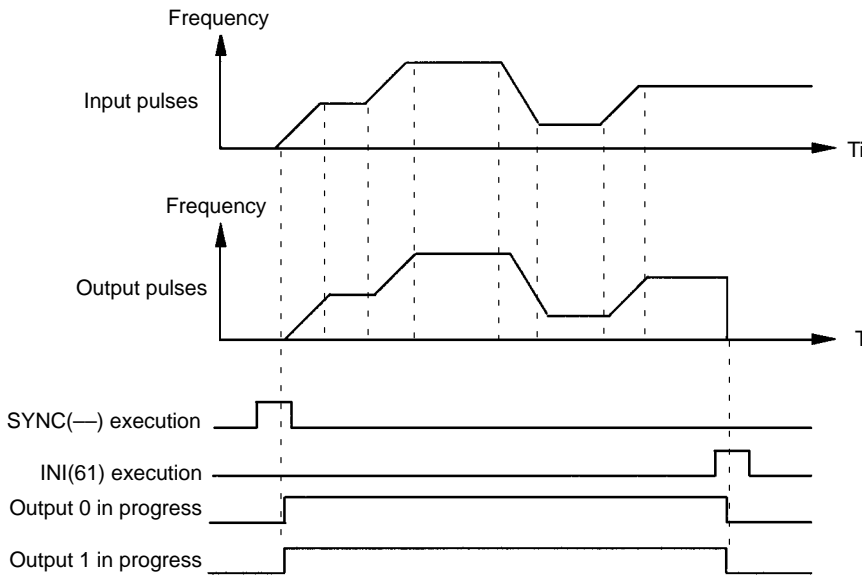

Application Example

Explanation

In this example, when the execution condition (00005) turns ON, synchronous pulse control is started and pulses are output from output 01000 (pulse output according to the pulses input by the high-speed counter). At this time, the frequency scaling factor can be changed by means of analog control 0. When execution condition (00005) turns OFF, synchronized pulse control is stopped.

Wiring

Wire the CPM2A as shown in the following illustration.

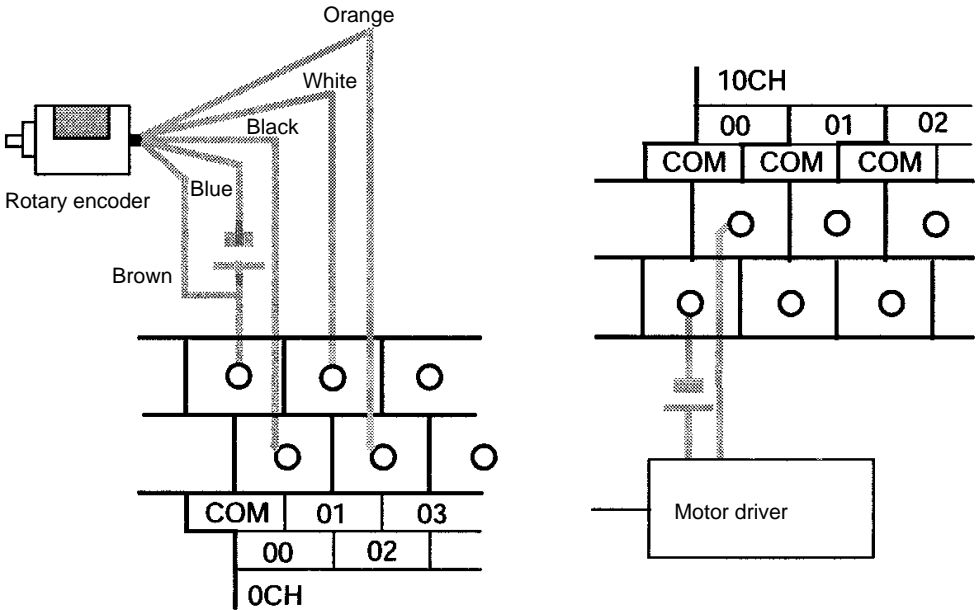

Wire the CPM2C as shown in the following illustration. In this case, a CPU with sinking transistor outputs is used.

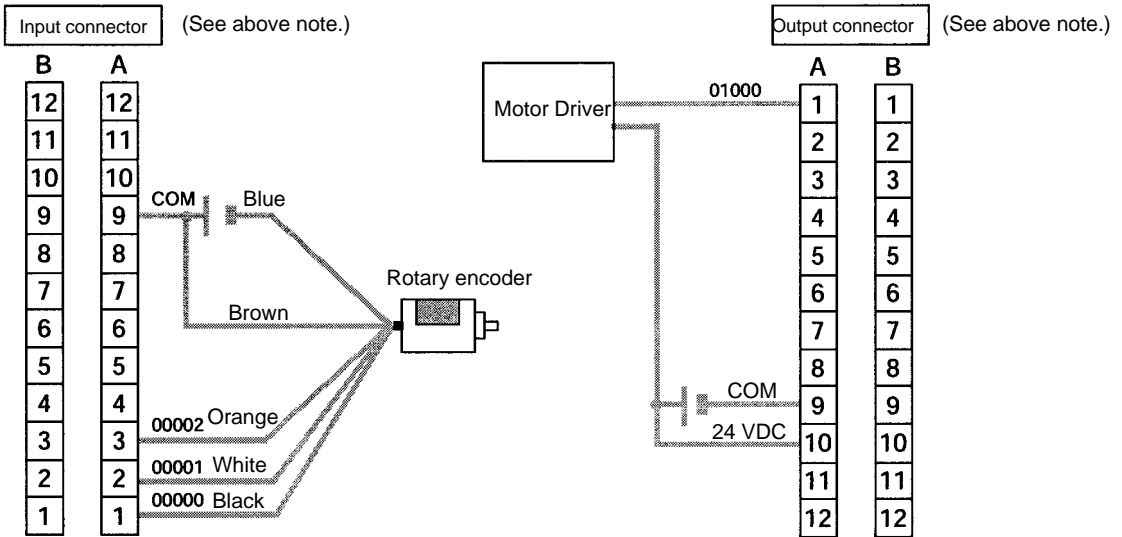

Note For details regarding motor driver wiring to outputs and rotary encoder wiring to inputs, refer to the *CPM2A Operation Manual (W352)/CPM2C (W356) Operation Manual* or *CPM2C-S Operation Manual (W377)*.

PC Setup

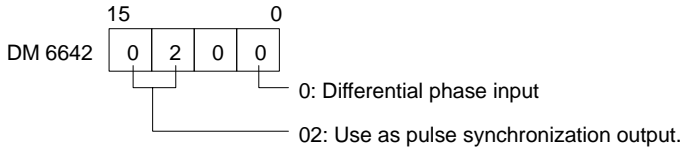

Programming (Example for CPM2A)

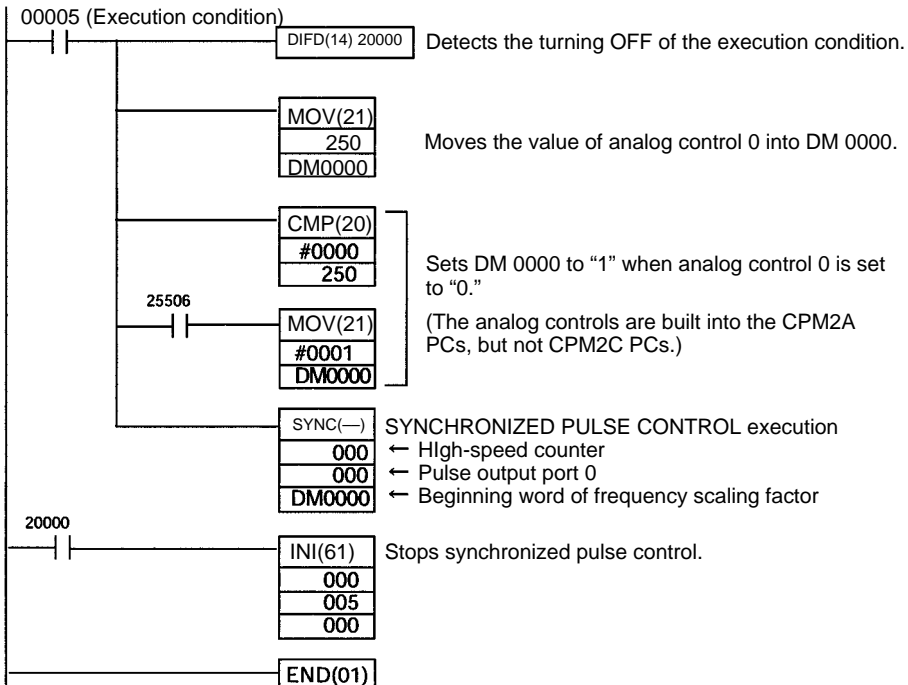

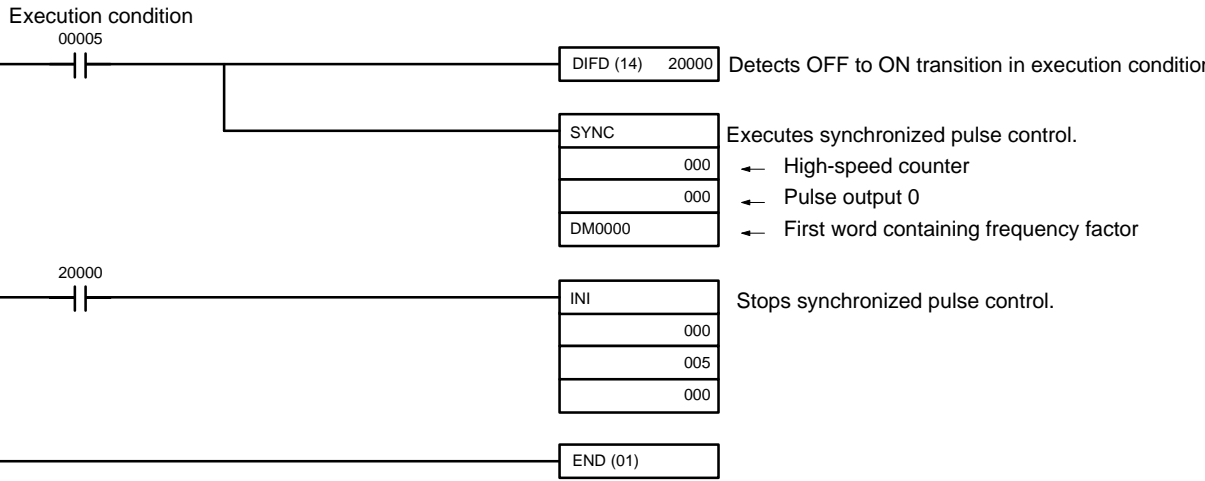

The degree of error and synchronization in pulse outputs and synchronized pulse control are described in this section.

3-1 Pulse Outputs

Changes in Frequency

There will be a delay before a change in the frequency during pulse output is actually applied to the output, as shown below.

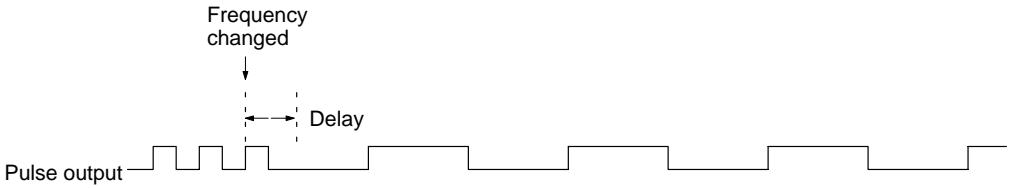

$$\text{Maximum delay (ms)} = \text{One period of the current pulse output} \div 2 + 10 + \text{instruction execution time}$$

Frequency Error

There will be an error between the frequency of the output pulse and the set frequency of less than $\pm 1\%$ due to internal processing error.

3-2 Synchronized Pulse Control

Delay in Start of Pulse Output

The following diagram shows the delay that will occur between starting synchronized pulse control and the start of actual pulse output.

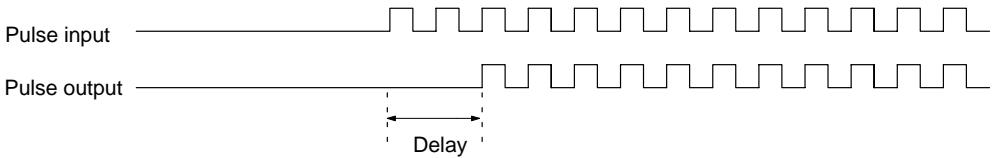

$$\text{Maximum delay (ms)} = \text{One period of the pulse input} \times 2 + 16.25$$

Changes in Frequency

There will be a delay before a change in the frequency during pulse output is actually applied to the output when performing synchronized pulse control, as shown below.

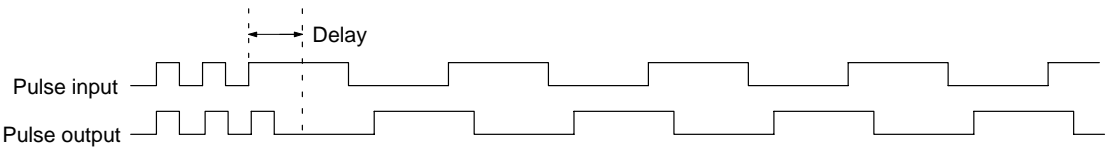

$$\text{Maximum delay (ms)} = \text{One period of the current pulse output} \div 2 + 10$$

Delay in Stop of Pulse Output

The following diagram shows the delay that will occur between stopping synchronized pulse control (0 Hz) and the end of actual pulse output during synchronized pulse control.

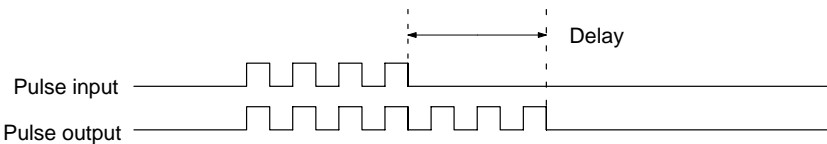

$$\text{Maximum delay (ms)} = \text{Setting in DM 6642 (see below)} + \text{One period of the current pulse output} \div 2 + 10$$

Setting of DM 6642 bits 08 to 15	Frequency range	Delay
02	10 to 500 Hz	262 ms
03	20 Hz to 1 kHz	66 ms
04	300 Hz to 20 kHz	4 ms

pulse, as described below. The error consists of error in the input pulse frequency measurement and error in the output pulse frequency.

Input Pulse Frequency Measurement Error

The error in measuring the frequency of the input pulse depends on the setting of DM 6642, as shown below. If a multiplication factor is specified for synchronous pulse control, the error given in the table must also be multiplied by the multiplication factor.

Setting of DM 6642 bits 08 to 15	Frequency range	Error
02	10 to 500 Hz	± 1 Hz
03	20 Hz to 1 kHz	± 1 Hz
04	300 Hz to 20 kHz	± 10 Hz

Output Pulse Frequency Error

There will be an error between the frequency of the output pulse and the set frequency of less than $\pm 1\%$ due to internal processing error.

Example

DM 6642 bits 08 to 15: 4 (frequency range: 300 Hz to 20 kHz)

Multiplication factor: 300%

Input frequency: 1 kHz (error: 0%)

If synchronized pulse control is performed under the above conditions, there will be an error of ± 10 Hz in measuring the frequency range of the input pulse. The input frequency will thus be 990 to 1010 Hz. The multiplication factor of 300% however, would make this 2970 to 3030 Hz. There would also be an error of ± 10 Hz in the frequency of the output pulse, so the output would be in the range 2940 to 3060 Hz.

9 Analog I/O Functions (CPM1/CPM1A/CPM2A/CPM2C Only)

One or more Analog I/O Units can be connected to the PC to provide analog inputs and outputs. One Analog I/O Unit allows 2 analog inputs and 1 analog output. See *3-1 Analog I/O Units* for details.

10 Temperature Sensor Input Functions (CPM1A/CPM2A/CPM2C Only)

Temperature Sensor Units can be added to directly input temperature sensor signals into the PC. Temperature Sensor Units are available for either thermocouple or platinum resistance thermometer inputs.

For the CPM1A or CPM2A, up to three CPM1A-TS001/101 Temperature Sensor Units or one CPM1A-TS002/102 Temperature Sensor Unit can be connected. Up to 6 temperature inputs are possible for one PC.

For the CPM2C, up to four CPM2C-TS001/101 Temperature Sensor Units can be connected, enabling up to 8 temperature inputs for one PC. Up to three Units can be connected for the CPM2C-S.

11 CompoBus/S I/O Slave Functions (CPM1A/CPM2A/CPM2C Only)

The PC can function as a Slave to a CompoBus/S Master Unit (or SRM1 CompoBus/S Master Control Unit) when a CompoBus/S I/O Link Unit is connected. See *3-3 CompoBus/S I/O Link Unit* for details.

CPM2C-S Only)

Maximum Number of Nodes A maximum of either 16 or 32 CompoBus/S nodes may be connected.

Communications mode	No. of nodes set	Communications response time
High-speed mode	16	0.5 ms
	32	0.8 ms
Long-distance mode	16	4.0 ms
	32	6.0 ms

The communications mode and maximum number of nodes are set in the Setup, as shown in the following table.

Word	Bit(s)	Function	Setting
DM 6603	00 to 03	Maximum number of CompoBus/S nodes 0: 32 nodes 1: 16 nodes	0 or 1
	04 to 07	CompoBus/S communications mode 0: High-speed communications 1: Long-distance communications	0 or 1
	08 to 15	Not used.	00

Note When changes are made to these settings, always turn the power off and on again to make the new setting effective.

Interrupts

Input bits in IR 000 to IR 007 and output bits in IR 010 to IR 017 are used as interrupts for CompoBus/S I/O Terminals. The CompoBus/S I/O Terminal interrupt (IN 0 to 15 and OUT 0 to 15) are allocated as indicated in the following table. IN0 to IN15 are the node addresses for the Input Terminals and OUT0 to OUT15 are the node addresses for the Output Terminals.

Word		Bit															
		15	14	13	12	11	10	9	8	7	6	5	4	3	2	1	
Input	IR 000	IN1								IN0							
	IR 001	IN3								IN2							
	IR 002	IN5								IN4							
	IR 003	IN7								IN6							
	IR 004	IN9								IN8							
	IR 005	IN11								IN10							
	IR 006	IN13								IN12							
	IR 007	IN15								IN14							
Output	IR 010	OUT1								OUT0							
	IR 011	OUT3								OUT2							
	IR 012	OUT5								OUT4							
	IR 013	OUT7								OUT6							
	IR 014	OUT9								OUT8							
	IR 015	OUT11								OUT10							
	IR 016	OUT13								OUT12							
	IR 017	OUT15								OUT14							

Note

1. When the maximum number of CompoBus/S nodes is set to 16, IN8 to IN15 can be used as work bits.
2. CompoBus/S Terminals with less than 8 points are allocated bit addresses from either 0 or 8.

4. Analog Terminals can be set for only even number addresses.

Status Flags

The communications status between CompoBus/S terminals is output through AR04 to AR07 Slave Add Flags and Slave Communications Error Flags.

Word	Uppermost bits: Slave Communications Error Flags								Lower Bits: Slave Add Flags							
	15	14	13	12	11	10	9	8	7	6	5	4	3	2	1	
04	OUT 7	OUT 6	OUT 5	OUT 4	OUT 3	OUT 2	OUT 1	OUT 0	OUT 7	OUT 6	OUT 5	OUT 4	OUT 3	OUT 2	OUT 1	
05	IN7	IN6	IN5	IN4	IN3	IN2	IN1	IN0	IN7	IN6	IN5	IN4	IN3	IN2	IN1	
06	OUT 15	OUT 14	OUT 13	OUT 12	OUT 11	OUT 10	OUT 9	OUT 8	OUT 15	OUT 14	OUT 13	OUT 12	OUT 11	OUT 10	OUT 9	
07	IN15	IN14	IN13	IN12	IN11	IN10	IN9	IN8	IN15	IN14	IN13	IN12	IN11	IN10	IN9	

- Note**
1. IN0 to IN15 are the input terminals and OUT0 to OUT15 are the output terminals.
 2. When the maximum number of CompoBus/S units is set to 16, IN8 to IN15 and OUT8 to OUT15 cannot be used.
 3. The Slave Add Flag turns ON when a slave joins the communications. When the power to the CPU Unit is turned OFF and ON again all bits will turn OFF.
 4. The Slave Communications Error Flag turns ON when a slave participating in the network is separated from the network. The bit will turn OFF when the slave re-enters the network.
 5. For the SRM1, an error will not occur even if the same node address is allocated to more than one slave. Errors will also not occur when communications go down or communications errors, such as broken lines, occur. Set node addresses very carefully and confirm slave operation by including a check section of ladder program using the Status Flags. An example is shown below.

Example

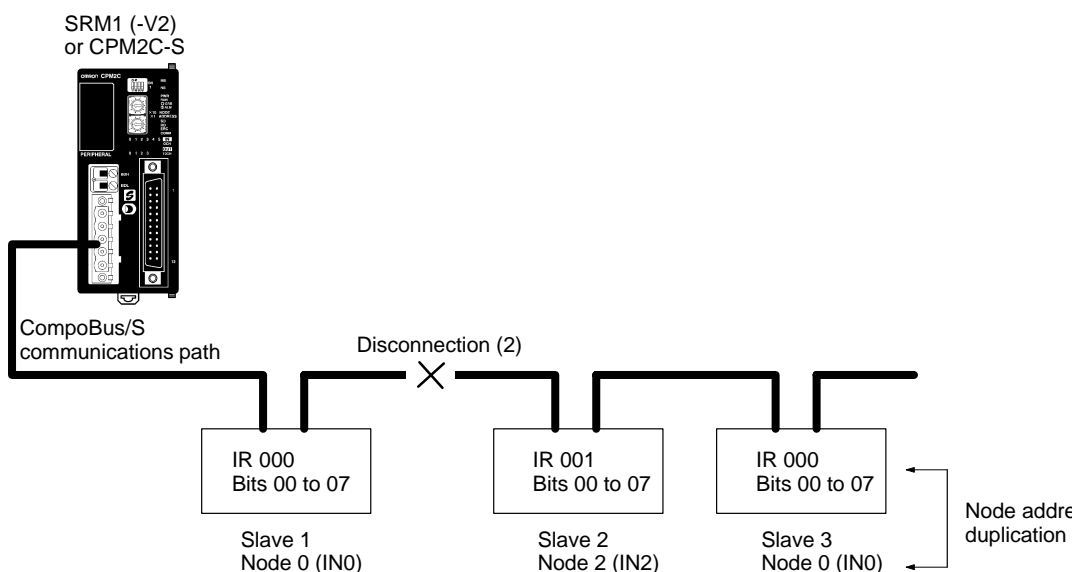

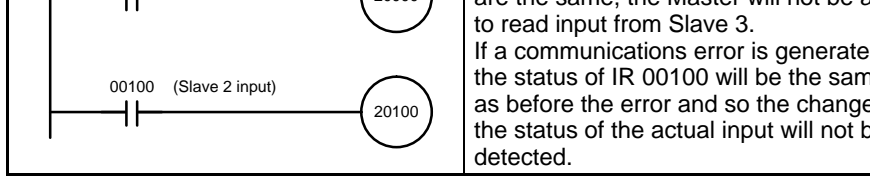

• Example of Countermeasure in Ladder Program

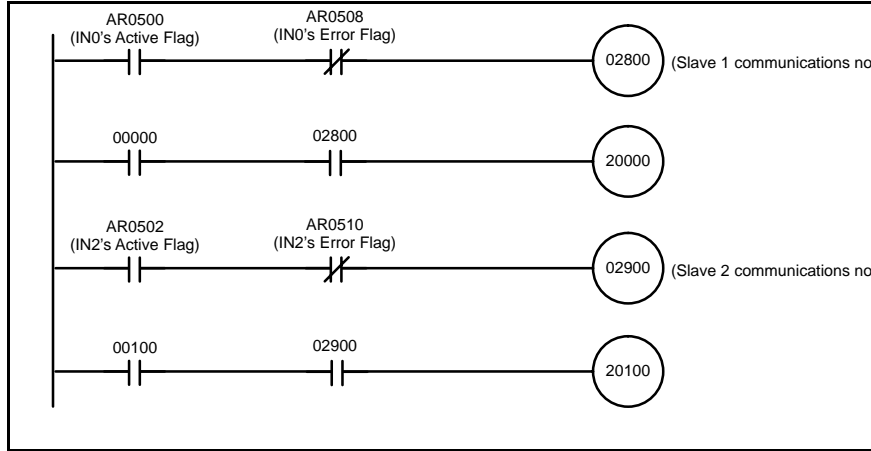

13 Analog Controls (CPM1/CPM1A/CPM2A Only)

The PCs are equipped with analog controls that automatically transfer the settings on the CPU Unit's adjustment switches to words in the CPU Unit's I/O memory. This function is very useful when there are set values that need to be precisely adjusted during operation. These set values can be changed just by turning the adjustment switches on the CPU Unit.

Settings

The PCs have two analog adjustment controls that can be used for a wide range of timer and counter analog settings. The following diagrams show the adjustment controls. As these controls are turned, values from 0000 to 0200 (BCD) are stored in the SR Area. Use a Phillips screwdriver to adjust the settings.

CPM1

The analog setting for control 0 is in SR 250.
The analog setting for control 1 is in SR 251.

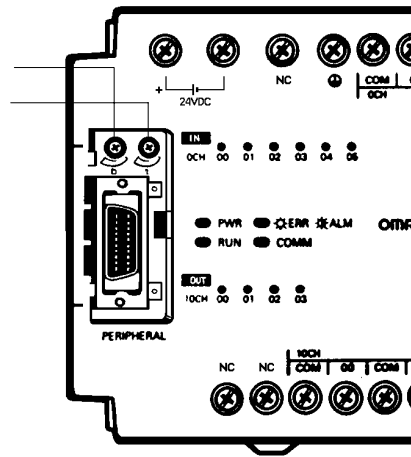

CPM1A/CPM2A

The analog setting for control 0 is in SR 250.
The analog setting for control 1 is in SR 251.

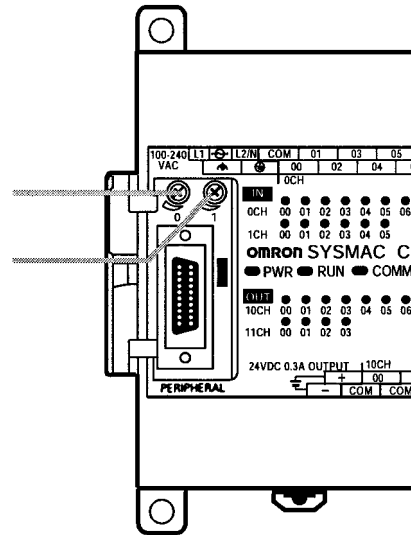

Note The above diagram shows the CPM2A, but the settings are the same for CPM1A.



Caution The analog setting may change with changing temperatures. Do not use analog adjustment controls for applications that require a precise, fixed set

Make the analog settings.

Use a Phillips screwdriver to adjust the controls.

Connect a Programming Device such as a Programming Console, and check the values stored in SR 250 and SR 251.

Create a ladder diagram program.

Read the values in SR 250 and SR 251 with the ladder diagram program.

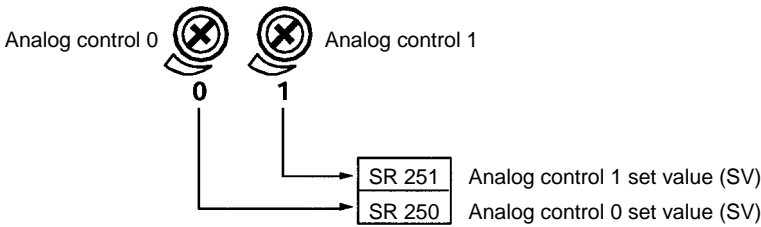

Adjusting the Analog Settings

Use a Phillips screwdriver to adjust the analog controls. The set values can be checked by connecting a Programming Device such as a Programming Console and reading the values stored in SR 250 and SR 251.

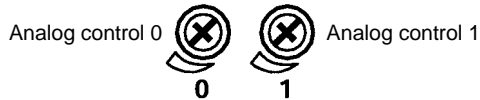

Ladder Diagram Programming

The following table shows the words and bits where the analog settings are stored.

Word	Bit	Name	Value
SR 250	00 to 15	Analog control 0 SV storage area	0000 to 0200 (BCD)
SR 251	00 to 15	Analog control 1 SV storage area	

In the following example program, the analog control SV (0000 to 0200 BCD) stored in SR 250 is set as a timer SV. The timer's set range is 0.0 s to 20.0 s.

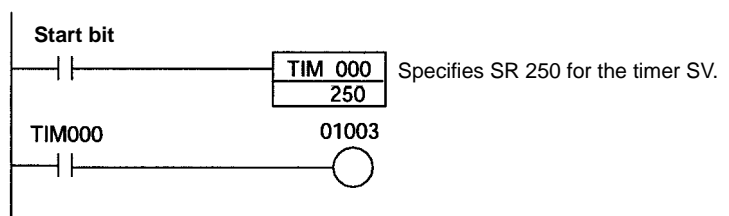

14 Quick-response Inputs

14-1 CPM1/CPM1A Quick-response Inputs

The CPM1/CPM1A have quick response inputs that can be used to enable putting shorter signals.

All 10-point CPU Units have 2 quick-response input terminals and the 20-, and 40-point CPU Units have 4 quick-response input terminals. The same terminals are used for quick-response inputs and interrupt inputs.

cycle can be detected. Signals with a pulse width as short as 0.2 ms can be detected, regardless of their timing during the PC cycle.

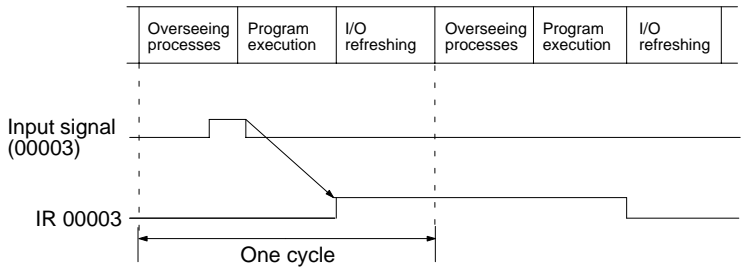

CPU Unit	Input bits	Min. input pulse width
10-point CPU Units	IR 00003 to IR 00004	0.2 ms
20-, 30-, 40-point CPU Units	IR 00003 to IR 00006	

Setting Quick-response inputs

The input bits in the above table can be set as quick-response input DM 6628, as shown in the following table.

Word	Settings
DM 6628	0: Normal input 1: Interrupt input 2: Quick-response input (Default setting: 0)

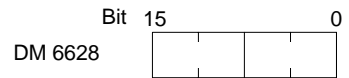

- Setting for input 00006: Set to 2
- Setting for input 00005: Set to 2
- Setting for input 00004: Set to 2
- Setting for input 00003: Set to 2

Program Example

In this example, DM 6628 has been set to 0002.

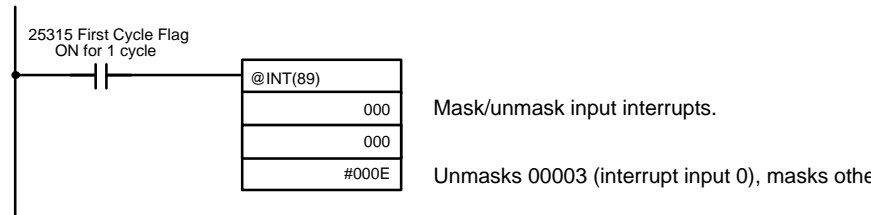

The CPM2A and CPM2C have four inputs used for quick-response in (shared with interrupt inputs and 2-kHz high-speed counter inputs). With quick-response inputs, signals that are changed within a cycle can be received while maintaining an internal buffer.

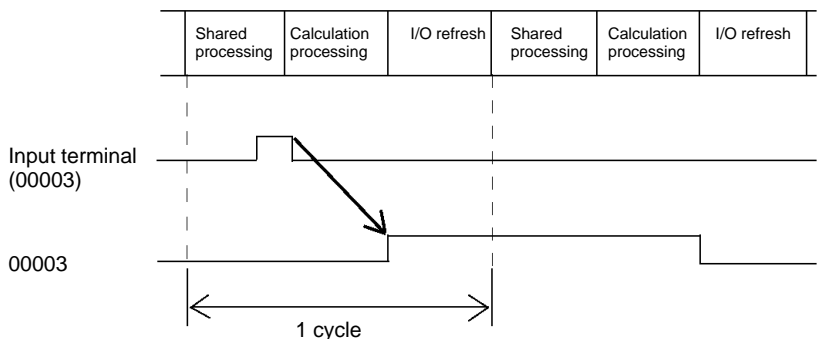

Input number (See note.)	Minimum input signal width
00003	50 μs
00004	
00005	
00006 (See note 2.)	

- Note**
1. Input numbers 00003 to 00006 can be used as interrupt inputs, 2-kHz high-speed counter inputs, or quick-response inputs. If they are not used for one of these purposes, then they can be used as ordinary inputs.
 2. Input number 00006 does not exist in CPM2C CPU Units with 10 I/O ports.

The following table shows the relationships between quick-response inputs and the CPM2A/CPM2C's other functions.

Function	Interval timer interrupts
Synchronized pulse control	Can be used simultaneously.
Interrupt inputs	See note 1.
Interval timer interrupts	Can be used simultaneously.
High-speed counters	Can be used simultaneously.
Interrupt inputs (counter mode)	See note 2.
Pulse outputs	Can be used simultaneously.
Quick-response inputs	See note 3.
Input time constant	See note 4.
Clock	Can be used simultaneously.

- Note**
1. Quick-response inputs utilize the interrupt input function, so the same input number from 00003 to 00006 cannot be assigned for both a quick-response input and an interrupt input in the PC Setup.
 2. A quick-response input and an interrupt in counter mode cannot be assigned the same input number in the PC Setup.
 3. The input numbers allocated for quick-response inputs are 00003 to 00006. These inputs can be set and operated as quick-response inputs.
 4. Input time constants are disabled for all inputs that are set as quick-response inputs.

Wire the inputs.

Input numbers 00003, 00004, 00005, and 00006



PC Setup (DM 6628)

2: Use as quick-response inputs.

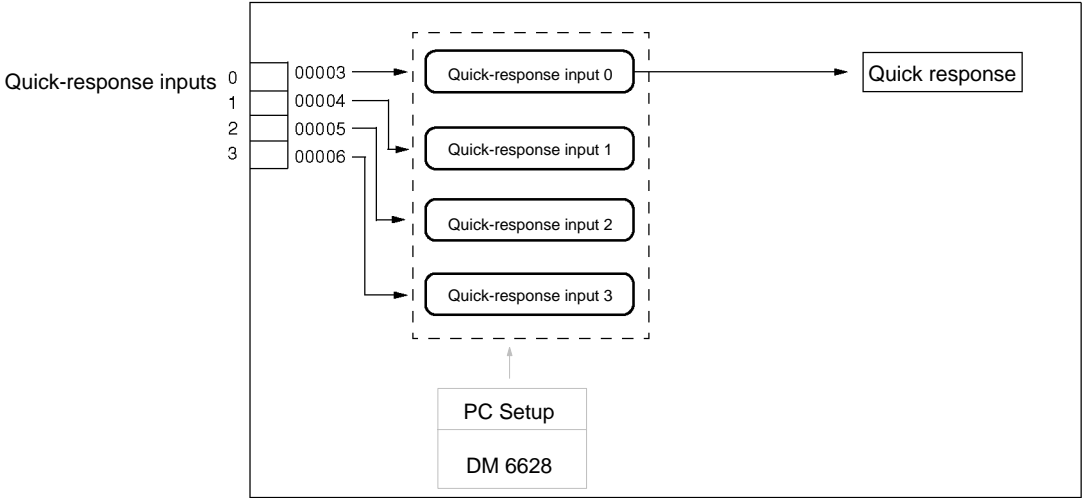

Wiring the Inputs

Wire the CPM2A's inputs as shown in the following diagram.

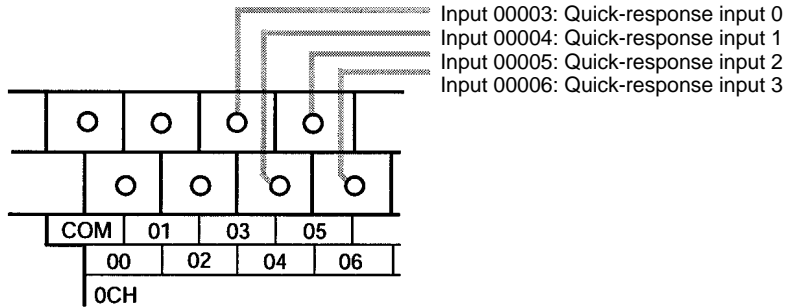

Note The following examples are for Fujitsu-compatible connectors. Input bit addresses and connector pin numbers depend on the models. Refer to the *CPM2C Operation Manual (W356)* or the *CPM2C-S Operation Manual (W377)* for details.

CPU Units with 10 I/O Points

Input terminal



Input 00004: Quick-response input 1
 Input 00003: Quick-response input 0

Input connector

(See above note.)

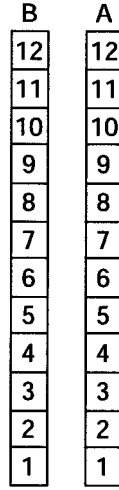

00004: Quick-response input 1
 00003: Quick-response input 0

CPU Units with 20/32 I/O Points

Input connector

(See above note.)

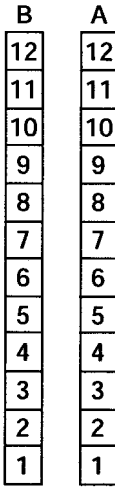

00006: Quick-response input 3*
 00005: Quick-response input 2*
 00004: Quick-response input 1
 00003: Quick-response input 0

Setup

To use quick-response inputs with the CPM2A or CPM2C, make the following settings in the System Setup Area (DM 6628) from a Programming Device:

Word	Bits	Function		Setting
DM 6628	00 to 03	Interrupt setting for input number 3	0: Ordinary input 1: Interrupt input (interrupt input mode or counter mode) 2: Quick-response input	2
	04 to 07	Interrupt setting for input number 4		
	08 to 11	Interrupt setting for input number 5*		
	12 to 15	Interrupt setting for input number 6*		

The settings will go into effect when the mode is changed (from PROGRAM MONITOR/RUN) or when the power supply is turned ON to the PC.

15 Macro Function

The macro function allows a single subroutine (programming pattern) to be used by simply changing the I/O word. A number of similar program sections can be managed with just one subroutine, thereby greatly reducing the number of lines in the program and making the program easier to understand.

Using Macros

To use a macro, call a subroutine by means of the MACRO instruction MCRO(99), as shown below, in stead of SBS(91) (SUBROUTINE ENTRY).

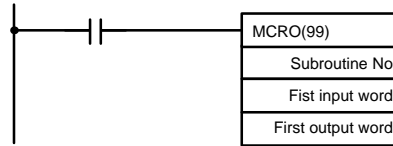

When MCRO(99) is executed, operation will proceed as follows:

- 1, 2, 3... 1. The contents of the four consecutive words beginning with the first input word will be transferred to SR 232 through SR 235.
2. The specified subroutine will be executed until RET(93) (Subroutine Return) is executed.
3. The contents of SR 236 through SR 239 (results of the subroutine execution) will be transferred to the four consecutive words beginning with the first output word.
4. MCRO(99) will then be finished.

When MCRO(99) is executed, the same instruction pattern can be used for other subroutines needed simply by changing the first input word or the first output word.

The following restrictions apply when the macro function is used.

- The only words that can be used for each execution of the macro are the four consecutive words beginning with the first input word number (for input) and the four consecutive words beginning with the first output word (for output).
- The specified inputs and outputs must correctly correspond to the words used in the subroutine.
- Even when the direct output method is used for outputs, subroutine results will not be actually reflected in the specified output words only when the subroutine has been completed (step 3 above).

Note SR 232 through SR 239 can be used as work bits when MCRO(99) is not used.

The first input word and the first output word can be specified not with I/O bits but also with other bits (such as HR bits, work bits, etc.) or with DM words.

Subroutines called by MCRO(99) are defined by SBN(92) and RET(93), just as they are ordinary subroutines.

Macro not used

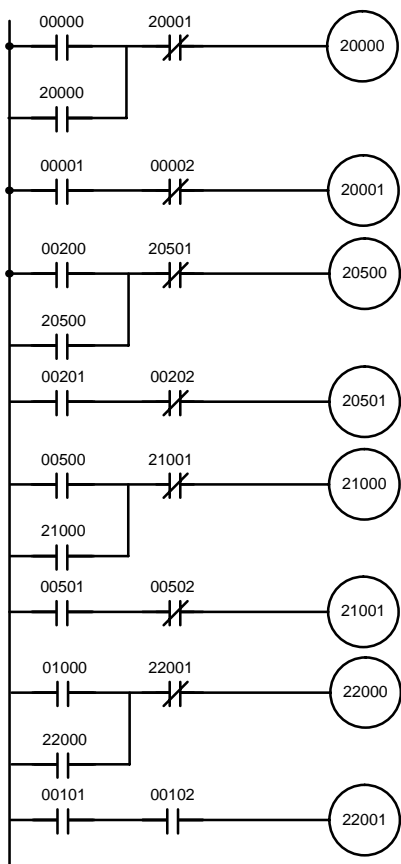

Subroutine used to define macro

Macro used

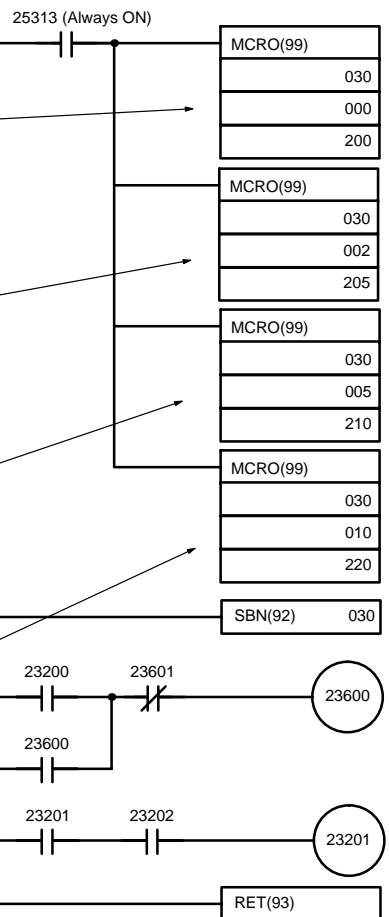

16 Calculating with Signed Binary Data

The CPM1/CPM1A/CPM2A/SRM1(-V2) allow calculations on signed binary data. The following instructions manipulate signed binary data. Signed data is handled using 2's complements.

CPM2A/CPM2C and SRM1(-V2) Instructions

The following signed-binary instructions are available in CPM2A, CPM2C, SRM1(-V2) PCs:

- BINARY ADD – ADB(50)
- BINARY SUBTRACT – SBB(51)
- 2'S COMPLEMENT – NEG(—)

CPM1/CPM1A Instructions

The following signed-binary instructions are available in CPM1/CPM1A PCs:

- BINARY ADD – ADB(50)
- BINARY SUBTRACT – SBB(51)

Signed Data Calculations

Addition

$$7 + 3 = 10$$

$$(-7) + 3 = -4$$

$$7 + (-3) = 4$$

$$(-7) + (-3) = -10$$

Subtraction

$$7 - 3 = 4$$

$$(-7) - 3 = -10$$

$$7 - (-3) = 10$$

$$(-7) - (-3) = -4$$

Signed binary data is manipulated using 2's complements and bit 15 is used as the sign bit. The range of data that can be expressed using one word is as follows: -32,768 to 32,767 (8000 to 7FFF hexadecimal).

The following table shows equivalents between decimal and hexadecimal values.

Decimal	4-digit Hexadecimal
32,767	7FFF
32,766	7FFE
.	.
.	.
.	.
2	0002
1	0001
0	0000
-1	FFFF
-2	FFFE
.	.
.	.
.	.
-32,767	8001
-32,768	8000

16-2 Arithmetic Flags

The results of executing signed binary instructions is reflected in the arithmetic flags. The flags and the conditions under which it will turn ON are given in the following table. The flags will be OFF when these conditions are not met.

Flag	ON conditions
Carry Flag (SR 25504)	Carry in an addition. Negative results for subtraction.
Equals Flag (SR 25506)	The results of addition, subtraction, multiplication, or division is 0. Results of converting 2's complement is 0.

16-3 Inputting Signed Binary Data Using Decimal Values

Although calculations for signed binary data use hexadecimal expressions, inputs from the Programming Console or SSS can be done using decimal values and mnemonics for the instructions. The procedure to using the Programming Console to input using decimal values is shown in the *CPM1 Operation Manual*, *CPM1A Operation Manual*, *CPM2A Operation Manual*, *CPM2C Operation Manual*, and *SRM1 Master Control Unit Operation Manual*. Refer to the *SSS Operation Manual: C-series PCs* for details on using the SSS.

Inputting Instructions

Refer to the *CPM1 Operation Manual*, *CPM1A Operation Manual*, *CPM2C Operation Manual*, *CPM2A Operation Manual*, and *SRM1 Master Control Unit Operation Manual* details on inputting instructions from the Programming Console.

17 Differential Monitor

The CPM1/CPM1A, CPM2A/CPM2C, and SRM1(-V2) support differential monitoring from either the Programming Console or the SSS. The operator can detect on OFF-to-ON or ON-to-OFF transition in a specified bit. When the specified transition takes place, the transition is indicated on the display and a buzzer sounds to enable easy recognition of the transition.

Refer to the *CPM1 Operation Manual*, *CPM1A Operation Manual*, *CPM2A Operation Manual*, *CPM2C Operation Manual*, or *SRM1 Master Control Units Operation Manual* for details on the Programming Console Differential Monitor procedure and to the *SSS Operation Manual: C-series PCs* for the SYSMAC Support Software procedure.

A set of expansion instructions is available for the CPM2A, CPM2C (including the CPM2C-S), and SRM1(-V2) to aid in special programming needs. Function codes can be assigned to up to 18 of the expansion instructions to enable use of them in programs. This allows the user to pick the instructions needed by either CPM2A, CPM2C, or SRM1(-V2) program to more effectively use the function codes required to input instructions.

The mnemonics of expansion instructions are followed by “(—)” as the function code to indicate that they must be assigned function codes by the user in the instructions table before they can be used in programming (unless they are used under their default settings).

Any of the instructions not assigned function codes will need to be assigned function codes in the instructions table used by the Programming Device and the CPM2A/CPM2C or SRM1(-V2) before they can be used in programming. The assignments of expansion instructions in the instructions table will change the meaning of instructions and operands, so be sure to set the instructions table before programming and transfer the proper instructions table to the CPM2A/CPM2C or SRM1(-V2) before program execution.

Example: CPM2A/CPM2C PCs

The specific instructions used in the following example are for the CPM2A/CPM2C. The concepts are the same for the SRM1(-V2).

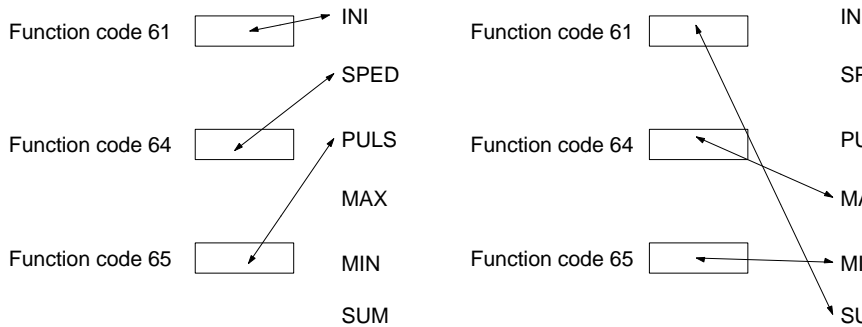

At the time of shipping, the function codes are assigned as shown above. (In this example, the instructions all relate to pulse outputs.)

If pulse outputs are not being used, and maximum values, minimum values, and sums are required, then the Set Instruction operation can be used as shown above to reassign instructions in the instruction table.

- Note**
1. Set the PC model to “CQM1” when setting the expansion instructions for the CPM2A/CPM2C or SRM1(-V2) from the SSS.
 2. The PC Setup must be set for user-defined expansion instruction function codes in order for function codes to be assigned. Set bits 08 to 15 of the DM 6602 to 1.

The following 18 function codes can be used for expansion instructions: 17, 19, 47, 48, 60, 61, 62, 63, 64, 65, 66, 67, 68, 69, 87, 88, and 89. The function code assignments can be changed with a Programming Console or the Support Software.

Refer to *4-4-5 Assigning Expansion Instruction Function Codes* in the CPM2C CPM2C Operation Manual for the Programming Console procedure.

Refer to the *SSS Operation Manual: C-series PCs* for the SSS procedure.

Refer to the *SYSMAC-CPT Support Software Quick Start Guide (W332)*

User Manual (W333) for the SYSMAC-CPT Support Software procedure.

The expansion instructions that can be used are listed below, along with the fault function codes that are assigned when the PC is shipped.

Mnemonic	Function code
ASFT	17
---	18
---	19
RXD	47
TXD	48
CMPL	60
INI	61
PRV	62
CTBL	63
SPED	64
PULS	65
SCL	66
BCNT	67
BCMP	68
STIM	69
---	87
---	88
INT	89
ACC	---
AVG	---
FCS	---
HEX	---
HMS	---
MAX	---
MIN	---
NEG	---
PID	---
PWM	---
SCL2	---
SCL3	---
SEC	---
SRCH	---
STUP	---
SUM	---
SYNC	---
TIML	---
TMHH	---
ZCP	---
ZCPL	---

The following 18 function codes can be used for expansion instructions: 17, 19, 47, 48, 60, 61, 62, 63, 64, 65, 66, 67, 68, 69, 87, 88, and 89. The function code assignments can be changed with a Programming Console or the Support Software.

Refer to 4-2-6 *Setting Expansion Instructions* in the *SRM1 Master Control Operation Manual* for the Programming Console procedure. Refer to the *Operation Manual: C-series PCs* for the SSS procedure. Refer to the *SYSTEM CPT Support Software Quick Start Guide (W332)* and *User Manual (W333)* for the SYSMAC-CPT Support Software procedure.

The expansion instructions that can be used are listed below, along with the fault function codes that are assigned when the SRM1(-V2) is shipped.

Mnemonic	Function code
ASFT	17
---	18
---	19
RXD	47
TXD	48
CMPL	60
---	61
---	62
---	63
---	64
---	65
SCL*	66
BCNT	67
BCMP	68
STIM	69
---	87
---	88
---	89
FCS	---
HEX	---
NEG*	---
PID*	---
STUP	---
ZCP*	---

Note *SCL(66), NEG(—), PID(—), and ZCP (—) are supported by SRM1-C0□-V2 CPUs only.

The CPM2A PCs and some CPM2C (including the CPM2C-S) PCs have a built-in clock function. This section explains how to use the clock.

19-1 Data Area Words

The following illustration shows the configuration of the words (AR 17 through AR 21) that are used with the clock. These words can be read and used as required. (AR 17 is provided so that the hour and minute can be accessed quickly.)

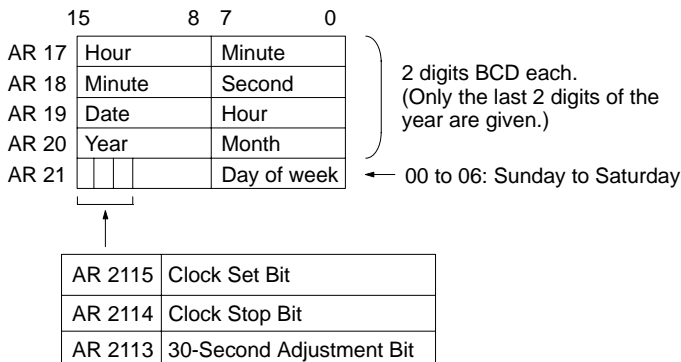

19-2 Setting the Time

To set the time, use a programming device as follows:

Setting Everything

- 1, 2, 3... 1. Turn ON AR 2114 (Clock Stop Bit) to stop the clock and allow AR 18 through AR 21 to be overwritten.
2. Using a Programming Device, set AR 18 through AR 20 (minute/second, date/hour, and year/month) and AR 2100 through AR 2107 (day of week).
3. Turn ON AR 2115 (Clock Set Bit) when the time set in step 2 is reached. The clock will start operating from the time that is set, and the Clock Stop Bit and Clock Set Bit will be turned OFF automatically.

Setting Only the Seconds

It is also possible, by using AR 2113, to simply set the seconds to "00" without going through a complicated procedure. When AR 2113 is turned ON, the clock time will change as follows:

If the seconds setting is from 00 to 29, the seconds will be reset to "00" and the minute setting will remain the same.

If the seconds setting is from 30 to 59, the seconds will be reset to "00" and the minute setting will advance by one.

When the time setting is complete, AR 2113 will turn OFF automatically.

Note The time can be set easily using menu operations from a Programming Console or SSS. Refer to the *CPM2A Operation Manual* or the *CPM2C Operation Manual* for the Programming Console procedure or to the *SSS Operation Manual* for *series PCs* for the SSS procedure.

This section describes how to use the CPM1A-MAD01, CPM1A-MAD11, and CPM2C-MAD11 Analog I/O Units; the CPM1A-TS001/002/101/102 and CPM2C-TS001/101 Temperature Sensor Units; the CPM1A-SRT21 and CPM2C-SRT21 CompoBus/S I/O Link Units; and the CPM1A-DRT21 DeviceNet I/O Link Unit. The CPM1A-MAD11 and CPM2C-MAD11 Analog I/O Units provide the same functions, and are thus described in the same section even though they are supported on different PCs.

3-1	Analog I/O Units	162
3-1-1	CPM1A-MAD01 Analog I/O Unit	162
3-1-2	CPM1A-MAD11 and CPM2C-MAD11 Analog I/O Units	173
3-2	Temperature Sensor Units	189
3-2-1	CPM1A/CPM2A Temperature Sensor Units	189
3-2-2	CPM2C Temperature Sensor Units	190
3-2-3	Using Temperature Sensor Units	191
3-2-4	Connecting Temperature Sensor Units	191
3-2-5	Setting Temperature Ranges	193
3-2-6	Connecting Temperature Sensors	196
3-2-7	Ladder Programming	198
3-2-8	Two-decimal-place Mode	204
3-3	CompoBus/S I/O Link Units	210
3-4	DeviceNet I/O Link Unit	215

-1 CPM1A-MAD01 Analog I/O Unit

A maximum of 3 Expansion Units or Expansion I/O Units, including CPM1A-MAD01 Analog I/O Units, can be connected to a CPM1, CPM1A (see note), or CPM2A PC. One Analog I/O Unit allows 2 analog inputs and 1 analog output. With the maximum of 3 Analog I/O Units connected, 6 analog inputs and 3 analog outputs are possible.

- The analog input range can be set to 0 to 10 VDC, 1 to 5 VDC, or 4 to 20 mA with a resolution of 1/256.
- An open-circuit detection function can be used with the 1 to 5 VDC and 4 to 20 mA settings.
- The analog output range can be set to 0 to 10 VDC, 4 to 20 mA, or -10 to 10 VDC. The output has a resolution of 1/256 when the range is set to 0 to 10 VDC or 4 to 20 mA, or a resolution of 1/512 when set to -10 to 10 VDC.

A maximum of 3 Expansion Units or Expansion I/O Units can be connected.

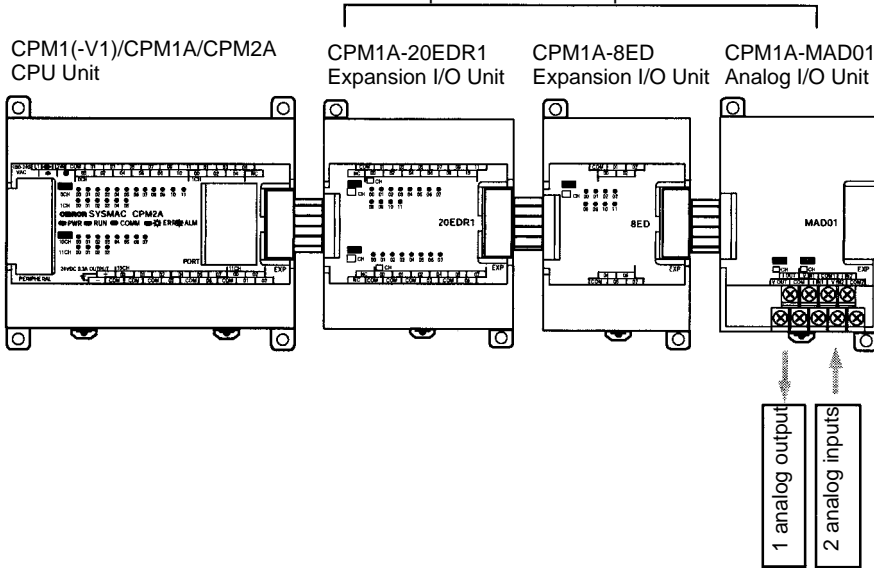

Note The CPM1-30CDR-□-V1 is the only CPM1 CPU Unit to which 3 Expansion Units or Expansion I/O Units can be connected. Only one Expansion Unit or Expansion I/O Unit can be connected to models without the “V1” suffix. Analog I/O Units cannot be connected to 10-point or 20-point CPM1A CPU Units. You must use a 30-point or 40-point CPU Unit to connect to the CPM1A.

Digital Input Function	Number of inputs	2	
	Input signal range	0 to 10 V/1 to 5 V	4 to 20 mA
	Max. rated input	±15 V	±30 mA
	External input impedance	1 MΩ min.	250 Ω rated current
	Resolution	1/256	
	Accuracy	1.0% full scale	
	A/D conversion data	8-bit binary	
Analog Output Function (see note 1.)	Number of outputs	1	
	Output signal range	0 to 10 V or -10 to 10 V	4 to 20 mA
	Max. external output current	5 mA	---
	Allowable external output load resistance	---	350 Ω
	Resolution	1/256 (1/512 when the output signal range is -10 to 10 V)	
	Accuracy	1.0% of full scale	
	Set data	8-bit signed binary	
Conversion time	10 ms max. per Unit (See note 2.)		
Isolation method	Photocoupler isolation between I/O terminals and PC signals No isolation between analog I/O signals.		

- Note**
1. With analog outputs it is possible to use both voltage outputs and current outputs at the same time. In this case however, the total output current must not exceed 21 mA.
 2. The conversion time is the total time for 2 analog inputs and 1 analog output.

Port Names

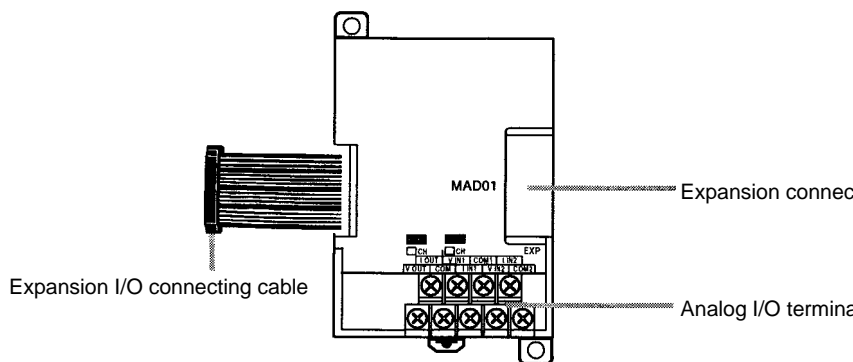

Analog I/O Terminals

Connected to analog I/O devices.

Expansion I/O Connecting Cable

Connected to the CPU Unit or previous Expansion Unit. The cable is provided with the Unit and cannot be removed.



Caution

Do not touch the cables during operation. Static electricity may cause operational errors.

Expansion Connector

Connected to the next Expansion Unit or Expansion I/O Unit.

alog Input Signal Ranges

0 to 10 V inputs
Conversion value

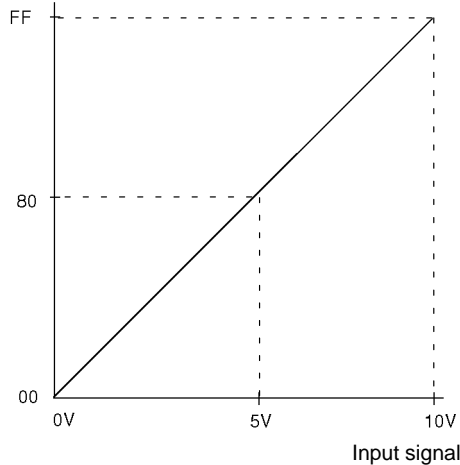

1 to 5 V inputs
Conversion value

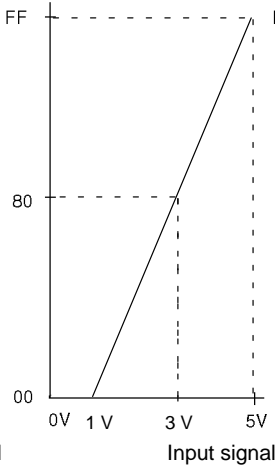

4 to 20 mA inputs
Conversion value

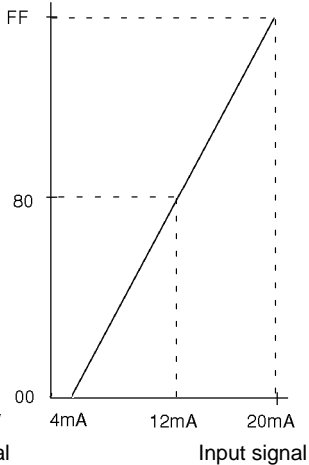

alog Output Signal Ranges

0 to 10 V outputs and
-10 to +10 V outputs

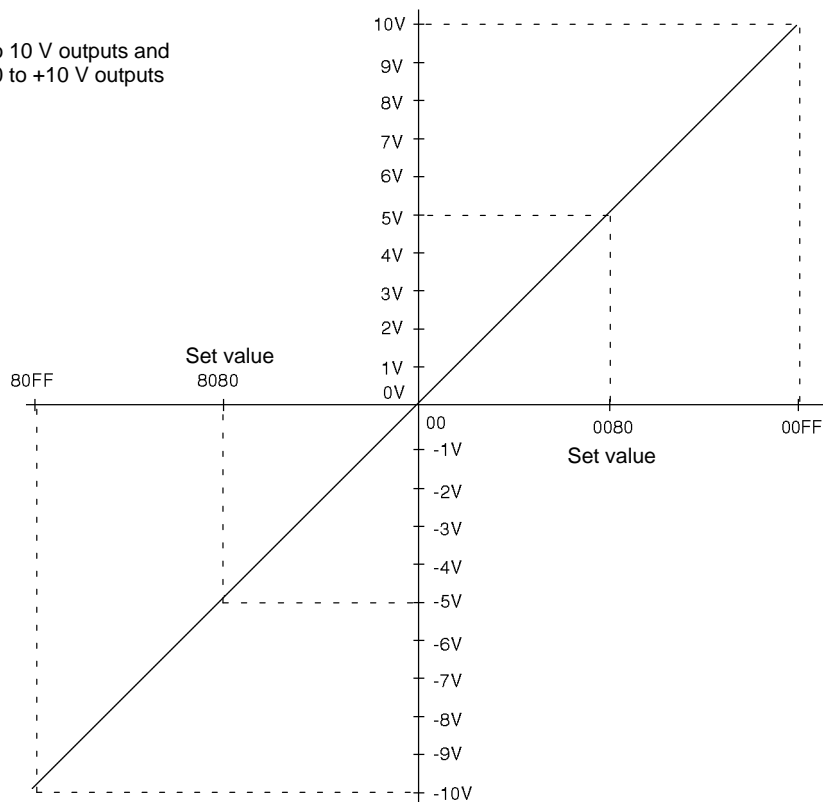

4 to 20 mA outputs

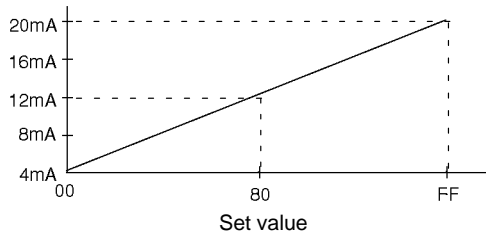

Set the I/O range

Analog inputs: 0 to 10 V, 1 to 5 V, or 4 to 20 mA
Analog outputs: 0 to 10 V, -10 to +10 V, or 4 to 20 mA



Connect the Unit

Connect the Analog I/O Unit.



Wire the analog I/O

Connect an analog input device.



Create a ladder program

Write the range code.
Analog input: Read converted data.
Analog output: Write set value.

Analog Inputs

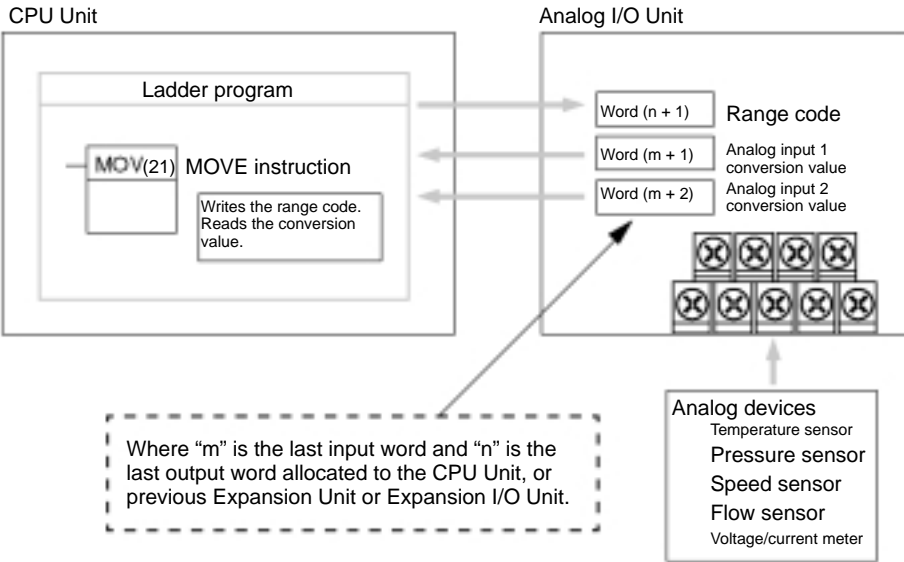

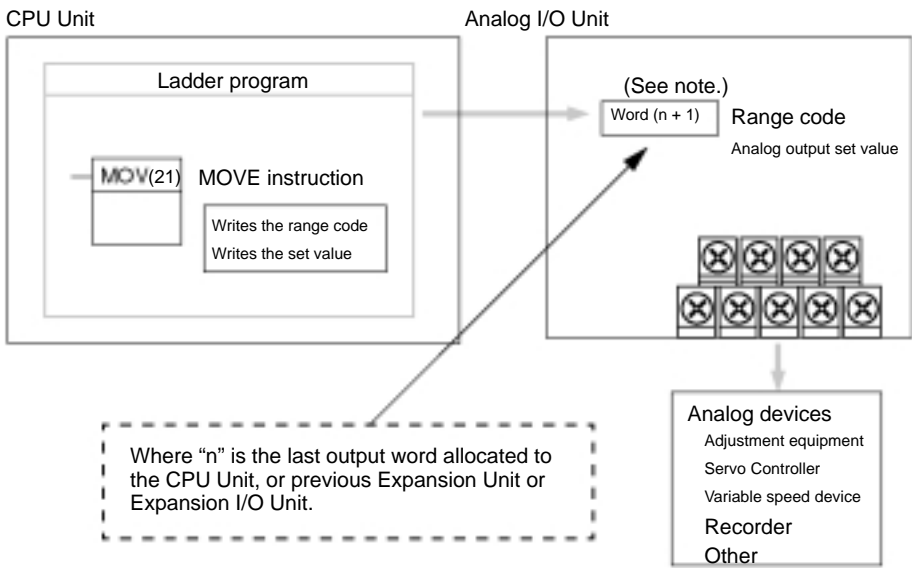

Note Word (n + 1) can be used for either the range code or the analog output set value.

Setting I/O Signal Range

The I/O signal range is set by wiring the I/O terminal and by writing the range code to the Analog I/O Unit's output word.

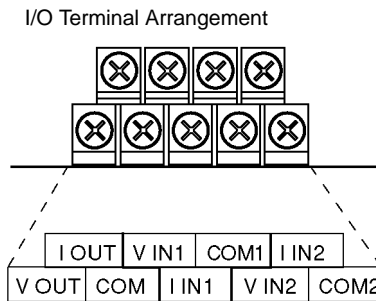

Note When using current inputs, short terminal V IN1 with I IN1 and terminal V IN2 with I IN2.

V OUT	Voltage output
I OUT	Current output
COM	Output common
V IN1	Voltage input 1
I IN1	Current input 1
COM1	Input common 1
V IN2	Voltage input 2
I IN2	Current input 2
COM2	Input common 2

Range Code

The range code must be set for the Analog I/O Unit to convert data.

The 8 range code settings provide 8 combinations of signal ranges for the analog inputs and analog output, as shown in the following table.

Code	Signal range	Signal range	Signal range
FF00	0 to 10 V	0 to 10 V	0 to 10 V or 4 to 20 mA
FF01	0 to 10 V	0 to 10 V	-10 to 10 V or 4 to 20 mA
FF02	1 to 5 V or 4 to 20 mA	0 to 10 V	0 to 10 V or 4 to 20 mA
FF03	1 to 5 V or 4 to 20 mA	0 to 10 V	-10 to 10 V or 4 to 20 mA
FF04	0 to 10 V	1 to 5 V or 4 to 20 mA	0 to 10 V or 4 to 20 mA
FF05	0 to 10 V	1 to 5 V or 4 to 20 mA	-10 to 10 V or 4 to 20 mA
FF06	1 to 5 V or 4 to 20 mA	1 to 5 V or 4 to 20 mA	0 to 10 V or 4 to 20 mA
FF07	1 to 5 V or 4 to 20 mA	1 to 5 V or 4 to 20 mA	-10 to 10 V or 4 to 20 mA

Write the range code to the Analog I/O Unit's output word (n + 1) in the first cycle of program execution.

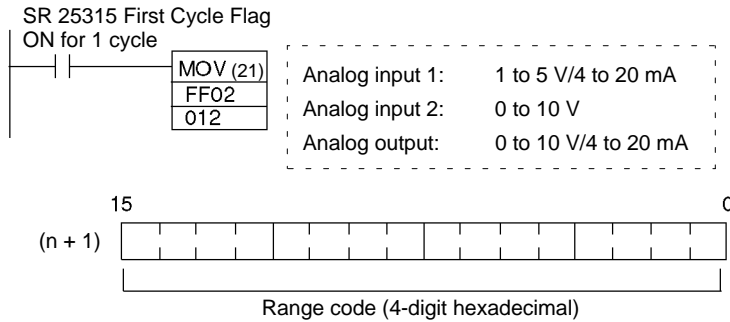

The Analog I/O Unit will not start converting analog I/O values until the range code has been written.

Once the range code has been set, it is not possible to change the setting while power is being supplied to the CPU Unit. To change the I/O range, turn the CPU Unit OFF then ON again.

Note If a range code other than those specified in the above table is written to n+1, the range code will not be received by the Analog I/O Unit and analog I/O conversion will not start.

Analog I/O Unit Connection

This section describes how to connect an Analog I/O Unit to the CPU Unit. A maximum of 3 Expansion Units or Expansion I/O Units, including Analog I/O Units, can be connected to one PC. When the Analog I/O Unit is used in combination with other Expansion Units or Expansion I/O Units, there are no restrictions on the connection order.

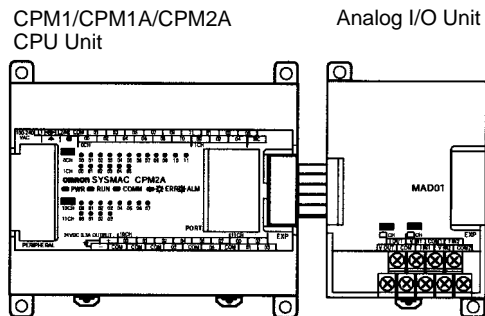

I/O Allocation

I/O is allocated for the Analog I/O Unit in the same way as other Expansion Units or Expansion I/O Units starting from the next word following the last allocated word on the CPU Unit, or previous Expansion Unit or Expansion I/O Unit. Where "m" is the last allocated input word and "n" the last allocated output word on the

be as follows:

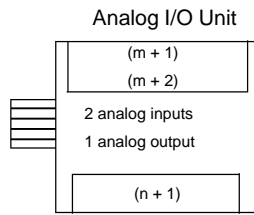

For example, in the following diagram an Analog I/O Unit is connected to a CPU Unit with 30 I/O points.

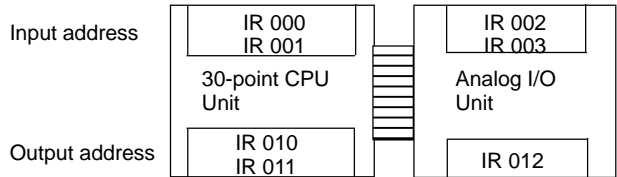

Wiring Analog I/O Devices

Analog Input Wiring

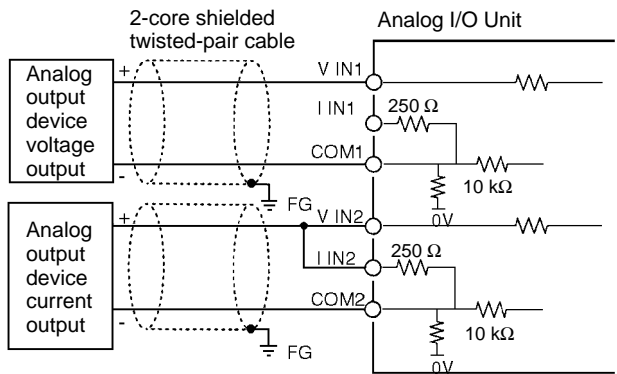

Analog Output Wiring

Voltage Outputs

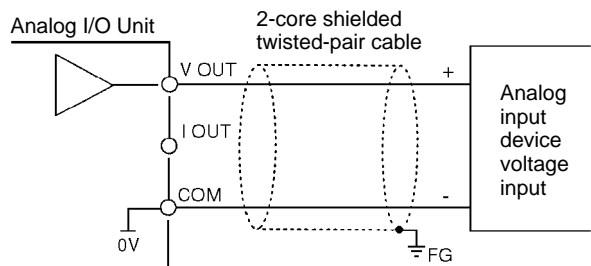

Current Outputs

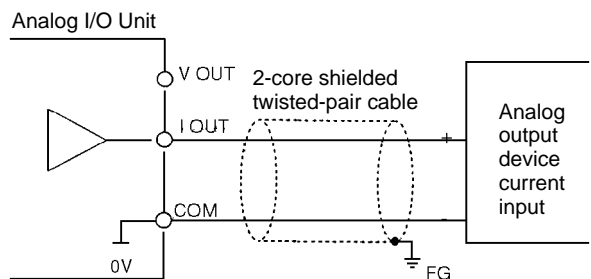

- Note**
1. Use 2-core shielded twisted-pair cables.
 2. Wire away from power lines (AC power supply wires, power lines, etc)
 3. When an input is not being used, short V IN and I IN to the COM terminal.
 4. Use crimp terminals. (Tighten terminals to a torque of 0.5 N·m.)
 5. When using current inputs, short V IN to I IN.
 6. When there is noise in the power supply line, install a noise filter on the input section and the Power Supply Unit.

Ladder Program

Specifying the Range Code

Specify the I/O signal range by writing the range code to the Analog I/O Unit's output word from the ladder program in the first cycle of program execution. Analog I/O Unit will start to convert analog I/O values once the range code has been specified. (Refer to page 166.)

Write the range code to the Analog I/O Unit's output word in the first cycle of program execution; the Analog I/O Unit's output word is "n+1" when "n" is the last word allocated to the CPU Unit, or previous Expansion Unit or Expansion I/O Unit in the configuration.

Reading Converted Analog Input Values

A ladder program can be used to read the memory area where the converted analog input values are stored. Values are output to the next two words (m + 1, m + 2) following the last input word (m) allocated to the CPU Unit, or previous Expansion Unit or Expansion I/O Unit.

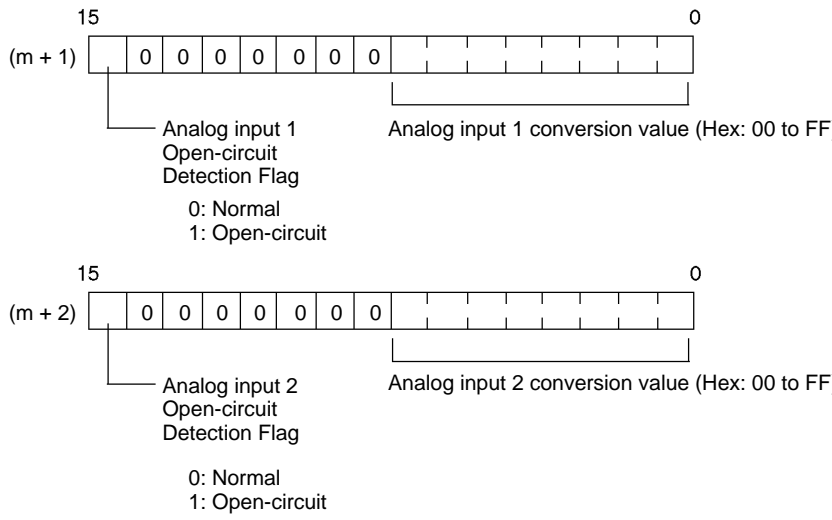

Note The Open-circuit Detection Flag is turned ON when the input signal range is set to 1 to 5 V or 4 to 20 mA and the input signal falls below 1 V or 4 mA. (Open-circuits are not detected when the input signal range is set to 0 to 10 V.)

A ladder program can be used to write data to the output word where the set value is stored. The output word will be “n+1” when “n” is the last output word connected to the CPU Unit, or previous Expansion Unit or Expansion I/O Unit.

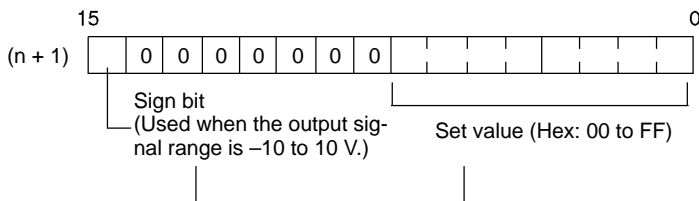

- 1, 2, 3...**
1. The set value range is 0000 to 00FF when the output signal range is 10 V/4 to 20 mA.
 2. The set value range is divided into two parts: 80FF to 8000 (-10 to 0 V) 0000 to 00FF (0 to 10 V) when the output signal range is -10 to 10 V.

Startup Operation

After power is turned ON, it will require two cycle times plus approx. 100 ms before the first data is converted. The following instructions can be placed at beginning of the program to delay reading converted data from analog input until conversion is actually possible.

Note Analog input data will be 0000 until initial processing has been completed. Analog output data will be 0 V or 0 mA until the range code has been written. After range code has been written, the analog output data will be 0 V or 4 mA if the range is 0 to 10 V, -10 to 10 V, or 4 to 20 mA.

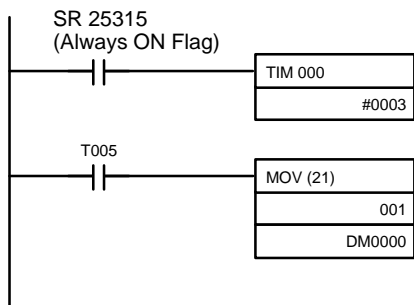

TIM 000 will start as soon as power turns ON. After 0.2 to 0.3 s (200 to 300 ms), the Completion Flag for TIM 000 will turn ON, and the converted data from analog input will be read from IR 001 and stored in DM 0000.

Handling Unit Errors

If an error occurs in an Analog I/O Unit, the Error Flags in AR 0200 to AR 0204 will be turned ON. The addresses of the Error Flags are in the order that the Expansion Units and Expansion I/O Units are connected in the PC, with AR 0200 used for the Expansion Unit or Expansion I/O Unit closest to the CPU Unit. Use the error flags in the program when it is necessary to detect errors.

When an error occurs in the Analog I/O Unit, analog input data will be 0000 and 0 V or 4 mA will be output as the analog output.

This programming example uses these ranges:
 Analog input 0: 0 to 10 V
 Analog input 1: 1 to 5 V or 4 to 20 mA
 Analog output: 0 to 10 V or 4 to 20 mA

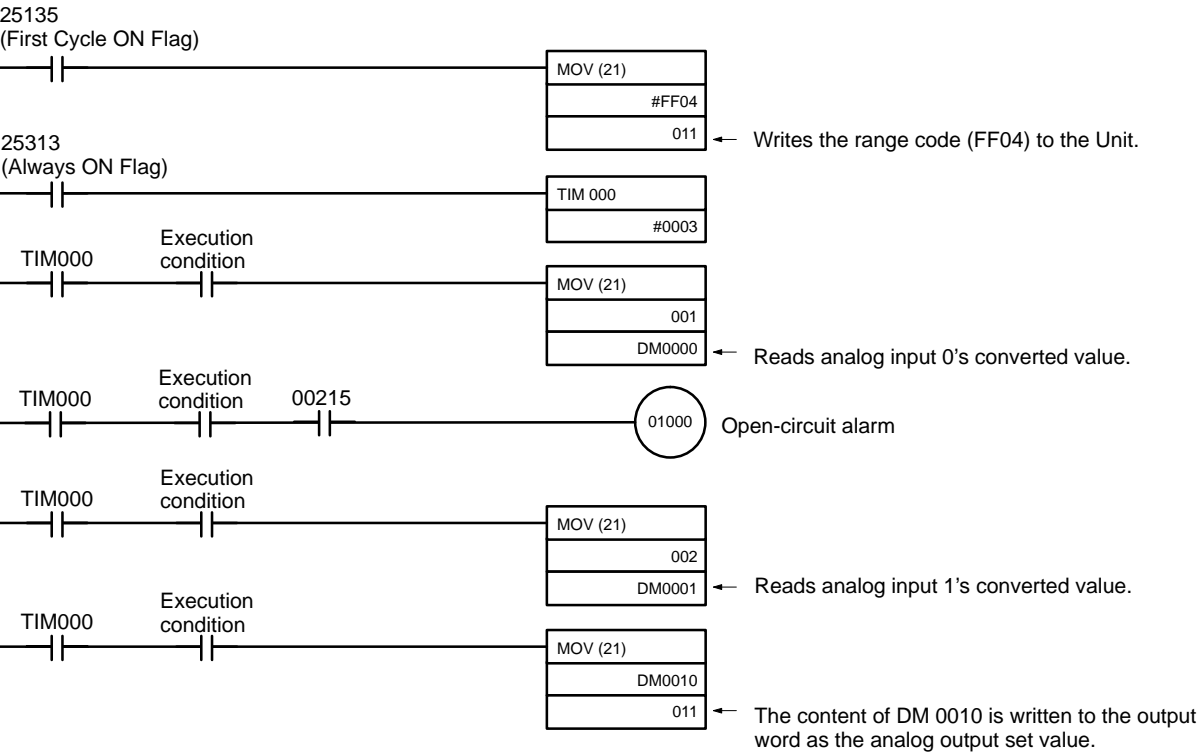

Example

Analog Input Program Example

Analog I/O Unit Connection

In this example, an Analog I/O Unit is connected to a CPU Unit with 30 I/O points. 30 I/O words are allocated to the Analog I/O Unit beginning with the next word address following the last words allocated to the CPU Unit.

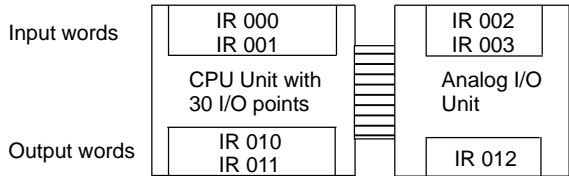

Using analog input 1 as a voltage input

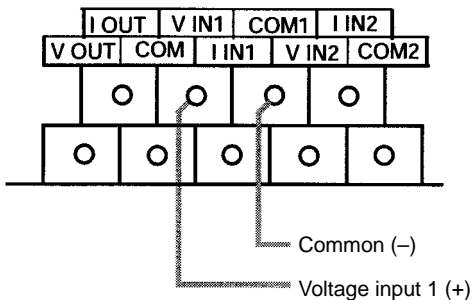

Using analog input 2 as a current input

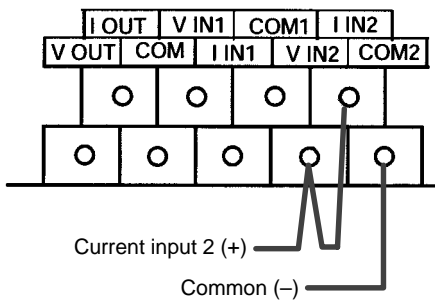

Using analog output as a voltage output

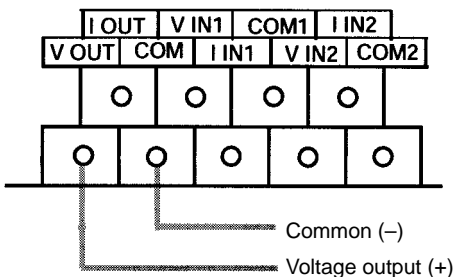

Analog I/O Settings

Input 1 signal range: 0 to 10 V
 Input 2 signal range: 4 to 20 mA
 Output signal range: 0 to 10 V
 Range Code Setting: FF04

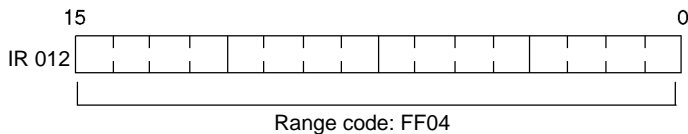

Program

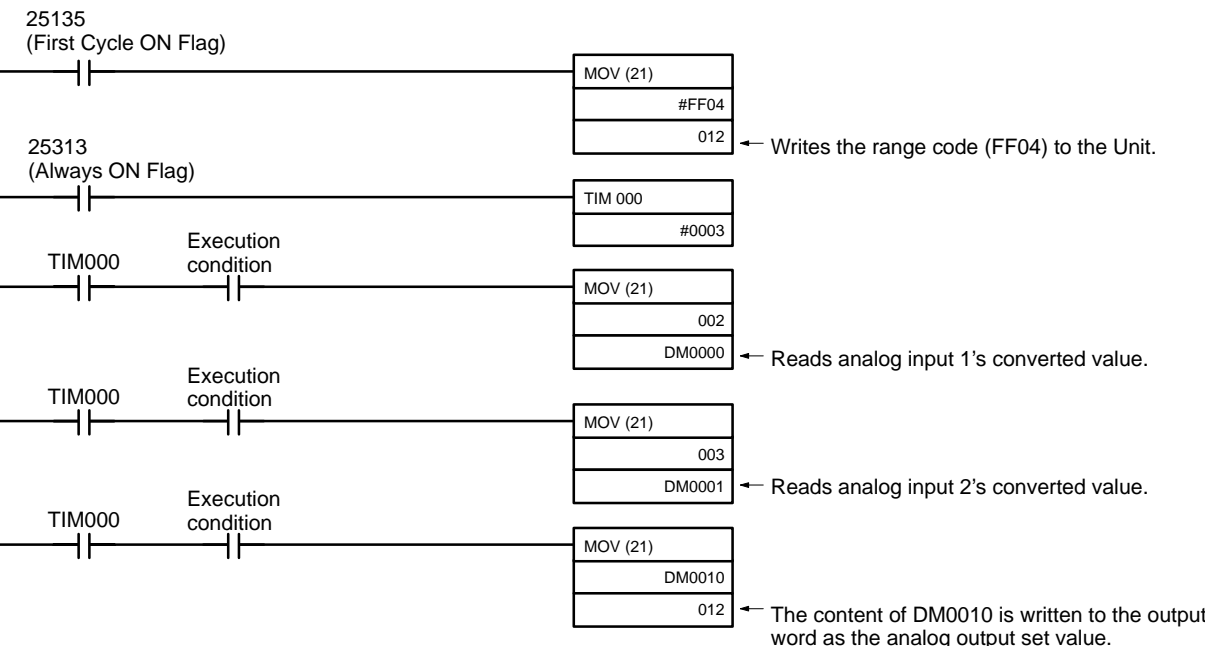

The following information applies to both the CPM1A-MAD11 and CPM1A-MAD11 Analog I/O Units unless otherwise specified.

A maximum of 3 Expansion Units or Expansion I/O Units, including up to 3 CPM1A-MAD11 Analog I/O Units, can be connected to a CPM2A or CPM1A-MAD11. One Analog I/O Unit allows 2 analog inputs and 1 analog output. With the maximum of 3 Analog I/O Units connected, 6 analog inputs and 3 analog outputs are possible.

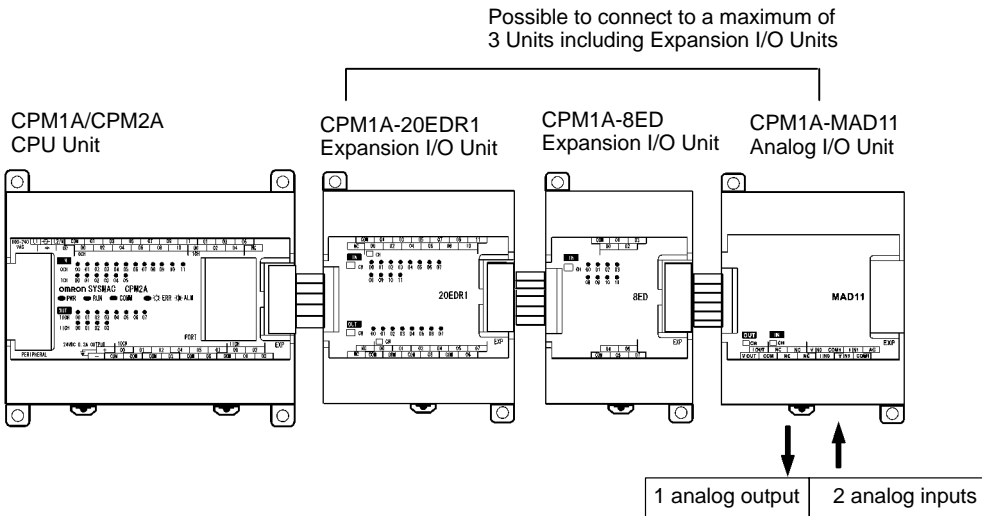

A maximum of 5 Expansion Units or Expansion I/O Units, including up to 5 CPM2C-MAD11 Analog I/O Units, can be connected to a CPM2C (A maximum of 3 Units can be connected to the CPM2C-S). One Analog I/O Unit allows 2 analog inputs and 1 analog output. With the maximum of 4 Analog I/O Units connected, 8 analog inputs and 4 analog outputs are possible.

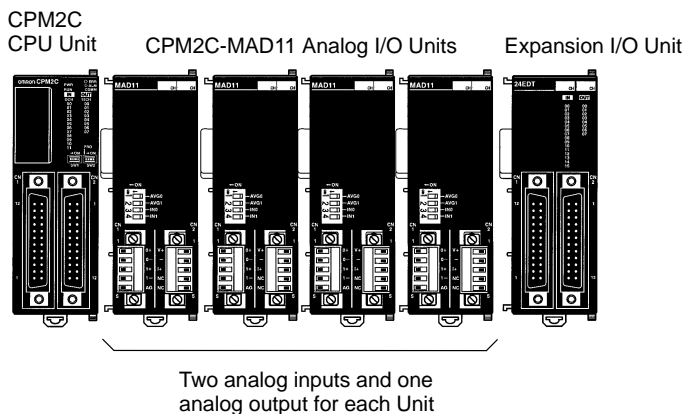

- The analog input range can be set to 0 to 5 VDC, 1 to 5 VDC, 0 to 10 VDC, to 10 VDC, 0 to 20 mA, or 4 to 20 mA. The inputs have a resolution of 1/6000.
- An open-circuit detection function can be used with the 1 to 5 VDC and 20 mA settings.
- The analog output range can be set to 1 to 5 VDC, 0 to 10 VDC, -10 to 10 VDC, 0 to 20 mA, or 4 to 20 mA. The outputs have a resolution of 1/6000.

Analog Input Function	Number of inputs		2 inputs (2 words allocated)	
	Input signal range		0 to 5 VDC, 1 to 5 VDC, 0 to 10 VDC, or -10 to 10 VDC	0 to 20 mA or 4 to 20 mA
	Max. rated input		±15 V	±30 mA
	External input impedance		1 MΩ min.	250 Ω
	Resolution		1/6000 (full scale)	
	Overall accuracy	25°C	0.3% full scale	0.4% full scale
		0 to 55°C	0.6% full scale	0.8% full scale
	A/D conversion data		16-bit binary (4-digit hexadecimal) Full scale for -10 to 10 V: F448 to 0BB8 Hex Full scale for other ranges: 0000 to 1770 Hex	
	Averaging function		Supported (Settable for individual inputs via DIP switch)	
	Open-circuit detection function		Supported	
Analog Output Function	Number of outputs		1 output (1 word allocated)	
	Output signal range		1 to 5 VDC, 0 to 10 VDC, or -10 to 10 VDC,	0 to 20 mA or 4 to 20 mA
	Allowable external output load resistance		1 kΩ min.	600 Ω max.
	External output impedance		0.5 Ω max.	---
	Resolution		1/6000 (full scale)	
	Overall accuracy	25°C	0.4% full scale	
		0 to 55°C	0.8% full scale	
	Set data (D/A conversion)		16-bit binary (4-digit hexadecimal) Full scale for -10 to 10 V: F448 to 0BB8 Hex Full scale for other ranges: 0000 to 1770 Hex	
Conversion time		2 ms/point (6 ms/all points)		
Isolation method		Photocoupler isolation between analog I/O terminals and internal circuitry No isolation between analog I/O signals.		

M1A-MAD11 Part Names

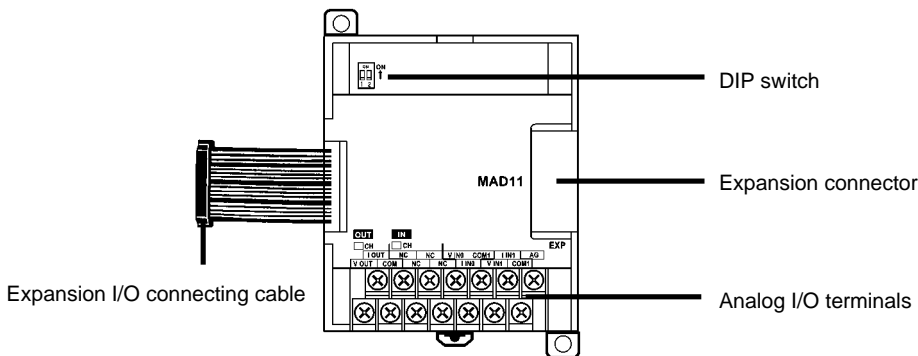

Analog I/O Terminals

Connected to analog I/O devices.

Expansion I/O Connecting Cable

Connected to the CPU Unit or previous Expansion Unit. The cable is provided with the Unit and cannot be removed.



Caution

Do not touch the cables during operation. Static electricity may cause operational errors.

Expansion Connector

Connected to the next Expansion Unit or Expansion I/O Unit.

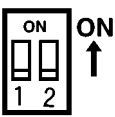

Pin1: Average processing for analog input 0
 (OFF: Average processing not performed; ON: Average processing performed)
 Pin2: Average processing for analog input 1
 (OFF: Average processing not performed; ON: Average processing performed)

M2C-MAD11 Part Names

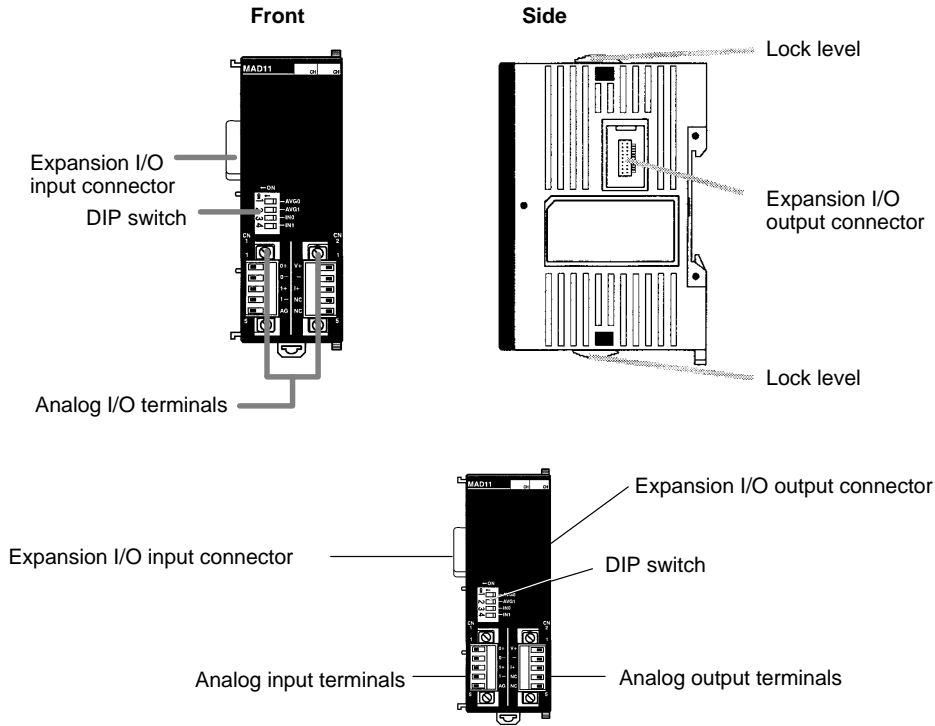

analog I/O Terminals

Connected to analog I/O devices.

Switch

Used to specify current or voltage inputs and to enable or disable averaging.

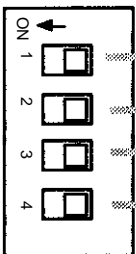

- 1 Average processing for analog input 0
(OFF: Average processing not performed; ON: Average processing performed)
- 2 Average processing for analog input 1
(OFF: Average processing not performed; ON: Average processing performed)
- 3 Input type for analog input 0
(OFF: Voltage input; ON: Current input)
- 4 Input type for analog input 1
(OFF: Voltage input; ON: Current input)



Caution

Do not touch the DIP switch during operation. Static electricity may cause operating errors.

Expansion I/O Input Connector

Connected to the expansion I/O output connector on the CPU Unit or previous Expansion (I/O) Unit.

Expansion I/O Output Connector

Connected to the expansion I/O input connector on the next Expansion (I/O) Unit.

Note

1. A maximum of 5 Expansion (I/O) Units can be connected to the CPU Unit and the total number of allocated words must be 10 maximum for inputs and 10 maximum for outputs.

**Caution**

Do not touch the cables during operation. Static electricity may cause operational errors.

Lock Levers

Used to secure the Expansion Unit.

Analog I/O Signal Ranges

Analog I/O signal ranges are digitally converted as described in this section.

Analog Input Signal Ranges

The Analog I/O Unit converts analog input data to digital values. The digital values depend on the input signal ranges, as shown in the following diagrams. When the input exceeds the specified range, the AD converted data will be fixed at either the lower limit or upper limit.

-10 to 10 V

The -10- to 10-V range corresponds to the hexadecimal values F448 to 0BB8 (-3000 to 3000). The entire data range is F31C to 0CE4 (-3300 to 3300). A negative voltage is expressed as a two's complement.

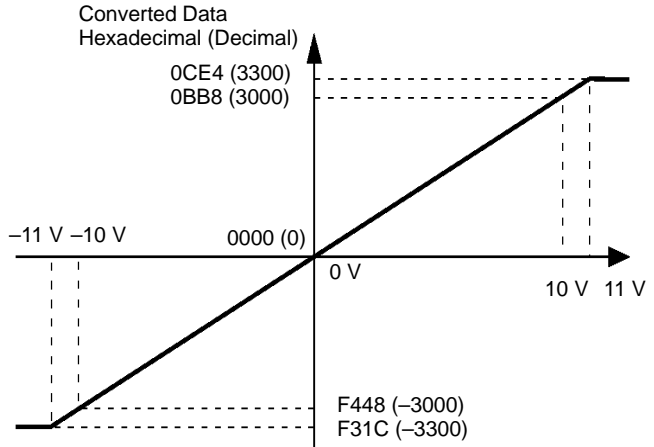
**0 to 10 V**

The 0- to 10-V range corresponds to the hexadecimal values 0000 to 1770 (-6000 to 6000). The entire data range is FED4 to 189C (-300 to 6300). A negative voltage is expressed as a two's complement.

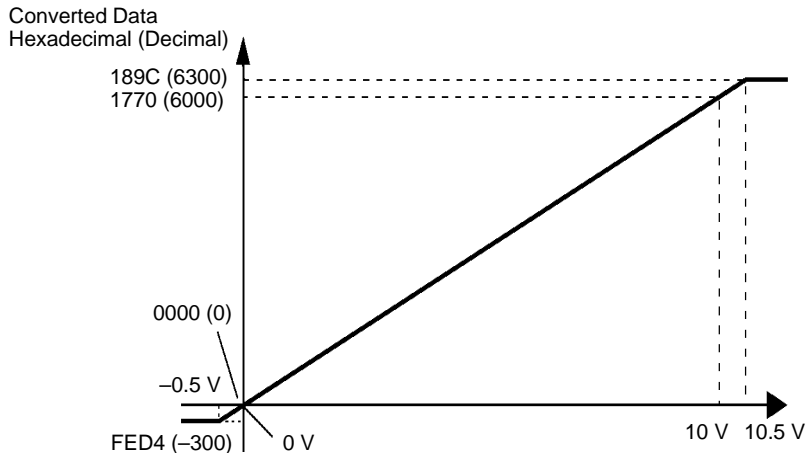

The 0- to 5-V range corresponds to the hexadecimal values 0000 to 1770 (6000). The entire data range is FED4 to 189C (-300 to 6300). A negative voltage is expressed as a two's complement.

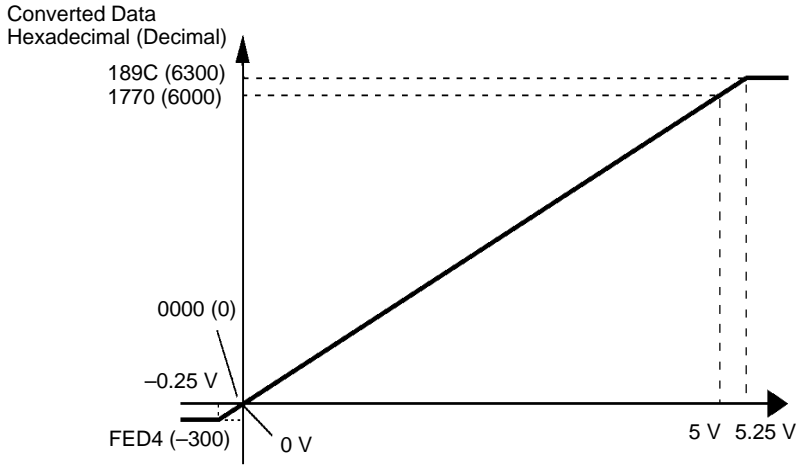

1 to 5 V

The 1- to 5-V range corresponds to the hexadecimal values 0000 to 1770 (6000). The entire data range is FED4 to 189C (-300 to 6300). Inputs between 0.8 and 1 V are expressed as two's complements. If the input falls below 0.8 V, open-circuit detection will activate and converted data will be 8000.

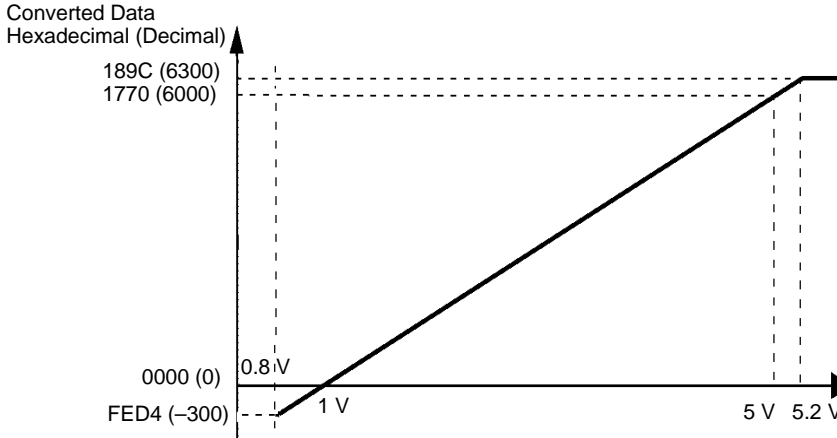

0 to 20 mA

The 0- to 20-mA range corresponds to the hexadecimal values 0000 to 1770 (6000). The entire data range is FED4 to 189C (-300 to 6300). A negative current is expressed as a two's complement.

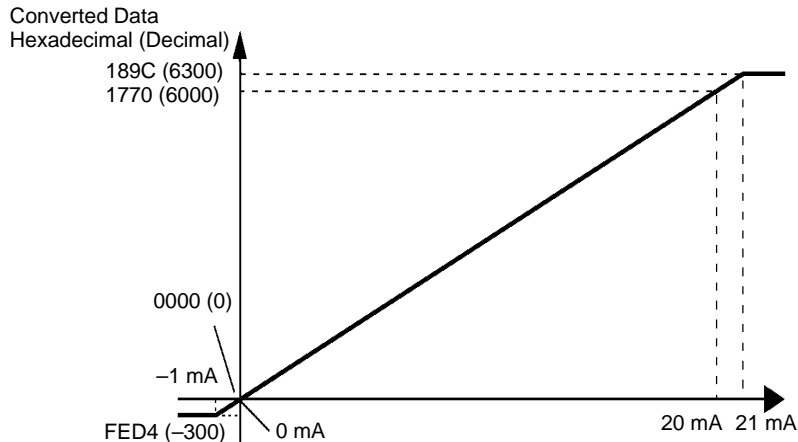

The 4 to 20 mA range corresponds to the hexadecimal values 0000 to 1770 (0 to 6000). The entire data range is FED4 to 189C (−300 to 6300). Inputs between 3.2 and 4 mA are expressed as two's complements. If the input falls below 3.2 mA, open-circuit detection will activate and converted data will be 8000.

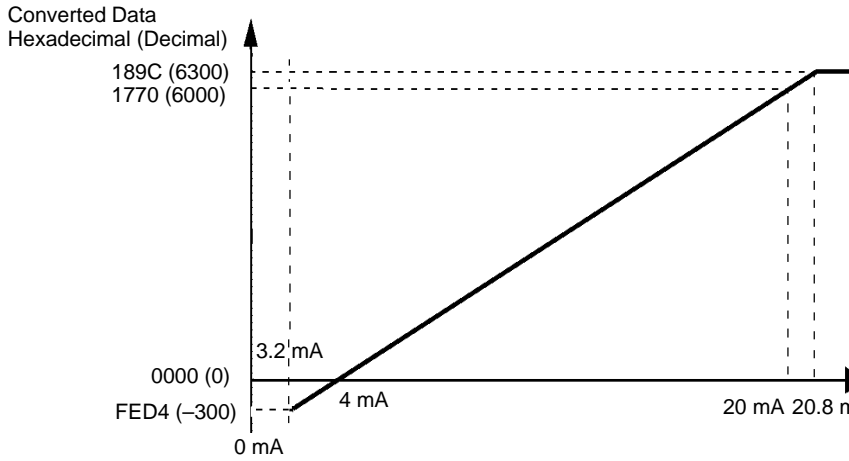

Log Output Signal Ranges

The Analog I/O Unit converts the digital output data to analog values. The analog values depend on the output signal ranges, as shown in the following diagrams.

−10 to 10 V

The hexadecimal values F448 to 0BB8 (−3000 to 3000) correspond to an analog voltage range of −10 to 10 V. The entire output range is −11 to 11 V. Specify a negative voltage as a two's complement.

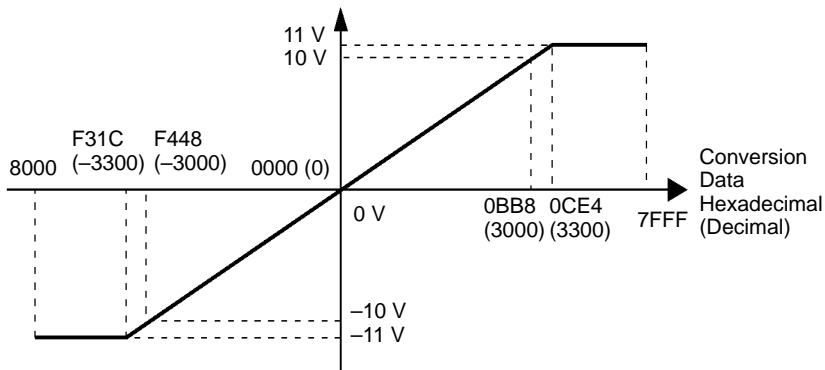

0 to 10 V

The hexadecimal values 0000 to 1770 (0 to 6000) correspond to an analog voltage range of 0 to 10 V. The entire output range is −0.5 to 10.5 V. Specify a negative voltage as a two's complement.

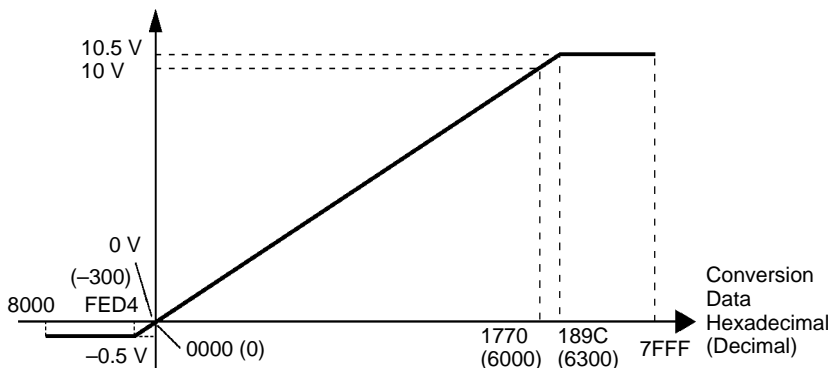

The hexadecimal values 0000 to 1770 (0 to 6000) correspond to an analog range of 1 to 5 V. The entire output range is 0.8 to 5.2 V.

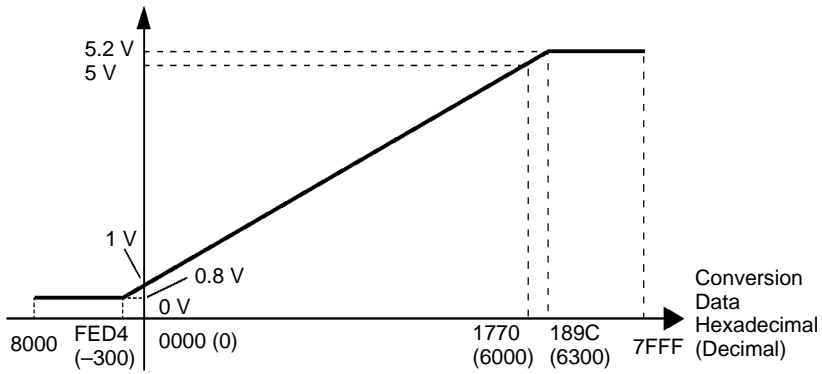

0 to 20 mA

The hexadecimal values 0000 to 1770 (0 to 6000) correspond to an analog current range of 0 to 20 mA. The entire output range is 0 to 21 mA.

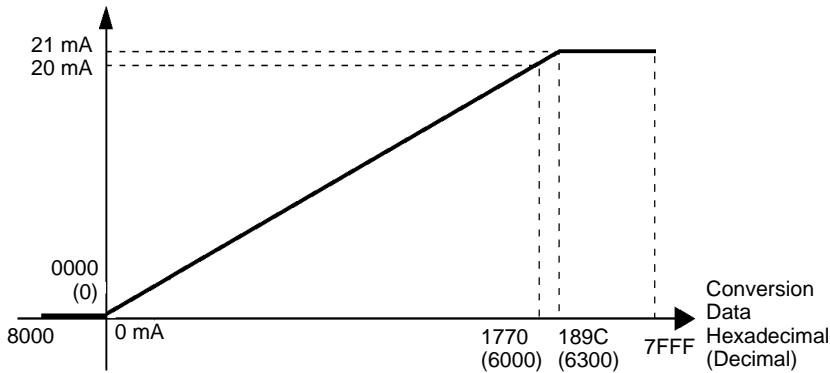

4 to 20 mA

The hexadecimal values 0000 to 1770 (0 to 6000) correspond to an analog current range of 4 to 20 mA. The entire output range is 3.2 to 20.8 mA.

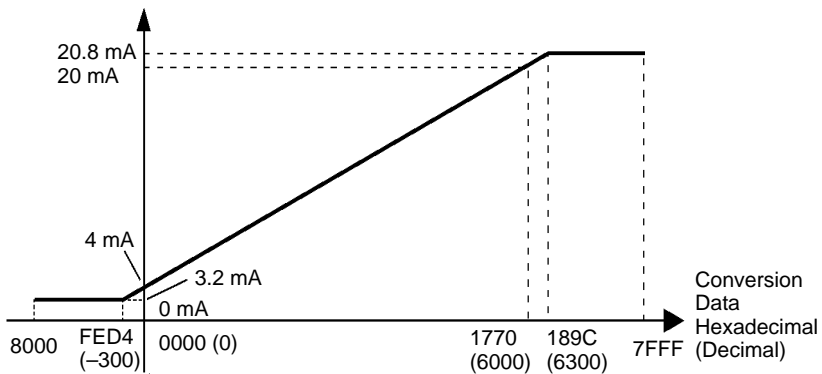

Averaging Function for Analog Inputs

The averaging function can be enabled for inputs using the DIP switch. The averaging function stores the average (a moving average) of the last eight input values as the converted value. Use this function to smooth inputs that vary over a short interval.

Open-Circuit Detection Function for Analog Inputs

The open-circuit detection function is activated when the input range is set to 5 V and the voltage drops below 0.8 V, or when the input range is set to 20 mA and the current drops below 3.2 mA. When the open-circuit detection function is activated, the converted data will be set to 8000.

verted. If the input returns to the convertible range, the open circuit detection is cleared automatically and the output returns to the normal range.

Configuring Analog I/O

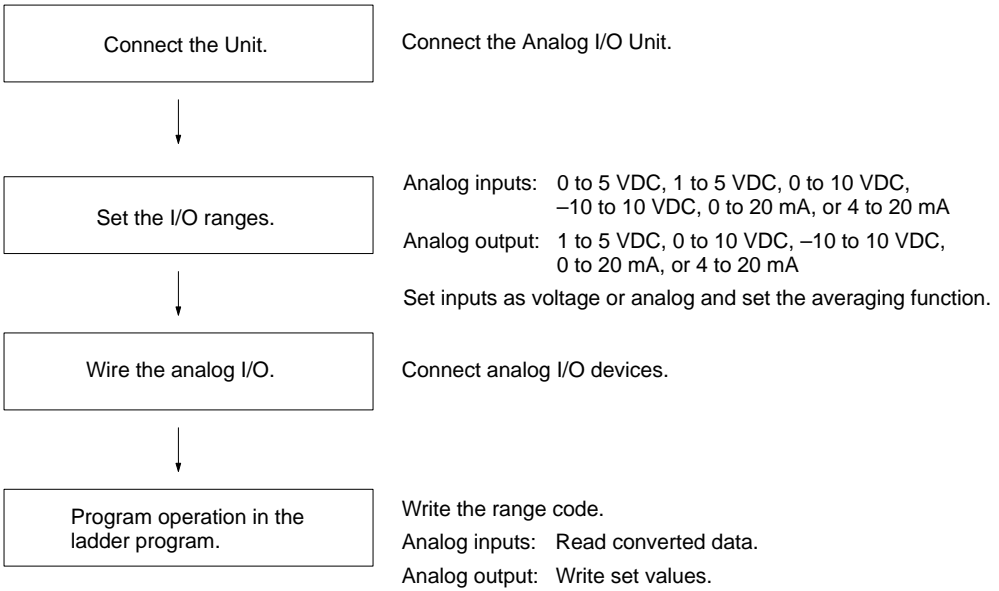

Analog Inputs

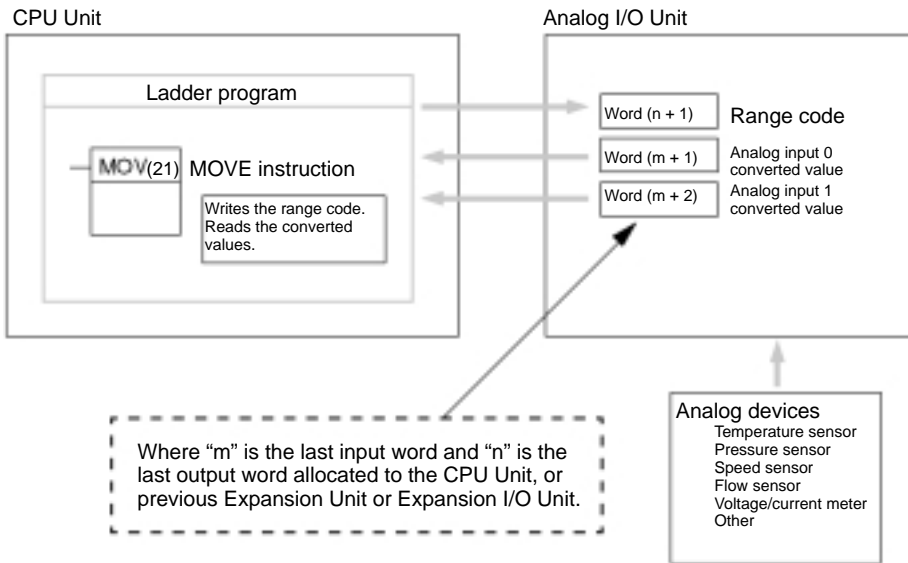

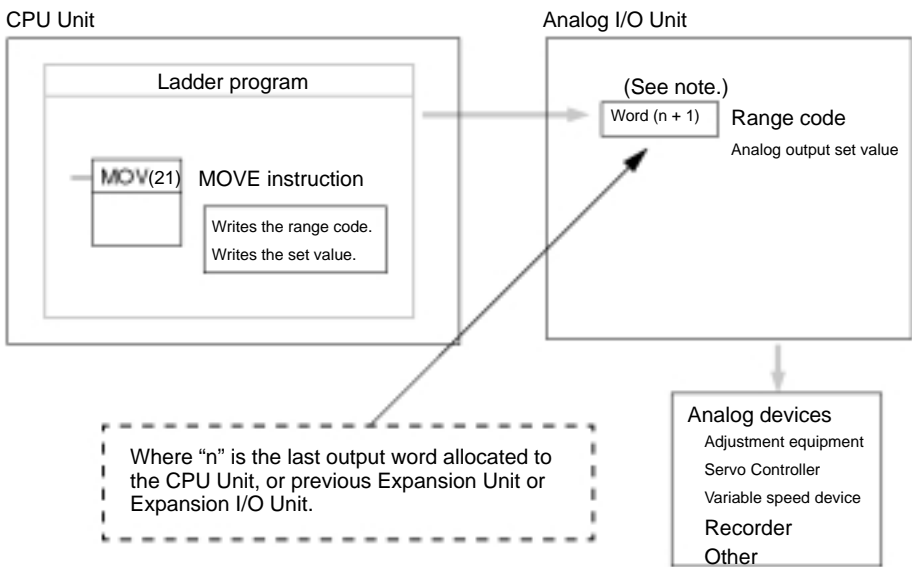

Note Word (n + 1) can be used for either the range code or the analog output set value.

Connecting the CPM1A-MAD11 Analog Unit

This section describes how to connect an Analog I/O Unit to the CPU Unit. A maximum of 3 Expansion Units or Expansion I/O Units, including up to 3 Analog I/O Units, can be connected to one CPM2A or CPM1A PC. When the Analog I/O Unit is used in combination with other Expansion Units or Expansion I/O Units, there are no restrictions on the connection order.

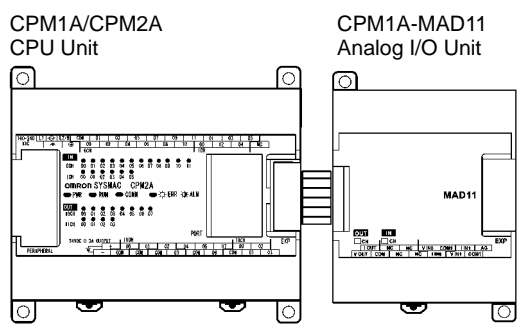

I/O Allocation

I/O is allocated for the Analog I/O Unit in the same way as other Expansion Units or Expansion I/O Units starting from the next word following the last allocated word on the CPU Unit or previous Expansion Unit or Expansion I/O Unit. Where "m" is the last allocated input word and "n" the last allocated output word on the CPU Unit, or previous Expansion Unit or Expansion I/O Unit, the allocation can be as follows:

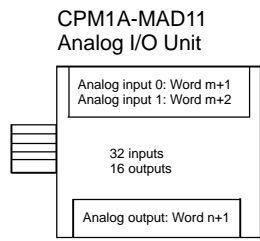

Unit with 30 I/O points.

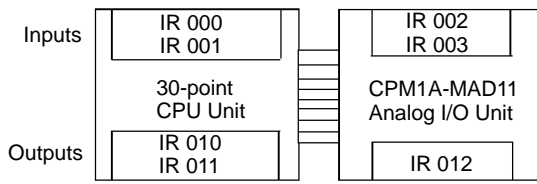

Connecting the CPM2C-MAD11 Analog I/O Unit

This section describes how to connect an Analog I/O Unit to the CPU Unit. A maximum of 5 Expansion Units or Expansion I/O Units (a maximum of 3 Units for the CPM2C-S), including up to 4 Analog I/O Units, can be connected to the CPM2C PC. When the Analog I/O Unit is used in combination with other Expansion Units or Expansion I/O Units, there are no restrictions on the connection order.

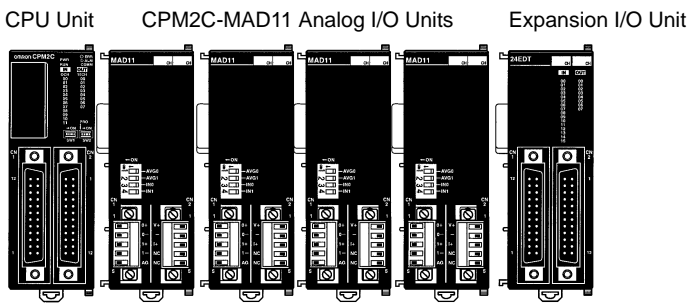

I/O Allocation

I/O is allocated for the Analog I/O Unit in the same way as other Expansion Units or Expansion I/O Units starting from the next word following the last allocated word on the CPU Unit or previous Expansion Unit or Expansion I/O Unit. Word "m" is the last allocated input word and "n" the last allocated output word on the CPU Unit, or previous Expansion Unit or Expansion I/O Unit, the allocation can be as follows:

CPM2C-MAD11 Analog I/O Unit

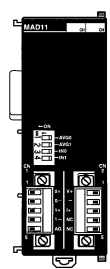

- Analog input 0: Word m+1
- Analog input 1: Word m+2
- Analog output: Word n+1

For example, in the following diagram an Analog I/O Unit is connected to a CPU Unit with 20 I/O points.

CPU Unit CPM2C-MAD11 Analog I/O Unit

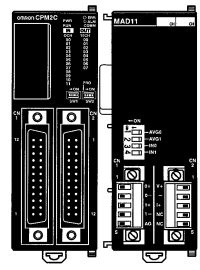

- CPU Unit inputs: IR 000
- Analog input 0: IR 001
- Analog input 1: IR 002
- CPU Unit outputs: IR 010
- Analog output: IR 011

The range code settings provide the combinations of signal ranges for the analog inputs and analog output, as shown in the following table.

Voltage/current selections for the CPM1A-MAD11 are made by connecting appropriate terminals. Refer to page 184 for details.

Voltage/current selections for the CPM2C-MAD11 are made using pins 3 and 4 on the DIP switch. refer to page 175 for details.

Range code	Analog input 1 signal range	Analog input 2 signal range	Analog output signal range
000	-10 to 10 V		-10 to 10 V
001	0 to 10 V		0 to 10 V
010	1 to 5 V or 4 to 20 mA		1 to 5 V
011	1 to 5 V or 0 to 20 mA		0 to 20 mA
100	---		4 to 20 mA

Note Be sure to write the correct terminals or set the DIP switch to specify either voltage or current inputs.

Write the range codes to the Analog I/O Unit's output word (n + 1) in the first cycle of program execution.

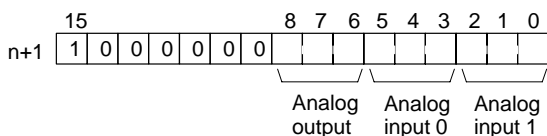

Example

The following instructions set analog input 0 to 4 to 20 mA, analog input 1 to 0 to 10 V, and the analog output to -10 to 10 V.

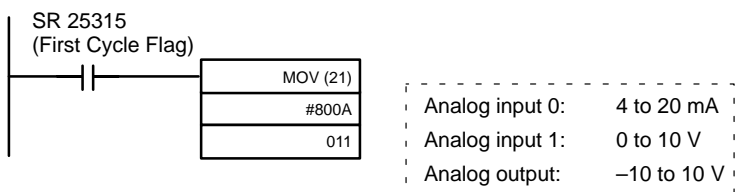

The Analog I/O Unit will not start converting analog I/O values until the range code has been written. Until conversion starts, inputs will be 0000, and 0 mA will be output.

After the range code has been set, 0 V or 0 mA will be output for the 0 to 10 V, -10 to 10-V, or 0 to 20-mA ranges, and 1 V or 4 mA will be output for the 1 to 5 V and 4 to 20-mA ranges until a convertible value has been written to the output word.

Once the range code has been set, it is not possible to change the setting while power is being supplied to the CPU Unit. To change the I/O range, turn the CPU Unit OFF then ON again.

Analog Inputs

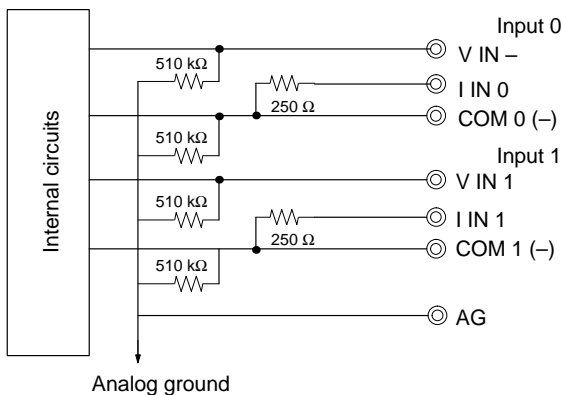

Analog Outputs

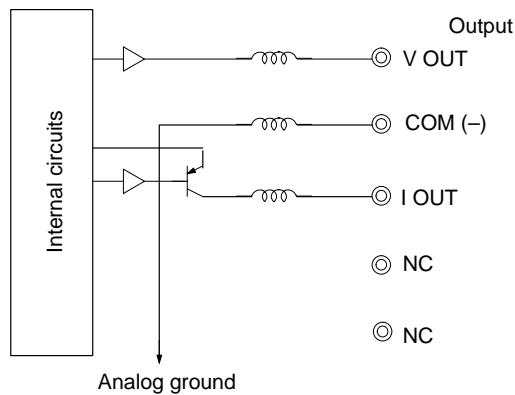

CPM1A-MAD11 Terminal Arrangements

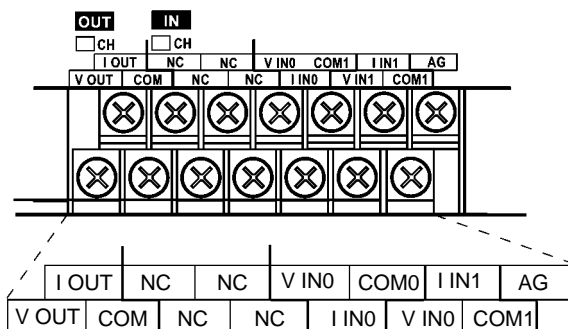

Label	Signal
V OUT	Voltage output
I OUT	Current output
COM	Output common
V IN 0	Voltage input 0
I IN 0	Current input 0
COM 0	Input common 0
V IN 1	Voltage input 1
I IN 1	Current input 1
COM 1	Input common 1

Note For current inputs, short V IN 0 to I IN 0 and V IN 1 to I IN 1

Wiring for Analog Inputs

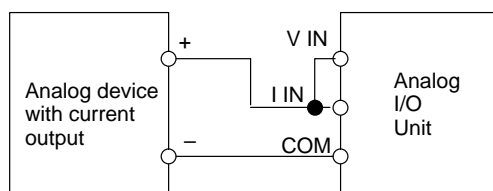
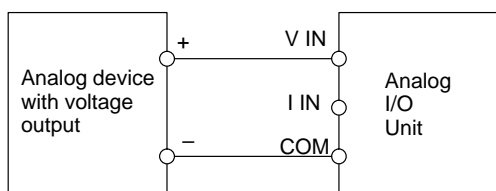

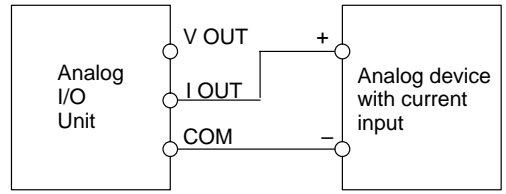
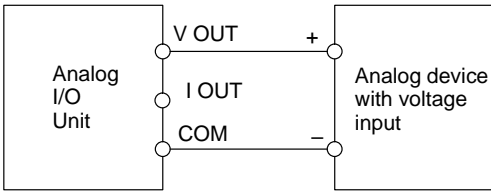

- Note**
1. Use shielded twisted-pair cables, but do not connect the shield.
 2. When an input is not being used, short the + and – terminals.
 3. Separate wiring from power lines (AC power supply lines, high-voltage lines, etc.)
 4. When there is noise in the power supply line, install a noise filter on the power supply section and the Power Supply Unit.

CPM2C-MAD11 Internal Circuits

Analog Inputs

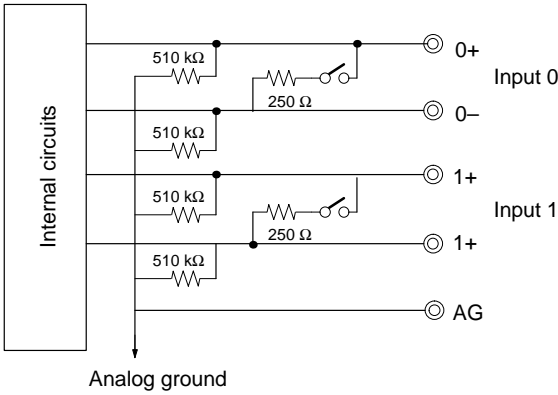

Analog Outputs

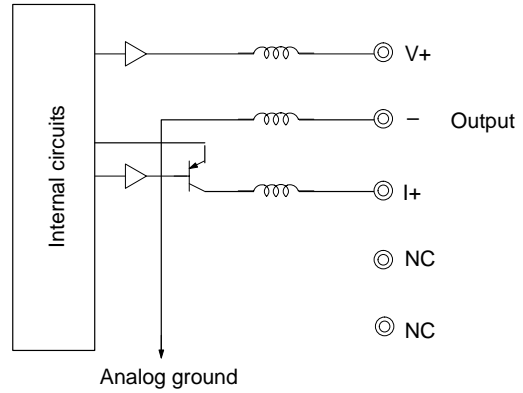

CPM2C-MAD11 Terminal Arrangements

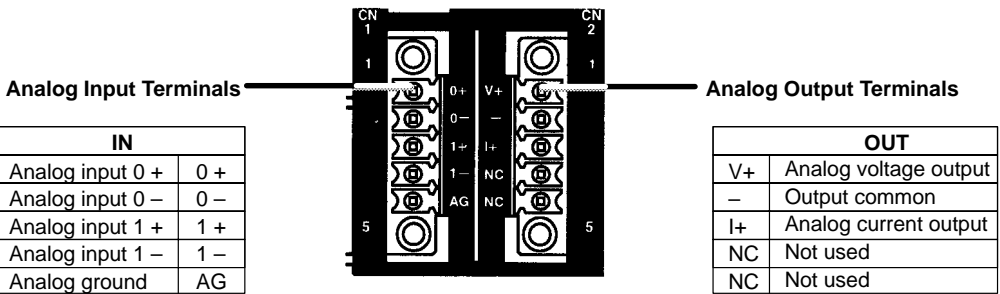

Analog Input Wiring

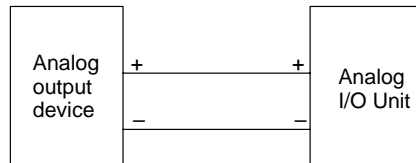

Analog Output Wiring

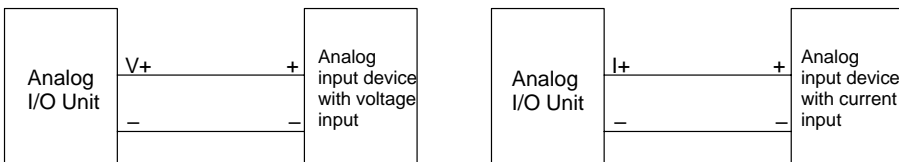

2. When an input is not being used, short the + and – terminals.
3. Separate wiring from power lines (AC power supply lines, high-voltage lines, etc.)
4. When there is noise in the power supply line, install a noise filter on the input section and the Power Supply Unit.

Reference Information

Consider the following information on open input circuits when using voltage inputs.

If the same power supply is used as shown in the following diagram and an open circuit occurs at point A or B, an unwanted current flow will occur as shown by the dotted lines in the diagram, creating a voltage at the other input of about 1/3 to 1/2. If the 1 to 5-V range is being used, the open-circuit detection function will not operate. Also, if there is an open circuit at C, the open-circuit detection function will not operate because the negative sides are the same.

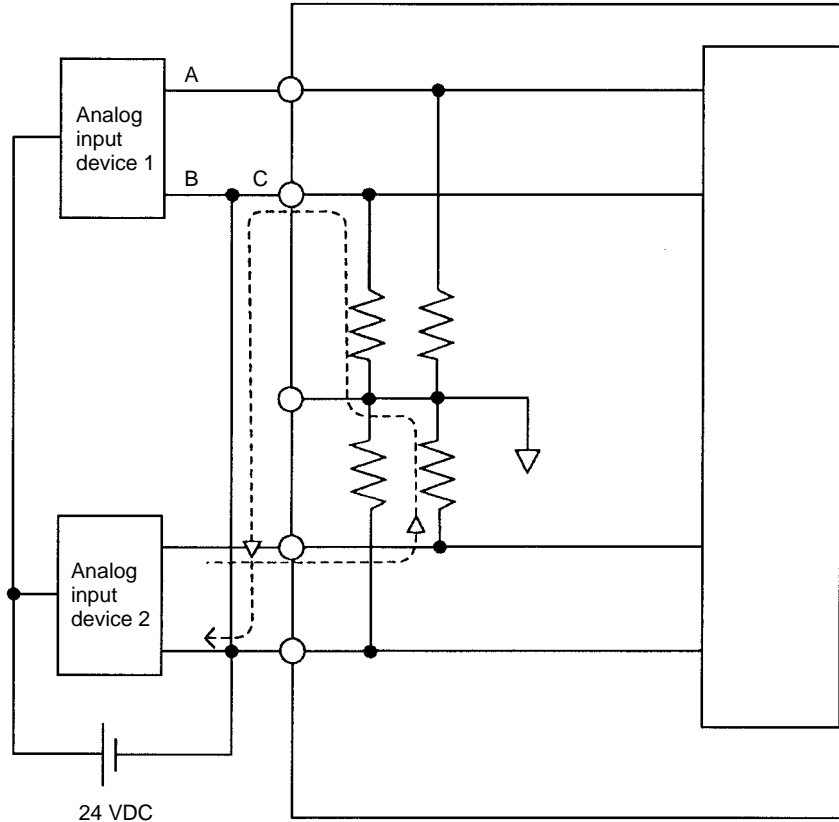

For example, if analog input device 2 is outputting 5 V and the same power supply is being used as shown above, about 1/3, or 1.6 V, will be applied at the input for input device 1.

To eliminate the above problem, either use separate power supplies, or install an isolator at each input. This problem will not occur for current inputs even if the same power supply is used.

Note When power is supplied (when setting the range code), or when there is a power interruption, pulse-form analog output of up to 1 ms may be generated. If this causes problems with operation, take countermeasure such as those suggested below.

- Turn ON the power supply for the CPU Unit first, and then turn ON the power supply for the load after confirming correct operation.

Specifying the Range Code

Specify the I/O signal range by writing the range code to the Analog I/O Unit output word from the ladder program in the first cycle of program execution. Analog I/O Unit will start to convert analog I/O values once the range code has been specified and convertible values are provided. (Refer to p. 10 for AUCUN LIEN.)

Write the range code to the Analog I/O Unit's output word in the first cycle of operation; the Analog I/O Unit's output word is "n+1" when "n" is the last word allocated to the CPU Unit, or previous Expansion Unit or Expansion I/O Unit in configuration.

Reading Converted Analog Input Values

The ladder program can be used to read the memory area where the converted values are stored. Values are output to the next two words (m + 1, m + 2) following the last input word (m) allocated to the CPU Unit or previous Expansion Unit or Expansion I/O Unit.

Writing Analog Output Set Values

The ladder program can be used to write data to the output word where the value is stored. The output word will be "n+1" when "n" is the last output word allocated to the CPU Unit, or previous Expansion Unit or Expansion I/O Unit.

Startup Operation

After power is turned ON, it will require two cycle times plus approx. 50 ms before the first data is converted. The following instructions can be placed at the beginning of the program to delay reading converted data from analog inputs until conversion is actually possible.

Note Analog input data will be 0000 until initial processing has been completed. Analog output data will be 0 V or 0 mA until the range code has been written. After the range code has been written, the analog output data will be 0 V or 0 mA if the range is 0 to 10 V, -10 to 10 V, or 0 to 20 mA, or it will be 1 V or 4 mA if the range is 1 to 5 V or 4 to 20 mA.

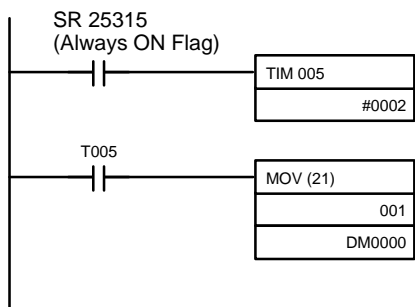

TIM 005 will start as soon as power turns ON. After 0.1 to 0.2 s (100 to 200 ms), the Completion Flag for TIM 005 will turn ON, and the converted data from analog input will be read from IR 001 and stored in DM 0000.

Handling Unit Errors

If an error occurs in an Analog I/O Unit, the Error Flags in AR 0200 to AR 0202 for the CPM2C and AR 0200 to AR 0202 for the CPM1A/CPM2A will be turned ON. The addresses of the Error Flags are in the order that the Expansion Units or Expansion I/O Units are connected in the PC, with AR 0200 used for the Expansion Unit or Expansion I/O Unit closest to the CPU Unit. Use these flags in your program when it is necessary to detect errors.

When an error occurs in the Analog I/O Unit, analog input data will be 0000 and 0 V or 0 mA will be output as the analog output.

If a CPU error or an I/O bus error (fatal errors) occurs at the CPU Unit and the analog output is set to 1 to 5 V or 4 to 20 mA, 0 V or 0 mA will be output. For other fatal errors at the CPU Unit, 1 V or 4 mA will be output.

This programming example uses these ranges:
 Analog input 0: 0 to 10 V
 Analog input 1: 4 to 20 mA
 Analog output: 0 to 10 V

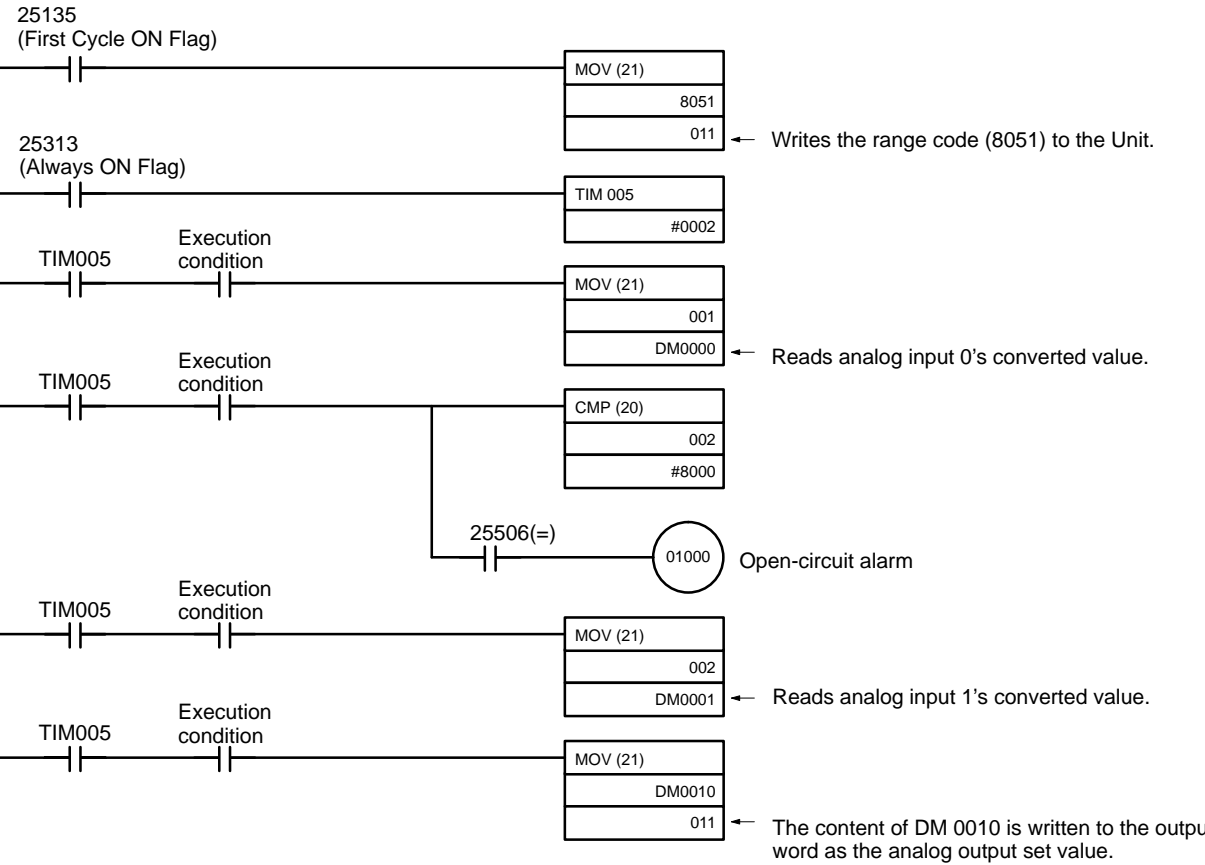

2-1 CPM1A/CPM2A Temperature Sensor Units

With the CPM1A or CPM2A, up to three Expansion Units or Expansion I/O Units can be connected to the CPU Unit. One, two, or three of these Units can be CPM1A-TS001 or CPM1A-TS101 Temperature Sensor Units. If a CPM1A-TS002 or CPM1A-TS102 Temperature Sensor Unit is connected to the CPU Unit, then only one other Expansion Unit or Expansion I/O Unit can be connected. The other Unit can be a CPM1A-TS001/TS101 Temperature Sensor Unit.

The CPM1A-TS001/TS101 Temperature Sensor Units each provide 2 input points and the CPM1A-TS002/TS102 Temperature Sensor Units each provide 4 input points, meaning up to 6 temperature input points can be used on a CPM1A or CPM2A PC. The inputs can be from thermocouples or platinum resistance thermometers.

Up to 3 Units, including Expansion I/O Units and other Expansion Units. (Only 2 Units if CPM1A-TS002/TS102 is used.)

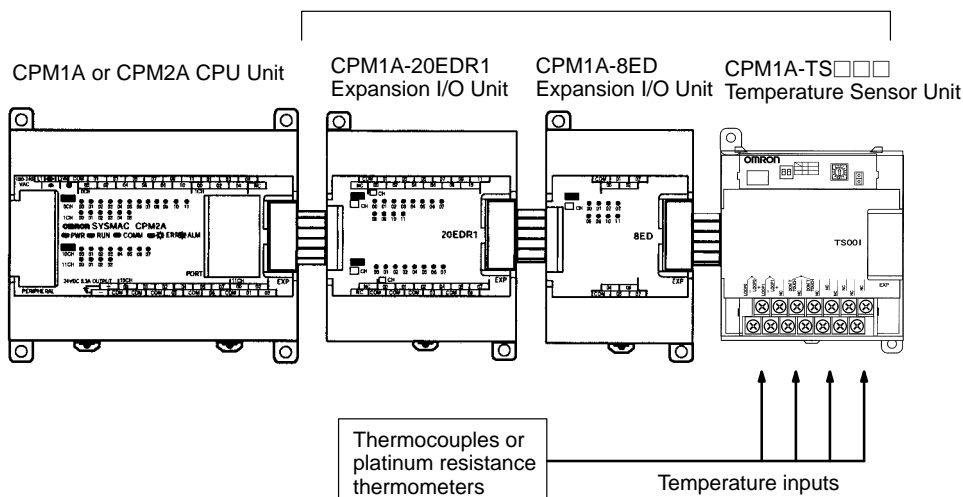

Specifications

Item	CPM1A-TS001	CPM1A-TS002	CPM1A-TS101	CPM1A-TS102
Temperature sensors	Thermocouples Switchable between K and J, but same type must be used for all inputs.		Platinum resistance thermometer Switchable between Pt100 and JPt100, same type must be used for all inputs.	
Number of inputs	2	4	2	4
Allocated input words	2	4	2	4
Max. number of Units (See note 1.)	3	1	3	1
Accuracy	(The larger of $\pm 0.5\%$ of converted value or $\pm 2^\circ\text{C}$) ± 1 digit max. (See note 2.)		(The larger of $\pm 0.5\%$ of converted value or $\pm 1^\circ\text{C}$) ± 1 digit max.	
Conversion time	250 ms for 2 or 4 input points			
Converted temperature data	16-bit binary data (4-digit hexadecimal)			
Isolation	Photocouplers between all temperature input signals			

Note 1. If only the CPM1A-TS001 and CPM1A-TS101 are connected, then up to 3 Expansion Units including Expansion I/O Units and other Expansion Units can be connected. If the CPM1A-TS002 or CPM1A-TS102 is connected, then only one other Expansion I/O Unit or Expansion Unit can be connected. The CPM1A-TS001 or CPM1A-TS101 may be the other Unit, but another CPM1A-TS001 or CPM1A-TS102 cannot be connected.

2-2 CPM2C Temperature Sensor Units

With the CPM2C (including the CPM2C-S), up to four CPM2C-TS001/TS101 Temperature Sensor Units can be connected (up to three Units for CPM2C-S). Each Temperature Sensor Unit provides 2 input points meaning a total of 8 input points can be used. The inputs can be from thermocouple platinum resistance thermometers.

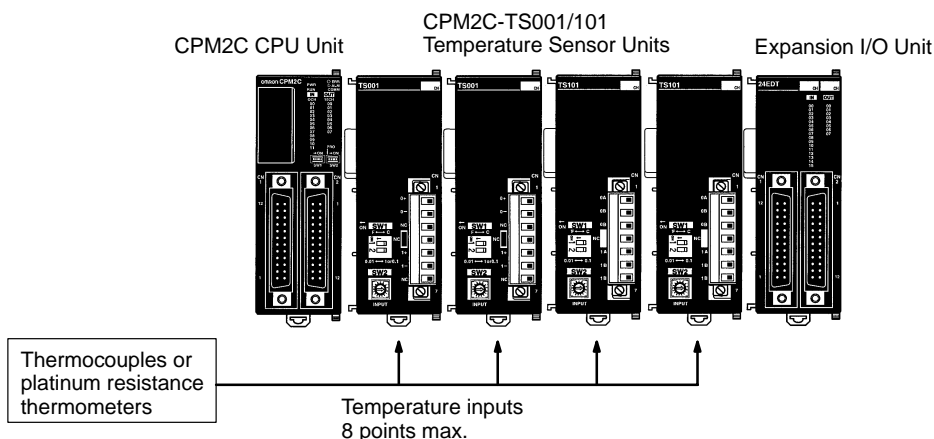

Specifications

Item	CPM2C-TS001	CPM2C-TS101
Temperature sensors	Thermocouples Switchable between K and J, but same type must be used for all inputs.	Platinum resistance thermometer Switchable between Pt100 and JPt100, but same type must be used for all inputs.
Number of inputs	2	
Allocated input words	2	
Max. number of Units (See note 1.)	4	4
Accuracy	(The larger of $\pm 0.5\%$ of converted value or $\pm 2^\circ\text{C}$) ± 1 digit max. (See note.)	(The larger of $\pm 0.5\%$ of converted value or $\pm 1^\circ\text{C}$) ± 1 digit max.
Conversion time	250 ms for 2 input points	
Converted temperature data	16-bit binary data (4-digit hexadecimal)	
Isolation	Photocouplers between all temperature input signals	

- Note**
1. Accuracy for a K-type sensor at -100°C or less is $\pm 4^\circ\text{C} \pm 1$ digit max.
 2. The error deviation for temperatures in $^\circ\text{F}$ is double that for $^\circ\text{C}$.

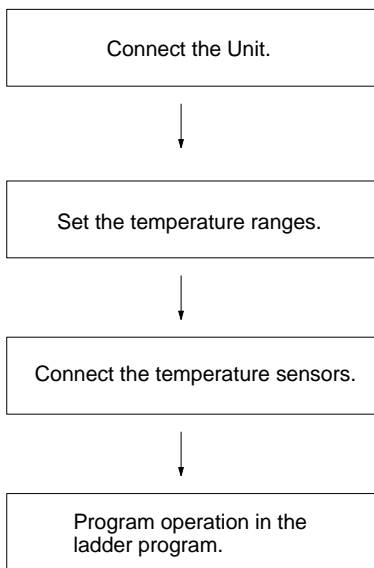

Connect the Temperature Sensor Unit.
Refer to 3-2-4 Connecting Temperature Sensor Units.

Set the temperature unit, 2-decimal-place Mode if required, and set the temperature input range.
Refer to 3-2-5 Setting Temperature Ranges.

Connect temperature sensors.
Refer to 3-2-6 Connecting Temperature Sensors.

Read temperature data stored in the input word.
Refer to 3-2-7 Ladder Programming.

3-2-4 Connecting Temperature Sensor Units

This section shows example configurations containing Temperature Sensor Units.

CPM1A/CPM2A Temperature Sensor Unit Allocations

Words are allocated to Temperature Sensor Units just like other Expansion Units and Expansion Units: In the order in which the Units are connected. A Temperature Sensor Unit will thus be allocated the next input words after the Unit which it is connected (CPU Unit or other Unit).

Note Only one 4-input Temperature Sensor Unit (CPM1A-TS002 or CPM1A-TS001) can be mounted to the CPU Unit. There are, however, no restrictions on the mounting order.

Temperature Sensor Units with 2 Inputs: CPM1A-TS001 and CPM1A-TS101 (2 Words Allocated)

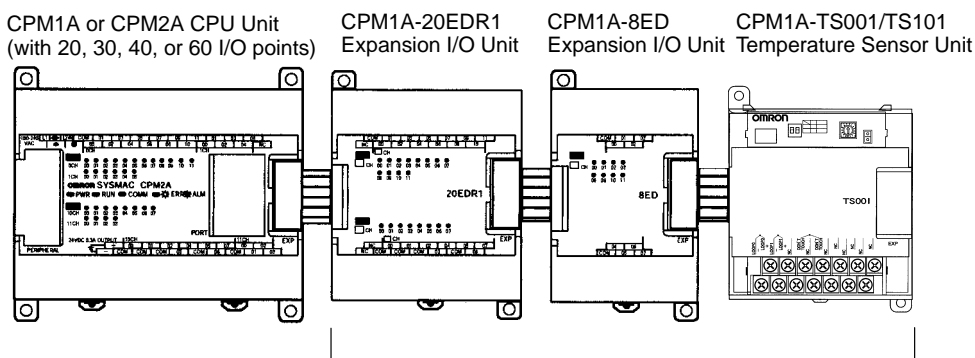

Temperature Sensor Units	2 inputs	CPM1A-TS001 CPM1A-TS101	Up to 3 Units can be connected. There are no restrictions on the order in which Units are connected.
Expansion I/O Units		With 8 or 20 I/O points	
Analog I/O Units		CPM1A-MAD01	
CompoBus/S I/O Link Unit		CPM1A-SRT21	

each input point). No output words are allocated.

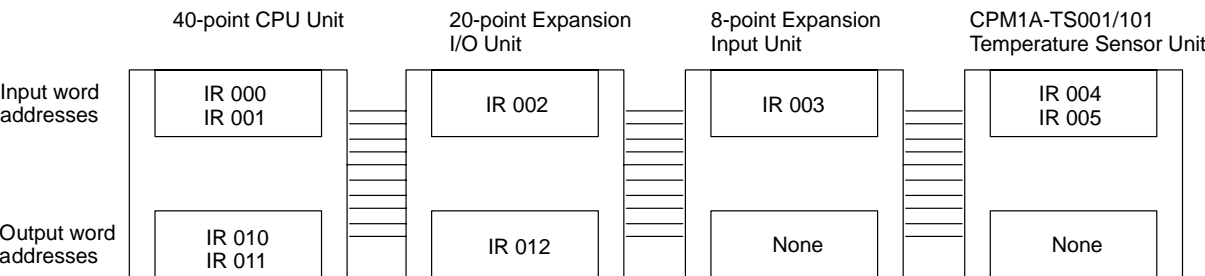

Temperature Sensor Units with 4 Inputs (4 Words Allocated): CPM1A-TS002 and CPM1A-TS102

CPM1A or CPM2A CPU Unit (with 20, 30, 40, or 60 I/O points) CPM1A-20EDR1 Expansion I/O Unit CPM1A-TS002/TS102 Temperature Sensor Unit

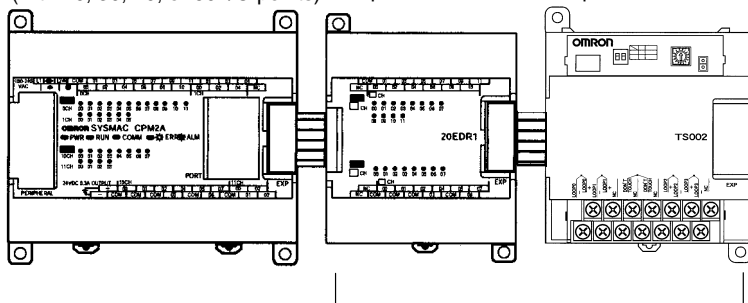

Temperature Sensor Units	4 inputs	CPM1A-TS002 or CPM1A-TS102	1 Unit only	Up to 2 Units can be connected. There are no restrictions on the order in which Units are connected.
	2 inputs	CPM1A-TS001 or CPM1A-TS101	1 Unit only	
Expansion I/O Units		With 8 or 20 I/O points		
Analog I/O Units		CPM1A-MAD01		
CompoBus/S I/O Link Unit		CPM1A-SRT21		

Word Allocations

The CPM1A-TS002 and CPM1A-TS102 are allocated four words each (one for each input point). No output words are allocated.

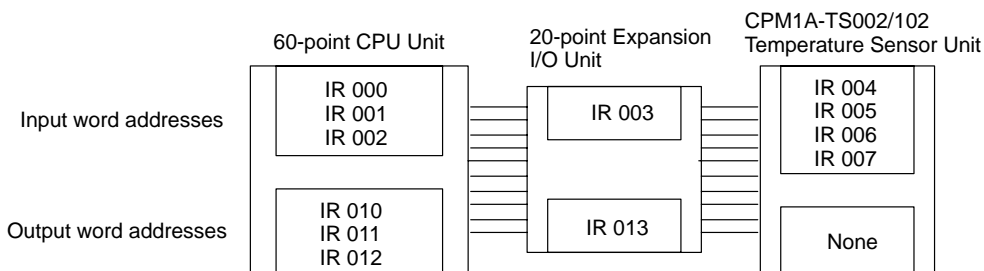

CPM2C Temperature Sensor Unit Allocations

Up to four CPM2C-TS001/101 Temperature Sensor Units can be connected to a total of five Expansion I/O Units and Expansion Units can be connected

the CPM2C CPU. No matter how many Units are connected, however, no more than 0 input words and 10 output words can be allocated in one PC. There are restrictions on the order in which Units can be connected.

Example

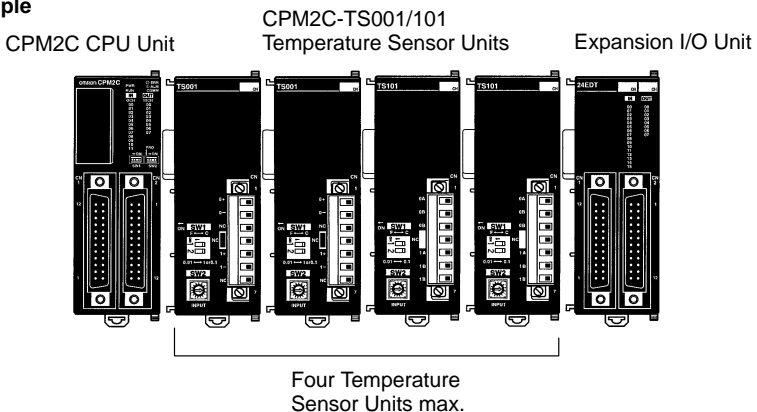

Word Allocation

Words are allocated to Temperature Sensor Units just like other Expansion Units and Expansion Units: In the order in which the Units are connected CPM2C-TS001 or CPM2C-TS101 Temperature Sensor Unit will thus be allocated the next two input words after the Unit to which it is connected (CPU Unit or other Unit). No output words are allocated.

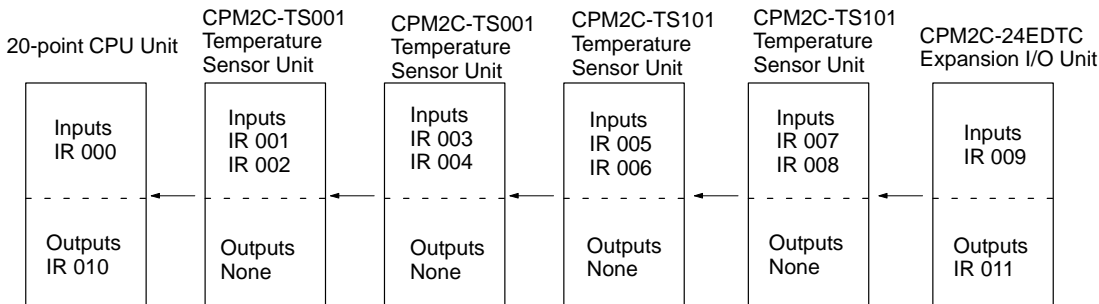

2-5 Setting Temperature Ranges

The temperature unit, the number of decimal places used, and the temperature input range are set on the DIP switch and rotary switch on the Temperature Sensor Unit.

- Note**
1. Always turn OFF the power supply before setting the temperature range.
 2. Never touch the DIP switch or rotary switch during Temperature Sensor operation. Static electricity may cause operating errors.

DIP Switch
Used to set the temperature unit and the number of decimal places used.

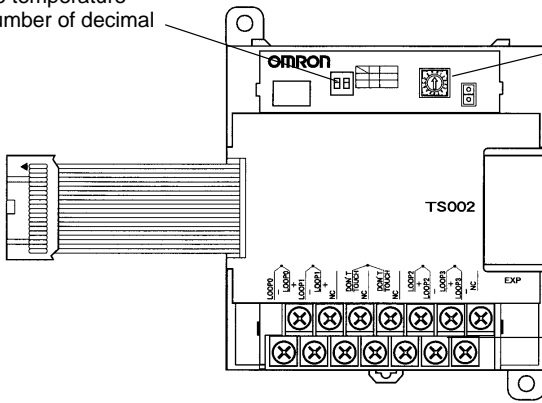

Rotary Switch
Used to set the temperature input range.

Temperature input terminals

M2C Temperature Sensor Units M2C-TS001/101

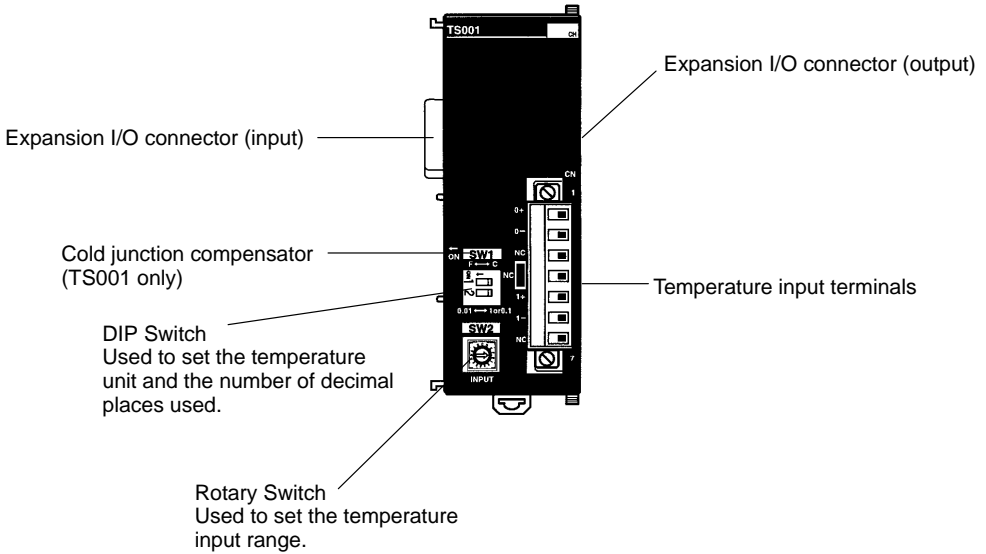

Switch Settings

The DIP switch is used to set the temperature unit (°C or °F) and the number of decimal places used.

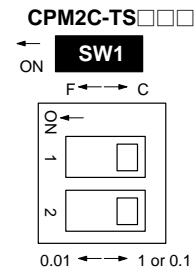
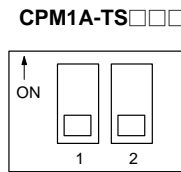

SW1	Setting		
1	Temperature unit	OFF	°C
		ON	°F
2	Number of decimal places used	OFF	Normal (0 or 1 digit after the decimal point, depending on the input range)
		ON	2-decimal-place Mode (e.g., 0.01)

Note For details on 2-decimal-place Mode, refer to 3-2-8 *Two-decimal-place Mode*

2. Do not touch the DIP switch or rotary switches while power is turned on.
Static electricity may cause malfunctions.

Rotary Switch Setting

The rotary switch is used to set the temperature range.



Caution

Set the temperature range according to the type of temperature sensor connected to the Unit. Temperature data will not be converted correctly if the temperature range does not match the sensor.



Caution

Do not set the temperature range to any values other than those for which the temperature ranges are given in the following table. An incorrect setting may cause operating errors.

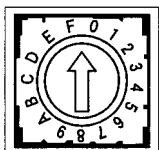

Setting	CPM1A-TS001/002 CPM2C-TS001			CPM1A-TS101/102 CPM2C-TS101		
	Input type	Range (°C)	Range (°F)	Input type	Range (°C)	Range (°F)
0	K	-200 to 1,300	-300 to 2,300	Pt100	-200.0 to 650.0	-300.0 to 1,200.0
1		0.0 to 500.0	0.0 to 900.0	JPt100	-200.0 to 650.0	-300.0 to 1,200.0
2	J	-100 to 850	-100 to 1,500	---	Setting not possible	
3		0.0 to 400.0	0.0 to 750.0	---		
4 to F	---	Setting not possible		---		

CPM1A/CPM2A Temperature Sensor Units

Thermocouples

CPM1A-TS001

Either K or J thermocouples can be connected, but both of the thermocouples must be of the same type and the same input range must be used for each.

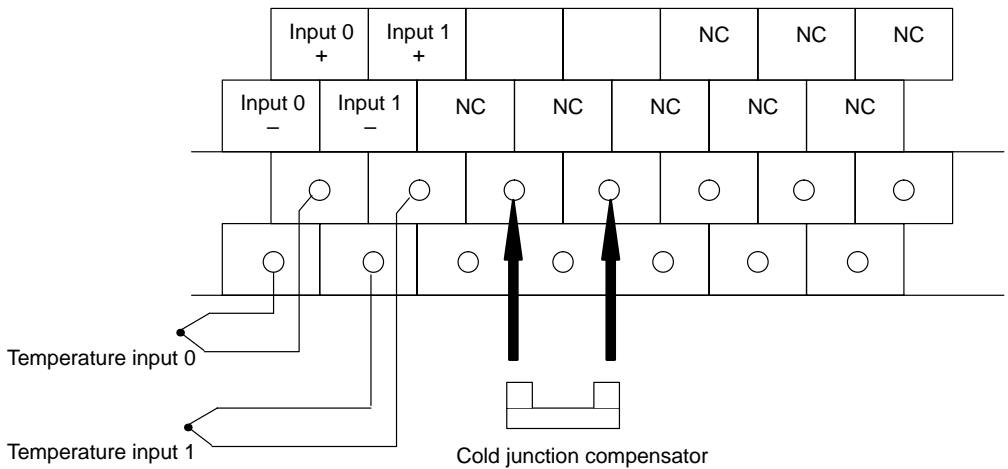

CPM1A-TS002

Either K or J thermocouples can be connected, but all four of the thermocouples must be of the same type and the same input range must be used for each.

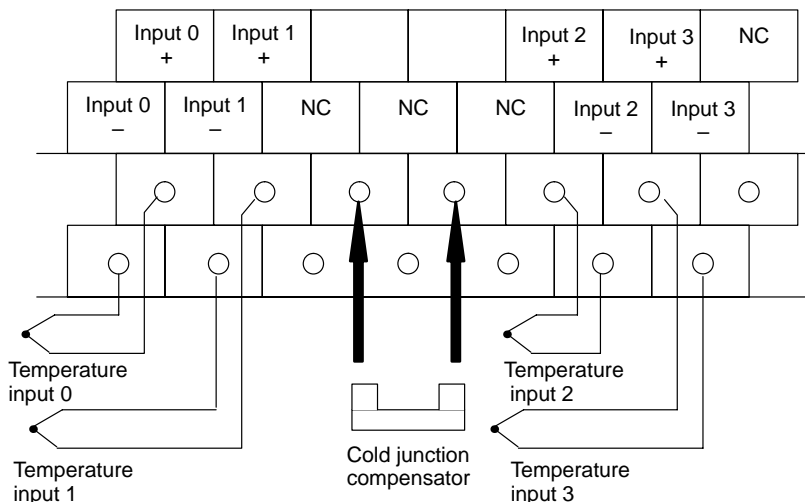

Note When using a Temperature Sensor Unit with a thermocouple input, observe the following precautions:

- Do not remove the cold junction compensator attached at the time of delivery. If the cold junction compensator is removed, the Unit will not be able to measure temperatures correctly.
- Each of the input circuits is calibrated with the cold junction compensator attached to the Unit. If the Unit is used with the cold junction compensator from other Units, the Unit will not be able to measure temperatures correctly.
- Do not touch the cold junction compensator. Doing so may result in incorrect temperature measurement.

CPM1A-TS101

Either Pt100 or JPt100 platinum resistance thermometers can be connected but both of the thermometers must be of the same type and the same input range must be used for each.

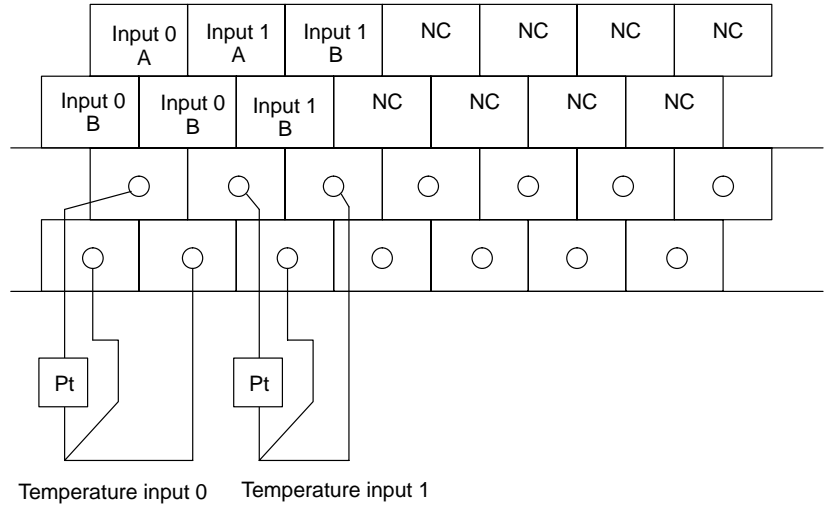

CPM1A-TS102

Either Pt100 or JPt100 platinum resistance thermometers can be connected but all four of the thermometers must be of the same type and the same input range must be used for each.

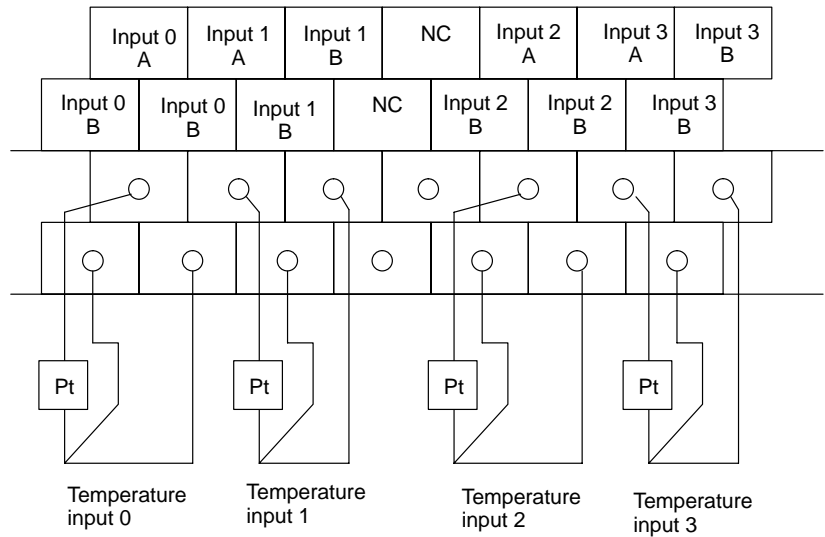

Note Do not connect anything to terminals not used for inputs.

CPM2C-TS001 (Thermocouples)

Either K or J thermocouples can be connected, but both of the thermocouples must be of the same type and the same input range must be used for each.

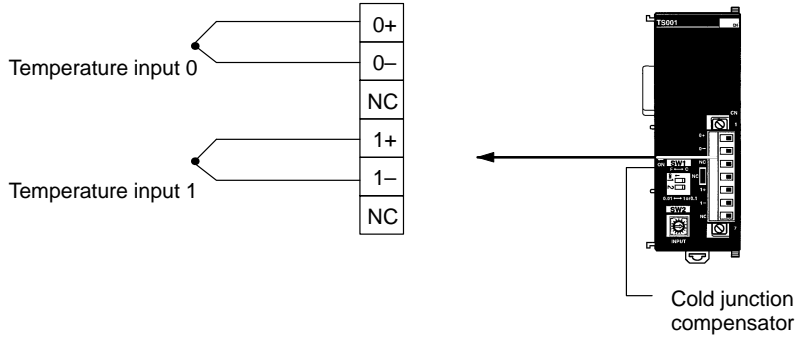

Note When using a Temperature Sensor Unit with a thermocouple input, observe the following precautions:

- Do not touch the cold junction compensator. Doing so may result in incorrect temperature measurement.

CPM2C-TS101 (Platinum Resistance Thermometers)

Either Pt100 or JPt100 platinum resistance thermometers can be connected, but both of the thermometers must be of the same type and the same input range must be used for each.

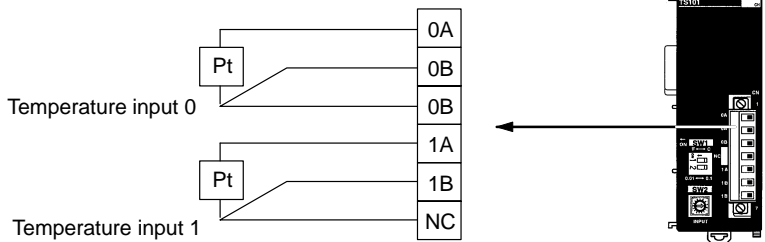

2-7 Ladder Programming

Inverted Temperature

The temperature data will be stored in the input words allocated to the Temperature Sensor Unit in 4-digit hexadecimal.

CPM1A-TS001/TS101 and CPM2C-TS001/TS101

“m” is the last word allocated to the CPU Unit, Expansion I/O Unit, or Expansion Unit connected immediately before the Temperature Sensor Unit.

Word	Contents
m + 1	Converted temperature data from input 0
m + 2	Converted temperature data from input 1

CPM1A-TS002/TS102

“m” is the last word allocated to the CPU Unit, Expansion I/O Unit, or Expansion Unit connected immediately before the Temperature Sensor Unit.

Word	Contents
m + 1	Converted temperature data from input 0
m + 2	Converted temperature data from input 1
m + 3	Converted temperature data from input 2
m + 4	Converted temperature data from input 3

All Temperature Sensor Units

Negative values are stored as 2’s complements. Data for range codes that

10 times the actual value is stored. Some examples are provided in the following table.

Input		Data conversion examples
Unit: 1°	K or J	850° → 0352 Hex -200° → FF38 Hex
Unit: 0.1°	K, J, Pt100 or JPt100	×10 500.0° → 5000 → 1388 Hex -20.0° → -200 → FF38 Hex -200.0° → -2000 → F830 Hex

If the input temperature exceeds the range that can be converted, the converted temperature data will be held at the maximum or minimum value in the range. If the input temperature exceeds the range by more than a specified amount, the open-circuit detection function will detect an open-circuit and the converted temperature data will be set to 7FFF. The open-circuit detection function will operate if the cold junction compensator is faulty. The open-circuit detection function will be automatically cleared and normal input temperature conversion will begin automatically when the input temperature returns to the conversion range.

Startup Operation

After power is turned ON, it will require approximately 1 s before the first data is converted. The following instructions can be placed at the beginning of the program and then IR 02000 can be used to delay reading converted data until conversion is actually begun.

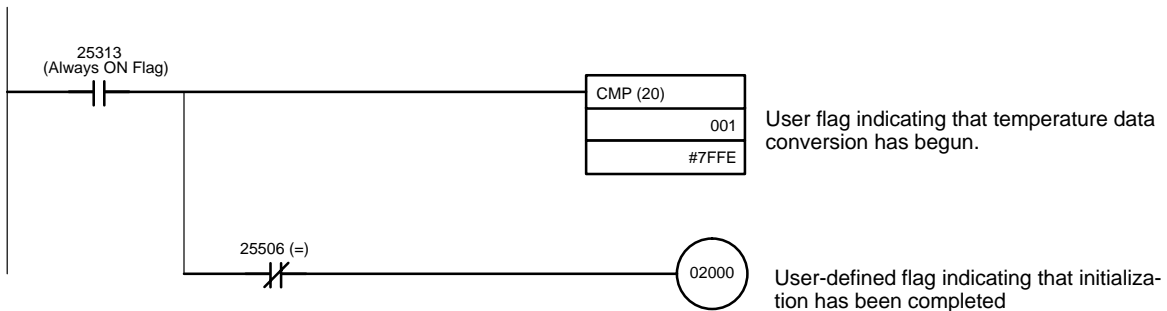

Note Input data will be 7FFE until actual conversion starts.

Handling Unit Errors

If an error occurs in an Expansion Unit, the Error Flags in AR 0200 to AR 0204 will be turned ON (AR 0200 to AR 0202 for the CPM1A/CPM2A). Refer to page 568 for details. The addresses of the Error Flags are in order that the Expansion Units are connected in the PC, with AR 0200 used for the Expansion Unit closest to the CPU Unit. Use these flags in the program when it is necessary to detect errors.

When an error occurs in a Temperature Sensor Unit, converted temperature data will be 7FFF.

Note The status of AR 0200 to AR 0204 will not change for the open-circuit detection function.

Programming Example 1

The following programming example shows how to convert the input data from temperature sensor inputs to BCD and store the result in DM 0000 to DM 0001. The following system configuration is used.

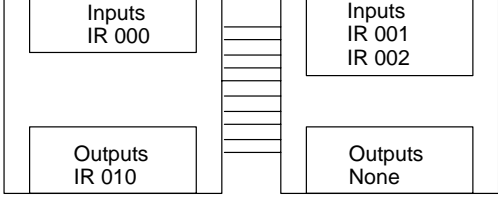

Temperature unit setting: OFF (°C)
Two-decimal-place Mode: OFF (normal)
Input range setting: 1 (K2, 0.0 to 500.0°C)
Temperature input 0 storage word: IR 001
Temperature input 1 storage word: IR 002

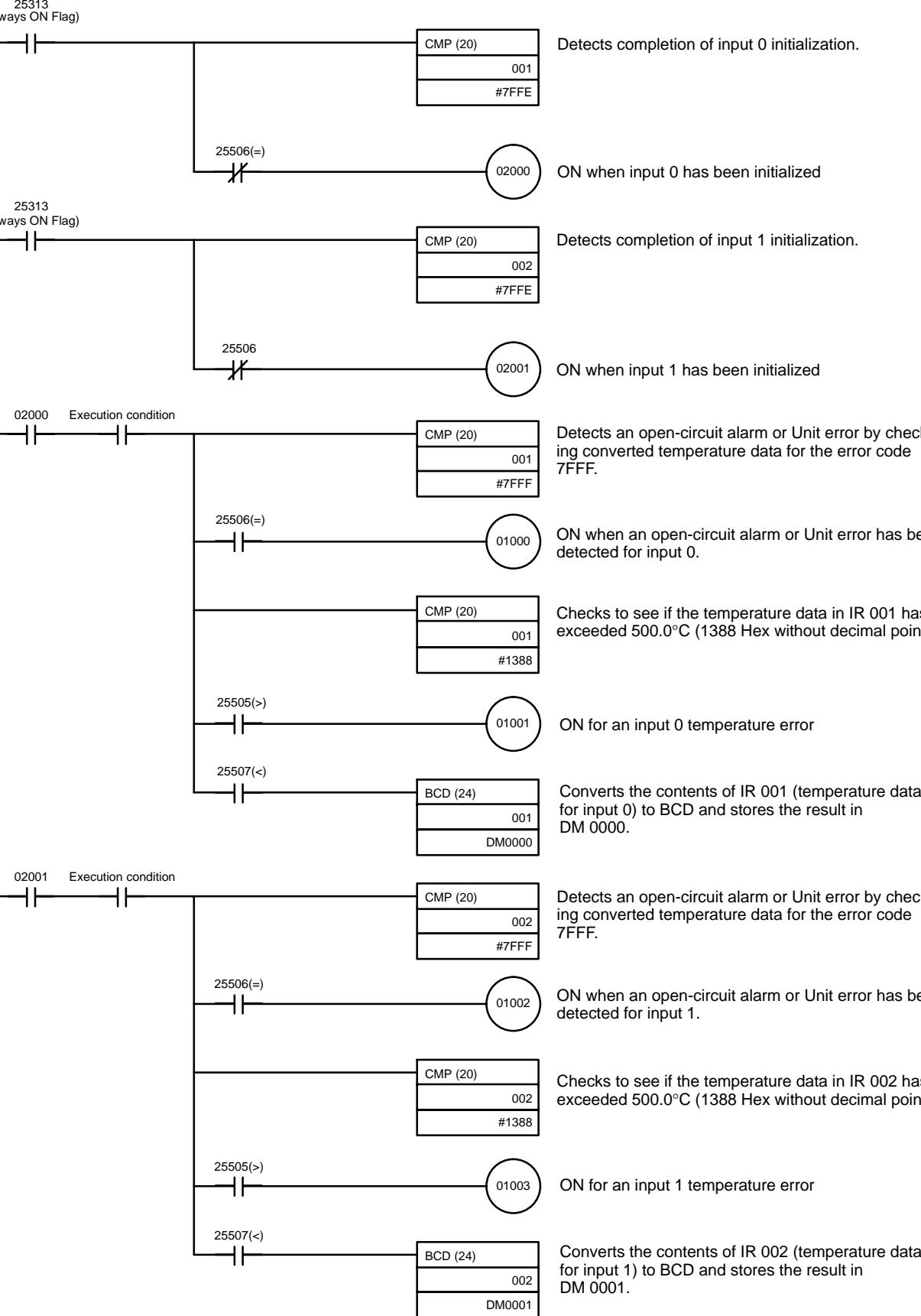

Temperature input 0 to BCD and store the result in DM 0000 and DM 0001. 0000 is stored in DM 0001 when the input data is a negative value. The following system configuration is used.

20-point CPU Unit

Temperature Sensor Unit

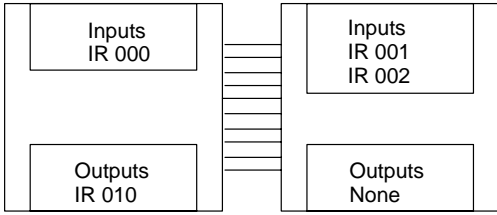

Temperature unit setting: OFF (°C)
 Two-decimal-place Mode: OFF (normal)
 Input range setting: 1 (Pt100, -200.0 to 650.0°C)
 Temperature input 0 storage word: IR 001

Programming with BCD(24) Instruction

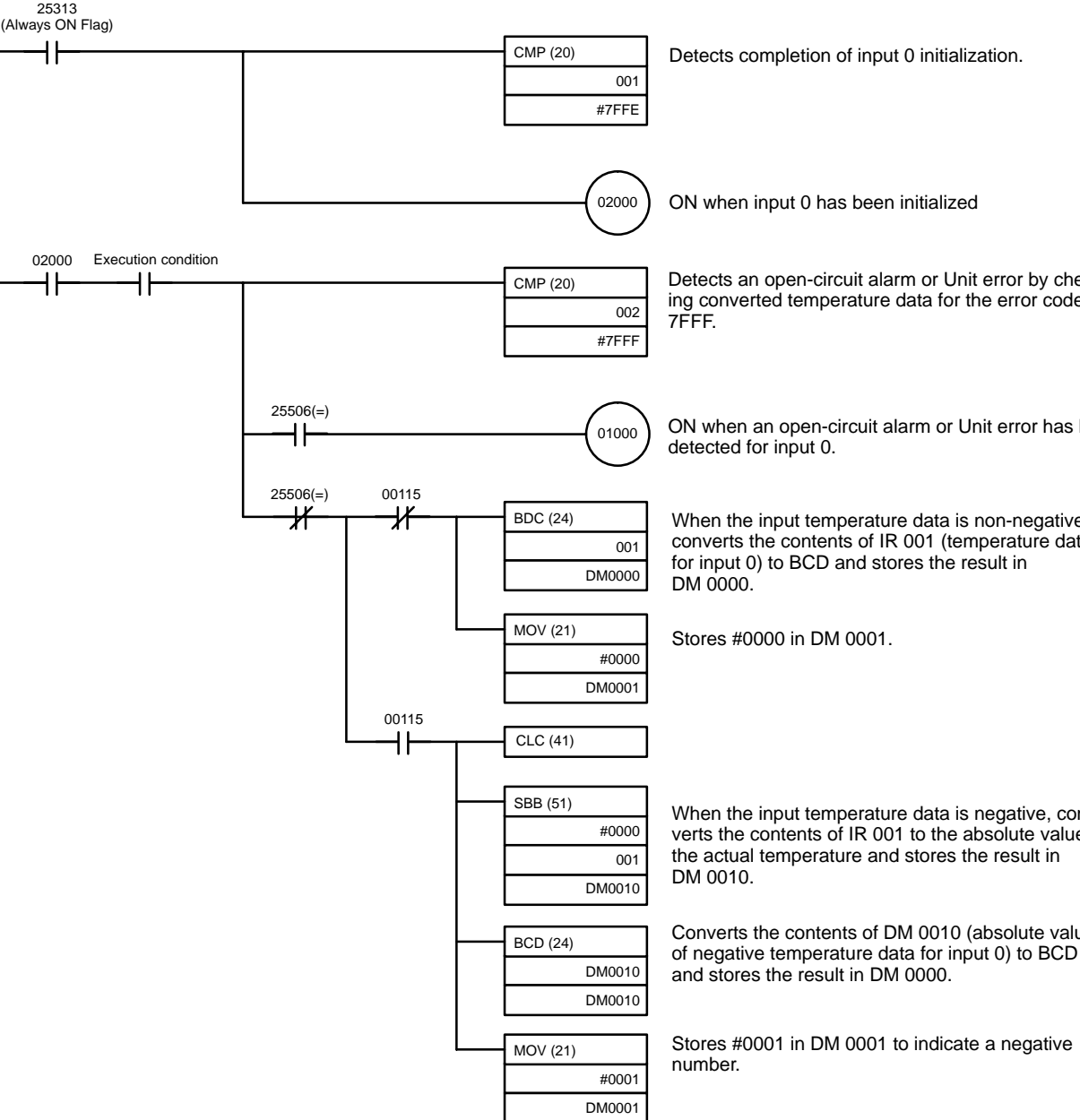

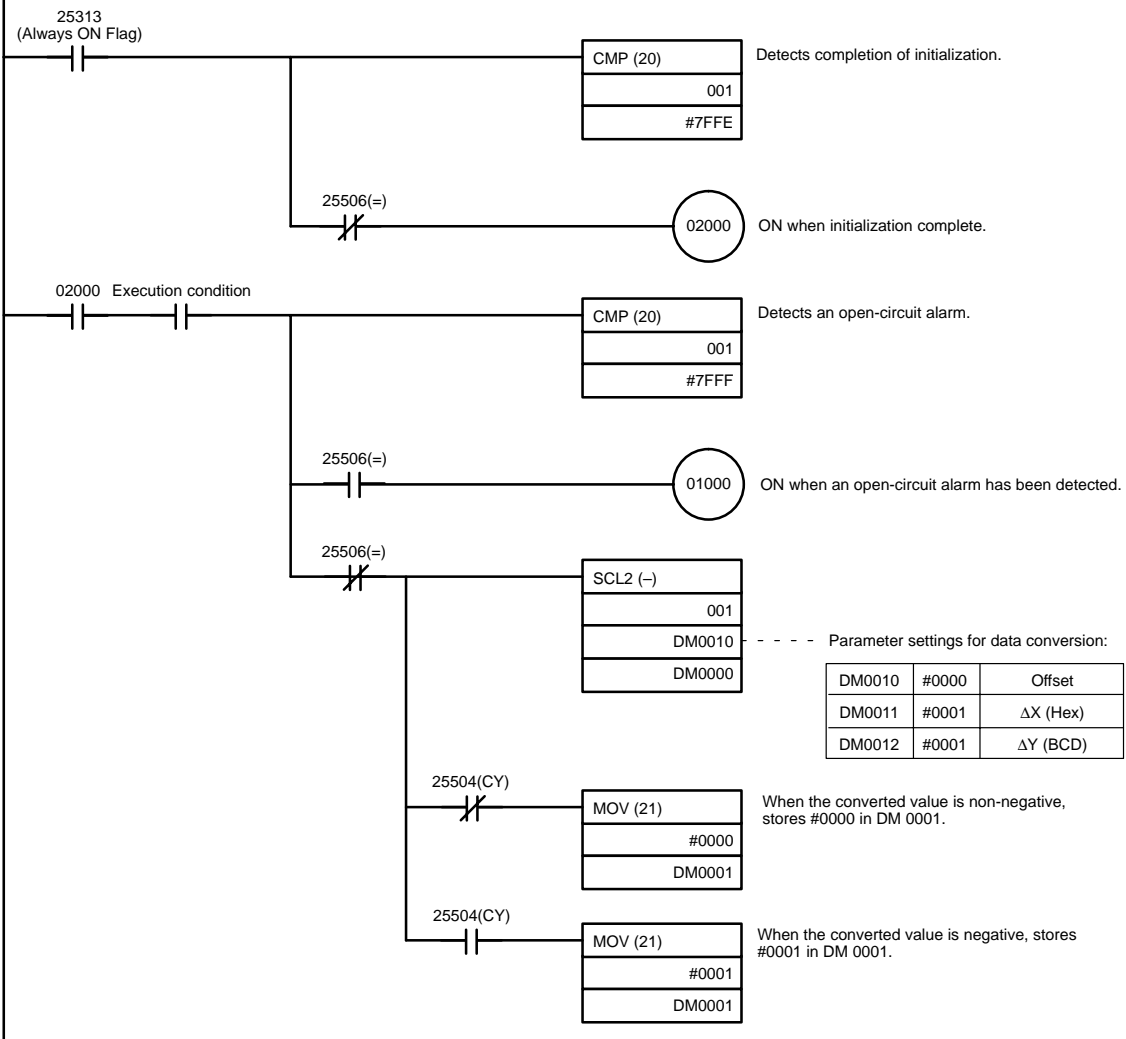

Operation

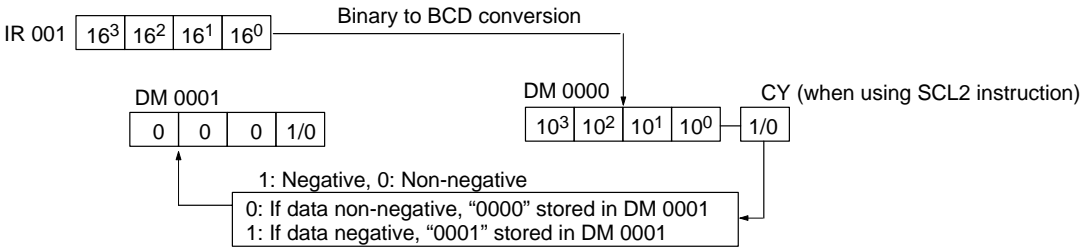

If pin 2 on the DIP switch is turned ON, values are stored to two decimal places. In this case, temperature data is stored as 6-digit signed hexadecimal (binary) data with 4 digits in the integer portion and 2 digits after the decimal point. The actual data stored in memory is 100 times the actual value, i.e., the decimal point is not indicated. Methods for handling this data are described in this section.

Note When set to store values to two decimal places, temperature data as far as 2 digits after the decimal point is converted to 6-digit binary data, but the actual resolution is not 0.01°C (°F). For this reason, there may be skipping and inaccuracies in the first digit after the decimal point (0.1). Treat any resolution other than that specified for the normal data format as reference data.

Data Structure

The structure of the data stored in memory is shown below. The value will be 100 times the actual temperature.

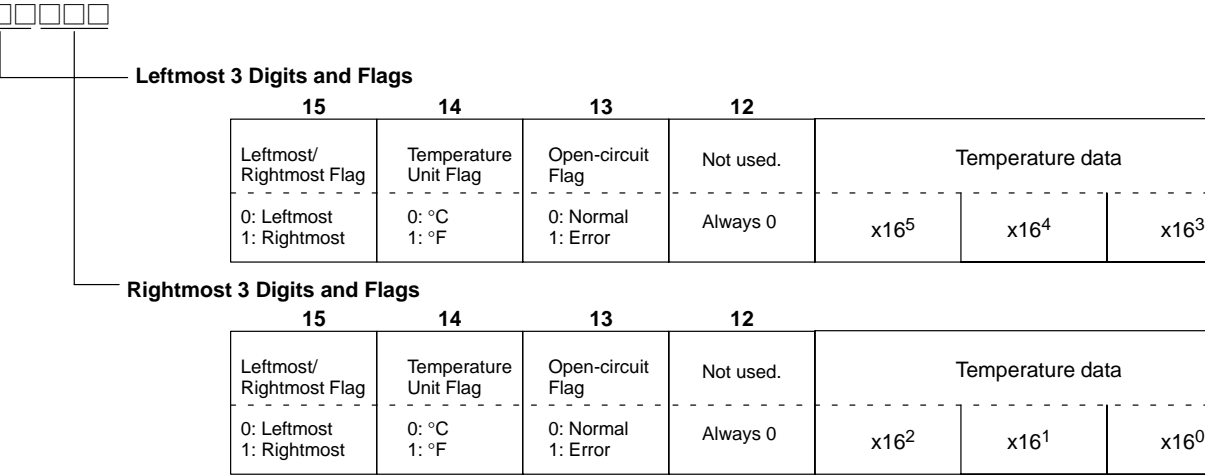

- Leftmost/Rightmost Flag:** Indicates whether the leftmost or rightmost 3 digits are provided.
- Temperature Unit Flag:** Indicates whether the temperature is in °C or °F.
- Open-circuit Flag:** Turns ON (1) when an open-circuit is detected. The temperature data will be 7FF FFF if this flag is ON.

Example 1

Temperature: 1,130.25°C

×100: 113025

Temperature Data: 01B981 (hexadecimal for 113025)

Leftmost 3 Digits and Flags

	Flags				x16 ⁵	x16 ⁴	x16 ³
Bits	15	14	13	12	08 to 11	04 to 07	00 to 03
Data	0	0	0	0	0	1	B

Normal
°C
Leftmost

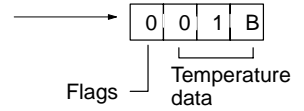

Rightmost 3 Digits and Flags

	Flags				x16 ²	x16 ¹	x16 ⁰
Bits	15	14	13	12	08 to 11	04 to 07	00 to 03
Data	1	0	0	0	9	8	1

Normal
°C
Rightmost

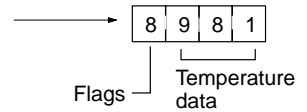

Example 2

Temperature: -100.12°C

×100: -10012

Temperature Data: FFD8E4 (hexadecimal for -10012)

Leftmost 3 Digits and Flags

	Flags				x16 ⁵	x16 ⁴	x16 ³
Bits	15	14	13	12	08 to 11	04 to 07	00 to 03
Data	0	0	0	0	F	F	D

Normal
°C
Leftmost

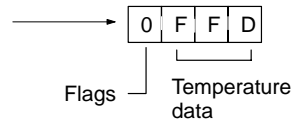

Rightmost 3 Digits and Flags

	Flags				x16 ²	x16 ¹	x16 ⁰
Bits	15	14	13	12	08 to 11	04 to 07	00 to 03
Data	1	0	0	0	8	E	4

Normal
°C
Rightmost

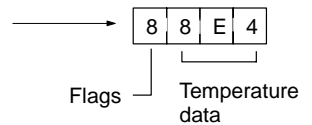

Temperature: -20012
 ×100: -20012
 Temperature Data: FFB1D4 (hexadecimal for -20012)

Leftmost 3 Digits and Flags

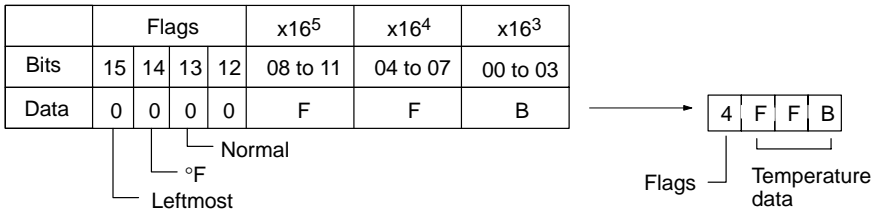

Rightmost 3 Digits and Flags

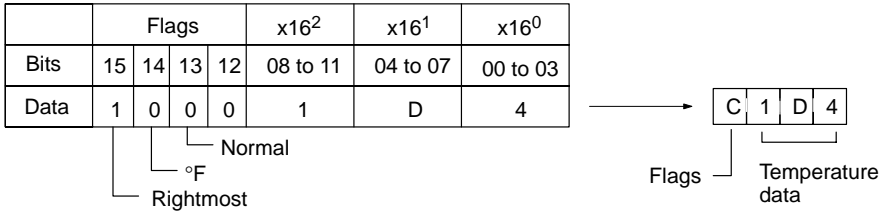

Example 4

Temperature: Open circuit (°F)
 Temperature Data: 7FFFFFFF

Leftmost 3 Digits and Flags

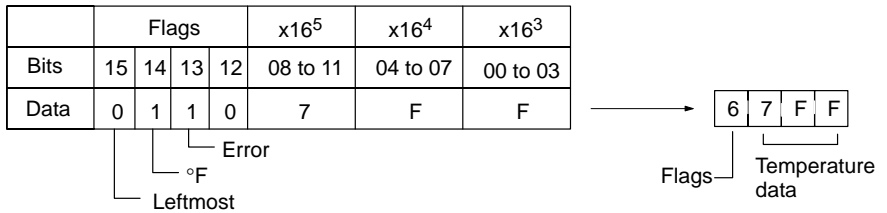

Rightmost 3 Digits and Flags

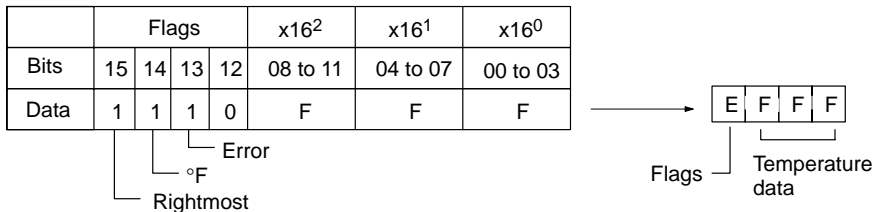

- Note**
1. Leftmost digits are stored in the lower memory addresses. Treat the data at the lower memory address as the leftmost digits when programming.
 2. Be sure that the data is read at least once every 125 ms to allow for the Unit's cycle time and communications time. Correct data may not be obtained if the read cycle is greater than 125 ms.

for the following I/O configuration:

20-point CPU Unit

20-point Expansion
I/O Unit

Temperature Sensor Unit

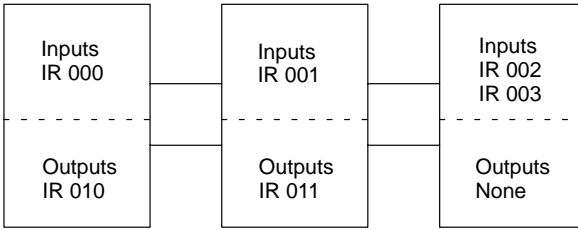

Temperature unit setting:
OFF (°C)

Two-decimal-place Mode:
ON (2 digits after decimal point stored)

In this example, 100 times the temperature data for temperature input 0 is stored in binary form in DM 0100 to DM 0102.

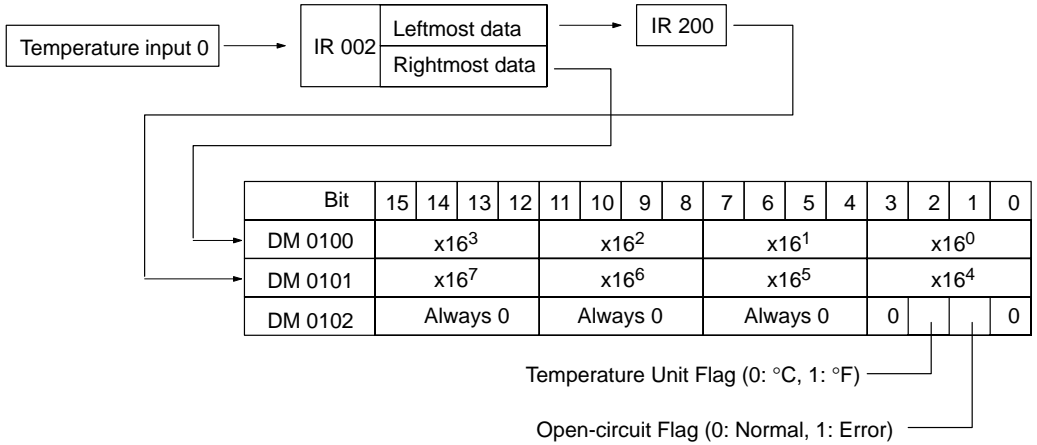

The following program would be used.

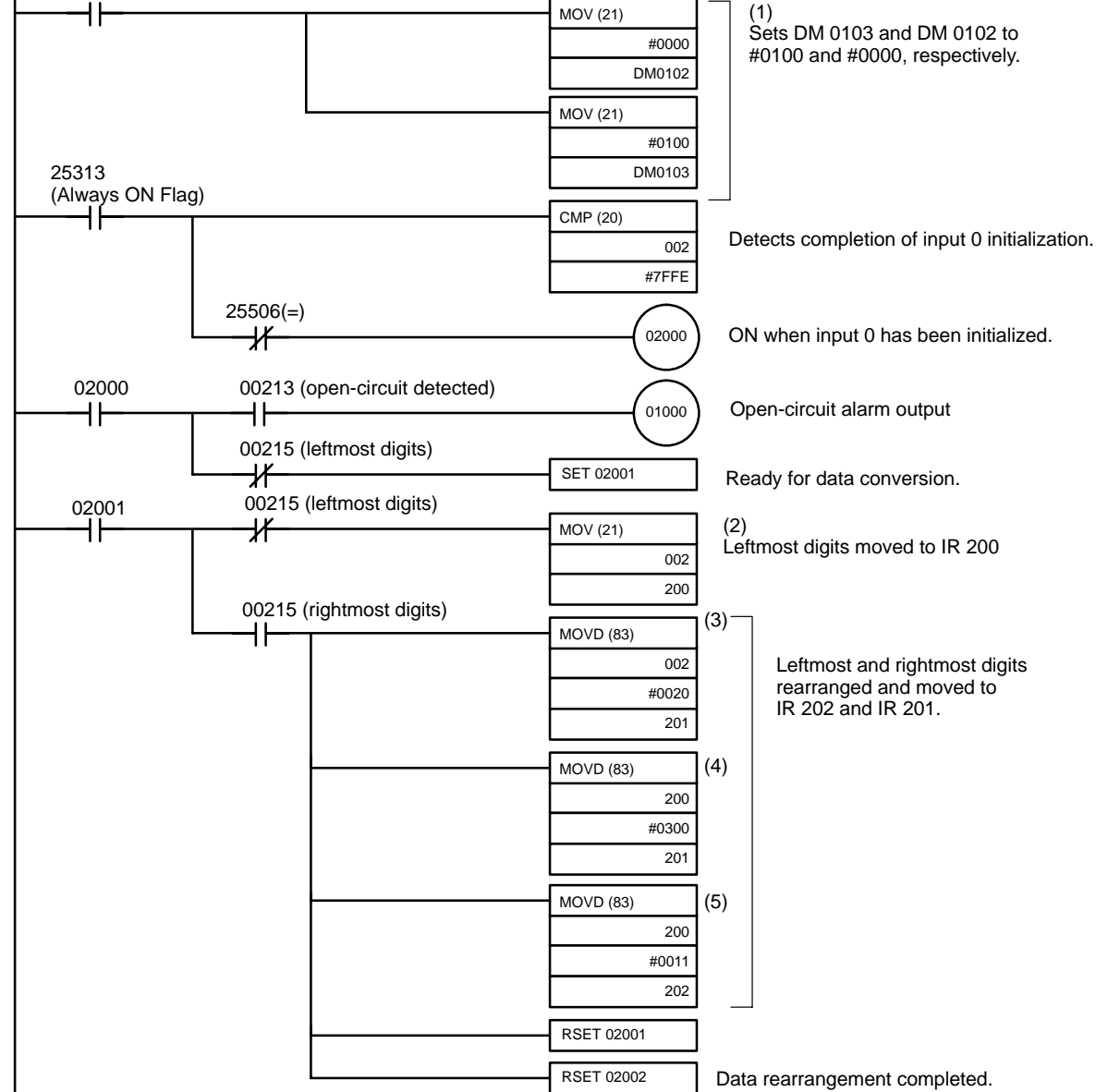

(continued next page.)

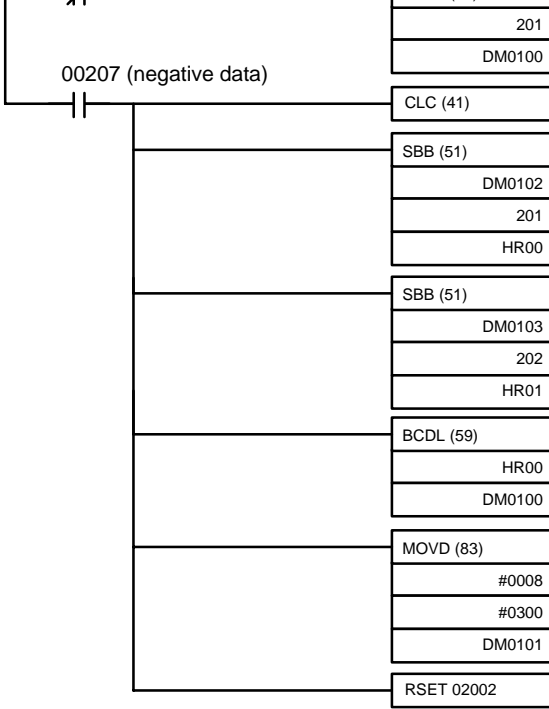

If the temperature data is non-negative, the binary data in IR 202 and IR 201 is converted to BCD and placed in DM 0101 and DM 0100.

(7)
If the temperature data is negative, the 2's complement data in IR 202 and IR 201 is converted to binary data representing the absolute value of the temperature input and placed in HR 01 and HR 00.

(8)
The binary data in HR 01 and HR 00 is converted to BCD and placed in DM 0101 and DM 0100.

(9)
"1" is written to the bit in DM 0101 indicating negative data.

Note The BCDL(59) instruction is only available with the CPM2A and CPM2C.

The data movements corresponding to the numbers in the above ladder programming example are illustrated in the following diagram.

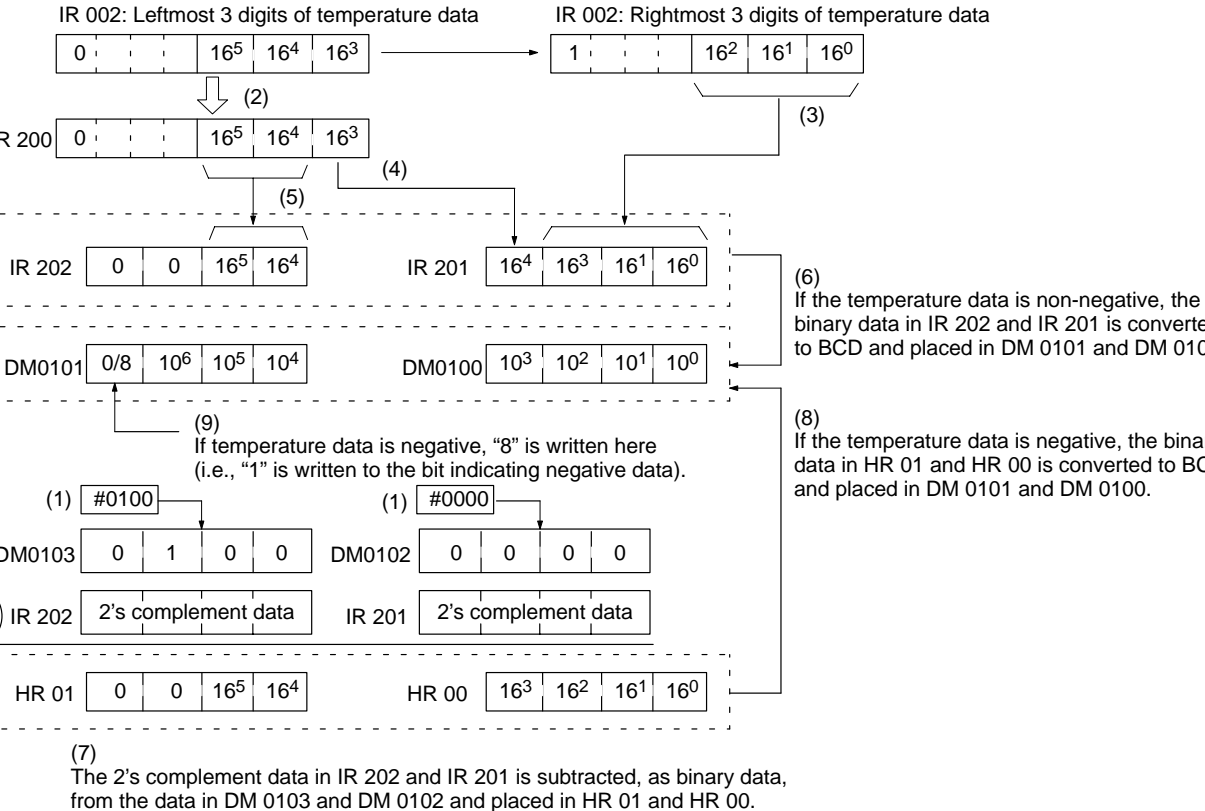

The CPM1A, CPM2A, or CPM2C (including the CPM2C-S) PCs can function as Slaves to a CompoBus/S Master Unit (or SRM1 CompoBus/S Master Control Unit) when a CompoBus/S I/O Link Unit is connected. The CompoBus/S I/O Link Unit establishes an I/O link of 8 inputs and 8 outputs between the Master and the PC.

Note For the CPM1A, a CPM1A CPU Unit with 30 or 40 I/O points must be used when connected to the CompoBus/S I/O Link Unit. It cannot be connected to a CPM1A CPU Unit with 10 or 20 I/O points.

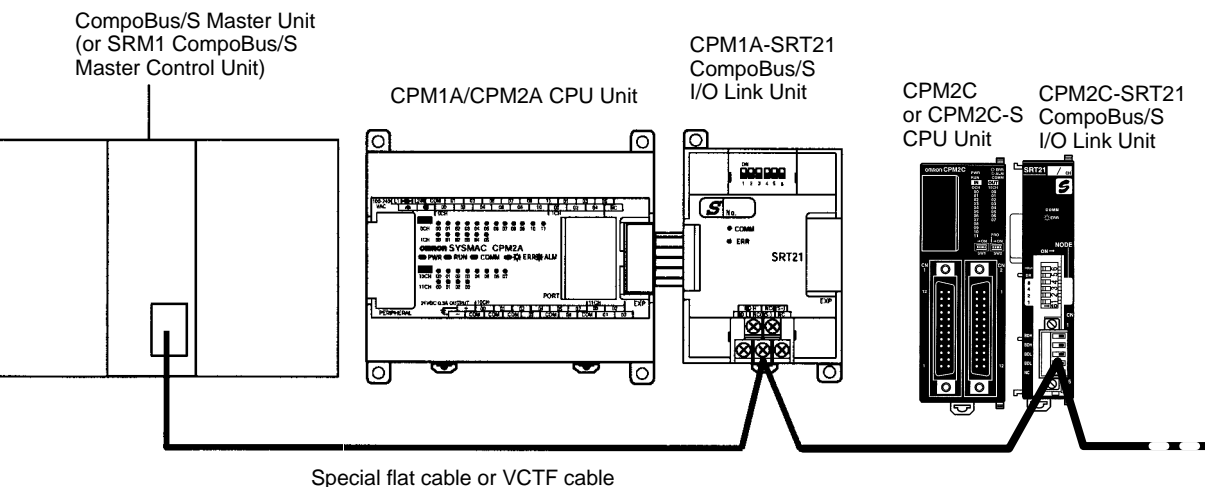

From the standpoint of the CPU Unit, the 8 input bits and 8 output bits allocated to the CompoBus/S I/O Link Unit are identical to input and output bits allocated to Expansion I/O Units even though the CompoBus/S I/O Link Unit does not contain actual inputs and outputs. The input and output bits allocated to the CompoBus/S I/O Link Unit are one side of an I/O link between the slave CPU Unit and the CPU Unit to which the Master Unit is connected.

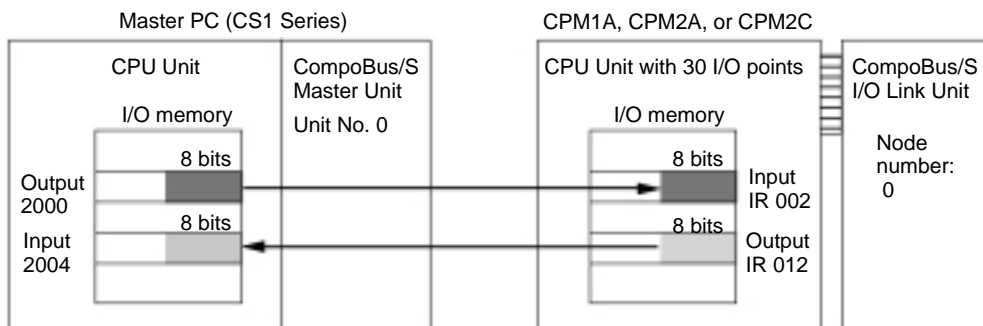

Specifications

Item	Specification
Model number	CPM1A or CPM2A: CPM1A-SRT21 CPM2C or CPM2C-S : CPM2C-SRT21
Master/slave	CompoBus/S Slave
Number of I/O points	8 input points, 8 output points
Number of words allocated in CPU Unit I/O memory	1 input word, 1 output word (Allocated in the same way as Expansion I/O Units and other Expansion Units)
Node number setting	Set using the DIP switch (Set before turning on the CPU Unit's power supply)

COMM (yellow)	ON	Communications in progress.
	OFF	Communications stopped or error has occurred.
ERR (red)	ON	A communications error has occurred.
	OFF	Indicates normal communications or stand-by.

Installation Procedure

Connect the Unit.

Connect the CompoBus/S I/O Link Unit.

Determine the node address of the CompoBus/S I/O Link Unit and set the DIP switch.

The node number should be a unique number between 0 and 15. Use the DIP switch to set the CompoBus/S I/O Link Unit's node number, communications mode, and the status of output data when a communications error occurs.

Wire the CompoBus/S transmission path.

Connect the CompoBus/S I/O Link Unit to a CompoBus/S transmission path.

Connecting the CompoBus/S I/O Link Unit

Connect the CompoBus/S I/O Link Unit to the CPU Unit. The number of CompoBus/S I/O Link Units that can be connected depends on the PC. Three Units can be connected to the CPM1A/CPM2A, five Units can be connected to the CPM2C, and three Units can be connected to the CPM2C-S. When Expansion I/O Units or other Expansion Units are also connected, they can be connected in any order from the CPU Unit.

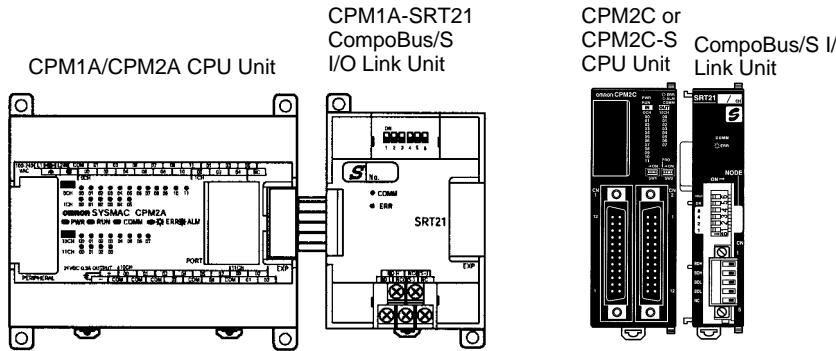

I/O Allocation

I/O words are allocated to the CompoBus/S I/O Link Unit in the same way as Expansion I/O Units or other Expansion Units, the next available input and output words are allocated. When "m" is the last allocated input word and "n" is the last allocated output word, the CompoBus/S I/O Link Unit is allocated "m+1" as its input word and "n+1" as its output word.

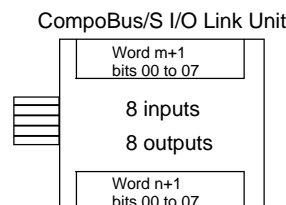

Unit with 30 I/O points.

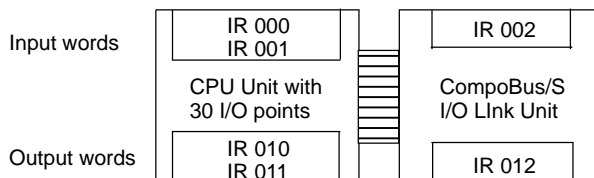

The input word (m+1) contains the 8 bits of data from the Master Unit and CompoBus/S communications flags.

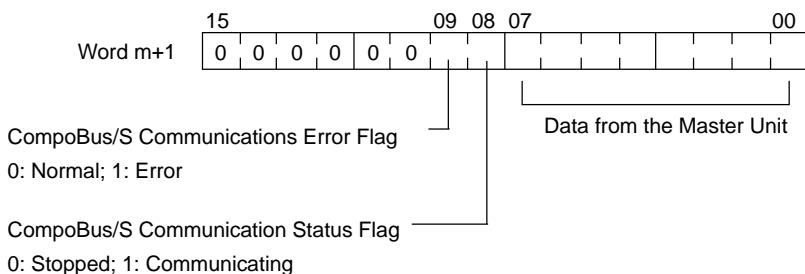

Write the data to be transmitted to the Master Unit in the output word (n+1).

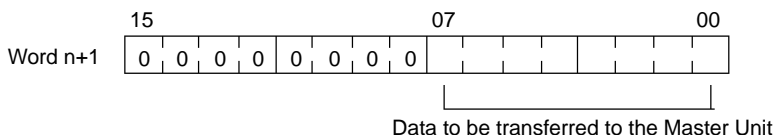

The 8 bits of I/O data are not always transmitted simultaneously. In other words, 8 bits of data transmitted from the Master CPU Unit at the same time will not always reach the Slave CPU Unit simultaneously, and 8 bits of data transmitted from the Slave CPU Unit at the same time will not always reach the Master CPU Unit simultaneously.

When the 8 bits of input data must be read together, modify the ladder program of the CPU Unit receiving the data. For example, read the input data twice in succession and accept the data only when the two values match.

Unused bits in the CompoBus/S I/O Link Unit's output word can be used as work bits, but unused bits in the output slaves cannot be used as work bits.

Unused bits in input word cannot be used as work bits.

Determining the Node Number and Making DIP Switch Settings

Node Number

The CompoBus/S I/O Link Unit is a Slave Unit with 8 input bits and 8 output bits. The node number setting is made using the DIP switch; the inputs and outputs share the same node number.

The range of possible node number settings is determined by the type of PC Master Unit is mounted to and the settings on the Master Unit. For details refer to the *CompoBus/S Operation Manual*.

Use the DIP switch to set the CompoBus S/IO Link Unit's node number, communications mode, and the status of output data when a communications error occurs.

CPM1A-SRT21

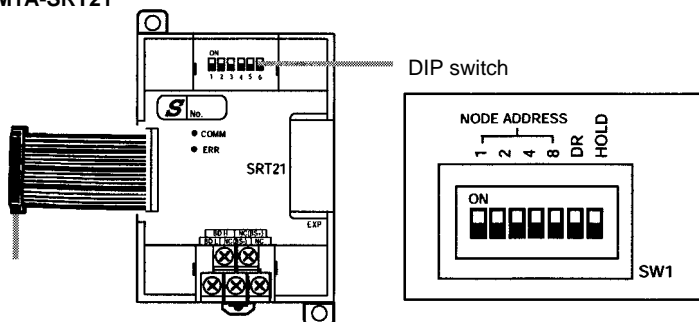

CPM2C-SRT21

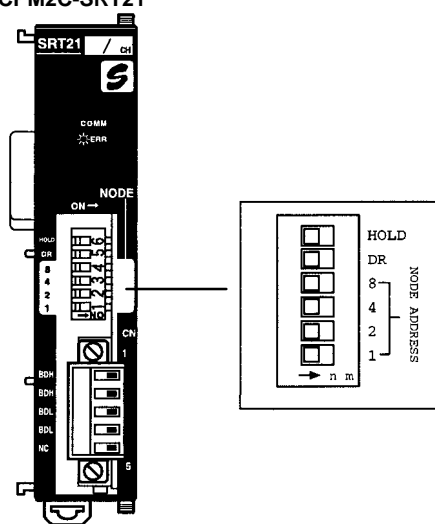

Pin labels	Contents			
1, 2, 4, and 8	Node Address Setting			
	Address	Pins	Address	Pins
		8421		8421
	0	0000	8	1000
	1	0001	9	1001
	2	0010	10	1010
	3	0011	11	1011
	4	0100	12	1100
	5	0101	13	1101
	6	0110	14	1110
7	0111	15	1111	
	1 = ON, 0 = OFF			
DR	ON	Long-distance communications mode (See note 2.)		
	OFF	High-speed communications mode		
HOLD	ON	Retain inputs after a communications error.		
	OFF	Clear inputs after a communications error.		

- Note**
1. Always turn OFF the power supply before changing the DIP switch settings.
 2. Never touch the DIP switch when the Unit is operating. Static electricity cause operating errors.

ing the CompoBus/S communications Path

following Master Units is connected. CQM1-SRM21-V1, or SRM1-C0□-V2.

Wire the CompoBus/S communications path as shown in the following diagrams.

CPM1A-SRT21

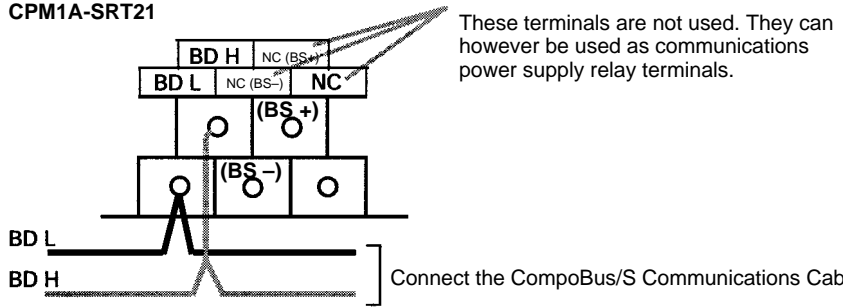

These terminals are not used. They can however be used as communications power supply relay terminals.

CPM2C-SRT21

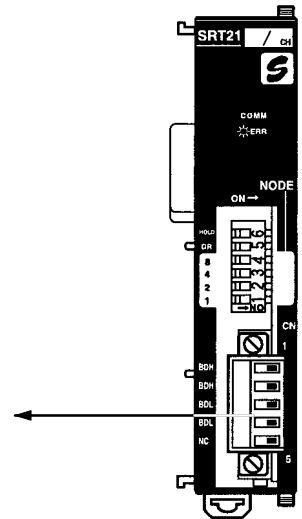
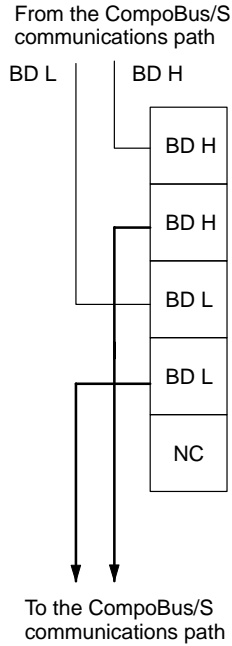

The CPM1A or CPM2A PCs can function as slaves to a DeviceNet master when a DeviceNet I/O Link Unit is connected. The DeviceNet I/O Link Unit establishes an I/O link of 32 inputs and 32 outputs between the master and the PC.

A maximum of 3 DeviceNet I/O Link Units, can be connected to a CPM2A CPM1A to create I/O Links for up to 192 points (96 inputs and 96 outputs).

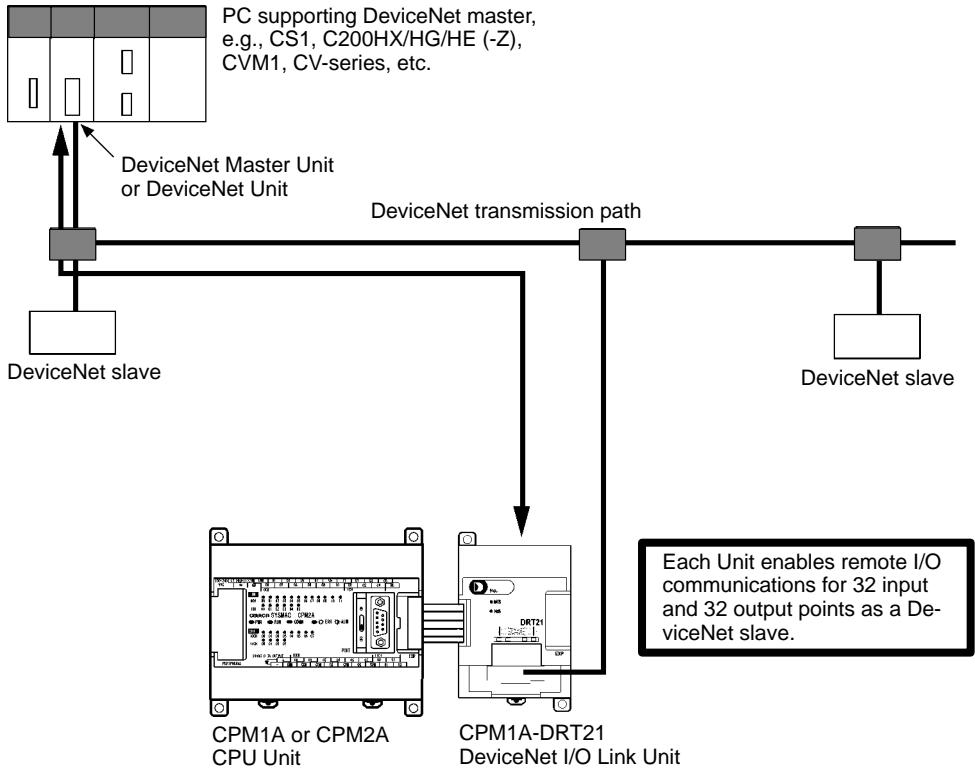

From the standpoint of the CPU Unit, the 32 input bits and 32 output bits cated to the DeviceNet I/O Link Unit are identical to input and output bits cated to Expansion I/O Units even though the DeviceNet I/O Link Unit does control external inputs and outputs. The input and output bits allocated to DeviceNet I/O Link Unit are one side of an I/O link between the slave CPU and the CPU Unit to which the Master Unit is connected.

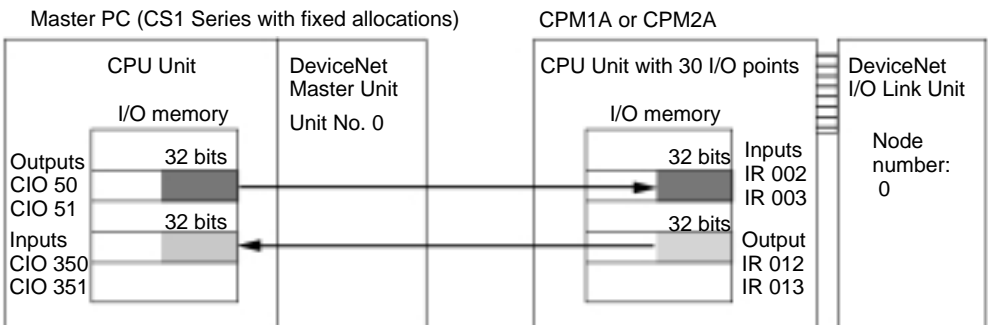

Note Refer to the *DeviceNet Slaves Operation Manual (W347)* for details on DeviceNet networks.

Model number	CPM1A-DR121
Master/slave	DeviceNet Slave
Number of I/O points	32 input points, 32 output points
Number of words allocated in CPU Unit I/O memory	2 input words, 2 output words (Allocated in the same way as Expansion I/O Units and other Expansion Units)
Node number setting	Set using the rotary switches (Set before turning ON the CPU Unit's power supply)

Indicators

Indicator	Color	Status	Meaning
MS	Green	Lit	Normal status
		Flashing	Switch settings being read
	Red	Lit	Fatal hardware error (watchdog timer)
		Flashing	Nonfatal error: Incorrect switch settings.
	---	OFF	Power not supplied. Waiting for initialization to start. Reset in progress.
NS	Green	Lit	Network normal and communications established.
		Flashing	Network normal and communications not established.
	Red	Lit	Fatal communications error: Unit has detected network status preventing normal communications. Node number duplications Bus OFF detected.
		Flashing	Nonfatal communications error: Communication timeout or communications error for one or more slaves.
	---	OFF	Waiting for node number check by master. Switch setting error. Power not supplied.

Handling Unit Errors

If an error occurs in the DeviceNet I/O Link Unit, the Error Flags in AR 0200 to AR 0202 will be turned ON. The addresses of the Error Flags are in the order of the Expansion Units are connected in the PC, with AR 0200 used for the Expansion Unit closest to the CPU Unit. Use these flags in the program when it is necessary to detect errors.

Wiring Procedure

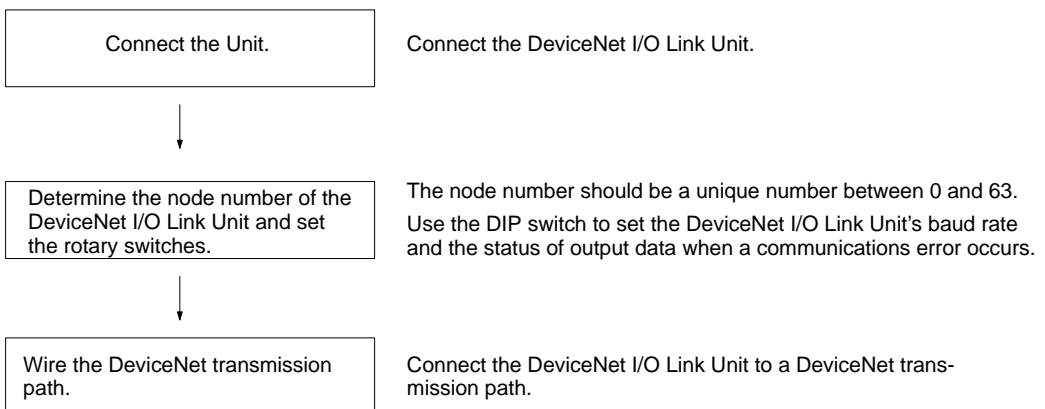

connected to the CPM1A/CPM2A. When Expansion I/O Units or other Expansion Units are also connected, they can be connected in any order from the CPU Unit.

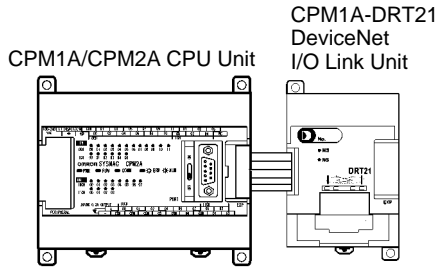

I/O Allocation

I/O words are allocated to the DeviceNet I/O Link Unit in the same way as Expansion I/O Units or other Expansion Units, the next available input and output words are allocated. When “m” is the last allocated input word and “n” is the last allocated output word, the DeviceNet I/O Link Unit is allocated “m+1” as its input word and “n+1” as its output word.

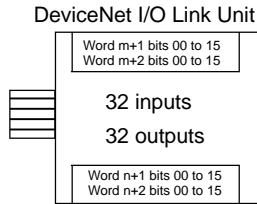

In the following example, a DeviceNet I/O Link Unit is connected to a CPU Unit with 30 I/O points.

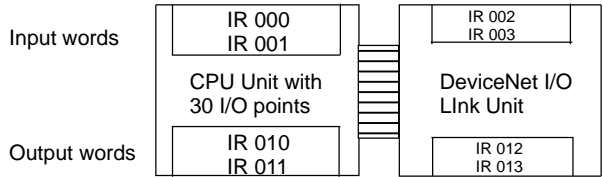

All of the words allocated to the DeviceNet I/O Link Unit are used to read and write data between the CPU Unit of the DeviceNet I/O Link Unit and the CPU Unit of the DeviceNet master, as shown in the following illustration.

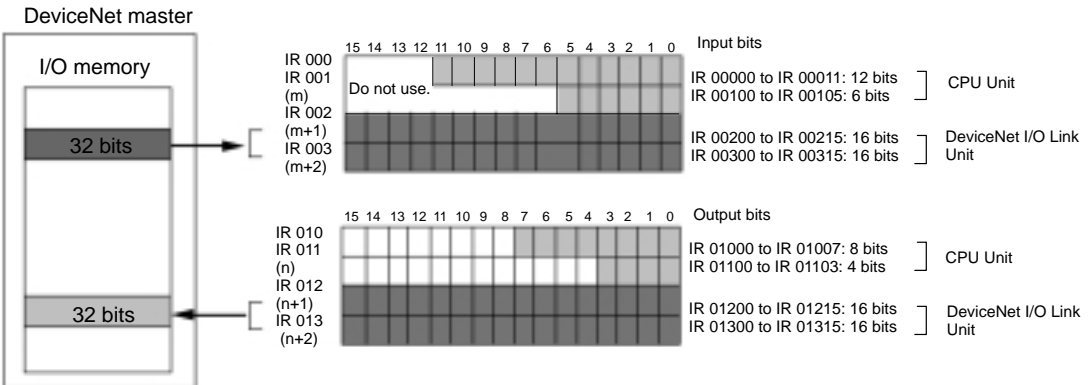

The 32 bits each of I/O data are not always transmitted simultaneously. In other words, 32 bits of data transmitted from the Master CPU Unit at the same time will not always reach the Slave CPU Unit simultaneously, and 32 bits of data transmitted from the Slave CPU Unit at the same time will not always reach the Master CPU Unit simultaneously.

In the CP I/O Unit receiving the data. For example, read the input data twice in succession and accept the data only when the two values match.

Unused bits in the DeviceNet I/O Link Unit's output words can be used as work bits if they are not used for output from the slave.

Unused bits in input word cannot be used as work bits.

Terminating the Node Number and Making DIP Switch Settings

Node Address Switches

Use these switches to set the node address of the Unit.

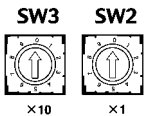

Setting method: Two-digit decimal

Setting range: 0 to 63 (Do not set 64 to 99.)

Note

1. Set the rotary switches before turning ON the power supply. The switch settings are read only at startup.
2. Any node address from 0 through 63 can be set as long as it hasn't been set on another slave node.
3. If the node address is the same as one set on another node, a node address duplication error will occur and it won't be possible to start up network communications. Refer to the *DeviceNet Slaves Operation Manual (W347)* for details.

Switch

The DIP switch on the front of the DeviceNet I/O Link Unit is used to set the baud rate and whether to hold or clear the remote outputs when a communication error occurs in the slave.

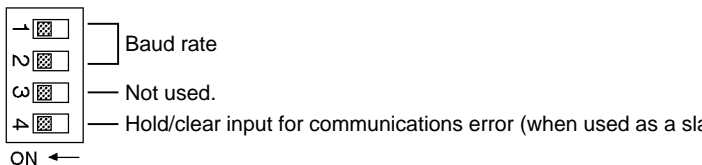

The settings of the DIP switch pins are shown in the following table. All pins are set to OFF at the factory.

Pin	Function	Setting
1	Baud rate	See the next table.
2		
3	Not used	OFF
4	Hold/clear remote outputs for communications error	OFF: Clear remote outputs ON: Hold remote outputs

Baud Rate

Pins 1 and 2 are used to set the baud rate as shown in the following table.

Pin 1	Pin 2	Baud rate	Max. transmission path length (reference)
OFF	OFF	125 kbps	500 m
ON	OFF	250 kbps	250 m
OFF	ON	500 kbps	100 m
ON	ON	Not allowed.	---

Note

1. Always turn OFF the PC before changing the DIP switch settings.
2. Set the same baud rate on all of the nodes (Master and Slaves) in the work. Any slaves with baud rates different from the master's rate won't be able to participate in communications and may cause a communication error between nodes that have been set properly.

When the DeviceNet is used as a slave, pin 4 is used to set whether to or clear remote outputs when a communications error occurs.

Note When using AR 02 (Expansion Unit Error Flags) in the program, turn ON pin the DIP switch. If communications are set to be cleared, the timing for clear outputs and setting the Error Flags may not agree.

Wiring the DeviceNet Communications Path

Wire the DeviceNet communications path as shown in the following diagram.

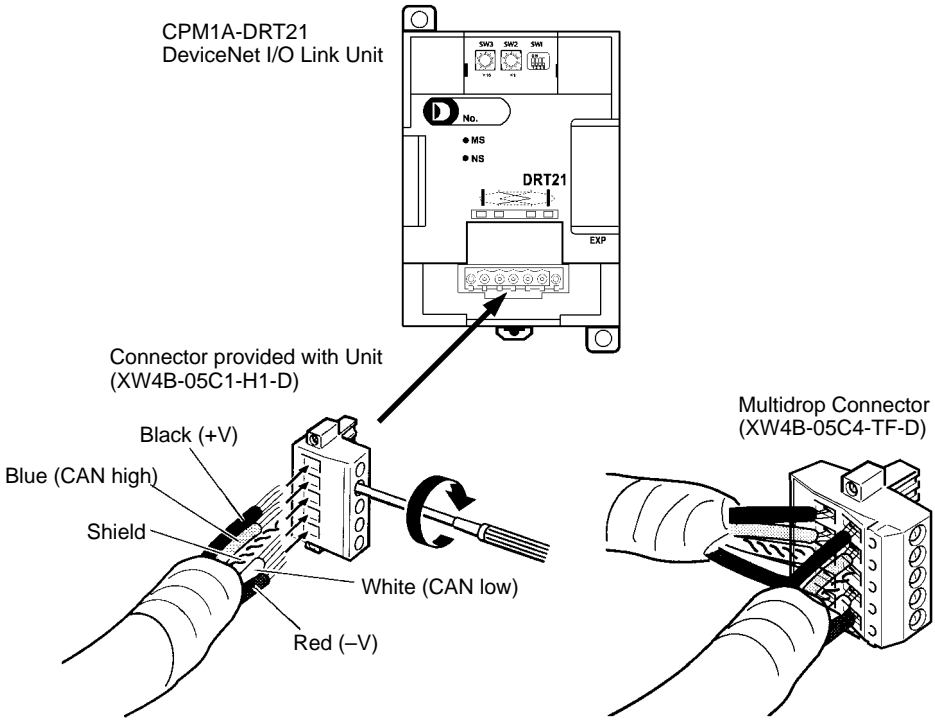

DeviceNet Connectors

Use the following connectors.

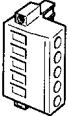
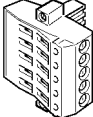
Model	Form and specifications
 XW4B-05C1-H1-D	OMRON connector with screws (included with DeviceNet I/O Link Unit).
 XW4B-05C4-TF-D	OMRON connector for multidrop connections (See note.)

Note Use the XW4B-05C4-TF-D when wiring multidrop connections using Thick Cables.

Use the following screwdriver for the above connector.

XW4Z-00C

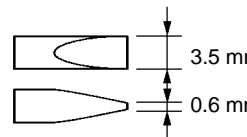
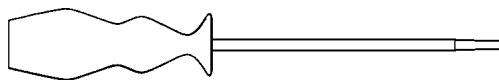

Refer to the *DeviceNet Slaves Operation Manual (V3.41)* for details on the response time. The data read/write time for one cycle for the CPM1A-DRT2 is approximately 0.5 ms. Add a maximum of 1 ms to the I/O response time.

Communications Functions

This section describes how to use the communications functions provided in the CPM1, CPM1A, CPM2A, CPM2C (including the CPM2C-S), and SRM1(-V2) PCs.

4-1	Introduction	222
4-1-1	Overview	222
4-1-2	Wiring Ports	222
4-2	CPM1/CPM1A Communications Functions	223
4-2-1	Host Link Communications	223
4-2-2	One-to-one NT Link Communications	224
4-2-3	One-to-one PC Link Communications	225
4-3	CPM2A/CPM2C Communications Functions	227
4-3-1	Host Link Communications	227
4-3-2	No-protocol Communications	247
4-3-3	One-to-one NT Link Communications	256
4-3-4	One-to-one PC Link Communications	259
4-4	SRM1(-V2) Communications Functions	264
4-4-1	Host Link Communications	264
4-4-2	No-protocol Communications	268
4-4-3	One-to-one NT Link Communications	273
4-4-4	One-to-N NT Link Communications	274
4-4-5	One-to-one PC Link Communications	275
4-5	Host Link Commands	277
4-5-1	IR/SR AREA READ – RR	277
4-5-2	LR AREA READ – RL	278
4-5-3	HR AREA READ – RH	278
4-5-4	PV READ – RC	278
4-5-5	TC STATUS READ – RG	279
4-5-6	DM AREA READ – RD	279
4-5-7	AR AREA READ – RJ	280
4-5-8	IR/SR AREA WRITE – WR	281
4-5-9	LR AREA WRITE – WL	281
4-5-10	HR AREA WRITE – WH	282
4-5-11	PV WRITE – WC	282
4-5-12	TC STATUS WRITE – WG	283
4-5-13	DM AREA WRITE – WD	284
4-5-14	AR AREA WRITE – WJ	284
4-5-15	SV READ 1 – R#	285
4-5-16	SV READ 2 – R\$	286
4-5-17	SV CHANGE 1 – W#	287
4-5-18	SV CHANGE 2 – W\$	288
4-5-19	STATUS READ – MS	289
4-5-20	STATUS WRITE – SC	290
4-5-21	ERROR READ – MF	291
4-5-22	FORCED SET – KS	292
4-5-23	FORCED RESET – KR	293
4-5-24	MULTIPLE FORCED SET/RESET – FK	294
4-5-25	FORCED SET/RESET CANCEL – KC	295
4-5-26	PC MODEL READ – MM	296
4-5-27	TEST – TS	296
4-5-28	PROGRAM READ – RP	297
4-5-29	PROGRAM WRITE – WP	297
4-5-30	COMPOUND COMMAND – QQ	298
4-5-31	ABORT – XZ	300
4-5-32	INITIALIZE – ::	300
4-5-33	TXD RESPONSE – EX	300
4-5-34	Undefined Command – IC	301

1-1 Overview

CPM1/CPM1A Communications

The CPM1/CPM1A can execute a variety of communications through its peripheral port via an RS-232C Adapter or an RS-422 Adapter.

Host Link Communications

The CPM1/CPM1A PCs are compatible with the Host Link System, which allows up to 32 PCs to be controlled from a host computer. An RS-232C Adapter is used for 1:1 communications and an RS-422 Adapter and B500-AL004 Link Adapter are used for 1:N communications.

A CPM1/CPM1A equipped with an RS-232C Adapter can also communicate with an OMRON Programmable Terminal using host link commands.

Refer to *4-2-1 CPM1/CPM1A Host Link Communications* in this manual or *1-2-2 Host Link Communications* in the *CPM1 Operation Manual* or *1-2-2 Host Link Communications* in the *CPM1A Operation Manual* for more details.

One-to-one PC Link

A data link can be created with a data area in another CPM1, CPM1A, CPM1B, CPM2C, CQM1, C200HX/HG/HE, or C200HS PC. An RS-232C Adapter is used to make the 1:1 connection.

Refer to *4-2-3 CPM1/CPM1A 1:1 PC Link Communications* in this manual or *1-2-3 One-to-one PC Communications Links* in the *CPM1 Operation Manual* or *1-2-3 One-to-one PC Communications Links* in the *CPM1A Operation Manual* for more details.

One-to-one NT Link

Using the 1:1 NT Link, the CPM1/CPM1A PC can be connected to the OMRON Programmable Terminal (NT Link Interface) through an RS-232C Adapter.

Refer to *4-2-2 CPM1/CPM1A 1:1 NT Link Communications* in this manual or *1-2-4 One-to-one NT Link Communications* in the *CPM1 Operation Manual* or *1-2-4 One-to-one NT Link Communications* in the *CPM1A Operation Manual* for more details.

CPM2A/CPM2C Communications

The following types of communications can be executed through the ports of the CPM2A/CPM2C.

- Host Link communications with a host computer
- RS-232C communications with a computer or other device
- One-to-one PC Link communications with another PC
- One-to-one NT Link communications with OMRON Programmable Terminal

This section explains the required PC Setup and methods for using these types of communications.

SRM1(-V2) Communications

The following types of communications can be executed through the ports of the SRM1(-V2).

- Host Link communications with a host computer
- RS-232C communications with a computer or other device
- One-to-one PC Link communications with another PC
- One-to-one NT Link communications with OMRON Programmable Terminal

Note One-to-one NT Link communications are not possible with the SRM1-C01, which is equipped with only a peripheral port. The SRM1-C01 may be connected to a PT through an RS-232C Adapter in Host Link mode.

1-2 Wiring Ports

Refer to the *CPM1 Operation Manual*, *CPM1A Operation Manual*, *CPM2A Operation Manual*, *CPM2C Operation Manual*, or *SRM1 Master Control Units Operation Manual* for information on wiring the communications ports.

2-1 Host Link Communications

Host Link communications were developed by OMRON for the purpose of connecting PCs and one or more host computers by RS-232C cable, and controlling PC communications from the host computer. Normally the host computer issues a command to a PC, and the PC automatically sends back a response. Thus, communications are carried out without the PCs being actively involved. PCs also have the ability to initiate data transmissions when direct involvement is necessary.

In general, there are two means for implementing Host Link communications. One is based on C-mode commands, and the other on FINS (CV-mode) commands. The CPM1/CPM1A supports C-mode commands only. For details on Host Link communications, refer to *4-5 Host Link Commands*.

Setup Settings

The CPM1/CPM1A's peripheral port settings must be set properly in order to use the Host Link communications, as shown in the following table.

Word	Bit	Function	Setting																																																																
16650	00 to 07	Port settings ¹ 00: Standard (1 start bit, 7-bit data, 2 stop bits, even parity, 9,600 bps) 01: Settings in DM 6651	00																																																																
	08 to 11	Link area for 1:1 PC Link via peripheral port 0: LR 00 to LR 15	0 (Any value is OK)																																																																
	12 to 15	Communications mode ¹ 0: Host Link; 2: 1:1 PC Link Slave; 3: 1:1 PC Link Master; 4: 1:1 NT Link	0																																																																
16651	00 to 07	Baud rate ¹ 00: 1.2K, 01: 2.4K, 02: 4.8K, 03: 9.6K, 04: 19.2K	00 (Any value is OK)																																																																
	08 to 15	Frame format ¹ <table border="1" style="margin-left: 20px; border-collapse: collapse;"> <thead> <tr> <th></th> <th>Start</th> <th>Length</th> <th>Stop</th> <th>Parity</th> </tr> </thead> <tbody> <tr><td>00:</td><td>1 bit</td><td>7 bits</td><td>1 bit</td><td>Even</td></tr> <tr><td>01:</td><td>1 bit</td><td>7 bits</td><td>1 bit</td><td>Odd</td></tr> <tr><td>02:</td><td>1 bit</td><td>7 bits</td><td>1 bit</td><td>None</td></tr> <tr><td>03:</td><td>1 bit</td><td>7 bits</td><td>2 bit</td><td>Even</td></tr> <tr><td>04:</td><td>1 bit</td><td>7 bits</td><td>2 bit</td><td>Odd</td></tr> <tr><td>05:</td><td>1 bit</td><td>7 bits</td><td>2 bit</td><td>None</td></tr> <tr><td>06:</td><td>1 bit</td><td>8 bits</td><td>1 bit</td><td>Even</td></tr> <tr><td>07:</td><td>1 bit</td><td>8 bits</td><td>1 bit</td><td>Odd</td></tr> <tr><td>08:</td><td>1 bit</td><td>8 bits</td><td>1 bit</td><td>None</td></tr> <tr><td>09:</td><td>1 bit</td><td>8 bits</td><td>2 bit</td><td>Even</td></tr> <tr><td>10:</td><td>1 bit</td><td>8 bits</td><td>2 bit</td><td>Odd</td></tr> <tr><td>11:</td><td>1 bit</td><td>8 bits</td><td>2 bit</td><td>None</td></tr> </tbody> </table>		Start	Length	Stop	Parity	00:	1 bit	7 bits	1 bit	Even	01:	1 bit	7 bits	1 bit	Odd	02:	1 bit	7 bits	1 bit	None	03:	1 bit	7 bits	2 bit	Even	04:	1 bit	7 bits	2 bit	Odd	05:	1 bit	7 bits	2 bit	None	06:	1 bit	8 bits	1 bit	Even	07:	1 bit	8 bits	1 bit	Odd	08:	1 bit	8 bits	1 bit	None	09:	1 bit	8 bits	2 bit	Even	10:	1 bit	8 bits	2 bit	Odd	11:	1 bit	8 bits	2 bit	None
	Start	Length	Stop	Parity																																																															
00:	1 bit	7 bits	1 bit	Even																																																															
01:	1 bit	7 bits	1 bit	Odd																																																															
02:	1 bit	7 bits	1 bit	None																																																															
03:	1 bit	7 bits	2 bit	Even																																																															
04:	1 bit	7 bits	2 bit	Odd																																																															
05:	1 bit	7 bits	2 bit	None																																																															
06:	1 bit	8 bits	1 bit	Even																																																															
07:	1 bit	8 bits	1 bit	Odd																																																															
08:	1 bit	8 bits	1 bit	None																																																															
09:	1 bit	8 bits	2 bit	Even																																																															
10:	1 bit	8 bits	2 bit	Odd																																																															
11:	1 bit	8 bits	2 bit	None																																																															
16652	00 to 15	Transmission delay (Host Link) ¹ 0000 to 9999: In ms.	0000																																																																
16653	00 to 07	Node number (Host Link) ¹ 00 to 31 (BCD)	00 to 31																																																																
	08 to 15	Not used.	00 (Any value is OK)																																																																

- Note**
1. If an improper setting is used, a non-fatal error will occur, AR 1302 will be turned ON, and the default setting (0, 00, or 0000) will be used.
 2. For information on the Host Link settings for another OMRON PC, refer to that PC's Operation Manual.

Communications mode: Host Link
 Communications format: Standard settings
 (1 start bit, 7-bit data; 2 stop bits, even parity
 9,600 bps)
 Transmission delay: No
 Node number: 00

Sample Program

This example shows a BASIC program that reads the status of the CPM1 outputs in IR 000. For more details, refer to *4-5 Host Link Commands*.

An FCS (frame check sequence) check isn't performed on the received response data in this program. Be sure that the host computer's RS-232C port is configured correctly before executing the program.

```

1010 'CPM1 SAMPLE PROGRAM
1020 'SET THE COMMAND DATA
1030 S$="@0RR00000001"
1040 FCS=0
1050 FOR I=1 TO LEN(S$)
1060 FCS=FCS XOR ASC(MID$(S$,I,1))
1070 NEXT I
1080 FCS$(FCS):IF LEN(FCS$)=1 THEN FCS$="0"+FCS$
1090 CLOSE 1
1100 CLS
1110 PRINT "SENDING COMMAND"
1120 OPEN "COM:E73" AS #1
1130 PRINT #1,S$ + FCS + CHR$(13);
1140 CLS
1150 PRINT "RECEIVING RESPONSE DATA"
1160 LINE INPUT #1,A$
1170 PRINT A$
1180 END
  
```

2-2 One-to-one NT Link Communications

Using the 1:1 NT Link, the CPM1/CPM1A PC can be connected to the Programmable Terminal (NT Link Interface) through an RS-232C Adapter.

CPM1 PCs

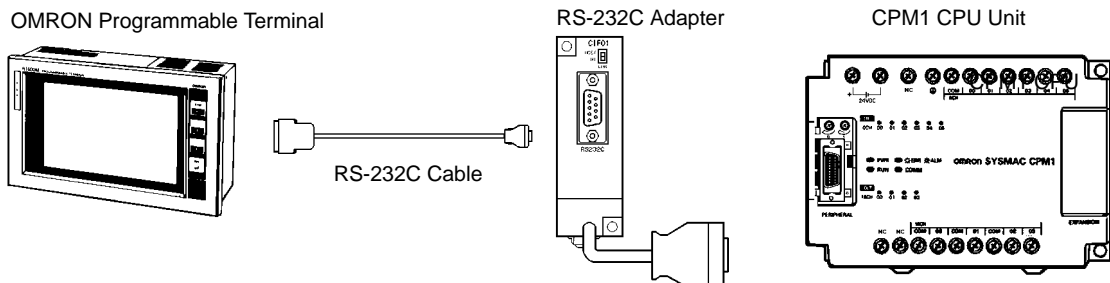

OMRON Programmable Terminal

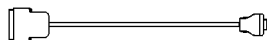
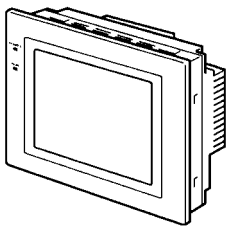

RS-232C Cable

RS-232C Adapter

CPM1A CPU Unit

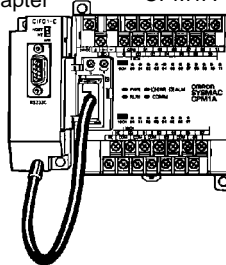

Setup Settings

The settings relating to 1:1 NT Link PC communications must be set as shown in the following table.

Word	Bit	Function	Setting
DM 6650	00 to 07	Port settings ¹ 00: Standard (1 start bit, 7-bit data, 2 stop bits, even parity, 9,600 bps) 01: Settings in DM 6651	00 (Any value is OK)
	08 to 11	Link area for 1:1 PC Link via peripheral port 0: LR 00 to LR 15	0 (Any value is OK)
	12 to 15	Communications mode ¹ 0: Host Link; 2: 1:1 PC Link Slave; 3: 1:1 PC Link Master; 4: 1:1 NT Link	4

- Note**
1. If an improper setting is used, a non-fatal error will occur, AR 1302 will be turned ON, and the default setting (0 or 00) will be used.
 2. For information on the NT Link settings for another OMRON PC, refer to the PC's Operation Manual.
 3. If an out-of-range value is set, the following communications conditions will result. In that case, reset the value so that it is within the permissible range.

Communications mode:	Host Link
Communications format:	Standard settings (1 start bit, 7-bit data; 2 stop bits, even parity, 9,600 bps)
Transmission delay:	No
Node number:	00

2-3 One-to-one PC Link Communications

In a 1:1 PC Link, a CPM1/CPM1A is linked to another CPM1/CPM1A, CPM2C, CQM1, C200HX/HG/HE, or C200HS PC through an RS-232C Adapter and standard RS-232C cable. One of the PCs will serve as the Master and the other as the Slave. The 1:1 PC Link can connect up to 256 bits (LR 0000 to LR 1515) in the two PCs.

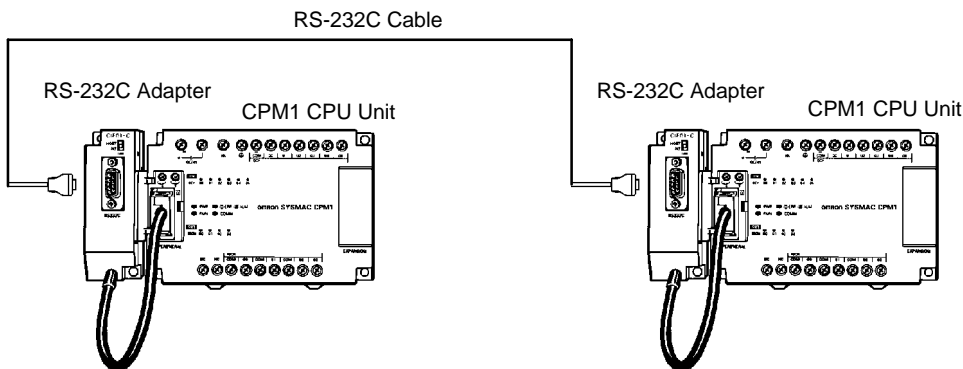

The words used for the 1:1 PC Link are as shown below.

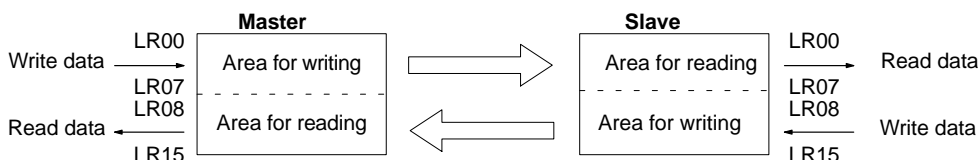

Limitations of 1:1 PC Links in a CPM1/CPM1A

Only the 16 LR words from LR 00 to LR 15 can be linked in the CPM1/CPM1A. The CPM1/CPM1A can use only those 16 words in the CQM1 or C200HS when making a 1:1 PC Link with one of those PCs. A 1:1 PC Link cannot be made to a CPM1/CPM1A using LR 16 through LR 63 in the CQM1, C200HX/HG/HE, or C200HS.

Setup Settings

The settings relating to 1:1 PC Link communications must be set as shown in the following table.

Word	Bit	Function	Setting (Master)	Setting (Slave)
6650	00 to 07	Port settings ¹ 00: Standard (1 start bit, 7-bit data, 2 stop bits, even parity, 9,600 bps) 01: Settings in DM 6651	00 (Any value is OK)	00 (Any value is OK)
	08 to 11	Link area for 1:1 PC Link via peripheral port 0: LR 00 to LR 15	0	0 (Any value is OK)
	12 to 15	Communications mode ¹ 0: Host Link; 2: 1:1 PC Link Slave; 3: 1:1 PC Link Master; 4: 1:1 NT Link	3	2

- Note**
- If an improper setting is used, a non-fatal error will occur, AR 1302 will be turned ON, and the default setting (0 or 00) will be used.
 - For information on the 1:1 PC Link settings for another OMRON PC, refer to that PC's Operation Manual.
 - For information on CPM1/CPM1A 1:1 PC Link connections and wiring diagrams refer to 3-4-7 *Host Link Connections* in the *CPM1 Operation Manual* or *CPM1A Operation Manual*. For the SRM1(-V2) refer to 3-4-4 *RS-232C Port Wiring* in the *SRM1 Master Control Unit Operation Manual*.
 - If an out-of-range value is set, the following communications conditions result. In that case, reset the value so that it is within the permissible range.
- Communications mode: Host Link
 Communications format: Standard settings
 (1 start bit, 7-bit data; 2 stop bits, even parity, 9,600 bps)
 Transmission delay: No
 Node number: 00

Program in the Master

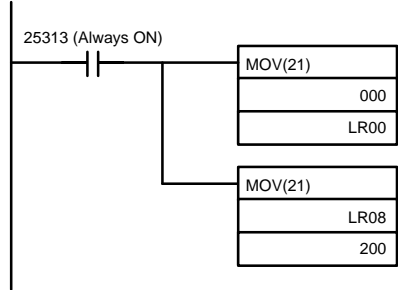

Program in the Slave

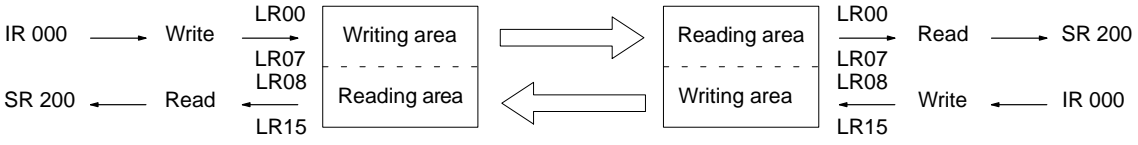
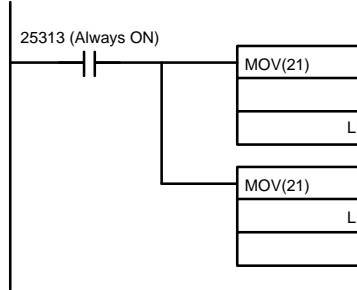

3 CPM2A/CPM2C Communications Functions

This section describes how to use CPM2A/CPM2C (including the CPM2C) communications functions. Read this section if you are using Host Link, protocol, 1:1 NT Link, or 1:1 PC Link communications.

3-1 Host Link Communications

Host Link communications are a conversational-type communications protocol in which the PC sends responses to commands issued from a host computer and can be used to read or write data in the PC's data areas and control some operations. There is no need for a communications program in the PC. Host Link communications can be used through the peripheral port or the CPM2C's RS-232C port.

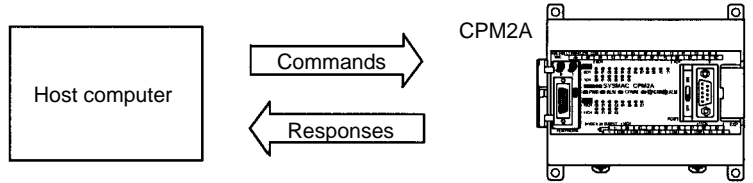

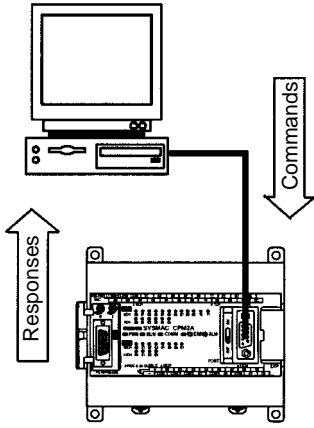

CPM2A RS-232C port connection
(See note.)

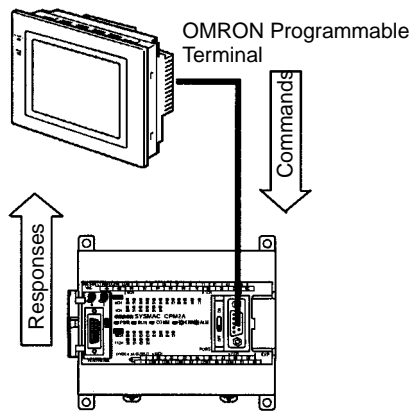

CPM2A RS-232C port connection
(See note.)

Note When connecting to the peripheral port, an RS-232C Adapter or computer connection cable (CQM1-CIF01 or CQM1-CIF02) is necessary.

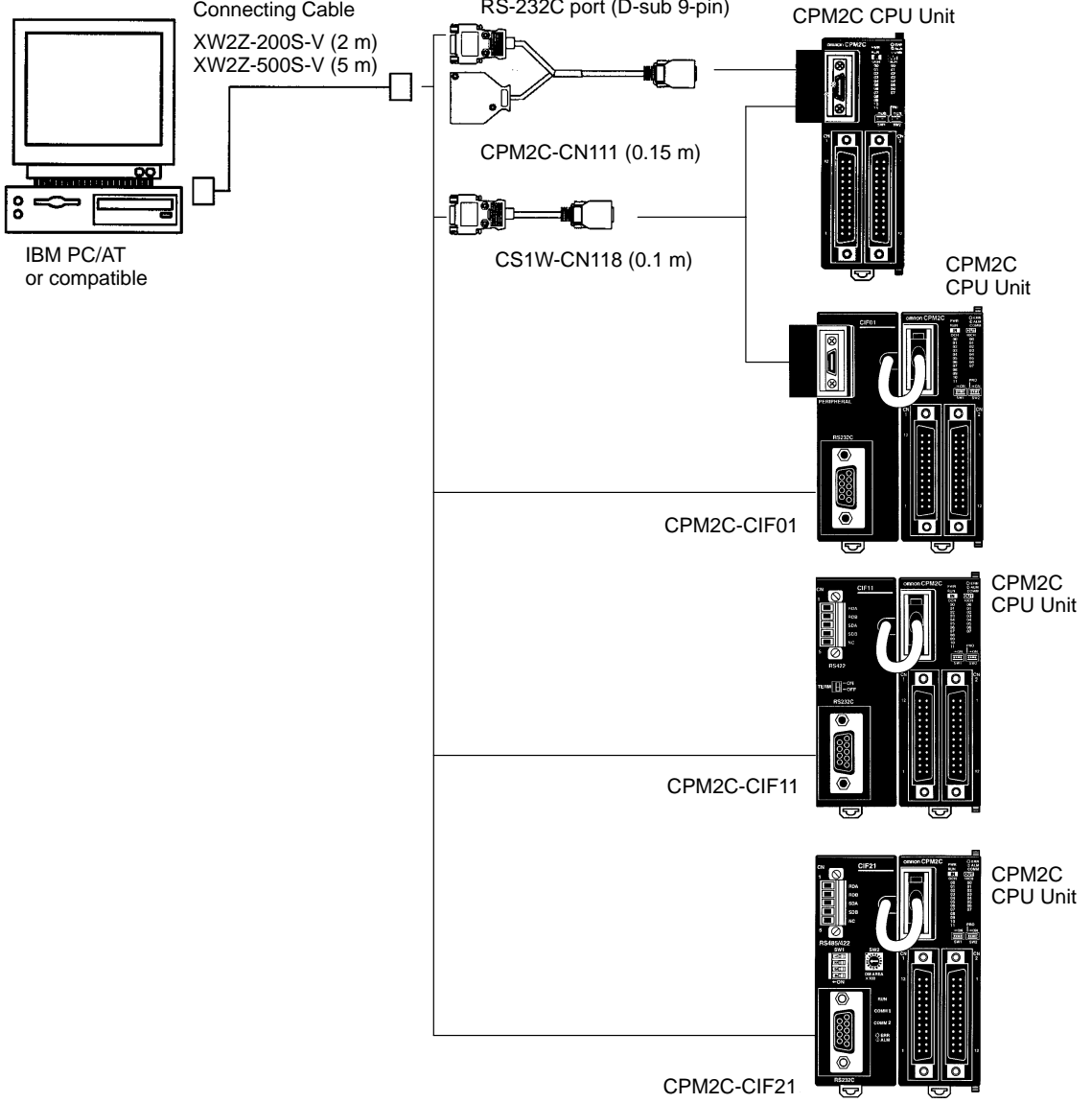

Note The CSW1-CN226/626 can be connected directly to the CPU Unit. They can be connected to the CPM2C-CIF01.

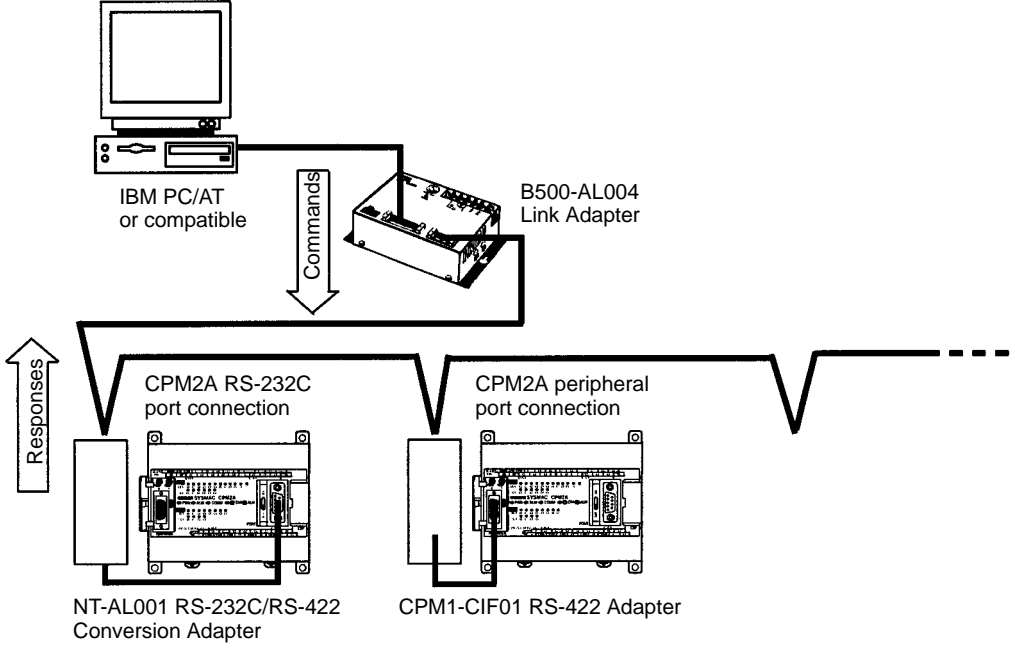

IBM PC/AT or compatible computer

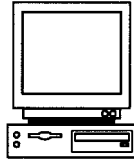

Connecting Cable
XW2Z-200S-V (2 m)
XW2Z-500S-V (5 m)

B500-AL004 or NT-AL001 (requires +5 V)
(See notes 1 and 2.)
RS-422 (Total length: 500 m max.)

en using the port
a peripheral port

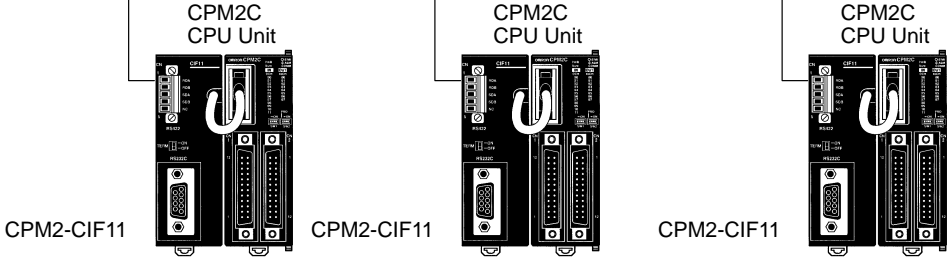

en using
port as
RS-232C

NT-AL001
(See note 1.)

NT-AL001
(See note 1.)

NT-AL001
(See note 1.)

NT-AL001
(See note 1.)

RS-232C port

CPM2C CPU Unit

CPM2C CPU Unit

CPM2C CPU Unit

CPM2C CPU Unit

Z-070T-1 (0.7 m)
Z-200T-1 (2 m)

XW2Z-070T-1 (0.7 m)
XW2Z-200T-1 (2 m)

XW2Z-070T-1 (0.7 m)
XW2Z-200T-1 (2 m)

XW2Z-070T-1 (0.7 m)
XW2Z-200T-1 (2 m)

RS-232C port
CPM2C-CN111
Connecting Cable
(0.15 m)

RS-232C port
CSW1-CN118 Cor
necting Cable (0.15 m)

CPM2C-CIF01

CPM2C-CIF21

Up to 32 PCs

In Host Link communications, the host computer ordinarily has the transmission right first and initiates the communications. The CPM2A/CPM2C then automatically sends a response.

Commands and responses are exchanged in the order shown in the illustration below. The block of data transferred in a single transmission is called a "frame." A single frame is configured of a maximum of 131 characters of data. The right to send a frame is called the "transmission right." The Unit that has the transmission right is the one that can send a frame at any given time. The transmission right is traded back and forth between the host computer and the CPM2A/CPM2C each time a frame is transmitted. The transmission right is passed from the transmitting Unit to the receiving Unit when either a terminator (the code that marks the end of a command or response) or a delimiter (the code that separates frames apart) is received.

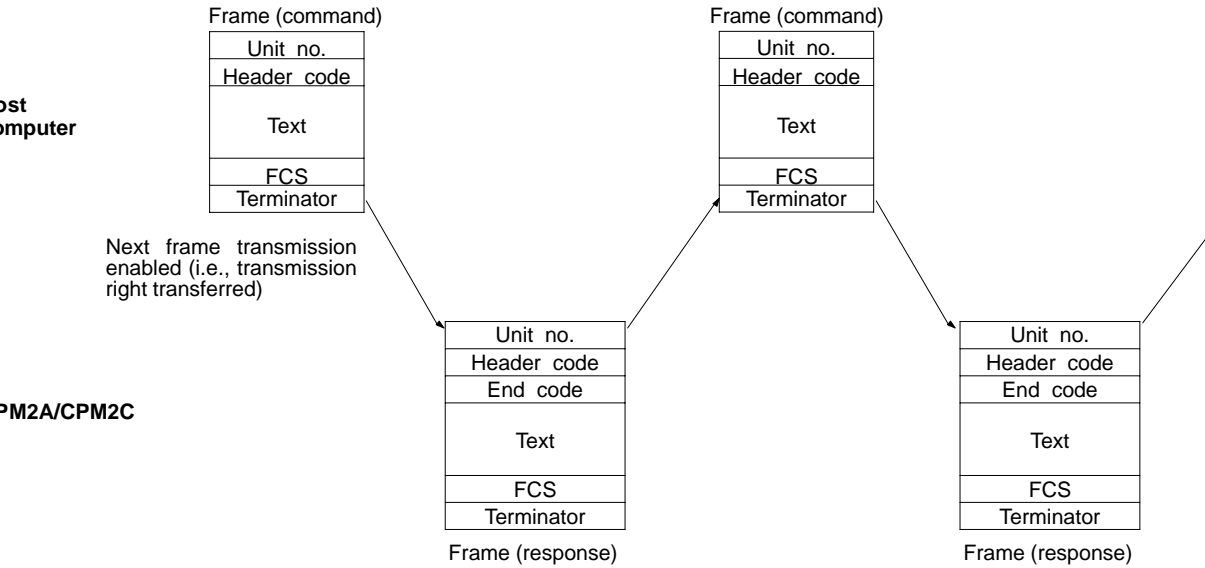

Host-initiated communications

Data transmissions from the PC to the host computer can be initiated by the CPM2A/CPM2C Unit using TXD(48).

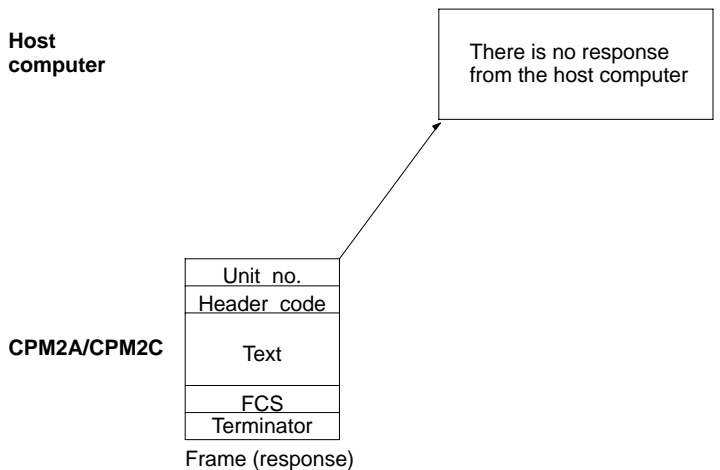

This section explains the formats for the commands and responses that are changed in Host Link communications.

Command Format

When transmitting a command from the host computer, prepare the command data in the format shown below.

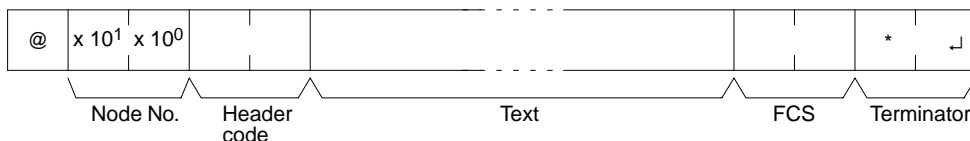

@

An "@" symbol must be placed at the beginning.

Node No.

Identifies the CPM2A/CPM2C PC communicating with the host computer. Specify the CPM2A/CPM2C's node number in the PC Setup (DM 6653).

Header Code

Set the 2-character command code.

Text

Set the command parameters.

FCS

Set a 2-character Frame Check Sequence code. See page 235.

Terminator

Set two characters, "*" and the carriage return (CHR\$(13)) to indicate the end of the command.

Response Format

The response from the CPM2A/CPM2C is returned in the format shown below. Prepare a program so that the response data can be interpreted and processed.

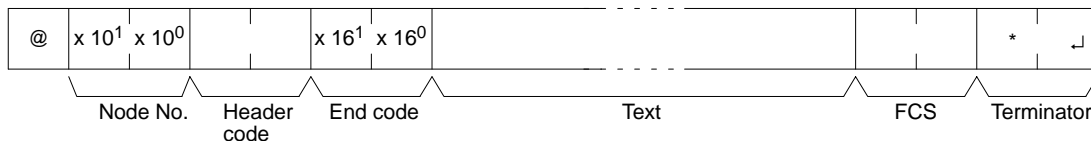

@, Node No., Header Code

Contents identical to those of the command are returned.

End Code

The completion status of the command (e.g., whether or not an error has occurred) is returned.

Text

Text is returned only when there is data such as read data.

FCS

The set 2-character Frame Check Sequence is returned.

Terminator

Set two characters, "*" and the carriage return (CHR\$(13)) to indicate the end of the response.

Long Transmissions

The largest block of data that can be transmitted as a single frame is 131 characters. A command or response of 132 characters or more must therefore be divided into more than one frame before transmission. When a transmission is split, the ends of the first and intermediate frames are marked by a delimiter instead of a terminator.

delimiter to be transmitted from the CPM2A/CPM2C. After the delimiter has been transmitted, the next frame will then be sent. This procedure is repeated until the entire command has been transmitted.

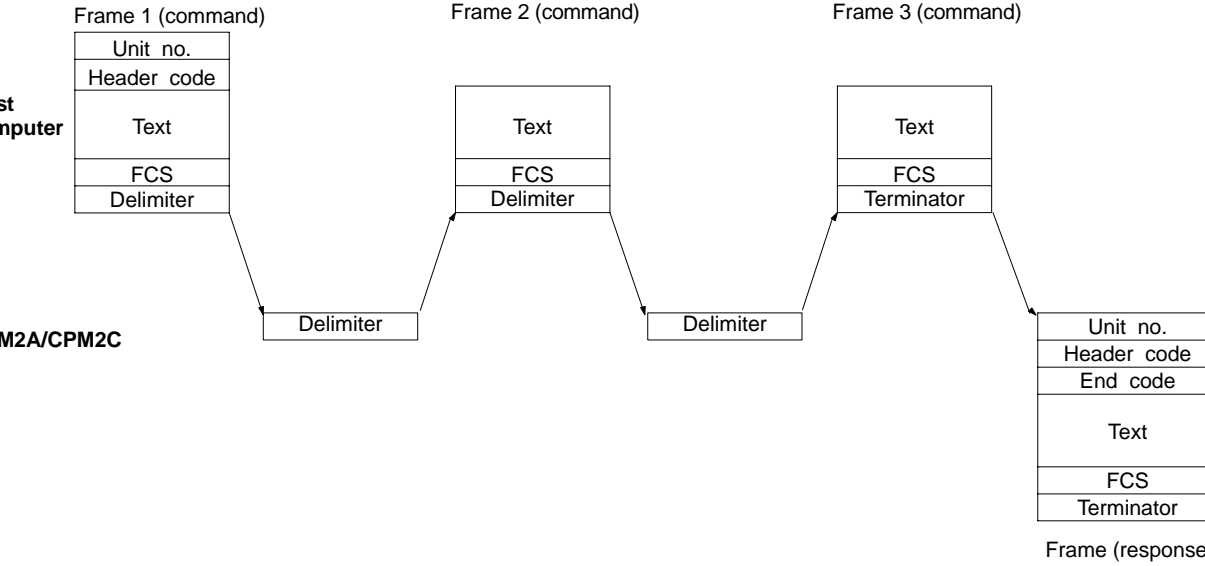

Handling Responses

As each frame is received by the host computer, a delimiter is transmitted to CPM2A/CPM2C. After the delimiter has been transmitted, the CPM2A/CPM2C will transmit the next frame. This procedure is repeated until the entire response has been transmitted.

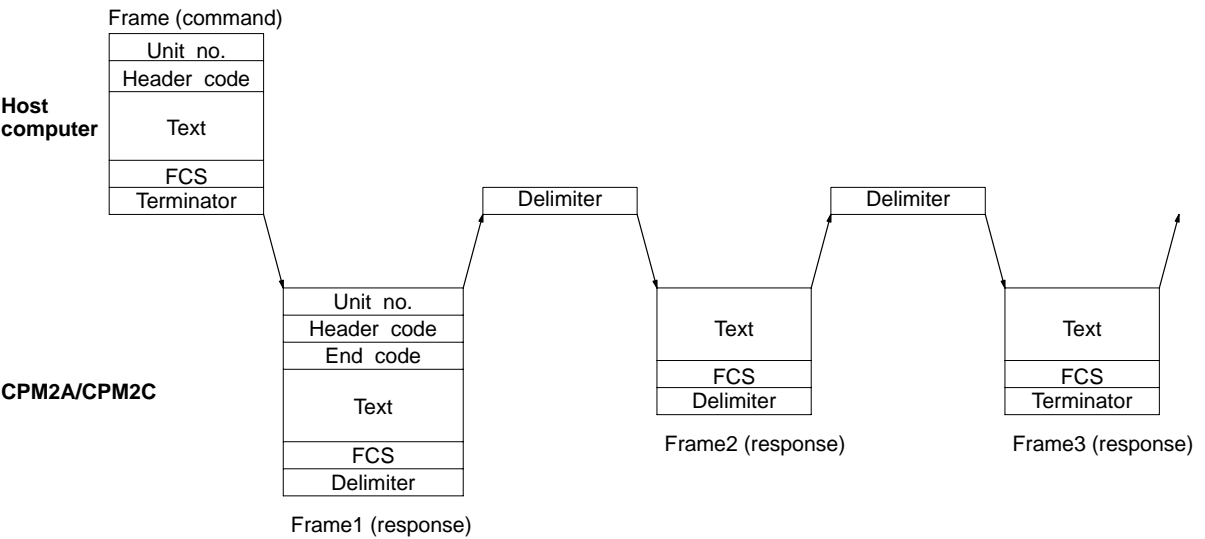

erations, be careful not to divide into separate frames that is to be w
 into a single word. As shown in the illustration below, be sure to divide frame
 that they coincide with the divisions between words.

Frame 1 (131 characters maximum)

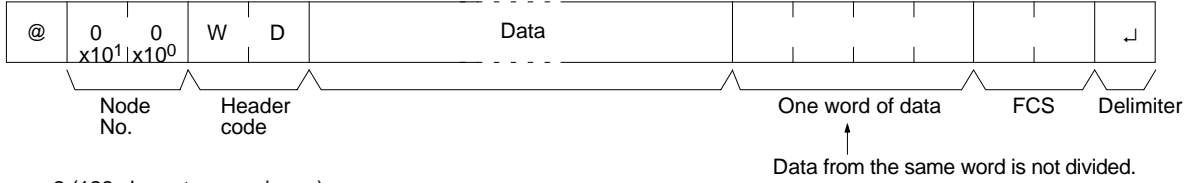

Frame 2 (128 characters maximum)

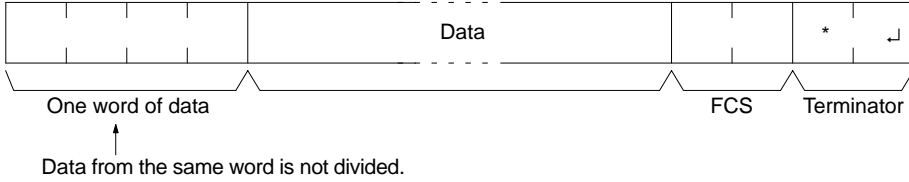

S (Frame Check Sequence)

When a frame is transmitted, an FCS is placed just before the delimiter or te
 nator in order to check whether any data error has been generated. The FC
 8-bit data converted into two ASCII characters. The 8-bit data is the result o
 EXCLUSIVE OR performed on the data from the beginning of the frame unti
 end of the text in that frame (i.e., just before the FCS). Calculating the FCS e
 time a frame is received and checking the result against the FCS that is inclu
 in the frame makes it possible to check for data errors in the frame.

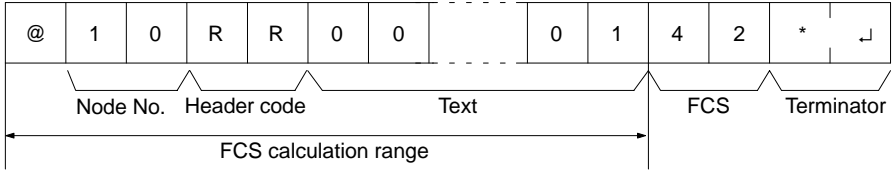

ASCII code	Leftmost	Rightmost
@ → 40 →	0100	0000
1 → 31 →	0011	0001
0 → 30 →	0011	0000
R → 52 →	0101	0010
0 → 30 →	0011	0000
0 → 30 →	0011	0000
to		
0 → 30 →	0011	0000
1 → 31 →	0011	0001
Calculation results	0100	0010
	↓ ↓	Converted to hexadecimal.
	4 2	Handled as ASCII characters.

on a frame received by the host computer.
Normal reception data includes the FCS, delimiter or terminator, and so
When an error occurs in transmission, however the FCS or some other data
not be included. Be sure to program the system to cover this possibility.

```
) *FSCHECK
) L = LEN ( RESPONSE$ ) ' ..... Data transmitted and received
) Q = 0 : FCCK$ = " "
) A$ = RIGHT$ ( RESPONSE$ , 1)
) PRINT RESPONSE$ , A$ , L
) IF A$ = "*" THEN LENG$ = LEN ( RESPONSE$ ) - 3
)           ELSE LENG$ = LEN ( RESPONSE$ ) - 2
) FCSP$ = MID$ ( RESPONSE$ , LENG$ + 1 , 2 ) ' ..... FCS data received
) FOR I = 1 TO LENG$ ' ..... Number of characters in FCS
)   Q = ASC ( MID$ ( RESPONSE$ , I , 1 ) ) XOR Q
) NEXT I
) FCSD$ = HEX$ ( Q )
) IF LEN ( FCSD$ ) = 1 THEN FCSD$ = " 0 " + FCSD$ ' ..... FCS result
) IF FCSD$ < > FCSP$ THEN FCCK$ = " ERR "
) PRINT " FCSD$ = " ; FCSD$ , " FCSP$ = " ; FCSP$ , " FCCK$ = " ; FCCK$
) RETURN
```

Header code	CPM2A/CPM2C Operating Mode			Name	Pa
	RUN	MONITOR	PROGRAM		
	Valid	Valid	Valid	IR/WR/SR AREA READ	277
	Valid	Valid	Valid	LR AREA READ	278
	Valid	Valid	Valid	HR AREA READ	278
	Valid	Valid	Valid	TC PV READ	278
	Valid	Valid	Valid	TC STATUS READ	279
	Valid	Valid	Valid	DM AREA READ	279
	Valid	Valid	Valid	AR AREA READ	280
R	Not Valid	Valid	Valid	IR/WR/SR AREA WRITE	281
.	Not Valid	Valid	Valid	LR AREA WRITE	281
H	Not Valid	Valid	Valid	HR AREA WRITE	282
C	Not Valid	Valid	Valid	TC PV WRITE	282
B	Not Valid	Valid	Valid	TC STATUS WRITE	283
D	Not Valid	Valid	Valid	DM AREA WRITE	284
	Not Valid	Valid	Valid	AR AREA WRITE	284
	Valid	Valid	Valid	SV READ 1	285
	Valid	Valid	Valid	SV READ 2	286
z	Not Valid	Valid	Valid	SV CHANGE 1	287
S	Not Valid	Valid	Valid	SV CHANGE 2	288
S	Valid	Valid	Valid	STATUS READ	289
	Valid	Valid	Valid	STATUS WRITE	290
	Valid	Valid	Valid	ERROR READ	291
	Not Valid	Valid	Valid	FORCED SET	292
	Not Valid	Valid	Valid	FORCED RESET	293
	Not Valid	Valid	Valid	MULTIPLE FORCED SET/RESET	294
	Valid	Valid	Valid	FORCED SET/RESET CANCEL	295
M	Valid	Valid	Valid	PC MODEL READ	296
	Valid	Valid	Valid	TEST	296
	Valid	Valid	Valid	PROGRAM READ	297
P	Not Valid	Not Valid	Valid	PROGRAM WRITE	297
Q	Valid	Valid	Valid	COMPOUND COMMAND	298
	Valid	Valid	Valid	ABORT (command only)	300
	Valid	Valid	Valid	INITIALIZE (command only)	300
	Valid	Valid	Not Valid	TXD RESPONSE (response only)	300
	---	---	---	Undefined command (response only)	301

Note ---: Not affected by the mode.

Code	Contents	Probable cause	Corrective measures
	Normal completion	---	---
	Not executable in RUN mode	The command that was sent cannot be executed when the PC is in RUN mode.	Check the relation between the command and the PC mode.
	Not executable in MONITOR mode	The command that was sent cannot be executed when the PC is in MONITOR mode.	
	Address over	The user program area's highest address was exceeded.	Check the program.
	Not executable in PROGRAM mode	The command that was sent cannot be executed when the PC is in PROGRAM mode.	This code is not presently being used.
	FCS error	The FCS is wrong. Either the FCS calculation is mistaken or there is adverse influence from noise.	Check the FCS calculation method. If there was influence from noise, transfer the command again.
	Format error	The command format is wrong.	Check the format and transfer the command again.
	Entry number data error	The read/write area specification is wrong.	Correct the areas and transfer the command again.
	Command not supported	The specified command does not exist in the specified address. (Reading the SV, etc.)	Check the address and instruction.
	Frame length error	The maximum frame length was exceeded.	Divide the command into multiple frames.
	Not executable	Items to read not registered for composite command (QQ).	Execute QQ to register items to read before attempting batch read.
	User memory write-protected	The memory is write-protected in the PC Setup.	Change the setting in the PC Setup (DM 6602).
	Aborted due to FCS error in transmit data	<p>The error was generated while a command extending over more than one frame was being executed.</p> <p>Note: The data up to that point has already been written to the appropriate area of the CPU Unit.</p>	Check for corrupted frames, correct if necessary, and try the transfer again.
	Aborted due to format error in transmit data		
	Aborted due to entry number data error in transmit data		
	Aborted due to frame length error in transmit data		
Other	---	Influence from noise was received.	Transfer the command again.

Application Procedure

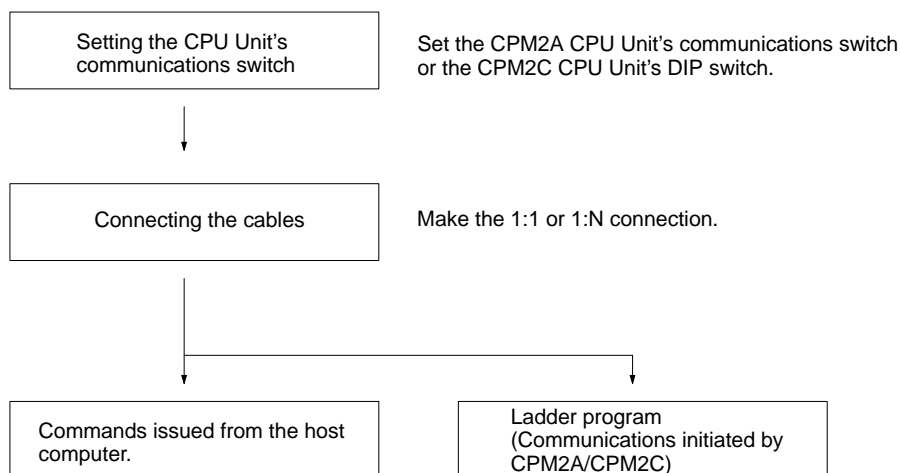

the front of the CPU Unit and the CPM2A's communications are controlled by the DIP switch on the front of the CPU Unit.

CPM2A Communications Switch Setting

When the communications switch is set to OFF, communications through the peripheral port and RS-232C port are governed by the settings in the PC Setup.

When the communications switch is set to ON, communications through the peripheral port and RS-232C port are governed by the standard Host Link settings (1 start bit, 7 data bits, 2 stop bits, even parity, and 9,600 bps baud rate).

Note When a Programming Console is connected to the peripheral port, communications with the Programming Console are unaffected by either the communications switch or PC Setup.

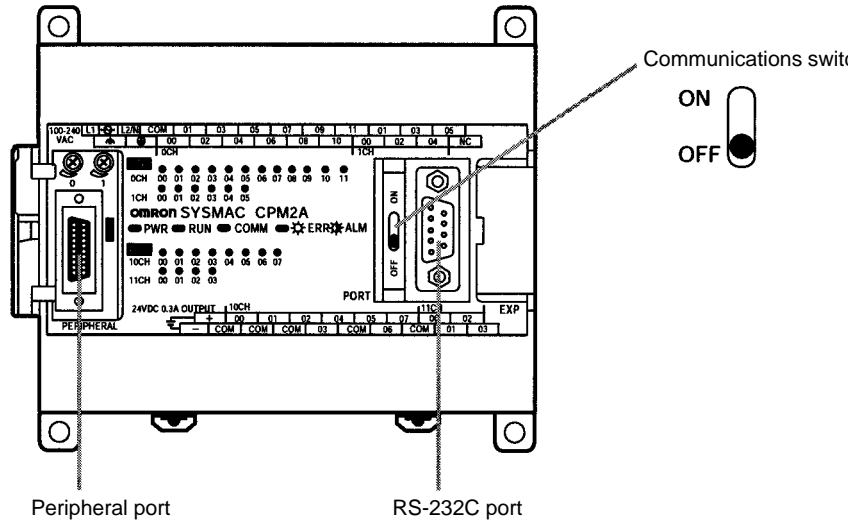

An RS-232C Adapter is needed to perform Host Link communications from the peripheral port.

Programming Console protocol, regardless of the setting of pin 1 or the setting in the PC Setup.

Front View

CPU Unit with Relay Outputs via Terminal Block

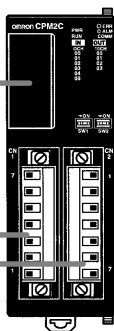

- 1. Communications port
- 2. Input terminals
- 3. Output terminals

CPU Unit with Transistor Outputs via Fujitsu-compatible Connector

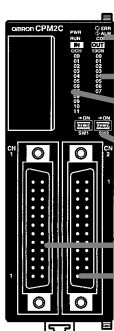

- 4. Status indicators
- 6. Output indicators
- 5. Input indicators
- 8. Communications switch
- 9. Customize switch
- 2. Input connector
- 3. Output connector

DIP switch for Unit with 10/20 I/O points

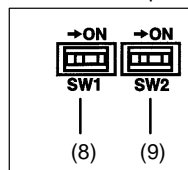

CPU Unit with Transistor Outputs via MIL Connector

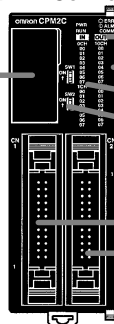

- 4. Status indicators
- 6. Output indicators
- 5. Input indicators
- 8. Communications switch
- 9. Customize switch
- 2. Input connector
- 3. Output connector

DIP switch for Unit with 32 I/O points

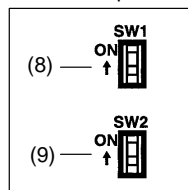

When SW 2 is set to ON, the status of SW 1 determines whether communications through the peripheral port and RS-232C port are governed by the settings in the PC Setup or the standard settings (1 start bit, 7 data bits, 2 stop bits, even parity, and 9,600 bps baud rate).

SW1	Communications settings
OFF	The communications settings for the peripheral port and RS-232C port will be determined by the settings in the PC Setup (DM 6645 to DM 6649, DM 6650 to DM 6654). If a Programming Console is connected to the peripheral port, however, operation for that port will be in the Programming Console mode.
ON	The communications settings for the peripheral port and RS-232C port will be the standard settings. If a Programming Console is connected to the peripheral port, however, operation for that port will be in the Programming Console mode.

An RS-232C Adapter is needed to perform Host Link communications from the peripheral port.

Note When performing host link communications via the peripheral port of a CPU Unit with a manufacturing number of 31800 or earlier (i.e., manufactured on or before April 31, 2000), set SW2 to ON. See above for details of the setting of SW2. When using a CPU Unit with a manufacturing number of 31800 or earlier (i.e., manufactured on or before April 31, 2000), do not change the setting of SW2 with a Programming Console, the CPM2C-CIF01/11, or CQM1-CIF01/02 connected. If the setting of SW2 is changed in this state, communications will be interrupted, and a communications error will be generated. In this state, the Programming Console will enter a “no-response” state (i.e., pressing any keys of the Programming Console will have no effect and the display will stay the same).

One-to-one Connections

The RS-232C port on the Host Link computer and the RS-232C port on the CPM2A/CPM2C or CPM1-CIF01 RS-232C Adapter are connected as shown in the following diagram when there is no CTS control on the RS-232C port. In the CPM2C, the CPM2C-CN111 and CS1W-CN118 connecting cables can be used in place of the RS-232C Adapter.

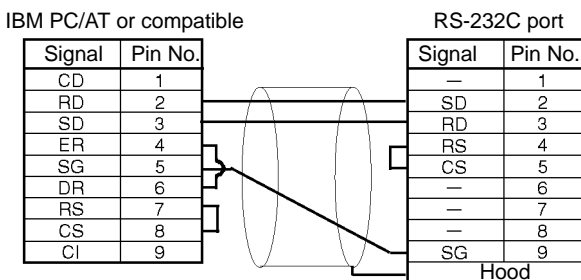

One-to-N Connections

Set the DIP switch on the NT-AL001 RS-232C/RS-422 Conversion Adapter

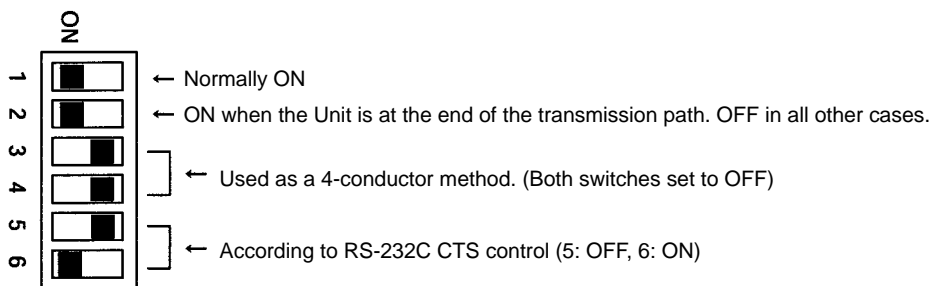

The RS-232C port with the NT-AL001 RS-232C/RS-422 Conversion Adapter and the RS-232C port of the CPM2A/CPM2C or CPM1-CIF01 RS-232C Adapter are connected as shown in the following diagram when there is no CTS control on the RS-232C port. A power supply of 5 VDC is supplied to the RS-232C/RS-422 Conversion Adapter. With the CPM2C, the CPM2C-CN111 and CS1W-CN118 connecting cables can be used in place of the RS-232C Adapter.

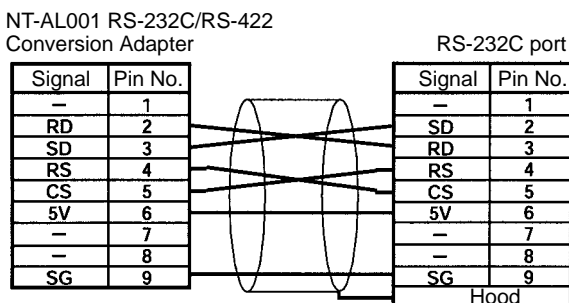

Note Do not connect external devices other than the NT-AL001 Conversion Adapter to the 5 VDC power supply of pin number 6 on the CPM2A/CPM2C's RS-232C port. Doing so may result in damage to the CPM2A/CPM2C or to the external device.

all RS-232C port is used.

Settings for RS-232C Port

Note If SW1 on the front panel of the CPU Unit is ON, the RS-232C port will operate with the default settings regardless of the settings in DM 6645 to DM 6649.

Word	Bit	Function	Setting																																																															
6645	00 to 03	Port settings 0: Standard (1 start bit, 7-bit data, 2 stop bits, even parity, 9,600 bps; Host Link unit number: 0) 1: Settings in DM 6646 (Other settings will cause a non-fatal error, the default setting will be used, and AR 1302 will turn ON.)	Match host parameters																																																															
	04 to 07	CTS control settings 0: Disable; 1: Set	0 or 1																																																															
	08 to 11	Link words for 1:1 PC Link 0: LR 00 to LR 15; Other: Not effective	Any																																																															
	12 to 15	Communications mode 0: Host Link (default setting); 1: RS-232C (no-protocol); 2: 1:1 PC Link Slave; 3: 1:1 PC Link Master; 4: 1:1 NT Link (Other settings will cause a non-fatal error, the Host Link setting will be used, and AR 1302 will turn ON.)	0																																																															
6646	00 to 07	Baud rate: 00: 1,200 bps 01: 2,400 bps 02: 4,800 bps 03: 9,600 bps 04: 19,200 bps	Match host parameters																																																															
	08 to 15	<table style="width: 100%; border-collapse: collapse;"> <thead> <tr> <th style="text-align: left;"></th> <th style="text-align: left;">Start</th> <th style="text-align: left;">Length</th> <th style="text-align: left;">Stop</th> <th style="text-align: left;">Parity</th> </tr> </thead> <tbody> <tr><td>00:</td><td>1</td><td>7</td><td>1</td><td>Even</td></tr> <tr><td>01:</td><td>1</td><td>7</td><td>1</td><td>Odd</td></tr> <tr><td>02:</td><td>1</td><td>7</td><td>1</td><td>None</td></tr> <tr><td>03:</td><td>1</td><td>7</td><td>2</td><td>Even</td></tr> <tr><td>04:</td><td>1</td><td>7</td><td>2</td><td>Odd</td></tr> <tr><td>05:</td><td>1</td><td>7</td><td>2</td><td>None</td></tr> <tr><td>06:</td><td>1</td><td>8</td><td>1</td><td>Even</td></tr> <tr><td>07:</td><td>1</td><td>8</td><td>1</td><td>Odd</td></tr> <tr><td>08:</td><td>1</td><td>8</td><td>1</td><td>None</td></tr> <tr><td>09:</td><td>1</td><td>8</td><td>2</td><td>Even</td></tr> <tr><td>10:</td><td>1</td><td>8</td><td>2</td><td>Odd</td></tr> <tr><td>11:</td><td>1</td><td>8</td><td>2</td><td>None</td></tr> </tbody> </table> (Other settings will cause a non-fatal error, the default settings (03) will be used, and AR 1302 will turn ON.)			Start	Length	Stop	Parity	00:	1	7	1	Even	01:	1	7	1	Odd	02:	1	7	1	None	03:	1	7	2	Even	04:	1	7	2	Odd	05:	1	7	2	None	06:	1	8	1	Even	07:	1	8	1	Odd	08:	1	8	1	None	09:	1	8	2	Even	10:	1	8	2	Odd	11:	1	8
	Start	Length	Stop	Parity																																																														
00:	1	7	1	Even																																																														
01:	1	7	1	Odd																																																														
02:	1	7	1	None																																																														
03:	1	7	2	Even																																																														
04:	1	7	2	Odd																																																														
05:	1	7	2	None																																																														
06:	1	8	1	Even																																																														
07:	1	8	1	Odd																																																														
08:	1	8	1	None																																																														
09:	1	8	2	Even																																																														
10:	1	8	2	Odd																																																														
11:	1	8	2	None																																																														
6647	00 to 15	Transmission delay (Host Link) 0000 to 9999 (BCD): Set in units of 10 ms, e.g., setting of 0001 equals 10 ms (Other settings will cause a non-fatal error, the default setting (0000) will be used, and AR 1302 will turn ON.)	0000 to 9999																																																															
6648	00 to 07	00 to 31 (BCD): Node number (Host Link) (Other settings will cause a non-fatal error, the default setting (00) will be used, and AR 1302 will turn ON.)	00 to 31																																																															
	08 to 11	Start code enable (RS-232C) 0: Disable; 1: Use start code in DM 6649.	Any																																																															
	12 to 15	End code enable (RS-232C) 0: Disable (number of bytes received) 1: Use end code in DM 6649. 2: CR, LF (Other settings will cause a non-fatal error, the disable setting will be used, and AR 1302 will turn ON.)	Any																																																															

6649	00 to 07	Start code (01 to FF) (No-protocol, effective when bits 8 to 11 of DM 6648 are set to 1.)	Any
	00 to 15	No. of bytes of data received (No-protocol, effective when bits 12 to 15 of DM 6648 are set to 0.) 00: 256 bytes 01 to FF: 1 to 255 bytes	Any
		End code (00 to FF) (No-protocol, effective when bits 12 to 15 of DM 6648 are set to 1.)	

Settings for Peripheral Port

Word	Bit	Function	Setting																																																															
6650	00 to 03	Port settings 0: Standard (1 start bit, 7-bit data, 2 stop bits, even parity, 9,600 bps; Host Link unit number: 0) 1: Settings in DM 6651 (Other settings will cause a non-fatal error, the default setting (0) will be used, and AR 1302 will turn ON.)	Match host parameters																																																															
	04 to 11	Not used	0																																																															
	12 to 15	Communications mode 0: Host Link or peripheral bus; 1: No-protocol (Other settings will cause a non-fatal error, the Host Link setting (0) will be used, and AR 1302 will turn ON.)	0																																																															
6651	00 to 07	Baud rate 00: 1,200 bps, 01: 2,400 bps, 02: 4,800 bps, 03: 9,600 bps, 04: 19,200 bps	Match host parameters																																																															
	08 to 15	Frame format <table style="margin-left: 20px; border-collapse: collapse;"> <thead> <tr> <th></th> <th>Start</th> <th>Length</th> <th>Stop</th> <th>Parity</th> </tr> </thead> <tbody> <tr><td>00:</td><td>1</td><td>7</td><td>1</td><td>Even</td></tr> <tr><td>01:</td><td>1</td><td>7</td><td>1</td><td>Odd</td></tr> <tr><td>02:</td><td>1</td><td>7</td><td>1</td><td>None</td></tr> <tr><td>03:</td><td>1</td><td>7</td><td>2</td><td>Even</td></tr> <tr><td>04:</td><td>1</td><td>7</td><td>2</td><td>Odd</td></tr> <tr><td>05:</td><td>1</td><td>7</td><td>2</td><td>None</td></tr> <tr><td>06:</td><td>1</td><td>8</td><td>1</td><td>Even</td></tr> <tr><td>07:</td><td>1</td><td>8</td><td>1</td><td>Odd</td></tr> <tr><td>08:</td><td>1</td><td>8</td><td>1</td><td>None</td></tr> <tr><td>09:</td><td>1</td><td>8</td><td>2</td><td>Even</td></tr> <tr><td>10:</td><td>1</td><td>8</td><td>2</td><td>Odd</td></tr> <tr><td>11:</td><td>1</td><td>8</td><td>2</td><td>None</td></tr> </tbody> </table> (Other settings will cause a non-fatal error, the default settings (03) will be used, and AR 1302 will turn ON.)			Start	Length	Stop	Parity	00:	1	7	1	Even	01:	1	7	1	Odd	02:	1	7	1	None	03:	1	7	2	Even	04:	1	7	2	Odd	05:	1	7	2	None	06:	1	8	1	Even	07:	1	8	1	Odd	08:	1	8	1	None	09:	1	8	2	Even	10:	1	8	2	Odd	11:	1	8
	Start	Length	Stop	Parity																																																														
00:	1	7	1	Even																																																														
01:	1	7	1	Odd																																																														
02:	1	7	1	None																																																														
03:	1	7	2	Even																																																														
04:	1	7	2	Odd																																																														
05:	1	7	2	None																																																														
06:	1	8	1	Even																																																														
07:	1	8	1	Odd																																																														
08:	1	8	1	None																																																														
09:	1	8	2	Even																																																														
10:	1	8	2	Odd																																																														
11:	1	8	2	None																																																														
6652	00 to 15	Transmission delay (Host Link) 0000 to 9999 (BCD): Set in units of 10 ms. (Other settings will cause a non-fatal error, the default setting (0000) will be used, and AR 1302 will turn ON.)	0000 to 9999																																																															

- Note**
1. If SW1 on the front panel of the CPU Unit is ON, the peripheral port will operate with the default settings regardless of the settings in DM 6649 to DM 6649.
 2. When connecting a computer running Support Software via the peripheral bus, turn OFF SW1 on the front panel of the CPU Unit and set DM 6651 to 0001 (Host Link). The CPU Unit will automatically switch to peripheral communications for the serial communications port.

6653	00 to 07	Node number (Host Link) 00 to 31 (BCD) (Other settings will cause a non-fatal error, the default setting (03) will be used, and AR 1302 will turn ON.)	00 to 31
	08 to 11	Start code enable (Peripheral port) 0: Disable 1: Use start code in DM 6654.	Any
	12 to 15	End code enable (Peripheral port) 0: Disable (number of bytes received) 1: Use end code in DM 6654. 2: CR, LF (Other settings will cause a non-fatal error, the disable setting (0) will be used, and AR 1302 will turn ON.)	Any
6654	00 to 07	Start code (Peripheral port, effective when bits 08 to 11 of DM 6653 are set to 1.) 01 to FF (Hex)	Any
	08 to 15	No. of bytes of data received (Peripheral port, effective when bits 12 to 15 of DM 6653 are set to 0.) 00: 256 bytes 01 to FF: 1 to 255 bytes	Any
		End code (00 to FF) (Peripheral port, effective when bits 12 to 15 of DM 6653 are set to 1.)	

of M2C's inputs in its case. For more details see 4.6 Host Link Commands.
An FCS (frame check sequence) check isn't performed on the received
response data in this program.

Be sure that the host computer's RS-232C port is configured correctly before
executing the program.

```
00 ' -----
00 ' CPM2A/CPM2C Sample Program for BASIC
00 ' -----
00 ' ---Set value RS-232C SPEED:9600BPS,PARITY:EVEN,DATA:7,STOP:2---
00 OPEN "COM:E73" AS #1
00 *REPEAT
00   ---Transmission data input-----
00 INPUT " send data : ",send$
00 ' ---FCS Calculation-----
00 FCS=0
00 FOR IFCS = 1 TO LEN ( send$ )
00   FCS = FCS XOR ASC( MID$ ( SEND$ , IFCS , 1 ) )
00 NEXT
00 FCS$ = RIGHT$ ( "0" + HEX$ ( FCS ) , 2 )
00 ' ---Communications execute-----
00 ZZZ$ = SEND$ + SCS$ + "*" + CHR$(13)
00 PRINT #1 , ZZZ$ ;
00 ' ---Response check-----
00 RECCNT = 0 : TMP$ = ""
00 *DRECLOOP
00 IF LOC ( 1 ) < > 0 THEN *DRECL
00 RECCNT = RECCNT + 1
00 IF RECCNT = 5000 THEN *DRECERR ELSE *DRECLOOP
00 *DRECL
00 TMP$ = TMP$ + INPUT$ ( LOC ( 1 ) , #1 )
00 IF RIGHT$ ( TMP$ , 1 ) = CHR$ ( 13 ) THEN *DRECEND ELSE RECCNT = 0 : GOTO
DRECLOOP
00 *DRECERR
00 TMP$ = " No response !! " + CHR$ ( 13 )
00 *DRECEND
00 PRINT " receive data : " ; RECV$
00 ' ---Go to transmission data input-----
00 GOTO *REPEAT
00 ' ---Processing complete-----
00 CLOSE #1
00 END
```

Mnemonic	Control	Contents
(@)TXD(48)	Communications port output	Reads data from I/O memory and transmits it in the specified frame format.

Host Link communications are controlled with the following AR area flags.

Word	Bit(s)	Contents
AR 08	00 to 03	RS-232C Port Error Code 0: Normal completion 1: Parity error 2: Frame error 3: Overrun error
	04	RS-232C Communications Error Flag ON: RS-232C port communications error occurred OFF: Normal
	05	RS-232C Transmit Ready Flag ON: The PC is ready to transmit data.
	08 to 11	Peripheral Port Error Code 0: Normal completion 1: Parity error 2: Frame error 3: Overrun error
	12	Peripheral Port Communications Error Flag ON: Peripheral port communications error occurred.
	13	Peripheral Port Transmit Ready Flag ON: The PC is ready to transmit data.

Unsolicited Communications

A data transmission to the host computer is initiated by the PC.

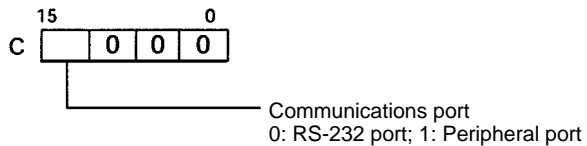
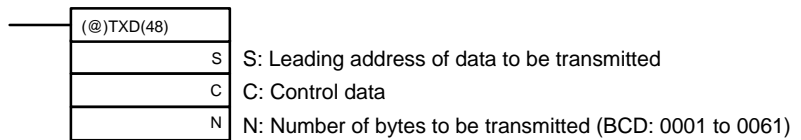

When Host Link communications are being used, TXD(48) converts the N-b of data starting at S to ASCII, adds the Host Link header, FCS, and termin and transmits this data as a Host Link frame.

The transmitted Host Link frame will be as shown in the following diagram

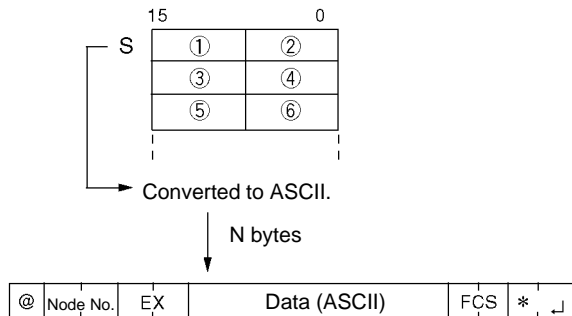

RS-232C port to a host computer. If the RS-232C transmission flag (Flag) is ON when IR 00100 turns ON, the ten bytes of data (DM 010 DM 0104) will be transmitted to the host computer, leftmost bytes first.

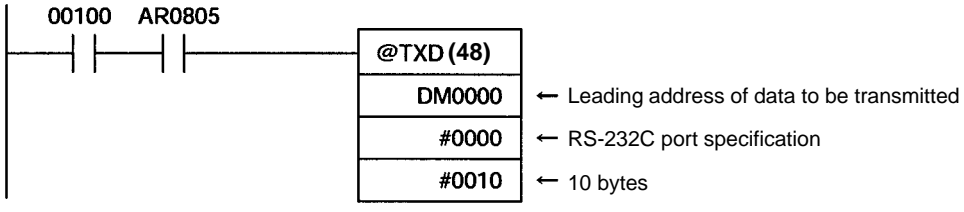

3-2 No-protocol Communications

Overview

When no-protocol communications are used, data can be exchanged with devices such as bar code readers and serial printers using TXD(48) RXD(47). No-protocol communications can be used with either an RS-232C port or peripheral port.

CPM2A Connections

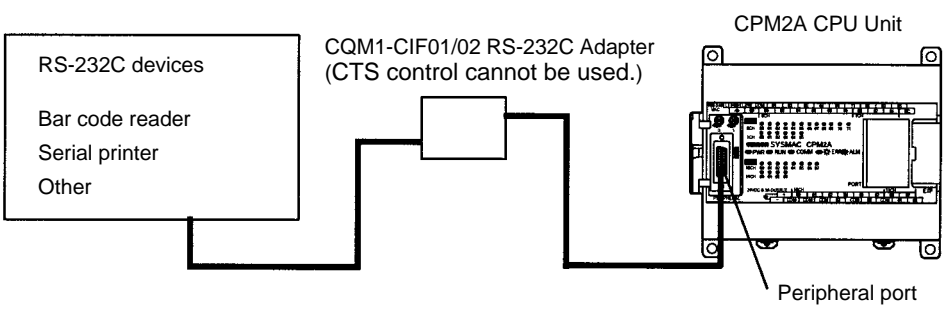
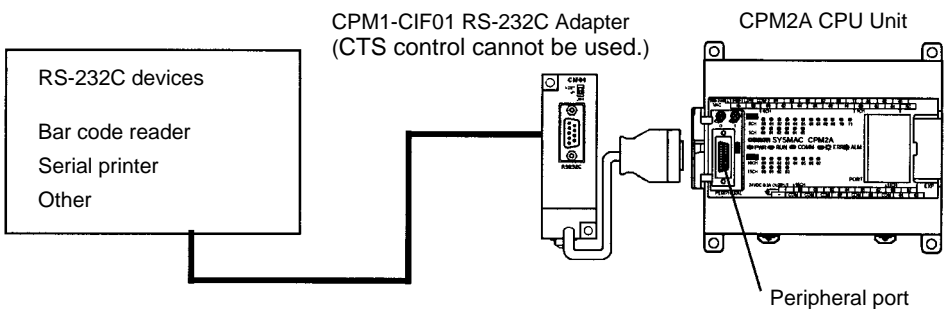
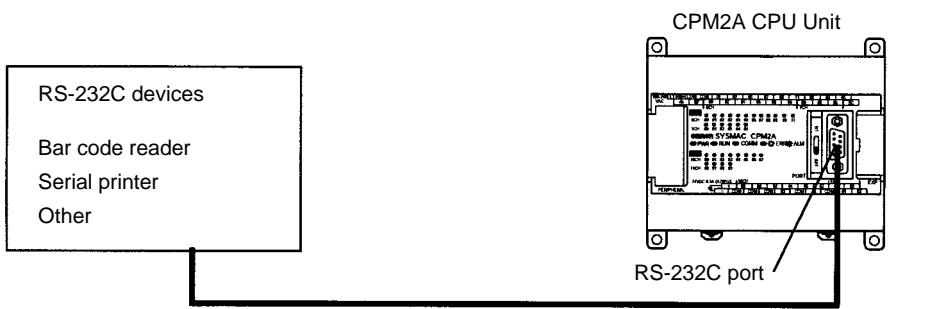

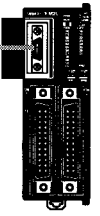
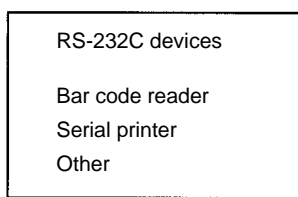

Note A CPM1-CIF01 RS-232C Adapter can also be used for no-protocol communications through the peripheral port, or for a CPM2C, a CPM2C-CIF01 Peripheral RS-232C Adapter Unit can be used to connect to external devices. Refer to *CPM2C Operation Manual* for details.

Transmission Data Configuration

When no-protocol communications are used, TXD(48) is used to send data and RXD(47) to receive data. The maximum amount of data that can be either sent or received is 259 bytes, including the start and end codes.

Start or End Code:

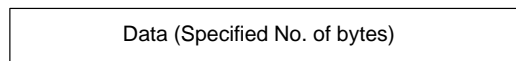

Specify a Start Code:

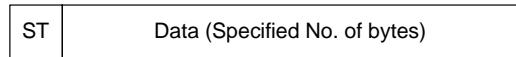

Specify an End Code:

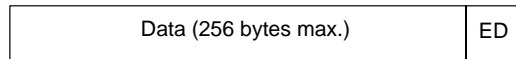

Specify a Start and End Code:

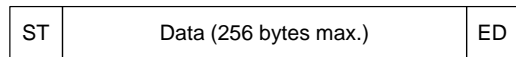

Specify a Start Code of CR, LF:

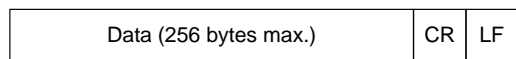

Specify a Start Code 00-FF/End Code CR,LF:

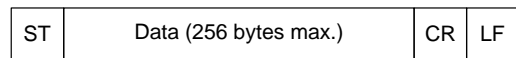

- Note**
1. The start and end codes are set in DM 6648 to DM 6649 (RS-232C) and DM 6653 to DM 6654 (peripheral port) in the PC Setup.
 2. When there are several start or end codes in the transmission, the first one each will be effective.
 3. When the end code is accidentally duplicated in the transmission data, the transmission is stopped part way through, use CR and LF as the end code.
 4. The start and end codes themselves are not transmitted and received.

Transmission Flags

When sending data from the CPM2A/CPM2C, check that the Transmission Enable Flag is ON for executing TXD(48). The Transmission Enable Flag will

tion is complete.
 After the CPM2A/CPM2C has received data, the Receive Enable Flag turns ON. When RXD(47) is executed, the data received will be written to the specified words and the Reception Complete Flag will turn OFF.

Flag	Peripheral port	RS-232C port
Transmit Ready Flag	AR 0813	AR 0805
Reception Completed Flag	AR 0814	AR 0806

Note The CPM2A/CPM2C starts and completes data reception at the following points:

Reception Start:

Start code disabled: Continually available for reception

Start code enabled: After start code is received

Reception Complete:

When either the end code, the specified no. of bytes, or 256 bytes are received.

Application Procedure

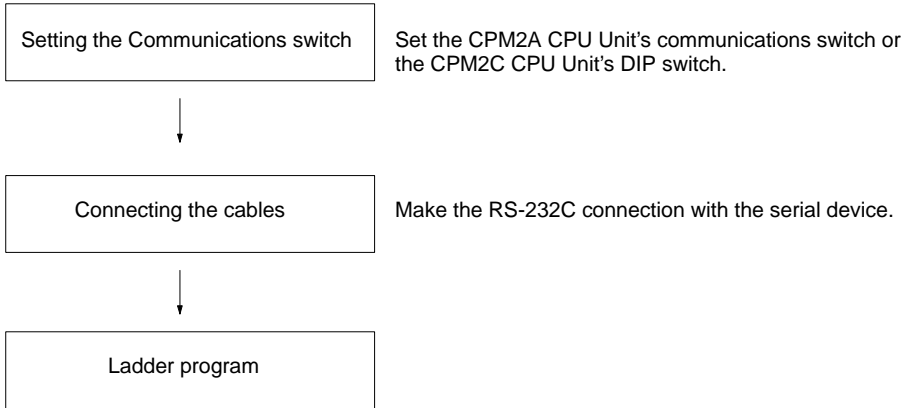

Communications Switch Setting

The CPM2A's communications are controlled by the communications switch on the front of the CPU Unit and the CPM2C's communications are controlled by the DIP switch on the front of the CPU Unit.

CPM2A Communications Switch Setting

Turn OFF the Communications switch when using no-protocol communications. No-protocol communications will not be possible if the communications switch is ON.

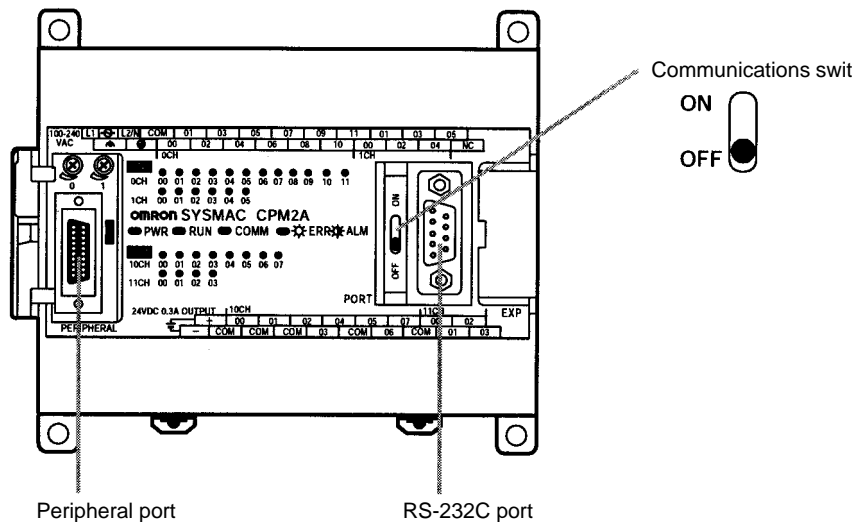

CPM2C DIP Switch Settings

Turn OFF pin 1 of the DIP switch when using no-protocol communication that communications through the RS-232C port are governed by the setting the PC Setup (DM 6645 to DM 6649).

Front View

CPU Unit with Relay Outputs via Terminal Block

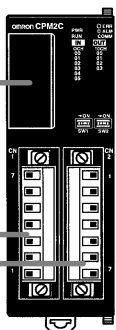

CPU Unit with Transistor Outputs via Fujitsu-compatible Connector

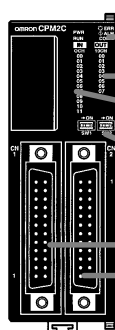

DIP switch for Units with 10/20 I/O points

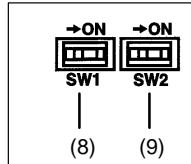

CPU Unit with Transistor Outputs via MIL Connector

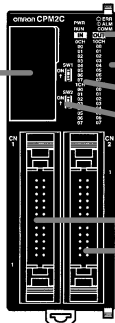

7. Communications port

DIP switch for Units with 32 I/O points

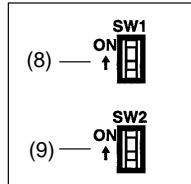

Pin settings	RS-232C port communications
Pin 1	
OFF	Governed by the PC Setup (DM 6645 to DM 6649)
ON	Governed by standard settings

Note An RS-232C Adapter is needed to perform no-protocol communications through the peripheral port.

Connecting the Cables

This section describes RS-232C connections.

The RS-232C port on the serial device and the RS-232C port of the CPM2C or CPM1-CIF01 RS-232C Adapter are connected as shown in the

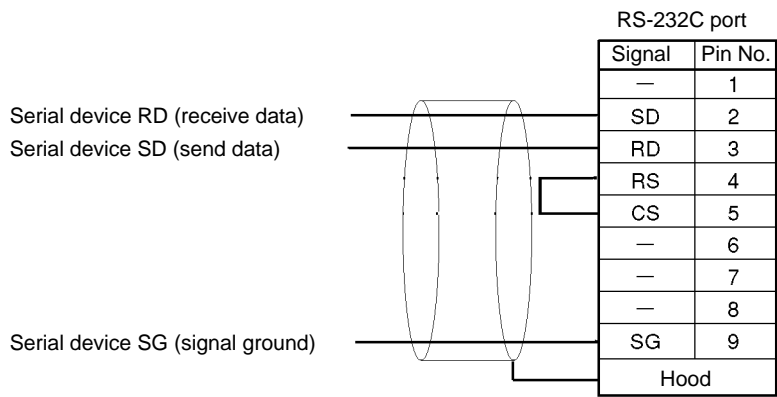

Setup

The PC Setup settings that are required depend on whether a peripheral port or an RS-232C port is used.

Settings for RS-232C Port

Word	Bit	Function	Setting																																																															
6645	00 to 03	Port settings 0: Standard (1 start bit, 7-bit data, 2 stop bits, even parity, 9,600 bps; Host Link unit number: 0) 1: Settings in DM 6646 (Other settings will cause a non-fatal error, the default setting will be used, and AR 1302 will turn ON.)	As required																																																															
	04 to 07	CTS control settings 0: Disable; 1: Set																																																																
	08 to 11	Link words for 1:1 PC Link 0: LR 00 to LR 15; Other: Not effective																																																																
6646	12 to 15	Communications mode 0: Host Link; 1: No-protocol; 2: 1:1 PC Link Slave; 3: 1:1 PC Link Master; 4: 1:1 NT Link (Other settings will cause a non-fatal error, the Host Link setting will be used, and AR 1302 will turn ON.)	1																																																															
	00 to 07	Baud rate 00: 1,200 bps; 01: 2,400 bps; 02: 4,800 bps; 3: 9,600 bps; 04: 19,200 bps	As required																																																															
08 to 15	Frame format <table border="1" style="margin-left: 20px;"> <thead> <tr> <th></th> <th>Start</th> <th>Length</th> <th>Stop</th> <th>Parity</th> </tr> </thead> <tbody> <tr><td>00:</td><td>1</td><td>7</td><td>1</td><td>Even</td></tr> <tr><td>01:</td><td>1</td><td>7</td><td>1</td><td>Odd</td></tr> <tr><td>02:</td><td>1</td><td>7</td><td>1</td><td>None</td></tr> <tr><td>03:</td><td>1</td><td>7</td><td>2</td><td>Even</td></tr> <tr><td>04:</td><td>1</td><td>7</td><td>2</td><td>Odd</td></tr> <tr><td>05:</td><td>1</td><td>7</td><td>2</td><td>None</td></tr> <tr><td>06:</td><td>1</td><td>8</td><td>1</td><td>Even</td></tr> <tr><td>07:</td><td>1</td><td>8</td><td>1</td><td>Odd</td></tr> <tr><td>08:</td><td>1</td><td>8</td><td>1</td><td>None</td></tr> <tr><td>09:</td><td>1</td><td>8</td><td>2</td><td>Even</td></tr> <tr><td>10:</td><td>1</td><td>8</td><td>2</td><td>Odd</td></tr> <tr><td>11:</td><td>1</td><td>8</td><td>2</td><td>None</td></tr> </tbody> </table> (Other settings will cause a non-fatal error, the default settings (03) will be used, and AR 1302 will turn ON.)			Start	Length	Stop	Parity	00:	1	7	1	Even	01:	1	7	1	Odd	02:	1	7	1	None	03:	1	7	2	Even	04:	1	7	2	Odd	05:	1	7	2	None	06:	1	8	1	Even	07:	1	8	1	Odd	08:	1	8	1	None	09:	1	8	2	Even	10:	1	8	2	Odd	11:	1	8	2
	Start	Length	Stop	Parity																																																														
00:	1	7	1	Even																																																														
01:	1	7	1	Odd																																																														
02:	1	7	1	None																																																														
03:	1	7	2	Even																																																														
04:	1	7	2	Odd																																																														
05:	1	7	2	None																																																														
06:	1	8	1	Even																																																														
07:	1	8	1	Odd																																																														
08:	1	8	1	None																																																														
09:	1	8	2	Even																																																														
10:	1	8	2	Odd																																																														
11:	1	8	2	None																																																														
6647	00 to 15	Transmission delay (Host Link) 0000 to 9999 (BCD): Set in units of 10 ms, e.g., setting of 0001 equals 10 ms (Other settings will cause a non-fatal error, the default setting (0000) will be used, and AR 1302 will turn ON.)	0000 to 9999																																																															

6648	00 to 07	00 to 31 (BCD): Node number (Host Link) (Other settings will cause a non-fatal error, the default setting (00) will be used, and AR 1302 will turn ON.)	As requ
	08 to 11	Start code enable (RS-232C) 0: Disable; 1: Use start code in DM 6649.	0 or 1
	12 to 15	End code enable (RS-232C) 0: Disable (number of bytes received) 1: Use end code in DM 6649. 2: CR, LF (Other settings will cause a non-fatal error, the default setting (0) will be used, and AR 1302 will turn ON.)	0 to 2
6649	00 to 07	Start code (00 to FF) (No-protocol, effective when bits 8 to 11 of DM 6648 are set to 1.)	00 to FF
	08 to 15	No. of bytes of data received (No-protocol, effective when bits 12 to 15 of DM 6648 are set to 0.) 00: 256 bytes 01 to FF: 1 to 255 bytes	00 to FF
		End code (00 to FF) (No-protocol, effective when bits 12 to 15 of DM 6648 are set to 1.)	00 to FF

Note If SW1 on the front panel of the CPU Unit is ON, the RS-232C port will operate with the default settings regardless of the settings in DM 6645 to DM 6649.

Settings for Peripheral Port

Word	Bit	Function	Setting																																																																
6650	00 to 03	Port settings 0: Standard (1 start bit, 7-bit data, 2 stop bits, even parity, 9,600 bps; Host Link unit number: 0) 1: Settings in DM 6651 (Other settings will cause a non-fatal error, the default setting (0) will be used, and AR 1302 will turn ON.)	As requ																																																																
	04 to 11	Not used	0																																																																
	12 to 15	Communications mode 0: Host Link or peripheral bus; 1: No-protocol (Other settings will cause a non-fatal error, the Host Link setting will be used, and AR 1302 will turn ON.)	1																																																																
6651	00 to 07	Baud rate 00: 1,200 bps; 01: 2,400 bps; 02: 4,800 bps; 03: 9,600 bps; 04: 19,200 bps	As requ																																																																
	08 to 15	Frame format <table border="1" style="margin-left: 20px;"> <thead> <tr> <th></th> <th>Start</th> <th>Length</th> <th>Stop</th> <th>Parity</th> </tr> </thead> <tbody> <tr><td>00:</td><td>1</td><td>7</td><td>1</td><td>Even</td></tr> <tr><td>01:</td><td>1</td><td>7</td><td>1</td><td>Odd</td></tr> <tr><td>02:</td><td>1</td><td>7</td><td>1</td><td>None</td></tr> <tr><td>03:</td><td>1</td><td>7</td><td>2</td><td>Even</td></tr> <tr><td>04:</td><td>1</td><td>7</td><td>2</td><td>Odd</td></tr> <tr><td>05:</td><td>1</td><td>7</td><td>2</td><td>None</td></tr> <tr><td>06:</td><td>1</td><td>8</td><td>1</td><td>Even</td></tr> <tr><td>07:</td><td>1</td><td>8</td><td>1</td><td>Odd</td></tr> <tr><td>08:</td><td>1</td><td>8</td><td>1</td><td>None</td></tr> <tr><td>09:</td><td>1</td><td>8</td><td>2</td><td>Even</td></tr> <tr><td>10:</td><td>1</td><td>8</td><td>2</td><td>Odd</td></tr> <tr><td>11:</td><td>1</td><td>8</td><td>2</td><td>None</td></tr> </tbody> </table> (Other settings will cause a non-fatal error, the default settings (03) will be used, and AR 1302 will turn ON.)		Start	Length	Stop	Parity	00:	1	7	1	Even	01:	1	7	1	Odd	02:	1	7	1	None	03:	1	7	2	Even	04:	1	7	2	Odd	05:	1	7	2	None	06:	1	8	1	Even	07:	1	8	1	Odd	08:	1	8	1	None	09:	1	8	2	Even	10:	1	8	2	Odd	11:	1	8	2	None
	Start	Length	Stop	Parity																																																															
00:	1	7	1	Even																																																															
01:	1	7	1	Odd																																																															
02:	1	7	1	None																																																															
03:	1	7	2	Even																																																															
04:	1	7	2	Odd																																																															
05:	1	7	2	None																																																															
06:	1	8	1	Even																																																															
07:	1	8	1	Odd																																																															
08:	1	8	1	None																																																															
09:	1	8	2	Even																																																															
10:	1	8	2	Odd																																																															
11:	1	8	2	None																																																															
6652	00 to 15	Transmission delay (Host Link) 0000 to 9999 (BCD): Set in units of 10 ms. (Other settings will cause a non-fatal error, the default setting (0000) will be used, and AR 1302 will turn ON.)	0000 to 9999																																																																

6653	00 to 07	00 to 31 (BCD): Node number (Host Link) (Other settings will cause a non-fatal error, the default setting (00) will be used, and AR 1302 will turn ON.)	As requ
	08 to 11	Start code enable (Peripheral port) 0: Disable 1: Use start code in DM 6654.	0 or 1
	12 to 15	End code enable (Peripheral port) 0: Disable (number of bytes received) 1: Use end code in DM 6654. 2: CR. LF (Other settings will cause a non-fatal error, the default setting (0) will be used, and AR 1302 will turn ON.)	0 to 2
6654	00 to 07	Start code (00 to FF) (Peripheral port, effective when bits 8 to 11 of DM 6653 are set to 1.)	00 to FF
	08 to 15	No. of bytes of data received (Peripheral port, effective when bits 12 to 15 of DM 6653 are set to 0.) 00: 256 bytes 01 to FF: 1 to 255 bytes	00 to FF
		End code (00 to FF) (Peripheral port, effective when bits 12 to 15 of DM 6653 are set to 1)	00 to FF

- Note**
1. If SW1 on the front panel of the CPU Unit is ON, the peripheral port will operate with the default settings regardless of the settings in DM 6649 to DM 6649.
 2. When connecting a computer running Support Software via the peripheral bus, turn OFF SW1 on the front panel of the CPU Unit and set DM 6653 to 0001 (Host Link). The CPU Unit will automatically switch to peripheral communications for the serial communications port.

gram

The following instructions are used in no-protocol communications.

Mnemonic	Control	Contents
(@)TXD(48)	Communications port output	Reads data from I/O memory and transmits it in the specified frame format (the start and end codes can be enabled/disabled).
(@)RXD(47)	Communications port input	Receives data in the specified frame format (the start and end codes can be enabled/disabled) and stores only the data in I/O memory.

Word	Bit(s)	Contents
AR 08	00 to 03	RS-232C Port Error Code 0: Normal completion; 1: Parity error; 2: Frame error; 3: Overrun error
	04	RS-232C Communications Error Flag ON: RS-232C port communications error occurred. OFF: Normal
	05	RS-232C Transmit Ready Flag ON: The PC is ready to transmit data.
	06	RS-232C Reception Completed Flag ON: The PC has completed reading data.
	07	RS-232C Reception Overflow Flag ON: A reception overflow has occurred.
	08 to 11	Peripheral Port Error Code 0: Normal completion; 1: Parity error; 2: Frame error; 3: Overrun error
	12	Peripheral Port Communications Error Flag ON: A peripheral port communications error occurred. OFF: Normal
	13	Peripheral Port Transmit Ready Flag ON: The PC is ready to transmit data.
	14	Peripheral Port Reception Completed Flag ON: The PC has completed reading data.
	15	Peripheral Port Reception Overflow Flag ON: A reception overflow has occurred.
AR 09	00 to 15	RS-232C Port Reception Counter (4 digits BCD)
AR 10	00 to 15	Peripheral Port Reception Counter (4 digits BCD)

No-protocol Data Transmission

TXD(48) is used to transmit data to RS-232C devices.

(@)TXD(48)	
S	S: Leading address of data to be transmitted
C	C: Control data
N	N: Number of bytes to be transmitted (BCD: 0001 to 0256)



When no-protocol communications are being used, TXD(48) transmits N b of data beginning at S.

RXD(47) is used to receive data from RS-232C devices.

(@)RXD(47)
S
C
N

D: Leading address for storing reception data
 C: Control data
 N: Number of bytes to receive (BCD: 0001 to 0256)

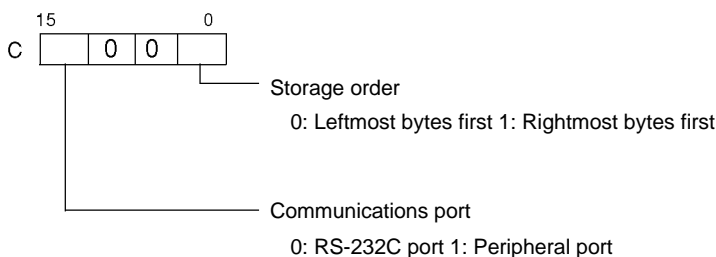

The following program example is for no-protocol communications conducted through a RS-232C port using TXD(48) and RXD(47) instructions.

If AR 0805 (the RS-232C Transmit Ready Flag) is ON when 00100 turns on then data from DM 0100 to DM 0104 is transmitted from leftmost bytes to rightmost bytes. When AR 0806 (the Reception Completed Flag) turns ON, 256 bytes of received data are read and written to DM 0200 from leftmost bytes to rightmost bytes.

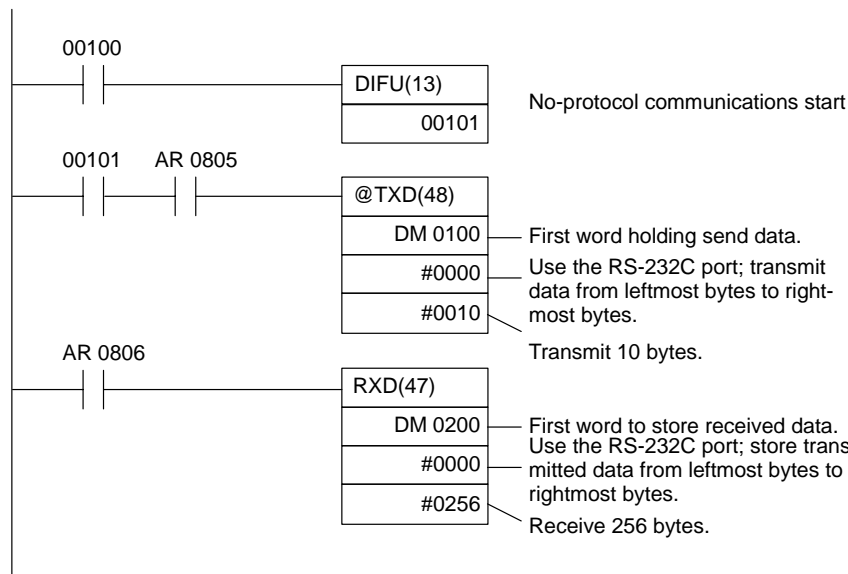

The NT Link allows a CPM2A/CPM2C PC to be connected directly to an OMRON Programmable Terminal. There is no need for a communications program on the PC. The NT Link can be used with an RS-232C port.

CPM2A Connection

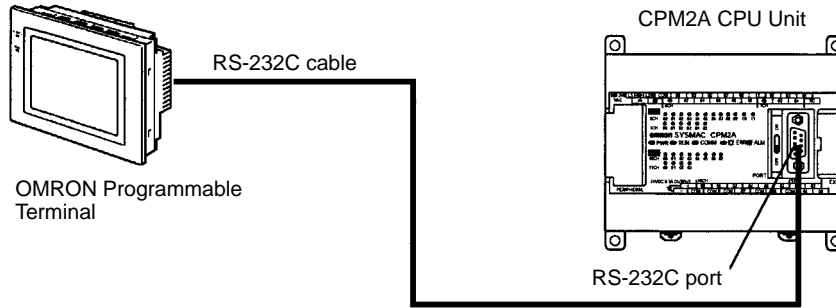

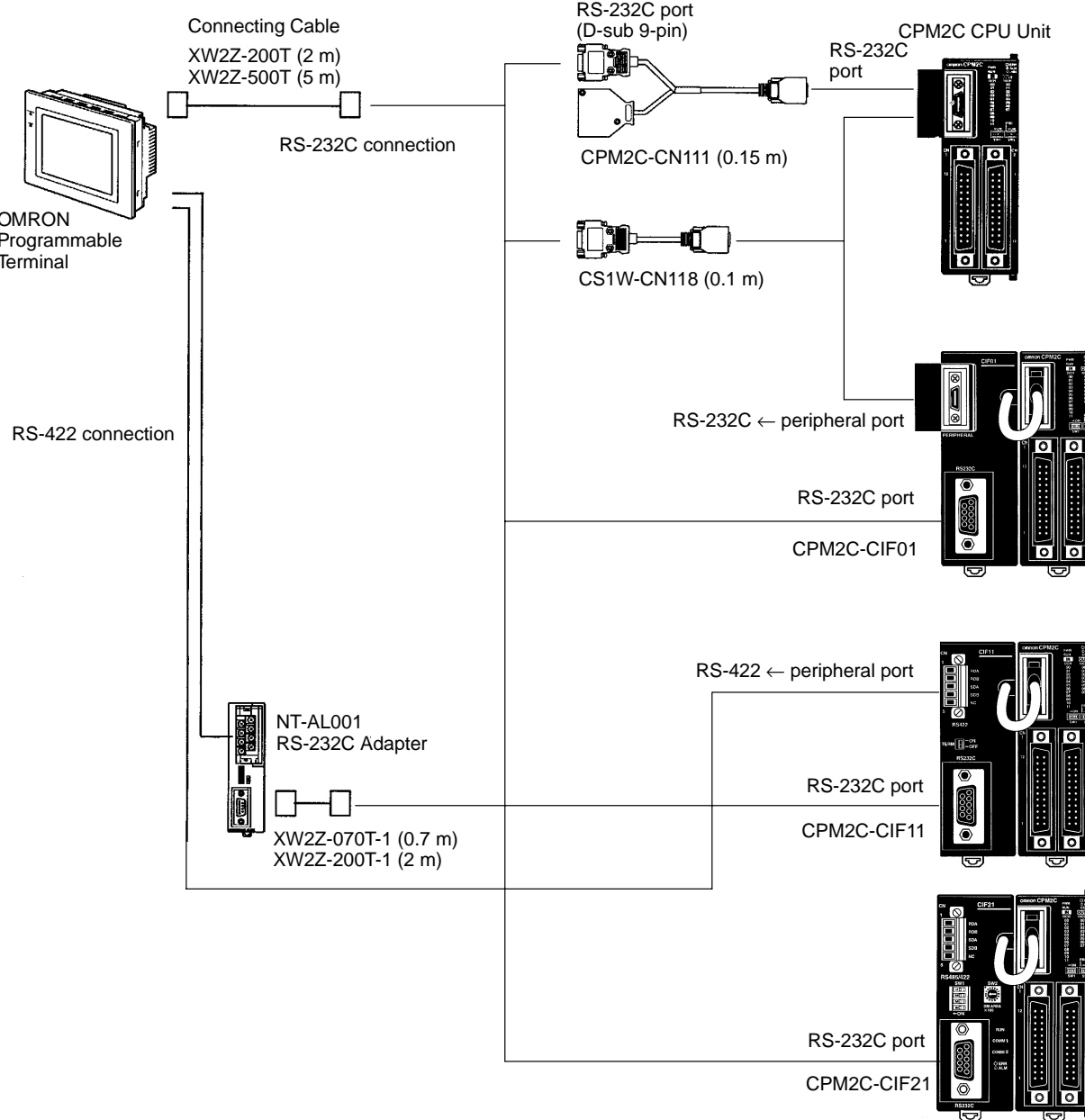

Note The Programmable Terminal cannot be connected using a peripheral port connection when communicating via a 1:1 NT Link.

Application Procedure

Setting communications.

Use the settings in the PC Setup (DM6645 to DM 6649) for RS-232C communications.
(Turn OFF the Communications switch on the CPM2A's CPU Unit or pin 1 of the DIP Switch on the CPM2C's CPU Unit.)

Connecting the cables

Connect to a Programmable Terminal.

Communications Switch Setting

The CPM2A's communications are controlled by the communications switch on the front of the CPU Unit and the CPM2C's communications are controlled by the DIP switch on the front of the CPU Unit.

One-to-one NT Link communications will not be possible if the communications switch is ON.

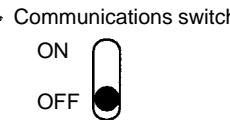
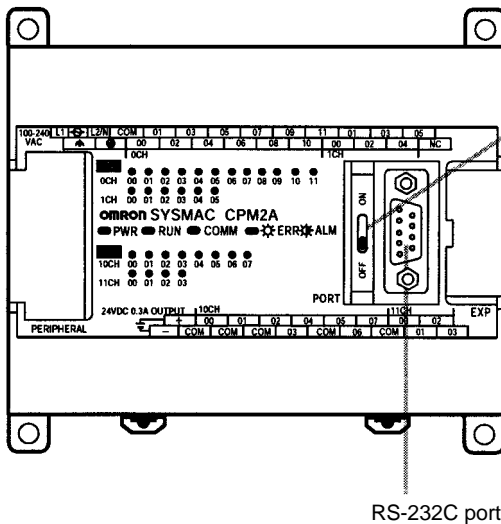

CPM2C DIP Switch Settings

Turn OFF pin 1 of the DIP switch when using 1:1 NT Link communications so communications through the RS-232C port are governed by the settings in PC Setup (DM 6645 to DM 6649).

Front View

CPU Unit with Relay Outputs via Terminal Block

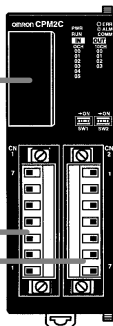

CPU Unit with Transistor Outputs via Fujitsu-compatible Connector

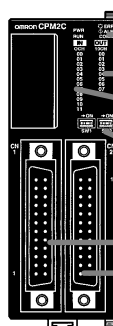

DIP switch for Units with 10/20 I/O points

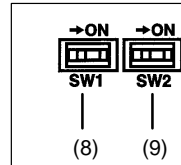

CPU Unit with Transistor Outputs via MIL Connector

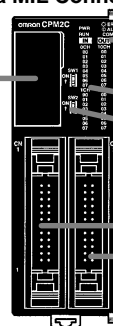

DIP switch for Units with 32 I/O points

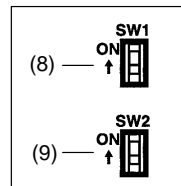

Pin settings	RS-232C port communications
Pin 1	
OFF	Governed by the PC Setup (DM 6645 to DM 6649)
ON	Governed by standard settings

Word	Bit	Function	Setting
DM 6645	00 to 03	Port settings 0: Standard (1 start bit, 7-bit data, 2 stop bits, even parity, 9,600 bps; Host Link unit number: 0) 1: Settings in DM 6646 (Other settings will cause a non-fatal error, the default setting (00) will be used, and AR 1302 will turn ON.)	Any
	04 to 07	CTS control settings 0: Disable 1: Set	Any
	08 to 11	Link area for 1:1 PC Link 0: LR 00 to LR 15 (Other settings: Disabled)	Any
	12 to 15	Communications mode 0: Host Link; 1: No-protocol; 2: 1:1 PC Link Slave; 3: 1:1 PC Link Master; 4: 1:1 NT Link (Other settings will cause a non-fatal error, the Host Link setting will be used, and AR 1302 will turn ON.)	4

For information on the 1:1 NT Link settings of an OMRON Programmable Terminal, refer to that PT's Operation Manual.

Connecting the Cables

This section describes RS-232C connections.

The RS-232C port on the Programmable Terminal and the RS-232C port on the CPM2A/CPM2C or CPM1-CIF01 RS-232C Adapter are connected as shown in the following diagram when there is no CTS control on the RS-232C port. For the CPM2C, the CPM2C-CN111 and CS1W-CN118 connecting cables are used.

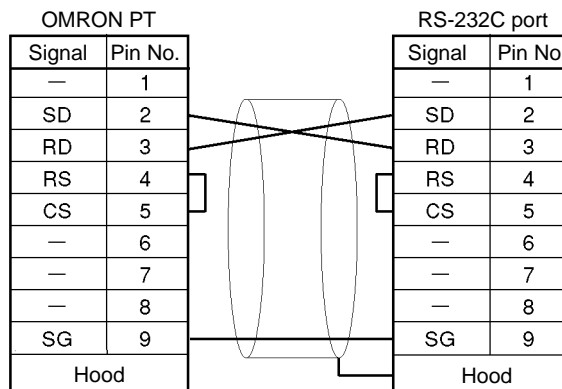

Recommended cables:
XW2Z-200T: 2m
XW2Z-500T: 5m

3-4 One-to-one PC Link Communications

A 1:1 PC Link of up to 256 bits (LR0000 to LR1515) can be created with the area of another CPM2A/CPM2C, CQM1, CPM1, CPM1A, SRM1(-V2), C200HX/HG/HE PC, where one serves as the Master, the other as a Slave. There is no need for a communications program on the PC.

The 1:1 PC Link can be used with an RS-232C port.

One-to-one PC Link

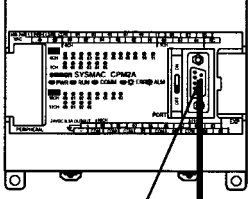

RS-232C port

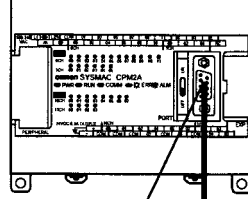

RS-232C port

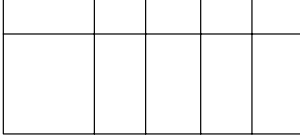

OMRON PC (CQM1, CPM1, CPM1A, CPM2C, SRM1(-V2), C200HS, or C200HX/HG/HE)

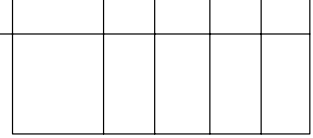

OMRON PC (CQM1, CPM1, CPM1A, CPM2C, SRM1(-V2), C200HS, or C200HX/HG/HE)

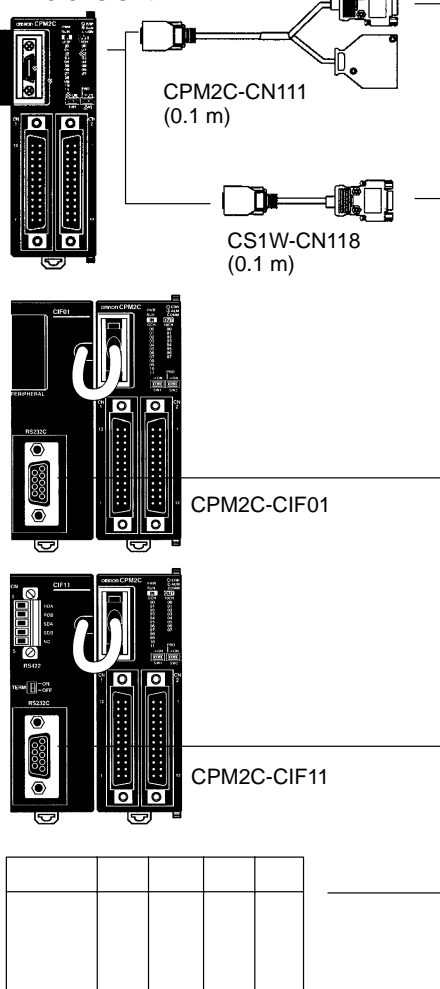

OMRON PC (CQM1, CPM1, CPM1A, CPM2A, SRM1(-V2), C200HS, or C200HX/HG/HE)
Master

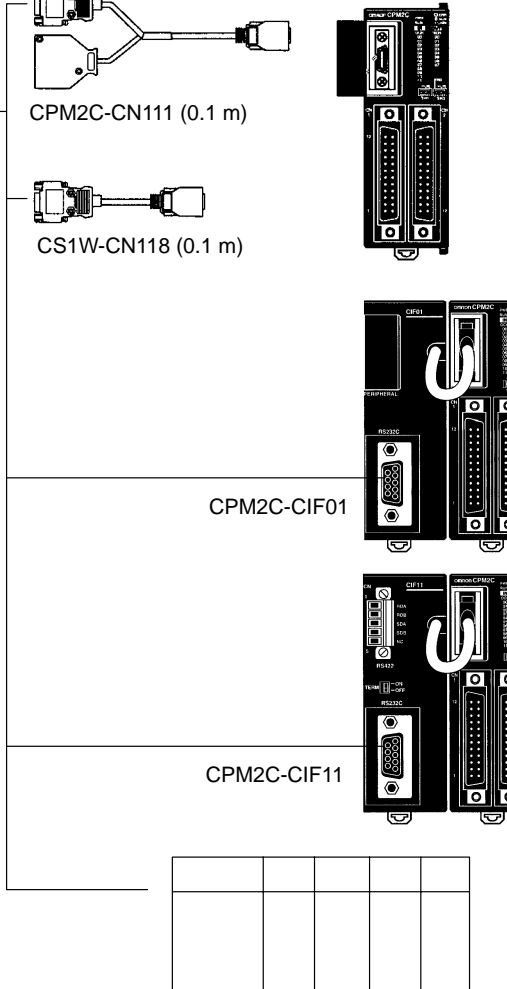

OMRON PC (CQM1, CPM1, CPM1A, CPM2A, SRM1(-V2), C200HS, or C200HX/HG/HE)
Slave



Even though the peripheral port on the CPM2C-CIF01 can output RS-232C, this port cannot be used for one-to-one link communications.

When performing a 1:1 PC Link with a CPM2A/CPM2C PC and a C200HS, or C200HX/HE/HG use the corresponding 16 words, LR00 to LR15, of the CQM1, C200HS, or C200HX/HE/HG PC. A 1:1 PC Link with a CPM2A/CPM2C PC cannot be formed using LR16 to LR 63.

Application Procedure

Setting communications.

Use the settings in the PC Setup (DM6645 to DM 6649) for RS-232C communications.
(Turn OFF the Communications switch on the CPM2A's CPU Unit or pin 1 of the DIP Switch on the CPM2C's CPU Unit.)



Connecting the cables

Connect a 1:1 PC Link with another PC.

Communications Switch Setting

The CPM2A's communications are controlled by the communications switch on the front of the CPU Unit and the CPM2C's communications are controlled by the DIP switch on the front of the CPU Unit.

CPM2A Communications Switch Setting

Turn OFF the Communications switch when using 1:1 PC Link communications. One-to-one PC Link communications will not be possible if the communications switch is ON.

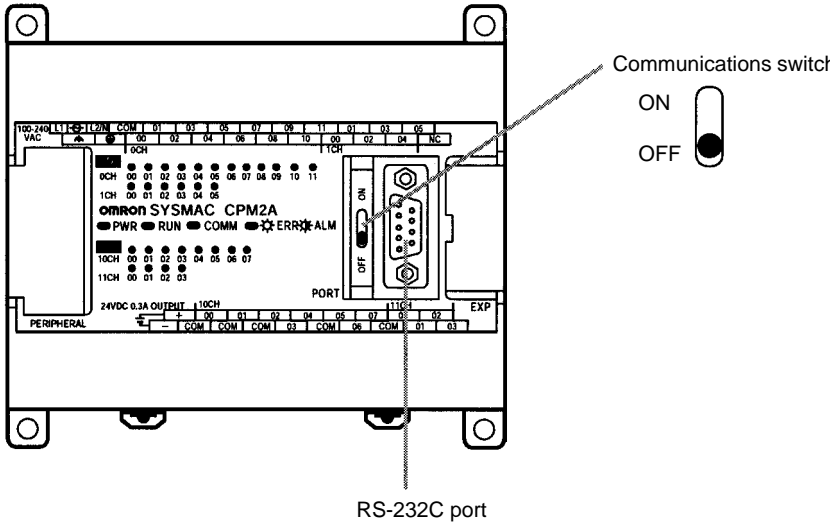

Turn ON pin 1 of the DIP switch when using I/O Link communications that communications through the RS-232C port are governed by the settings the PC Setup (DM 6645 to DM 6649).

Front View

CPU Unit with Relay Outputs via Terminal Block

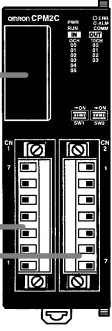

- 7. Communications port
- 2. Input terminals
- 3. Output terminals

CPU Unit with Transistor Outputs via Fujitsu-compatible Connector

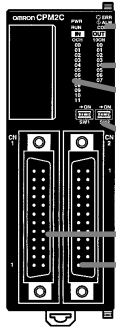

- 4. Status indicators
- 6. Output indicators
- 5. Input indicators
- 8. Communications switch
- 9. Customize switch
- 2. Input connector
- 3. Output connector

DIP switch for Units with 10/20 I/O points

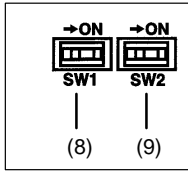

CPU Unit with Transistor Outputs via MIL Connector

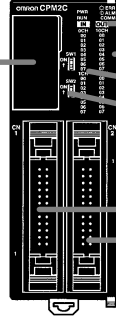

- 7. Communications port
- 4. Status indicators
- 6. Output indicators
- 5. Input indicators
- 8. Communications switch
- 9. Customize switch
- 2. Input connector
- 3. Output connector

DIP switch for Units with 32 I/O points

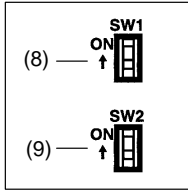

Pin settings	RS-232C port communications
Pin 1	
OFF	Governed by the PC Setup (DM 6645 to DM 6649)
OFF	
ON	Governed by standard settings
ON	

Device to make the following settings to the PC Setup (DM 6646) in the Master and Slave.

Word	Bit	Function	Master Setting	Slave Setting
DM 6645	00 to 03	Port settings 00: Standard (1 start bit, 7-bit data, 2 stop bits, even parity, 9,600 bps) 01: Settings in DM 6646 (Other settings will cause a non-fatal error, the default setting (00) will be used, and AR 1302 will turn ON.)	Any	Any
	04 to 07	CTS control settings 0: Disable 1: Set	0	0
	08 to 11	Link area for 1:1 PC Link 0: LR 00 to LR 15 (Other settings: Disabled)	0	0
	12 to 15	Communications mode 0: Host Link; 1: No-protocol; 2: 1:1 PC Link Slave; 3: 1:1 PC Link Master; 4: 1:1 NT Link (Other settings will cause a non-fatal error, the Host Link setting will be used, and AR 1302 will turn ON.)	3	2

For information on the 1:1 PC Link settings of another OMRON PC, refer to the PC's Operation Manual.

Connecting the Cables

This section describes the RS-232C connection.

The RS-232C cable used for 1:1 PC Links is a cross connection cable. When there is no CTS control on the RS-232C port, the connection is made as shown in the following diagram. With the CPM2C, the CPM2C-CN111 and CS-CN118 connecting cables are used.

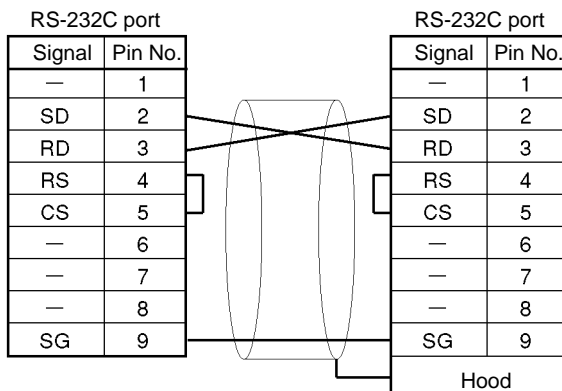

Recommended cables
XW2Z-200T: 2m
XW2Z-500T: 5m

4 SRM1(-V2) Communications Functions

4-1 Host Link Communications

Host Link communications were developed by OMRON for the purpose of connecting PCs and one or more host computers by RS-232C cable, and controlling PC communications from a host computer. Normally the host computer issues a command to a PC, and the PC automatically sends back a response. Thus, communications are carried out without the PCs being actively involved. PCs also have the ability to initiate data transmissions when direct involvement is necessary.

In general, there are two means for implementing Host Link communications. One is based on C-mode commands, and the other on FINS (CV-mode) commands.

Setup Settings

The SRM1(-V2)'s peripheral port and RS-232C port settings must be set properly in order to use the Host Link communications, as shown in the following table.

Word	Bit	Function	Setting																																																																
Peripheral Port Settings																																																																			
The following settings are effective after transfer to the PC.																																																																			
6650	00 to 03	Port settings 0: Standard (1 start bit, 7-bit data, 2 stop bits, even parity, 9,600 bps) 1: Settings in DM 6651 (Other settings will cause a non-fatal error, the default setting (0) will be used, and AR 1302 will turn ON.)	To match host parameters																																																																
	04 to 07	Not used.	0																																																																
	08 to 11	Not used.	0																																																																
	12 to 15	Communications mode 0: Host Link; 1: No-protocol (Other settings will cause a non-fatal error, the default setting (0) will be used, and AR 1302 will turn ON.)	0: Host Link																																																																
6651	00 to 07	Baud rate 00: 1.2K, 01: 2.4K, 02: 4.8K, 03: 9.6K, 04: 19.2K	To match host parameters																																																																
	08 to 15	Frame format <table border="1"> <thead> <tr> <th></th> <th>Start</th> <th>Length</th> <th>Stop</th> <th>Parity</th> </tr> </thead> <tbody> <tr> <td>00:</td> <td>1 bit</td> <td>7 bits</td> <td>1 bit</td> <td>Even</td> </tr> <tr> <td>01:</td> <td>1 bit</td> <td>7 bits</td> <td>1 bit</td> <td>Odd</td> </tr> <tr> <td>02:</td> <td>1 bit</td> <td>7 bits</td> <td>1 bit</td> <td>None</td> </tr> <tr> <td>03:</td> <td>1 bit</td> <td>7 bits</td> <td>2 bit</td> <td>Even</td> </tr> <tr> <td>04:</td> <td>1 bit</td> <td>7 bits</td> <td>2 bit</td> <td>Odd</td> </tr> <tr> <td>05:</td> <td>1 bit</td> <td>7 bits</td> <td>2 bit</td> <td>None</td> </tr> <tr> <td>06:</td> <td>1 bit</td> <td>8 bits</td> <td>1 bit</td> <td>Even</td> </tr> <tr> <td>07:</td> <td>1 bit</td> <td>8 bits</td> <td>1 bit</td> <td>Odd</td> </tr> <tr> <td>08:</td> <td>1 bit</td> <td>8 bits</td> <td>1 bit</td> <td>None</td> </tr> <tr> <td>09:</td> <td>1 bit</td> <td>8 bits</td> <td>2 bit</td> <td>Even</td> </tr> <tr> <td>10:</td> <td>1 bit</td> <td>8 bits</td> <td>2 bit</td> <td>Odd</td> </tr> <tr> <td>11:</td> <td>1 bit</td> <td>8 bits</td> <td>2 bit</td> <td>None</td> </tr> </tbody> </table> (Other settings will cause a non-fatal error, the default setting (00) will be used, and AR 1302 will turn ON.)		Start	Length	Stop	Parity	00:	1 bit	7 bits	1 bit	Even	01:	1 bit	7 bits	1 bit	Odd	02:	1 bit	7 bits	1 bit	None	03:	1 bit	7 bits	2 bit	Even	04:	1 bit	7 bits	2 bit	Odd	05:	1 bit	7 bits	2 bit	None	06:	1 bit	8 bits	1 bit	Even	07:	1 bit	8 bits	1 bit	Odd	08:	1 bit	8 bits	1 bit	None	09:	1 bit	8 bits	2 bit	Even	10:	1 bit	8 bits	2 bit	Odd	11:	1 bit	8 bits	2 bit	None
	Start	Length	Stop	Parity																																																															
00:	1 bit	7 bits	1 bit	Even																																																															
01:	1 bit	7 bits	1 bit	Odd																																																															
02:	1 bit	7 bits	1 bit	None																																																															
03:	1 bit	7 bits	2 bit	Even																																																															
04:	1 bit	7 bits	2 bit	Odd																																																															
05:	1 bit	7 bits	2 bit	None																																																															
06:	1 bit	8 bits	1 bit	Even																																																															
07:	1 bit	8 bits	1 bit	Odd																																																															
08:	1 bit	8 bits	1 bit	None																																																															
09:	1 bit	8 bits	2 bit	Even																																																															
10:	1 bit	8 bits	2 bit	Odd																																																															
11:	1 bit	8 bits	2 bit	None																																																															
6652	00 to 15	Transmission delay (Host Link) 0000 to 9999 (BCD): Set in units of 10 ms. (Other settings will cause a non-fatal error, the default setting (0000) will be used, and AR 1302 will turn ON.)	To match host parameters																																																																
6653	00 to 07	Node number (Host Link) 00 to 31 (BCD) (Other settings will cause a non-fatal error, the default setting (0000) will be used, and AR 1302 will turn ON.)	00 to 31																																																																
	08 to 11	Start code enable (RS-232C, effective when bits 12 to 15 of DM 6650 are set to 1.) 0: Disable 1: Set	Any																																																																
	12 to 15	End code enable (RS-232C, effective when bits 12 to 15 of DM 6650 are set to 1.) 0: Disable (number of bytes received) 1: Set (specified end code) 2: CR, LF	Any																																																																

6654	00 to 07	Start code (effective when bits 08 to 11 of DM6650 are set to 1.) 00: 256 bytes 01 to FF: 1 to 255 bytes	Any
	08 to 15	End code (no-protocol) When bits 12 to 15 of DM6653 are set to 0: 00: 256 bytes 01 to FF: 1 to 255 bytes When bits 12 to 15 of DM6653 are set to 1: Setting: 00 to FF (Hex)	Any

Note If an out-of-range value is set, the following communications conditions will result. In that case, reset the value so that it is within the permissible range.

Communications mode: Host Link
Communications format: Standard settings
(1 start bit, 7-bit data; 2 stop bits, even parity, 9,600 bps)
Transmission delay: No
Node number: 00

Word	Bit	Function	Setting
------	-----	----------	---------

232C Port Settings

The following settings are effective after transfer to the PC.

6645	00 to 03	Port settings 0: Standard (1 start bit, 7-bit data, 2 stop bits, even parity, 9,600 bps) 1: Settings in DM 6646	To match host parameters																																																																	
	04 to 07	CTS control settings 0: Disable; 1: Set	0																																																																	
	08 to 11	When using a 1:1 PC Link: Sets the link words for 1:1 PC Link. 0: LR 00 to LR 15 Not 0: Disable When using a 1:N NT Link: Sets the maximum PT node number. 1 to 7																																																																		
	12 to 15	Communications mode 0: Host Link; 1: No-protocol; 2: 1:1 PC Link Slave; 3: 1:1 PC Link Master; 4: 1:1 NT Link; 5: 1:N NT Link (Any other setting specifies Host Link mode, causes a non-fatal error, and turns ON AR 1302.) The 1:N NT Link is supported by SRM1-C02-V2 only.	0																																																																	
6646	00 to 07	Baud rate 00: 1.2K, 01: 2.4K, 02: 4.8K, 03: 9.6K, 04: 19.2K	To match host parameters																																																																	
	08 to 15	Frame format <table border="1"> <thead> <tr> <th></th> <th>Start</th> <th>Length</th> <th>Stop</th> <th>Parity</th> </tr> </thead> <tbody> <tr><td>00:</td><td>1 bit</td><td>7 bits</td><td>1 bit</td><td>Even</td></tr> <tr><td>01:</td><td>1 bit</td><td>7 bits</td><td>1 bit</td><td>Odd</td></tr> <tr><td>02:</td><td>1 bit</td><td>7 bits</td><td>1 bit</td><td>None</td></tr> <tr><td>03:</td><td>1 bit</td><td>7 bits</td><td>2 bit</td><td>Even</td></tr> <tr><td>04:</td><td>1 bit</td><td>7 bits</td><td>2 bit</td><td>Odd</td></tr> <tr><td>05:</td><td>1 bit</td><td>7 bits</td><td>2 bit</td><td>None</td></tr> <tr><td>06:</td><td>1 bit</td><td>8 bits</td><td>1 bit</td><td>Even</td></tr> <tr><td>07:</td><td>1 bit</td><td>8 bits</td><td>1 bit</td><td>Odd</td></tr> <tr><td>08:</td><td>1 bit</td><td>8 bits</td><td>1 bit</td><td>None</td></tr> <tr><td>09:</td><td>1 bit</td><td>8 bits</td><td>2 bit</td><td>Even</td></tr> <tr><td>10:</td><td>1 bit</td><td>8 bits</td><td>2 bit</td><td>Odd</td></tr> <tr><td>11:</td><td>1 bit</td><td>8 bits</td><td>2 bit</td><td>None</td></tr> </tbody> </table>		Start	Length	Stop	Parity	00:	1 bit	7 bits	1 bit	Even	01:	1 bit	7 bits	1 bit	Odd	02:	1 bit	7 bits	1 bit	None	03:	1 bit	7 bits	2 bit	Even	04:	1 bit	7 bits	2 bit	Odd	05:	1 bit	7 bits	2 bit	None	06:	1 bit	8 bits	1 bit	Even	07:	1 bit	8 bits	1 bit	Odd	08:	1 bit	8 bits	1 bit	None	09:	1 bit	8 bits	2 bit	Even	10:	1 bit	8 bits	2 bit	Odd	11:	1 bit	8 bits	2 bit	None	To match host parameters
	Start	Length	Stop	Parity																																																																
00:	1 bit	7 bits	1 bit	Even																																																																
01:	1 bit	7 bits	1 bit	Odd																																																																
02:	1 bit	7 bits	1 bit	None																																																																
03:	1 bit	7 bits	2 bit	Even																																																																
04:	1 bit	7 bits	2 bit	Odd																																																																
05:	1 bit	7 bits	2 bit	None																																																																
06:	1 bit	8 bits	1 bit	Even																																																																
07:	1 bit	8 bits	1 bit	Odd																																																																
08:	1 bit	8 bits	1 bit	None																																																																
09:	1 bit	8 bits	2 bit	Even																																																																
10:	1 bit	8 bits	2 bit	Odd																																																																
11:	1 bit	8 bits	2 bit	None																																																																
6647	00 to 15	Transmission delay (Host Link) 0000 to 9999 (BCD): Set in units of 10 ms, e.g., setting of 0001 equals 10 ms	To match host parameters																																																																	

6648	00 to 07	Node number (Host Link, effective when bits 12 to 15 of DM 6645 are set to 0.) 00 to 31 (BCD)	00 to 31
	08 to 11	Start code enable (RS-232C, effective when bits 12 to 15 of DM 6645 are set to 1.) 0: Disable; 1: Set	Any
	12 to 15	End code enable (RS-232C, effective when bits 12 to 15 of DM 6645 are set to 1.) 0: Disable (number of bytes received) 1: Set (specified end code) 2: CR, LF	Any
6649	00 to 07	Start code (RS-232C) 00: 256 bytes 01 to FF: 1 to 255 bytes	Any
	08 to 15	End code enable (RS-232C) 00 to FF (BIN)	Any

Note If an out-of-range value is set, the following communications conditions will result. In that case, reset the value so that it is within the permissible range.

Communications mode: Host Link
Communications format: Standard settings
(1 start bit, 7-bit data; 2 stop bits, even parity, 9,600 bps)
Transmission delay: No
Node number: 00

Sample Program

This example shows a BASIC program that reads the status of the SRM1(-) inputs in IR 000. For more details, refer to *4-5 Host Link Commands*.
An FCS (frame check sequence) check isn't performed on the received response data in this program. Be sure that the host computer's RS-232C port is configured correctly before executing the program.

```

00 ' -----
00 'SRM1 Sample Program for BASIC
00 '
00 ' -----
00 ' ----- Set value RS-232C SPEED:9600BPS,PARITY:EVEN,DATA:7,STOP:2 ---
00 OPEN "COM:E73" AS #1
00 *REPEAT
00 ' ----- Transmission data input -----
00 INPUT "send data:",SEND$
00 ' ----- FCS Calculation-----
00 FCS=0
00 FOR IFCS=1 TO LEN(SEND$)
00 FCS=FCS XOR ASC(MID$(SEND$;IFCS,1)
00 NEXT
00 FCS$=RIGHT$("0"+HEX$(FCS),2)
00 ' ----- Communications execute -----
00 ZZZ$=SEND$+FCS$+"*"+CHR$(13)
00 PRINT #1,ZZZ$;
00 ' ----- Response check -----
00 RECCNT=0:TMP$=""
00 *DRECLOOP
00 IF LOC(1)<>0 THEN *DREC1
00 RECCNT=RECCNT+1
00 IF RECCNT=5000 THEN *DRECERR ELSE *DRECLOOP
00 *DREC1
00 TMP$=TMP$+INPUT$(LOC(1),#1)
00 IF RIGHT$(TMP$,1)=CHR$(13) THEN *DRECEND ELSE RECCNT=0:GOTO *DRECLOOP
00 *DRECERR

```

```

30 DRECELD
30 RECV$=TMP$
30 PRINT "receive data:";RECV$
30 ' ----- Go to transmission data input -----
30 GOTO *REPEAT
30 ' ----- Processing complete -----
30 CLOSE #1
30 END

```

4-2 No-protocol Communications

This section explains no-protocol (RS-232C) communications. No-protocol communications allow data to be exchanged with standard RS-232C devices such as printers and bar code readers. Data can be printed out by a printer or read by a bar code reader. Handshaking is not supported for no-protocol communications.

Communications Procedure

Transmissions

- 1, 2, 3... 1. Check to see that AR 0805 (the RS-232C Port Transmit Ready Flag) is turned ON.
2. Use the TXD(48) instruction to transmit the data.

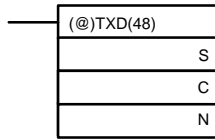

- S: Leading word no. of data to be transmitted
- C: Control data
- N: Number of bytes to be transmitted (4 digits BCD), 0000 to 0255

From the time this instruction is executed until the data transmission is complete, AR 0805 (or AR0813 for the peripheral port) will remain OFF. (It will turn ON again upon completion of the data transmission.)

Start and end codes are not included when the number of bytes to be transmitted is specified. The largest transmission that can be sent with or without start and end codes is 256 bytes, N will be between 254 and 256 depending on the definitions for start and end codes. If the number of bytes to be sent is set to 0, only the start and end codes will be sent.

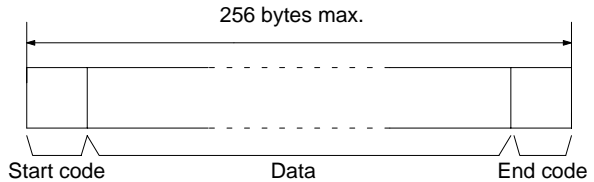

To reset the RS-232C port (i.e., to restore the initial status), turn on SR 25208 to reset the peripheral port, turn on SR 25208. These bits will turn OFF automatically after the reset.

Receptions

- 1, 2, 3... 1. Confirm that AR 0806 (RS-232C Reception Complete Flag) or AR 0814 (Peripheral Reception Complete Flag) is ON.



D: Leading word no. for storing reception data

C: Control data

Bits 00 to 03

0: Leftmost bytes first

1: Rightmost bytes first

Bits 12 to 15

0: RS-232C port

1: Peripheral port

N: Number of bytes stored (4 digits BCD), 0000 to 0256

3. The results of reading the data received will be stored in the AR area. Check the AR area to see that the operation was successfully completed. The contents of the AR area will be reset each time RXD(47) is executed.

RS-232C port	Peripheral port	Error
AR 0800 to AR 0803	AR 0808 to AR 0811	RS-232C port error code (1 digit BCD) 0: Normal completion 1: Parity error 2: Framing error 3: Overrun error
AR 0804	AR0812	Communications error
AR 0807	AR0815	Reception Overrun Flag (After reception was completed, the subsequent data was received before the data was read by means of the RXD(47) instruction)
AR 09	AR10	Number of bytes received

To reset the RS-232C port (i.e., to restore the initial status), turn ON SR 25208. To reset the peripheral port, turn ON SR 25208. These bits will turn OFF automatically after the reset.

The start code and end code are not included in AR 09 or AR 10 (number of bytes received).

The data will be as follows: "31323132313231323132CR LF"

Peripheral Port Settings

When the peripheral port is used to conduct no-protocol communications, the following settings must be made from the Programming Device to DM 6653 in the SRM1(-V2).

Word	Bit	Function	Setting
Peripheral Port Settings			
The following settings are effective after transfer to the PC.			
6650	00 to 03	Port settings 0: Standard (1 start bit, 7-bit data, 2 stop bits, even parity, 9,600 bps) 1: Settings in DM 6651 (Other settings will cause a non-fatal error, the default setting (0) will be used, and AR 1302 will turn ON.)	As required
	04 to 07	Not used.	0
	08 to 11	Not used.	0
	12 to 15	Communications mode 0: Host Link; 1: No-protocol (Other settings will cause a non-fatal error, the default setting (0) will be used, and AR 1302 will turn ON.)	1: No-protocol

6651	00 to 07	Baud rate 00: 1.2K, 01: 2.4K, 02: 4.8K, 03: 9.6K, 04: 19.2K	As required																																																																	
	08 to 15	Frame format <table border="1"> <thead> <tr> <th></th> <th>Start</th> <th>Length</th> <th>Stop</th> <th>Parity</th> </tr> </thead> <tbody> <tr><td>00:</td><td>1 bit</td><td>7 bits</td><td>1 bit</td><td>Even</td></tr> <tr><td>01:</td><td>1 bit</td><td>7 bits</td><td>1 bit</td><td>Odd</td></tr> <tr><td>02:</td><td>1 bit</td><td>7 bits</td><td>1 bit</td><td>None</td></tr> <tr><td>03:</td><td>1 bit</td><td>7 bits</td><td>2 bit</td><td>Even</td></tr> <tr><td>04:</td><td>1 bit</td><td>7 bits</td><td>2 bit</td><td>Odd</td></tr> <tr><td>05:</td><td>1 bit</td><td>7 bits</td><td>2 bit</td><td>None</td></tr> <tr><td>06:</td><td>1 bit</td><td>8 bits</td><td>1 bit</td><td>Even</td></tr> <tr><td>07:</td><td>1 bit</td><td>8 bits</td><td>1 bit</td><td>Odd</td></tr> <tr><td>08:</td><td>1 bit</td><td>8 bits</td><td>1 bit</td><td>None</td></tr> <tr><td>09:</td><td>1 bit</td><td>8 bits</td><td>2 bit</td><td>Even</td></tr> <tr><td>10:</td><td>1 bit</td><td>8 bits</td><td>2 bit</td><td>Odd</td></tr> <tr><td>11:</td><td>1 bit</td><td>8 bits</td><td>2 bit</td><td>None</td></tr> </tbody> </table> (Other settings will cause a non-fatal error, the default setting (00) will be used, and AR 1302 will turn ON.)		Start	Length	Stop	Parity	00:	1 bit	7 bits	1 bit	Even	01:	1 bit	7 bits	1 bit	Odd	02:	1 bit	7 bits	1 bit	None	03:	1 bit	7 bits	2 bit	Even	04:	1 bit	7 bits	2 bit	Odd	05:	1 bit	7 bits	2 bit	None	06:	1 bit	8 bits	1 bit	Even	07:	1 bit	8 bits	1 bit	Odd	08:	1 bit	8 bits	1 bit	None	09:	1 bit	8 bits	2 bit	Even	10:	1 bit	8 bits	2 bit	Odd	11:	1 bit	8 bits	2 bit	None	As required
	Start	Length	Stop	Parity																																																																
00:	1 bit	7 bits	1 bit	Even																																																																
01:	1 bit	7 bits	1 bit	Odd																																																																
02:	1 bit	7 bits	1 bit	None																																																																
03:	1 bit	7 bits	2 bit	Even																																																																
04:	1 bit	7 bits	2 bit	Odd																																																																
05:	1 bit	7 bits	2 bit	None																																																																
06:	1 bit	8 bits	1 bit	Even																																																																
07:	1 bit	8 bits	1 bit	Odd																																																																
08:	1 bit	8 bits	1 bit	None																																																																
09:	1 bit	8 bits	2 bit	Even																																																																
10:	1 bit	8 bits	2 bit	Odd																																																																
11:	1 bit	8 bits	2 bit	None																																																																
6652	00 to 15	Transmission delay (Host Link) 0000 to 9999 (BCD): Set in units of 10 ms. (Other settings will cause a non-fatal error, the default setting (0000) will be used, and AR 1302 will turn ON.)	To match host parameters																																																																	
6653	00 to 07	Node number (Host Link) 00 to 31 (BCD) (Other settings will cause a non-fatal error, the default setting (0000) will be used, and AR 1302 will turn ON.)	00 to 31																																																																	
	08 to 11	Start code enable (RS-232C, effective when bits 12 to 15 of DM 6650 are set to 1.) 0: Disable 1: Set	As required																																																																	
	12 to 15	End code enable (RS-232C, effective when bits 12 to 15 of DM 6650 are set to 1.) 0: Disable (number of bytes received) 1: Set (specified end code) 2: CR, LF	As required																																																																	
6654	00 to 07	Start code (effective when bits 08 to 11 of DM6650 are set to 1.) 00: 256 bytes 01 to FF: 1 to 255 bytes	As required																																																																	
	08 to 15	End code (no-protocol) When bits 12 to 15 of DM6653 are set to 0: 00: 256 bytes 01 to FF: 1 to 255 bytes When bits 12 to 15 of DM6653 are set to 1: Setting: 00 to FF (Hex)	As required																																																																	

Note If an out-of-range value is set, the following communications conditions will result. In that case, reset the value so that it is within the permissible range.

Communications mode: Host Link
 Communications format: Standard settings
 (1 start bit, 7-bit data; 2 stop bits, even parity, 9,600 bps)
 Transmission delay: No
 Node number: 00

232C Port Settings

When the RS-232C port is used to conduct no-protocol communications, the following settings must be made from the Programming Device to DM 6649 in the SRM1(-V2).

232C Port Settings

following settings are effective after transfer to the PC.

6645	00 to 03	Port settings 0: Standard (1 start bit, 7-bit data, 2 stop bits, even parity, 9,600 bps) 1: Settings in DM 6646	As required																																																																
	04 to 07	CTS control settings 0: Disable; 1: Set																																																																	
	08 to 11	When using a 1:1 PC link: Sets the link words for 1:1 PC Link. 0: LR 00 to LR 15 Not 0: Disable When using a 1:N NT Link: Sets the maximum PT node number. 1 to 7 The 1:N NT Link is supported by SRM1-C02-V2 only.	0																																																																
	12 to 15	Communications mode 0: Host Link; 1: No-protocol; 2: 1:1 PC Link Slave; 3: 1:1 PC Link Master; 4: 1:1 NT Link; 5: 1:N NT Link (Any other setting specifies Host Link mode, causes a non-fatal error, and turns ON AR 1302.) The 1:N NT Link is supported by SRM1-C02-V2 only.	1																																																																
6646	00 to 07	Baud rate 00: 1.2K, 01: 2.4K, 02: 4.8K, 03: 9.6K, 04: 19.2K	As required																																																																
	08 to 15	Frame format <table border="1"> <thead> <tr> <th></th> <th>Start</th> <th>Length</th> <th>Stop</th> <th>Parity</th> </tr> </thead> <tbody> <tr><td>00:</td><td>1 bit</td><td>7 bits</td><td>1 bit</td><td>Even</td></tr> <tr><td>01:</td><td>1 bit</td><td>7 bits</td><td>1 bit</td><td>Odd</td></tr> <tr><td>02:</td><td>1 bit</td><td>7 bits</td><td>1 bit</td><td>None</td></tr> <tr><td>03:</td><td>1 bit</td><td>7 bits</td><td>2 bit</td><td>Even</td></tr> <tr><td>04:</td><td>1 bit</td><td>7 bits</td><td>2 bit</td><td>Odd</td></tr> <tr><td>05:</td><td>1 bit</td><td>7 bits</td><td>2 bit</td><td>None</td></tr> <tr><td>06:</td><td>1 bit</td><td>8 bits</td><td>1 bit</td><td>Even</td></tr> <tr><td>07:</td><td>1 bit</td><td>8 bits</td><td>1 bit</td><td>Odd</td></tr> <tr><td>08:</td><td>1 bit</td><td>8 bits</td><td>1 bit</td><td>None</td></tr> <tr><td>09:</td><td>1 bit</td><td>8 bits</td><td>2 bit</td><td>Even</td></tr> <tr><td>10:</td><td>1 bit</td><td>8 bits</td><td>2 bit</td><td>Odd</td></tr> <tr><td>11:</td><td>1 bit</td><td>8 bits</td><td>2 bit</td><td>None</td></tr> </tbody> </table>		Start	Length	Stop	Parity	00:	1 bit	7 bits	1 bit	Even	01:	1 bit	7 bits	1 bit	Odd	02:	1 bit	7 bits	1 bit	None	03:	1 bit	7 bits	2 bit	Even	04:	1 bit	7 bits	2 bit	Odd	05:	1 bit	7 bits	2 bit	None	06:	1 bit	8 bits	1 bit	Even	07:	1 bit	8 bits	1 bit	Odd	08:	1 bit	8 bits	1 bit	None	09:	1 bit	8 bits	2 bit	Even	10:	1 bit	8 bits	2 bit	Odd	11:	1 bit	8 bits	2 bit	None
	Start	Length	Stop	Parity																																																															
00:	1 bit	7 bits	1 bit	Even																																																															
01:	1 bit	7 bits	1 bit	Odd																																																															
02:	1 bit	7 bits	1 bit	None																																																															
03:	1 bit	7 bits	2 bit	Even																																																															
04:	1 bit	7 bits	2 bit	Odd																																																															
05:	1 bit	7 bits	2 bit	None																																																															
06:	1 bit	8 bits	1 bit	Even																																																															
07:	1 bit	8 bits	1 bit	Odd																																																															
08:	1 bit	8 bits	1 bit	None																																																															
09:	1 bit	8 bits	2 bit	Even																																																															
10:	1 bit	8 bits	2 bit	Odd																																																															
11:	1 bit	8 bits	2 bit	None																																																															
6647	00 to 15	Transmission delay (Host Link) 0000 to 9999 (BCD): Set in units of 10 ms, e.g., setting of 0001 equals 10 ms	As required																																																																
6648	00 to 07	Node number (Host Link, effective when bits 12 to 15 of DM 6645 are set to 0.) 00 to 31 (BCD)	As required																																																																
	08 to 11	Start code enable (RS-232C, effective when bits 12 to 15 of DM 6645 are set to 1.) 0: Disable; 1: Set	As required																																																																
	12 to 15	End code enable (RS-232C, effective when bits 12 to 15 of DM 6645 are set to 1.) 0: Disable (number of bytes received) 1: Set (specified end code) 2: CR, LF																																																																	
6649	00 to 07	Start code (RS-232C) 00: 256 bytes 01 to FF: 1 to 255 bytes	As required																																																																
	08 to 15	End code enable (RS-232C) 00 to FF (BIN)																																																																	

Note If an out-of-range value is set, the following communications conditions will result. In that case, reset the value so that it is within the permissible range.

Communications mode: Host Link

Communications format: Standard settings
(1 start bit, 7-bit data; 2 stop bits, even parity, 9,600 bps)

Transmission delay: No

When no-protocol communications are used, TXD(48) is used to send data and RXD(47) to receive data. The maximum amount of data that can be either sent or received is 259 bytes, including the start/end code.

• **No Start or End Code:**

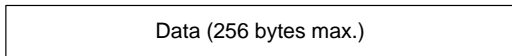

• **Only a Start Code:**

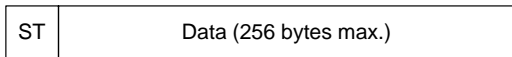

• **Only an End Code:**

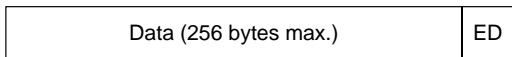

• **Both an Start and End Code:**

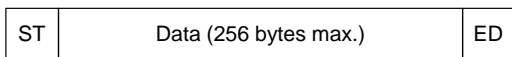

• **End Code of CR, LF:**

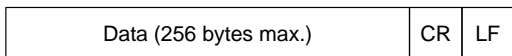

• **Start Code 00-FF/End Code CR,LF:**

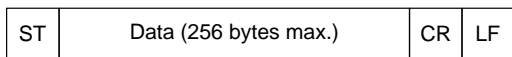

- Note**
1. The start and end codes are set in DM 6648 to DM 6649 and DM 6650 to DM 6654 of the PC Setup.
 2. When there are several start and end codes, the first part of each will be effective.
 3. When the end code duplicates the transmission data and the transmission is stopped part way through, use CR or LF as the end code.
 4. The start and end codes are not stored.

When sending data from the SRM1(-V2), check that the Transmission Enable Flag is ON for executing the TXD(48) instruction. The Transmission Enable Flag will turn OFF while the data is being transmitted and will turn ON again when the transmission is complete.

Transmission Flags

After the SRM1(-V2) has received data, the Receive Enable Flag turns OFF. When the RXD instruction is executed, the data received will be written to the specified words and the Reception Complete Flag will turn OFF.

Flag	Peripheral port	RS-232C port
Transmission Enable Flag	AR 0813	AR 0805
Reception Complete Flag	AR 0814	AR 0806

Note The timing from data reception starting to completion for the SRM1(-V2) is indicated below.

Reception Start:

- Without start code: Normal reception status
- With start code: After start code is received.

Program Example

The following program example is for no-protocol communication conducted through a RS-232C port using TXD(48) and RXD(47) instructions.

If AR 0805 (Transmission Enable Flag) is ON when 00100 is ON, then data DM0100 to DM0104 is transmitted from higher to lower values. When AR 0806 (Reception Enable Flag) turns ON, 256 bytes of received data are read and stored in DM 0200 from higher to lower values.

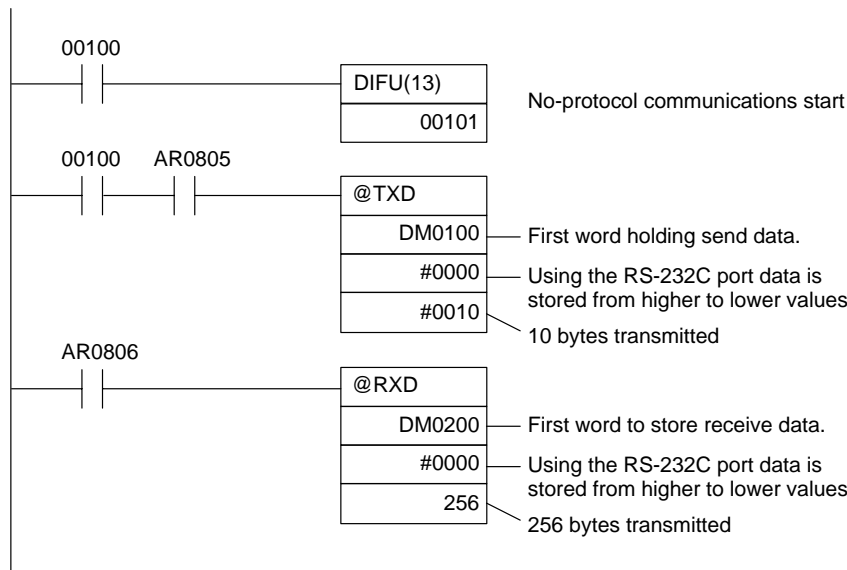

4-3 One-to-one NT Link Communications

Using the 1:1 NT Link, the SRM1(-V2) PC can be connected to the Programmable Terminal (NT Link Interface.) The RS-232C port can be used for the 1:1 NT Link.

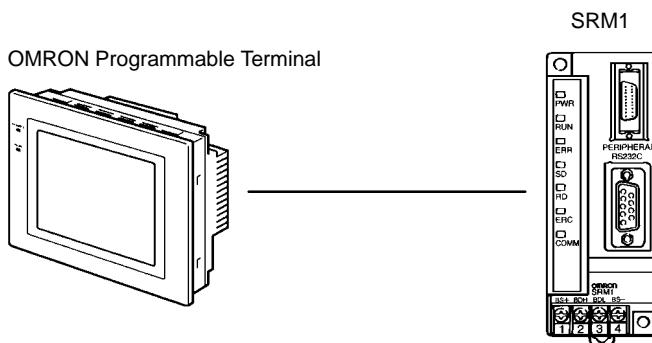

The 1:1 NT Link is possible only with the SRM1-C02-V1/-V2 PCs, which have an RS-232C port.

Setup Settings

The settings relating to 1:1 NT Link PC communications must be set as shown in the following table.

Word	Bit	Function	Setting
DM 6645	00 to 03	Port settings ¹ 00: Standard (1 start bit, 7-bit data, 2 stop bits, even parity, 9,600 bps) 01: Settings in DM 6646	00 or 01
	04 to 07	CTS control settings 0: Disable 1: Set	0 or 1

08 to 11	When using a 1:1 PC Link: Sets the link words for 1:1 PC Link. 0: LR 00 to LR 15 Not 0: Disable When using a 1:N NT Link: Sets the maximum PT node number. 1 to 7 The 1:N NT Link is supported by SRM1-C02-V2 only.	Any
12 to 15	Communications mode ¹ 0: Host Link; 1: No-protocol; 2: 1:1 PC Link Slave; 3: 1:1 PC Link Master; 4: 1:1 NT Link; 5: 1:N NT Link The 1:N NT Link is supported by SRM1-C02-V2 only.	4

- Note**
1. If an improper setting is used, a non-fatal error will occur, AR 1302 will be turned ON, and the default setting (0 or 00) will be used.
 2. For information on the NT Link settings for another OMRON PC, refer to the PC's Operation Manual.
 3. If an out-of-range value is set, the following communications conditions will result. In that case, reset the value so that it is within the permissible range.
- Communications mode: Host Link
Communications format: Standard settings
(1 start bit, 7-bit data; 2 stop bits, even parity; 9,600 bps)
Transmission delay: No
Node number: 00

4-4 One-to-N NT Link Communications

The 1:N NT Link allows an SRM1(-V2) PC to be connected to as many as 8 OMRON Programmable Terminals (PTs) and direct access provides high-speed communications. The 1:N NT Link can be used with the RS-232C port.

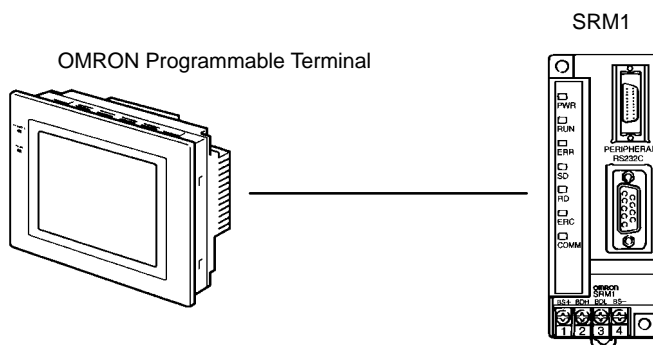

The 1:N NT Link is possible only with the SRM1-C02-V2 PCs, which have the RS-232C port.

Setup Settings

When the RS-232C port is used for a 1:N NT Link, make the following PC settings from a Programming Device.

Word	Bit	Function	Setting
DM 6645	00 to 03	Port settings ¹ 00: Standard (1 start bit, 7-bit data, 2 stop bits, even parity, 9,600 bps) 01: Settings in DM 6646	00 or 01
	04 to 07	CTS control settings 0: Disable 1: Set	0 or 1
	08 to 11	When using a 1:1 PC link: Sets the link words for 1:1 PC Link. 0: LR 00 to LR 15 Not 0: Disable When using a 1:N NT Link: Sets the maximum PT node number. 1 to 7 The 1:N NT Link is supported by SRM1-C02-V2 only.	1 to 7
	12 to 15	Communications mode ¹ 0: Host Link; 1: No-protocol; 2: 1:1 PC Link Slave; 3: 1:1 PC Link Master; 4: 1:1 NT Link; 5: 1:N NT Link The 1:N NT Link is supported by SRM1-C02-V2 only.	5

- Note**
1. If an improper setting is used, a non-fatal error will occur, AR 1302 will be turned ON, and the default setting (0 or 00) will be used.
 2. For information on 1:N NT Link settings for OMRON PTs, refer to the PT Operation Manual.
 3. If an out-of-range value is set, the following communications conditions will result. In that case, reset the value so that it is within the permissible range.

Communications mode: Host Link
 Communications format: Standard settings
 (1 start bit, 7-bit data; 2 stop bits, even parity, 9,600 bps)
 Transmission delay: No
 Node number: 00

4-5 One-to-one PC Link Communications

In a 1:1 PC Link, an SRM1 is linked to another SRM1, CPM1, CPM1A, CPM1B, CPM2C, CQM1, C200HS, or C200HX/HG/HE PC through a standard RS-232C cable. One of the PCs will serve as the master and the other as the slave. The 1:1 PC Link can connect up to 256 bits (LR 0000 to LR 1515) in the two PCs.

One-to-one SRM1(-V2) Links

The following diagram shows a 1:1 PC Link between two SRM1(-V2)s.

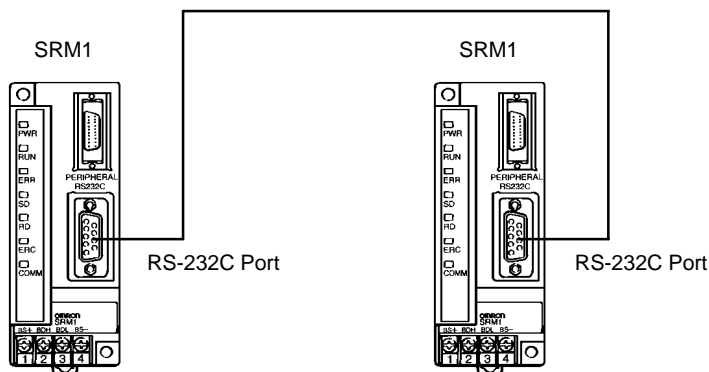

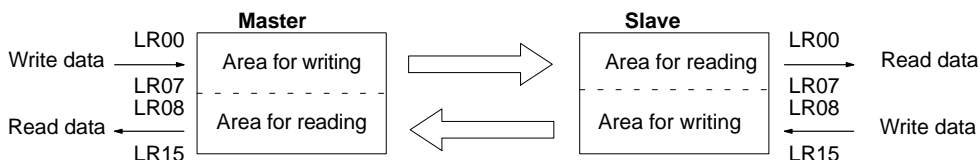

Limitations of 1:1 PC Links in an SRM1(-V2)

A 1:1 PC Link is possible only with the SRM1-C02-V1/V2 PCs, which are equipped with an RS-232C port.

Only the 16 LR words from LR 00 to LR 15 can be linked in the SRM1, so use only those 16 words in the CQM1 or C200HS when making a 1:1 PC Link with one of those PCs. A 1:1 PC Link cannot be made to an SRM1 PC using LR 16 through LR 63 in the CQM1 or C200HS.

Cable Connections

Refer to the *SRM1 Master Control Units Operation Manual* for information on cable connections in a 1:1 PC Link.

Setup Settings

When an SRM1(-V2) is used in a 1:1 PC Link, make the following PC Setup Settings from a Programming Device.

Word	Bit	Function	Setting (Master)	Setting (Slave)
DM 6645	00 to 03	Port settings ¹ 00: Standard (1 start bit, 7-bit data, 2 stop bits, even parity, 9,600 bps) 01: Settings in DM 6651	00 or 01	00 or 01
	04 to 07	CTS Control settings 0: Disable 1: Set	0	0
	08 to 11	When using a 1:1 PC Link: Sets the link words for 1:1 PC Link. 0: LR 00 to LR 15 Not 0: Disable When using a 1:N NT Link: Sets the maximum PT node number. 1 to 7	0	0
	12 to 15	Communications mode ¹ 0: Host Link; 1: No-protocol; 2: 1:1 PC Link Slave; 3: 1:1 PC Link Master; 4: 1:1 NT Link; 5: 1:N NT Link	3	2

- Note**
1. If an improper setting is used, a non-fatal error will occur, AR 1302 will be turned ON, and the default setting (0 or 00) will be used.
 2. For information on the 1:1 PC Link settings for another OMRON PC, refer to that PC's Operation Manual.
 3. If an out-of-range value is set, the following communications conditions will result. In that case, reset the value so that it is within the permissible range.

Communications mode: Host Link

Communications format: Standard settings
(1 start bit, 7-bit data; 2 stop bits, even parity, 9,600 bps)

Transmission delay: No

Node number: 00

Program in the Master

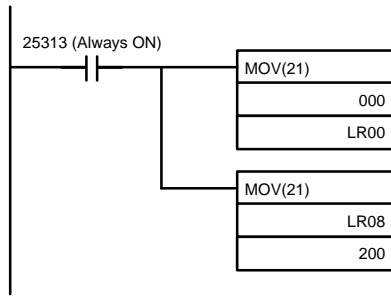

Program in the Slave

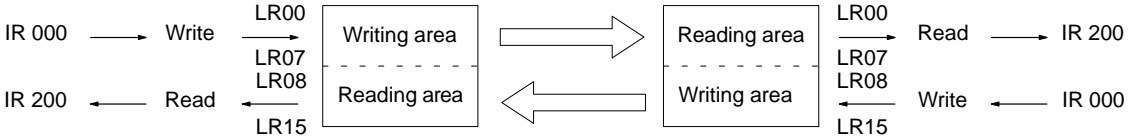
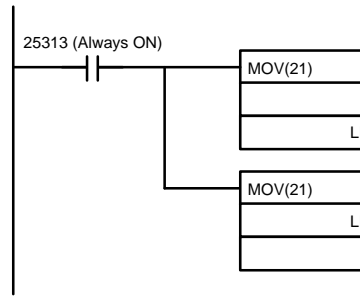

5 Host Link Commands

This section explains the commands that can be issued from the host computer to the PC.

5-1 IR/SR AREA READ – RR

Reads the contents of the specified number of IR and SR words, starting from the specified word.

Command Format

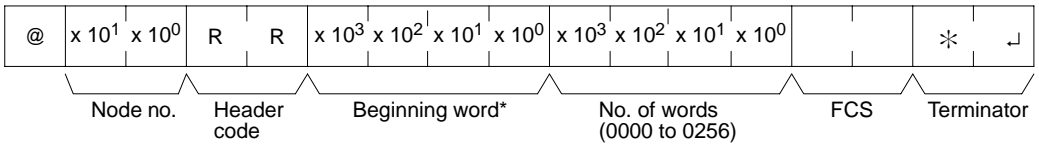

Note *Beginning word: 0000 to 0049 and 0200 to 0255 in CPM2A/CPM2C PCs, 0000 to 0019 and 0200 to 0255 in CPM1/CPM1A/SRM1(-V2) PCs. (A response of "0000" will be returned for non-existent IR and SR words.)

Response Format

An end code of 00 indicates normal completion.

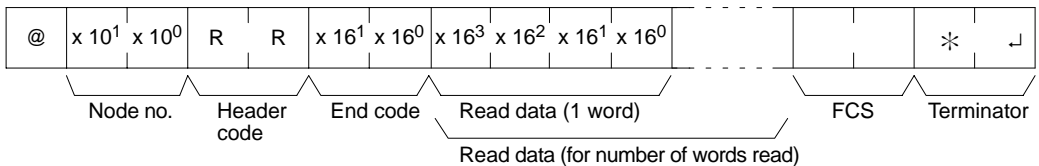

Note 1. Words 0050 to 0199 cannot be specified in CPM2A/CPM2C PCs and words 0020 to 0199 cannot be specified in CPM1/CPM1A/SRM1(-V2) PCs. If an attempt to read any of these words is made, a response of 0000 will be returned.

2. The response will be divided when reading more than 30 words of data.

Parameters

Read Data (Response)

The contents of the number of words specified by the command are returned in hexadecimal as a response. The words are returned in order, starting from the specified beginning word.

Reads the contents of the specified number of LR words, starting from the specified word.

Command Format

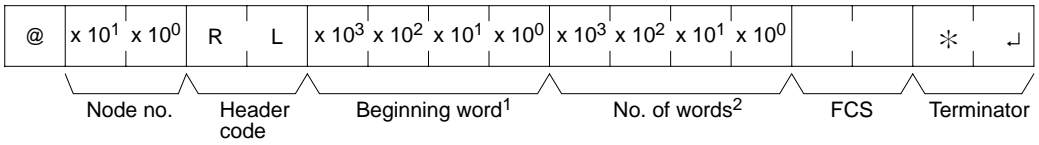

- Note**
1. Beginning word: 0000 to 0015
 2. No. of words: 0001 to 0016

Response Format

An end code of 00 indicates normal completion.

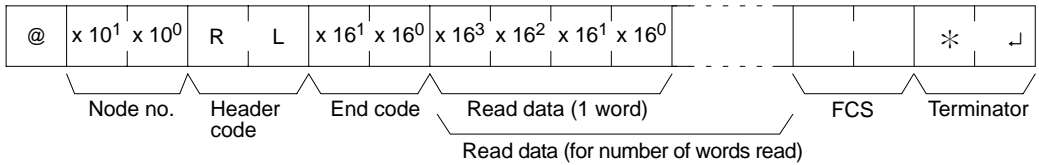

Parameters

Read Data (Response)

The contents of the number of words specified by the command are returned in hexadecimal as a response. The words are returned in order, starting with the specified beginning word.

5-3 HR AREA READ – RH

Reads the contents of the specified number of HR words, starting from the specified word.

Command Format

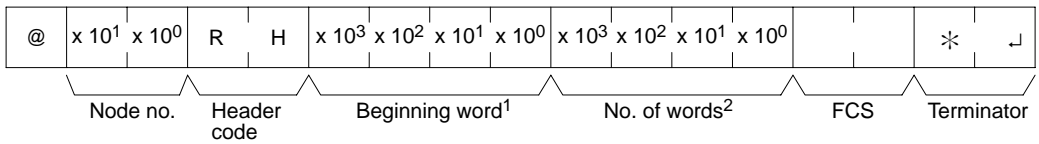

- Note**
1. Beginning word: 0000 to 0019
 2. No. of words: 0001 to 0020

Response Format

An end code of 00 indicates normal completion.

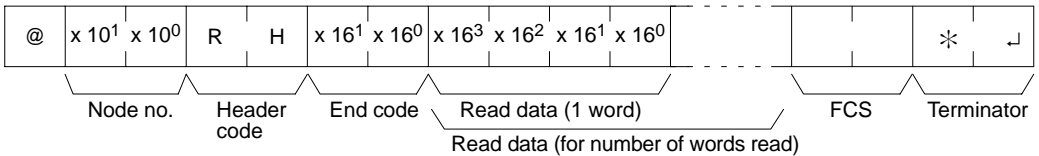

Parameters

Read Data (Response)

The contents of the number of words specified by the command are returned in hexadecimal as a response. The words are returned in order, starting with the specified beginning word.

5-4 PV READ – RC

Reads the contents of the specified number of timer/counter PVs (present values), starting from the specified timer/counter.

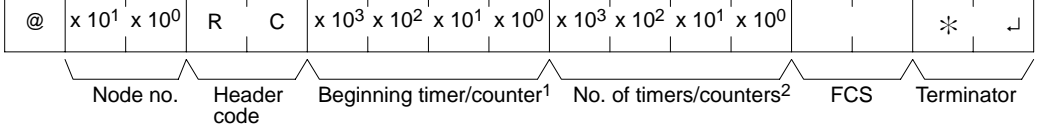

- Note**
1. Beginning T/C: 0000 to 0255 in CPM2A/CPM2C PCs, 0000 to 0127 in CPM1/CPM1A/SRM1(-V2) PCs
 2. No. of T/Cs: 0001 to 0256 in CPM2A/CPM2C PCs, 0001 to 0127 in CPM1/CPM1A/SRM1(-V2) PCs

Response Format

An end code of 00 indicates normal completion.

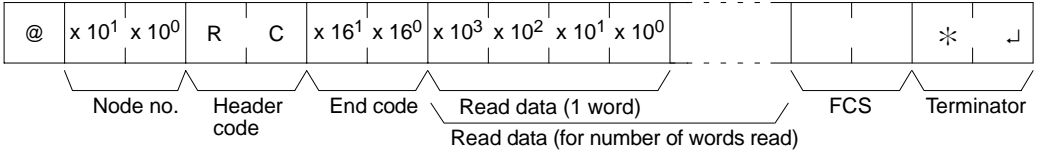

The response will be divided when reading more than 30 words of data.

Parameters

Read Data (Response)

The number of present values specified by the command is returned in hexadecimal as a response. The PVs are returned in order, starting with the specified beginning timer/counter.

5-5 TC STATUS READ – RG

Reads the status of the Completion Flags of the specified number of timer/counters, starting from the specified timer/counter.

Command Format

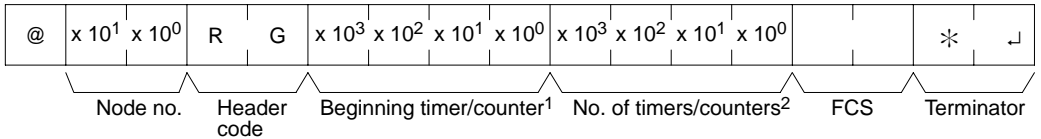

- Note**
1. Beginning T/C: 0000 to 0255 in CPM2A/CPM2C PCs, 0000 to 0127 in CPM1/CPM1A/SRM1(-V2) PCs
 2. No. of T/Cs: 0001 to 0256 in CPM2A/CPM2C PCs, 0001 to 0127 in CPM1/CPM1A/SRM1(-V2) PCs

Response Format

An end code of 00 indicates normal completion.

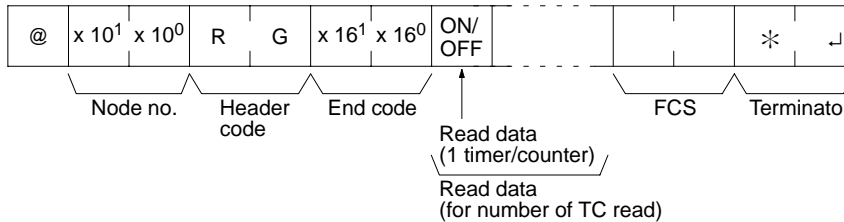

The response will be divided when reading the status of more than 123 timer/counters.

Parameters

Read Data (Response)

The status of the number of Completion Flags specified by the command is returned as a response. "1" indicates that the Completion Flag is ON.

5-6 DM AREA READ – RD

Reads the contents of the specified number of DM words, starting from the specified word.

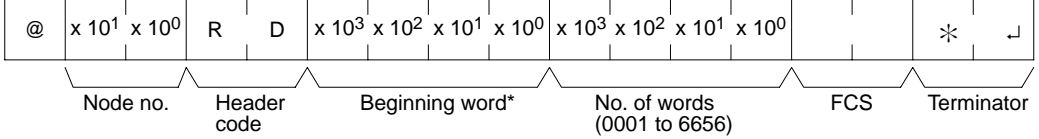

Note Beginning word:

DM 0000 to DM 1023 and DM 6144 to DM 6655 in CPM1/CPM1A PCs
 DM 0000 to DM 2047 and DM 6144 to DM 6655 in CPM2A/CPM2C/SRM1(PCs. (A response of "0000" will be returned for non-existent DM words.)

Response Format

An end code of 00 indicates normal completion.

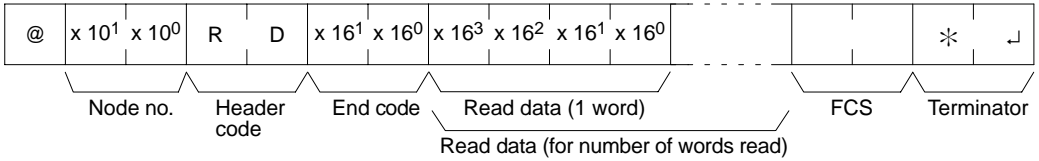

Note

1. Words DM 1024 to DM 6143 in CPM1/CPM1A PCs and words DM 2048 to DM 6143 in CPM2A/CPM2C/SRM1(-V2) PCs cannot be specified. If an attempt to read any of these words is made, a response of 0000 will be returned.
2. The response will be divided when reading more than 30 words of data.

Parameters

Read Data (Response)

The contents of the number of words specified by the command are returned in hexadecimal as a response. The words are returned in order, starting with the specified beginning word.

Note

Be careful about the configuration of the DM area, as it varies depending on CPU Unit model.

5-7 AR AREA READ – RJ

Reads the contents of the specified number of AR words, starting from the specified word.

Command Format

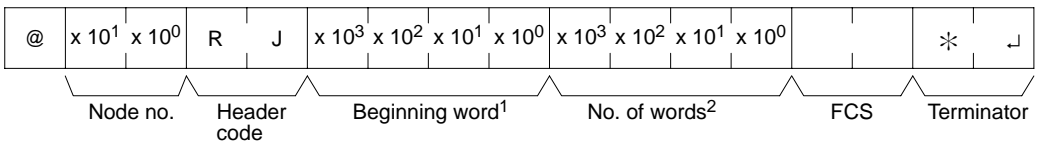

Note

1. Beginning word: 0000 to 0023 in CPM2A/CPM2C PCs, 0000 to 0023 in CPM1/CPM1A/SRM1(-V2) PCs
2. No. of words: 0001 to 0024 in CPM2A/CPM2C PCs, 0001 to 0024 in CPM1/CPM1A/SRM1(-V2) PCs

Response Format

An end code of 00 indicates normal completion.

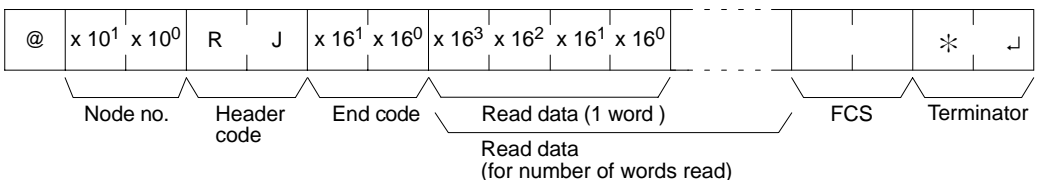

The contents of the number of words specified by the command are returned in hexadecimal as a response. The words are returned in order, starting with the specified beginning word.

5-8 IR/SR AREA WRITE – WR

Writes data to the IR and SR areas, starting from the specified word. Writing is done word by word.

Command Format

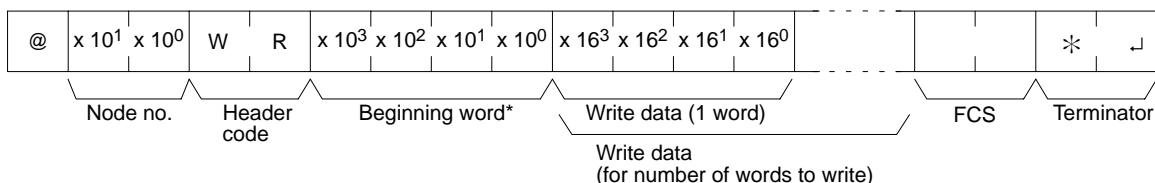

- Note**
1. Beginning word: 0000 to 0049 and 0200 to 0252 in CPM2A/CPM2C PCs
0000 to 0019 and 0200 to 0252 in CPM1/CPM1A/SRM1(-V2) PCs.
 2. Divide the command when writing more than 30 words of data.

Response Format

An end code of 00 indicates normal completion.

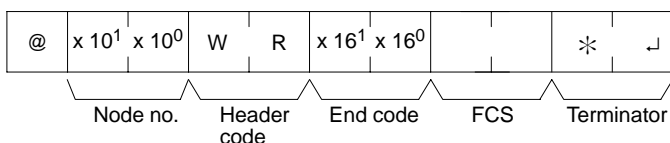

- Note** Words 0050 to 0199 cannot be specified in CPM2A/CPM2C PCs and words 0020 to 0199 cannot be specified in CPM1/CPM1A/SRM1(-V2) PCs. If an attempt is made to write to any of these words, the writing operation will not be executed and normal completion occurs.

Parameters

Write Data (Command)

Specify in order the contents of the number of words to be written to the IR or SR area in hexadecimal, starting with the specified beginning word.

- Note** If data is specified for writing which exceeds the allowable range, an error will be generated and the writing operation will not be executed. If, for example, 253 is specified as the beginning word for writing, and two words of data are specified, then 253 will become the last word for writing data, and the command will not be executed because SR 253 is beyond the writable range.

5-9 LR AREA WRITE – WL

Writes data to the LR area, starting from the specified word. Writing is done word by word.

Command Format

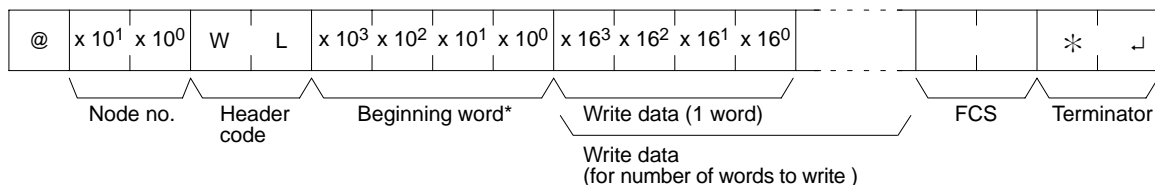

- Note** Beginning word: 0000 to 0015

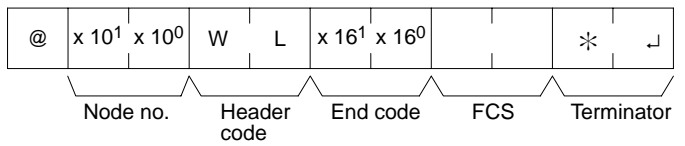

Parameters

Write Data (Command)

Specify in order the contents of the number of words to be written to the LR in hexadecimal, starting with the specified beginning word.

Note If data is specified for writing which exceeds the allowable range, an error will be generated and the writing operation will not be executed. If, for example, 16 is specified as the beginning word for writing and five words of data are specified, then 16 will become the last word for writing data, and the command will not be executed because LR 16 is beyond area boundary.

5-10 HR AREA WRITE – WH

Writes data to the HR area, starting from the specified word. Writing is done word by word.

Command Format

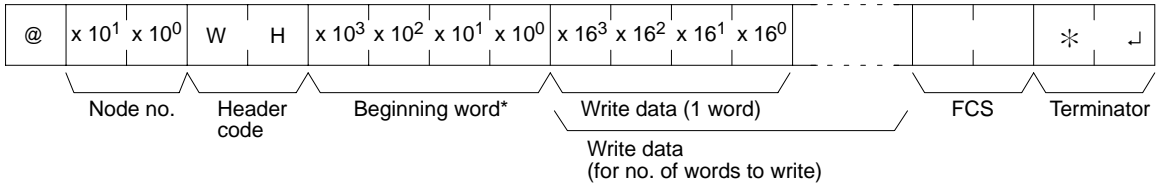

Note Beginning word:0000 to 0019

Response Format

An end code of 00 indicates normal completion.

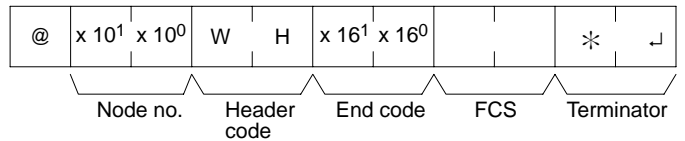

Parameters

Write Data (Command)

Specify in order the contents of the number of words to be written to the HR in hexadecimal, starting with the specified beginning word.

Note If data is specified for writing which exceeds the allowable range, an error will be generated and the writing operation will not be executed. If, for example, 20 is specified as the beginning word for writing, and three words of data are specified, then 20 will become the last word for writing data, and the command will not be executed because HR 20 is beyond area boundary.

5-11 PV WRITE – WC

Writes the PVs (present values) of timers/counters starting from the specified timer/counter.

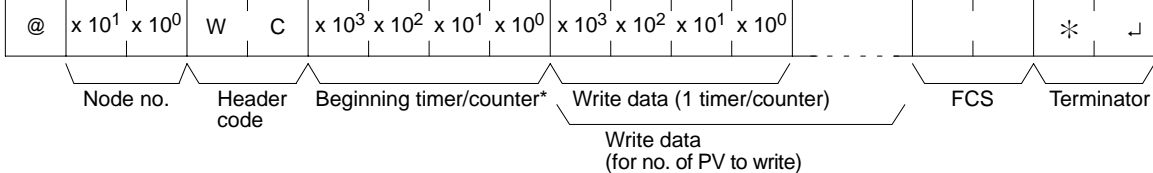

- Note**
1. Beginning T/C: 0000 to 0255 in CPM2A/CPM2C PCs, 0000 to 0127 in CPM1/ CPM1A/SRM1(-V2) PCs
 2. Divide the command when writing more than 29 words of data.

Response Format

An end code of 00 indicates normal completion.

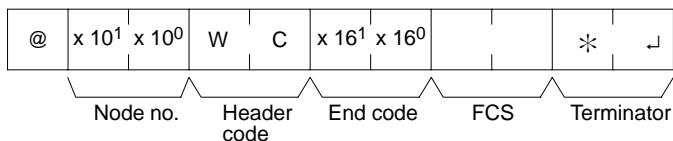

Parameters

Write Data (Command)

Specify in decimal numbers (BCD) the present values for the number of timer/counters that are to be written, starting from the beginning timer/counter.

- Note**
1. When this command is used to write data to the PV area, the Completion Flags for the timers/counters that are written will be turned OFF.
 2. If data is specified for writing which exceeds the allowable range, an error will be generated and the writing operation will not be executed. If, for example, 126 is specified as the beginning word for writing in a CPM1 PC, and three words of data are specified, then 128 will become the last word for writing data, and the command will not be executed because TC 128 is beyond the area boundary.

5-12 TC STATUS WRITE – WG

Writes the status of the Completion Flags for timers and counters in the TC area starting from the specified timer/counter (number). Writing is done in order of the number.

Command Format

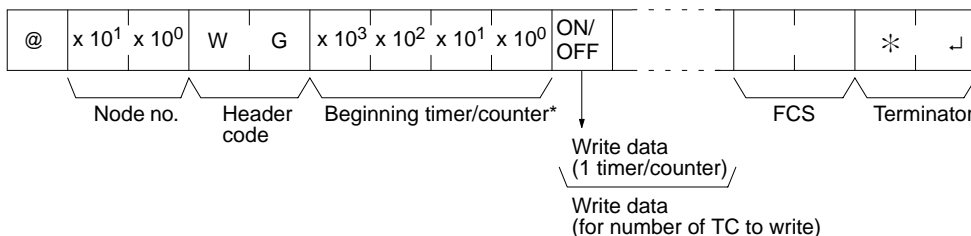

- Note**
1. Beginning T/C: 0000 to 0255 in CPM2A/CPM2C PCs, 0000 to 0127 in CPM1/ CPM1A/SRM1(-V2) PCs
 2. Divide the command when writing the status of more than 118 timer/counters.

Response Format

An end code of 00 indicates normal completion.

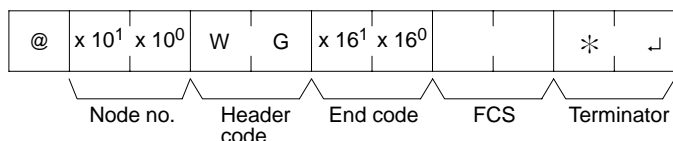

Specify the status of the Completion Flag, for the number of timers/counters to be written, in order (from the beginning word) as ON (i.e., "1") or OFF (i.e., "0"). When a Completion Flag is ON, it indicates that the time or count is up.

Note If data is specified for writing which exceeds the allowable range, an error will be generated and the writing operation will not be executed. If, for example, 128 is specified as the beginning word for writing in a CPM1 PC, and three words of data are specified, then 128 will become the last word for writing data, and the command will not be executed because TC 128 is beyond area boundary.

5-13 DM AREA WRITE – WD

Writes data to the DM area, starting from the specified word. Writing is done word by word.

Command Format

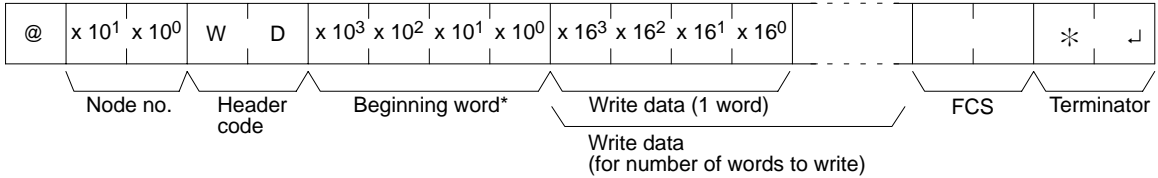

- Note**
1. Beginning word:
DM 0000 to DM 1023 and DM 6144 to DM 6655 in CPM1/CPM1A PCs
DM 0000 to DM 2047 and DM 6144 to DM 6655 in CPM2A/CPM2C/SRM1(-V2) PCs
 2. Divide the command when writing more than 29 words of data.

Response Format

An end code of 00 indicates normal completion.

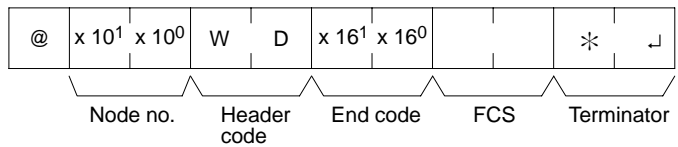

Note Words DM 1024 to DM 6143 in CPM1/CPM1A PCs and words DM 2048 to DM 6143 in CPM2A/CPM2C/SRM1(-V2) PCs cannot be specified. If an attempt is made to write to any of these words, the writing operation will not be executed for these words and the command will end normally.

Parameters

Write Data (Command)

Specify in order the contents of the number of words to be written to the DM area in hexadecimal, starting with the specified beginning word.

- Note**
1. If data is specified for writing which exceeds the allowable range, an error will be generated and the writing operation will not be executed. If, for example, 1022 is specified as the beginning word for writing in a CPM1 PC, and three words of data are specified, then 1024 will become the last word for writing data, and the command will not be executed because DM 1022 is beyond the writable range.
 2. Be careful about the configuration of the DM area, as it varies depending on the CPU Unit model.

5-14 AR AREA WRITE – WJ

Writes data to the AR area, starting from the specified word. Writing is done word by word.

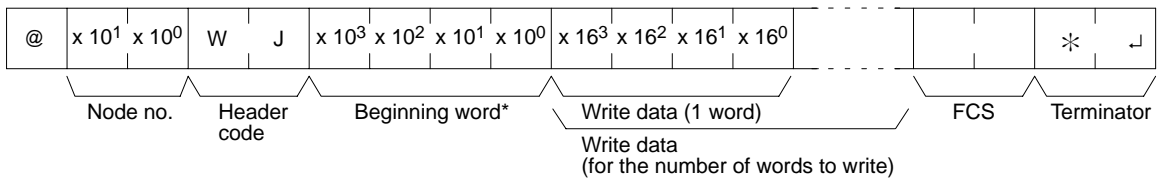

Note Beginning word: 0000 to 0023 in CPM2A/CPM2C PCs, 0000 to 0015 in CPM1/CPM1A and SRM1(-V2) PCs

Response Format

An end code of 00 indicates normal completion.

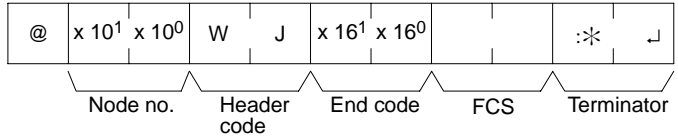

Parameters

Write Data (Command)

Specify in order the contents of the number of words to be written to the AR in hexadecimal, starting with the specified beginning word.

Note If data is specified for writing which exceeds the allowable range, an error will be generated and the writing operation will not be executed. If, for example, 16 words are specified as the beginning word for writing in a CPM1 PC, and five words of data are specified, then 16 will become the last word for writing data, and the command will not be executed because AR 16 is beyond the writable range.

5-15 SV READ 1 – R#

Searches for the first instance of a timer or counter instruction (TIM, TIMH, TIML(—), TMHH(—), CNT, or CNTR(12)) with the specified TC number in the user's program and reads the PV, which is assumed to be set as a constant. The SV that is read is a 4-digit decimal number (BCD). The program is searched from the beginning, which may take as much as 10 seconds to produce a response.

Command Format

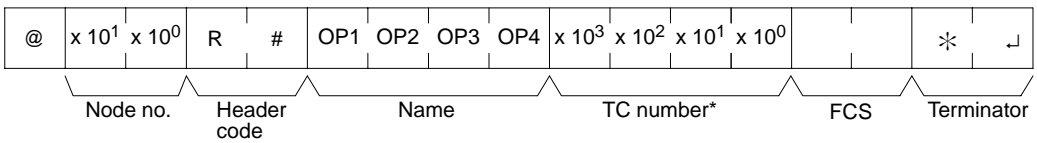

Note TC number: 0000 to 0255 in CPM2A/CPM2C PCs and 0000 to 0127 in CPM1/CPM1A/SRM1(-V2) PCs

Response Format

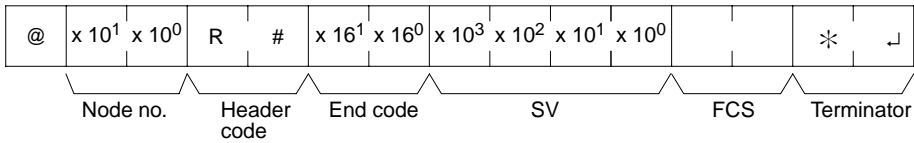

Specify the instruction for reading the SV in "Name." Make this setting in 4 characters. In "TC number," specify the timer/counter number used for the instruction.

Name				Instruction name
OP1	OP2	OP3	OP4	
T	I	M	(Space)	TIMER
T	I	M	H	HIGH-SPEED TIMER
T	I	M	L	LONG TIMER
T	M	H	H	VERY HIGH-SPEED TIMER
C	N	T	(Space)	COUNTER
C	N	T	R	REVERSIBLE COUNTER

SV (Response)

The constant SV is returned.

- Note**
1. The instruction specified under "Name" must be in four characters.
 2. If the same instruction is used more than once in a program, only the first will be read.
 3. Use this command only when it is definite that a constant SV has been entered.
 4. The response end code will indicate an error (16) if the SV wasn't entered as a constant.

5-16 SV READ 2 – R\$

Reads the constant SV or the word address where the SV is stored. The SV is read is a 4-digit decimal number (BCD) written as the second operand for TIM, TIMH(15), TIML(—), TMHH(—), CNT, or CNTR(12) instruction at the specified program address in the user's program. This can only be done with a program of less than 10K.

Command Format

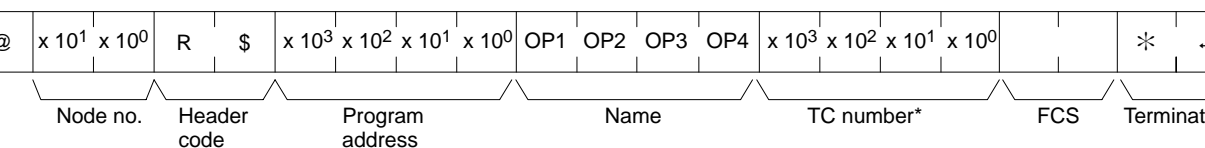

- Note** TC number: 0000 to 0255 in CPM2A/CPM2C PCs and 0000 to 0127 in CPM1/CPM1A/SRM1(-V2) PCs

Response Format

An end code of 00 indicates normal completion.

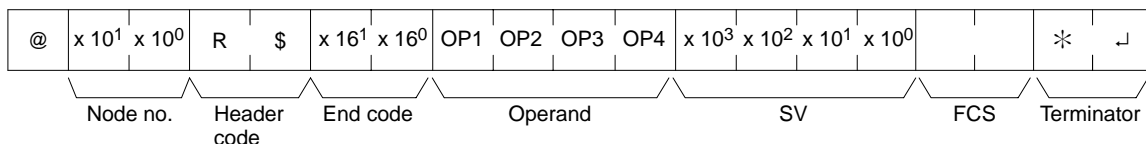

Specify the name of the instruction for reading the SV in 4 characters. In "TC number," specify the timer/counter number used in 4 characters. In "TC number," specify the timer/counter number used in the instruction.

Name				Instruction name
OP1	OP2	OP3	OP4	
T	I	M	(Space)	TIMER
T	I	M	H	HIGH-SPEED TIMER
T	I	M	L	LONG TIMER
T	M	H	H	VERY HIGH-SPEED TIMER
C	N	T	(Space)	COUNTER
C	N	T	R	REVERSIBLE COUNTER

Operand, SV (Response)

The name that indicates the SV classification is returned to "Operand," and either the word address where the SV is stored or the constant SV is returned to "SV."

Operand				Classification	Constant or word address	
OP1	OP2	OP3	OP4		CPM2A/ CPM2C PCs	CPM1 PC
C	I	O	(Space)	IR or SR	0000 to 0049 0200 to 0255	0000 to 0015 0200 to 0255
L	R	(Space)	(Space)	LR	0000 to 0015	0000 to 0015
H	R	(Space)	(Space)	HR	0000 to 0019	0000 to 0019
A	R	(Space)	(Space)	AR	0000 to 0023	0000 to 0023
D	M	(Space)	(Space)	DM	0000 to 6655	0000 to 6655
D	M	*	(Space)	DM (indirect)	0000 to 6655	0000 to 6655
C	O	N	(Space)	Constant	0000 to 9999	0000 to 9999

Note The instruction name specified under "Name" must be in four characters. Fill gaps with spaces to make a total of four characters.

5-17 SV CHANGE 1 – W#

Searches for the first instance of the specified TIM, TIMH(15), TIML(15), TMHH(—), CNT, or CNTR(12) instruction in the user's program and changes the SV to new constant SV specified in the second word of the instruction. The program is searched from the beginning, and it may therefore take approximately 10 seconds to produce a response.

Command Format

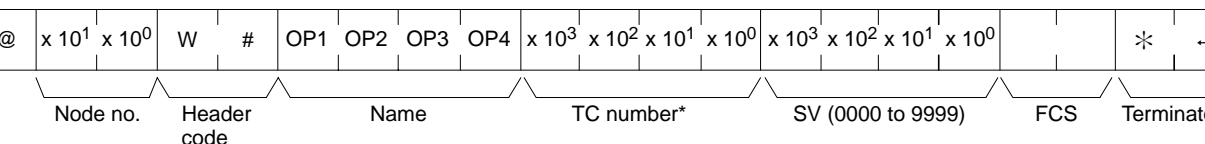

Note TC number: 0000 to 0255 in CPM2A/CPM2C PCs and 0000 to 0127 in CPM1/CPM1A/SRM1(-V2) PCs

Response Format

An end code of 00 indicates normal completion.

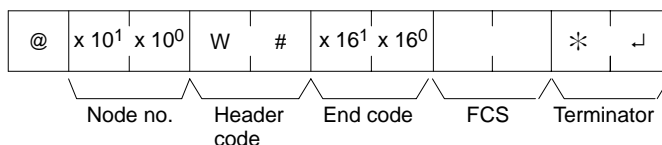

In "Name," specify the name of the instruction, in four characters, for changing the SV. In "TC number," specify the timer/counter number used for the instruction.

Instruction name				Classification
OP1	OP2	OP3	OP4	
T	I	M	(Space)	TIMER
T	I	M	H	HIGH-SPEED TIMER
T	I	M	L	LONG TIMER
T	M	H	H	VERY HIGH-SPEED TIMER
C	N	T	(Space)	COUNTER
C	N	T	R	REVERSIBLE COUNTER

5-18 SV CHANGE 2 – W\$

Changes the contents of the second word of the TIM, TIMH(15), TIML(15), TMHH(—), CNT, or CNTR(12) at the specified program address in the user program. This can only be done with a program of less than 10K.

Command Format

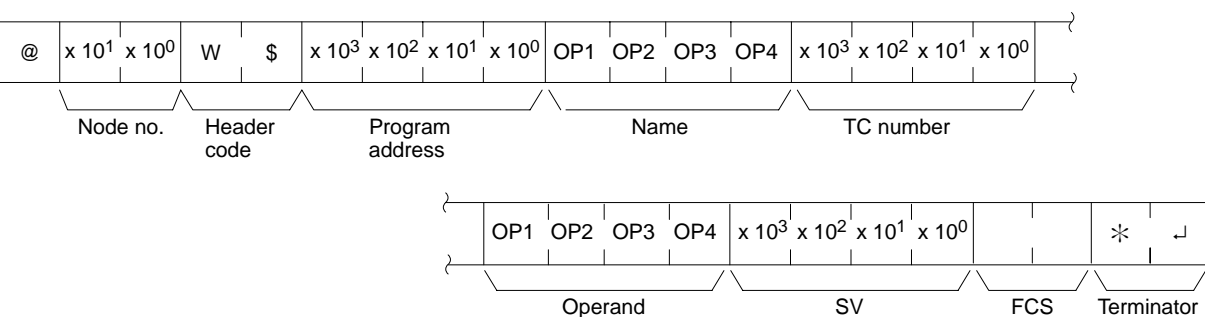

Note TC number: 0000 to 0255 in CPM2A/CPM2C PCs and 0000 to 0127 in CPM1/CPM1A/SRM1(-V2) PCs

Response Format

An end code of 00 indicates normal completion.

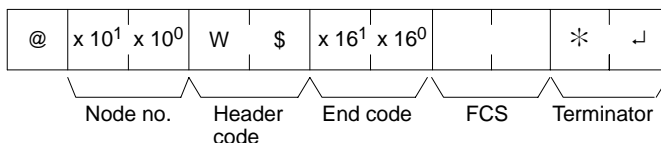

Parameters

Name, TC Number (Command)

In "Name," specify the name of the instruction, in four characters, for changing the SV. In "TC number," specify the timer/counter number used for the instruction.

Instruction name				Classification
OP1	OP2	OP3	OP4	
T	I	M	(Space)	TIMER
T	I	M	H	HIGH-SPEED TIMER
T	I	M	L	LONG TIMER
T	M	H	H	VERY HIGH-SPEED TIMER
C	N	T	(Space)	COUNTER
C	N	T	R	REVERSIBLE COUNTER

In "Operand," specify the name that indicates the SV classification. Specify the name in four characters. In "SV," specify either the word address where the SV is stored or the constant SV.

Operand				Classification	Constant or word address	
OP1	OP2	OP3	OP4		CPM2A/ CPM2C PCs	CPM1/CPM SRM1(-V2) PCs
C	I	O	(Space)	IR or SR	0000 to 0049 0200 to 0252	0000 to 0019 0200 to 0252
L	R	(Space)	(Space)	LR	0000 to 0015	0000 to 0015
H	R	(Space)	(Space)	HR	0000 to 0019	0000 to 0019
A	R	(Space)	(Space)	AR	0000 to 0023	0000 to 0015
D	M	(Space)	(Space)	DM	0000 to 2047 6144 to 6655	0000 to 1023 6144 to 6655
D	M	*	(Space)	DM (indirect)	0000 to 2047 6144 to 6655	0000 to 1023 6144 to 6655
C	O	N	(Space)	Constant	0000 to 9999	0000 to 9999

Note *For SRM1(-V2) PCs, the DM range is from 0000 to 2047.

5-19 STATUS READ – MS

Reads the PC operating conditions.

Command Format

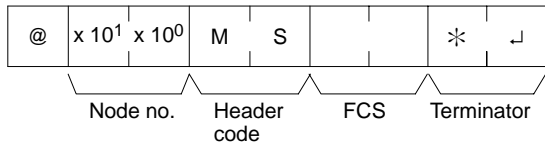

Response Format

An end code of 00 indicates normal completion.

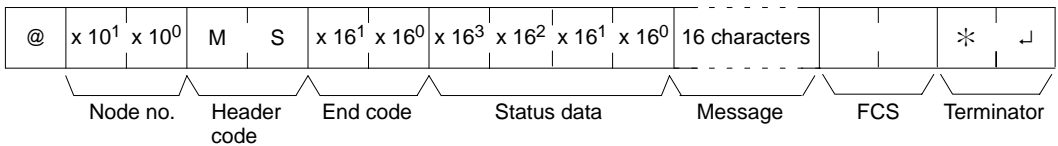

Status data consists of four digits (two bytes) hexadecimal. The leftmost indicates CPU Unit operation mode, and the rightmost byte indicates the size of the program area.

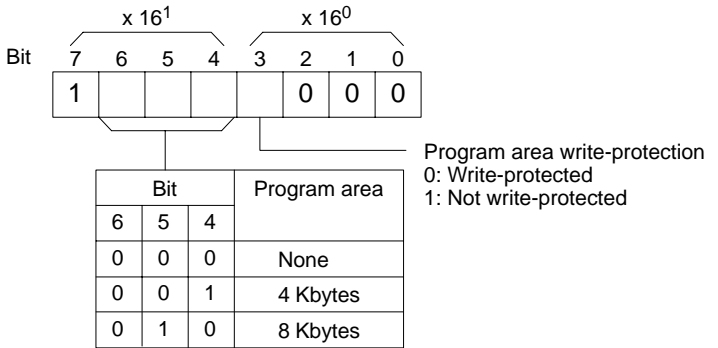
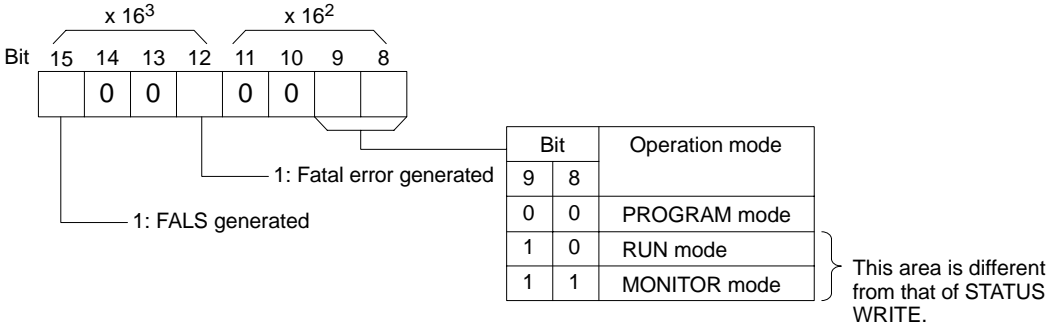

The "Message" parameter is a 16-character message that exists when MSG has been executed. When there is no message, this parameter is omitted.

5-20 STATUS WRITE – SC

Changes the PC operating mode.

Command Format

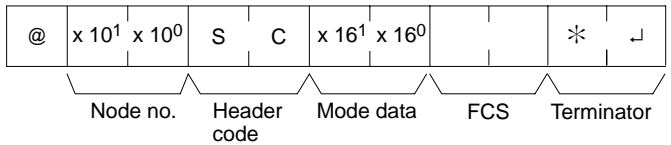

Response Format

An end code of 00 indicates normal completion.

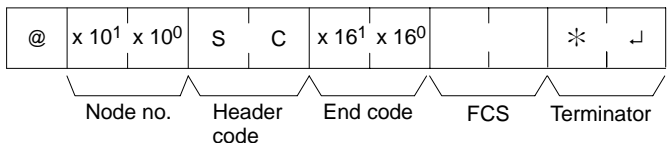

mode data consists of two digits (one byte) hexadecimal. With the remaining bits, specify the PC operating mode. Set all of the remaining bits to "0."

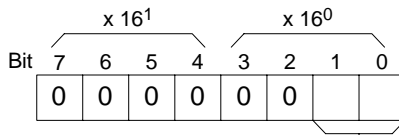

Bit	Operation mode
1 0	
0 0	PROGRAM mode
1 0	MONITOR mode
1 1	RUN mode

This area is different from that of STATUS READ.

5-21 ERROR READ – MF

Reads and clears errors in the PC. Also checks whether previous errors have been cleared.

Command Format

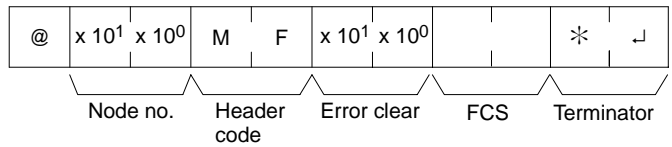

Response Format

An end code of 00 indicates normal completion.

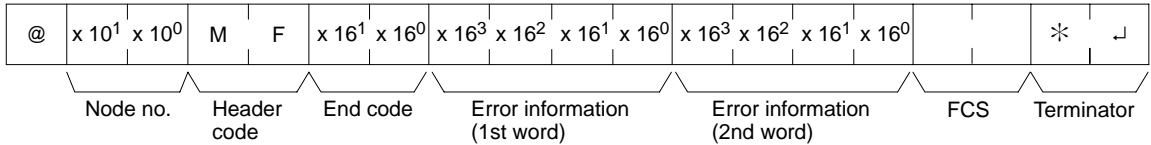

Parameters

Error Clear (Command)

Specify 01 to clear errors and 00 to not clear errors (BCD). Fatal errors can be cleared only when the PC is in PROGRAM mode.

Error Information (Response)

The error information comes in two words.

1st word

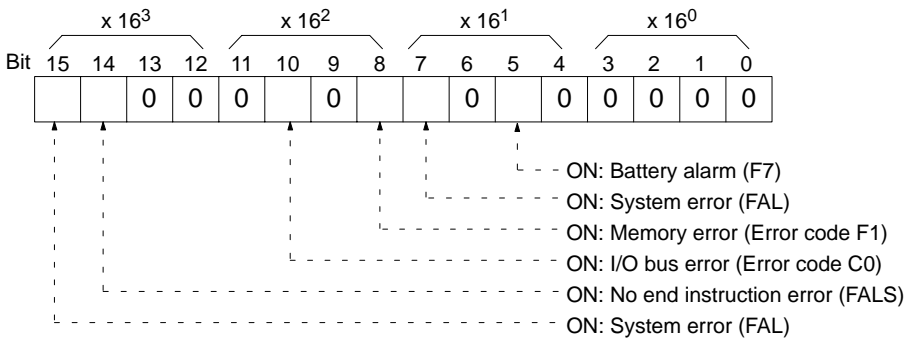

2nd word

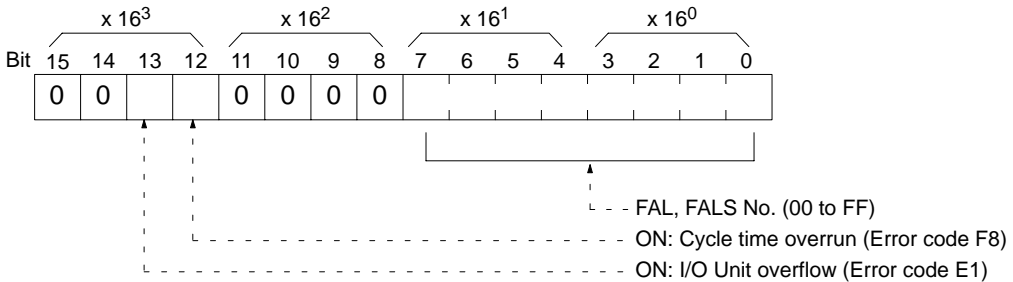

M1(-V2) PCs

1st word

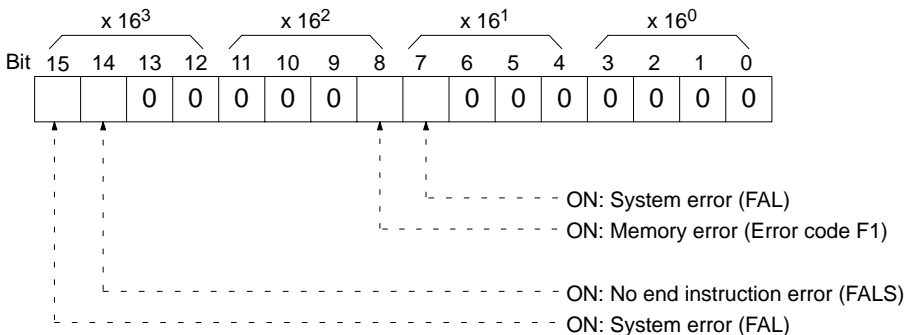

2nd word

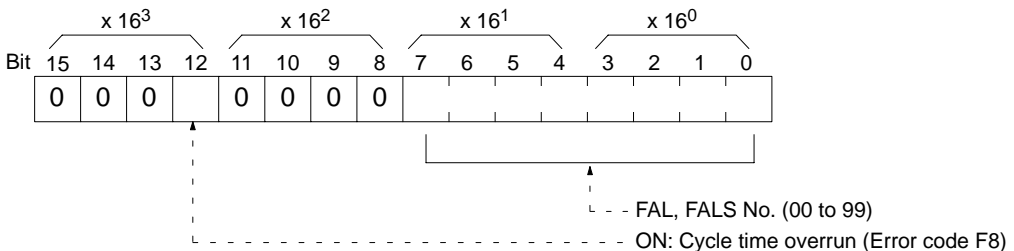

5-22 FORCED SET – KS

Force sets a bit in the IR, SR, LR, HR, AR, or TC area. Just one bit can be forced set at a time.

Once a bit has been forced set or reset, that status will be retained until a FORCED SET/RESET CANCEL (KC) command or the next FORCED SET/RESET SET command is transmitted.

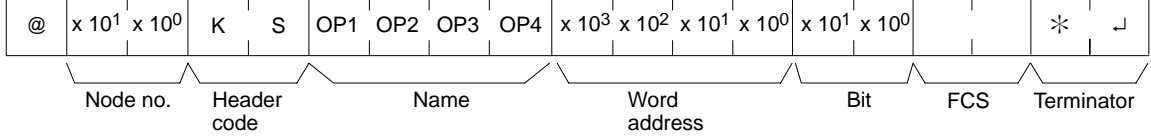

Response Format

An end code of 00 indicates normal completion.

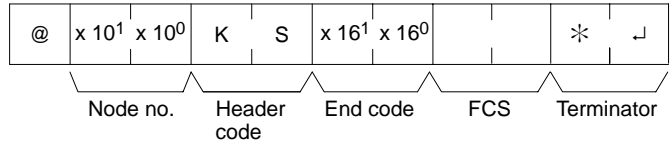

Parameters

Name, Word address, Bit (Command)

In "Name," specify the area (i.e., IR, SR, LR, HR, AR, or TC) that is to be forced set. Specify the name in four characters. In "Word address," specify the address of the word, and in "Bit" the number of the bit that is to be forced set.

Name				Classification	Word address setting range		Bit
OP1	OP2	OP3	OP4		CPM2A/ CPM2C PCs	CPM1/ CPM1A/ SRM1(-V2) PCs	
	I	O	(Space)	IR or SR	0000 to 0049 0200 to 0252	0000 to 0019 0200 to 0252	00 to 01 (decimal)
	R	(Space)	(Space)	LR	0000 to 0015	0000 to 0015	
	R	(Space)	(Space)	HR	0000 to 0019	0000 to 0019	
	R	(Space)	(Space)	AR	0000 to 0023	0000 to 0015	
	I	M	(Space)	Completion Flag (timer)	0000 to 0255	0000 to 0127	Always 00
	I	M	H	Completion Flag (high-speed timer)			
	I	M	L	Completion Flag (long timer)			
	M	H	H	Completion Flag (very high-speed timer)			
	N	T	(Space)	Completion Flag (counter)			
	N	T	R	Completion Flag (reversible counter)			

Note The area specified under "Name" must be in four characters. Add spaces to the data area name if it is shorter than four characters.

5-23 FORCED RESET – KR

Force resets a bit in the IR, SR, LR, HR, AR, or TC area. Just one bit can be forced reset at a time.

Once a bit has been forced set or reset, that status will be retained until a FORCED SET/RESET CANCEL (KC) command or the next FORCED SET/RESET command is transmitted.

Command Format

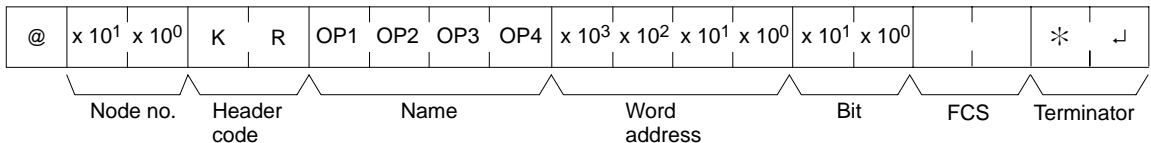

Response Format

An end code of 00 indicates normal completion.

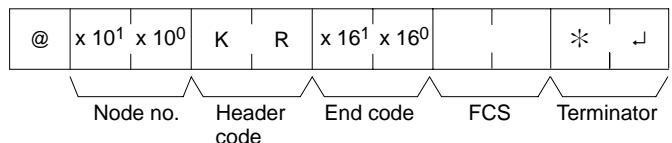

In "Name," specify the area (i.e., IR, SR, LR, HR, AR, or TC) that is to be forced set, reset, or canceled. Specify the name in four characters. In "Word address," specify the address of the word, and in "Bit" the number of the bit that is to be forced res

Name				Classification	Word address setting range		Bit
OP1	OP2	OP3	OP4		CPM2A/ CPM2C PCs	CPM1/CPM1A /SRM1(-V2) PCs	
I	O	(Space)	(Space)	IR or SR	0000 to 0049 0200 to 0252	0000 to 0019 0200 to 0252	00 to 19 (decimal)
R	(Space)	(Space)	(Space)	LR	0000 to 0015	0000 to 0015	
R	(Space)	(Space)	(Space)	HR	0000 to 0019	0000 to 0019	
R	(Space)	(Space)	(Space)	AR	0000 to 0023	0000 to 0015	
I	M	(Space)	(Space)	Completion Flag (timer)	0000 to 0255	0000 to 0127	Always
I	M	H	(Space)	Completion Flag (high-speed timer)			
I	M	L	(Space)	Completion Flag (long timer)			
M	H	H	(Space)	Completion Flag (very high-speed timer)			
N	T	(Space)	(Space)	Completion Flag (counter)			
N	T	R	(Space)	Completion Flag (reversible counter)			

Note The area specified under "Name" must be in four characters. Add spaces to the data area name if it is shorter than four characters.

5-24 MULTIPLE FORCED SET/RESET – FK

Force sets, force resets, or cancels the status of the bits in one word in the SR, LR, HR, AR, or TC area.

Command Format

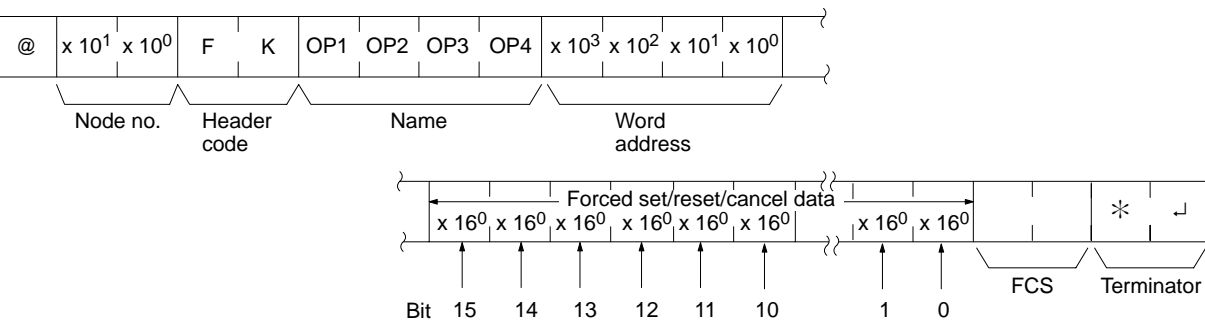

Response Format

An end code of 00 indicates normal completion.

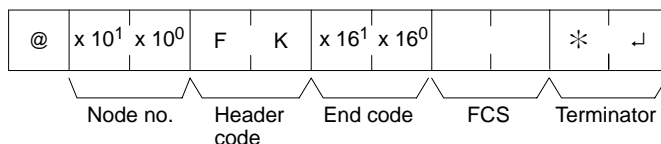

in Name, specify the area (i.e., IR, SR, ER, FR, AR, or CR) that is to be forced set or reset. Specify the name in four characters. In "Word address," specify address of the word that is to be forced set or reset.

Name				Classification	Word address setting range	
OP1	OP2	OP3	OP4		CPM2A/CPM2C PCs	CPM1/CPM1A SRM1(-V2) PC
	I	O	(Space)	IR or SR	0000 to 0049 0200 to 0252	0000 to 0019 0200 to 0252
	R	(Space)	(Space)	LR	0000 to 0015	0000 to 0015
	R	(Space)	(Space)	HR	0000 to 0019	0000 to 0019
	R	(Space)	(Space)	AR	0000 to 0023	0000 to 0015
	I	M	(Space)	Completion Flag (timer)	0000 to 0255	0000 to 0127
	I	M	H	Completion Flag (high-speed timer)	0000 to 0255	0000 to 0127
	I	M	L	Completion Flag (long timer)	0000 to 0255	0000 to 0127
	M	H	H	Completion Flag (very high-speed timer)	0000 to 0255	0000 to 0127
	N	T	(Space)	Completion Flag (counter)		
	N	T	R	Completion Flag (reversible counter)		

Forced set/Reset/Cancel data (Command)

If a timer or counter completion flag is specified, only bit 15 is effective and all other bits will be ignored. Only force-setting and force-resetting are possible for timers/counters.

If a word address is specified, the content of the word specifies the desired process for each bit in the specified word, as shown in the following table.

Hexadecimal setting	Process
0000	No action (bit status not changed)
0002	Reset
0003	Set
0004	Forced-reset
0005	Forced-set
0008	Forced set/reset status cancel

The bits that are merely set or reset may change status the next time the program is executed, but bits that are force-set or force-reset will maintain their forced status until it is cleared.

Response Format

An end code of 00 indicates normal completion.

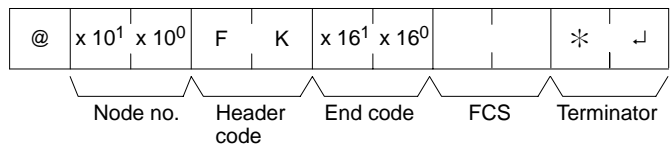

5-25 FORCED SET/RESET CANCEL – KC

Cancels all forced set and forced reset bits (including those set by FORCED SET, FORCED RESET, and MULTIPLE FORCED SET/RESET). If multiple bits are set, the forced status will be cancelled for all of them. It is not possible to cancel bits one by one using KC.

Command Format

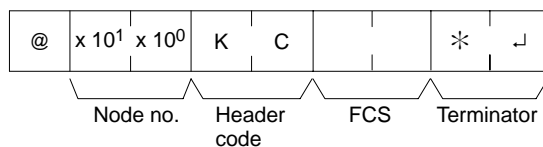

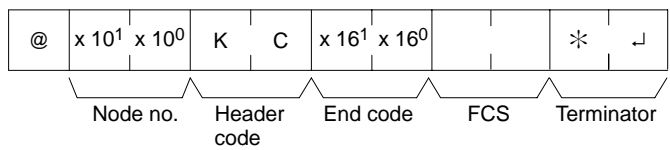

5-26 PC MODEL READ – MM

Reads the model type of the PC.

Command Format

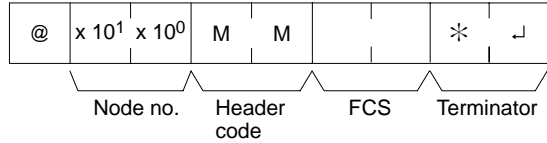

Response Format

An end code of 00 indicates normal completion.

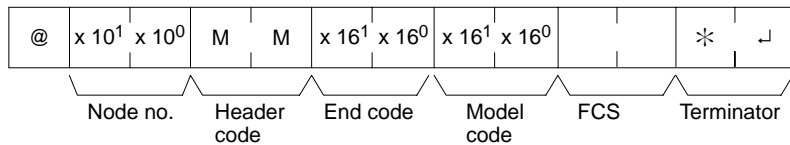

Parameters

Model Code

“Model code” indicates the PC model in two digits hexadecimal.

Model code	Model
01	C250
02	C500
03	C120
0E	C2000
10	C1000H
11	C2000H/CQM1/CPM2A/CPM2C/CPM1/CPM1A/SRM1(-V2)
12	C20H/C28H/C40H/C200H/C200HS
20	CV500
21	CV1000
22	CV2000
40	CVM1-CPU01-E
41	CVM1-CPU11-E
42	CVM1-CPU21-E

5-27 TEST – TS

Returns, unaltered, one block of data transmitted from the host computer.

Command Format

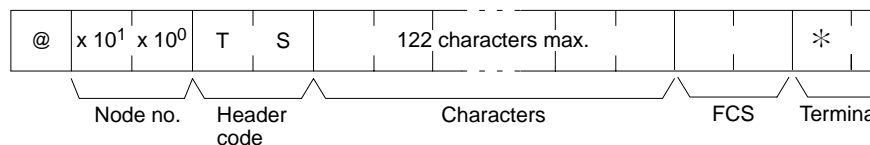

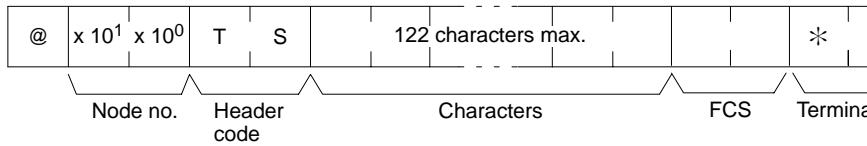

Parameters

Characters (Command, Response)

For the command, this setting specifies any characters other than the carriage return (CHR\$(13)). For the response, the same characters as specified by the command will be returned unaltered if the test is successful.

5-28 PROGRAM READ – RP

Reads the contents of the PC user's program area in machine language (object code). The contents are read as a block, from the beginning to the end.

Command Format

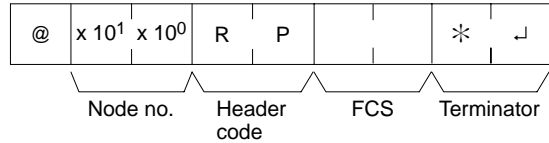

Response Format

An end code of 00 indicates normal completion.

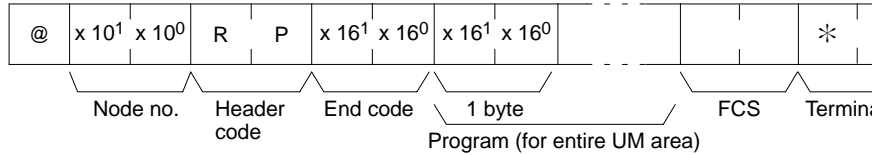

Parameters

Program (Response)

The program is read from the entire program area.

Note To stop this operation in progress, execute the ABORT (XZ) command.

5-29 PROGRAM WRITE – WP

Writes to the PC user's program area the machine language (object code) program transmitted from the host computer. The contents are written as a block from the beginning.

Command Format

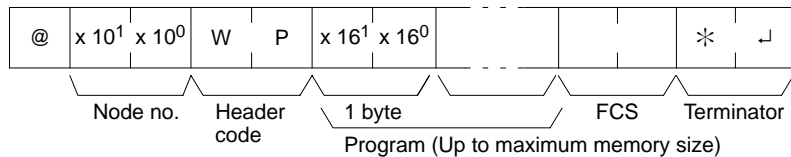

Response Format

An end code of 00 indicates normal completion.

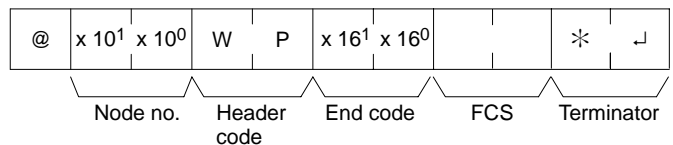

Parameters

Program (Command)

Program data up to the maximum memory size.

Registers at the PC all of the bits, words, and timers/counters that are to be read and reads the status of all of them as a batch.

Registering Read Information

Register the information on all of the bits, words, and timers/counters that are to be read.

Command Format

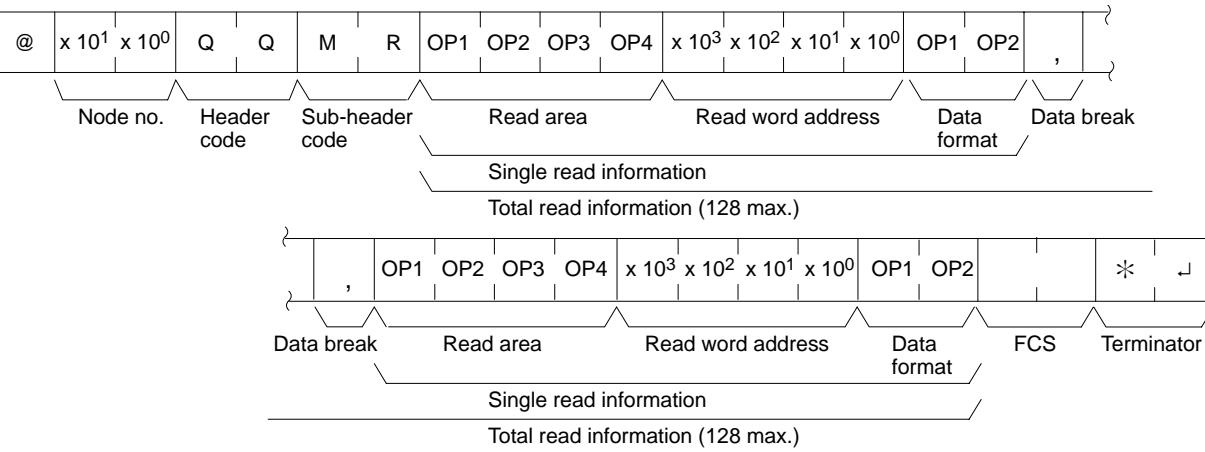

Response Format

An end code of 00 indicates normal completion.

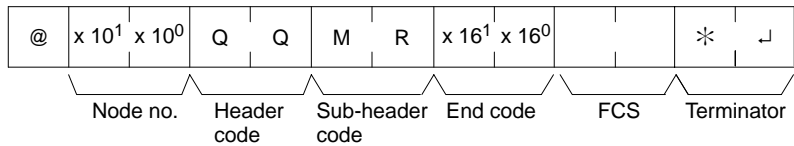

Parameters

Read Area (Command)

Specify in four-character code the area that is to be read. The codes that are specified are listed in the following table.

Depending on the area and type of data that are to be read, the information read is as shown in the following table. The “read data” is specified in four BCD, and the data format is specified in two digits BCD.

Area classification	Read data	Read area	Read word		Data format
			CPM2A/ CPM2C PCs	CPM1/ CPM1A/ SRM1(-V2) PCs	
or SR	Bit	C I O (S)	0000 to 0049	0000 to 0019	00 to 15 (decimal)
	Word		0200 to 0255	0200 to 0255	“CH”
	Bit	L R (S) (S)	0000 to 0015	0000 to 0015	00 to 15 (decimal)
	Word				“CH”
	Bit	H R (S) (S)	0000 to 0019	0000 to 0019	00 to 15 (decimal)
	Word				“CH”
	Bit	A R (S) (S)	0000 to 0023	0000 to 0015	00 to 15 (decimal)
	Bit				“CH”
er	Completion Flag	T I M (S)	0000 to 0255	0000 to 0127	2 characters other than “C
	PV				“CH”
h-speed timer	Completion Flag	T I M H	0000 to 0255	0000 to 0127	2 characters other than “C
	PV				“CH”
ng timer	Completion Flag	T I M L	0000 to 0255	Not used.	2 characters other than “C
	PV				“CH”
y high-speed timer	Completion Flag	T M H H	0000 to 0255	Not used.	2 characters other than “C
	PV				“CH”
unter	Completion Flag	C N T (S)	0000 to 0255	0000 to 0127	2 characters other than “C
	PV				“CH”
versible counter	Completion Flag	C N T R	0000 to 0255	0000 to 0127	2 characters other than “C
	PV				“CH”
	Word	D M (S) (S)	0000 to 2047 6144 to 6655	0000 to 1023* 6144 to 6655	Any 2 characters

Note *For SRM1(-V2) PCs, the DM range is from 0000 to 2047.

(S): Space

Data Break (Command)

The read information is specified one item at a time separated by a break code (.,). The maximum number of items that can be specified is 128. (When the P a timer/counter is specified, however, the status of the Completion Flag is returned, and must therefore be counted as two items.)

Batch Reading

The bit, word, and timer/counter status is read as a batch according to the information that was registered with QQ.

Command Format

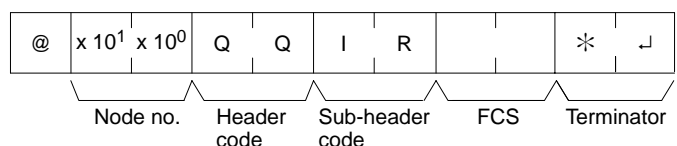

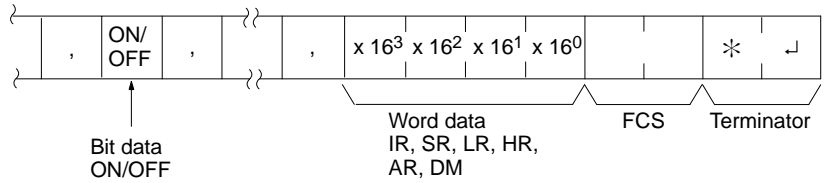
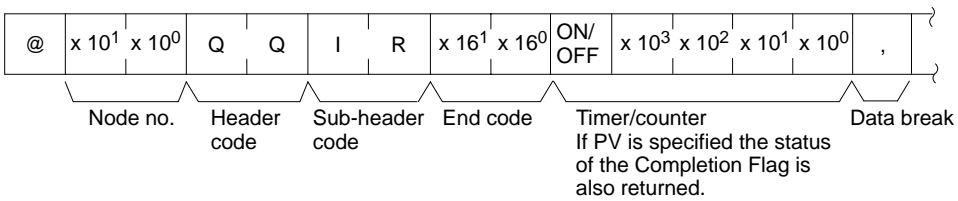

Parameters

Read Data (Response)

Read data is returned according to the data format and the order in which information was registered using QQ. If "Completion Flag" has been specified then bit data (ON or OFF) is returned. If "Word" has been specified, then word data is returned. If "PV" has been specified for timers/counters, however, the PV is returned following the Completion Flag.

Data Break (Response)

The break code (,) is returned between sections that are read.

5-31 ABORT – XZ

Aborts the Host Link operation that is currently being processed, and then enables reception of the next command. The ABORT command does not receive a response.

Command Format

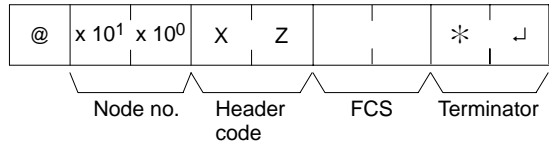

5-32 INITIALIZE – **

Initializes the transmission control procedure of all the PCs connected to the host computer. The INITIALIZE command does not use node numbers or FCS and does not receive a response.

Command Format

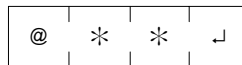

5-33 TXD RESPONSE – EX

This command is supported by CPM2A/CPM2C PCs only.

This is the response format used when the PC's TXD(48) instruction is executed in Host Link communications mode. There is no command associated with TXD(48) converts the specified data into ASCII and transmits it to the host computer with this format. The response can contain up to 122 characters of ASCII data. (TXD(48) does not support multiple frames.)

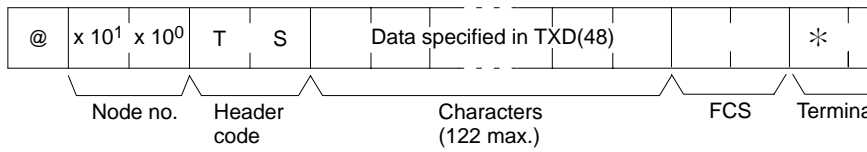

Parameters

Characters (Response)

This is the data specified in TXD(48) that has been converted to ASCII.

5-34 Undefined Command – IC

This response is returned if the header code of a command cannot be decoded.
Check the header code.

Response Format

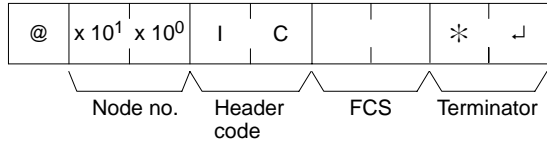

s section describes the structure of the PC memory areas and explains how to use them.

5-1	Memory Area Functions	304
5-1-1	Memory Area Structure	304
5-1-2	Functions	307
5-1-3	CPM1/CPM1A/SRM1(-V2) Flash Memory	309
5-2	I/O Allocation for CPM1/CPM1A/CPM2A PCs	309
5-2-1	CPU Units	309
5-2-2	Expansion I/O Units	313
5-2-3	Expansion Units	314
5-2-4	Examples of Expansion Unit and Expansion I/O Unit Allocation	315
5-3	I/O Allocation for CPM2C PCs	319
5-3-1	CPU Units	319
5-3-2	Expansion I/O Units	321
5-3-3	Expansion Units	324
5-3-4	Examples of Expansion Unit and Expansion I/O Unit Allocation	325

2-1 Memory Area Structure

CPM1/CPM1A

The following memory areas can be used with the CPM1/CPM1A.

Data area		Words	Bits	Function
area ¹	Input area	IR 000 to IR 009 (10 words)	IR 00000 to IR 00915 (160 bits)	These bits are allocated to the external I/O terminals.
	Output area	IR 010 to IR 019 (10 words)	IR 01000 to IR 01915 (160 bits)	
	Work area	IR 200 to IR 231 (32 words)	IR 20000 to IR 23115 (512 bits)	Work bits can be freely used within the program.
area		SR 232 to SR 255 (24 words)	SR 23200 to SR 25515 (384 bits)	These bits serve specific functions such as flags and control bits.
area		---	TR 0 to TR 7 (8 bits)	These bits are used to temporarily store ON/OFF status at program branches.
area ²		HR 00 to HR 19 (20 words)	HR 0000 to HR 1915 (320 bits)	These bits store data and retain their ON/OFF status when power is turned off, or operation starts or stops. They are used in the same way as work bits.
area ²		AR 00 to AR 15 (16 words)	AR 0000 to AR 1515 (256 bits)	These bits serve specific functions such as flags and control bits.
area ¹		LR 00 to LR 15 (16 words)	LR 0000 to LR 1515 (256 bits)	Used for a 1:1 PC Link with another PC.
Timer/Counter area ²		TC 000 to TC 127 (timer/counter numbers) ³		Timers and counters use the TIM, TIMH(15), CNT and CNTR(12) instructions. The same numbers are used for both timers and counters.
DM area	Read/write ²	DM 0000 to DM 0999 DM 1022 to DM 1023 (1,002 words)	---	DM area data can be accessed in word units only. Word values are retained when the power is turned off, or operation started or stopped. Read/write areas can be read and written freely within the program.
	Error log	DM 1000 to DM 1021 (22 words)	---	Used to store the time of occurrence and error code of errors that occur. These words can be used as ordinary read/write DM when the error log function is not being used.
	Read-only ⁴	DM 6144 to DM 6599 (456 words)	---	Cannot be overwritten from program.
	PC Setup ⁴	DM 6600 to DM 6655 (56 words)	---	Used to store various parameters that control PC operation.

- Note**
1. IR and LR bits that are not used for their allocated functions can be used as work bits.
 2. The contents of the HR area, AR area, Counter area, and read/write area are backed up by a capacitor. The backup time varies with the ambient temperature, but at 25°C, the capacitor will back up memory for 20 days if the power supply is off longer than the backup time, memory contents will be cleared and AR1314 will turn ON. (This flag turns ON when data can no longer be retained by the built-in capacitor.) Refer to 2-1-2 *Characteristics of the CPM1 and CPM1A Operation Manual* for a graph showing the backup time vs. temperature.
 3. When accessing a PV, TC numbers are used as word data; when accessing Completion Flags, they are used as bit data.
 4. Data in DM 6144 to DM 6655 cannot be overwritten from the program; however, they can be changed from a Programming Device.

Data area		Words	Bits	Function
area ¹	Input area	IR 000 to IR 009 (10 words)	IR 00000 to IR 00915 (160 bits)	These bits are allocated to the external I/O terminals.
	Output area	IR 010 to IR 019 (10 words)	IR 01000 to IR 01915 (160 bits)	
	Work area	IR 020 to IR 049, IR 200 to IR 227 (58 words)	IR 02000 to IR 04915, IR 20000 to IR 22715 (928 bits)	Work bits can be freely used within the program.
area		SR 228 to SR 255 (28 words)	SR 22800 to SR 25515 (448 bits)	These bits serve specific functions such as flags and control bits.
area		---	TR 0 to TR 7 (8 bits)	These bits are used to temporarily store ON/OFF status at program branches.
area ²		HR 00 to HR 19 (20 words)	HR 0000 to HR 1915 (320 bits)	These bits store data and retain their ON/OFF status when power is turned OFF, or operation starts or stops. They are used in the same way as work bits.
area ²		AR 00 to AR 23 (24 words)	AR 0000 to AR 2315 (384 bits)	These bits serve specific functions such as flags and control bits.
area ¹		LR 00 to LR 15 (16 words)	LR 0000 to LR 1515 (256 bits)	Used for a 1:1 PC Link with another PC.
Timer/Counter area ²		TC 000 to TC 255 (timer/counter numbers) ³		Timers and counters use the TIM, TIMH(15), CNT, CNTR(12), TMHH(—), and TIML(—) instructions. The same numbers are used for both timers and counters.
DM area	Read/write ²	DM 0000 to DM 1999 DM 2022 to DM 2047 (2,026 words)	---	DM area data can be accessed in word units only. Word values are retained when the power is turned off, or operation started or stopped. Read/write areas can be read and written freely within the program.
	Error log	DM 2000 to DM 2021 (22 words)	---	Used to store the time of occurrence and error code of errors that occur. These words can be used as ordinary read/write DM when the error log function isn't being used.
	Read-only ^{4,5}	DM 6144 to DM 6599 (456 words)	---	Cannot be overwritten from program.
	PC Setup ^{4,5}	DM 6600 to DM 6655 (56 words)	---	Used to store various parameters that control PC operation.

- Note**
1. IR and LR bits that are not used for their allocated functions can be used as work bits.
 2. The contents of the HR area, AR area, Counter area, and read/write area are backed up by the CPU Unit's battery. If the battery is removed or fails, the contents of these areas will be lost and returned to default values. (In CPM2C CPU Units without a battery, these areas are backed up by a capacitor.)
 3. When a TC number is used as a word operand, the timer or counter is accessed; when used as a bit operand, its Completion Flag is accessed.
 4. Data in DM 6144 to DM 6655 cannot be overwritten from the program; they can be changed from a Programming Device.
 5. The program and data in DM 6144 to DM 6655 are stored in flash memory.

Data area		Words	Bits	Function
area ¹	Input area	IR 000 to IR 007 (8 words)	IR 00000 to IR 00715 (128 bits)	These bits are allocated to the external I/O terminals. The ON/OFF status of the I/O bits will be the same as the ON/OFF status of the I/O terminals
	Output area	IR 010 to IR 017 (8 words)	IR 01000 to IR 01715 (128 bits)	(When the CompoBus/S is used in 128-bit mode, IR 004 to IR 007 and IR 014 to IR 017 can also be used as work bits.)
	Work area	IR 008 to IR 009 IR 018 to IR 019 IR 200 to IR 239 (44 words)	IR 00800 to IR 00915 IR 01800 to IR 01915 IR 20000 to IR 23915 (704 bits)	Work bits can be freely used within the program. IR 232 to IR 239 however, are used as the MACRO input area when MCRO(99) is being used.
area		SR 240 to SR 255 (16 words)	SR 24000 to SR 25507 (248 bits)	These bits serve specific functions such as flags and control bits.
area		---	TR 0 to TR 7 (8 bits)	These bits are used to temporarily store ON/OFF status at program branches.
area ²		HR 00 to HR 19 (20 words)	HR 0000 to HR 1915 (320 bits)	These bits store data and retain their ON/OFF status when power is turned off, or operation starts or stops. They are used in the same way as work bits.
area ²		AR 00 to AR 15 (16 words)	AR 0000 to AR 1515 (256 bits)	These bits serve specific functions such as flags and control bits. AR 04 to 07 are used as slaves. Refer to <i>AR Area</i> .
area ¹		LR 00 to LR 15 (16 words)	LR 0000 to LR 1515 (256 bits)	Used for a 1:1 PC Link with another PC.
Timer/Counter area ²		TC 000 to TC 127 (timer/counter numbers) ³		Timers and counters use the TIM, TIMH(15), CNT and CNTR(12) instructions. The same numbers are used for both timers and counters.
DM area	Read/write ²	DM 0000 to DM 1999 (2,000 words)	---	DM area data can be accessed in word units only. Word values are retained when the power is turned off, or operation started or stopped. Read/write areas can be read and written freely within the program.
	Error log	DM 2000 to DM 2021 (22 words)	---	Used to store the time of occurrence and error code of errors that occur. These words can be used as ordinary read/write DM when the error log function is not being used.
	Read-only ⁴	DM 6144 to DM 6599 (456 words)	---	Cannot be overwritten from program.
	PC Setup ⁴	DM 6600 to DM 6655 (56 words)	---	Used to store various parameters that control PC operation.

- Note**
1. IR and LR bits that are not used for their allocated functions can be used as work bits.
 2. The contents of the HR area, AR area, Counter area, and read/write DM area are backed up by a capacitor or a battery. Refer to 2-1-2 *Characteristics* in the *SRM1 Master Control Unit Operation Manual* for a graph showing backup time vs. temperature.
 3. When accessing a PV, TC numbers are used as word data; when accessing Completion Flags, they are used as bit data.
 4. Data in DM 6144 to DM 6655 cannot be overwritten from the program; they can be changed from a Programming Device.

Area

The functions of the IR area are explained below.

With CPM1, CPM1A, CPM2A, and CPM2C PCs, IR area bits from IR 0000 to IR 01915 are allocated to terminals on the CPU Unit and Expansion I/O Unit. With the SRM1(-V2), IR area bits from IR 00000 to IR 00715 and IR 01000 to IR 01715 are allocated to CompoBus/S Slaves. They reflect the ON/OFF status of input and output signals. Input bits begin at IR 00000, and output bits begin at IR 01000.

IR words that are not allocated to inputs or outputs can be used as work words. In addition, unused bits in IR words allocated to outputs can be used as work words.

Work Bits

The work bits can be used freely within the program. They can only be used as work words in the program, however, and not for direct external I/O.

- Note** 1. The input bits shown in the following tables can operate as normal inputs or they can be assigned special functions in the PC Setup.

Special functions for input bits IR 00000 through IR 00002 are set in DM 6642:

Bit address	PC Setup setting (DM 6642 bits 08 to 15)		
	00	01	02, 03, or 04
IR 00000	Used as normal inputs.	Used as high-speed counter inputs.	Used as inputs for synchronized pulse control.
IR 00001			
IR 00002			Used as a normal input.

Special functions for input bits IR 00003 through IR 00006 are set in DM 6628:

Bit address	Bits in DM 6628	PC Setup setting (in DM 6628)		
		0	1	2
IR 00003	00 to 03	Used as normal inputs.	Used as interrupt inputs (including counter mode).	Used as quick-response inputs.
IR 00004	04 to 07			
IR 00005*	08 to 11			
IR 00006*	12 to 15			

Note *Input 00006 does not exist and input 00005 must be used as a normal input in CPM2C CPU Units with 10 I/O points.

2. Output bits IR 01000 and IR 01001 can operate as normal inputs or they can be used for pulse outputs with PULS(65), SYNC(—), or PWM(—). (Use the CPU Unit with transistor outputs for the pulse output functions.)

Instruction	Function
PULS(65)	With SPED(64): Single-phase pulse output without acceleration or deceleration
	With ACC(—): Single-phase pulse output with trapezoidal acceleration and deceleration
SYNC(—)	Synchronized pulse control output
PWM(—)	Variable duty-ratio pulse output

Area

These bits mainly serve as flags to PC operation or contain present and set/reset values for various functions. For details on the various bit functions, refer to relevant sections in this manual or to *Appendix C Memory Areas*.

Some SR area words can be used as work words when they are not used for their assigned purpose.

Area

When a complex ladder diagram cannot be programmed in mnemonic code as it is, these bits are used to temporarily store ON/OFF execution conditions.

directly with ladder diagrams using the SIMATIC Support Software (SSS).
SYSMAC-CPT Support Software, TR bits are automatically processed for
The same TR bits cannot be used more than once within the same instruction
block, but can be used again in different instruction blocks. The ON/OFF status
of TR bits cannot be monitored from a Programming Device.

Examples showing the use of TR bits in programming are provided on page

Area

These bits retain their ON/OFF status even after the PC power supply has been
turned off or when operation begins or stops. They are used in the same way as
work bits.

Area

These bits mainly serve as flags related to PC operation. These bits retain their
status even after the PC power supply has been turned off or when operation
begins or stops. For details on the various bit functions, refer to relevant sections
in this manual or to *Appendix C Memory Areas*.

Area

When the CPM1/CPM1A/CPM2A/CPM2C/SRM1(-V2) is linked 1:1 with another
CPM1/CPM1A/CPM2A/CPM2C/SRM1(-V2), a CQM1, an C200HS, or
C200HX/HG/HE PC, these bits are used to share data. For details, refer to page
225.

LR bits can be used as work bits when not used for 1:1 PC Links.

Timer/Counter Area

This area is used to manage timers and counters created with TIM, TIMH(15),
TMHH(—)*, TIML(—)*, CNT, and CNTR(12). The same numbers are used for
both timers and counters and each number can be used only once in the program.
Do not use the same TC number twice even for different instructions.
Use TC numbers 000 through 003 for TIMH(15) and TC numbers 004 to 007 for
TMHH(—)*. When these timer numbers are used, timing is performed as a
interrupt process and the cycle timer does not affect timer operation.

TC numbers are used to create timers and counters, as well as to access
Completion Flags and present values (PVs). If a TC number is designated for
word data, it will access the present value (PV); if it is used for bit data, it will
access the Completion Flag for the timer/counter.

Refer to instructions beginning on page 384 for details on timers and counters.

Area

DM area data is accessed in word units only. The contents of the DM area are
retained even after the PC power supply has been turned off or when operation
begins or stops.

CPM1/CPM1A

DM words DM 0000 through DM 0999, DM 1022, and DM 1023 can be used
freely in the program; other DM words are allocated specific functions,
described below.

DM 1000 through DM 1021 contain the error log information. Refer to *Section 10
Troubleshooting* for details on the error log.

CPM2A/CPM2C

DM words DM 0000 through DM 1999 and DM 2022 through DM 2047 can be
used freely in the program; other DM words are allocated specific functions,
described below.

DM 2000 through DM 2021 contain the error log information. Refer to *Section 10
Troubleshooting* for details on the error log.

SRM1(-V2)

DM words DM 0000 through DM 1999 can be used freely in the program; other
DM words are allocated specific functions, described below.

DM 2000 through DM 2021 contain the error log information. Refer to *Section 10
Troubleshooting* for details on the error log.

Note DM 6600 through DM 6655 contain the PC Setup. Refer to *1-1 PC Setup* for details.

ting Data

The following settings must be made to use the flash memory area of CPM1/CPM1A/SRM1(-V2) PCs.

In order to write the contents of the UM area, the DM read-only area (DM 6144 to DM 6599), and the PC Setup area (DM 6600 to DM 6655) to the flash memory, either one of the following operations must be performed.

- Switch the PC to either the MONITOR or PROGRAM mode.
- Turn the power to the PC OFF and ON again.

Note SRM1-CO01/02 Capacitor Backup

If changes are made to the above memory areas, they are not written to the flash memory, and the power is switched off for 20 days or more (at 25°C), any changes (in RAM) will be lost. If this occurs, the unchanged contents will be restored from the flash memory when the PC is started again.

Changing Memory Areas

When operating the SRM1 for the first time after changes have been made to the UM area, the DM read only area (DM 6144 to DM 6599), and the PC Setup area (DM 6600 to DM 6655), beware of the effect resulting from the SRM1's delay in the operation on other devices.

The first operation for the SRM1 after the above memory areas have been changed will be a maximum of 850 ms later than the normal first operation without changes.

SRM1 Cycle Times

A cycle time overflow warning will not be issued when any of the following operations are performed in either MONITOR or OPERATION modes. Be careful of the effect of using online editing on SRM1 I/O response time.

- Changes to the program using online editing.
- Changes to the read-only DM area (DM 6144 to DM 6599.)
- Changes to the PC Setup area (DM 6600 to DM 6655.)

When any of the above operations are performed, the SRM1 cycle time will be increased by a maximum of 850 ms. During this time interrupts will be disabled while the program or memory contents is written.

2 I/O Allocation for CPM1/CPM1A/CPM2A PCs

2-1 CPU Units

CPM1

No. of I/O (in CPU Unit)	Model number	I/O	Allocated bits	Max. No. of Expansion I/O Units	Max. No. of (see note 1)
	CPM1-10CDR-□	Input	6 inputs: 00000 to 00005	1 (see note 1)	30
		Output	4 outputs: 01000 to 01003		
	CPM1-20CDR-□	Input	12 inputs: 00000 to 00011	1 (see note 1)	40
		Output	8 outputs: 01000 to 01007		
	CPM1-30CDR-□	Input	18 inputs: 00000 to 00011 00100 to 00105	1 (see note 1)	50
		Output	12 outputs: 01000 to 01007 01100 to 01103		
	CPM1-30CDR-□-V1	Input	18 inputs: 00000 to 00011 00100 to 00105	3 (see note 2)	90
		Output	12 outputs: 01000 to 01007 01100 to 01103		

- Expansion I/O Units:
- When using a CPM1 CPU Unit other than the CPM1-30CDR-□-V1, only the following 20-point Expansion I/O Units can be connected to the PC
 - CPM1-20EDR (relay outputs)
 - CPM1A-20EDRT (sinking transistor outputs)
 - CPM1A-20EDT1 (sourcing transistor outputs)
 - When using the CPM1-30CDR-□-V1, up to 3 CPM1/CPM1A Expansion I/O Units or CPM1A-MAD01 Analog I/O Units can be connected to the PC.

CPM1A

No. of I/O (on CPU Unit)	Model number	I/O	Allocated bits	Max. No. of Expansion I/O Units	Max. No. of (see note)
	CPM1A-10CDR-□ CPM1A-10CDT-D CPM1A-10CDT1-D	Input	6 inputs: 00000 to 00005	None	10
		Output	4 outputs: 01000 to 01003		
	CPM1A-20CDR-□ CPM1A-20CDT-D CPM1A-20CDT1-D	Input	12 inputs: 0000 to 00011	None	20
		Output	8 outputs: 01000 to 01007		
	CPM1A-30CDR-□ CPM1A-30CDT-D CPM1A-30CDT1-D	Inputs	18 inputs: 00000 to 00011 00100 to 00105	3 (see note)	90
		Output	12 outputs: 01000 to 01007 01100 to 01103		
	CPM1A-40CDR-□ CPM1A-40CDT-D CPM1A-40CDT1-D	Inputs	24 inputs: 00000 to 00011 00100 to 00111	3 (see note)	100
		Output	16 outputs: 01000 to 01007 01100 to 01107		

- Note**
- The values for the maximum number of I/O in the above table include I/O Expansion I/O Units.
 - When using a CPM1A CPU Unit with 30 or 40 I/O points, up to 3 Expansion I/O Units or Expansion I/O Units can be connected to the PC.

No. of I/O on CPU Unit)	Model number	I/O	Allocated bits	Max. No. of Expansion I/O Units	Max. No. of (see note
	CPM2A-20CDR-□ CPM2A-20CDT-D CPM2A-20CDT1-D	Input	12 inputs: 0000 to 00011	3	80
		Output	8 outputs: 01000 to 01007		
	CPM2A-30CDR-□ CPM2A-30CDT-D CPM2A-30CDT1-D	Input	18 inputs: 00000 to 00011 00100 to 00105	3	90
		Output	12 outputs: 01000 to 01007 01100 to 01103		
	CPM2A-40CDR-□ CPM2A-40CDT-D CPM2A-40CDT1-D	Input	24 inputs: 00000 to 00011 00100 to 00111	3	100
		Output	16 outputs: 01000 to 01007 01100 to 01107		
	CPM2A-60CDR-□ CPM2A-60CDT-D CPM2A-60CDT1-D	Input	36 inputs: 00000 to 00011 00100 to 00111 00200 to 00211	3	120
		Output	24 outputs: 01000 to 01007 01100 to 01107 01200 to 01207		

- Note**
1. The values for the maximum number of I/O in the above table include the on Expansion I/O Units.
 2. When using a CPM2A CPU Unit, up to 3 Expansion Units or Expansion Units can be connected to the PC.

I/O Unit Allocation

- In the following diagrams, shaded areas indicate bits actually used for input outputs.
- Input bits are allocated starting from IR 00000.
- Output bits are allocated starting from IR 01000.
- Bits in the output words that are not used as output bits can be used as v bits.
- Bits in the input words that are not used as input bits cannot be used as v bits.

I/O Units with 10 I/O Points

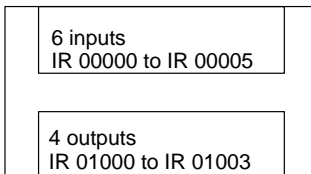

CPM1-10CDR-□
CPM1A-10CD□-□

Bits	15	14	13	12	11	10	09	08	07	06	05	04	03	02	01	00
Inputs IR 000	Do not use															
Outputs IR 010																

12 inputs IR 00000 to IR 00011
8 outputs IR 01000 to IR 01007

CPM1-20CDR-
 CPM1A-20CD-
 CPM2A-20CD-

Bits		15	14	13	12	11	10	09	08	07	06	05	04	03	02	01	00	
Inputs	IR 000	Do not use																
Outputs	IR 010																	

J Units with 30 I/O Points

18 inputs IR 00000 to IR 00011 IR 00100 to IR 00105
12 outputs IR 01000 to IR 01007 IR 01100 to IR 01103

CPM1-30CDR-/CPM1-30CDR--V1
 CPM1A-30CD-
 CPM2A-30CD-

Bits		15	14	13	12	11	10	09	08	07	06	05	04	03	02	01	00	
Inputs	IR 000	Do not use																
	IR 001																	
Outputs	IR 010																	
	IR 011																	

J Units with 40 I/O Points

24 inputs IR 00000 to IR 00011 IR 00100 to IR 00111
16 outputs IR 01000 to IR 01007 IR 01100 to IR 01107

CPM1A-40CD-
 CPM2A-40CD-

Bits		15	14	13	12	11	10	09	08	07	06	05	04	03	02	01	00	
Inputs	IR 000	Do not use																
	IR 001																	
Outputs	IR 010																	
	IR 011																	

36 inputs
 IR 00000 to IR 00011
 IR 00100 to IR 00111
 IR 00200 to IR 00211

CPM1A-60CD□-□

24 outputs
 IR 01000 to IR 01007
 IR 01100 to IR 01107
 IR 01200 to IR 01207

Bits		15	14	13	12	11	10	09	08	07	06	05	04	03	02	01	00				
Inputs	IR 000	Do not use																			
	IR 001																				
	IR 002																				
Outputs	IR 010																				
	IR 011																				
	IR 012																				

2-2 Expansion I/O Units

No. of I/O	Model number	I/O	Allocated bits	Compatible CPU Unit
	CPM1A-8ED	Input	8 inputs: Word (m+1), bits 00 to 07	CPM1-30CDR-□-V1 CPM1A CPM2A
		Output	---	
	CPM1A-8ER CPM1A-8ET CPM1A-8ET1	Input	---	CPM1-30CDR-□-V1 CPM1A CPM2A
		Output	8 outputs: Word (n+1), bits 00 to 07	
	CPM1A-20EDR CPM1A-20EDR1 CPM1A-20EDT CPM1A-20EDT1	Input	12 inputs: Word (m+1), bits 00 to 11	CPM1-30CDR-□-V1 CPM1A CPM2A
		Output	8 outputs: Word (n+1), bits 00 to 07	
	CPM1A-20EDR	Input	12 inputs: Word (m+1), bits 00 to 11	CPM1-10CDR-□ CPM1-20CDR-□ CPM1-30CDR-□(-V1)
		Output	8 outputs: Word (n+1), bits 00 to 07	

Note m: “m” denotes the last input word allocated to the CPU Unit, or to the previous Expansion Unit or Expansion I/O Unit if one is already connected.

n: “n” denotes the last output word allocated to the CPU Unit, or to the previous Expansion Unit or Expansion I/O Unit if one is already connected.

Expansion I/O Unit Allocation

- In the following diagrams, shaded areas indicate bits actually used for input and outputs.
- Input bits are allocated to Expansion I/O Units from word (m+1), where “m” is the last input word allocated to the CPU Unit, or to the previous Expansion Unit or Expansion I/O Unit if one is already connected.
- Output bits are allocated to Expansion I/O Units from word (n+1), where “n” is the last output word allocated to the CPU Unit, or to the previous Expansion Unit or Expansion I/O Unit if one is already connected.
- Bits in the output words that are not used as output bits can be used as input bits.
- Bits in the input words that are not used as input bits cannot be used as output bits.

CPM1A-8ED

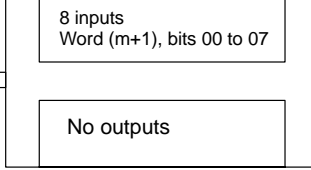

Bits	15	14	13	12	11	10	09	08	07	06	05	04	03	02	01	00	
Inputs	m+1	Do not use															

Expansion I/O Units with 8 Outputs

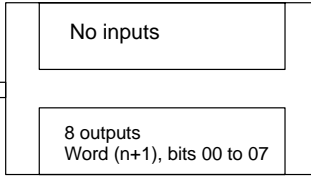

CPM1A-8ER
CPM1A-8ET
CPM1A-8ET1

Bits	15	14	13	12	11	10	09	08	07	06	05	04	03	02	01	00
Outputs	n+1															

Expansion I/O Units with 20 I/O Points

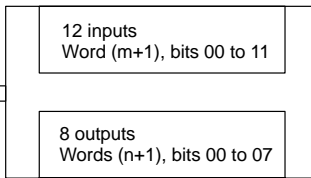

CPM1-20EDR
CPM1A-20EDR
CPM1A-20EDR1
CPM1A-20EDT
CPM1A-20EDT1

Bits	15	14	13	12	11	10	09	08	07	06	05	04	03	02	01	00	
Inputs	m+1	Do not use															
Outputs	n+1																

2-3 Expansion Units

Unit	Model number	I/O	Allocated words/bits	Max. No. of Units	Compatible CPU Units
Analog I/O Unit	CPM1A-MAD01 CPM1A-MAD11	Input	2 words: m+1, m+2	3 (see note 2)	CPM1 CPM1A CPM2A
		Output	1 word: n+1		
Temperature Sensor Units	CPM1A-TS001 CPM1A-TS101	Input	2 words: m+1, m+2	3	CPM1A CPM2A
		Output	---		
	CPM1A-TS002 CPM1A-TS102	Input	4 words: m+1 to m+4	1	CPM1A CPM2A
		Output	---		
CompoBus/S I/O Unit	CPM1A-SRT21	Input	8 bits: m+1	3	CPM1A CPM2A
		Output	8 bits: n+1		
DeviceNet I/O Unit	CPM1A-DRT21	Input	32 bits: m+1, m+2	3	CPM1A CPM2A
		Output	32 bits: n+1, n+2		

Note 1. m: "m" denotes the last input word allocated to the CPU Unit, or to the previous Expansion Unit or Expansion I/O Unit if one is already connected.

2. Only CPM1 CPU Units with the “-V1” suffix can have 3 Analog I/O Units connected. CPU Units without the “-V1” suffix can only have one Analog I/O connected.
3. Only one CPM1A-TS002/102 Temperature Sensor Unit can be connected to the PC. If a CPM1A-TS002/102 Temperature Sensor Unit is connected to the PC, one more Expansion Unit (other than another CPM1A-TS002/102 Temperature Sensor Unit) or Expansion I/O Unit can be connected.

Analog I/O Unit

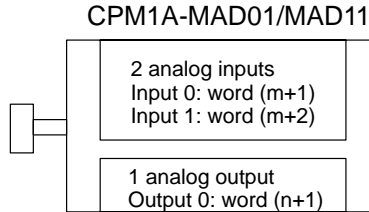

Temperature Sensor Units

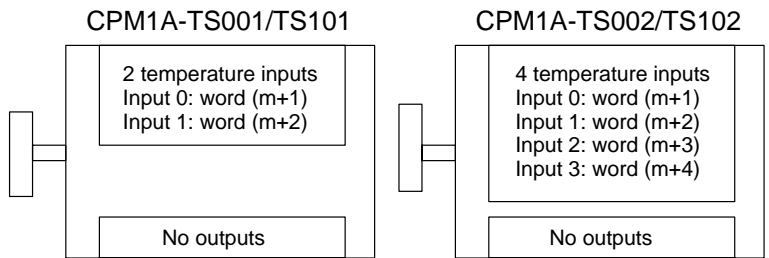

CompoBus/S I/O Link Unit and DeviceNet I/O Link Unit

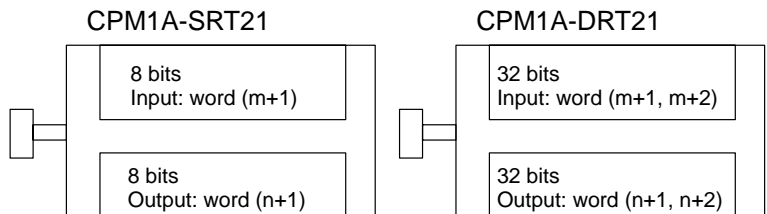

Note Input bits 00 to 07 in word (m+1) are for outputs from the Master. Output bits 00 to 07 in word (n+1), are for inputs to the Master.

2-4 Examples of Expansion Unit and Expansion I/O Unit Allocation

- When using a CPM1 CPU Unit without “-V1” at the end of the model number, only one Expansion I/O Unit can be connected.
- When using a CPM1 CPU Unit with “-V1” at the end of the model number, up to 3 CPM1A-series Expansion I/O Units can be connected.
- When using a CPM1A CPU Unit with 30 or 40 I/O points, or when using a CPM2A CPU Unit, up to 3 Expansion Units or Expansion I/O Units, excluding 4-input Temperature Sensor Units, can be connected. Only one 4-input Temperature Sensor Unit can be connected. If a 4-input Temperature Sensor Unit is connected to the PC, only one more Expansion Unit (except for another 4-input Temperature Sensor Unit) or Expansion I/O Unit can be connected.

CPU Unit
(20 I/O points)

Expansion I/O Unit
(20 I/O points)

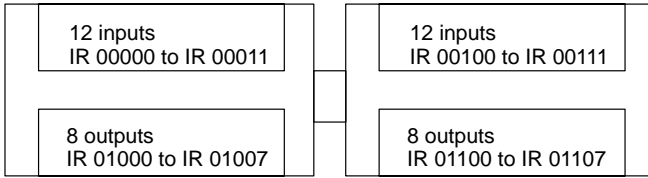

Bits		15	14	13	12	11	10	09	08	07	06	05	04	03	02	01	00	
Inputs	IR 000	Do not use																
	IR 001	Do not use																
Outputs	IR 010																	
	IR 011																	

- IR 00000 to IR 00011 and IR 00100 to IR 00111 are allocated as input IR 00012 to 00015 cannot be used.
- IR 01000 to IR 01007 and IR 01100 to IR 01107 are allocated as output IR 01108 to IR 01115 can be used as work bits.
- IR 002 to IR 009 of the input words and IR 012 to IR 019 of the output words all be used as work words.

Example: CPU Unit with 30 I/O Points + 3 Expansion I/O Units with 20 I/O Points

CPU Unit
(30 I/O points)

Expansion I/O Unit
(20 I/O points)

Expansion I/O Unit
(20 I/O points)

Expansion I/O Unit
(20 I/O points)

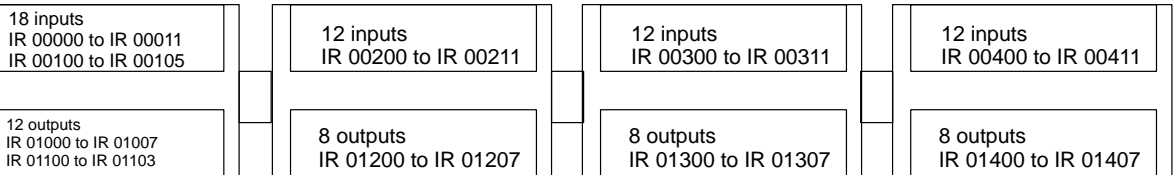

Bits		15	14	13	12	11	10	09	08	07	06	05	04	03	02	01	00	
Inputs	IR 000	Do not use																
	IR 001	Do not use																
	IR 002	Do not use																
	IR 003	Do not use																
	IR 004	Do not use																
Outputs	IR 010																	
	IR 011																	
	IR 012																	
	IR 013																	
	IR 014																	

CPU Unit
(60 I/O points)

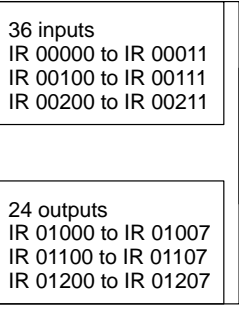

Expansion I/O Unit
(20 I/O points)

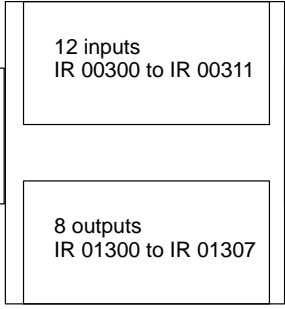

Expansion I/O Unit
(16 outputs)

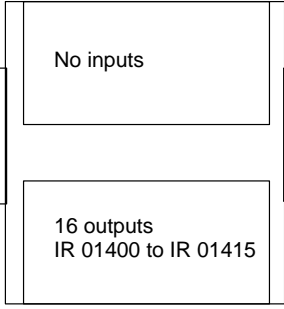

Expansion I/O Unit
(20 I/O points)

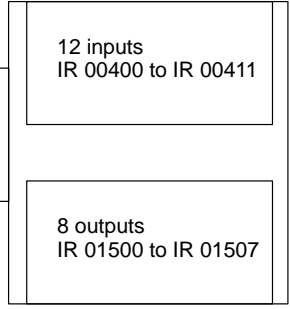

Bits		15	14	13	12	11	10	09	08	07	06	05	04	03	02	01	00	
Inputs	IR 000	Do not use																
	IR 001	Do not use																
	IR 002	Do not use																
	IR 003	Do not use																
	IR 004	Do not use																
Outputs	IR 010																	
	IR 011																	
	IR 012																	
	IR 013																	
	IR 014																	
	IR 015																	

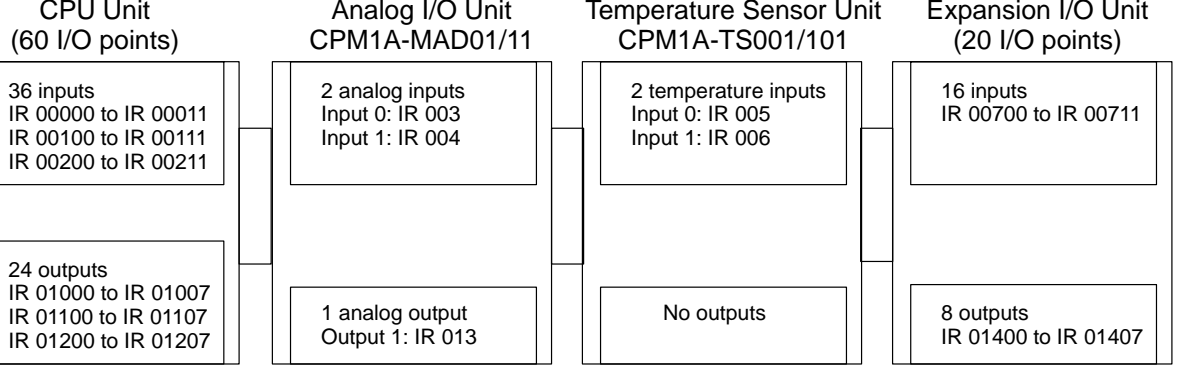

Bits	15	14	13	12	11	10	09	08	07	06	05	04	03	02	01	00	
Inputs	IR 000	Do not use															
	IR 001	Do not use															
	IR 002	Do not use															
	IR 003	Used for input 0 of the Analog I/O Unit															
	IR 004	Used for input 1 of the Analog I/O Unit															
	IR 005	Used for input 0 of the Temperature Sensor Unit															
	IR 006	Used for input 1 of the Temperature Sensor Unit															
Outputs	IR 007	Do not use															
	IR 010																
	IR 011																
	IR 012																
	IR 013	Used for the output of the Analog I/O Unit															
IR 014																	

With the exception of CPM1A-TS002/102 Temperature Sensor Units, up to 16 Expansion Units (Analog I/O Units, Temperature Sensor Units, or CompoB Units) can be connected to a CPM1A or CPM2A PC. Only 1 CPM1A-TS002/102 Temperature Sensor Unit can be connected. (See page 319 for an example of CPM1A-TS002/102 allocations.)

CPU Unit
(60 I/O points)

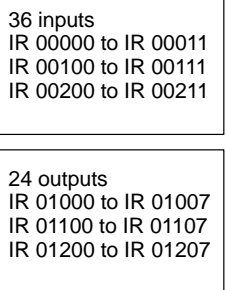

Temperature Sensor Unit
CPM1A-TS002/102

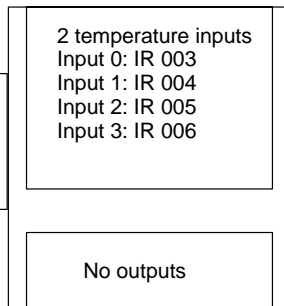

CompoBus/S I/O Link Unit
CPM1A-SRT21

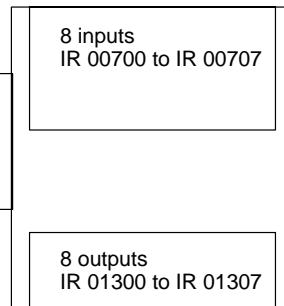

Bits	15	14	13	12	11	10	09	08	07	06	05	04	03	02	01	00
Inputs	IR 000	Do not use														
	IR 001	Do not use														
	IR 002	Do not use														
	IR 003	Used for input 0 of the Temperature Sensor Unit														
	IR 004	Used for input 1 of the Temperature Sensor Unit														
	IR 005	Used for input 1 of the Temperature Sensor Unit														
	IR 006	Used for input 1 of the Temperature Sensor Unit														
	IR 007						Do not use									
Outputs	IR 010															
	IR 011															
	IR 012															
	IR 013															

Only one 4-input Temperature Sensor Unit (CPM1A-TS002/102) can be connected to the PC. The CPM1A-TS002/102 can, however, be connected together with an Expansion I/O Unit or a different Expansion Unit.

3 I/O Allocation for CPM2C PCs

3-1 CPU Units

No. of I/O in CPU Unit)	Model number	I/O	Allocated bits	Max. No. of Expansion I/O Units	Max. No. of (see note)
	CPM2C-10C□□□□□-D	Inputs	6 inputs: 00000 to 00005	5	170
		Outputs	4 outputs: 01000 to 01003		
	CPM2C-20C□□□□□-D	Inputs	12 inputs: 00000 to 00011	5	180
		Outputs	8 outputs: 01000 to 01007		
	CPM2C-32CDT□□□-D	Inputs	16 inputs: 00000 to 00007 and 00100 to 00107	5	192
		Outputs	16 outputs: 01000 to 01007 and 01100 to 01107		

- Note**
1. The values for the maximum number of I/O in the above table include the I/O on Expansion I/O Units.
 2. Although only up to 5 Expansion Units or Expansion I/O Units can be connected to a CPM2C PC, no more than 10 input words and 10 output words can be allocated.

- In the following diagrams, shaded areas indicate bits actually used for input or outputs.
- Input bits are allocated starting from IR 00000.
- Output bits are allocated starting from IR 01000.
- Bits in the output words that are not used as output bits can be used as v bits.
- Bits in the input words that are not used as input bits cannot be used as v bits.

J Units with 10 I/O Points

6 inputs
IR 00000
to
IR 00005

CPM2C-10C□D□□□-□

4 outputs
IR 01000
to
IR 01003

Bits		15	14	13	12	11	10	09	08	07	06	05	04	03	02	01	00
Inputs	IR 000	Do not use															
Outputs	IR 010																

J Units with 20 I/O Points

12 inputs
IR 00000
to
IR 00011

CPM2C-20C□D□□□-□

8 outputs
IR 01000
to
IR 01007

Bits		15	14	13	12	11	10	09	08	07	06	05	04	03	02	01	00	
Inputs	IR 000	Do not use																
Outputs	IR 010																	

16 inputs
IR 0000 to IR 0007
and
IR 00100 to IR 00107

CPM2C-32CDT□□-D

16 outputs
IR 01000 to IR 01007
and
IR 01100 to IR 01107

Bits		15	14	13	12	11	10	09	08	07	06	05	04	03	02	01	00	
Inputs	IR 000	Do not use																
	IR 001																	
Bits		15	14	13	12	11	10	09	08	07	06	05	04	03	02	01	00	
Outputs	IR 010																	
	IR 011																	

3-2 Expansion I/O Units

No. of I/O	Model number	I/O	Allocated bits	Max. No. of Units	
				CPM2C	CPM2C
	CPM2C-8ED□	Input	8 inputs: Word (m+1), bits 00 to 07	5	3
		Output	---		
	CPM2C-16ED□	Input	16 inputs: Word (m+1), bits 00 to 15	5	3
		Output	---		
	CPM2C-8ER CPM2C-8ET□ CPM2C-8ET1□	Input	---	5	3
		Output	8 outputs: Word (n+1), bits 00 to 07		
	CPM2C-16ET□ CPM2C-16ET1□	Input	---	5	3
		Output	16 outputs: Word (n+1), bits 00 to 15		
	CPM2C-10EDR	Input	6 inputs: Word (m+1), bits 00 to 05	5	3
		Output	4 outputs: Word (n+1), bits 00 to 03		
	CPM2C-20EDR	Input	12 inputs: Word (m+1), bits 00 to 11	5	3
		Output	8 outputs: Word (n+1), bits 00 to 07		
	CPM2C-24EDT□ CPM2C-24EDT1□	Input	16 inputs: Word (m+1), bits 00 to 15	5	3
		Output	8 outputs: Word (n+1), bits 00 to 07		
	CPM2C-32EDT□ CPM2C-32EDT1□	Input	16 inputs: Word (m+1), bits 00 to 15	5	3
		Output	16 outputs: Word (n+1), bits 00 to 15		

Note m: “m” denotes the last input word allocated to the CPU Unit, or to the previous Expansion Unit or Expansion I/O Unit if one is already connected.

n: “n” denotes the last output word allocated to the CPU Unit, or to the previous Expansion Unit or Expansion I/O Unit if one is already connected.

Expansion I/O Unit Allocation

- In the following diagrams, shaded areas indicate bits actually used for input and outputs.
- Input bits are allocated to Expansion I/O Units starting from word (m+1), where “m” is the last input word allocated to the CPU Unit, or to the previous Expansion Unit or Expansion I/O Unit if one is already connected.
- Output bits are allocated to Expansion I/O Units starting from word (n+1), where “n” is the last output word allocated to the CPU Unit, or to the previous Expansion Unit or Expansion I/O Unit if one is already connected.

- Bits in the input words that are not used as input bits can be used as work

Expansion I/O Unit with 8 Inputs

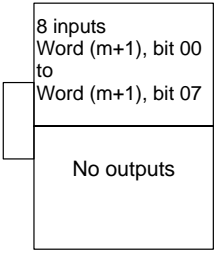

CPM2C-8EDC
CPM2C-8EDM

Bits	15	14	13	12	11	10	09	08	07	06	05	04	03	02	01	00	
Inputs	m+1	Do not use															

Expansion I/O Unit with 16 Inputs

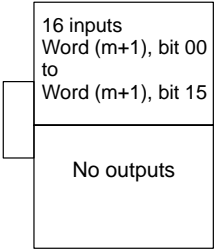

CPM2C-16EDC
CPM2C-16EDM

Bits	15	14	13	12	11	10	09	08	07	06	05	04	03	02	01	00
Inputs	m+1															

Expansion I/O Units with 8 Outputs

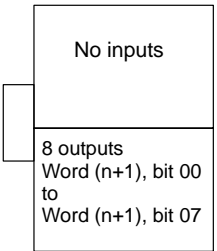

CPM2C-8ER
CPM2C-8ETC
CPM2C-8ET1C
CPM2C-8ETM
CPM2C-8ET1M

Bits	15	14	13	12	11	10	09	08	07	06	05	04	03	02	01	00
Outputs	n+1															

Expansion I/O Units with 16 Outputs

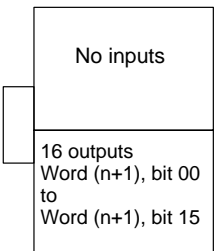

CPM2C-16ETC
CPM2C-16ET1C
CPM2C-16ETM
CPM2C-16ET1M

Bits	15	14	13	12	11	10	09	08	07	06	05	04	03	02	01	00
Outputs	n+1															

6 inputs
Word (m+1), bit 00
to
Word (m+1), bit 05

4 outputs
Word (n+1), bit 00
to
Word (n+1), bit 03

CPM2C-10EDR

Bits		15	14	13	12	11	10	09	08	07	06	05	04	03	02	01	00
Inputs	m+1	Do not use															
Outputs	n+1																

Expansion I/O Unit with 20 I/O Points

12 inputs
Word (m+1), bit 00
to
Word (m+1), bit 11

8 outputs
Word (n+1), bit 00
to
Word (n+1), bit 07

CPM2C-20EDR

Bits		15	14	13	12	11	10	09	08	07	06	05	04	03	02	01	00
Inputs	m+1	Do not use															
Outputs	n+1																

Expansion I/O Units with 24 I/O Points

16 inputs
Word (m+1), bit 00
to
Word (m+1), bit 15

8 outputs
Word (n+1), bit 00
to
Word (n+1), bit 07

CPM2C-24EDTC
CPM2C-24EDT1C
CPM2C-24EDTM
CPM2C-24EDT1M

Bits		15	14	13	12	11	10	09	08	07	06	05	04	03	02	01	00
Inputs	m+1																
Outputs	n+1																

16 inputs
Word (m+1), bit 00
to
Word (m+1), bit 15

CPM2C-32EDTC
CPM2C-32EDT1C
CPM2C-32EDTM
CPM2C-32EDT1M

16 outputs
Word (n+1), bit 00
to
Word (n+1), bit 15

Bits		15	14	13	12	11	10	09	08	07	06	05	04	03	02	01	00
Inputs	m+1																
Outputs	n+1																

3-3 Expansion Units

Unit	Model number	I/O	Allocated words	Max. No. of Units	
				CPM2C	CPM2M
Analog I/O Unit	CPM2C-MAD11	Input	2 inputs: m+1, m+2	4	3
		Output	1 output: n+1		
Temperature Sensor Unit	CPM2C-TS001 CPM2C-TS101	Input	2 inputs: m+1, m+2	4	3
		Output	---		
CompoBus/S I/O Link Unit	CPM2C-SRT21	Input	1 input: m+1	5	3
		Output	1 output: n+1		

- Note**
1. m: "m" denotes the last input word allocated to the CPU Unit, or to the previous Expansion Unit or Expansion I/O Unit if one is already connected.
n: "n" denotes the last output word allocated to the CPU Unit, or to the previous Expansion Unit or Expansion I/O Unit if one is already connected.
 2. Because the CPM2C-MAD11 Analog I/O Unit and the CPM2C-TS001/CPM2C-TS101 Temperature Sensor Units require 2 I/O words each, only 4 of these Units can be connected to the PC. (The CPU Unit itself requires one input word and one output word.) A different Unit, such as an Expansion I/O Unit or CPM2C-SRT21 CompoBus/S I/O Link Unit, can, however, be connected in addition to 4 Analog I/O Units or Temperature Sensor Units.

Analog I/O Unit

CPM2C-MAD11

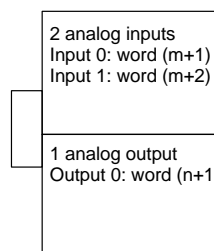

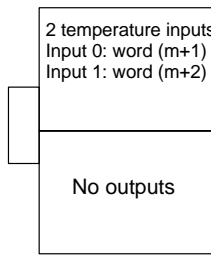

CompoBus/S I/O Link Unit

CPM2C-SRT21

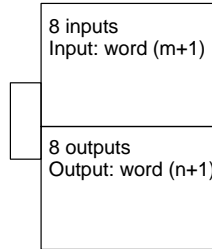

Note Input bits 00 to 07 in word (m+1) are for outputs from the Master. Output bits 00 to 07 in word (n+1), are for inputs to the Master.

3-4 Examples of Expansion Unit and Expansion I/O Unit Allocation

Up to 5 Expansion Units or Expansion I/O Units can be connected to a CPM2C PC. Input bits and output bits are automatically allocated starting from the CPU Unit and continuing through Expansion Units and Expansion I/O Units in the order in which they are connected. The input area consists of the 10 words from IR 000 to 009, and the output area consists of the 10 words from IR 010 to 019. Although I/O bits are allocated automatically, it is necessary to ensure that the number of input words and the number of output words do not exceed 10. For example, the Analog I/O Unit and Temperature Sensor Unit require 2 input words and so it is not possible to connect 5 of these Units.

Example: CPU Unit with 20 I/O Points + Expansion I/O Unit with 24 I/O Points

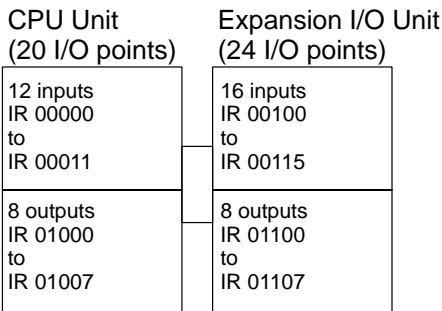

Bits		15	14	13	12	11	10	09	08	07	06	05	04	03	02	01	00	
Inputs	IR 000	Do not use																
	IR 001																	
Outputs	IR 010																	
	IR 011																	

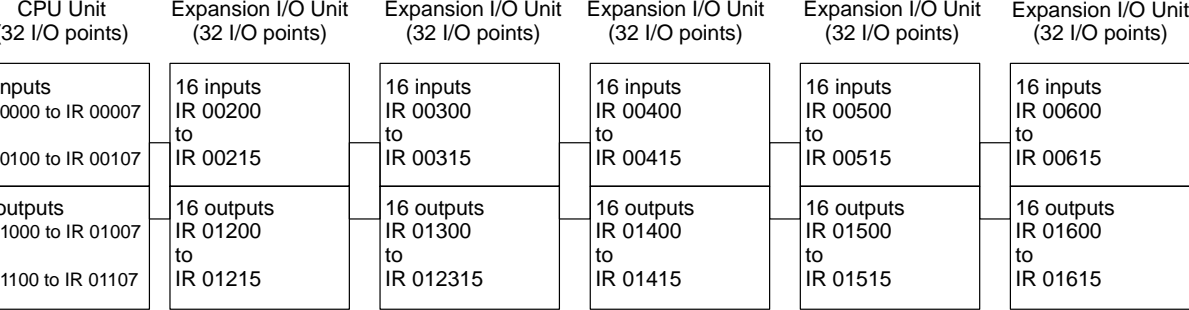

Bits		15	14	13	12	11	10	09	08	07	06	05	04	03	02	01	00	
Inputs	IR 000	Do not use																
	IR 001																	
	IR 002																	
	IR 003																	
	IR 004																	
	IR 005																	
	IR 006																	
Outputs	IR 010																	
	IR 011																	
	IR 012																	
	IR 013																	
	IR 014																	
	IR 015																	
	IR 016																	

Example: Configuration Including Expansion I/O Units and a CompoBus/S I/O Link Unit

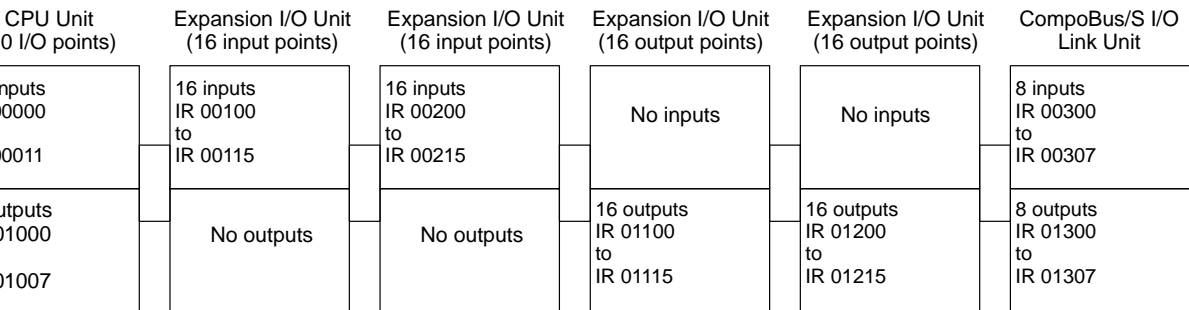

Bits		15	14	13	12	11	10	09	08	07	06	05	04	03	02	01	00
Inputs	IR 000	Do not use															
	IR 001																
	IR 002																
	IR 003	Do not use															
Outputs	IR 010																
	IR 011																
	IR 012																
	IR 013																

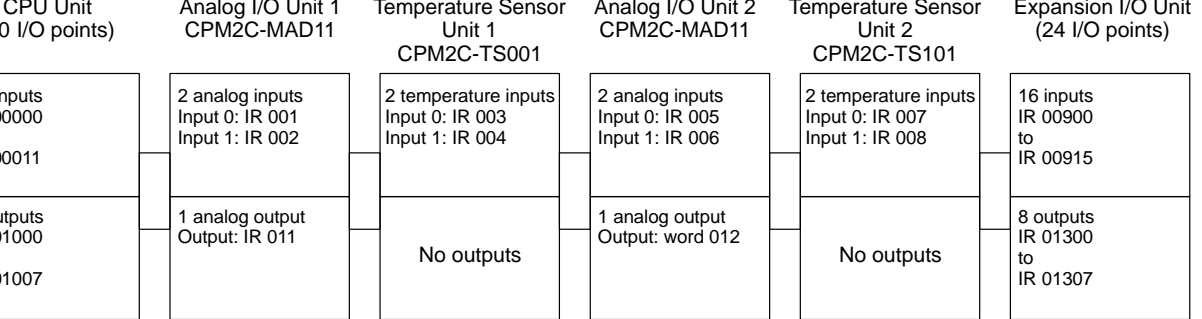

Bits	15	14	13	12	11	10	09	08	07	06	05	04	03	02	01	00	
Inputs	IR 000	Do not use															
	IR 001	Used for input 0 of Analog I/O Unit 1															
	IR 002	Used for input 1 of Analog I/O Unit 1															
	IR 003	Used for input 0 of Temperature Sensor Unit 1															
	IR 004	Used for input 1 of Temperature Sensor Unit 1															
	IR 005	Used for input 0 of Analog I/O Unit 2															
	IR 006	Used for input 1 of Analog I/O Unit 2															
	IR 007	Used for input 0 of Temperature Sensor Unit 2															
	IR 008	Used for input 1 of Temperature Sensor Unit 2															
Outputs	IR 010																
	IR 011	Used for the output of Analog I/O Unit 1															
	IR 012	Used for the output of Analog I/O Unit 2															
	IR 013																

Ladder-diagram Programming

This section explains the basic steps and concepts involved in writing a basic ladder diagram program. It introduces the instructions that are used to build the basic structure of the ladder diagram and control its execution. The entire set of instructions used in programming is described in *Section 7 Instruction Set*.

6-1	Basic Procedure	330
6-2	Instruction Terminology	330
6-3	Basic Ladder Diagrams	331
6-3-1	Basic Terms	331
6-3-2	Mnemonic Code	332
6-3-3	Ladder Instructions	333
6-3-4	OUTPUT and OUTPUT NOT	336
6-3-5	The END Instruction	337
6-3-6	Logic Block Instructions	337
6-3-7	Coding Multiple Right-hand Instructions	345
6-3-8	Branching Instruction Lines	345
6-3-9	Jumps	349
6-4	Controlling Bit Status	350
6-4-1	SET and RESET	350
6-4-2	DIFFERENTIATE UP and DIFFERENTIATE DOWN	351
6-4-3	KEEP	351
6-4-4	Self-maintaining Bits (Seal)	352
6-5	Work Bits (Internal Relays)	352
6-6	Programming Precautions	354
6-7	Program Execution	356

There are several basic steps involved in writing a program. Sheets that can be copied to aid in programming are provided in *Appendix D I/O Assignment Sheet* and *Appendix E Program Coding Sheet*.

- 1, 2, 3... 1. Obtain a list of all I/O devices and the I/O points that have been assigned to them and prepare a table that shows the I/O bit allocated to each I/O device.
2. If you are using LR bits to link two PCs, prepare sheet showing the use of these bits.
3. Determine what words are available for work bits and prepare a table in which you can allocate these as you use them.
4. Also prepare tables of TC numbers and jump numbers so that you can allocate these as you use them. Remember, the function of a TC number can be defined only once within the program; jump numbers 01 through 99 can be used only once each. (TC numbers are described in *7-15 Timer Counter Instructions*; jump numbers are described later in this section).
5. Draw the ladder diagram.
6. Input the program into the CPU Unit. When using the Programming Console, this will involve converting the program to mnemonic form.
7. Check the program for syntax errors and correct these.
8. Execute the program to check for execution errors and correct these.
9. After the entire Control System has been installed and is ready for use, execute the program and fine tune it if required.

The basics of ladder-diagram programming and conversion to mnemonic code are described in *6-3 Basic Ladder Diagrams*. Preparing for and inputting the program via the Programming Console are described in the *CPM1 Operation Manual*, the *CPM1A Operation Manual*, the *CPM2A Operation Manual*, the *CPM2C Operation Manual*, and the *SRM1 Master Control Units Manual* and the SSS in the *SSS Operation Manual: C-series PCs*.

The rest of Section 6 covers more advanced programming, programming cautions, and program execution. All special application instructions are covered in *Section 7 Instruction Set*. Debugging is described in the *CPM1 Operation Manual*, the *CPM1A Operation Manual*, the *CPM2A Operation Manual*, the *CPM2C Operation Manual*, the *SRM1 Master Control Units Manual*, and the *Operation Manual: C-series PCs*. *Section 9 Troubleshooting* also provides information required for debugging.

2 Instruction Terminology

There are basically two types of instructions used in ladder-diagram programming: instructions that correspond to the conditions on the ladder diagram and are used in instruction form only when converting a program to mnemonic code, and instructions that are used on the right side of the ladder diagram and are executed according to the conditions on the instruction lines leading to the

Most instructions have at least one or more operands associated with them. Operands indicate or provide the data on which an instruction is to be performed. These are sometimes input as the actual numeric values, but are usually the addresses of data area words or bits that contain the data to be used. For instance, a MOVE instruction that has IR 000 designated as the source operand will move the contents of IR 000 to some other location. The other location is also designated as an operand. A bit whose address is designated as an operand is called an operand bit; a word whose address is designated as an operand is called an operand word. If the actual value is entered as a constant, it is preceded by a # to indicate that it is not an address.

3 Basic Ladder Diagrams

A ladder diagram consists of one line running down the left side with lines branching off to the right. The line on the left is called the bus bar; the branching lines, instruction lines or rungs. Along the instruction lines are placed conditions that lead to other instructions on the right side. The logical combinations of the conditions determine when and how the instructions at the right are executed. A ladder diagram is shown below.

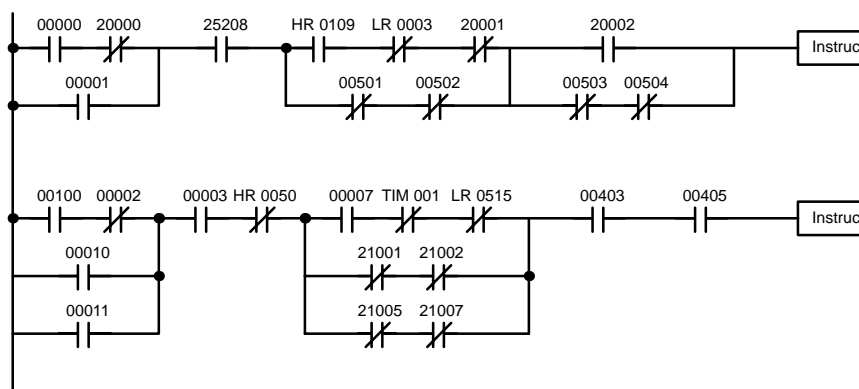

As shown in the diagram above, instruction lines can branch apart and they join back together. The vertical pairs of lines are called conditions. Conditions without diagonal lines through them are called normally open conditions and correspond to a LOAD, AND, or OR instruction. The conditions with diagonal lines through them are called normally closed conditions and correspond to a LOAD NOT, AND NOT, or OR NOT instruction. The number above each condition indicates the operand bit for the instruction. It is the status of the operand bit associated with each condition that determines the execution condition for the following instructions. The way the operation of each of the instructions corresponds to a condition is described below. Before we consider these, however, there are some basic terms that must be explained.

Note When displaying ladder diagrams with the SSS, a second bus bar will be shown on the right side of the ladder diagram and will be connected to all instructions on the right side. This does not change the ladder-diagram program in any functional sense. No conditions can be placed between the instructions on the right side and the right bus bar, i.e., all instructions on the right must be connected directly to the right bus bar. Refer to the *SSS Operation Manual: C-series PCs* for details.

3-1 Basic Terms

Normally Open and Normally Closed Conditions

Each condition in a ladder diagram is either ON or OFF depending on the status of the operand bit that has been assigned to it. A normally open condition is ON if the operand bit is ON; OFF if the operand bit is OFF. A normally closed condition is ON if the operand bit is OFF; OFF if the operand bit is ON. Generally speaking, you use a normally open condition when you want something to happen when

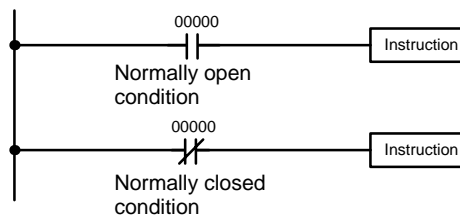

Instruction is executed when IR bit 00000 is ON.

Instruction is executed when IR bit 00000 is OFF.

Execution Conditions

In ladder diagram programming, the logical combination of ON and OFF conditions before an instruction determines the compound condition under which an instruction is executed. This condition, which is either ON or OFF, is called an execution condition for the instruction. All instructions other than LOAD instructions have execution conditions.

Operand Bits

The operands designated for any of the ladder instructions can be any bit in the IR, SR, HR, AR, LR, or TC areas. This means that the conditions in a ladder diagram can be determined by I/O bits, flags, work bits, timers/counters, etc. LOAD and OUTPUT instructions can also use TR area bits, but they do so only in special applications. Refer to *6-3-8 Branching Instruction Lines* for details.

Logic Blocks

The way that conditions correspond to what instructions is determined by the relationship between the conditions within the instruction lines that connect them. Any group of conditions that go together to create a logic result is called a logic block. Although ladder diagrams can be written without actually analyzing individual logic blocks, understanding logic blocks is necessary for efficient programming and is essential when programs are to be input in mnemonic code.

Instruction Block

An instruction block consists of all the instructions that are interconnected across the ladder diagram. One instruction block thus consists of all the instructions between where you can draw a horizontal line across the ladder diagram without intersecting any vertical lines and the next place where you can draw the same type of horizontal line.

3-2 Mnemonic Code

The ladder diagram cannot be directly input into the PC via a Programming Console; the SSS is required. To input from a Programming Console, it is necessary to convert the ladder diagram to mnemonic code. The mnemonic code provides exactly the same information as the ladder diagram, but in a form that can be typed directly into the PC. Actually you can program directly in mnemonic code, although it is not recommended for beginners or for complex programs. Regardless of the Programming Device used, the program is stored in memory in mnemonic form, making it important to understand mnemonic code.

Because of the importance of the Programming Console as a Programming Device and because of the importance of mnemonic code in completely understanding a program, we will introduce and describe the mnemonic code along with the ladder diagram. Remember, you will not need to use the mnemonic code if you are inputting via the SSS (although you can use it with the SSS if you prefer).

Program Memory Structure

The program is input into addresses in Program Memory. Addresses in Program Memory are slightly different to those in other memory areas because each address does not necessarily hold the same amount of data. Rather, each address holds one instruction and all of the definers and operands (described in memory structure).

operands, while others require up to three operands. Program memory addresses can be from one to four words long.

Program Memory addresses start at 00000 and run until the capacity of Program Memory has been exhausted. The first word at each address defines the instruction. Any definers used by the instruction are also contained in the first word. Also, if an instruction requires only a single bit operand (with no definer), the operand is also programmed on the same line as the instruction. The rest of the words required by an instruction contain the operands that specify what data to be used. When converting to mnemonic code, all but ladder diagram instructions are written in the same form, one word to a line, just as they appear in ladder diagram symbols. An example of mnemonic code is shown below. The instructions used in it are described later in the manual.

Address	Instruction	Operands
00000	LD	HR 0001
00001	AND	00001
00002	OR	00002
00003	LD NOT	00100
00004	OR	00101
00005	AND LD	
00006	MOV(21)	
		000
		DM 0000
00007	CMP(20)	
		DM 0000
		HR 00
00008	AND	25505
00009	OUT	20000
00010	MOV(21)	
		DM 0000
		DM 0500
00011	LD	00502
00012	AND	00005
00013	OUT	20001

The address and instruction columns of the mnemonic code table are filled in with the instruction word only. For all other lines, the left two columns are left blank. If the instruction requires no definer or bit operand, the operand column is left blank for first line. It is a good idea to cross through any blank data column spaces (for all instruction words that do not require data) so that the data column can be quickly scanned to see if any addresses have been left out.

When programming, addresses are automatically displayed and do not have to be input unless for some reason a different location is desired for the instruction. When converting to mnemonic code, it is best to start at Program Memory address 00000 unless there is a specific reason for starting elsewhere.

3-3 Ladder Instructions

The ladder instructions are those instructions that correspond to the conditions on the ladder diagram. Ladder instructions, either independently or in combination with the logic block instructions described next, form the execution conditions upon which the execution of all other instructions are based.

spends to a LOAD or LOAD NOT instruction. Each of these instructions requires one line of mnemonic code. "Instruction" is used as a dummy instruction in the following examples and could be any of the right-hand instructions described earlier in this manual.

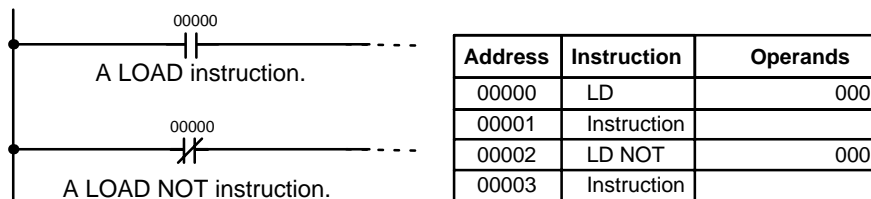

When this is the only condition on the instruction line, the execution condition for the instruction at the right is ON when the condition is ON. For the LOAD instruction (i.e., a normally open condition), the execution condition would be ON when IR 00000 was ON; for the LOAD NOT instruction (i.e., a normally closed condition), it would be ON when 00000 was OFF.

AND and AND NOT

When two or more conditions lie in series on the same instruction line, the first one corresponds to a LOAD or LOAD NOT instruction; and the rest of the conditions, to AND or AND NOT instructions. The following example shows three conditions which correspond in order from the left to a LOAD, an AND NOT, an AND instruction. Again, each of these instructions requires one line of mnemonic code.

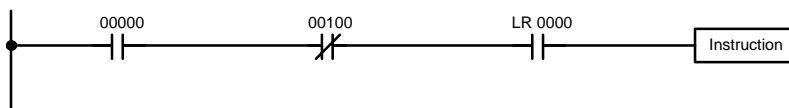

Address	Instruction	Operands
00000	LD	00000
00001	AND NOT	00100
00002	AND	LR 0000
00003	Instruction	

The instruction would have an ON execution condition only when all three conditions are ON, i.e., when IR 00000 was ON, IR 00100 was OFF, and LR 0000 was ON.

AND instructions in series can be considered individually, with each taking the logical AND of the execution condition (i.e., the total of all conditions up to that point) and the status of the AND instruction's operand bit. If both of these are ON, an ON execution condition will be produced for the next instruction. If either is OFF, the result will also be OFF. The execution condition for the first AND instruction in a series is the first condition on the instruction line.

Each AND NOT instruction in a series would take the logical AND between the execution condition and the inverse of its operand bit.

and then joining together, the first condition corresponds to a LOAD or LD NOT instruction; the rest of the conditions correspond to OR or OR NOT instructions. The following example shows three conditions which correspond in order from the top to a LOAD NOT, an OR NOT, and an OR instruction. Again, each of these instructions requires one line of mnemonic code.

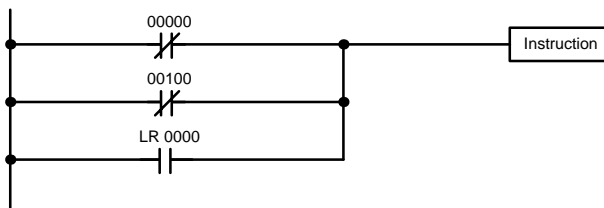

Address	Instruction	Operands
00000	LD NOT	00000
00001	OR NOT	00100
00002	OR	LR 0000
00003	Instruction	

The instruction would have an ON execution condition when any one of the three conditions was ON, i.e., when IR 00000 was OFF, when IR 00100 was OFF, or when LR 0000 was ON.

OR and OR NOT instructions can be considered individually, each taking a logical OR between its execution condition and the status of the OR instruction operand bit. If either one of these were ON, an ON execution condition would be produced for the next instruction.

Combining AND and OR Instructions

When AND and OR instructions are combined in more complicated diagrams, they can sometimes be considered individually, with each instruction performing a logic operation on the execution condition and the status of the operand bit. The following is one example. Study this example until you are convinced that the mnemonic code follows the same logic flow as the ladder diagram.

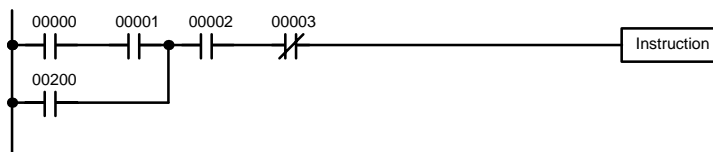

Address	Instruction	Operands
00000	LD	00000
00001	AND	00001
00002	OR	00200
00003	AND	00002
00004	AND NOT	00003
00005	Instruction	

Here, an AND is taken between the status of IR 00000 and that of IR 00001 to determine the execution condition for an OR with the status of IR 00200. The result of this operation determines the execution condition for an AND with the status of IR 00002, which in turn determines the execution condition for an AND NOT with the inverse (i.e., and AND NOT) of the status of IR 00003.

before an execution condition can be determined for the final instruction, that's where AND LOAD and OR LOAD instructions are used. Before we cover more complicated diagrams, however, we'll look at the instructions required to complete a simple "input-output" program.

3-4 OUTPUT and OUTPUT NOT

The simplest way to output the results of combining execution conditions is to output it directly with the OUTPUT and OUTPUT NOT. These instructions are used to control the status of the designated operand bit according to the execution condition. With the OUTPUT instruction, the operand bit will be turned ON as long as the execution condition is ON and will be turned OFF as long as the execution condition is OFF. With the OUTPUT NOT instruction, the operand bit will be turned ON as long as the execution condition is OFF and turned OFF as long as the execution condition is ON. These appear as shown below. In mnemonic code, each of these instructions requires one line.

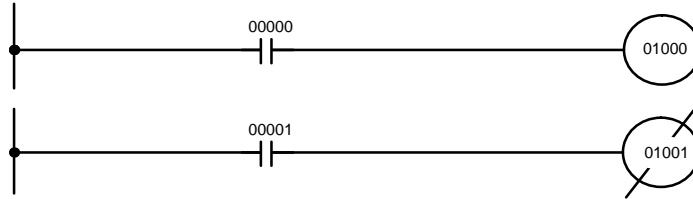

Address	Instruction	Operands
00000	LD	00000
00001	OUT	01000

Address	Instruction	Operands
00000	LD	00001
00001	OUT NOT	01001

In the above examples, IR 01000 will be ON as long as IR 00000 is ON and IR 01001 will be OFF as long as IR 00001 is ON. Here, IR 00000 and IR 00001 would be input bits and IR 01000 and IR 01001 output bits assigned to the PLC controlled by the PC, i.e., the signals coming in through the input points assigned to IR 00000 and IR 00001 are controlling the output points assigned to IR 01000 and IR 01001, respectively.

The length of time that a bit is ON or OFF can be controlled by combining the OUTPUT or OUTPUT NOT instruction with Timer instructions. Refer to Examples under 7-15-1 *Timer – TIM* for details.

The last instruction required to complete a simple program is the END instruction. When the CPU Unit scans the program, it executes all instructions up to the first END instruction before returning to the beginning of the program and beginning execution again. Although an END instruction can be placed at any point in a program, which is sometimes done when debugging, no instructions past the first END instruction will be executed until it is removed. The number following the END instruction in the mnemonic code is its function code, which is used when inputted most instructions into the PC. These are described later. The END instruction requires no operands and no conditions can be placed on the END instruction line with it.

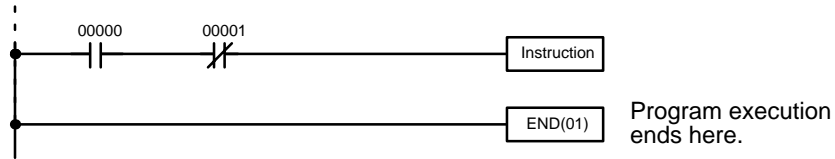

Address	Instruction	Operands
00500	LD	00000
00501	AND NOT	00001
00502	Instruction	
00503	END(01)	---

If there is no END instruction anywhere in the program, the program will not be executed at all.

Now you have all of the instructions required to write simple input-output programs. Before we finish with ladder diagram basic and go onto inputting the program into the PC, let's look at logic block instruction (AND LOAD and OR LOAD) which are sometimes necessary even with simple diagrams.

3-6 Logic Block Instructions

Logic block instructions do not correspond to specific conditions on the ladder diagram; rather, they describe relationships between logic blocks. The AND LOAD instruction logically ANDs the execution conditions produced by two logic blocks. The OR LOAD instruction logically ORs the execution conditions produced by two logic blocks.

AND LOAD

Although simple in appearance, the diagram below requires an AND LOAD instruction.

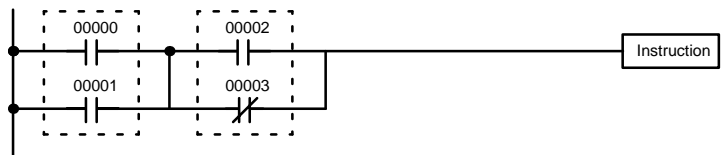

Address	Instruction	Operands
00000	LD	00000
00001	OR	00001
00002	LD	00002
00003	OR NOT	00003
00004	AND LD	---

that an ON execution condition will be produced when: either of the conditions on the left logic block is ON (i.e., when either IR 00000 or IR 00001 is ON), when either of the conditions in the right logic block is ON (i.e., when either 00002 is ON or IR 00003 is OFF).

The above ladder diagram cannot, however, be converted to mnemonic code using AND and OR instructions alone. If an AND between IR 00002 and the results of an OR between IR 00000 and IR 00001 is attempted, the OR NOT between IR 00002 and IR 00003 is lost and the OR NOT ends up being an OR NOT between just IR 00003 and the result of an AND between IR 00002 and the OR. What we need is a way to do the OR (NOT)'s independently and then combine the results.

To do this, we can use the LOAD or LOAD NOT instruction in the middle of an instruction line. When LOAD or LOAD NOT is executed in this way, the current execution condition is saved in special buffers and the logic process is begun over. To combine the results of the current execution condition with that of a previous "unused" execution condition, an AND LOAD or an OR LOAD instruction is used. Here "LOAD" refers to loading the last unused execution condition. An unused execution condition is produced by using the LOAD or LOAD NOT instruction for any but the first condition on an instruction line.

Analyzing the above ladder diagram in terms of mnemonic instructions, the condition for IR 00000 is a LOAD instruction and the condition below it is an AND NOT instruction between the status of IR 00000 and that of IR 00001. The condition for IR 00002 is another LOAD instruction and the condition below it is an OR NOT instruction, i.e., an OR between the status of IR 00002 and the inverse of the status of IR 00003. To arrive at the execution condition for the instruction at the right, the logical AND of the execution conditions resulting from these two blocks would have to be taken. AND LOAD does this. The mnemonic code for the ladder diagram is shown below. The AND LOAD instruction requires no operands of its own, because it operates on previously determined execution conditions. Here too, dashes are used to indicate that no operands need designated outputs.

OR LOAD

The following diagram requires an OR LOAD instruction between the top logic block and the bottom logic block. An ON execution condition would be produced for the instruction at the right either when IR 00000 is ON and IR 00001 is OFF or when IR 00002 and IR 00003 are both ON. The operation of and mnemonic code for the OR LOAD instruction is exactly the same as those for a AND LOAD instruction except that the current execution condition is ORed with the last unused execution condition.

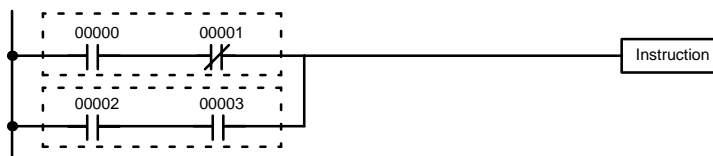

Address	Instruction	Operands
00000	LD	00000
00001	AND NOT	00001
00002	LD	00002
00003	AND	00003
00004	OR LD	---

Naturally, some diagrams will require both AND LOAD and OR LOAD instructions.

divided into logic blocks. Each block is coded using a LOAD instruction to code the first condition, and then AND LOAD or OR LOAD is used to logically combine the blocks. With both AND LOAD and OR LOAD there are two ways to achieve this. One is to code the logic block instruction after the first two blocks and after each additional block. The other is to code all of the blocks to be combined starting each block with LOAD or LOAD NOT, and then to code the logic block instructions which combine them. In this case, the instructions for the last pair of blocks should be combined first, and then each preceding block should be combined, working progressively back to the first block. Although either of these methods will produce exactly the same result, the second method, that of coding all logic block instructions together, can be used only if eight or fewer blocks are being combined, i.e., if seven or fewer logic block instructions are required.

The following diagram requires AND LOAD to be converted to mnemonic code because three pairs of parallel conditions lie in series. The two means of coding the programs are also shown.

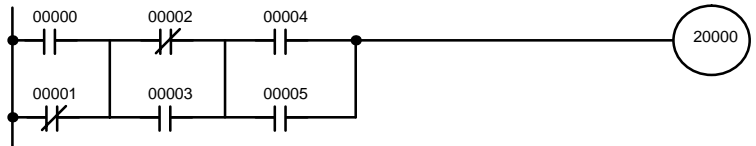

Address	Instruction	Operands
00000	LD	00000
00001	OR NOT	00001
00002	LD NOT	00002
00003	OR	00003
00004	AND LD	—
00005	LD	00004
00006	OR	00005
00007	AND LD	—
00008	OUT	20000

Address	Instruction	Operands
00000	LD	00000
00001	OR NOT	00001
00002	LD NOT	00002
00003	OR	00003
00004	LD	00004
00005	OR	00005
00006	AND LD	—
00007	AND LD	—
00008	OUT	20000

Again, with the method on the right, a maximum of eight blocks can be combined. There is no limit to the number of blocks that can be combined with the first method.

The following diagram requires OR LOAD instructions to be converted to mnemonic code because three pairs of conditions in series lie in parallel to each other.

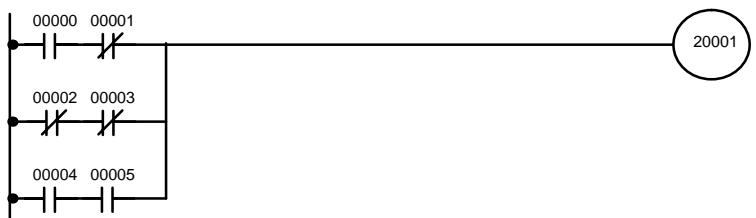

operand and then ANDed with the other condition. The first two blocks can be coded first, followed by OR LOAD, the last block, and another OR LOAD, or the three blocks can be coded first followed by two OR LOADs. The mnemonic coding for both methods is shown below.

Address	Instruction	Operands
00000	LD	00000
00001	AND NOT	00001
00002	LD NOT	00002
00003	AND NOT	00003
00004	OR LD	—
00005	LD	00004
00006	AND	00005
00007	OR LD	—
00008	OUT	20001

Address	Instruction	Operands
00000	LD	00000
00001	AND NOT	00001
00002	LD NOT	00002
00003	AND NOT	00003
00004	LD	00004
00005	AND	00005
00006	OR LD	—
00007	OR LD	—
00008	OUT	20001

Again, with the method on the right, a maximum of eight blocks can be combined. There is no limit to the number of blocks that can be combined with the first method.

Combining AND LOAD and OR LOAD

Both of the coding methods described above can also be used when using AND LOAD and OR LOAD, as long as the number of blocks being combined does not exceed eight.

The following diagram contains only two logic blocks as shown. It is not necessary to further separate block b components, because it can be coded directly with only AND and OR.

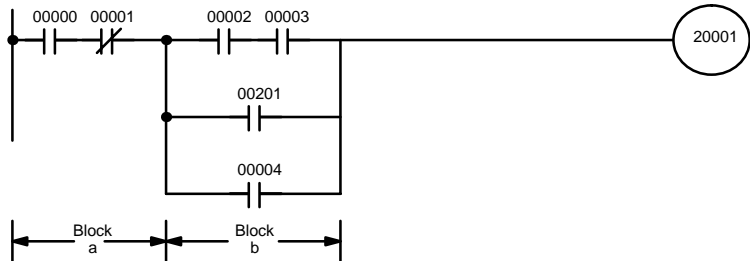

Address	Instruction	Operands
00000	LD	00000
00001	AND NOT	00001
00002	LD	00002
00003	AND	00003
00004	OR	00201
00005	OR	00004
00006	AND LD	—
00007	OUT	20001

Although the following diagram is similar to the one above, block b in the diagram below cannot be coded without separating it into two blocks combined with AND LOAD. In this example, the three blocks have been coded first and then AND LOAD has been used to combine the last two blocks followed by AND LOAD to combine the execution condition produced by the OR LOAD with the execution condition of block a.

they are combining, they must, as shown below, be coded in reverse order, the logic block instruction for the last two blocks is coded first, followed by one to combine the execution condition resulting from the first logic block instruction and the execution condition of the logic block third from the end, on back to the first logic block that is being combined.

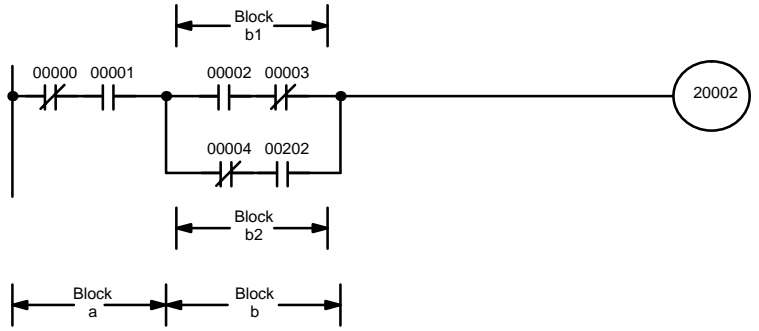

Address	Instruction	Operands
00000	LD NOT	00000
00001	AND	00001
00002	LD	00002
00003	AND NOT	00003
00004	LD NOT	00004
00005	AND	00202
00006	OR LD	—
00007	AND LD	—
00008	OUT	20002

Complicated Diagrams

When determining what logic block instructions will be required to code a diagram, it is sometimes necessary to break the diagram into large blocks and continue breaking the large blocks down until logic blocks that can be coded without logic block instructions have been formed. These blocks are then coded by combining the small blocks first, and then combining the larger blocks. Either AND LOAD or OR LOAD is used to combine the blocks, i.e., AND LOAD or OR LOAD always combines the last two execution conditions that existed, regardless of whether the execution conditions resulted from a single condition, from logic blocks, or from previous logic block instructions.

When working with complicated diagrams, blocks will ultimately be coded starting at the top left and moving down before moving across. This will generally mean that, when there might be a choice, OR LOAD will be coded before AND LOAD.

then broken into two blocks before it can be coded. As shown below, blocks a1 and b1 require an AND LOAD. Before AND LOAD can be used, however, LOAD must be used to combine the top and bottom blocks on both sides, i.e. combine a1 and a2; b1 and b2.

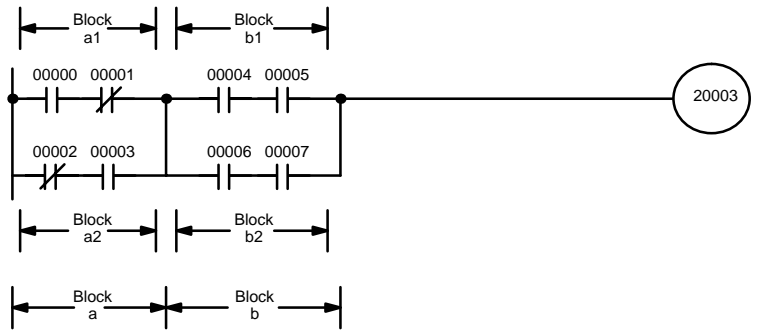

Address	Instruction	Operands
00000	LD	00000
00001	AND NOT	00001
00002	LD NOT	00002
00003	AND	00003
00004	OR LD	—
00005	LD	00004
00006	AND	00005
00007	LD	00006
00008	AND	00007
00009	OR LD	—
00010	AND LD	—
00011	OUT	20003

Blocks a1 and a2

Blocks b1 and b2

Blocks a and b

The following type of diagram can be coded easily if each block is coded in order first top to bottom and then left to right. In the following diagram, blocks a and b would be combined using AND LOAD as shown above, and then block c would be coded and a second AND LOAD would be used to combine it with the execution condition from the first AND LOAD. Then block d would be coded, a third AND LOAD would be used to combine the execution condition from block d with the execution condition from the second AND LOAD, and so on through to block n.

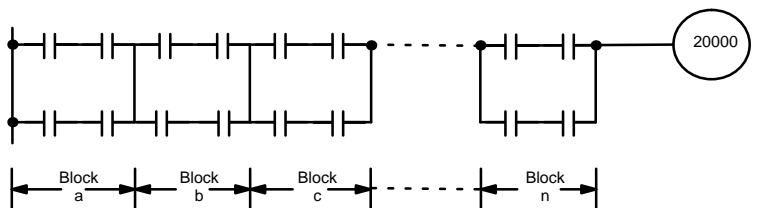

monic code.

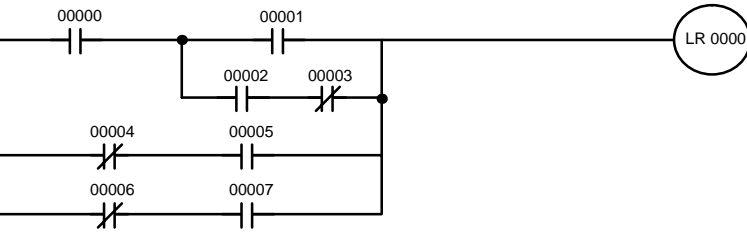

Address	Instruction	Operands
00000	LD	00000
00001	LD	00001
00002	LD	00002
00003	AND NOT	00003
00004	OR LD	-
00005	AND LD	-
00006	LD NOT	00004
00007	AND	00005
00008	OR LD	-
00009	LD NOT	00006
00010	AND	00007
00011	OR LD	-
00012	OUT	LR 0000

Although the program will execute as written, this diagram could be drawn as shown below to eliminate the need for the first OR LOAD and the AND LOAD, simplifying the program and saving memory space.

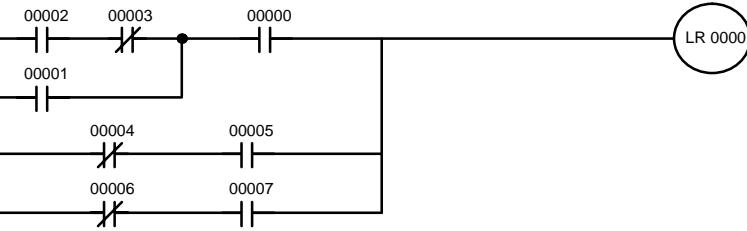

Address	Instruction	Operands
00000	LD	00002
00001	AND NOT	00003
00002	OR	00001
00003	AND	00000
00004	LD NOT	00004
00005	AND	00005
00006	OR LD	-
00007	LD NOT	00006
00008	AND	00007
00009	OR LD	-
00010	OUT	LR 0000

The following diagram requires five blocks, which here are coded in order by using OR LOAD and AND LOAD to combine them starting from the last block and working backward. The OR LOAD at program address 00008 combines blocks d and e, the following AND LOAD combines the resulting execution condition with that of block c, etc.

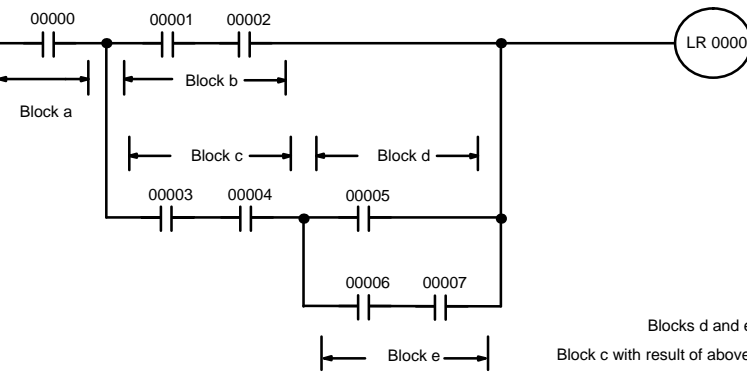

Blocks d and e
Block c with result of above
Block b with result of above
Block a with result of above

Address	Instruction	Operands
00000	LD	00000
00001	LD	00001
00002	AND	00002
00003	LD	00003
00004	AND	00004
00005	LD	00005
00006	LD	00006
00007	AND	00007
00008	OR LD	--
00009	AND LD	--
00010	OR LD	--
00011	AND LD	--
00012	OUT	LR 0000

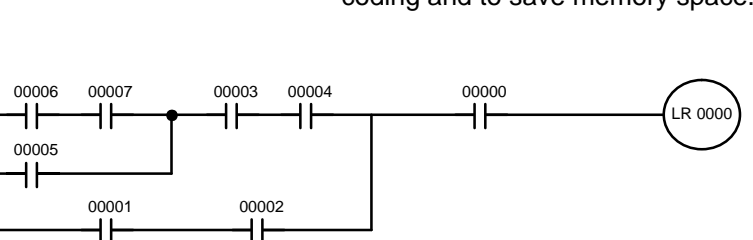

Address	Instruction	Operands
00000	LD	00006
00001	AND	00007
00002	OR	00005
00003	AND	00003
00004	AND	00004
00005	LD	00005
00006	AND	00001
00007	OR LD	
00008	AND	00002
00009	OUT	LR 0000

The next and final example may at first appear very complicated but can be coded using only two logic block instructions. The diagram appears as follows:

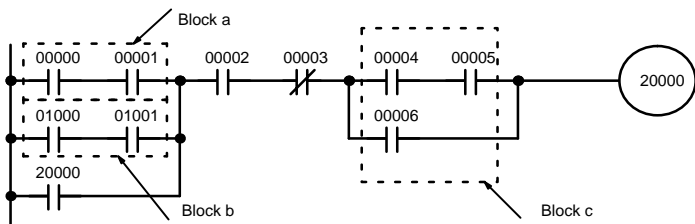

The first logic block instruction is used to combine the execution conditions resulting from blocks a and b, and the second one is to combine the execution condition of block c with the execution condition resulting from the normally closed condition assigned IR 00003. The rest of the diagram can be coded using OR, AND, and AND NOT instructions. The logical flow for this and the resulting code are shown below.

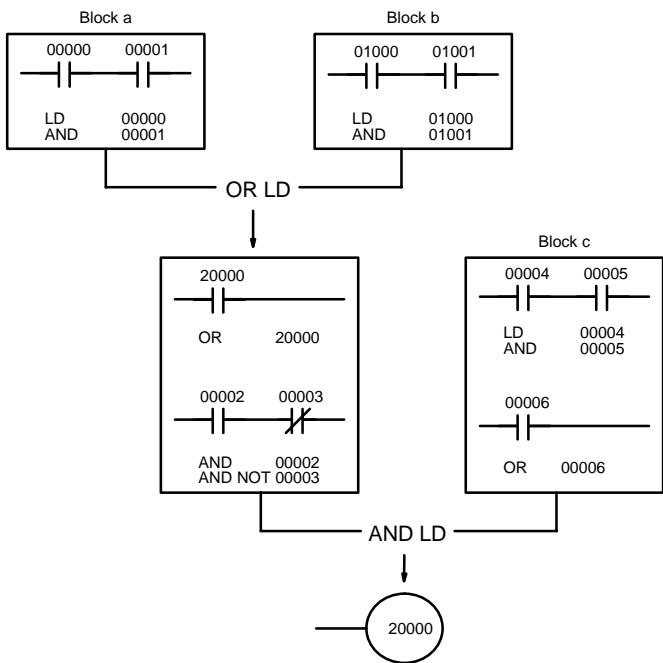

Address	Instruction	Operands
00000	LD	00000
00001	AND	00001
00002	LD	01000
00003	AND	01001
00004	OR LD	--
00005	OR	20000
00006	AND	00002
00007	AND NOT	00003
00008	LD	00004
00009	AND	00005
00010	OR	00006
00011	AND LD	--
00012	OUT	20000

If there is more than one right-hand instruction executed with the same execution condition, they are coded consecutively following the last condition on the instruction line. In the following example, the last instruction line contains more condition that corresponds to an AND with IR 00004.

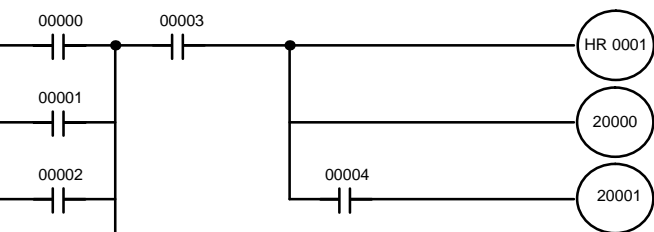

Address	Instruction	Operands
00000	LD	00000
00001	OR	00001
00002	OR	00002
00003	OR	HR 0000
00004	AND	00004
00005	OUT	HR 0001
00006	OUT	20000
00007	AND	00001
00008	OUT	20001

3-8 Branching Instruction Lines

When an instruction line branches into two or more lines, it is sometimes necessary to use either interlocks or TR bits to maintain the execution condition that existed at a branching point. This is because instruction lines are executed across to a right-hand instruction before returning to the branching point to execute instructions one a branch line. If a condition exists on any of the instruction lines after the branching point, the execution condition could change during this time making proper execution impossible. The following diagrams illustrate this. In both diagrams, instruction 1 is executed before returning to the branching point and moving on to the branch line leading to instruction 2.

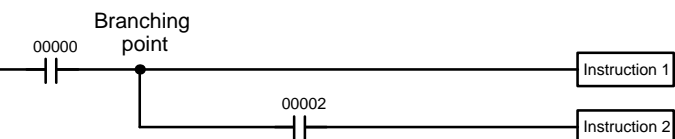

Diagram A: Correct Operation

Address	Instruction	Operands
00000	LD	00000
00001	Instruction 1	
00002	AND	00002
00003	Instruction 2	

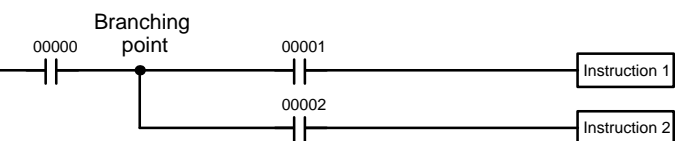

Diagram B: Incorrect Operation

Address	Instruction	Operands
00000	LD	00000
00001	AND	00001
00002	Instruction 1	
00003	AND	00002
00004	Instruction 2	

If, as shown in diagram A, the execution condition that existed at the branching point cannot be changed before returning to the branch line (instructions as far right do not change the execution condition), then the branch line will be executed correctly and no special programming measure is required.

If, as shown in diagram B, a condition exists between the branching point and the last instruction on the top instruction line, the execution condition at the branching point and the execution condition after completing the top instruction line can sometimes be different, making it impossible to ensure correct execution on the branch line.

There are two means of programming branching programs to preserve the execution condition. One is to use TR bits; the other, to use interlocks (IL(02)/IL(03)).

family preserve execution conditions: if a TR bit is placed at a branching point, the current execution condition will be stored at the designated TR bit. When returning to the branching point, the TR bit restores the execution status that was saved when the branching point was first reached in program execution.

The previous diagram B can be written as shown below to ensure correct execution. In mnemonic code, the execution condition is stored at the branching point using the TR bit as the operand of the OUTPUT instruction. This execution condition is then restored after executing the right-hand instruction by using the same TR bit as the operand of a LOAD instruction

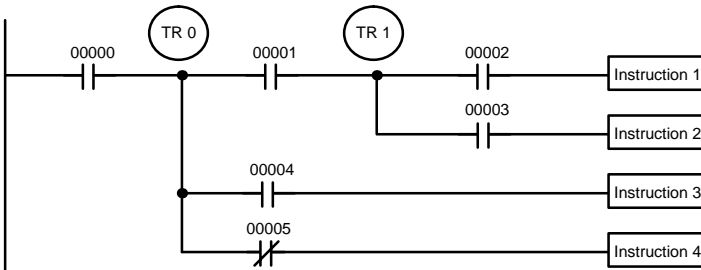

Diagram B: Corrected Using a TR bit

Address	Instruction	Operands
00000	LD	00000
00001	OUT	TR 0
00002	AND	00001
00003	Instruction 1	
00004	LD	TR 0
00005	AND	00002
00006	Instruction 2	

In terms of actual instructions the above diagram would be as follows: The status of IR 00000 is loaded (a LOAD instruction) to establish the initial execution condition. This execution condition is then output using an OUTPUT instruction to TR 0 to store the execution condition at the branching point. The execution condition is then ANDed with the status of IR 00001 and instruction 1 is executed accordingly. The execution condition that was stored at the branching point is then re-loaded (a LOAD instruction with TR 0 as the operand), this is ANDed with the status of IR 00002, and instruction 2 is executed accordingly.

The following example shows an application using two TR bits.



Address	Instruction	Operands
00000	LD	00000
00001	OUT	TR 0
00002	AND	00001
00003	OUT	TR 1
00004	AND	00002
00005	Instruction 1	
00006	LD	TR 0
00007	AND	00003
00008	Instruction 2	
00009	LD	TR 0
00010	AND	00004
00011	Instruction 3	
00012	LD	TR 0
00013	AND NOT	00005
00014	Instruction 4	

In this example, TR 0 and TR 1 are used to store the execution conditions at branching points. After executing instruction 1, the execution condition stored in TR 1 is loaded for an AND with the status IR 00003. The execution condition stored in TR 0 is loaded twice, the first time for an AND with the status of IR 00004 and the second time for an AND with the inverse of the status of IR 00005.

used more than once in the same instruction block. Here, a new instruction block is begun each time execution returns to the bus bar. If, in a single instruction block, it is necessary to have more than eight branching points that require an execution condition be saved, interlocks (which are described next) must be used.

When drawing a ladder diagram, be careful not to use TR bits unless necessary. Often the number of instructions required for a program can be reduced and the ease of understanding a program increased by redrawing a diagram that would otherwise require TR bits. In both of the following pairs of diagrams, the bottom versions require fewer instructions and do not require TR bits. In the first example, this is achieved by reorganizing the parts of the instruction block: the bottom one, by separating the second OUTPUT instruction and using another LOGIC instruction to create the proper execution condition for it.

Note Although simplifying programs is always a concern, the order of execution of instructions is sometimes important. For example, a MOVE instruction may be required before the execution of a BINARY ADD instruction to place the proper data in the required operand word. Be sure that you have considered execution order before reorganizing a program to simplify it.

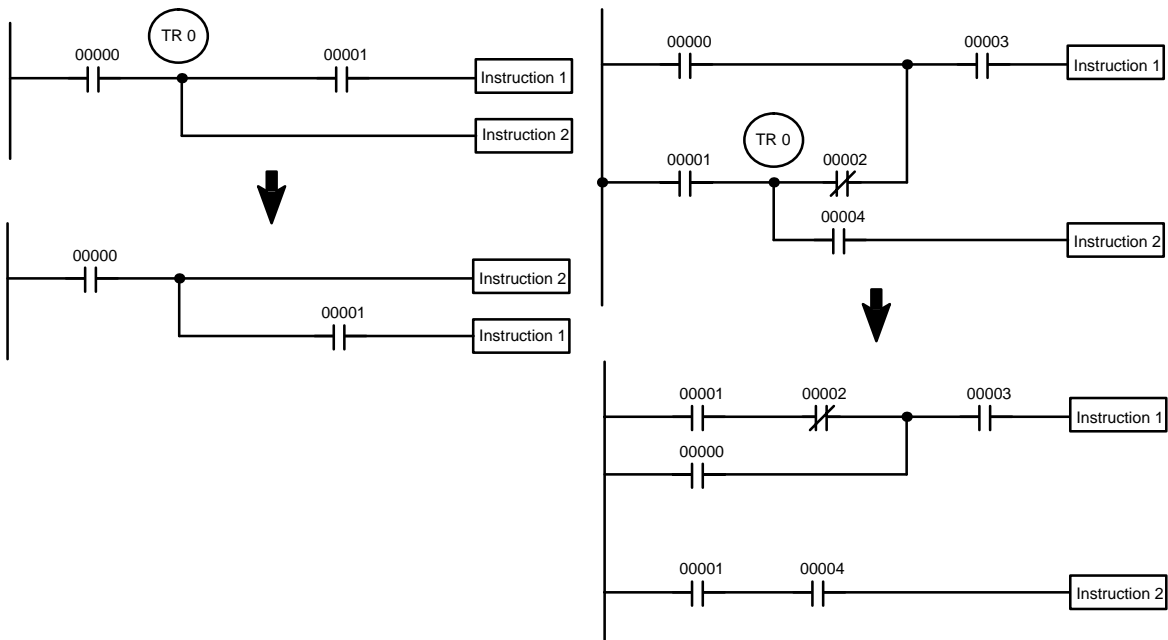

Note TR bits are must be input by the user only when programming using mnemonic code. They are not necessary when inputting ladder diagrams directly because they are processed for you automatically. The above limitations on the number of branching points requiring TR bits, and considerations on methods to reduce the number of programming instructions, still hold.

Interlocks

The problem of storing execution conditions at branching points can also be handled by using the INTERLOCK (IL(02)) and INTERLOCK CLEAR (ILC(02)) instructions to eliminate the branching point completely while allowing a specific execution condition to control a group of instructions. The INTERLOCK and INTERLOCK CLEAR instructions are always used together.

gram, the execution condition for the INTERLOCK instruction will control the execution of all instruction up to the next INTERLOCK CLEAR instruction. If the execution condition for the INTERLOCK instruction is OFF, all right-hand instructions through the next INTERLOCK CLEAR instruction will be executed with OFF execution conditions to reset the entire section of the ladder diagram. The effect that this has on particular instructions is described in 7-11 INTERLOCK and INTERLOCK CLEAR – IL(02) and ILC(03).

Diagram B can also be corrected with an interlock. Here, the conditions leading up to the branching point are placed on an instruction line for the INTERLOCK instruction, all of lines leading from the branching point are written as separate instruction lines, and another instruction line is added for the INTERLOCK CLEAR instruction. No conditions are allowed on the instruction line for INTERLOCK CLEAR. Note that neither INTERLOCK nor INTERLOCK CLEAR requires an operand.



Address	Instruction	Operands
00000	LD	00000
00001	IL(02)	---
00002	LD	00001
00003	Instruction 1	
00004	LD	00002
00005	Instruction 2	
00006	ILC(03)	---

If IR 00000 is ON in the revised version of diagram B, above, the status of IR 00001 and that of IR 00002 would determine the execution conditions for instructions 1 and 2, respectively. Because IR 00000 is ON, this would produce the same results as ANDing the status of each of these bits. If IR 00000 is OFF, the INTERLOCK instruction would produce an OFF execution condition for instructions 1 and 2 and then execution would continue with the instruction following the INTERLOCK CLEAR instruction.

As shown in the following diagram, more than one INTERLOCK instruction can be used within one instruction block; each is effective through the next INTERLOCK CLEAR instruction.

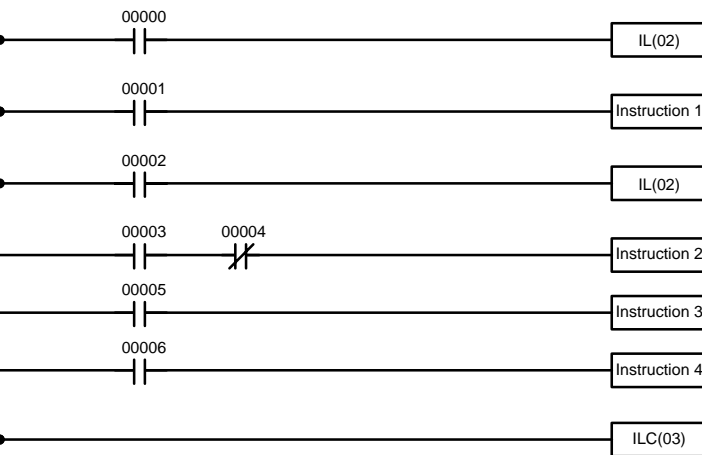

Address	Instruction	Operands
00000	LD	00000
00001	IL(02)	---
00002	LD	00001
00003	Instruction 1	
00004	LD	00002
00005	IL(02)	---
00006	LD	00003
00007	AND NOT	00004
00008	Instruction 2	
00009	LD	00005
00010	Instruction 3	
00011	LD	00006
00012	Instruction 4	
00013	ILC(03)	---

first INTERLOCK instruction is OFF), instructions 1 through 4 would be executed with OFF execution conditions and execution would move to instruction following the INTERLOCK CLEAR instruction. If IR 00000 is ON, status of IR 00001 would be loaded as the execution condition for instruction 1 and then the status of IR 00002 would be loaded to form the execution condition for the second INTERLOCK instruction. If IR 00002 is OFF, instructions 1 through 4 will be executed with OFF execution conditions. If IR 00002 is ON, IR 00003, IR 00005, and IR 00006 will determine the first execution condition for new instruction lines.

3-9 Jumps

A specific section of a program can be skipped according to a designated execution condition. Although this is similar to what happens when the execution condition for an INTERLOCK instruction is OFF, with jumps, the operands for instructions maintain status. Jumps can therefore be used to control devices that require a sustained output, e.g., pneumatics and hydraulics, whereas interlocks can be used to control devices that do not require a sustained output, e.g., electronic instruments.

Jumps are created using the JUMP (JMP(04)) and JUMP END (JME(05)) instructions. If the execution condition for a JUMP instruction is ON, the program is executed normally as if the jump did not exist. If the execution condition for a JUMP instruction is OFF, program execution moves immediately to a JUMP END instruction without changing the status of anything between the JUMP and JUMP END instruction.

All JUMP and JUMP END instructions are assigned jump numbers ranging between 00 and 99. There are two types of jumps. The jump number used determines the type of jump.

A jump can be defined using jump numbers 01 through 99 only once, i.e., each of these numbers can be used once in a JUMP instruction and once in a JUMP END instruction. When a JUMP instruction assigned one of these numbers is executed, execution moves immediately to the JUMP END instruction that has the same number as if all of the instructions between them did not exist. Diagram B from the TR bit and interlock example could be redrawn as shown below using a jump. Although 01 has been used as the jump number, any number between 01 and 99 could be used as long as it has not already been used in a different part of the program. JUMP and JUMP END require no other operand and JUMP END never has conditions on the instruction line leading to it.

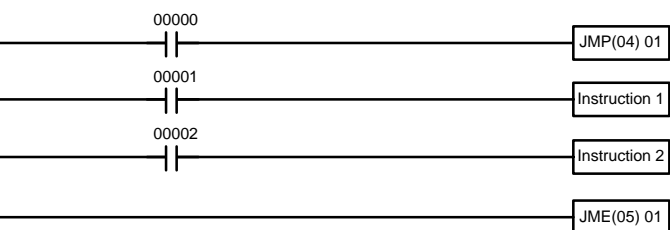

Diagram B: Corrected with a Jump

Address	Instruction	Operands
00000	LD	00000
00001	JMP(04)	
00002	LD	00002
00003	Instruction 1	
00004	LD	00004
00005	Instruction 2	
00006	JME(05)	

This version of diagram B would have a shorter execution time when IR 00002 was OFF than any of the other versions.

desired can be created using jump number 00 and JUMP instructions using 00. JUMP instructions can be used consecutively without a JUMP END using 00 between them. It is even possible for all JUMP 00 instructions to move program execution to the same JUMP END 00, i.e., only one JUMP END 00 instruction is required for all JUMP 00 instructions in the program. When 00 is used as the jump number in a JUMP instruction, program execution moves to the instruction following the JUMP instruction with a jump number of 00. Although, as in all jumps, the status is changed and no instructions are executed between the JUMP 00 and the JUMP END 00 instructions, the program must search for the next JUMP END 00 instruction, producing a slightly longer execution time.

Execution of programs containing multiple JUMP 00 instructions for one JUMP END 00 instruction is similar to that of interlocked sections. The following program is the same as that used for the interlock example above, except redesigned with jumps. The execution of this diagram would differ from that of the diagram described above (e.g., in the previous diagram interlocks would reset certain parts of the interlocked section, however, jumps do not affect the status of any bits between the JUMP and JUMP END instructions).

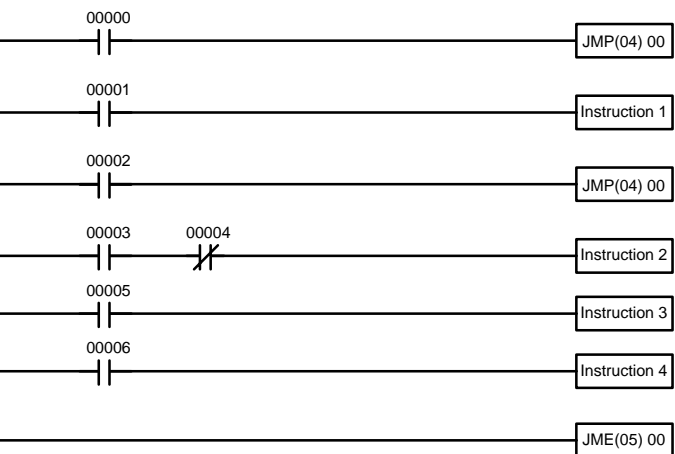

Address	Instruction	Operands
00000	LD	00000
00001	JMP(04)	
00002	LD	00002
00003	Instruction 1	
00004	LD	00004
00005	JMP(04)	
00006	LD	00006
00007	AND NOT	00004
00008	Instruction 2	
00009	LD	00009
00010	Instruction 3	
00011	LD	00011
00012	Instruction 4	
00013	JME(05)	

4 Controlling Bit Status

There are seven basic instructions that can be used generally to control individual bit status. These are the OUTPUT, OUTPUT NOT, SET, RESET, DIFFERENTIATE UP, DIFFERENTIATE DOWN, and KEEP instructions. All of these instructions appear as the last instruction in an instruction line and take a bit address for an operand. Although details are provided in *7-8 Bit Control Instructions*, these instructions (except for OUTPUT and OUTPUT NOT, which have already been introduced) are described here because of their importance in most programs. Although these instructions are used to turn ON and OFF output bits in the IR area (i.e., to send or stop output signals to external devices), they are also used to control the status of other bits in the IR area or in other areas.

4-1 SET and RESET

The SET and RESET instructions are very similar to the OUTPUT and OUTPUT NOT instructions except that they only change the status of their operand bit when execution conditions are ON. Neither instructions will affect the status of its operand bit when the execution condition is OFF.

like the OUTPUT ON instruction, SET will not turn ON the operand bit when the execution condition goes OFF. RESET will turn OFF the operand bit when the execution condition goes OFF, but unlike OUTPUT NOT, RESET will not turn the operand bit when the execution condition goes OFF.

In the following example, IR 20000 will be turned ON when IR 00100 goes ON and will remain ON until IR 00101 goes ON, regardless of the status of IR 00100. When IR 00101 goes ON, RESET will turn IR 20000 OFF.

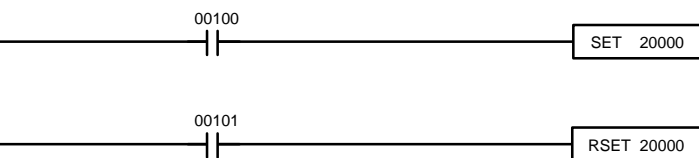

Address	Instruction	Operands
00000	LD	00100
00001	SET	20000
00002	LD	00101
00003	RSET	20000

Note SET and RSET do not have function codes. To input them from the Programming Console, press the FUN and SET Keys or FUN and RSET Keys followed by the bit address.

4-2 DIFFERENTIATE UP and DIFFERENTIATE DOWN

DIFFERENTIATE UP and DIFFERENTIATE DOWN instructions are used to turn the operand bit ON for one cycle at a time. The DIFFERENTIATE UP instruction turns ON the operand bit for one cycle after the execution condition for it goes from OFF to ON; the DIFFERENTIATE DOWN instruction turns OFF the operand bit for one cycle after the execution condition for it goes from ON to OFF. Both of these instructions require only one line of mnemonic code.

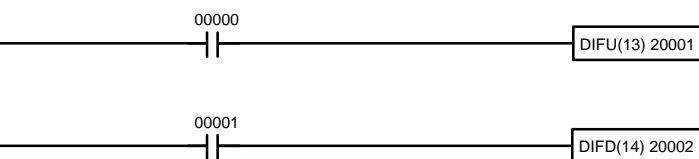

Address	Instruction	Operands
00000	LD	00000
00001	DIFU(13)	20001

Address	Instruction	Operands
00000	LD	00001
00001	DIFD(14)	20002

Here, IR 20001 will be turned ON for one cycle after IR 00000 goes ON. The next time DIFU(13) 20001 is executed, IR 20001 will be turned OFF, regardless of the status of IR 00000. With the DIFFERENTIATE DOWN instruction, IR 20002 will be turned ON for one cycle after IR 00001 goes OFF (IR 20002 will be kept ON until then), and will be turned OFF the next time DIFD(14) 20002 is executed.

4-3 KEEP

The KEEP instruction is used to maintain the status of the operand bit based on two execution conditions. To do this, the KEEP instruction is connected to two instruction lines. When the execution condition at the end of the first instruction line is ON, the operand bit of the KEEP instruction is turned ON. When the execution condition at the end of the second instruction line is ON, the operand bit of the KEEP instruction is turned OFF. The operand bit for the KEEP instruction will maintain its ON or OFF status even if it is located in an interlocked condition of the diagram.

00003 is OFF, HR 0000 will remain ON until either IR 00004 or IR 00005 turns ON. With KEEP, as with all instructions requiring more than one instruction line, the instruction lines are coded first before the instruction that they control.

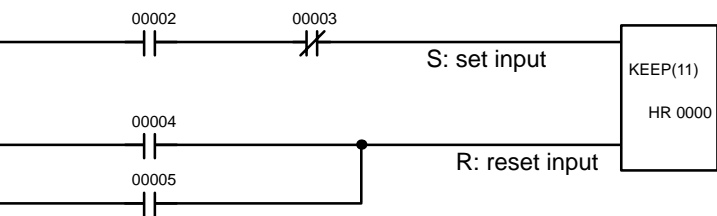

Address	Instruction	Operands
00000	LD	0000
00001	AND NOT	0000
00002	LD	0000
00003	OR	0000
00004	KEEP(11)	HR 0000

4-4 Self-maintaining Bits (Seal)

Although the KEEP instruction can be used to create self-maintaining bits, sometimes necessary to create self-maintaining bits in another way so that they can be turned OFF when in an interlocked section of a program.

To create a self-maintaining bit, the operand bit of an OUTPUT instruction is used as a condition for the same OUTPUT instruction in an OR setup so that the operand bit of the OUTPUT instruction will remain ON or OFF until changes occur in other bits. At least one other condition is used just before the OUTPUT instruction to function as a reset. Without this reset, there would be no way to control the operand bit of the OUTPUT instruction.

The above diagram for the KEEP instruction can be rewritten as shown below. The only difference in these diagrams would be their operation in an interlocked program section when the execution condition for the INTERLOCK instruction was ON. Here, just as in the same diagram using the KEEP instruction, two reset bits are used, i.e., HR 0000 can be turned OFF by turning ON either IR 00004 or IR 00005.

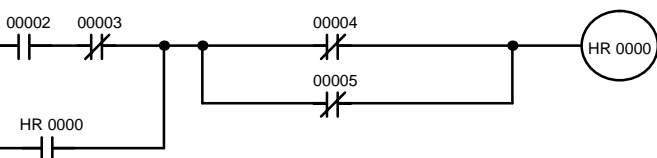

Address	Instruction	Operands
00000	LD	0000
00001	AND NOT	0000
00002	OR	HR 0000
00003	AND NOT	0000
00004	OR NOT	0000
00005	AND LD	-
00006	OUT	HR 0000

5 Work Bits (Internal Relays)

In programming, combining conditions to directly produce execution conditions is often extremely difficult. These difficulties are easily overcome, however, using certain bits to trigger other instructions indirectly. Such programming is achieved by using work bits. Sometimes entire words are required for these purposes. These words are referred to as work words.

Work bits are not transferred to or from the PC. They are bits selected by the programmer to facilitate programming as described above. I/O bits and dedicated bits cannot be used as work bits. All bits in the IR area that are not allocated as I/O bits, and certain unused bits in the AR area, are available for use as work bits. Be careful to keep an accurate record of how and where you use work bits. This helps in program planning and writing, and also aids in debugging operations.

employ work bits. These should act as a guide to the almost limitless number of ways in which the work bits can be used. Whenever difficulties arise in programming a control action, consideration should be given to work bits and how they might be used to simplify programming.

Work bits are often used with the OUTPUT, OUTPUT NOT, DIFFERENTIATE UP, DIFFERENTIATE DOWN, and KEEP instructions. The work bit is used as the operand for one of these instructions so that later it can be used as a condition that will determine how other instructions will be executed. Work bits can also be used with other instructions, e.g., with the SHIFT REGISTER instruction (SFT(10)). An example of the use of work words and bits with the SHIFT REGISTER instruction is provided in 7-16-1 SHIFT REGISTER INSTRUCTION (SFT(10)).

Although they are not always specifically referred to as work bits, many of the bits used in the examples in Section 7 Instruction Set use work bits. Understanding the use of these bits is essential to effective programming.

Producing Complex Conditions

Work bits can be used to simplify programming when a certain combination of conditions is repeatedly used in combination with other conditions. In the following example, IR 00000, IR 00001, IR 00002, and IR 00003 are combined in a logic block that stores the resulting execution condition as the status of IR 21600. IR 21600 is then combined with various other conditions to determine output conditions for IR 20000, IR 20001, and IR 20002, i.e., to turn the outputs allocated to these bits ON or OFF.

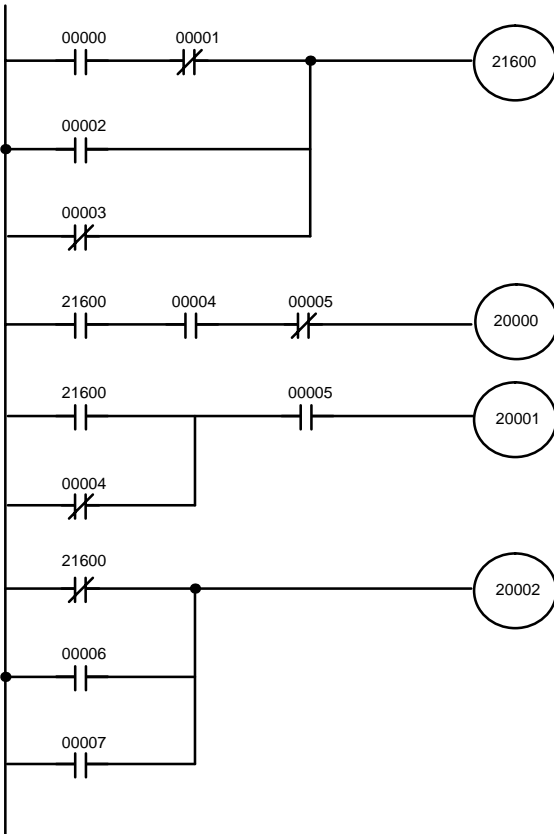

Address	Instruction	Operands
00000	LD	00000
00001	AND NOT	00001
00002	OR	00002
00003	OR NOT	00003
00004	OUT	21600
00005	LD	21600
00006	AND	00004
00007	AND NOT	00005
00008	OUT	20000
00009	LD	21600
00010	OR NOT	00004
00011	AND	00005
00012	OUT	20001
00013	LD NOT	21600
00014	OR	00006
00015	OR	00007
00016	OUT	20002

all, or the conditions required for execution of an instruction. In this example, IR 20000 must be left ON continuously as long as IR 001001 is ON and IR 00002 and IR 00003 are OFF, or as long as IR 00004 is ON and IR 00005 is OFF. It must be turned ON for only one cycle each time IR 00000 turns ON (less one of the preceding conditions is keeping it ON continuously).

This action is easily programmed by using IR 22500 as a work bit as the operand of the DIFFERENTIATE UP instruction (DIFU(13)). When IR 00000 turns ON, IR 22500 will be turned ON for one cycle and then be turned OFF the next cycle by the DIFU(13). Assuming the other conditions controlling IR 20000 are not kept ON, the work bit IR 22500 will turn IR 20000 ON for one cycle only.

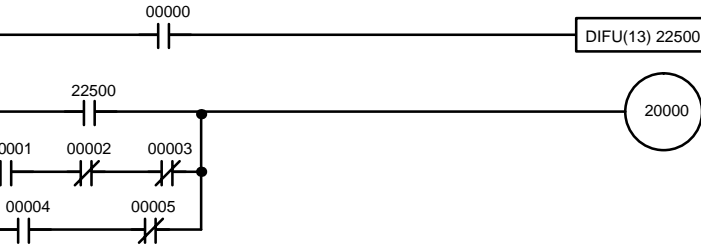

Address	Instruction	Operands
00000	LD	00000
00001	DIFU(13)	22500
00002	LD	22500
00003	LD	00001
00004	AND NOT	00001
00005	AND NOT	00005
00006	OR LD	
00007	LD	00004
00008	AND NOT	00005
00009	OR LD	
00010	OUT	20000

6 Programming Precautions

The number of conditions that can be used in series or parallel is unlimited, as long as the memory capacity of the PC is not exceeded. Therefore, use as many conditions as required to draw a clear diagram. Although very complicated diagrams can be drawn with instruction lines, there must not be any condition lines running vertically between two other instruction lines. Diagram A shown below, for example, is not possible, and should be drawn as diagram B. Mnemonic code is provided for diagram B only; coding diagram A would be impossible.

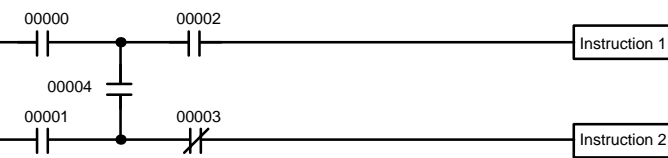

Diagram A: Not Programmable

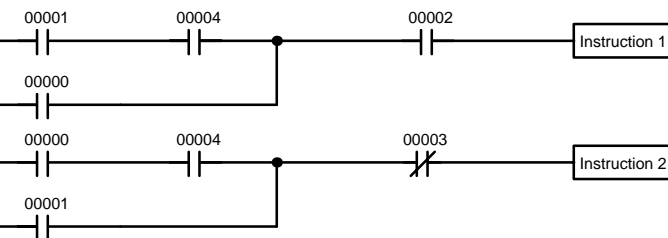

Diagram B: Correct Version

Address	Instruction	Operands
00000	LD	00001
00001	AND	00004
00002	OR	00002
00003	AND	00003
00004	Instruction 1	
00005	LD	00000
00006	AND	00004
00007	OR	00002
00008	AND NOT	00003
00009	Instruction 2	

ted, so use them as many times as required to simplify your program. Complicated programs are the result of attempts to reduce the number of times a bit is used.

Except for instructions for which conditions are not allowed (e.g., INTERLOCK CLEAR and JUMP END, see below), every instruction line must also have at least one condition on it to determine the execution condition for the instruction at the right. Again, diagram A, below, must be drawn as diagram B. If an instruction must be continuously executed (e.g., if an output must always be kept on while the program is being executed), the Always ON Flag (SR 25313) in the instruction area can be used.



Diagram A: Not Programmable for Most Instructions

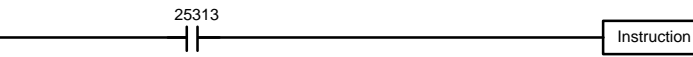

Diagram B: Correct Version

Address	Instruction	Operands
00000	LD	25313
00001	Instruction	

There are a few exceptions to this rule, including the INTERLOCK CLEAR and JUMP END, and step instructions. Each of these instructions is used as the second condition of a pair of instructions and is controlled by the execution condition of the first of the pair. Conditions should not be placed on the instruction lines leading to these instructions. Refer to *Section 7 Instruction Set* for details.

When drawing ladder diagrams, it is important to keep in mind the number of instructions that will be required to input it. In diagram A, below, an OR LOAD instruction will be required to combine the top and bottom instruction lines. This can be avoided by redrawing as shown in diagram B so that no AND LOAD or OR LOAD instructions are required. Refer to *7-7-2 AND LOAD and OR LOAD* for more details.

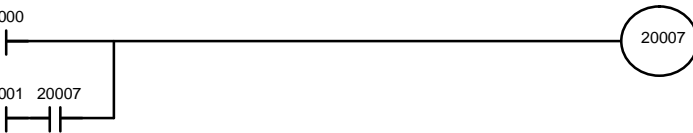

Diagram A

Address	Instruction	Operands
00000	LD	000
00001	LD	001
00002	AND	20007
00003	OR LD	
00004	OUT	20007

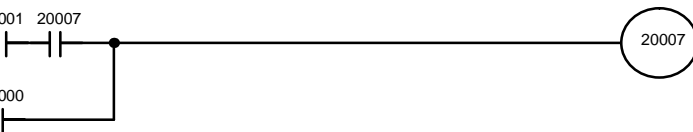

Diagram B

Address	Instruction	Operands
00000	LD	001
00001	AND	20007
00002	OR	000
00003	OUT	20007

When program execution is started, the CPU Unit scans the program from top to bottom, checking all conditions and executing all instructions accordingly. The program counter moves down the bus bar. It is important that instructions be placed in the program order so that, for example, the desired data is moved to a word before that word is used as the operand for an instruction. Remember that an instruction line is not completed to the terminal instruction at the right before executing an instruction. Lines branching from the first instruction line to other terminal instructions are also at the right.

Program execution is only one of the tasks carried out by the CPU Unit as part of the cycle time. Refer to *Section 8 PC Operations and Processing Time* for details.

CPM1, CPM1A, CPM2A, CPM2C (including the CPM2C-S), and SRM1(-V2) PCs have large programming instructions that allow for easy programming of complicated control processes. This section explains instructions individually and provides the ladder diagram symbol, data areas, and flags used with each.

Many instructions provided by these PCs are organized in the following subsections by instruction group. These groups include Ladder Diagram Instructions, instructions with fixed function codes, and set instructions.

Some instructions, such as Timer and Counter instructions, are used to control execution of other instructions, e.g., a Completion Flag might be used to turn ON a bit when the time period set for the timer has expired. Although these instructions are often used to control output bits through the Output instruction, they can be used to control execution of other instructions as well. The Output instructions used in examples in this manual can therefore generally be replaced by other instructions to modify the program for specific applications other than controlling output bits directly.

7-1	Notation	360
7-2	Instruction Format	360
7-3	Data Areas, Definer Values, and Flags	360
7-4	Differentiated Instructions	362
7-5	Coding Right-hand Instructions	363
7-6	Instruction Tables	366
7-6-1	CPM1/CPM1A Function Codes	366
7-6-2	CPM2A/CPM2C Function Codes	367
7-6-3	SRM1(-V2) Function Codes	368
7-6-4	Alphabetic List by Mnemonic	369
7-7	Ladder Diagram Instructions	372
7-7-1	LOAD, LOAD NOT, AND, AND NOT, OR, and OR NOT	372
7-7-2	AND LOAD and OR LOAD	373
7-8	Bit Control Instructions	373
7-8-1	OUTPUT and OUTPUT NOT – OUT and OUT NOT	373
7-8-2	SET and RESET – SET and RSET	374
7-8-3	KEEP – KEEP(11)	375
7-8-4	DIFFERENTIATE UP and DOWN – DIFU(13) and DIFD(14)	376
7-9	NO OPERATION – NOP(00)	377
7-10	END – END(01)	377
7-11	INTERLOCK and INTERLOCK CLEAR – IL(02) and ILC(03)	377
7-12	JUMP and JUMP END – JMP(04) and JME(05)	379
7-13	User Error Instructions: FAILURE ALARM AND RESET – FAL(06) and SEVERE FAILURE ALARM – FALS(07)	381
7-14	Step Instructions: STEP DEFINE and STEP START–STEP(08)/SNXT(09)	381
7-15	Timer and Counter Instructions	384
7-15-1	TIMER – TIM	385
7-15-2	HIGH-SPEED TIMER – TIMH(15)	386
7-15-3	VERY HIGH-SPEED TIMER: TMHH(—)	387
7-15-4	LONG TIMER: TIML(—)	388
7-15-5	COUNTER – CNT	390
7-15-6	REVERSIBLE COUNTER – CNTR(12)	391
7-15-7	REGISTER COMPARISON TABLE – CTBL(63)	392
7-15-8	MODE CONTROL – INI(61)	395
7-15-9	HIGH-SPEED COUNTER PV READ – PRV(62)	397

7-16-1	SHIFT REGISTER – SFT(16)	400
7-16-2	WORD SHIFT – WSFT(16)	401
7-16-3	ARITHMETIC SHIFT LEFT – ASL(25)	401
7-16-4	ARITHMETIC SHIFT RIGHT – ASR(26)	402
7-16-5	ROTATE LEFT – ROL(27)	402
7-16-6	ROTATE RIGHT – ROR(28)	403
7-16-7	ONE DIGIT SHIFT LEFT – SLD(74)	404
7-16-8	ONE DIGIT SHIFT RIGHT – SRD(75)	404
7-16-9	REVERSIBLE SHIFT REGISTER – SFTR(84)	405
7-16-10	ASYNCHRONOUS SHIFT REGISTER – ASFT(17)	406
7-17	Data Movement Instructions	407
7-17-1	MOVE – MOV(21)	407
7-17-2	MOVE NOT – MVN(22)	408
7-17-3	BLOCK TRANSFER – XFER(70)	409
7-17-4	BLOCK SET – BSET(71)	410
7-17-5	DATA EXCHANGE – XCHG(73)	411
7-17-6	SINGLE WORD DISTRIBUTE – DIST(80)	411
7-17-7	DATA COLLECT – COLL(81)	413
7-17-8	MOVE BIT – MOVB(82)	415
7-17-9	MOVE DIGIT – MOVD(83)	416
7-18	Data Control Instructions	417
7-18-1	SCALING – SCL(66)	417
7-18-2	SIGNED BINARY TO BCD SCALING – SCL2(—)	418
7-18-3	BCD TO SIGNED BINARY SCALING – SCL3(—)	420
7-18-4	PID CONTROL – PID(—)	422
7-19	Comparison Instructions	428
7-19-1	COMPARE – CMP(20)	428
7-19-2	TABLE COMPARE – TCMP(85)	429
7-19-3	BLOCK COMPARE – BCMP(68)	430
7-19-4	DOUBLE COMPARE – CMPL(60)	432
7-19-5	AREA RANGE COMPARE – ZCP(—)	433
7-19-6	DOUBLE AREA RANGE COMPARE – ZCPL(—)	434
7-20	Conversion Instructions	435
7-20-1	BCD-TO-BINARY – BIN(23)	435
7-20-2	BINARY-TO-BCD – BCD(24)	436
7-20-3	DOUBLE BCD-TO-DOUBLE BINARY – BINL(58)	436
7-20-4	DOUBLE BINARY-TO-DOUBLE BCD – BCDL(59)	437
7-20-5	4-TO-16 DECODER – MLPX(76)	438
7-20-6	16-TO-4 ENCODER – DMPX(77)	440
7-20-7	7-SEGMENT DECODER – SDEC(78)	442
7-20-8	ASCII CONVERT – ASC(86)	445
7-20-9	ASCII-TO-HEXADECIMAL – HEX(—)	447
7-20-10	HOURS-TO-SECONDS – SEC(—)	449
7-20-11	SECONDS-TO-HOURS – HMS(—)	450
7-20-12	2’S COMPLEMENT – NEG(—)	451
7-21	BCD Calculation Instructions	453
7-21-1	SET CARRY – STC(40)	453
7-21-2	CLEAR CARRY – CLC(41)	453
7-21-3	BCD ADD – ADD(30)	453
7-21-4	BCD SUBTRACT – SUB(31)	454
7-21-5	BCD MULTIPLY – MUL(32)	456
7-21-6	BCD DIVIDE – DIV(33)	457
7-21-7	DOUBLE BCD ADD – ADDL(54)	458
7-21-8	DOUBLE BCD SUBTRACT – SUBL(55)	460
7-21-9	DOUBLE BCD MULTIPLY – MULL(56)	462
7-21-10	DOUBLE BCD DIVIDE – DIVL(57)	462

7-22-1	BINARY ADD – ADD(50)	463
7-22-2	BINARY SUBTRACT – SBB(51)	464
7-22-3	BINARY MULTIPLY – MLB(52)	466
7-22-4	BINARY DIVIDE – DVB(53)	466
7-23	Special Math Instructions	467
7-23-1	DATA SEARCH – SRCH(—)	467
7-23-2	FIND MAXIMUM – MAX(—)	468
7-23-3	FIND MINIMUM – MIN(—)	470
7-23-4	AVERAGE VALUE – AVG(—)	472
7-23-5	SUM – SUM(—)	474
7-24	Logic Instructions	475
7-24-1	COMPLEMENT – COM(29)	475
7-24-2	LOGICAL AND – ANDW(34)	476
7-24-3	LOGICAL OR – ORW(35)	477
7-24-4	EXCLUSIVE OR – XORW(36)	477
7-24-5	EXCLUSIVE NOR – XNRW(37)	478
7-25	Increment/Decrement Instructions	479
7-25-1	BCD INCREMENT – INC(38)	479
7-25-2	BCD DECREMENT – DEC(39)	479
7-26	Subroutine Instructions	480
7-26-1	SUBROUTINE ENTER – SBS(91)	480
7-26-2	SUBROUTINE DEFINE and RETURN – SBN(92)/RET(93)	482
7-26-3	MACRO – MCRO(99)	482
7-27	Pulse Output Instructions	483
7-27-1	SET PULSES – PULS(65)	483
7-27-2	SPEED OUTPUT – SPED(64)	485
7-27-3	ACCELERATION CONTROL – ACC(—)	487
7-27-4	PULSE WITH VARIABLE DUTY RATIO – PWM(—)	490
7-27-5	SYNCHRONIZED PULSE CONTROL – SYNC(—)	492
7-28	Special Instructions	493
7-28-1	MESSAGE DISPLAY – MSG(46)	493
7-28-2	I/O REFRESH – IORF(97)	494
7-28-3	BIT COUNTER – BCNT(67)	495
7-28-4	FRAME CHECKSUM – FCS(—)	496
7-29	Interrupt Control Instructions	497
7-29-1	INTERRUPT CONTROL – INT(89)	497
7-29-2	INTERVAL TIMER – STIM(69)	500
7-30	Communications Instructions	501
7-30-1	RECEIVE – RXD(47)	501
7-30-2	TRANSMIT – TXD(48)	503
7-30-3	CHANGE RS-232C SETUP – STUP(—)	505

In the remainder of this manual, all instructions will be referred to by their mnemonics. For example, the OUTPUT instruction will be called OUT; the AND LOAD instruction, AND LD. If you're not sure of the instruction a mnemonic used for, refer to *Appendix A Programming Instructions*.

If an instruction is assigned a function code, it will be given in parentheses after the mnemonic. These function codes, which are 2-digit decimal numbers, are used to input most instructions into the CPU Unit. A table of instructions listed in order of function codes is also provided in *Appendix A Programming Instructions*. Lists of instructions are also provided in *7-6 Instruction Tables*.

An @ before a mnemonic indicates the differentiated version of that instruction. Differentiated instructions are explained in *Section 7-4*.

2 Instruction Format

Most instructions have at least one or more operands associated with them. Operands indicate or provide the data on which an instruction is to be performed. These are sometimes input as the actual numeric values (i.e., as constants) and are usually the addresses of data area words or bits that contain the data to be used. A bit whose address is designated as an operand is called an operand bit; a word whose address is designated as an operand is called an operand word. In some instructions, the word address designated in an instruction indicates the first of multiple words containing the desired data.

Each instruction requires one or more words in Program Memory. The first word is the instruction word, which specifies the instruction and contains any definer (described below) or operand bits required by the instruction. Other operands required by the instruction are contained in following words, one operand per word. Some instructions require up to four words.

A definer is an operand associated with an instruction and contained in the same word as the instruction itself. These operands define the instruction rather than telling what data it is to use. Examples of definers are TC numbers, which are used in timer and counter instructions to create timers and counters, as well as jump numbers (which define which Jump instruction is paired with which Jump End instruction). Bit operands are also contained in the same word as the instruction itself, although these are not considered definers.

3 Data Areas, Definer Values, and Flags

In this section, each instruction description includes its ladder diagram symbol, the data areas that can be used by its operands, and the values that can be used as definers. Details for the data areas are also specified by the operand name and the type of data required for each operand (i.e., word or bit and, for words, hexadecimal or BCD).

Not all addresses in the specified data areas are necessarily allowed for an operand, e.g., if an operand requires two words, the last word in a data area cannot be designated as the first word of the operand because all words for a single operand must be within the same data area. Other specific limitations are given in the *Limitations* subsection. Refer to *Section 5 Memory Areas* for addressing conventions and the addresses of flags and control bits.



Caution

The IR and SR areas are considered as separate data areas. If an operand has access to one area, it doesn't necessarily mean that the same operand will have access to the other area. The border between the IR and SR areas can, however, be crossed for a single operand, i.e., the last bit in the IR area may be specified for an operand that requires more than one word as long as the SR area is also allowed for that operand.

These flags include the following SR area flags:

Abbreviation	Name	Bit
ER	Instruction Execution Error Flag	25503
CY	Carry Flag	25504
GR	Greater Than Flag	25505
EQ	Equals Flag	25506
LE	Less Than Flag	25507

ER is the flag most commonly used for monitoring an instruction's execution. When ER goes ON, it indicates that an error has occurred in attempting to execute the current instruction. The *Flags* subsection of each instruction lists the possible reasons for ER being ON. ER will turn ON if operands are not entered correctly. Instructions are not executed when ER is ON. A table of instructions and the flags they affect is provided in *Appendix B Error and Arithmetic Flag Generation*.

Indirect Addressing

When the DM area is specified for an operand, an indirect address can be used. Indirect DM addressing is specified by placing an asterisk before the DM: *DM 0001.

When an indirect DM address is specified, the designated DM word will contain the address of the DM word that contains the data that will be used as the operand of the instruction. If, for example, *DM 0001 was designated as the first operand and LR 00 as the second operand of MOV(21), the contents of DM 0001 was 1111, and DM 1111 contained 5555, the value 5555 would be moved to LR 00.

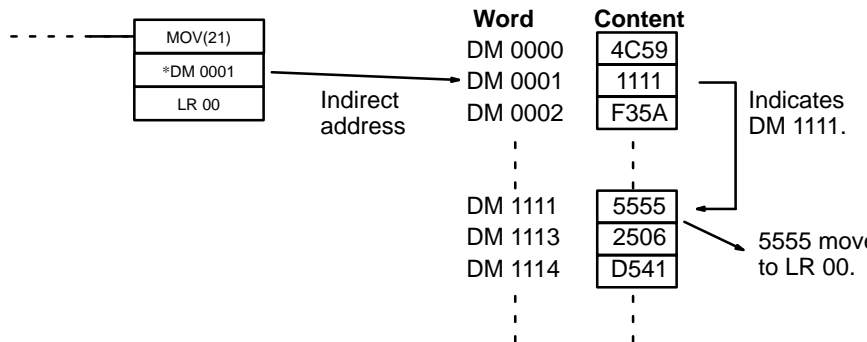

When using indirect addressing, the address of the desired word must be in BCD and it must specify a word within the DM area. In the above example, the contents of DM 0001 has to be in BCD and has to specify an address in the DM area of the PC being used. (Refer to *Section 5 Memory Areas* for DM area details.)

Signifying Constants

Although data area addresses are most often given as operands, many operands and all definers are input as constants. The available value range for a definer or operand depends on the particular instruction that uses it. Constants must also be entered in the form required by the instruction, i.e. BCD or in hexadecimal.

Most instructions are provided in both differentiated and non-differentiated forms. Differentiated instructions are distinguished by an @ in front of instruction mnemonic.

A non-differentiated instruction is executed each time it is scanned as long as execution condition is ON. A differentiated instruction is executed only once after its execution condition goes from OFF to ON. If the execution condition is not changed or has changed from ON to OFF since the last time the instruction was scanned, the instruction will not be executed. The following two examples show how this works with MOV(21) and @MOV(21), which are used to move data in the address designated by the first operand to the address designated by the second operand.

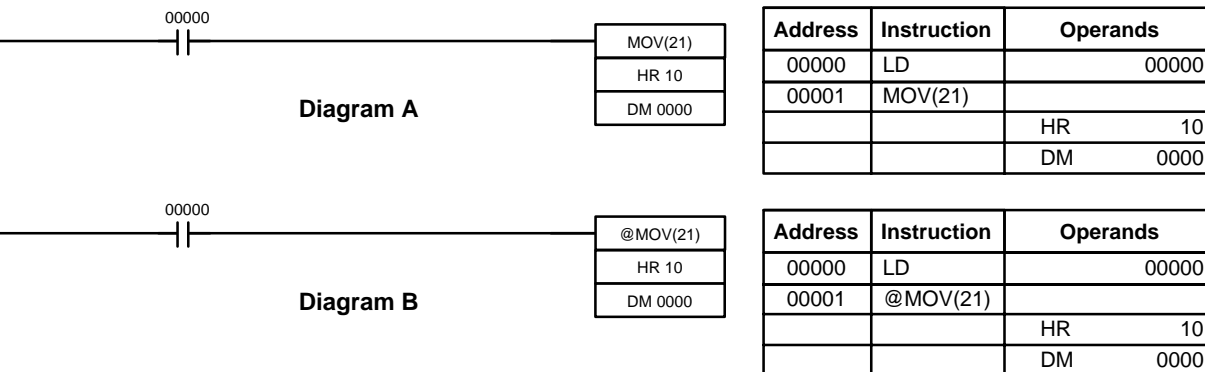

In diagram A, the non-differentiated MOV(21) will move the content of HR 10 to DM 0000 whenever it is scanned with 00000. If the cycle time is 80 ms and 00000 remains ON for 2.0 seconds, this move operation will be performed 25 times. Only the last value moved to DM 0000 will be preserved there.

In diagram B, the differentiated @MOV(21) will move the content of HR 10 to DM 0000 only once after 00000 goes ON. Even if 00000 remains ON for 2.0 seconds with the same 80 ms cycle time, the move operation will be executed only once during the first cycle in which 00000 has changed from OFF to ON. Because the content of HR 10 could very well change during the 2 seconds while 00000 is ON, the final content of DM 0000 after the 2 seconds could be different depending on whether MOV(21) or @MOV(21) was used.

All operands, ladder diagram symbols, and other specifications for instructions are the same regardless of whether the differentiated or non-differentiated form of an instruction is used. When inputting, the same function codes are also used, but NOT is input after the function code to designate the differentiated form of instruction. Most, but not all, instructions have differentiated forms.

Refer to 7-11 INTERLOCK and INTERLOCK CLEAR – IL(02) and IL(03) for the effects of interlocks on differentiated instructions.

The CPM2A/CPM2C also provides differentiation instructions: DIFU(13) and DIFD(14). DIFU(13) operates the same as a differentiated instruction, but is used to turn ON a bit for one cycle. DIFD(14) also turns ON a bit for one cycle, but does it when the execution condition has changed from ON to OFF. Refer to 7-8-4 DIFFERENTIATE UP and DOWN - DIFU(13) and DIFD(14) for details.

Writing mnemonic code for ladder instructions is described in *Section 6 Ladder diagram Programming*. Converting the information in the ladder diagram symbols for all other instructions follows the same pattern, as described below, and is specified for each instruction individually.

The first word of any instruction defines the instruction and provides any definers. If the instruction requires only a signal bit operand with no definer, the operand is also placed on the same line as the mnemonic. All other operands are placed on lines after the instruction line, one operand per line and in the same order as they appear in the ladder symbol for the instruction.

The address and instruction columns of the mnemonic code table are filled in the instruction word only. For all other lines, the left two columns are left blank. If the instruction requires no definer or bit operand, the data column is left blank on the first line. It is a good idea to cross through any blank data column spaces (for instructions that do not require data) so that the data column can be quickly scanned to see if any addresses have been left out.

If an IR or SR address is used in the data column, the left side of the column is blank. If any other data area is used, the data area abbreviation is placed on the left side and the address is placed on the right side. If a constant to be input is used, the number symbol (#) is placed on the left side of the data column and the number to be input is placed on the right side. Any numbers input as definers in the instruction word do not require the number symbol on the right side. TCs, once defined as a timer or counter, take a TIM (timer) or CNT (counter) prefix.

When coding an instruction that has a function code, be sure to write in the function code, which will be necessary when inputting the instruction via the Programming Console. Also be sure to designate the differentiated instruction with the @ symbol.

Note The mnemonics of expansion instructions are followed by “(—)” as the function code to indicate that they must be assigned function codes by the user in the instructions table before they can be used in programming. Refer to page 15 for details.

described previously.

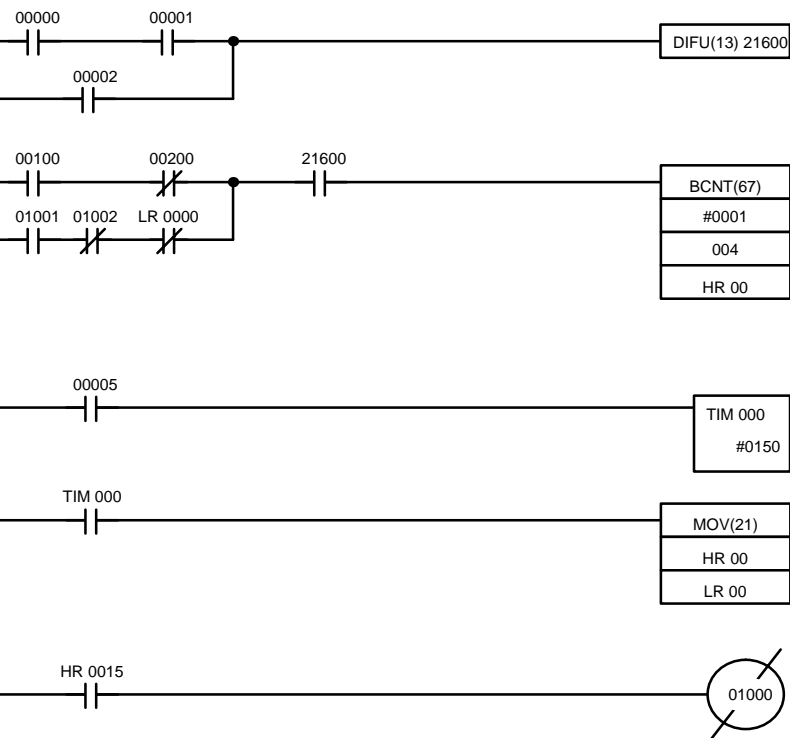

Address	Instruction	Data
00000	LD	00000
00001	AND	00001
00002	OR	00002
00003	DIFU(13)	21600
00004	LD	00100
00005	AND NOT	00200
00006	LD	01000
00007	AND NOT	01001
00008	AND NOT	LR 0000
00009	OR LD	
00010	AND	21600
00011	BCNT(67)	
		#
		HR
00012	LD	00005
00013	TIM	00000
		#
00014	LD	TIM 000
00015	MOV(21)	
		HR
		LR
00016	LD	HR 0015
00017	OUT NOT	01000

all of the lines for the instruction are entered before the right hand instruction.
 Each of the lines for the instruction is coded, starting with LD or LD NOT, to form
 'logic blocks' that are combined by the right-hand instruction. An example of the
 for SFT(10) is shown below.

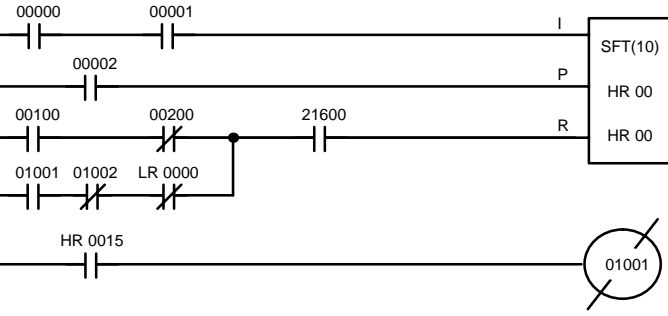

Address	Instruction	Data
00000	LD	00000
00001	AND	00001
00002	LD	00002
00003	LD	00100
00004	AND NOT	00200
00005	LD	01001
00006	AND NOT	01002
00007	AND NOT	LR 0000
00008	OR LD	
00009	AND	21600
00010	SFT(10)	HR 00
		HR 00
00011	LD	HR 0015
00012	OUT NOT	01001

This section provides tables of the instructions supported by the CPM1/CPM2A/CPM2C, and SRM1(-V2) PCs. The first few tables can be used to find instructions by function code. The last table can be used to find instructions by mnemonic. In both tables, the @ symbol indicates instructions with differentiated forms.

6-1 CPM1/CPM1A Function Codes

The following table lists the CPM1/CPM1A instructions that have fixed function codes. Each instruction is listed by mnemonic and by instruction name. Use the numbers in the leftmost column as the left digit and the number in the column heading as the right digit of the function code.

Left digit	Right digit									
	0	1	2	3	4	5	6	7	8	9
	NOP NO OPERATION	END END	IL INTERLOCK	ILC INTERLOCK CLEAR	JMP JUMP	JME JUMP END	(@) FAL FAILURE ALARM AND RESET	FALS SEVERE FAILURE ALARM	STEP STEP DEFINE	SNXT STEP STOP
	SFT SHIFT REGISTER	KEEP KEEP	CNTR REVERSIBLE COUNTER	DIFU DIFFERENTIATE UP	DIFD DIFFERENTIATE DOWN	TIMH HIGH-SPEED TIMER	(@) WSFT WORD SHIFT	(@) ASFT ASYNCHRONOUS SHIFT REGISTER	---	---
	CMP COMPARE	(@) MOV MOVE	(@) MVN MOVE NOT	(@) BIN BCD TO BINARY	(@) BCD BINARY TO BCD	(@) ASL SHIFT LEFT	(@) ASR SHIFT RIGHT	(@) ROL ROTATE LEFT	(@) ROR ROTATE RIGHT	(@) COM COMPLEMENT
	(@) ADD BCD ADD	(@) SUB BCD SUBTRACT	(@) MUL BCD MULTIPLY	(@) DIV BCD DIVIDE	(@) ANDW LOGICAL AND	(@) ORW LOGICAL OR	(@) XORW EXCLUSIVE OR	(@) XNRW EXCLUSIVE NOR	(@) INC INCREMENT	(@) DEC DECREMENT
	(@) STC SET CARRY	(@) CLC CLEAR CARRY	---	---	---	---	(@) MSG MESSAGE DISPLAY	---	---	---
	(@) ADB BINARY ADD	(@) SBB BINARY SUBTRACT	(@) MLB BINARY MULTIPLY	(@) DVB BINARY DIVIDE	(@) ADDL DOUBLE BCD ADD	(@) SUBL DOUBLE BCD SUBTRACT	(@) MULL DOUBLE BCD MULTIPLY	(@) DIVL DOUBLE BCD DIVIDE	---	---
	CMPL DOUBLE COMPARE	(@) INI MODE CONTROL	(@) PRV HIGH-SPEED COUNTER PV READ	(@) CTBL COMPARISON TABLE LOAD	(@) SPED SPEED OUTPUT (see note)	(@) PULS SET PULSES (see note)	---	(@) BCNT BIT COUNTER	(@) BCMP BLOCK COMPARE	(@) STIM INTERVAL TIMER
	(@) XFER BLOCK TRANSFER	(@) BSET BLOCK SET	---	(@) XCHG DATA EXCHANGE	(@) SLD ONE DIGIT SHIFT LEFT	(@) SRD ONE DIGIT SHIFT RIGHT	(@) MLPX 4-TO-16 DECODER	(@) DMPX 16-TO-4 ENCODER	(@) SDEC 7-SEGMENT DECODER	---
	(@) DIST SINGLE WORD DISTRIBUTE	(@) COLL DATA COLLECT	(@) MOVB MOVE BIT	(@) MOVD MOVE DIGIT	(@) SFTR REVERSIBLE SHIFT REGISTER	(@) TCMP TABLE COMPARE	(@) ASC ASCII CONVERT	---	---	(@) INT INTERRUPT CONTROL
	---	(@) SBS SUBROUTINE ENTRY	SBN SUBROUTINE DEFINE	RET SUBROUTINE RETURN	---	---	---	(@) IORF I/O REFRESH	---	(@) MCR MACRO

Note Only for the CPM1A transistor output models.

The following table lists the CPM2A/CPM2C (including the CPM2C-S) instructions that have fixed function codes. Each instruction is listed by mnemonic by instruction name. Use the numbers in the leftmost column as the left digit of the function code and the number in the column heading as the right digit of the function code.

Left digit	Right digit									
	0	1	2	3	4	5	6	7	8	9
	NOP NO OPERATION	END END	IL INTERLOCK	ILC INTERLOCK CLEAR	JMP JUMP	JME JUMP END	(@) FAL FAILURE ALARM AND RESET	FALS SEVERE FAILURE ALARM	STEP STEP DEFINE	SNXT STEP STOP
	SFT SHIFT REGISTER	KEEP KEEP	CNTR REVERSIBLE COUNTER	DIFU DIFFERENTIATE UP	DIFD DIFFERENTIATE DOWN	TIMH HIGH-SPEED TIMER	(@) WSFT WORD SHIFT	(@) ASFT ASYNCHRONOUS SHIFT REGISTER	---	---
	CMP COMPARE	(@) MOV MOVE	(@) MVN MOVE NOT	(@) BIN BCD TO BINARY	(@) BCD BINARY TO BCD	(@) ASL SHIFT LEFT	(@) ASR SHIFT RIGHT	(@) ROL ROTATE LEFT	(@) ROR ROTATE RIGHT	(@) COM COMPLEMENT
	(@) ADD BCD ADD	(@) SUB BCD SUBTRACT	(@) MUL BCD MULTIPLY	(@) DIV BCD DIVIDE	(@) ANDW LOGICAL AND	(@) ORW LOGICAL OR	(@) XORW EXCLUSIVE OR	(@) XNRW EXCLUSIVE NOR	(@) INC INCREMENT	(@) DEC DECREMENT
	(@) STC SET CARRY	(@) CLC CLEAR CARRY	---	---	---	---	(@) MSG MESSAGE DISPLAY	(@) RXD RECEIVE	(@) TXD TRANSMIT	---
	(@) ADB BINARY ADD	(@) SBB BINARY SUBTRACT	(@) MLB BINARY MULTIPLY	(@) DVB BINARY DIVIDE	(@) ADDL DOUBLE BCD ADD	(@) SUBL DOUBLE BCD SUBTRACT	(@) MULL DOUBLE BCD MULTIPLY	(@) DIVL DOUBLE BCD DIVIDE	(@) BINL DOUBLE BCD-TO-DOUBLE BINARY	(@) BCDL DOUBLE BINARY-TO-DOUBLE BCD
	CMPL DOUBLE COMPARE	(@) INI MODE CONTROL	(@) PRV HIGH-SPEED COUNTER PV READ	(@) CTBL COMPARISON TABLE LOAD	(@) SPED SPEED OUTPUT	(@) PULS SET PULSES	(@) SCL SCALING	(@) BCNT BIT COUNTER	(@) BCMP BLOCK COMPARE	(@) STIM INTERVAL TIMER
	(@) XFER BLOCK TRANSFER	(@) BSET BLOCK SET	---	(@) XCHG DATA EXCHANGE	(@) SLD ONE DIGIT SHIFT LEFT	(@) SRD ONE DIGIT SHIFT RIGHT	(@) MLPX 4-TO-16 DECODER	(@) DMPX 16-TO-4 ENCODER	(@) SDEC 7-SEGMENT DECODER	---
	(@) DIST SINGLE WORD DISTRIBUTE	(@) COLL DATA COLLECT	(@) MOVb MOVE BIT	(@) MOVD MOVE DIGIT	(@) SFTR REVERSIBLE SHIFT REGISTER	(@) TCMP TABLE COMPARE	(@) ASC ASCII CONVERT	---	---	(@) INT INTERVAL CONTROL
	---	(@) SBS SUBROUTINE ENTRY	SBN SUBROUTINE DEFINE	RET SUBROUTINE RETURN	---	---	---	(@) IORF I/O REFRESH	---	(@) MCR MACRO

Note The shaded areas are function codes to which expansion instructions are catered by default or to which the user can allocate expansion instructions. The following expansion instructions are available in addition to the ones listed above with default function codes.

Mnemonic	Name	Mnemonic	Name
(@)ACC	ACCELERATION CONTROL	(@)SCL3	BCD TO SIGNED BINARY SCALING
AVG	AVERAGE VALUE	(@)SEC	HOURS TO SECONDS
(@)FCS	FCS CALCULATE	(@)SRCH	DATA SEARCH
(@)HEX	ASCII-TO-HEXADECIMAL	(@)STUP	CHANGE RS-232C SETUP
(@)HMS	SECONDS TO HOURS	(@)SUM	SUM CALCULATE
(@)MAX	FIND MAXIMUM	SYNC	SYNCHRONIZED PULSE CONTROL
(@)MIN	FIND MINIMUM	TIML	LONG TIMER
(@)NEG	2'S COMPLEMENT	TMHH	VERY HIGH-SPEED TIMER
PID	PID CONTROL	ZCP	AREA RANGE COMPARE
(@)PWM	PULSE WITH VARIABLE DUTY RATIO	ZCPL	DOUBLE AREA RANGE COMPARE
(@)SCL2	SIGNED BINARY TO BCD SCALING		

The following table lists the function codes for the SRM1(-V2) CPUs. Each instruction is listed by mnemonic and by instruction name. Use numbers in the leftmost column as the left digit and the number in the column heading as the right digit of the function code.

Left digit	Right digit									
	0	1	2	3	4	5	6	7	8	9
	NOP NO OPERATION	END END	IL INTERLOCK	ILC INTERLOCK CLEAR	JMP JUMP	JME JUMP END	(@) FAL FAILURE ALARM AND RESET	FALS SEVERE FAILURE ALARM	STEP STEP DEFINE	SNXT STEP STOP
	SFT SHIFT REGISTER	KEEP KEEP	CNTR REVERSIBLE COUNTER	DIFU DIFFERENTIATE UP	DIFD DIFFERENTIATE DOWN	TIMH HIGH-SPEED TIMER	(@) WSFT WORD SHIFT	(@) ASFT ASYNCHRONOUS SHIFT REGISTER	---	---
	CMP COMPARE	(@) MOV MOVE	(@) MVN MOVE NOT	(@) BIN BCD TO BINARY	(@) BCD BINARY TO BCD	(@) ASL SHIFT LEFT	(@) ASR SHIFT RIGHT	(@) ROL ROTATE LEFT	(@) ROR ROTATE RIGHT	(@) COM COMPLEMENT
	(@) ADD BCD ADD	(@) SUB BCD SUBTRACT	(@) MUL BCD MULTIPLY	(@) DIV BCD DIVIDE	(@) ANDW LOGICAL AND	(@) ORW LOGICAL OR	(@) XORW EXCLUSIVE OR	(@) XNRW EXCLUSIVE NOR	(@) INC INCREMENT	(@) DEC DECREMENT
	(@) STC SET CARRY	(@) CLC CLEAR CARRY	---	---	---	---	(@) MSG MESSAGE DISPLAY	(@) RXD RECEIVE	(@) TXD TRANSMIT	---
	(@) ADB BINARY ADD	(@) SBB BINARY SUBTRACT	(@) MLB BINARY MULTIPLY	(@) DVB BINARY DIVIDE	(@) ADDL DOUBLE BCD ADD	(@) SUBL DOUBLE BCD SUBTRACT	(@) MULL DOUBLE BCD MULTIPLY	(@) DIVL DOUBLE BCD DIVIDE	---	---
	CMPL DOUBLE COMPARE	---	---	---	---	---	(@) SCL SCALING	(@) BCNT BIT COUNTER	(@) BCMP BLOCK COMPARE	(@) STIM INTERVAL TIMER
	(@) XFER BLOCK TRANSFER	(@) BSET BLOCK SET	---	(@) XCHG DATA EXCHANGE	(@) SLD ONE DIGIT SHIFT LEFT	(@) SRD ONE DIGIT SHIFT RIGHT	(@) MLPX 4-TO-16 DECODER	(@) DMPX 16-TO-4 ENCODER	(@) SDEC 7-SEGMENT DECODER	---
	(@) DIST SINGLE WORD DISTRIBUTE	(@) COLL DATA COLLECT	(@) MOVB MOVE BIT	(@) MOVD MOVE DIGIT	(@) SFTR REVERSIBLE SHIFT REGISTER	(@) TCMP TABLE COMPARE	(@) ASC ASCII CONVERT	---	---	---
	---	(@) SBS SUBROUTINE ENTRY	SBN SUBROUTINE DEFINE	RET SUBROUTINE RETURN	---	---	---	---	---	(@) MCR MACRO

Note The shaded areas are function codes to which expansion instructions are allocated by default or to which the user can allocate expansion instructions. The following expansion instructions are available in addition to the ones listed above with default function codes.

Mnemonic	Name
(@)FCS	FCS CALCULATE
(@)HEX	ASCII-TO-HEXADECIMAL
(@)NEG*	2'S COMPLEMENT
PID*	PID CONTROL
(@)STUP	CHANGE RS-232C SETUP
ZCP*	AREA RANGE COMPARE

Note *SCL(66), NEG(—), PID(—), and ZCP (—) are supported by SRM1-C0□-V2 CPUs only.

Dashes (“—”) in the *Code* column indicate expansion instructions, which do not have fixed function codes. “None” indicates instructions for which function codes are not used.

In the *CPU Units* column, “SRM1” indicates all versions of the SRM1 CPU Units and “SRM1(-V2)” indicates only version 2 of the SRM1 CPU Units.

emonic	Code	Words	Name	CPU Units	Pa
C (@)	—	4	ACCELERATION CONTROL	CPM2A/CPM2C	487
B (@)	50	4	BINARY ADD	All	463
D (@)	30	4	BCD ADD	All	453
DL (@)	54	4	DOUBLE BCD ADD	All	459
D	None	1	AND	All	372
D LD	None	1	AND LOAD	All	373
D NOT	None	1	AND NOT	All	372
DW (@)	34	4	LOGICAL AND	All	476
C (@)	86	4	ASCII CONVERT	All	445
FT(@)	17	4	ASYNCHRONOUS SHIFT REGISTER	All	406
L (@)	25	2	ARITHMETIC SHIFT LEFT	All	401
R (@)	26	2	ARITHMETIC SHIFT RIGHT	All	402
G	—	4	AVERAGE VALUE	CPM2A/CPM2C	472
D (@)	24	3	BINARY TO BCD	All	436
DL (@)	59	3	DOUBLE BINARY-TO-DOUBLE BCD	CPM2A/CPM2C	437
MP (@)	68	4	BLOCK COMPARE	All	430
NT (@)	67	4	BIT COUNTER	All	495
N (@)	23	3	BCD-TO-BINARY	All	435
NL (@)	58	3	DOUBLE BCD-TO-DOUBLE BINARY	CPM2A/CPM2C	436
ET (@)	71	4	BLOCK SET	All	410
C (@)	41	1	CLEAR CARRY	All	453
IP	20	3	COMPARE	All	428
IPL	60	4	DOUBLE COMPARE	All	432
T	None	2	COUNTER	All	390
TR	12	3	REVERSIBLE COUNTER	All	391
LL (@)	81	4	DATA COLLECT	All	413
M (@)	29	2	COMPLEMENT	All	475
BL(@)	63	4	COMPARISON TABLE LOAD	All	392
C (@)	39	2	BCD DECREMENT	All	479
FD	14	2	DIFFERENTIATE DOWN	All	376
FU	13	2	DIFFERENTIATE UP	All	376
ST (@)	80	4	SINGLE WORD DISTRIBUTE	All	411
/ (@)	33	4	BCD DIVIDE	All	457
/L (@)	57	4	DOUBLE BCD DIVIDE	All	462
IPX (@)	77	4	16-TO-4 ENCODER	All	440
B (@)	53	4	BINARY DIVIDE	All	466
D	01	1	END	All	377
L (@)	06	2	FAILURE ALARM AND RESET	All	381
LS	07	2	SEVERE FAILURE ALARM	All	381
S (@)	—	4	FCS CALCULATE	CPM2A/CPM2C/SRM1(-V2)	496
X (@)	—	4	ASCII-TO-HEXADECIMAL	CPM2A/CPM2C/SRM1(-V2)	447
IS	—	4	SECONDS TO HOURS	CPM2A/CPM2C	450
	02	1	INTERLOCK	All	377

	03	1	INTERLOCK CLEAR	All	377
C (@)	38	2	INCREMENT	All	479
(@)	61	4	MODE CONTROL	All	395
r (@)	89	4	INTERRUPT CONTROL	All	497
RF (@)	97	3	I/O REFRESH	All except SRM1	494
E	05	2	JUMP END	All	379
P	04	2	JUMP	All	379
EP	11	2	KEEP	All	375
	None	1	LOAD	All	372
NOT	None	1	LOAD NOT	All	372
X (@)	—	4	FIND MAXIMUM	CPM2A/CPM2C	468
RO (@)	99	4	MACRO	All	482
N (@)	—	4	FIND MINIMUM	CPM2A/CPM2C	470
B (@)	52	4	BINARY MULTIPLY	All	466
PX (@)	76	4	4-TO-16 DECODER	All	438
OV (@)	21	3	MOVE	All	407
OV B (@)	82	4	MOVE BIT	All	415
OV D (@)	83	4	MOVE DIGIT	All	416
G (@)	46	2	MESSAGE	All	493
L (@)	32	4	BCD MULTIPLY	All	456
L L (@)	56	4	DOUBLE BCD MULTIPLY	All	462
N (@)	22	3	MOVE NOT	All	408
G (@)	—	4	2'S COMPLEMENT	CPM2A/CPM2C/SRM1(-V2)	451
P	00	1	NO OPERATION	All	377
R	None	1	OR	All	372
R LD	None	1	OR LOAD	All	373
R NOT	None	1	OR NOT	All	372
R W (@)	35	4	LOGICAL OR	All	477
T	None	2	OUTPUT	All	373
T NOT	None	2	OUTPUT NOT	All	373
D	—	4	PID CONTROL	CPM2A/CPM2C/SRM1(-V2)	422
V (@)	62	4	HIGH-SPEED COUNTER PV READ	All except SRM1	397
LS (@)	65	4	SET PULSES	CPM1A/CPM2A/CPM2C (Transistor outputs only)	483
VM (@)	—	4	PULSE WITH VARIABLE DUTY RATIO	CPM2A/CPM2C	490
T	93	1	SUBROUTINE RETURN	All	482
L (@)	27	2	ROTATE LEFT	All	402
R (@)	28	2	ROTATE RIGHT	All	403
ET	None	2	RESET	All	374
D (@)	47	4	RECEIVE	CPM2A/CPM2C/SRM1	501
B (@)	51	4	BINARY SUBTRACT	All	464
N	92	2	SUBROUTINE DEFINE	All	482
S (@)	91	2	SUBROUTINE ENTRY	All	480
L (@)	66	4	SCALING	CPM2A/CPM2C/SRM1(-V2)	417
L2 (@)	—	4	SIGNED BINARY TO BCD SCALING	CPM2A/CPM2C	418
L3 (@)	—	4	BCD TO SIGNED BINARY SCALING	CPM2A/CPM2C	420
EC (@)	78	4	7-SEGMENT DECODER	CPM2A/CPM2C	442
C	—	4	HOURS TO SECONDS	CPM2A/CPM2C	449
T	None	2	SET	All	374

	10	3	SHIFT REGISTER	All	400
TR (@)	84	4	REVERSIBLE SHIFT REGISTER	All	405
D (@)	74	3	ONE DIGIT SHIFT LEFT	All	404
XT	09	2	STEP START	All	381
ED (@)	64	4	SPEED OUTPUT	CPM1A/CPM2A/CPM2C (Transistor outputs only)	485
CH (@)	—	4	DATA SEARCH	CPM2A/CPM2C	467
D (@)	75	3	ONE DIGIT SHIFT RIGHT	All	404
C (@)	40	1	SET CARRY	All	453
EP	08	2	STEP DEFINE	All	381
IM (@)	69	4	INTERVAL TIMER	All	500
UP	—	3	CHANGE RS-232C SETUP	CPM2A/CPM2C/SRM1	505
B (@)	31	4	BCD SUBTRACT	All	454
BL (@)	55	4	DOUBLE BCD SUBTRACT	All	460
M (@)	—	4	SUM	CPM2A/CPM2C	474
NC (@)	—	4	SYNCHRONIZED PULSE CONTROL	CPM2A/CPM2C	492
MP (@)	85	4	TABLE COMPARE	All	429
M	None	2	TIMER	All	385
MH	15	3	HIGH-SPEED TIMER	All	386
ML	—	4	LONG TIMER	CPM2A/CPM2C	388
MHH	—	4	VERY HIGH-SPEED TIMER	CPM2A/CPM2C	387
D (@)	48	4	TRANSMIT	CPM2A/CPM2C/SRM1	503
SFT (@)	16	3	WORD SHIFT	All	401
HG (@)	73	3	DATA EXCHANGE	All	411
ER (@)	70	4	BLOCK TRANSFER	All	409
NRW (@)	37	4	EXCLUSIVE NOR	All	478
ORW (@)	36	4	EXCLUSIVE OR	All	477
P	—	4	AREA RANGE COMPARE	CPM2A/CPM2C/SRM1(-V2)	433
PL	—	4	DOUBLE AREA RANGE COMPARE	CPM2A/CPM2C	434

Ladder diagram instructions include ladder instructions and logic block instructions and correspond to the conditions on the ladder diagram. Logic block instructions are used to relate more complex parts.

7-1 LOAD, LOAD NOT, AND, AND NOT, OR, and OR NOT

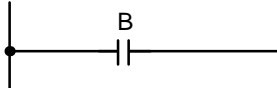
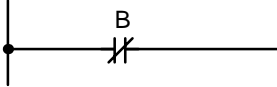
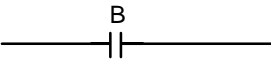
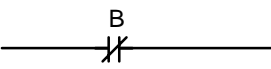
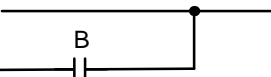
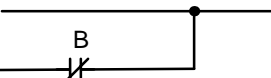
	Ladder Symbols	Operand Data Areas		
LD – LD		<table border="1"> <tr><td>B: Bit</td></tr> <tr><td>IR, SR, AR, HR, TC, LR, TR</td></tr> </table>	B: Bit	IR, SR, AR, HR, TC, LR, TR
B: Bit				
IR, SR, AR, HR, TC, LR, TR				
LD NOT – LD NOT		<table border="1"> <tr><td>B: Bit</td></tr> <tr><td>IR, SR, AR, HR, TC, LR</td></tr> </table>	B: Bit	IR, SR, AR, HR, TC, LR
B: Bit				
IR, SR, AR, HR, TC, LR				
AND – AND		<table border="1"> <tr><td>B: Bit</td></tr> <tr><td>IR, SR, AR, HR, TC, LR</td></tr> </table>	B: Bit	IR, SR, AR, HR, TC, LR
B: Bit				
IR, SR, AR, HR, TC, LR				
AND NOT – AND NOT		<table border="1"> <tr><td>B: Bit</td></tr> <tr><td>IR, SR, AR, HR, TC, LR</td></tr> </table>	B: Bit	IR, SR, AR, HR, TC, LR
B: Bit				
IR, SR, AR, HR, TC, LR				
OR – OR		<table border="1"> <tr><td>B: Bit</td></tr> <tr><td>IR, SR, AR, HR, TC, LR</td></tr> </table>	B: Bit	IR, SR, AR, HR, TC, LR
B: Bit				
IR, SR, AR, HR, TC, LR				
OR NOT – OR NOT		<table border="1"> <tr><td>B: Bit</td></tr> <tr><td>IR, SR, AR, HR, TC, LR</td></tr> </table>	B: Bit	IR, SR, AR, HR, TC, LR
B: Bit				
IR, SR, AR, HR, TC, LR				

Restrictions There is no limit to the number of any of these instructions, or restrictions in the order in which they must be used, as long as the memory capacity of the PLC is not exceeded.

Description These six basic instructions correspond to the conditions on a ladder diagram. As described in *Section 6 Ladder-diagram Programming*, the status of the bit operand assigned to each instruction determines the execution conditions for all other instructions. Each of these instructions and each bit address can be used many times as required. Each can be used in as many of these instructions as required.

The status of the bit operand (B) assigned to LD or LD NOT determines the execution condition. AND takes the logical AND between the execution condition and the status of its bit operand; AND NOT, the logical AND between the execution condition and the inverse of the status of its bit operand. OR takes the logical OR between the execution condition and the status of its bit operand; OR NOT, the logical OR between the execution condition and the inverse of the status of its bit operand.

Flags There are no flags affected by these instructions.

AND LD – AND LD

Ladder Symbol

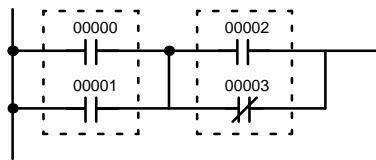

OR LD – OR LD

Ladder Symbol

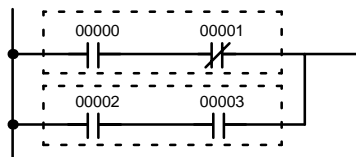

Description

When instructions are combined into blocks that cannot be logically combined using only OR and AND operations, AND LD and OR LD are used. When AND and OR operations logically combine a bit status and an execution condition, AND LD and OR LD logically combine two execution conditions, the current one and the last unused one.

In order to draw ladder diagrams, it is not necessary to use AND LD and OR LD instructions, nor are they necessary when inputting ladder diagrams directly. It is possible from the SSS. They are required, however, to convert the program and input it in mnemonic form.

In order to reduce the number of programming instructions required, a basic understanding of logic block instructions is required. For an introduction to logic blocks, refer to *6-3-6 Logic Block Instructions*.

Flags

There are no flags affected by these instructions.

8 Bit Control Instructions

There are seven instructions that can be used generally to control individual bit status. These are OUT, OUT NOT, DIFU(13), DIFD(14), SET, RSET, KEEP(11). These instructions are used to turn bits ON and OFF in different ways.

8-3-1 OUTPUT and OUTPUT NOT – OUT and OUT NOT

OUTPUT – OUT

Ladder Symbol

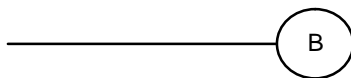

Operand Data Areas

B: Bit
IR, SR, AR, HR, LR, TR

OUTPUT NOT – OUT NOT

Ladder Symbol

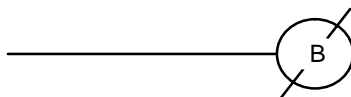

Operand Data Areas

B: Bit
IR, SR, AR, HR, LR

Limitations

Any output bit can generally be used in only one instruction that controls its status.

Description

OUT and OUT NOT are used to control the status of the designated bit according to the execution condition.

the designated bit for an OFF execution condition. With a TR bit, OUT appears as a branching point rather than at the end of an instruction line. Refer to 6-1 *Branching Instruction Lines* for details.

OUT NOT turns ON the designated bit for a OFF execution condition, and turns OFF the designated bit for an ON execution condition.

OUT and OUT NOT can be used to control execution by turning ON and OFF bits that are assigned to conditions on the ladder diagram, thus determining execution conditions for other instructions. This is particularly helpful and allows a complex set of conditions to be used to control the status of a single work bit, then that work bit can be used to control other instructions.

The length of time that a bit is ON or OFF can be controlled by combining OUT or OUT NOT with TIM. Refer to Examples under 7-15-1 *TIMER – TIMER* for details.

There are no flags affected by these instructions.

3-2 SET and RESET – SET and RSET

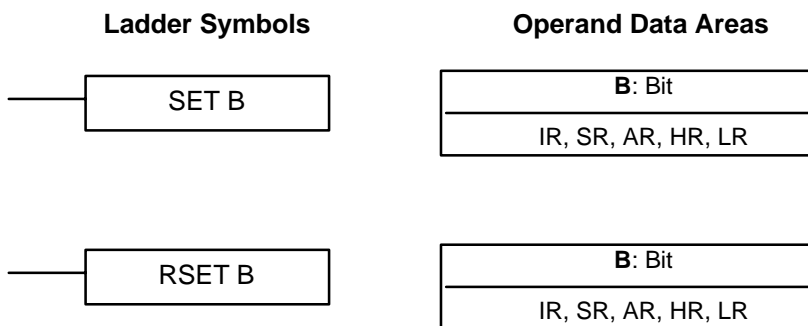

Description

SET turns the operand bit ON when the execution condition is ON, and does not affect the status of the operand bit when the execution condition is OFF. RSET turns the operand bit OFF when the execution condition is ON, and does not affect the status of the operand bit when the execution condition is OFF.

The operation of SET differs from that of OUT because the OUT instruction turns the operand bit OFF when its execution condition is OFF. Likewise, RSET differs from OUT NOT because OUT NOT turns the operand bit ON when its execution condition is OFF.

Note On the Programming Console, input SET by pressing the FUN and SET keys and input RSET by pressing the FUN and RESET keys.

Precautions

The status of operand bits for SET and RSET programmed between IL(02), ILC(03) or JMP(04) and JME(05) will not change when the interlock or jump condition is met (i.e., when IL(02) or JMP(04) is executed with an OFF execution condition).

Flags

There are no flags affected by these instructions.

Examples

The following examples demonstrate the difference between OUT and RSET. In the first example (Diagram A), IR 20000 will be turned ON or OFF whenever IR 00000 goes ON or OFF.

goes ON and will remain ON (even if IR 00001 goes OFF) until IR 00002 goes ON.

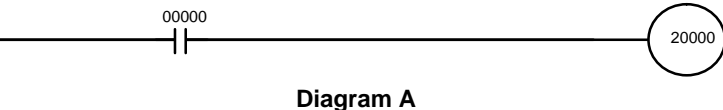

Diagram A

Address	Instruction	Operands
00000	LD	00000
00001	OUT	20000

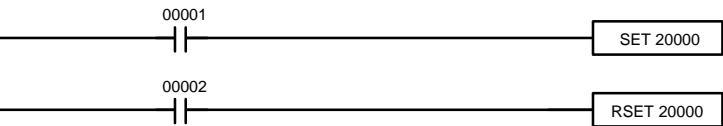
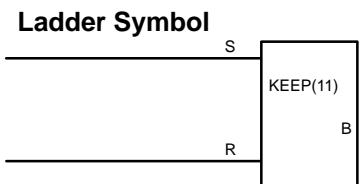

Diagram B

Address	Instruction	Operands
00000	LD	00001
00001	SET	20000
00002	LD	00002
00003	RSET	20000

3-3 KEEP – KEEP(11)



Operand Data Areas

B: Bit
IR, SR, AR, HR, LR

Limitations

Any output bit can generally be used in only one instruction that controls its status.

Description

KEEP(11) is used to maintain the status of the designated bit based on execution conditions. These execution conditions are labeled S and R. S is set input; R, the reset input. KEEP(11) operates like a latching relay that is set by S and reset by R.

When S turns ON, the designated bit will go ON and stay ON until reset, regardless of whether S stays ON or goes OFF. When R turns ON, the designated bit will go OFF and stay OFF until reset, regardless of whether R stays ON or goes OFF. The relationship between execution conditions and KEEP(11) bit status is shown below.

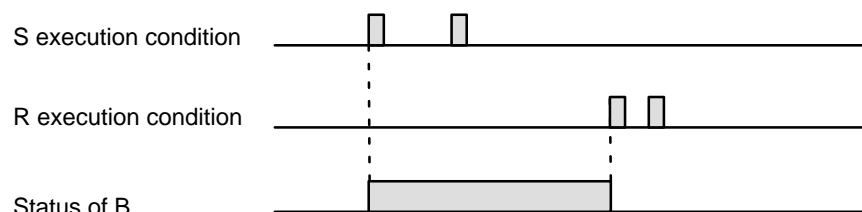

Flags

There are no flags affected by this instruction.

normally closed device. Never use an input bit in an inverse condition on the set (R) for KEEP(11) when the input device uses an AC power supply. The delay in shutting down the PC's DC power supply (relative to the AC power supply of the input device) can cause the designated bit of KEEP(11) to be reset. This situation is shown below.

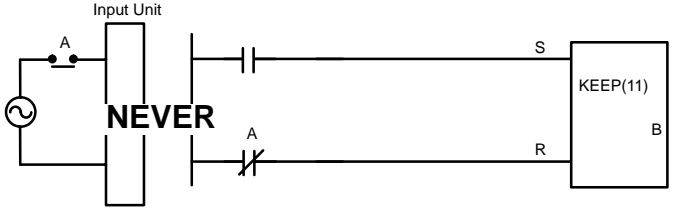

Bits used in KEEP are not reset in interlocks. Refer to the 7-11 INTERLOCK and INTERLOCK CLEAR IL(02) and ILC(03) for details.

3-4 DIFFERENTIATE UP and DOWN – DIFU(13) and DIFD(14)

Ladder Symbols



Operand Data Areas

B: Bit
IR, SR, AR, HR, LR

B: Bit
IR, SR, AR, HR, LR

Precautions

Any output bit can generally be used in only one instruction that controls its status.

Description

DIFU(13) and DIFD(14) are used to turn the designated bit ON for one cycle only.

Whenever executed, DIFU(13) compares its current execution with the previous execution condition. If the previous execution condition was OFF and the current one is ON, DIFU(13) will turn ON the designated bit. If the previous execution condition was ON and the current execution condition is either ON or OFF, DIFU(13) will either turn the designated bit OFF or leave it OFF (i.e., if the designated bit is already OFF). The designated bit will thus never be ON for longer than one cycle, assuming it is executed each cycle (see *Precautions*, below).

Whenever executed, DIFD(14) compares its current execution with the previous execution condition. If the previous execution condition was ON and the current one is OFF, DIFD(14) will turn ON the designated bit. If the previous execution condition was OFF and the current execution condition is either ON or OFF, DIFD(14) will either turn the designated bit OFF or leave it OFF. The designated bit will thus never be ON for longer than one cycle, assuming it is executed each cycle (see *Precautions*, below).

These instructions are used when differentiated instructions (i.e., those prefixed with an @) are not available and single-cycle execution of a particular instruction is desired. They can also be used with non-differentiated forms of instructions that have differentiated forms when their use will simplify programming. Examples of these are shown below.

Flags

There are no flags affected by these instructions.

programmed between ILE and ILC, between JMI and JME, or in subroutines. Refer to 7-11 INTERLOCK and INTERLOCK CLEAR – IL(02) and ILC(03), JUMP and JUMP END – JMP(04) and JME(05), 7-26 Subroutine Instructions and 7-29-1 INTERRUPT CONTROL – INT(89).

Example

In this example, IR 20014 will be turned ON for one cycle when IR 00000 goes from OFF to ON. IR 20015 will be turned ON for one cycle when IR 00000 goes from ON to OFF.

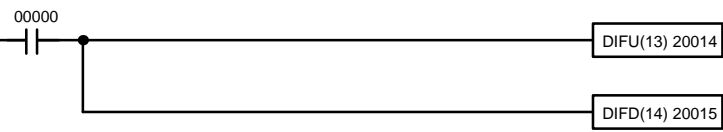

Address	Instruction	Operands
00000	LD	00000
00001	DIFU(13)	20014
00002	DIFD(14)	20015

9 NO OPERATION – NOP(00)

Description

NOP(00) is not generally required in programming and there is no ladder symbol for it. When NOP(00) is found in a program, nothing is executed and the program execution moves to the next instruction. When memory is cleared prior to programming, NOP(00) is written at all addresses. NOP(00) can be input through the 00 function code.

Flags

There are no flags affected by NOP(00).

10 END – END(01)

Ladder Symbol



Description

END(01) is required as the last instruction in any program. If there are subroutines, END(01) is placed after the last subroutine. No instruction written after END(01) will be executed. END(01) can be placed anywhere in the program to execute all instructions up to that point, as is sometimes done to debug a program, but it must be removed to execute the remainder of the program.

If there is no END(01) in the program, no instructions will be executed and an error message “NO END INST” will appear.

Flags

END(01) turns OFF the ER, CY, GR, EQ, and LE flags.

11 INTERLOCK and INTERLOCK CLEAR – IL(02) and ILC(03)

Ladder Symbol



Ladder Symbol



Description

IL(02) is always used in conjunction with ILC(03) to create interlocks. Interlocks are used to enable branching in the same way as can be achieved with TR bits, but treatment of instructions between IL(02) and ILC(03) differs from that of TR bits when the execution condition for IL(02) is OFF. If the execution condition of IL(02) is ON, the program will be executed as written, with an ON execution condition used to start each instruction line from the point where IL(02) is located through the next ILC(03). Refer to 6-3-8 Branching Instruction Lines for both descriptions of both methods.

Instruction	Treatment
OUT and OUT NOT	Designated bit turned OFF.
TIM and TIMH(15)	Reset.
CNT, CNTR(12)	PV maintained.
KEEP(11)	Bit status maintained.
DIFU(13) and DIFD(14)	Not executed (see below).
All other instructions	The instructions are not executed, and all IR, AR, LR, HR, and SR bits and words written to as operands in the instructions are turned OFF.

IL(02) and ILC(03) do not necessarily have to be used in pairs. IL(02) can be used several times in a row, with each IL(02) creating an interlocked section through the next ILC(03). ILC(03) cannot be used unless there is at least one IL(02) between it and any previous ILC(03).

DIFU(13) and DIFD(14) in Interlocks

Changes in the execution condition for a DIFU(13) or DIFD(14) are not recorded if the DIFU(13) or DIFD(14) is in an interlocked section and the execution condition for the IL(02) is OFF. When DIFU(13) or DIFD(14) is execution in an interlocked section immediately after the execution condition for the IL(02) has gone ON, the execution condition for the DIFU(13) or DIFD(14) will be compared to the execution condition that existed before the interlock became effective (before the interlock condition for IL(02) went OFF). The ladder diagram and status changes for this are shown below. The interlock is in effect while 0000 is OFF. Notice that 20000 is not turned ON at the point labeled A even though 00001 has turned OFF and then back ON.

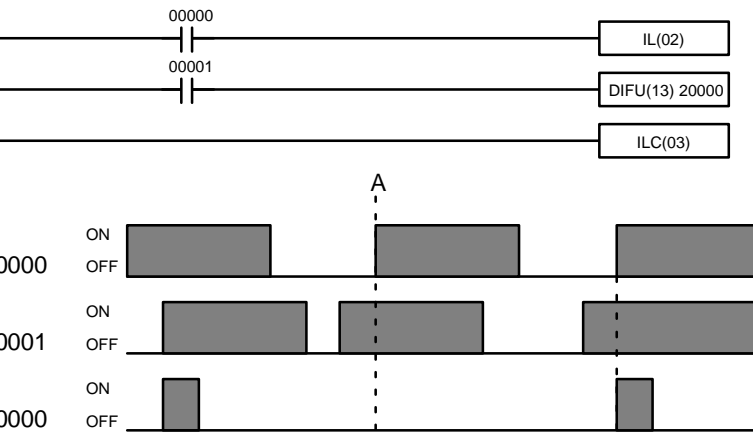

Address	Instruction	Operands
00000	LD	00000
00001	IL(02)	
00002	LD	00001
00003	DIFU(13)	20000
00004	ILC(03)	

Precautions

There must be an ILC(03) following any one or more IL(02).

Although as many IL(02) instructions as are necessary can be used with ILC(03), ILC(03) instructions cannot be used consecutively without at least one IL(02) in between, i.e., nesting is not possible. Whenever a ILC(03) is executed, all interlocks between the active ILC(03) and the preceding ILC(03) are cleared.

When more than one IL(02) is used with a single ILC(03), an error message will appear when the program check is performed, but execution will proceed normally.

Flags

There are no flags affected by these instructions.

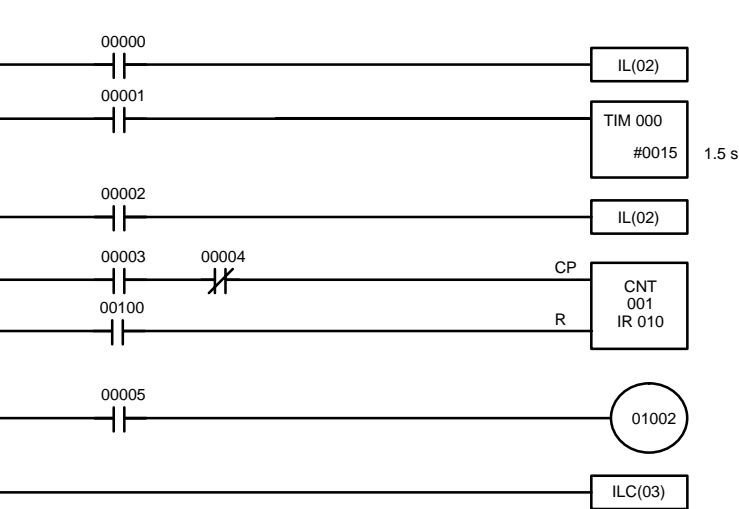

Address	Instruction	Operands
00000	LD	00000
00001	IL(02)	
00002	LD	00001
00003	TIM	000
		# 0015
00004	LD	00002
00005	IL(02)	
00006	LD	00003
00007	AND NOT	00004
00008	LD	00100
00009	LD	00100
00010	CNT	001
		010
00011	LD	00005
00012	OUT	01002
00013	ILC(03)	

When the execution condition for the first IL(02) is OFF, TIM 000 will be reset to 1.5 s, CNT 001 will not be changed, and 01002 will be turned OFF. When the execution condition for the first IL(02) is ON and the execution condition for the second IL(02) is OFF, TIM 000 will be executed according to the status of 00003. CNT 001 will not be changed, and 01002 will be turned OFF. When the execution conditions for both the IL(02) are ON, the program will execute as written.

12 JUMP and JUMP END – JMP(04) and JME(05)

Ladder Symbols

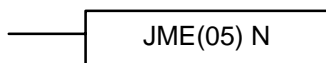
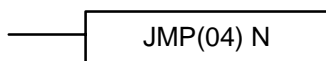

Definer Values

N: Jump number
#

N: Jump number
#

Applications

Jump numbers 01 through 49 may be used only once in JMP(04) and only once in JME(05), i.e., each can be used to define one jump only. Jump number 00 can be used as many times as desired.

Description

JMP(04) is always used in conjunction with JME(05) to create jumps, i.e., to transfer execution from one point in a ladder diagram to another point. JMP(04) defines the point from which the jump will be made; JME(05) defines the destination of the jump. When the execution condition for JMP(04) is ON, no jump is made and the program is executed consecutively as written. When the execution condition for JMP(04) is OFF, a jump is made to the JME(05) with the same jump number, and the instruction following JME(05) is executed next.

If the jump number for JMP(04) is between 01 and 49, jumps, when made, transfer execution immediately to JME(05) with the same jump number without executing any instructions in between. The status of timers, counters, bits used in OUT, bits used in OUT NOT, and all other status bits controlled by the instructions between JMP(04) and JME(05) will not be changed. Each of these jump numbers can be used to define only one jump. Because all of the instructions between JMP(04) and JME(05) are skipped, jump numbers 01 through 49 can be used to reduce execution time.

if the jump number for JMP(04) is 00, the CPU Unit will look for the next JME(05) with a jump number of 00. To do so, it must search through the program, causing a longer cycle time (when the execution condition is OFF) than for other jumps. The status of timers, counters, bits used in OUT, bits used in OUT NOT, and other status controlled by the instructions between JMP(04) 00 and JME(05) 00 will not be changed. jump number 00 can be used as many times as desired. A jump from JMP(04) 00 will always go to the next JME(05) 00 in the program. It is thus possible to use JMP(04) 00 consecutively and match them all with the same JME(05) 00. It makes no sense, however, to use JME(05) 00 consecutively because all jumps made to them will end at the first JME(05) 00.

DIFU(13) and DIFD(14) in jumps

Although DIFU(13) and DIFD(14) are designed to turn ON the designated bit for one cycle, they will not necessarily do so when written between JMP(04) and JME(05). Once either DIFU(13) or DIFD(14) has turned ON a bit, it will remain ON until the next time DIFU(13) or DIFD(14) is executed again. In normal programming, this means the next cycle. In a jump, this means the next time a jump from JMP(04) to JME(05) is not made, i.e., if a bit is turned ON by DIFU(13) or DIFD(14) and then a jump is made in the next cycle so that DIFU(13) or DIFD(14) are skipped, the designated bit will remain ON until the next time the execution condition for the JMP(04) controlling the jump is ON.

TIMH(15) and TMHH(—) in jumps

When TIMH(15) or TMHH(—) is programmed between JMP(04) and JME(05), timing will be performed by interrupt if jump numbers 01 through 49 are used. Timing won't be performed if jump number 00 is used.

Precautions

When JMP(04) and JME(05) are not used in pairs, an error message will appear when the program check is performed. This message also appears if JMP(04) 00 and JME(05) 00 are not used in pairs, but the program will execute properly as written.

Flags

There are no flags affected by these instructions.

Examples

Examples of jump programs are provided in *6-3-9 Jumps*.

FAILURE ALARM AND RESET – FAL(06) and SEVERE FAILURE ALARM – FALS(07)

Ladder Symbols

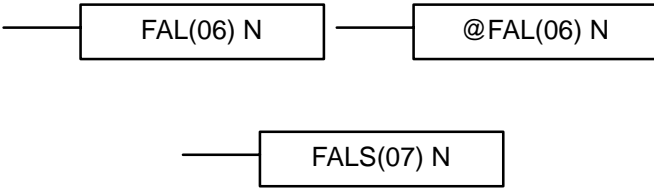

Definer Data Areas

N: FAL number
(00 to 99)

N: FAL number
(01 to 99)

Description

FAL(06) and FALS(07) are provided so that the programmer can output error numbers for use in operation, maintenance, and debugging. When executed with an ON execution condition, either of these instructions will output a number to bits 00 to 07 of SR 253. The FAL number that is output can be between 01 and 99 and is input as the definer for FAL(06) or FALS(07). FAL(06) with a definer of 00 is used to reset this area (see below).

FAL Area

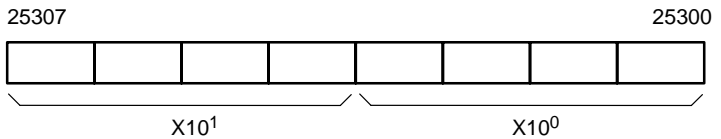

FAL(06) produces a non-fatal error and FALS(07) produces a fatal error. When FAL(06) is executed with an ON execution condition, the ALARM/ERROR indicator on the front of the CPU Unit will flash, but PC operation will continue. When FALS(07) is executed with an ON execution condition, the ALARM/ERROR indicator will light and PC operation will stop.

The system also generates error codes to the FAL area.

Setting Errors

FAL error codes will be retained in memory, although only one of these is available in the FAL area. To access the other FAL codes, reset the FAL area by executing FAL(06) 00. Each time FAL(06) 00 is executed, another FAL error code will be moved to the FAL area, clearing the one that is already there.

FAL(06) 00 is also used to clear message programmed with the instruction MSG(46).

If the FAL area cannot be cleared, as is generally the case when FALS(07) is executed, first remove the cause of the error and then clear the FAL area through the Programming Console or SSS.

14 Step Instructions: STEP DEFINE and STEP START–STEP(08)/SNXT(09)

Ladder Symbols

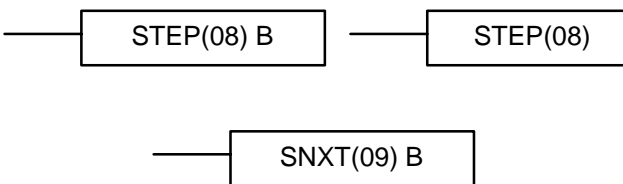

Definer Data Areas

B: Control bit
IR, AR, HR, LR

B: Control bit
IR, AR, HR, LR

The step instructions STEP(08) and SNXT(09) are used together to set breakpoints between sections in a large program so that the sections can be executed as units and reset upon completion. A section of program will usually be defined to correspond to an actual process in the application. (Refer to application examples later in this section.) A step is like a normal program code, except that certain instructions (i.e., END(01), IL(02)/ILC(03), JMP(04)/JME(05), and SBN(92)) may not be included.

STEP(08) uses a control bit in the IR or HR areas to define the beginning of a section of the program called a step. STEP(08) does not require an execution condition, i.e., its execution is controlled through the control bit. To start execution of the step, SNXT(09) is used with the same control bit as used in STEP(08). If SNXT(09) is executed with an ON execution condition, the step with the same control bit is executed. If the execution condition is OFF, the step is not executed. The SNXT(09) instruction must be written into the program so that it is executed before the program reaches the step it starts. It can be used at different locations before the step to control the step according to two different execution conditions (see example 2, below). Any step in the program that has not been started with SNXT(09) will not be executed.

Once SNXT(09) is used in the program, step execution will continue until STEP(08) is executed without a control bit. STEP(08) without a control bit must be preceded by SNXT(09) with a dummy control bit. The dummy control bit must be any unused IR or HR bit. It cannot be a control bit used in a STEP(08).

turning OFF the control bit for the step (see example 3 below). When the step is completed, all of the IR and HR bits in the step are turned OFF and all time the step are reset to their SVs. Counters, shift registers, and bits use KEEP(11) maintain status. Two simple steps are shown below.

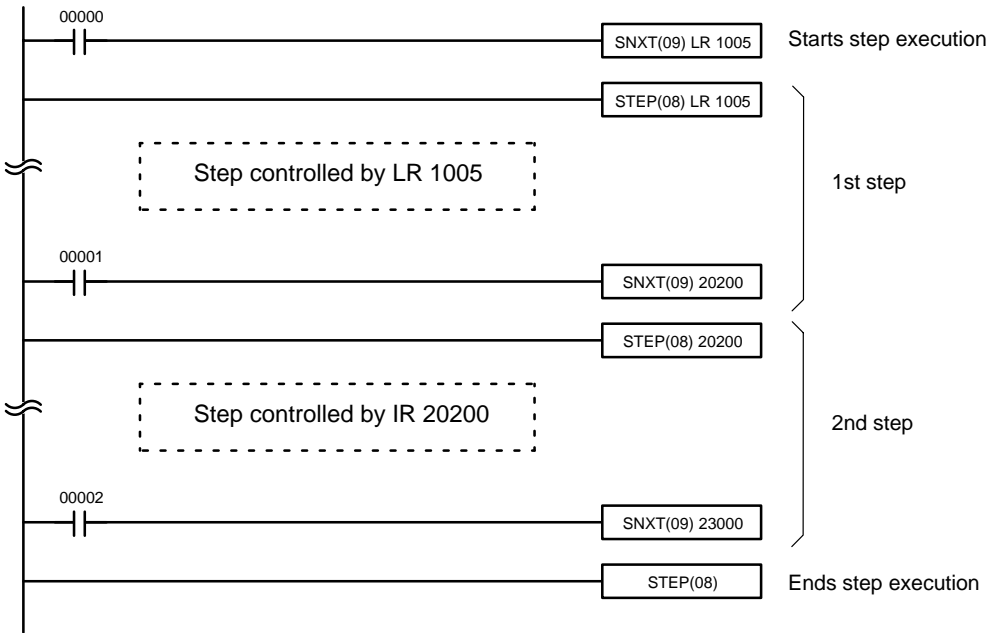

Address	Instruction	Operands
00000	LD	00000
00001	SNXT(09)	LR 1005
00002	STEP(08)	LR 1005
Step controlled by LR 1005.		
00100	LD	00001
00101	SNXT(09)	20200

Address	Instruction	Operands
00102	STEP(08)	20200
Step controlled by IR 20200.		
00200	LD	00002
00201	SNXT(09)	23000
00202	STEP(08)	---

Steps can be programmed in consecutively. Each step must start with STEP and generally ends with SNXT(09) (see example 3, below, for an exception). When steps are programmed in series, three types of execution are possible: sequential, branching, or parallel. The execution conditions for, and the positioning of, SNXT(09) determine how the steps are executed. The three examples given below demonstrate these three types of step execution.

Cautions

Interlocks, jumps, SBN(92), and END(01) cannot be used within step programs.

Bits used as control bits must not be used anywhere else in the program unless they are being used to control the operation of the step (see example 3, below). All control bits must be in the same word and must be consecutive.

If IR or LR bits are used for control bits, their status will be lost during any power interruption. If it is necessary to maintain status to resume execution at the start of a step, HR bits must be used.

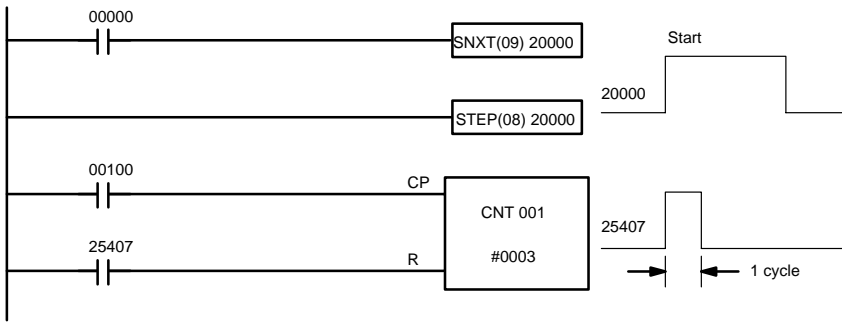

Address	Instruction	Operands
00000	LD	00000
00001	SNXT(09)	20000
00002	STEP(08)	20000
00003	LD	00100

Address	Instruction	Operands
00004	LD	25407
00005	CNT	01
		# 0003

15 Timer and Counter Instructions

TIM and TIMH(15) are decrementing ON-delay timer instructions which require a TC number and a set value (SV). STIM(69) is used to control the interval timers, which are used to activate interrupt routines.

CNT is a decrementing counter instruction and CNTR(12) is a reversible counter instruction. Both require a TC number and a SV. Both are also connected to multiple instruction lines which serve as an input signal(s) and a reset. CTBL(8), INT(89), and PRV(62) are used to manage the high-speed counter. INT(8) is also used to stop pulse output.

Any one TC number cannot be defined twice, i.e., once it has been used as a definer in any of the timer or counter instructions, it cannot be used again. Once defined, TC numbers can be used as many times as required as operands in instructions other than timer and counter instructions.

TC numbers run from 000 through 255 in the CPM2A/CPM2C PCs and from 000 through 127 in the CPM1/CPM1A/SRM1(-V2) PCs. No prefix is required when using a TC number as a definer in a timer or counter instruction. Once defined as a timer, a TC number can be prefixed with TIM for use as an operand in counter instructions. The TIM prefix is used regardless of the timer instruction that was used to define the timer. Once defined as a counter, a TC number can be prefixed with CNT for use as an operand in certain instructions. The CNT prefix is used regardless of the counter instruction that was used to define the counter.

TC numbers can be designated as operands that require either bit or word data. When designated as an operand that requires bit data, the TC number accesses a bit that functions as a 'Completion Flag' that indicates when the time/counter has expired, i.e., the bit, which is normally OFF, will turn ON when the designated time/counter has expired. When designated as an operand that requires word data, the TC number accesses a memory location that holds the present value (PV) of the timer or counter. The PV of a timer or counter can thus be used as an operand in instructions such as CMP(20), or any other instruction for which the TC area is allowed. This is done by designating the TC number used to define that timer or counter to access the memory location that holds the PV.

number 000, to designate the Completion Flag for this timer, and to designate the PV of this timer. The meaning of the term in context should be clear, i.e. the first is always an instruction, the second is always a bit operand, and the third is always a word operand. The same is true of all other TC numbers prefixed with TIM or CNT.

An SV can be input as a constant or as a word address in a data area. If a data area word assigned to an Input Unit is designated as the word address, the Input Unit can be wired so that the SV can be set externally through thumbwheel switches or similar devices. Timers and counters wired in this way can only be set externally during RUN or MONITOR mode. All SVs, including those set externally, must be in BCD.

7-15-1 TIMER – TIM

Ladder Symbol

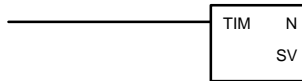

Definer Values

N: TC number
#

Operand Data Areas

SV: Set value (word, BCD)
IR, SR, AR, DM, HR, LR, #

Precautions

SV is between 000.0 and 999.9. The decimal point is not entered.

Each TC number can be used as the definer in only one TIMER or COUNTER instruction. TC numbers run from 000 through 255 in the CPM2A/CPM2C PCs and from 000 through 127 in the CPM1/CPM1A/SRM1(-V2) PCs.

TC 000 through TC 003 (TC 000 through TC 015 in the CPM2A/CPM2C) should not be used in TIM if they are required for TIMH(15). Refer to 7-15-2 HIGH-SPEED TIMER – TIMH(15) for details.

In the CPM2A/CPM2C PCs, TC 004 through TC 007 should not be used in TIM if they are required for TMHH(—). Refer to 7-15-3 VERY HIGH-SPEED TIMER – TMHH(—) for details.

Description

A timer is activated when its execution condition goes ON and is reset (turned OFF) when the execution condition goes OFF. Once activated, TIM measures in units of 0.1 second from the SV.

If the execution condition remains ON long enough for TIM to time down to zero, the Completion Flag for the TC number used will turn ON and will remain ON until TIM is reset (i.e., until its execution condition is goes OFF).

The following figure illustrates the relationship between the execution condition for TIM and the Completion Flag assigned to it.

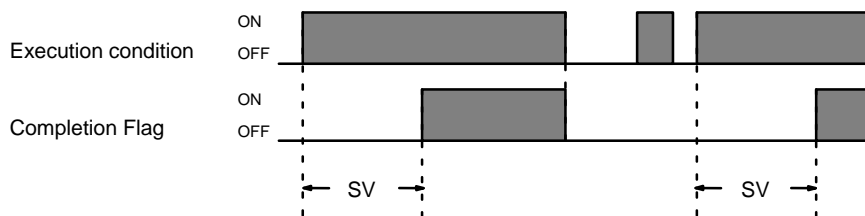

Precautions

Timers in interlocked program sections are reset when the execution condition for IL(02) is OFF. Power interruptions also reset timers. If a timer that is not reset under these conditions is desired, SR area clock pulse bits can be counted to produce timers using CNT. Refer to 7-15-5 COUNTER – CNT for details.

from the user program.
Always reset the timer after changing between TIM and TIMH(015) in online editing. The timer will not work properly if it is not reset.

If the timer's set value is set to 0000, the Completion Flag will turn ON as soon as the timer's execution condition turns ON. If the timer's set value is set to 0001, the Completion Flag will turn ON somewhere between 0 and 0.1 s after the timer's execution condition turns ON (i.e., the timer accuracy will actually determine the time), and may turn ON as soon as the timer's execution condition turns ON.

Always consider the accuracy of the timer (0 to -0.1 s) in application programming.

ER: Indirectly addressed DM word is non-existent. (Content of *DM word is not BCD, or the DM area boundary has been exceeded.)

7-15-2 HIGH-SPEED TIMER – TIMH(15)

Ladder Symbol

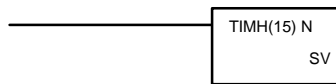

Definer Values

N: TC number
#

Operand Data Areas

SV: Set value (word, BCD)
IR, SR, AR, DM, HR, LR, #

Conditions

SV is between 00.00 and 99.99. (Although 00.00 and 00.01 may be set, 00.01 will disable the timer, i.e., turn ON the Completion Flag immediately, and 00.01 is not reliably scanned.) The decimal point is not entered.

Each TC number can be used as the definer in only one **TIMER** or **COUNTER** instruction. TC numbers run from 000 through 255 in the CPM2A/CPM2C and from 000 through 127 in the CPM1/CPM1A/SRM1(-V2) PCs.

Description

TIMH(15) operates in the same way as TIM except that TIMH measures in units of 0.01 second. Refer to 7-15-1 **TIMER – TIM** for operational details.

Precautions

Timers in interlocked program sections are reset when the execution condition for IL(02) is OFF. Power interruptions also reset timers. If a timer that is not reset under these conditions is desired, SR area clock pulse bits can be counted to produce timers using CNT. Refer to 7-15-5 **COUNTER – CNT** for details.

Timers in jumped program sections will not be reset when the execution condition for JMP(04) is OFF. The timer will stop timing if jump number 00 is used. The timer will continue timing if other jump numbers are used.

Always reset the timer when changing between TIM and TIMH(15) in online editing. Also, when changing a TIMH(15) instruction with interrupt refreshing, do so only in PROGRAM mode.

Use timer numbers 000 to 003 for TIMH(15). High-speed timers with timer numbers TC 004 through TC 127 (TC 016 through TC 255 in the CPM2A/CPM2C) may not be accurate when the cycle time exceeds 10 ms.

PC	Interrupt refreshing every 10 ms	Refreshed when TIMH(15) is executed
CPM2A/CPM2C	TC 000 through TC 003	TC 004 through TC 255
CPM1, CPM1A, and SRM1(-V2)	TC 000 through TC 003	TC 004 through TC 127

TIMH(15) if they are required for TIMHH(—): Refer to 7-10.5 VERY HIGH-SPEED TIMER: TMHH(—) for details.

If the timer's set value is set to 0000, the Completion Flag will turn ON as soon as the timer's execution condition turns ON. If TIM000 to TIM003 are used, however, there may be a delay before the flag turns ON.

If the timer's set value is set to 0001, the Completion Flag will turn ON somewhere between 0 and 0.01 s after the timer's execution condition turns ON (where the timer accuracy will actually determine the time), and may turn ON as soon as the timer's execution condition turns ON.

Always consider the accuracy of the timer (0 to -0.01 s) in application programs.

ER: Indirectly addressed DM word is non-existent. (Content of *DM word is not BCD, or the DM area boundary has been exceeded.)

The following example shows a timer set with a constant. CIO 01600 will be turned ON after CIO 00000 goes ON and stays ON for at least 1.5 seconds. When 00000 goes OFF, the timer will be reset and CIO 01600 will be turned OFF.

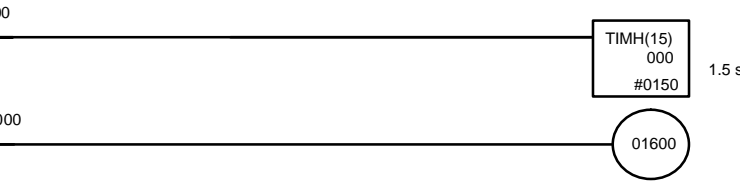

Address	Instruction	Operands
00000	LD	00000
00001	TIMH(15)	
		# 00000
00002	LD	TIM
00003	OUT	01600

15-3 VERY HIGH-SPEED TIMER: TMHH(—)

Ladder Symbol

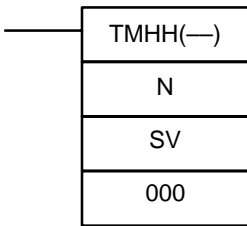

Operand Data Areas

N: #
TIM000 to TIM255
SV: Set value
IR, SR, AR, DM, HR, LR, #
000
Set to 000.

This instruction is supported by the **CPM2A/CPM2C only**.

Each TC number can be used as the definer in only one TIMER or COUNTER instruction. TC numbers run from TIM000 through TIM255. (You must enter "TIM" along with the actual timer number when using TIML(—). The instruction will not work if only the number is entered.)

SV is BCD between 0000 and 9999 (0 to 9.999 s).

Set the third operand to 000. (This operand is ignored.)

TMHH(—) is a decrementing ON-delay timer that times in 1-ms units. The timer set value can be 0 to 9.999 s and the timer has a accuracy of 1 ms.

A very high-speed timer is activated when its execution condition goes ON and reset (to the SV) when the execution condition goes OFF. Once activated, TMHH(—) times down from the SV in units of 1 ms.

The timer will time out when the PV reaches #0000 (0 ms). Once the timer has timed out, the PV and Completion Flag status will be maintained. The timer can be restarted by temporarily turning its execution condition from ON to OFF.

MOV(21):

The operation of very high-speed timers in jumped program sections depends upon the TC number used to define the timer, as shown in the following table.

TC number	Operation
000 to 003, 008 to 255	The timer will stop when the execution condition for JMP(04) is ON. This can greatly reduce the accuracy of timers in jumped program sections.
004 to 007	If jump number 00 is used, the timer will stop timing when the execution condition for JMP(04) is OFF. This can greatly reduce the accuracy of timers in jumped program sections. If any other jump number is used, the timer will continue timing normally when the execution condition for JMP(04) is OFF.

cautions

Very high-speed timers with timer numbers other than TC 004 through TC 007 may not be accurate when the cycle time exceeds 1 ms. (The cycle time will affect very high-speed timers defined with TC 004 through TC 007.)

Very high-speed timers in interlocked program sections are reset (to the set value) when the execution condition for IL(02) is OFF.

If the timer's set value is set to 0000, the Completion Flag will turn ON as soon as the timer's execution condition turns ON. If TIM004 to TIM007 are used, however, there may be a delay before the flag turns ON.

If the timer's set value is set to 0001, the Completion Flag will turn ON somewhere between 0 and 1 ms after the timer's execution condition turns ON (where the timer accuracy will actually determine the time), and may turn ON as soon as the timer's execution condition turns ON.

Always consider the accuracy of the timer (0 to -1 ms) in application programs.

ER: N is not a valid TC number.

gs

ample

In the following example, CIO 20000 will be turned ON after CIO 00000 goes ON and stays ON for at least 1.5 seconds. When 00000 goes OFF, the timer will be reset and CIO 20000 will be turned OFF.

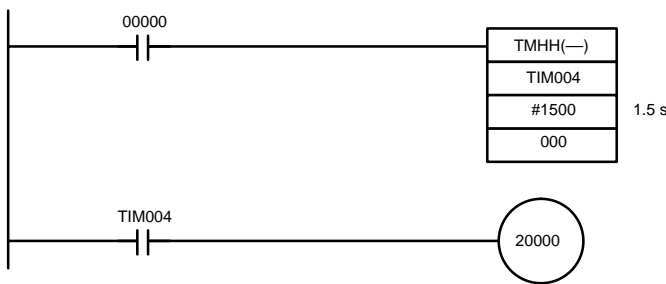

Address	Instruction	Operands
00000	LD	00000
00001	TMHH(--)	
		TIM 004
		# 1500
		000
00002	LD	TIM 004
00003	OUT	20000

5-4 LONG TIMER: TIML(--)

Ladder Symbol

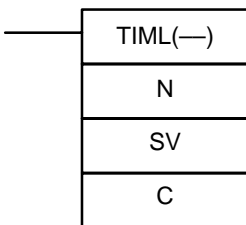

Operand Data Areas

N: Timer number (see <i>Limitations</i>)
TIM000 to TIM255
SV: Set value
IR, SR, AR, DM, HR, LR, #
C: Control data
000 or 001

This instruction is supported by the **CPM2A/CPM2C only**.

instruction: timer numbers run from TIM000 through TIM255. (You must enter "TIM" along with the actual timer number when using TIML(—). The instruction will not work if only the number is entered.)

SV is BCD between 0000 and 9999 (0 to 9,999 s when C=000 and 0 to 99,999 s when C=001).

C must be 000 (1-s timing units) or 001 (10-s timing units).

description

TIML(—) is a decrementing ON-delay timer that can time in 1-s units or 10-s units. The timer set value can be 0 to 9,999 s (accuracy 0 to 1 s) when 1-s units are used (C=000) or 0.10 to 99,990 s (accuracy 0 to 10 s) when 10-s units are used (C=001).

A long timer is activated when its execution condition goes ON and is reset (to the SV) when the execution condition goes OFF. Once activated, TIML(—) times down from the SV in units of 1 s or 10 s (depending upon the value of C). TIML(—) accuracy is 0 to 1 s with 1-s units or 0 to 10 s with 10-s units.

The timer will time out when the PV reaches #0000 (0 s). Once the timer has timed out, the PV and Completion Flag status will be maintained. The timer can be restarted by temporarily turning its execution condition from ON to OFF and changing its PV to a value other than #0000 with an instruction such as MOV(21).

Long timers in jumped program sections will not be reset when the execution condition for JMP(04) is OFF, but the timer will stop timing and the PV will be maintained. Timing will resume when the execution condition for JMP(04) goes ON again. This can greatly reduce the accuracy of long timers in jumped program sections.

cautions

TIML(—) may not be accurate when the cycle time exceeds 1 s (C=000) or 10 s (C=001).

Long timers in interlocked program sections are reset (to the SV) when the execution condition for IL(02) is OFF.

The timing units in C can be changed while the long timer is timing. Changing timing units during operation reduces the timer's accuracy by up to 10 s.

You must enter "TIM" along with the actual timer number when using TIML(—). The instruction will not work if only the number is entered.

If the timer's set value is set to 0000, the Completion Flag will turn ON as soon as the timer's execution condition turns ON. If the timer's set value is set to 0001, the Completion Flag will turn ON somewhere between 0 and 1 s or between 0.10 and 10 s after the timer's execution condition turns ON (i.e., the timer accuracy will actually determine the time), and may turn ON as soon as the timer's execution condition turns ON.

Always consider the accuracy of the timer (0 to -1 s or 0 to -10 s) in application programs.

errors

ER: N is not a valid timer number.

C is not 000 or 001.

and stays ON for at least 1,000 seconds. When 0000 goes OFF, the timer will be reset and CIO 20000 will be turned OFF.

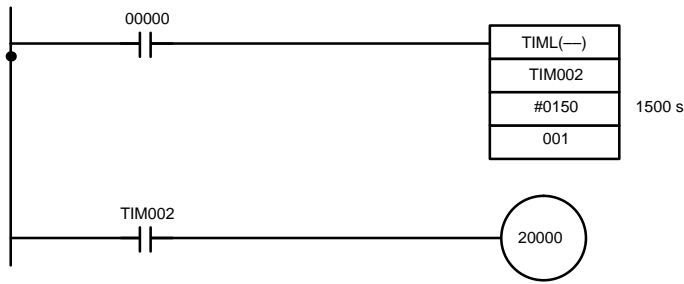

Address	Instruction	Operands
00000	LD	00000
00001	TIML(—)	
		TIM 002
		# 0150
		001
00002	LD	TIM 002
00003	OUT	20000

15-5 COUNTER – CNT

Ladder Symbol

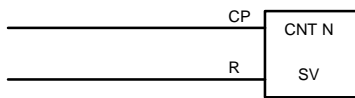

Definer Values

N: TC number
#

Operand Data Areas

SV: Set value (word, BCD)
IR, SR, AR, DM, HR, LR, #

Applications

Each TC number can be used as the definer in only one TIMER or COUNTER instruction. TC numbers run from 000 through 255 in the CPM2A/CPM2C and from 000 through 127 in the CPM1/CPM1A/SRM1(-V2) PCs.

Description

CNT is used to count down from SV when the execution condition on the count pulse, CP, goes from OFF to ON, i.e., the present value (PV) will be decremented by one whenever CNT is executed with an ON execution condition for the first time and the execution condition was OFF for the last execution. If the execution condition has not changed or has changed from ON to OFF, the PV of CNT will not be changed. The Completion Flag for a counter is turned ON when the counter reaches zero and will remain ON until the counter is reset.

CNT is reset with a reset input, R. When R goes from OFF to ON, the PV is reset to SV. The PV will not be decremented while R is ON. Counting down from SV will begin again when R goes OFF. The PV for CNT will not be reset in interlocked program sections or by power interruptions.

Changes in execution conditions, the Completion Flag, and the PV are illustrated below. PV line height is meant only to indicate changes in the PV.

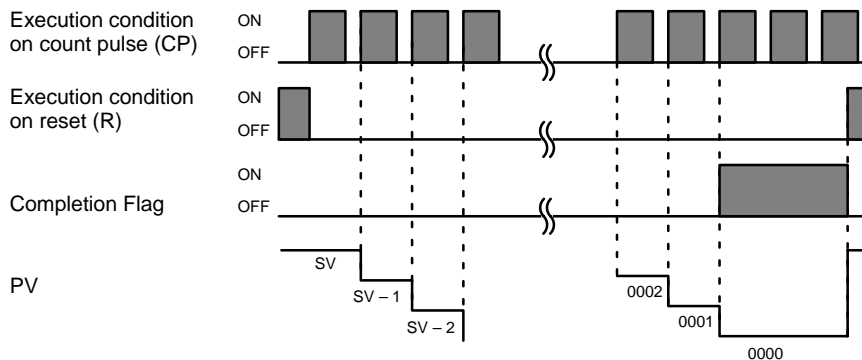

gs

not be connect.

ER: Indirectly addressed DM word is non-existent. (Content of *DM word is not BCD, or the DM area boundary has been exceeded.)

Example

In the following example, CNT is used to create extended timers by counting area clock pulse bits.

CNT 001 counts the number of times the 1-second clock pulse bit (SR 25502) goes from OFF to ON. Here again, IR 00000 is used to control the times when CNT is operating.

Because in this example the SV for CNT 001 is 700, the Completion Flag CNT 002 turns ON when 1 second x 700 times, or 11 minutes and 40 seconds have expired. This would result in IR 20002 being turned ON.

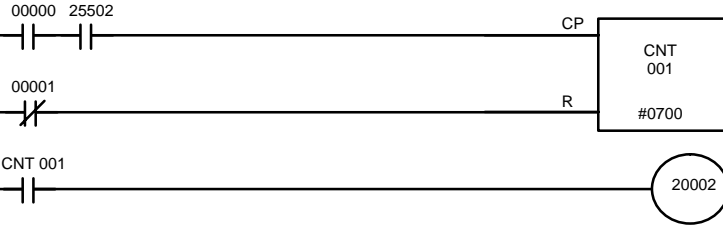

Address	Instruction	Operands
00000	LD	00000
00001	AND	25502
00002	LD NOT	00001
00003	CNT	001
		# 0700
00004	LD	CNT 001
00005	OUT	20002



Caution

The shorter clock pulses will not necessarily produce accurate timers because their short ON times might not be read accurately during longer cycles. In particular, the 0.02-second and 0.1-second clock pulses should not be used to create timers with CNT instructions.

15-6 REVERSIBLE COUNTER – CNTR(12)

Ladder Symbol

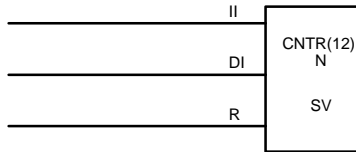

Definer Values

N: TC number
#

Operand Data Areas

SV: Set value (word, BCD)
IR, SR, AR, DM, HR, LR, #

Limitations

Each TC number can be used as the definer in only one TIMER or COUNTER instruction. TC numbers run from 000 through 255 in the CPM2A/CPM2C and from 000 through 127 in the CPM1/CPM1A/SRM1(-V2) PCs.

Description

The CNTR(12) is a reversible, up/down circular counter, i.e., it is used to count between zero and SV according to changes in two execution conditions, those in the increment input (II) and those in the decrement input (DI).

The present value (PV) will be incremented by one whenever CNTR(12) is executed with an ON execution condition for II and the last execution condition for II was OFF. The present value (PV) will be decremented by one whenever CNTR(12) is executed with an ON execution condition for DI and the last execution condition for DI was OFF. If OFF to ON changes have occurred in both II and DI since the last execution, the PV will not be changed.

for both II and DI, the PV of CNT will not be changed.
 When decremented from 0000, the present value is set to SV and the Completion Flag is turned ON until the PV is decremented again. When incremented past the SV, the PV is set to 0000 and the Completion Flag is turned ON until the PV is incremented again.

CNTR(12) is reset with a reset input, R. When R goes from OFF to ON, the PV is reset to zero. The PV will not be incremented or decremented while R is ON. Counting will begin again when R goes OFF. The PV for CNTR(12) will not be reset in interlocked program sections or by the effects of power interruptions. Changes in II and DI execution conditions, the Completion Flag, and the PV are illustrated below starting from part way through CNTR(12) operation (i.e., with a reset, counting begins from zero). PV line height is meant to indicate changes in the PV only.

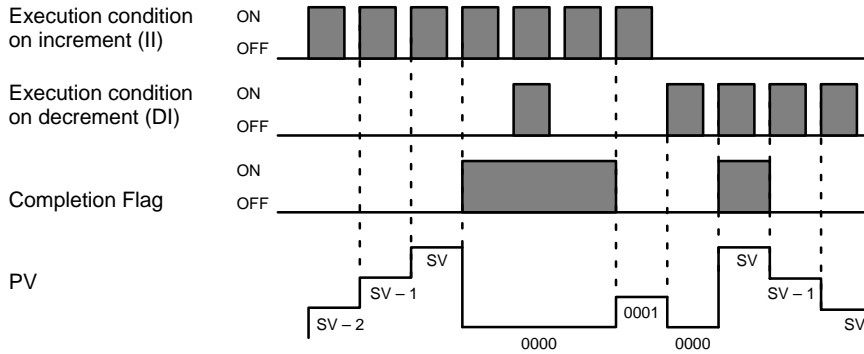

Precautions: Program execution will continue even if a non-BCD SV is used, but the SV will not be correct.

Errors: Indirectly addressed DM word is non-existent. (Content of *DM word is not BCD, or the DM area boundary has been exceeded.)

15-7 REGISTER COMPARISON TABLE – CTBL(63)

Ladder Symbols

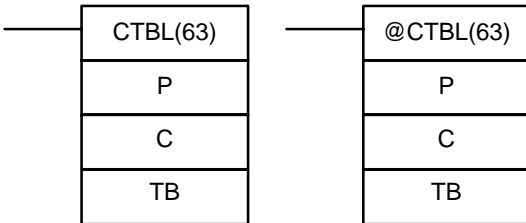

Operand Data Areas

P: Port specifier
000
C: Control data
000 to 003
TB: First comparison table word
IR, SR, AR, DM, HR, LR

This instruction is not supported by SRM1(-V2) PCs.

Restrictions: The first and last comparison table words must be in the same data area. (The length of the comparison table varies according to the settings.)
 P must be 000 and C must be between 000 and 003.

Description: When the execution condition is OFF, CTBL(63) is not executed. When the execution condition is ON, CTBL(63) registers a comparison table for use with the high-speed counter PV. Depending on the value of C, comparison with the high-speed counter PV can begin immediately or it can be started separately with INI(61).

comparison: Always set 1 to 000.

The function of CTBL(63) is determined by the control data, C, as shown in the following table. These functions are described after the table.

C	CTBL(63) function
000	Registers a target value comparison table and starts comparison.
001	Registers a range comparison table and starts comparison.
002	Registers a target value comparison table. Start comparison with INI(61).
003	Registers a range comparison table. Start comparison with INI(61).

When the PV agrees with a target value or falls within a specified range, the specified subroutine is called and executed. Refer to 2-3-5 *High-speed Counter Interrupts* for more details on table comparison.

If the high-speed counter is enabled in the PC Setup (DM 6642), it will begin counting from zero when the CPM2A/CPM2C begins operation. The PV will be compared to the comparison table until the table is registered and comparison is initiated with INI(61) or CTBL(63). Comparison can be stopped, started, or the PV can be reset with INI(61).

Common Characteristics of Target Value and Range Comparisons

1, 2, 3...

The operation of a target value comparison is different from a range comparison but the two functions share some common characteristics.

1. Subroutine numbers 000 to 049 can be used and the same subroutine number can be used more than once in the table.
2. An undefined subroutine number or FFFF can be set for the subroutine number if interrupt processing is not required.
3. Comparison can be stopped with INI(61). A registered table is valid until operation stops or a new comparison table is registered.
4. CTBL(62) cannot be executed if the high-speed counter is disabled in the PC Setup (DM 6642). (An error will occur if CTBL(63) is executed when the high-speed counter is disabled.)

Target Value Comparison

A target value comparison table contains up to sixteen target values. A subroutine number is also registered for each target value. The corresponding subroutine is called and executed when the PV matches a target value. (When interrupt processing is not required, an undefined subroutine number may be entered.)

- In the CPM1/CPM1A, target value comparisons are performed one item at a time in order of the comparison table. When the PV reaches the first target value in the table, the interrupt subroutine is executed and comparison continues to the next value in the table. When processing has been completed for the target value in the table, comparison returns to the first value in the table and the process is repeated.
- In the CPM2A/CPM2C, the PV is compared to all of the target values in the table each time CTBL(63) is executed. When the PV matches a target value, the corresponding subroutine is called and executed.

The following diagram shows the structure of a target value comparison table. Target values must be unique; an error will occur if a target value appears in the table more than once.

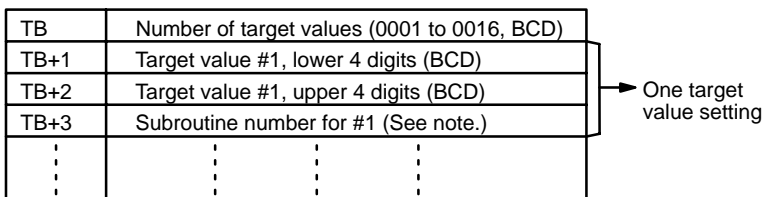

decrementing and can be 0000 to 0049 to activate the subroutine when incrementing. An error will occur if the high-speed counter is set to increment mode but a decrementing subroutine number (F000 to F049) is specified.

Range Comparison

A range comparison table contains 8 ranges which are defined by an 8-digit lower limit and an 8-digit upper limit, as well as their corresponding subroutine numbers. The comparison is performed once each cycle at the end of program execution and can be performed during program execution with INI(61).

When the PV falls within a given range the corresponding subroutine is called and executed. (When interrupt processing is not required, an undefined subroutine number may be entered.) Ranges can overlap, so the PV can fall within more than one range; in the PV is within two or more ranges, the subroutine of the first of the ranges will be executed.

The following diagram shows the structure of a range comparison table. Always set 8 ranges. If fewer than 8 ranges are needed, set the remaining subroutine numbers to FFFF.

TB	Lower limit #1, lower 4 digits (BCD)	} First range setting
TB+1	Lower limit #1, upper 4 digits (BCD)	
TB+2	Upper limit #1, lower 4 digits (BCD)	
TB+3	Upper limit #1, upper 4 digits (BCD)	
TB+4	Subroutine number (See note 2.)	
⋮	⋮	
TB+35	Lower limit #8, lower 4 digits (BCD)	} Eighth range setting
TB+36	Lower limit #8, upper 4 digits (BCD)	
TB+37	Upper limit #8, lower 4 digits (BCD)	
TB+38	Upper limit #8, upper 4 digits (BCD)	
TB+39	Subroutine number (See note 2.)	

- Note**
1. Each range's lower limit must be less than its upper limit. An error will occur if the lower limit is greater than the upper limit.
 2. The subroutine number can be 0000 to 0049 and the subroutine will be executed as long as the counter's PV is within the specified range. A value of FFFF indicates that no subroutine is to be executed.
 3. Since the comparison is usually performed just once each cycle, be sure to take the cycle time into account when the upper and lower limits represent time values.
 4. A subroutine number can be used more than once in the table.

ER: The comparison table exceeds the data area boundary, or there is an error in the comparison table settings.

Indirectly addressed DM word is non-existent. (Content of *DM word is not BCD, or the DM area boundary has been exceeded.)

P is not 000 or C is not between 000 and 003.

There is a CTBL(63) instruction using a different comparison format than the subroutine called by another CTBL(63) instruction.

A CTBL(63) instruction using a different comparison format is executed during comparison.

CTBL(63) is executed in an interrupt subroutine while a pulse I/O high-speed counter instruction (INI(61), PRV(62), CTBL(63), SPED(64), PULS(65), ACC(—), PWM(—), or SYNC(—)) is being executed in the main program.

The number of target values (in 1B) is not between 0001 and 0004 (difference mode), pulse + direction input mode, and up/down input mode.
 A target value is not between F838 8608 and 0838 8607 (difference mode), pulse + direction input mode, and up/down input mode.
 A target value is not between 0000 0001 and 1677 7215 or a subword number is not between 0000 and 0049 (increment mode).
 If 0000 0000 is set in increment mode, 25503 (ER) will turn ON and the instruction will not be executed.

Range Comparison Errors:

A range's upper limit value is less than its lower limit value.
 A target value is not between F838 8608 and 0838 8607 (difference mode), pulse + direction input mode, and up/down input mode.
 A target value is not between 0000 0000 and 1677 7215 or a subword number is not between 0000 and 0049 (increment mode).

15-8 MODE CONTROL – INI(61)

Ladder Symbols

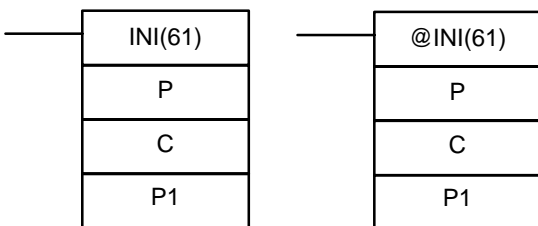

Operand Data Areas

P: Port specifier
000, 010, 100, 101, 102, 103
C: Control data
000 to 005
P1: First PV word
IR, SR, AR, DM, HR, LR (or 000)

This instruction is not supported by SRM1(-V2) PCs.

In the CPM1/CPM1A PCs, P must be 000 and C must be 000 to 003.
 In CPM2A/CPM2C PCs, P must be 000, 010, 100, 101, 102, or 103 and C must be 000 to 005.
 P1 must be 000 unless C is 002 or 004.
 P1 and P1+1 must be in the same data area.
 If a DM address is used for P1, it must be read/write DM.

Description

When the execution condition is OFF, INI(61) is not executed. When the execution condition is ON, INI(61) is used to control high-speed counter operation stop pulse output.
 The port specifier (P) specifies the high-speed counter or pulse output that will be controlled.

P	Function
000	Specifies high-speed counter input (inputs 00000, 00001, and 00002), single-phase pulse output 0 with no acceleration/deceleration (output 01000 or 01001), single-phase pulse output 0 with trapezoidal acceleration/deceleration (output 01000).
010*	Specifies single-phase pulse output 1 with no acceleration/deceleration (output 01001).
100*	Specifies interrupt input 0 in counter mode (input 00003).
101*	Specifies interrupt input 1 in counter mode (input 00004).
102*	Specifies interrupt input 2 in counter mode (input 00005).
103*	Specifies interrupt input 3 in counter mode (input 00006).

Note *These settings can be used in CPM2A/CPM2C PCs only.

C	P1	INI(61) function
000	000	Starts CTBL(63) table comparison.
001	000	Stops CTBL(63) table comparison.
002	New PV	Changes PV of the high-speed counter or an interrupt input counter mode.
003	000	Stops pulse output.
004*	New PV	Changes PV of the pulse output.
005*	000	Stops synchronized pulse control output.

Note *These settings can be used in CPM2A/CPM2C PCs only.

Start or Stop Comparison (C=000 or C=001)

If C is 000 or 001, INI(61) starts or stops comparison of the high-speed counter to the comparison table registered with CTBL(63). An error will occur if the function is executed without first registering a comparison table with CTBL(63). In general, @INI(61) should be used when C=000 because the instruction needs to be executed only one time to start table comparison.

Change PV (C=002)

If C is 002, INI(61) changes the PV of the specified high-speed counter or interrupt input (counter mode).

High-speed Counter PV (P=000)

INI(61) changes the PV of the specified high-speed counter to the 8-digit BCD value in P1 and P1+1.

The new PV can be F838 8608 to 0838 8607 in differential phase mode, pulse direction input mode, or up/down input mode. (The hexadecimal "F" in the first digit acts as a minus sign.)

The new PV can be 0000 0000 to 1677 7215 in increment mode.

Interrupt Input PV (P=100 to 103)

INI(61) changes the PV of the specified interrupt input (counter mode) to the 4-digit hexadecimal value (0000 to FFFF) in P1.

Stop Pulse Output (C=003)

If C is 003, INI(61) stops the pulse output.

Change PV (C=004)

INI(61) changes the PV of the pulse output to the 8-digit BCD value in P1 and P1+1. The PV cannot be changed while the pulse output is in progress.

The new PV can be -16,777,215 to 16,777,215. Bit 15 of P1+1 acts as a sign bit; the number is negative if bit 15 is ON, positive if it is OFF.

Stop Synchronized Pulse Control Output (C=005)

If C is 005, INI(61) stops the synchronized pulse control output.

Errors

ER: The port specifier and control data are incompatible. (For example: P=010 and C=000)

There is an error in the operand settings or the specified PV is not within the acceptable range.

The address specified for P1 or P1+1 exceeds the data area boundary.

Indirectly addressed DM word is non-existent. (Content of *DM word is not BCD, or the DM area boundary has been exceeded.)

The specified function is incompatible with actual PC operation. For example, do not set C=005 if synchronized pulse control is not being used.

INI(61) is executed to change the PV of a pulse output (C=004) while the pulse output is operating.

INI(61) is executed in an interrupt subroutine while a pulse I/O or high-speed counter instruction (INI(61), PRV(62), CTBL(63), SPED(64), PULS(65), ACC(—), PWM(—), or SYNC(—)) is being executed in the main program.

15-9 HIGH-SPEED COUNTER PV READ – PRV(62)

Ladder Symbols

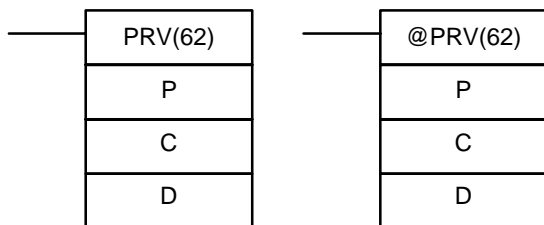

Operand Data Areas

P: Port specifier
000, 010, 100, 101, 102, 103
C: Control data
000, 001, 002, or 003
D: First destination word
IR, SR, AR, DM, HR, LR

This instruction is not supported by SRM1(-V2) PCs.

Conditions

In the CPM1/CPM1A PCs, P must be 000 and C must be 000 to 002.

In CPM2A/CPM2C PCs, P must be 000, 010, 100, 101, 102, or 103 and C must be 000 to 003.

D and D+1 must be in the same data area.

If a DM address is used for D, it must be read/write DM.

Description

When the execution condition is OFF, PRV(62) is not executed. When the execution condition is ON, PRV(62) controls the high-speed counter PV, pulse output PV, interrupt input (counter mode) PV, or input frequency for synchronized control as specified by P and C.

The port specifier (P) specifies the high-speed counter or pulse output that will be controlled.

P	Function
000	Specifies high-speed counter input (inputs 00000, 00001, and 00002), input frequency for synchronized pulse control (inputs 00000, 00001, and 00002), single-phase pulse output 0 with no acceleration/deceleration (outputs 01000 and 01001), single-phase pulse output 0 with trapezoidal acceleration/deceleration (output 01000), or synchronized pulse control output 0 (output 01000/01001).
010*	Specifies single-phase pulse output 1 with no acceleration/deceleration (output 01001) or synchronized pulse control output 1 (output 01001).
100*	Specifies interrupt input 0 in counter mode (input 00003).
101*	Specifies interrupt input 1 in counter mode (input 00004).
102*	Specifies interrupt input 2 in counter mode (input 00005).
103*	Specifies interrupt input 3 in counter mode (input 00006).

Note *These settings can be used in CPM2A/CPM2C PCs only.

The control data, C, determines which type of data will be accessed.

C	Function	Destination word
000	Reads the PV of the high-speed counter or interrupt input (counter mode) or the input frequency of the synchronized pulse control.	D and D+1
001	Reads the status of the high-speed counter or pulse output.	D
002	Reads the results of range comparison.	D
003*	Reads the PV of the pulse output.	D and D+1

Note *This setting can be used in CPM2A/CPM2C PCs only.

input (counter mode).

High-speed Counter PV or Input Frequency (P=000)

When the output is used for a high-speed counter, PRV(62) reads the PV of the specified high-speed counter and writes the 8-digit BCD value in D and D+1. (The leftmost 4 digits are written to D+1.)

The PV can be F838 8608 to 0838 8607 in differential phase mode, pulse direction input mode, or up/down input mode. (The hexadecimal "F" in the first digit acts as a minus sign.)

The PV can be 0000 0000 to 1677 7215 in increment mode.

When the output is used for synchronized pulse control, PRV(62) reads the input frequency and writes the 8-digit BCD value in D and D+1. The input frequency can be 0000 0000 to 0002 0000.

Interrupt Input PV (P=100 to 103)

PRV(62) reads the PV of the specified interrupt input (counter mode) and writes the 4-digit hexadecimal value (0000 to FFFF) in D.

Counter Status (C=001)

If C is 001, PRV(62) reads the operating status of the specified high-speed counter or pulse output and writes the data to D.

High-speed Counter or Pulse Output 0 Status (P=000)

The following table shows the function of the bits in D when P=000. Bits not listed in the table are not used and will always be 0.

Usage	Bit	Function
High-speed counter	00	High-speed counter comparison status. (0: Stopped; 1: Comparing)
	01	High-speed counter underflow/overflow. (0: Normal; 1: Underflow/Overflow occurred.)
Pulse output	05	Total number of pulses specified for pulse output 0. (0: Not specified; 1: Specified.)
	06	Pulse output 0 completed. (0: Not completed; 1: Completed)
	07	Pulse output 0 status (0: Stopped; 1: Outputting)
	08	Pulse output 0 PV underflow/overflow. (0: Normal; 1: Underflow/Overflow occurred.)
	09	Pulse output 0 acceleration (0: Constant; 1: Accelerating or decelerating)

Pulse Output 1 Status (P=010)

The following table shows the function of the bits in D when P=010. Bits not listed in the table are not used and will always be 0.

Bit	Function
05	Total number of pulses specified for pulse output 1. (0: Not specified; 1: Specified.)
06	Pulse output 1 completed. (0: Not completed; 1: Completed)
07	Pulse output 1 status (0: Stopped; 1: Outputting)
08	Pulse output 1 PV underflow/overflow. (0: Normal; 1: Underflow/Overflow occurred.)
09	Pulse output 1 acceleration (0: Constant; 1: Accelerating or decelerating)

Counter Range Comparison Results (C=002)

If C is 002, PRV(62) reads the results of the comparison of the PV to the 8 ranges defined by CTBL(63) and writes this data to D. Bits 00 through 07 of D contain the Comparison Result Flags for ranges 1 to 8. (0: Not in range; 1: In range)

Pulse Output PV (C=003)

If C is 003, PRV(62) reads the pulse output PV and writes the 8-digit BCD value in D and D+1. (The leftmost 4 digits are written to D+1.)

The PV can be -16,777,215 to 16,777,215. Bit 15 of D+1 acts as a sign bit. The number is negative if bit 15 is ON, positive if it is OFF.

(For example: P=010 and C=000)

The address specified for D or D+1 exceeds the data area bound

There is an error in the operand settings.

Indirectly addressed DM word is non-existent. (Content of *DM word is not BCD, or the DM area boundary has been exceeded.)

PRV(62) is executed in an interrupt subroutine while a pulse I/O or high speed counter instruction (INI(61), PRV(62), CTBL(63), SPED(64), PULS(65), ACC(—), PWM(—), or SYNC(—)) is being executed in the main program.

16-1 SHIFT REGISTER – SFT(10)

Ladder Symbol

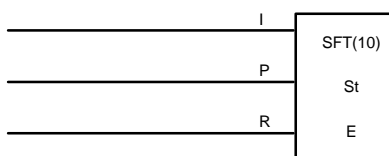

Operand Data Areas

St: Starting word
IR, SR, AR, HR, LR
E: End word
IR, SR, AR, HR, LR

Restrictions

E must be greater than or equal to St, and St and E must be in the same operand data area.

If a bit address in one of the words used in a shift register is also used in another instruction that controls individual bit status (e.g., OUT, KEEP(11)), an error message (“COIL/OUT DUPL”) will be generated when program syntax is checked on the Programming Console or another Programming Device. The program, however, will be executed as written. See *Example 2: Controlling Bits in Shift Register* for a programming example that does this.

Description

SFT(10) is controlled by three execution conditions, I, P, and R. If SFT(10) is executed and 1) execution condition P is ON and was OFF the last time SFT(10) was executed and 2) R is OFF, then execution condition I is shifted into the rightmost bit of the shift register defined between St and E, i.e., if I is ON, a 1 is shifted into the register; if I is OFF, a 0 is shifted in. When I is shifted into the register, all bits previously in the register are shifted to the left and the leftmost bit of the register is lost.

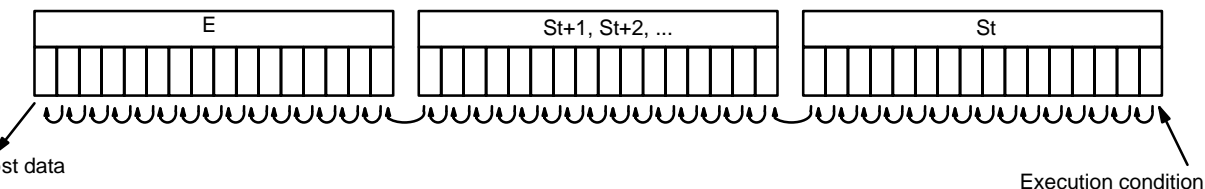

The execution condition on P functions like a differentiated instruction, i.e., a 1 will be shifted into the register only when P is ON and was OFF the last time SFT(10) was executed. If execution condition P has not changed or has gone from ON to OFF, the shift register will remain unaffected.

St designates the rightmost word of the shift register; E designates the leftmost word. The shift register includes both of these words and all words between them. The same word may be designated for St and E to create a 16-bit (i.e., 1-word) shift register.

When execution condition R goes ON, all bits in the shift register will be turned OFF (i.e., set to 0) and the shift register will not operate until R goes OFF again.

Warnings

ER: St and E are not in the same area or St is greater than E.

Execution condition by 00000 is shifted into HR 00 every second. put 20000 is turned ON whenever a "1" is shifted into HR 0007.

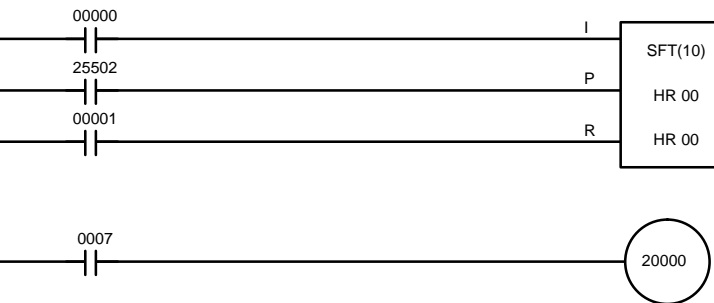

Address	Instruction	Operands
00000	LD	00000
00001	LD	25502
00002	LD	00001
00003	SFT(10)	HR 00
		HR 00
00004	LD	HR 0007
00005	OUT	20000

16-2 WORD SHIFT – WSFT(16)

Ladder Symbols

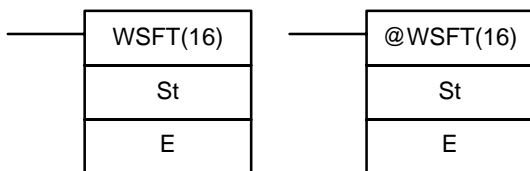

Operand Data Areas

St: Starting word
IR, SR, AR, DM, HR, LR
E: End word
IR, SR, AR, DM, HR, LR

Restrictions

St and E must be in the same data area, and E must be greater than or equal to St.

DM 6144 to DM 6655 cannot be used for St or E.

Description

When the execution condition is OFF, WSFT(16) is not executed. When the execution condition is ON, WSFT(16) shifts data between St and E in word units. Zeros are written into St and the content of E is lost.

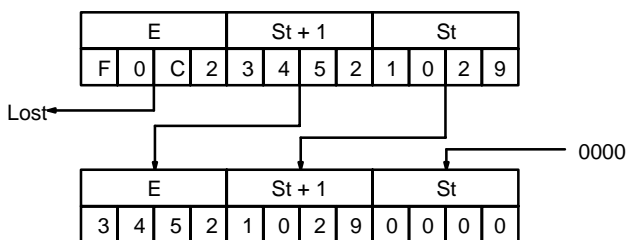

Errors

ER: The St and E words are in different areas, or St is greater than E. Indirectly addressed DM word is non-existent. (Content of *DM word is not BCD, or the DM area boundary has been exceeded.)

16-3 ARITHMETIC SHIFT LEFT – ASL(25)

Ladder Symbols

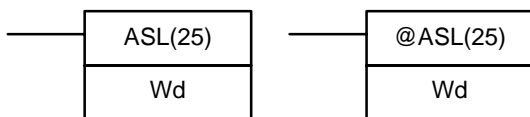

Operand Data Areas

Wd: Shift word
IR, SR, AR, DM, HR, LR

Restrictions

DM 6144 to DM 6655 cannot be used for Wd.

tion condition is ON, ASL(25) shifts a 0 into bit 15 of Wd, shifts the bits of Wd one bit to the left, and shifts the status of bit 15 into CY.

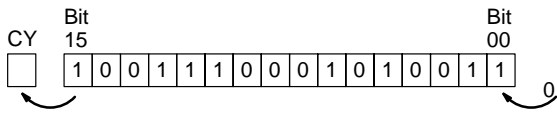

cautions

A 0 will be shifted into bit 00 every cycle if the undifferentiated form of ASL(25) is used. Use the differentiated form (@ASL(25)) or combine ASL(25) with DIFU(13) or DIFD(14) to shift just one time.

gs

ER: Indirectly addressed DM word is non-existent. (Content of *DM word is not BCD, or the DM area boundary has been exceeded.)

CY: Receives the status of bit 15.

EQ: ON when the content of Wd is zero; otherwise OFF.

16-4 ARITHMETIC SHIFT RIGHT – ASR(26)

Ladder Symbols

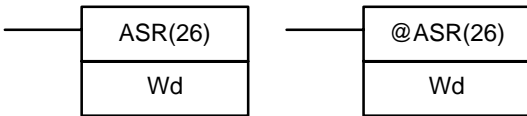

Operand Data Areas

Wd: Shift word
IR, SR, AR, DM, HR, LR

itations

DM 6144 to DM 6655 cannot be used for Wd.

escription

When the execution condition is OFF, ASR(25) is not executed. When the execution condition is ON, ASR(25) shifts a 0 into bit 15 of Wd, shifts the bits of Wd one bit to the right, and shifts the status of bit 00 into CY.

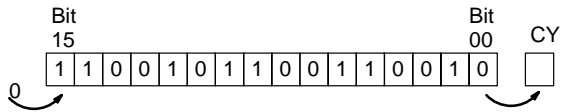

cautions

A 0 will be shifted into bit 15 every cycle if the undifferentiated form of ASR(25) is used. Use the differentiated form (@ASR(26)) or combine ASR(26) with DIFU(13) or DIFD(14) to shift just one time.

gs

ER: Indirectly addressed DM word is non-existent. (Content of *DM word is not BCD, or the DM area boundary has been exceeded.)

CY: Receives the data of bit 00.

EQ: ON when the content of Wd is zero; otherwise OFF.

16-5 ROTATE LEFT – ROL(27)

Ladder Symbols

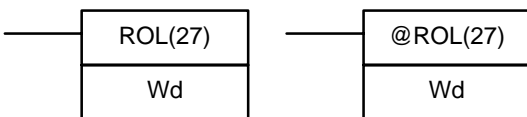

Operand Data Areas

Wd: Rotate word
IR, SR, AR, DM, HR, LR

itations

DM 6144 to DM 6655 cannot be used for Wd.

execution condition is ON, ROL(27) shifts all Wd bits one bit to the left, shifting bit 15 of Wd into bit 00 of Wd and shifting bit 00 of Wd into CY.

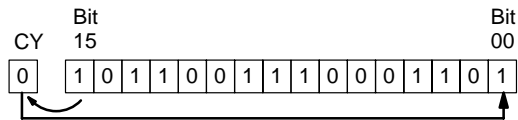

cautions

Use STC(41) to set the status of CY or CLC(41) to clear the status of CY before doing a rotate operation to ensure that CY contains the proper status before executing ROL(27).

CY will be shifted into bit 00 every cycle if the undifferentiated form of ROL(27) is used. Use the differentiated form (@ROL(27)) or combine ROL(27) with DIFU(13) or DIFD(14) to shift just one time.

gs

ER: Indirectly addressed DM word is non-existent. (Content of *DM word is not BCD, or the DM area boundary has been exceeded.)

CY: Receives the data of bit 15.

EQ: ON when the content of Wd is zero; otherwise OFF.

16-6 ROTATE RIGHT – ROR(28)

Ladder Symbols

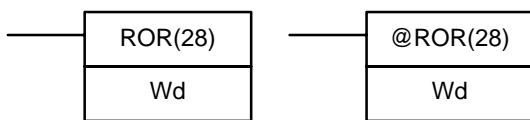

Operand Data Areas

Wd: Rotate word
IR, SR, AR, DM, HR, LR

ications

DM 6144 to DM 6655 cannot be used for Wd.

escription

When the execution condition is OFF, ROR(28) is not executed. When the execution condition is ON, ROR(28) shifts all Wd bits one bit to the right, shifting bit 00 of Wd into bit 15 of Wd and shifting bit 15 of Wd into CY.

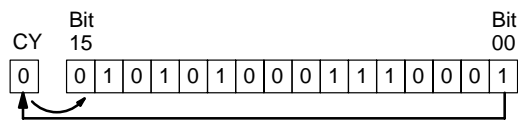

cautions

Use STC(41) to set the status of CY or CLC(41) to clear the status of CY before doing a rotate operation to ensure that CY contains the proper status before executing ROR(28).

CY will be shifted into bit 15 every cycle if the undifferentiated form of ROR(28) is used. Use the differentiated form (@ROR(28)) or combine ROR(28) with DIFU(13) or DIFD(14) to shift just one time.

gs

ER: Indirectly addressed DM word is non-existent. (Content of *DM word is not BCD, or the DM area boundary has been exceeded.)

CY: Receives the data of bit 00.

EQ: ON when the content of Wd is zero; otherwise OFF.

Ladder Symbols

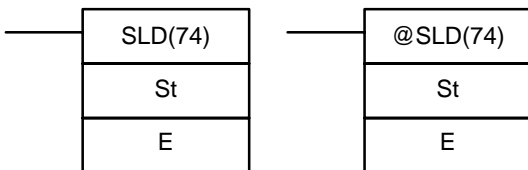

Operand Data Areas

St: Starting word
IR, SR, AR, DM, HR, LR
E: End word
IR, SR, AR, DM, HR, LR

Conditions

St and E must be in the same data area, and E must be greater than or equal to St.

DM 6144 to DM 6655 cannot be used for St or E.

Description

When the execution condition is OFF, SLD(74) is not executed. When the execution condition is ON, SLD(74) shifts data between St and E (inclusive) by one digit (four bits) to the left. 0 is written into the rightmost digit of the St, and the content of the leftmost digit of E is lost.

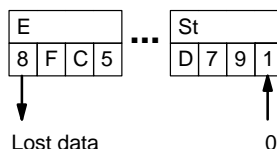

Precautions

If a power failure occurs during a shift operation across more than 50 words, the shift operation might not be completed.

A 0 will be shifted into the least significant digit of St every cycle if the undifferentiated form of SLD(74) is used. Use the differentiated form (@SLD(74)) or combine SLD(74) with DIFU(13) or DIFD(14) to shift just one time.

Errors

ER: The St and E words are in different areas, or St is greater than E. Indirectly addressed DM word is non-existent. (Content of *DM word is not BCD, or the DM area boundary has been exceeded.)

16-8 ONE DIGIT SHIFT RIGHT – SRD(75)

Ladder Symbols

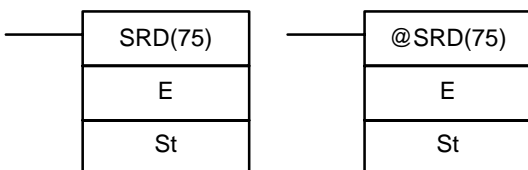

Operand Data Areas

E: End word
IR, SR, AR, DM, HR, LR
St: Starting word
IR, SR, AR, DM, HR, LR

Conditions

St and E must be in the same data area, and E must be less than or equal to St. DM 6144 to DM 6655 cannot be used for St or E.

Description

When the execution condition is OFF, SRD(75) is not executed. When the execution condition is ON, SRD(75) shifts data between St and E (inclusive) by one digit (four bits) to the right. 0 is written into the leftmost digit of St and the rightmost digit of E is lost.

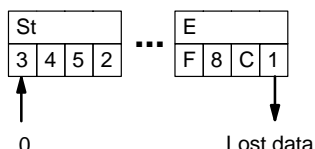

Shift operation might not be completed.
 A 0 will be shifted into the most significant digit of St every cycle if the undifferentiated form of SRD(75) is used. Use the differentiated form (@SRD(75)) or combine SRD(75) with DIFU(13) or DIFD(14) to shift just one time.

ER: The St and E words are in different areas, or St is less than E.
 Indirectly addressed DM word is non-existent. (Content of *DM word not BCD, or the DM area boundary has been exceeded.)

16-9 REVERSIBLE SHIFT REGISTER – SFTR(84)

Ladder Symbols

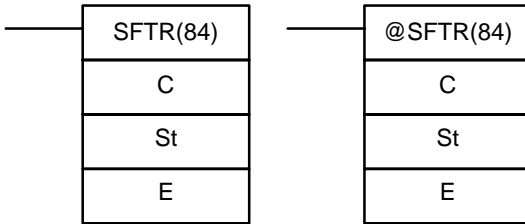

Operand Data Areas

C: Control word
IR, SR, AR, DM, HR, LR
St: Starting word
IR, SR, AR, DM, HR, LR
E: End word
IR, SR, AR, DM, HR, LR

Limitations St and E must be in the same data area and St must be less than or equal to E.

DM 6144 to DM 6655 cannot be used for C, St, or E.

Description SFTR(84) is used to create a single- or multiple-word shift register that can shift data to either the right or the left. To create a single-word register, designate the same word for St and E. The control word provides the shift direction, the status to be put into the register, the shift pulse, and the reset input. The control word is allocated as follows:

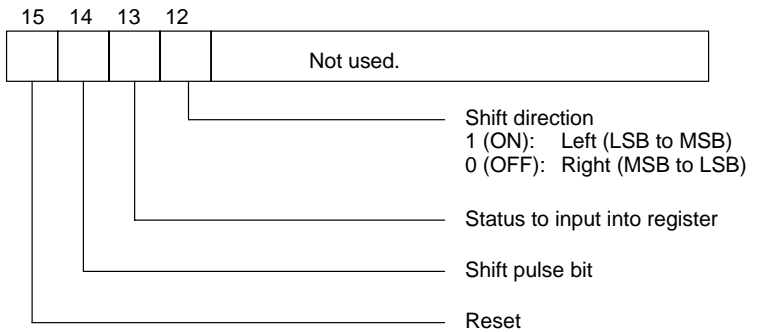

The data in the shift register will be shifted one bit in the direction indicated by bit 12, shifting one bit out to CY and the status of bit 13 into the other end when SFTR(84) is executed with an ON execution condition as long as the reset bit is OFF and as long as bit 14 is ON. If SFTR(84) is executed with an OFF execution condition or if SFTR(84) is executed with bit 14 OFF, the shift register will remain unchanged. If SFTR(84) is executed with an ON execution condition and the reset bit (bit 15) is OFF, the entire shift register and CY will be set to zero.

ER: St and E are not in the same data area or ST is greater than E.
 Indirectly addressed DM word is non-existent. (Content of *DM word not BCD, or the DM area boundary has been exceeded.)

Example

In the following example, IR 00000, IR 00001, IR 00002, and IR 00003 are used to control the bits of C used in @SFTR(84). The shift register is in DM 0010, it is controlled through IR 00004.

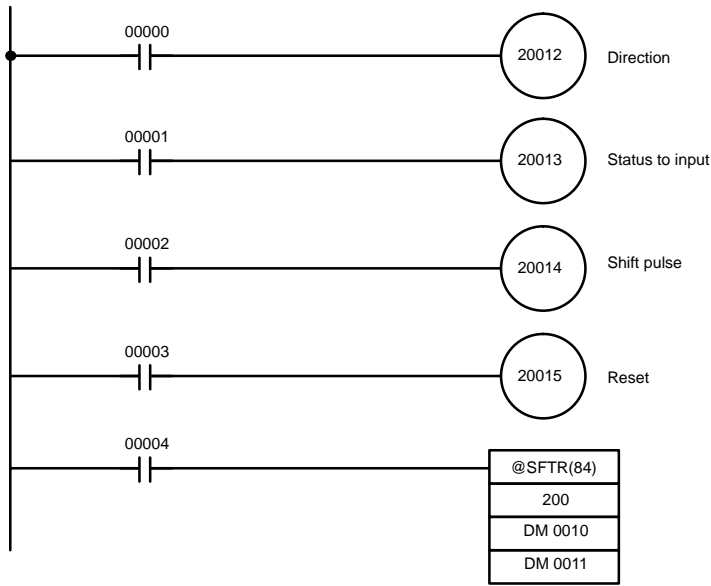

Address	Instruction	Operands
00000	LD	00000
00001	OUT	20012
00002	LD	00001
00003	OUT	20013
00004	LD	00002
00005	OUT	20014
00006	LD	00003
00007	OUT	20015
00008	LD	00004
00009	@SFTR(84)	
		200
		DM 0010
		DM 0011

16-10 ASYNCHRONOUS SHIFT REGISTER – ASFT(17)

Operand Data Areas

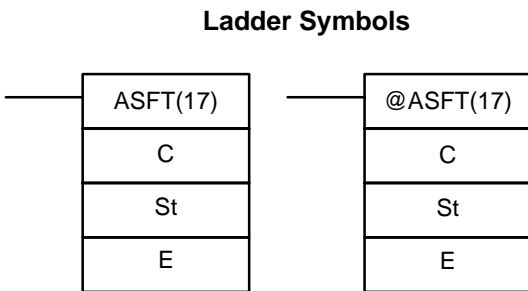

C: Control word
IR, SR, AR, DM, HR, LR, #
St: Starting word
IR, SR, AR, DM, HR, LR
E: End word
IR, SR, AR, DM, HR, LR

Note ASFT(17) is an expansion instruction for the SRM1(-V2). The function code is the factory setting and can be changed for the SRM1(-V2) if desired.

Limitations

St and E must be in the same data area, and E must be greater than or equal to St.

DM 6144 to DM 6655 cannot be used for St or E.

Description

When the execution condition is OFF, ASFT(17) does nothing and the program moves to the next instruction. When the execution condition is ON, ASFT(17) is used to create and control a reversible asynchronous word shift register between St and E. This register only shifts words when the next word in the register is zero, e.g., if no words in the register contain zero, nothing is shifted. Also, only one word is shifted for each word in the register that contains zero. When the contents of a word are shifted to the next word, the original word's contents are set to zero. In essence, when the register is shifted, each zero word in the register trades places with the next word. (See *Example* below.)

The shift direction (i.e. whether the "next word" is the next higher or the next lower word) is designated in C. C is also used to reset the register. All or any portion of the register can be reset by designating the desired portion with St and E.

shift down (toward lower addressed words) and OFF to shift up (toward higher addressed words). Bit 14 is the Shift Enable Bit: turn bit 14 ON to enable register operation according to bit 13 and OFF to disable the register. Bit 15 is Reset bit: the register will be reset (set to zero) between St and E words. ASFT(17) is executed with bit 15 ON. Turn bit 15 OFF for normal operation.

Note If the non-differentiated form of ASFT(17) is used, data will be shifted every cycle while the execution condition is ON. Use the differentiated form to prevent this.

ER: The St and E words are in different areas, or St is greater than E. Indirectly addressed DM word is non-existent. (Content of *DM word is not BCD, or the DM area boundary has been exceeded.)

The following example shows instruction ASFT(17) used to shift words in an 11-word shift register created between DM 0100 and DM 0110 with C=#6000. Non-zero data is shifted towards St (DM 0110).

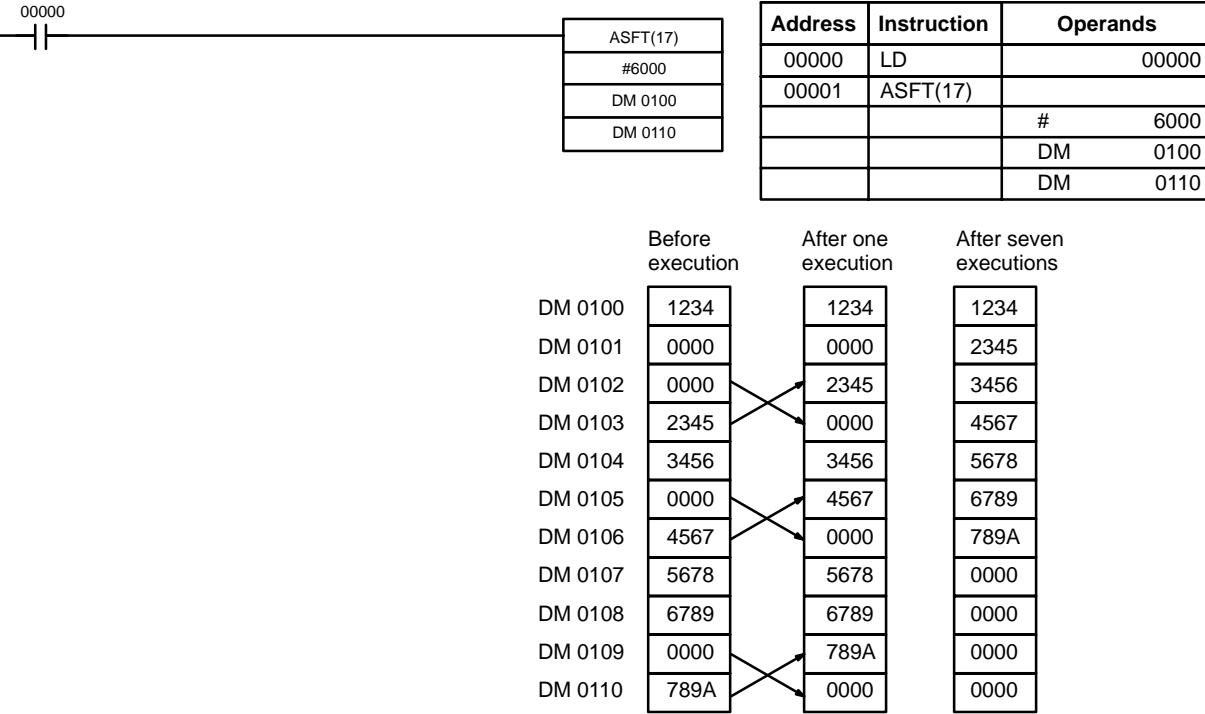

Note The zeroes are shifted "upward" if C=4000, and the entire shift register is set to zero if C=8000.

17 Data Movement Instructions

17-1 MOVE – MOV(21)

Ladder Symbols

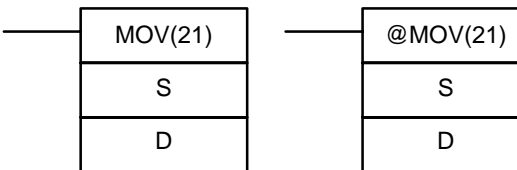

Operand Data Areas

S: Source word
IR, SR, AR, DM, HR, TC, LR, #
D: Destination word
IR, SR, AR, DM, HR, LR

escription

When the execution condition is OFF, MOV(21) is not executed. When execution condition is ON, MOV(21) copies the content of S to D.

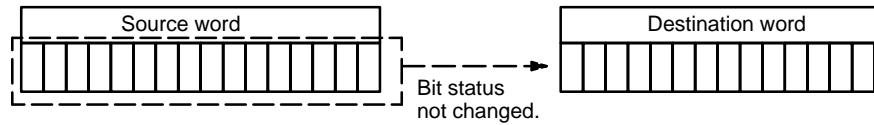

cautions

TC numbers cannot be designated as D to change the PV of the timer or counter. You can, however, easily change the PV of a timer or a counter by using BSET(71).

gs

ER: Indirectly addressed DM word is non-existent. (Content of *DM word is not BCD, or the DM area boundary has been exceeded.)

EQ: ON when all zeros are transferred to D.

ample

The following example shows @MOV(21) being used to copy the content of IR 001 to HR 05 when IR 00000 goes from OFF to ON.

00000

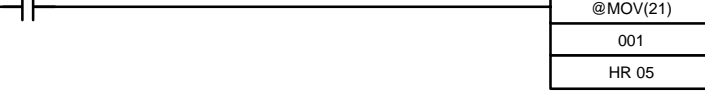

Address	Instruction	Operands
00000	LD	00000
00001	@MOV(21)	
		001
		HR 05

IR 000 0 1 1 1 1 0 0 1 1 1 0 0 0 0 1 0 1



HR 05 0 1 1 1 1 0 0 1 1 1 0 0 0 0 1 0 1

17-2 MOVE NOT – MVN(22)

Ladder Symbols

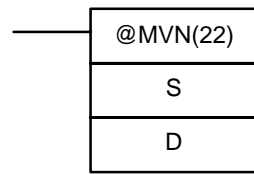
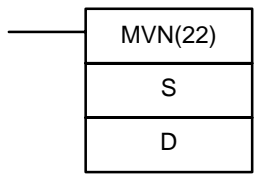

Operand Data Areas

S: Source word
IR, SR, AR, DM, HR, TC, LR, #
D: Destination word
IR, SR, AR, DM, HR, LR

itations

DM 6144 to DM 6655 cannot be used for D.

escription

When the execution condition is OFF, MVN(22) is not executed. When execution condition is ON, MVN(22) transfers the inverted content of S (specified word or four-digit hexadecimal constant) to D, i.e., for each ON bit in S, the corresponding bit in D is turned OFF, and for each OFF bit in S, the corresponding bit in D is turned ON.

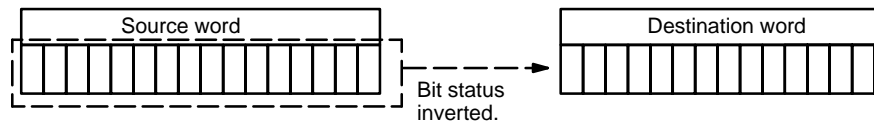

cautions

TC numbers cannot be designated as D to change the PV of the timer or counter. However, these can be easily changed using BSET(71).

not BCD, of the DM area boundary has been exceeded.)

EQ: ON when all zeros are transferred to D.

Example

The following example shows @MVN(22) being used to copy the compleme #F8C5 to DM 0010 when IR 00001 goes from OFF to ON.

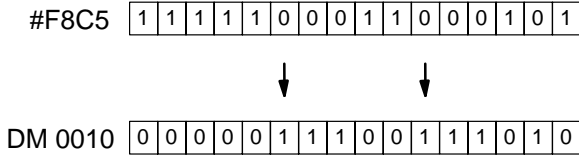
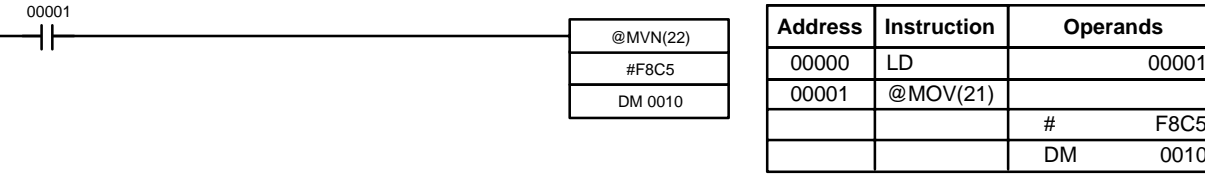

7-3 BLOCK TRANSFER – XFER(70)

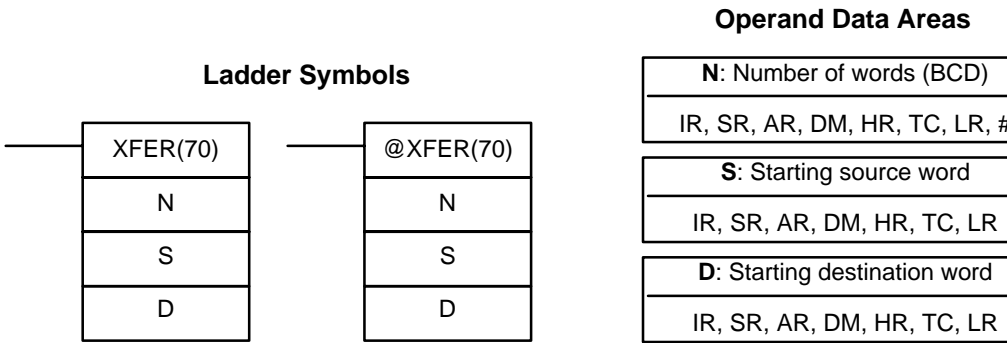

Limitations

S and S+N must be in the same data area, as must D and D+N.
DM 6144 to DM 6655 cannot be used for D.

Description

When the execution condition is OFF, XFER(70) is not executed. When execution condition is ON, XFER(70) copies the contents of S, S+1, ..., S+N to D, D+1, ..., D+N.

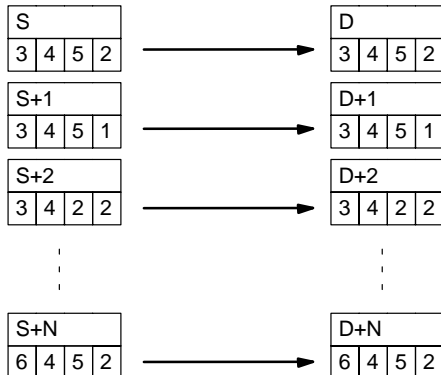

Errors

ER: N is not BCD
S and S+N or D and D+N are not in the same data area.

17-4 BLOCK SET – BSET(71)

not BCD, or the DM area boundary has been exceeded.)

Operand Data Areas

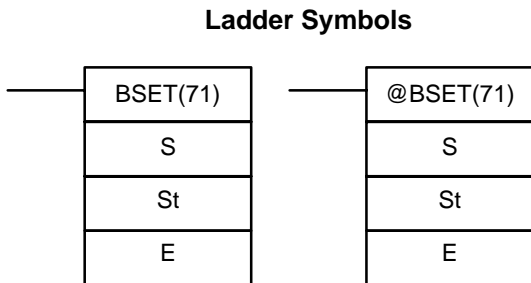

S: Source data
IR, SR, AR, DM, HR, TC, LR, #
St: Starting word
IR, SR AR, DM, HR, TC, LR
E: End Word
IR, SR, AR, DM, HR, TC, LR

Limitations

St must be less than or equal to E, and St and E must be in the same data area. DM 6144 to DM 6655 cannot be used for St or E.

Description

When the execution condition is OFF, BSET(71) is not executed. When the execution condition is ON, BSET(71) copies the content of S to all words from St through E.

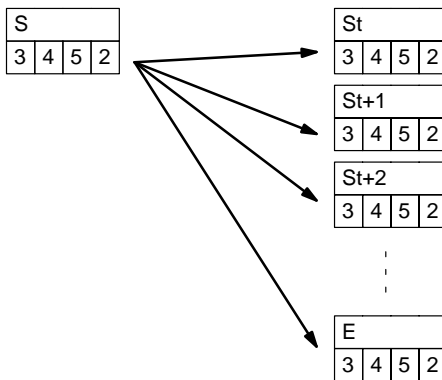

BSET(71) can be used to change timer/counter PV. (This cannot be done with MOV(21) or MVN(22).) BSET(71) can also be used to clear sections of a data area, i.e., the DM area, to prepare for executing other instructions. It can also be used to clear words by transferring all zeros.

Errors

ER: St and E are not in the same data area or St is greater than E.
Indirectly addressed DM word is non-existent. (Content of *DM word is not BCD, or the DM area boundary has been exceeded.)

Example

The following example shows how to use BSET(71) to copy a constant (#0000) to a block of the DM area (DM 0000 to DM 0500) when IR 00000 is ON.

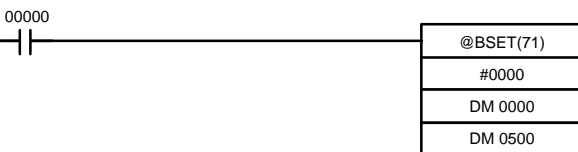

Address	Instruction	Operands
00000	LD	00000
00001	@BSET(71)	# 0000 DM 0000 DM 0500

Ladder Symbols

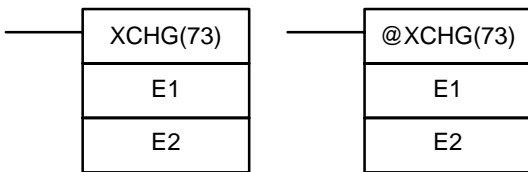

Operand Data Areas

E1: Exchange word 1
IR, SR, AR, DM, HR, TC, LR
E2: Exchange word 2
IR, SR, AR, DM, HR, TC, LR

Limitations

DM 6144 to DM 6655 cannot be used for E1 or E2.

Description

When the execution condition is OFF, XCHG(73) is not executed. When the execution condition is ON, XCHG(73) exchanges the content of E1 and E2.

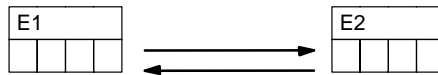

If you want to exchange content of blocks whose size is greater than 1 word, work words as an intermediate buffer to hold one of the blocks using XFER three times.

Flags

ER: Indirectly addressed DM word is non-existent. (Content of *DM word not BCD, or the DM area boundary has been exceeded.)

17-6 SINGLE WORD DISTRIBUTE – DIST(80)

Ladder Symbols

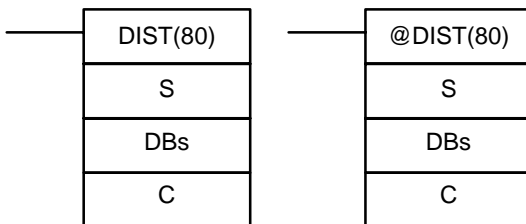

Operand Data Areas

S: Source data
IR, SR, AR, DM, HR, TC, LR, #
DBs: Destination base word
IR, SR, AR, DM, HR, TC, LR
C: Control word (BCD)
IR, SR, AR, DM, HR, TC, LR, #

Limitations

C must be BCD.

DM 6144 to DM 6655 cannot be used for DBs or C.

Description

DIST(80) can be used for single-word distribution or for a stack operation pending on the content of the control word, C.

Single-word Distribution

When bits 12 to 15 of C=0 to 8, DIST(80) can be used for a single word distribution operation. The entire contents of C specifies an offset, Of (0000 to 2047 in BCD).

When the execution condition is OFF, DIST(80) is not executed. When the execution condition is ON, DIST(80) copies the content of S to DBs+Of, i.e., Of is added to DBs to determine the destination word.

Note DBs and DBs+Of must be in the same data area and cannot be between DM 6144 and DM 6655.

Example

The following example shows how to use DIST(80) to copy #00FF to HR 10 -

00000



Address	Instruction	Operands
00000	LD	0000
00001	@DIST(80)	
		# 00FF
		HR
		LR

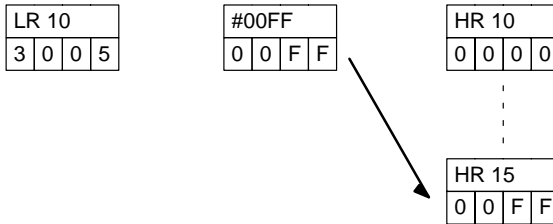

Stack Operation

When bits 12 to 15 of C=9, DIST(80) can be used for a stack operation. The 3 digits of C specify the number of words in the stack (000 to 999 in BCD). The content of DBs is the stack pointer.

When the execution condition is OFF, DIST(80) is not executed. When the execution condition is ON, DIST(80) copies the content of S to DBs+1+the content of DBs. In other words, 1 and the content of DBs are added to DBs to determine the destination word. The content of DBs is then incremented by 1.

- Note**
1. DIST(80) will be executed every cycle unless the differentiated function is used (@DIST(80)) is used or DIST(80) is used with DIFU(13) or DIFD(14).
 2. Be sure to initialize the stack pointer before using DIST(80) as a stack operation.

Example

The following example shows how to use DIST(80) to create a stack between DM 0001 and DM 0005. DM 0000 acts as the stack pointer.

00000

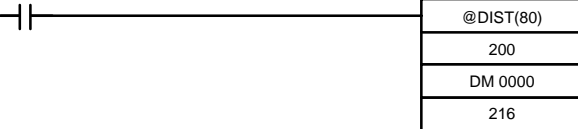

Address	Instruction	Operands
00000	LD	0000
00001	@DIST(80)	
		200
		DM 0000
		216

IR 200 FFFF

IR 216 9005

DM 0000	0000
DM 0001	0000
DM 0002	0000
DM 0003	0000
DM 0004	0000
DM 0005	0000

First execution
→
Stack pointer incremented

DM 0000	0001
DM 0001	FFFF
DM 0002	0000
DM 0003	0000
DM 0004	0000
DM 0005	0000

Second execution
→
Stack pointer incremented

DM 0000	0002
DM 0001	FFFF
DM 0002	FFFF
DM 0003	0000
DM 0004	0000
DM 0005	0000

gs

- ER:**
- The offset or stack length in the control word is not BCD.
 - Indirectly addressed DM word is non-existent. (Content of *DM word is not BCD, or the DM area boundary has been exceeded.)

EQ: ON when the content of S is zero; otherwise OFF.

17-7 DATA COLLECT – COLL(81)

Ladder Symbols

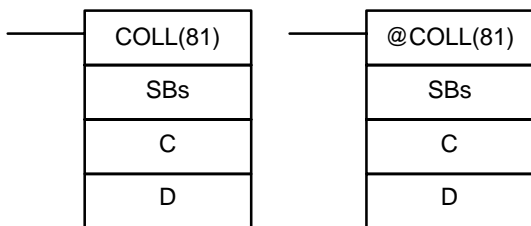

Operand Data Areas

SBs: Source base word
IR, SR, AR, DM, HR, TC, LR
C: Control word (BCD)
IR, SR, AR, DM, HR, TC, LR, #
D: Destination word
IR, SR, AR, DM, HR, TC, LR

Limitations

C must be BCD.

DM 6144 to DM 6655 cannot be used for D.

Description

COLL(81) can be used for data collection, an FIFO stack operation, or an LIFO stack operation depending on the content of the control word, C.

Data Collection

When bits 12 to 15 of C=0 to 7, COLL(81) is used for data collection. The content of C specifies an offset, Of (0000 to 2047 in BCD).

When the execution condition is OFF, COLL(81) is not executed. When the execution condition is ON, COLL(81) copies the content of SBs + Of to D, i.e. Of is added to SBs to determine the source word.

Note SBs and SBs+Of must be in the same data area.

Example

The following example shows how to use COLL(81) to copy the content of DM 0000+Of to LR 00. The content of 200 is #0005, so the content of DM 0005 (DM 0000 + 5) is copied to LR 00 when IR 00001 is ON.



Address	Instruction	Operands
00000	LD	00001
00001	@DIST(80)	
		DM 0000
		200
		LR 00

200
0 0 0 5

DM 0000
0 0 0 0

DM 0005
0 0 F F

LR 00
0 0 F F

FIFO Stack Operation

When bits 12 to 15 of C=9, COLL(81) can be used for an FIFO stack operation. The other 3 digits of C specify the number of words in the stack (000 to 999 in BCD). The content of SBs is the stack pointer.

When the execution condition is ON, COLL(81) shifts the contents of each word within the stack down by one address, finally shifting the data from SBs+1 to the destination word (D). The content of SBs (the first value written to the stack) is then decremented by one.

Example

The following example shows how to use COLL(81) to create a stack between DM 0001 and DM 0005. DM 0000 acts as the stack pointer.

When IR 00000 goes from OFF to ON, COLL(81) shifts the contents of DM 0001 to DM 0005 down by one address, and shifts the data from DM 0001 to IR 001. The content of the stack pointer (DM 0000) is then decremented by one.

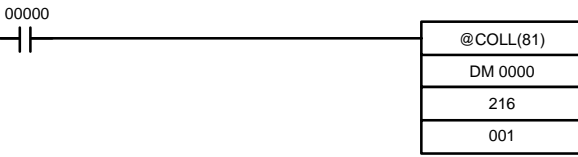

Address	Instruction	Operands
00000	LD	00000
00001	@COLL(81)	
		DM 0001
		216
		001

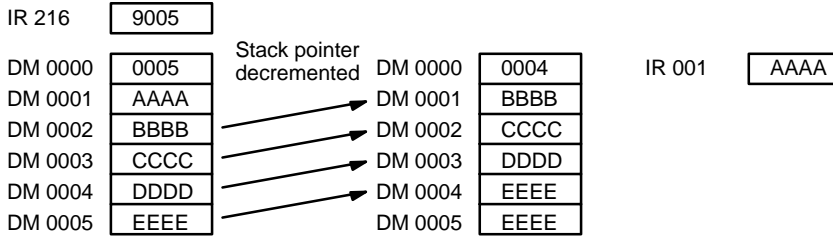

Stack Operation

When bits 12 to 15 of C=8, COLL(81) can be used for an LIFO stack operation. The other 3 digits of C specify the number of words in the stack (000 to 999). The content of SBs is the stack pointer.

When the execution condition is ON, COLL(81) copies the data from the word indicated by the stack pointer (SBs+the content of SBs) to the destination word (D). The content of the stack pointer (SBs) is then decremented by one. The stack pointer is the only word changed in the stack.

Note COLL(81) will be executed every cycle unless the differentiated instruction (@DIST(80)) is used or DIST(80) is used with DIFU(13) or DIFD(14).

Example

The following example shows how to use COLL(81) to create a stack between DM 0001 and DM 0005. DM 0000 acts as the stack pointer.

When IR 00000 goes from OFF to ON, COLL(81) copies the content of DM 0005 (DM 0000 + 5) to IR 001. The content of the stack pointer (DM 0000) is then decremented by one.

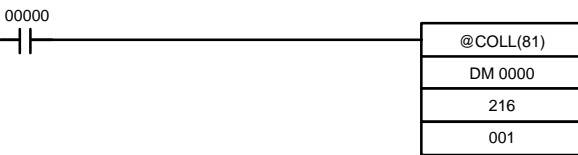

Address	Instruction	Operands
00000	LD	00000
00001	@COLL(81)	
		DM 0005
		216
		001

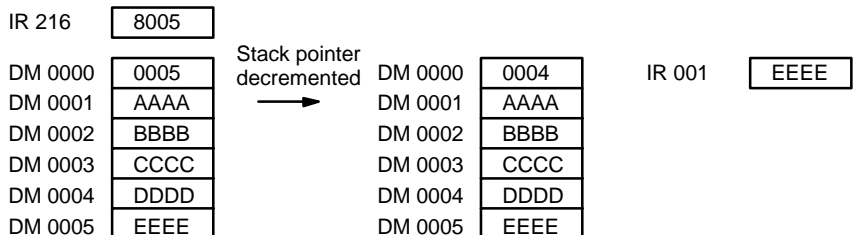

Indirectly addressed DM word is non-existent. (Content of *DM word is not BCD, or the DM area boundary has been exceeded.)

During stack operation, the value of the stack pointer exceeds the length of the stack; an attempt was made to write to a word beyond the end of the stack.

EQ: ON when the content of S is zero; otherwise OFF.

17-8 MOVE BIT – MOVB(82)

Ladder Symbols

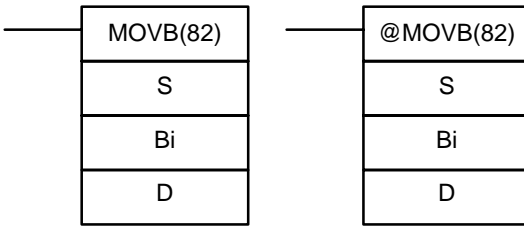

Operand Data Areas

S: Source word
IR, SR, AR, DM, HR, LR, #
Bi: Bit designator (BCD)
IR, SR, AR, DM, HR, TC, LR, #
D: Destination word
IR, SR, AR, DM, HR, LR

Restrictions

The rightmost two digits and the leftmost two digits of Bi must each be between 00 and 15.

DM 6144 to DM 6655 cannot be used for Bi or D.

Description

When the execution condition is OFF, MOV B(82) is not executed. When the execution condition is ON, MOV B(82) copies the specified bit of S to the specified bit in D. The bits in S and D are specified by Bi. The rightmost two digits designate the source bit; the leftmost two bits designate the destination bit.

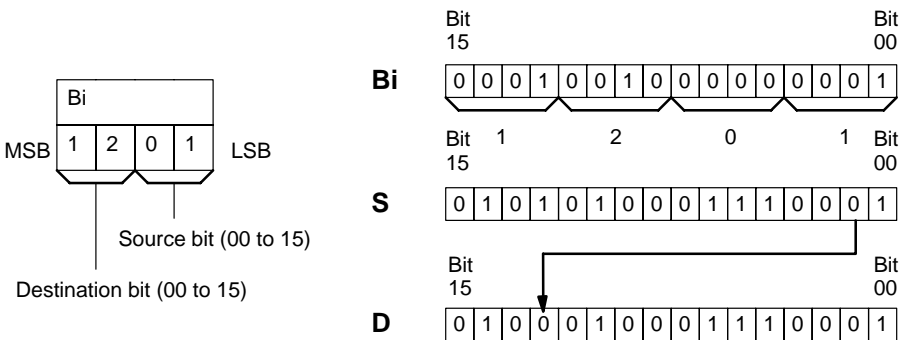

Errors

ER: Bi is not BCD, or it is specifying a non-existent bit (i.e., bit specification must be between 00 and 15).

Indirectly addressed DM word is non-existent. (Content of *DM word is not BCD, or the DM area boundary has been exceeded.)

Operand Data Areas

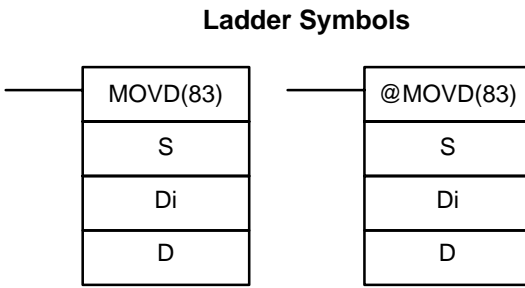

S: Source word
IR, SR, AR, DM, HR, TC, LR, #
Di: Digit designator (BCD)
IR, SR, AR, DM, HR, TC, LR, #
D: Destination word
IR, SR, AR, DM, HR, TC, LR

Limitations

The rightmost three digits of Di must each be between 0 and 3.
DM 6144 to DM 6655 cannot be used for Di or D.

Description

When the execution condition is OFF, MOV(D) is not executed. When the execution condition is ON, MOV(D) copies the content of the specified digit(s) in S to the specified digit(s) in D. Up to four digits can be transferred at one time. The first digit to be copied, the number of digits to be copied, and the first digit to receive the copy are designated in Di as shown below. Digits from S will be copied to consecutive digits in D starting from the designated first digit and continued for the designated number of digits. If the last digit is reached in either S or D, further digits are used starting back at digit 0.

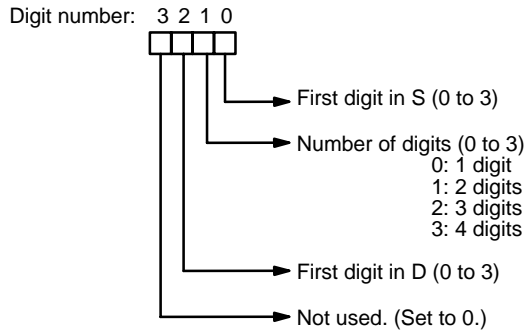

Digit Designator

The following show examples of the data movements for various values of Di.

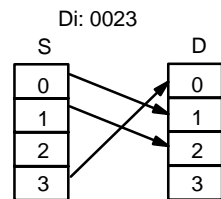
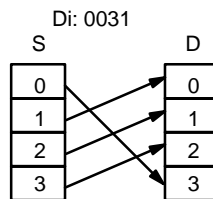
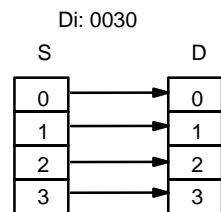
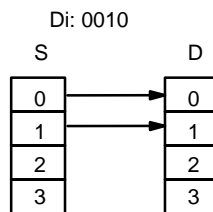

Errors

ER: At least one of the rightmost three digits of Di is not between 0 and 3.
Indirectly addressed DM word is non-existent. (Content of *DM word is not BCD, or the DM area boundary has been exceeded.)

18-1 SCALING – SCL(66)

Ladder Symbols

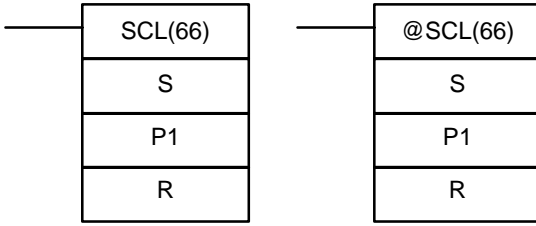

Operand Data Areas

S: Source word
IR, SR, AR, DM, HR, TC, LR, #
P1: First parameter word
IR, SR, AR, DM, HR, TC, LR
R: Result word
IR, SR, AR, DM, HR, LR

Applications

This instruction is available in the **CPM2A/CPM2C/SRM1(-V2) only**.

S must be BCD.

P1 through P1+3 must be in the same data area.

DM 6144 to DM 6655 cannot be used for P1 through P1+3 or R.

Description

SCL(66) is used to linearly convert a 4-digit hexadecimal value to a 4-digit BCD value. Unlike BCD(24), which converts a 4-digit hexadecimal value to its 4-digit BCD equivalent ($S_{hex} \rightarrow S_{BCD}$), SCL(66) can convert the hexadecimal value according to a specified linear relationship. The conversion line is defined by two points specified in the parameter words P1 to P1+3.

When the execution condition is OFF, SCL(66) is not executed. When the execution condition is ON, SCL(66) converts the 4-digit hexadecimal value in S to a 4-digit BCD value on the line defined by points (P1, P1+1) and (P1+2, P1+3). It places the results in R. The results is rounded off to the nearest integer. If the results is less than 0000, then 0000 is written to R, and if the result is greater than 9999, then 9999 is written to R.

The following table shows the functions and ranges of the parameter words.

Parameter	Function	Range	Comments
P1	BCD point #1 (A_Y)	0000 to 9999	---
P1+1	Hex. point #1 (A_X)	0000 to FFFF	Do not set P1+1=P1+3.
P1+2	BCD point #2 (B_Y)	0000 to 9999	---
P1+3	Hex. point #2 (B_X)	0000 to FFFF	Do not set P1+3=P1+1.

The following diagram shows the source word, S, converted to D according to the line defined by points (A_Y , A_X) and (B_Y , B_X).

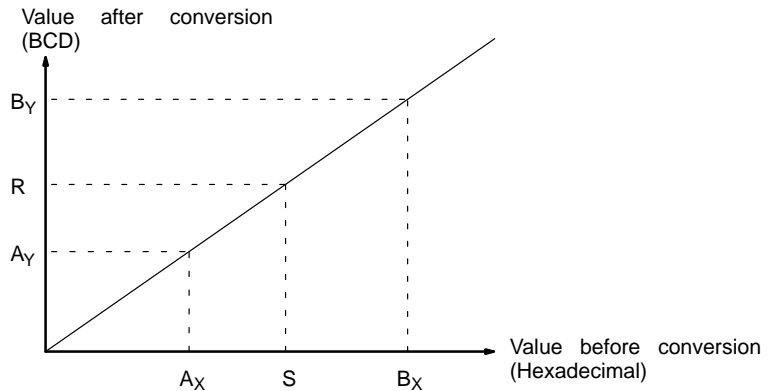

The results can be calculated by first converting all values to BCD and then using the following formula.

js

ER: The value in P1+1 equals that in P1+3.

Indirectly addressed DM word is non-existent. (Content of *DM word is not BCD, or the DM area boundary has been exceeded.)

P1 and P1+3 are not in the same data area, or other setting error

EQ: ON when the result, R, is 0000.

Example

When 00000 is turned ON in the following example, the BCD source data in DM 0100 (#0100) is converted to hexadecimal according to the parameters in DM 0150 to DM 0153. The result (#0512) is then written to DM 0200.



Address	Instruction	Operands
00000	LD	00000
00001	@SCL(66)	
		DM 0100
		DM 0150
		DM 0200

DM 0150	0010
DM 0151	0005
DM 0152	0050
DM 0153	0019

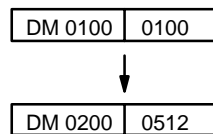

18-2 SIGNED BINARY TO BCD SCALING – SCL2(—)

Ladder Symbols

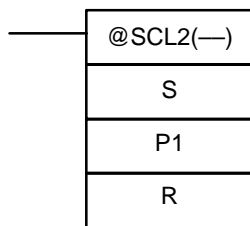
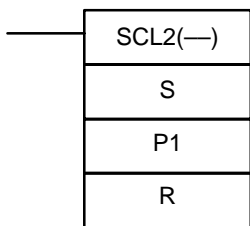

Operand Data Areas

S: Source word
IR, SR, AR, DM, HR, LR
P1: First parameter word
IR, SR, AR, DM, HR, LR
R: Result word
IR, SR, AR, DM, HR, LR

Limitations

This instruction is available in the **CPM2A/CPM2C only**.

S must be BCD.

P1 through P1+2 must be in the same data area.

DM 6144 to DM 6655 cannot be used for R.

Description

SCL2(—) is used to linearly convert a 4-digit signed hexadecimal value to a 4-digit BCD value. Unlike BCD(24), which converts a 4-digit hexadecimal value to its 4-digit BCD equivalent ($S_{hex} \rightarrow S_{BCD}$), SCL2(—) can convert the signed hexadecimal value according to a specified linear relationship. The conversion line is defined by the x-intercept and the slope of the line specified in the parameter words P1 to P1+2.

When the execution condition is OFF, SCL2(—) is not executed. When the execution condition is ON, SCL2(—) converts the 4-digit signed hexadecimal value in S to the 4-digit BCD value on the line defined by the x-intercept (P1) and the slope ($P1+2 \div P1+1$) and places the results in R. The result is rounded to the nearest integer.

0000 is written to R. If the result is greater than 9999, then 0000 is written to R.

Parameter	Function	Range
P1	x-intercept (signed hex.)	8000 to 7FFF (-32,768 to 32,767)
P1+1	ΔX (signed hex.)	8000 to 7FFF (-32,768 to 32,767)
P1+2	ΔY (BCD)	0000 to 9999

The following diagram shows the source word, S, converted to R according to the line defined by the point (P1, 0) and slope $\Delta Y/\Delta X$.

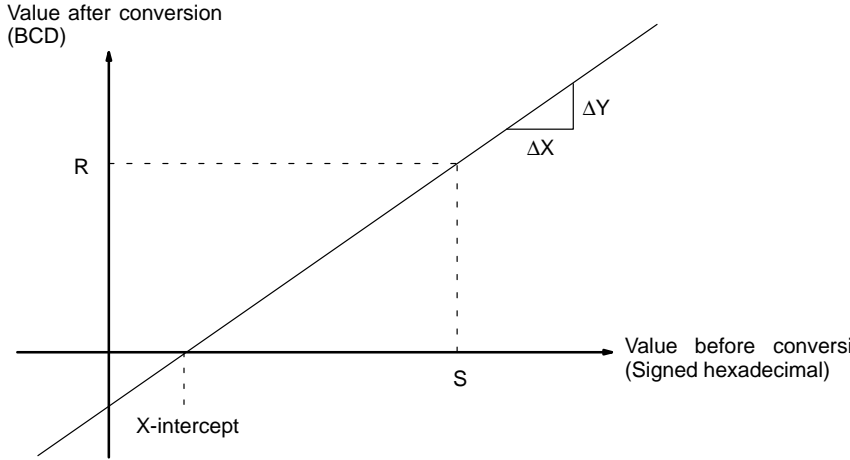

The result can be calculated by first converting all signed hexadecimal values to BCD and then using the following formula.

$$R = \frac{\Delta Y}{\Delta X} \times (S - P1)$$

ER: Indirectly addressed DM word is non-existent. (Content of *DM word is not BCD, or the DM area boundary has been exceeded.)

P1 and P1+2 are not in the same data area, or other setting error.

CY: ON when the result, R, is negative.

EQ: ON when the result, R, is 0000.

When 05000 is turned ON in the following example, the signed binary source data in 200 (#FFE2) is converted to BCD according to the parameter

turned ON because the result is negative.



Address	Instruction	Operands
00000	LD	05000
00001	@SCL2(---)	
		200
		DM 0000
		LR 00

DM 0000	FFFD
DM 0001	0003
DM 0002	0002

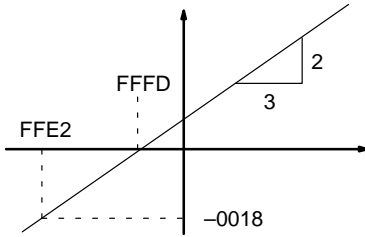

IR 200	FFE2
--------	------

LR 00	0018
-------	------

CY=1

CY flag is turned ON because the conversion result is negative.

$$R = \frac{0002}{0003} \times (FFE2 - FFFD)$$

$$= \frac{2}{3} \times (-1B) = -18$$

18-3 BCD TO SIGNED BINARY SCALING – SCL3(---)

Ladder Symbols

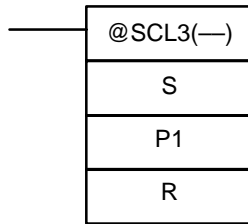
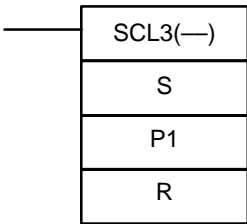

Operand Data Areas

S: Source word
IR, SR, AR, DM, HR, LR
P1: First parameter word
IR, SR, AR, DM, HR, LR
R: Result word
IR, SR, AR, DM, HR, LR

Restrictions

This instruction is available in the **CPM2A/CPM2C only**.

P1+1 must be BCD.

P1 through P1+4 must be in the same data area.

DM 6144 to DM 6655 cannot be used for R.

Description

SCL3(---) is used to linearly convert a 4-digit BCD value to 4-digit signed hexadecimal. SCL3(---) converts the BCD value according to a specified linear relationship. The conversion line is defined by the y-intercept and the slope of the line specified in the parameter words P1 to P1+2.

When the execution condition is OFF, SCL3(---) is not executed. When the execution condition is ON, SCL3(---) converts the 4-digit BCD value in S to a 4-digit signed hexadecimal value on the line defined by the y-intercept (0, FFFD), and the slope $(P1+2 \div P1+1)$ and places the result in R. The result is rounded to the nearest integer.

The content of S can be 0000 to 9999, but S will be treated as a negative value if the high bit is set. CY=1, so the effective range of S is actually -9999 to 9999. Be sure to set the desired sign in CY using STC(40) or CLC(41).

Parameter words P1+3 and P1+4 define upper and lower limits for the result. If the result is greater than the upper limit in P1+3, then the upper limit is written to R.

Note The upper and lower limits for a 12-bit Analog Input Unit would be 07FF F800.

The following table shows the functions and ranges of the parameter words

Parameter	Function	Range
P1	x-intercept (signed hex.)	8000 to 7FFF (-32,768 to 32,767)
P1+1	ΔX (BCD)	0001 to 9999
P1+2	ΔY (signed hex.)	8000 to 7FFF (-32,768 to 32,767)
P1+3	Upper limit (signed hex.)	8000 to 7FFF (-32,768 to 32,767)
P1+4	Lower limit (signed hex.)	8000 to 7FFF (-32,768 to 32,767)

The following diagram shows the source word, S, converted to R according to the line defined by the point (0, P1) and slope $\Delta Y/\Delta X$.

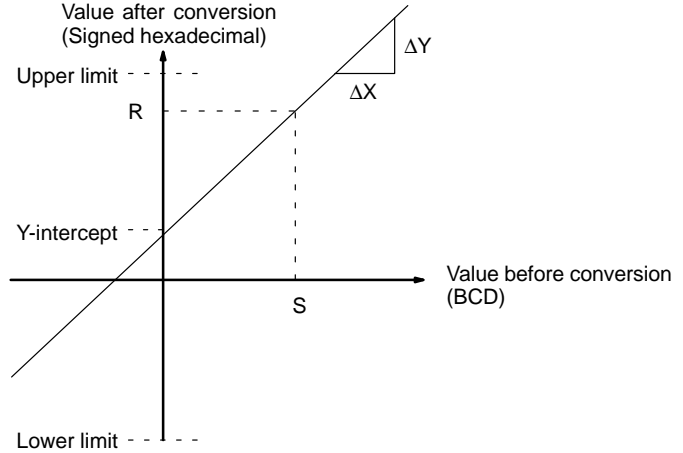

The result can be calculated by first converting all BCD values to signed binary and then using the following formula.

$$R = \left(\frac{\Delta Y}{\Delta X} \times S \right) + P1$$

ER: Indirectly addressed DM word is non-existent. (Content of *DM word is not BCD, or the DM area boundary has been exceeded.)
The content of S is not BCD.

CY: CY is not changed by SCL3(—). (CY shows the sign of S before execution.)

EQ: ON when the result, R, is 0000.

example: If 00101 is ON, then the source word is negative. When 00101 is turned ON, the BCD source data in LR 02 is converted to signed binary according to the parameters in DM 0000 to DM 0004. The result is then written to DM 0100. (In the second conversion, the signed binary equivalent of -103 is less than the lower limit specified in DM 0004, so the lower limit is written to DM 0100.)

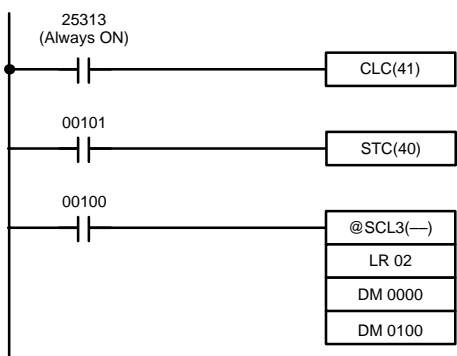

Address	Instruction	Operands
00000	LD	25313
00001	CLC(41)	
00002	LD	00101
00101	STC(40)	
00004	LD	00100
00005	SCL3(—)	
		LR 02
		DM 0000
		DM 0100

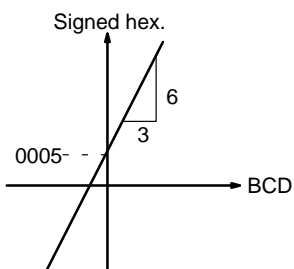

DM 0000	0005
DM 0001	0003
DM 0002	0006
DM 0003	07FF
DM 0004	F800

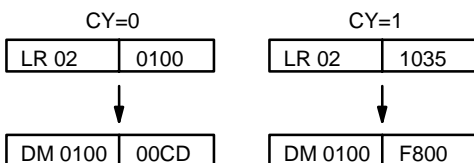

18-4 PID CONTROL – PID(—)

Ladder Symbol

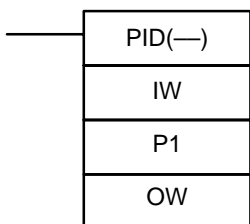

Operand Data Areas

IW: Input data word
IR, SR, AR, DM, HR, LR
P1: First parameter word
IR, SR, DM, HR, LR
OW: Output data word
IR, SR, AR, DM, HR, LR

Limitations

This instruction is available in the **CPM2A/CPM2C** and **SRM1(-V2)** only.

DM 6144 to DM 6655 cannot be used for P1 or OW.

P1 to P1+32 must be in the same data area.



Caution

A total of 33 continuous words starting with P1 must be provided for PID(—) to operate correctly. Also, PID(—) may not operate dependably in any of the following situations: In interrupt programs, in subroutines, between IL(02) and ILC(03), between JMP(04) and JME(05), and in step programs between STEP(08)/SNXT(09)). Do not program PID(—) in these situations.

When the execution condition OFF, PID(—) is not executed. When the execution condition is ON, PID(—) carries out PID control according to the design parameters. It takes the specified input range of binary data from the content of IW and carries out the PID action according to the parameters that are set. The result is then stored as the manipulated variable in OW.

The following table shows the function of the parameter words.

Word	Bits	Parameter name	Function/Setting range
	00 to 15	Set value (SV).	This is the target value for PID control. It can be set to any binary number with the number of bits set by the input range parameter.
+1	00 to 15	Proportional band width.	This parameter specifies the proportional band width/input range ratio from 0.1% to 999.9%. It must be BCD from 0001 to 9999.
+2	00 to 15	Integral time (Tik)/sampling period (τ)	Sets the strength of integral action. Increasing this value strengthens the integral action. It must be BCD from 0001 to 8191, or 9999. A setting of 9999 disables integral control. Set the integral time divided by the sampling time.
+3	00 to 15	Derivative time (Tdk)/sampling period (τ)	Sets the strength of derivative action. Increasing this value strengthens the derivative action. It must be BCD from 0001 to 8191, or 0000. (A setting of 0000 disables derivative control.) Set the derivative time divided by the sampling time.
+4	00 to 15	Sampling period (τ)	Sets the interval between samplings of the input data. It must be BCD from 0001 to 1023. The period will be from 0.1 to 102.3 s
+5	00 to 03	Operation specifier	Sets reverse or normal operation. Set to 0 to specify reverse operation and 1 to specify normal operation.
	04 to 15	Input filter coefficient (α)	Determines the strength of the input filter. The lower the coefficient, the weaker the filter. This setting must be BCD from 100 to 199, or 000. A setting of 000 sets the default value (0.65) and a setting of 100 to 199 sets the coefficient from 0.00 to 0.99.
+6	00 to 03	Output range	Determines the number of bits of output data. This setting must be between 0 and 8, which sets the output range between 8 and 16 bits.
	08 to 15	Input range	Determines the number of bits of input data. This setting must be between 00 and 08, which sets the input range between 8 and 16 bits.
+7 to +32	00 to 15	Work area	Do not use. (Used by the system.)



Caution Changes made to the parameters will not be effective until the execution condition for PID(—) goes from OFF to ON.

Note Do not use PID(—) in the following situations; it may not be executed properly:

- In interrupt programs
- In subroutine programs
- In interlocked program sections (between IL and ILC)
- In jump program sections (between JMP and JME)
- In step ladder program section (created with STEP)

When the execution condition is ON, PID(—) performs the PID calculation using the input data when the sampling period has elapsed. The sampling period is the time that must pass before input data is read for processing.

PID processing. PID processing is performed only when the sampling period (100 ms in this case) has elapsed.

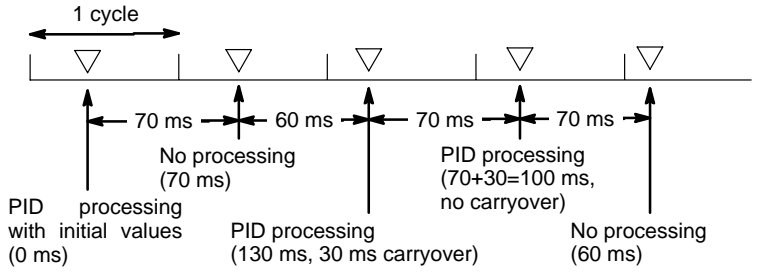

CONTROL Action

Execution Condition OFF

All data that has been set is retained. When the execution condition is OFF, the manipulated variable can be written to the output word (OW) to achieve manual control.

Rising Edge of the Execution Condition

The work area is initialized based on the PID parameters that have been set, and the PID control action begins. Sudden and radical changes in the manipulated variable output are not made when starting action to avoid adverse effects on the controlled system (bumpless operation).

When PID parameters are changed, they first become valid when the execution condition changes from OFF to ON.

Execution Condition ON

The PID action is executed at the intervals based on the sampling period, according to the PID parameters that have been set.

Sampling Period and PID Execution Timing

The sampling period is the time interval to retrieve the measurement data and carry out a PID action. PID(—), however, is executed according to the sampling cycle, so there may be cases where the sampling period is exceeded. In such cases, the time interval until the next sampling is reduced.

Control Method

PID control actions are executed by means of PID control with feed-forward control (two degrees of freedom).

When overshooting is prevented with simple PID control, stabilization of disturbances is slowed (1). If stabilization of disturbances is speeded up, on the other hand, overshooting occurs and response toward the target value is slowed. With feed-forward PID control, there is no overshooting, and response toward the target value and stabilization of disturbances can both be speeded up.

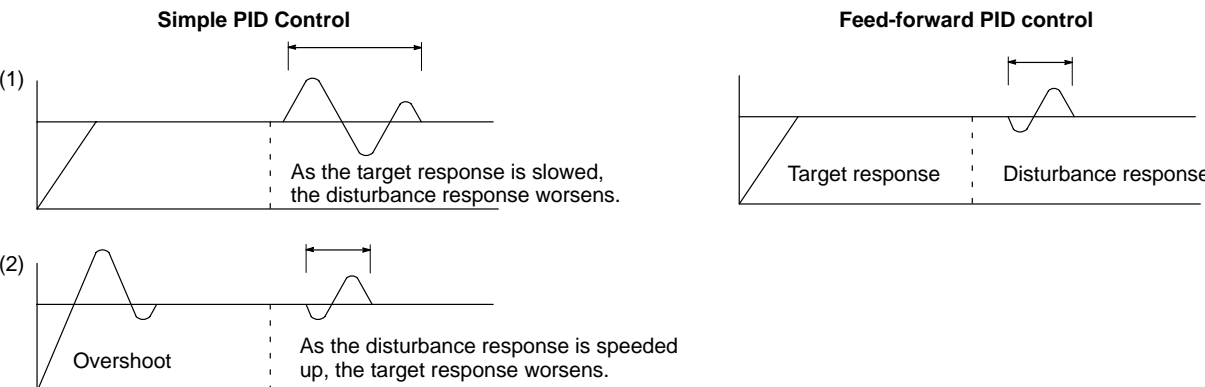

Proportional action is an operation in which a proportional band is established with respect to the set value (SV), and within that band the manipulated variable (MV) is made proportional to the deviation. An example for reverse operation is shown in the following illustration

If the proportional action is used and the present value (PV) becomes smaller than the proportional band, the manipulated variable (MV) is 100% (i.e., maximum value). Within the proportional band, the MV is made proportional to the deviation (the difference between from SV and PV) and gradually decreases until the SV and PV match (i.e., until the deviation is 0), at which time the MV will be 0% (i.e., the minimum value). The MV will also be 0% when the PV is larger than the SV.

The proportional band is expressed as a percentage of the total input range. The smaller the proportional band, the larger the proportional constant and the stronger the corrective action will be. With proportional action an offset (residual deviation) generally occurs, but the offset can be reduced by making the proportional band smaller. If it is made too small, however, hunting will occur.

Proportional Action (Reverse Action)

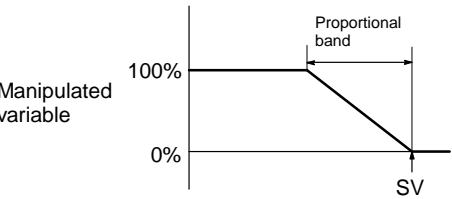

Adjusting the Proportional Band

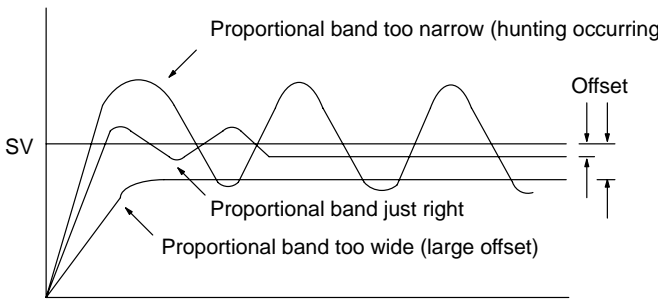

Integral Action (I)

Combining integral action with proportional action reduces the offset according to the time that has passed. The strength of the integral action is indicated by the integral time, which is the time required for the manipulated variable of the integral action to reach the same level as the manipulated variable of the proportional action with respect to the step deviation, as shown in the following illustration. The shorter the integral time, the stronger the correction by the integral action will be. If the integral time is too short, the correction will be too strong and cause hunting to occur.

Integral Action

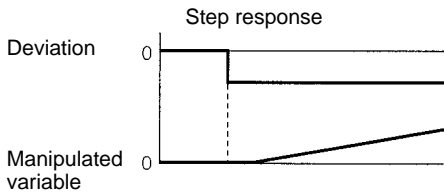

Pi Action and Integral Time

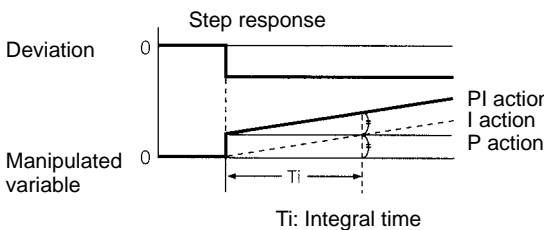

Proportional action and integral action both make corrections with respect to control results, so there is inevitably a response delay. Derivative action compensates for that drawback. In response to a sudden disturbance it delivers a large manipulated variable and rapidly restores the original status. A correction is executed with the manipulated variable made proportional to the inclination (derivative coefficient) caused by the deviation.

The strength of the derivative action is indicated by the derivative time, which is the time required for the manipulated variable of the derivative action to reach the same level as the manipulated variable of the proportional action with respect to the step deviation, as shown in the following illustration. The longer the derivative time, the stronger the correction by the derivative action will be.

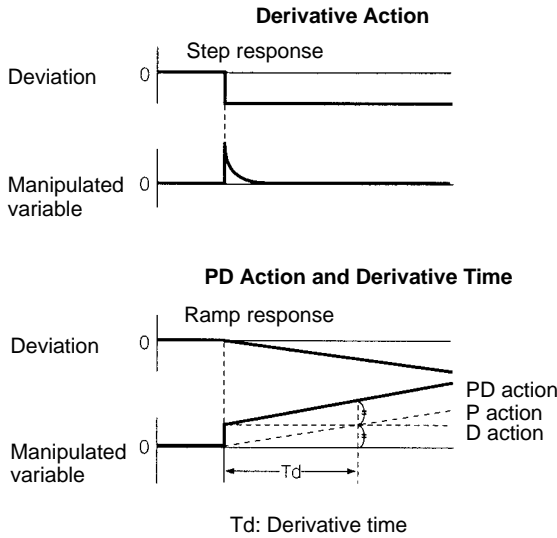

PID Action

PID action combines proportional action (P), integral action (I), and derivative action (D). It produces superior control results even for control objects with long time. It employs proportional action to provide smooth control without hunting, integral action to automatically correct any offset, and derivative action to speed up the response to disturbances.

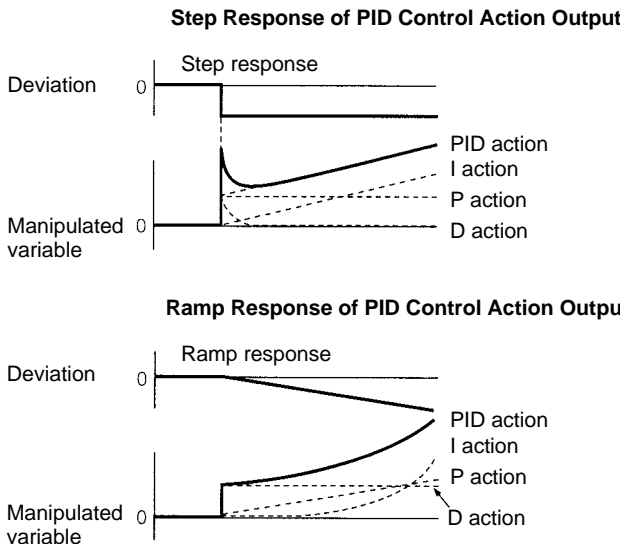

either direction, the MV increases as the difference between the SV and the PV increases.

- Forward action: MV is increased when the PV is larger than the SV.
- Reverse action: MV is increased when the PV is smaller than the SV.

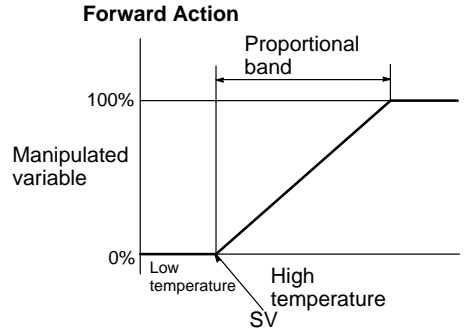
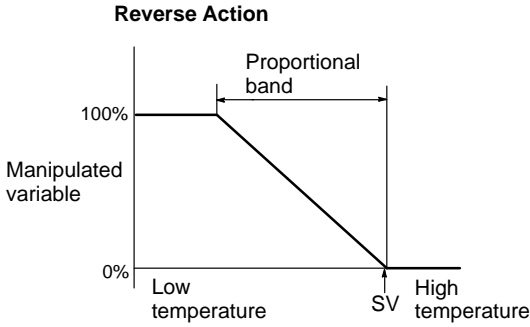

Using PID Parameters

The general relationship between PID parameters and control status is shown below.

- When it is not a problem if a certain amount of time is required for stabilization (settling time), but it is important not to cause overshooting, then enlarge the proportional band.

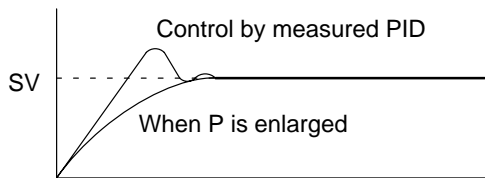

- When overshooting is not a problem but it is desirable to quickly stabilize the control, then narrow the proportional band. If the proportional band is narrowed too much, however, then hunting may occur.

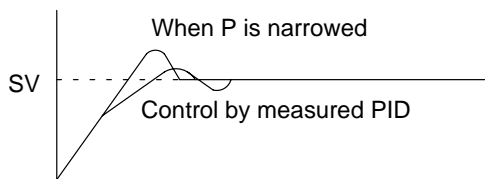

- When there is broad hunting, or when operation is tied up by overshooting or undershooting, it is probably because integral action is too strong. The hunting will be reduced if the integral time is increased or the proportional band is enlarged.

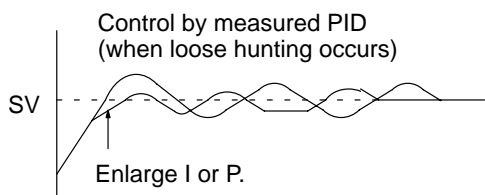

response is quick and the derivative action is too strong. In that case, set the derivative action lower.

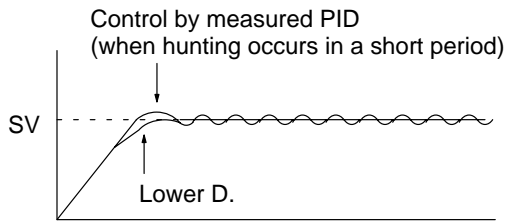

- ER:** There is an error in the parameter settings.
The cycle time is more than twice as long as the sampling period.
PID(—) cannot be executed accurately. PID(—) will be executed in the next cycle.
P1 and P1+32 are not in the same area or a parameter setting is outside the specified range.
Indirectly addressed DM word is non-existent. (Content of *DM word is not BCD, or the DM area boundary has been exceeded.)
- CY:** ON when PID processing is being performed. (OFF when the sampling period has not elapsed.)

19 Comparison Instructions

19-1 COMPARE – CMP(20)

Ladder Symbols

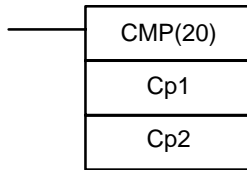

Operand Data Areas

Cp1: First compare word
IR, SR, AR, DM, HR, TC, LR, #
Cp2: Second compare word
IR, SR, AR, DM, HR, TC, LR, #

Conditions: When comparing a value to the PV of a timer or counter, the value must be in BCD.

Description: When the execution condition is OFF, CMP(20) is not executed. When the execution condition is ON, CMP(20) compares Cp1 and Cp2 and outputs the result to the GR, EQ, and LE flags in the SR area.

Precautions: Placing other instructions between CMP(20) and the operation which accesses the EQ, LE, and GR flags may change the status of these flags. Be sure to access them before the desired status is changed.

- ER:** Indirectly addressed DM word is non-existent. (Content of *DM word is not BCD, or the DM area boundary has been exceeded.)
- EQ:** ON if Cp1 equals Cp2.
- LE:** ON if Cp1 is less than Cp2.
- GR:** ON if Cp1 is greater than Cp2.

Flag	Address	C1 < C2	C1 = C2	C1 > C2
GR	25505	OFF	OFF	ON
EQ	25506	OFF	ON	OFF
LE	25507	ON	OFF	OFF

the content of HR 09 is greater than that of DM 0000, 20000 is turned ON; if content of HR 09 is less than of DM 0000, 20002 is turned ON. In some applications, only one of the three OUTs would be necessary, making the use of TR 0 unnecessary. With this type of programming, 20000, 20001, and 20002 are changed only when CMP(2) is executed.

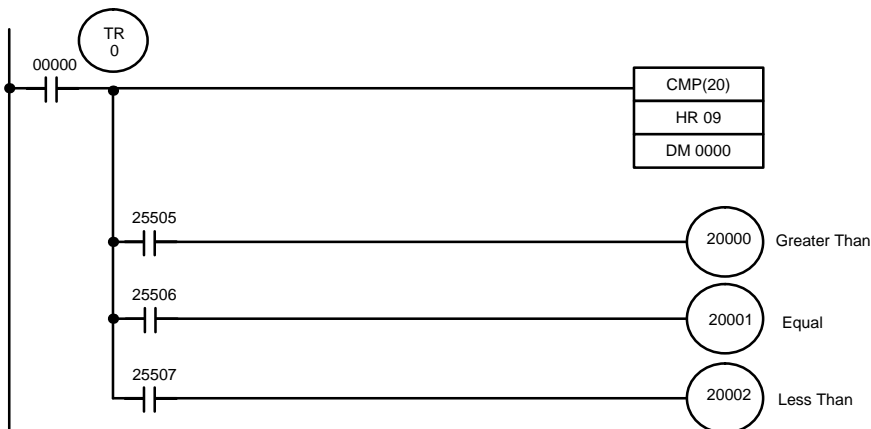

Address	Instruction	Operands
00000	LD	00000
00001	OUT	TR 0
00002	CMP(20)	
		HR 09
		DM 0000
00003	AND	25505
00004	OUT	20000

Address	Instruction	Operands
00005	LD	TR 0
00006	AND	25506
00007	OUT	20001
00008	LD	TR 0
00009	AND	25507
00010	OUT	20002

19-2 TABLE COMPARE – TCMP(85)

Operand Data Areas

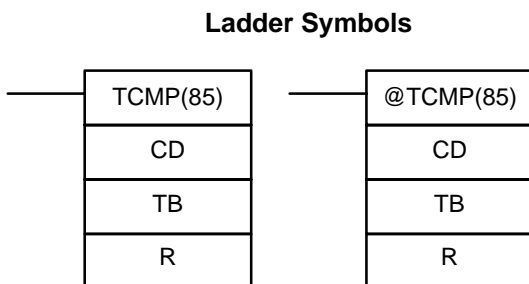

CD: Compare data
IR, SR, DM, HR, TC, LR, #
TB: First comparison table word
IR, SR, DM, HR, TC, LR
R: Result word
IR, SR, DM, HR, TC, LR

Limitations

DM 6144 to DM 6655 cannot be used for R.

Description

When the execution condition is OFF, TCMP(85) is not executed. When the execution condition is ON, TCMP(85) compares CD to the content of TB, TB+1, TB+2, ..., and TB+15. If CD is equal to the content of any of these words, the corresponding bit in R is set, e.g., if the CD equals the content of TB, bit 0 of R is turned ON, if it equals that of TB+1, bit 01 is turned ON, etc. The rest of the bits of R will be turned OFF.

Flags

ER: The comparison table (i.e., TB through TB+15) exceeds the data area boundary. Indirectly addressed DM word is non-existent. (Content of *DM word is not BCD, or the DM area boundary has been exceeded.)

for TCMP(85). Here, the comparison is made during each cycle when IR 001 is ON.

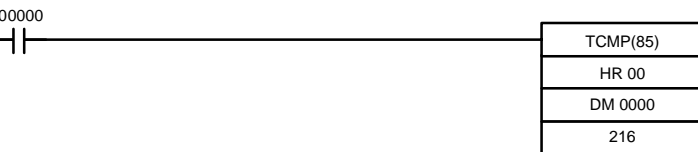

Address	Instruction	Operands
00000	LD	00000
00001	TCMP(85)	
		HR
		DM 0000
		216

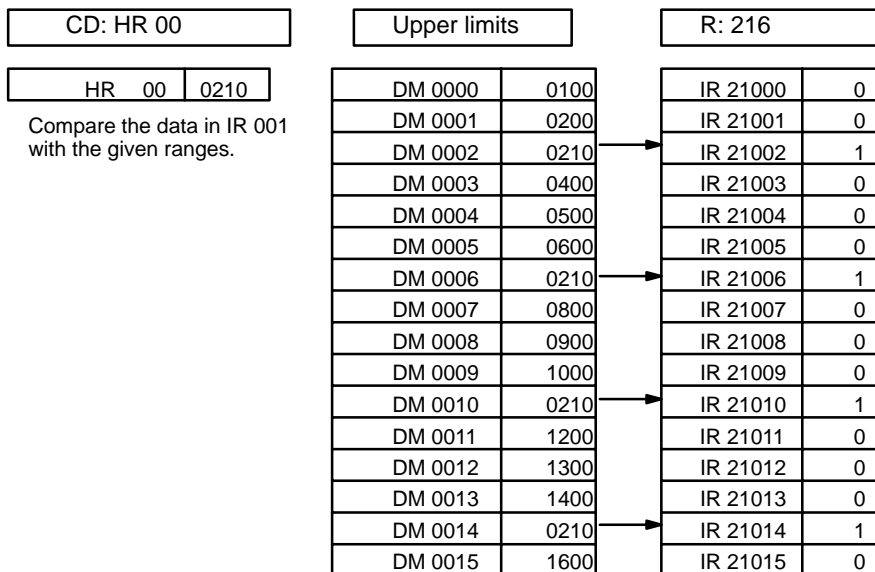

19-3 BLOCK COMPARE – BCMP(68)

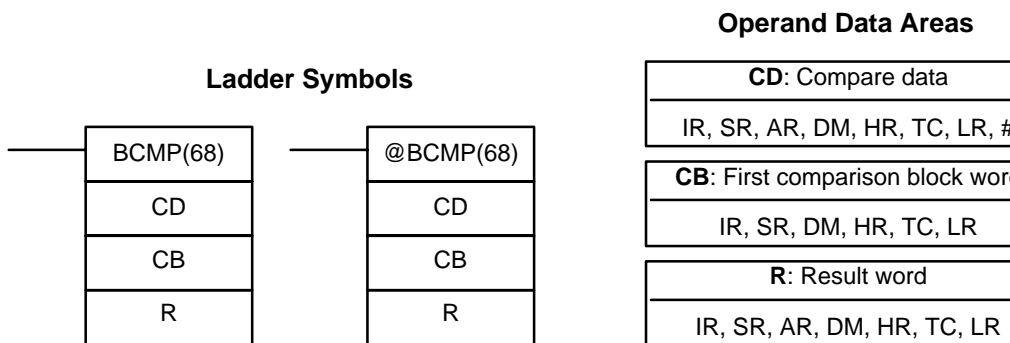

Note BCMP(68) is an expansion instruction for the SRM1(-V2). The function code is the factory setting and can be changed for the SRM1(-V2) if desired.

Limitations Each lower limit word in the comparison block must be less than or equal to the upper limit.

DM 6144 to DM 6655 cannot be used for R.

execution condition is ON, DDMR (CB) compares CD to the ranges defined by the comparison block consisting of CB, CB+1, CB+2, ..., CB+31. Each range is defined by two words, the first one providing the lower limit and the second word providing the upper limit. If CD is found to be within any of these ranges (inclusive of the upper and lower limits), the corresponding bit in R is set. The comparisons that are made and the corresponding bit in R that is set for each true comparison are shown below. The rest of the bits in R will be turned OFF.

$CB \leq CD \leq CB+1$	Bit 00
$CB+2 \leq CD \leq CB+3$	Bit 01
$CB+4 \leq CD \leq CB+5$	Bit 02
$CB+6 \leq CD \leq CB+7$	Bit 03
$CB+8 \leq CD \leq CB+9$	Bit 04
$CB+10 \leq CD \leq CB+11$	Bit 05
$CB+12 \leq CD \leq CB+13$	Bit 06
$CB+14 \leq CD \leq CB+15$	Bit 07
$CB+16 \leq CD \leq CB+17$	Bit 08
$CB+18 \leq CD \leq CB+19$	Bit 09
$CB+20 \leq CD \leq CB+21$	Bit 10
$CB+22 \leq CD \leq CB+23$	Bit 11
$CB+24 \leq CD \leq CB+25$	Bit 12
$CB+26 \leq CD \leq CB+27$	Bit 13
$CB+28 \leq CD \leq CB+29$	Bit 14
$CB+30 \leq CD \leq CB+31$	Bit 15

ER: The comparison block (i.e., CB through CB+31) exceeds the data area boundary. Indirectly addressed DM word is non-existent. (Content of *DM word is not BCD, or the DM area boundary has been exceeded.)

for DM (68). Here, the operation is made during each cycle when IR 00 is ON.



Address	Instruction	Operands
00000	LD	00000
00001	BCMP(68)	
		HR 00
		DM 0010
		LR 05

HR 00

Lower limits

Upper limits

R:LR 05

HR 00	0210
-------	------

Compare data in IR 001 (which contains 0210) with the given ranges.

DM 0010	0000
DM 0012	0101
DM 0014	0201
DM 0016	0301
DM 0018	0401
DM 0020	0501
DM 0022	0601
DM 0024	0701
DM 0026	0801
DM 0028	0901
DM 0030	1001
DM 0032	1101
DM 0034	1201
DM 0036	1301
DM 0038	1401
DM 0040	1501

DM 0011	0100
DM 0013	0200
DM 0015	0300
DM 0017	0400
DM 0019	0500
DM 0021	0600
DM 0023	0700
DM 0025	0800
DM 0027	0900
DM 0029	1000
DM 0031	1100
DM 0033	1200
DM 0035	1300
DM 0037	1400
DM 0039	1500
DM 0041	1600

LR 0500	0
LR 0501	0
LR 0502	1
LR 0503	0
LR 0504	0
LR 0505	0
LR 0506	0
LR 0507	0
LR 0508	0
LR 0509	0
LR 0510	0
LR 0511	0
LR 0512	0
LR 0513	0
LR 0514	0
LR 0515	0

19-4 DOUBLE COMPARE – CMPL(60)

Ladder Symbols

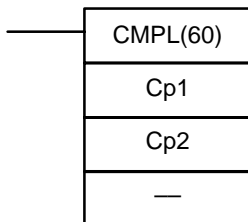

Operand Data Areas

Cp1: First word of first compare word pair
IR, SR, AR, DM, HR, TC, LR
Cp2: First word of second compare word pair
IR, SR, AR, DM, HR, TC, LR

Note CMPL(60) is an expansion instruction for the SRM1(-V2). The function code is the factory setting and can be changed for the SRM1(-V2) if desired.

Limitations

Cp1 and Cp1+1 must be in the same data area.

Cp2 and Cp2+1 must be in the same data area.

Set the third operand to 000.

Description

When the execution condition is OFF, CMPL(60) is not executed. When the execution condition is ON, CMPL(60) joins the 4-digit hexadecimal contents of Cp1+1 with that of Cp1, and that of Cp2+1 with that of Cp2 to create two 8-hexadecimal numbers, Cp+1,Cp1 and Cp2+1,Cp2. The two 8-digit numbers are then compared and the result is output to the GR, EQ, and LE flags in the data area.

Precautions

Placing other instructions between CMPL(60) and the operation which accesses the EQ, LE, and GR flags may change the status of these flags. Be careful to access them before the desired status is changed.

GR: ON if Cp1+1,Cp1 is greater than Cp2+1,Cp2.

EQ: ON if Cp1+1,Cp1 equals Cp2+1,Cp2.

LE: ON if Cp1+1,Cp1 is less than Cp2+1,Cp2.

Example:
Using CMPL(60) Results

The following example shows how to save the comparison result immediately to the content of HR 10, HR 09 is greater than that of DM 0001, DM 0000, then 20000 is turned ON; if the two contents are equal, 20001 is turned ON; if the content of HR 10, HR 09 is less than that of DM 0001, DM 0000, then 20002 is turned ON. In some applications, only one of the three OUTs would be necessary, making the use of TR 0 unnecessary. With this type of programming, 20000, 20001, 20002 are changed only when CMPL(60) is executed.

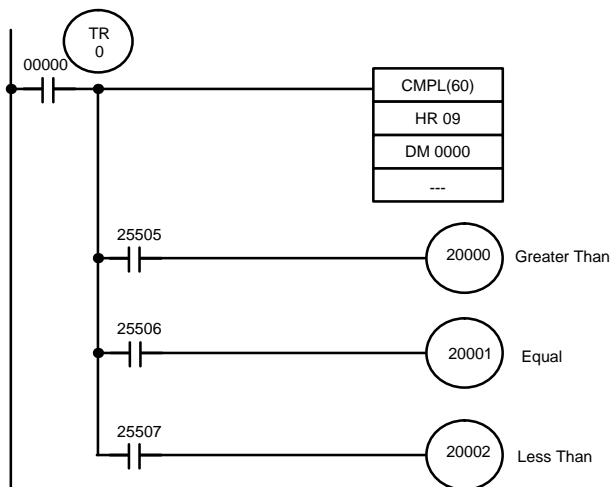

Address	Instruction	Operands
00000	LD	00000
00001	OUT	TR 0
00002	CMPL(60)	
		HR 09
		DM 0000
00003	AND	25505
00004	OUT	20000
00005	LD	TR 0
00006	AND	25506
00007	OUT	20001
00008	LD	TR 0
00009	AND	25507
00010	OUT	20002

19-5 AREA RANGE COMPARE – ZCP(—)

Ladder Symbol

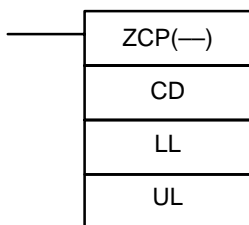

Operand Data Areas

CD: Compare data
IR, SR, AR, DM, HR, TC, LR, #
LL: Lower limit of range
IR, SR, AR, DM, HR, TC, LR, #
UL: Upper limit of range
IR, SR, AR, DM, HR, TC, LR, #

Restrictions

This instruction is available in the **CPM2A/CPM2C/SRM1(-V2) only**.

LL must be less than or equal to UL.

Description

When the execution condition is OFF, ZCP(—) is not executed. When the execution condition is ON, ZCP(—) compares CD to the range defined by lower limit LL and upper limit UL and outputs the result to the GR, EQ, and LE flags in the SR area. The resulting flag status is shown in the following table.

Comparison result	Flag status		
	GR (SR 25505)	EQ (SR 25506)	LE (SR 25507)
CD < LL	0	0	1
LL ≤ CD ≤ UL	0	1	0
UL < CD	1	0	0

the EQ, LL, and GR flags may change the status of these flags. Be sure to process them before the desired status is changed.

ER: Indirectly addressed DM word is non-existent. (Content of *DM word not BCD, or the DM area boundary has been exceeded.)

LL is greater than UL.

EQ: ON if $LL \leq CD \leq UL$

LE: ON if $CD < LL$.

GR: ON if $CD > UL$.

Example

In the following example, the content of IR 200 (#6FA4) is compared to the range #0010 to #AB1F. Since $\#0010 \leq \#6FA4 \leq \#AB1F$, the EQ flag and IR 10101 are turned ON.

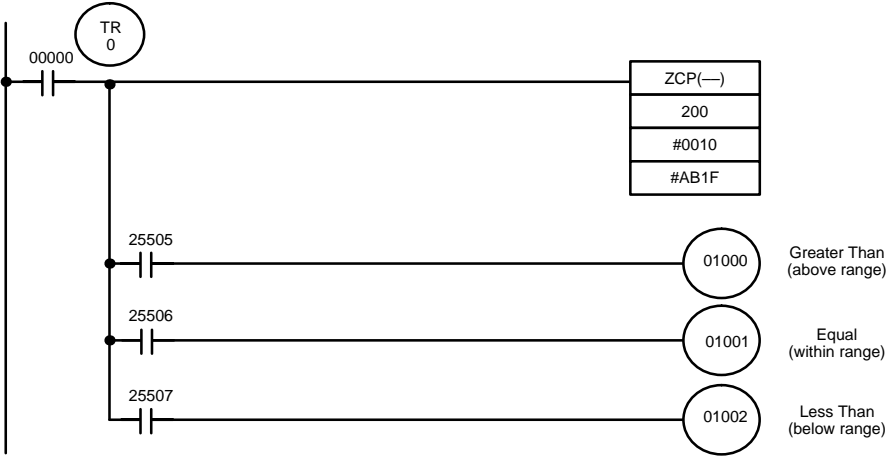

Address	Instruction	Operands
00000	LD	00000
00001	OUT	TR 0
00002	ZCP(—)	
		200
		# 0010
		# AB1F
00003	AND	25505

Address	Instruction	Operands
00004	OUT	01000
00005	LD	TR 0
00006	AND	25506
00007	OUT	01001
00008	LD	TR 0
00009	AND	25507
00010	OUT	01002

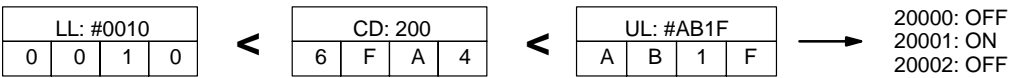

19-6 DOUBLE AREA RANGE COMPARE – ZCPL(—)

Operand Data Areas

Ladder Symbol

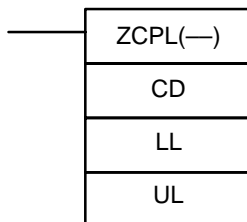

CD: Compare data
IR, SR, AR, DM, HR, LR
LL: Lower limit of range
IR, SR, AR, DM, HR, LR
UL: Upper limit of range
IR, SR, AR, DM, HR, LR

Description

The 8-digit value in LL+1,LL must be less than or equal to UL+1,UL. When the execution condition is OFF, ZCPL(—) is not executed. When the execution condition is ON, ZCPL(—) compares the 8-digit value in CD, CD+1 to the range defined by lower limit LL+1,LL and upper limit UL+1,UL and outputs the result to the GR, EQ, and LE flags in the SR area. The resulting flag status is shown in the following table.

Comparison result	Flag status		
	GR (SR 25505)	EQ (SR 25506)	LE (SR 25507)
CD, CD+1 < LL+1,LL	0	0	1
LL+1,LL ≤ CD, CD+1 ≤ UL+1,UL	0	1	0
UL+1,UL < CD, CD+1	1	0	0

Precautions

Placing other instructions between ZCPL(—) and the operation which accesses the EQ, LE, and GR flags may change the status of these flags. Be sure to access them before the desired status is changed.

Flags

ER: Indirectly addressed DM word is non-existent. (Content of *DM word is not BCD, or the DM area boundary has been exceeded.)
LL+1,LL is greater than UL+1,UL.

EQ: ON if LL+1,LL ≤ CD, CD+1 ≤ UL+1,UL

LE: ON if CD, CD+1 < LL+1,LL.

GR: ON if CD, CD+1 > UL+1,UL.

20 Conversion Instructions

20-1 BCD-TO-BINARY – BIN(23)

Ladder Symbols

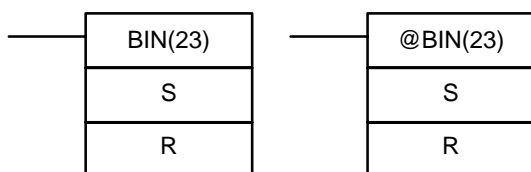

Operand Data Areas

S: Source word (BCD)
IR, SR, AR, DM, HR, TC, LR
R: Result word
IR, SR, AR, DM, HR, LR

Limitations

Description

DM 6144 to DM 6655 cannot be used for R.

When the execution condition is OFF, BIN(23) is not executed. When the execution condition is ON, BIN(23) converts the BCD content of S into the numerically equivalent binary bits, and outputs the binary value to R. Only the content of R is changed; the content of S is left unchanged.

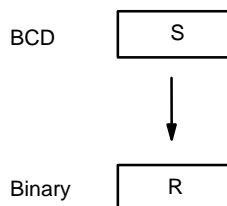

BIN(23) can be used to convert BCD to binary so that displays on the Programming Console or any other programming device will appear in hexadecimal rather than decimal. It can also be used to convert to binary to perform binary arithmetic operations rather than BCD arithmetic operations, e.g., when BCD binary values must be added.

Indirectly addressed DM word is non-existent. (Content of *DM word is not BCD, or the DM area boundary has been exceeded.)

EQ: ON when the result is zero.

20-2 BINARY-TO-BCD – BCD(24)

Ladder Symbols

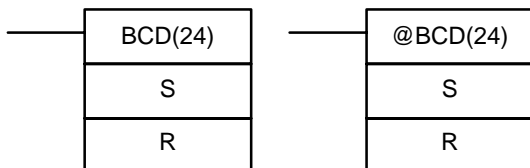

Operand Data Areas

S: Source word (binary)
IR, SR, AR, DM, HR, LR
R: Result word
IR, SR, AR, DM, HR, LR

Limitations

If the content of S exceeds 270F, the converted result would exceed 9999. BCD(24) will not be executed. When the instruction is not executed, the content of R remains unchanged.

DM 6144 to DM 6655 cannot be used for R.

Description

BCD(24) converts the binary (hexadecimal) content of S into the numerically equivalent BCD bits, and outputs the BCD bits to R. Only the content of R is changed; the content of S is left unchanged.

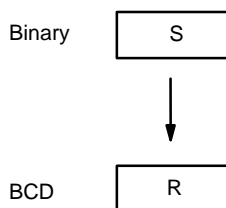

BCD(24) can be used to convert binary to BCD so that displays on the Programming Console or any other programming device will appear in decimal rather than hexadecimal. It can also be used to convert to BCD to perform BCD arithmetic operations rather than binary arithmetic operations, e.g., when BCD binary values must be added.

Flags

ER: Indirectly addressed DM word is non-existent. (Content of *DM word is not BCD, or the DM area boundary has been exceeded.)

EQ: ON when the result is zero.

20-3 DOUBLE BCD-TO-DOUBLE BINARY – BINL(58)

Ladder Symbols

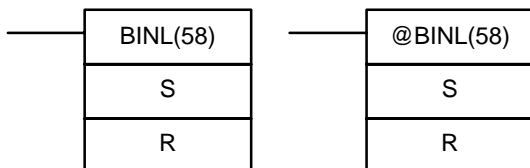

Operand Data Areas

S: First source word (BCD)
IR, SR, AR, DM, HR, TC, LR
R: First result word
IR, SR, AR, DM, HR, LR

Limitations

This instruction is available in the **CPM2A/CPM2C only**.

DM 6144 to DM 6655 cannot be used for R.

execution condition is ON, BINL(59) converts an eight digit number in S and S+1 into 32-bit binary data, and outputs the converted data to R and R+1.

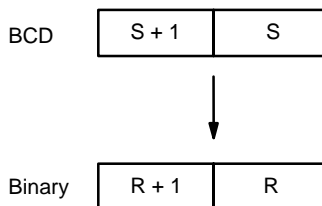

gs

ER: The contents of S and/or S+1 words are not BCD.

Indirectly addressed DM word is non-existent. (Content of *DM word is not BCD, or the DM area boundary has been exceeded.)

EQ: ON when the result is zero.

20-4 DOUBLE BINARY-TO-DOUBLE BCD – BCDL(59)

Ladder Symbols

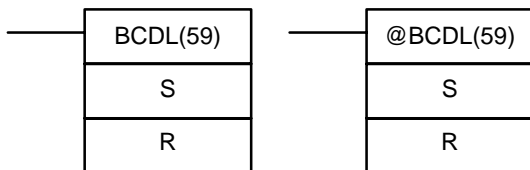

Operand Data Areas

S: First source word (binary)
IR, SR, AR, DM, HR, LR
R: First result word
IR, SR, AR, DM, HR, LR

itations

This instruction is available in the **CPM2A/CPM2C only**.

If the content of S exceeds 05F5E0FF, the converted result would exceed 99999999 and BCDL(59) will not be executed. When the instruction is executed, the content of R and R+1 remain unchanged.

DM 6144 to DM 6655 cannot be used for R.

cription

BCDL(59) converts the 32-bit binary content of S and S+1 into eight digit BCD data, and outputs the converted data to R and R+1.

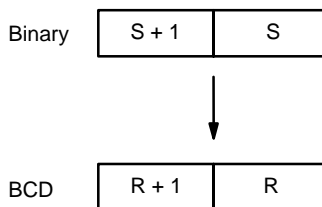

gs

ER: Content of R and R+1 exceeds 99999999.

Indirectly addressed DM word is non-existent. (Content of *DM word is not BCD, or the DM area boundary has been exceeded.)

EQ: ON when the result is zero.

Operand Data Areas

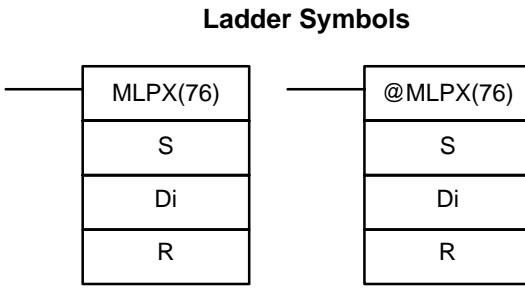

S: Source word
IR, SR, AR, DM, HR, TC, LR
Di: Digit designator
IR, SR, AR, DM, HR, TC, LR, #
R: First result word
IR, SR, AR, DM, HR, LR

Limitations

The rightmost two digits of Di must each be between 0 and 3.
 All result words must be in the same data area.
 DM 6144 to DM 6655 cannot be used for R.

Description

When the execution condition is OFF, MLPX(76) is not executed. When the execution condition is ON, MLPX(76) converts up to four, four-bit hexadecimal digits from S into decimal values from 0 to 15, each of which is used to indicate a bit position. The bit whose number corresponds to each converted value is turned ON in a result word. If more than one digit is specified, then one bit will be turned ON in each of consecutive words beginning with R. (See examples below.)

The following is an example of a one-digit decode operation from digit number 0 of S, i.e., here Di would be 0001.

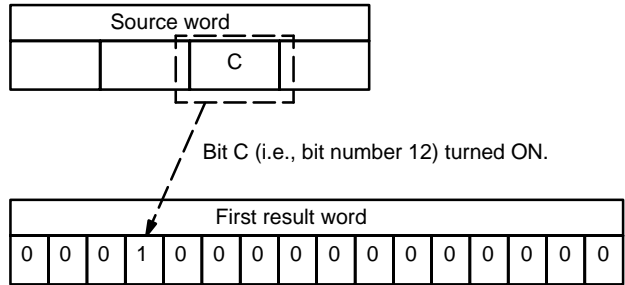

The first digit and the number of digits to be converted are designated in Di. If more digits are designated than remain in S (counting from the designated digit), the remaining digits will be taken starting back at the beginning of S. The final word required to store the converted result (R plus the number of digits to be converted) must be in the same data area as R, e.g., if two digits are converted, the last word address in a data area cannot be designated; if three digits are converted, the last two words in a data area cannot be designated.

Digit Designator

The digits of Di are set as shown below.

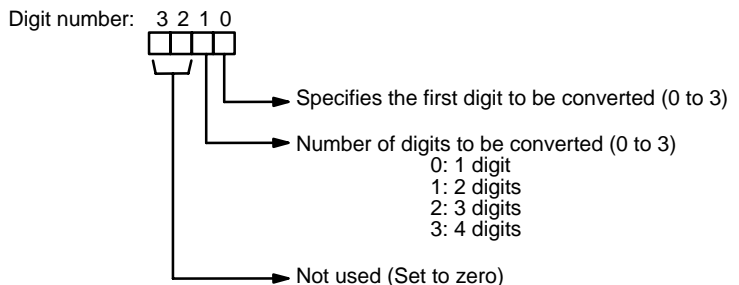

are shown below.

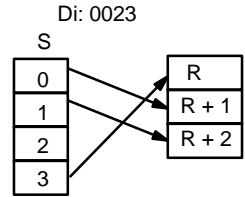
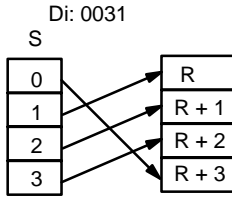
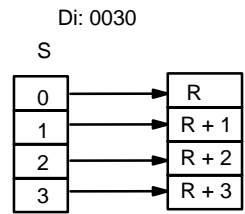
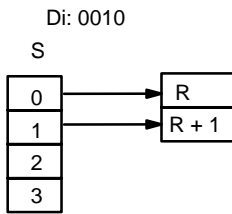

gs

ER: Undefined digit designator, or R plus number of digits exceeds a area.

Indirectly addressed DM word is non-existent. (Content of *DM word not BCD or the DM area boundary has been exceeded.)

ample

The following program converts digits 1 to 3 of data from DM 0020 to bit positions and turns ON the corresponding bits in three consecutive words starting with 10. Digit 0 is not converted.

000

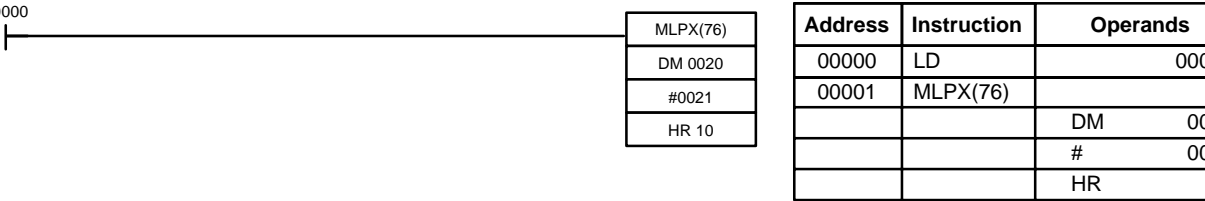

S: DM 0020

DM 0020	Digit	Value
DM 0020	00	
DM 0020	01	
DM 0020	02	
DM 0020	03	
DM 0020	04	1
DM 0020	05	1
DM 0020	06	1
DM 0020	07	1
DM 0020	08	0
DM 0020	09	1
DM 0020	10	1
DM 0020	11	0
DM 0020	12	0
DM 0020	13	0
DM 0020	14	0
DM 0020	15	0

Not
Converted

15

6

0

R: HR 10

HR	Bit
HR 1000	0
HR 1001	0
HR 1002	0
HR 1003	0
HR 1004	0
HR 1005	0
HR 1006	0
HR 1007	0
HR 1008	0
HR 1009	0
HR 1010	0
HR 1011	0
HR 1012	0
HR 1013	0
HR 1014	0
HR 1015	1

R+1: HR 11

HR	Bit
HR 1100	0
HR 1101	0
HR 1102	0
HR 1103	0
HR 1104	0
HR 1105	0
HR 1106	1
HR 1107	0
HR 1108	0
HR 1109	0
HR 1110	0
HR 1111	0
HR 1112	0
HR 1113	0
HR 1114	0
HR 1115	0

R+2: HR 12

HR	Bit
HR 1200	1
HR 1201	0
HR 1202	0
HR 1203	0
HR 1204	0
HR 1205	0
HR 1206	0
HR 1207	0
HR 1208	0
HR 1209	0
HR 1210	0
HR 1211	0
HR 1212	0
HR 1213	0
HR 1214	0
HR 1215	0

Operand Data Areas

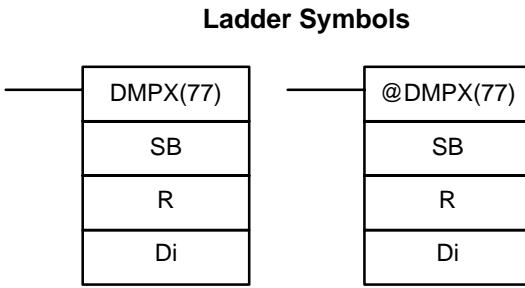

SB: First source word
IR, SR, AR, DM, HR, TC, LR
R: Result word
IR, SR, AR, DM, HR, LR
Di: Digit designator
IR, SR, AR, DM, HR, TC, LR, #

ications

The rightmost two digits of Di must each be between 0 and 3.

All source words must be in the same data area.

DM 6144 to DM 6655 cannot be used for SB, R, or Di.

cription

When the execution condition is OFF, DMPX(77) is not executed. When execution condition is ON, DMPX(77) determines the position of the highest bit in S, encodes it into single-digit hexadecimal value corresponding to the number of the highest ON bit number, then transfers the hexadecimal value to the specified digit in R. The digits to receive the results are specified in Di, which also specifies the number of digits to be encoded.

The following is an example of a one-digit encode operation to digit number R, i.e., here Di would be 0001.

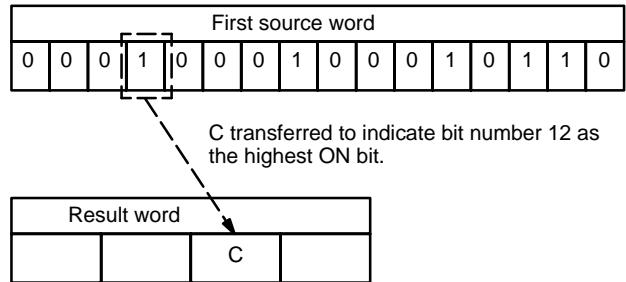

Up to four digits from four consecutive source words starting with S may be encoded and the digits written to R in order from the designated first digit. If more digits are designated than remain in R (counting from the designated first digit) the remaining digits will be placed at digits starting back at the beginning of R. The final word to be converted (S plus the number of digits to be converted) must be in the same data area as SB.

Digit Designator

The digits of Di are set as shown below.

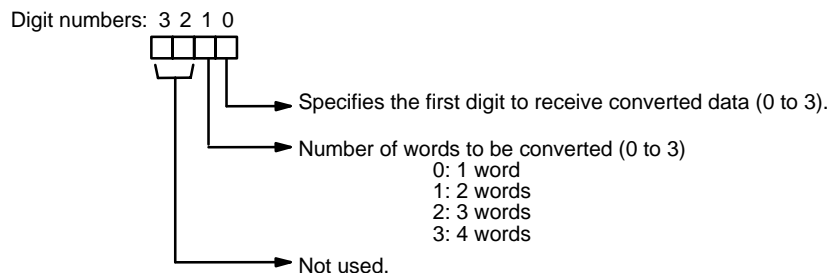

are shown below.

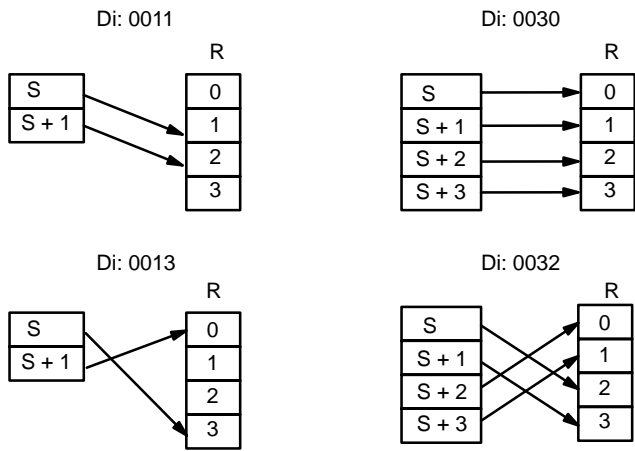

gs

ER: Undefined digit designator, or S plus number of digits exceeds a area.

Content of a source word is zero.

Indirectly addressed DM word is non-existent. (Content of *DM word not BCD, or the DM area boundary has been exceeded.)

ample

When 00000 is ON, the following diagram encodes IR words 200 and 201 to the first two digits of HR 10 and then encodes LR 10 and 11 to the last two digits of HR 10. Although the status of each source word bit is not shown, it is assumed that the bit with status 1 (ON) shown is the highest bit that is ON in the word.

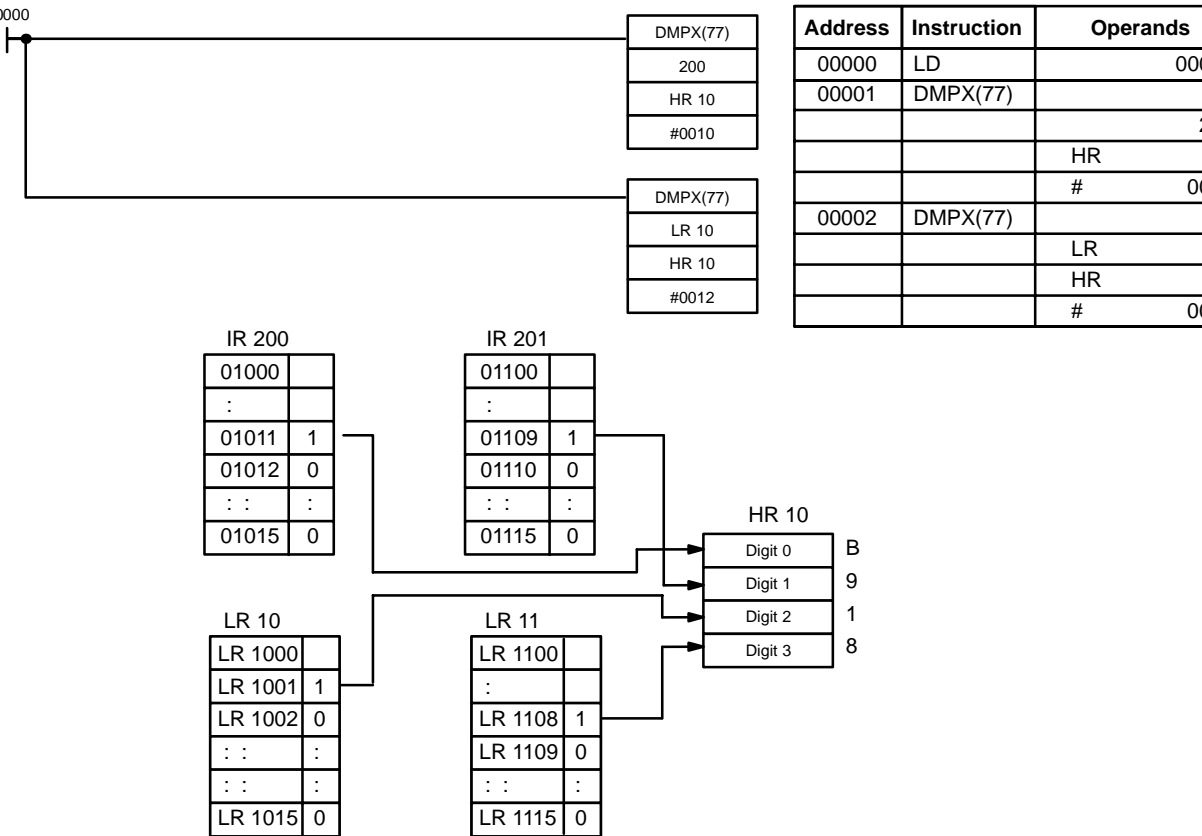

Operand Data Areas

S: Source word (binary)
IR, SR, AR, DM, HR, TC, LR
Di: Digit designator
IR, SR, AR, DM, HR, TC, LR, #
D: First destination word
IR, SR, AR, DM, HR, LR

Ladder Symbols

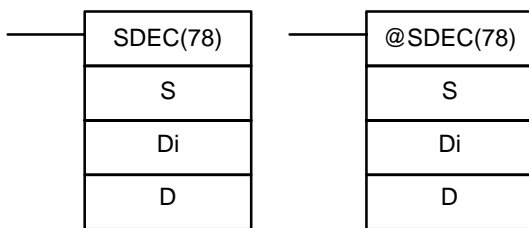

Limitations

Di must be within the values given below.

All destination words must be in the same data area.

DM 6144 to DM 6655 cannot be used for D.

Description

When the execution condition is OFF, SDEC(78) is not executed. When the execution condition is ON, SDEC(78) converts the designated digit(s) of S to the equivalent 8-bit, 7-segment display code and places it into the destination word(s) beginning with D.

Any or all of the digits in S may be converted in sequence from the designated first digit. The first digit, the number of digits to be converted, and the half of D to receive the first 7-segment display code (rightmost or leftmost 8 bits) are designated in Di. If multiple digits are designated, they will be placed in order starting from the designated half of D, each requiring two digits. If more digits are designated than remain in S (counting from the designated first digit), further digits will be used starting back at the beginning of S.

Digit Designator

The digits of Di are set as shown below.

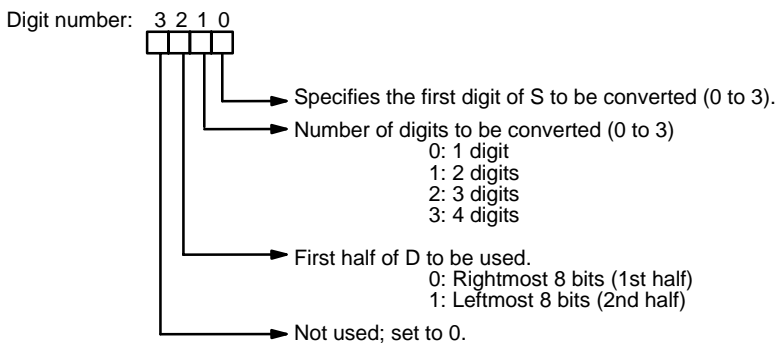

that they produce are shown below.

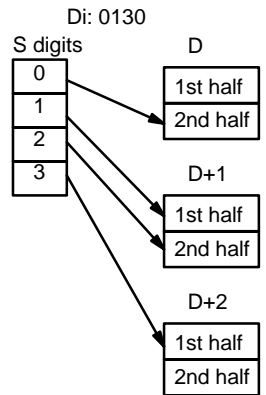
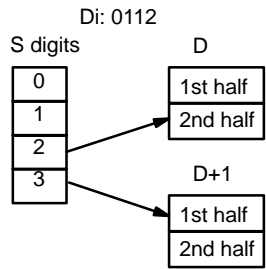
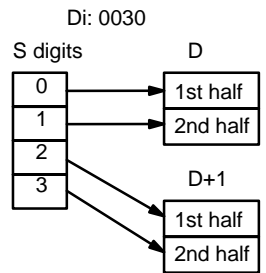
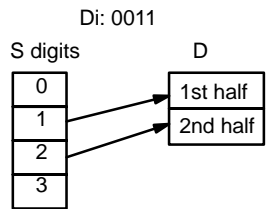

show which bits correspond to which segments of the 7 segment display. table underneath shows the original data and converted code for all hexadecimal digits.

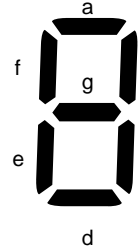
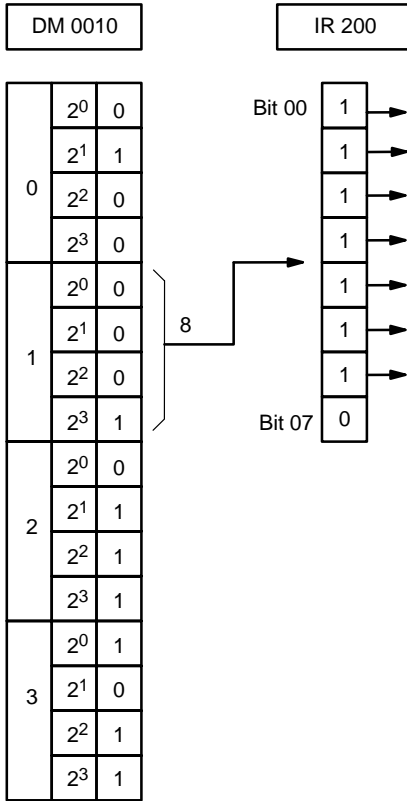
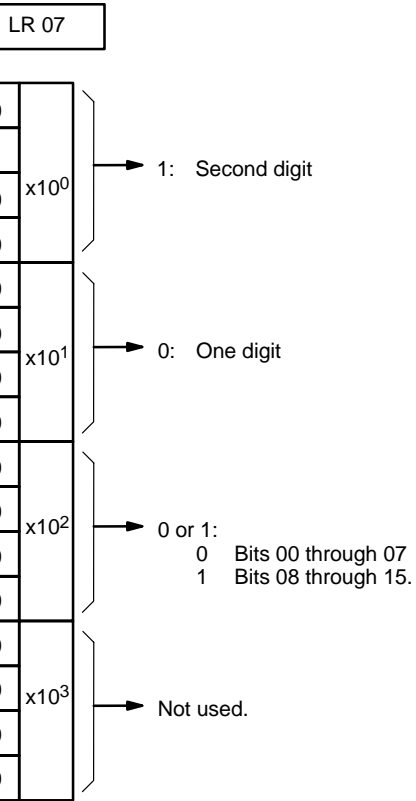
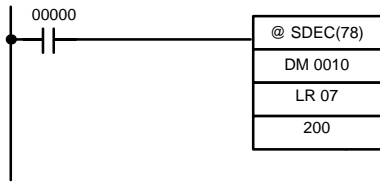

Original data					Converted code (segments)								Display
Digit	Bits				-	g	f	e	d	c	b	a	
0	0	0	0	0	0	0	1	1	0	0	0	0	0
1	0	0	0	1	0	0	1	1	0	0	0	0	1
2	0	0	1	0	0	0	1	1	0	0	1	1	2
3	0	0	1	1	0	0	1	1	0	0	1	1	3
4	0	1	0	0	0	0	1	1	0	1	0	0	4
5	0	1	0	1	0	0	1	1	0	1	0	1	5
6	0	1	1	0	0	0	1	1	0	1	0	1	6
7	0	1	1	1	0	0	1	1	0	1	1	1	7
8	1	0	0	0	0	0	1	1	1	0	0	0	8
9	1	0	0	1	0	0	1	1	1	0	0	1	9
A	1	0	1	0	0	1	0	0	0	0	0	1	A
B	1	0	1	1	0	1	0	0	0	0	1	0	b
C	1	1	0	0	0	1	0	0	0	0	1	1	C
D	1	1	0	1	0	1	0	0	0	1	0	0	d
E	1	1	1	0	0	1	0	0	0	1	0	1	E
F	1	1	1	1	0	1	0	0	0	1	1	0	F

20-8 ASCII CONVERT – ASC(86)

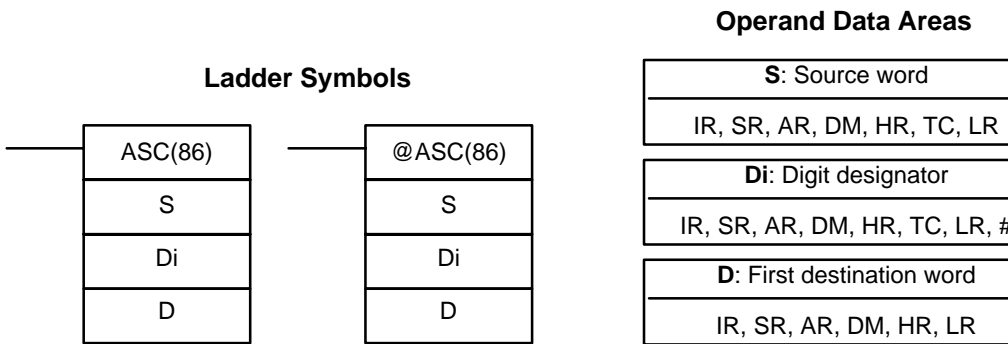

Conditions

Di must be within the values given below.

All destination words must be in the same data area.

DM 6144 to DM 6655 cannot be used for D.

Description

When the execution condition is OFF, ASC(86) is not executed. When the execution condition is ON, ASC(86) converts the designated digit(s) of S into equivalent 8-bit ASCII code and places it into the destination word(s) beginning with D.

Any or all of the digits in S may be converted in order from the designated digit. The first digit, the number of digits to be converted, and the half of D to receive the first ASCII code (rightmost or leftmost 8 bits) are designated in Di. If multiple digits are designated, they will be placed in order starting from the designated half of D, each requiring two digits. If more digits are designated than remain in S (counting from the designated first digit), further digits will be unused starting back at the beginning of S.

Note Refer to *Appendix G* for a table of ASCII characters.

Digit Designator

The digits of Di are set as shown below.

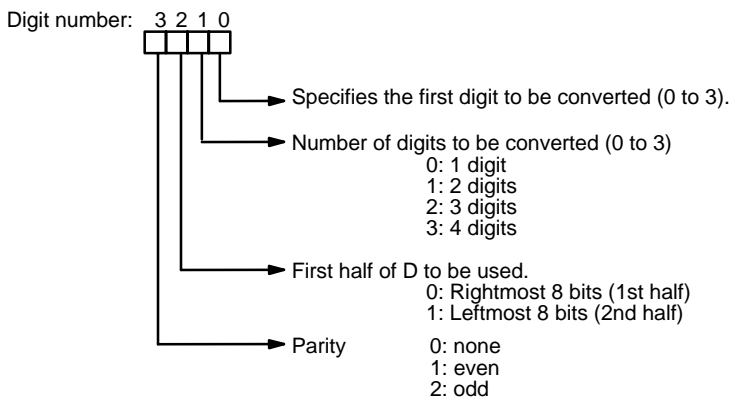

they produce are shown below.

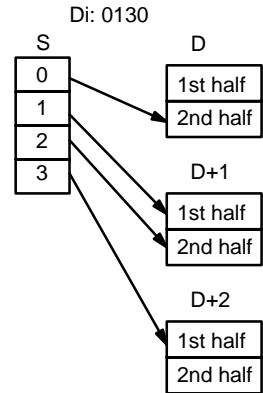
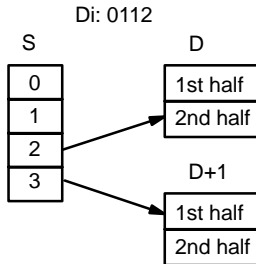
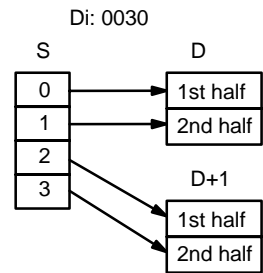
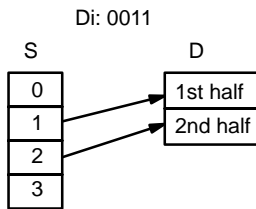

The leftmost bit of each ASCII character (2 digits) can be automatically adjusted for either even or odd parity. If no parity is designated, the leftmost bit will always be zero.

When even parity is designated, the leftmost bit will be adjusted so that the number of ON bits is even, e.g., when adjusted for even parity, ASCII "B" (00110001) will be "B1" (10110001: parity bit turned ON to create an even number of ON bits); ASCII "36" (00110110) will be "36" (00110110: parity bit turned OFF because the number of ON bits is already even). The status of the parity bit does not affect the meaning of the ASCII code.

When odd parity is designated, the leftmost bit of each ASCII character will be adjusted so that there is an odd number of ON bits.

ER: Incorrect digit designator, or data area for destination exceeded.
Indirectly addressed DM word is non-existent. (Content of *DM word is not BCD, or the DM area boundary has been exceeded.)

Operand Data Areas

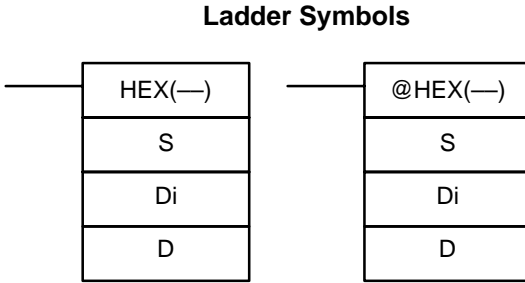

S: First source word
IR, SR, AR, DM, HR, TC, LR, #
Di: Digit designator
IR, SR, AR, DM, HR, TC, LR, #
D: Destination word
IR, SR, AR, DM, HR, LR

Limitations

This instruction is available in the **CPM2A/CPM2C/SRM1(-V2) only**.

Di must be within the values given below.

All source words must be in the same data area.

Bytes in the source words must contain the ASCII code equivalent of hexadecimal values, i.e., 30 to 39 (0 to 9) or 41 to 46 (A to F).

DM 6144 to DM 6655 cannot be used for D.

Description

When the execution condition is OFF, HEX(—) is not executed. When the execution condition is ON, HEX(—) converts the designated byte(s) of ASCII code from the source word(s) into the hexadecimal equivalent and places it in D.

Up to 4 ASCII codes may be converted beginning with the designated first digit of S. The converted hexadecimal values are then placed in D in order from the designated digit. The first byte (rightmost or leftmost 8 bits), the number of bytes to be converted, and the digit of D to receive the first hexadecimal value are designated in Di. If multiple bytes are designated, they will be converted in order starting from the designated half of S and continuing to S+1 and S+2 as necessary.

If more digits are designated than remain in D (counting from the designated digit), further digits will be used starting back at the beginning of D. Digits that do not receive converted data will not be changed.

Digit Designator

The digits of Di are set as shown below.

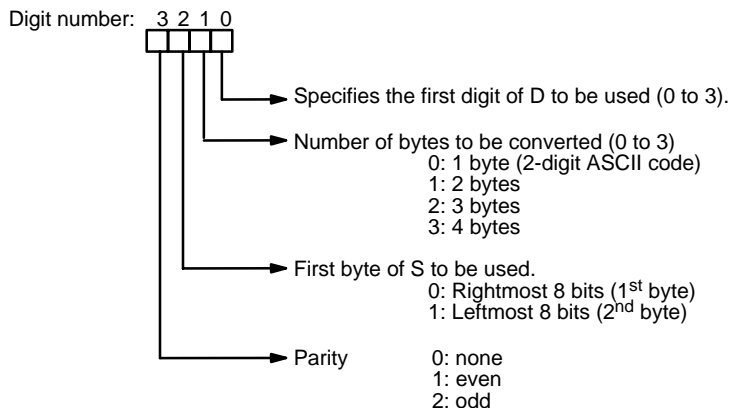

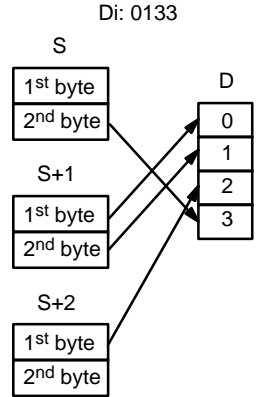
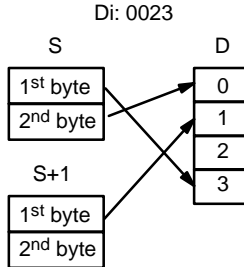
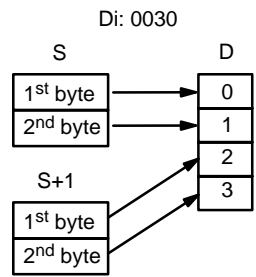
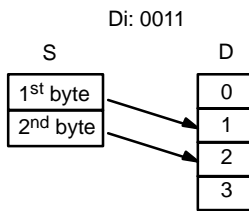

ASCII Code Table

The following table shows the ASCII codes before conversion and the hexadecimal values after conversion. Refer to *Appendix G* for a table of ASCII characters.

Original data									Converted data			
ASCII Code	Bit status (See note.)								Digit	Bits		
30	*	0	1	1	0	0	0	0	0	0	0	0
31	*	0	1	1	0	0	0	1	1	0	0	0
32	*	0	1	1	0	0	1	0	2	0	0	1
33	*	0	1	1	0	0	1	1	3	0	0	1
34	*	0	1	1	0	1	0	0	4	0	1	0
35	*	0	1	1	0	1	0	1	5	0	1	0
36	*	0	1	1	0	1	1	0	6	0	1	1
37	*	0	1	1	0	1	1	1	7	0	1	1
38	*	0	1	1	1	0	0	0	8	1	0	0
39	*	0	1	1	1	0	0	1	9	1	0	0
41	*	1	0	1	0	0	0	1	A	1	0	1
42	*	1	0	1	0	0	1	0	B	1	0	1
43	*	1	0	1	0	0	1	1	C	1	1	0
44	*	1	0	1	0	1	0	0	D	1	1	0
45	*	1	0	1	0	1	0	1	E	1	1	1
46	*	1	0	1	0	1	1	0	F	1	1	1

Note The leftmost bit of each ASCII code is adjusted for parity.

The leftmost bit of each ASCII character (2 digits) is automatically adjusted for either even or odd parity.

With no parity, the leftmost bit should always be zero. With odd or even parity, the leftmost bit of each ASCII character should be adjusted so that there is an odd or even number of ON bits.

If the parity of the ASCII code in S does not agree with the parity specified in the ER Flag (SR 25503) will be turned ON and the instruction will not be executed.

The source data does not contain ASCII data that can be converted to hexadecimal, i.e., values ranging from 0 to 9 or A to F.

Indirectly addressed DM word is non-existent. (Content of *DM word is not BCD, or the DM area boundary has been exceeded.)

Example

In the following example, the 2nd byte of LR 10 and the 1st byte of LR 11 are converted to hexadecimal values and those values are written to the first and second bytes of IR 200.



Address	Instruction	Operands
00000	LD	00000
00001	@HEX(---)	
		LR 10
		HR 10
		200

HR 10

0	1	1	0
---	---	---	---

LR 12

3	5	3	4
---	---	---	---

LR 11

4	2	3	2
---	---	---	---

LR 10

3	1	3	0
---	---	---	---

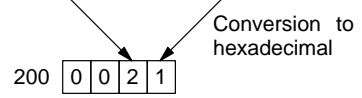

20-10 HOURS-TO-SECONDS – SEC(---)

Ladder Symbols

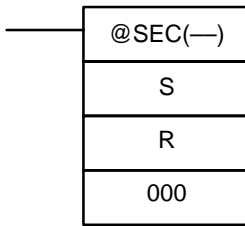
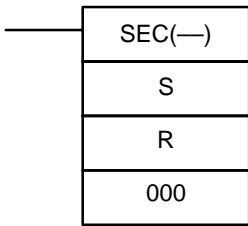

Operand Data Areas

S: Beginning source word (BCD)
IR, SR, AR, DM, HR, TC, LR
R: Beginning result word (BCD)
IR, SR, AR, DM, HR, TC, LR
000: No function
000

Limitations

This instruction is available in the **CPM2A/CPM2C only**.

S and S+1 must be within the same data area. R and R+1 must be within the same data area. S and S+1 must be BCD and must be in the proper hours/minutes/seconds format.

DM 6144 to DM 6655 cannot be used for R.

Description

SEC(---) is used to convert time notation in hours/minutes/seconds to an equivalent in just seconds.

For the source data, the seconds are designated in bits 00 through 07 and minutes are designated in bits 08 through 15 of S. The hours are designated in bits 16 through 31 of S+1. The maximum is thus 9,999 hours, 59 minutes, and 59 seconds.

The result is output to R and R+1. The maximum obtainable value is 35,999 seconds.

Errors

- ER:** S and S+1 or R and R+1 are not in the same data area.
- S and/or S+1 do not contain BCD.

Indirectly addressed DM word is non-existent. (Content of *DM word is not BCD, or the DM area boundary has been exceeded.)

EQ: ON when the result is zero.

Example

When 00000 is OFF (i.e., when the execution condition is ON), the following instruction would convert the hours, minutes, and seconds given in HR 12 and HR 13 to seconds and store the results in DM 0100 and DM 0101 as shown.

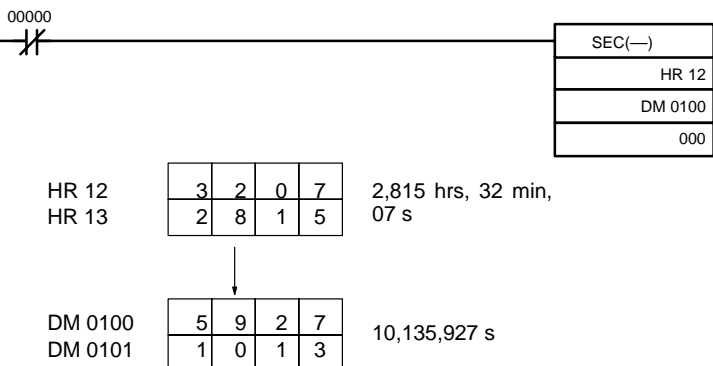

Address	Instruction	Operands
00000	LD NOT	00000
00001	SEC(—)	
		HR 12
		DM 0100
		HR 13
		000

20-11 SECONDS-TO-HOURS – HMS(—)

Ladder Symbols

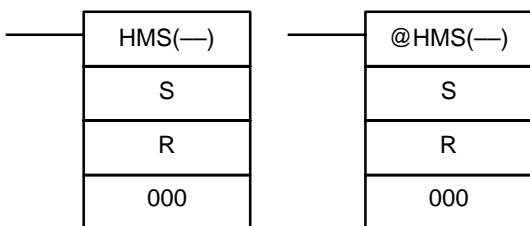

Operand Data Areas

S: Beginning source word (BCD)
IR, SR, AR, DM, HR, TC, LR
R: Beginning result word (BCD)
IR, SR, AR, DM, HR, TC, LR
000: No function
000

Restrictions

This instruction is available in the **CPM2A/CPM2C only**.

S and S+1 must be within the same data area. R and R+1 must be within the same data area. S and S+1 must be BCD and must be between 0 and 35,999,999 seconds.

DM 6144 to DM 6655 cannot be used for R.

Description

HMS(—) is used to convert time notation in seconds to an equivalent in hours/minutes/seconds.

The number of seconds designated in S and S+1 is converted to hours/minutes/seconds and placed in R and R+1.

For the results, the seconds are placed in bits 00 through 07 and the minutes are placed in bits 08 through 15 of R. The hours are placed in R+1. The maximum is 9,999 hours, 59 minutes, and 59 seconds.

Errors

ER: S and S+1 or R and R+1 are not in the same data area.

S and/or S+1 do not contain BCD or exceed 36,000,000 seconds.

Indirectly addressed DM word is non-existent. (Content of *DM word is not BCD, or the DM area boundary has been exceeded.)

EQ: ON when the result is zero.

minutes, and seconds and store the results in DM 0100 and DM 0101 as shown.

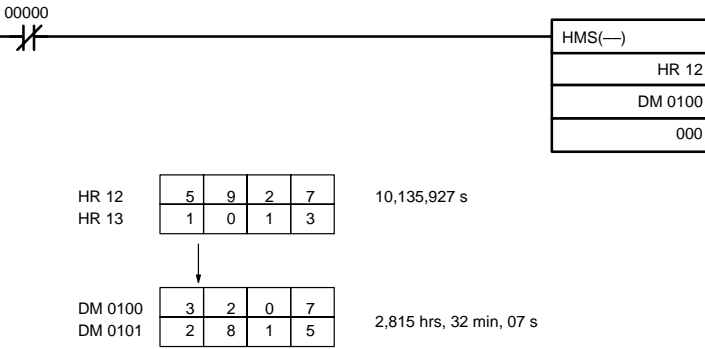

Address	Instruction	Operands
00000	LD NOT	00000
00001	HMS(—)	
		HR 12
		DM 0100
		000

20-12 2'S COMPLEMENT – NEG(—)

Ladder Symbols

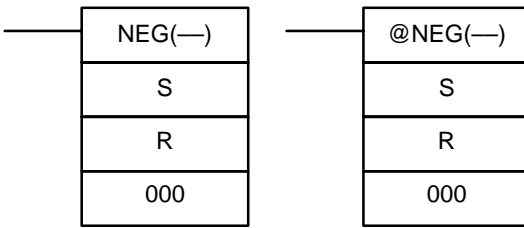

Operand Data Areas

S: Source word
IR, SR, AR, DM, HR, TC, LR, #
R: Result word
IR, SR, AR, DM, HR, LR
000
Not used. Set to 000.

Restrictions

This instruction is available in the **CPM2A/CPM2C/SRM1(-V2) only**.
DM 6144 to DM 6655 cannot be used for R.

Description

Converts the four-digit hexadecimal content of the source word (S) to its two's complement and outputs the result to the result word (R). This operation is effectively the same as subtracting S from 0000 and outputting the result to R; it is used to calculate the absolute value of negative signed binary data.

If the content of S is 0000, the content of R will also be 0000 after execution. EQ (SR 25506) will be turned on.

If the content of S is 8000, the content of R will also be 8000 after execution. UF (SR 25405) will be turned on.

Note Refer to 2-16 *Calculating with Signed Binary Data* for more details.

Flags

- ER:** Indirectly addressed DM word is non-existent. (Content of *DM word is not BCD, or the DM area boundary has been exceeded.)
- EQ:** ON when the content of R is zero after execution; otherwise OFF.
- UF:** ON when the content of S is 8000; otherwise OFF.
- N:** ON when bit 15 of R is ON; otherwise OFF.

the content of DM 0005 and output the result to IR 105.

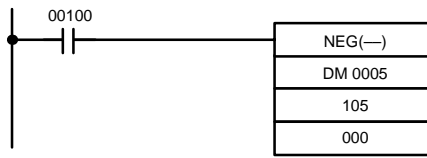

Address	Instruction	Operands
00000	LD	00100
00001	NEG(—)	
		DM 0005
		105
		000

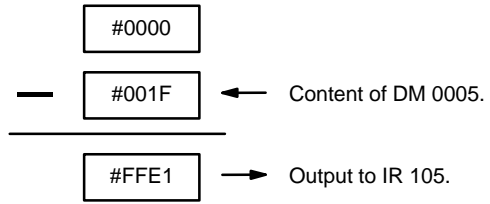

21-1 SET CARRY – STC(40)

Ladder Symbols

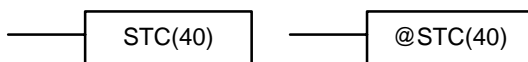

When the execution condition is OFF, STC(40) is not executed. When execution condition is ON, STC(40) turns ON CY (SR 25504).

Note Refer to *Appendix B Error and Arithmetic Flag Operation* for a table listing instructions that affect CY.

21-2 CLEAR CARRY – CLC(41)

Ladder Symbols

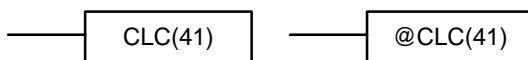

When the execution condition is OFF, CLC(41) is not executed. When execution condition is ON, CLC(41) turns OFF CY (SR 25504).

CLEAR CARRY is used to reset (turn OFF) CY (SR 25504) to "0."

Note Refer to *Appendix B Error and Arithmetic Flag Operation* for a table listing instructions that affect CY.

21-3 BCD ADD – ADD(30)

Ladder Symbols

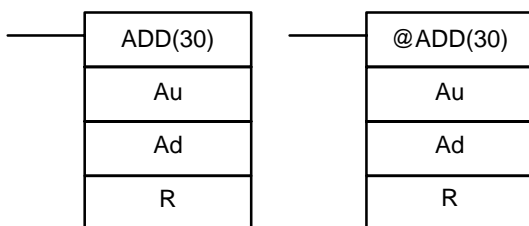

Operand Data Areas

Au: Augend word (BCD)
IR, SR, AR, DM, HR, TC, LR, #
Ad: Addend word (BCD)
IR, SR, AR, DM, HR, TC, LR, #
R: Result word
IR, SR, AR, DM, HR, LR

Limitations

DM 6144 to DM 6655 cannot be used for R.

Description

When the execution condition is OFF, ADD(30) is not executed. When execution condition is ON, ADD(30) adds the contents of Au, Ad, and CY, and places the result in R. CY will be set if the result is greater than 9999.

$$\boxed{\text{Au}} + \boxed{\text{Ad}} + \boxed{\text{CY}} \rightarrow \boxed{\text{CY}} \quad \boxed{\text{R}}$$

Flags

ER: Au and/or Ad is not BCD.

Indirectly addressed DM word is non-existent. (Content of *DM word is not BCD, or the DM area boundary has been exceeded.)

CY: ON when there is a carry in the result.

EQ: ON when the result is 0.

CLC(41), adds the content of R 200 to a constant (3100), places the result in R 0100, and then moves either all zeros or 0001 into DM 0101 depending on the status of CY (25504). This ensures that any carry from the last digit is present in R+1 so that the entire result can be later handled as eight-digit data.

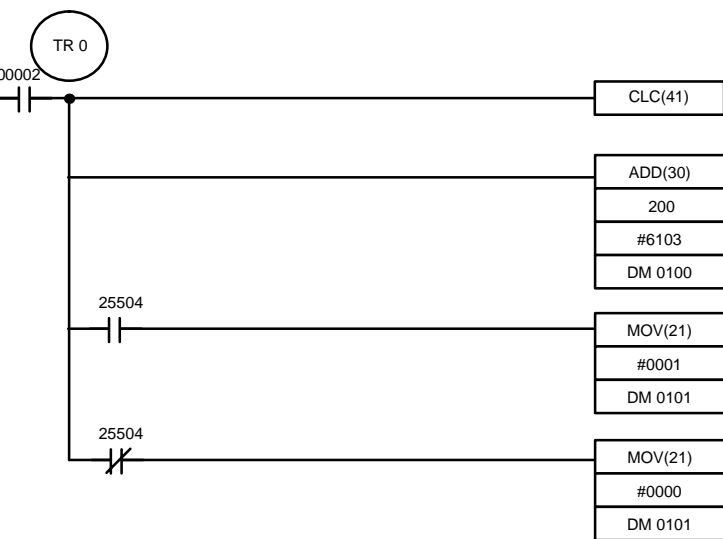

Address	Instruction	Operands
00000	LD	00002
00001	OUT	TR 0
00002	CLC(41)	
00003	ADD(30)	
		200
		# 6103
		DM 0100
00004	AND	25504
00005	MOV(21)	
		# 0001
		DM 0101
00006	LD	TR 0
00007	AND NOT	25504
00008	MOV(21)	
		# 0000
		DM 0101

Although two ADD(30) can be used together to perform eight-digit BCD addition, ADDL(54) is designed specifically for this purpose.

21-4 BCD SUBTRACT – SUB(31)

Operand Data Areas

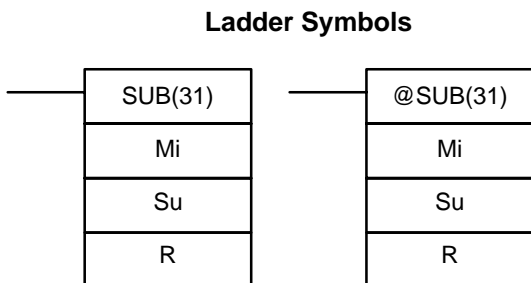

Mi: Minuend word (BCD)
IR, SR, AR, DM, HR, TC, LR, #
Su: Subtrahend word (BCD)
IR, SR, AR, DM, HR, TC, LR, #
R: Result word
IR, SR, AR, DM, HR, LR

Limitations

DM 6144 to DM 6655 cannot be used for R.

Description

When the execution condition is OFF, SUB(31) is not executed. When the execution condition is ON, SUB(31) subtracts the contents of Su and CY from Mi, and places the result in R. If the result is negative, CY is set and the 10's complement of the actual result is placed in R. To convert the 10's complement to true result, subtract the content of R from zero (see example below).

$$\boxed{Mi} - \boxed{Su} - \boxed{CY} \rightarrow \boxed{CY} \quad \boxed{R}$$

Flags

ER: Mi and/or Su is not BCD.

Indirectly addressed DM word is non-existent. (Content of *DM word is not BCD, or the DM area boundary has been exceeded.)

CY: ON when the result is negative, i.e., when Mi is less than Su plus CY.

EQ: ON when the result is 0.

Example

When 00002 is ON, the following ladder program clears CY, subtracts the contents of DM 0100 and CY from the content of 201 and places the result in HR 10.

If CY is set by executing SUB(31), the result in HR 10 is subtracted from 201 (note that CLC(41) is again required to obtain an accurate result), the result is placed back in HR 10, and HR 1100 is turned ON to indicate a negative result.

If CY is not set by executing SUB(31), the result is positive, the second subtraction is not performed, and HR 1100 is not turned ON. HR 1100 is programmed as a self-maintaining bit so that a change in the status of CY will not turn it OFF when the program is rescanned.

In this example, differentiated forms of SUB(31) are used so that the subtraction operation is performed only once each time 00002 is turned ON. When another subtraction operation is to be performed, 00002 will need to be turned OFF for at least one cycle (resetting HR 1100) and then turned back ON.

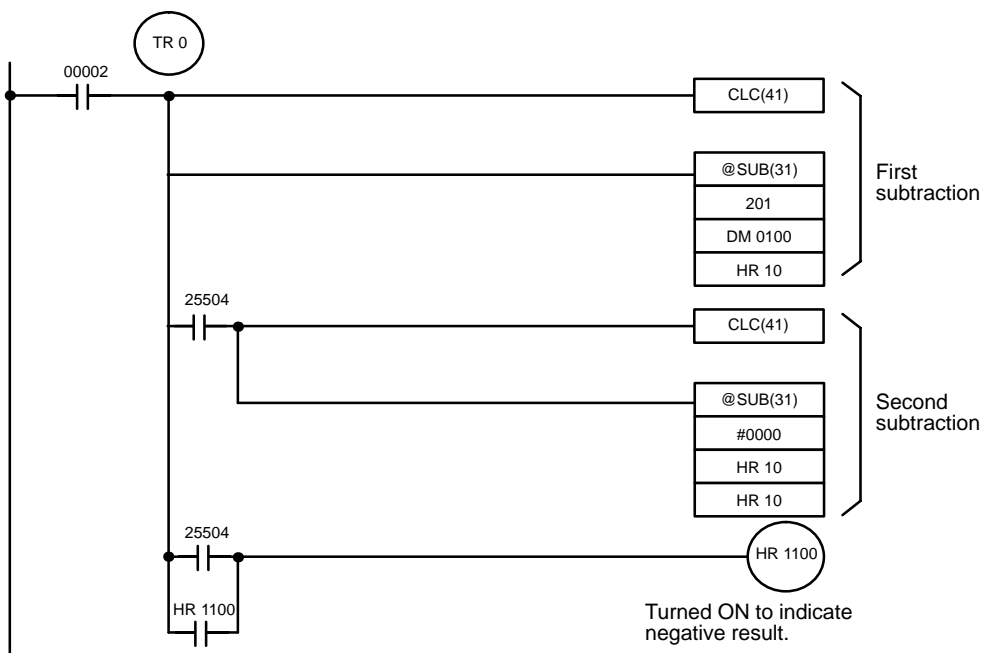

00000	LD		00002
00001	OUT	TR	0
00002	CLC(41)		
00003	@SUB(31)		
			201
		DM	0100
		HR	10
00004	AND		25504
00005	CLC(41)		
00006	@SUB(31)		
		#	0000
		HR	10
		HR	10
00007	LD	TR	0
00008	LD		25504
00009	OR	HR	1100
00010	AND LD		---
00011	OUT	HR	1100

The first and second subtractions for this diagram are shown below using example data for 201 and DM 0100.

Note The actual SUB(31) operation involves subtracting Su and CY from 10,000 Mi. For positive results the leftmost digit is truncated. For negative results 10s complement is obtained. The procedure for establishing the correct answer is given below.

First Subtraction

```

IR 201    1029
DM 0100  - 3452
CY       - 0
-----
HR 10    7577 (1029 + (10000 - 3452))
CY       1    (negative result)

```

Second Subtraction

```

0000
HR 10  -7577
CY     -0
-----
HR 10  2423 (0000 + (10000 - 7577))
CY     1    (negative result)

```

In the above case, the program would turn ON HR 1100 to indicate that the value held in HR 10 is negative.

21-5 BCD MULTIPLY – MUL(32)

Ladder Symbols

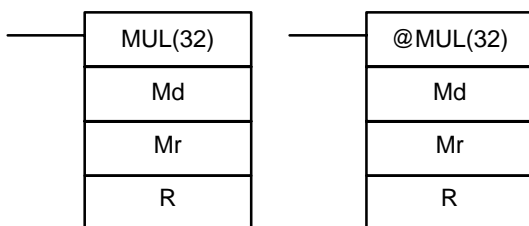

Operand Data Areas

Md: Multiplicand (BCD)
IR, SR, AR, DM, HR, TC, LR, #
Mr: Multiplier (BCD)
IR, SR, AR, DM, HR, TC, LR, #
R: First result word
IR, SR, AR, DM, HR LR

Limitations

DM 6144 to DM 6655 cannot be used for R.

Execution condition is ON, MUL(32) multiplies Md by the content of Mr, places the result in R and R+1.

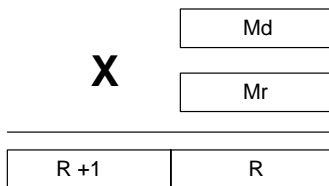

Example

When IR 00000 is ON with the following program, the contents of IR 013 DM 0005 are multiplied and the result is placed in HR 07 and HR 08. Example data and calculations are shown below the program.

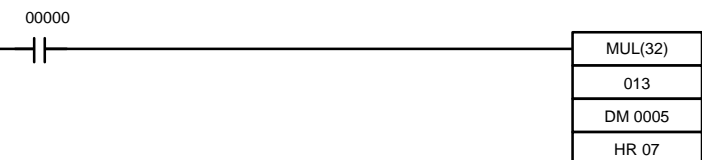

Address	Instruction	Operands
00000	LD	00000
00001	MUL(32)	
		DM 0005
		HR 07

Md: IR 013			
3	3	5	6

X

Mr: DM 0005			
0	0	2	5

R+1: HR 08				R: HR 07			
0	0	0	8	3	9	0	0

Errors

- ER:** Md and/or Mr is not BCD.
Indirectly addressed DM word is non-existent. (Content of *DM word is not BCD, or the DM area boundary has been exceeded.)
- CY:** ON when there is a carry in the result.
- EQ:** ON when the result is 0.

21-6 BCD DIVIDE – DIV(33)

Ladder Symbol

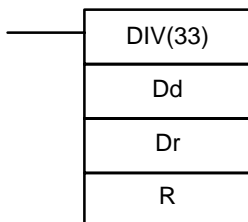

Operand Data Areas

Dd: Dividend word (BCD) IR, SR, AR, DM, HR, TC, LR, #
Dr: Divisor word (BCD) IR, SR, AR, DM, HR, TC, LR, #
R: First result word (BCD) IR, SR, AR, DM, HR, LR

Restrictions

R and R+1 must be in the same data area. DM 6144 to DM 6655 cannot be used for R.

moves to the next instruction. When the execution condition is ON, Dd is updated by Dr and the result is placed in R and R + 1: the quotient in R and the remainder in R + 1.

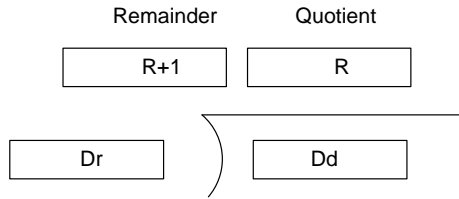

ER: Dd or Dr is not in BCD.

Indirectly addressed DM word is non-existent. (Content of *DM word is not BCD, or the DM area boundary has been exceeded.)

EQ: ON when the result is 0.

Example

When IR 00000 is ON with the following program, the content of IR 216 is divided by the content of HR 09 and the result is placed in DM 0017 and DM 0018. Example data and calculations are shown below the program.

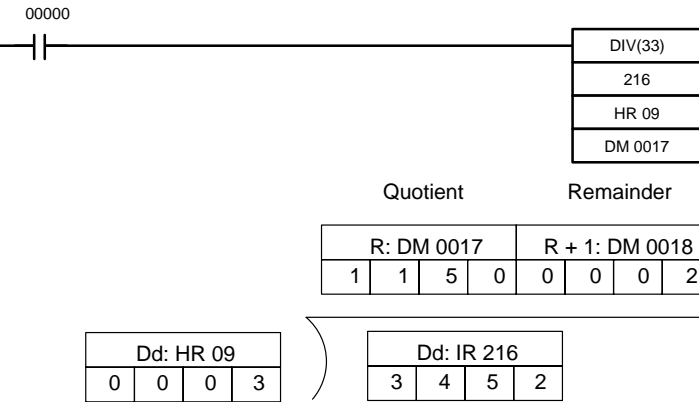

Address	Instruction	Operands
00000	LD	00000
00001	DIV(33)	
		216
		HR 09
		DM 0017

21-7 DOUBLE BCD ADD – ADDL(54)

Ladder Symbols

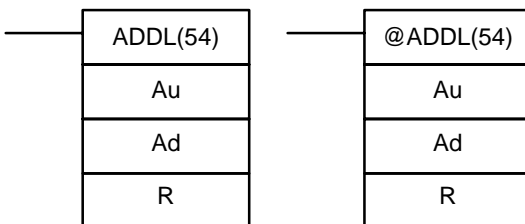

Operand Data Areas

Au: First augend word (BCD)
IR, SR, AR, DM, HR, TC, LR
Ad: First addend word (BCD)
IR, SR, AR, DM, HR, TC, LR
R: First result word
IR, SR, AR, DM, HR, LR

Limitations

DM 6144 to DM 6655 cannot be used for R.

Execution condition is ON; ADDL(54) adds the contents of CY to the 8-digit value in Au and Au+1 to the 8-digit value in Ad and Ad+1, and places the result in R+1. CY will be set if the result is greater than 99999999.

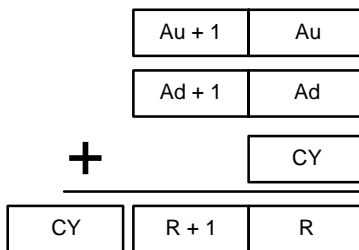

gs

ER: Au and/or Ad is not BCD.

Indirectly addressed DM word is non-existent. (Content of *DM word is not BCD, or the DM area boundary has been exceeded.)

CY: ON when there is a carry in the result.

EQ: ON when the result is 0.

ample

When 00000 is ON, the following program section adds two 12-digit numbers: the first contained in LR 00 through LR 02 and the second in DM 0010 through DM 0012. The result is placed in HR 10 through HR 13.

The rightmost 8 digits of the two numbers are added using ADDL(54), i.e. the contents of LR 00 and LR 01 are added to DM 0010 and DM 0011 and the result is placed in HR 10 and HR 11. The second addition adds the leftmost 4 digits of each number using ADD(30), and includes any carry from the first addition. The last instruction, ADB(50) (see 7-22-1 BINARY ADD – ADB(50)) adds two zero constants to place any carry from the second addition into HR 13.

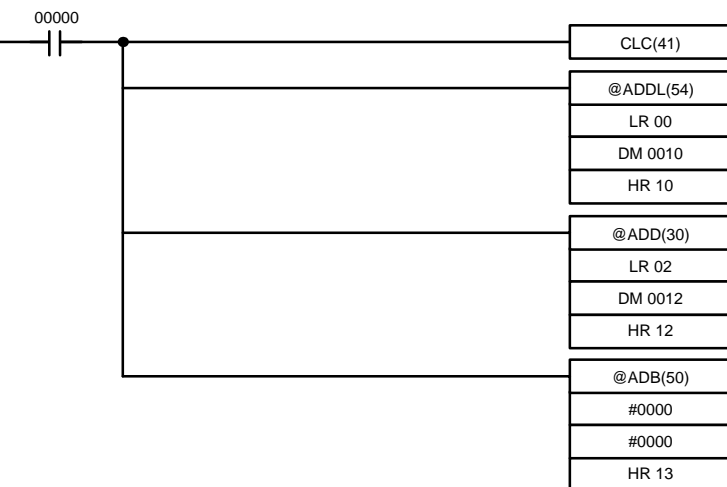

Address	Instruction	Operands
00000	LD	00000
00001	CLC(41)	
00002	@ADDL(54)	
		LR 00
		DM 0010
		HR 10
00003	@ADD(30)	
		LR 02
		DM 0012
		HR 12
00004	@ADB(50)	
		# 0000
		# 0000
		HR 13

Operand Data Areas

Ladder Symbols

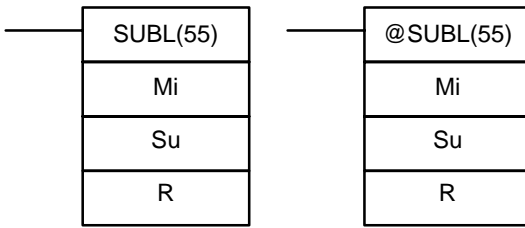

Mi: First minuend word (BCD)
IR, SR, AR, DM, HR, TC, LR, #
Su: First subtrahend word (BCD)
IR, SR, AR, DM, HR, TC, LR, #
R: First result word
IR, SR, AR, DM, HR, LR

Initiations
Description

DM 6144 to DM 6655 cannot be used for R.

When the execution condition is OFF, SUBL(55) is not executed. When the execution condition is ON, SUBL(55) subtracts CY and the 8-digit contents of Mi and Su+1 from the 8-digit value in Mi and Mi+1, and places the result in R and R+1. If the result is negative, CY is set and the 10's complement of the absolute value of the result is placed in R. To convert the 10's complement to the true result, subtract the content of R from zero. Since an 8-digit constant cannot be directly entered, use the BSET(71) instruction (see 7-17-4 BLOCK SET – BSET(71)) to create an 8-digit constant.

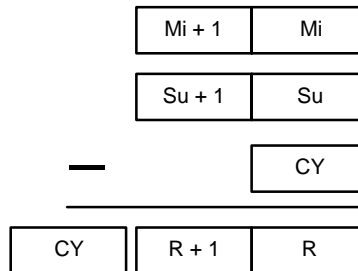

gs

ER: Mi, M+1, Su, or Su+1 are not BCD.

Indirectly addressed DM word is non-existent. (Content of *DM word is not BCD, or the DM area boundary has been exceeded.)

CY: ON when the result is negative, i.e., when Mi is less than Su.

EQ: ON when the result is 0.

example, however, BSET(71) is required to clear the content of DM 0000 and DM 0001 so that a negative result can be subtracted from 0 (inputting an 8-bit constant is not possible).

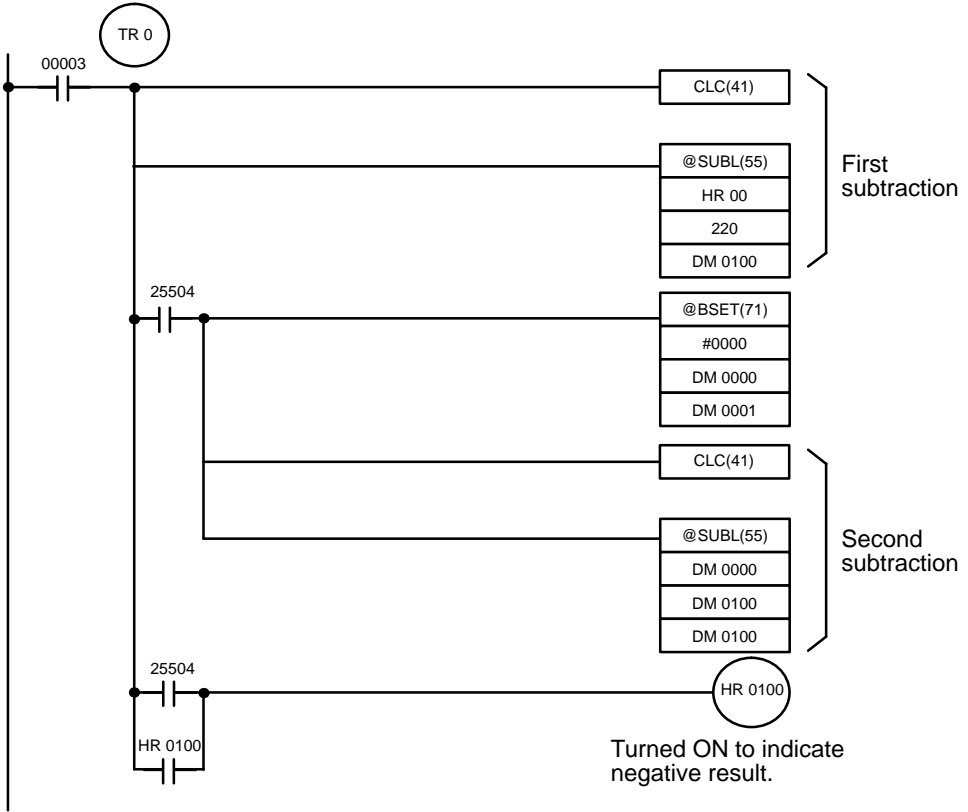

Address	Instruction	Operands
00000	LD	00003
00001	OUT	TR 0
00002	CLC(41)	
00003	@SUBL(55)	
		HR 00
		220
		DM 0100
00004	AND	25504
00005	@BSET(71)	
		# 0000
		DM 0000
		DM 0001

Address	Instruction	Operands
00006	CLC(41)	
00007	@SUBL(55)	
		DM 0000
		DM 0100
		DM 0100
00008	LD	TR 0
00009	LD	25504
00010	OR	HR 0100
00011	AND LD	
00012	OUT	HR 0100

Operand Data Areas

Ladder Symbols

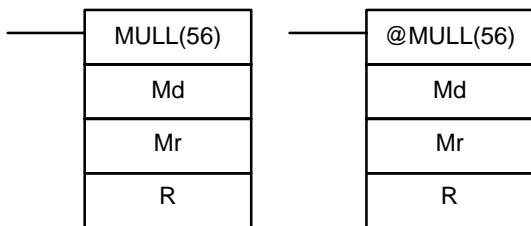

Md: First multiplicand word (BCD)
IR, SR, AR, DM, HR, TC, LR
Mr: First multiplier word (BCD)
IR, SR, AR, DM, HR, TC, LR
R: First result word
IR, SR, AR, DM, HR LR

Limitations
Description

DM 6144 to DM 6655 cannot be used for R.

When the execution condition is OFF, MULL(56) is not executed. When execution condition is ON, MULL(56) multiplies the eight-digit content of Md and Md+1 by the content of Mr and Mr+1, and places the result in R to R+3.

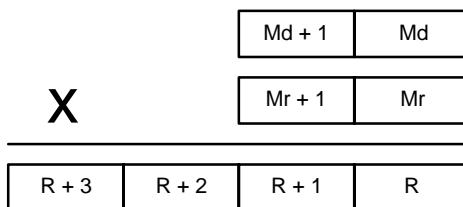

Flags

ER: Md, Md+1, Mr, or Mr+1 is not BCD.

Indirectly addressed DM word is non-existent. (Content of *DM word is not BCD, or the DM area boundary has been exceeded.)

CY: ON when there is a carry in the result.

EQ: ON when the result is 0.

21-10 DOUBLE BCD DIVIDE – DIVL(57)

Operand Data Areas

Ladder Symbols

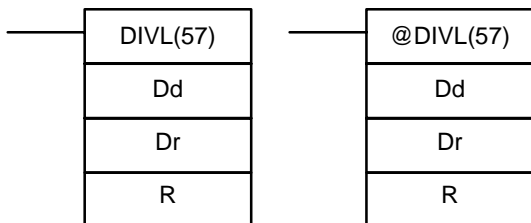

Dd: First dividend word (BCD)
IR, SR, AR, DM, HR, TC, LR
Dr: First divisor word (BCD)
IR, SR, AR, DM, HR, TC, LR
R: First result word
IR, SR, AR, DM, HR LR

Limitations
Description

DM 6144 to DM 6655 cannot be used for R.

When the execution condition is OFF, DIVL(57) is not executed. When execution condition is ON, DIVL(57) divides the eight-digit content of Dd and D+1 by the content of Dr and Dr+1 and the result is placed in R to R+3: the quotient in R and R+1, the remainder in R+2 and R+3.

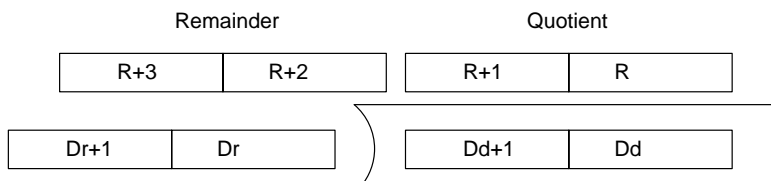

Dd, Dd+1, Dr, or Dr+1 is not BCD.

Indirectly addressed DM word is non-existent. (Content of *DM word not BCD, or the DM area boundary has been exceeded.)

EQ: ON when the result is 0.

22 Binary Calculation Instructions

22-1 BINARY ADD – ADB(50)

Ladder Symbols

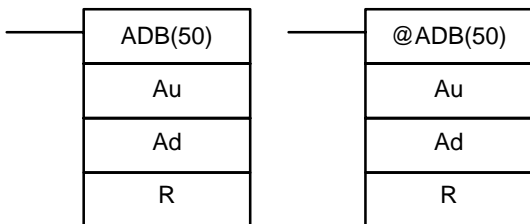

Operand Data Areas

Au: Augend word (binary)
IR, SR, AR, DM, HR, TC, LR, #
Ad: Addend word (binary)
IR, SR, AR, DM, HR, TC, LR, #
R: Result word
IR, SR, AR, DM, HR, LR

ications

cription

DM 6144 to DM 6655 cannot be used for R.

When the execution condition is OFF, ADB(50) is not executed. When execution condition is ON, ADB(50) adds the contents of Au, Ad, and CY, places the result in R. CY will be set if the result is greater than FFFF.

$$\boxed{\text{Au}} + \boxed{\text{Ad}} + \boxed{\text{CY}} \rightarrow \boxed{\text{CY}} \boxed{\text{R}}$$

ADB(50) can also be used to add signed binary data. With the CPM1A, CPM2C, and SRM1(-V2), the underflow and overflow flags (SR 25404 SR 25405) indicate whether the result has exceeded the lower or upper limit of the 16-bit signed binary data range.

gs

ER: Indirectly addressed DM word is non-existent. (Content of *DM word not BCD, or the DM area boundary has been exceeded.)

CY: ON when the result is greater than FFFF.

EQ: ON when the result is 0.

OF: ON when the result exceeds +32,767 (7FFF).

UF: ON when the result is below -32,768 (8000).

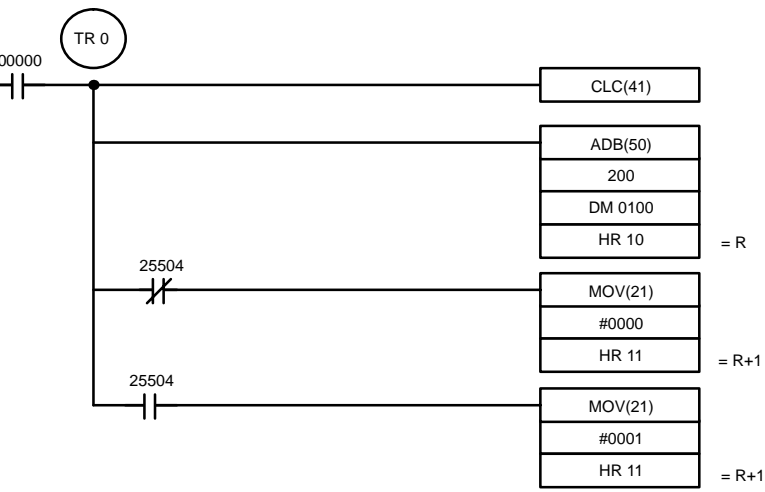

Address	Instruction	Operands
00000	LD	000
00001	OUT	TR
00002	CLC(41)	
00003	ADB(50)	
		2
		DM 01
		HR
00004	AND NOT	255
00005	MOV(21)	
		# 00
		HR
00006	LD	TR
00007	AND	255
00008	MOV(21)	
		# 000
		HR

In the case below, $A6E2 + 80C5 = 127A7$. The result is a 5-digit number, so $(SR\ 25504) = 1$, and the content of $R + 1$ becomes #0001.

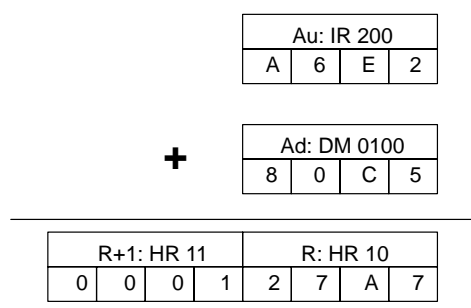

Note For signed binary calculations, the status of the UF and OF flags indicate whether the result has exceeded the signed binary data range (-32,768 (8000) to +32,767 (7FFF)).

22-2 BINARY SUBTRACT – SBB(51)

Ladder Symbols

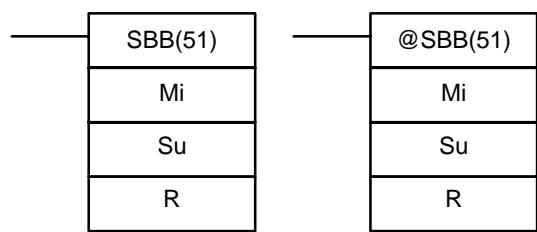

Operand Data Areas

Mi: Minuend word (binary)
IR, SR, AR, DM, HR, TC, LR, #
Su: Subtrahend word (binary)
IR, SR, AR, DM, HR, TC, LR, #
R: Result word
IR, SR, AR, DM, HR, LR

Limitations

DM 6144 to DM 6655 cannot be used for R.

Execution condition is ON, SBB(51) subtracts the contents of Su and CY from Mi and places the result in R. If the result is negative, CY is set and the 2's complement of the actual result is placed in R.



SBB(51) can also be used to subtract signed binary data. With the CPM2A, CPM2C, and SRM1(-V2), the underflow and overflow flags (SR 25404 and SR 25405) indicate whether the result has exceeded the lower or upper limits of the 16-bit signed binary data range.

- ER:** Indirectly addressed DM word is non-existent. (Content of *DM word is not BCD, or the DM area boundary has been exceeded.)
- CY:** ON when the result is negative, i.e., when Mi is less than Su plus CY.
- EQ:** ON when the result is 0.
- OF:** ON when the result exceeds +32,767 (7FFF).
- UF:** ON when the result is below -32,768 (8000).

The following example shows a four-digit subtraction. When IR 00001 is ON, the content of LR 00 and CY are subtracted from the content of IR 002 and the result is written to HR 01.

CY is turned ON if the result is negative. If normal data is being used, a negative result (signed binary) must be converted to normal data using NEG(—). Refer to 7-20-12 2's COMPLEMENT - NEG(—) for details.

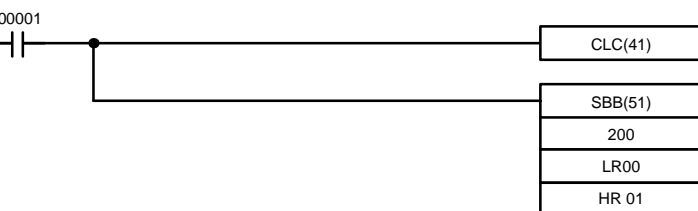

Address	Instruction	Operands
00000	LD	00001
00001	OUT	TR
00002	CLC(41)	
00003	SBB(51)	
		200
		LR
		HR

In the case below, the content of LR 00 (#7A03) and CY are subtracted from the content of IR 002 (#F8C5). Since the result is positive, CY is 0.

If the result had been negative, CY would have been set to 1. For normal data, the result would have to be converted to its 2's complement.

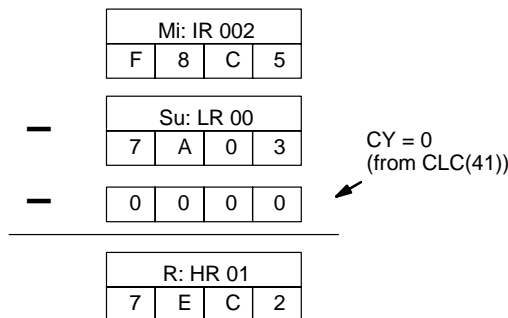

Note For signed binary calculations, the status of the UF and OF flags indicate whether the result has exceeded the signed binary data range (-32,768 (8000) to +32,767 (7FFF)).

Operand Data Areas

Ladder Symbols

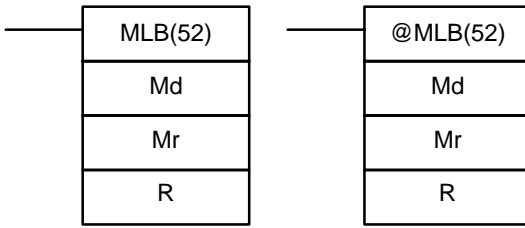

Md: Multiplicand word (binary)
IR, SR, AR, DM, HR, TC, LR, #
Mr: Multiplier word (binary)
IR, SR, AR, DM, HR, TC, LR, #
R: First result word
IR, SR, AR, DM, HR LR

Limitations

DM 6144 to DM 6655 cannot be used for R.

MLB(52) cannot be used to multiply signed binary data.

Description

When the execution condition is OFF, MLB(52) is not executed. When execution condition is ON, MLB(52) multiplies the content of Md by the content of Mr, places the rightmost four digits of the result in R, and places the leftmost four digits in R+1.

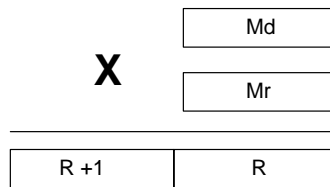

Flags

ER: Indirectly addressed DM word is non-existent. (Content of *DM word is not BCD, or the DM area boundary has been exceeded.)

EQ: ON when the result is 0.

22-4 BINARY DIVIDE – DVB(53)

Operand Data Areas

Ladder Symbols

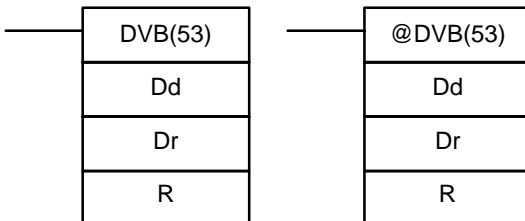

Dd: Dividend word (binary)
IR, SR, AR, DM, HR, TC, LR, #
Dr: Divisor word (binary)
IR, SR, AR, DM, HR, TC, LR, #
R: First result word
IR, SR, AR, DM, HR LR

Limitations

DM 6144 to DM 6655 cannot be used for R.

DVB(53) cannot be used to divide signed binary data.

Description

When the execution condition is OFF, DVB(53) is not executed. When execution condition is ON, DVB(53) divides the content of Dd by the content of Dr and the result is placed in R and R+1: the quotient in R, the remainder in R+1.

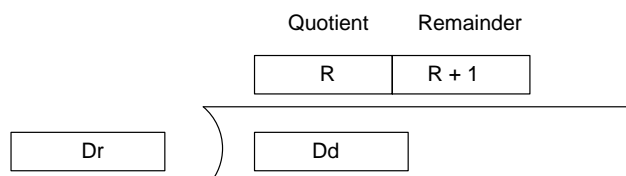

Indirectly addressed DM word is non-existent. (Content of *DM word is not BCD, or the DM area boundary has been exceeded.)

EQ: ON when the result is 0.

23 Special Math Instructions

23-1 DATA SEARCH – SRCH(—)

Ladder Symbols

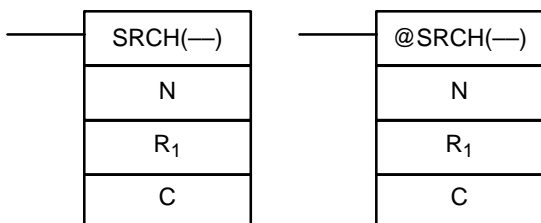

Operand Data Areas

N: Number of words
IR, SR, AR, DM, HR, TC, LR, #
R₁: First word in range
IR, SR, AR, DM, HR, TC, LR
C: Comparison data, result word
IR, SR, AR, DM, HR, LR

Applications

This instruction is available in the **CPM2A/CPM2C only**.

N must be BCD between 0001 to 9999.

R₁ and R₁+N-1 must be in the same data area.

DM 6144 to DM 6655 cannot be used for C.

Description

When the execution condition is OFF, SRCH(—) is not executed. When the execution condition is ON, SRCH(—) searches the range of memory from R₁ to R₁+N-1 for addresses that contain the comparison data in C. If one or more addresses contain the comparison data, the EQ Flag (SR 25506) is turned ON and the lowest address containing the comparison data is identified in C+1. The address is identified differently for the DM area:

- 1, 2, 3...**
 1. For an address in the DM area, the word address is written to C+1. For example, if the lowest address containing the comparison data is DM 0114, then #0114 is written in C+1.
 2. For an address in another data area, the number of addresses from the beginning of the search is written to C+1. For example, if the lowest address containing the comparison data is IR 114 and the first word in the search range is IR 014, then #0100 is written in C+1.

If none of addresses in the range contain the comparison data, the EQ Flag (SR 25506) is turned OFF and C+1 is left unchanged.

Flags

ER: Indirectly addressed DM word is non-existent. (Content of *DM word is not BCD, or the DM area boundary has been exceeded.)

N is not BCD between 0001 and 9999.

R₁ and R₁+N-1 are not in the same data area.

EQ: ON when the comparison data has been matched in the search range.

Example

In the following example, the 10 word range from IR 200 to IR 209 is searched for addresses that contain the same data as DM 0100 (89AB). Since IR 204

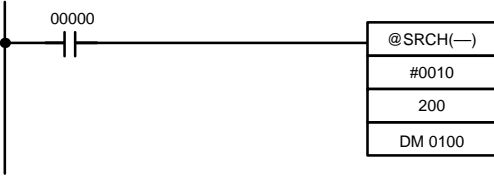

Address	Instruction	Operands
00000	LD	00000
00001	@SRCH(—)	
		# 0010
		0200
		DM 0100

DM 0100	89AB
---------	------

IR 200	1234
IR 201	5678
IR 202	ABCD
IR 203	EF13
IR 204	89AB
IR 205	8860
IR 206	90CD
IR 207	00FF
IR 208	89AB
IR 209	810C

Offset: 0004

Offset of first word containing the search data

DM 0101	0004
---------	------

← Search data found

← Search data found

Note The matching search data in IR 208 is ignored because the search data found in an earlier word in the range.

23-2 FIND MAXIMUM – MAX(—)

Ladder Symbols

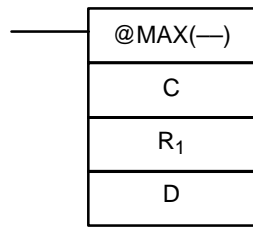
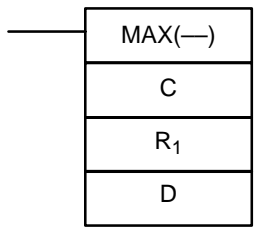

Operand Data Areas

C: Control data
IR, SR, AR, DM, HR, TC, LR, #
R₁: First word in range
IR, SR, AR, DM, HR, TC, LR
D: Destination word
IR, SR, AR, DM, HR, LR

Limitations

- This instruction is available in the **CPM2A/CPM2C only**.
- N must be BCD between 0001 to 9999.
- R₁ and R₁+N-1 must be in the same data area.
- DM 6144 to DM 6655 cannot be used for D.

Description

When the execution condition is OFF, MAX(—) is not executed. When execution condition is ON, MAX(—) searches the range of memory from R₁ to R₁+N-1 for the address that contains the maximum value and outputs the maximum value to the destination word (D).

The address is identified differently for the DM area:

- 1, 2, 3...** For an address in the DM area, the word address is written to C+1. For example, if the address containing the maximum value is DM 0114, then #0114 is written in D+1.
- For an address in another data area, the number of addresses from the beginning of the search is written to D+1. For example, if the address containing the maximum value is IR 114 and the first word in the search range is IR 014, then #0100 is written in D+1.

...; the position of the lowest of the addresses will be output to D+1. The position will be output as the DM address for the DM area, but as an absolute position relative to the first word in the range for all other areas.

The number of words within the range (N) is contained in the 3 rightmost digits of C, which must be BCD between 001 and 999.

When bit 15 of C is OFF, data within the range is treated as unsigned binary when it is ON the data is treated as signed binary.

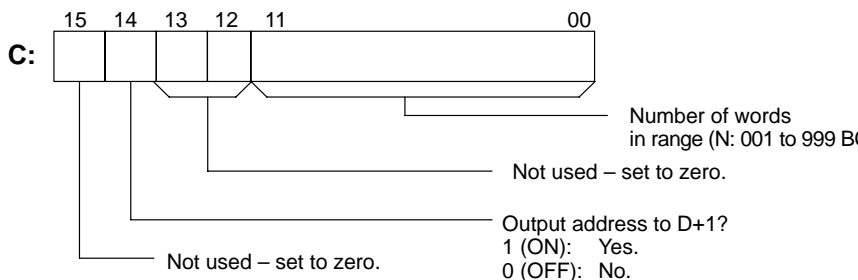

Caution

If bit 14 of C is ON, values above #8000 are treated as negative numbers, so results will differ depending on the specified data type. Be sure that the correct data type is specified.

gs

ER: Indirectly addressed DM word is non-existent. (Content of *DM word is not BCD, or the DM area boundary has been exceeded.)
 R_1 and R_1+N-1 are not in the same data area.

EQ: ON when the maximum value is #0000.

ample

When IR 00000 is ON, the control data in DM 0000 (4010) will cause a search for the maximum value in the 10 words starting at IR 200. The largest unsigned

MAX(—)
DM 0000
200
DM 0500

Address	Instruction	Operands
00000	LD	00000
00001	MAX(—)	
		DM 0000
		200
		DM 0500

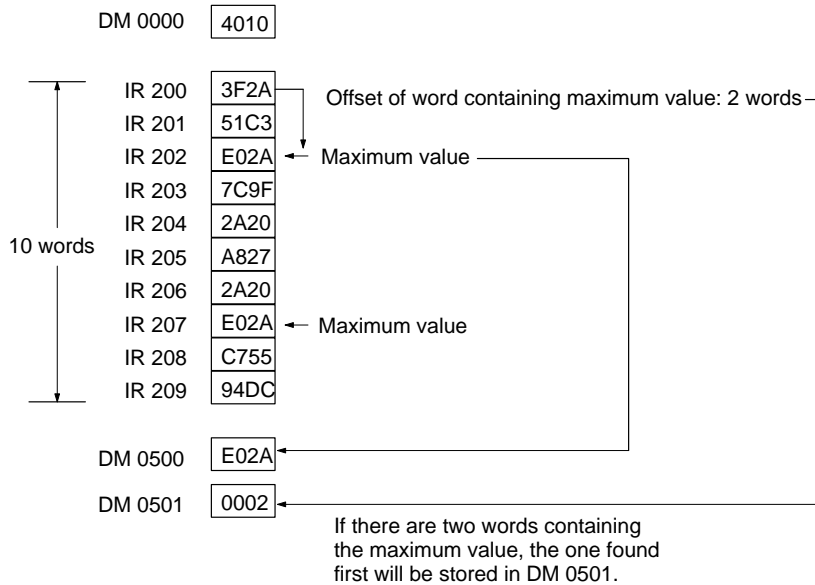

23-3 FIND MINIMUM – MIN(—)

Ladder Symbols

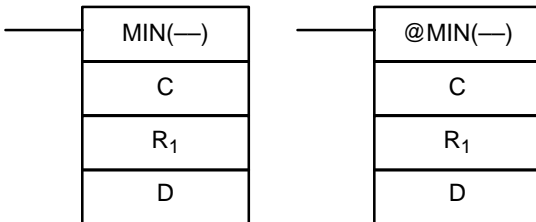

Operand Data Areas

C: Control data
IR, SR, AR, DM, HR, TC, LR, #
R₁: First word in range
IR, SR, AR, DM, HR, TC, LR
D: Destination word
IR, SR, AR, DM, HR, LR

Conditions

This instruction is available in the **CPM2A/CPM2C only**.

N must be BCD between 0001 to 9999.

R₁ and R₁+N-1 must be in the same data area.

DM 6144 to DM 6655 cannot be used for D.

Description

When the execution condition is OFF, MIN(—) is not executed. When the execution condition is ON, MIN(—) searches the range of memory from R₁ to R₁+N-1 for the address that contains the minimum value and outputs the minimum value to the destination word (D).

The address is identified differently for the DM area:

- 1, 2, 3...**
- For an address in the DM area, the word address is written to C+1. For example, if the address containing the minimum value is DM 0114, then #0114 is written in D+1.

gining of the search is written to D+1. For example, if the address containing the minimum value is IR 114 and the first word in the search range is IR 014, then #0100 is written in D+1.

If bit 14 of C is ON and more than one address contains the same minimum value, the position of the lowest of the addresses will be output to D+1. The position will be output as the DM address for the DM area, but as an absolute position relative to the first word in the range for all other areas.

The number of words within the range (N) is contained in the 3 rightmost digits of C, which must be BCD between 001 and 999.

When bit 15 of C is OFF, data within the range is treated as unsigned binary when it is ON the data is treated as signed binary.

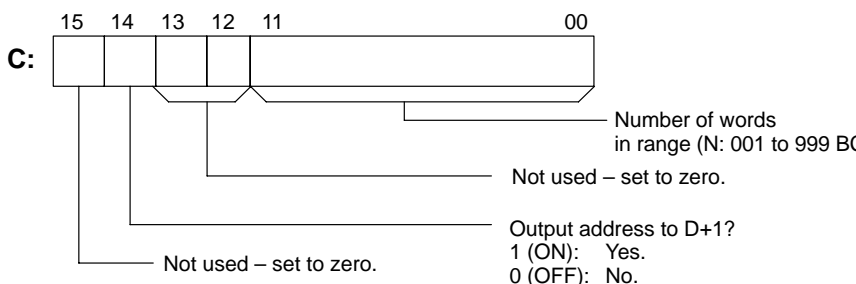

Caution

If bit 14 of C is ON, values above #8000 are treated as negative numbers, so results will differ depending on the specified data type. Be sure that the correct data type is specified.

ER: Indirectly addressed DM word is non-existent. (Content of *DM word is not BCD, or the DM area boundary has been exceeded.)
R₁ and R₁+N-1 are not in the same data area.

EQ: ON when the minimum value is #0000.

When IR 00000 is ON, the control data in DM 0300 (4010) will cause a search for the maximum value in the 10 words starting at DM 0000. The smallest unsigned

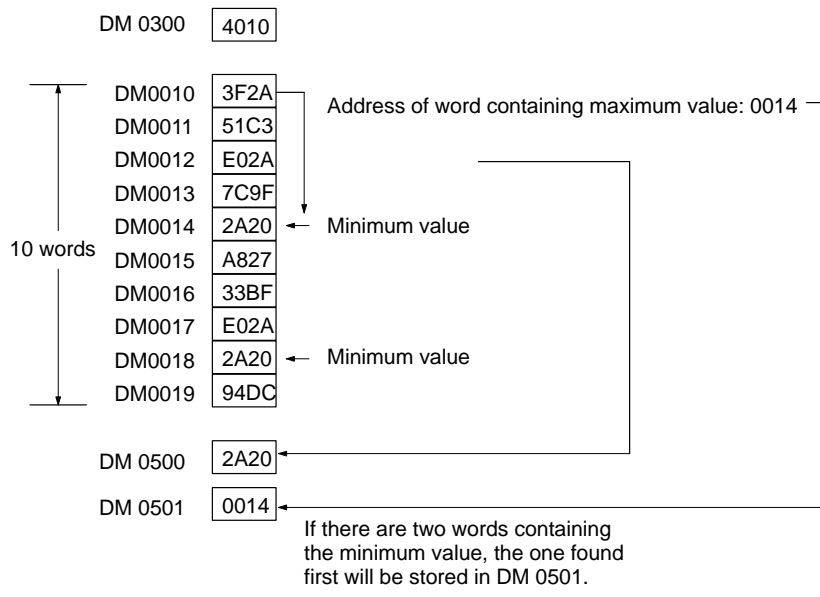
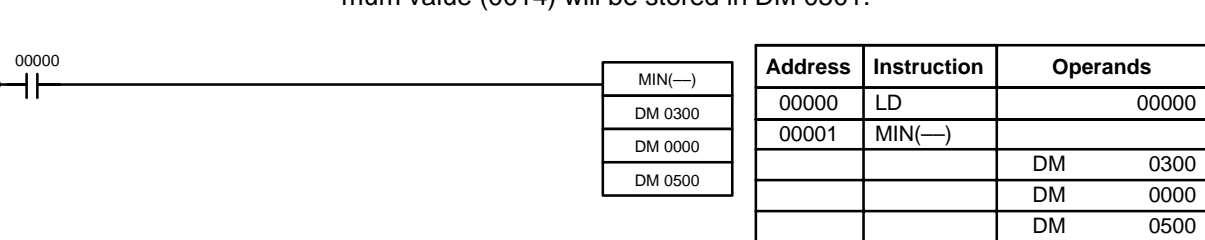

23-4 AVERAGE VALUE – AVG(—)

Ladder Symbols

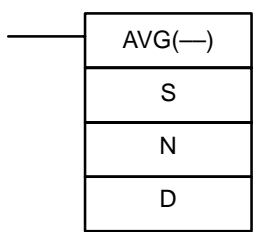

Operand Data Areas

S: Source word
IR, SR, AR, DM, HR, TC, LR
N: Number of cycles
IR, SR, AR, DM, HR, TC, LR, #
D: First destination word
IR, SR, AR, DM, HR, LR

Restrictions

This instruction is available in the **CPM2A/CPM2C only**.
 S must be hexadecimal.
 N must be BCD from #0001 to #0064.
 D and D+N+1 must be in the same data area.
 DM 6144 to DM 6655 cannot be used for S, N, or D to D+N+1.

Description

AVG(—) is used to calculate the average value of S over N cycles.
 When the execution condition is OFF, AVG(—) is not executed.
 Each time that AVG(—) is executed, the content of S is stored in words D+2 to D+N+1. On the first execution, AVG(—) writes the content of S to D+2; on the second execution it writes the content of S to D+3, etc. On the Nth execution, the content of S is stored in D+N+1, AVG(—) calculates the average value of the values stored in D+2 to D+N+1, and writes the average value to D+2.

D	Average value (after N or more executions)
D+1	Used by the system.
D+2	Content of S from the 1 st execution of AVG(—)
D+3	Content of S from the 2 nd execution of AVG(—)
⋮	⋮
D+N+1	Content of S from the N th execution of AVG(—)

cautions

The average value is calculated in binary. Be sure that the content of S is binary.

N must be BCD from #0001 to #0064. If the content of N \geq #0065, AVG(—) operates with N=64.

The average value will be rounded off to the nearest integer value. (0 rounded up to 1.)

Set the contents of D+1 to #0000 to execute AVG(—) from the first scan.

gs

ER: Indirectly addressed DM word is non-existent. (Content of *DM word not BCD, or the DM area boundary has been exceeded.)

One or more operands have been set incorrectly.

D and D+N+1 are not in the same data area.

ample

In the following example, the content of IR 200 is set to #0000 and then incremented by 1 each cycle. For the first two cycles, AVG(—) moves the content of IR 200 to DM 1002 and DM 1003. On the third and later cycles AVG(—) calculates the average value of the contents of DM 1002 to DM 1004 and writes the average value to DM 1000.

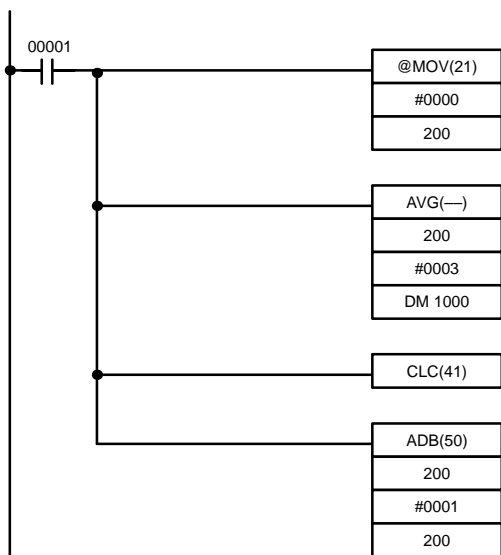

Address	Instruction	Operands
00000	LD	00001
00001	@MOV(21)	# 0000 200
00002	AVG(—)	200 # 0003 DM 1000
00003	CLC(41)	
00004	ADB(50)	200 # 0001 200

	1 st cycle	2 nd cycle	3 rd cycle	4 th cycle
IR 200	0000	0001	0002	0003

	1 st cycle	2 nd cycle	3 rd cycle	4 th cycle
DM 1000	0000	0001	0001	0002
DM 1001				
DM 1002	0000	0000	0000	0003
DM 1003	---	0001	0001	0001
DM 1004	---	---	0002	0002

Average
Used by the system.
Previous
values of
IR 200

Ladder Symbols

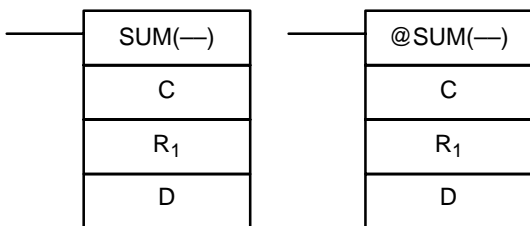

Operand Data Areas

C: Control data
IR, SR, AR, DM, HR, LR, #
R₁: First word in range
IR, SR, AR, DM, HR, TC, LR
D: First destination word
IR, SR, AR, DM, HR, LR

Conditions

This instruction is available in the **CPM2A/CPM2C only**.

The 3 rightmost digits of C must be BCD between 001 and 999.

DM 6144 to DM 6655 cannot be used for D.

If bit 14 of C is OFF (setting for BCD data), all data within the range R₁ to R₁+N must be BCD.

Description

When the execution condition is OFF, SUM(—) is not executed. When the execution condition is ON, SUM(—) adds either the contents of words R₁ to R₁+N-1 or the bytes in words R₁ to R₁+N/2-1 and outputs that value to the destination words (D and D+1). The data can be summed as binary or BCD and can be output in the same form. Binary data can be either signed or unsigned.

The function of bits in C are shown in the following diagram and explained in more detail below.

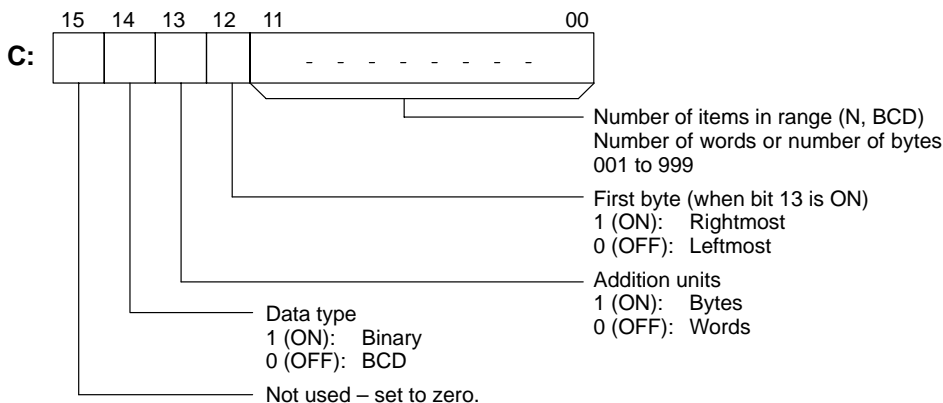

Number of Items in Range

The number of items within the range (N) is contained in the 3 rightmost digits of C, which must be BCD between 001 and 999. This number will indicate the number of words or the number of bytes depending on the items being summed.

Addition Units

Words will be added if bit 13 is OFF and bytes will be added if bit 13 is ON. If bytes are specified, the range can begin with the leftmost or rightmost byte of R₁. The leftmost byte of R₁ will not be added if bit 12 is ON.

	MSB	LSB
R ₁	1	2
R ₁ +1	3	4
R ₁ +2	5	6
R ₁ +3	7	8
⋮	⋮	⋮
⋮	⋮	⋮
⋮	⋮	⋮

a Type

The bytes will be added in this order when bit 12 is ON: 2+3+4....
 Data within the range is treated as unsigned binary when bit 14 of C is ON and bit 15 is OFF, and it is treated as signed binary when both bits 14 and 15 are ON.
 Data within the range is treated as BCD when bit 14 of C is OFF, regardless of the status of bit 15.

gs

ER: Indirectly addressed DM word is non-existent. (Content of *DM word is not BCD, or the DM area boundary has been exceeded.)

R_1 and R_1+N-1 are not in the same data area.

The number of items in C is not BCD between 001 and 999.

The data being summed is not BCD when BCD was designated.

EQ: ON when the result is zero.

ample

In the following example, the BCD contents of the 8 words from DM 0000 to DM 0007 are added when IR 00001 is ON and the result is written to DM 0010 and DM 0011.

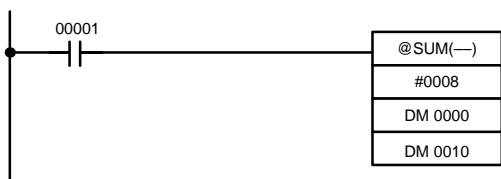

Address	Instruction	Operands
00000	LD	00001
00001	@SUM(→)	
		# 0008
		DM 0000
		DM 0010

DM 0000	0001
DM 0001	0002
DM 0002	0003
DM 0003	0004
DM 0004	0005
DM 0005	0006
DM 0006	0007
DM 0007	0008



DM 0010	0036
DM 0011	0000

24 Logic Instructions

24-1 COMPLEMENT – COM(29)

Ladder Symbols

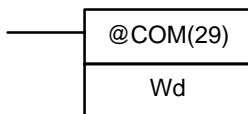
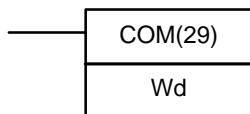

Operand Data Areas

Wd: Complement word
IR, SR, AR, DM, HR, LR

ications

DM 6144 to DM 6655 cannot be used for Wd.

escription

When the execution condition is OFF, COM(29) is not executed. When the execution condition is ON, COM(29) clears all ON bits and sets all OFF bits in Wd.

of COM(29) is used. Use the differentiated form (@COM(29)) or COM(29) with DIFU(13) or DIFD(14) to calculate the complement just once.

Example

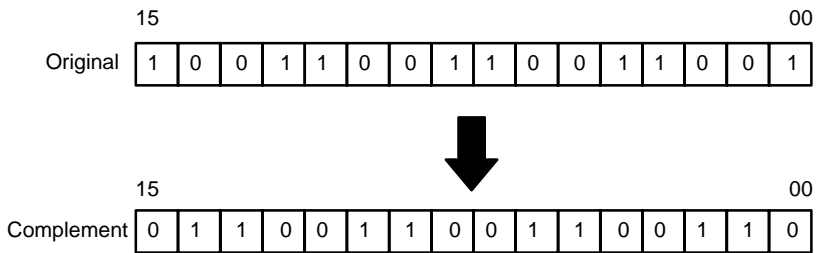

Flags

ER: Indirectly addressed DM word is non-existent. (Content of *DM word is not BCD, or the DM area boundary has been exceeded.)

EQ: ON when the result is 0.

24-2 LOGICAL AND – ANDW(34)

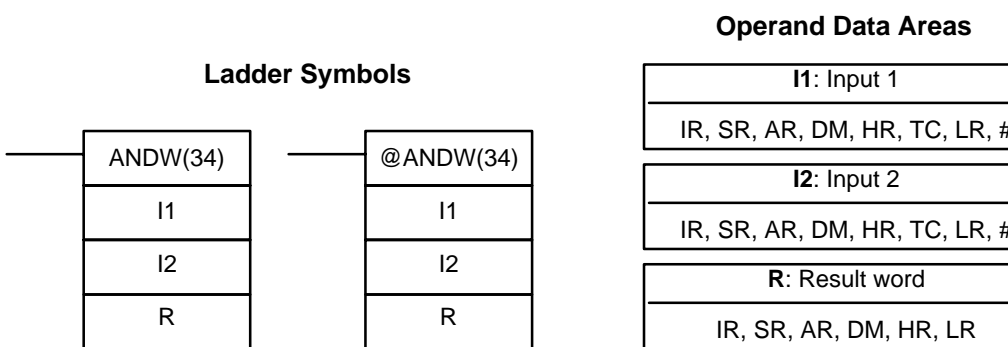

Restrictions

DM 6144 to DM 6655 cannot be used for R.

Description

When the execution condition is OFF, ANDW(34) is not executed. When the execution condition is ON, ANDW(34) logically AND's the contents of I1 and I2 bit-by-bit and places the result in R.

Example

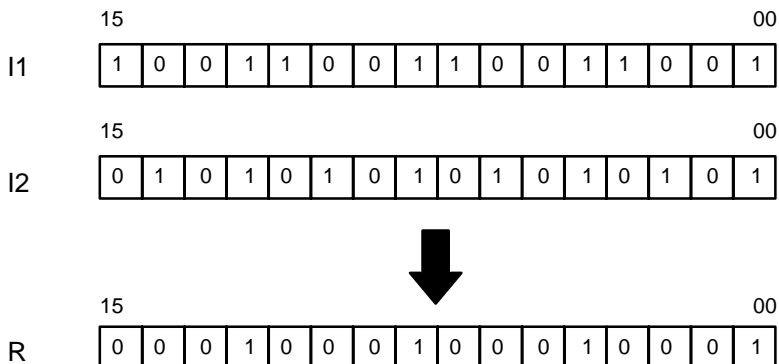

Flags

ER: Indirectly addressed DM word is non-existent. (Content of *DM word is not BCD, or the DM area boundary has been exceeded.)

EQ: ON when the result is 0.

Operand Data Areas

I1: Input 1
IR, SR, AR, DM, HR, TC, LR, #
I2: Input 2
IR, SR, AR, DM, HR, TC, LR, #
R: Result word
IR, SR, AR, DM, HR, LR

Ladder Symbols

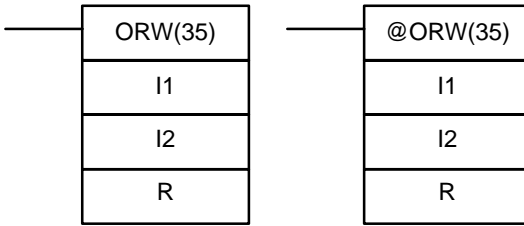

Limitations

DM 6144 to DM 6655 cannot be used for R.

Description

When the execution condition is OFF, ORW(35) is not executed. When the execution condition is ON, ORW(35) logically OR's the contents of I1 and I2 by-bit and places the result in R.

Example

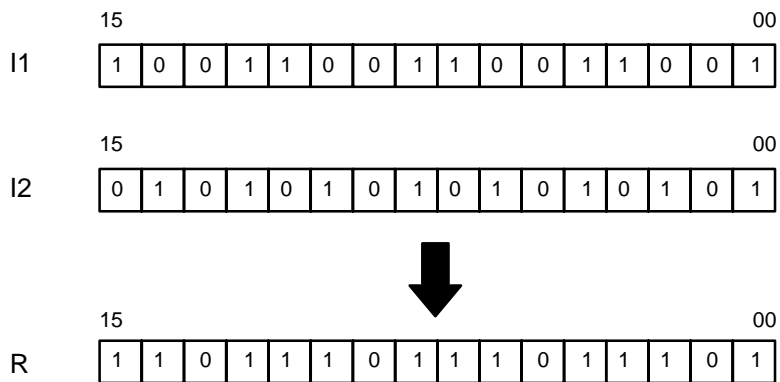

Flags

ER: Indirectly addressed DM word is non-existent. (Content of *DM word is not BCD, or the DM area boundary has been exceeded.)

EQ: ON when the result is 0.

24-4 EXCLUSIVE OR – XORW(36)

Operand Data Areas

I1: Input 1
IR, SR, AR, DM, HR, TC, LR, #
I2: Input 2
IR, SR, AR, DM, HR, TC, LR, #
R: Result word
IR, SR, AR, DM, HR, LR

Ladder Symbols

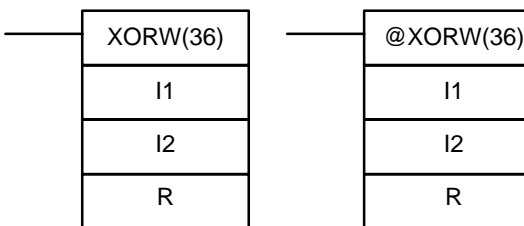

Limitations

DM 6144 to DM 6655 cannot be used for R.

execution condition is ON, XORW(30) exclusively OR's the contents of I1 and I2 bit-by-bit and places the result in R.

Example

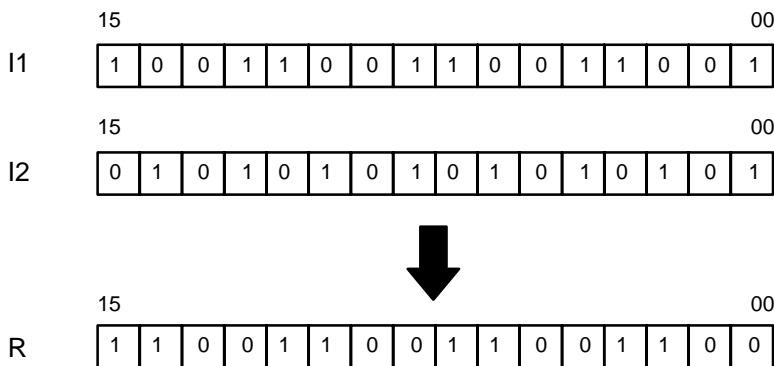

ER: Indirectly addressed DM word is non-existent. (Content of *DM word not BCD, or the DM area boundary has been exceeded.)

EQ: ON when the result is 0.

24-5 EXCLUSIVE NOR – XNRW(37)

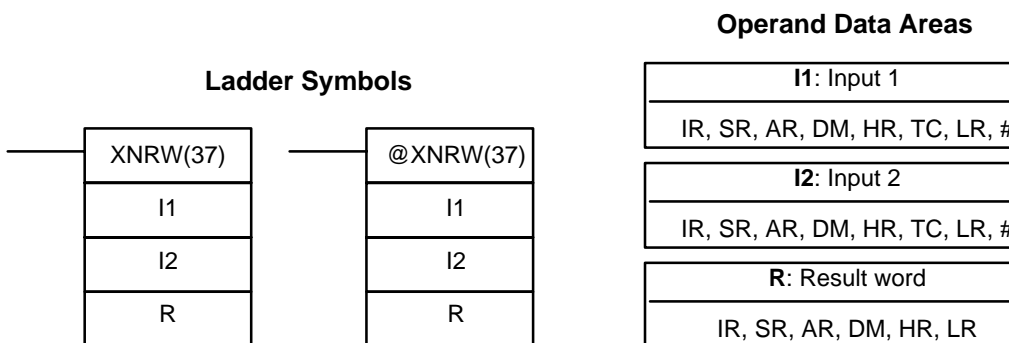

Limitations

DM 6144 to DM 6655 cannot be used for R.

Description

When the execution condition is OFF, XNRW(37) is not executed. When the execution condition is ON, XNRW(37) exclusively NOR's the contents of I1 and I2 bit-by-bit and places the result in R.

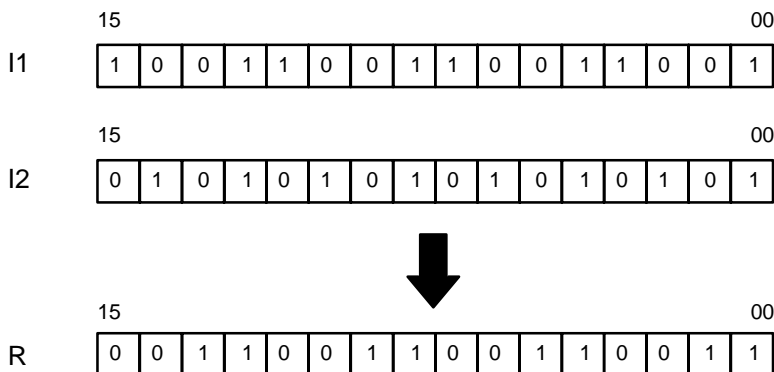

ER: Indirectly addressed DM word is non-existent. (Content of *DM word not BCD, or the DM area boundary has been exceeded.)

EQ: ON when the result is 0.

25-1 BCD INCREMENT – INC(38)

Ladder Symbols

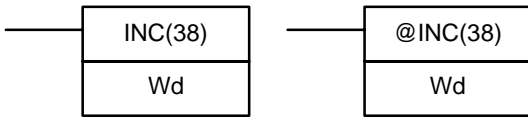

Operand Data Areas

Wd: Increment word (BCD)
IR, SR, AR, DM, HR, LR

Limitations

DM 6144 to DM 6655 cannot be used for Wd.

Description

When the execution condition is OFF, INC(38) is not executed. When the execution condition is ON, INC(38) increments Wd, without affecting Carry (CY).

Precautions

The content of Wd will be incremented every cycle if the undifferentiated form INC(38) is used. Use the differentiated form (@INC(38)) or combine INC(38) with DIFU(13) or DIFD(14) to increment Wd just once.

Flags

ER: Wd is not BCD

Indirectly addressed DM word is non-existent. (Content of *DM word is not BCD, or the DM area boundary has been exceeded.)

EQ: ON when the incremented result is 0.

25-2 BCD DECREMENT – DEC(39)

Ladder Symbols

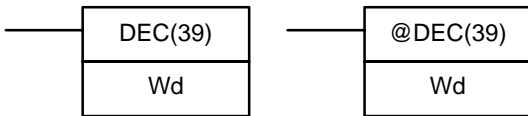

Operand Data Areas

Wd: Decrement word (BCD)
IR, SR, AR, DM, HR, LR

Limitations

DM 6144 to DM 6655 cannot be used for Wd.

Description

When the execution condition is OFF, DEC(39) is not executed. When the execution condition is ON, DEC(39) decrements Wd, without affecting Carry (CY). DEC(39) works the same way as INC(38) except that it decrements the value instead of incrementing it.

Precautions

The content of Wd will be decremented every cycle if the undifferentiated form DEC(39) is used. Use the differentiated form (@DEC(39)) or combine DEC(39) with DIFU(13) or DIFD(14) to decrement Wd just once.

Flags

ER: Wd is not BCD.

Indirectly addressed DM word is non-existent. (Content of *DM word is not BCD, or the DM area boundary has been exceeded.)

EQ: ON when the decremented result is 0.

Subroutines break large control tasks into smaller ones and enable you to reuse a given set of instructions. When the main program calls a subroutine, control is transferred to the subroutine and the subroutine instructions are executed. The instructions within a subroutine are written in the same way as main program code. When all the subroutine instructions have been executed, control returns to the main program to the point just after the point from which the subroutine was entered (unless otherwise specified in the subroutine).

26-1 SUBROUTINE ENTER – SBS(91)

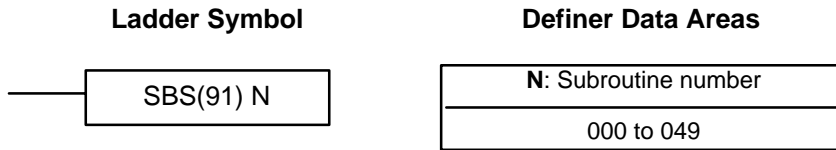

Limitations

The subroutine number must be between 000 and 049.

Description

A subroutine can be executed by placing SBS(91) in the main program at a point where the subroutine is desired. The subroutine number used in SBS(91) indicates the desired subroutine. When SBS(91) is executed (i.e., when its execution condition for it is ON), the instructions between the SBN(92) with the same subroutine number and the first RET(93) after it are executed before execution returns to the instruction following the SBS(91) that made the call.

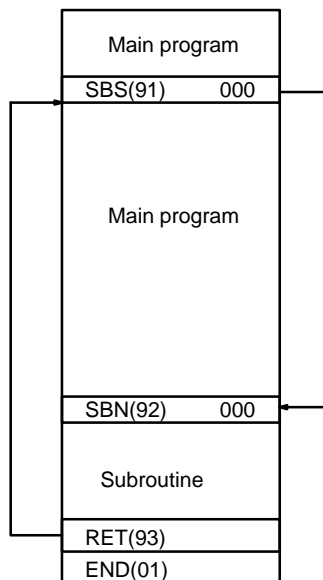

SBS(91) may be used as many times as desired in the program, i.e., the same subroutine may be called from different places in the program).

One subroutine to another, i.e., subroutines may be nested. When the sub-
subroutine has been completed (i.e., RET(93) has been reached), pro-
gram execution returns to the original subroutine which is then completed before
turning to the main program. Nesting is possible to up to sixteen levels. A
subroutine cannot call itself (e.g., SBS(91) 000 cannot be programmed within
a subroutine defined with SBN(92) 000). The following diagram illustrates two
levels of nesting.

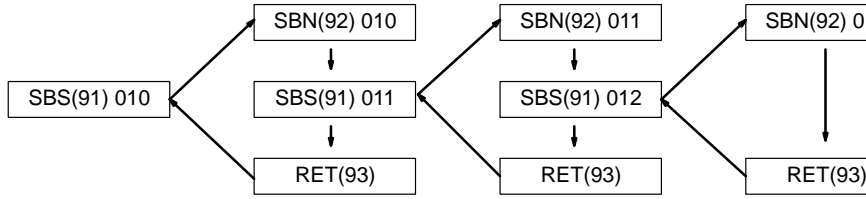

The following diagram illustrates program execution flow for various execu-
tion conditions for two SBS(91).

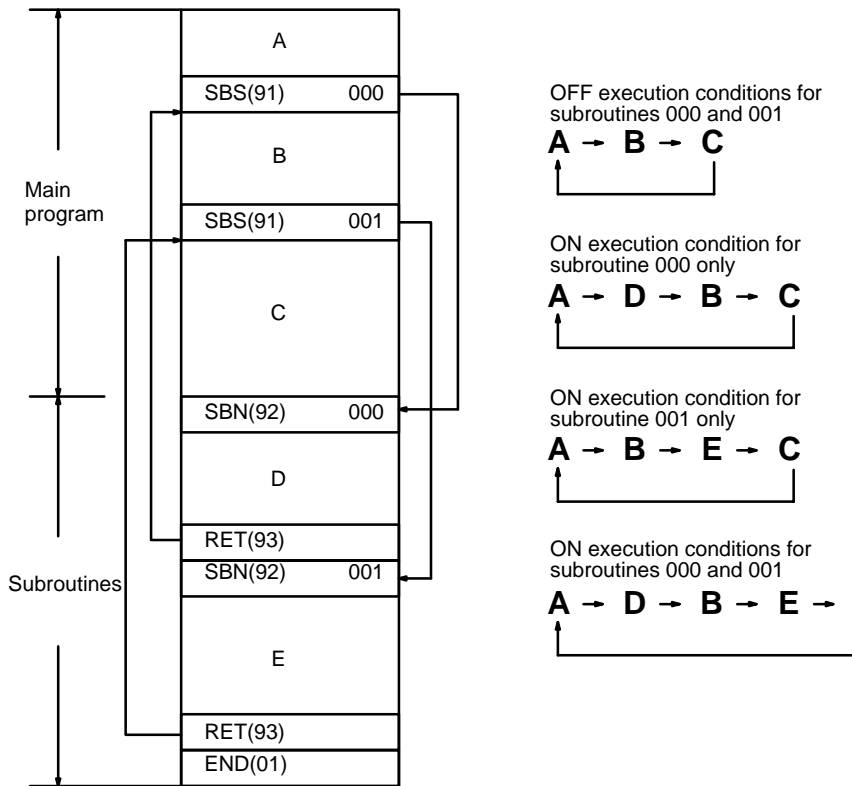

- ER:** A subroutine does not exist for the specified subroutine number.
- A subroutine has called itself.
- An active subroutine has been called.



Caution

SBS(91) will not be executed and the subroutine will not be called when E
ON.

Ladder Symbols

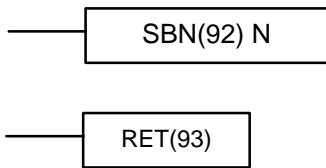

N: Subroutine number
000 to 049

Conditions

The subroutine number must be between 000 and 049. Each subroutine number can be used in SBN(92) once only.

Description

SBN(92) is used to mark the beginning of a subroutine program; RET(93) is used to mark the end. Each subroutine is identified with a subroutine number that is programmed as a definer for SBN(92). This same subroutine number is used in any SBS(91) that calls the subroutine (see 7-26-1 SUBROUTINE CALLER – SBS(91)). No subroutine number is required with RET(93).

All subroutines must be programmed at the end of the main program. When one or more subroutines have been programmed, the main program will be executed up to the first SBN(92) before returning to address 00000 for the next cycle. Subroutines will not be executed unless called by SBS(91).

END(01) must be placed at the end of the last subroutine program, i.e., after the last RET(93). It is not required at any other point in the program.

Precautions

If SBN(92) is mistakenly placed in the main program, it will inhibit program execution past that point, i.e., program execution will return to the beginning when SBN(92) is encountered.

If either DIFU(13) or DIFU(14) is placed within a subroutine, the operand bit will not be turned OFF until the next time the subroutine is executed, i.e., the operand bit and bit may stay ON longer than one cycle.

Flags

There are no flags directly affected by these instructions.

7-26-3 MACRO – MCRO(99)

Ladder Symbols

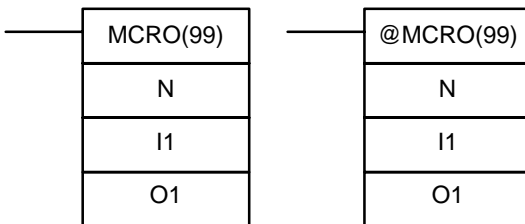

Operand Data Areas

N: Subroutine number
000 to 127
I1: First input word
IR, SR, AR, DM, HR, TC, LR
O1: First output word
IR, SR, AR, DM, HR, LR

Conditions

The subroutine number must be between 000 and 049.

If a DM address is used for O1, O1 through O1+3 must be read/write DM.

Description

The MACRO instruction allows a single subroutine to replace several subroutines that have identical structure but different operands. There are 4 input words (SR 232 to SR 235) and 4 output words (SR 236 to SR 239), allocated to MCRO(99). These 8 words are used in the subroutine and take their contents from I1 to I1+3 and O1 to O1+3 when the subroutine is executed.

When the execution condition is OFF, MCRO(99) is not executed. When the execution condition is ON, MCRO(99) copies the contents of I1 to I1+3 to SR 232 to SR 235, and then calls and executes the subroutine specified in N. When the subroutine is completed, the contents of SR 236 through SR 239 are then transferred back to O1 to O1+3 before MCRO(99) is completed.

Example

In this example, the contents of DM 0010 through DM 0013 are copied to SR 235, and then subroutine 10 is called and executed. When the routine is completed, the contents of SR 236 through SR 239 are copied to put words DM 0020 to DM 0023.

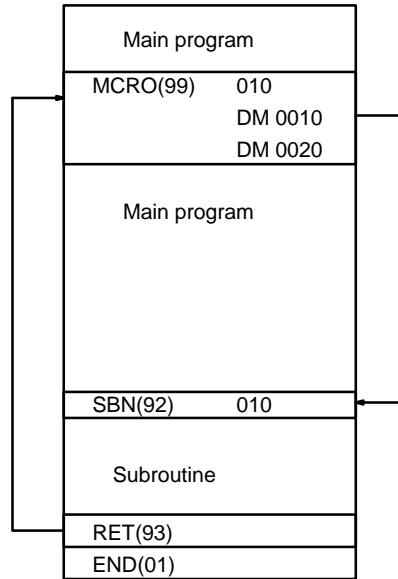

Errors

ER: A subroutine does not exist for the specified subroutine number.
An operand has exceeded a data area boundary.

Indirectly addressed DM word is non-existent. (Content of *DM word is not BCD, or the DM area boundary has been exceeded.)

A subroutine has called itself.

An active subroutine has been called.

27 Pulse Output Instructions

27-1 SET PULSES – PULS(65)

Ladder Symbols

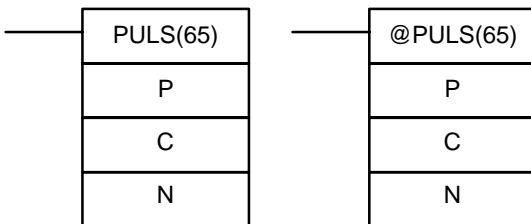

Operand Data Areas

P: Port specifier
000 or 010
C: Control data
000 or 001
N: Number of pulses
IR, SR, AR, DM, HR, LR

Restrictions

This instruction is supported by the **CPM1A and CPM2A/CPM2C PCs with transistor outputs only.**

N and N+1 must be in the same data area.

DM 6144 to DM 6655 cannot be used for N.

later in the program using SPED(64) or ACC(—). The number of pulses set by PULS(65) are output in independent mode.

The number of pulses cannot be changed while pulses are being output. In general, PULS(65) should be executed just once each time that the number of pulses needs to be set; use the differentiated variation (@PULS(65)) or an instruction condition that is ON for just one cycle.

Note Refer to 2-5 Pulse Output Functions for more details.

Port Specifier (P)

The port specifier indicates the pulse output location. The parameters set by INI(61) in C and N will apply to the next SPED(64) or ACC(—) instruction in which the same port output location is specified.

P	Pulse output location(s)
000	Single-phase pulse output 0 without acceleration or deceleration (output 01000) or single-phase pulse output 0 with trapezoidal acceleration and deceleration (outputs 01000 and 01001)
010	Single-phase pulse output 1 without acceleration or deceleration (output 01001) This setting is supported by CPM2A/CPM2C PCs only.

Control Data (C)

The control data determines the type of pulses (relative or absolute).

C	Pulse type
000	Relative pulse specification
001	Absolute pulse specification (Valid only when the absolute coordinate system is being used.) This setting is supported by CPM2A/CPM2C PCs only.

Number of Output Pulses (N+1 and N)

N+1 and N contain the 8-digit BCD number of output pulses setting for independent mode pulse outputs. The number of output pulses can be -16,777,215 to 16,777,215. Bit 15 of N+1 acts as a sign bit; the number is negative if bit 15 is ON, positive if it is OFF.

Positive: 0 to +16,777,215 (0000 0000 to 1677 7215)

Negative: -16,777,215 to 0 (9677 7215 to 8000 0000)

N+1 contains the leftmost 4 digits and N contains the rightmost 4 digits.

The number of movement pulses depends upon the number of output pulses (N+1 and N) and the pulse type (C).

Coordinate system	Movement pulses
Relative	Number of movement pulses = Number of output pulses
Absolute	Pulse type: Relative (C=000) Number of movement pulses = Number of output pulses
	Pulse type: Absolute (C=001, CPM2A/CPM2C only) Number of movement pulses = Number of output pulses - P

After PULS(65) has been executed, the calculated number of movement pulses will not be changed even if INI(61) is executed to change the pulse output location.

A specification that causes movement outside of the allowed PV range (-16,777,215 to 16,777,215) can be specified without problems.

PULS(65) will not be executed and an error will occur (SR 25503 ON) if the calculated number of movement pulses is 0.

When the pulse output is operating in independent mode without acceleration or deceleration and the number of movement pulses is negative, the absolute

Number of Movement
Pulses

ER: A data area boundary is exceeded.
 Indirectly addressed DM word is non-existent. (Content of *DM word is not BCD, or the DM area boundary has been exceeded.)
 P is not 000 or 010.
 C is not 000 or 001. (C cannot be set to 001 when relative coordinates are being used.)
 The number of output pulses is not between -16,777,215 and 16,777,215.
 PULS(65) is executed in an interrupt subroutine while a pulse I/O high-speed counter instruction (INI(61), PRV(62), CTBL(63), SPED(64), PULS(65), ACC(—), PWM(—), or SYNC(—)) is being executed in the main program.
 After PULS(65) is executed, the absolute value of the number of movement pulses is not between 1 and 16,777,215.

27-2 SPEED OUTPUT– SPED(64)

Ladder Symbols

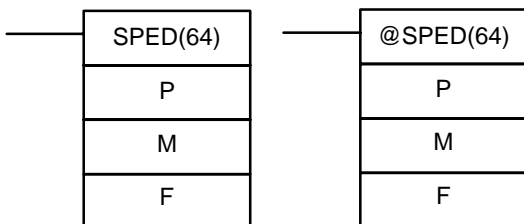

Operand Data Areas

P: Port specifier
001 or 010
M: Output mode
000 or 001
F: Target frequency
IR, SR, AR, DM, HR, LR, #

Conditions

This instruction is supported by the **CPM1A and CPM2A/CPM2C PCs with transistor outputs only.**

In the CPM1A: F must be BCD, #0000 or #0002 to #0200.

In the CPM2A/CPM2C: F must be BCD, #0000 or #0001 to #1000.

DM 6144 to DM 6655 cannot be used for F.

Description

SPED(64) is used to set the output pulse frequency and start the pulse output from the specified output bit. When the execution condition is OFF, SPED(64) is not executed. When the execution condition is ON, SPED(64) sets the pulse frequency F for the output bit specified by P. M determines the output mode.

In general, SPED(64) should be executed just once each time that the frequency needs to be set; use the differentiated variation (@SPED(64)) or an input condition that is ON for just one cycle.

Note Refer to 2-5 *Pulse Output Functions* for more details.

Port Specifier (P)

The port specifier indicates the output bit where the pulses will be output.

P	Pulse output location(s)
000	Single-phase pulse output 0 without acceleration or deceleration (output 01000)
010	Single-phase pulse output 1 without acceleration or deceleration (output 01001)
	This setting is supported by CPM2A/CPM2C PCs only.

M	Pulse type
000	Independent mode
001	Continuous mode

Operation in independent mode and continuous mode is described below.

Target Frequency (F)

The 4-digit BCD value of F sets the pulse frequency in units of 10 Hz, as shown below. Setting F to 0000 will stop the pulse output from the specified output.

PC	Possible values of F
CPM1A	0000 (stops pulse output) or 0002 to 0200 (20 Hz to 2 kHz)
CPM2A/CPM2C	0000 (stops pulse output) or 0001 to 1000 (10 Hz to 10 kHz)

General Operation

The pulse output started by SPED(64) will continue until one of the following occurs:

- 1, 2, 3... 1. The INI(61) instruction is executed with C=003.
2. In independent mode, the number of output pulses specified by PULS(65) is reached. (Execute PULS(65) before SPED(64).)
3. SPED(64) is executed again with the target frequency, F, set to #0000.
4. The PC is switched to PROGRAM mode.

Pulses can be output simultaneously and independently from two output bits.

When outputting pulses in independent mode, specify the number of pulses in advance by executing PULS(65). The number of output pulses must be specified again with PULS(65) each time that the pulse output has been stopped.

The frequency cannot be changed with SPED(64) when pulses are already being output from the specified output bit by ACC(—) or PWM(—). An error will occur and SR 25503 will be turned ON if SPED(64) is executed under these circumstances.

Operation in Independent Mode

In independent mode, just the number of output pulses set by PULS(65) will be output. The number of output pulses must be specified by executing PULS(65) before executing SPED(64). (Pulses won't be output if the number of output pulses has not been specified in advance.)

When the calculated number of movement pulses is negative, the absolute value of the number of movement pulses will be used. (For example, if the number of movement pulses is -500, a value of 500 will be used.)

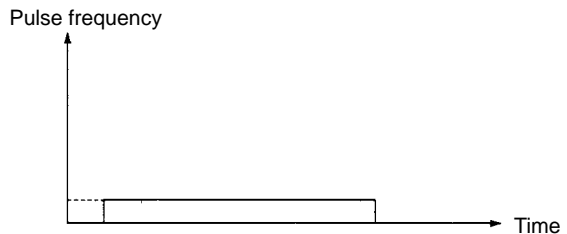

INI(61) with C=000, executing OP ED(64) again with F=0000, or switching PC to PROGRAM mode.

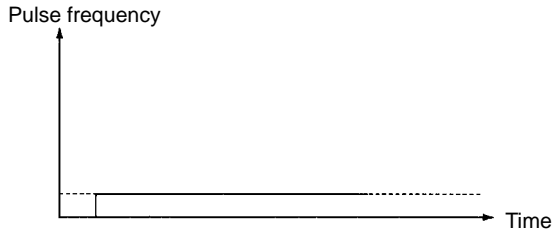

gs

ER: A data area boundary is exceeded.

Indirectly addressed DM word is non-existent. (Content of *DM word is not BCD, or the DM area boundary has been exceeded.)

P is not 000 or 010, M is not 000 or 001, or F is not 0000 to 1000.

SPED(64) is executed in an interrupt subroutine while a pulse I/O high-speed counter instruction (INI(61), PRV(62), CTBL(63), SPED(64), PULS(65), ACC(—), PWM(—), or SYNC(—)) is being executed in the main program.

27-3 ACCELERATION CONTROL – ACC(—)

Ladder Symbols

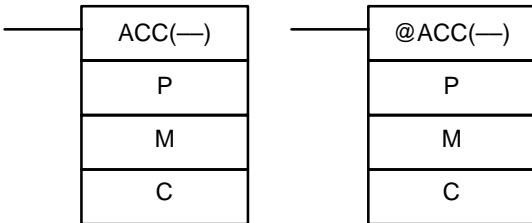

Operand Data Areas

P: Port specifier
000
M: Mode specifier
000, 002, or 010 to 013
C: First control word
IR, SR, AR, DM, HR, LR

itations

This instruction is available in the **CPM2A/CPM2C only**.

P must be 001 or 002 and M must be 000 to 003.

C to C+3 must be in the same data area.

cription

ACC(—) is used to specify the acceleration/deceleration rate and start the pulse output for a pulse output with trapezoidal acceleration and deceleration.

In general, ACC(—) should be executed just once each time that the acceleration/deceleration rate needs to be set; use the differentiated variable (@ACC(—)) or an input condition that is ON for just one cycle.

Note Refer to 2-5 *Pulse Output Functions* for more details.

Port Specifier (P)

Always set the port specifier to 000. The 000 setting specifies single-phase pulse output 0 with trapezoidal acceleration and deceleration.

The value of M determines the output mode.

M	Mode	Note
000	Independent mode and up/down pulse output mode	---
002	Independent mode and pulse + direction output mode	---
010	CW (continuous mode and up/down pulse output mode)	CW: Clockwise
011	CCW (continuous mode and up/down pulse output mode)	CCW: Counterclockwise
012	CW (continuous mode and pulse + direction output mode)	
013	CCW (continuous mode and pulse + direction output mode)	

In independent mode, the output direction is set when PULS(65) is executed.

Control Words (C, C+1, and C+2)

The 3 control words indicate the acceleration rate, target frequency, and deceleration rate. (Each frequency is set in multiples of 10 Hz.)

Word	Function
C	The content of C determines the acceleration rate. During acceleration, the output frequency is increased by the amount set in C every 10 ms. C must be BCD from 0001 to 1000 (10 Hz to 10 kHz).
C+1	The content of C+1 specifies the target frequency. C+1 must be BCD from 0001 to 1000 (10 Hz to 10 kHz).
C+2	The content of C+2 determines the deceleration rate. During deceleration, the output frequency is decreased by the amount set in C+2 every 10 ms. C must be BCD from 0001 to 1000 (10 Hz to 10 kHz).

General Operation

Two output bits are required for pulse outputs controlled by ACC(—).

Up/down pulse output mode

IR 01000 (CW operation)

IR 01001 (CCW operation)



Pulse + direction output mode

IR 01000 (Pulse output)

IR 01001 (Direction specifier)

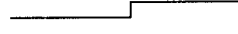

The pulse output will start when ACC(—) is executed and the output frequency will be increased every 10 ms by amount specified in control word C. When the target frequency (specified in C+1) is reached, acceleration is stopped and pulse output continues at a constant frequency.

When the pulse output is operating with trapezoidal acceleration and deceleration, the pulse output can be stopped by one of the following methods.

- 1, 2, 3...
 1. Execute the INI(61) instruction with C=003. (Immediate stop)
 2. In independent mode, the number of output pulses specified by PULS(6) is reached. (Decelerates to a stop.)
 3. ACC(—) is executed with the target frequency (in C+1) set to 0000.
 - a) When pulses are being output in independent mode, the output will decelerate to a stop at the deceleration rate set when the pulse output started.
 - b) When pulses are being output in continuous mode, the output will decelerate to a stop at the specified deceleration rate.
 4. Switch the PC to PROGRAM mode. (Immediate stop)

output. The number of output pulses must be specified by executing PULS(65) before executing ACC(—). (Pulses won't be output if the number of output pulses has not been specified in advance.)

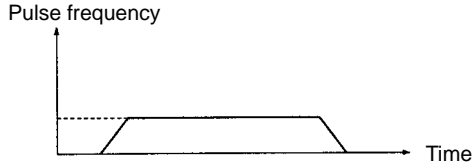

The number of output pulses must be specified again with PULS(65) each time that the pulse output has been stopped.

In independent mode, the pulse output will begin decelerating at the point determined by the preset number of output pulses and the acceleration/deceleration rates. The pulse output will stop when the preset number of output pulses has been output.

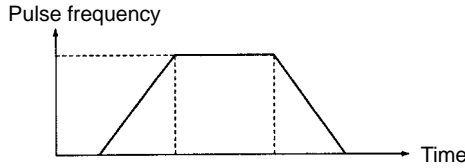

(The number of output pulses is always accurately output.)

If the number of output pulses required for acceleration and deceleration (time to reach the target frequency \times the target frequency) exceeds the preset number of pulses, the acceleration and deceleration will be cut short and the pulse output will be triangular rather than trapezoidal.

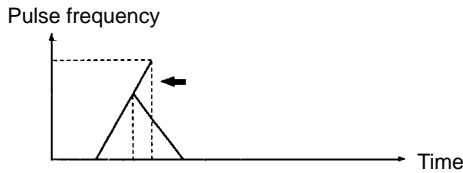

(The number of output pulses is always accurately output.)

If a high acceleration/deceleration rate and a low number of output pulses are set, there will be effectively no acceleration and deceleration. (The pulse output will operate at a constant speed.)

If the (target frequency \div acceleration/deceleration rate) is not an integer value, the specified acceleration/deceleration rates will be increased or decreased. In the following example, the acceleration and deceleration are 10-ms long, (1) is the acceleration/deceleration rate, and (2) is the target frequency.

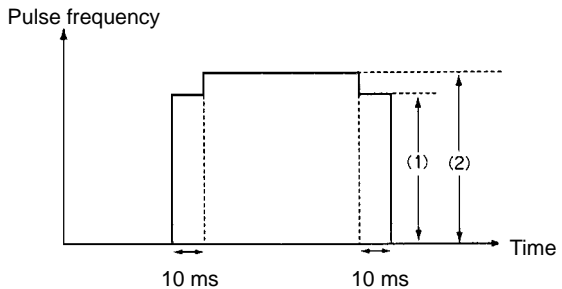

INI(61) with S=000, executing ACC(—) again with the target frequency (INI(61) set to 0000, or switching the PC to PROGRAM mode.

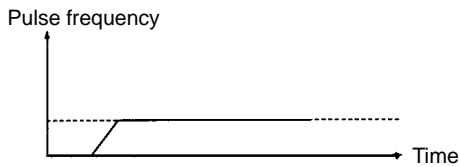

The following conditions apply when ACC(—) is executed while pulses are already being output with trapezoidal acceleration/deceleration.

- ACC(—) will have no effect if it is executed when the pulse output is accelerating or decelerating.
- When ACC(—) is executed while pulses are being output in continuous mode, the frequency can be changed to a new target frequency (0001 to 1000: 10 Hz to 10 kHz) with the set acceleration/deceleration rates.
- If pulses are being output in independent mode, the pulse output can be decelerated to a stop while by executing ACC(—) with the target frequency (in C set to 0000. The acceleration/deceleration rates and number of output pulses won't be checked or changed.
- ACC(—) will have no effect if it is executed when pulses are being output by one of the following instructions. (The pulse output will continue unchanged.)
 - Pulses being output from output 01000 by SPED(64).
 - Pulses being output from output 01001 by SPED(64).
 - Pulses being output from output 01000 by PWM(—).
 - Pulses being output from output 01001 by PWM(—).

Note Be sure to check the status of the pulse output before executing ACC(—)

- ER:** A data area boundary is exceeded.
 Indirectly addressed DM word is non-existent. (Content of *DM word is not BCD, or the DM area boundary has been exceeded.)
 P is not 000.
 M is not 000, 002, or 010 to 013. (The mode specifier is read only when starting the pulse output.)
 ACC(—) is executed for a bit from which pulses are already being output by PWM(—) or SPED(64).
 ACC(—) is executed in an interrupt subroutine while a pulse I/O or high speed counter instruction (INI(61), PRV(62), CTBL(63), SPED(64), PULS(65), ACC(—), PWM(—), or SYNC(—)) is being executed in the main program.

27-4 PULSE WITH VARIABLE DUTY RATIO – PWM(—)

Ladder Symbols

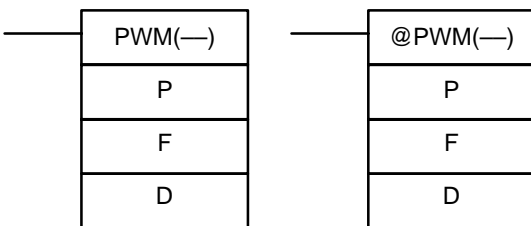

Operand Data Areas

P: Port specifier
000 or 010
F: Frequency
IR, SR, AR, DM, HR, LR, #
D: Duty ratio
IR, SR, AR, DM, HR, LR, #

Description

PWM(—) is used to output pulses with the specified duty ratio from the specified output bit. The pulse output continues until PWM(—) is executed again with a different duty ratio, INI(61) is executed with C=003, or the PC is switched to PROGRAM mode.

In general, PWM(—) should be executed just once to start the pulse output; the differentiated variation (@PWM(—)) or an input condition that is ON for one cycle.

Variable duty-ratio pulses can be output simultaneously and independently from two output bits.

When variable duty-ratio pulses are being output from an output bit and PWM(—) is executed for that bit again with a different duty ratio, pulses will continue being output with the new duty ratio. The frequency cannot be changed.

PWM(—) cannot be executed for an output bit if pulses are already being output from that bit by SPED(64) or ACC(—). An error will occur and SR 25503 will be turned ON if PWM(—) is executed under these circumstances.

Note Refer to *2-5 Pulse Output Functions* for more details.

Port Specifier (P)

The port specifier indicates the output bit where the pulses will be output.

P	Pulse output location(s)
000	Variable duty-ratio pulse output 0 (output 01000)
010	Variable duty-ratio pulse output 1 (output 01001)

Frequency (F)

The 4-digit BCD value of F sets the pulse frequency in units of 0.1 Hz. The pulse frequency can be set between 0001 and 9999 (0.1 to 999.9 Hz).

Duty Ratio (D)

The 4-digit BCD value of D specifies the duty ratio of the pulse output, i.e., the percentage of time that the output is ON. The duty ratio can be set between 0001 and 0100 (1% to 100%). The duty ratio is 75% in the following diagram.

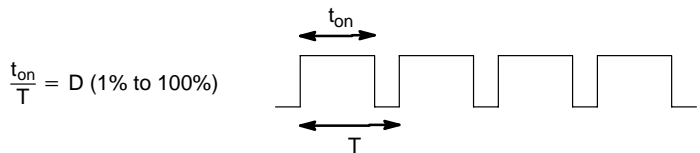

gs

ER: A data area boundary is exceeded.

Indirectly addressed DM word is non-existent. (Content of *DM word is not BCD, or the DM area boundary has been exceeded.)

P is not 000 or 010, F is not BCD between 0001 and 9999, or D is not BCD between 0001 and 0100. (The frequency setting in F is read when starting the pulse output.)

ACC(—) is executed for a bit from which pulses are already being output by ACC(—) or SPED(64).

PWM(—) is executed in an interrupt subroutine while a pulse I/O high-speed counter instruction (INI(61), PRV(62), CTBL(63), SPED(64), PULS(65), ACC(—), PWM(—), or SYNC(—)) is being executed in the main program.

Ladder Symbols

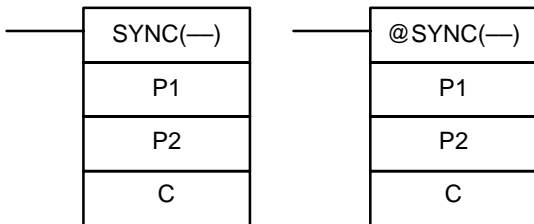

Operand Data Areas

P1: Input port specifier
000
P2: Output port specifier
000 or 010
C: Scaling factor
IR, SR, AR, DM, HR, LR, #

Limitations

This instruction is available in the **CPM2A/CPM2C only**.

P1 must be 000 and P2 must be 000 or 010.

Description

SYNC(—) takes the frequency of the input pulse received through the high-speed counter inputs, multiplies it by a fixed scaling factor, and outputs pulse from the specified output bit at the resulting frequency.

Output frequency = Input frequency × Scaling factor/100

In general, SYNC(—) should be executed just once each time that synchronous pulse output control needs to be set; use the differentiated variable (@SYNC(—)) or an input condition that is ON for just one cycle.

Note Refer to 2-5 *Pulse Output Functions* for more details.

Input Port Specifier (P1)

Always set P1 to 000.

Output Port Specifier (P2)

The value of P2 determines where the scaled pulse frequency is output.

P2	Pulse output location(s)
000	Synchronized pulse output 0 (output 01000)
010	Synchronized pulse output 1 (output 01001)

Scaling Factor (C)

The 4-digit BCD value of C sets the scaling factor by which the input frequency is multiplied. The scaling factor can be set between 0001 and 1000 (1 to 1,000).

Setup Settings and General Operation

The counter input mode for inputs 00000 and 00001 is set in bits 00 to 03 of DM 6642.

DM 6642 bits 00 to 03	High-speed counter setting
0	Differential phase mode (5 kHz)
1	Pulse + direction input mode (20 kHz)
2	Up/down input mode (20 kHz)
4	Increment mode (20 kHz)

Input Frequency Range

The input frequency range for the synchronized pulse control is set in bits 02 to 04 of DM 6642, as shown in the following table.

DM 6642 bits 08 to 15	Function of inputs 00000 and 00001
02	Use for synchronized pulse control (10 to 500 Hz)
03	Use for synchronized pulse control (20 Hz to 1 kHz).
04	Use for synchronized pulse control (300 Hz to 20 kHz)

Synchronized pulse control cannot be executed unless inputs 00000 to 00001 are set for synchronized pulse control in bits 08 to 15 (settings 02, 03, and 04). An error will occur and SR 25503 will be turned ON if SYNC(—) is executed when DM 6642 is not set for synchronized pulse control.

When the synchronized pulse control is in operation, an error will occur and ER will be turned ON if a related pulse output instruction is executed to use one of these functions while synchronized pulse control is being performed.

If the input frequency exceeds the maximum in the table above, the maximum input frequency for that range will be used. If the input frequency falls below the minimum, an input frequency of 0 Hz will be used.

Output Frequency Range

The output frequency range is 10 Hz to 10 kHz. If the calculated output frequency (input frequency × scaling factor/100) exceeds 10 kHz, pulses will be output at 10 kHz. If the calculated output frequency falls below 10 Hz, pulses will not be output (0 Hz).

Changing the Scaling Factor or Output Port

The scaling factor can be changed while synchronized pulse control is in operation by executing SYNC(—) again with a different scaling factor, but the output port specifier cannot be changed during operation.

Stopping the Synchronized Pulse Control Output

The synchronized pulse output can be stopped by executing INI(61) with C=0 or switching the PC to PROGRAM mode.

ER: A data area boundary is exceeded.

Indirectly addressed DM word is non-existent. (Content of *DM word is not BCD, or the DM area boundary has been exceeded.)

P1 is not 000, P2 is not 000 or 010, or C is not BCD between 0001 and 1000.

SYNC(—) is executed when bits 08 to 15 of DM 6642 are not set for the synchronized pulse control.

SYNC(—) is executed in an interrupt subroutine while a pulse I/O instruction (INI(61), PRV(62), CTBL(63), SPED(64), PULS(65), ACC(—), PWM(—), or SYNC(—)) is being executed in the main program.

28 Special Instructions

28-1 MESSAGE DISPLAY – MSG(46)

Ladder Symbols

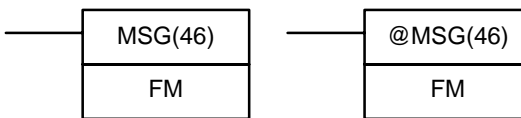

Operand Data Areas

FM: First message word
IR, SR, AR, DM, HR, LR

DM 6649 to DM 6655 cannot be used for FM.

When executed with an ON execution condition, MSG(46) reads eight words of extended ASCII code from FM to FM+7 and displays the message on the programming Console. The displayed message can be up to 16 characters long, i.e., each ASCII character code requires eight bits (two digits). Refer to Appendix G for the ASCII codes. Japanese katakana characters are included in the code.

If not all eight words are required for the message, it can be stopped at any point by inputting "OD." When OD is encountered in a message, no more words will be read and the words that normally would be used for the message can be used for other purposes.

are displayed on a first in, first out basis. Since it is possible that more than one MSG(46)s may be executed within a single cycle, there is a priority scheme based on the area where the messages are stored, for the selection of the messages to be buffered.

The priority of the data areas is as follows for message display:

LR > IR > HR > AR > TC > DM

In handling messages from the same area, those with the lowest address values have higher priority.

In handling indirectly addressed messages (i.e. *DM), those with the lowest final DM addresses have higher priority.

Clearing Messages

To clear a message, execute FAL(06) 00 or clear it via a Programming Console or the Support Software.

If the message data changes while the message is being displayed, the display will also change.

Errors

ER: Indirectly addressed DM word is non-existent. (Content of *DM word not BCD, or the DM area boundary has been exceeded.)

Example

The following example shows the display that would be produced for the instruction and data given when 00000 was ON. If 00001 goes ON, a message will be cleared.

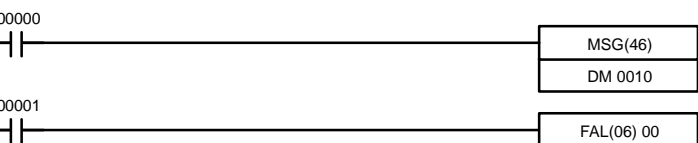

Address	Instruction	Operands
00000	LD	000
00001	MSG(46)	
		DM 00
00002	LD	000
00003	FAL(06)	

DM contents					ASCII equivalent	
00010	4	1	4	2	A	B
00011	4	3	4	4	C	D
00012	4	5	4	6	E	F
00013	4	7	4	8	G	H
00014	4	9	4	A	I	J
00015	4	B	4	C	K	L
00016	4	D	4	E	M	N
00017	4	F	5	0	O	P

MSG
ABCDEFGHIJKLMNPO

28-2 I/O REFRESH – IORF(97)

Ladder Symbol

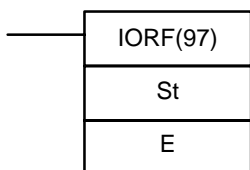

Operand Data Areas

St: Starting word
IR 000 to IR 019
E: End word
IR 000 to IR 019

Note This instruction is not supported by SRM1(-V2) PCs.

Limitations

St must be less than or equal to E.

When the execution condition for IORF(97) is ON, all words between St and E will be refreshed. This will be in addition to the normal I/O refresh performed during the CPU Unit's cycle.

(If St>E, IORF(97) will be treated as NOP(00).)

Normally, I/O refreshing is performed just once each cycle at the end of program execution, but IORF(97) can be used to refresh I/O words immediately during program execution.



Caution

Although IORF(97) can be used in interrupt subroutines, you must be careful of the interval between IORF(97) executions. If IORF(97) is executed to frequently, a fatal system error may occur (FALS 9F), stopping operation. The interval between executions of IORF(97) should be at least 1.3 ms + total execution time of the interrupt subroutine.

ER: St or E is not within the allowed range (IR 000 to IR 019).

St is greater than E. (If St>E, IORF(97) will be treated as NOP(00).)

There are no flags affected by this instruction.

28-3 BIT COUNTER – BCNT(67)

Ladder Symbols

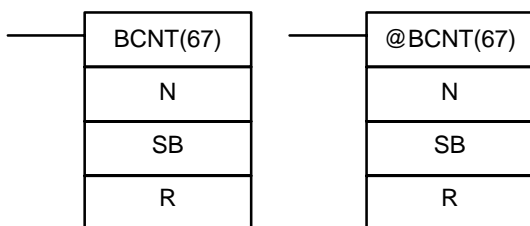

Operand Data Areas

N: Number of words (BCD)
IR, SR, AR, DM, HR, TC, LR, #
SB: Source beginning word
IR, SR, AR, DM, HR, TC, LR
R: Destination word
IR, SR, AR, DM, HR, TC, LR

Note BCNT(67) is an expansion instruction in the CPM2A/CPM2C and SRM1(-). The function code 67 is the factory setting and can be changed for if desired.

N cannot be 0.

DM 6144 to DM 6655 cannot be used for R.

When the execution condition is OFF, BCNT(67) is not executed. When the execution condition is ON, BCNT(67) counts the total number of bits that are ON in all words between SB and SB+(N-1) and places the result in R.

ER: N is not BCD, or N is 0; SB and SB+(N-1) are not in the same area.
A DM address is used for SB, but SB through SB+(N-1) are not a read/write DM.

Indirectly addressed DM word is non-existent. (Content of *DM word is not BCD, or the DM area boundary has been exceeded.)

EQ: ON when the result is 0.

Ladder Symbols

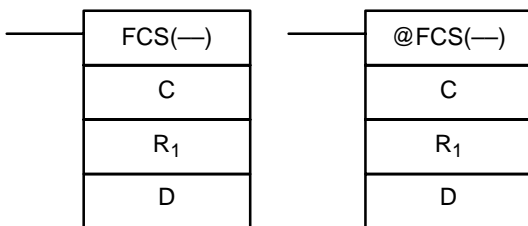

Operand Data Areas

C: Control data
IR, SR, AR, DM, HR, LR, #
R₁: First word in range
IR, SR, AR, DM, HR, TC, LR
D: First destination word
IR, SR, AR, DM, HR, LR

Limitations

This instruction is available in the **CPM2A/CPM2C/SRM1(-V2) only**.

The 3 rightmost digits of C must be BCD between 001 and 999.

DM 6144 to DM 6655 cannot be used for D.

Description

FCS(—) can be used to check for errors when transferring data through communications ports.

When the execution condition is OFF, FCS(—) is not executed. When the execution condition is ON, FCS(—) calculates the frame checksum of the specified range by exclusively ORing either the contents of words R₁ to R₁+N-1 or bytes in words R₁ to R₁+N-1. The frame checksum value (hexadecimal) is converted to ASCII and output to the destination words (D and D+1).

The function of bits in C are shown in the following diagram and explained in more detail below.

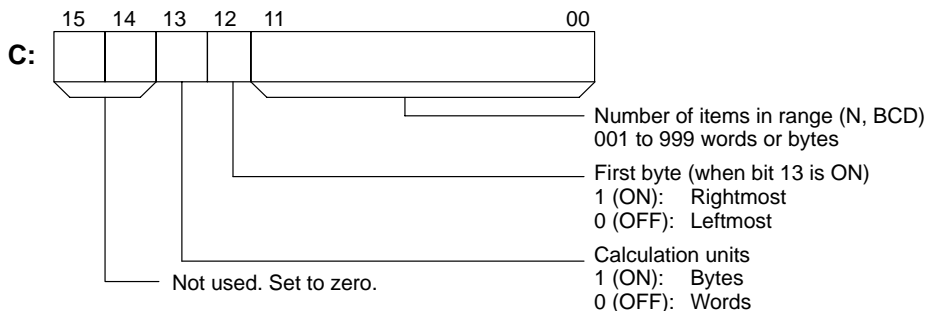

Number of Items in Range

The number of items within the range (N) is contained in the 3 rightmost digits of C, which must be BCD between 001 and 999.

Calculation Units

The frame checksum of words will be calculated if bit 13 is OFF and the frame checksum of bytes will be calculated if bit 13 is ON.

If bytes are specified, the range can begin with the leftmost or rightmost byte of R₁. The leftmost byte of R₁ will not be included if bit 12 is ON.

	MSB	LSB
R ₁	1	2
R ₁ +1	3	4
R ₁ +2	5	6
R ₁ +3	7	8
⋮	⋮	⋮
⋮	⋮	⋮

When bit 12 is OFF the bytes will be ORed in this order: 1, 2, 3, 4,

When bit 12 is ON the bytes will be ORed in this order: 2, 3, 4, 5,

Conversion to ASCII

The byte frame checksum calculation yields a 2-digit hexadecimal value which is converted to its 4-digit ASCII equivalent. The word frame checksum calculation

Byte frame checksum value

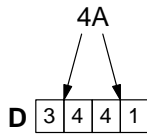

Word frame checksum value

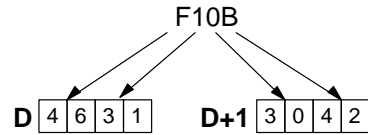

ER: Indirectly addressed DM word is non-existent. (Content of *DM word not BCD, or the DM area boundary has been exceeded.)
The number of items is not 001 to 999 BCD.

When IR 00000 is ON in the following example, the frame checksum (0003 3038) calculated for the 8 words from DM 0000 to DM 0007 and the ASCII equivalent (30 30 30 38) is written to DM 0010 and DM 0011.

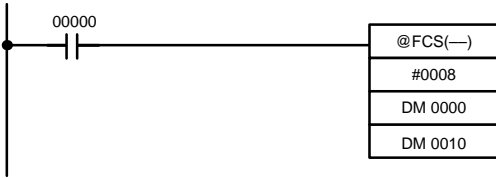

Address	Instruction	Operands
00000	LD	00000
00001	@FCS(-)	
		# 0008
		DM 0000
		DM 0010

DM 0000	0001
DM 0001	0002
DM 0002	0003
DM 0003	0004
DM 0004	0005
DM 0005	0006
DM 0006	0007
DM 0007	0008

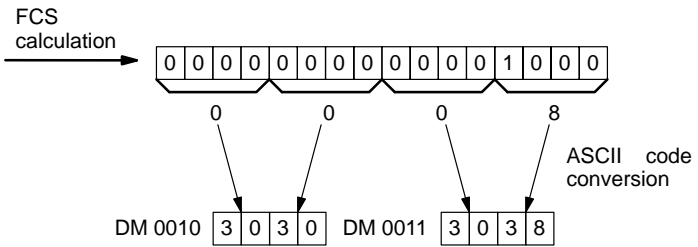

29 Interrupt Control Instructions

This section describes the operation of INT(89) and STIM(69). For general information on interrupt processing in CPM1/CPM1A, CPM2A/CPM2C, SRM1(-V2) PCs refer to the section shown in the following table.

PC	Reference
CPM1/CPM1A	See 2-3 CPM1/CPM1A Interrupt Functions.
CPM2A/CPM2C	See 2-1 CPM2A/CPM2C Interrupt Functions.
SRM1(-V2)	See 2-4 SRM1 Interrupt Functions.

29-1 INTERRUPT CONTROL – INT(89)

Ladder Symbols

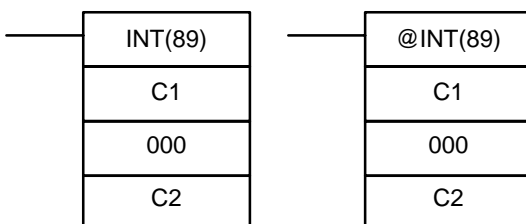

Operand Data Areas

C1: Control code
(000 to 004, 100, or 200)
000: No function
000
C2: Control data
IR, SR, AR, DM, HR, TC, LR, #

When the execution condition is OFF, INT(89) is not executed. When the execution condition is ON, INT(89) is used to control interrupts and performs one of seven functions shown in the following table depending on the value of C1:

C1	INT(89) function
000	Mask/unmask interrupt inputs
001	Clear interrupt inputs
002	Read current mask status of interrupt inputs
003	Restart decrementing counter and unmask interrupt
004*	Restart incrementing counter and unmask interrupt
100	Mask all interrupts
200	Unmask all interrupts

Note *This setting can be used in CPM2A/CPM2C PCs only.

Mask/Unmask Interrupt Inputs (C1=000)

This function is used to mask and unmask interrupt inputs 00003 to 00006. Masked inputs are recorded, but ignored. When an input is masked, the interrupt program for it will be run as soon as the bit is unmasked (unless it is cleared beforehand by executing INT(89) with C1=001).

Set the corresponding bit in C2 to 0 or 1 to unmask or mask an interrupt input. Bits 00 to 03 correspond to 00003 to 00006. Bits 04 to 15 should be set to 0.

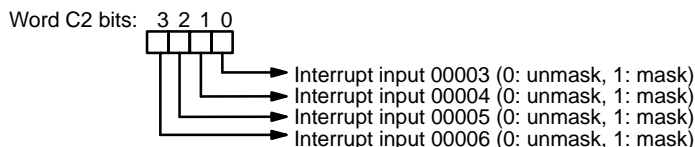

All of the interrupt inputs are masked at the start of PC operation, so the inputs must be unmasked in order to be used.

Clear Interrupt Inputs (C1=001)

This function is used to clear interrupt inputs 00003 to 00006. Since interrupt inputs are recorded, masked interrupts will be serviced as soon as the mask is removed unless they are cleared first.

Set the corresponding bit in C2 to 1 to clear an I/O interrupt input. Bits 00 to 03 correspond to 00003 to 00006. Bits 04 to 15 should be set to 0.

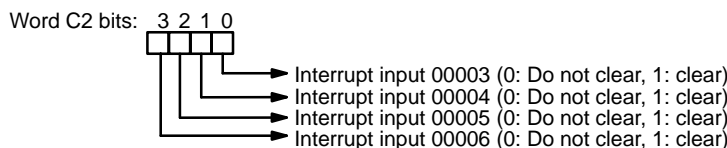

Read Current Mask Status (C1=002)

This function reads the current mask status for interrupt inputs 00003 to 00006 and writes that information to word C2. The corresponding bit will be ON if the input is masked. (Bits 00 to 03 correspond to 00003 to 00006.)

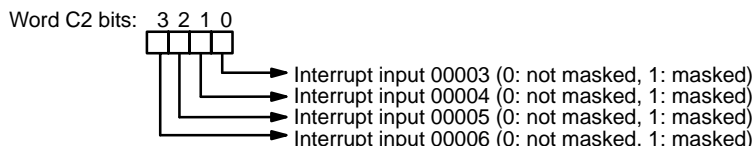

Restart Counter and Unmask Interrupt (C1=003 or C1=004)

These functions are used to restart interrupt inputs (counter mode) by refreshing the counter SV (in SR 240 to SR 243) and unmasking the interrupt input (00003 to 00006).

to restart incrementing counters.
 Set the corresponding bit in C2 to 0 to refresh the input's counter SV and unmask the interrupt. (Bits 00 to 03 correspond to 00003 to 00006.)

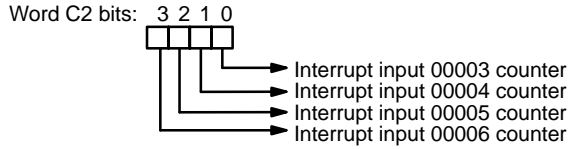

Use the differentiated variation (@INT(89)) or an input condition that is ON for just one cycle when executing INT(89) with C1=003 or C1=004. The counter will be reset to the SV if INT(89) is executed while the counter is operating, so an interrupt will never be generated if INT(89) is executed every cycle.

When INT(89) is executed with C1=003 or C1=004 and the SV word contains a non-zero SV (0001 to FFFF), the corresponding counter will begin operating (decrementing or incrementing) and the corresponding interrupt will be enabled in counter mode. When the count reaches the SV, an interrupt will be generated and the PV will be returned to the SV, so interrupts will be generated repeatedly until the counter is stopped.

Writing 0000 to a counter's SV word (SR 240 to SR 243) and executing INT(89) to refresh the SV will stop the counter and disable the corresponding interrupt. To restart the counter, write the non-zero SV to its SV word and execute INT(89). (The SV words are reset to 0000 at the start of operation, so the counter's SV must be written to its SV word from the ladder program.)

When an interrupt has already been enabled (unmasked), the SV cannot be refreshed just by writing a new value to the SV word. Refresh the SV by executing INT(89) with C1=003 (C1=004 for an incrementing counter).

A counter mode interrupt can be masked by executing INT(89) with C1=000 and the corresponding bit in C2 set to 1, but an input will operate in interrupt input mode, not counter mode, when its corresponding bit in C2 is set to 0.

Masking or Unmasking All Interrupts (C1=100 or C1=200)

All interrupts, including input interrupts, interval timer interrupts, and high-speed counter interrupts, can be masked or unmasked as a group by executing INT(89) with C1=100 or C1=200. The masked inputs are recorded, but ignored.

The global mask is in addition to any masks on the individual types of interrupts. Furthermore, clearing the masks for all interrupts does not clear the masks on the individual types of interrupts, but restores them to the masked conditions that existed before INT(89) was executed to mask them as a group.

Do not use INT(89) to mask interrupts unless it is necessary to temporarily mask all interrupts. Always use INT(89) instructions in pairs to do so, using the first INT(89) instruction to mask all interrupts and the second one to unmask all interrupts.

INT(89) cannot be used to mask and unmask all interrupts from within interrupt routines.

Masking Interrupts (C1=100)

Use the INT(89) instruction with C1=100 to mask all interrupts.

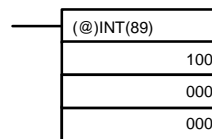

If an interrupt is generated while interrupts are masked, interrupt processing will not be executed but the interrupt will be recorded for the input, interval timer, high-speed counter interrupts. The interrupts will then be serviced as soon as the interrupts are unmasked.

(@)INT(89)
200
000
000

ER: A data area boundary is exceeded.
 Indirectly addressed DM word is non-existent. (Content of *DM word is not BCD, or the DM area boundary has been exceeded.)
 C1 is not 000 to 004,100, or 200.
 C2 is not 0000 to 000F.
 INT(89) is executed with C1=100 or C1=200 while an interrupt program was being executed.
 INT(89) is executed with C1=100 when all inputs were already masked.
 C1=200 when inputs were not all unmasked.

29-2 INTERVAL TIMER – STIM(69)

Ladder Symbols

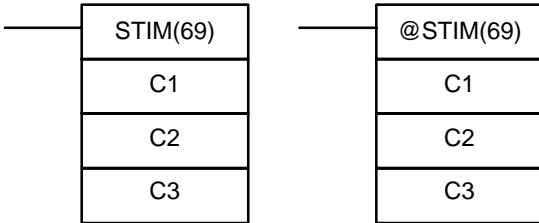

Operand Data Areas

C1: Control data #1
000 to 008, 010 to 012
C2: Control data #2
IR, SR, AR, DM, HR, TC, LR, #
C3: Control data #3
IR, SR, AR, DM, HR, TC, LR, #

Note STIM(69) is an expansion instruction in the CPM2A/CPM2C and SRM1(-). The function code 69 is the default setting and can be changed if desired.

C1 must be 000, 003, 006, or 010.
 If C1 is 000 or 003, C3 represents a BCD subroutine number up to 0049.
 If C1 is 006, constants cannot be used for C2 or C3.
 If C1 is 010, both C2 and C3 must be set to 000.

STIM(69) is used to control the interval timers by performing four basic functions: starting the timer for a one-shot interrupt, starting the timer for scheduled interrupts, reading the timer's PV, and stopping the timer. Set the value of C1 to specify which of these functions will be performed, as shown in the following table. Refer to *Section 2 Special Features* for more detailed descriptions of using interval timer interrupts. STIM(69) is also described in more detail after the table.

C1 value	Function
000	Starts the one-shot interrupt timer.
003	Starts the scheduled interrupt timer.
006	Reads the timer PV.
010	Stops the timer.

Starting Interrupt Timers (C1 = 000 or 003)
 Set C1=000 to activate the one-shot interrupt timer. Set C1=003 to start the scheduled interrupt timer.

containing the SV. The settings are slightly different depending on the mode used.

C2 = Constant

If C2 is a constant, it specifies the SV of the decrementing counter in BCD. setting range is 0000 to 9999 (0 to 9.999 ms). (The timing units are fixed at 1

C3 specifies subroutine number: 0000 to 0049.

C2 = Word Address

If C2 is a word address, the content of C2 contains the SV of the decrementing counter (BCD, 0000 to 9999).

The content of C2+1 specifies the timing units (BCD, 0005 to 0320) in units of 0.1 ms. The decrementing time interval can thus be 0.5 to 32 ms.

The timer SV is: (the content of C2) × (the content of C2+1) × 0.1 ms.

C3 specifies subroutine number: 0000 to 0049.

Setting the Timer PV (006)

Set C1=006 to read the timer PV.

C2 specifies the first of two destination words that will receive the timer's PV. C2 receives the number of times the decrementing counter has been decremented (hexadecimal, 0000 to 9999) and C2+1 receives the timing units (BCD in 0.1 ms units).

C3 specifies the destination word that receives the time which has elapsed since the last time the timer was decremented (BCD in 0.1 ms units).

Note The time that has elapsed since the timer was started is computed as follows: ((Content of C2) × (Content of C2+1)) + ((Content of C3)) × 0.1 ms

Stopping the Timer (010)

Set C1=010 to stop the timer. C2 and C3 have no function and should both be set to 000.

Errors

ER: C1 is not 000, 003, 006, or 010.

A specified subroutine number is not between 0000 and 0049.

Indirectly addressed DM word is non-existent. (Content of *DM word is not BCD, or the DM area boundary has been exceeded.)

A data area boundary has been exceeded.

30 Communications Instructions

30-1 RECEIVE – RXD(47)

Ladder Symbols

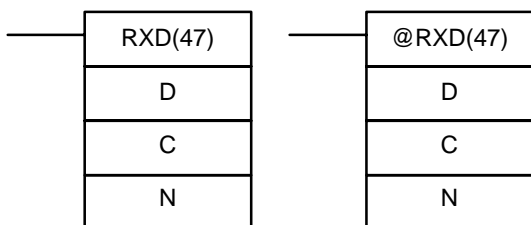

Operand Data Areas

D: First destination word
IR, SR, AR, DM, HR, TC, LR
C: Control word
#
N: Number of bytes
IR, SR, AR, DM, HR, TC, LR, #

Restrictions

This instruction is available in the **CPM2A/CPM2C and SRM1(-V2) only.**

D and D+(N÷2)-1 must be in the same data area.

DM 6144 to DM 6655 cannot be used for D or N.

When the execution condition is OFF, RXD(47) is not executed. When execution condition is ON, RXD(47) reads N bytes of data received at the specified in the control word, and then writes that data in words D to D+(N-2). Up to 256 bytes of data can be read at one time.

If fewer than N bytes are received, the amount received will be read.

Note Refer to *4-1 Communications Functions* for details on using the RXD(47) function, setting communications protocol in the PC Setup, etc.



Caution The PC will be incapable of receiving more data once 256 bytes have been received if received data is not read using RXD(47). Read data as soon as possible after the Reception Completed Flag is turned ON (AR 0806 for RS-232C port, AR 0814 for the peripheral port.)

Control Word

The value of the control word determines the port from which data will be read and the order in which data will be written to memory.

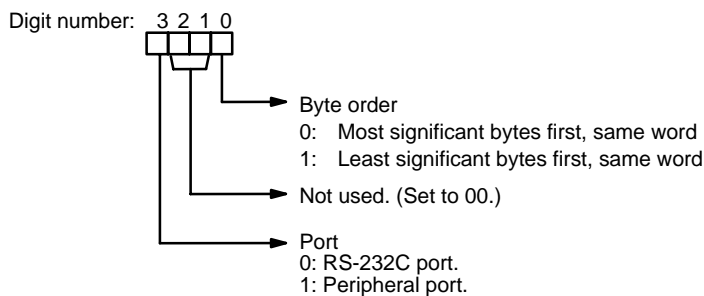

The order in which data is written to memory depends on the value of digit 0. Eight bytes of data 12345678... will be written in the following manner:

Digit 0 = 0

	MSB	LSB
D	1	2
D+1	3	4
D+2	5	6
D+3	7	8
⋮	⋮	⋮
⋮	⋮	⋮

Digit 0 = 1

	MSB	LSB
D	2	1
D+1	4	3
D+2	6	5
D+3	8	7
⋮	⋮	⋮
⋮	⋮	⋮

Digit 0 = 2

	MSB	LSB
D		1
D+1	2	3
D+2	4	5
D+3	6	7
⋮	⋮	⋮
⋮	⋮	⋮

Digit 0 = 3

	MSB	LSB
D	1	
D+1	2	3
D+2	4	5
D+3	6	7
⋮	⋮	⋮
⋮	⋮	⋮

ER: The settings in C are not correct.
N is greater than 256.

The PC Setup is not set for no-protocol mode.

RXD(47) is already being executed.

AR 08: AR 0806 will be turned ON when data has been received normally a RS-232C port. Reset when RXD(47) is executed.

AR 09: Contains the number of bytes received at the RS-232C port. Reset when RXD(47) is executed. 0000 when RXD(47) is executed.

AR 10: Contains the number of bytes received at the peripheral port. Reset when RXD(47) is executed. 0000 when RXD(47) is executed.

Note Communications flags and counters can be cleared either by specifying 0000 N or using the Port Reset Bits (SR 25208 for peripheral port and SR 25209 for RS-232C port.)

30-2 TRANSMIT – TXD(48)

Ladder Symbols

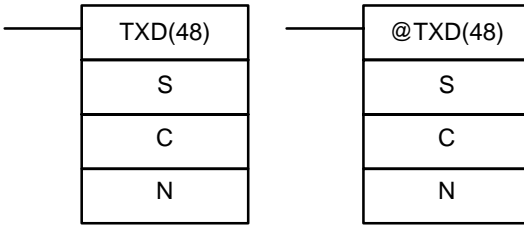

Operand Data Areas

S: First source word
IR, SR, AR, DM, HR, TC, LR
C: Control word
#
N: Number of bytes
IR, SR, AR, DM, HR, TC, LR, #

Conditions

This instruction is available in the **CPM2A/CPM2C and SRM1(-V2) only**.

S and S+(N÷2)-1 must be in the same data area.

DM 6144 to DM 6655 cannot be used for S or N.

N must be BCD from #0000 to #0256. (#0000 to #0061 in Host Link mode)

Description

When the execution condition is OFF, TXD(48) is not executed. When the execution condition is ON, TXD(48) reads N bytes of data from words S+(N÷2)-1, converts it to ASCII, and outputs the data from the specified port. TXD(48) operates differently in Host Link mode and RS-232C mode, so the modes are described separately.

- Note**
1. Flag AR 0805 will be ON when the PC is capable of transmitting data through the RS-232C port and AR 0813 will be ON when the PC is capable of transmitting data through the peripheral port.
 2. Refer to *4-1 Communications Functions* for details on using the TXD(48) instruction, setting communications protocol in the PC Setup, etc.

Host Link Mode

N must be BCD from #0000 to #0061 (i.e., up to 122 bytes of ASCII). The value of the control word determines the port from which data will be output, as shown below.

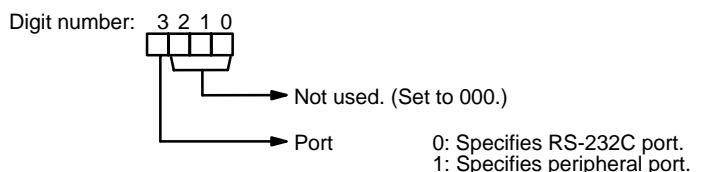

to ASCII, and transmitted through the specified port. The bytes of source data shown below will be transmitted in this order: 12345678...

	MSB	LSB
S	1	2
S+1	3	4
S+2	5	6
S+3	7	8
⋮	⋮	⋮
⋮	⋮	⋮

The following diagram shows the format for Host Link command (TXD) sent to the CPM2A/CPM2C. The CPM2A/CPM2C automatically attaches the prefixes and suffixes, such as the node number, header, and FCS.

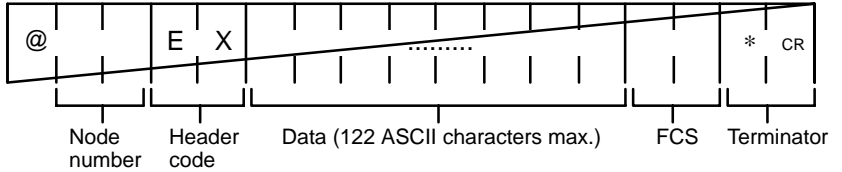

RS-232C Mode

N must be BCD from #0000 to #00256. The value of the control word determines the port from which data will be output and the order in which data will be written to memory.

Control Word

The value of the control word determines the port from which data will be read and the order in which data will be written to memory.

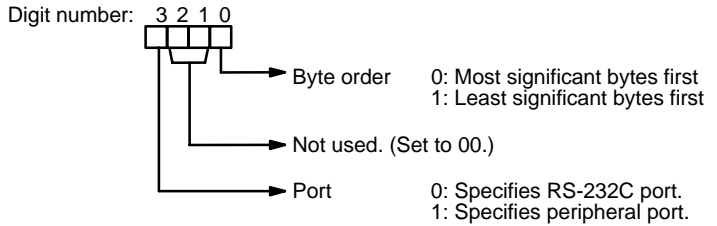

The specified number of bytes will be read from S through S+(N÷2)-1 and transmitted through the specified port.

	MSB	LSB
S	1	2
S+1	3	4
S+2	5	6
S+3	7	8
⋮	⋮	⋮
⋮	⋮	⋮

When digit 0 of C is 0, the bytes of source data shown above will be transmitted in this order: 12345678...

When digit 0 of C is 1, the bytes of source data shown above will be transmitted in this order: 21436587...

Note When start and end codes are specified the total data length should be 256 bytes max., including the start and end codes.

ER: The settings in C are not correct.

N is greater than 256 for no-protocol mode or greater than 61 for Host Link mode.

Indirectly addressed DM word is non-existent. (Content of *DM word is not BCD, or the DM area boundary has been exceeded.)

TXD(48) is already being executed.

AR 08: AR 0805 will be turned ON when it is possible to transmit through RS-232C port. AR 0813 will be turned ON when it is possible to transmit through the peripheral port.

30-3 CHANGE RS-232C SETUP – STUP(—)

Ladder Symbols

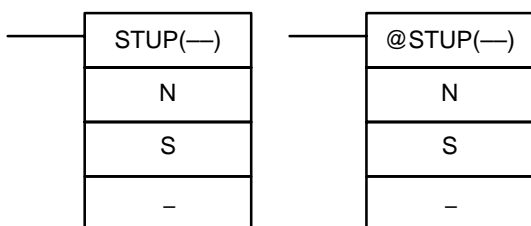

Operand Data Areas

N: RS-232C port specifier
000
S: First source word
IR, SR, AR, DM, HR, LR, #

The third operand is ignored.

Restrictions

This instruction is available in the **CPM2A/CPM2C and SRM1(-V2) only.**

N must be 000.

S and S+4 must be in the same data area.

(S can be set to #0000 to change the RS-232C settings to their defaults.)

STUP(—) can't be executed within an interrupt subroutine.

Description

When the execution condition is OFF, STUP(—) is not executed. When the execution condition is ON, STUP(—) changes the PC Setup settings for the built-in RS-232C port. The settings are changed in the PC Setup, but they are not written to flash memory until the PC is switched to PROGRAM mode (PROGRAM RUN or MONITOR mode) or the PC is turned OFF and then ON again.

In CPM2A/CPM2C and SRM1(-V2) PCs, N must be 000 because STUP(—) only changes the RS-232C Setup for the built-in RS-232C port (DM 6645 to DM 6649) only.

If S is a word address, the contents of S through S+4 are copied to DM 6645 through DM 6649.

If S is input as the constant #0000, the settings for the built-in RS-232C port are returned to their default values.

S	Function
Word address	The contents of S through S+4 are copied to DM 6645 through DM 6649.
Constant (#0000)	The settings in DM 6645 through DM 6649 are returned to their default values.

- Note**
1. The Changing RS-232C Setup Flag (SR 25312) will be ON while STUP(—) is being executed; it is turned OFF when STUP(—) is completed.
 2. In the CPM2A/CPM2C, an error will occur and STUP(—) will not be executed if the Communications Switch on the front of the CPU Unit is ON. When this switch is ON, RS-232C communications are governed by the default settings.

DM 0104 to the PC Setup area for the built-in RS-232C port (DM 6646 through DM 6649).

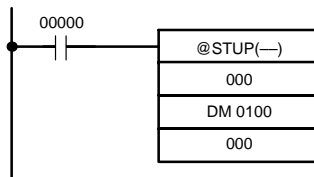

Address	Instruction	Operands
00000	LD	00000
00001	@STUP(—)	
		000
		DM 0100
		000

The settings are transferred as shown below. The Changing RS-232C Stop Flag (SR 25312) will be turned OFF when the transfer has been completed.

The following table shows the function of the transferred setup data.

Source word	Destination word	Content	Function
DM 0100	DM 6645	1001	Enables the communications settings in DM 0101 and sets the communications mode to no-protocol.
DM 0101	DM 6646	0803	Sets the following communications settings: 9,600 bps, 1 start bit, 8-bit data, 1 stop bit, no parity.
DM 0102	DM 6647	0000	No transmission delay (0 ms)
DM 0103	DM 6648	2000	Enables the end code CR, LF.
DM 0104	DM 6649	0000	(No function when DM 6648 is set to 2000)

ER: Indirectly addressed DM word is non-existent. (Content of *DM word is not BCD, or the DM area boundary has been exceeded.)

The port specifier (N) isn't 000.

In the CPM2A/CPM2C, the Communications Switch on the front of the CPU Unit is ON.

Another STUP(—) instruction is already being executed or event processing is being performed.

The specified source words exceed the data area.

The instruction was executed from an interrupt program.

The PC Setup is write-protected.

PC Operations and Processing Times

This section explains the internal processing of the CPM1, CPM1A, CPM2A, CPM2C, and SRM1(-V2), as well as the times required for processing and execution. Refer to this section to gain an understanding of the precise timing of PC operations.

8-1	CPM1/CPM1A Cycle Time and I/O Response Time	508
8-1-1	The CPM1/CPM1A Cycle	508
8-1-2	CPM1/CPM1A Cycle Time	509
8-1-3	I/O Response Time	510
8-1-4	One-to-one PC Link I/O Response Time	511
8-1-5	Interrupt Processing Time	513
8-1-6	CPM1/CPM1A Instruction Execution Times	514
8-2	CPM2A/CPM2C Cycle Time and I/O Response Time	519
8-2-1	CPM2A/CPM2C Cycle Time	519
8-2-2	I/O Response Time	520
8-2-3	One-to-one PC Link I/O Response Time	521
8-2-4	Interrupt Processing Time	523
8-2-5	CPM2A/CPM2C Instruction Execution Times	524
8-3	SRM1(-V2) Cycle Time and I/O Response Time	533
8-3-1	The SRM1(-V2) Cycle	533
8-3-2	SRM1(-V2) Cycle Time	534
8-3-3	I/O Response Time	536
8-3-4	One-to-one PC Link I/O Response Time	537
8-3-5	Interrupt Processing Time	538
8-3-6	SRM1(-V2) Instruction Execution Times	539

I-1 The CPM1/CPM1A Cycle

The overall flow of CPM1/CPM1A operation is as shown in the following flow chart.

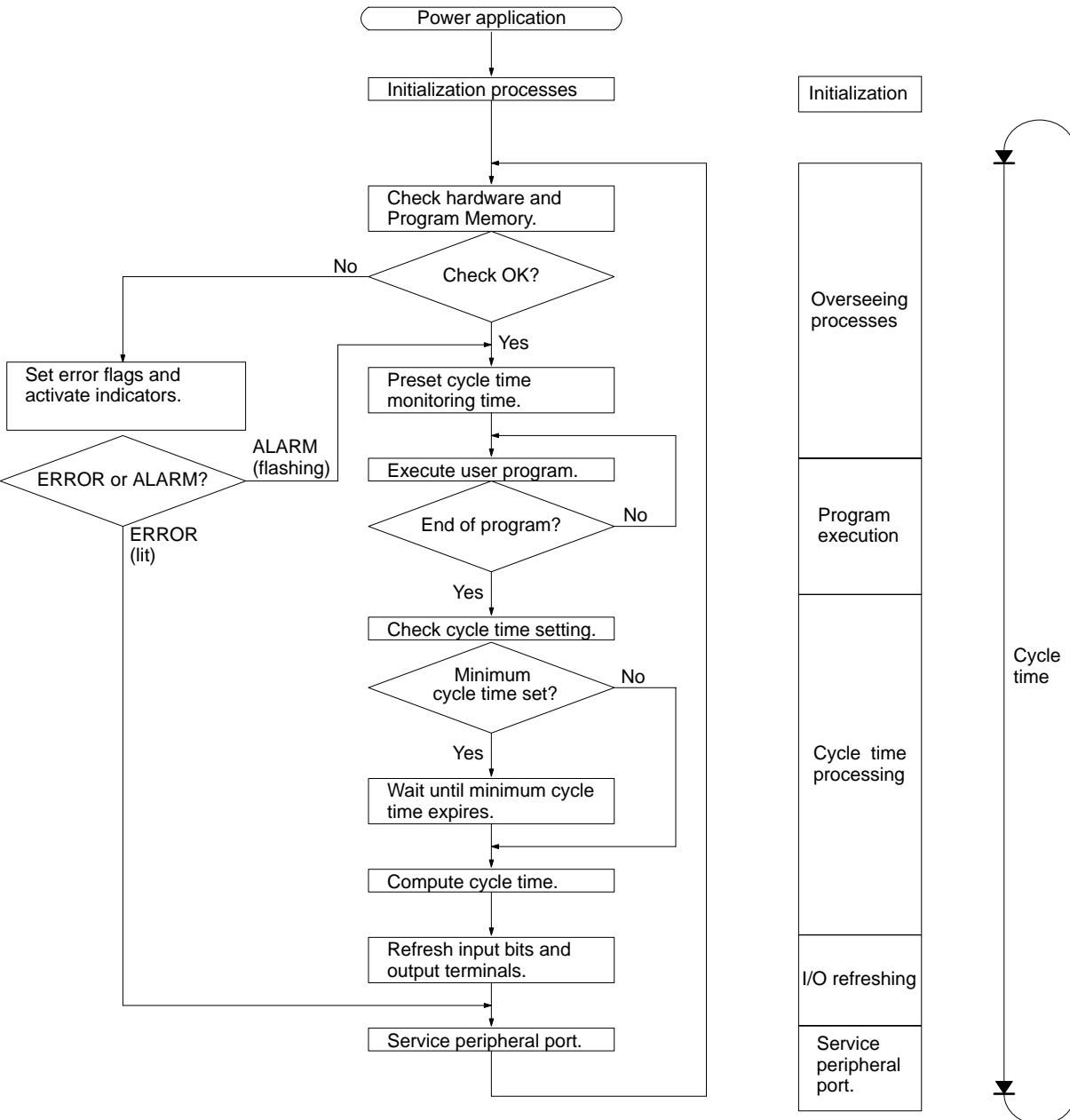

Note Initialization processes include clearing the IR, SR, and AR areas, presetting system timers, and checking I/O Units.

The processes involved in a single CPM1/CPM1A cycle are shown in the following table, and their respective processing times are explained.

Process	Content	Time requirements
Standby processing	Setting cycle watchdog timer, I/O bus check, UM check, clock refreshing, refreshing bits allocated to new functions, etc.	0.6 ms
User program execution	User program is executed.	Total time for executing instruction (Varies according to content of user program.)
Cycle time calculation	Standby until set time, when minimum cycle time is set in DM 6619 of PC Setup. Calculation of cycle time.	Almost instantaneous, except for standby processing.
Refresh	Input information is read to input bits. Output information (results of executing program) is written to output bits.	10-point CPU : 0.06 ms 20-point CPU: 0.06 ms 30-point CPU: 0.3 ms Expansion I/O Unit: 0.3 ms
Peripheral port servicing	Devices connected to peripheral port serviced.	0.26 ms min., 5% or less of cycle time up to 66 ms (see note)

Note The percentage of the cycle allocated to peripheral port servicing can be changed in the PC Setup (DM 6617).

Cycle Time and Operations The effects of the cycle time on CPM1/CPM1A operations are as shown below. When a long cycle time is affecting operation, either reduce the cycle time or improve responsiveness with interrupt programs.

Cycle time	Operation conditions
100 ms or longer	TIMH(15) may be inaccurate when TC 004 through TC 127 are used (operation will be normal for TC 000 through TC 003).
100 ms or longer	Programming using the 0.02-second Clock Bit (SR 25401) may be inaccurate.
100 ms or longer	TIM may be inaccurate. Programming using the 0.1-second Clock Bit (SR 25500) may be inaccurate. A CYCLE TIME OVER error is generated (SR 25309 will turn ON). See note 1.
100 ms or longer	The FALS 9F monitoring time SV is exceeded. A system error (FALS 9F) is generated, and operation stops. See note 2.
100 ms or longer	Programming using the 0.2-second Clock Bit (SR 25501) may be inaccurate.

Note

1. The PC Setup (DM 6655) can be used to disable detection of CYCLE TIME OVER error.
2. The cycle monitoring time can be changed in the PC Setup (DM 6618).

Cycle Time Example In this example, the cycle time is calculated for a CPM1/CPM1A CPU Unit with 20 I/O points (12 input points and 8 output points). The I/O is configured as follows:

Inputs: 1 word (00000 to 00011)
Outputs: 1 word (01000 to 01007)

The rest of the operating conditions are assumed to be as follows:

User's program: 500 instructions (consists of only LD and OUT)
Cycle time: Variable (no minimum set)

Process	Calculation method	Time with Programming Device	Time without Programming Device
Overseeing	Fixed	0.6 ms	0.6 ms
Program execution	2.86×500 (μs)	1.43 ms	1.43 ms
Cycle time calculation	Negligible	0 ms	0 ms
I/O refresh	$0.01 \times 1 + 0.005 \times 1$ (μs)	0.06 ms	0.06 ms
Peripheral port servicing	Minimum time	0.26 ms	0 ms
Cycle time	(1) + (2) + (3) + (4) + (5)	2.35 ms	2.09 ms

- Note**
1. The cycle time can be read from the PC via a Programming Device.
 2. The maximum and current cycle time are stored in AR 14 and AR 15.
 3. The cycle time can vary with actual operating conditions and will not necessarily agree precisely with the calculated value.

I-3 I/O Response Time

The I/O response time is the time it takes after an input signal has been received (i.e., after an input bit has turned ON) for the PC to check and process the information and to output a control signal (i.e., to output the result of the processing to an output bit). The I/O response time varies according to the timing processing conditions.

The minimum and maximum I/O response times are shown here, using the following program as an example.

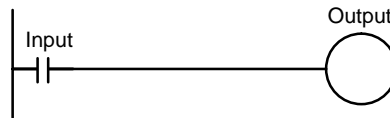

The following conditions are taken as examples for calculating the I/O response times.

- Input ON delay: 8 ms (input time constant: default setting)
- Overseeing time: 1 ms (includes I/O refresh for CPM1A)
- Instruction execution time: 14 ms
- Output ON delay: 10 ms
- Peripheral port: Not used.

Minimum I/O Response Time The CPM1/CPM1A responds most quickly when it receives an input signal prior to I/O refreshing, as shown in the illustration below.

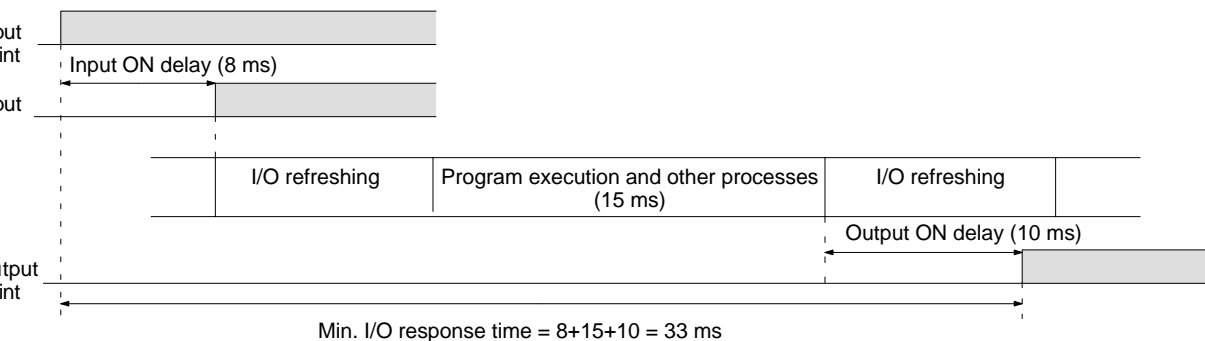

just after the input refresh phase of the cycle, as shown in the illustration below. In that case, a delay of approximately one cycle will occur.

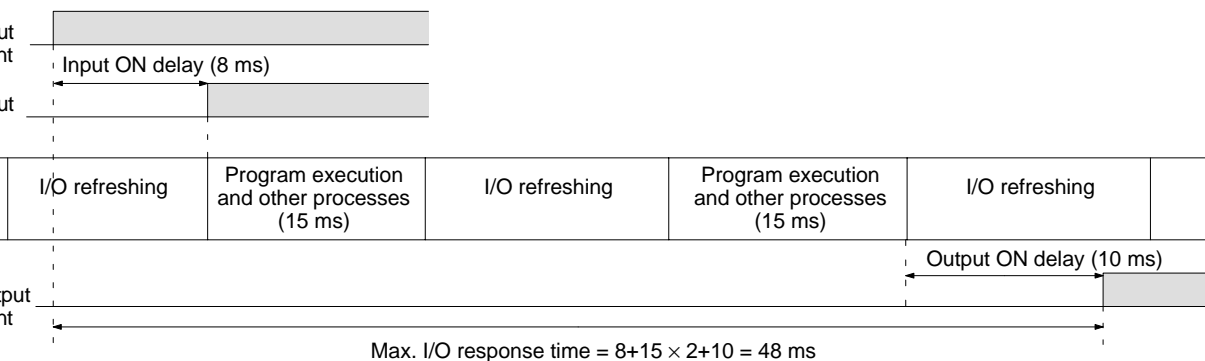

I-4 One-to-one PC Link I/O Response Time

When two CPM1/CPM1As are linked 1:1, the I/O response time is the time required for an input executed at one of the CPM1/CPM1As to be output to the other CPM1/CPM1A by means of 1:1 PC Link communications.

The minimum and maximum I/O response times are shown here, using as an example the following instructions executed at the master and the slave. In this example, communications proceed from the master to the slave.

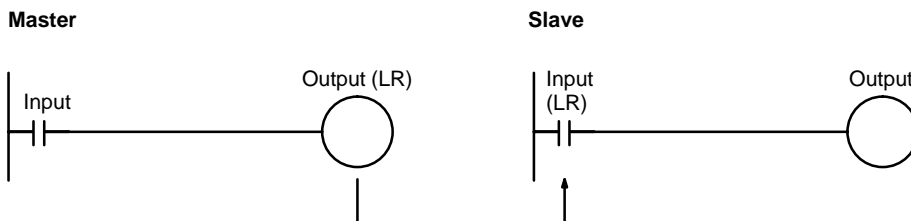

The following conditions are taken as examples for calculating the I/O response times. In CPM1/CPM1A PCs, LR area words LR 00 to LR 15 are used in 1:1 links and the transmission time is fixed at 12 ms.

- Input ON delay: 8 ms (input time constant: default setting)
- Master cycle time: 10 ms
- Slave cycle time: 15 ms
- Output ON delay: 10 ms
- Peripheral port: Not used.

Minimum I/O Response Time The CPM1/CPM1A responds most quickly under the following circumstances:

- 1, 2, 3...**
 1. The CPM1/CPM1A receives an input signal just prior to the input refresh phase of the cycle.
 2. The Master's communications servicing occurs just as the Master-to-Slave transmission begins.

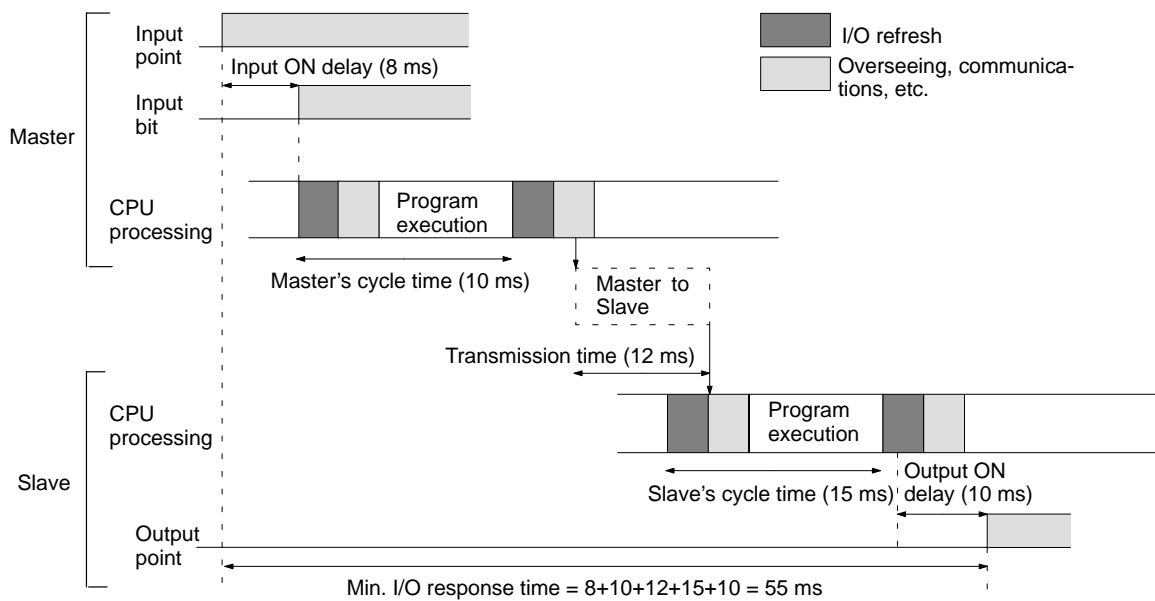

Calculation formula = Input ON response time + Master's cycle time + Slave's cycle time + Output ON response time

Maximum I/O Response Time The CPM1/CPM1A takes the longest to respond under the following circumstances:

- 1, 2, 3... 1. The CPM1/CPM1A receives an input signal just after the input refresh phase of the cycle.
2. The Master's communications servicing just misses the Master-to-Slave transmission.
3. The transmission is completed just after the Slave's communications servicing ends.

Maximum Response Time Input ON response time + Master's cycle time x 2 + Transmission time x 3 + Output ON response time

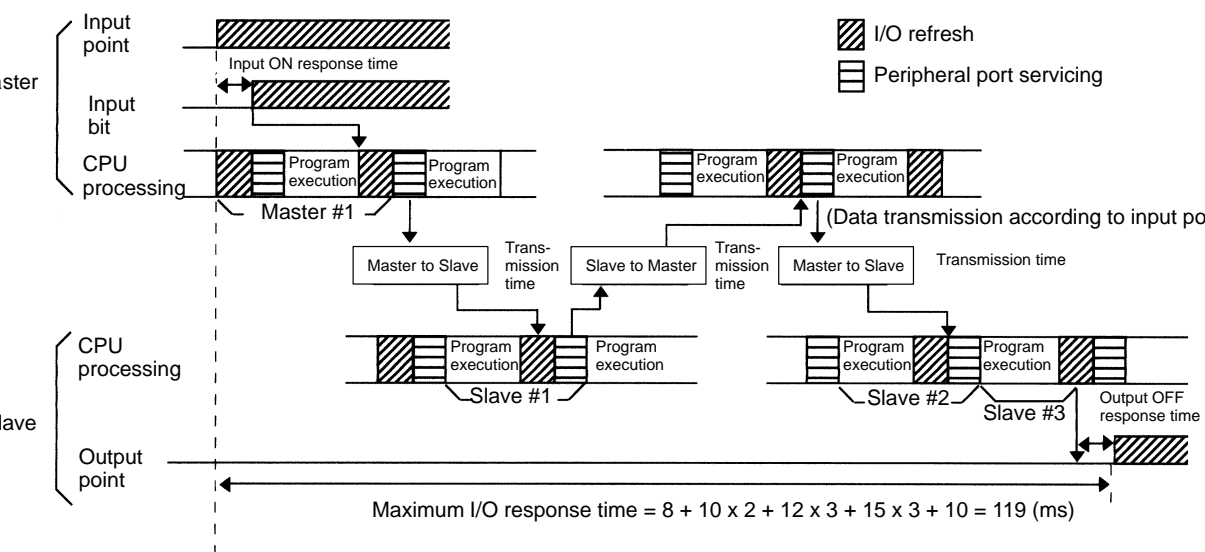

This section explains the processing times involved from the time an interrupt is executed until the interrupt processing routine is called, and from the time an interrupt processing routine is completed until returning to the initial location. This explanation applies to input interrupts, interval timer interrupts, and high-speed counter interrupts.

- 1, 2, 3...**
1. Source of interrupt
 2. Interrupt ON delay
 3. Wait for completion of interrupt-mask processing
 4. Change to interrupt processing
 5. Interrupt routing (CPM1A only)
 6. Return to initial location

The table below shows the times involved from the generation of an interrupt until the interrupt processing routine is called, and from when the interrupt processing routine is completed until returning to the original position.

Item	Contents	Time
Interrupt ON delay	This is the delay time from the time the interrupt input bit turns ON until the time that the interrupt is executed. This is unrelated to other interrupts.	100 μ s
Wait for completion of interrupt-mask processing	This is the time during which interrupts are waiting until processing has been completed. This situation occurs when a mask processes is executed. It is explained below in more detail.	See below
Change to interrupt processing	This is the time it takes to change processing to an interrupt.	30 μ s
Return	This is the time it takes, from execution of RET(93), to return to the processing that was interrupted.	30 μ s

Mask Processing

Interrupts are masked during processing of the operations described below. Until the processing is completed, any interrupts will remain masked for the indicated times.

Generation and clearing of non-fatal errors:

When a non-fatal error is generated and the error contents are registered in the CPM1, or when an error is being cleared, interrupts will be masked for a maximum of 100 μ s until the processing has been completed.

Online editing:

Interrupts will be masked for a maximum of 600 ms (i.e.: editing DM 6144 to DM 6655) when online editing is executed during operation. In addition, system processing may have to wait for a maximum of 170 μ s during processing.

Example Calculation

This example shows the interrupt response time (i.e., the time from when the interrupt input turns ON until the start of the interrupt processing routine) when input interrupts are used under the conditions shown below.

Minimum Response Time

Interrupt ON delay:	100 μ s
Interrupt mask standby time:	0 μ s
<u>+ Change-to-interrupt processing:</u>	<u>30 μs</u>
Minimum response time:	130 μ s

Maximum Response Time

(Except for the Online Editing of DM 6144 to DM6655)

Interrupt ON delay:	100 μ s
Interrupt mask standby time:	170 μ s
<u>+ Change-to-interrupt processing:</u>	<u>30 μs</u>
Maximum response time:	300 μ s

the interrupt processing routine itself and a return time of 60 µs must also be counted for when returning to the process that was interrupted.

4-6 CPM1/CPM1A Instruction Execution Times

The following table lists the execution times for CPM1/CPM1A instructions.

Basic Instructions

Code	Mnemonic	ON execution time (µs)	Conditions (Top: min.; bottom: max.)	OFF execution time (µs)		
				RSET	IL	JMP
	LD LD NOT	1.72	Any	---		
	AND AND NOT OR OR NOT	1.32				
	AND LD OR LD	0.72				
	OUT OUT NOT	4.0				
	SET	5.8				
	RSET	5.9				
TIM		10.0	Constant for SV	16.2	16.0	6.4
			*DM for SV	31.4	31	6.4
CNT		12.5	Constant for SV	14.1	6.2	6.6
			*DM for SV	29.1	6.2	6.6

Special Instructions

Code	Mnemonic	ON execution time (µs)	Conditions (Top: min.; bottom: max.)	OFF execution time (µs)			
				RSET	IL	JMP	
	NOP	0.36	Any	---			
	END	10.8					
	IL	4.6		2.6	---	---	
	ILC	3.6		3.6	---	---	
	JMP	4.3		2.4	---	---	
	JME	4.7		4.7	---	---	
	FAL	38.5		5.5	---	---	
	FALS	5.0		5.4	---	---	
	STEP	14.9		11.1	---	---	
	SNXT	14.2		7.6	---	---	
SFT		21.9	With 1-word shift register	Reset	IL	JMP	
			With 10-word shift register	19.7	2.6	2.6	
			With 100-word shift register	26.5	2.6	2.6	
			---	60.1	2.6	2.6	
KEEP		6.2	Any	Reset	IL	JMP	
				6.1	3.1	3.1	
CNTR		25.8	Constant for SV	Reset	IL	JMP	
			41.2	*DM for SV	16.8	12.2	12.2
			---	---	---	---	
DIFU		11.8	Any	Shift	IL	JMP	
				10.1	12.2	12.2	
DIFD		11.0	Any	Shift	IL	JMP	
				10.0	9.9	2.3	

	time (µs)		Reset	IL	JMP
TIMH	19.0	Regular execution, constant for SV	25.7	28.4	15.8
	20.2	Interrupt execution, constant for SV			
	19.0	Regular execution, *DM for SV	41.2	43.6	15.8
	20.2	Interrupt execution, *DM for SV			
WSFT	29.2	With 1-word shift register	5.6		
	40.7	With 10-word shift register			
	1.42 ms	With 1,024-word shift register using *DM			
ASFT	29.6	Shifting a word	5.6		
	50.2	Shifting 10 words			
	1.76 ms	Shifting 1,023 words via *DM			
CMP	15.8	When comparing a constant to a word	5.6		
	17.2	When comparing two words			
	46.3	When comparing two *DM			
MOV	16.3	When transferring a constant to a word	5.6		
	17.7	When transferring from one word to another			
	45.5	When transferring *DM to *DM			
MVN	16.4	When transferring a constant to a word	5.6		
	17.5	When transferring from one word to another			
	45.7	When transferring *DM to *DM			
BIN	31.6	When converting a word to a word	5.6		
	45.7	When converting *DM to *DM			
BCD	29.5	When converting a word to a word	5.6		
	57.3	When converting *DM to *DM			
ASL	17.3	When shifting a word	5.5		
	31.3	When shifting *DM			
ASR	16.9	When shifting a word	5.5		
	31.1	When shifting *DM			
ROL	14.5	When rotating a word	5.5		
	28.5	When rotating *DM			
ROR	14.5	When rotating a word	5.5		
	28.5	When rotating *DM			
COM	18.1	When inverting a word	5.5		
	32.1	When inverting *DM			
ADD	29.5	Constant + word → word	5.6		
	30.9	Word + word → word			
	72.7	*DM + *DM → *DM			
SUB	29.3	Constant – word → word	5.6		
	30.5	Word – word → word			
	72.5	*DM – *DM → *DM			
MUL	49.1	Constant × word → word	5.6		
	50.5	Word × word → word			
	95.1	*DM × *DM → *DM			
DIV	47.7	Word ÷ constant → word	5.6		
	50.9	word ÷ word → word			
	94.3	*DM ÷ *DM → *DM			
ANDW	27.1	Constant ∩ word → word	5.6		
	28.7	Word ∩ word → word			
	70.7	*DM ∩ *DM → *DM			

	time (µs)		
ORW	27.1	Constant V word → word	5.6
	28.7	Word V word → word	
	70.7	*DM V *DM → *DM	
XORW	27.1	Constant √ word → word	5.6
	28.7	Word √ word → word	
	70.5	*DM √ *DM → *DM	
XNRW	27.0	Constant ∇ word → word	5.6
	28.6	Word ∇ word → word	
	70.5	*DM ∇ *DM → *DM	
INC	17.9	When incrementing a word	5.5
	31.9	When incrementing *DM	
DEC	18.3	When decrementing a word	5.5
	32.3	When decrementing *DM	
STC	6.3	Any	5.5
CLC	6.3		5.5
MSG	21.5	With message in words	5.5
	35.7	With message in *DM	
ADB	30.5	Constant + word → word	5.6
	32.1	Word + word → word	
	73.9	*DM + *DM → *DM	
SBB	30.9	Constant – word → word	5.6
	32.7	Word – word → word	
	74.5	*DM – *DM → *DM	
MLB	34.7	Constant × word → word	5.6
	36.3	Word × word → word	
	80.7	*DM × *DM → *DM	
DVB	35.1	Word ÷ constant → word	5.6
	36.7	Word ÷ word → word	
	81.1	*DM ÷ *DM → *DM	
ADDL	48.9	Word + word → word	5.6
	94.7	*DM + *DM → *DM	
SUBL	48.9	Word – word → word	5.6
	94.7	*DM – *DM → *DM	
MULL	138.7	Word × word → word	5.6
	184.3	*DM × *DM → *DM	
DIVL	136.7	Word ÷ word → word	5.6
	181.3	*DM ÷ *DM → *DM	
CMPL	30.4	Comparing words	5.6
	60.8	Comparing *DM	
INI	112.0	Starting comparison via word	5.6
	126.0	Starting comparison via *DM	
	48.0	Stopping comparison via word	
	48.0	Stopping comparison via *DM	
	120.0	Changing PV via word	
	128.0	Changing PV via *DM	
	46.0	Stopping pulse output via word	
	60.0	Stopping pulse output via *DM	
PRV	62.2	Designating output via word	5.6
	78.0	Designating output via *DM	

	time (ms)		
CTBL	106.3	Target table with 1 target in words and start	5.6
	120.3	Target table with 1 target in *DM and start	
	775.5	Target table with 16 targets in words and start	
	799.5	Target table with 16 targets in *DM and start	
	711.5	Range table in words and start	
	722.5	Range table in *DM and start	
	91.9	Target table with 1 target in words	
	106.3	Target table with 1 target in *DM	
	693.5	Target table with 16 targets in words	
	709.5	Target table with 16 targets in *DM	
	607.5	Range table in words	
	621.5	Range table in *DM	
SPED	73.6	Specifying a constant	5.6
	75.0	Specifying a word	
	88.8	Specifying *DM	
PULS	62.0	Specifying a word	5.6
	78.0	Specifying *DM	
BCNT	52.6	Counting a word	5.6
	4.08 ms	Counting 6,656 words via *DM	
BCMP	79.6	Comparing constant, results to word	5.6
	80.8	Comparing word, results to word	
	123.2	Comparing *DM, results to *DM	
STIM	47.5	Word-set one-shot interrupt start	5.6
	58.7	*DM-set one-shot interrupt start	
	47.9	Word-set scheduled interrupt start	
	59.1	*DM-set scheduled interrupt start	
	33.5	Word-set timer read	
	63.5	*DM-set timer read	
	25.7	Word-set timer stop	
	54.1	*DM-set timer stop	
XFER	45.5	When transferring a constant to a word	5.6
	47.1	When transferring a word to a word	
	1.78 ms	When transferring 1,024 words using *DM	
BSET	28.1	When setting a constant to 1 word	5.6
	38.3	When setting word constant to 10 words	
	1.12 ms	When setting *DM to 1,024 words	
XCHG	30.5	Word → word	5.6
	59.1	*DM → *DM	
SLD	25.9	Shifting 1 word	5.6
	51.7	Shifting 10 word	
	3.02 ms	Shifting 1024 words using *DM	
SRD	25.9	Shifting 1 word	5.6
	51.7	Shifting 10 word	
	3.02 ms	Shifting 1,024 words using *DM	
MLPX	47.7	When decoding word to word	5.6
	92.7	When decoding *DM to *DM	
DMPX	59.5	When encoding word to word	5.6
	95.5	When encoding *DM to *DM	

	time (µs)		
SDEC	51.1	When decoding word to word	5.6
	96.3	When decoding *DM to *DM	
DIST	39.1	When setting a constant to a word + a word	5.6
	40.9	When setting a word to a word + a word	
	84.7	When setting *DM to *DM + *DM	
	63.4	When setting a constant to a stack	
	65.0	When setting a word to a stack	
	109.6	When setting *DM to a stack via *DM	
COLL	42.6	When setting a constant + a word to a word	5.6
	43.6	When setting a word + a word to a word	
	83.4	When setting *DM + *DM to *DM	
	78.0	When setting a word + constant to FIFO stack	
	79.2	When setting a word + word to FIFO stack	
	1.76 ms	When setting a *DM + *DM to FIFO stack via *DM	
	66.8	When setting a word + constant to LIFO stack	
	68.0	When setting a word + word to LIFO stack	
	112.0	When setting a *DM + *DM to LIFO stack via *DM	
MOVB	32.5	When transferring a constant to a word	5.6
	37.5	When transferring from one word to another	
	79.1	When transferring *DM to *DM	
MOVD	28.3	When transferring a constant to a word	5.6
	33.3	When transferring from one word to another	
	75.5	When transferring *DM to *DM	
SFTR	39.3	Shifting 1 word	5.6
	52.9	Shifting 10 word	
	1.42 ms	Shifting 1,024 words using *DM	
TCMP	57.7	Comparing constant to word-set table	5.6
	58.9	Comparing word to word-set table	
	101.9	Comparing *DM to *DM-set table	
ASC	56.7	Word → word	5.6
	103.9	*DM → *DM	
INT	32.3	Set masks via word	5.6
	46.3	Set masks via *DM	
	29.1	Clear interrupts via word	
	43.1	Clear interrupts via *DM	
	27.3	Read mask status via word	
	41.5	Read mask status via *DM	
	29.7	Change counter SV via word	
	43.7	Change counter SV via *DM	
	15.3	Mask all interrupts via word	
	15.3	Mask all interrupts via *DM	
	15.9	Clear all interrupts via word	
15.9	Clear all interrupts via *DM		
SBS	36.6	Any	5.5
SBN	1.7		1.7
RET	15.0		2.5

	Time (µs)		
IORF	40.0	Refreshing IR 000	6.0
	142.6	Refreshing one input word	
	135.4	Refreshing one output word	
MCRO	74.0	With word-set I/O operands	5.6
	116.4	With *DM-set I/O operands	

2 CPM2A/CPM2C Cycle Time and I/O Response Time

2-1 CPM2A/CPM2C Cycle Time

The processes involved in a single CPM2A/CPM2C cycle are shown in the following table, and their respective processing times are explained. Refer to *CPM2C-S Operation Manual (W377)* for information on the cyclic operation of the CPM2C-S.

Process	Content	Time requirements
Overseeing	Setting cycle watchdog timer, I/O bus check, UM check, clock refreshing, refreshing bits allocated to new functions.	0.3 ms
Program execution	User program is executed.	Total time for executing instructions. (Varies according to content of user's program.)
Cycle time calculation	Automatic delay until minimum cycle time when a minimum cycle time is set in DM 6619 of PC Setup. Calculation of cycle time.	Negligible except for the delay itself when required.
Refreshing	Output information (results of executing program) is written to output bits. Input information is read to input bits.	CPM2C CPU Unit: 0.06 ms 20-point CPM2A CPU Unit: 0.06 ms 30-point CPM2A CPU Unit: 0.3 ms 40-point CPM2A CPU Unit: 0.3 ms 60-point CPM2A CPU Unit: 0.54 ms Expansion I/O Unit: 0.3 ms
RS-232C port servicing	Communications processing when a Programming Device or Communications Adapter is connected to the RS-232C port.	0.55 ms min., 5% or less of cycle time up to 131 ms (The percentage of cycle time allocated to RS-232C servicing can be set in DM 6616.)
Peripheral port servicing	Devices connected to peripheral port serviced.	0.55 ms min., 5% or less of cycle time up to 131 ms (The percentage of cycle time allocated to peripheral port servicing can be set in DM 6617.)

Cycle Time and Operations The effects of the cycle time on CPM2A/CPM2C operations are as shown below. When a long cycle time is affecting operation, either reduce the cycle time or improve responsiveness with interrupt programs.

Cycle time	Operation conditions
10 ms or longer	TMHH(—) may be inaccurate when TC 000 through TC 003 or TC 008 through TC 255 are used (operation will be normal for TC 004 through TC 007).
10 ms or longer	TIMH(15) may be inaccurate when TC 004 through TC 255 are used (operation will be normal for TC 000 through TC 003).
10 ms or longer	Programming using the 0.02-second Clock Bit (SR 25401) may be inaccurate.
10 ms or longer	TIM may be inaccurate. Programming using the 0.1-second Clock Bit (SR 25500) may be inaccurate. A CYCLE TIME OVER error is generated (SR 25309 will turn ON).
10 ms or longer	The FALS 9F monitoring time SV is exceeded. A system error (FALS 9F) is generated, and operation stops.
10 ms or longer	Programming using the 0.2-second Clock Bit (SR 25501) may be inaccurate.

10 I/O points (10 input points and 12 output points). The I/O is configured as follows:

18 inputs: 2 words (00000 to 00011, 00100 to 00105)
 12 outputs: 2 words (01000 to 01007, 01100 to 01103)

The rest of the operating conditions are assumed to be as follows:

User's program: 500 instructions (consists of only LD and OUT)
 Cycle time: Variable (no minimum set)

The average processing time for a single instruction in the user's program is assumed to be 1.26 μ s. The cycle times are as shown in the following table.

Process	Calculation method	Time with Programming Device	Time without Programming Device
Overseeing	Fixed	0.3 ms	0.3 ms
Program execution	1.26×500 (μ s)	0.6 ms	0.6 ms
Cycle time calculation	Negligible	0 ms	0 ms
I/O refreshing	Fixed	0.3 ms (CPM2C: 0.06 ms)	0.3 ms (CPM2C: 0.06 ms)
Peripheral port servicing	Minimum time	0.55 ms	0 ms
Cycle time	(1) + (2) + (3) + (4) + (5)	1.75 ms (CPM2C: 1.51 ms)	1.2 ms (CPM2C: 0.96 ms)

- Note**
1. The cycle time can be read from the PC via a Programming Device.
 2. The maximum and current cycle time are stored in AR 14 and AR 15.
 3. The cycle time can vary with actual operating conditions and will not necessarily agree precisely with the calculated value.

2-2 I/O Response Time

The I/O response time is the time it takes after an input signal has been received (i.e., after an input bit has turned ON) for the PC to check and process the information and to output a control signal (i.e., to output the result of the processing to an output bit). The I/O response time varies according to the timing processing conditions.

The minimum and maximum I/O response times are shown here, using the following program as an example.



The following conditions are taken as examples for calculating the I/O response times.

Input ON delay: 10 ms (input time constant: default set)
 Overseeing time: 1 ms (includes I/O refreshing)
 Instruction execution time: 14 ms
 Output ON delay: 15 ms
 Communications ports: Not used.

prior to I/O refreshing, as shown in the illustration below.

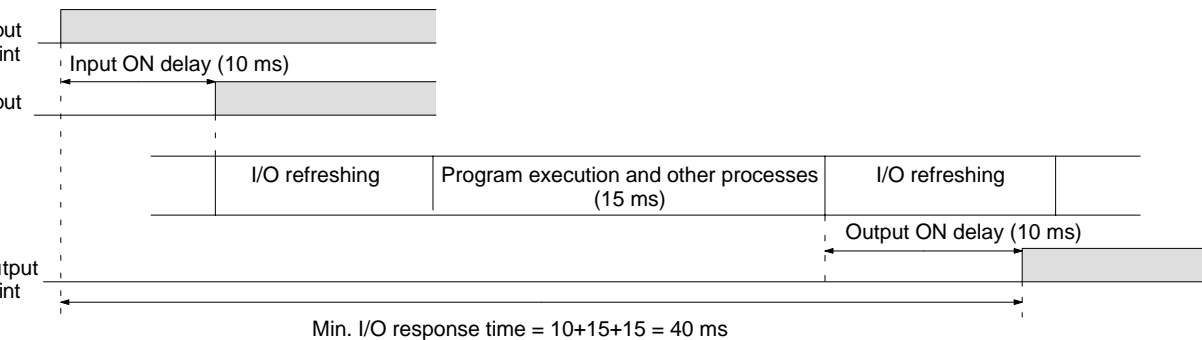

Maximum I/O Response Time The CPM2A/CPM2C takes longest to respond when it receives the input signal just after the input refresh phase of the cycle, as shown in the illustration below. In that case, a delay of approximately one cycle will occur.

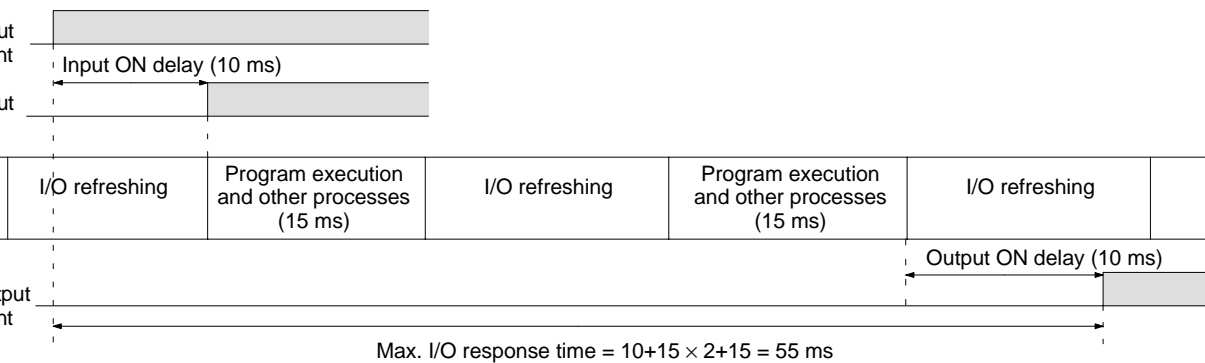

2-3 One-to-one PC Link I/O Response Time

When two CPM2A/CPM2Cs are linked 1:1, the I/O response time is the time required for an input executed at one of the CPM2A/CPM2Cs to be output to the other CPM2A/CPM2C by means of 1:1 PC Link communications.

The minimum and maximum I/O response times are shown here, using as an example the following instructions executed at the master and the slave. In this example, communications proceed from the master to the slave.

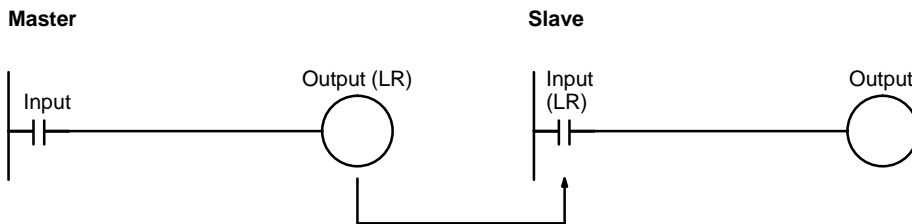

The following conditions are taken as examples for calculating the I/O response times. In CPM2A/CPM2C PCs, LR area words LR 00 to LR 15 are used in PC Link communications and the transmission time is fixed at 21 ms.

- Input ON delay: 10 ms (input time constant: default setting)
- Master cycle time: 10 ms
- Slave cycle time: 15 ms
- Output ON delay: 15 ms

Minimum I/O Response Time The CPM2A/CPM2C responds most quickly under the following circumstances:

- phase of the cycle.
- The Master's communications servicing occurs just as the Master-to-Slave transmission begins.
 - The Slave's communications servicing occurs just after the transmission is completed.

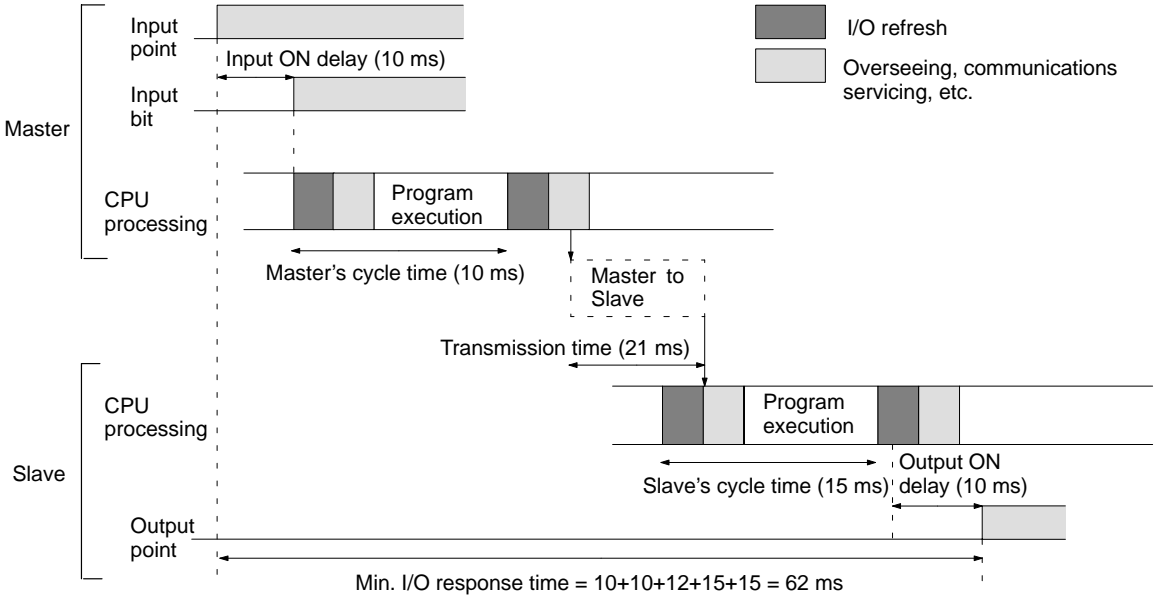

Maximum I/O Response Time The CPM2A/CPM2C takes the longest to respond under the following circumstances:

- 1, 2, 3... The CPM2A/CPM2C receives an input signal just after the input refresh phase of the cycle.
- The Master's communications servicing just misses the Master-to-Slave transmission.
- The transmission is completed just after the Slave's communications servicing ends.

Maximum Response Time Input ON response time + Master's cycle time × 2 + Transmission time × 2 + Slave's cycle time × 2 + Output ON response time

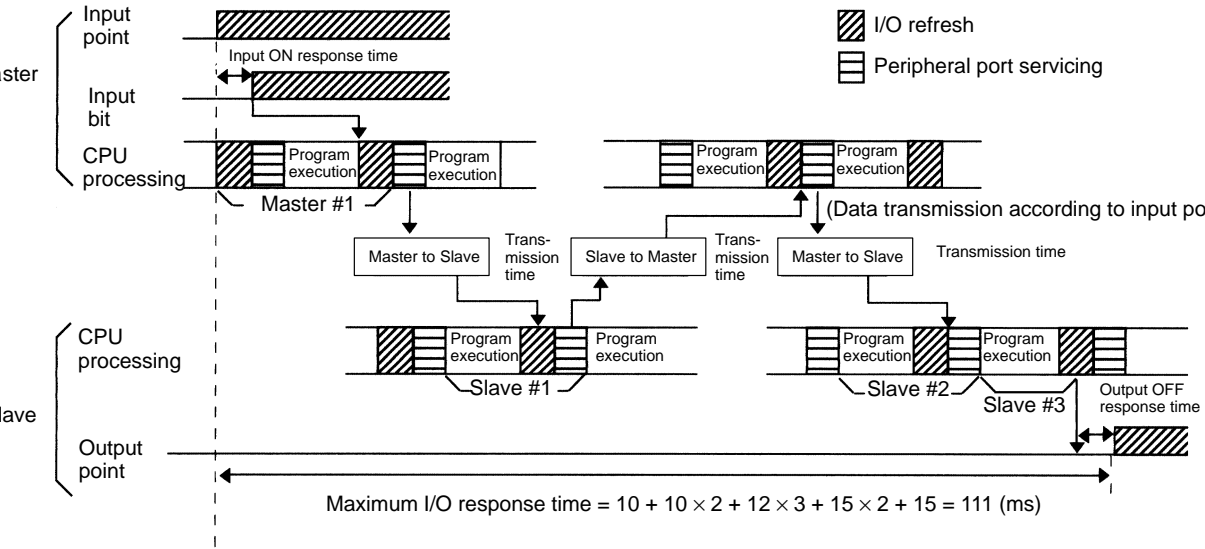

This section explains the processing times involved from the time an interrupt is executed until the interrupt processing routine is called, and from the time an interrupt processing routine is completed until returning to the initial location. This explanation applies to input interrupts, interval timer interrupts, and high-speed counter interrupts.

- 1, 2, 3...**
1. Source of interrupt
 2. Interrupt ON delay
 3. Wait for completion of interrupt-mask processing
 4. Change to interrupt processing
 5. Interrupt routing (CPM1A/CPM2A/CPM2C only)
 6. Return to initial location

The table below shows the times involved from the generation of an interrupt signal until the interrupt processing routine is called, and from when the interrupt processing routine is completed until returning to the original position.

Item	Contents	Time
Interrupt ON delay	This is the delay time from the time the interrupt input bit turns ON until the time that the interrupt is executed. This delay does not affect other interrupts.	100 μ s
Wait for completion of interrupt-mask processing	When a process that disables (masks) the interrupt is being executed, this is the time required for that process to be completed.	See below
Change to interrupt processing	This is the time it takes to change processing to the interrupt process.	30 μ s
Return	This is the time it takes, from execution of RET(93), to return to the processing that was interrupted.	30 μ s

Mask Processing

Interrupts are masked during processing of the operations described below. Until the processing is completed, any interrupts will remain masked for the indicated times.

Generation and clearing of non-fatal errors:

Interrupts will be masked for up to 100 μ s when a non-fatal error has been generated and the error contents are being registered in the PC, or when the error is being cleared.

Online editing:

Operation will stop and interrupts will be masked for up to 600 ms (DM 6144 to DM 6655) when online editing is executed or the settings are changed with STUP(—) during operation. The program or PC Setup can be overwritten during that delay.

In addition to the online editing delay, interrupts may be masked for up to 170 μ s for system processing.

Example Calculation

This example shows the interrupt response time (i.e., the time from when an interrupt input turns ON until the start of the interrupt processing routine) when input interrupts are used under the conditions shown below.

Minimum Response Time

Interrupt ON delay:	100 μ s
Interrupt mask standby time:	0 μ s
<u>+ Change-to-interrupt processing:</u>	<u>30 μs</u>
Minimum response time:	130 μ s

Maximum Response Time

(Except for the Online Editing of DM 6144 to DM 6655)

Interrupt ON delay:	100 μ s
Interrupt mask standby time:	170 μ s
<u>+ Change-to-interrupt processing:</u>	<u>30 μs</u>
Maximum response time:	300 μ s

the interrupt processing routine itself and a return time of 60 µs must also be counted for when returning to the process that was interrupted.

2-5 CPM2A/CPM2C Instruction Execution Times

The following table lists the execution times for CPM2A/CPM2C (including CPM2C-S) instructions.

Basic Instructions

Code	Mnemonic	ON execution time (µs)	Conditions (Top: min.; bottom: max.)	OFF execution time (µs)		
				RSET	IL	JMP
	LD LD NOT	0.64	Any	---		
	AND AND NOT OR OR NOT	0.52				
	AND LD OR LD	0.26				
	OUT OUT NOT	1.88				
	SET RSET	2.58				
	TIM	4.76	Constant for SV	7.8	7.6	2.9
			*DM for SV	15.6	15.4	2.9
	CNT	4.50	Constant for SV	6.8	2.9	3.1
			*DM for SV	14.5	2.9	3.1

Special Instructions

Code	Mnemonic	ON execution time (µs)	Conditions (Top: min.; bottom: max.)	OFF execution time (µs)		
				RSET	IL	JMP
	NOP	0.15	Any	---		
	END	6.2				
	IL	1.1		2.1	---	
	ILC	1.6		1.6	---	
	JMP	0.95		1.8	---	
	JME	2.1		2.1	---	
	FAL	20.5		2.5	---	
	FALS	2.9		2.5	---	
	STEP	7.3		6.0	---	
	SNXT	5.1		3.6	---	
	SFT	10.4	With 1-word shift register	Reset	IL	JMP
		15.3	With 10-word shift register	9.2	0.98	0.98
		39.6	With 53-word shift register	11.9	1.0	1.0
				26.2	1.0	1.0
	KEEP	3.2	Any	Reset	IL	JMP
				3.1	1.2	1.3
	CNTR	10.9	Constant for SV	Reset	IL	JMP
		18.8	*DM for SV	7.9	5.5	5.6
	DIFU	5.5	Any	Shift	IL	JMP
				5.1	4.8	0.96
	DIFD	5.3	Any	Shift	IL	JMP
				5.4	4.7	0.97

	time (µs)		Reset	IL	JMP
TIMH	9.0	Regular execution, constant for SV	13.0	12.6	6.1
	9.6	Interrupt execution, constant for SV	14.4	14.0	7.5
	9.8	Regular execution, *DM for SV	20.8	20.5	6.1
	10.7	Interrupt execution, *DM for SV	22.2	22.0	7.5
WSFT	14.0	With 1-word shift register	2.6		
	18.6	With 10-word shift register			
	1.15 ms	With 2,048-word shift register using *DM			
ASFT	13.0	Shifting 1 word	2.6		
	22.9	Shifting 10 words			
	1.51 ms	Shifting 2,048 words via *DM			
CMP	7.0	When comparing a constant to a constant	2.6		
	8.3	When comparing two words			
	12.1	When comparing two *DM			
MOV	7.8	When transferring a constant to a word	2.6		
	8.4	When transferring from one word to another			
	22.8	When transferring *DM to *DM			
MVN	7.9	When transferring a constant to a word	2.6		
	8.4	When transferring from one word to another			
	22.8	When transferring *DM to *DM			
BIN	15.8	When converting a word to a word	2.6		
	30.3	When converting *DM to *DM			
BCD	14.6	When converting a word to a word	2.6		
	29.0	When converting *DM to *DM			
ASL	8.6	When shifting a word	2.5		
	15.8	When shifting *DM			
ASR	8.4	When shifting a word	2.5		
	15.6	When shifting *DM			
ROL	7.3	When rotating a word	2.5		
	14.5	When rotating *DM			
ROR	7.3	When rotating a word	2.5		
	14.5	When rotating *DM			
COM	8.9	When inverting a word	2.5		
	16.1	When inverting *DM			
ADD	14.7	Constant + constant → word	2.6		
	16.0	Word + word → word			
	37.6	*DM + *DM → *DM			
SUB	14.6	Constant – constant → word	2.6		
	15.8	Word – word → word			
	37.5	*DM – *DM → *DM			
MUL	26.8	Constant × constant → word	2.6		
	28.3	Word × word → word			
	51.0	*DM × *DM → *DM			
DIV	25.9	Constant ÷ constant → word	2.6		
	27.5	word ÷ word → word			
	50.1	*DM ÷ *DM → *DM			
ANDW	12.3	Constant ∧ constant → word	2.6		
	13.8	Word ∧ word → word			
	35.4	*DM ∧ *DM → *DM			

	time (µs)		
ORW	12.3	Constant V constant → word	2.6
	13.8	Word V word → word	
	35.4	*DM V *DM → *DM	
XORW	12.3	Constant ∨ constant → word	2.6
	13.8	Word ∨ word → word	
	35.4	*DM ∨ *DM → *DM	
XNRW	12.3	Constant ∇ constant → word	2.6
	13.8	Word ∇ word → word	
	35.5	*DM ∇ *DM → *DM	
INC	8.8	When incrementing a word	2.5
	15.9	When incrementing *DM	
DEC	8.9	When decrementing a word	2.5
	16.1	When decrementing *DM	
STC	3.0	Any	2.5
CLC	3.0		2.5
MSG	9.9	With message in words	2.5
	17.8	With message in *DM	
RXD	71.9	Word specification, 1 byte input	2.6
	314.5	*DM specification, 256 bytes input	
TXD	32.4	Word specification, 1 byte input, RS-232C	2.6
	264.5	*DM specification, 256 bytes input, RS-232C	
	27.7	Word specification, 1 byte input, Host Link	
	42.2	*DM specification, 256 bytes input, Host Link	
ADB	14.1	Constant + constant → word	2.6
	15.6	Word + word → word	
	37.4	*DM + *DM → *DM	
SBB	14.4	Constant – constant → word	2.6
	15.9	Word – word → word	
	37.7	*DM – *DM → *DM	
MLB	16.8	Constant × constant → word	2.6
	18.5	Word × word → word	
	41.2	*DM × *DM → *DM	
DVB	16.9	Constant ÷ constant → word	2.6
	18.6	Word ÷ word → word	
	41.3	*DM ÷ *DM → *DM	
ADDL	25.3	Word + word → word	2.6
	48.6	*DM + *DM → *DM	
SUBL	25.3	Word – word → word	2.6
	48.6	*DM – *DM → *DM	
MULL	79.1	Word × word → word	2.6
	102.1	*DM × *DM → *DM	
DIVL	73.9	Word ÷ word → word	2.6
	98.6	*DM ÷ *DM → *DM	
BINL	23.9	When converting word data to a word	2.6
	38.5	When converting *DM to *DM	
BCDL	19.1	When converting word data to a word	2.6
	33.7	When converting *DM to *DM	
CMPL	14.8	Comparing words	2.6
	30.6	Comparing *DM	

	time (µs)		
INI	68.8	Starting high-speed counter comparison	2.6
	12.0	Stopping high-speed counter comparison	
	43.3	Specifying a constant when changing high-speed counter PV	
	51.8	Specifying *DM when changing high-speed counter PV	
	42.8	Specifying increment mode via constant	
	50.8	Specifying increment mode via *DM	
	60.1	Stopping pulse output	
	42.7	Specifying a constant when changing pulse output PV	
	50.7	Specifying *DM when changing pulse output PV	
	17.8	Stopping synchronized control of high-speed counter	
	20.0	Specifying a constant when changing interrupt counter PV	
	27.6	Specifying *DM when changing interrupt counter PV	
	PRV	36.9	
44.7		Reading high-speed counter PV *DM	
36.6		Specifying increment mode via word	
44.3		Specifying increment mode via *D	
38.5		Specifying a word when using synchronized control	
46.2		Specifying *DM when using synchronized control	
20.2		Reading high-speed counter pulse output status via word	
27.4		Reading high-speed counter pulse output status via *DM	
24.4		Reading high-speed counter read range comparison results via word	
32.4		Reading high-speed counter read range comparison results via *DM	
39.9		Reading pulse output PV via word	
47.8		Reading pulse output PV via *DM	
20.1		Reading interrupt counter PV via word	
27.1		Reading interrupt counter PV via *DM	

CTBL	186.0	Registering a target value comparison table and starting comparison in incrementing/decrementing pulse input mode via word	2.6
	807.5	Registering a target value comparison table and starting comparison in incrementing/decrementing pulse input mode via *DM	
	185.8	Registering a target value comparison table and starting comparison in incrementing mode via word	
	781.9	Registering a target value comparison table and starting comparison in incrementing mode via *DM	
	410.0	Registering a range comparison table and starting comparison in incrementing/decrementing pulse input mode via word	
	418.9	Registering a range comparison table and starting comparison in incrementing/decrementing pulse input mode via *DM	
	380.6	Registering a range comparison table and starting comparison in incrementing mode via word	
	399.7	Registering a range comparison table and starting comparison in incrementing mode via *DM	
	183.4	Only registering a target value comparison table in incrementing/decrementing pulse input mode via word	
	810.3	Only registering a target value comparison table in incrementing/decrementing pulse input mode via *DM	
	182.4	Only registering a target value comparison table in incrementing mode via word	
	776.3	Only registering a target value comparison table in incrementing mode via *DM	
	351.0	Only registering a range comparison table in incrementing/decrementing pulse input mode via word	
	359.1	Only registering a range comparison table in incrementing/decrementing pulse input mode via *DM	
	331.2	Only registering a range comparison table in incrementing mode via word	
335.9	Only registering a range comparison table in incrementing mode via *DM		
SPED	44.6	Specifying a constant in independent mode	2.6
	53.8	Specifying *DM in independent mode	
	42.9	Specifying a constant in continuous pulse output mode	
	52.0	Specifying *DM in continuous pulse output mode	
	34.1	Specifying a word when changing output frequency	
	39.8	Specifying *DM when changing output frequency	

	time (µs)		
PULS	38.4	Specifying a relative pulse for the set pulse output via a word	2.6
	46.6	Specifying a relative pulse for the set pulse output via *DM	
	40.0	Specifying an absolute pulse for the set pulse output via a word	
	48.1	Specifying an absolute pulse for the set pulse output via *DM	
SCL	37.9	Specifying a parameter word; constant to word	2.6
	39.2	Specifying a parameter word; word to word	
	59.9	Specifying a parameter *DM ; *DM to *DM	
BCNT	24.9	When counting 1 word	2.6
	4.32 ms	When counting 2,048 words via *DM	
BCMP	35.3	Comparing constant, results to word	2.6
	38.3	Comparing word, results to word	
	58.1	Comparing *DM, results to *DM	
STIM	25.7	Constant-set one-shot interrupt start	2.6
	47.8	*DM-set one-shot interrupt start	
	25.9	Constant-set scheduled interrupt start	
	47.8	*DM-set scheduled interrupt start	
	34.0	Constant-set timer read	
	46.4	*DM-set timer read	
	10.6	Stopping timer	
XFER	21.3	When transferring a constant to a word	2.6
	23.8	When transferring a word to a word	
	1.52 ms	When transferring 2,048 words using *DM	
BSET	13.8	When setting a constant to a word	2.6
	14.3	When setting a word to a word	
	971.1	When setting *DM to 2,048 words	
XCHG	14.5	Word → word	2.6
	29.3	*DM → *DM	
SLD	12.3	Shifting 1 word	2.6
	23.9	Shifting 10 words	
	2.83 ms	Shifting 2,048 words using *DM	
SRD	12.3	Shifting 1 word	2.6
	23.9	Shifting 10 words	
	2.83 ms	Shifting 2,048 words using *DM	
MLPX	16.8	When decoding word to word	2.6
	46.1	When decoding *DM to *DM	
DMPX	19.7	When encoding word to word	2.6
	52.1	When encoding *DM to *DM	
SDEC	19.8	When decoding word to word	2.6
	48.3	When decoding *DM to *DM	
DIST	18.7	When setting a constant to a word + a word	2.6
	20.2	When setting a word to a word + a word	
	43.1	When setting *DM to *DM + *DM	
	31.0	When setting a constant to a stack	
	32.7	When setting a word to a stack	
	55.9	When setting *DM to a stack via *DM	

	time (µs)		
COLL	21.5	When setting a constant + a word to a word	2.6
	21.9	When setting a word + a word to a word	
	42.5	When setting *DM + *DM to *DM	
	31.5	When setting a word + constant to FIFO stack	
	32.0	When setting a word + word to FIFO stack	
	784.7	When setting a *DM + *DM to FIFO stack via *DM	
	33.6	When setting a word + constant to LIFO stack	
	34.0	When setting a word + word to LIFO stack	
	57.1	When setting a *DM + *DM to LIFO stack via *DM	
MOVB	17.3	When transferring a constant to a word	2.6
	18.0	When transferring from one word to another	
	41.7	When transferring *DM to *DM	
MOVD	13.8	When transferring a constant to a word	2.6
	16.2	When transferring from one word to another	
	38.1	When transferring *DM to *DM	
SFTR	22.8	Shifting 1 word	2.6
	24.3	Shifting 10 words	
	1.15 ms	Shifting 2,048 words using *DM	
TCMP	27.5	Comparing constant to word-set table	2.6
	28.0	Comparing word to word-set table	
	48.3	Comparing *DM to *DM-set table	
ASC	19.1	Word → word	2.6
	52.2	*DM → *DM	
INT	22.1	Set masks via word	2.6
	30.1	Set masks via *DM	
	18.4	Clear interrupts via word	
	26.4	Clear interrupts via *DM	
	17.2	Read mask status via word	
	24.1	Read mask status via *DM	
	23.1	Change counter SV via word	
	31.1	Change counter SV via *DM	
	10.7	Mask all interrupts via word	
	10.7	Mask all interrupts via *DM	
	11.0	Clear all interrupts via word	
11.0	Clear all interrupts via *DM		
SBS	10.8	Any	2.6
SBN	---		0.76
RET	6.2		1.0
IORF	16.8	Refreshing IR 000	2.8
	130.7	Refreshing one input word	
	110.7	Refreshing one output word	
MCRO	26.1	With word-set I/O operands	2.6
	42.3	With *DM-set I/O operands	

de	Mnemonic	ON execution time (μs)	Conditions (Top: min.; bottom: max.)	OFF execution time (μs)
	ACC	66.5	When specifying a word in independent mode and CW/CCW mode	2.6
		92.1	When specifying *DM in independent mode and CW/CCW mode	
		66.2	When specifying a word in independent mode and Feed/Dir mode	
		92.2	When specifying *DM in independent mode and Feed/Dir mode	
		65.5	When executing the word designation in CW continuous mode and CW/CCW mode	
		75.0	When executing the *DM designation in CW continuous mode and CW/CCW mode	
		45.4	When changing the word designation in CW continuous mode and CW/CCW mode	
		53.8	When changing the *DM designation in CW continuous mode and CW/CCW mode	
		65.5	When executing the word designation in CCW continuous mode and CW/CCW mode	
		75.0	When executing the *DM designation in CCW continuous mode and CW/CCW mode	
		45.5	When changing the word designation in CCW continuous mode and CW/CCW mode	
		53.6	When changing the *DM designation in CCW continuous mode and CW/CCW mode	
		65.0	When executing the word designation in CW continuous mode and Feed/Dir mode	
		74.5	When executing the *DM designation in CW continuous mode and Feed/Dir mode	
		45.4	When changing the word designation in CW continuous mode and Feed/Dir mode	
		53.5	When changing the *DM designation in CW continuous mode and Feed/Dir mode	
		65.4	When executing the word designation in CCW continuous mode and Feed/Dir mode	
		74.8	When executing the *DM designation in CCW continuous mode and Feed/Dir mode	
		45.5	When changing the word designation in CCW continuous mode and Feed/Dir mode	
		53.6	When changing the *DM designation in CCW continuous mode and Feed/Dir mode	
	AVG	23.2	Average for 1 cycle (constant designation)	3.2
		23.9	Average for 1 cycle (word designation)	
		84.2	Average for 64 cycles (*DM designation)	
	FCS	27.6	Adding one word and outputting to word	2.6
		592.3	Adding 999 words and outputting to *DM	
	HEX	25.8	Word → Word	2.6
		72.2	*DM → *DM	
	HMS	30.7	When converting word to word	2.6
		45.0	When converting *DM to *DM	
	MAX	21.9	Searching one word and outputting to word	2.6
		713.9	Searching 999 words and outputting to *DM	
	MIN	21.9	Searching one word and outputting to word	2.6
		713.9	Searching 999 words and outputting to *DM	

	time (µs)				
NEG	12.0	Converting constant to word	3.0		
	12.8	Converting word to word			
	28.3	Converting *DM to *DM			
PID	392.5	Initializing word to word	3.3		
	418.8	Initializing *DM to *DM			
	29.3	Sampling word to word			
	58.7	Sampling *DM to *DM			
PWM	30.3	Constant for pulse width ratio	2.6		
	43.4	Word for pulse width ratio			
	46.0	*DM for pulse width ratio			
SCL2	35.1	Parameter word designation, word to word	2.6		
	59.3	Parameter *DM designation, *DM to *DM			
SCL3	37.1	Parameter word designation, word to word	2.6		
	62.3	Parameter *DM designation, *DM to *DM			
SEC	29.8	Converting from word to word	2.6		
	44.0	Converting from *DM to *DM			
SRCH	28.9	Searching one word and outputting to a word	2.6		
	1.40 ms	*DM specification, searching 2,048 words and outputting to *DM			
STUP	3.42 ms	Constant specification, executed first scan	2.6		
	34.1	Constant specification, executed second scan or later			
	3.44 ms	*DM specification, executed first scan			
	39.8	*DM specification, executed second scan or later			
SUM	22.8	Word added and output to word	2.6		
	1.44 ms	*DM specification, 999 bytes added and output to *DM			
SYNC	34.6	Constant ratio specification, when executed	2.6		
	35.3	Word ratio specification, when executed			
	42.5	*DM ratio specification, when executed			
	25.3	Word ratio specification, when changed			
	32.6	*DM ratio specification, when changed			
TIML			Reset	IL	JMP
	12.8	Normal execution, constant specification	17.9	17.5	8.1
	13.5	Interrupt execution, constant specification	25.7	25.5	8.1
TMHH			Reset	IL	JMP
	12.3	Normal execution, constant specification	15.6	15.1	7.4
	12.7	Interrupt execution, constant specification	17.2	16.9	9.1
	12.7	Normal execution, *DM specification	23.6	23.3	7.7
ZCP	13.6	Interrupt execution, *DM specification	25.1	24.7	9.1
	9.4	Comparing a constant to a constant range and output to word	2.6		
	11.8	Comparing a word to a word range and output to word			
33.4	Comparing *DM to *DM and output to *DM				
ZCPL	19.5	Comparing a word to a word range	2.6		
	45.2	Comparing *DM to *DM			

3-1 The SRM1(-V2) Cycle

The overall flow of SRM1(-V2) operation is as shown in the following flowchart

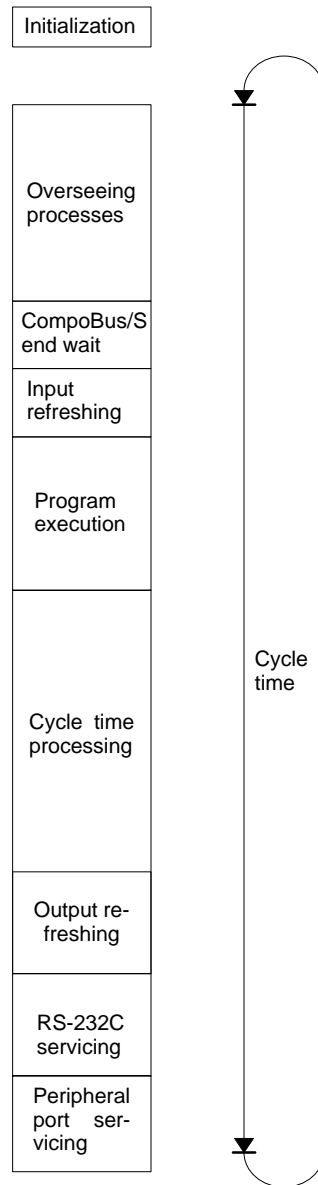

- Note**
1. The cycle time can be read using Programming Devices.
 2. Cycle time maximum and current cycle time are stored in AR 14 and AR 15.
 3. Change to processing will cause cycle times to change therefore the calculated values and actual values (for cycle time) will no always match.

The processes involved in a single SRM1(-V2) cycle are shown in the following table, and their respective processing times are explained.

Process	Content	Time requirements
Overseeing	Setting cycle watchdog timer, UM check, etc.	0.18 ms
CompoBus/S end wait	Waiting for CompoBus/S processing to finish	CompoBus/S communications response time – Overseeing time – RS-232C port servicing time – peripheral port servicing time
Input refreshing	Input information is read to input bits.	0.02 ms
Program execution	User program is executed. Refer to 8-3-6 SRM1(-V2) <i>Instruction Execution Times</i> .	Total time for executing instruction (Varies according to content of user program.)
Cycle time calculation	Standby until set time, when minimum cycle time is set in DM 6619 of PC Setup. Calculation of cycle time.	Almost instantaneous, except for standby processing.
Output refreshing	Output information (results of executing program) is written to output bits. CompoBus/S communications are started.	0.05 ms
RS-232C port servicing	Devices connected to RS-232C port serviced.	5% or less of cycle time, but always between 0.55 and 131 ms (Set in DM 6616.)
Peripheral port servicing	Devices connected to peripheral port serviced.	5% or less of cycle time, but always between 0.55 and 131 ms (Set in DM 6617.)

Minimum Cycle Time

In SRM1(-V2) PCs, CompoBus/S communications are started after the output refresh is completed. As a result, when the overseeing time plus the RS-232C port servicing time plus the peripheral port servicing time is shorter than CompoBus/S communications response time, processing is placed on standby until CompoBus/S communications are completed.

The minimum cycle time therefore is the CompoBus/S communications response time plus the program execution time plus the input refresh time plus the output refresh time. The CompoBus/S communications response time depends on the “maximum number of nodes” and “communications mode” settings as follows:

Max. number of nodes	Communications mode	CompoBus/S response time
32	High-speed mode	0.8 ms
	Long-distance mode	6.0 ms
16	High-speed mode	0.5 ms
	Long-distance mode	4.0 ms

Note The maximum number of nodes and communications mode are set in the PC Setup (DM 6603).

When a long cycle time is affecting operation, either reduce the cycle time or improve responsiveness with interrupt programs.

Cycle time	Operation conditions
ms or longer	TIMH(15) may be inaccurate when TC 004 through TC 127 are used (operation will be normal for TC 000 through TC 003).
ms or longer	Programming using the 0.02-second Clock Bit (SR 25401) may be inaccurate.
0 ms or longer	TIM may be inaccurate. Programming using the 0.1-second Clock Bit (SR 25500) may be inaccurate. A CYCLE TIME OVER error is generated (SR 25309 will turn ON). See note 1.
0 ms or longer	The FALS 9F monitoring time SV is exceeded. A system error (FALS 9F) is generated, and operation stops. See note 2.
0 ms or longer	Programming using the 0.2-second Clock Bit (SR 25501) may be inaccurate.

- Note**
1. The PC Setup (DM 6655) can be used to disable detection of CYCLE TIME OVER error.
 2. The cycle monitoring time can be changed in the PC Setup (DM 6618).

Cycle Time Example

The following is an example of a cycle time calculation.

The operating conditions are assumed to be as follows:

User's program: 500 instructions (consists of only LD and OUT)

Cycle time: Variable (no minimum set)

RS-232C port: Not used.

Max. nodes: 32 nodes and high-speed communications mode
(CompoBus/S communication response time = 0.8 ms)

Peripheral: 0.7 ms

The average processing time for a single instruction in the user's program is assumed to be 1.16 μ s. The cycle times are as shown in the following table.

Process	Calculation method	Peripheral port used	Peripheral port not used
Overseeing	Fixed	0.18 ms	0.18 ms
CompoBus/S end wait	See previous page.	0.00 ms	0.62 ms
Input refresh	Fixed	0.02 ms	0.02 ms
Program execution	$1.16 \times 500 (\mu\text{s})$	0.8 ms	0.8 ms
Cycle time calculation	Negligible	0.00 ms	0.00 ms
Output refresh	$0.01 \times 1 + 0.005 \times 1 (\mu\text{s})$	0.05 ms	0.05 ms
RS-232C port servicing	Not required	0.00 ms	0.00 ms
Peripheral port servicing	5% of cycle time	0.7 ms	0.00 ms
Cycle time	(1) + (2) + (3) + ... + (8)	1.75 ms	1.67 ms

- Note**
1. The cycle time can be read from the PC via a Programming Device.
 2. The maximum and current cycle time are stored in AR 14 and AR 15.
 3. The cycle time can vary with actual operating conditions and will not necessarily agree precisely with the calculated value.
 4. When the peripheral port is used, there is no CompoBus/S end wait time. It is always 0 or less.
 5. CompoBus/S end wait time = $0.8 - 0.18 - 0 - 0 = 0.62$ (CompoBus/S communication response time - Overseeing - RS-232C port servicing time - peripheral port servicing time).

The I/O response time is the time it takes after an input signal has been received (i.e., after an input bit has turned ON) for the PC to check and process the information and to output a control signal (i.e., to output the result of the processing to an output bit).

CompoBus/S communications are started when the SRM1(-V2) input refreshes. The ON/OFF status is read from the Input Terminals during the input refresh and the ON/OFF status is output to the Output Terminal during the output refresh. Accordingly, the SRM1(-V2) I/O response time varies according to the cycle time and CompoBus/S communications cycle status or I/O timing.

Example calculations of the I/O response time are provided next.

Minimum I/O Response Time

Minimum I/O response time =
 Input ON delay + Output ON delay + CompoBus/S communications cycle time
 SRM1(-V2) cycle time

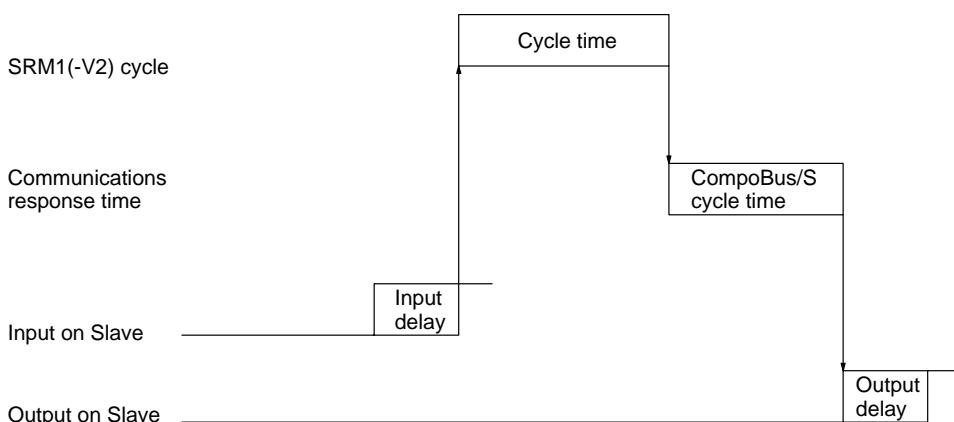

Maximum I/O Response Time

Maximum I/O response time =
 Input ON delay + Output ON delay + CompoBus/S communications cycle time
 SRM1(-V2) cycle time x 2

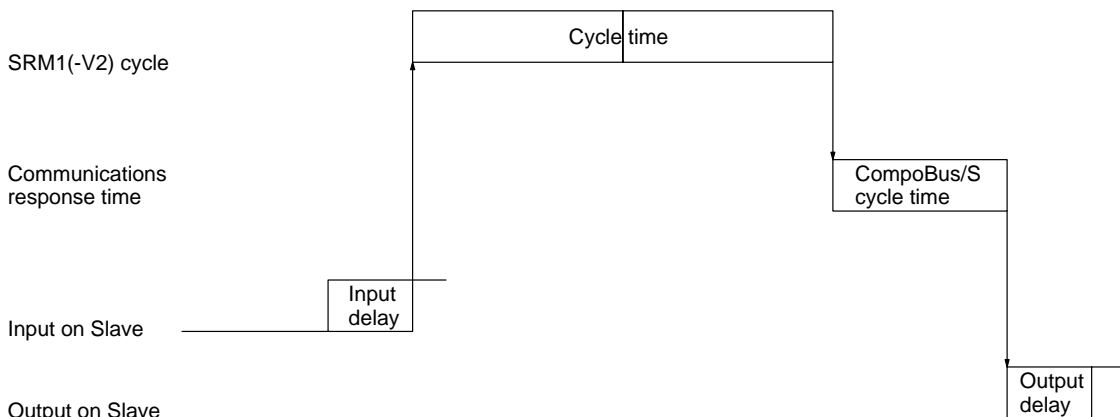

When two SRM1s are linked in a 1:1 PC Link, the I/O response time is the required for an input executed at one of the SRM1s to be output to the other SRM1 by means of 1:1 PC Link communications.

Minimum I/O Response Time The SRM1(-V2) responds most quickly under the following circumstances:

- 1, 2, 3... 1. The SRM1(-V2) receives an input signal just prior to the I/O refresh phase of the cycle.
2. The Master's communications servicing occurs just as the Master-to-Slave transmission begins.
3. The Slave's communications servicing occurs just after the transmission is completed.

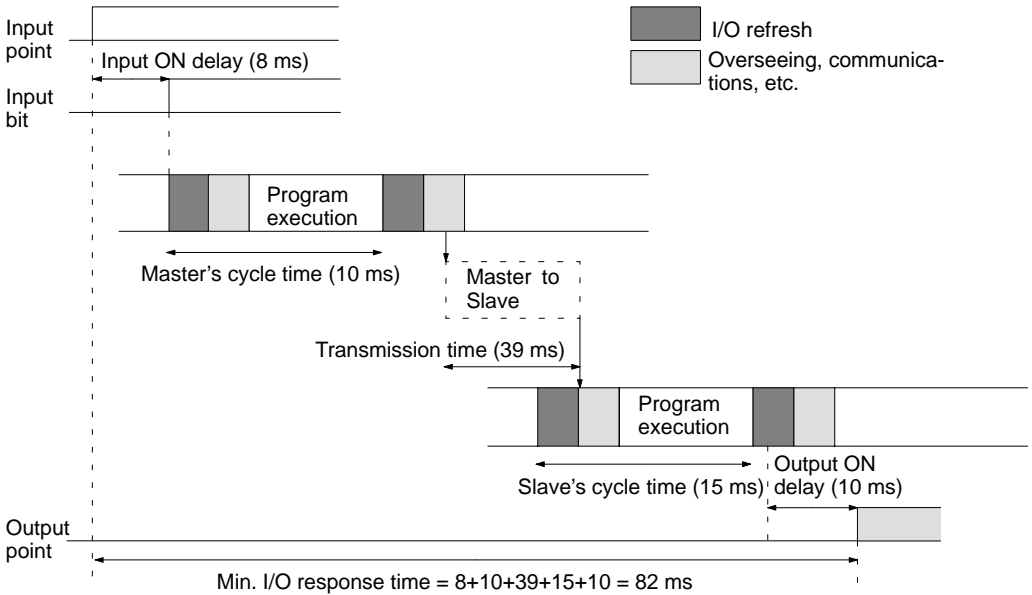

Maximum I/O Response Time The SRM1(-V2) takes the longest to respond under the following circumstances:

- 1, 2, 3... 1. The SRM1(-V2) receives an input signal just after the I/O refresh phase of the cycle.
2. The Master's communications servicing just misses the Master-to-Slave transmission.

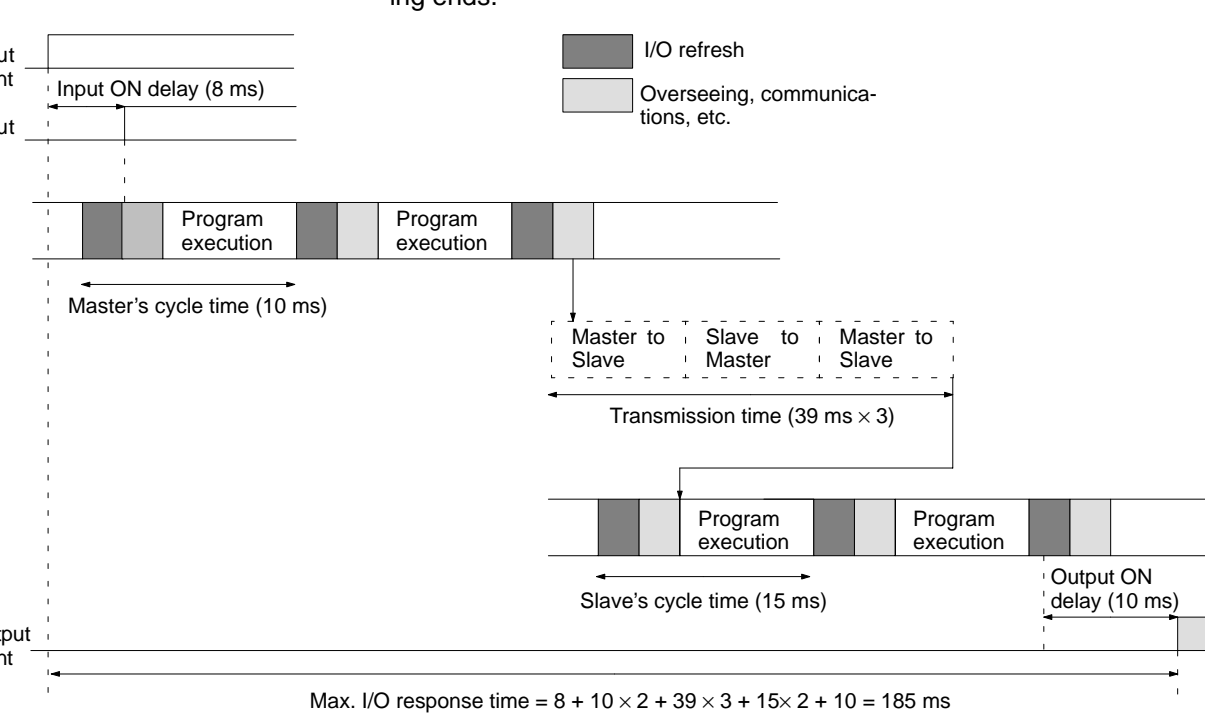

3-5 Interrupt Processing Time

This section explains the processing times involved from the time an interrupt is generated until the interrupt processing routine is called, and from the time an interrupt processing routine is completed until returning to the initial location. This explanation applies to input, interval timer interrupts.

- 1, 2, 3...
1. Source of interrupt
 2. Wait for completion of interrupt-mask processing
 3. Change to interrupt processing
 4. Interrupt routing (CPM1A only)
 5. Return to initial location

The table below shows the times involved from the generation of an interrupt signal until the interrupt processing routine is called, and from when the interrupt processing routine is completed until returning to the original position.

Item	Contents	Time
Wait for completion of interrupt-mask processing	This is the time during which interrupts are waiting until processing has been completed. This situation occurs when a mask processes is executed. It is explained below in more detail.	See below
Change to interrupt processing	This is the time it takes to change processing to an interrupt.	15 μs
Return	This is the time it takes, from execution of RET(93), to return to the processing that was interrupted.	15 μs

Mask Processing

Interrupts are masked during processing of the operations described below. Until the processing is completed, any interrupts will remain masked for the indicated times.

Generation and clearing of non-fatal errors:

When a non-fatal error is generated and the error contents are registered in the SRM1(-V2), or when an error is being cleared, interrupts will be masked for a maximum of 100 μs until the processing has been completed.

Interruptions will be masked for a maximum of 600 ms (i.e.: editing DM 614 DM 6655) when online editing is executed during operation. In addition, system processing may have to wait for a maximum of 170 μs during processing.

3-6 SRM1(-V2) Instruction Execution Times

The following table lists the execution times for SRM1(-V2) instructions.

Basic Instructions

Code	Mnemonic	ON execution time (μs)	Conditions (Top: min.; bottom: max.)	OFF execution time (μs)		
				RSET	IL	JMP
	LD	0.97	Any	---		
	LD NOT	0.97		---		
	AND AND NOT	0.77		---		
	OR OR NOT	0.78	Any	---		
	AND LD OR LD	0.39	Any	---		
	OUT OUT NOT	2.2		---		
	SET	2.7		---		
	RSET	2.8		---		
	TIM	5.7	Constant for SV	9.3	9.1	3.5
			*DM for SV	17.4	17.2	3.5
	CNT	6.6	Constant for SV	8.0	3.6	3.8
			*DM for SV	16.3	3.6	3.8

Special Instructions and Expansion Instructions

Code	Mnemonic	ON execution time (μs)	Conditions (Top: min.; bottom: max.)	OFF execution time (μs)		
				RSET	IL	JMP
	NOP	0.20	Any	---		
	END	4.8		---		
	IL	2.5		1.4	---	
	ILC	1.9		1.9	---	
	JMP	2.2		1.3	---	
	JME	2.5		2.5	---	
	FAL	18.4		2.9	---	
	FALS	3.6		2.9	---	
	STEP	10.7		9.0	---	
	SNXT	5.9		4.1	---	
	SFT	14.5	With 1-word shift register	Reset	IL	JMP
		21.0	With 10-word shift register	11.0	1.4	1.4
		49.1	With 100-word shift register	14.9	1.4	1.4
	KEEP	3.0	Any	Reset	IL	JMP
				3.4	1.6	1.7
	CNTR	14.8	Constant for SV	Reset	IL	JMP
		23.2	*DM for SV	9.1	6.6	6.5
	DIFU	6.7	Any	Shift	IL	JMP
				5.8	5.2	1.3

	time (ns)		Shift	IL	JMP
DIFD	6.4	Any	5.8	5.7	1.3
TIMH	10.3	Regular execution, constant for SV	Reset	IL	JMP
	10.9	Interrupt execution, constant for SV	14.1	13.9	7.0
	10.3	Regular execution, *DM for SV	22.8	22.1	7.0
	10.9	Interrupt execution, *DM for SV	23.9	23.6	8.5
WSFT	16.2	With 1-word shift register	2.9		
	23.0	With 10-word shift register			
	712.3	With 1,024-word shift register using *DM			
ASFT*	18.6	Shifting a word	3.0		
	25.9	Shifting 10 words			
	865.7	Shifting 1,023 words via *DM			
CMP	9.1	When comparing a constant to a word	3.0		
	9.9	When comparing two words			
	25.6	When comparing two *DM			
MOV	9.1	When transferring a constant to a word	3.0		
	9.5	When transferring from one word to another			
	24.9	When transferring *DM to *DM			
MVN	9.3	When transferring a constant to a word	3.0		
	9.8	When transferring from one word to another			
	25.1	When transferring *DM to *DM			
BIN	17.2	When converting a word to a word	3.0		
	32.0	When converting *DM to *DM			
BCD	15.8	When converting a word to a word	3.0		
	30.6	When converting *DM to *DM			
ASL	9.9	When shifting a word	2.9		
	17.3	When shifting *DM			
ASR	9.7	When shifting a word	3.0		
	17.2	When shifting *DM			
ROL	8.5	When rotating a word	2.9		
	16.1	When rotating *DM			
ROR	8.5	When rotating a word	2.9		
	16.1	When rotating *DM			
COM	10.5	When inverting a word	3.0		
	17.7	When inverting *DM			
ADD	15.9	Constant + word → word	3.1		
	16.4	Word + word → word			
	39.5	*DM + *DM → *DM			
SUB	15.6	Constant – word → word	3.0		
	16.3	Word – word → word			
	38.6	*DM – *DM → *DM			
MUL	29.7	Constant × word → word	3.0		
	28.5	Word × word → word			
	51.6	*DM × *DM → *DM			
DIV	27.2	Word ÷ constant → word	2.9		
	28.5	word ÷ word → word			
	53.1	*DM ÷ *DM → *DM			

	time (µs)		
ANDW	14.3	Constant \cap word \rightarrow word	2.9
	15.2	Word \cap word \rightarrow word	
	37.3	*DM \cap *DM \rightarrow *DM	
ORW	14.3	Constant \cup word \rightarrow word	2.9
	15.2	Word \cup word \rightarrow word	
	37.3	*DM \cup *DM \rightarrow *DM	
XORW	14.3	Constant ∇ word \rightarrow word	2.9
	15.2	Word ∇ word \rightarrow word	
	37.3	*DM ∇ *DM \rightarrow *DM	
XNRW	14.3	Constant $\bar{\nabla}$ word \rightarrow word	2.9
	15.2	Word $\bar{\nabla}$ word \rightarrow word	
	37.3	*DM $\bar{\nabla}$ *DM \rightarrow *DM	
INC	9.9	When incrementing a word	2.9
	17.3	When incrementing *DM	
DEC	10.2	When decrementing a word	2.9
	17.4	When decrementing *DM	
STC	3.5	Any	2.9
CLC	3.0		2.9
MSG	11.3	With message in words	2.9
	19.4	With message in *DM	
RXD*	39.1	Word specification, 1 byte input	2.9
	116.8	*DM specification, 256 bytes input	
TXD*	31.3	Word specification, 1 byte input (RS-232C)	2.9
	266.5	*DM specification, 256 bytes input (RS-232C)	
	26.7	Word specification, 1 byte input (Host Link)	
	34.0	*DM specification, 256 bytes input (Host Link)	
ADB	16.8	Constant + word \rightarrow word	3.0
	17.6	Word + word \rightarrow word	
	39.9	*DM + *DM \rightarrow *DM	
SBB	17.0	Constant - word \rightarrow word	3.0
	17.8	Word - word \rightarrow word	
	40.2	*DM - *DM \rightarrow *DM	
MLB	19.1	Constant \times word \rightarrow word	3.0
	20.1	Word \times word \rightarrow word	
	43.5	*DM \times *DM \rightarrow *DM	
DVB	19.5	Word \div constant \rightarrow word	3.0
	20.4	Word \div word \rightarrow word	
	43.7	*DM \div *DM \rightarrow *DM	
ADDL	26.7	Word + word \rightarrow word	3.0
	49.9	*DM + *DM \rightarrow *DM	
SUBL	26.8	Word - word \rightarrow word	3.0
	49.9	*DM - *DM \rightarrow *DM	
MULL	81.4	Word \times word \rightarrow word	3.0
	106.2	*DM \times *DM \rightarrow *DM	
DIVL	76.9	Word \div word \rightarrow word	3.0
	101.8	*DM \div *DM \rightarrow *DM	
CMPL	16.9	Comparing words	2.9
	32.9	Comparing *DM	

	time (µs)		
SCL*	69.5	Word specification	3.0
	91.5	*DM specification	
BCNT*	26.9	Counting a word	3.0
	2.29 ms	Counting 6,656 words via *DM	
BCMP*	41.4	Comparing constant, results to word	3.0
	41.9	Comparing word, results to word	
	64.5	Comparing *DM, results to *DM	
STIM*	34.7	Word specification, one-shot timer start	3.0
	49.5	*DM specification, one-shot timer start	
	35.3	Word specification, scheduled interrupt start	
	50.0	*DM specification, scheduled interrupt start	
	33.9	Words specification, timer read	
	49.5	*DM specification timer read	
	11.4	Word specification, timer stop	
XFER	22.9	When transferring a constant to a word	3.0
	24.0	When transferring a word to a word	
	902.0	When transferring 1,024 words using *DM	
BSET	15.2	When setting a constant to 1 word	3.0
	15.7	When setting word constant to 10 words	
	565.2	When setting *DM to 1,024 words	
XCHG	16.2	Word → word	3.1
	31.5	*DM → *DM	
SLD	13.6	Shifting 1 word	3.0
	26.7	Shifting 10 word	
	1.54 ms	Shifting 1024 words using *DM	
SRD	13.6	Shifting 1 word	3.0
	26.6	Shifting 10 word	
	1.54 ms	Shifting 1,024 words using *DM	
MLPX	25.5	When decoding word to word	3.0
	48.9	When decoding *DM to *DM	
DMPX	35.1	When encoding word to word	3.0
	58.1	When encoding *DM to *DM	
SDEC	26.8	When decoding word to word	2.9
	49.9	When decoding *DM to *DM	
DIST	21.3	When setting a constant to a word + a word	3.0
	21.9	When setting a word to a word + a word	
	45.7	When setting *DM to *DM + *DM	
	34.3	When setting a constant to a stack	
	35.3	When setting a word to a stack	
	59.3	When setting *DM to a stack via *DM	

	time (µs)		
COLL	21.4	When setting a constant + a word to a word	3.0
	21.8	When setting a word + a word to a word	
	44.9	When setting *DM + *DM to *DM	
	34.0	When setting a word + constant to FIFO stack	
	33.9	When setting a word + word to FIFO stack	
	892.0	When setting a *DM + *DM to FIFO stack via *DM	
	35.4	When setting a word + constant to LIFO stack	
	36.1	When setting a word + word to LIFO stack	
	60.5	When setting a *DM + *DM to LIFO stack via *DM	
MOVB	18.2	When transferring a constant to a word	3.0
	19.0	When transferring one word to another	
	42.1	When transferring *DM to *DM	
MOVD	16.3	When transferring a constant to a word	2.9
	17.6	When transferring one word to another	
	39.9	When transferring *DM to *DM	
SFTR	21.0	Shifting 1 word	3.0
	26.9	Shifting 10 word	
	718.5	Shifting 1,024 words using *DM	
TCMP	30.0	Comparing constant to word-set table	3.0
	30.7	Comparing word to word-set table	
	53.1	Comparing *DM to *DM-set table	
ASC	30.0	Word → word	3.0
	53.7	*DM → *DM	
SBS	13.2	Any	3.0
SBN	---		1.3
RET	7.8		1.3
MCRO	26.8	With word-set I/O operands	3.0
	43.5	With *DM-set I/O operands	

Note Those instructions marked with an asterisk are expansion instructions.

Expansion Instructions without Default Function Codes

Code	Mnemonic	ON execution time (µs)	Conditions (Top: min.; bottom: max.)	OFF execution time (µs)
	FCS	23.4	Adding one word and outputting to word	3.0
		643.7	Adding 999 words and outputting to *DM	
	HEX	43.6	DM → DM	3.0
		73.5	*DM → *DM	
	NEG	46.0	Converting constant to word	3.0
		48.0	Converting word to word	
		65.5	Converting *DM to *DM	
	PID	420.0	Initializing word to word	3.0
		452.0	Initializing *DM to *DM	
		63.0	Sampling word to word	
		84.5	Sampling *DM to *DM	
	STUP	51.2	Transferring constant to word	3.0
		58.2	Transferring word to word	

	time (ms)		
ZCP	45.0	Comparing a word to a constant range	3.0
	46.5	Comparing a word to a word range	
	69.0	Comparing *DM to *DM	

This section describes how to diagnose and correct the hardware and software errors that can occur during PC operation.

9-1	Introduction	546
9-2	Programming Console Operation Errors	546
9-3	Programming Errors	547
9-4	User-defined Errors	548
9-5	Operating Errors	549
9-5-1	Non-fatal Errors	549
9-5-2	Fatal Errors	550
9-5-3	Other Errors	550
9-6	Error Log	551
9-7	Host Link Errors	553
9-8	Troubleshooting Flowcharts	553

PC errors can be divided broadly into the following four categories:

1, 2, 3...

1. Program Input Errors

These errors occur when inputting a program or attempting an operation used to prepare the PC for operation.

2. Programming Errors

These errors will occur when the program is checked using the Program Check operation.

3. User-defined Errors

There are three instructions that the user can use to define his own error messages. The instructions will be executed when a particular condition (defined by the user) has occurred during operation.

4. Operating Errors

These errors occur after program execution has been started.

a) Non-fatal Operating Errors

PC operation and program execution will continue after one or more of these errors have occurred.

b) Fatal Operating Errors

PC operation and program execution will stop and all outputs from the PC will be turned OFF when any of these errors have occurred.

The PC's indicators will indicate when a PC error has occurred and an error message or code will be displayed on the Programming Console or host computer if one is connected. The error code is also contained in SR 25300 to SR 25350.

For the most recent errors, both the type of error and time of occurrence will be recorded in the PC's error log area. Details are provided starting on page 553.

There are flags and other information provided in the SR and AR areas that can be used in troubleshooting. Refer to *Section 3 Memory Areas* for lists of the flags.

Note In addition to the errors described above, communications errors can occur when the PC is part of a Host Link System. Refer to page 553 for details.

2 Programming Console Operation Errors

The following error messages may appear when performing operations on the Programming Console. Correct the error as indicated and continue with the operation. The asterisks in the displays shown below will be replaced with numerical data, normally an address, in the actual display. Refer to the *Ladder Support Software Operation Manual*, *SYSMAC Support Software Operation Manual* for series PCs, or *Data Access Console Operation Manual* for errors that may appear when operating the SSS or a Data Access Console.

Message	Meaning and appropriate response
REPL ROM	An attempt was made to write to write-protected memory. Set bits 00 to 03 of DM 6602 to "0."
PROG OVER	The instruction at the last address in memory is not NOP(00). Erase all unnecessary instructions at the end of the program.
ADDR OVER	An address was set that is larger than the highest memory address in Program Memory. Input a smaller address.
SET DATA ERR	FALS 00 has been input, and "00" cannot be input. Re-input the data.
I/O NO. ERR	A data area address has been designated that exceeds the limit of the data area, e.g., an address is too large. Confirm the requirements for the instruction and re-enter the address.

These errors in program syntax will be detected when the program is checked using the Program Check operation.

Three levels of program checking are available. The desired level must be designated to indicate the type of errors that are to be detected. The following table provides the error types, displays, and explanations of all syntax errors. Check level 0 checks for type A, B, and C errors; check level 1, for type A and B errors; and check level 2, for type A errors only.

Level A Errors

Message	Meaning and appropriate response
?????	The program has been damaged, creating a non-existent function code. Re-enter the program.
CIRCUIT ERR	The number of logic blocks and logic block instructions does not agree, i.e., either LD or LD NOT has been used to start a logic block whose execution condition has not been used by another instruction, or a logic block instruction has been used that does not have the required number of logic blocks. Check your program.
OPERAND ERR	A constant entered for the instruction is not within defined values. Change the constant so that it lies within the proper range.
NO END INSTR	There is no END(01) in the program. Write END(01) at the final address in the program.
LOCN ERR	An instruction is in the wrong place in the program. Check instruction requirements and correct the program.
JME UNDEFD	A JME(05) instruction is missing for a JMP(04) instruction. Correct the jump number or insert the proper JME(05) instruction.
DUPL	The same jump number or subroutine number has been used twice. Correct the program so that the same number is only used once each.
SBN UNDEFD	The SBS(91) instruction has been programmed for a subroutine number that does not exist. Correct the subroutine number or program the required subroutine.
STEP ERR	STEP(08) with a section number and STEP(08) without a section number have been used incorrectly. Check STEP(08) programming requirements and correct the program.

Level B Errors

Message	Meaning and appropriate response
IL-ILC ERR	IL(02) and ILC(03) are not used in pairs. Correct the program so that each IL(02) has a unique ILC(03). Although this error message will appear if more than one IL(02) is used with the same ILC(03), the program will be executed as written. Make sure your program is written as desired before proceeding.
JMP-JME ERR	JMP(04) and JME(05) are not used in pairs. Make sure your program is written as desired before proceeding.
SBN-RET ERR	If the displayed address is that of SBN(92), two different subroutines have been defined with the same subroutine number. Change one of the subroutine numbers or delete one of the subroutines. If the displayed address is that of RET(93), RET(93) has not been used properly. Check requirements for RET(93) and correct the program.

COIL DUPL	The same bit is being controlled (i.e., turned ON and/or OFF) by more than one instruction (e.g., OUT, OUT NOT, DIFU(13), DIFD(14), KEEP(11), SFT(10)). Although this is allowed for certain instructions, check instruction requirements to confirm that the program is correct or rewrite the program so that each bit is controlled by only one instruction.
JMP UNDEFD	JME(05) has been used with no JMP(04) with the same jump number. Add a JMP(04) with the same number or delete the JME(05) that is not being used.
SBS UNDEFD	A subroutine exists that is not called by SBS(91). Program a subroutine call in the proper place, or delete the subroutine if it is not required.



Caution

Expansion instructions (those assigned to function codes 17, 18, 19, 47, 48 to 69, 87, 88, and 89) are not subject to program checks. Program checks do not cover DM 1024 to DM 6143 for PCs that do not support this part of the area. Data will not be written even if these areas are specified and data read these areas will always be "0000."

4 User-defined Errors

There are four instructions that the user can use to define his own errors or messages. These instructions are used to send messages to the Programming Console connected to the PC, cause a non-fatal or a fatal error.

MESSAGE – MSG(46)

MSG(46) is used to display a message on the Programming Console. The message, which can be up to 16 characters long, is displayed when the instruction execution condition is ON. Refer to page 493 for details.

FAILURE ALARM – FAL(06)

FAL(06) is an instruction that causes a non-fatal error. Refer to page 381 for details. The following will occur when an FAL(06) instruction is executed:

- 1, 2, 3... 1. The ERR/ALM indicator on the CPU Unit will flash. PC operation will continue.
2. The instruction's 2-digit BCD FAL number (01 to 99) will be written to SR 25300 to SR 25307.
3. The FAL number will be recorded in the PC's error log area. The time of occurrence will also be recorded in CPM2A PCs and CPM2C PCs that are equipped with an internal clock.

The FAL numbers can be set arbitrarily to indicate particular conditions. The same number cannot be used as both an FAL number and an FALS number. To clear an FAL error, correct the cause of the error, execute FAL 00, and clear the error using the Programming Console.

SEVERE FAILURE ALARM – FALS(07)

FALS(07) is an instruction that causes a fatal error. Refer to page 381 for details. The following will occur when an FALS(07) instruction is executed:

- 1, 2, 3... 1. Program execution will be stopped and outputs will be turned OFF.
2. The ERR/ALM indicator on the CPU Unit will be lit.
3. The instruction's 2-digit BCD FALS number (01 to 99) will be written to SR 25300 to SR 25307.
4. The FALS number will be recorded in the PC's error log area. The time of occurrence will also be recorded in CPM2A PCs and CPM2C PCs that are equipped with an internal clock.

The FALS numbers can be set arbitrarily to indicate particular conditions. The same number cannot be used as both an FAL number and an FALS number. To clear an FALS error, switch the PC to PROGRAM Mode, correct the cause of the error, and then clear the error using the Programming Console.

There are two kinds of operating errors, non-fatal and fatal. PC operation continues after a non-fatal error occurs, but operation will be stopped if a fatal error occurs.



Caution Investigate all errors, whether fatal or not. Remove the cause of the error as soon as possible and restart the PC. Refer to the *CPM1 Operation Manual*, *CPM2A Operation Manual*, or *CPM2C Operation Manual* for hardware information and Programming Console operations related to errors. Refer to the *CPM2C Operation Manual* for SSS operations related to errors.

5-1 Non-fatal Errors

PC operation and program execution will continue after one or more of these errors have occurred. Although PC operation will continue, the cause of the error should be corrected and the error cleared as soon as possible.

When one of these errors occurs, the POWER and RUN indicators will remain on and the ERR/ALM indicator will flash.

Message	FAL No.	Meaning and appropriate response
S FAIL FAL** (See note.)	01 to 99	An FAL(06) instruction has been executed in the program. Check the FAL number to determine conditions that would cause execution, correct the cause, and clear the error.
	9B	An error has been detected in the PC Setup. Check flags AR 1300 to AR 1302, and correct as directed. AR 1300 ON: An incorrect setting was detected in the PC Setup (DM 6600 to DM 6614) when power was turned on. Correct the settings in PROGRAM Mode and turn on the power again. AR 1301 ON: An incorrect setting was detected in the PC Setup (DM 6615 to DM 6644) when switching to RUN Mode. Correct the settings in PROGRAM Mode and switch to RUN Mode again. AR 1302 ON: An incorrect setting was detected in the PC Setup (DM 6645 to DM 6655) during operation. Correct the settings and clear the error.
TT LOW CPM2A/CPM2C (S only)	F7	If the voltage of the CPM2A-BAT01 or CPM2C-BAT01 backup battery is below the minimum level, the ERR/ALM indicator will flash and SR 25308 will be turned ON. Replace the battery.
AN TIME OVER	F8	Watchdog timer has exceeded 100 ms. (SR 25309 will be ON.) This indicates that the program cycle time is longer than recommended. Reduce cycle time if possible. (The PC Setup can be set so that this error won't be detected.)

Note ** is 01 to 99 or 9B.

PC operation and program execution will stop and all outputs from the PC will be turned OFF when any of these errors have occurred.

All CPU Unit indicators will be OFF for the power interruption error. For all other fatal operating errors, the POWER and ERR/ALM indicators will be lit. The PWR indicator will be OFF.

Message	FALS No.	Meaning and appropriate response
Power interruption error (see note 1.)	00	Power has been interrupted for at least 10 ms. Check power supply voltage and power lines. Try to power-up again.
MEMORY ERR	F1	AR 1308 ON: An unspecified bit area exists in the user program. Check the program and correct errors.
		AR 1309 ON: An error has occurred in the flash memory. Since the number of writes to the flash memory has exceeded the specified level, replace the CPU Unit.
		AR 1310 ON: A checksum error has occurred in read-only DM (DM 6144 to DM 6599). Check and correct the settings in the read-only DM area.
		AR 1311 ON: A checksum error has occurred in the PC Setup. Initialize all of the PC Setup and re-input.
		AR 1312 ON: A checksum error has occurred in the program. Check the program and correct any errors detected.
		AR 1313 ON: A checksum error has occurred in the expansion instruction's function code assignment area. Expansion instruction function codes will be returned to default settings. Assign function codes again.
		AR 1314 ON: Power interruption hold area was not held. Clear the error and reset the settings of the power interruption hold area.
		AR 1315 ON: An error has occurred in CompoBus/S communications. If the error cannot be corrected, replace the CPU Unit (SRM1(-V2) only).
END INST	F0	END(01) is not written in the program. Write END(01) at the end of the program.
BUS ERR (see note 1.)	C0	An error has occurred during data transfer between the CPU Unit and an Expansion Unit or Expansion I/O Unit. Check the Unit's connecting cable.
UNIT OVER (see note 1.)	E1	Too many Expansion Units or Expansion I/O Units have been connected. Check the PC configuration.
S FAIL FALS** (see note 2.)	01 to 99	A FALS(07) instruction has been executed in the program. Check the FALS number to determine the conditions that caused execution, correct the cause, and clear the error.
	9F	The cycle time has exceeded the FALS 9F Cycle Time Monitoring Time (DM 6618). Check the cycle time and adjust the Cycle Time Monitoring Time if necessary.

- Note**
1. CPM1/CPM1A/CPM2A/CPM2C only.
 2. ** is 01 to 99 or 9F.

5-3 Other Errors

The PWR indicator will be ON for the following fatal errors. Ignore the status of other indicators unless a specific status is given in the following table.

Error status	FALS No.	Meaning and appropriate response
CompoBus/S communications error	None	The ERC indicator will light to indicate an error in CompoBus/S communications. Check the slaves and the transmission path and restart the system.
RS-232C port communications error	None	If an error occurs in communications through the RS-232C port, the COMM indicator will be OFF and the error flag (AR 0804) will be ON. Check the connecting cables and restart.
Peripheral port communications error	None	If an error occurs in communications through the peripheral port, the COMM indicator will be OFF and the error flag (AR 0812) will be ON. Check the connecting cables and restart.

The error log function registers the error code of any fatal or non-fatal error that occurs in the PC. The date and time at which the error occurred are registered along with the error code. Refer to page 549 for error codes.

CPM1/CPM1A Error Log

In CPM1/CPM1A PCs, the error log is stored in DM 1000 through DM 1021.

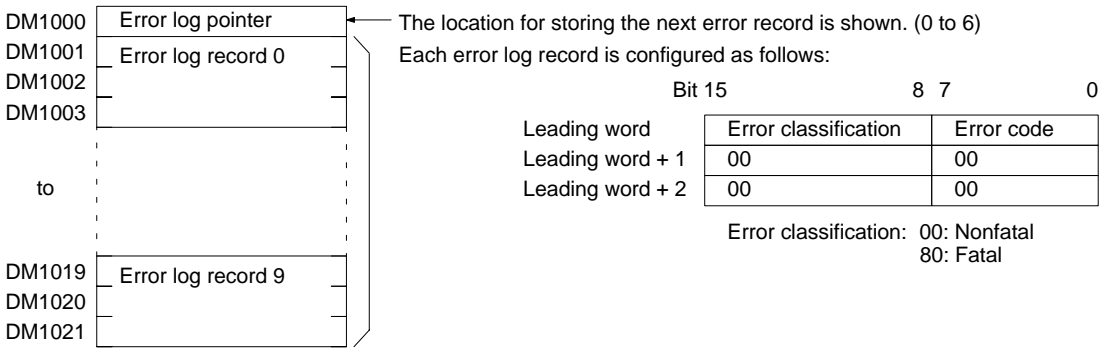

Error Log Storage Methods

The error log storage method is set in the PC Setup (DM 6655). Set any of the following methods.

- 1, 2, 3...**
1. You can store the most recent 10 error log records and discard older records. This is achieved by shifting the records as shown below so that the oldest record (record 0) is lost whenever a new record is generated.

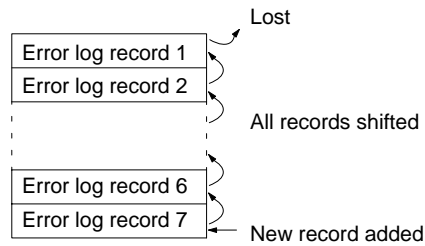

2. You can store only the first 10 error log records, and ignore any subsequent errors beyond those 10.
3. You can disable the log so that no records are stored.

The default setting is the first method. Refer to *Error Log Settings* on page 2 for details on the PC Setup for the error log.

Clearing the Error Log

To clear the entire error log, turn ON SR 25214 from a Programming Device. After the error log has been cleared, SR 25214 will turn OFF again automatically.

CPM2A/CPM2C Error Log

In CPM2A/CPM2C PCs, the error log is stored in DM 2000 through DM 2021. Up to 7 error records can be stored.

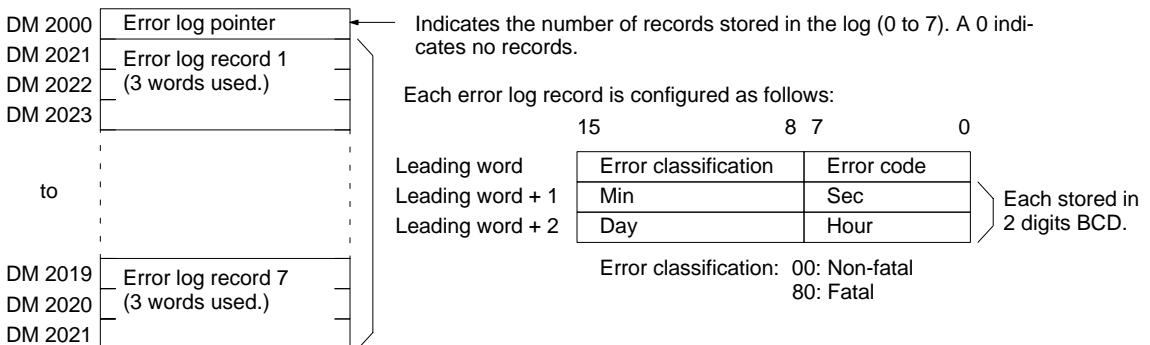

Error Log Storage Methods

The error log storage method is set in the PC Setup (DM 6655). Set any of the following methods.

- 1, 2, 3...**
1. You can store the most recent 7 error log records and discard older records. This is achieved by shifting the records as shown below so that the oldest record (record 0) is lost whenever a new record is generated.



2. You can store only the first 7 error log records, and ignore any subsequent errors beyond those 7.
3. You can disable the log so that no records are stored.

The default setting is the first method. Refer to *Error Log Settings* on page 2 for details on the PC Setup for the error log.

Clearing the Error Log

To clear the entire error log, turn ON SR 25214 from a Programming Device. After the error log has been cleared, SR 25214 will turn OFF again automatically.

DM Error Log Area

In SRM1(-V2) PCs, the error log is stored in DM 2000 through DM 2021.

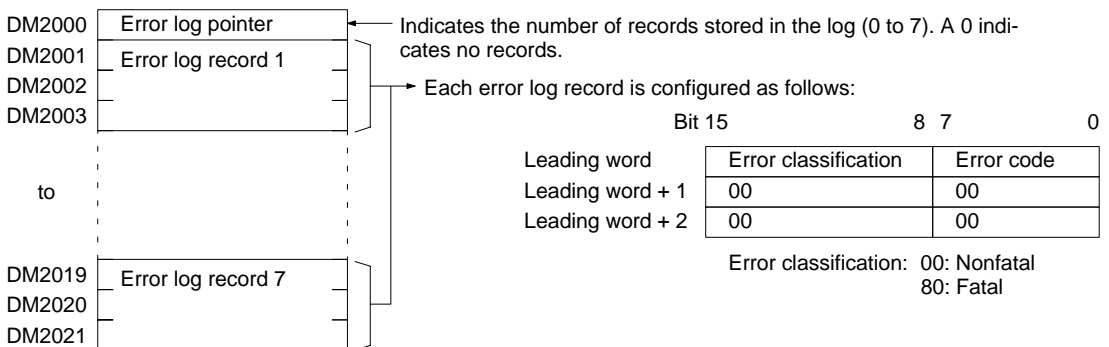

Error Log Storage Methods

The error log storage method is set in the PC Setup (DM 6655). Set any of the following methods.

- 1, 2, 3...**
1. You can store the most recent 7 error log records and discard older records. This is achieved by shifting the records as shown below so that the oldest record (record 0) is lost whenever a new record is generated.



2. You can store only the first 7 error log records, and ignore any subsequent errors beyond those 7.

The default setting is the first method. Refer to *Error Log Settings* on page 2 for details on the PC Setup for the error log.

Clearing the Error Log

To clear the entire error log, turn ON SR 25214 from a Programming Device. After the error log has been cleared, SR 25214 will turn OFF again automatically.

7 Host Link Errors

See *4-3 Host Link Communications* for a description of the response format and the response codes that are returned when a command from a host computer cannot be processed.

8 Troubleshooting Flowcharts

The troubleshooting flowcharts are available in the Operation Manuals.

CPM1 Flowcharts

Refer to *5-6 Troubleshooting Flowcharts* in the *CPM1 Operation Manual*.

CPM1A Flowcharts

Refer to *5-6 Troubleshooting Flowcharts* in the *CPM1A Operation Manual*.

CPM2A Flowcharts

Refer to *5-5 Troubleshooting Flowcharts* in the *CPM2A Operation Manual*.

CPM2C Flowcharts

Refer to *5-5 Troubleshooting Flowcharts* in the *CPM2C Operation Manual*.

SRM1 Flowcharts

Refer to *5-6 Troubleshooting Flowcharts* in the *SRM1 Operation Manual*.

Programming Instructions

C instruction is input either by pressing the corresponding Programming Console key(s) (e.g., LD, AND, T) or by using function codes. To input an instruction with its function code, press FUN, the function code, n WRITE. Refer to the pages listed programming and instruction details.

Code	Mnemonic	Name	Function	Page
	AND	AND	Logically ANDs status of designated bit with execution condition.	37
	AND LD	AND LOAD	Logically ANDs results of preceding blocks.	37
	AND NOT	AND NOT	Logically ANDs inverse of designated bit with execution condition.	37
	CNT	COUNTER	A decremting counter.	39
	LD	LOAD	Used to start instruction line with the status of the designated bit or to define a logic block for use with AND LD and OR LD.	37
	LD NOT	LOAD NOT	Used to start instruction line with inverse of designated bit.	37
	OR	OR	Logically ORs status of designated bit with execution condition.	37
	OR LD	OR LOAD	Logically ORs results of preceding blocks.	37
	OR NOT	OR NOT	Logically ORs inverse of designated bit with execution condition.	37
	OUT	OUTPUT	Turns ON operand bit for ON execution condition; turns OFF operand bit for OFF execution condition.	37
	OUT NOT	OUTPUT NOT	Turns operand bit OFF for ON execution condition; turns operand bit ON for OFF execution condition (i.e., inverts operation).	37
	RSET	RESET	Turns the operand bit OFF when the execution condition is ON, and does not affect the status of the operand bit when the execution condition is OFF.	37
	SET	SET	Turns the operand bit ON when the execution condition is ON, and does not affect the status of the operand bit when the execution condition is OFF.	37
	TIM	TIMER	ON-delay (decrementing) timer operation.	38
	NOP	NO OPERATION	Nothing is executed and program moves to next instruction.	37
	END	END	Required at the end of the program.	37
	IL	INTERLOCK	If interlock condition is OFF, all outputs are turned OFF and all timer PVs reset between this IL(02) and the next ILC(03). Other instructions are treated as NOP; counter PVs are maintained.	37
	ILC	INTERLOCK CLEAR		37
	JMP	JUMP	If jump condition is OFF, all instructions between JMP(04) and the corresponding JME(05) are ignored.	37
	JME	JUMP END		37
	(@)FAL	FAILURE ALARM AND RESET	Generates a non-fatal error and outputs the designated FAL number to the Programming Console.	38
	FALS	SEVERE FAILURE ALARM	Generates a fatal error and outputs the designated FALS number to the Programming Console.	38
	STEP	STEP DEFINE	When used with a control bit, defines the start of a new step and resets the previous step. When used without N, defines the end of step execution.	38
	SNXT	STEP START	Used with a control bit to indicate the end of the step, reset the step, and start the next step.	38
	SFT	SHIFT REGISTER	Creates a bit shift register.	40
	KEEP	KEEP	Defines a bit as a latch controlled by set and reset inputs.	37
	CNTR	REVERSIBLE COUNTER	Increases or decreases PV by one whenever the increment input or decrement input signals, respectively, go from OFF to ON.	39
	DIFU	DIFFERENTIATE UP	Turns ON the designated bit for one cycle on the rising edge of the input signal.	37

	DIFD	DIFFERENTIATE DOWN	Turns ON the bit for one cycle on the trailing edge.	37
	TIMH	HIGH-SPEED TIMER	A high-speed, ON-delay (decrementing) timer.	38
	(@)WSFT	WORD SHIFT	Shifts data between starting and ending words in word units, writing zeros into starting word.	40
to 19	For expansion instructions.			15
	CMP	COMPARE	Compares the contents of two words and outputs result to GR, EQ, and LE Flags.	42
	(@)MOV	MOVE	Copies source data (word or constant) to destination word.	40
	(@)MVN	MOVE NOT	Inverts source data (word or constant) and then copies it to destination word.	40
	(@)BIN	BCD TO BINARY	Converts four-digit, BCD data in source word into 16-bit binary data, and outputs converted data to result word.	43
	(@)BCD	BINARY TO BCD	Converts binary data in source word into BCD, and outputs converted data to result word.	43
	(@)ASL	ARITHMETIC SHIFT LEFT	Shifts each bit in single word of data one bit to left, with CY.	40
	(@)ASR	ARITHMETIC SHIFT RIGHT	Shifts each bit in single word of data one bit to right, with CY.	40
	(@)ROL	ROTATE LEFT	Rotates bits in single word of data one bit to left, with CY.	40
	(@)ROR	ROTATE RIGHT	Rotates bits in single word of data one bit to right, with CY.	40
	(@)COM	COMPLEMENT	Inverts bit status of one word of data.	47
	(@)ADD	BCD ADD	Adds two four-digit BCD values and content of CY, and outputs result to specified result word.	45
	(@)SUB	BCD SUBTRACT	Subtracts a four-digit BCD value and CY from another four-digit BCD value and outputs result to the result word.	45
	(@)MUL	BCD MULTIPLY	Multiplies two four-digit BCD values and outputs result to specified result words.	45
	(@)DIV	BCD DIVIDE	Divides four-digit BCD dividend by four-digit BCD divisor and outputs result to specified result words.	45
	(@)ANDW	LOGICAL AND	Logically ANDs two 16-bit input words and sets corresponding bit in result word if corresponding bits in input words are both ON.	47
	(@)ORW	LOGICAL OR	Logically ORs two 16-bit input words and sets corresponding bit in result word if one or both of corresponding bits in input data are ON.	47
	(@)XORW	EXCLUSIVE OR	Exclusively ORs two 16-bit input words and sets bit in result word when corresponding bits in input words differ in status.	47
	(@)XNRW	EXCLUSIVE NOR	Exclusively NORs two 16-bit input words and sets bit in result word when corresponding bits in input words are same in status.	47
	(@)INC	BCD INCREMENT	Increments four-digit BCD word by one.	47
	(@)DEC	BCD DECREMENT	Decrements four-digit BCD word by one.	47
	(@)STC	SET CARRY	Sets carry flag (i.e., turns CY ON).	45
	(@)CLC	CLEAR CARRY	Clears carry flag (i.e., turns CY OFF).	45
	(@)MSG	MESSAGE	Displays a 16-character message on the Programming Console display.	49
& 48	For expansion instructions.			15
	(@)ADB	BINARY ADD	Adds two four-digit hexadecimal values and content of CY, and outputs result to specified result word.	46
	(@)SBB	BINARY SUBTRACT	Subtracts a four-digit hexadecimal value and CY from another four-digit hexadecimal value and outputs result to the result word.	46
	(@)MLB	BINARY MULTIPLY	Multiplies two four-digit hexadecimal values and outputs result to specified result words.	46
	(@)DVB	BINARY DIVIDE	Divides four-digit hexadecimal dividend by four-digit hexadecimal divisor and outputs result to specified result words.	46

	(@)ADDL	DOUBLE BCD ADD	Adds two eight-digit values (2 words each) and content of CY, and outputs result to specified result words.	45
	(@)SUBL	DOUBLE BCD SUBTRACT	Subtracts an eight-digit BCD value and CY from another eight-digit BCD value and outputs result to the result words.	46
	(@)MULL	DOUBLE BCD MULTIPLY	Multiplies two eight-digit BCD values and outputs result to specified result words.	46
	(@)DIVL	DOUBLE BCD DIVIDE	Divides eight-digit BCD dividend by eight-digit BCD divisor and outputs result to specified result words.	46
	(@)BINL	DOUBLE BCD TO DOUBLE BINARY	Converts BCD value in two consecutive source words into binary and outputs converted data to two consecutive result words. (CPM2A only)	43
	(@)BCDL	DOUBLE BINARY TO DOUBLE BCD	Converts binary value in two consecutive source words into BCD and outputs converted data to two consecutive result words. (CPM2A only)	43
to 69	For expansion instructions.			15
	(@)XFER	BLOCK TRANSFER	Moves content of several consecutive source words to consecutive destination words.	40
	(@)BSET	BLOCK SET	Copies content of one word or constant to several consecutive words.	41
	(@)XCHG	DATA EXCHANGE	Exchanges contents of two different words.	41
	(@)SLD	ONE DIGIT SHIFT LEFT	Left shifts data between starting and ending words by one digit (four bits).	40
	(@)SRD	ONE DIGIT SHIFT RIGHT	Right shifts data between starting and ending words by one digit (four bits).	40
	(@)MLPX	4-TO-16 DECODER	Converts up to four hexadecimal digits in source word into decimal values from 0 to 15 and turns ON, in result word(s), bit(s) whose position corresponds to converted value.	43
	(@)DMPX	16-TO-4 ENCODER	Determines position of highest ON bit in source word(s) and turns ON corresponding bit(s) in result word.	44
	(@)SDEC	7-SEGMENT DECODER	Converts hexadecimal values from source word to data for seven-segment display.	44
	(@)DIST	SINGLE WORD DISTRIBUTE	Moves one word of source data to destination word whose address is given by destination base word plus offset.	41
	(@)COLL	DATA COLLECT	Extracts data from source word and writes it to destination word.	41
	(@)MOVB	MOVE BIT	Transfers designated bit of source word or constant to designated bit of destination word.	41
	(@)MOVD	MOVE DIGIT	Moves hexadecimal content of specified four-bit source digit(s) to specified destination digit(s) for up to four digits.	41
	(@)SFTR	REVERSIBLE SHIFT REGISTER	Shifts data in specified word or series of words to either left or right.	40
	(@)TCMP	TABLE COMPARE	Compares four-digit hexadecimal value with values in table consisting of 16 words.	42
	(@)ASC	ASCII CONVERT	Converts hexadecimal values from the source word to eight-bit ASCII code starting at leftmost or rightmost half of starting destination word.	44
to 89	For expansion instructions.			15
	(@)SBS	SUBROUTINE ENTRY	Calls and executes subroutine N.	48
	SBN	SUBROUTINE DEFINE	Marks start of subroutine N.	48
	RET	RETURN	Marks the end of a subroutine and returns control to main program.	48
	(@)IORF	I/O REFRESH	Refreshes all I/O words between the start and end words. Cannot be used with the SRM1(-V2).	49
	(@)MCRO	MACRO	Calls and executes a subroutine replacing I/O words.	48

The following table shows the instructions that can be treated as expansion instructions in the CPM2A, CPM2C and SRM1(-V2) PCs. The default function codes are given for instructions that have codes assigned by default.

Code	Mnemonic	Name	Function	CPU Units	Port
	(@)ASFT	ASYNCHRONOUS SHIFT REGISTER	Creates a shift register that exchanges the contents of adjacent words when one of the words is zero and the other is not.	All	40
	(@)RXD	RECEIVE	Receives data via a communications port.	All	50
	(@)TXD	TRANSMIT	Sends data via a communications port.	All	50
	CMPL	DOUBLE COMPARE	Compares two eight-digit hexadecimal values.	All	43
	(@)INI	MODE CONTROL	Starts and stops counter operation, compares and changes counter PVs, and stops pulse output.	All	39
	(@)PRV	HIGH-SPEED COUNTER PV READ	Reads counter PVs and status data for the high-speed counter.	CPM2A/ CPM2C	39
	(@)CTBL	COMPARISON TABLE LOAD	Compares counter PVs and generates a direct table or starts operation.	CPM2A/ CPM2C	39
	(@)SPED	SPEED OUTPUT	Outputs pulses at the specified frequency (10 Hz to 50 KHz in 10 Hz units). The output frequency can be changed while pulses are being output.	CPM2A/ CPM2C	48
	(@)PULS	SET PULSES	Outputs the specified number of pulses at the specified frequency. The pulse output cannot be stopped until the specified number of pulses have been output.	CPM2A/ CPM2C	48
	(@)SCL	SCALING	Performs a scaling conversion on the calculated value. Use the Programming Console or SSS to access this instruction for the SRM1(-V2).	All (But, Version 2 only for SRM1)	41
	(@)BCNT	BIT COUNTER	Counts the total number of bits that are ON in the specified block of words.	All	49
	(@)BCMP	BLOCK COMPARE	Judges whether the value of a word is within 16 ranges (defined by lower and upper limits).	All	43
	(@)STIM	INTERVAL TIMER	Controls interval timers used to perform scheduled interrupts.	All	50
	(@)INT	INTERRUPT CONTROL	Performs interrupt control, such as masking and unmasking the interrupt bits for I/O interrupts.	CPM2A/ CPM2C	49
	(@)ACC	ACCELERATION CONTROL	Together with PULS(—), ACC(—) controls the acceleration and/or deceleration of pulses output from port 1 or 2.	CPM2A/ CPM2C	48
	AVG	AVERAGE VALUE	Adds the specified number of hexadecimal words and computes the mean value. Rounds off to 4 digits past the decimal point.	CPM2A/ CPM2C	47
	(@)FCS	FCS CALCULATE	Checks for errors in data transmitted by a Host Link command.	All	49
	(@)HEX	ASCII-TO-HEXADECIMAL	Converts ASCII data to hexadecimal data.	All	44
	(@)HMS	SECONDS TO HOURS	Converts second data to hour and minute data.	CPM2A/ CPM2C	45
	(@)MAX	FIND MAXIMUM	Finds the maximum value in specified data area and outputs that value to another word.	CPM2A/ CPM2C	46
	(@)MIN	FIND MINIMUM	Finds the minimum value in specified data area and outputs that value to another word.	CPM2A/ CPM2C	47
	(@)NEG	2'S COMPLEMENT	Converts the four-digit hexadecimal content of the source word to its 2's complement and outputs the result to R. Use the Programming Console or SSS to access this instruction for the SRM1(-V2).	All (But, Version 2 only for SRM1)	45

PID	PID CONTROL	Performs PID control based on the specified parameters. Use the Programming Console or SSS to access this instruction for the SRM1(-V2).	All (But, Version 2 only for SRM1)	42
(@)PWM	PULSE WITH VARIABLE DUTY RATIO	Outputs pulses with the specified duty ratio (0% to 99%) from port 1 or 2.	CPM2A/ CPM2C	49
(@)SCL2	SIGNED BINARY TO BCD SCALING	Linearly converts a 4-digit signed hexadecimal value to a 4-digit BCD value.	CPM2A/ CPM2C	41
(@)SCL3	BCD TO SIGNED BINARY SCALING	Linearly converts a 4-digit BCD value to a 4-digit signed hexadecimal value.	CPM2A/ CPM2C	42
(@)SEC	HOURS TO SECONDS	Converts hour and minute data to second data.	CPM2A/ CPM2C	44
(@)SRCH	DATA SEARCH	Searches the specified range of memory for the specified data. Outputs the word address(es) of words in the range that contain the data.	CPM2A/ CPM2C	46
(@)STUP	CHANGE RS-232C SETUP	Changes the communications parameters in the PC Setup for a specified port.	All	50
(@)SUM	SUM CALCULATE	Computes the sum of the contents of the words in the specified range of memory.	CPM2A/ CPM2C	47
SYNC	SYNCHRONIZED PULSE CONTROL	Multiplies an input pulse frequency by a fixed scaling factor and outputs pulses from the specified output bit at the resulting frequency.	CPM2A/ CPM2C	49
TIML	LONG TIMER	A decrementing ON-delay timer with SV of up to 99,990 s	CPM2A/ CPM2C	38
TMHH	VERY HIGH-SPEED TIMER	A high-speed, decrementing ON-delay timer that times in 1-ms units	CPM2A/ CPM2C	38
ZCP	AREA RANGE COMPARE	Compares a word to a range defined by lower and upper limits and outputs the result to the GR, EQ, and LE flags. Use the Programming Console or SSS to access this instruction for the SRM1(-V2).	All (But, Version 2 only for SRM1)	43
ZCPL	DOUBLE AREA RANGE COMPARE	Compares an 8-digit value to a range defined by lower and upper limits and outputs the result to the GR, EQ, and LE flags.	CPM2A/ CPM2C	43

Error and Arithmetic Flag Operation

The following table shows the instructions that affect the ER, CY, GT, LT and EQ flags. In general, ER indicates that the operand data is not within requirements. CY indicates arithmetic or data shift results. GT indicates that a comparison result is larger than some standard, LT that it is smaller, and EQ, that it is the same. EQ also indicates a result of zero for arithmetic operations. Refer to *Section 7 Instruction Set* for details.

Vertical arrows in the table indicate the flags that are turned ON and OFF according to the result of the instruction. Although ladder diagram instructions, TIM, and CNT are executed when ER is ON, other instructions with a vertical arrow under the ER column are not executed if ER is ON. All of the other flags in the following table will also operate when ER is ON.

Instructions not shown do not affect any of the flags in the table. Although only the non-differentiated form of each instruction is shown, differentiated instructions affect flags in exactly the same way.

The ER, CY, GT, LT and EQ Flags are turned OFF when END(01) is executed, so their status cannot be monitored in a Programming Device.

The status of the ER, CY, GT, LT and EQ Flags is affected by instruction execution and will change each time an instruction that affects them is executed. Differentiated instructions are executed only once when their execution condition changes (ON to OFF or OFF to ON) and are not executed again until the next specified change in the execution condition. The status of the ER, CY, GT, LT and EQ Flags is thus affected by a differentiated instruction only when the execution condition changes and is not affected during scans when the instruction is not executed when the specified change does not occur in the execution condition. When a differentiated instruction is executed, the status of the ER, CY, GT, LT and EQ Flags will not change and will maintain the status produced by the last instruction that was executed.

Instructions	25503 (ER)	25504 (CY)	25505 (GR)	25506 (EQ)	25507 (LE)	25402 (N)	Page
M	↕	Unaffected	Unaffected	Unaffected	Unaffected	Unaffected	385
T							390
D(01)	OFF	OFF	OFF	OFF	OFF	OFF	377
EP(08)	Unaffected	Unaffected	Unaffected	Unaffected	Unaffected	Unaffected	381
XT(09)							381
TR(12)	↕						391
MH(15)							386
SFT(16)							401
IP(20)	↕	Unaffected	↕	↕	↕	Unaffected	428
OV(21)	↕	Unaffected	Unaffected	↕	Unaffected	↕	407
IN(22)	408						
IN(23)						OFF	435
D(24)						Unaffected	436
L(25)	↕	↕	Unaffected	↕	Unaffected	↕	401
R(26)						OFF	402
L(27)						↕	402
R(28)							403
M(29)	↕	Unaffected	Unaffected	↕	Unaffected	↕	475
D(30)	↕			↕		↕	Unaffected
B(31)							454

C(32)	↕	Unaffected	Unaffected	↕	Unaffected	Unaffected	456	
V(33)							457	
DW(34)						↕	476	
W(35)							477	
RW(36)							477	
RW(37)							478	
C(38)						Unaffected	479	
C(39)							479	
C(40)	Unaffected	ON	Unaffected	Unaffected	Unaffected	Unaffected	453	
C(41)		OFF						
CG(46)	↕	Unaffected					493	
B(50)	↕	↕	Unaffected	↕	Unaffected	↕	463	
B(51)								
B(52)	Unaffected	↕	Unaffected	Unaffected	↕		466	
B(53)	↕	Unaffected	Unaffected	↕	Unaffected		466	
DL(54)	↕	↕		↕		Unaffected	459	
BL(55)							460	
JLL(56)	↕	Unaffected	Unaffected	↕	Unaffected	Unaffected	462	
L(57)							462	
NL(58)							OFF	436
DL(59)							Unaffected	437
ER(70)	↕	Unaffected	Unaffected	Unaffected	Unaffected	Unaffected	409	
ET(71)							410	
HG(73)	↕	Unaffected	Unaffected	Unaffected	Unaffected	Unaffected	411	
D(74)							404	
D(75)							404	
PX(76)							438	
IPX(77)							440	
EC(78)							442	
BT(80)	↕	Unaffected					Unaffected	↕
LL(81)	↕		413					
VB(82)				Unaffected	Unaffected	415		
VD(83)							416	
TR(84)	↕	↕	Unaffected	Unaffected	Unaffected	Unaffected	405	
MP(85)	↕	Unaffected		↕			429	
C(86)	↕			Unaffected			445	
S(91)							480	
RO(99)	↕						482	

Instructions	25503 (ER)	25504 (CY)	25505 (GR)	25506 (EQ)	25507 (LE)	25402 (N)	Page			
FT(17)	↓	Unaffected	Unaffected	Unaffected	Unaffected	Unaffected	406			
D(47)							501			
D(48)							503			
IPL(60)			↓	↓	↓	↓	432			
(61)	↓	Unaffected	Unaffected	Unaffected	Unaffected	Unaffected	395			
V(62)							397			
BL(63)							392			
ED(64)							485			
LS(65)							483			
L(66)							Unaffected	Unaffected	↓	417
NT(67)									495	
MP(68)									Unaffected	430
IM(69)										500
Γ(89)										
CH(—)			↓				467			
X(—)					↓		468			
N(—)							470			
IS(—)					Unaffected		450			
G(—)*							451			
C(—)							449			
M(—)					↓		474			
S(—)				Unaffected	Unaffected	Unaffected	496			
X(—)									447	
G(—)							472			
D(—)							422			
P(—)		Unaffected	↓	↓	↓		433			

* Depending on the results, NEG(—) may also affect the status of the underflow flag (SR 25405).

Expansion Instructions (CPM2A/CPM2C Only)

Instructions	25503 (ER)	25504 (CY)	25505 (GR)	25506 (EQ)	25507 (LE)	Page		
VM(—)	↓	Unaffected	Unaffected	Unaffected	Unaffected	490		
PL(—)			↓			↓	↓	434
C(—)								487
L2(—)		↓	Unaffected		Unaffected	418		
L3(—)		Unaffected				420		
NC(—)						420		

Memory Areas

CPM1/CPM1A Memory Areas

Memory Area Structure

The following memory areas can be used with the CPM1/CPM1A.

Data area		Words	Bits	Function
area ¹	Input area	IR 000 to IR 009 (10 words)	IR 00000 to IR 00915 (160 bits)	These bits can be allocated to the external I/O terminals.
	Output area	IR 010 to IR 019 (10 words)	IR 01000 to IR 01915 (160 bits)	
	Work area	IR 200 to IR 231 (32 words)	IR 20000 to IR 23115 (512 bits)	Work bits can be freely used within the program.
area		SR 232 to SR 255 (24 words)	SR 23200 to SR 25515 (384 bits)	These bits serve specific functions such as flags and control bits.
area		---	TR 0 to TR 7 (8 bits)	These bits are used to temporarily store ON/OFF status at program branches.
area ²		HR 00 to HR 19 (20 words)	HR 0000 to HR 1915 (320 bits)	These bits store data and retain their ON/OFF status when power is turned off.
area ²		AR 00 to AR 15 (16 words)	AR 0000 to AR 1515 (256 bits)	These bits serve specific functions such as flags and control bits.
area ¹		LR 00 to LR 15 (16 words)	LR 0000 to LR 1515 (256 bits)	Used for a 1:1 data link with another PC.
Timer/Counter area ²		TC 000 to TC 127 (timer/counter numbers) ³		The same numbers are used for both timers and counters.
DM area	Read/write ²	DM 0000 to DM 0999 DM 1022 to DM 1023 (1,002 words)	---	DM area data can be accessed in word units only. Word values are retained when the power is turned off.
	Error log ²	DM 1000 to DM 1021 (22 words)	---	Used to store the error code of errors that occur. These words can be used as ordinary read/write DM when the error log function isn't being used.
	Read-only ⁴	DM 6144 to DM 6599 (456 words)	---	Cannot be overwritten from program.
	PC Setup ⁴	DM 6600 to DM 6655 (56 words)	---	Used to store various parameters that control PC operation.

1. IR and LR bits that are not used for their allocated functions can be used as work bits.
2. The contents of the HR area, AR area, Counter area, and read/write DM area are backed up by a capacitor. The backup time varies with the ambient temperature, but at 25°C, the capacitor will back up memory for 20 days. If the power supply is off longer than the backup time, memory contents will be cleared and AR1314 will turn ON. (This flag turns ON when data can no longer be retained by the backup capacitor.) Refer to 2-1-2 *Characteristics* in the *CPM1 Operation Manual* for a graph showing the backup time vs. temperature.
3. When accessing a PV, TC numbers are used as word data; when accessing Completion Flags, they are used as bit data.
4. Data in DM 6144 to DM 6655 cannot be overwritten from the program, but they can be changed from the Programming Device.

SR Area

These bits mainly serve as flags related to CPM1/CPM1A operation or contain present and set values for various functions. The functions of the SR area are explained in the following table.

1. "Read-only" words and bits can be read as status in controller PC operation, but they cannot be written from the ladder program. Bits and words that are "Not used" are also read-only.

			Write	
232	00 to 15	Macro Function Input Area Contains the input operands for MCRO(99). (Can be used as work bits when MCRO(99) is not used.)	Read/ write	154
235				
236	00 to 15	Macro Function Output Area Contains the output operands for MCRO(99). (Can be used as work bits when MCRO(99) is not used.)		
239				
240	00 to 15	Input Interrupt 0 Counter Mode SV SV when input interrupt 0 is used in counter mode (4 digits hexadecimal). (Can be used as work bits when input interrupt 0 is not used in counter mode.)		78
241	00 to 15	Input Interrupt 1 Counter Mode SV SV when input interrupt 1 is used in counter mode (4 digits hexadecimal). (Can be used as work bits when input interrupt 1 is not used in counter mode.)		
242	00 to 15	Input Interrupt 2 Counter Mode SV SV when input interrupt 2 is used in counter mode (4 digits hexadecimal). (Can be used as work bits when input interrupt 2 is not used in counter mode.)		
243	00 to 15	Input Interrupt 3 Counter Mode SV SV when input interrupt 3 is used in counter mode (4 digits hexadecimal). (Can be used as work bits when input interrupt 3 is not used in counter mode.)		
244	00 to 15	Input Interrupt 0 Counter Mode PV Minus One Counter PV-1 when input interrupt 0 is used in counter mode (4 digits hexadecimal).	Read- only	79
245	00 to 15	Input Interrupt 1 Counter Mode PV Minus One Counter PV-1 when input interrupt 1 is used in counter mode (4 digits hexadecimal).		
246	00 to 15	Input Interrupt 2 Counter Mode PV Minus One Counter PV-1 when input interrupt 2 is used in counter mode (4 digits hexadecimal).		
247	00 to 15	Input Interrupt 3 Counter Mode PV Minus One Counter PV-1 when input interrupt 3 is used in counter mode (4 digits hexadecimal).		
248, 249	00 to 15	High-speed Counter PV Area (Can be used as work bits when the high-speed counter is not used.)		84
250	00 to 15	Analog Setting 0 Used to store the 4-digit BCD set value (0000 to 0200) from analog control 0.		
251	00 to 15	Analog Setting 1 Used to store the 4-digit BCD set value (0000 to 0200) from analog control 1.		147

252	00	High-speed Counter Reset Bit	Read/write	85
	01 to 07	Not used.		
	08	Peripheral Port Reset Bit Turn ON to reset peripheral port. (Not valid when Programming Device is connected.) Automatically turns OFF when reset is complete.	Read/write	268
	09	Not used.		
	10	PC Setup Reset Bit Turn ON to initialize PC Setup (DM 6600 through DM 6655). Automatically turns OFF again when reset is complete. Only effective if the PC is in PROGRAM mode.	Read/write	2
	11	Forced Status Hold Bit (See note.) OFF: The forced status of bits that are forced set/reset is cleared when switching between PROGRAM mode and MONITOR mode. ON: The status of bits that are forced set/reset are maintained when switching between PROGRAM mode and MONITOR mode. The status of this bit can be maintained when PC power turns off by using the PC Setup.		17
	12	I/O Hold Bit (See note.) OFF: IR and LR bits are reset when starting or stopping operation. ON: IR and LR bit status is maintained when starting or stopping operation. The status of this bit can be maintained when PC power turns off by using the PC Setup.		17
	13	Not used.		
	14	Error Log Reset Bit Turn ON to clear error log. Automatically turns OFF again when operation is complete.	Read/write	551
	15	Not used.		
253	00 to 07	FAL Error Code The error code (a 2-digit number) is stored here when an error occurs. The FAL number is stored here when FAL(06) or FALS(07) is executed. This word is reset (to 00) by executing a FAL 00 instruction or by clearing the error from a Programming Device.	Read-only	381
	08	Not used.		
	09	Cycle Time Overrun Flag Turns ON when a cycle time overrun occurs (i.e., when the cycle time exceeds 100 ms).	Read-only	---
	10 to 12	Not used.		
	13	Always ON Flag	Read-only	---
	14	Always OFF Flag		---
15	First Cycle Flag Turns ON for 1 cycle at the start of operation.	---		
254	00	1-minute clock pulse (30 seconds ON; 30 seconds OFF)		---
	01	0.02-second clock pulse (0.01 second ON; 0.01 second OFF)		---
	02	Negative (N) Flag		---
	03 to 05	Not used.		
	06	Differential Monitor Complete Flag Turns ON when differential monitoring is complete.	Read-only	156
	07	STEP(08) Execution Flag Turns ON for 1 cycle only at the start of process based on STEP(08).		381
	08 to 15	Not used.		

255	00	0.1-second clock pulse (0.05 second ON; 0.05 second OFF)	Read-only	---
	01	0.2-second clock pulse (0.1 second ON; 0.1 second OFF)		---
	02	1.0-second clock pulse (0.5 second ON; 0.5 second OFF)		---
	03	Instruction Execution Error (ER) Flag Turns ON when an error occurs during execution of an instruction.		---
	04	Carry (CY) Flag Turns ON when there is a carry in the results of an instruction execution.		---
	05	Greater Than (GR) Flag Turns ON when the result of a comparison operation is "greater."		---
	06	Equals (EQ) Flag Turns ON when the result of a comparison operation is "equal," or when the result of an instruction execution is 0.		---
	07	Less Than (LE) Flag Turns ON when the result of a comparison operation is "less."		---
	08 to 15	Not used.		

DM 6601 in the PC Setup can be set to maintain the previous status of the I/O Hold Bit (SR 25212) and I/O Hold Bit (SR 25212) when power is turned OFF. If power is left OFF for longer than the backup time, however, status may be cleared. For details regarding the backup time, refer to the *CPM1A or CPM1A Operation Manual*. Refer to 1-1-2 *CPM1/CPM1A PC Setup Settings* for details on the PC Setup.

R Area

These bits mainly serve as flags related to CPM1/CPM1A operation. These bits retain their status even after CPM1/CPM1A power supply has been turned off or when operation begins or stops.

Word(s)	Bit(s)	Function	Pa
00, 01	00 to 15	Not used.	
02	00	Expansion Unit Error Flag for 1st Unit	These flags turn ON when there is an error in the corresponding Unit.
	01	Expansion Unit Error Flag for 2nd Unit (Not used by CPM1 CPU Units without "-V1" suffix.)	
	02	Expansion Unit Error Flag for 3rd Unit (Not used by CPM1 CPU Units without "-V1" suffix.)	
	03 to 07	Not used.	---
	08 to 11	Number of I/O Units Connected	---
	12 to 15	Not used.	
03 to 07	00 to 15	Not used.	
08	00 to 07	Not used.	
	08 to 11	Programming Device Error Code 0: Normal completion 1: Parity error 2: Frame error 3: Overrun error	269
	12	Programming Device Error Flag	
	13 to 15	Not used.	
09	00 to 15	Not used.	
10	00 to 15	Power-off Counter (4 digits BCD) This is the count of the number of times that the power has been turned off. To clear the count, write "0000" from a Programming Device.	---

00 to 07	High-speed Counter Range Comparison Flags 00 ON: Counter PV is within comparison range 1 01 ON: Counter PV is within comparison range 2 02 ON: Counter PV is within comparison range 3 03 ON: Counter PV is within comparison range 4 04 ON: Counter PV is within comparison range 5 05 ON: Counter PV is within comparison range 6 06 ON: Counter PV is within comparison range 7 07 ON: Counter PV is within comparison range 8	87	
08 to 14	Not used.		
15	Pulse Output Status ON: Stopped. OFF: Pulses being output.	---	
12	00 to 15	Not used.	
13	00	Power-up PC Setup Error Flag Turns ON when there is an error in DM 6600 to DM 6614 (the part of the PC Setup area that is read at power-up).	549
	01	Start-up PC Setup Error Flag Turns ON when there is an error in DM 6615 to DM 6644 (the part of the PC Setup area that is read at the beginning of operation).	
	02	RUN PC Setup Error Flag Turns ON when there is an error in DM 6645 to DM 6655 (the part of the PC Setup area that is always read).	
	03, 04	Not used.	
	05	Long Cycle Time Flag Turns ON if the actual cycle time is longer than the cycle time set in DM 6619.	---
	06, 07	Not used.	
	08	Memory Area Specification Error Flag Turns ON when a non-existent data area address is specified in the program.	---
	09	Flash Memory Error Flag Turns ON when there is an error in flash memory.	---
	10	Read-only DM Error Flag (See note 3.) Turns ON when a checksum error occurs in the read-only DM (DM 6144 to DM 6599) and that area is initialized.	550
	11	PC Setup Error Flag Turns ON when a checksum error occurs in the PC Setup area.	
	12	Program Error Flag Turns ON when a checksum error occurs in the program memory (UM) area, or when an improper instruction is executed.	---
	13	Not used.	
	14	Data Save Error Flag Turns ON when power is turned on if data could not be saved with the built-in capacitor. Data is saved in the following areas with the built-in capacitor: DM area (Read/write-capable: DM 0000 to 0999 and DM 1022 to 1023) HR area (HR 00 to 19) Counter area (CNT 000 to 127) SR area, word 252, bits 11, 12 (when PC Setup in DM 6601 is set to maintain status) AR area, word 10 (power-off counter) Operation mode (when PC Setup in DM 6600 is set to continue mode last used before power failure) If data could not be saved in the above areas: The DM, error log, HR, counter, SR (word 252, bits 11 and 12), and AR (word 10) areas will be cleared and the operating mode will go into PROGRAM mode if DM 0000 is set to continue mode last used before power failure or if DM6604 is set to generate an error. (For details regarding the holding time, refer to the <i>CPM1A Operation Manual</i> .)	---
	15	Not used.	

00 to 15	Maximum Cycle Time (4 digits BCD) (See note 1.) The longest cycle time since the beginning of operation is stored. It is cleared at the beginning, and not at the end, of operation. The units can be any of the following, depending on the setting of in DM 6618. Default: 0.1 ms; "10 ms" setting: 0.1 ms; "100 ms" setting: 1 ms; "1 s" setting: 10 ms
15	Current Cycle Time (4 digits BCD) (See note 1.) The most recent cycle time during operation is stored. The Current Cycle Time is not cleared when operation stops. The units can be any of the following, depending on the setting of in DM 6618. Default: 0.1 ms; "10 ms" setting: 0.1 ms; "100 ms" setting: 1 ms; "1 s" setting: 10 ms

1. The units will be as follows, depending on the unit setting for the cycle monitor time (DM 6618):
- | | |
|--------------------------|-------------|
| Initial status: | 0.1-ms unit |
| When 10-ms unit is set: | 0.1-ms unit |
| When 100-ms unit is set: | 1-ms unit |
| When 1-s unit is set: | 10-ms unit |
2. Areas that cannot be used are cleared when the power is turned on.
3. The contents of AR 10 is backed up by the built-in capacitor. If power is left OFF for longer than the backup time, however, the contents may be cleared. For details regarding the backup time, refer to *CPM1A* or *CPM1 Operation Manual*.

CPM2A/CPM2C Memory Areas

Memory Area Structure

The following memory areas can be used with the CPM2A/CPM2C. Refer to the *CPM2C-S Operation Manual* (377) for information on CPM2C-S memory areas.

Data area		Words	Bits	Function
area ¹	Input area	IR 000 to IR 009 (10 words)	IR 00000 to IR 00915 (160 bits)	These bits can be allocated to the external I/O terminals.
	Output area	IR 010 to IR 019 (10 words)	IR 01000 to IR 01915 (160 bits)	
	Work area	IR 020 to IR 049 IR 200 to IR 227 (58 words)	IR 02000 to IR 04915 IR 20000 to IR 22715 (928 bits)	Work bits can be freely used within the program.
area		SR 228 to SR 255 (28 words)	SR 22800 to SR 25515 (448 bits)	These bits serve specific functions such as flags and control bits.
area		---	TR 0 to TR 7 (8 bits)	These bits are used to temporarily store ON/OFF status at program branches.
area ²		HR 00 to HR 19 (20 words)	HR 0000 to HR 1915 (320 bits)	These bits store data and retain their ON/OFF status when power is turned off.
area ²		AR 00 to AR 23 (24 words)	AR 0000 to AR 2315 (384 bits)	These bits serve specific functions such as flags and control bits.
area ¹		LR 00 to LR 15 (16 words)	LR 0000 to LR 1515 (256 bits)	Used for a 1:1 data link with another PC.
Timer/Counter area ²		TC 000 to TC 255 (timer/counter numbers) ³		The same numbers are used for both timers and counters.
DM area	Read/write ²	DM 0000 to DM 1999 DM 2022 to DM 2047 (2,026 words)	---	DM area data can be accessed in word units only. Word values are retained when the power is turned off.
	Error log ²	DM 2000 to DM 2021 (22 words)	---	Used to store the error code of errors that occur. These words can be used as ordinary read/write DM when the error log function isn't being used.
	Read-only ⁴	DM 6144 to DM 6599 (456 words)	---	Cannot be overwritten from program.
	PC Setup ⁴	DM 6600 to DM 6655 (56 words)	---	Used to store various parameters that control PC operation.

2. The contents of the HR area, AR area, Counter area, and read/write DM area are backed up by the CPU Unit's battery. If the battery is removed or fails, the data in these areas will be lost and reset to default values. (In CPM2C CPU Units without a battery, these areas are backed up by a capacitor. At 25°C a capacitor will back up memory for 10 days.)
3. When a TC number is used as a word operand, it accesses the timer or counter's PV; when used as a bit operand, it accesses the Completion Flag.
4. Data in DM 6144 to DM 6655 cannot be overwritten from the program, but they can be changed from the Programming Device. The program and data in DM 6144 to DM 6655 are backed up in flash memory.

SR Area

SR bits mainly serve as flags related to CPM2A/CPM2C operation or contain present and set values for various functions. The functions of the SR area are explained in the following table.

SR "Read-only" words and bits can be read as status in controller PC operation, but they cannot be written from the ladder program. Bits and words that are "Not used" are also read-only.

Word(s)	Bit(s)	Function	Read/write	Parameter
228, 229	00 to 15	Pulse Output PV 0 Contains the pulse output PV (–16,777,215 to 16,777,215). SR 22915 acts as the sign bit; a negative number is indicated when SR 22915 is ON. (The same PV data can be read immediately with PRV(62).) Only Pulse Output PV 0 is used for ACC(—).	Read-only	103
230, 231	00 to 15	Pulse Output PV 1 Contains the pulse output PV (–16,777,215 to 16,777,215). SR 23115 acts as the sign bit; a negative number is indicated when SR 23115 is ON. (The same PV data can be read immediately with PRV(62).)		
232, 235	00 to 15	Macro Function Input Area Contains the input operands for MCRO(99). (Can be used as work bits when MCRO(99) is not used.)	Read/write	154
236, 239	00 to 15	Macro Function Output Area Contains the output operands for MCRO(99). (Can be used as work bits when MCRO(99) is not used.)		
240	00 to 15	Interrupt Input 00003 Counter Mode SV SV when interrupt input 00003 is used in counter mode (4 digits hexadecimal). (Can be used as work bits when interrupt input 00003 is not used in counter mode.)		70
241	00 to 15	Interrupt Input 00004 Counter Mode SV SV when interrupt input 00004 is used in counter mode (4 digits hexadecimal). (Can be used as work bits when interrupt input 00004 is not used in counter mode.)		
242	00 to 15	Interrupt Input 00005 Counter Mode SV SV when interrupt input 00005 is used in counter mode (4 digits hexadecimal). (Can be used as work bits when interrupt input 00005 is not used in counter mode.)		
243	00 to 15	Interrupt Input 00006 Counter Mode SV SV when interrupt input 00006 is used in counter mode (4 digits hexadecimal). (Can be used as work bits when interrupt input 00006 is not used in counter mode.) (Input 00006 does not exist in CPM2C CPU Units with 10 I/O points.)		

244	00 to 15	Interrupt Input 00003 Counter Mode PV Counter PV when interrupt input 00003 is used in counter mode (4 digits hexadecimal).	Read-only	72
245	00 to 15	Interrupt Input 00004 Counter Mode PV Counter PV when interrupt input 00004 is used in counter mode (4 digits hexadecimal).		
246	00 to 15	Interrupt Input 00005 Counter Mode PV Counter PV when interrupt input 00005 is used in counter mode (4 digits hexadecimal).		
247	00 to 15	Interrupt Input 00006 Counter Mode PV Counter PV when interrupt input 00006 is used in counter mode (4 digits hexadecimal). (Input 00006 does not exist in CPM2C CPU Units with 10 I/O points.)		
248, 249	00 to 15	High-speed Counter PV Area (Can be used as work bits when the high-speed counter is not used.)		
250	00 to 15	Analog Setting 0 (CPM2A PCs only) Used to store the 4-digit BCD set value (0000 to 0200) from analog control 0.	147	
251	00 to 15	Analog Setting 1 (CPM2A PCs only) Used to store the 4-digit BCD set value (0000 to 0200) from analog control 1.		
252	00	High-speed Counter Reset Bit		
	01 to 03	Not used.	Read/write	94
	04	Pulse Output 0 PV Reset Bit Turn ON to clear the PV of pulse output 0.		
	05	Pulse Output 1 PV Reset Bit Turn ON to clear the PV of pulse output 1.		
	06, 07	Not used.	Read/write	---
	08	Peripheral Port Reset Bit Turn ON to reset the peripheral port. Automatically turns OFF when reset is complete.		
	09	RS-232C Port Reset Bit Turn ON to reset the RS-232C port. Automatically turns OFF when reset is complete.		
	10	PC Setup Reset Bit Turn ON to initialize PC Setup (DM 6600 through DM 6655). Automatically turns OFF again when reset is complete. Only effective if the PC is in PROGRAM mode.		
	11	Forced Status Hold Bit (See note.) OFF: The forced status of bits that are forced set/reset is cleared when switching between PROGRAM mode and MONITOR mode. ON: The status of bits that are forced set/reset are maintained when switching between PROGRAM mode and MONITOR mode. The PC Setup can be set to maintain the status of this bit when the PC is turned off.		
	12	I/O Hold Bit (See note.) OFF: IR and LR bits are reset when starting or stopping operation. ON: IR and LR bit status is maintained when starting or stopping operation. The PC Setup can be set to maintain the status of this bit when the PC is turned off.		
	13	Not used.		
	14	Error Log Reset Bit Turn ON to clear error log. Automatically turns OFF again when operation is complete.	Read/write	551
	15	Not used.		

253	00 to 07	FAL Error Code The error code (a 2-digit number) is stored here when an error occurs. The FAL number is stored here when FAL(06) or FALS(07) is executed. This word is reset (to 00) by executing a FAL 00 instruction or by clearing the error from a Programming Device.	Read-only	381
	08	Battery Error Flag Turns ON when the CPU Unit backup battery's voltage is too low.		---
	09	Cycle Time Overrun Flag Turns ON when a cycle time overrun occurs (i.e., when the cycle time exceeds 100 ms).		---
	10,11	Not used.		
	12	Changing RS-232C Setup Flag Turns ON when the RS-232C port's settings are being changed.	Read/write	---
	13	Always ON Flag	Read-only	---
	14	Always OFF Flag		---
	15	First Cycle Flag Turns ON for 1 cycle at the start of operation.		---

254	00	1-minute clock pulse (30 seconds ON; 30 seconds OFF)		---
	01	0.02-second clock pulse (0.01 second ON; 0.01 second OFF)		---
	02	Negative (N) Flag		---
	03	Not used.		
	04	Overflow (OF) Flag Turns ON when an overflow occurs in a signed binary calculation.	Read-only	---
	05	Underflow (UF) Flag Turns ON when an underflow occurs in a signed binary calculation.		---
	06	Differential Monitor Complete Flag Turns ON when differential monitoring is completed.		156
	07	STEP(08) Execution Flag Turns ON for 1 cycle only at the start of process based on STEP(08).		381
	08 to 15	Not used.		
255	00	0.1-second clock pulse (0.05 second ON; 0.05 second OFF)	Read-only	---
	01	0.2-second clock pulse (0.1 second ON; 0.1 second OFF)		---
	02	1.0-second clock pulse (0.5 second ON; 0.5 second OFF)		---
	03	Instruction Execution Error (ER) Flag Turns ON when an error occurs during execution of an instruction.		---
	04	Carry (CY) Flag Turns ON when there is a carry in the results of an instruction execution.		---
	05	Greater Than (GR) Flag Turns ON when the result of a comparison operation is "greater."		---
	06	Equals (EQ) Flag Turns ON when the result of a comparison operation is "equal," or when the result of an instruction execution is 0.		---
	07	Less Than (LE) Flag Turns ON when the result of a comparison operation is "less."		---
	08 to 15	Not used.		

DM 6601 in the PC Setup can be set to maintain the previous status of the Forced Status Word (SR 25211) and the I/O Hold Bit (SR 25212) when power is turned OFF. Refer to 1-1-3 CPM2A/CPM2C Setup Settings for details on the PC Setup.

These bits mainly serve as flags related to CPM2A/CPM2C operation. These bits retain their status even after CPM2A/CPM2C power supply has been turned off or when operation begins or stops.

Word(s)	Bit(s)	Function	Page
00, 01	00 to 15	Not used.	
02	00	Expansion Unit Error Flag for 1st Unit	These flags turn ON when there is an error in the corresponding Unit.
	01	Expansion Unit Error Flag for 2nd Unit	
	02	Expansion Unit Error Flag for 3rd Unit	
	03	Expansion Unit Error Flag for 4th Unit (Not used by CPM2A.)	
	04	Expansion Unit Error Flag for 5th Unit (Not used by CPM2A.)	
	05 to 07	Not used.	
	08 to 11	Number of Expansion Units and Expansion I/O Units Connected	---
	12 to 15	Not used.	
03 to 06	00 to 15	Not used.	
07	00 to 11	Not used.	---
	12	Valid only for CPM2C CPU Units with lot numbers of 01900 or later. (Cannot be used for CPM2C CPU Units with lot numbers of 31800 or earlier and cannot be used with CPM2A CPU Units.) Refer to <i>1-3 Changes in SW2</i> for information on lot numbers. ON: SW2 on the front of the CPU Unit is ON. OFF: SW2 on the front of the CPU Unit is OFF.	
	13 to 15	Not used.	
08	00 to 03	RS-232C Port Error Code 0: Normal completion 1: Parity error 2: Frame error 3: Overrun error	246 254
	04	RS-232C Communications Error Flag Turns ON when an RS-232C port communications error occurs.	
	05	RS-232C Transmit Ready Flag Turns ON when the PC is ready to transmit data. (No-protocol and Host Link only)	
	06	RS-232C Reception Completed Flag Turns ON when the PC has completed reading data. (No-protocol only)	
	07	RS-232C Reception Overflow Flag Turns ON when an overflow has occurred. (No-protocol only)	
	08 to 11	Peripheral Port Error Code 0: Normal completion 1: Parity error 2: Frame error 3: Overrun error	
	12	Peripheral Port Communications Error Flag Turns ON when a peripheral port communications error occurs.	
	13	Peripheral Port Transmit Ready Flag Turns ON when the PC is ready to transmit data. (No-protocol and Host Link only)	
	14	Peripheral Port Reception Completed Flag Turns ON when the PC has completed reading data. (No-protocol only)	
	15	Peripheral Port Reception Overflow Flag Turns ON when an overflow has occurred. (No-protocol only)	
09	00 to 15	RS-232C Port Reception Counter (4 digits BCD) Valid only when no-protocol communications are used.	254
10	00 to 15	Peripheral Port Reception Counter (4 digits BCD) Valid only when no-protocol communications are used.	254

ote 1)	00 to 07	High-speed Counter Range Comparison Flags 00 ON: Counter PV is within comparison range 1 01 ON: Counter PV is within comparison range 2 02 ON: Counter PV is within comparison range 3 03 ON: Counter PV is within comparison range 4 04 ON: Counter PV is within comparison range 5 05 ON: Counter PV is within comparison range 6 06 ON: Counter PV is within comparison range 7 07 ON: Counter PV is within comparison range 8	58
	08	High-speed Counter Comparison Operation ON: Operating OFF: Stopped	
	09	High-speed Counter PV Overflow/Underflow Flag ON: An overflow or underflow occurred. OFF: Normal operation	
	10	Not used.	
	11	Pulse Output 0 Output Status ON: Pulse output 0 is accelerating or decelerating. OFF: Pulse output 0 is operating at a constant rate.	101
	12	Pulse Output 0 Overflow/Underflow Flag ON: An overflow or underflow occurred. OFF: Normal operation	
	13	Pulse Output 0 Pulse Quantity Set Flag ON: Pulse quantity has been set. OFF: Pulse quantity has not been set.	
	14	Pulse Output 0 Pulse Output Completed Flag ON: Completed OFF: Not completed	
	15	Pulse Output 0 Output Status ON: Pulses being output. OFF: Stopped.	
12 ote 1)	00 to 11	Not used.	
	12	Pulse Output 1 Overflow/Underflow Flag ON: An overflow or underflow occurred. OFF: Normal operation	101
	13	Pulse Output 1 Pulse Quantity Set Flag ON: Pulse quantity has been set. OFF: Pulse quantity has not been set.	
	14	Pulse Output 1 Pulse Output Completed Flag ON: Completed OFF: Not completed	
	15	Pulse Output 1 Output Status ON: Pulses being output. OFF: Stopped.	

	00	Power-up PC Setup Error Flag Turns ON when there is an error in DM 6600 to DM 6614 (the part of the PC Setup area that is read at power-up).	549
	01	Start-up PC Setup Error Flag Turns ON when there is an error in DM 6615 to DM 6644 (the part of the PC Setup area that is read at the beginning of operation).	
	02	RUN PC Setup Error Flag Turns ON when there is an error in DM 6645 to DM 6655 (the part of the PC Setup area that is always read).	
	03, 04	Not used.	
	05	Cycle Time Too Long Flag Turns ON if the actual cycle time is longer than the cycle time set in DM 6619.	---
	06, 07	Not used.	
	08	Memory Area Specification Error Flag Turns ON when a non-existent data area address is specified in the program.	---
	09	Flash Memory Error Flag Turns ON when there is an error in flash memory.	---
	10	Read-only DM Error Flag Turns ON when a checksum error occurs in the read-only DM (DM 6144 to DM 6599) and that area is initialized.	550
	11	PC Setup Error Flag Turns ON when a checksum error occurs in the PC Setup area.	
	12	Program Error Flag Turns ON when a checksum error occurs in the program memory (UM) area, or when an improper instruction is executed.	---
	13	Expansion Instruction Area Error Flag Turns ON when a checksum error occurs in the expansion instruction assignments area. The expansion instruction assignments will be cleared to their default settings.	
	14	Data Save Error Flag Turns ON if data could not be retained with the backup battery. The following words are normally backed up by the battery: DM read/write words (DM 0000 to DM 1999 and DM 2022 to DM 2047), Error Log (DM 2000 to DM 2021), HR area, counter area, SR 25511, SR 25512 (if DM 6601 is set to hold I/O memory at startup), AR 23, operating mode (if DM 6600 is set to use the previous operating mode), and clock words (AR 17 to AR 21, for CPU Units with clocks). If the above words cannot be retained, all data will be cleared except that AR 2114 will be turned ON. The CPU Unit will start in PROGRAM mode if DM 6600 is set to use the previous operating mode. (If DM 6604 is set to generate an error, the PC will start in PROGRAM mode regardless.)	---
	15	Not used.	
14	00 to 15	Maximum Cycle Time (4 digits BCD, see note 3) The longest cycle time since the beginning of operation is stored. It is not cleared when operation stops, but it is cleared when operation starts again.	519
15	00 to 15	Current Cycle Time (4 digits BCD, see note 3) The most recent cycle time during operation is stored. The Current Cycle Time is not cleared when operation stops.	
16	00 to 15	Not used.	
17	00 to 07	Minute (00 to 59, BCD)	160
ote 2)	08 to 15	Hour (00 to 59, BCD)	
18	00 to 07	Second (00 to 59, BCD)	
ote 2)	08 to 15	Minute (00 to 59, BCD)	
19	00 to 07	Hour (00 to 23, BCD)	
ote 2)	08 to 15	Day of the Month (01 to 31, BCD)	
20	00 to 07	Month (01 to 12, BCD)	
ote 2)	08 to 15	Year (00 to 99, BCD)	

00 to 07	Day of the Week^a (00 to 06, BCD) 00: Sunday 01: Monday 02: Tuesday 03: Wednesday 04: Thursday 05: Friday 06: Saturday	160
08 to 12	Not used.	
13	30-second Compensation Bit Turn this bit ON to round off to the nearest minute. When the seconds are 00 to 29, the seconds are cleared to 00 and the rest of the time setting is left unchanged. When the seconds are 30 to 59, the seconds are cleared to 00 and the time is incremented by one minute.	160
14	Clock Stop Bit Turn this bit ON to stop the clock. The time/date can be overwritten while this bit is ON.	
15	Clock Set Bit To change the time/date, turn ON AR 2114, write the new time/date (being sure to leave AR 2114 ON), and then turn this bit ON to enable a new time/date setting. The clock will restart and both AR 2114 and AR 2115 will be turned OFF automatically.	
22	00 to 15 Not used.	
23	00 to 15 Power-off Counter (4 digits BCD) This is the count of the number of times that the power has been turned off. To clear the count, write "0000" from a Programming Device.	---

- e 1. The same data can be read immediately with PRV(62).
 2. The time and date can be set while AR 2114 is ON. The new setting becomes effective when AR 2114 is turned ON. (AR 2114 and AR 2115 are turned OFF automatically when the new setting goes into effect.) These words will contain 0000 in CPM2C CPU Units that are not equipped with the clock function.
 3. The units for the maximum and current cycle times are determined by the setting in bits 08 to 12. 00 specifies 0.1-ms units, 01 specifies 0.1-ms units, 02 specifies 1-ms units, 03 specifies 10-ms units.

SRM1 Memory Areas

Memory Area Structure

The following memory areas can be used with the SRM1.

Data area		Words	Bits	Function
area ¹	Input area	IR 000 to IR 007 (8 words)	IR 00000 to IR 00715 (128 bits)	These bits can be allocated to the external I/O terminals. The ON/OFF status of the I/O bits will be the same as the ON/OFF status of the I/O terminals (When the CompoBus/S is used in 128-bit mode, IR 004 to IR 007 and IR 014 to IR 017 can also be used as work bits.)
	Output area	IR 010 to IR 017 (8 words)	IR 01000 to IR 01715 (128 bits)	
	Work area	IR 008 to IR 009 IR 018 to IR 019 IR 200 to IR 239 (44 words)	IR 00800 to IR 00915 IR 01800 to IR 01915 IR 20000 to IR 23915 (704 bits)	Work bits can be freely used within the program. IR 232 to IR 239 however, are used as the MACRO input area when MCRO(99) is being used.
area		SR 240 to SR 255 (16 words)	SR 24000 to SR 25507 (248 bits)	These bits serve as storage space for flags and function set values/present values for SRM1 operation. Refer to <i>SR Area</i> .
area		---	TR 0 to TR 7 (8 bits)	When a complicated ladder diagram cannot be recorded as a mnemonic these bits are used to temporarily store ON/OFF status at program branches. These temporary bits cannot be used within the same block but if the blocks are different several may be used. The ON/OFF status of these bits cannot be monitored using the monitoring function of a Programming Device.
area ²		HR 00 to HR 19 (20 words)	HR 0000 to HR 1915 (320 bits)	These bits store data and retain their ON/OFF status when power is turned off, or operation starts or stops. They are used in the same way as work bits.

area ⁴	AR 00 to AR 15 (16 words)	AR 0000 to AR 1515 (256 bits)	These bits serve specific functions such as flags and control bits. AR 04 to 07 are used as slaves. Refer to <i>AR Area</i> .	
area ¹	LR 00 to LR 15 (16 words)	LR 0000 to LR 1515 (256 bits)	Used for a 1:1 data link with another SRM1 CQM1 or C200HS PC.	
Timer/Counter area ²	TC 000 to TC 127 (timer/counter numbers) ³		Timers and counter use the TIM, TIMH(15), CNT and CNTR(12) instructions. The same numbers are used for both timers and counters. Timer/counter numbers should be specified as bits when dealing with timer/counter present values. The counter data will be stored even when the SRM1 power is turned off or operation is stopped or started. When timer/counter are treated as up-flags the number should be specified as relay data.	
DM area	Read/write ²	DM 0000 to DM 1999 (2,000 words)	---	DM area data can be accessed in word units only. Word values are retained when the power is turned off, or operation started or stopped. Read/write areas can be read and written freely within the program.
	Error log ⁴	DM 2000 to DM 2021 (22 words)	---	Used to store the time of occurrence and error code of errors that occur. Refer to <i>7-5 Coding Right-hand Instructions</i> .
	Read-only ⁴	DM 6144 to DM 6599 (456 words)	---	Cannot be overwritten from program.
	PC Setup ⁴	DM 6600 to DM 6655 (56 words)	---	Used to store various parameters that control PC operation.

1. IR and LR bits that are not used for their allocated functions can be used as work bits.
2. The contents of the HR area, LR area, Counter area, and read/write DM area are backed up by a capacitor. At 25°C, the capacitor will back up memory for 20 days. Refer to *2-1-2 Characteristics* in the *SRM1 Master Control Unit Operation Manual* for a graph showing the backup time vs. temperature.
3. When accessing a PV, TC numbers are used as word data; when accessing Completion Flags, they are used as bit data.
4. Data in DM 6144 to DM 6655 cannot be overwritten from the program, but they can be changed from the Programming Device.

SR Area

SR bits mainly serve as flags related to SRM1 operation or contain present and set values for various functions. The functions of the SR area are explained in the following table.

1. “Read-only” words and bits can be read as status in controller PC operation, but they cannot be written from the ladder program. Bits and words that are “Not used” are also read-only.

Word(s)	Bit(s)	Function	Read/write	Parity
240	00 to 15	Not used.		
247				
248, 249	00 to 15	Reserved.		
250, 251	00 to 15	Not used.		

252	00	Not used. (system use)		
	01 to 07	Not used.		
	08	Peripheral Port Reset Bit Turn ON to reset peripheral port. (Not valid when Programming Device is connected.) Automatically turns OFF when reset is complete.	Read/ write	268
	09	RS-232C Port Reset Bit Automatically turns OFF when reset is complete.		
	10	PC Setup Reset Bit Turn ON to initialize PC Setup (DM 6600 through DM 6655). Automatically turns OFF again when reset is complete. Only effective if the PC is in PROGRAM mode.		2
	11	Forced Status Hold Bit OFF: The forced status of bits that are forced set/reset is cleared when switching between PROGRAM mode and MONITOR mode. ON: The status of bits that are forced set/reset are maintained when switching between PROGRAM mode and MONITOR mode.		17
	12	I/O Hold Bit OFF: IR and LR bits are reset when starting or stopping operation. ON: IR and LR bit status is maintained when starting or stopping operation.		17
	13	Not used.		
	14	Error Log Reset Bit Turn ON to clear error log. Automatically turns OFF again when operation is complete.	Read/ write	551
	15	Not used.		
253	00 to 07	FAL Error Code The error code (a 2-digit number) is stored here when an error occurs. The FAL number is stored here when FAL(06) or FALS(07) is executed. This word is reset (to 00) by executing a FAL 00 instruction or by clearing the error from a Programming Device.	Read- only	381
	08	Not used.		
	09	Cycle Time Overrun Flag Turns ON when a cycle time overrun occurs.	Read- only	---
	10 to 11	Not used.		
	12	RS-232C Port Set Bit Turn ON to set RS-232C port. Turn OFF when reset is complete.	Read/ write	
	13	Always ON Flag	Read- only	---
	14	Always OFF Flag		---
15	First Cycle Flag Turns ON for 1 cycle at the start of operation.	---		
254	00	1-minute clock pulse (30 seconds ON; 30 seconds OFF)		---
	01	0.02-second clock pulse (0.01 second ON; 0.01 second OFF)		---
	02	Negative (N) Flag		---
	03	Not used.		
	04	Overflow Flag	Read- only	---
	05	Underflow Flag		---
	06	Differential Monitor Complete Flag Turns ON when differential monitoring is complete.		156
	07	STEP(08) Execution Flag Turns ON for 1 cycle only at the start of process based on STEP(08).		381
	08 to 15	Not used.		

255	00	0.1-second clock pulse (0.05 second ON; 0.05 second OFF)	Read-only	---
	01	0.2-second clock pulse (0.1 second ON; 0.1 second OFF)		---
	02	1.0-second clock pulse (0.5 second ON; 0.5 second OFF)		---
	03	Instruction Execution Error (ER) Flag Turns ON when an error occurs during execution of an instruction.		---
	04	Carry (CY) Flag Turns ON when there is a carry in the results of an instruction execution.		---
	05	Greater Than (GR) Flag Turns ON when the result of a comparison operation is "greater."		---
	06	Equals (EQ) Flag Turns ON when the result of a comparison operation is "equal," or when the result of an instruction execution is 0.		---
	07	Less Than (LE) Flag Turns ON when the result of a comparison operation is "less."		---
	08 to 15	Not used.		

R Area

These bits mainly serve as flags related to SRM1 operation. These bits retain their status even after the SRM1 power supply has been turned off or when operation begins or stops.

Word(s)	Bit(s)	Function	Parity
00, 01	00 to 15	Not used.	
02	00 to 07	Not used.	
	08 to 11	Not used. (system use)	
	12 to 15	Not used.	
03	00 to 15	Not used.	
04 to 07	00 to 15	Slave Status Flag	---
08	00 to 03	RS-232C Error Code (1-digit number) 0: Normal completion 1: Parity error 2: Framing error 3: Overrun error	---
	04	RS-232C Communications Error	---
	05	RS-232C Transmission Enabled Flag Valid only when Host Link, no-protocol communications are used.	---
	06	RS-232C Reception Completed Flag Valid only when no-protocol communications are used.	---
	07	RS-232C Reception Overflow Flag Valid only when no-protocol communications are used.	---
	08 to 11	Programming Device Error Code 0: Normal completion 1: Parity error 2: Frame error 3: Overrun error	269
	12	Programming Device Error Flag	
	13	Programming Device Transmission Enabled Flag Valid only when Host Link, no-protocol communications are used.	
	14	Programming Device Reception Completed Flag Valid only when no-protocol communications are used.	
	15	Programming Device Reception Overflow Flag Valid only when no-protocol communications are used.	---

00 to 15		When the no-protocol communications mode is being used: RS-232C Reception Counter (4 digits BCD)	---
		When the 1:N NT Link communications mode is being used (V2 only): Communicating with PT Flags (Bits 00 to 07 are flags for PTs 0 to 7.) Registering Priority with PT Flags (Bits 08 to 15 are flags for PTs 0 to 7.)	---
10	00 to 15	Programming Device Reception Counter (4 digits BCD) Valid only when no-protocol communications are used.	---
11	00 to 15	4 digits BCD Power supply cut frequency.	---
12	00 to 15	Not used.	
13	00	Power-up PC Setup Error Flag Turns ON when there is an error in DM 6600 to DM 6614 (the part of the PC Setup area that is read at power-up).	549
	01	Start-up PC Setup Error Flag Turns ON when there is an error in DM 6615 to DM 6644 (the part of the PC Setup area that is read at the beginning of operation).	
	02	RUN PC Setup Error Flag Turns ON when there is an error in DM 6645 to DM 6655 (the part of the PC Setup area that is always read).	
	03, 04	Not used.	
	05	Long Cycle Time Flag Turns ON if the actual cycle time is longer than the cycle time set in DM 6619.	---
	06	Turns ON when the program memory (UM) area is full.	---
	07	Turns ON when instructions other than those in the support software area used.	---
	08	Memory Area Specification Error Flag Turns ON when a non-existent data area address is specified in the program.	---
	09	Flash Memory Error Flag Turns ON when there is an error in flash memory.	---
	10	Read-only DM Error Flag Turns ON when a checksum error occurs in the read-only DM (DM 6144 to DM 6599) and that area is initialized.	550
	11	PC Setup Error Flag Turns ON when a checksum error occurs in the PC Setup area.	
	12	Program Error Flag Turns ON when a checksum error occurs in the program memory (UM) area, or when an improper instruction is executed.	---
	13	Not used. (Cleared when power is turned on.)	
13	14	Data Save Error Flag Turns ON when power is turned on if data could not be saved in the following areas: DM area (read/write-capable), HR area, CNT area, SR 252, bits 11, 12 (when PC Setup in DM 6601 is set to maintain status), error log, operation mode (when PC Setup in DM 6600 is set to continue mode last used before power failure). <i>(For details regarding the holding time, refer to the SRM1 Operation Manual.)</i> If data could not be saved in the above areas: The DM (read/write-capable), error log, HR, and CNT areas, and SR 252, bits 11 and 12 will be cleared. The operation mode will go into PROGRAM mode.	
	15	SRM1 CompoBus/S Communications Error Flag	---
14	00 to 15	Maximum Cycle Time (4 digits BCD) The longest cycle time since the beginning of operation is stored. It is cleared at the beginning, and not at the end, of operation. The units can be any of the following, depending on the setting of in DM 6618. Default: 0.1 ms; "10 ms" setting: 0.1 ms; "100 ms" setting: 1 ms; "1 s" setting: 10 ms	519
15	00 to 15	Current Cycle Time (4 digits BCD) The most recent cycle time during operation is stored. The Current Cycle Time is not cleared when operation stops. The units can be any of the following, depending on the setting of in DM 6618. Default: 0.1 ms; "10 ms" setting: 0.1 ms; "100 ms" setting: 1 ms; "1 s" setting: 10 ms	

I/O Assignment Sheet

Name of system		Produced by	Verified by	Authorized
model	Sheet No.			

_____	Unit No.:	Model:	IR _____	Unit No.:	Model:
			00		
			01		
			02		
			03		
			04		
			05		
			06		
			07		
			08		
			09		
			10		
			11		
			12		
			13		
			14		
			15		

_____	Unit No.:	Model:	IR _____	Unit No.:	Model:
			00		
			01		
			02		
			03		
			04		
			05		
			06		
			07		
			08		
			09		
			10		
			11		
			12		
			13		
			14		
			15		

Program Coding Sheet

Name of system				Produced by	Verified by	Authorized
Chart No.						

Address				Instruction	Function code	Operands		
		0	0					
		0	1					
		0	2					
		0	3					
		0	4					
		0	5					
		0	6					
		0	7					
		0	8					
		0	9					
		1	0					
		1	1					
		1	2					
		1	3					
		1	4					
		1	5					
		1	6					
		1	7					
		1	8					
		1	9					
		2	0					
		2	1					
		2	2					
		2	3					
		2	4					
		2	5					
		2	6					
		2	7					
		2	8					
		2	9					
		3	0					
		3	1					
		3	2					
		3	3					

		3	4				
		3	5				
		3	6				
		3	7				
		3	8				
		3	9				
		4	0				
		4	1				
		4	2				
		4	3				
		4	4				
		4	5				
		4	6				
		4	7				
		4	8				
		4	9				
		5	0				
		5	1				
		5	2				
		5	3				
		5	4				
		5	5				
		5	6				
		5	7				
		5	8				
		5	9				
		6	0				
		6	1				
		6	2				
		6	3				
		6	4				
		6	5				
		6	6				
		6	7				
		6	8				
		6	9				
		7	0				
		7	1				
		7	2				

				code			
		7	3				
		7	4				
		7	5				
		7	6				
		7	7				
		7	8				
		7	9				
		8	0				
		8	1				
		8	2				
		8	3				
		8	4				
		8	5				
		8	6				
		8	7				
		8	8				
		8	9				
		9	0				
		9	1				
		9	2				
		9	3				
		9	4				
		9	5				
		9	6				
		9	7				
		9	8				
		9	9				

List of FAL Numbers

Name of system		Produced by	Verified by	Authorized
model	Chart No.			

FAL No.	FAL contents	Corrective measure	FAL No.	FAL contents	Corrective measure
			35		
			36		
			37		
			38		
			39		
			40		
			41		
			42		
			43		
			44		
			45		
			46		
			47		
			48		
			49		
			50		
			51		
			52		
			53		
			54		
			55		
			56		
			57		
			58		
			59		
			60		
			61		
			62		
			63		
			64		
			65		
			66		
			67		
			68		
			69		

			NO.		
			85		
			86		
			87		
			88		
			89		
			90		
			91		
			92		
			93		
			94		
			95		
			96		
			96		
			97		
			99		

Extended ASCII

The following codes are used to output characters to the Programming Console or Data Access Console using the G(46). Refer to pages 493 for details.

Right digit	Left digit												
	0, 1, 8, 9	2	3	4	5	6	7	A	B	C	D	E	F
0			0	@	P	'	p		-	@	P	'	p
1		!	1	A	Q	a	q	!	1	A	Q	a	q
2		”	2	B	R	b	r	”	2	B	R	b	r
3		#	3	C	S	c	s	#	3	C	S	c	s
4		\$	4	D	T	d	t	\$	4	D	T	d	t
5		%	5	E	U	e	u	%	5	E	U	e	u
6		&	6	F	V	f	v	&	6	F	V	f	v
7		'	7	G	W	g	w	'	7	G	W	g	w
8		(8	H	X	h	x	(8	H	X	h	x
9)	9	I	Y	i	y)	9	I	Y	i	y
A		*	:	J	Z	j	z	*	:	J	Z	j	z
B		+	;	K	[k	{	+	;	K	[k	{
C		,	<	L	\	l		,	<	L	\	l	
D		-	=	M]	m	}	-	=	M]	m	}
E		.	>	N	^	n	~	.	>	N	^	n	~
F		/	?	O	_	o	«	/	?	O	_	o	«

Symbols

empty**, 568

Numbers

PC Link

CPM1/CPM1A, 225
CPM2A/CPM2C, 259
SRM1, 275

PC Link communications, I/O response timing
CPM1/CPM1A, 511
CPM2A/CPM2C, 521
SRM1, 537

A–B

log controls, 147

log I/O functions, 144, 162, 173

log I/O Units, 144
for CPM1A/CPM2A, 162
for CPM2C, 173

log Input Units
averaging function, 179
input range, 176
open-circuit detection function, 179

log inputs, 165, 180

log Output Units, output range, 178

log outputs, 166, 181

log settings, 147

arithmetic flags, 156, 361

ASCII
converting data, 445, 447
table of codes, 591
tagging function, 179

binary data, signed binary, 156

controlling, 373

C

check levels, program checks, 547

checksum, calculating frame checksum, 496

clock, 160

communications
1 NT Link
CPM2A/CPM2C, 256
SRM1, 273
1 PC Link

CPM1/CPM1A, 225
CPM2A/CPM2C, 259
SRM1, 275
1:N NT Link, SRM1, 274
errors, 550
host link
CPM1/CPM1A, 223
CPM2A/CPM2C, 227
SRM1, 264
NT Link, CPM1/CPM1A, 224
types, 222
wiring, 222

communications functions, 221

Communications Switch, setting
CPM2A, 249, 258, 262
CPM2C, 250, 258, 263

CompoBus/S I/O Link Unit, 144, 210
using, 210

CompoBus/S I/O Master functions, 145

CompoBus/S I/O Slave functions, 144, 210

constants, operands, 361

counter mode interrupts, CPM2A/CPM2C, 65

counters
conditions when reset, 390, 392
creating extended timers, 391
reversible counters, 391

cycle monitor time, PC Setup settings, 18

cycle time
CPM1/CPM1A
calculating, 509
effects on operations, 509
processes, 509
CPM2A/CPM2C
calculating, 519
effects on operations, 519
processes, 519
SRM1
calculating, 534
effects on operations, 535
processes, 534

cycle time (minimum), PC Setup settings, 19

D

data
computation standards, 143
decrementing, 479
incrementing, 479

decrementing. *See* data

definers, definition, 360

Differential Monitor, function, 156

differential monitoring, 156

differentiated instructions, 362

ratio
xed duty ratio pulse outputs, 98
variable duty ratio pulse outputs, 108

E

r codes, programming, 381
r log, PC Setup settings, 21
r log area, 548
r messages, programming, 493
rs
communications, 550
egree of error in pulse outputs, 143
etal, 550
eneral, 546
on-fatal, 549
her, 550
C Setup, 2
rogramming, 547
rogramming Console operations, 546
rogramming messages, 493
setting, 381
pes, 546
er-defined errors, 548
ution condition, definition, 332
ansion instructions, 367, 368, 558
unction codes, 157
ansion Units, using, 161

F

area, 381
numbers, table, 589
(06), 548
S(07), 548
ithmetic, programming example, 429, 433
Y
clearing, 453
setting, 453
s, error and arithmetic, 561
ne Check Sequence. *See* frames, FCS
ne checksum, calculating with FCS(—), 496
es, FCS, 235
tion codes, 360
ansion instructions, 157, 158, 159, 367, 368

high-speed counter interrupts
CPM1/CPM1A, 83
CPM2A/CPM2C, 43
high-speed counters, CPM2A/CPM2C, 42
hold bit status, PC Setup settings, 17
host link
CPM1/CPM1A, 223
CPM2A/CPM2C, 227
SRM1, 264
host link commands
**, 300
EX, 300
FK, 294
IC, 301
KC, 295
KR, 293
KS, 292
MF, 291
MM, 296
MS, 289
QQ, 298
R#, 285
R\$, 286
RC, 278
RD, 279
RG, 279
RH, 278
RJ, 280
RL, 278
RP, 297
RR, 277
SC, 290
TS, 296
W#, 287
W\$, 288
WC, 282
WD, 284
WG, 283
WH, 282
WJ, 284
WL, 281
WP, 297
WR, 281
XZ, 300

I-J

I/O points, refreshing, 494
I/O response time
1:1 PC Link communications
CPM1/CPM1A, 511
CPM2A/CPM2C, 521
SRM1, 537
CPM1/CPM1A. *See* timing
CPM2A/CPM2C. *See* timing
SRM1. *See* timing
incrementing, 479
indicators, CompoBus/S LED indicators, 211, 216

1), 130
alization processes, CPM1/CPM1A, 508

t interrupts
CPM1/CPM1A, 75
CPM2A/CPM2C, 27
t interrupts (counter mode), CPM2A/CPM2C, 65

t mode
CPM2A/CPM2C, 46
lecting, 134

t time constants, PC Setup settings, 19

ts, quick-response inputs, 149

uction set, 555

CC(—), 487

DB(50), 463

DD(30), 453

DDL(54), 458

ND, 334, 372

combining with OR, 335

ND LD, 337, 373

combining with OR LD, 340

use in logic blocks, 339

ND NOT, 334, 372

NDW(34), 476

SC(86), 445

SFT(17), 406

SL(25), 401

SR(26), 402

VG(—), 472

CD(24), 436

CDL(59), 437

CMP(68), 430

CNT(67), 495

IN(23), 435

INL(58), 436

SET(71), 410

LC(41), 453

MP(20), 428

MPL(60), 432

NT, 390

NTR(12), 391

OLL(81), 413

OM(29), 475

TBL(63), 392

EC(39), 479

IFD(14), 351, 376–385

using in interlocks, 378

using in jumps, 380

IFU(13), 351, 376–385

using in interlocks, 378

using in jumps, 380

IST(80), 411

IV(33), 457

IVL(57), 462

MPX(77), 440

VB(53), 466

ND(01), 337, 377

AL(06), 381

ALS(07), 381

CS(—), 496

EX(—), 447

ILC(03), 347, 377–379

INC(38), 479

INI(61), 130, 395

INT(89), 80, 497

IORF(97), 494

JME(05), 379

JMP(04), 379

JMP(04) and JME(05), 349

KEEP(11), 375

in controlling bit status, 351

ladder instructions, 333

LD, 334, 372

LD NOT, 334, 372

MAX(—), 468

MCRO(99), 154, 482

MIN(—), 470

MLB(52), 466

MLPX(76), 438

MOV(21), 407

MOVB(82), 415

MOVD(83), 416

MSG(46), 493

MUL(32), 456

MULL(56), 462

MVN(22), 408

NEG(—), 451

NOP(00), 377

NOT, 331

operands, 330

OR, 335, 372

combining with AND, 335

OR LD, 338, 373

combining with AND LD, 340

use in logic blocks, 339

OR NOT, 335, 372

ORW(35), 477

OUT, 336, 373

OUT NOT, 336, 373

PID(—), 422

PRV(62), 397

PULS(65), 129, 483

PWM(—), 490

RESET, 350

RET(93), 482

ROL(27), 402

ROR(28), 403

RSET, 374–375

RXD(47), 248, 272, 501

SBB(51), 464

SBN(92), 26, 74, 482

SBS(91), 480

SCL(66), 417

SCL2(—), 418

SCL3(—), 420

SDEC(78), 442

SET, 350, 374–375

SFT(10), 400

SFTR(84), 405

SLD(74), 404

SNXT(09), 381

SPE(64), 129, 485

SRCH(—), 467

SRD(75), 404

- TH(—), 450
- TIM(69), 500
- TUP(—), 505
- UB(31), 454
- UBL(55), 460
- UM(—), 474
- YNC(—), 492
- CMP(85), 429
- terminology, 330
- IM, 385
- IMH(15), 386
 - using in jumps, 380
- IML(—), 388
- IMHH(—), 387
 - using in jumps, 380
- XD(48), 248, 272, 503
- YSFT(16), 401
- CHG(73), 411
- FER(70), 409
- NRW(37), 478
- ORW(36), 477
- CP(—), 433
- CPL(—), 434
- uctions
- ecution times
 - CPM1/CPM1A, 514
 - CPM2A/CPM2C, 524
 - SRM1, 539
- xpansion, 157
- struction set lists, 366
- emonics list, ladder, 369
- ght-hand instructions, coding multiple, 345
- broutines, 480

- (89), 80
- locks, 377–379
- ing self-maintaining bits, 352
- rupt functions
 - CPM1/CPM1A, 73
 - CPM2A/CPM2C, 26
 - SRM1(-V2), 91
- rupt processing
 - calculating response time
 - CPM1/CPM1A, 513
 - CPM2A/CPM2C, 523
 - asking
 - CPM1/CPM1A, 513
 - CPM2A/CPM2C, 523
 - SRM1, 538
 - ming
 - CPM1/CPM1A, 513
 - CPM2A/CPM2C, 523
 - SRM1, 538
- rupts
 - ontrol, 497
 - CPM1/CPM1A
 - counter mode, 79
 - high-speed counter, 83
 - overflows and underflows, 85
 - input interrupt mode, 77
 - input interrupts, 75

- masking, 80
 - setting modes, 77
 - types, 74
 - unmasking, 81
- CPM2A/CPM2C
 - high-speed counter, 43
 - input interrupts, 27
 - interval timers, 34
 - scheduled interrupt mode, 36
 - masking, 31
 - order of priority, 27
 - selecting interrupts to be used, 48
 - setting modes, 30
 - types, 26
 - unmasking, 31, 32
 - high-speed counter, programming, 54, 87
 - masking, masking, 32
 - SRM1
 - interval timers, 91
 - scheduled interrupt mode, 92
 - types, 91
 - unmasking, 500
- interval timer interrupts
 - CPM1/CPM1A, 81
 - CPM2A/CPM2C, 34
 - SRM1, 91
- JOG operation, CPM2A/CPM2C, 106
- jogging, 125
- jump numbers, 379
- jumps, 379–380

L

- ladder diagram
 - branching, 345
 - IL(02) and ILC(03), 347
 - using TR bits, 346
 - combining logic blocks, 341
 - controlling bit status
 - using DIFU(13) and DIFD(14), 351, 376–385
 - using KEEP(11), 375–376
 - using OUT and OUT NOT, 336
 - using SET and RESET, 350
 - using SET and RSET, 374–375
 - converting to mnemonic code, 332–350
 - display via GPC, FIT, LSS, or SSS, 331
 - instructions
 - combining, AND LD and OR LD, 340
 - controlling bit status
 - using KEEP(11), 351
 - using OUT and OUT NOT, 373
 - format, 360
 - notation, 360
 - structure, 331
 - using logic blocks, 337
- ladder diagram instructions, 372–373
- logic block instructions, converting to mnemonic code, 337–344
- logic blocks. *See* ladder diagram

no function, subroutines. *See* programming

locking
CPM1/CPM1A interrupt processes, 513
CPM2A/CPM2C interrupt processes, 523
SRM1 interrupt processes, 538
PULS(99), 154
memory areas
PULS area bits
CPM2A/CPM2C, 574
SRM1, 580
flags and control bits
CPM1/CPM1A, 565
CPM2A/CPM2C, 571
SRM1, 578
structure
CPM1/CPM1A, 304, 565
CPM2A/CPM2C, 305, 570
SRM1, 306, 577
messages, programming, 493
monomic code, converting, 332–350
PULS(46), 548

N

locking, subroutines, 481
protocol communications
CPM2A/CPM2C, 247
program example, 253, 273
SRM1, 268
transmission data configuration, 248, 272
transmission flags, 248, 272
normally open/closed condition, definition, 331
PULS, definition, 331
PC Link
CPM1/CPM1A, 224
CPM2A/CPM2C, 256
SRM1, 273, 274

O

over-circuit detection function, 179
PULS and bit, 332
PULS stands, 360
allowable designations, 360
requirements, 360
operations
CPM1/CPM1A internal processing, flowchart, 508
effects on CPM1/CPM1A cycle time, 509
effects on CPM2A/CPM2C cycle time, 519
effects on SRM1 cycle time, 535
SRM1 internal processing, flowchart, 533
output bit
controlling ON/OFF time, 374
controlling status, 350, 352

PC Link, CPM2A/CPM2C, 259

PC Setup. *See* settings

PC Setup settings
CPM1/CPM1A, 3
CPM2A/CPM2C, 7
SRM1(-V2), 13

peripheral port, servicing time, 18

peripheral port servicing time, PC Setup settings, 18

positioning, 123

precautions, general, xiii

program coding sheet, 585

Program Memory, structure, 332

program write protection, PC Setup settings, 17

programming
errors, 547
for temperature monitoring, 198
high-speed counter
CPM1/CPM1A, 87
CPM2A/CPM2C, 54
instructions, 555
interrupts, 54, 87
jumps, 349
macro function, subroutines, 154
precautions, 354
preparing data in data areas, 410
program coding sheet, 585
special features, 157
writing, 330

programs
checking, check levels, 547
executing, 356

PULS(65), 129

pulse output
errors/delays, 143
fixed duty ratio, 98
synchronized to input frequency, 131, 492
variable duty ratio, 108

pulse output functions
CPM1A, 128
CPM2A/CPM2C, 94

PV
CNTR(12), 391
timers and counters, 385

R

range code, 169, 187

range comparison interrupts, CPM2A/CPM2C, 49

right-hand instructions, coding. *See* instructions

RS-232C
communications
receiving
CPM2A/CPM2C, 255

- CPM2A/CPM2C, 254
- SRM1, 268
- control bits, SRM1, 269
- 232C port, servicing time (CPM2A/CPM2C/SRM1), 18
- 232C port servicing time, PC Setup settings, 18
- TXD(47), 248, 272

S

- SRM1(92), 26, 74
- serial communications, CPM2A/CPM2C, 247
- status registers
 - basic operations
 - hold bit status, 17
 - startup mode, 16
 - switching, 2
 - communications, 222
 - host link
 - CPM1/CPM1A, 223
 - CPM2A/CPM2C, 227
 - SRM1, 264
 - defaults, 2
 - I/O operations, 16
 - port servicing scan time, 18, 19
- on-screen segment displays, converting data, 442
- signed binary data, 155, 156
- SRM1D(64), 129
- startup mode, PC Setup settings, 16
- routine number, 482
- subroutines, interrupt subroutines, 26
- SRM1NTR(12), 391
- timers and counters, 385
- synchronized pulse control, 131
- errors/delays, 143
- synchronized pulse output, 492
- target value comparison table, CPM2A/CPM2C, 54
- TC numbers, 384
- temperature sensor input functions, 144
- Temperature Sensor Units, 144, 189
- time
 - reading the time, 160
 - setting the time, 160
- timers, conditions when reset, 385, 386
 - TIML(—), 389
 - TMHH(—), 388
- timing
 - basic instructions
 - CPM1/CPM1A, 514
 - CPM2A/CPM2C, 524
 - SRM1, 539
 - CPM1/CPM1A cycle time, 509
 - CPM2A/CPM2C cycle time, 519
 - I/O response time
 - CPM1/CPM1A, 510
 - CPM2A/CPM2C, 520
 - SRM1, 536
 - instruction execution
 - CPM1/CPM1A. *See* instruction
 - CPM2A/CPM2C. *See* instruction
 - SRM1. *See* instruction
 - interrupt processing
 - CPM1/CPM1A, 513
 - CPM2A/CPM2C, 523
 - SRM1, 538
 - special instructions
 - CPM1/CPM1A, 514
 - CPM2A/CPM2C, 524, 531
 - SRM1, 539, 543
 - SRM1 cycle time, 534
- TR bits, use in branching, 346
- two-decimal place display, 204
- TXD(48), 248, 272
- write protecting the program, PC Setup settings, 17

Manual revision code appears as a suffix to the catalog number on the front cover of the manual.

Cat. No. W353-E1-3



The following table outlines the changes made to the manual during each revision. Page numbers refer to the previous version.

Revision code	Date	Revised content
1	May 1999	Original production
2	January 2000	<p>Information on new Expansion Units and the relevant PCs was added throughout the manual. Additional changes were made on the following pages:</p> <p>Page xi: Updated to new contents of manual.</p> <p>Page xv: Change made to first caution.</p> <p>Page xvi: Change made to first installation precaution.</p> <p>Page xvii: Ground precaution changed to warning and moved to safety precaution section. Other precautions expanded or reworded.</p> <p>Page xv: Caution on online editing reworded.</p> <p>Page xvi: First installation precaution expanded.</p> <p>Pages 9, 11, 185, 186, 194, 195, 200: Host Link unit number added to port settings.</p> <p>Pages 11, 186, 195: Communications mode description changed.</p> <p>Page 17: Setting to protect memory changed.</p> <p>Page 24: Position of notes changed.</p> <p>Pages 54, 55, 56, 57, 58, 71, 79, 92, 99, 106, 107, 112, 113, 115, 116, 117, 119, 133, 153, 154, 160, 174, 175, 198, 213, 348, 414, 425, 428, 429: Changes to graphics.</p> <p>Pages 96, 111: Change to "Pulse Output Flag" description.</p> <p>Page 120: Pulse output number changed in program.</p> <p>Page 134: Section added on data calculations.</p> <p>Pages 137 to 139: Analog control sections combined.</p> <p>Pages 148, 149: Corrections made for function codes.</p> <p>Page 159: Table removed.</p> <p>Pages 187, 207: Change to first line of program.</p> <p>Pages 190, 300, 475: Note added.</p> <p>Pages 238, 367, 444: Changes made to tables.</p> <p>Pages 283-285: Updated to new contents and order of section.</p> <p>Pages 293, 294: Changes made to existing table. Table added.</p> <p>Pages 311-314: Information added to "Precautions."</p> <p>Page 313: Changes made to graphics and "Limitations." Section moved to the end of section on "TMHH."</p> <p>Page 314: Changes made to graphics and "Limitations."</p> <p>Pages 387, 388: Example added.</p> <p>Page 413: Section on "SRCH" moved before section on "MAX."</p> <p>Page 443: Information on "I/O refreshing" added.</p> <p>Page 490: "Volume" removed from information on SR 250 and SR 251.</p> <p>Pages 490, 491, 495-497, 501-503: "Read/write" column added to table.</p> <p>Page 497: Changes made to information on AR 02.</p> <p>Page 498: Changes made to information on AR 1111.</p> <p>Page 499: Changes made to information on AR 1314.</p>

3	February 2001	<p>Revisions and additions were made accompanying specifications changes and new products.</p> <p>The CPM1A-MAD11 Analog I/O Unit was added as section 3-1-2 and the CPM1A-DRT21 DeviceNet I/O Link Unit was added as section 3-4.</p> <p>Interrupt programming precautions were added to sections 2-1 and 2-3.</p> <p>Specific changes are as follows:</p> <p>Pages xi, 1, 23, 148, 163, 177, 197, 203, 331, 341, 383, 495, 500, and 546: CPM2C-S added.</p> <p>Pages 7 and 21: Information added on DIP switch changes.</p> <p>Page 138: Note added.</p> <p>Page 161: Information added on startup operation.</p> <p>Page 162: Programming example modified.</p> <p>Pages 295 to 298 and 300: Models added.</p> <p>Page 545: Description of AR 1314 altered.</p> <p>Page 550: Description of AR 0712 added.</p>
---	---------------	---