

Signal Connections Configuration 111

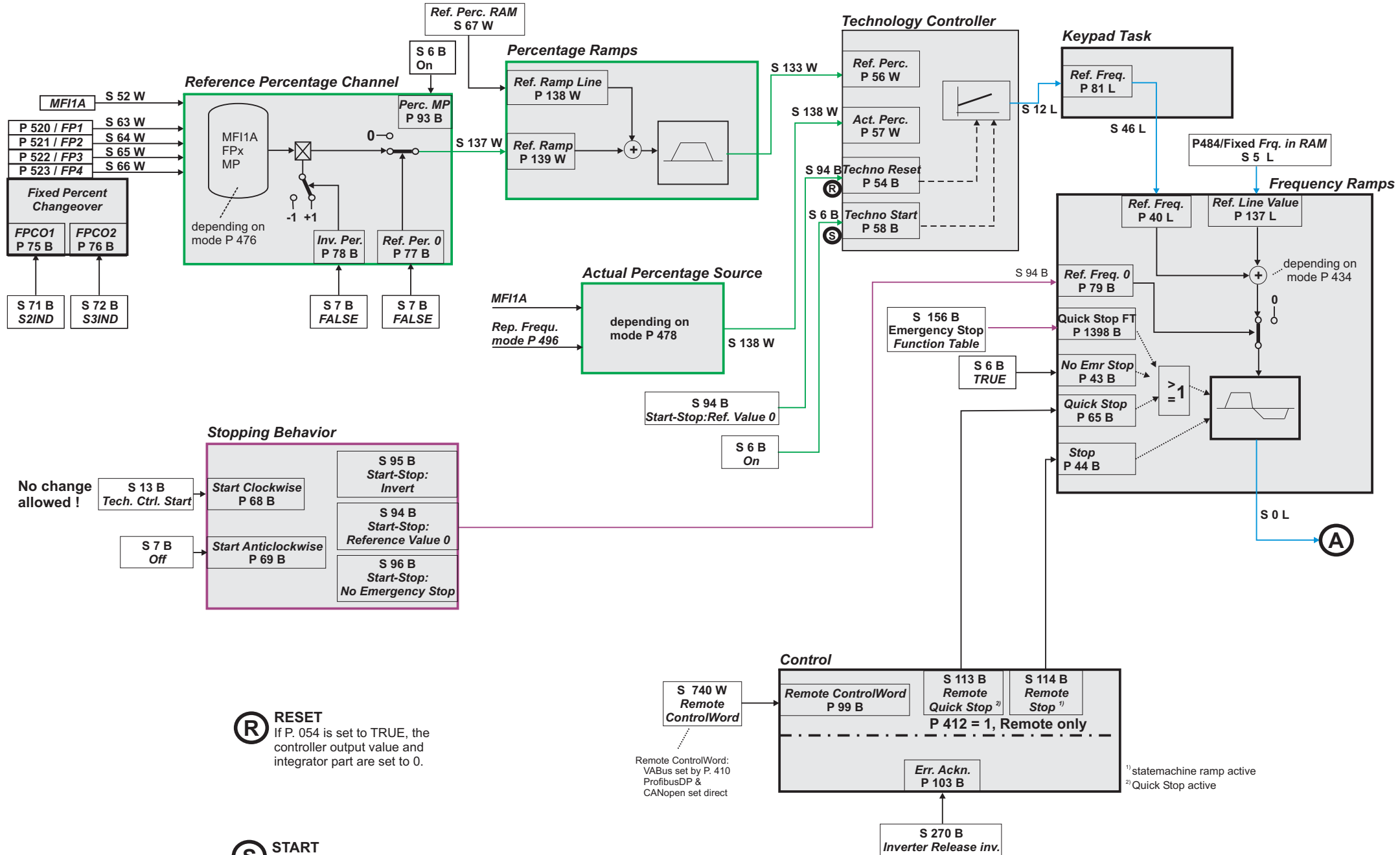

(R) RESET
If P. 054 is set to TRUE, the controller output value and integrator part are set to 0.

(S) START
If P. 058 is set to FALSE, the technology controller stops working. Integral part and output value remain on the last value.

Remote ControlWord: VABus set by P. 410 ProfibusDP & CANopen set direct

¹⁾ statemachine ramp active
²⁾ Quick Stop active

Signal Connections Configuration 111

