

YASKAWA

REGENERATIVE UNIT R1000

EN

DE



R1000 R1000

R1000
R1000

R1000

R1000

Content

- ▶ 02 **About YASKAWA**
A Leader in Inverter Drives
Technology
- ▶ 03 **The Power Regenerative Unit**
- ▶ 04 **Discover new Energy Saving
Potentials**
- ▶ 05 **Applications**
- ▶ 06 **Package Selection**
- ▶ 07 **Model Code Designation and
R1000 Packages**
- ▶ 08 **Specifications, Parts and
Options**
- ▶ 09 **Connection Diagram**
- ▶ 10 **Dimensions of Reactors and
Filters**

Experience and Innovation

Since 1915 YASKAWA has manufactured and supplied products for machine building and industrial automation. Our standard products as well as tailor-made solutions are well known and have a high reputation for outstanding quality and reliability.

YASKAWA is the leading global manufacturer of inverter drives, servo drives, machine controllers, medium voltage inverters, and industrial robots.

We have always been a pioneer in motion control and drive technology, launching product innovations, which optimise the productivity and efficiency of both machines and systems.

Today we produce more than 1.9 million inverters per year. Considering this, YASKAWA is probably the biggest inverter manufacturer in the world.



YASKAWA Motoman Robots

Furthermore, with a yearly production of more than 1 million servo motors and 25,000 robots we offer a wide range of products for drive automation processes in many different industries. YASKAWA technology is used in all fields of machine building and industrial automation.



YASKAWA Eschborn, Germany

Wherever You Are – Our Local Support is Near



Employing more than 14,600 people worldwide

More than 1,350 employees in worldwide service network

More than 1,500 employees in Europe

The Power Regenerative Unit

The R1000 regenerative braking unit is a smart and efficient alternative to dynamic braking for single or multi-axis drive installations with a high amount of regenerative motor operation. Instead of wasting it as heat, the R1000 feeds excessive braking energy back to the grid, thus reducing the energy consumption of the installation.



ENERGY EFFICIENT FOUR-QUADRANT

R1000 saves energy by making excessive braking energy available to other consumers in the same grid instead of wasting it as heat. R1000 provides high duty cycle braking capability, thus it can shorten machine cycles and increase productivity of machinery.



SMART SYSTEM DESIGN

R1000 is purely selected by braking power and can therefore be selected smaller than the drive it is connected to. Thus it allows to minimize system space, optimize cost and maximize efficiency.



COOL OPERATION

R1000 eliminates the need for safely located braking resistors, thus saving valuable space and reducing the risk of fire. Less heat is generated so that the demand for ventilation is greatly reduced. Additionally maintenance, e.g. for resistor cleaning becomes needless.



COMPATIBLE

R1000 Regenerative Braking Units can be used with any conventional drive that has full access to the DC bus.



SAVE ENERGY COST

Especially in high duty braking applications such as cranes, escalators or lifts the R1000 provides numerous advantages. The small installation space and low heat generation impact installation cost, while using the regenerated energy reduces the running cost so that the R1000 pays back in a short period.



EASY TO HANDLE PACKAGE

R1000 comes in an easy to handle package. Only one material number for all components makes procurement simple and assures completeness and parts compatibility.



Save Energy with Power Regeneration

Unlike dynamic braking, which dissipates all braking energy in the form of heat, the R1000 avoids wasted energy by delivering it back to the power source for use by other loads. R1000 can flexibly be used to maximise efficiency of single- and multi-axis systems.

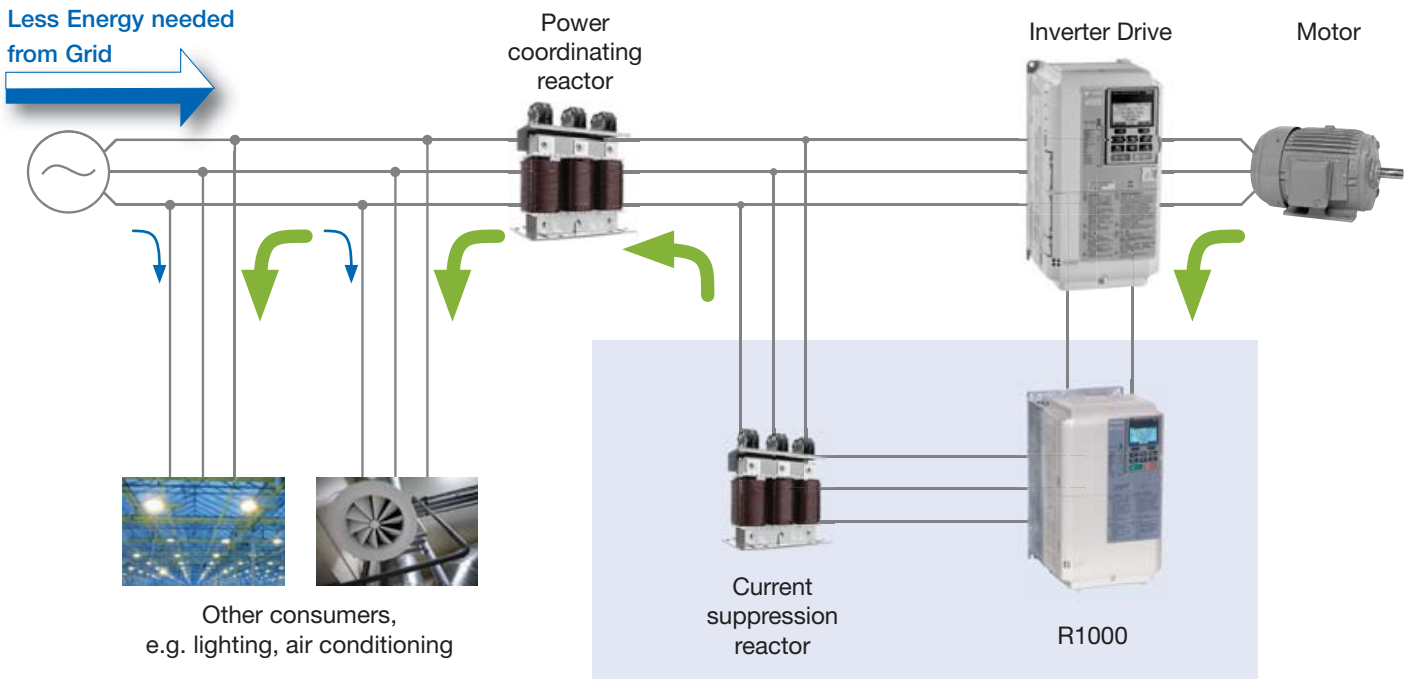

Economical Dynamic Braking

The R1000 provides the most economical way of dynamic braking by

- ▶ Selection purely by braking power – R1000 can be smaller than the drive
- ▶ Less energy consumption from grid as other consumers in the same installation can use braking energy
- ▶ Less space and heat by removed braking choppers and resistors
- ▶ Reduced ventilation requirements by less heat emission

Flexible Application

The R1000 can be used on single drives as well as in drives, servo or other systems that have an interconnected DC bus.

All Compatible

The R1000 can work with all conventional drives having full power access to DC bus. By that it is the perfect match when planning energy efficient new installations but when upgrading existing installations.

For a Wide Range of Applications

Using the R1000 Regenerative Unit saves energy and thereby money within a broad range of applications. This includes applications with large-inertia loads, 4-quadrant loads, long-term energy feedback and quick braking.



Motor Test Benches



Robots

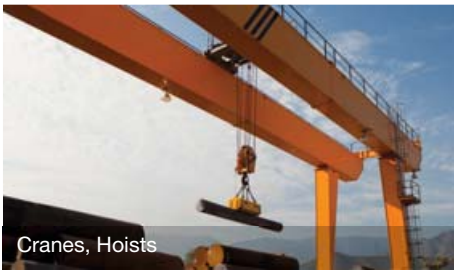

Cranes, Hoists



Winders



Elevators



Escalators

Stopping

- ▶ Elevators and Lifts
- ▶ Centrifuges
- ▶ Saws
- ▶ Large Fans
- ▶ Machine Tool Spindles

Eccentric

- ▶ Presses
- ▶ Dryers
- ▶ Vibratory Equipment

Continuous Regen

- ▶ Winders
- ▶ Downhill Conveyors
- ▶ Dynamometers

R1000 Selection

- ▶ Determine **the maximum regeneration (braking) power**
- ▶ Select an R1000 kit with a power rating higher than the calculated braking power, keeping in mind the R1000 duty cycle and overload capability (150% for 30 seconds).



Max. Regeneration Power (kW)	3.5	5	7	10	14	17	20	28	35	43	53	73	105	150	210	300
R1000 Kit R1KIT4____AA□AA	0003	0005	0007	0010	0014	0017	0020	0028	0035	0043	0053	0073	0105	0150	0210	0300
Braking Torque	150% braking torque for 30 s 100% braking torque for 30 s with 25% ED 80% braking torque continuous															

- ▶ **If the braking power is unknown**, a simple selection of the R1000 kit can be done with this table:

Motor / Drive Capacity (kW)	4.0 or less	5.5	7.5	11	15	18.5	22	30	37	45	55	75	110	160	220	315
R1000 Kit R1KIT4____AA□AA	0003	0005	0007	0010	0014	0017	0020	0028	0035	0043	0053	0073	0105	0150	0210	0300

- ▶ Select a Power Coordinating Reactor and EMC Filter according to the drive used (see tables below)

A1000 and V1000 General Inverter

A1000 Drive CIMR- AC4A□□□□	V1000 Drive CIMR- VC4A□□□□	Power Coordinating Reactor Model	EMC Filter Model
0002	0002	LR3 40-4/2	HLD 110-500/8
0004	0004	LR3 40-4/4	
0005	0005	LR3 40-4/6	
0007	0007	LR3 40-4/10	
0009	0009		
0011	0011	LR3 40-4/16	HLD 110-500/16
0018	0018	LR3 40-4/20	HLD 110-500/30
0023	0023	LR3 40-4/25	HLD 110-500/42
0031 / 0038	0031 / 0038	LR3 40-4/45	
0044 / 0058		LR3 40-4/63	
0072		LR3 40-4/70	
0088		LR3 40-4/90	
0103		LR3 40-4/115	
0139 / 0165		LR3 40-4/160	
0208		LR3 40-4/200	
0250		LR3 40-4/250	
0296		LR3 40-4/300	
0362 / 0414		LR3 40-4/400	
0515		LR3 40-4/500	
0675		LR3 40-4/710	
0930 / 1200		LR3 40-4/1200	

* Drawings, dimensions and weight information for reactors and filters can be found on pages 10 and 11.

L1000A and L1000V Lift Inverter

L1000A Drive CIMR- LC4x□□□□	L1000V Drive CIMR- LC4V□□□□	EN12015 Compliant Power Coordinating Reactor	EMC Filter Model
0005	0009	B 1103136	HLD 110-500/8
0006	0015		
0009	0018		
0015	0024	B 1103138	HLD 110-500/12
0018	0031		
0024		B 1103139	HLD 110-500/16
0031		B 1103140	HLD 110-500/30
0039		B 1103141	HLD 110-500/42
0045			
0060		B 1103142	FB-40105A
0075			
0091		B 0910013	FB-40170A
0112			
0150		B 1411053	FB-40250A
0180			
0216		2 x B 0910013	

* Drawings, dimensions and weight information for reactors and filters can be found on pages 10 and 11.

Model Number Key for the R1000 Package

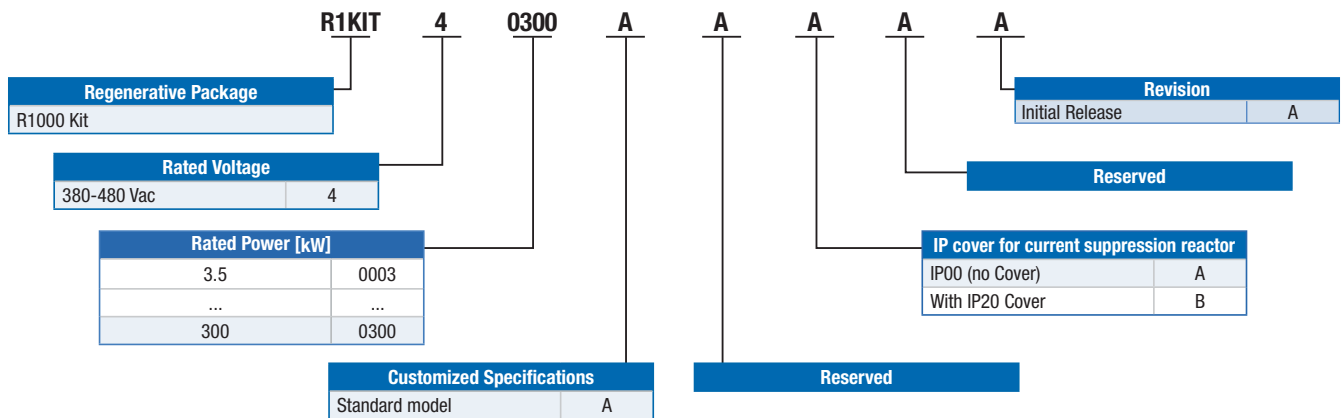

R1000 Packages

R1000 is available in pre configured packages including the R1000 and the current suppression reactor. Main reactors have to be selected according to the drive used.

Package Content

- ▶ R1000 Regenerative Braking Unit
- ▶ Current suppression reactor
- ▶ IP20 cover for current suppression reactor (optional)

Capacity [kW]	Part Number Kit		Part Number		IP20 cover for current suppression reactor (optional)
	Order Number	R1000 Unit	Current Suppr. Reactor (1%)		
3.5	R1KIT40003AA□AA	CIMR-RC4A03P5FAA	B1509105		IP20-Box31
5	R1KIT40005AA□AA	CIMR-RC4A0005FAA	B1509105		IP20-Box31
7	R1KIT40007AA□AA	CIMR-RC4A0007FAA	B1509106		IP20-Box31
10	R1KIT40010AA□AA	CIMR-RC4A0010FAA	B1509107		IP20-Box31
14	R1KIT40014AA□AA	CIMR-RC4A0014FAA	B1509108		IP20-Box31
17	R1KIT40017AA□AA	CIMR-RC4A0017FAA	B1509108		IP20-Box31
20	R1KIT40020AA□AA	CIMR-RC4A0020FAA	B1509109		IP20-Box31
28	R1KIT40028AA□AA	CIMR-RC4A0028FAA	B1509110		IP20-Box32
35	R1KIT40035AA□AA	CIMR-RC4A0035AAA	B1504118		IP20-Box32
43	R1KIT40043AA□AA	CIMR-RC4A0043AAA	B1509111		IP20-Box32
53	R1KIT40053AA□AA	CIMR-RC4A0053AAA	B1509112		IP20-Box33
73	R1KIT40073AA□AA	CIMR-RC4A0073AAA	B1509113		IP20-Box35
105	R1KIT40105AA□AA	CIMR-RC4A0105AAA	B1509114		IP20-Box35
150	R1KIT40150AA□AA	CIMR-RC4A0150AAA	B1505002		IP20-Box39
210	R1KIT40210AA□AA	CIMR-RC4A0210AAA	B1505008		IP20-Box39
300	R1KIT40300AA□AA	CIMR-RC4A0300AAA	B1505011		IP20-Box39



R1000
Regenerative Unit



Current Suppression Reactor



R1000 Specifications

Operating Environment

- ▶ **Ambient Temperature** -10 to +50 °C (open chassis)
- ▶ **Humidity** 95% RH or less (non condensating)
- ▶ **Storage Temperature** -20 to +60 °C (short-term temperature during transportation)
- ▶ **Altitude** Up to 1000 meters (output derating required above 1000 m, max. 3000 m)
- ▶ **Shock** Model 4A03P5 to 4A0073: 10 to 20 Hz: 9.8 m/s², 20 to 55 Hz: 5.9 m/s²
Model 4A0105 to 4A0300: 10 to 20 Hz: 9.8 m/s², 20 to 55 Hz: 2.0 m/s²
- ▶ **Protection Design** IP00 Open Type enclosure, Indoor use (Protected from corrosive gases and dust)
- ▶ **Standards** UL508C, IEC 61800-5-1, IEC 61800-3, RoHS

Power Ratings

CIMR-RC4□□□□□AA	03P5	0005	0007	0010	0014	0017	0020	0028	0035	0043	0053	0073	0105	0150	0210	0300
Max. Applicable Motor Capacity (kW)	3.7	5.5	7.5	11	15	18.5	22	30	37	45	55	75	110	160	220	315
Regeneration Power (kW)	3.5	5	7	10	14	17	20	28	35	43	53	73	105	150	210	300
Rated Current DC (A)	7	11	15	22	30	36	43	58	73	89	109	149	217	320	440	629
Rated Current AC (A)	5	8	11	16	22	27	32	43	54	66	81	110	161	237	326	466
Rated Voltage / Rated Frequency	380 to 480 VAC -15 to +10% / 50/60 Hz ± 2%															
Control Method	120° excitation method															
Input Power Factor	0.9 min. (for rated load)															
Overload Protection	30 s at approx. 150% of rated current															
Regenerative Torque	150% braking torque for 30 s 100% braking torque for 30 s with 25% ED 80% braking torque continuous															

Options

Item	Description	Model Code
Input / Output	▶ Analogue Monitor -10 to +10 VDC (Res. 1/2048)	AO-A3
	▶ Digital Output 8 channel digital output option 6 photo couplers (48 V, 50 mA or less), 2 relay contact outputs max 250 VAC/30 VDC, 1 A	DO-A3
Communication	▶ Communication Interface Unit	CANopen CC-Link DeviceNet EtherCAT EtherNet/IP MECHATROLINK-II Modbus/TCP POWERLINK PROFIBUS-DP PROFINET
		under development SI-C3
		under development SI-ES3*
		SI-EN3/SI-EN3D*
		SI-T3
		SI-EM3 SI-EL3
		under development SI-EP3
Others	▶ 24 V Power Supply	Provides power supply for the control circuit and option boards when main circuit power is off PS-A10LB PS-A10HB
	▶ USB Copy Unit	USB converter for PC Tool usage and copy unit for easy parameter setup duplication and backup in one JVOP-181
	▶ IP65 Operator Mounting Frame	Provides a simple way of installing the LCD Remote Operator on the panel JVOP-V11001
	▶ Heatsink Outside Mounting Kit	Mount the drive with heatsink outside of the panel Models 4A03P5 to 0007: EZZ020800B Models 4A0010 to 0014: EZZ020800C Models 4A0017 to 0028: EZZ020800D
	▶ DriveWizard Plus ▶ IP20/NEMA1 Kit	Software used for parametrization Models 4A0035 to 0043: DACT36126 Models 4A0053 to 0073: DACT36186 Models 4A0105 to 0150: DACT36662

Standard Connection Diagram

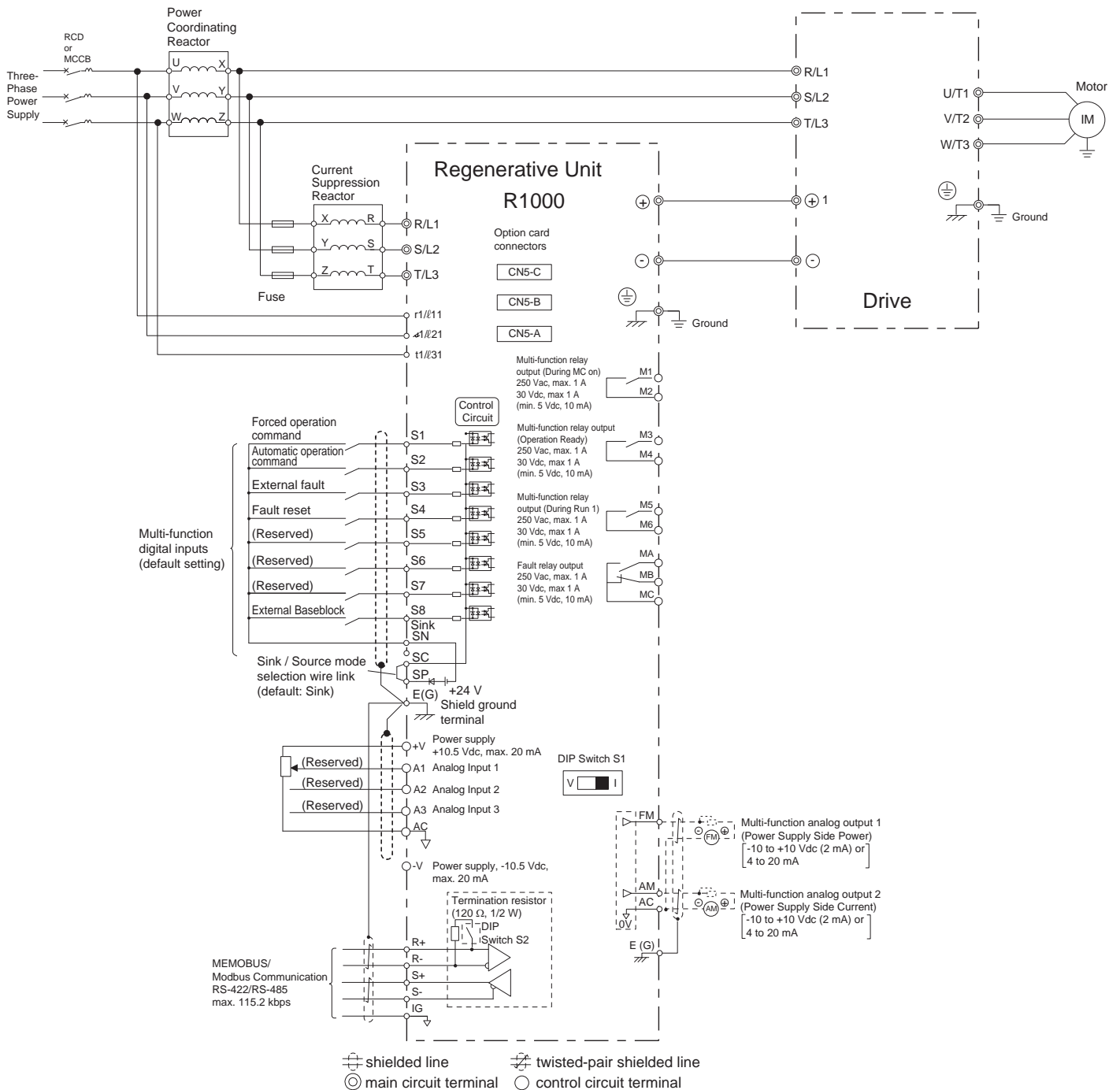

Dimensions for 400 V Models from 3.5 kW to 300 kW

R1000 Regenerative Unit 400 V

Part Number Kit	R1000 Model CIMR-RC4A□□□□	Regeneration Capacity [kW]	IP Protection	Figure	Dimensions [mm]											Weight [kg]															
					W	H	D	W1	H0	H1	H2	H3	D1	t1	t2		d														
R1KIT40003AA□AA	03P5	3.5	IP20/NEMA1, UL Type1	1	140	260	167	122	-	248	6	-	55	5	-	M5	4														
R1KIT40005AA□AA	0005	5																													
R1KIT40007AA□AA	0007	7																													
R1KIT40010AA□AA	0010	10																													
R1KIT40014AA□AA	0014	14																													
R1KIT40017AA□AA	0017	17																													
R1KIT40020AA□AA	0020	20	Open- Chassis IP00	2	220	365	197	192	350	335	8	15	78	5	-	M6	8														
R1KIT40028AA□AA	0028	28																													
R1KIT40035AA□AA	0035	35																													
R1KIT40043AA□AA	0043	43																													
R1KIT40053AA□AA	0053	53																													
R1KIT40073AA□AA	0073	73																													
R1KIT40105AA□AA	0105	105	3 (IP00), 4 (IP20)	3	275	450	258	220	-	435	7.5	-	100	2.3	2.3	M6	20														
R1KIT40150AA□AA	0150	150																													
R1KIT40210AA□AA	0210	210																													
R1KIT40300AA□AA	0300	300																													
																		1	500	800	350	370	-	773	13	-	130	4.5	4.5	M12	85.6
																															87

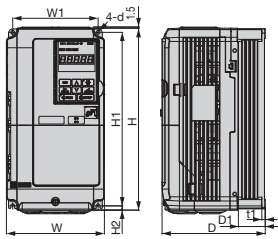

Figure 1

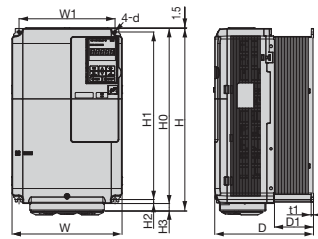

Figure 2

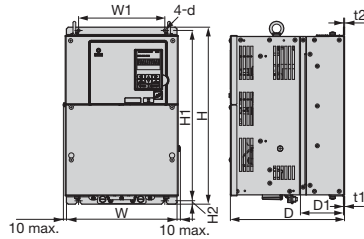

Figure 3

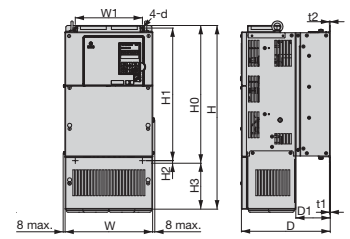

Figure 4

Current Suppression Reactor

Part Number Kit	Current Suppr. Reactor (1%)	Figure	Dimensions [mm]			Weight [kg]	IP20 cover (optional)	Dimensions [mm]			Weight [kg]
			W	H	D			W	H	D	
R1KIT40003AA□AA	B 1509105	5	78	102	63	0.85	IP20-Box31	170	130	170	0.9
R1KIT40005AA□AA	B 1509105										
R1KIT40007AA□AA	B 1509106										
R1KIT40010AA□AA	B 1509107		96	118	60	1.32					
R1KIT40014AA□AA	B 1509108										
R1KIT40017AA□AA	B 1509108										
R1KIT40020AA□AA	B 1509109	6	120	150	90	1.9	IP20-Box32	190	155	220	1.25
R1KIT40028AA□AA	B 1509110										
R1KIT40035AA□AA	B 1504118										
R1KIT40043AA□AA	B 1509111		155	195	102	4.43					
R1KIT40053AA□AA	B 1509112										
R1KIT40073AA□AA	B 1509113										
R1KIT40105AA□AA	B 1509114	7	185	160	125	6.9	IP20-Box33	205	170	280	1.5
R1KIT40150AA□AA	B 1505002										
R1KIT40210AA□AA	B 1505008										
R1KIT40300AA□AA	B 1505011		220	205	115	17					
		230	215	140	22	IP20-Box35	225	145	250	1.45	
		240	235	150	29	IP20-Box39	240	210	330	2.2	

* Appearance might change with capacity.

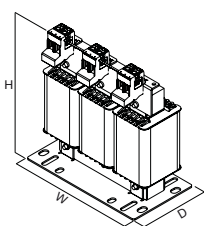

Figure 5 *

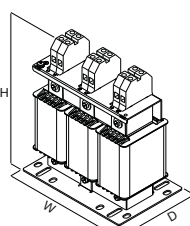

Figure 6 *

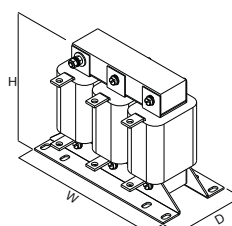
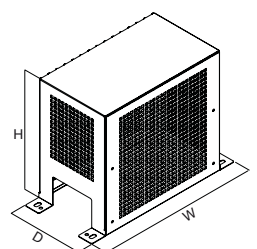

Figure 7 *



IP20 cover

Dimensions of the Power Coordinating Reactor

Power Coordinating Reactor for L1000A/L1000V Lift Inverter

AC Input Reactor 8% IP00 Model	Figure	Dimensions [mm]			Weight [kg]	IP20 cover (optional)	Dimensions [mm]			Weight [kg]
		W	H	D			W	H	D	
B 1103136	1	155	110	170	6.0	IP20-Box32	190	155	220	1.25
B 1103138	2	185	102	196	7.1	IP20-Box35	225	145	250	1.45
B 1103139		210	125	220	9.6	IP20-Box36	240	165	275	1.75
B 1103140			135		10.7	IP20-Box37	240	175	275	1.8
B 1103141	3	230	166	205	12.5	IP20-Box39	240	210	330	2.2
B 1103142		263		25.0						
B 0910013	3	330	180	270	36.4	IP20-Box42	290	220	395	2.9
B 1411053		412	220	320	61.5	on request				
2 x B 0910013		660	360	540	72.8	2 x IP20-Box42	580	440	790	5.8

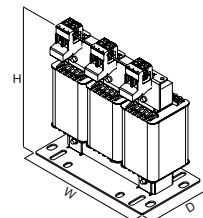

Figure 1 *

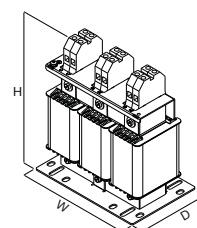

Figure 2 *

Power Coordinating Reactor for A1000/V1000 General Inverter

AC Input Reactor 4% IP00 Model	Figure	Dimensions [mm]			Weight [kg]	IP20 cover (optional)	Dimensions [mm]			Weight [kg]					
		W	H	D			W	H	D						
LR3 40-4/2	1	78	56	100	0.53	IP20-Box31	170	130	170	0.9					
LR3 40-4/4		96	60	117	1.31										
LR3 40-4/6		96	69	117	1.45										
LR3 40-4/10		120	85	140	2.00						IP20-Box32	190	155	220	1.25
LR3 40-4/16			95	140	2.70										
LR3 40-4/20		155	95	162	3.80						IP20-Box33	205	170	280	1.5
LR3 40-4/25	110		177	5.80											
LR3 40-4/45	185		112	210	8.25	IP20-Box35	225	145	250	1.45					
LR3 40-4/63		122	9.65		IP20-Box36	240	165	275	1.75						
LR3 40-4/70	210	117	240	10.8	IP20-Box37	240	175	275	1.8						
LR3 40-4/90		267	149	200	16.0					IP20-Box39	210	330	2.2		
LR3 40-4/115	291	179	210	21.0	IP20-Box41	280	240	400	2.75						
LR3 40-4/160		189		25.5											
LR3 40-4/200	3	194	260	32.0	IP20-Box44	430	250	420	4.2						
LR3 40-4/250		207		41.0											
LR3 40-4/300		219		48.0											
LR3 40-4/400		234		56.0											
LR3 40-4/500	480	235	380	102.0	IP20-Box45	460	472	650	15.3						
LR3 40-4/710		245		62.0											
LR3 40-4/1200	555	330	445	186.2	IP20-Box46	630	472	650	15.3						

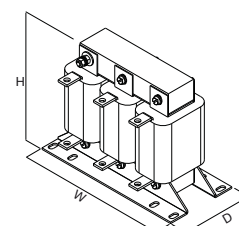
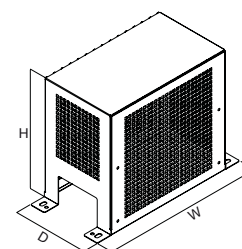

Figure 3 *



IP20 cover

* Appearance might change with capacity.



YASKAWA Europe GmbH

Drives & Motion Division
Hauptstr. 185
65760 Eschborn
Germany

+49 6196 569-500
support@yaskawa.eu.com
www.yaskawa.eu.com