

## DMP3 Position finder



 **Scanning range**  
200 ... 350 mm

**Position finder**

- Four switching outputs
- Integrated processing
- Simple operation
- Teach-in: two different positions



### Dimensional drawing

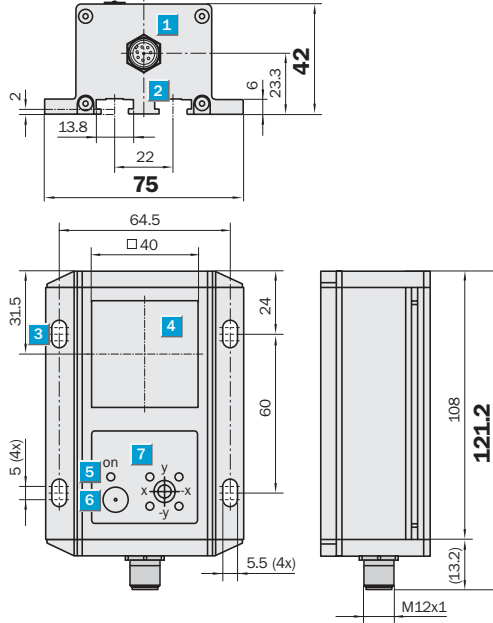

### Adjustments possible

DMP3-xxxx

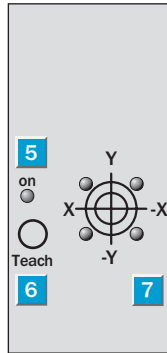

- 1 Plug M12, 8-pin
- 2 T-bar to mount
- 3 Fixing hole
- 4 Optical axis
- 5 LED green, power indicator
- 6 Teach button
- 7 Four LEDs, position indicator

### Connection type

DMP3-xxxx

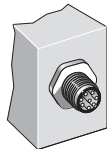

8-pin, M12

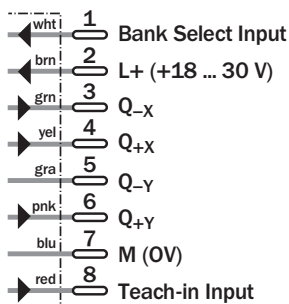

Technical Data		DMP3-	B1111	B1211								
<b>Scanning range</b>	200 ... 350 mm (Hole diametre 10 – 20 mm)											
<b>Repetition accuracy RW</b>	0.15 mm (at 300 mm RW)											
<b>Maximum tilt</b>	± 3°											
<b>Light sender, Light source</b>	Infrared, class 1M											
<b>Supply voltage <math>V_s</math> <sup>1)</sup></b>	18 ... 30 VDC											
Residual ripple <sup>2)</sup>	< 5 $V_{SS}$											
Current consumption <sup>3)</sup>	< 250 mA											
Current consumption with heating	< 1.3 A											
<b>Switching outputs</b>	HIGH = $U_V - \leq 2 V$ / LOW $\leq 2 V$											
<b>Operation mode</b>	Permanent											
<b>Teach-in input</b>												
Activ	> 7 V ... < $U_{Vmax}$											
Inactiv	0 V ... < 2 V or unconnected											
<b>Bank Select Input</b>												
Bank 1	0 V ... < 2 V or unconnected											
Bank 2	> 7 V ... < $U_{Vmax}$											
<b>Output current <math>I_o</math> max.</b>	100 mA total											
<b>Switching frequency</b>	20/s											
<b>Connection type</b>	M12 plug, 8-pin											
<b>VDE protection class</b>	⊠											
<b>Enclosure rating</b>	IP 54											
<b>Ambient rating <sup>4)</sup></b>	Operating: 0 ... +50 °C without heating Operating: -40 ... +50 °C with heating Storage: -40 ... +70 °C											
<b>Shock resistance</b>	IEC 68											
<b>Weight</b>	Approx. 450 g											
<b>Housing material</b>	Aluminium/zinc die-cast											

- <sup>1)</sup> Limit values, reverse-polarity protected
- <sup>2)</sup> May not exceed or fall short of  $V_s$  tolerances
- <sup>3)</sup> Without load
- <sup>4)</sup> Do not distort cable below 0 °C

Order information	
Type	Order no.
DMP3-B1111	1042918
DMP3-B1211	1042919

## Status indicators

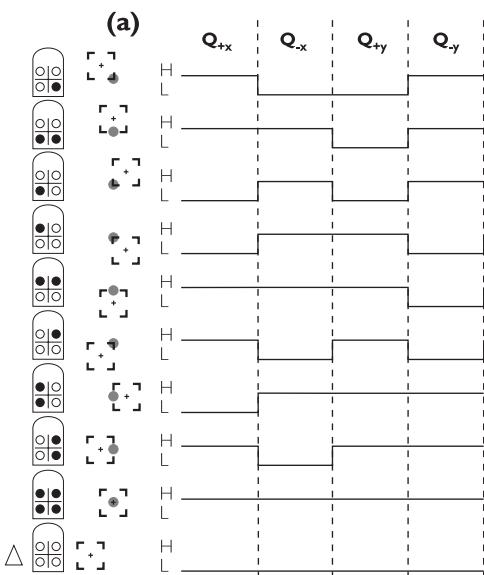

## Range of visibility

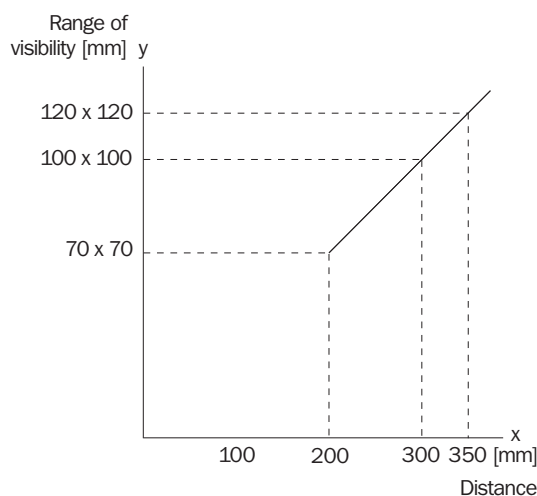

**Great Britain**  
Phone +44 (0)1727 83 11 21  
E-Mail info@sick.co.uk

**USA**  
Phone +1(952) 941-6780  
tollfree+1-800-325-7425  
E-Mail info@sickusa.com

**Australia**  
Phone +61 3 9497 4100  
tollfree+1800 33 48 02  
E-Mail sales@sick.com.au

More representatives and agencies in all major industrial nations at [www.sick.com](http://www.sick.com)

**SICK**  
Sensor Intelligence.