

Level sensors
LFP, TDR level sensor

LFP1600-G1AMB



- COMPOSANTS D'AUTOMATISME
- SYSTEMES D'AUTOMATISME
- CONSTITUANTS ELECTROTECHNIQUES
- MESURE ET CONTROLE
- SECURITE MACHINE

8, Avenue de la Malle - ZI Les Coïdes
51370 SAINT BRICE COURCELLES
Tél. : 03.26.04.20.21 - Fax : 03.26.04.28.20
Email : info@audin.fr - Web : <http://www.audin.fr>

SICK
Sensor Intelligence.

Model Name > **LFP1600-G1AMB**
Part No. > **1053655**



*Product may differ
from illustration*

At a glance

- Level monitoring in hygienic applications
- Manually retractable monoprobe up to 2,000 mm long with Ra 0.8 µm
- Process temperature up to 150 °C, process pressure up to 16 bar
- CIP/SIP resistant
- IP 67 and IP 69K enclosure rating
- Interchangeable hygienic process connections
- 3-in-1: combined display, analog output and binary output
- Analog output 4 mA ... 20 mA / 0 V ... 10 V, switchable, plus two binary outputs



Your benefits

- Robust design increases service life
- High flexibility due to retractable probe and interchangeable connection concept
- Cost savings due to multiple output signals: one system for both level detection and continuous level monitoring
- Time and cost savings due to low maintenance and quick commissioning
- No calibration or recalibration required for commissioning, thus saving time and costs



Features

Medium:	Fluids
Measurement:	switch, continuous
Probe length:	1,600 mm
Process pressure:	-1 bar ... 16 bar
Process temperature:	-20 °C ... 150 °C
EHEDG approval:	✓
GOST approval:	✓
RoHS certificate:	✓

Performance

Dielectricity constant:	≥ 5
Repeatability:	≤ 2 mm
Resolution:	< 2 mm
Accuracy of sensor element:	± 5 mm
Conductivity:	no limitation
Inactive area at process connector:	40 mm ¹⁾
Inactive area at probe end:	10 mm ²⁾

1) 2) With water under reference conditions

Mechanical data

Housing material:	303
Process connection:	G 3/4 A
Wetted parts:	316L (Ra ≤ 0,8 µm), PEEK
Max.probe load:	6 Nm

Electrical data

Supply voltage:	12 V DC ... 30 V DC ¹⁾
Power consumption:	≤ 75 mA at 24 V without output load
Initialization time:	≤ 2 s
Connection type:	M12x1, 5-pin
Response time:	< 400 ms
Signal voltage HIGH:	Vs - 2 V
Signal voltage LOW:	≤ 2 V
Output current:	< 100 mA
Output load:	0 V ... 10 V > 750 Ohm at Uv ≥ 14 V, 4 mA ... 20 mA < 400 Ohm at Uv > 12 V, 4 mA ... 20 mA < 500 Ohm at Uv > 13,5 V
Upper signal level:	20 mA ... 20.5 mA
Lower signal level:	3.8 mA ... 4 mA
Capacitive load:	100 nF
Inductive load:	< 1 H
Enclosure rating:	IP 67: EN 60529, IP 69K: EN 40050
Temperature drift:	< 0.1 mm/K
Protection class:	III
EMC:	EN 61326-1:2006, 2004/108/EG
Interference resistance:	EN 61000-6-2:2005
Interference emission:	EN 61000-6-4:2007
Single shock:	EN 60068-2-27
Continuous shock:	EN 60068-2-29

¹⁾ All connections are polarity protected. All outputs are overload and short-circuit protected.

Ambient data

Ambient temperature, operation:	-20 °C ... 60 °C
Ambient temperature, storage:	-40 °C ... 80 °C

Dimensional drawing

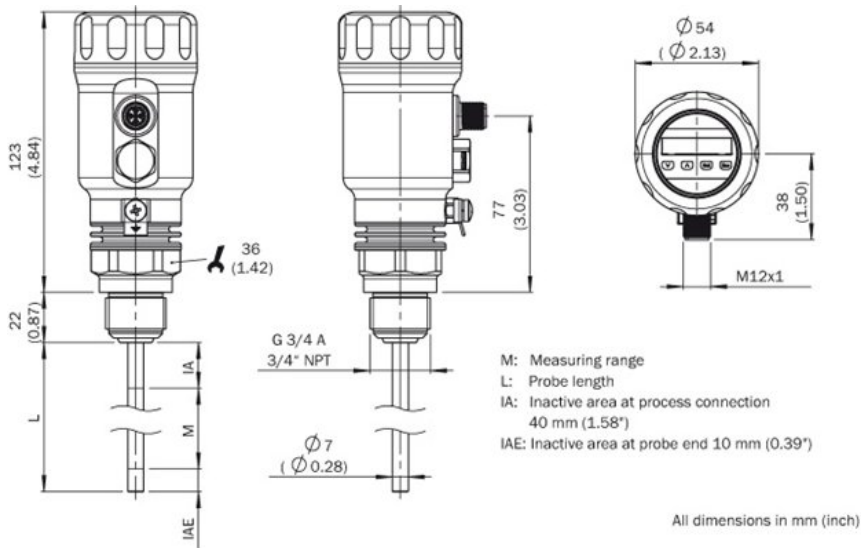

Connection type

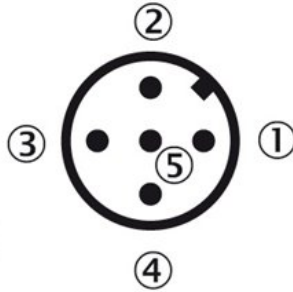
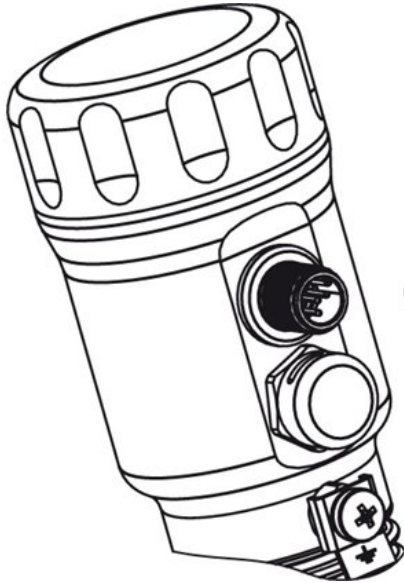

- [1] L+: Supply voltage, brown
- [2] QA: Analog current-/voltage output, white
- [3] M: Ground, OUT- for current-/voltage output, blue
- [4] C/Q1: Switching output 1, PNP/IO-Link-communication, |
- [5] Q2: Switching output 2, PNP/NPN, grey

Australia

Phone +61 3 9497 4100
1800 33 48 02 – tollfree
E-Mail sales@sick.com.au

Belgium/Luxembourg

Phone +32 (0)2 466 55 66
E-Mail info@sick.be

Brasil

Phone +55 11 3215-4900
E-Mail sac@sick.com.br

Ceská Republika

Phone +420 2 57 91 18 50
E-Mail sick@sick.cz

China

Phone +852-2763 6966
E-Mail ghk@sick.com.hk

Danmark

Phone +45 45 82 64 00
E-Mail sick@sick.dk

Deutschland

Phone +49 211 5301-301
E-Mail kundenservice@sick.de

España

Phone +34 93 480 31 00
E-Mail info@sick.es

France

Phone +33 1 64 62 35 00
E-Mail info@sick.fr

Great Britain

Phone +44 (0)1727 831121
E-Mail info@sick.co.uk

India

Phone +91-22-4033 8333
E-Mail info@sick-india.com

Israel

Phone +972-4-999-0590
E-Mail info@sick-sensors.com

Italia

Phone +39 02 27 43 41
E-Mail info@sick.it

Japan

Phone +81 (0)3 3358 1341
E-Mail support@sick.jp

Nederlands

Phone +31 (0)30 229 25 44
E-Mail info@sick.nl

Norge

Phone +47 67 81 50 00
E-Mail austefjord@sick.no

Österreich

Phone +43 (0)22 36 62 28 8-0
E-Mail office@sick.at

Polska

Phone +48 22 837 40 50
E-Mail info@sick.pl

Republic of Korea

Phone +82-2 786 6321/4
E-Mail info@sickkorea.net

Republika Slovenija

Phone +386 (0)1-47 69 990
E-Mail office@sick.si

România

Phone +40 356 171 120
E-Mail office@sick.ro

Russia

Phone +7 495 775 05 34
E-Mail info@sick-automation.ru

Schweiz

Phone +41 41 619 29 39
E-Mail contact@sick.ch

Singapore

Phone +65 6744 3732
E-Mail admin@sicksgp.com.sg

Suomi

Phone +358-9-25 15 800
E-Mail sick@sick.fi

Sverige

Phone +46 10 110 10 00
E-Mail info@sick.se

Taiwan

Phone +886 2 2375-6288
E-Mail sales@sick.com.tw

Türkiye

Phone +90 216 587 74 00
E-Mail info@sick.com.tr

United Arab Emirates

Phone +971 4 8865 878
E-Mail info@sick.ae

USA/Canada/México

Phone +1(952) 941-6780
1 800-325-7425 – tollfree
E-Mail info@sickusa.com

More representatives and agencies
in all major industrial nations at
www.sick.com