

HIPERFACE®-SSI Adapter, HIPERFACE®-Profibus Adapter, HIPERFACE®-DeviceNet Adapter and HIPERFACE®-CANopen Adapter: robust, flexible and versatile

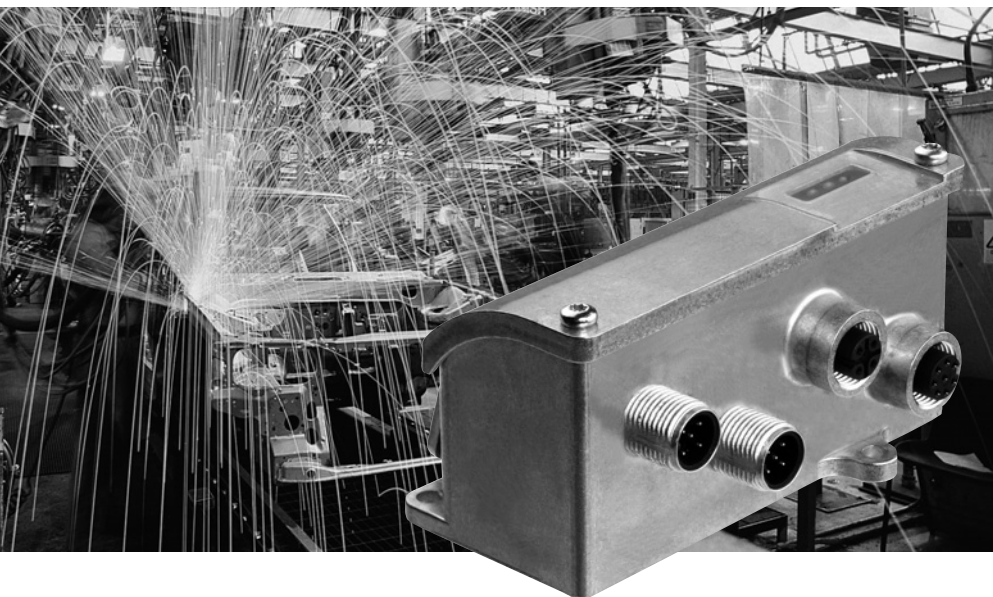

In conjunction with interface adapter modules, these can also be used in a broad range of applications in automation technology, for example in applications where

- space is very limited at the location of the installation
- environmental conditions such as dirt, temperature, shock and/or vibration must be isolated from a large part of the electronics
- customer-specific encoder flange and housing options are required, which must be realised quickly and at low-cost
- high encoder resolutions are necessary, which can be generated easily in the interface adapter via interpolation of the Hiperface® encoder signals.



The use of interface adapter modules for connecting up singleturn or multiturn encoders with the HIPERFACE® interface opens up a variety of application options in all areas of automation technology.

At the output of the interface adapter modules, SSI, Profibus DP, DeviceNet und CANopen are available, interfaces that fulfil the high requirements of automation technology. In line with future-oriented trends, M12 connectors are used for the interface adapter modules. The diverse range of possible combinations of interface adapter modules and encoders provides a high level of flexibility, as well as low part replacement and stocking costs for our customers.

Encoders with the HIPERFACE® interface are being designed as Motor Feedback systems for drive technology. This creates an extremely compact design. In addition to encoders integrated into drives, stand-alone designs are also available

Interface adapter module

Interface adapter module

Interface adapter module

Interface adapter module

SICK | STEGMANN



- SSI Output
- Automatic encoder detection
- Elektronically adjustable
- Enclosure rating IP 64

Dimensional drawing HIPERFACE®-SSI Adapter

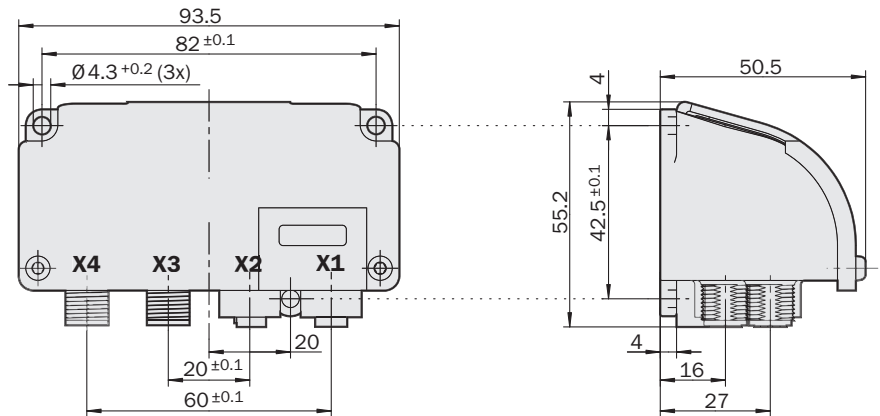

General tolerances to DIN ISO 2768-mk

PIN and wire allocation HIPERFACE® input (X1)

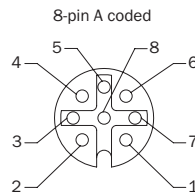

PIN	Colour of wires	Signal	Explanation
1	brown	REFSIN	Process data channel
2	white	+ SIN	Process data channel
3	black	REFCOS	Process data channel
4	pink	+ COS	Process data channel
5	yellow	Data +	RS 485 Parameter channel
6	violet	Data -	RS 485 Parameter channel
7	blue	GND	Ground connection
8	red	+ U _s	Encoder Supply voltage via the Adapter
	Screen		Housing potential

PIN and wire allocation SSI output, incl. U_s (X3)

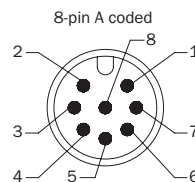

PIN	Colour of wires	Signal	Explanation
1	brown	Data -	Interface signals
2	white	Data +	Interface signals
3	black		N. C.
4	pink		N. C.
5	yellow	Clock +	Interface signals
6	violet	Clock -	Interface signals
7	blue	GND	Ground connection
8	red	+ U _s	Operating voltage
	Screen		Housing potential

Connections X2 and X4 on the HIPERFACE®-SSI Adapter not allocated.

The following encoders with a HIPERFACE® interface are detected by the HIPERFACE®-SSI Adapter:

Designation/ encoder series ¹⁾	Number of revs.	Steps/rev. ²⁾ Standard/DEFAULT	Max. steps/rev. ³⁾
SRS...	1	4096	32 768 (15-bit)
SCK...	1	4096	32 768 (15-bit)
SKS...	1	4096	32 768 (15-bit)
SEK...	1	4096	4096 (12-bit)
SRM...	4096	4096	32 768 (15-bit)
SCL...	4096	4096	32 768 (15-bit)
SKM...	4096	4096	32 768 (15-bit)

Output on the adapter – Gray code, right-justified to the 12th single bit.

¹⁾ Valid for all standard encoders from the relevant product range.

²⁾ Factory default setting

³⁾ Max. possible steps/rev. that can be configured at the factory on request.



Listed accessory which is to use with listee's listed SICK-STEGMANN GmbH encoders.

For use in NFPA 79 applications only. Interconnection cables and accessories are available from SICK-STEGMANN.

Accessories

Connection technology

Technical data		SSI								
Housing	Die-cast zinc									
Mass	Approx. 350 g									
Supported encoders	See encoder table on page 2									
Configuration of the adapter of the encoder connected	Automatically by using the electronic name plate									
Code type ¹⁾	GRAY									
Count direction cw/ccw	Via DIP switches									
Measurement step (rotary Encoder)	360°/step count per revolution									
Steps per revolution ¹⁾	See encoder table on page 2									
Number of revolutions	See encoder table on page 2									
Error limits	See encoder data sheet									
Reproducibility	See encoder data sheet									
Data format for singleturn encoders ¹⁾	12-bit (right-justified)									
Data format for multiturn encoders ¹⁾	24-bit (right-justified)									
Position sample time	100 µs									
Working temperature range	- 20 ... + 70 °C									
Storage temperature range	- 25 ... + 85 °C									
Permissible relative humidity ²⁾	90 %									
EMC ³⁾										
Resistance										
to shocks ⁴⁾	70 g/6 ms									
to vibration ⁵⁾	20 g/10 ... 2000 Hz									
Protection to IEC 60529 ⁶⁾	IP 64									
Operating voltage range (U_s)	10 ... 30 V DC									
Encoder operating voltage via the adapter	8 V DC ± 10 % (max. 500 mA)									
Power consumption (without encoder)	1.6 W									
Initialisation time ⁷⁾	Typ. 200 ms (50 ms after encoder-ready signal)									
Input interface HIPERFACE®										
Electrical connection to the encoder (HIPERFACE®)	Signal line via 8-pin female device connector, potential-free to the housing									
Output interface SSI										
Interface signals										
Clock +, Clock -, Data +, Data -	SSI max. clock frequency 1.0 MHz or min. LOW level (Clock +): 500 ns									
Electrical interface	RS422 for SSI									
DC isolation at the output to PLC	No									
Electronic adjustment (number set) ⁸⁾	Via DIP switches									
Status information	HIPERFACE® status (LED yellow) Adapter status (LED green)									
Error value output	No									
Electrical connection to control (SSI)	Signal line via 8-pin male device connector, potential-free to the housing									

¹⁾ Additional data formats, output codes and resolutions on request

²⁾ Condensation not permissible

³⁾ EN 61000-6-2

EN 61000-4-2
EN 61000-4-3
EN 61000-4-4
EN 61000-4-5
EN 61000-4-6

EN 61000-6-3
EN 55011

⁴⁾ To EN 60068-2-27

⁵⁾ To EN 60068-2-6

⁶⁾ With mating connector fitted

Exposure to direct sunlight over an extended period is not permissible

⁷⁾ The time that elapses after connection of the supply voltage until the data word can be correctly read in

⁸⁾ Set to zero (0) at the factory, other numbers set on request

Ordering information

HIPERFACE®-SSI Adapter

Type	Part no.
AD-HFSSIS2	1035482

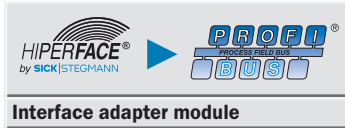

- Bus link RS 485 according to Profibus DP specification
- Automatic encoder detection
- Electronically adjustable, configurable resolution
- Enclosure rating IP 64

Dimensional drawing HIPERFACE®-Profibus Adapter

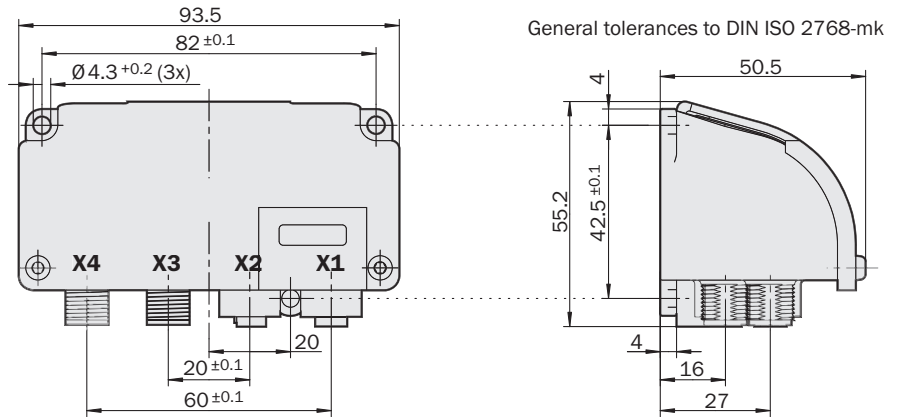

PIN and wire allocation HIPERFACE® input (X1)

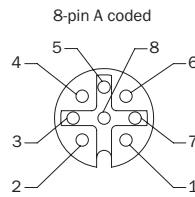

PIN	Colour of wires	Signal	Explanation
1	brown	REFSIN	Process data channel
2	white	+ SIN	Process data channel
3	black	REFCOS	Process data channel
4	pink	+ COS	Process data channel
5	yellow	Data +	RS 485 Parameter channel
6	violet	Data -	RS 485 Parameter channel
7	blue	GND	Ground connection
8	red	+ U _s	Encoder Supply voltage via the Adapter
	Screen		Housing potential

PIN and wire allocation Profibus DP (out) (X2)

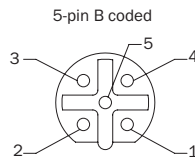

PIN	Signal	Explanation
1	2PS	+ 5 V (potential-free isolated) ¹⁾
2	A	A-cable Profibus DP
3	2M	0 V (potential-free isolated) ¹⁾
4	B	B-cable Profibus DP
5	Screen	Housing potential

¹⁾ For external bus connection or supply to the sender/receiver of an LWL connection.

PIN and wire allocation Operating voltage U_s (X3)

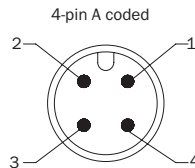

PIN	Signal	Explanation
1	U _s	Operating voltage
2	N. C.	-
3	GND	0 V (ground)
4	N. C.	-

PIN and wire allocation Profibus DP (in) (X4)

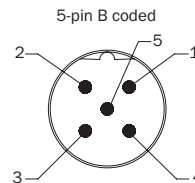

PIN	Signal	Explanation
1	N. C.	-
2	A	A-cable Profibus DP
3	N. C.	-
4	B	B-cable Profibus DP
5	Screen	Housing potential

The following encoders with a HIPERFACE® interface are detected by the HIPERFACE®-Profibus Adapter:

Designation/encoder series ¹⁾	Max. number of revs. ²⁾	Max. steps/rev. ²⁾
SRS...	1	262 144 (18-bit)
SCK...	1	262 144 (18-bit)
SKS...	1	32 768 (15-bit)
SEK...	1	4096 (12-bit)
SRM...	4096	262 144 (18-bit)
SCL...	4096	262 144 (18-bit)
SKM...	4096	32 768 (15-bit)
Designation/encoder series ¹⁾	Resolution ²⁾	
L230	on request	
XKS...	0.05 mm	

¹⁾ Valid for all standard encoders from the relevant product range.

²⁾ Scaling via bus protocol. Default values in EDS file = maximum values.

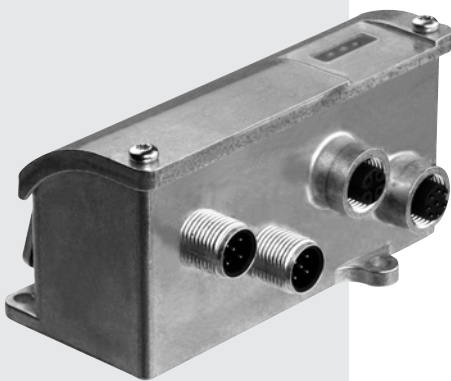

Listed accessory which is to use with listee's listed SICK-STEGMANN GmbH encoders.

For use in NFPA 79 applications only. Interconnection cables and accessories are available from SICK-STEGMANN.

Accessories

Connection technology

Technical data		Profib.								
Housing	Die-cast zinc									
Mass	Approx. 400 g									
Supported encoders	See encoder table on page 4									
Configuration of the adapter of the encoder connected	Automatically by using the electronic name plate									
Count direction cw/ccw	Via bus protocol									
Measurement step (rotary Encoder)	360°/step count per revolution									
Steps per revolution ¹⁾	See encoder table on page 4									
Number of revolutions	See encoder table on page 4									
Error limits	See encoder data sheet									
Reproducibility	See encoder data sheet									
Position sample time	100 µs									
Working temperature range	- 20 ... + 60 °C									
Storage temperature range	- 25 ... + 85 °C									
Permissible relative humidity ²⁾	90 %									
EMC ³⁾										
Resistance										
to shocks ⁴⁾	70 g/6 ms									
to vibration ⁵⁾	20 g/10 ... 2000 Hz									
Protection to IEC 60529 ⁶⁾	IP 64									
Operating voltage range (U_s)	10 ... 30 V DC									
Encoder operating voltage via the adapter	8 V DC ± 5 % (max. 650 mA)									
Power consumption (without encoder)	2.2 W									
Initialisation time ⁶⁾	Typ. 360 ms (50 ms after encoder-ready signal)									
Input interface HIPERFACE®										
Electrical connection to the encoder (HIPERFACE®)	Signal line via 8-pin female device connector, potential-free to the housing									
Output interface Profibus DP										
Electrical interface ⁷⁾	RS485 with DC isolation									
Protocol	DP V0 + isochronous Mode (DP V2) Encoderprofile Class 1 and 2									
Address setting (node no.)	1 ... 125 DIP switches 126 EEPROM addressing via protocol									
Data transfer rate (baud rate)	9.6 kBaud ... 12 MBaud automatic detection									
Electronic adjustment (number set)	Via bus protocol and DIP switches									
Status information	HIPERFACE® status (LED yellow) PROFIBUS status (LED red) and (LED bi-color red/green) [alternatively: green]									
Error value output	In accordance with bus diagnostic function									
Bus termination ⁸⁾	Via external terminating resistor									
Electrical connection to control (PROFIBUS)	Signal line via 5-pin male device connector (bus IN) and 5-pin female device connector (bus OUT) as well as 4-pin male device connector (U _s), potential-free to the housing									

¹⁾ Condensation not permissible²⁾ EN 61000-6-2EN 61000-4-2
EN 61000-4-3
EN 61000-4-4
EN 61000-4-5
EN 61000-4-6EN 61000-6-3
EN 55011³⁾ To EN 60068-2-27⁴⁾ To EN 60068-2-6⁵⁾ With mating connector fitted

Exposure to direct sunlight over an extended period is not permissible

⁶⁾ For encoders with type code FF, the initialisation time is typ. 240 ms⁷⁾ To EN 50170-2(DIN 19245 Part 1-3)
DC-isolated via opto-couplers⁸⁾ Activation only at the last bus subscriber of the line.**Ordering information****HIPERFACE®-Profibus Adapter**

Type	Part no.
AD-HFPRLS4	1035483



- Bus link to ISO11898
CAN-High Speed to
CAN Specification 2.0B
- Automatic encoder detection
- Electronically adjustable,
configurable resolution
- Enclosure rating IP 64

Dimensional drawing HIPERFACE®-DeviceNet Adapter

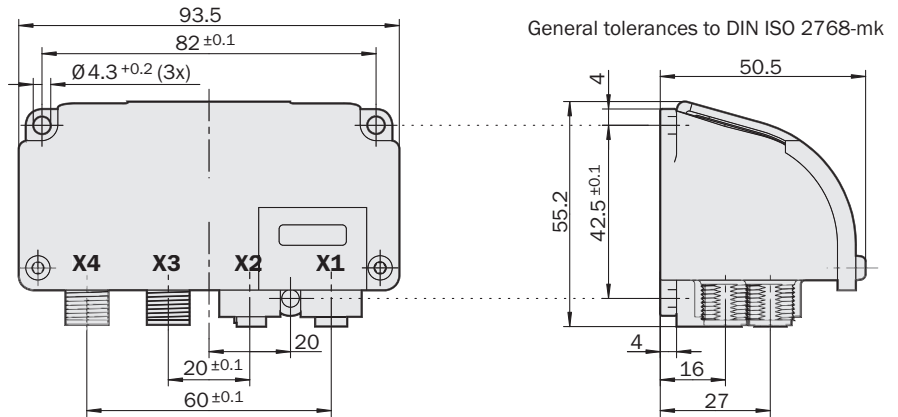

PIN and wire allocation HIPERFACE® input (X1)

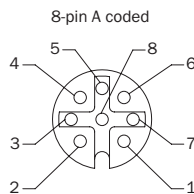

PIN	Colour of wires	Signal	Explanation
1	brown	REFSIN	Process data channel
2	white	+ SIN	Process data channel
3	black	REFCOS	Process data channel
4	pink	+ COS	Process data channel
5	yellow	Data +	RS 485 Parameter channel
6	violet	Data -	RS 485 Parameter channel
7	blue	GND	Ground connection
8	red	+ U _s	Encoder Supply voltage via the Adapter
	Screen		Housing potential

PIN and wire allocation DeviceNet (out) (X2)

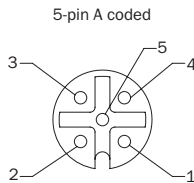

PIN	Signal	Explanation
1	Drain/Screen	Bus Drain/Screen must not have any connection to the housing
2	V +	Supply voltage via the Bus
3	V -	Ground connection (GND)
4	CAN_H	CAN High
5	CAN_L	CAN Low

PIN and wire allocation (X3) - not connected

PIN and wire allocation DeviceNet (in) (X4)

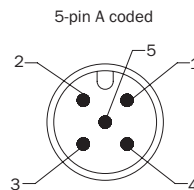

PIN	Signal	Explanation
1	Drain/Screen	Bus Drain/Screen must not have any connection to the housing
2	V +	Supply voltage via the Bus
3	V -	Ground connection (GND)
4	CAN_H	CAN High
5	CAN_L	CAN Low

The following encoders with a HIPERFACE® interface are detected by the HIPERFACE®-DeviceNet Adapter:

Designation/encoder series ¹⁾	Max. number of revs. ²⁾	Max. steps/rev. ²⁾
SRS...	1	262 144 (18-bit)
SCK...	1	262 144 (18-bit)
SKS...	1	32 768 (15-bit)
SEK...	1	4096 (12-bit)
SRM...	4096	262 144 (18-bit)
SCL...	4096	262 144 (18-bit)
SKM...	4096	32 768 (15-bit)
Designation/encoder series ¹⁾	Resolution ²⁾	
L230	on request	
XKS...	0.05 mm	

¹⁾ Valid for all standard encoders from the relevant product range.

²⁾ Scaling via bus protocol. Default values in EDS file = maximum values.

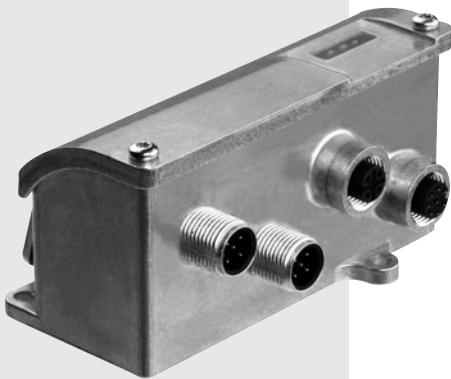

Listed accessory which is to use with listee's listed SICK-STEGMANN GmbH encoders.

For use in NFPA 79 applications only. Interconnection cables and accessories are available from SICK-STEGMANN.

Accessories

Connection technology

Technical data		DN								
Housing	Die-cast zinc									
Mass	Approx. 400 g									
Supported encoders	See encoder table on page 6									
Configuration of the adapter of the encoder connected	Automatically by using the electronic name plate									
Count direction cw/ccw	Via bus protocol									
Measurement step (rotary Encoder)	360°/step count per revolution									
Steps per revolution	See encoder table on page 6									
Max. Number of revolutions	See encoder table on page 6									
Error limits	See encoder data sheet									
Reproducibility	See encoder data sheet									
Position sample time	< 1 ms									
Working temperature range	- 20 ... + 60 °C									
Storage temperature range	- 25 ... + 85 °C									
Permissible relative humidity ¹⁾	90 %									
EMC ²⁾										
Resistance										
to shocks ³⁾	70 g/6 ms									
to vibration ⁴⁾	20 g/10 ... 2000 Hz									
Protection to IEC 60529 ⁵⁾	IP 64									
Operating voltage range (U_s)	10 ... 30 V DC									
Encoder operating voltage via the adapter	8 V DC ± 5 % (max. 500 mA)									
Power consumption (without encoder)	2.2 W									
Initialisation time	Appr. 2 s (incl. Duplicates MAC-ID-Check)									
Input interface HIPERFACE®										
Electrical connection to the encoder (HIPERFACE®)	Signal line via 8-pin female device connector, potential-free to the housing									
Output interface DeviceNet										
Electrical interface ⁶⁾										
Protocol ⁷⁾										
Address setting (node no.)	0 ... 63 DIP switches or addressing via bus protocol									
Data transfer rate (Baudrate)	100 ... 500 kBaud via DIP switches, bus protocol or Autobaud									
Electronic adjustment (number set)	Via bus protocol and DIP switches									
Status information	HIPERFACE® status (LED yellow) Supply voltage (LED green) Bus status (LED bicolor red/green)									
Error value output	Analysis of the alarms and warnings									
Bus termination ⁸⁾	Via external terminating resistor									
Electrical connection to control (DeviceNet)	Signal line via 5-pin male device connector (bus IN) and 5-pin female device connector (bus OUT) potential-free to the housing (Supply voltage via Bus-cable)									

¹⁾ Condensation not permissible

²⁾ EN 61000-6-2

EN 61000-4-2
EN 61000-4-3
EN 61000-4-4
EN 61000-4-5
EN 61000-4-6

EN 61000-6-3
EN 55011

³⁾ To EN 60068-2-27

⁴⁾ To EN 60068-2-6

⁵⁾ With mating connector fitted
Exposure to direct sunlight over an extended period is not permissible

⁶⁾ To ISO 11898 CAN-High Speed to CAN-specification 2.0B, DC-isolated

⁷⁾ DeviceNet protocol specification Release 2.0 Vol. 1 and 3; Device Profiles (Encoder Device Type 22_r)

⁸⁾ Activation only at the last bus subscriber of the line.

Ordering information

HIPERFACE®-DeviceNet Adapter

Type	Part no.
AD-HFCDNS3	1035646



Interface adapter module

- Bus link to ISO11898
CAN-High Speed to
CAN Specification 2.0B
- Automatic encoder detection
- Electronically adjustable,
configurable resolution
- Enclosure rating IP 64

Dimensional drawing HIPERFACE®-CANopen Adapter

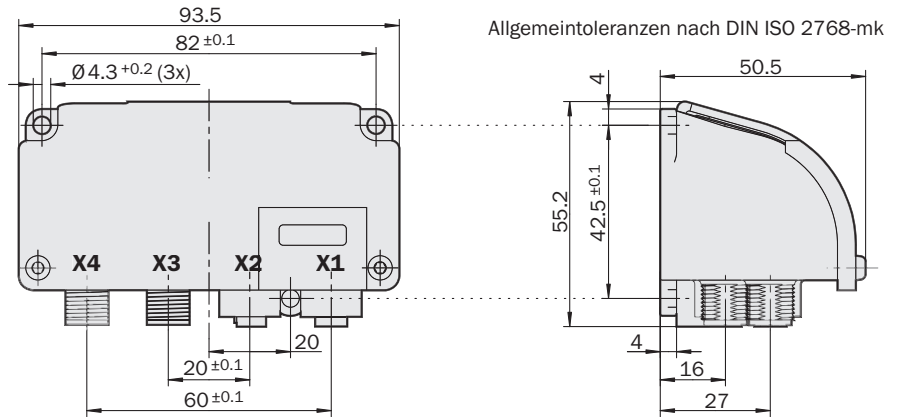

PIN and wire allocation HIPERFACE® input (X1)

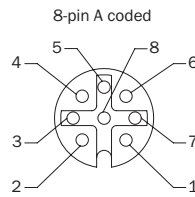

PIN	Colour of wires	Signal	Explanation
1	brown	REFSIN	Process data channel
2	white	+ SIN	Process data channel
3	black	REFCOS	Process data channel
4	pink	+ COS	Process data channel
5	yellow	Data +	RS 485 Parameter channel
6	violet	Data -	RS 485 Parameter channel
7	blue	GND	Ground connection
8	red	+ U _s	Encoder Supply voltage via the Adapter
	Screen		Housing potential

PIN and wire allocation CANopen (out) (X2)

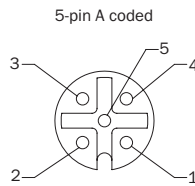

PIN	Signal	Explanation
1	Drain/ Screen	Housing potential
2	V +	Supply voltage via the Bus
3	V -	Ground connection (GND)
4	CAN_H	CAN High
5	CAN_L	CAN Low

PIN and wire allocation Operating voltage U_s (X3)

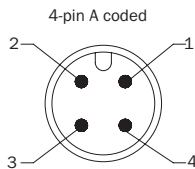

PIN	Signal	Explanation
1	U _s	Operating voltage
2	N. C.	-
3	GND	0 V (ground)
4	N. C.	-

PIN and wire allocation CANopen (in) (X4)

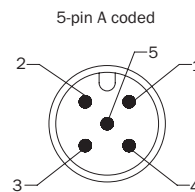

PIN	Signal	Explanation
1	Drain/ Screen	Housing potential
2	V +	Supply voltage via the Bus
3	V -	Ground connection (GND)
4	CAN_H	CAN High
5	CAN_L	CAN Low

The following encoders with a HIPERFACE® interface are detected by the HIPERFACE® CANopen Adapter:

Designation/encoder series ¹⁾	Max. number of revs. ²⁾	Max. steps/rev. ²⁾
SRS...	1	262 144 (18-bit)
SCK...	1	262 144 (18-bit)
SKS...	1	32 768 (15-bit)
SEK...	1	4096 (12-bit)
SRM...	4096	262 144 (18-bit)
SCL...	4096	262 144 (18-bit)
SKM...	4096	32 768 (15-bit)
Designation/encoder series ¹⁾	Resolution ²⁾	
L230	on request	
XKS...	0.05 mm	

¹⁾ Valid for all standard encoders from the relevant product range.

²⁾ Scaling via bus protocol. Default values in EDS file = maximum values.

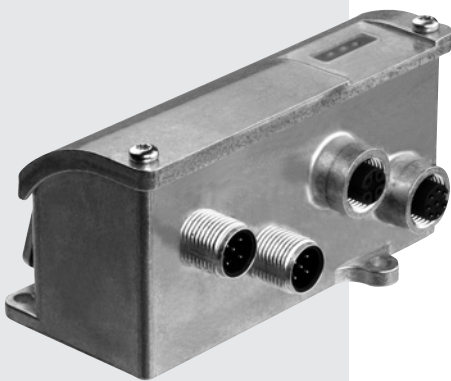

Listed accessory which is to use with listee's listed SICK-STEGMANN GmbH encoders.

For use in NFPA 79 applications only. Interconnection cables and accessories are available from SICK-STEGMANN.

Accessories

Connection technology

Technical data		CAN								
Housing	Die-cast zinc									
Mass	Approx. 400 g									
Supported encoders	See encoder table on page 8									
Configuration of the adapter of the encoder connected	Automatically by using the electronic name plate									
Count direction cw/ccw	Via bus protocol									
Measurement step (rotary Encoder)	360°/step count per revolution									
Steps per revolution	See encoder table on page 8									
Max. Number of revolutions	See encoder table on page 8									
Error limits	See encoder data sheet									
Reproducibility	See encoder data sheet									
Position sample time	< 1 ms									
Working temperature range	- 20 ... + 60 °C									
Storage temperature range	- 25 ... + 85 °C									
Permissible relative humidity ¹⁾	90 %									
EMC ²⁾										
Resistance										
to shocks ³⁾	70 g/6 ms									
to vibration ⁴⁾	20 g/10 ... 2000 Hz									
Protection to IEC 60529 ⁵⁾	IP 64									
Operating voltage range (U_s)	10 ... 30 V DC									
Encoder operating voltage via the adapter	8 V DC ± 5 % (max. 500 mA)									
Power consumption (without encoder)	2.2 W									
Initialisation time	< 1250 ms									
Input interface HIPERFACE®										
Electrical connection to the encoder (HIPERFACE®)	Signal line via 8-pin female device connector, potential-free to the housing									
Output interface CANopen										
Electrical interface ⁶⁾										
Protocol ⁷⁾										
Address setting (node no.)	1 ... 63 DIP switches									
Data transfer rate (Baudrate)	100 ... 1000 kBaud via DIP switches, bus protocol or Autobaud									
Electronic adjustment (number set)	Via bus protocol and DIP switches									
Status information	HIPERFACE® status (LED yellow) Supply voltage (LED green) Bus status (LED bicolor red/green)									
Error value output	Analysis of the alarms and warnings									
Bus termination ⁸⁾	Via external terminating resistor									
Electrical connection to control (CANopen)	Signal line via 5-pin male device connector (bus IN) and 5-pin female device connector (bus OUT) and 4-pin male device connector (U _s), potential-free to the housing									

¹⁾ Condensation not permissible

²⁾ EN 61000-6-2

EN 61000-4-2
EN 61000-4-3
EN 61000-4-4
EN 61000-4-5
EN 61000-4-6

EN 61000-6-3
EN 55011

³⁾ To EN 60068-2-27

⁴⁾ To EN 60068-2-6

⁵⁾ With mating connector fitted
Exposure to direct sunlight over an extended period is not permissible

⁶⁾ To ISO 11898 CAN-High Speed to CAN-Specification 2.0B, DC-isolated

⁷⁾ CANopen communication profile DS301 V4.01, Device Profile acc. CIA DS 406 V3.1 Device Profile for Encoder (Class 2)

⁸⁾ Activation only at the last bus subscriber of the line.

Ordering information

HIPERFACE®-CANopen Adapter

Type	Part no.
AD-HFCANS4	1035645

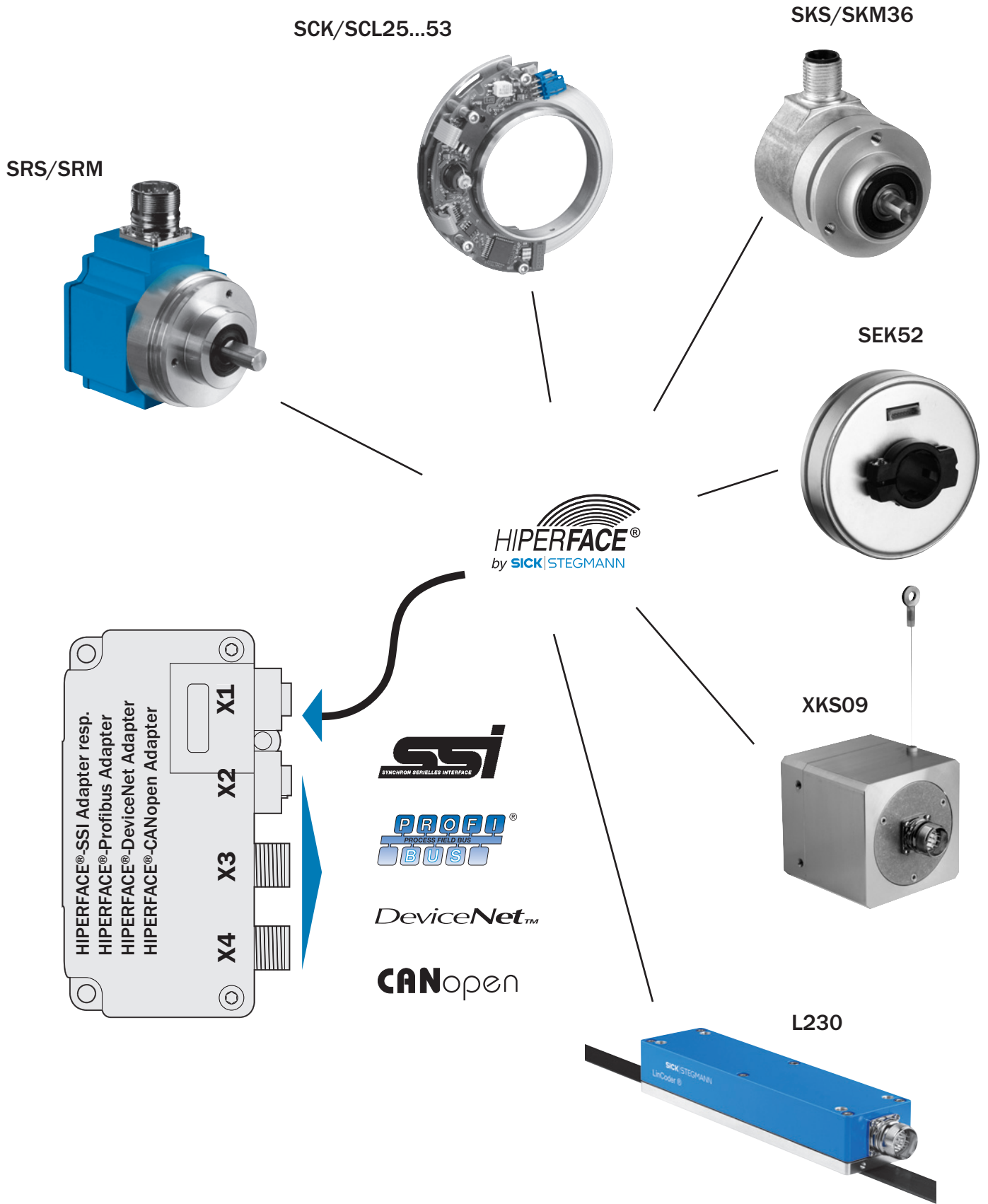

Dimensional drawings and ordering information

Round screw system M12/M23 for the HIPERFACE® connection (AD-HF. . . .)

1

Loose male connector M12, 8-pin, straight, screened,
for field assembly (adapter side)

Type	Part no.	Contacts/cable diameter
STE-1208-GA	6028370	8 / 4 ... 8 mm

Loose female connector M12, 8-pin, straight, screened,
for field assembly (encoder side)

Type	Part no.	Contacts/cable diameter
DOS-1208-GA	6028369	8 / 4 ... 8 mm

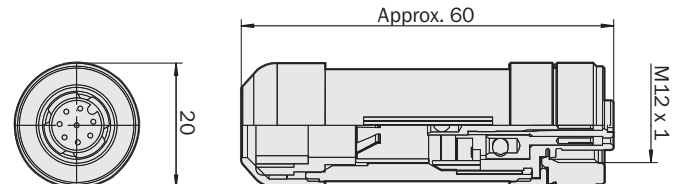
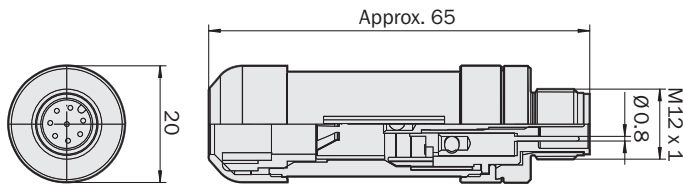

Loose female connector M23, 12-pin, straight, screened,
for field assembly (encoder side)

Type	Part no.	Contacts
DOS-2312-G	6027538	12

Cable 8-wire, per metre, 4 x 2 x 0.25 mm², screened,
flexible, cable diameter 7.0 mm

Type	Part no.	Wires
LTG-3208-MW	6032870	8

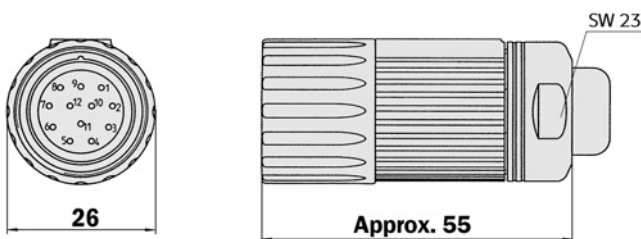

Male connector M12, 8-pin, straight, pre-wired with cable
8-wire, 4 x 2 x 0.25 mm², screened, flexible (adapter side)

Type	Part no.	Contacts	Cable length
STL-1208-G02MAC1	6032452	8	2.0 m
STL-1208-G05MAC1	6032453	8	5.0 m
STL-1208-G10MAC1	6032454	8	10.0 m
STL-1208-G20MAC1	6032455	8	20.0 m

Male connector M12 (adapter side) and female connector M12
(encoder side), 8-pin, straight, pre-wired with cable 8-wire,
4 x 2 x 0.25 mm², screened, flexible

Type	Part no.	Contacts	Cable length
DSL-1208-G05MAC1	6032913	8	5.0 m

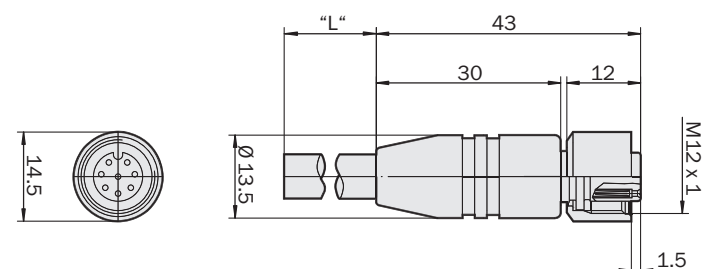
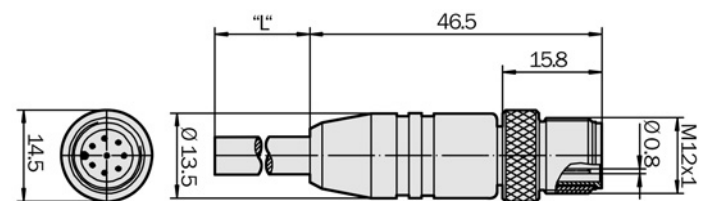
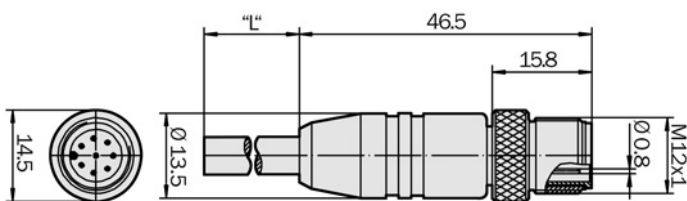

1 Max. permissible cable length between the encoder and the interface adapter ≤ 30m!

Dimensional drawings and ordering information

Round screw system M12 for the SSI connection (AD-HFSSIS2)

Loose female connector M12, 8-pin, straight, screened, for field assembly (adapter side)

Type	Part no.	Contacts/cable diameter
DOS-1208-GA	6028369	8 / 4 ... 8 mm

Cable 8-wire, per metre, 4 x 2 x 0.25 mm², screened, flexible, cable diameter 7.0 mm

Type	Part no.	Wires
LTG-3208-MW	6032870	8

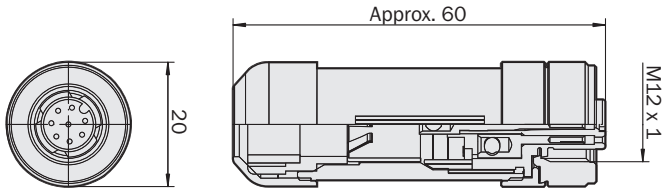

Female connector M12, 8-pin, straight, pre-wired with cable

8-wire, 4 x 2 x 0.25 mm², screened, flexible (adapter side)

Type	Part no.	Contacts	Cable length
DOL-1208-G02MAC1	6032866	8	2.0 m
DOL-1208-G05MAC1	6032867	8	5.0 m
DOL-1208-G10MAC1	6032868	8	10.0 m
DOL-1208-G20MAC1	6032869	8	20.0 m

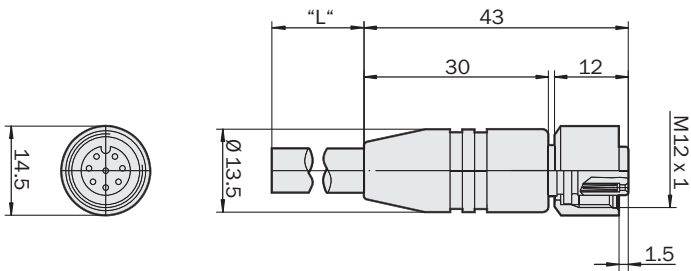

Dimensional drawings and ordering information

Round screw system M12 for the Profibus connection (AD-HFPRLS4)

Loose female connector M12, 4-pin, straight, for field assembly, for operating voltage (adapter side)

Type	Part no.	Contacts
DOS-1204-G	6007302	4

Female connector M12, 4-pin, straight, pre-wired with cable for operating voltage, (adapter side)

Type	Part no.	Description
DOL-1204-G05M	6009866	Cable 5 m, PVC

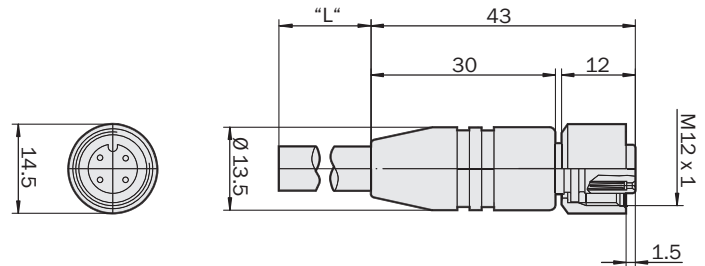
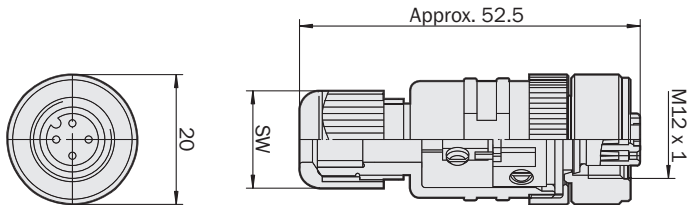

Loose female/male connector M12, 5-pin, straight, screened, for field assembly, for bus cable, B-coding (adapter side)

Type	Part no.	Description
PR-DOS-1205-G	6021353	Profibus female connector
PR-STE-1205-G	6021354	Profibus male connector

Bus cable, 2-wire, per metre 2 x 0.22 mm², screened

Type	Part no.	Wires
LTG-2102-MW	6021355	2

Profibus terminating resistor

Type	Part no.	Description
PRE-STE-END	6021156	Connector, 4 contacts

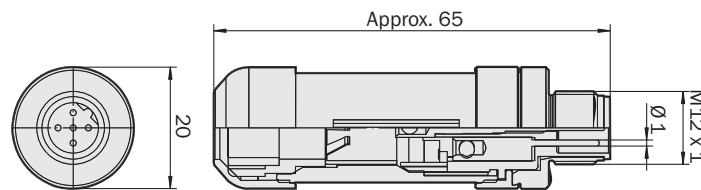
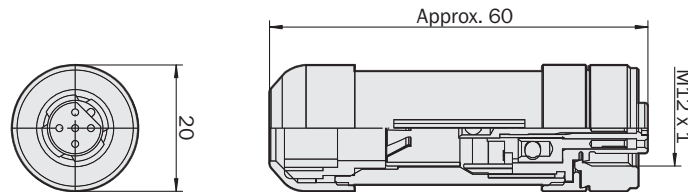

Female connector M12, 5-pin, straight, pre-wired with bus cable 2-wire, 2 x 0.22 mm², screened, B-coding (adapter side)

Type	Part no.	Description
DOL-12PR-G05M	6026006	Profibus cable 5 m
DOL-12PR-G10M	6026008	Profibus cable 10 m

Male connector M12, 5-pin, straight, pre-wired with bus cable 2-wire, 2 x 0.22 mm², screened, B-coding (adapter side)

Type	Part no.	Description
STL-12PR-G05M	6026005	Profibus cable 5 m
STL-12PR-G10M	6026007	Profibus cable 10 m

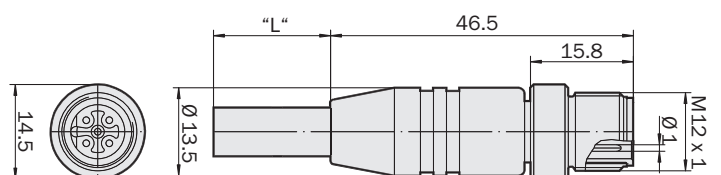
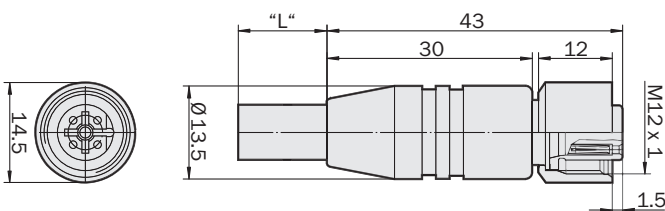

Dimensional drawings and ordering information

Round screw system M12 for the DeviceNet connection (AD-HFCDNS3)

Loose female connector M12, 5-pin, straight, screened 360°-shield on locking nut, field assembly for bus cable

Type	Part no.
DOS-1205-GA	6027534

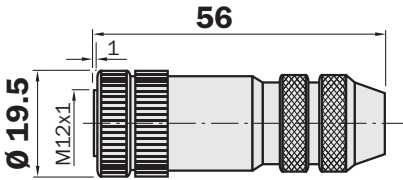

Cable Ø
max. 4.5 up to 7 mm

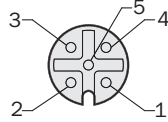

Male connector M12, 5-pin, straight, screened 360°-shield on locking nut, field assembly for bus cable

Type	Part no.
STE-1205-GA	6027533

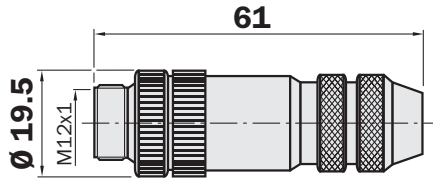

Cable Ø
max. 4.5 up to 7 mm

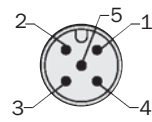

Bus cable per metre, 4 x 0,34 mm², twisted 2x in pairs, shielded with AL-PT tape

Type	Part no.	Description
LTG-2804-MW	6028328	Cable diameter 6.9 mm

Australia

Phone +61 3 9497 4100
1800 33 48 02 – tollfree
E-Mail sales@sick.com.au

Belgium/Luxembourg

Phone +32 (0)2 466 55 66
E-Mail info@sick.be

Brasil

Phone +55 11 3215-4900
E-Mail sac@sick.com.br

Ceská Republika

Phone +420 2 57 91 18 50
E-Mail sick@sick.cz

China

Phone +852-2763 6966
E-Mail ghk@sick.com.hk

Danmark

Phone +45 45 82 64 00
E-Mail sick@sick.dk

Deutschland

Phone +49 211 5301-250
E-Mail info@sick.de

España

Phone +34 93 480 31 00
E-Mail info@sick.es

France

Phone +33 1 64 62 35 00
E-Mail info@sick.fr

Great Britain

Phone +44 (0)1727 831121
E-Mail info@sick.co.uk

India

Phone +91-22-2822 7084
E-Mail info@sick-india.com

Italia

Phone +39 022 743 41
E-Mail info@sick.it

Japan

Phone +81 (0)3 3358 1341
E-Mail support@sick.jp

Nederlands

Phone +31 (0)30 229 25 44
E-Mail info@sick.nl

Norge

Phone +47 67 81 50 00
E-Mail austefjord@sick.no

Österreich

Phone +43 (0)22 36 62 28 8-0
E-Mail office@sick.at

Polska

Phone +48 22 837 40 50
E-Mail info@sick.pl

Republic of Korea

Phone +82-2 786 6321/4
E-Mail kang@sickkorea.net

Republika Slovenija

Phone +386 (0)1-47 69 990
E-Mail office@sick.si

România

Phone +40 356 171 120
E-Mail office@sick.ro

Russia

Phone +7 495 775 05 34
E-Mail denis.kesaev@
sickautomation.ru

Schweiz

Phone +41 41 619 29 39
E-Mail contact@sick.ch

Singapore

Phone +65 6744 3732
E-Mail admin@sicksgp.com.sg

Suomi

Phone +358-9-25 15 800
E-Mail sick@sick.fi

Sverige

Phone +46 10 110 10 00
E-Mail info@sick.se

Taiwan

Phone +886 2 2365-6292
E-Mail sickgrc@ms6.hinet.net

Türkiye

Phone +90 216 587 74 00
E-Mail info@sick.com.tr

USA

Phone +1 937-454-1956
E-Mail sales@stegmann.com

More representatives and agencies
in all major industrial nations at
www.sick.com