

MODEL GMDIO - GRAPHITE™ SERIES DIGITAL MODULE

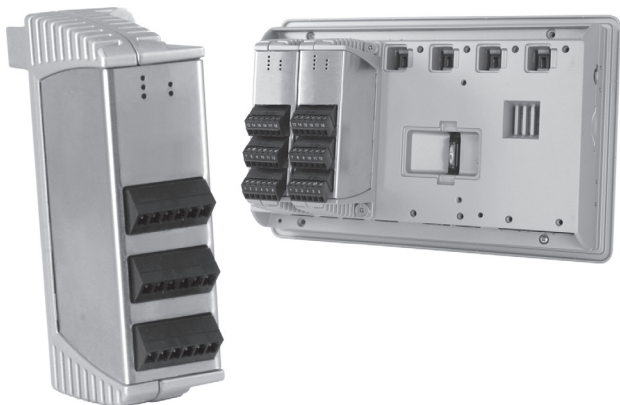

- ADDS I/O CAPABILITY TO THE GRAPHITE SERIES
- EIGHT INPUT, SIX OUTPUT DIGITAL MODULE
- INPUTS ISOLATED FROM OUTPUTS
- INPUTS INDEPENDENTLY SWITCH SELECTABLE FOR SINK OR SOURCE SIGNALS
- INPUTS INDEPENDENTLY CONFIGURABLE FOR HIGH OR LOW ACTIVE STATE
- INPUTS INDEPENDENTLY SWITCH SELECTABLE FOR HIGH OR LOW FREQUENCY SIGNALS
- RELAY OR NFET OUTPUT MODELS AVAILABLE



FOR USE IN HAZARDOUS LOCATIONS:
 Class I, Division 2, Groups A, B, C, and D
 Class II, Division 2, Groups F and G
 Class III, Division 2



For Model No. GMDIOS00 Only

GENERAL DESCRIPTION

The Model GMDIO14 module is a digital I/O module designed for use with the Graphite Series. This module offers eight inputs and six outputs that can be used to monitor contact or sensor inputs and actuate relays, solenoids, PLC inputs, etc.

The inputs accept standard DC inputs or contact closures, and are configured for Sink/Source signals via external switches. Additionally, each input has a switch selectable input filter that can be used to prevent contact bounce. Each input may also be software configured as a high-active or low-active input.

The module is available with relay or NFET outputs that are capable of switching up to one amp each (NFET DC only). For applications requiring large loads to be controlled, several DIN rail mount relays are available.

The module connects and communicates via proprietary USB connection to the various Graphite host devices. The Graphite host devices, equipped with serial ports as well as an Ethernet port(s), allows the system to share data with PCs, PLCs, and SCADA systems. The maximum number of modules varies for each Graphite device, see specific models for details.

Once programmed, the module will continue to operate/control independent of the Graphite host device as long as power is applied. Remove power from the host device before installing or replacing any modules.

CONFIGURATION

The Graphite Series is configured with Windows® compatible Crimson® software. The software is an easy to use, graphical interface that provides a means of communication configuration, as well as commissioning and calibration of new systems.

SAFETY SUMMARY

All safety related regulations, local codes and instructions that appear in the manual or on equipment must be observed to ensure personal safety and to prevent damage to either the instrument or equipment connected to it. If equipment is used in a manner not specified by the manufacturer, the protection provided by the equipment may be impaired.

Do not use the module to directly command motors, valves, or other actuators not equipped with safeguards. To do so can be potentially harmful to persons or equipment in the event of a fault to the module.

DIMENSIONS In inches (mm)

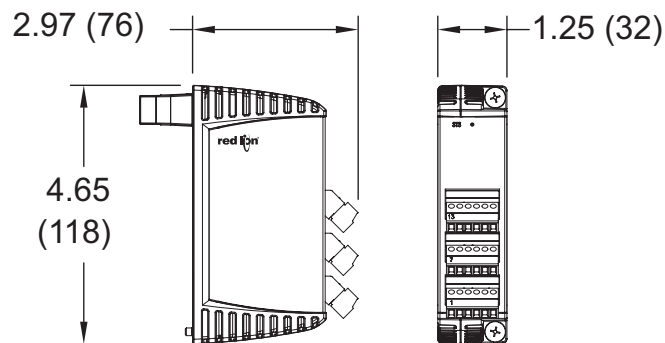





CAUTION: Risk of Danger.
Read complete instructions prior to installation and operation of the unit.



CAUTION: Risk of electric shock.

-  WARNING - EXPLOSION HAZARD - DO NOT DISCONNECT EQUIPMENT UNLESS POWER HAS BEEN SWITCHED OFF OR AREA IS KNOWN TO BE NON-HAZARDOUS.
-  WARNING - EXPLOSION HAZARD - SUBSTITUTION OF COMPONENTS MAY IMPAIR SUITABILITY FOR CLASS I, DIVISION 2

GENERAL SPECIFICATIONS

1. **POWER:** Power will be supplied by the Graphite host device.
2. **LEDs:**
 - STS** - Status LED shows module condition.
 - IN1-IN8** - LEDs are lit when associated input is active.
 - OP1-OP6** - LEDs are lit when associated output is active.
3. **MEMORY:** Non-volatile memory retains all programmable parameters.
4. **INPUTS:** DIP switch selectable for sink or source
 - Maximum voltage: +30 VDC, reverse polarity protected
 - Off Voltage: < 1.2 Volts
 - On Voltage: > 3.8 Volts
 - Input Impedance: Source Mode 10K ohms; Sink Mode 20K ohms
 - Input Frequency*:
 - Filter switch on: 50 Hz
 - Filter switch off: 300 Hz
 - * Actual useable frequency limited by communication to external device.
5. **OUTPUTS:** Outputs available as FORM-A relay or Solid State NFET.
 - Form A Relay Output:**
 - Type: N.O.
 - The following pairs of relays share the common terminal: 1&2, 3&4, 5&6
 - Current Rating by pair: 3 Amps @ 30 VDC / 125 VAC resistive
 - 1/10 HP @ 125 VAC
 - Life Expectancy: 200,000 cycles at maximum load rating. (Decreasing load, increasing cycle time, and use of surge suppression such as RC snubbers increases life expectancy.)
 - Solid State Output:**
 - Type: Switched DC, N Channel open drain MOSFET
 - Contact Rating: 1 ADC max
 - VDS ON: < 0.2 V @ 1 A
 - VDS MAX: 30 VDC
 - Offstate Leakage Current: 0.5 μ A max

6. **ISOLATION LEVEL:** 500 Vrms @ 50/60 Hz for 1 minute between the following:
 - Inputs
 - Outputs
 - Graphite Host Power Supply Input
7. **COMMUNICATIONS:** Provided by the Graphite Host
8. **ENVIRONMENTAL CONDITIONS:**
 - Operating Temperature Range: -40 to +70 °C; limited to host
 - Storage Temperature Range: -40 to +85 °C
 - Shock to IEC 68-2-27: Operational 40 g (10 g, modules w/relays)
 - Operating and Storage Humidity: 85% max relative humidity, non-condensing, from -40 to +75 °C
 - Altitude: Up to 2000 meters
9. **CERTIFICATIONS AND COMPLIANCES:**
 - CE Approved**
 - EN 61326-1 to Industrial Locations
 - IEC/EN 61010-1
 - RoHS Compliant
 - UL Listed: File #E302106
 - UL Hazardous (GMDIOS00 only): File #E317425
10. **CONSTRUCTION:** Case body is all metal construction. For indoor use only. Installation Category II, Pollution Degree 2.
11. **CONNECTIONS:** Removable wire clamp screw terminal blocks.
 - Wire Gage: 28-16 AWG terminal gage wire
 - Torque: 6.0 lbf-inch (96 oz-inch)
12. **MOUNTING:** Screws to host
13. **WEIGHT:** 8 oz (224 g)

BLOCK DIAGRAM

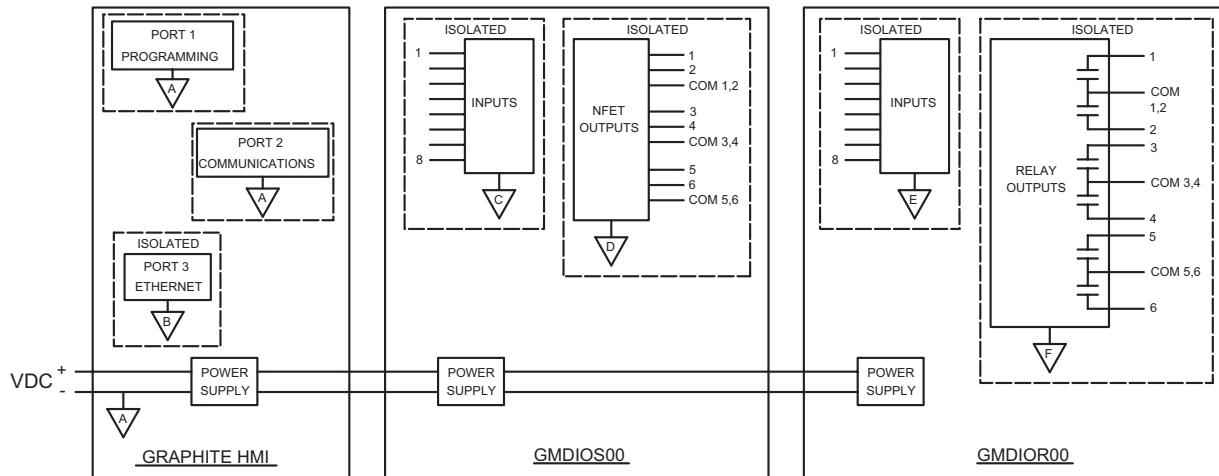

EMC INSTALLATION GUIDELINES

Although Red Lion Controls Products are designed with a high degree of immunity to Electromagnetic Interference (EMI), proper installation and wiring methods must be followed to ensure compatibility in each application. The type of the electrical noise, source or coupling method into a unit may be different for various installations. Cable length, routing, and shield termination are very important and can mean the difference between a successful or troublesome installation. Listed are some EMI guidelines for a successful installation in an industrial environment.

1. A unit should be mounted in a metal enclosure, which is properly connected to protective earth.
2. Use shielded (screened) cables for all Signal and Control inputs. The shield (screen) pigtail connection should be made as short as possible. The connection point for the shield depends somewhat upon the application. Listed below are the recommended methods of connecting the shield, in order of their effectiveness.
 - a. Connect the shield to earth ground (protective earth) at one end where the unit is mounted.
 - b. Connect the shield to earth ground at both ends of the cable, usually when the noise source frequency is over 1 MHz.
 - c. Connect the shield to common of the module and leave the other end of the shield unconnected and insulated from earth ground.
3. Never run Signal or Control cables in the same conduit or raceway with AC power lines, conductors, feeding motors, solenoids, SCR controls, and heaters, etc. The cables should be run through metal conduit that is properly grounded. This is especially useful in applications where cable runs are long and portable two-way radios are used in close proximity or if the installation is near a commercial radio transmitter. Also, Signal or Control cables within an enclosure should be routed as far away as possible from contactors, control relays, transformers, and other noisy components.
4. Long cable runs are more susceptible to EMI pickup than short cable runs. Therefore, keep cable runs as short as possible.
5. In extremely high EMI environments, the use of external EMI suppression devices such as Ferrite Suppression Cores for signal and control cables is

effective. The following EMI suppression devices (or equivalent) are recommended:

- Fair-Rite part number 0443167251 (RLC part number FCOR0000)
- TDK part number ZCAT3035-1330A
- Steward part number 28B2029-0A0

Line Filters for input power cables:

- Schaffner # FN610-1/07 (Red Lion Controls # LFIL0000)
- Schaffner # FN670-1.8/07
- Corcom # 1 VR3

Note: Reference manufacturer's instructions when installing a line filter.

6. To protect relay contacts that control inductive loads and to minimize radiated and conducted noise (EMI), some type of contact protection network is normally installed across the load, the contacts or both. The most effective location is across the load.
 - a. Using a snubber, which is a resistor-capacitor (RC) network or metal oxide varistor (MOV) across an AC inductive load is very effective at reducing EMI and increasing relay contact life.
 - b. If a DC inductive load (such as a DC relay coil) is controlled by a transistor switch, care must be taken not to exceed the breakdown voltage of the transistor when the load is switched. One of the most effective ways is to place a diode across the inductive load. Most RLC products with solid state outputs have internal zener diode protection. However external diode protection at the load is always a good design practice to limit EMI. Although the use of a snubber or varistor could be used.
 RLC part numbers: Snubber SNUB0000
 Varistor ILS11500 or ILS23000
Note: Reference manufacturer's instructions when installing any EMI suppression device.
7. Also care should be taken when connecting input and output devices to the instrument. When a separate input and output common is provided, they should not be mixed. Therefore a sensor common should NOT be connected to an output common. This would cause EMI on the sensitive input common, which could effect the instrument's operation.

Visit RLC's web site at www.redlion.net for more information on EMI guidelines, Safety and CE issues as they relate to Red Lion Controls products.

HARDWARE INPUT SWITCHES

Each input is independently configurable for sinking or sourcing signals. A filter capacitor is also selectable for avoiding contact bounce.

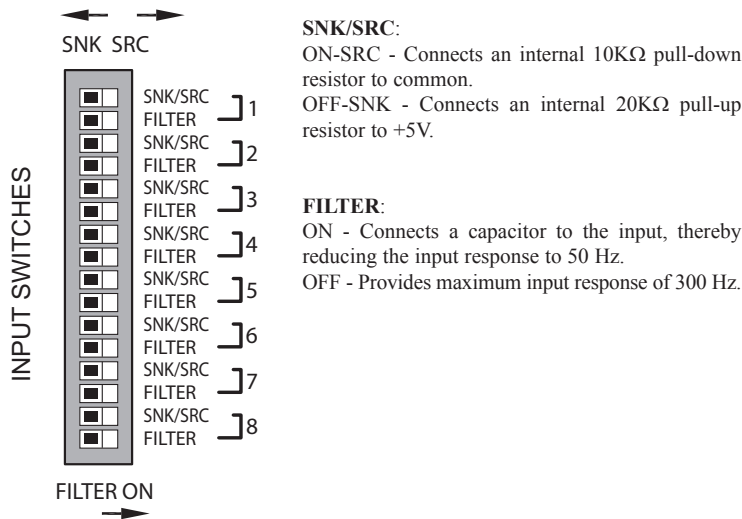

HARDWARE INSTALLATION

Modules must be installed beginning with slot 1 (left-most slot), with no empty slots between the modules, and the order must match the modules order in Crimson. Torque screws to 6.0 pound-force inch (96 ounce-force inch)

WARNING: Disconnect all power to the unit before installing or removing modules.

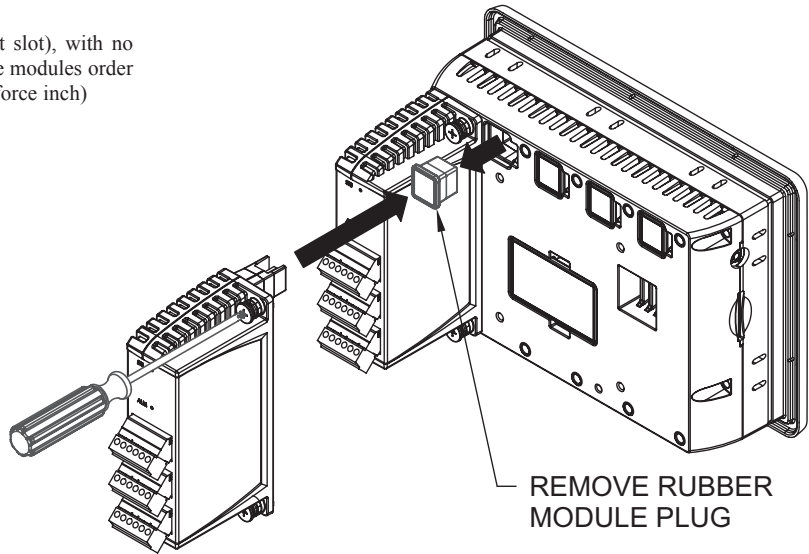

WIRING

WIRING CONNECTIONS

All conductors should meet voltage and current ratings for each terminal. Also, cabling should conform to appropriate standards of good installation, local codes and regulations and be suitably rated for the temperatures of the environment to which it is being installed. When wiring the module, use the numbers on the label to identify the position number with the proper function. Strip the wire, leaving approximately 1/4" (6 mm) of bare wire exposed. Insert the wire into the terminal, and tighten.

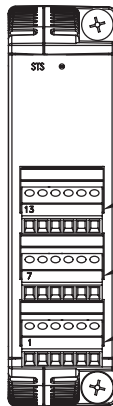

Terminals 13 to 18

Terminals 7 to 12

Terminals 1 to 6



WARNING - EXPLOSION HAZARD - DO NOT CONNECT OR DISCONNECT CABLES WHILE POWER IS APPLIED UNLESS AREA IS KNOWN TO BE NON-HAZARDOUS.

INPUT CONNECTIONS

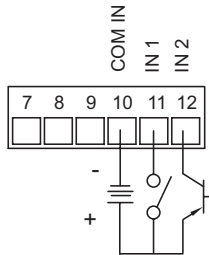
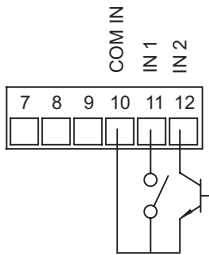
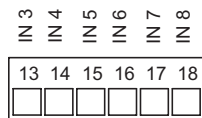
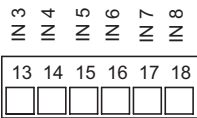

Sinking Input

Sourcing Input

OUTPUT CONNECTIONS

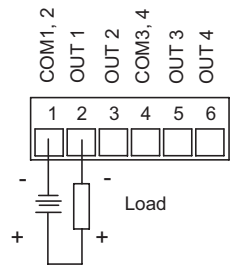
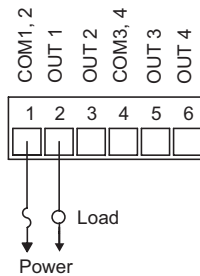
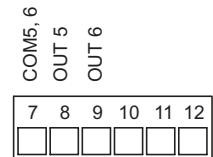
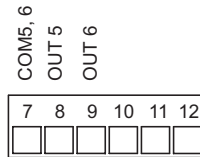

Relay Version

Solid State NFET Version

LEDS

STS – STATUS LED

The Status LED is a green LED that provides information regarding the state of the module. This includes indication of the various stages of the start-up routine (power-up), as well as any errors that may occur.

Startup Routine

Off	Module is currently running the boot loader and/or being flash upgraded by Crimson.
Flashing Green	Module switching to configuration.
Green	Module performing normally.

Error States

Flashing Green	Module is controlling properly, but has lost communication with the Host.
----------------	---

FIRMWARE UPGRADE

The module's firmware is stored in flash memory so that software/hardware conflicts are avoided, and so features can be added in the future.

During a download, Crimson compares its own library of firmware files with those stored in the module. If they do not match, Crimson will download the necessary firmware.

CONFIGURATION

Programming is done via Crimson, a Windows® compatible configuration interface. Please see the Crimson manual for more information.

ORDERING INFORMATION

TYPE	DESCRIPTION	PART NUMBER
Operator Interface Panels	Graphite 7" Color Touch Screen, Indoor, 24 VDC Powered	G07C0000
	Graphite 7" Color Touch Screen, Indoor/Outdoor, 24 VDC Powered	G07S0000
	Graphite 9" Color Touch Screen, Indoor, 24 VDC Powered	G09C0000
	Graphite 9" Color Touch Screen, Indoor, 24 VDC Powered, Additional Ethernet Port	G09C1000
	Graphite 10" Color Touch Screen, Indoor, 24 VDC Powered	G10C0000
	Graphite 10" Color Touch Screen, Indoor, 24 VDC Powered, Additional Ethernet Port	G10C1000
	Graphite 10" High Resolution Display, Color Touch Screen, Indoor, 24 VDC Powered	G10R0000
	Graphite 10" High Resolution Display, Color Touch Screen, Indoor, 24 VDC Powered, Additional Ethernet Port	G10R1000
	Graphite 10" Color Touch Screen, Indoor/Outdoor, 24 VDC Powered	G10S0000
	Graphite 10" Color Touch Screen, Indoor/Outdoor, 24 VDC Powered, Additional Ethernet Port	G10S1000
	Graphite 12" Color Touch Screen, Indoor, 24 VDC Powered	G12C0000
	Graphite 12" Color Touch Screen, Indoor, 24 VDC Powered, Additional Ethernet And Serial Port	G12C1100
	Graphite 15" Color Touch Screen, Indoor, 24 VDC Powered	G15C0000
	Graphite 15" Color Touch Screen, Indoor, 24 VDC Powered, Additional Ethernet And Serial Port	G15C1100
Input Modules	Graphite Module, Digital I/O, 8 Inputs And 6 Relays Outputs	GMDIOR00
	Graphite Module, Digital I/O, 8 Inputs And 6 Solid State Outputs	GMDIOS00

This page intentionally left blank

This page intentionally left blank

LIMITED WARRANTY

The Company warrants the products it manufactures against defects in materials and workmanship for a period limited to two years from the date of shipment, provided the products have been stored, handled, installed, and used under proper conditions. The Company's liability under this limited warranty shall extend only to the repair or replacement of a defective product, at The Company's option. The Company disclaims all liability for any affirmation, promise or representation with respect to the products.

The customer agrees to hold Red Lion Controls harmless from, defend, and indemnify RLC against damages, claims, and expenses arising out of subsequent sales of RLC products or products containing components manufactured by RLC and based upon personal injuries, deaths, property damage, lost profits, and other matters which Buyer, its employees, or sub-contractors are or may be to any extent liable, including without limitation penalties imposed by the Consumer Product Safety Act (P.L. 92-573) and liability imposed upon any person pursuant to the Magnuson-Moss Warranty Act (P.L. 93-637), as now in effect or as amended hereafter.

No warranties expressed or implied are created with respect to The Company's products except those expressly contained herein. The Customer acknowledges the disclaimers and limitations contained herein and relies on no other warranties or affirmations.

Red Lion Controls
Headquarters
20 Willow Springs Circle
York PA 17406
Tel +1 (717) 767-6511
Fax +1 (717) 764-0839

Red Lion Controls
Europe
Softwareweg 9
NL - 3821 BN Amersfoort
Tel +31 (0) 334 723 225
Fax +31 (0) 334 893 793

Red Lion Controls
India
201-B, 2nd Floor, Park Centra
Opp 32 Mile Stone, Sector-30
Gurgaon-122002 Haryana, India
Tel +91 984 487 0503

Red Lion Controls
China
Unit 302, XinAn Plaza
Building 13, No.99 Tianzhou Road
ShangHai, P.R. China 200223
Tel +86 21 6113 3688
Fax +86 21 6113 3683