

MODEL G307K2 - KADET 2 OPERATOR INTERFACE WITH 7" TFT DISPLAY



- CONFIGURED USING CRIMSON® 3 SOFTWARE
- THREE SERIAL COMMUNICATIONS PORTS (1 RS-232 AND 2 RS-232/422/485 PORTS)
- 10 BASE-T/100 BASE-TX ETHERNET PORT COMMUNICATES WITH UP TO FOUR PROTOCOLS SIMULTANEOUSLY
- UNIT'S CONFIGURATION IS STORED IN NON-VOLATILE FLASH MEMORY
- 7-INCH TFT LCD 32K COLOR 800 X 480 PIXEL DISPLAY
- NEMA 4/IP65 FRONT PANEL
- THREE FRONT PANEL LED INDICATORS
- POWER UNIT FROM 24 ±20% VDC
- RESISTIVE ANALOG TOUCHSCREEN



GENERAL DESCRIPTION

The G307K2 is the perfect solution for applications that require the operator to monitor and control more than just a single device. With three serial ports and an Ethernet port, the 7" Kadet 2 can connect to multiple serial and Ethernet devices simultaneously, including PLCs, motor drives, bar code scanners, etc.

The G307K2 performs the functions of a multiple protocol converter, using three high-speed RS-232/422/485 communications ports and a 10 Base-T Ethernet port. The Ethernet port supports up to four protocols simultaneously, allowing dissimilar Ethernet based products to communicate with one another.

The G3 Kadet 2 range of HMIs is programmed with Red Lion's free Crimson 3 software. Crimson offers easy to use drag and drop communications configuration, while the embedded image library allows the programmer to create intuitive screens and prompts for the operator.

SAFETY SUMMARY

All safety related regulations, local codes and instructions that appear in the manual or on equipment must be observed to ensure personal safety and to prevent damage to either the instrument or equipment connected to it. If equipment is used in a manner not specified by the manufacturer, the protection provided by the equipment may be impaired.

Do not use the controller to directly command motors, valves, or other actuators not equipped with safeguards. To do so can be potentially harmful to persons or equipment in the event of a fault to the unit.

CONTENTS OF PACKAGE

- G307K2 Operator Interface.
- Hardware packet for mounting unit into panel.
- Terminal block for connecting power.
- Spare fuse.

ORDERING INFORMATION

MODEL NO.	DESCRIPTION	PART NUMBER
G307K2	7" TFT Operator Interface	G307K200
CBL	Communications Cables and Adaptor ¹	CBLxxxx
G3FILM	Protective Film	G3FILM7K

¹ Contact your Red Lion distributor or visit our website for selection of adapters and cables.

Note: If replacing Model G306K000, see Tech Note TNG3K6.



CAUTION: Risk Of Danger.
Read complete instructions prior to installation and operation of the unit.



CAUTION: Risk of electric shock.

SPECIFICATIONS

1. POWER REQUIREMENTS:

Must use Class 2 or SELV rated power supply.
 Power connection via removable three position terminal block.
 Supply Voltage: 24 VDC \pm 20%, Class 2
 Maximum Power: 250 mA @ 24 VDC
 Fuse: Fast-blow 800 mA, 5x20 mm

2. BATTERY: Lithium coin cell. Typical lifetime of 10 years.

3. LCD DISPLAY:

SIZE	7-inch
TYPE	TFT
COLORS	32K
PIXELS	800 X 480
BRIGHTNESS	375 cd/m ²
BACKLIGHT TYPE	LED
BACKLIGHT LIFE	30,000 HR TYP.

4. TOUCHSCREEN: Four-wire resistive analog

5. MEMORY:

On Board User Memory: 128 Mbyte of non-volatile Flash memory.

6. COMMUNICATIONS: Three Serial Ports - One RS-232 port, two RS-232/422/485: One Ethernet Port

Serial Ports: Format and Baud Rates for each port are individually software programmable up to 115,200 baud.

Ethernet Port: 10/100 Mbps

7. ENVIRONMENTAL CONDITIONS:

Operating Temperature Range: 0 to 45°C

Operating and Storage Humidity: 10-90% relative humidity (non-condensing) from -20 to 60°C.

Vibration: Operational 10 to 25 Hz, in X, Y, Z direction, 30 minutes, 2 g's.

8. CERTIFICATIONS AND COMPLIANCES:

SAFETY

UL Listed, File #E302106, UL508

UL Type 4 Indoor Use Only Enclosure rating (Face only), UL50

IP65 Enclosure rating (Face only), IEC 529

ELECTROMAGNETIC COMPATIBILITY

Consult factory for EMC specifications

9. CONNECTIONS: Compression cage-clamp terminal block.

Wire Gauge: 12-28 AWG copper wire

Communications: DB9 connectors

10. CONSTRUCTION: Plastic enclosure with NEMA 4/IP65 front panel when properly installed.

11. WEIGHT: 30 oz. (850 g)

DIMENSIONS In inches (mm)

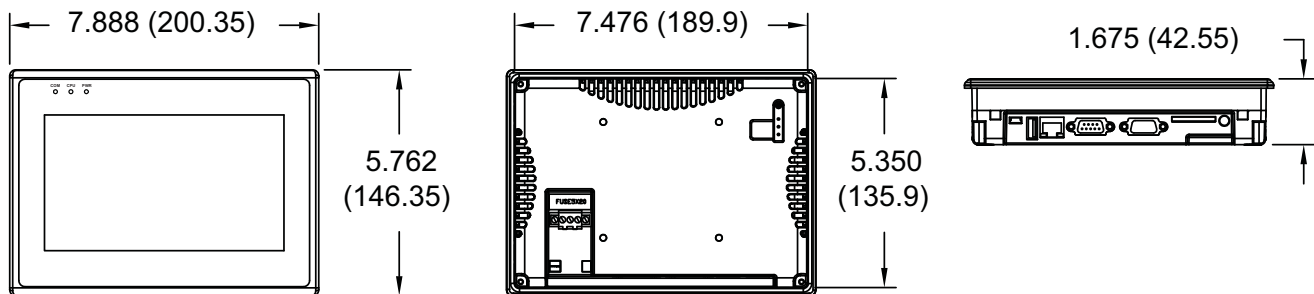

VESA Mount: VESA 75 (75 mm x 75 mm). Use four screws (M4-0.7 mm) less than 8 mm long.

INSTALLING AND POWERING THE G307K2

MOUNTING INSTRUCTIONS

The unit can be mounted into enclosures with a depth of 4". It is recommended that the unit be mounted on the front panel of a steel enclosure. Allow clearance of 1" around the sides of the unit for the mounting hardware. Allow 2.5" along the bottom edge if using Red Lion communication cables.

Place the unit in the panel cutout. Slide clamps into the four holes provided at the top and bottom of the case. Tighten the clamping screws in an even pattern until the unit is secured in the panel. Caution: Do not over tighten the clamps. To seal to NEMA4 specifications, all supplied mounting clamps must be used. (Torque is 2.6 – 3.5 in/lb.) The panel must not flex more than 0.010".

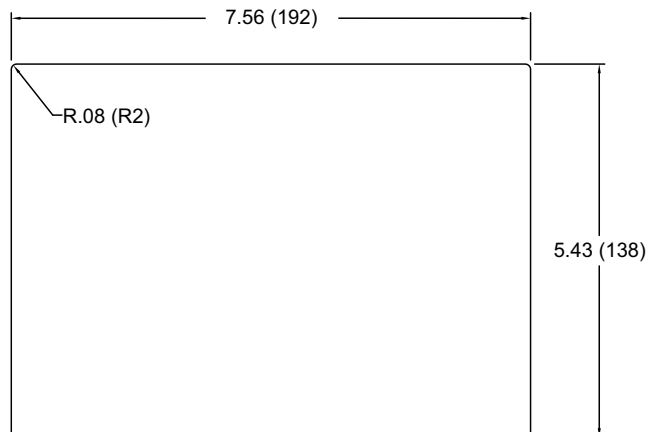

CONNECTING POWER

The G307K2 requires a 24 VDC $\pm 20\%$ power supply. Please take care to observe the following points:

- The wire used to connect the operator interface's power supply should be at least 22-gauge wire. If a longer cable run is used, a heavier gauge wire should be used. The routing of the cable should be kept away from large contactors, inverters, and other devices which may generate significant electrical noise.
- A power supply with a Class 2 or SELV rating is to be used. A Class 2 or SELV power supply provides isolation to accessible circuits from hazardous voltage levels generated by a mains power supply due to single faults. SELV is an acronym for "safety extra-low voltage." Safety extra-low voltage circuits shall exhibit voltages safe to touch both under normal operating conditions and after a single fault, such as a breakdown of a layer of basic insulation or after the failure of a single component has occurred.

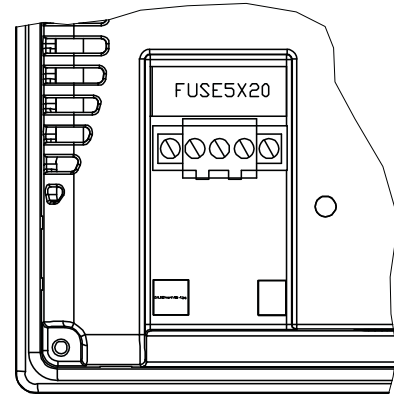

COMMUNICATING WITH THE G307K2

The G307K2 has three serial ports, as well as an Ethernet port. The serial ports are exposed via one DB9 male connector, and one DB9 female connector. You may assign one unique protocol to each of the ports for a total of three different serial protocols.

Note: If you assign a protocol to the Programming Port, you will no longer be able to download. You should create a means to call the StopSystem() function from the HMI touchscreen, such that the Programming Port activity can be halted on command. Alternatively, the HMI's memory can be cleared to restore download functionality.

The Ethernet port can be programmed to communicate via four protocols simultaneously. For more information on protocol support, please refer to the Crimson 3 programming software.

COM1

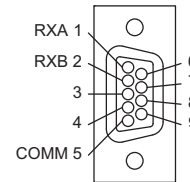

RS-485 (2-wire)
DB9-F

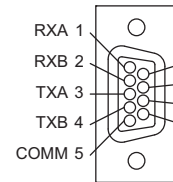

RS-485 (4-wire)
DB9-F

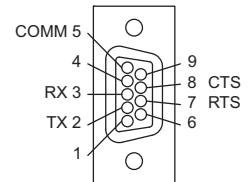

RS-232
DB9-M

RJ-45 Ethernet

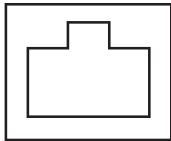

PROGRAMMING/COM2

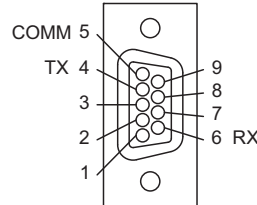

RS-232
DB9-M

COM3

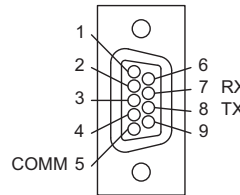

RS-232
DB9-F

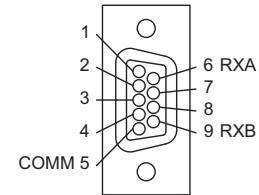

RS-485
DB9-F

PC CONNECTION

Configuration files are downloaded to the Kadet 2 via the PC port, which can be connected to a computer via various cables.

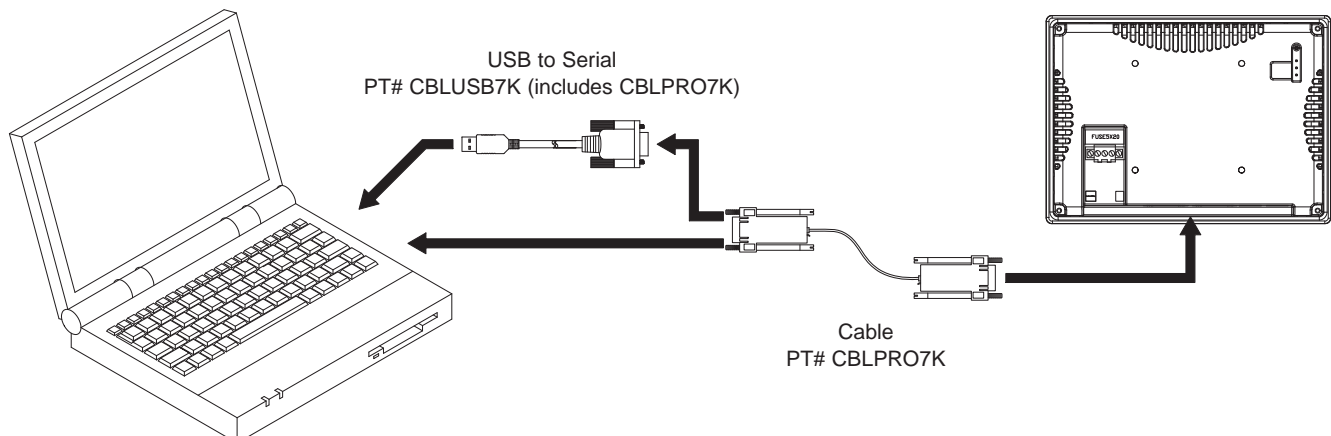

DEVICE COMMUNICATIONS

Several adapters are available which allow direct connection via Red Lion communications cables. For a list of adapters and cables, please visit <http://www.redlion.net/support/downloads.html>.

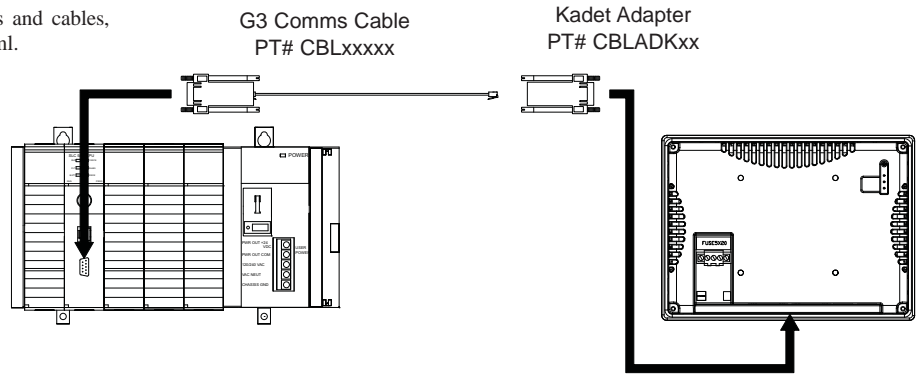

SETTING THE SWITCHES

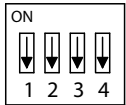

Normal mode.

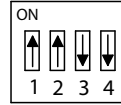

Cycle power with the switches as shown in order to display the Clear Database prompt. Touch the left side of the display to clear the database; touch the right side to continue in normal mode.

SOFTWARE/UNIT OPERATION

CRIMSON SOFTWARE

Crimson software is available as a free download from Red Lion's website or it can be purchased on a CD, see "Ordering Information" for part number. The latest version of the software is always available from the website, and updating your copy is free.

FRONT PANEL LEDs

There are three front panel LEDs. Shown below is the default status of the LEDs.

LED	INDICATION
RED (COM)	
FLASHING	Communications are active.
GREEN (CPU)	
STEADY	CPU is functioning
ORANGE (PWR)	
STEADY	Power is applied.

TOUCHSCREEN

This operator interface utilizes a resistive analog touchscreen for user input. The unit will only produce an audible tone (beep) when a touch on an active touchscreen cell is sensed. The touchscreen is fully functional as soon as the operator interface is initialized, and can be operated with gloved hands.

TROUBLESHOOTING YOUR G307K2

If for any reason you have trouble operating, connecting, or simply have questions concerning your new G307K2, contact Red Lion's technical support. For contact information, refer to the front page of this bulletin for phone and fax numbers.

EMAIL: techsupport@redlion.net

Web Site: <http://www.redlion.net>

BATTERY REPLACEMENT

The G307K2 uses one CR2032 coin type lithium battery to maintain the RTC (real-time clock) and for proper Ethernet download operation. To change the battery, remove power, cabling, and then the rear cover of the unit. Remove the old battery from the holder and replace with a new battery*. Replace the rear cover, cables, and re-apply power. Set the RTC to the proper date and time.

* Please note that the old battery must be disposed of in a manner that complies with your local waste regulations. Also, the battery must not be disposed of in fire, or in a manner whereby it may be damaged and its contents come into contact with human skin.



CAUTION: The circuit board contains static sensitive components. Before handling the operator interface without the rear cover attached, discharge static charges from your body by touching a grounded bare metal object. Ideally, handle the operator interface at a static controlled clean workstation. Also, do not touch the surface areas of the circuit board. Dirt, oil, or other contaminants may adversely affect circuit operation.



CAUTION: Danger of explosion if battery is incorrectly replaced. Replace only with the same or equivalent type recommended by the manufacturer. Dispose of used batteries according to the manufacturer's instructions.