

**New**

# ER-V SERIES



## A new style of charge removal

New ultra-compact, high-performance ionizer!

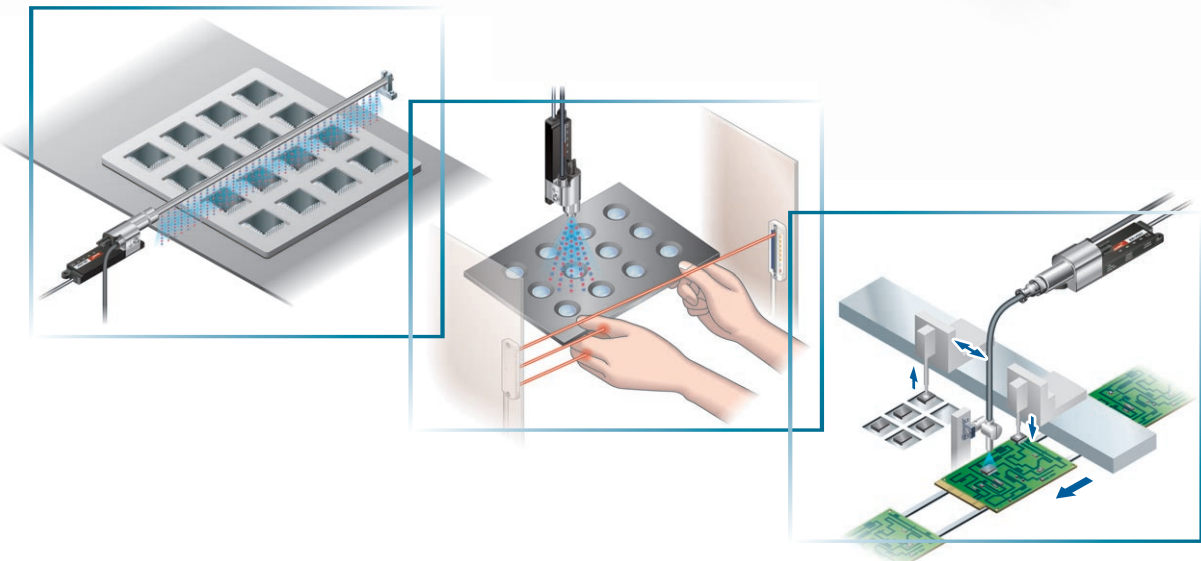

# A new style of ionizer

This compact ionizer has a full complement of functions.  
 Its charge removal performance produces excellent ion balance.  
 The compact design removes charges of objects even from narrow spaces.  
 Advanced functions developed with safety and easy maintenance in mind.  
 Nozzle variation allows charge removal for a variety of processes.  
 The SUNX ultra-compact, high-performance ER-V ionizer heralds a new style in charge removal.

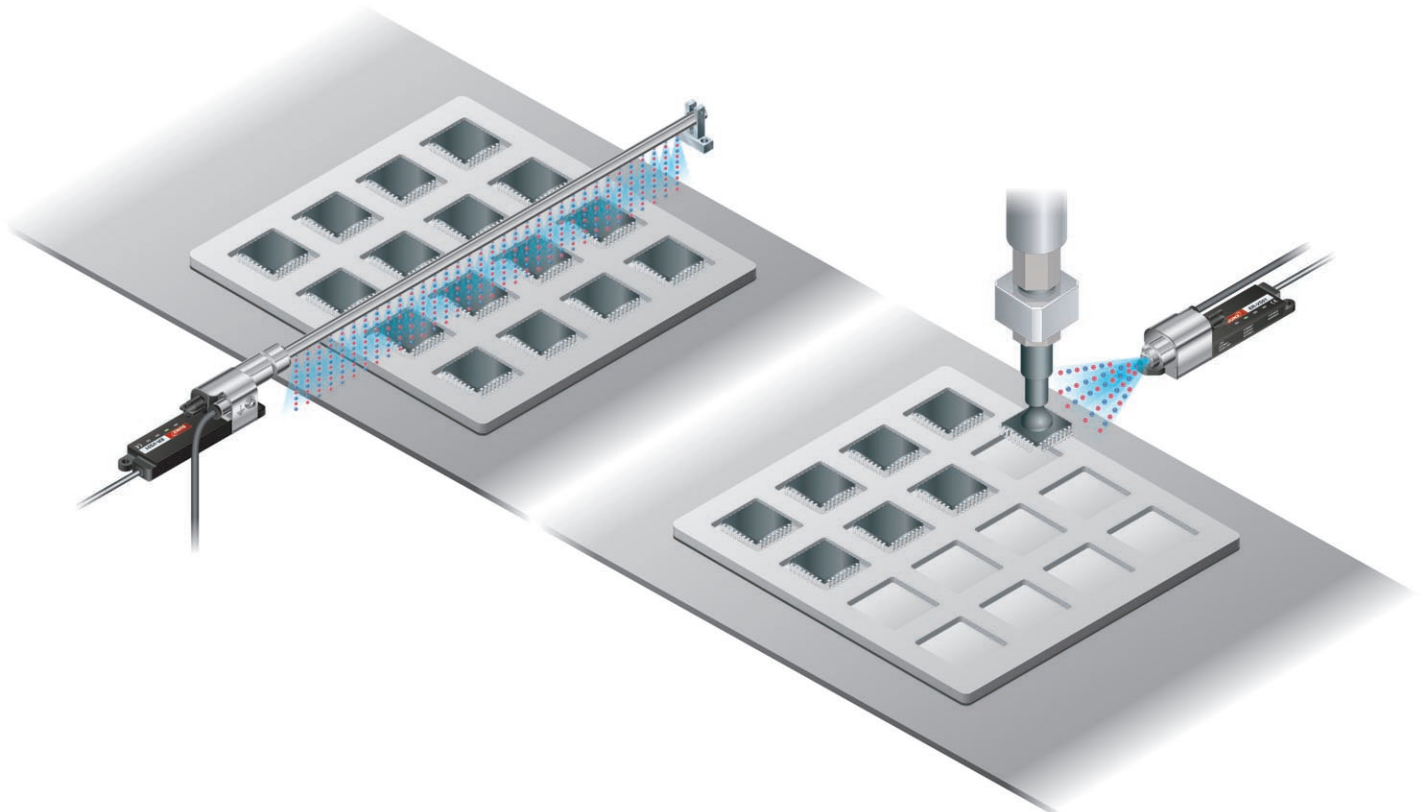

## Produces excellent ion balance

The adoption of high-frequency AC method allows extremely stable ion balance to be achieved. Because the ion balance is not affected by the pressure of air supplied or by the setup distance, no troublesome adjustments are required after setup.

## Charge removal time (typical)

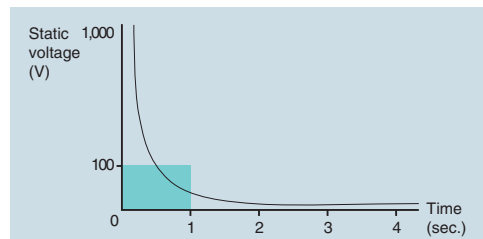

Spot type

### Ion balance comparison

— Conventional spot type using AC method  
 — SUNX ER-V with shower nozzle

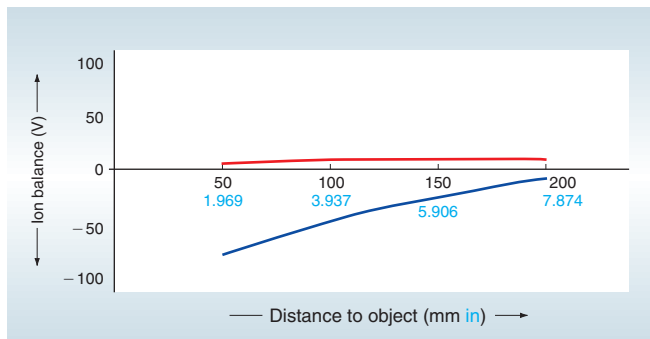

※Comparison test carried out by SUNX

Bar type

### Ion balance comparison

— Conventional bar type using DC method  
 — SUNX ER-V with bar nozzle

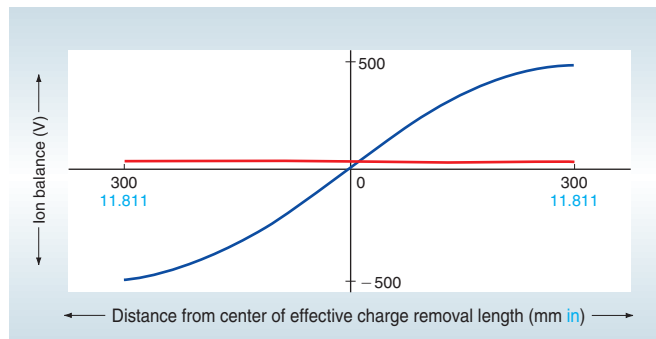

※Comparison test carried out by SUNX

## Ultra-compact design accurately removes charges of objects even from narrow spaces.

The main unit is merely 109×27×28 mm 4.291×1.063×1.102 in, so it can easily be combined with other devices and also be installed as an add-on. Furthermore, the high-voltage power supply is built-in, so no extra space is required except for the ionizer itself.

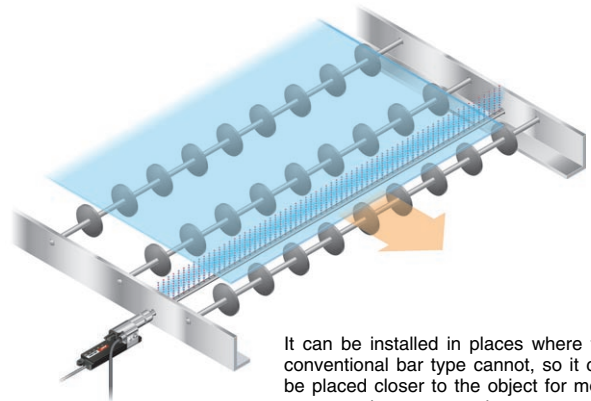

It can be installed in places where the conventional bar type cannot, so it can be placed closer to the object for more accurate charge removal.

## High performance with no controller needed

A full range of functions have been provided with full consideration given to ease of use in the workplace. No separate controller is needed.

### Discharge halt input

A signal from an external device can be used to turn discharge ON and OFF. Sensors can be used to detect the objects so that the ion air is generated only when required.

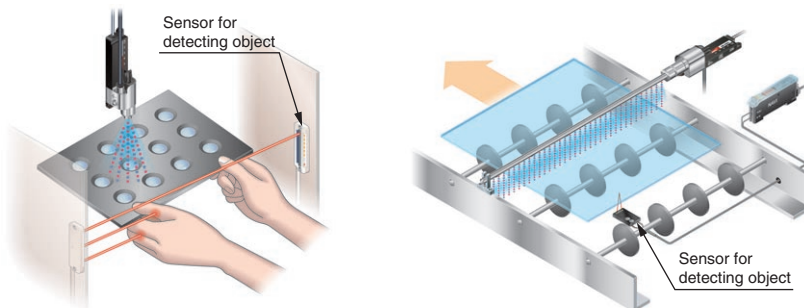

### Discharge indicator

The discharge ON / OFF status can be checked using an LED display. This lets you avoid problems such as when the power is on but no discharge is occurring.

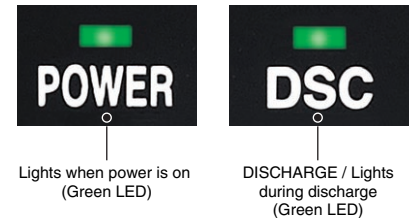

## Completely safe design and easy maintenance

### Easy discharge needle maintenance

The discharge needle can be removed from the rear of the main unit, so there is no need to remove the nozzle when replacing the needle. Maintenance is easy even when the ion air outlet is located close to the object.

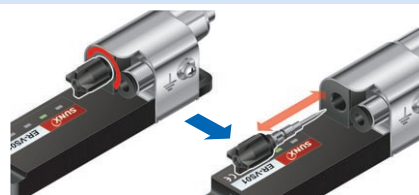

### Low power consumption and low-voltage wiring

The power supply voltage is 24 V DC, and the power consumed is only 70 mA. In addition, safety is enhanced because no high-voltage cables are required.

### Safe design

A 'checking function' and an 'abnormal discharge monitoring function' are provided to notify the operator when it is time to clean or replace the discharge needle and to prevent discharge problems from occurring. Each function has an LED display for use for checking. The output from each function can also be used to externally monitor the status of the ionizer during operation.



[Checking function] (Orange LED)  
When lit, the discharge needle may be worn or dirty. Please check it.

[Abnormal discharge monitoring function] (Red LED)  
When lit, an abnormal discharge has been detected, e.g. due to a foreign substance, and discharge halted in order to maintain safety.

### Discharge needle is covered by the nozzle

The discharge needle does not protrude from the main unit, so it cannot be touched by accident. Furthermore, no leaks can occur when it is brought close to metallic objects.



## Nozzle variations can be selected to suit the application

A shape-preserving tube, a conductive tube and a exclusive joint nozzle are also available in the lineup in addition to the shower nozzle and straight bar nozzle.

**Can be bent freely yet need not be affixed**

### Shape-preserving tube joint nozzle ER-VAJK Shape-preserving tube ER-VAK□

Easy shape-preserving flexibility renders anchoring unnecessary in most cases. Furthermore, can be set near the object from a narrow space enabling charge removal and dust removal at any targeted point.

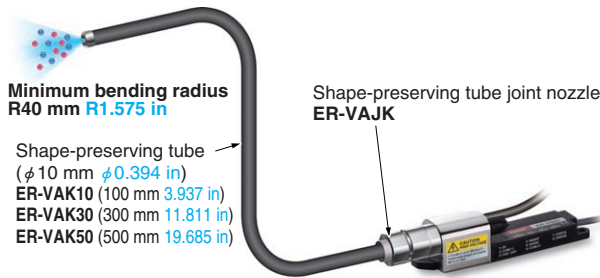

**Can be cut anywhere at will for universal installation**

### Conductive tube joint nozzle ER-VAJT-64 Conductive tube ER-AT50

The conductive tube can be cut wherever required, and it can be bent to a minimum radius of R15 mm R0.591 in, so that the tube tip can be positioned close to the objects for pinpoint charge and dust removal.

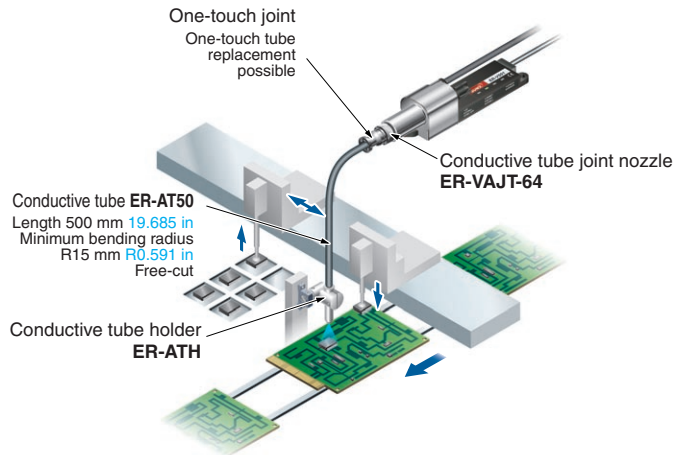

## APPLICATIONS

### Charge removal of large glass substrate

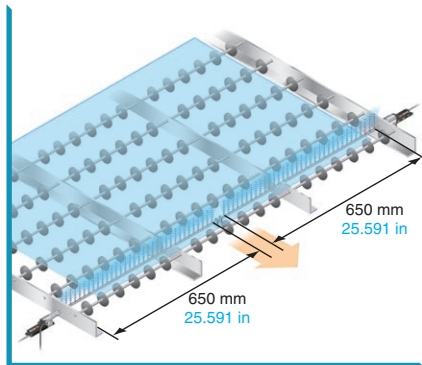

### Charge removal and dust removal of lenses

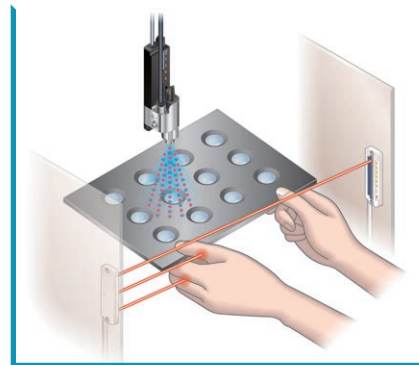

### Pinpoint charge removal of electronic components

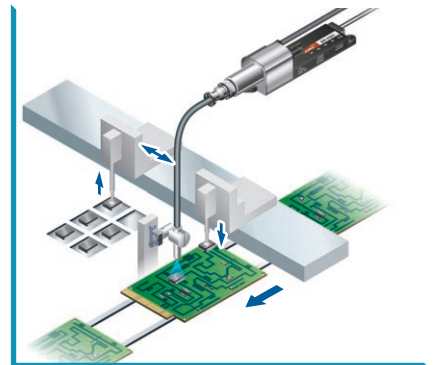

### Prevent discharge damage in circuit board LEDs

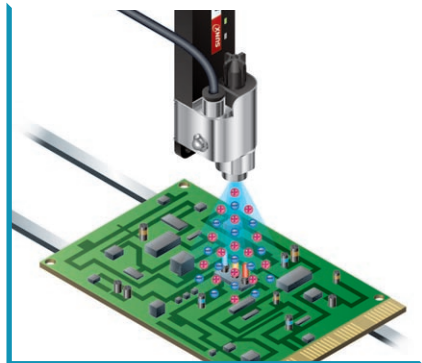

### Charge removal and dust removal of relay and switch contacts

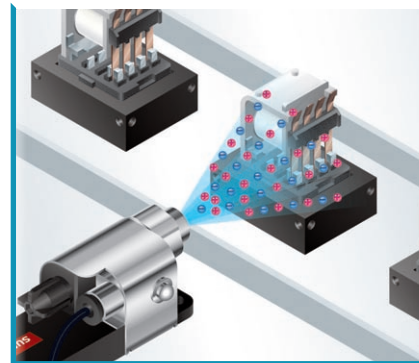

### Charge removal of FPD glass surfaces

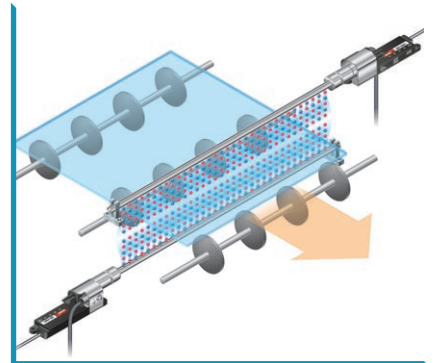





## ORDER GUIDE

**Ionizer main unit** Nozzle and cable with connector are not supplied with the ionizer main unit. Please order them separately.

Type	Appearance	Charge removal time ( $\pm 1,000\text{ V} \rightarrow \pm 100\text{ V}$ )	Ion balance	Model No.
Spot type	 <p>※The photograph shows the unit fitted with a shower nozzle.</p>	1 sec. or less (Note)	$\pm 15\text{ V}$ or less (Note)	<b>ER-VS01</b>

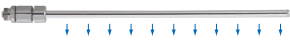
Note: A typical sample applied with a supply voltage of 24 V, a distance of 100 mm **3.937 in** from the front surface of the air flow outlet and a pressure of 0.25 MPa while the shower nozzle is in use. (Measured on a sample left in the atmosphere at a relative humidity of 65 % RH or less for 24 hours or more.)

**Nozzles** Nozzle is not supplied with the ionizer main unit. Please order it separately.

Type	Appearance	Model No.	Description
Shower nozzle		<b>ER-VAS</b>	Air dispersal type
Straight bar nozzle		<b>ER-VAB020</b>	Effective charge removal length 200 mm <b>7.874 in</b>
		<b>ER-VAB032</b>	Effective charge removal length 320 mm <b>12.598 in</b>
		<b>ER-VAB065</b>	Effective charge removal length 650 mm <b>25.591 in</b>
Shape-preserving tube		<b>ER-VAJK</b>	Joint nozzle for ionizer main unit and shape-preserving tube
		<b>ER-VAK10</b>	Tube length 112 mm <b>4.409 in</b>
		<b>ER-VAK30</b>	Tube length 312 mm <b>12.283 in</b>
		<b>ER-VAK50</b>	Tube length 512 mm <b>20.157 in</b>
Conductive tube		<b>ER-VAJT-64</b>	Joint nozzle for ionizer main unit and conductive tube
		<b>ER-AT50</b>	Tube length 500 mm <b>19.685 in</b>
			Bends freely, and can be cut to different length (Minimum bending radius: R15 mm <b>R0.591 in</b> )

**Cables with connector** Cable with connector is not supplied with the ionizer main unit. Please order it separately.

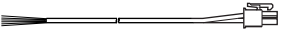
Appearance	Model No.	Description
	<b>ER-VCCJ2</b>	Length: 2 m <b>6.562 ft</b> , Weight: 52 g approx.
	<b>ER-VCCJ5</b>	Length: 5 m <b>16.404 ft</b> , Weight: 120 g approx.
	<b>ER-VCCJ9</b>	Length: 9 m <b>29.528 ft</b> , Weight: 240 g approx.
		0.15mm <sup>2</sup> 8-core cabtyre cable with connector Cable outer diameter: $\phi 4.2\text{ mm}$ $\phi 0.165\text{ in}$

## OPTIONS

Type	Model No.	Description
Conductive tube holder	<b>ER-ATH</b>	Used to secure conductive tubes
Mini line filter	<b>ER-AF10</b>	Processed air volume 40 $\ell$ /min. (ANR)
	<b>ER-AF20</b>	Processed air volume 80 $\ell$ /min. (ANR)
		Removes solid particles such as dirt and dust from air supply <ul style="list-style-type: none"> <li>• Collected particle dia. 0.1 <math>\mu\text{m}</math></li> <li>• Collection efficiency 99.9%</li> </ul>

### Conductive tube holder

- ER-ATH

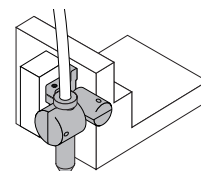

### Mini line filter

- ER-AF10
- ER-AF20



※The photograph shows ER-AF10

## SPECIFICATIONS

## Main unit

Type		Spot type
Item	Model No.	ER-VS01
Charge removal time ( $\pm 1,000V \rightarrow \pm 100V$ )		1 sec. or less (Note 1)
Ion balance		$\pm 15 V$ or less (Note 1)
Ozone generation		0.03 ppm or less (Note 2)
Applicable fluid		Air (dried clean air)
Supplied air flow		500 $\ell$ /min. (ANR) or less (Note 3)
Air pressure range		0.05 to 0.7 MPa (Note 3)
Supply voltage		24 V DC $\pm 10 \%$
Current consumption		70 mA or less
Discharge method		High frequency AC method
Discharge output voltage		2,000 V approx.
Check output		NPN open-collector transistor <ul style="list-style-type: none"> <li>• Maximum sink current: 50 mA</li> <li>• Applied voltage: 30 V DC or less (between check output and 0 V)</li> <li>• Residual voltage: 1 V or less (at 50 mA sink current)</li> </ul>
	Output operation	ON when the discharge needle is dirty or worn, OFF when operation is normal
	Short-circuit protection	Incorporated
Error output		NPN open-collector transistor <ul style="list-style-type: none"> <li>• Maximum sink current: 50 mA</li> <li>• Applied voltage: 30 V DC or less (between error output and 0 V)</li> <li>• Residual voltage: 1 V or less (at 50 mA sink current)</li> </ul>
	Output operation	OFF when abnormal discharge is detected, ON when operation is normal
	Short-circuit protection	Incorporated
Discharge halt input		Short-circuit to 0 V: Discharge halt Open: Discharge allowed (operation start)
Reset input		When abnormal discharge is detected, discharge is halted due to an error. Reset the discharge halt by briefly shorting the power supply's 0 V line.
Indicators	Power	Green LED (lights up when the power is ON)
	Discharge	Green LED (lights up when discharging)
	Check	Orange LED (lights up when the discharge needle is worn or dirty, etc.)
	Error	Red LED (lights up when abnormal discharge is detected)
Environmental resistance	Ambient temperature	0 to + 55 °C + 32 to + 131 °F (No dew condensation)
	Ambient humidity	35 to 65 % RH
	EMC	EN 61000-6-2
	Vibration resistance	10 to 150 Hz frequency, 0.75 mm 0.030 in amplitude in X, Y and Z directions for two hours each
Cable		Cable with a connector, 0.5 m 1.640 ft long
Material		Enclosure: PPS, Cover: Stainless steel, Discharge needle: Tungsten
Weight		120 g approx.
Accessory		Connector for wiring: 1 set [Manufactured by Molex: Housing (5557-08R), Terminal (5556TL)]

- Notes: 1) A typical sample applied with a supply voltage of 24 V, a distance of 100 mm 3.937 in from the front surface of the air flow outlet and a pressure of 0.25 MPa while the shower nozzle is in use. (Measured on a sample left in the atmosphere at a relative humidity of 65 % RH or less for 24 hours or more.)  
2) A typical sample applied with a power voltage of 24 V, a distance of 300 mm 11.811 in from the front surface of the air flow outlet and a pressure of 0.25 MPa while the shower nozzle is in use.  
3) The applicable pressure range depends on the nozzle to be used.

## Nozzles / Tubes

Type		Shower nozzle	Straight bar nozzle 200 mm 7.874 in	Straight bar nozzle 320 mm 12.598 in	Straight bar nozzle 650 mm 25.591 in
Item	Model No.	ER-VAS	ER-VAB020	ER-VAB032	ER-VAB065
Supplied air pressure range		0.05 to 0.40 MPa			
Charge removal range		—————	200 mm 7.874 in	320 mm 12.598 in	650 mm 25.591 in
Material		Stainless steel			
Accessories		Attachment and resin tube: 1 pc. each	Attachment and resin tube: 1 pc. each, Straight bar nozzle holder: 1 set		

## SPECIFICATIONS

### Nozzles / Tubes

Type	Shape-preserving tube joint nozzle	Conductive tube joint nozzle
Item Model No.	<b>ER-VAJK</b>	<b>ER-VAJT-64</b>
Air pressure range	0.02 to 0.5 MPa	0.02 to 0.7 MPa (Maximum applied pressure depends on the tube length. Refer to the following figure)
Material	Stainless steel	Stainless steel
Consumption air flow	30 to 250 ℓ/min. (ANR)	20 to 160 ℓ/min. (ANR) (at applied pressure of 0.02 to 0.7 MPa)
Accessories	Attachment (White): 1pc., Resin tube: 1pc.	Attachment (White): 1pc., Resin tube: 1pc.

Type	Shape-preserving tube			Conductive tube
Item Model No.	<b>ER-VAK10</b>	<b>ER-VAK30</b>	<b>ER-VAK50</b>	<b>ER-AT50</b>
Tube length	112 mm <b>4.409 in</b>	312 mm <b>12.283 in</b>	512 mm <b>20.157 in</b>	500 mm <b>19.685 in</b>
Material	Tube interior: Aluminum, Tube sheath: High-density polyethylene, Terminal cap: Stainless steel			Urethane
Air pressure range	0.02 to 0.5 MPa			0.02 to 0.7 MPa
Minimum bending radius	R40 mm <b>R1.575 in</b> or more			R15 mm <b>R0.591 in</b> or more

• Correlation between tube length and maximum applied pressure

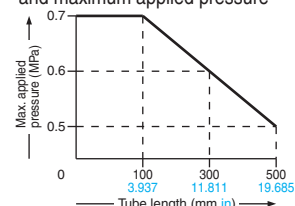

### Mini line filter

Designation	Mini line filter	
Item Model No.	<b>ER-AF10</b>	<b>ER-AF20</b>
Applicable ionizer	<b>ER-VS01, ER-SP□</b>	
Applicable fluid	Air	
Pipe connection port	R <sup>1</sup> / <sub>8</sub> , Rc <sup>1</sup> / <sub>8</sub>	R <sup>1</sup> / <sub>4</sub> , Rc <sup>1</sup> / <sub>4</sub>
Collected particle dia.	0.1 μm	
Collection efficiency	99.9 %	
Processed air volume (Note)	40 ℓ/min. (ANR) (Orange) Check output	80 ℓ/min. (ANR)
Membrane area	29.9 cm <sup>2</sup>	68.7 cm <sup>2</sup>
Max. operating pressure	0.97 MPa	
Warranted withstand pressure	1.47 MPa	
Ambient temperature	+ 5 to + 45 °C <b>+ 41 to + 113 °F</b>	
Material	Main body: Aluminum alloy (Almite processed), Element: Porous, hollow fiber membrane	
Weight	11 g approx.	18 g approx.

Note: Maximum processed air volume that the filter performance can be maintained.  
Approximately 0.1 MPa of pressure drop occurs with the max. processed air volume.

## I/O CIRCUIT AND WIRING DIAGRAMS

### ER-VS01

#### I/O circuit diagram

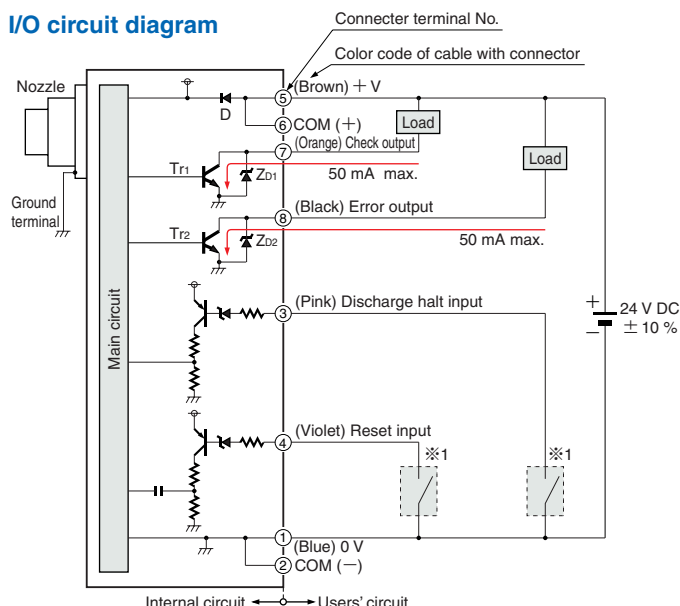

Symbols... D: Reverse supply polarity protection diode  
ZD1, ZD2: Surge absorption zener diode  
Tr1, Tr2: NPN output transistor

#### Connector terminal arrangement

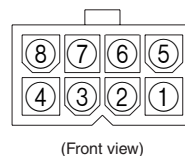

Terminal No.	Description	Color code of cable with connector
①	0 V	Blue
②	COM (-)	—
③	Discharge halt input	Pink
④	Reset input	Violet
⑤	24 V	Brown
⑥	COM (+)	—
⑦	Check output	Orange
⑧	Error output	Black

Note: ① and ② are short-circuited at the connector side.  
⑤ and ⑥ are short-circuited at the connector side.

※1

Non-voltage contact or NPN open-collector transistor

- Discharge halt input  
Low (0 V): Discharge halt  
High (Open): Discharge allowed (Operation starts)
- Reset input  
When abnormal discharge is detected, discharge is halted due to an error.  
Reset the discharge halt by briefly shorting the power supply's 0 V line.

## CHARGE REMOVAL CHARACTERISTICS (TYPICAL)

Please contact our office for details on data that is not listed here.

Measured using a 150 mm 5.906 in CPM (charge plate monitor). (At center of CPM)

### Common to all nozzles

#### Air flow

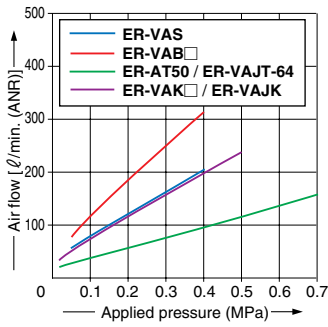

#### Correlation between charge removal distance and ion balance (Typical: ER-VAS)

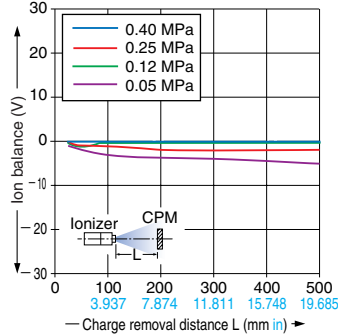

### ER-VAS Shower nozzle

#### Correlation between charge removal distance and charge removal time

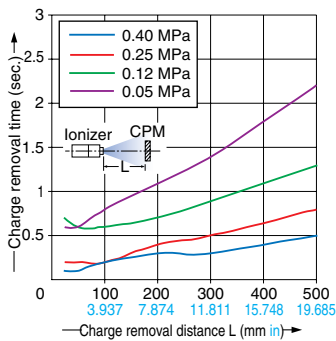

#### Charge removal field (0.40 MPa)

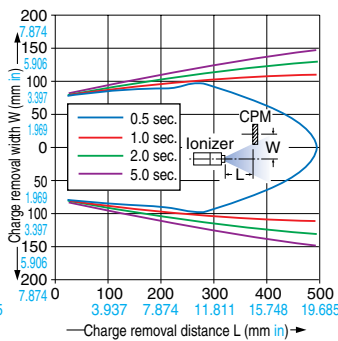

### ER-VAB020 Straight bar nozzle

#### Correlation between charge removal distance and charge removal time

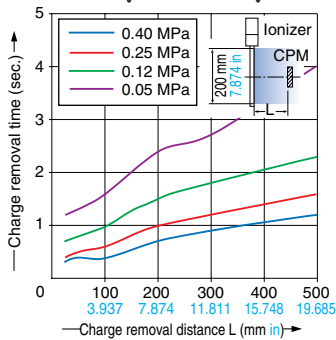

#### Charge removal field (0.40 MPa)

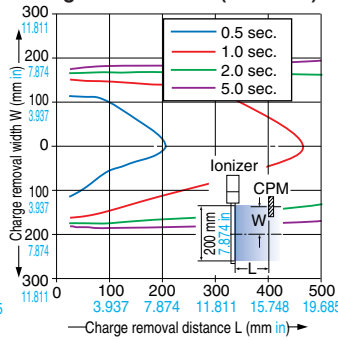

### ER-VAB032 Straight bar nozzle

#### Correlation between charge removal distance and charge removal time

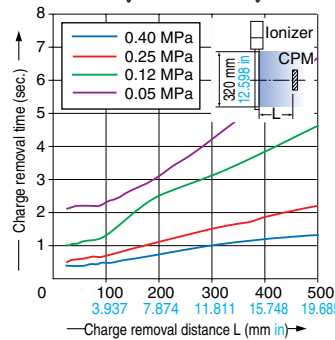

#### Charge removal field (0.40 MPa)

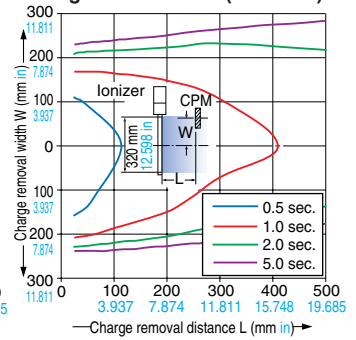

### ER-VAB065 Straight bar nozzle

#### Correlation between charge removal distance and charge removal time

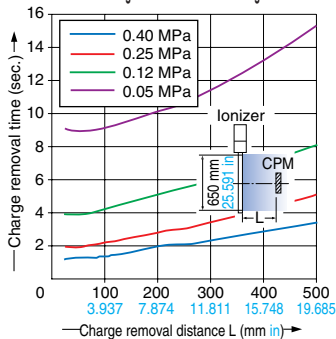

#### Charge removal field (0.40 MPa)

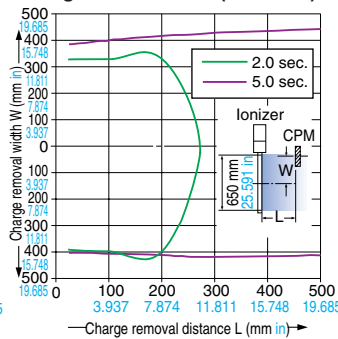



**CHARGE REMOVAL CHARACTERISTICS (TYPICAL)**

Please contact our office for details on data that is not listed here.

**ER-VAJK  
ER-VAK10**

Shape-preserving tube joint nozzle, Shape-preserving tube

Correlation between charge removal distance and charge removal time

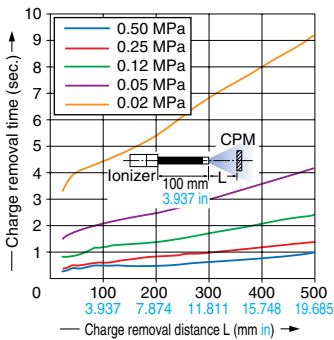

Charge removal field (0.50 MPa)

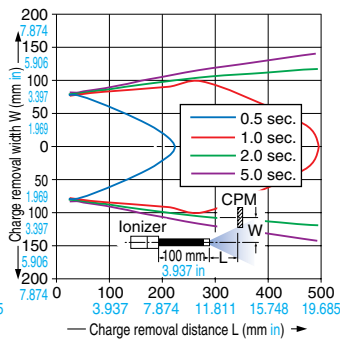

**ER-VAJK  
ER-VAK30**

Shape-preserving tube joint nozzle, Shape-preserving tube

Correlation between charge removal distance and charge removal time

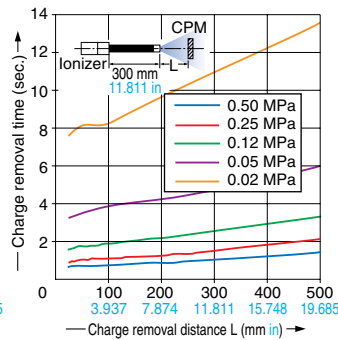

Charge removal field (0.50 MPa)

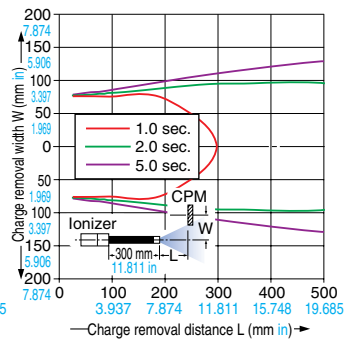

**ER-VAJK  
ER-VAK50**

Shape-preserving tube joint nozzle, Shape-preserving tube

Correlation between charge removal distance and charge removal time

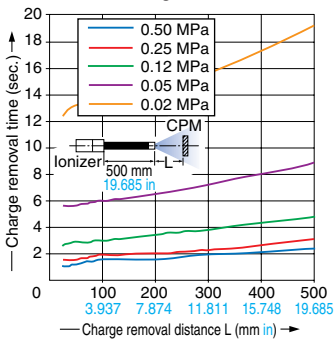

Charge removal field (0.50 MPa)

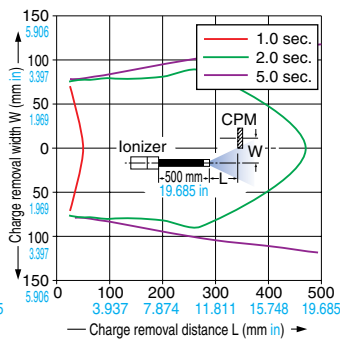

**ER-VAJT-64  
ER-AT50**

Conductive tube joint nozzle, Conductive tube

Correlation between charge removal distance and charge removal time (Tube length 100 mm 3.937 in)

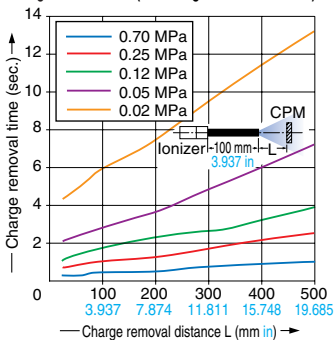

Correlation between charge removal distance and charge removal time (Tube length 300 mm 11.811 in)

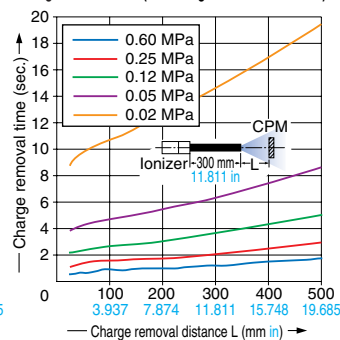

Correlation between charge removal distance and charge removal time (Tube length 500 mm 19.685 in)

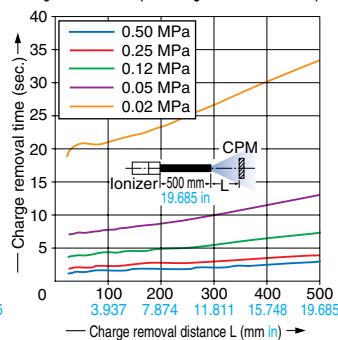

Correlation between tube length and max. applied pressure

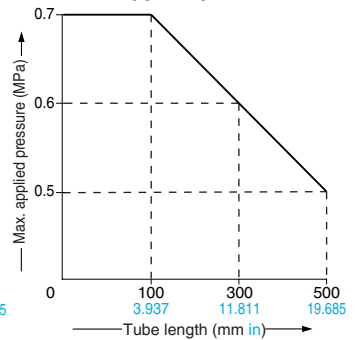

Charge removal field (0.70 MPa) (Tube length 100 mm 3.937 in)

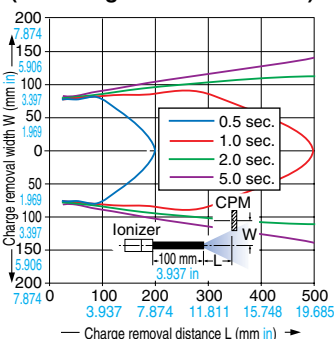

Charge removal field (0.60 MPa) (Tube length 300 mm 11.811 in)

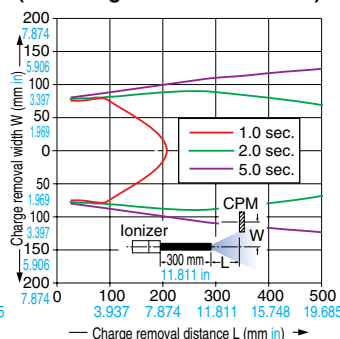

Charge removal field (0.50 MPa) (Tube length 500 mm 19.685 in)

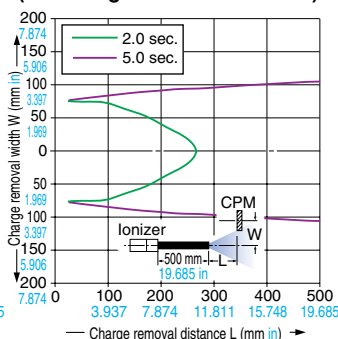

## PRECAUTIONS FOR PROPER USE



This product is designed to remove static electricity for industrial use. It is not intended to be used to prevent accidents, either to humans or properties, or for safety maintenance.

### Mounting

- When this product is mounted in a housing, use M4 screws (please arrange separately).
- If more than 2 units are mounted close together, keep 5 mm 0.197 in or more between them. If used at distances of less than 5 mm 0.197 in, performance may be affected.
- Ensure sufficient space for daily check and maintenance.
- Make sure to ground this product. If the grounding is not proper, charge removal may be impaired. (Direct earth or power supply common earth)
- If an electrostatically charged object is in contact with or near another object, charge removal may be impaired. Install this product such that ions are blown against the electrostatically charged object, when the object is at a distance from other objects or is floating in mid-air.

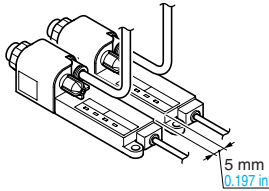

### Nozzle



The ionizer main unit cannot be used by itself. Always be sure to attach a nozzle (optional) before use.

- There are 8 nozzle models available (as of September 2003). Select the suitable model for your application.
- Appropriate air pressure for each nozzle should be used.
- To fit the air nozzle, screw it to the product till it stops.

### Piping

- The outer diameter of the air tube for the air inlet of this product should be  $\phi 6$  mm  $\phi 0.236$  in.
- Make sure that clean air (air containing no water, no oil and no dust) should be supplied.

### Maintenance



- Always be sure that the power supply and the air supply are both turned off before inspection and cleaning.
- Since the tip of the discharge needle is pointed, take sufficient care when cleaning.

- The charge removal effect will deteriorate if dirt is stuck to the tip of the discharge needle. If a check signal is output, clean the discharge needle.
- Clean the discharge needle periodically even if no check signal is output.
- The discharge needle's life-time is approximately 10,000 hours. Please change it after this period has elapsed. Use only **ER-V** discharge needle **ER-VANT** (optional).
- If a check signal is output even after the discharge needle has been cleaned, replace the discharge needle.
- If an error signal is output, it may indicate an abnormal discharge. Check the following points:
  - ① Make sure that the supply voltage is within the tolerance as per specifications.
  - ② Make sure that the discharge needle unit is mounted correctly on the main unit. Check the tip of the discharge needle for a chip or contamination. If the discharge needle is chipped or dirty, clean it or replace it with a new needle.
  - ③ Check that no foreign materials are inside the nozzle, that the nozzle is mounted correctly and that the ionizer is set up correctly.
  - ④ Make sure that the ground terminal is connected completely.
- To reset the ionizer after an error signal has been output, input a reset signal.

### Procedure for cleaning

- ① Check that the power supply and the air supply are both turned off.
- ② Remove the discharge needle from the rear of the main unit.
- ③ Remove the dirt on and around the discharge needle with a cotton swab soaked in alcohol.
- ④ Check the discharge needle once more to make sure it is free from foreign particles such as thread scraps.
- ⑤ After cleaning the discharge needle, mount it.

### Replacing the discharge needle

- ① Check that the power supply and the air supply are both turned off.
- ② Remove the discharge needle from the rear of the main unit.
- ③ After checking that there is no contamination on or around the new discharge needle, mount the nozzle.

### Wiring

- Make sure that the power supply is off while wiring. Otherwise, there is a danger of electric shock.
- After wiring, reconfirm the wiring connections before switching on the power supply.
- Note, wrong wiring will damage the product.
- Verify that the supply voltage variation is within the rating.
- Do not run the wires together with high-voltage lines or power lines or put them in the same raceway. This can cause malfunction due to induction.

### Others

- Make sure to use the DC power supply insulated by an isolation transformer, etc. for this product.
- If an auto-transformer, etc. (single winding transformer) is used, this product or the power supply may be damaged due to short-circuit.

- Do not use this product beyond its rated specifications. Doing so can cause product breakdown, non-function, or damage. Furthermore, it will also cause a marked reduction in product life.
- Never disassemble, repair, modify, or misuse this product, as this can cause an accident or malfunction.
- Do not throw this product into fire: it may explode or generate poisonous gas.
- Since high voltage is applied to the discharge needle, keep your fingers, body, metal, e.g. wires or tools, etc., away from the needle. If you fail to keep away from the needle, electric shock or malfunction may be the result.
- This product is not explosion-proof. Do not use it in places where combustible or flammable material is present. There is a danger of catching fire.
- Since this product emits ozone into the atmosphere, circulate air to prevent foul smells. If ozone lingers for long periods, metals, etc. may oxidize / decay. Furthermore, do not try to confirm that foul smells are caused by the ozone by drawing your face near the nozzle outlet and air outlet: you may hurt your nose, throat, etc.
- Do not use this product in steamy or dusty places, in places where water and oil splash, or where spatter flies when welding.
- If the power supply is switched on immediately after being switched off, fault output may be generated. After the power supply is switched off, wait at least 1 sec. before switching it on again.
- Confirm the wiring and piping state before supplying power or air. Wrong wiring and piping may cause malfunction.
- Do not use this product for any purpose other than charge removal.
- When this product is no longer usable or required, dispose of properly as industrial waste.
- If the air supplied to this product is turned ON / OFF by a solenoid valve, for example, make sure to turn the discharge halt input ON / OFF simultaneously.
- Use air (dry, clean air) for the fluid. Any fluid other than air (dry, clean air) or even air containing corrosive gas may cause an accident or malfunction.
- Do not use air that contains foreign particles, e.g. carbon dust, dust, water or oil. Since these substances may cause electric shock or malfunction, take appropriate countermeasures, e.g. install an airfilter, air-drier, etc.

**DIMENSIONS (Unit: mm in)**

The CAD data in the dimensions can be downloaded from the SUNX website: <http://www.sunx.co.jp/>

**ER-VS01 Ionizer main unit**

**Mounting drawing with shower nozzle (ER-VAS, Optional)**

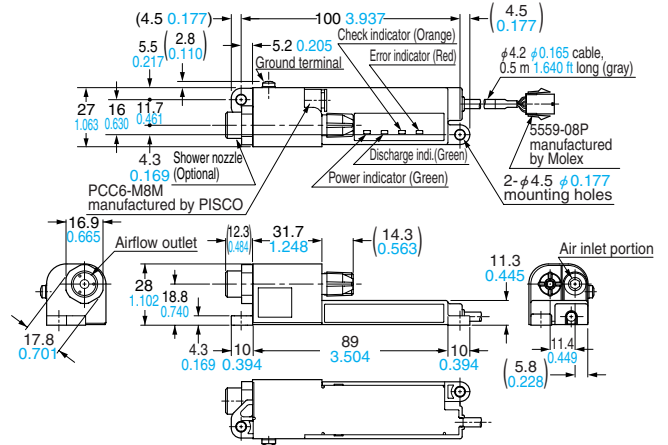
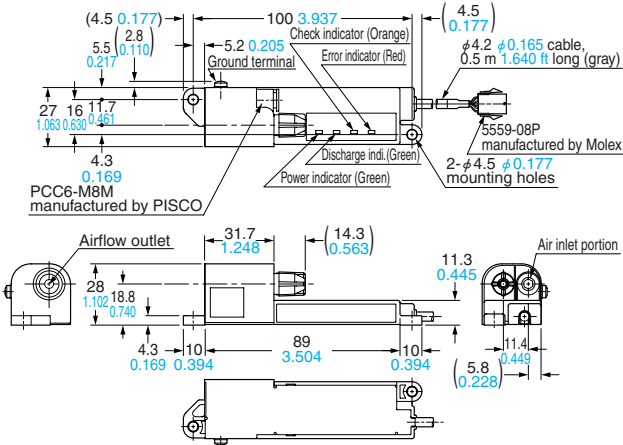

**Mounting drawing with straight bar nozzle (ER-VAB□, Optional)**

**Mounting drawing with shape-preserving tube and joint nozzle (ER-VAK□, ER-VAJK, Optional)**

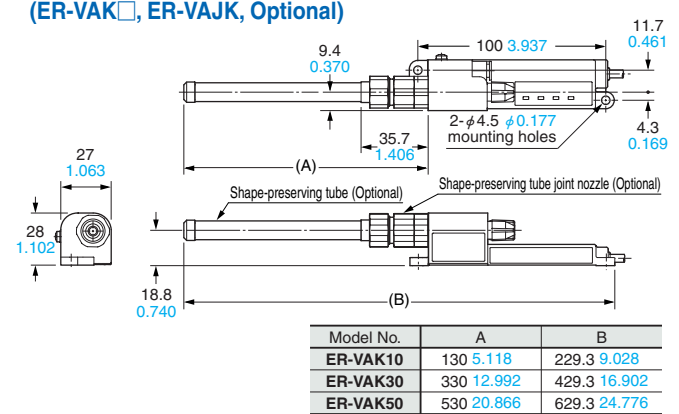
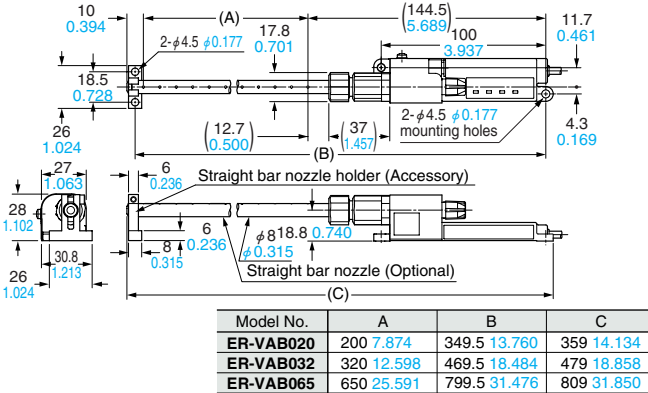

**Mounting drawing with conductive tube joint nozzle (ER-VAJT-64, Optional)**

**ER-ATH Conductive tube holder (Optional)**

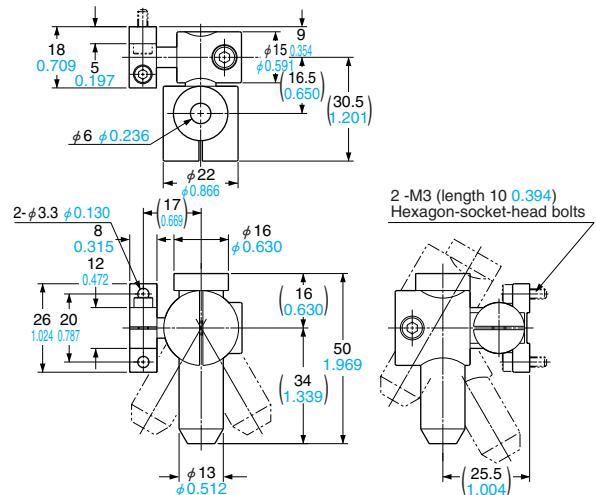
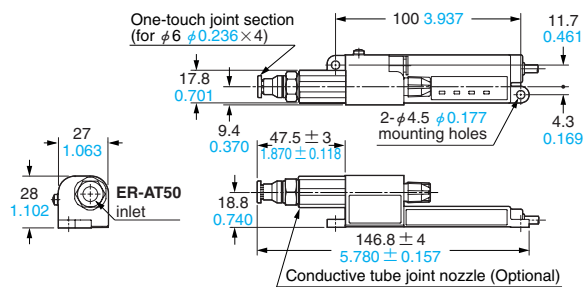

**ER-VAJK Shape-preserving tube joint nozzle (Optional)**

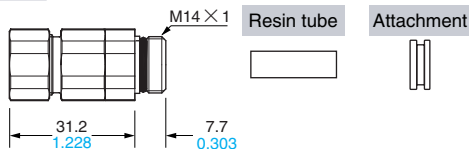

**ER-VAJT-64 Conductive tube joint nozzle (Optional)**

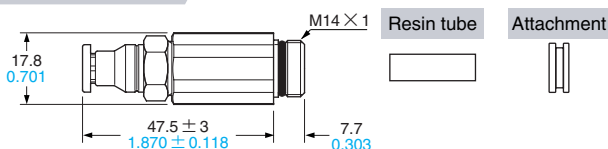

## DIMENSIONS (Unit: mm in)

### ER-VAK□ Shape-preserving tube (Optional)

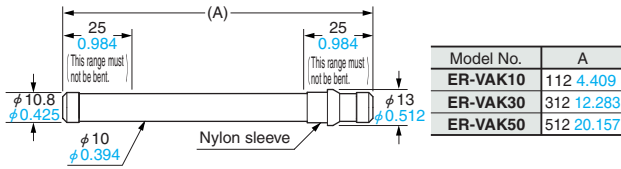

### ER-AT50 Conductive tube (Optional)

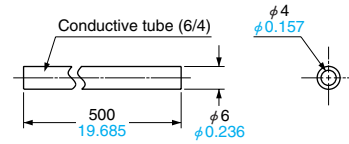

### ER-AF10 Mini line filter (Optional)

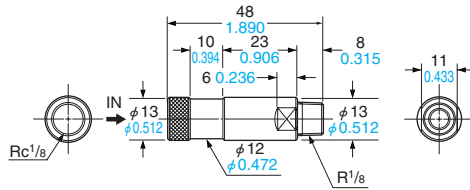

### ER-AF20 Mini line filter (Optional)

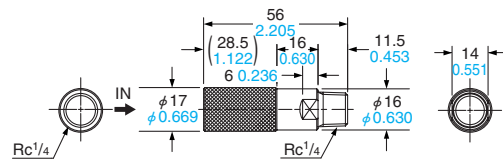

All information is subject to change without prior notice.



<http://www.sunx.co.jp/>

#### SUNX Limited

2431-1 Ushiyama-cho, Kasugai-shi, Aichi,  
486-0901, Japan  
Phone: +81-(0)568-33-7211  
FAX: +81-(0)568-33-2631

#### Overseas Sales Dept.

Phone: +81-(0)568-33-7861  
FAX: +81-(0)568-33-8591