

# US-N300

## Thru-beam Type Ultrasonic Sensor



Suitable for Detecting  
Transparent Films or  
Transparent Bottles

### Reliable Detection of Transparent Objects

The sensor reliably detects transparent films or transparent objects.



### Only 16mm thick

Its 16mm thick compact body allows mounting in a narrow space.

### Simple Operation Mode Selection

The operation mode can be selected either sound-received-ON or sound-blocked-ON simply by changing the connection of the control input wire.

## APPLICATIONS

Detecting transparent film or transparent glass

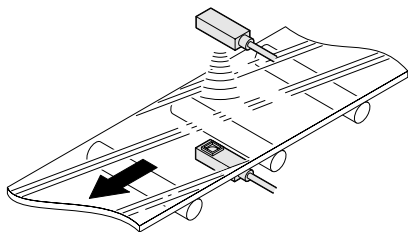

Detecting transparent bottles

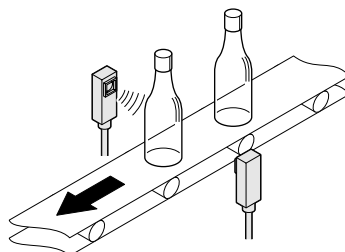

Detecting transparent and opaque objects

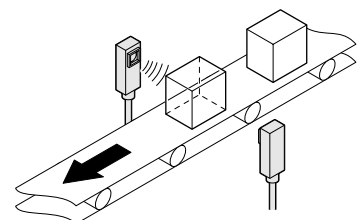

## ORDER GUIDE

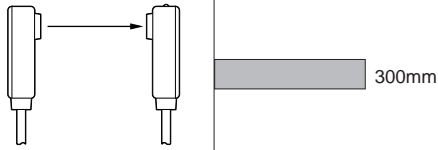
Type	Appearance	Sensing range	Model No.
Thru-beam		300mm	<b>US-N300</b>

## SPECIFICATIONS

Item	Type	Thru-beam
	Model No.	<b>US-N300</b>
Sensing range		300mm
Sensing object		Transparent, translucent or opaque object: 20 × 20mm or more, Hole: 10 × 10mm or more
Supply voltage		12 to 24V DC ± 10% Ripple P-P 10% or less
Current consumption		Transmitter: 35mA or less, Receiver: 35mA or less
Output		NPN transistor universal • Maximum sink current: 100mA • Residual voltage: 1V or less (at 100mA sink current)
	Output operation	Selectable either sound-received-ON or sound-blocked-ON by the control input
	Short-circuit protection	Incorporated
Response time		5ms or less
Operation indicator		Red LED (lights up when the output is ON)
Sensitivity adjuster		Continuously variable adjuster
Transmission frequency		220kHz approx.
Environmental resistance	Protection	IP62 (IEC)
	Ambient temperature	0 to + 50°C (No dew condensation), Storage: - 25 to + 70°C
	Ambient humidity	35 to 85% RH, Storage: 35 to 85% RH
	Noise immunity	Power line: 1,000Vp, and 1 μs pulse width; Radiation: 2,000Vp, and 1 μs pulse width (with noise simulator)
	Voltage withstandability	1,500V AC for one min. between all supply terminals connected together and enclosure
	Insulation resistance	20MΩ, or more, with 500V DC megger between all supply terminals connected together and enclosure
	Vibration resistance	10 to 55Hz frequency, 1.5mm amplitude in X, Y and Z directions for two hours each
Shock resistance	100m/s <sup>2</sup> acceleration (10G approx.) in X, Y and Z directions for three times each	
Material		Enclosure: Polycarbonate
Cable		0.2mm <sup>2</sup> 4-core (transmitter: 2-core) cabtyre cable, 2m long
Cable extension		Extension up to total 100m is possible, for both transmitter and receiver, with 0.2mm <sup>2</sup> , or more, cable.
Weight		Transmitter: 80g approx., Receiver: 85g approx.
Accessories		<b>MS-N30</b> (Sensor mounting bracket): 2 sets, Adjusting screwdriver: 1 No.

# US-N300

## I/O CIRCUIT AND WIRING DIAGRAMS

### I/O circuit diagram

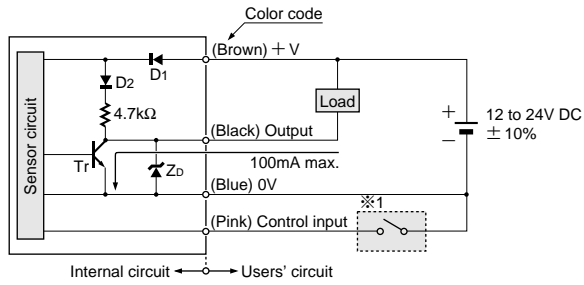

Note: The transmitter has only two power supply wires (+ V and 0V).

Symbols ... D1: Reverse supply polarity protection diode  
D2: Reverse current protection diode  
ZD: Surge absorption zener diode  
Tr : NPN output transistor

### Wiring diagram

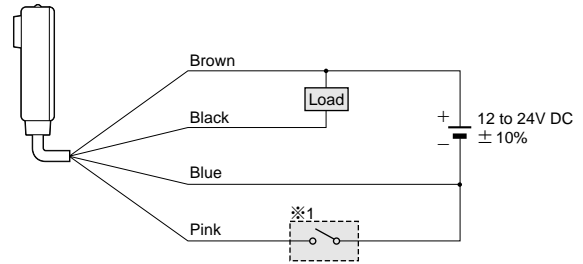

※1

Non-voltage contact, NPN open-collector transistor or NPN non-contact transistor

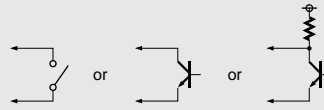

Low (- 0.5 to + 1.5V, or connected to 0V): sound-received-ON  
High (6V to supply voltage, or open): sound-blocked-ON

## SENSING CHARACTERISTICS (TYPICAL)

### Parallel deviation

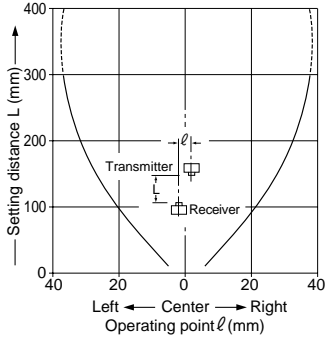

### Angular deviation

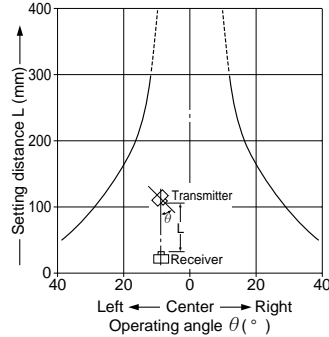

### Sensing field

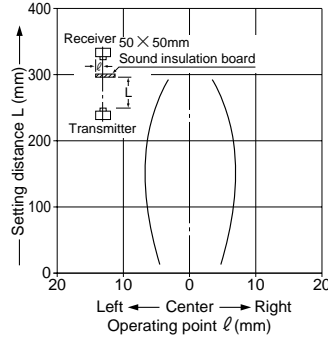

# US-N300

ULTRASONIC SENSOR  
Thru-beam Type  
US-N300

## PRECAUTIONS FOR PROPER USE

 This product is not a safety sensor. Its use is not intended or designed to protect life and prevent body injury or property damage from dangerous parts of machinery. It is a normal object detection sensor.

### Mounting

- The tightening torque should be 0.49N·m or less.

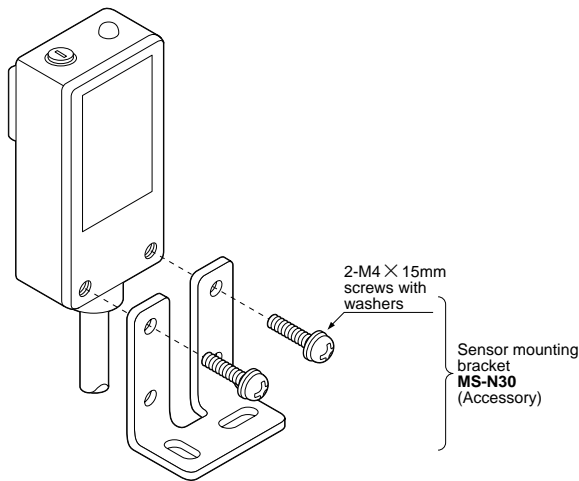

### Sensitivity adjustment

- Normally, use the sensor at the maximum sensitivity. However, if the sensing is not proper due to surrounding objects (reflection from surrounding objects, etc.), adjust the sensitivity as follows.

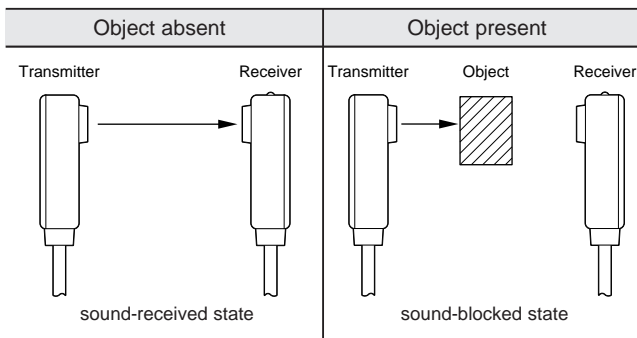

- Set the adjuster to Min. Then, without any sensing object, turn the adjuster gradually clockwise, while seeing the operation indicator, to determine the point where the sensor enters the 'sound-received state'.
- With a sensing object between the sensor heads, turn the adjuster further clockwise until the sensor enters the 'sound-received state' again. Then, turn the adjuster back a little to determine the point where the sensor just enters the 'sound-blocked state'.
- Set the adjuster at the center of the two points described in ① and ②, which is the optimum sensitivity position.

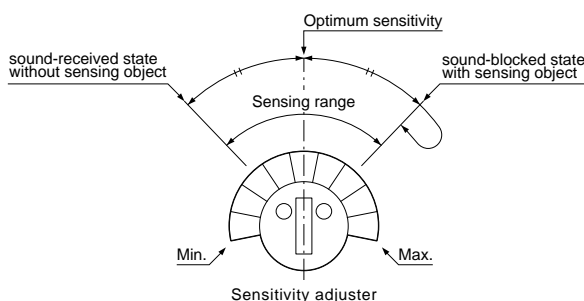

### Influence of surrounding objects

#### Influence of an object parallel to the sensing axis

- If there is a wall or a curtain near the sensing axis, the sound reflection may cause the operation to be unstable.

#### <Countermeasure>

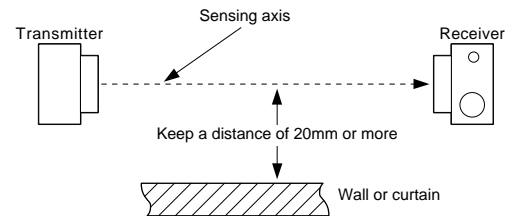

#### Influence of background objects

- If sensor heads are installed as shown in the figure below, the operation may become unstable by the reflected sound wave.

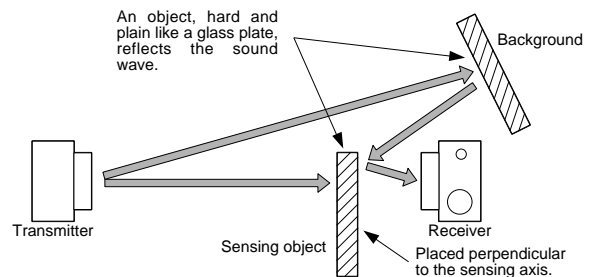

#### <Countermeasure>

The receiver should be placed away from the object and at an angle to it as shown below.

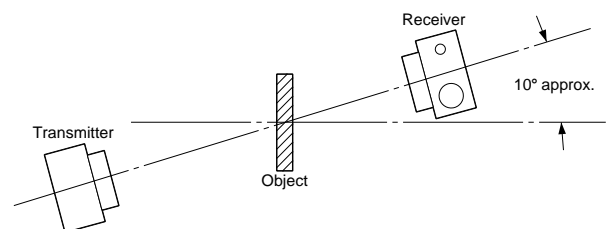

### Mutual interference

- When two or more sensors are mounted closely, the sensors may not enter the 'sound-blocked state' due to mutual interference.

#### <Countermeasure>

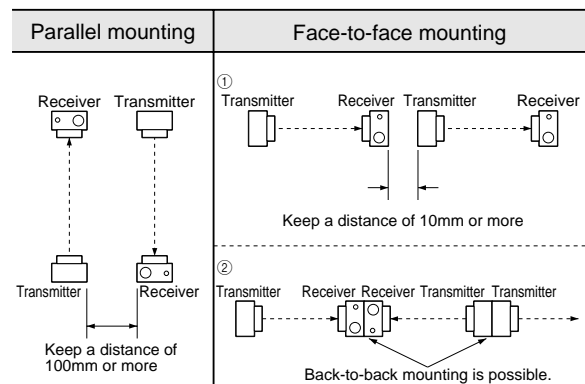

# US-N300

## PRECAUTIONS FOR PROPER USE

### Traveling speed and minimum sensing object width

- Minimum sensing object width is 20×20mm in the stationary condition.

The minimum sensing width of a traveling object is related to the traveling speed and the sensor response time by the following formula.

$$W = VT + A$$

W: Minimum sensing object width (m)  
 V: Traveling speed of the object (m/sec.)  
 T: Sensor response time = 0.005 (sec.)  
 A: Minimum sensing object width in the stationary condition = 0.02 (m)

Example: If V = 10m/sec.  
 $W = 10 \times 0.005 + 0.02 = 0.07\text{m}$   
 = 70mm

### Wiring

- Make sure to carry out the wiring in the power supply off condition.
- Verify that the supply voltage variation is within the rating.
- If power is supplied from a commercial switching regulator, ensure that the frame ground (F.G.) terminal of the power supply is connected to an actual ground.

- In case noise generating equipment (switching regulator, inverter motor, etc.) is used in the vicinity of this product, connect the frame ground (F.G.) terminal of the equipment to an actual ground.

- Do not run the wires together with high-voltage lines or power lines or put them in the same raceway. This can cause malfunction due to induction.

### Others

- Do not use during the initial transient time (50ms) after the power supply is switched on.
- The ultrasonic sound propagates through the air. If the sensor is used at a place where air blows or the temperature suddenly changes (near a door, an air conditioner, etc.) the operation may become unstable. Avoid using **US-N300** at such places.
- Take care that the sensor may malfunction due to an intense extraneous sound, such as, metal impact sound.
- Do not expose the transmitting element or the receiving element to moisture or dust. It may affect the sensing operation.

## DIMENSIONS (Unit: mm)

### US-N300 Sensor

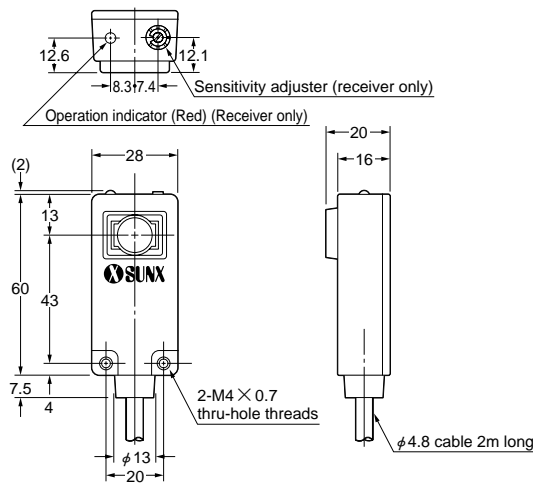

### MS-N30 Sensor mounting bracket (Accessory)

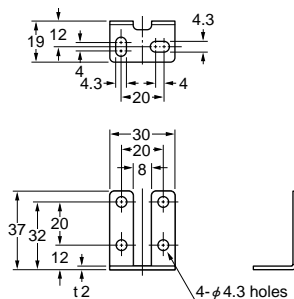

Material: Cold rolled carbon steel (SPCC)  
 Two M4 (length 15mm) screws with washers are attached.

### Assembly dimensions

Mounting drawing with the receiver

