

GL SERIES

- FIBER SENSORS
- LASER SENSORS
- PHOTOELECTRIC SENSORS
- MICRO PHOTOELECTRIC SENSORS
- AREA SENSORS
- LIGHT CURTAINS
- PRESSURE / FLOW SENSORS
- INDUCTIVE PROXIMITY SENSORS**
- PARTICULAR USE SENSORS
- SENSOR OPTIONS
- SIMPLE WIRE-SAVING UNITS
- WIRE-SAVING SYSTEMS
- MEASUREMENT SENSORS
- STATIC CONTROL DEVICES
- ENDOSCOPE
- LASER MARKERS
- PLC / TERMINALS
- HUMAN MACHINE INTERFACES
- ENERGY CONSUMPTION VISUALIZATION COMPONENTS
- FA COMPONENTS
- MACHINE VISION SYSTEMS
- UV CURING SYSTEMS
- Selection Guide
- Amplifier Built-in
- Amplifier-separated
- GX-F/H
- GXL
- GL**
- GX-U/GX-FU/GX-N
- GX

- Related Information
- General terms and conditions..... F-17
 - Sensor selection guide P.757~
 - Glossary of terms..... P.1386~
 - General precautions P.1405

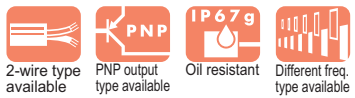
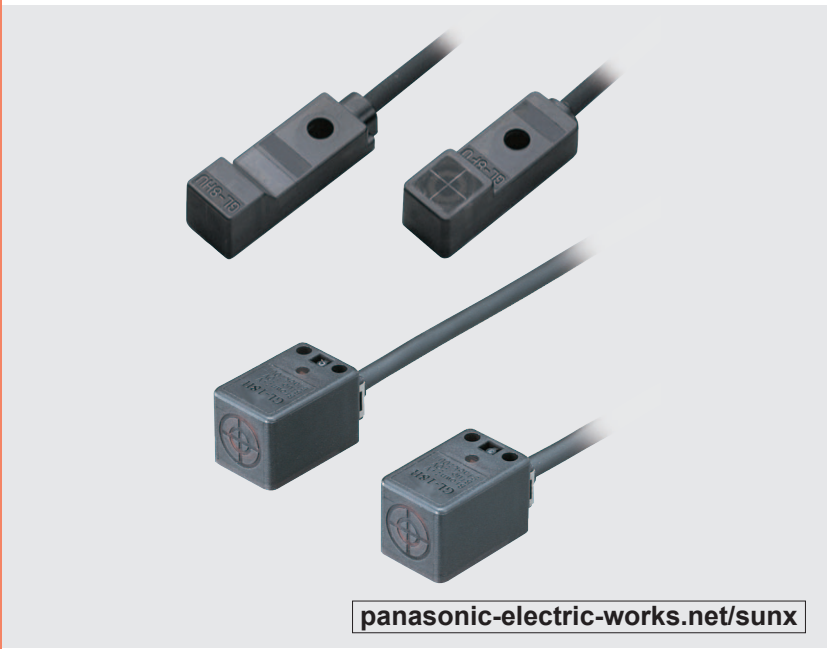

Wide variety, high performance in surprisingly small body at low cost

VARIETIES

Wide variation

A wide variety of 46 models, front sensing type / top sensing type, normally open type / normally closed type, as well as, different frequency type, etc., is available.

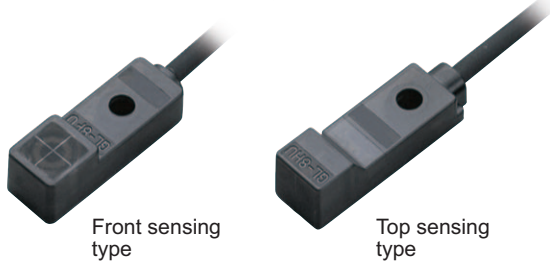

Close mounting

Two sensors can be mounted close together because different frequency type are available.

(The **GL-18HL** type can be mounted with a space of 20 mm **0.787 in** between the two sensors.)

Energy-efficient and wire-saving **DC 2-wire type**

Its electric current consumption is just 0.8 mA or less and the wiring workload is reduced by about 30 %.

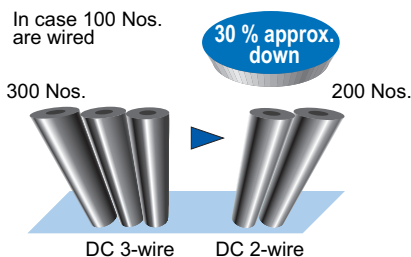

BASIC PERFORMANCE

Long sensing range

GL-18HL type offers a long sensing range of 12 mm **0.472 in**.

Small variations in the positions of the sensing objects do not affect detection.

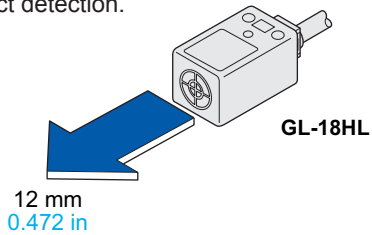

ENVIRONMENTAL RESISTANCE

Protection structure IP67g (JEM)

GL-18H/18HL type are resistant to oil and have a protection structure IP67g (JEM). (**GL-8U** type: IP67)

FUNCTIONS

Operation indicator

The **GL** series incorporates an operation indicator (orange, **GL-18H/18HL** type: red) for operation check.

OTHERS

Low price

The **GL** series satisfies the need for a low price inductive proximity sensor. It is recommended to large volume users for cost reduction.

The **GL-8U** type are available in units of ten.

APPLICATIONS

Detecting table over-run

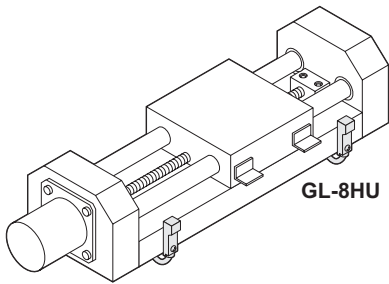

Detecting cam position

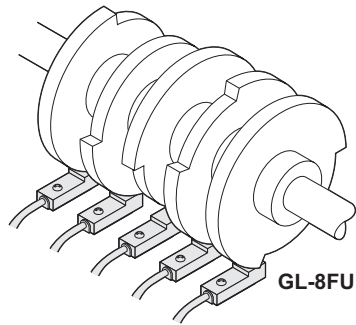

Positioning metal pallet

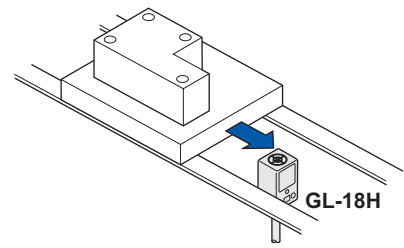

Detecting aluminum lid

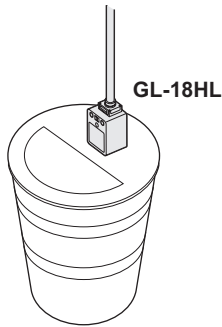

FIBER SENSORS
LASER SENSORS
PHOTO-ELECTRIC SENSORS
MICRO PHOTO-ELECTRIC SENSORS
AREA SENSORS
LIGHT CURTAINS
PRESSURE / FLOW SENSORS
INDUCTIVE PROXIMITY SENSORS
PARTICULAR USE SENSORS
SENSOR OPTIONS
SIMPLE WIRE-SAVING UNITS
WIRE-SAVING SYSTEMS
MEASURE-MENT SENSORS
STATIC CONTROL DEVICES
ENDOSCOPE

ORDER GUIDE

GL-8U type

Type	Appearance (mm in)	Sensing range (Note 1)	Model No. (Note 2)	Output	Output operation
DC 2-wire			GL-8FU×10	Non-contact DC 2-wire type	Normally open
			GL-8FU×10		Normally closed
			GL-8FUB×10		Normally open
			GL-8HU×10		Normally open
			GL-8HU×10		Normally closed
			GL-8HUB×10		Normally open
			GL-8HUIB×10	Normally closed	

Notes: 1) The maximum operation distance stands for the maximum distance for which the sensor can detect the standard sensing object. The stable sensing range stands for the sensing range for which the sensor can stably detect the standard sensing object even if there is an ambient temperature drift and/or supply voltage fluctuation.
2) "I" in the model No. indicates a different frequency type.

NOTE: GL-8U type is available in units of ten.

GL-18H/18HL type

Type	Appearance (mm in)	Sensing range (Note)	Model No.	Output	Output operation	
Standard Different frequency			GL-18H	NPN open-collector transistor	Normally open	
			GL-18HI			Normally closed
			GL-18HB			
Long sensing range Different frequency			GL-18HL		Normally open	
			GL-18HLI		Normally closed	
			GL-18HLB			

Note: The maximum operation distance stands for the maximum distance for which the sensor can detect the standard sensing object. The stable sensing range stands for the sensing range for which the sensor can stably detect the standard sensing object even if there is an ambient temperature drift and/or supply voltage fluctuation.

Accessory

• **MS-GL18HL**
(Sensor mounting bracket for GL-18HL type)

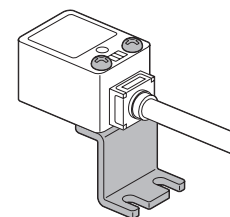

Two M3 (length 25 mm 0.948 in) pan head screws are attached.

LASER MARKERS
PLC / TERMINALS
HUMAN MACHINE INTERFACES
ENERGY CONSUMPTION VISUALIZATION COMPONENTS
FA COMPONENTS
MACHINE VISION SYSTEMS
UV CURING SYSTEMS

Selection Guide
Amplifier Built-in
Amplifier-separated

GX-F/H
GX
GL
GX-UGX-FU/
GX-N
GX

FIBER SENSORS
LASER SENSORS
PHOTO-ELECTRIC SENSORS
MICRO PHOTO-ELECTRIC SENSORS
AREA SENSORS
LIGHT CURTAINS
PRESSURE / FLOW SENSORS
INDUCTIVE PROXIMITY SENSORS
PARTICULAR USE SENSORS
SENSOR OPTIONS
SIMPLE WIRE-SAVING UNITS
WIRE-SAVING SYSTEMS
MEASUREMENT SENSORS
STATIC CONTROL DEVICES
ENDOSCOPE
LASER MARKERS
PLC / TERMINALS
HUMAN MACHINE INTERFACES
ENERGY CONSUMPTION VISUALIZATION COMPONENTS
FA COMPONENTS
MACHINE VISION SYSTEMS
UV CURING SYSTEMS
Selection Guide
Amplifier Built-in
Amplifier-separated
GX-F/H
GXL
GL
GX-J/GX-F/H/GX-N
GX

ORDER GUIDE

5 m 16.404 ft cable length type

5 m 16.404 ft cable length type (standard: 1m 3.281 ft) is also available for **GL-8U** type (different frequency of normally open type: excluding the type with the model No. having the suffix "IB").
When ordering this type, suffix "-C5" to the model No.
(e.g.) 5 m 16.404 ft cable length type of **GL-8FUB×10** is "**GL-8FUB-C5×10**".

NOTE: GL-8U type are available in units of ten.

OPTIONS

Designation	Model No.	Description
Sensor mounting bracket	MS-GL8×10	Sensor mounting bracket for GL-8U type.

NOTE: Sensor mounting bracket (MS-GL8×10) is available in units of ten.

Sensor mounting bracket • MS-GL8×10

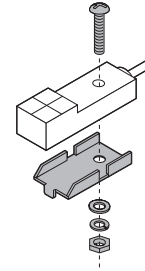

1 pc. each of M3 (length 12 mm 0.472 in) truss head screw, nut, spring washer and plain washer is attached.

SPECIFICATIONS

GL-8U type

Item	Model No.	Type	DC 2-wire type			
			Front sensing		Top sensing	
			GL-8FU×10	GL-8FUB×10	GL-8HU×10	GL-8HUB×10
		Different frequency	GL-8FUI×10	GL-8FUIB×10	GL-8HUI×10	GL-8HUIB×10
Max. operation distance (Note 2)		2.5 mm 0.098 in ±20 %				
Stable sensing range (Note 2)		0 to 1.8 mm 0 to 0.071 in				
Standard sensing object		Iron sheet 15 × 15 × t 1 mm 0.591 × 0.591 × t 0.039 in				
Hysteresis		20 % or less of operation distance (with standard sensing object)				
Supply voltage		12 to 24 V DC ±10 % Ripple P-P 10 % or less				
Current consumption		0.8 mA or less (Note 3)				
Output		Non-contact DC 2-wire type • Load current: 3 to 70 mA (Note 5) • Residual voltage: 3 V or less (Note 6)				
Utilization category		DC-12 or DC-13				
Output operation		Normally open	Normally closed	Normally open	Normally closed	
Short-circuit protection		Incorporated				
Max. response frequency		1kHz				
Operation indicator		Orange LED (lights up when the output is ON)				
Pollution degree		3 (Industrial environment)				
Protection		IP67 (IEC)				
Ambient temperature		-25 to +70 °C -13 to +158 °F , Storage: -30 to +80 °C -22 to +176 °F				
Ambient humidity		35 to 95 % RH, Storage: 35 to 95 % RH				
EMC		EN 60947-5-2				
Voltage withstandability		1,000 V AC for one min. between all supply terminals connected together and enclosure				
Insulation resistance		50 MΩ, or more, with 250 V DC megger between all supply terminals connected together and enclosure				
Vibration resistance		10 to 55 Hz frequency, 1.5 mm 0.059 in amplitude in X, Y and Z directions for two hours each				
Shock resistance		1,000 m/s ² acceleration (100 G approx.) in X, Y and Z directions for three times each				
Sensing range variation	Temperature characteristics	Over ambient temperature range -25 to +70 °C -13 to +158 °F : within ⁺¹⁰ / ₋₁₅ % of sensing range at +20 °C +68 °F				
	Voltage characteristics	Within ±2 % for ±10 % fluctuation of the supply voltage				
Material		Enclosure: Polyallylate				
Cable		0.15 mm ² 2-core cabtyre cable, 1 m 3.281 ft long				
Cable extension		Extension up to total 50 m 164.042 ft is possible with 0.3 mm ² , or more, cable.				
Weight		Net weight : 12 g approx.				

- Notes: 1) Where measurement conditions have not been specified precisely, the conditions used were an ambient temperature of +23 °C **+73.4 °F**.
 2) The maximum operation distance stands for the maximum distance for which the sensor can detect the standard sensing object.
 The stable sensing range stands for the sensing range for which the sensor can stably detect the standard sensing object even if there is an ambient temperature drift and/or supply voltage fluctuation.
 3) It is the leakage current when the output is in the OFF state.
 4) When the ambient temperature is +60 to +70 °C **+140 to +158 °F**, the maximum sink current varies depending on the ambient humidity. Refer to "I/O CIRCUIT AND WIRING DIAGRAMS" for more details.
 5) The maximum load current varies depending on the ambient temperature. Refer to "I/O CIRCUIT AND WIRING DIAGRAMS" for more details.
 6) When the cable is extended, the residual voltage becomes larger according to the resistance of the cable.

SPECIFICATIONS**GL-18H/18HL type**

Item	Type Model No.	Standard			Long sensing range		
		Different frequency			Different frequency		
		GL-18H	GL-18HI	GL-18HB	GL-18HL	GL-18HLI	GL-18HLB
Max. operation distance (Note 2)		5 mm 0.197 in ±10 %			12 mm 0.472 in ±10 %		
Stable sensing range (Note 2)		0 to 4 mm 0 to 0.157 in			0 to 10 mm 0 to 0.394 in		
Standard sensing object		Iron sheet 25 × 25 × t 1 mm 0.984 × 0.984 × t 0.039 in			Iron sheet 40 × 40 × t 1 mm 1.575 × 1.575 × t 0.039 in		
Hysteresis		15 % or less of operation distance (with standard sensing object)					
Supply voltage		10 to 30 V DC Ripple P-P 10 % or less					
Current consumption		10 mA or less					
Output		NPN open-collector transistor • Maximum sink current: 100 mA • Applied voltage: 30 V DC or less (between output and 0 V) • Residual voltage: 1.5 V or less (at 100 mA sink current) 0.4 V or less (at 16 mA sink current)					
	Utilization category	DC-12 or DC-13					
	Output operation	Normally open		Normally closed		Normally open	Normally closed
Max. response frequency		1kHz			500Hz		
Operation indicator		Red LED (lights up when the output is ON)					
Environmental resistance	Pollution degree	3 (Industrial environment)					
	Protection	IP67 (IEC), IP67g (JEM)					
	Ambient temperature	-25 to +70 °C -13 to +158 °F , Storage: -25 to +70 °C -13 to +158 °F					
	Ambient humidity	45 to 85 % RH, Storage: 45 to 85 % RH					
	EMC	EN 60947-5-2					
	Voltage withstandability	1,000 V AC for one min. between all supply terminals connected together and enclosure					
	Insulation resistance	50 MΩ, or more, with 250 V DC megger between all supply terminals connected together and enclosure					
	Vibration resistance	10 to 55 Hz frequency, 1.5 mm 0.059 in amplitude in X, Y and Z directions for two hours each					
Shock resistance	1,000 m/s ² acceleration (100 G approx.) in X, Y and Z directions for three times each						
Sensing range variation	Temperature characteristics	Over ambient temperature range -25 to +70 °C -13 to +158 °F : within ±10 % of sensing range at +20 °C +68 °F					
	Voltage characteristics	Within ±2 % for ±10 % fluctuation of the supply voltage					
Material		Enclosure: Polyallylate					
Cable		0.3 mm ² 3-core oil resistant cabtyre cable, 1 m 3.281 ft long					
Cable extension		Extension up to total 100 m 328.084 ft is possible with 0.3 mm ² , or more, cable.					
Weight		Net weight : 45 g approx.					
Accessory		MS-GL18HL (Sensor mounting bracket): 1 set					

Notes: 1) Where measurement conditions have not been specified precisely, the conditions used were an ambient temperature of +23 °C **+73.4 °F**.

2) The maximum operation distance stands for the maximum distance for which the sensor can detect the standard sensing object.
The stable sensing range stands for the sensing range for which the sensor can stably detect the standard sensing object even if there is an ambient temperature drift and/or supply voltage fluctuation.

FIBER
SENSORSLASER
SENSORSPHOTO-
ELECTRIC
SENSORSMICRO
PHOTO-
ELECTRIC
SENSORSAREA
SENSORSLIGHT
CURTAINSPRESSURE /
FLOW
SENSORSINDUCTIVE
PROXIMITY
SENSORSPARTICULAR
USE
SENSORSSENSOR
OPTIONSSIMPLE
WIRE-SAVING
UNITSWIRE-SAVING
SYSTEMSMEASURE-
MENT
SENSORSSTATIC
CONTROL
DEVICES

ENDOSCOPE

LASER
MARKERSPLC /
TERMINALSHUMAN
MACHINE
INTERFACESENERGY
CONSUMPTION
VISUALIZATION
COMPONENTSFA
COMPONENTSMACHINE
VISION
SYSTEMSUV
CURING
SYSTEMSSelection
GuideAmplifier
Built-inAmplifier-
separated**GX-F/H****GXL****GL**GX-U/GX-FU/
GX-N**GX**

- FIBER SENSORS
- LASER SENSORS
- PHOTO-ELECTRIC SENSORS
- MICRO PHOTO-ELECTRIC SENSORS
- AREA SENSORS
- LIGHT CURTAINS
- PRESSURE / FLOW SENSORS
- INDUCTIVE PROXIMITY SENSORS
- PARTICULAR USE SENSORS
- SENSOR OPTIONS
- SIMPLE WIRE-SAVING UNITS
- WIRE-SAVING SYSTEMS
- MEASUREMENT SENSORS
- STATIC CONTROL DEVICES
- ENDOSCOPE
- LASER MARKERS
- PLC / TERMINALS
- HUMAN MACHINE INTERFACES
- ENERGY CONSUMPTION VISUALIZATION COMPONENTS
- FA COMPONENTS
- MACHINE VISION SYSTEMS
- UV CURING SYSTEMS
- Selection Guide
- Amplifier Built-in
- Amplifier-separated
- GX-F/H
- GXL
- GL
- GX-U/GX-FU/GX-N
- GX

I/O CIRCUIT AND WIRING DIAGRAMS

DC 2-wire type

GL-8U type

I/O circuit diagram

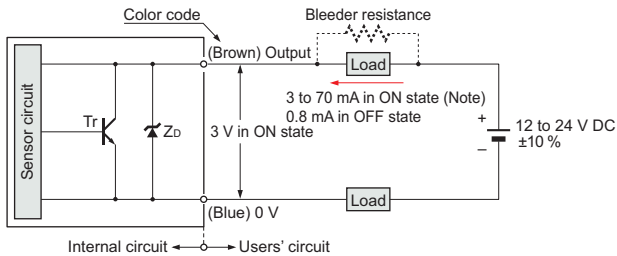

Note: The maximum load current varies depending on the ambient temperature.

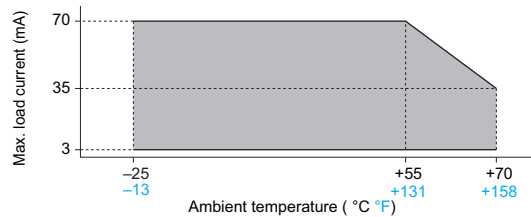

Symbols ... ZD: Surge absorption zener diode
Tr: NPN output transistor

Wiring diagram

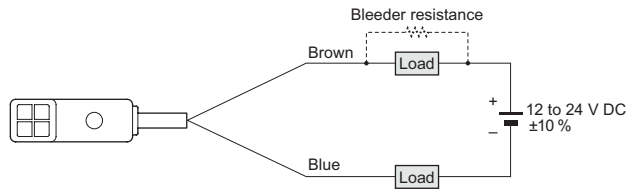

Conditions for the load

- 1) The load should not be actuated by the leakage current (0.8 mA) in the OFF state.
- 2) The load should be actuated by (supply voltage - 3 V) in the ON state.
- 3) The current in the ON state should be between 3 to 70 mA DC.
[In case the current is less than 3 mA, connect a bleeder resistance in parallel to the load so that a current of 3 mA, or more, flows.]

NPN output type

GL-18H/18HL type

I/O circuit diagram

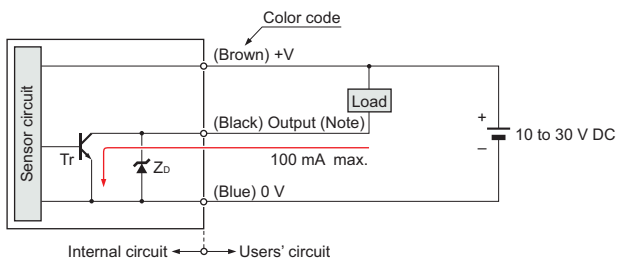

Note: Please carry out the wiring carefully since protection circuit against reverse power supply connection is not incorporated. Further, the output does not incorporate a short-circuit protection circuit. Do not connect it directly to a power supply or a capacitive load.

Symbols ... ZD: Surge absorption zener diode
Tr: NPN output transistor

Wiring diagram

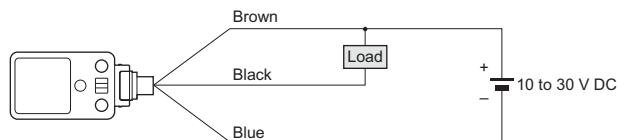

SENSING CHARACTERISTICS (TYPICAL)

GL-8U type

Sensing field

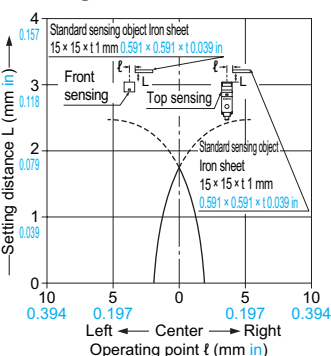

Correlation between sensing object size and sensing range

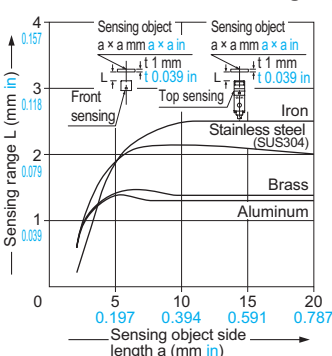

As the sensing object size becomes smaller than the standard size (iron sheet 15 × 15 × 1 mm 0.591 × 0.591 × 0.039 in), the sensing range shortens as shown in the left figure.

SENSING CHARACTERISTICS (TYPICAL)

GL-18H type

Sensing field

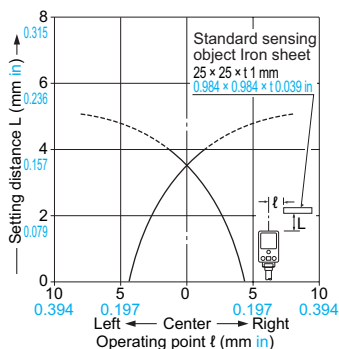

Correlation between sensing object size and sensing range

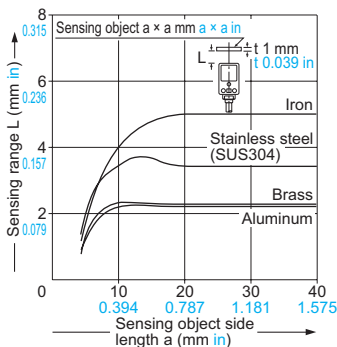

As the sensing object size becomes smaller than the standard size (iron sheet 25 × 25 × t 1 mm 0.984 × 0.984 × t 0.039 in), the sensing range shortens as shown in the left figure.

GL-18HL type

Sensing field

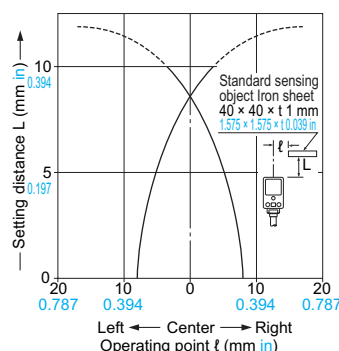

Correlation between sensing object size and sensing range

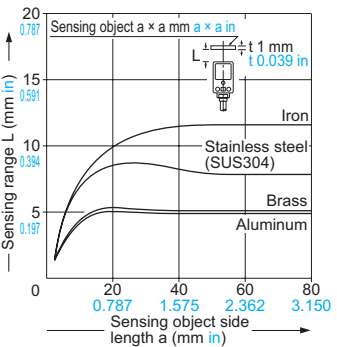

As the sensing object size becomes smaller than the standard size (iron sheet 40 × 40 × t 1 mm 1.575 × 1.575 × t 0.039 in), the sensing range shortens as shown in the left figure.

PRECAUTIONS FOR PROPER USE

Refer to General precautions.



- Never use this product as a sensing device for personnel protection.
- In case of using sensing devices for personnel protection, use products which meet laws and standards, such as OSHA, ANSI or IEC etc., for personnel protection applicable in each region or country.

Mounting

GL-8U type

- Make sure to mount with an M3 (length 12 mm 0.472 in or more) truss head screw with a tightening torque of 0.5 N·m or less.

(Do not use a flat head screw or a pan head screw.)

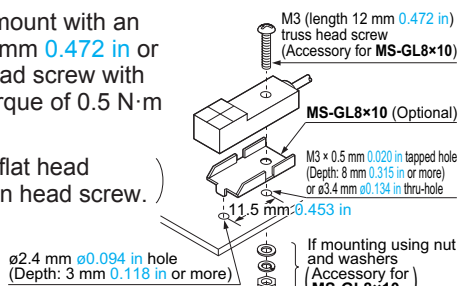

GL-18H/18HL type

- The tightening torque should be 0.5 N·m or less.
- To mount the sensor with a nut, the thru-hole diameter should be $\varnothing 3.4$ mm $\varnothing 0.134$ in.
- Screws, nuts or washers are not supplied. Please arrange them separately.

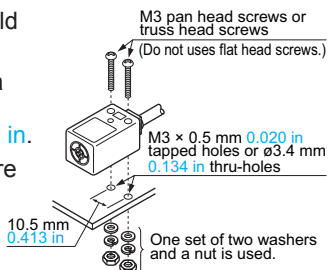

Influence of surrounding metal

- When there is a metal near the sensor, keep the minimum separation distance specified below.

Front sensing type

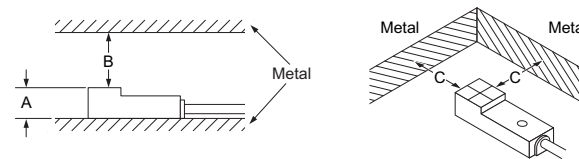

	GL-8FU \square ×10
A	7.4 mm 0.291 in
B	8 mm 0.315 in
C	3 mm 0.118 in

Top sensing type, GL-18H/18HL type

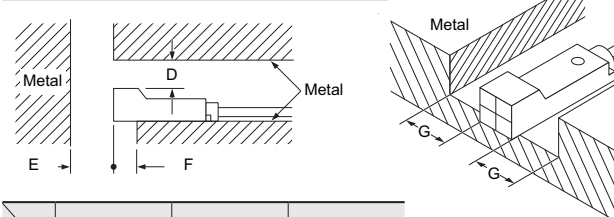

	GL-8HU \square ×10	GL-18H \square	GL-18HL \square
D	3 mm 0.118 in	5 mm 0.197 in	25 mm 0.984 in
E	10 mm 0.394 in	20 mm 0.787 in	60 mm 2.362 in
F	3 mm 0.118 in	0 mm 0 in	20 mm 0.787 in (Note)
G	3 mm 0.118 in	5 mm 0.197 in	30 mm 1.181 in

Note: When mounting the GL-18HL \square to an insulator or using the attached sensor mounting bracket, "F" becomes 0 mm 0 in.

FIBER SENSORS

LASER SENSORS

PHOTO-ELECTRIC SENSORS

MICRO PHOTO-ELECTRIC SENSORS

AREA SENSORS

LIGHT CURTAINS

PRESSURE / FLOW SENSORS

INDUCTIVE PROXIMITY SENSORS

PARTICULAR USE SENSORS

SENSOR OPTIONS

SIMPLE WIRE-SAVING UNITS

WIRE-SAVING SYSTEMS

MEASUREMENT SENSORS

STATIC CONTROL DEVICES

ENDOSCOPE

LASER MARKERS

PLC / TERMINALS

HUMAN MACHINE INTERFACES

ENERGY CONSUMPTION VISUALIZATION COMPONENTS

FA COMPONENTS

MACHINE VISION SYSTEMS

UV CURING SYSTEMS

Selection Guide

Amplifier Built-in

Amplifier-separated

GX-F/H

GXL

GL

GX-U/GX-FU/GX-N

GX

PRECAUTIONS FOR PROPER USE

Refer to General precautions.

Mutual interference prevention

- When two or more sensors are installed in parallel or face to face, keep the minimum separation distance specified below to avoid mutual interference.

Front sensing type

Top sensing type GL-18H/18HL type

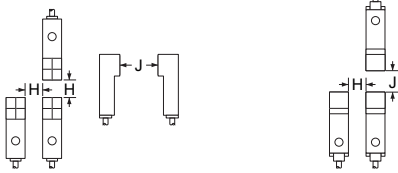

		H	J
GL-8FU □×10	Between "I" type and non "I" type.	0 mm (Note 2) 0 in	15 mm 0.591 in
	Between two "I" types or two non "I" types.	20 mm 0.787 in	40 mm 1.575 in
GL-8HU □×10	Between "I" type and non "I" type.	0 mm (Note 2) 0 in	15 mm 0.591 in
	Between two "I" types or two non "I" types.	25 mm 0.984 in	40 mm 1.575 in
GL-18H type	Between "I" type and non "I" type.	0 mm (Note 2) 0 in	20 mm 0.787 in
	Between two "I" types or two non "I" types.	40 mm 1.575 in	70 mm 2.756 in
GL-18HL type	Between "I" type and non "I" type.	20 mm 0.787 in	40 mm 1.575 in
	Between two "I" types or two non "I" types.	130 mm 5.118 in	200 mm 7.874 in

Notes: 1) "I" in the model No. specifies the different frequency type.

2) Close mounting is possible for up to two sensors. When mounting three sensors or more at an equal spacing, align the model with "I" and the model without "I" alternately.
The minimum value of dimension "H" should be as given below.

GL-8FU□×10: 6 mm **0.236 in**

GL-8HU□×10: 8.5 mm **0.335 in**

GL-18H type: 11 mm **0.433 in**

Sensing range

- The sensing range is specified for the standard sensing object.
With a non-ferrous metal, the sensing range is obtained by multiplying with the correction coefficient specified below.
Further, the sensing range also changes if the sensing object is smaller than the standard sensing object or if the sensing object is plated.

Correction coefficient

	GL-8U type	GL-18H type	GL-18HL type
Iron	1	1	1
Stainless steel (SUS304)	0.80 approx.	0.68 approx.	0.65 approx.
Brass	0.54 approx.	0.45 approx.	0.42 approx.
Aluminum	0.52 approx.	0.43 approx.	0.41 approx.

Wiring

- Please carry out the wiring carefully since protection circuit against reverse power supply connection is not incorporated. (Excluding **GL-8U** type)
- The output does not incorporate a short-circuit protection circuit. Do not connect it directly to a power supply or a capacitive load. (Excluding **GL-8U** type)
- Make sure that the power supply is off while wiring.
- Verify that the supply voltage variation is within the rating.
- If power is supplied from a commercial switching regulator, ensure that the frame ground (F.G.) terminal of the power supply is connected to an actual ground.
- In case noise generating equipment (switching regulator, inverter motor, etc.) is used in the vicinity of this sensor, connect the frame ground (F.G.) terminal of the equipment to an actual ground.
- Do not run the wires together with high-voltage lines or power lines or put them in the same raceway. This can cause malfunction due to induction.

Others

- Do not use during the initial transient time (50ms) after the power supply is switched on.
- Take care that the sensor does not come in direct contact with oil, grease, or organic solvents, such as, thinner, etc.
- Make sure that the sensing end is not covered with metal dust, scrap or spatter. It will result in malfunction.

FIBER SENSORS

LASER SENSORS

PHOTO-ELECTRIC SENSORS
MICRO PHOTO-ELECTRIC SENSORS

AREA SENSORS

LIGHT CURTAINS

PRESSURE / FLOW SENSORS

INDUCTIVE PROXIMITY SENSORS

PARTICULAR USE SENSORS

SENSOR OPTIONS

SIMPLE WIRE-SAVING UNITS

WIRE-SAVING SYSTEMS

MEASUREMENT SENSORS

STATIC CONTROL DEVICES

ENDOSCOPE

LASER MARKERS

PLC / TERMINALS

HUMAN MACHINE INTERFACES

ENERGY CONSUMPTION VISUALIZATION COMPONENTS

FA COMPONENTS

MACHINE VISION SYSTEMS

UV CURING SYSTEMS

Selection Guide

Amplifier Built-in

Amplifier-separated

GX-F/H

GXL

GL

GX-U/GX-FU/
GX-N

GX

DIMENSIONS (Unit: mm in)

The CAD data in the dimensions can be downloaded from our website.

GL-8FU□×10 Sensor

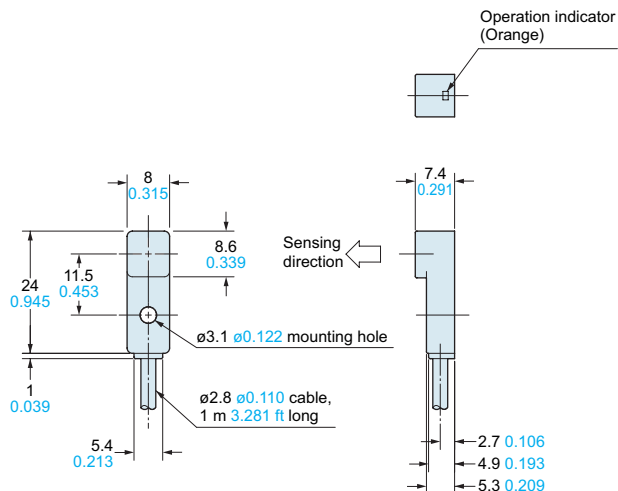

GL-8HU□×10 Sensor

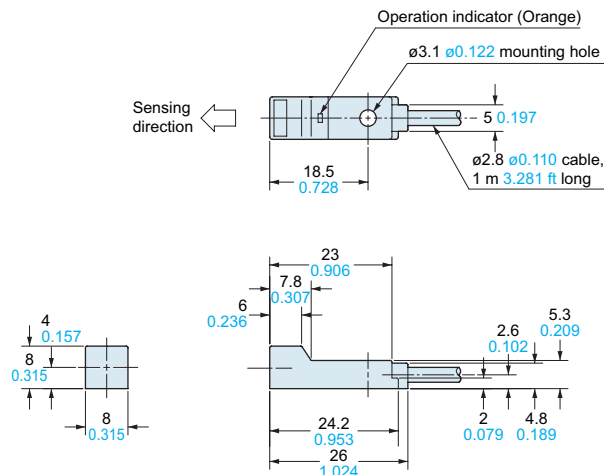

GL-18H□ GL-18HL□ Sensor

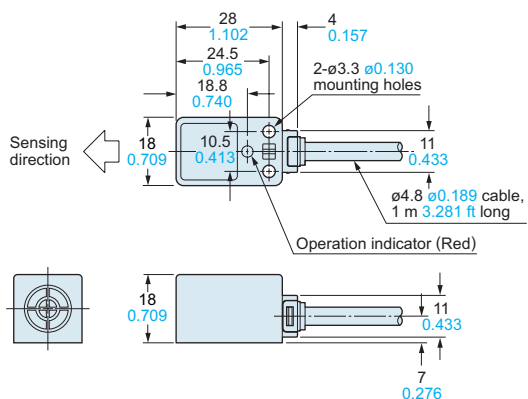

MS-GL8×10 Sensor mounting bracket for GL-8U type (Optional)

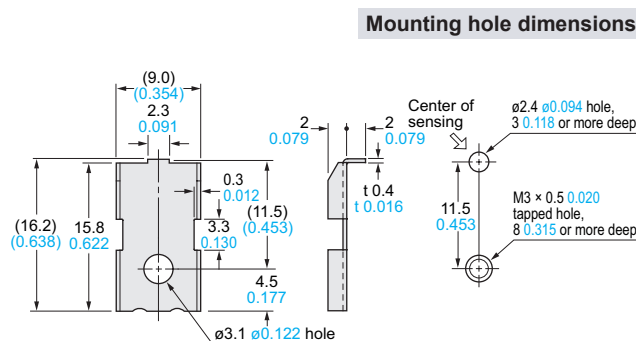

Material: Stainless steel (SUS304)
1 pc. each of M3 (length 12 mm 0.472 in) truss head screw, nut, spring washer and plain washer is attached.

MS-GL18HL Sensor mounting bracket for GL-18HL type (Accessory)

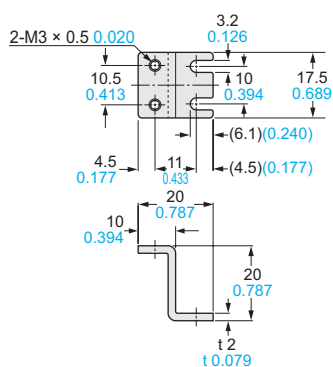

Material: Aluminum
Two M3 (length 25 mm 0.984 in) pan head screws are attached.

FIBER SENSORS
LASER SENSORS
PHOTO-ELECTRIC SENSORS
MICRO PHOTO-ELECTRIC SENSORS
AREA SENSORS
LIGHT CURTAINS
PRESSURE / FLOW SENSORS
INDUCTIVE PROXIMITY SENSORS
PARTICULAR USE SENSORS
SENSOR OPTIONS
SIMPLE WIRE-SAVING UNITS
WIRE-SAVING SYSTEMS
MEASUREMENT SENSORS
STATIC CONTROL DEVICES
ENDOSCOPE
LASER MARKERS
PLC / TERMINALS
HUMAN MACHINE INTERFACES
ENERGY CONSUMPTION VISUALIZATION COMPONENTS
FA COMPONENTS
MACHINE VISION SYSTEMS
UV CURING SYSTEMS
Selection Guide
Amplifier Built-in
Amplifier-separated
GX-F/H
GXL
GL
GX-U/GX-FU/GX-N
GX