

PM-64 SERIES

Related Information

- General terms and conditions F-17
- Sensor selection guide P.441~
- Glossary of terms P.1359~
- General precautions P.1405

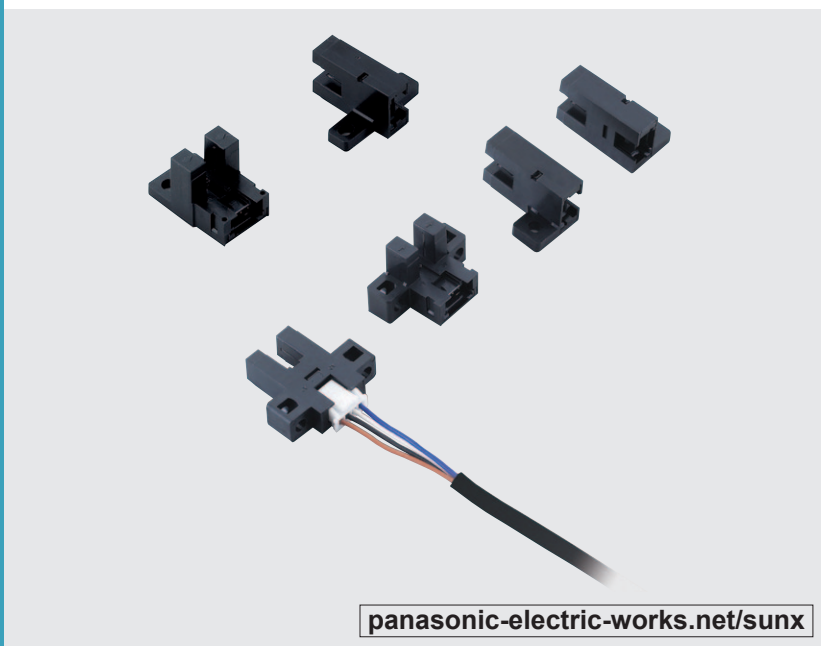

Easy connection with a single touch using commercially-available connectors

Built-in connector saves space

This greatly reduces the amount of space taken up compared to previous models. The dimension between the beam axis and cable bending part has been reduced to half at maximum.

Can be connected using commercially-available connectors

The connector connection type eliminates the extra work of soldering and insulation processing. In addition, the connector used is a commercially-available multi-purpose connector which is also currently used by the DP-100 series of digital pressure sensors.

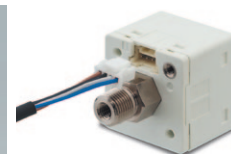
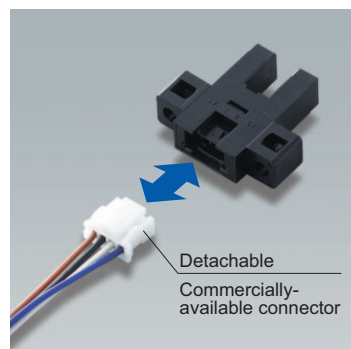
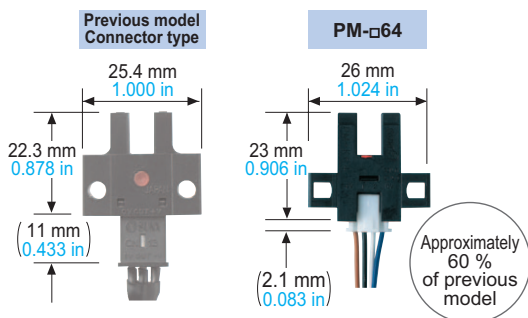

Digital pressure sensor DP-100 series

- FIBER SENSORS
- LASER SENSORS
- PHOTOELECTRIC SENSORS
- MICRO PHOTOELECTRIC SENSORS
- AREA SENSORS
- LIGHT CURTAINS
- PRESSURE / FLOW SENSORS
- INDUCTIVE PROXIMITY SENSORS
- PARTICULAR USE SENSORS
- SENSOR OPTIONS
- SIMPLE WIRE-SAVING UNITS
- WIRE-SAVING SYSTEMS
- MEASUREMENT SENSORS
- STATIC CONTROL DEVICES
- ENDOSCOPE
- LASER MARKERS
- PLC / TERMINALS
- HUMAN MACHINE INTERFACES
- ENERGY CONSUMPTION VISUALIZATION COMPONENTS
- FA COMPONENTS
- MACHINE VISION SYSTEMS
- UV CURING SYSTEMS
- Selection Guide
- U-shaped
- Convergent Reflective
- PM-64
- PM-24
- PM-44/PM-54

APPLICATIONS

Determining the pallet position

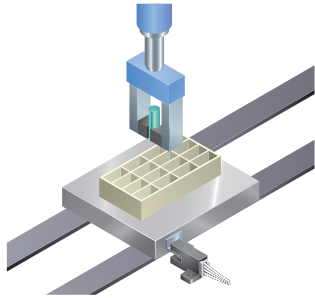

Pallet is stopped by sensing the dog.

Sensing the starting point and overrun of a moving body

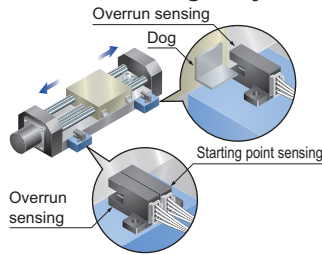

Starting point and overrun is sensed using the dog on the base.

Sensing the starting point on a rotating body

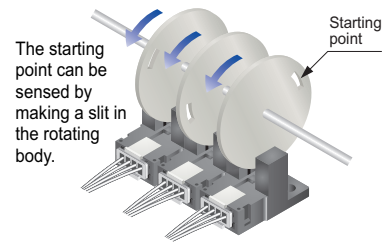

The starting point can be sensed by making a slit in the rotating body.

Improved maintenance and workability significantly reduces total cost

The processing cost of the connector cables can be drastically reduced through the use of commercially-available crimping connectors.

Previous model (Soldering: Connector type)

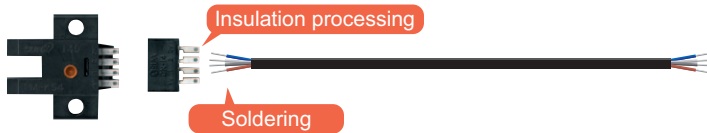

- Automation is hard because of soldering.
- Insulation processing is required.
- A large space is necessary at the terminal area.
- Connectors are not reliable (not fully connected or seated).

Previous model (Converted to the cable-type commercially-available connector)

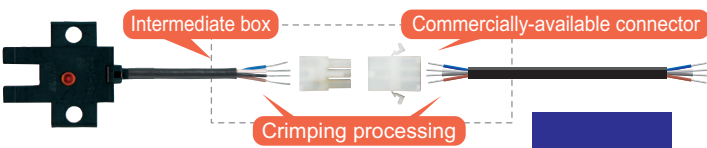

- Crimping processing is required in two places.
- A set of commercially-available connectors is necessary.
- There are many processes for cable connections.
- An intermediate box is required.

Suggestion

PM-64 series (Commercially-available connectors can be used)

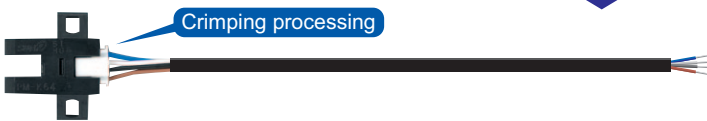

- Crimping processing makes automation possible so the connectors are also highly reliable.
- Soldering, insulation processing, and an intermediate box are not necessary.
- Connectors are widely available.
- Mounting in a small space is easy.
- Strongly connected using a locking connector.
- 1 m 3.281 ft, 2 m 6.562 ft, 3 m 9.843 ft, and 5 m 16.404 ft connector cables are available.

FIBER SENSORS

LASER SENSORS

PHOTOELECTRIC SENSORS

MICRO PHOTOELECTRIC SENSORS

AREA SENSORS

LIGHT CURTAINS

PRESSURE / FLOW SENSORS

INDUCTIVE PROXIMITY SENSORS

PARTICULAR USE SENSORS

SENSOR OPTIONS

SIMPLE WIRE-SAVING UNITS

WIRE-SAVING SYSTEMS

MEASUREMENT SENSORS

STATIC CONTROL DEVICES

ENDOSCOPE

LASER MARKERS

PLC / TERMINALS

HUMAN MACHINE INTERFACES

ENERGY CONSUMPTION VISUALIZATION COMPONENTS

FA COMPONENTS

MACHINE VISION SYSTEMS

UV CURING SYSTEMS

Selection Guide

U-shaped

Convergent Reflective

PM-64

PM-24

PM-44/PM-54

- FIBER SENSORS
- LASER SENSORS
- PHOTO-ELECTRIC SENSORS
- MICRO PHOTO-ELECTRIC SENSORS**
- AREA SENSORS
- LIGHT CURTAINS
- PRESSURE / FLOW SENSORS
- INDUCTIVE PROXIMITY SENSORS
- PARTICULAR USE SENSORS
- SENSOR OPTIONS
- SIMPLE WIRE-SAVING UNITS
- WIRE-SAVING SYSTEMS
- MEASUREMENT SENSORS
- STATIC CONTROL DEVICES
- ENDOSCOPE
- LASER MARKERS
- PLC / TERMINALS
- HUMAN MACHINE INTERFACES
- ENERGY CONSUMPTION VISUALIZATION COMPONENTS
- FA COMPONENTS
- MACHINE VISION SYSTEMS
- UV CURING SYSTEMS

ORDER GUIDE

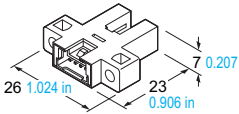
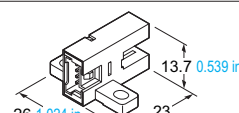
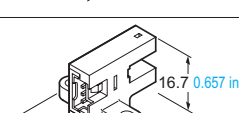
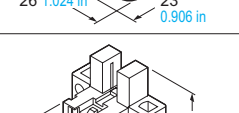
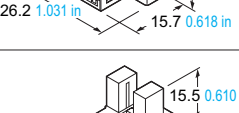
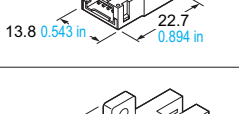
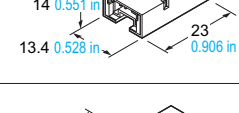
Type	Appearance (mm in)	Sensing range	Model No.	Output	Output operation
Small and built-in connector type	 26 1.024 in, 23, 7 0.207 in, 0.906 in	5 mm 0.197 in (fixed)	PM-K64	NPN open-collector transistor	Incorporated with 2 outputs: Light-ON / Dark-ON
			PM-K64P	PNP open-collector transistor	
	 26 1.024 in, 23, 13.7 0.539 in, 0.906 in		PM-T64	NPN open-collector transistor	
			PM-T64P	PNP open-collector transistor	
	 26 1.024 in, 23, 16.7 0.657 in, 0.906 in		PM-T64W (Note)	NPN open-collector transistor	
			PM-L64	NPN open-collector transistor	
	 26.2 1.031 in, 23, 15.5 0.610 in, 15.7 0.618 in		PM-L64P	PNP open-collector transistor	
			PM-Y64	NPN open-collector transistor	
	 13.8 0.543 in, 22.7 0.894 in, 15.5 0.610 in		PM-Y64P	PNP open-collector transistor	
			PM-F64	NPN open-collector transistor	
	 14 0.551 in, 23, 13.4 0.528 in, 0.906 in		PM-F64P	PNP open-collector transistor	
			PM-R64	NPN open-collector transistor	
 14 0.551 in, 23, 13.4 0.528 in, 0.906 in	PM-R64P	PNP open-collector transistor			

Note: **PM-T64W** is compatible with our conventional **PM-T53(B)**.

OPTIONS

Designation	Model No.	Description
Connector attached cable	CN-14A-C1	Length: 1m 3.281 ft
	CN-14A-C2	Length: 2m 6.562 ft
	CN-14A-C3	Length: 3m 9.843 ft
	CN-14A-C5	Length: 5m 16.404 ft
Connector attached cable (Flexible cable)	CN-14A-R-C1	Length: 1m 3.281 ft
	CN-14A-R-C2	Length: 2m 6.562 ft
	CN-14A-R-C3	Length: 3m 9.843 ft
	CN-14A-R-C5	Length: 5m 16.404 ft
Connector	CN-14A	Set of 10 housings and 40 contacts

Connector attached cable

- **CN-14A(-R)-C□**

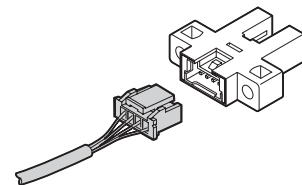

Connector

- **CN-14A**

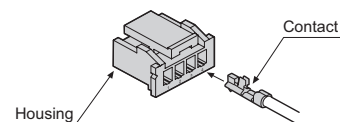

Recommended connector

Contact: SPHD-001T-P0.5, Housing: PAP-04V-S (Manufactured by J.S.T. Mfg. Co., Ltd.)

Note: Contact the manufacturer for details of the recommended products.

Recommended crimping tool

Model No. : YC-610R (Manufactured by J.S.T. Mfg. Co., Ltd.)

Note: Contact the manufacturer for details of the recommended products.

- Selection Guide
- U-shaped
- Convergent Reflective
- PM-64**
- PM-24**
- PM-44/PM-54**

SPECIFICATIONS

Item	Model No.	Type	Small and built-in connector type					
			K type	T type	L type	Y type	F type	R type
			NPN output	PM-K64	PM-T64(W)	PM-L64	PM-Y64	PM-F64
PNP output	PM-K64P	PM-T64P	PM-L64P	PM-Y64P	PM-F64P	PM-R64P		
Sensing range			5 mm 0.197 in (fixed)					
Minimum sensing object			0.8 × 1.8 mm 0.031 × 0.071 in opaque object					
Hysteresis			0.05 mm 0.002 in or less (Note 2)					
Repeatability			0.01 mm 0.0004 in or less (Note 3)					
Supply voltage			5 to 24 V DC ±10 % Ripple P-P 10 % or less					
Current consumption			15 mA or less					
Output			<NPN output type> NPN open-collector transistor			<PNP output type> PNP open-collector transistor		
			<ul style="list-style-type: none"> Maximum sink current: 50 mA Applied voltage: 30 V DC or less (between output and 0 V) Residual voltage: 0.7 V or less (at 50 mA sink current) 0.4 V or less (at 16 mA sink current) 			<ul style="list-style-type: none"> Maximum source current: 50 mA Applied voltage: 30 V DC or less (between output and +V) Residual voltage: 0.7 V or less (at 50 mA source current) 0.4 V or less (at 16 mA source current) 		
Utilization category			DC-12 or DC-13					
Output operation			Incorporated with 2 outputs: Light-ON / Dark-ON					
Response time			Under light received condition: 20 μs or less Under light interrupted condition: 100 μs or less (Response frequency: 1 kHz or more) (Note 4)					
Operation indicator			Orange LED (lights up under light received condition)					
Environmental resistance			Pollution degree					
			3 (Industrial environment)					
			Ambient temperature					
			-25 to +55 °C -13 to +131 °F (No dew condensation or icing allowed), Storage: -30 to +80 °C -22 to +176 °F					
			Ambient humidity					
			35 to 85 % RH, Storage: 5 to 95 % RH (Note 5)					
			Ambient illuminance					
			Fluorescent light: 1,000 lx at the light-receiving face					
			EMC					
EN 60947-5-2								
Voltage withstandability			1,000 V AC for one min. between all supply terminals connected together and enclosure					
Insulation resistance			50 MΩ, or more, with 250 V DC megger between all supply terminals connected together and enclosure					
Vibration resistance			10 to 2,000 Hz frequency, 1.5 mm 0.059 in amplitude in X, Y and Z directions for two hours each					
Shock resistance			15,000 m/s ² acceleration (1,500 G approx.) in X, Y and Z directions for three times each					
Emitting element			Infrared LED (Peak emission wavelength: 940 nm 0.037 mil, non-modulated)					
Material			Enclosure: PBT, Slit cover: Polycarbonate					
Cable length			Total length up to 100 m 328.084 ft is possible with 0.3 mm ² , or more, cable. (Note 6)					
Weight			Net weight: 3 g approx.					

Notes: 1) Where measurement conditions have not been specified precisely, the conditions used were an ambient temperature of +23 °C +73.4 °F.

2) This is the value when a sensing object is moved in a lateral direction to the U-shape.

3) This is the value when a sensing object is moved in a lateral direction to the U-shape and when the inserting length of the sensing board is 5 mm 0.197 in.

4) The response frequency is the value when the disc, given in the figure below, is rotated.

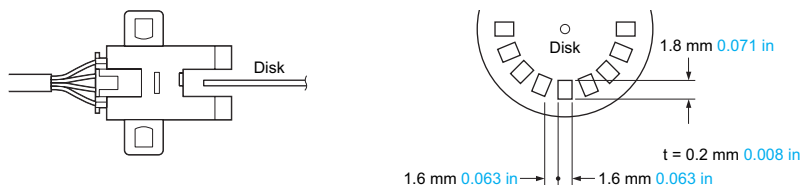

5) 5-35% RH in an ambient temperature of +23 °C +73.4 °F.

6) Confirm that the sensor terminal voltage is more than 4.5 V when using an extension of over 20 m 65.617 ft.

FIBER SENSORS

LASER SENSORS

PHOTO-ELECTRIC SENSORS

MICRO PHOTO-ELECTRIC SENSORS

AREA SENSORS

LIGHT CURTAINS

PRESSURE / FLOW SENSORS

INDUCTIVE PROXIMITY SENSORS

PARTICULAR USE SENSORS

SENSOR OPTIONS

SIMPLE WIRE-SAVING UNITS

WIRE-SAVING SYSTEMS

MEASUREMENT SENSORS

STATIC CONTROL DEVICES

ENDOSCOPE

LASER MARKERS

PLC / TERMINALS

HUMAN MACHINE INTERFACES

ENERGY CONSUMPTION VISUALIZATION COMPONENTS

FA COMPONENTS

MACHINE VISION SYSTEMS

UV CURING SYSTEMS

Selection Guide

U-shaped

Convergent Reflective

PM-64

PM-24

PM-44/
PM-54

FIBER SENSORS
LASER SENSORS
PHOTO-ELECTRIC SENSORS
MICRO PHOTO-ELECTRIC SENSORS
AREA SENSORS
LIGHT CURTAINS
PRESSURE / FLOW SENSORS
INDUCTIVE PROXIMITY SENSORS
PARTICULAR USE SENSORS
SENSOR OPTIONS
SIMPLE WIRE-SAVING UNITS
WIRE-SAVING SYSTEMS
MEASUREMENT SENSORS
STATIC CONTROL DEVICES
ENDOSCOPE
LASER MARKERS
PLC / TERMINALS
HUMAN MACHINE INTERFACES
ENERGY CONSUMPTION VISUALIZATION COMPONENTS
FA COMPONENTS
MACHINE VISION SYSTEMS
UV CURING SYSTEMS

I/O CIRCUIT AND WIRING DIAGRAMS

PM-□64(W) NPN output type

I/O circuit diagram

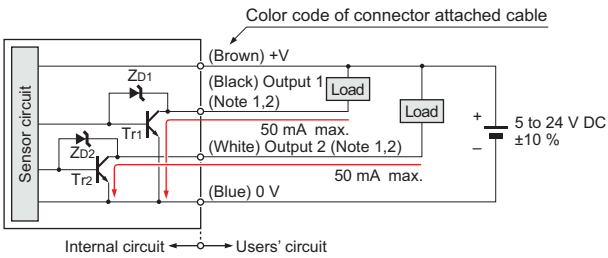

Notes: 1) Make sure to connect terminals correctly as the sensor does not incorporate a reverse polarity protection circuit. Further, the output is not incorporated with a short-circuit protection circuit. Do not connect it directly to a power supply or a capacitive load. Faulty wiring may result in damage.
2) Ensure to insulate the unused output wire.

Symbols ... ZD1, ZD2 : Surge absorption zener diode
Tr1, Tr2 : NPN output transistor

Terminal arrangement diagram

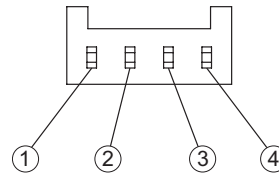

Terminal No.	Designation
①	+V
②	Output1: Light-ON
③	Output2: Dark-ON
④	0 V

PM-□64P PNP output type

I/O circuit diagram

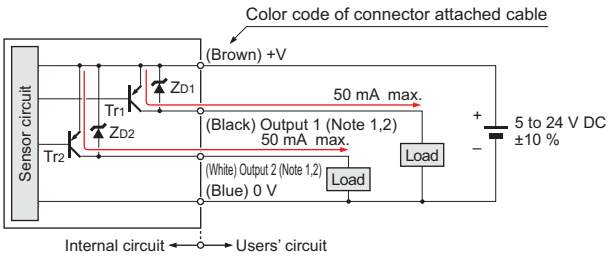

Notes: 1) Make sure to connect terminals correctly as the sensor does not incorporate a reverse polarity protection circuit. Further, the output is not incorporated with a short-circuit protection circuit. Do not connect it directly to a power supply or a capacitive load. Faulty wiring may result in damage.
2) Ensure to insulate the unused output wire.

Symbols ... ZD1, ZD2 : Surge absorption zener diode
Tr1, Tr2 : PNP output transistor

Terminal arrangement diagram

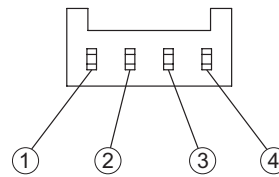

Terminal No.	Designation
①	+V
②	Output1: Light-ON
③	Output2: Dark-ON
④	0 V

SENSING CHARACTERISTICS (TYPICAL)

PM-K64(P) PM-L64(P)

Sensing position

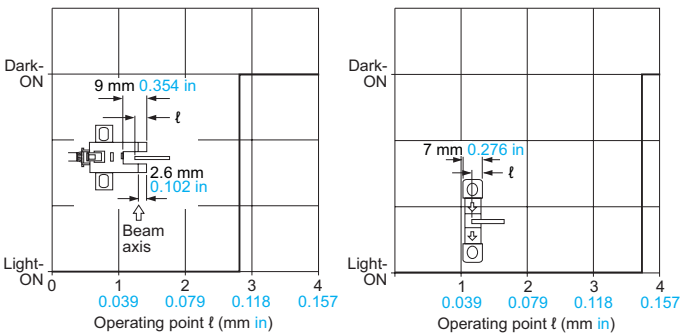

PM-64
PM-24
PM-44/
PM-54

Selection Guide
U-shaped
Convergent Reflective

PRECAUTIONS FOR PROPER USE

Refer to General precautions.



- Never use this product as a sensing device for personnel protection.
- In case of using sensing devices for personnel protection, use products which meet laws and standards, such as OSHA, ANSI or IEC etc., for personnel protection applicable in each region or country.



Make sure to connect terminals correctly as the sensor does not incorporate a reverse polarity protection circuit. Further, the output is not incorporated with a short-circuit protection circuit. Do not connect it directly to a power supply or a capacitive load. Faulty wiring may result in damage.

Mounting

- When fixing the sensor with screws, use M3 screws and the tightening torque should be 0.5 N·m or less. Further, use small, round type plain washers (ø6 mm ø0.236 in).

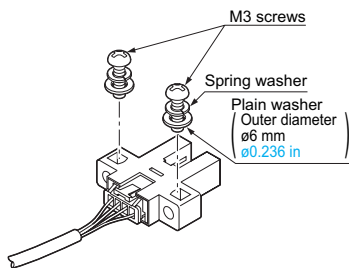

Wiring

Connection method

- Insert the connector attached cable **CN-14A(-R)-C** in the connector part of this product as shown in the right figure.

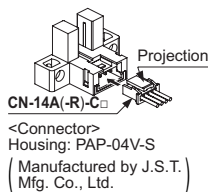

<Connector pin position>

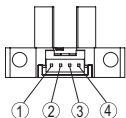

Connector pin No.	①	②	③	④
Terminal designation	+V	Output 1	Output 2	0V

Disconnection method

- Pressing the projection of the connector attached cable, pull out the connector.

Note: Take care that if the cable is pulled out without pressing the projection, the cable may break.

Cable extension

- Cable extension is possible up to an overall length of 100 m **328.084 ft** with a 0.3 mm², or more, cable. However, since a voltage drop shall occur due to the cable extension, ensure that the power supply voltage at the end of the cable attached to the sensor or at the sensor terminals is within the rating.

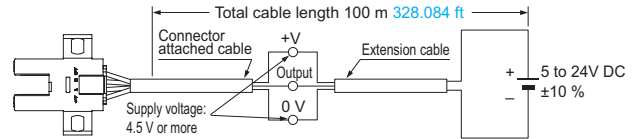

But, when the overall cable length, including the cable attached to the sensor, is as given below, there is no need to confirm the voltage.

Conductor cross-section area of extension cable	Total cable length
0.08 to 0.1 mm ²	Up to 5 m 16.404 ft
0.2 mm ²	Up to 10 m 32.808 ft
0.3 mm ²	Up to 20 m 65.617 ft

Others

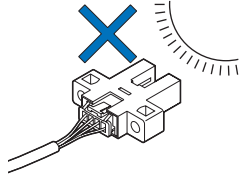
- Since the sensor is intended for use inside machines, no special countermeasures have been taken against extraneous light. Take care that extraneous light is not directly incident on the beam receiving section. 
- Do not use during the initial transient time (50 ms) after the power supply is switched on.
- If the sensor is used in a place having excessive dust, periodically clean the emitting and receiving sections with a dry, soft cloth.
- If there is a large surge generating equipment, such as, motor, solenoid, electromagnetic valve, etc., in the vicinity of the sensor, use a surge absorber on that equipment. Further, do not run the sensor cables along power lines and use a capacitor between +V and 0 V, if required. Use the sensor after confirming that the surge has been eliminated.

FIBER SENSORS
LASER SENSORS
PHOTO-ELECTRIC SENSORS
MICRO PHOTO-ELECTRIC SENSORS
AREA SENSORS
LIGHT CURTAINS
PRESSURE / FLOW SENSORS
INDUCTIVE PROXIMITY SENSORS
PARTICULAR USE SENSORS
SENSOR OPTIONS
SIMPLE WIRE-SAVING UNITS
WIRE-SAVING SYSTEMS
MEASUREMENT SENSORS
STATIC CONTROL DEVICES
ENDOSCOPE
LASER MARKERS
PLC / TERMINALS
HUMAN MACHINE INTERFACES
ENERGY CONSUMPTION VISUALIZATION COMPONENTS
FA COMPONENTS
MACHINE VISION SYSTEMS
UV CURING SYSTEMS
Selection Guide
U-shaped
Convergent Reflective
PM-64
PM-24
PM-44/ PM-54

FIBER SENSORS
LASER SENSORS
PHOTO-ELECTRIC SENSORS
MICRO PHOTO-ELECTRIC SENSORS
AREA SENSORS
LIGHT CURTAINS
PRESSURE / FLOW SENSORS
INDUCTIVE PROXIMITY SENSORS
PARTICULAR USE SENSORS
SENSOR OPTIONS
SIMPLE WIRE-SAVING UNITS
WIRE-SAVING SYSTEMS
MEASUREMENT SENSORS
STATIC CONTROL DEVICES
ENDOSCOPE
LASER MARKERS
PLC/ TERMINALS
HUMAN MACHINE INTERFACES
ENERGY CONSUMPTION VISUALIZATION COMPONENTS
FA COMPONENTS
MACHINE VISION SYSTEMS
UV CURING SYSTEMS

DIMENSIONS (Unit: mm in)

The CAD data in the dimensions can be downloaded from our website.

PM-K64(P) Sensor

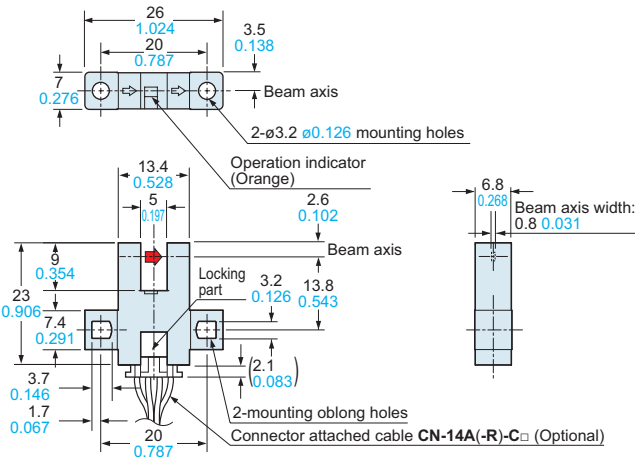

PM-T64(P) Sensor

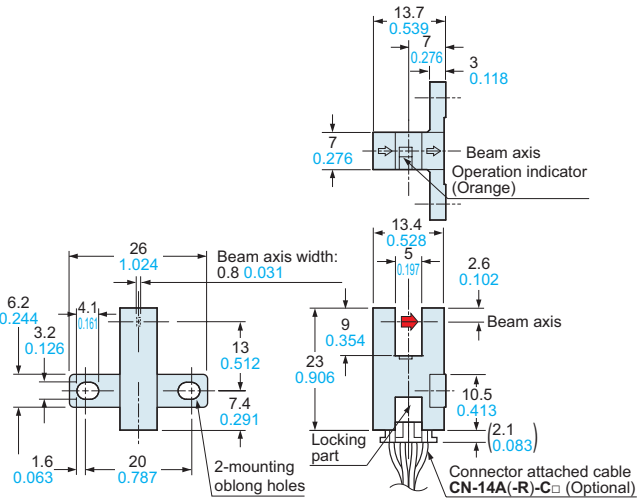

PM-T64W Sensor

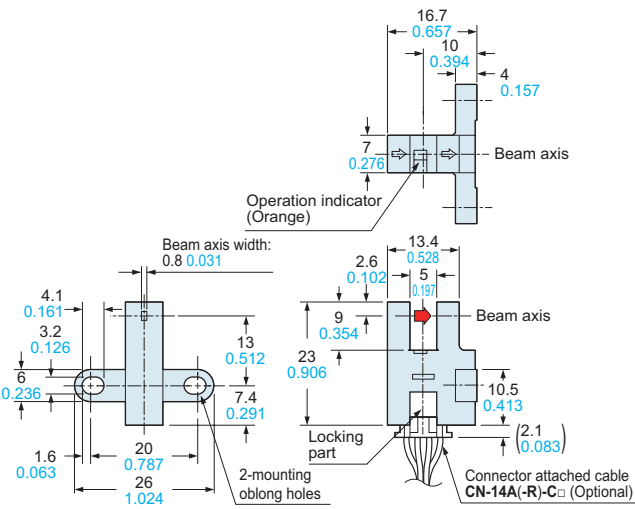

PM-L64(P) Sensor

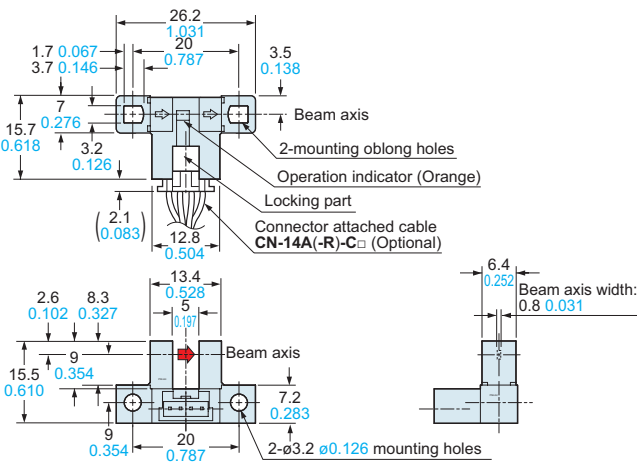

PM-Y64(P) Sensor

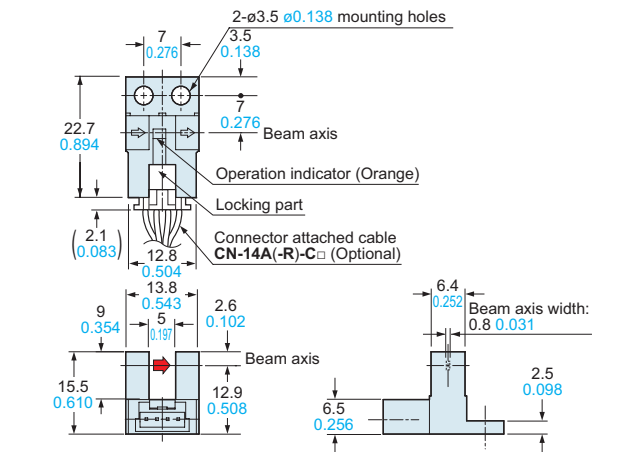

PM-F64(P) Sensor

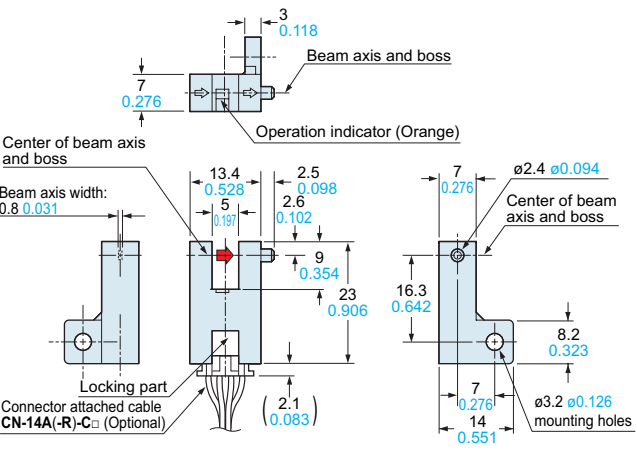

Selection Guide
U-shaped
Convergent Reflective
PM-64
PM-24
PM-44/ PM-54

DIMENSIONS (Unit: mm in)

The CAD data in the dimensions can be downloaded from our website.

PM-R64(P) Sensor

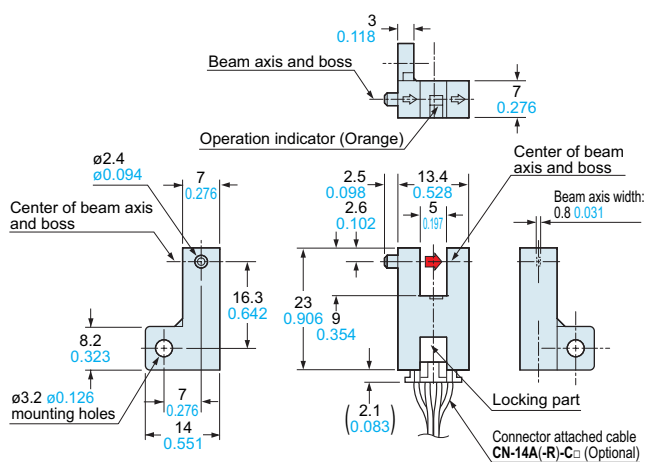

CN-14A-C□ CN-14A-R-C□ Connector attached cable (Optional)

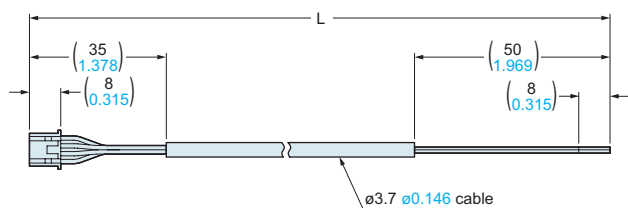

• Length L

Model No.	Length L
CN-14A(-R)-C1	1,000 39.370
CN-14A(-R)-C2	2,000 78.740
CN-14A(-R)-C3	3,000 118.110
CN-14A(-R)-C5	5,000 196.850

FIBER SENSORS

LASER SENSORS

PHOTO-ELECTRIC SENSORS

MICRO PHOTO-ELECTRIC SENSORS

AREA SENSORS

LIGHT CURTAINS

PRESSURE / FLOW SENSORS

INDUCTIVE PROXIMITY SENSORS

PARTICULAR USE SENSORS

SENSOR OPTIONS

SIMPLE WIRE-SAVING UNITS

WIRE-SAVING SYSTEMS

MEASUREMENT SENSORS

STATIC CONTROL DEVICES

ENDOSCOPE

LASER MARKERS

PLC / TERMINALS

HUMAN MACHINE INTERFACES

ENERGY CONSUMPTION VISUALIZATION COMPONENTS

FA COMPONENTS

MACHINE VISION SYSTEMS

UV CURING SYSTEMS

Selection Guide

U-shaped

Convergent Reflective

PM-64

PM-24

PM-44/ PM-54