

Digital Fiber Sensor FX-100 SERIES

Related Information

- General terms and conditions..... F-17
- Sensor selection guide..... P.3~
- Glossary of terms / General precautions..... P.1359~ / P.1405
- Fiber selection..... P.5~



panasonic-electric-works.net/sunx



FX-100 series has been modified from July 2011 production. The color of enclosure has been changed from white to dark gray and the protection cover has been attached.

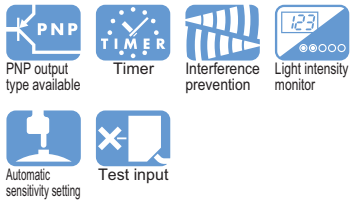

Taking fiber sensors to the next level

Setup is made simple, using a dual digital display

The dual digital display allows users to check both the threshold value and incident light intensity at the same time, allowing for clear and intuitive control of the sensor's functions.



Commercially-available connectors are used so that lead time and spare part numbers can both be reduced

The connectors used are commercially-available connectors, so that processing costs and lead time required for carrying out processing after purchase of the sensors can be greatly reduced. The same connection parts as the DP-100 series of digital pressure sensors and the PM-64 series of micro photoelectric sensors can be used.

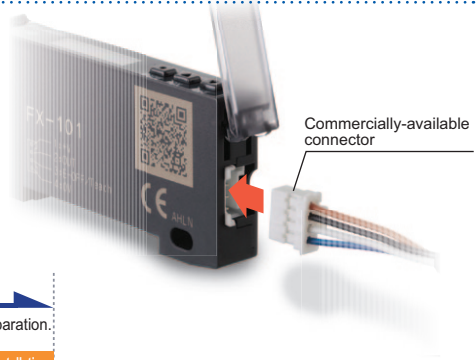

Commercially-available press-fit connectors are used, so that the processing costs for connection cables can be greatly reduced.

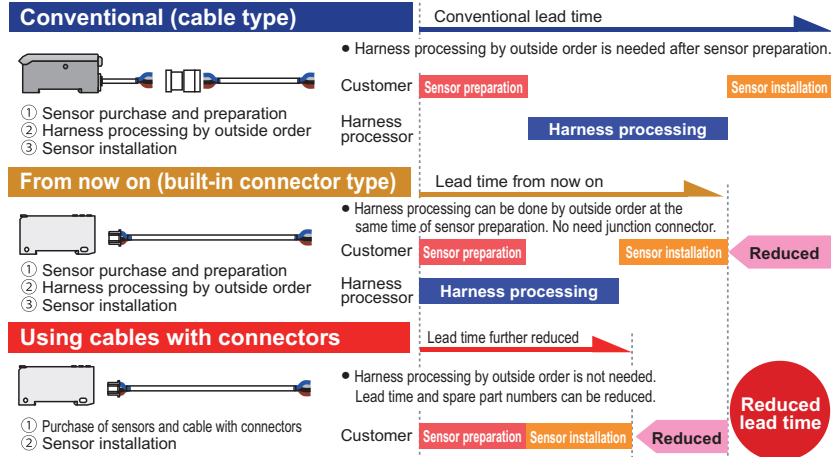

Reduced lead time

- FIBER SENSORS
- LASER SENSORS
- PHOTOELECTRIC SENSORS
- MICRO PHOTOELECTRIC SENSORS
- AREA SENSORS
- LIGHT CURTAINS
- PRESSURE / FLOW SENSORS
- INDUCTIVE PROXIMITY SENSORS
- PARTICULAR USE SENSORS
- SENSOR OPTIONS
- SIMPLE WIRE-SAVING UNITS
- WIRE-SAVING SYSTEMS
- MEASUREMENT SENSORS
- STATIC CONTROL DEVICES
- ENDOSCOPE
- LASER MARKERS
- PLC / TERMINALS
- HUMAN MACHINE INTERFACES
- ENERGY CONSUMPTION VISUALIZATION COMPONENTS
- FA COMPONENTS
- MACHINE VISION SYSTEMS
- UV CURING SYSTEMS

- Selection Guide
- Fibers
- Amplifiers

- FX-500
- FX-100
- FX-300
- FX-410
- FX-311
- FX-301-F7/ FX-301-F

Saving-space with a width of 9 mm 0.354 in

Very slim at only 9 mm 0.354 in. This is much thinner than existing fiber sensors. Even if the difference is small when only using one unit, when using many units this makes a very large difference.



Improved stability over both long terms

Utilizes the standard Panasonic Electric Works SUNX digital fiber sensor element "Four-chemical emitting element" for light emission. The light emission is guaranteed to be stable over long periods of time.

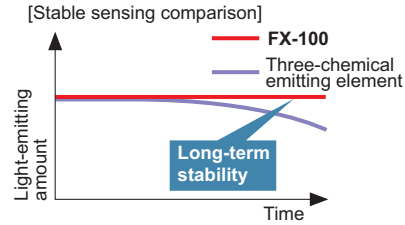

Simple operation due to clear operation system

We are using the operation system of digital pressure sensor **DP-100**, which has been highly praised since it went on sale. We have separated the settings levels into three levels: RUN mode, SET mode, and PRO mode, making operation simpler and easier.

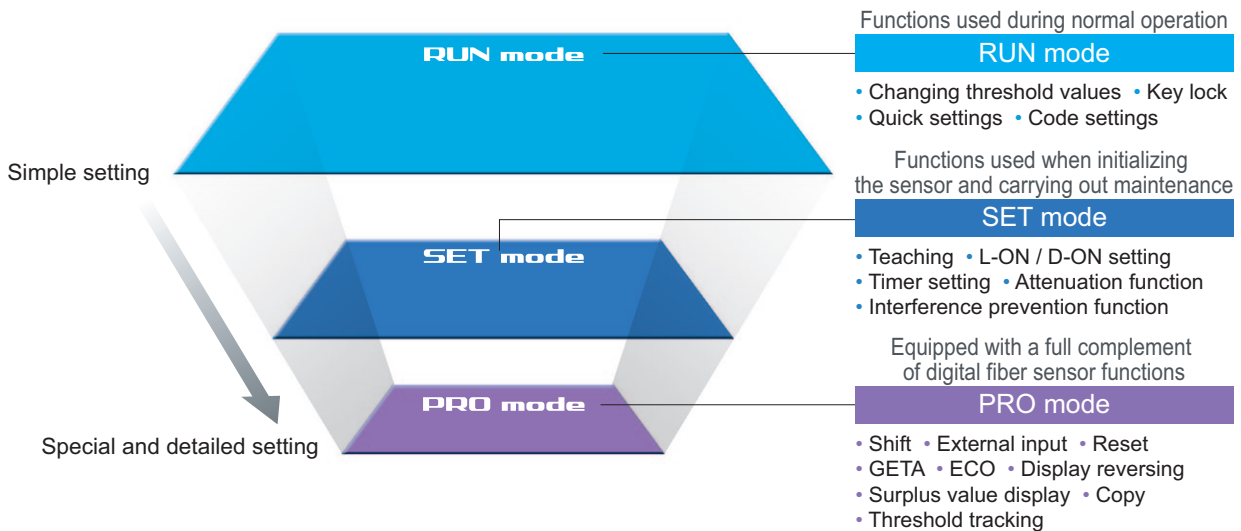

Quick code input function

Simply inputting the default setting "Code (number)" will enable sensor settings. Even if the settings are accidentally changed, inputting the code will restore the default settings. Confirmation can be carried out smoothly via telephone by simply quoting numbers. This can be of great assistance when dealing with foreign country customers.



RUN mode



Quick setting: Press and simultaneously for 2 sec.

Code setting: Press and simultaneously for 4 sec.

Quick setting numbers (summary)

No	Output operation	Timer	Light-emitting amount selection
-00-	Dark-ON	None	OFF
-01-	Dark-ON	None	ON
-02-	Dark-ON	OFF-delay 10 ms	OFF
-03-	Dark-ON	OFF-delay 10 ms	ON
-10-	Light-ON	ON-delay 40 ms	ON
-11-	Light-ON	ON-delay 40 ms	OFF
-12-	Light-ON	ON-delay 10 ms	ON
-13-	Light-ON	ON-delay 10 ms	OFF

Refer to "Quick setting function" and "Code setting function" in "PRECAUTIONS FOR PROPER USE" for details.

FIBER SENSORS

LASER SENSORS

PHOTOELECTRIC SENSORS

MICRO PHOTOELECTRIC SENSORS

AREA SENSORS

LIGHT CURTAINS

PRESSURE / FLOW SENSORS

INDUCTIVE PROXIMITY SENSORS

PARTICULAR USE SENSORS

SENSOR OPTIONS

SIMPLE WIRE-SAVING UNITS

WIRE-SAVING SYSTEMS

MEASUREMENT SENSORS

STATIC CONTROL DEVICES

ENDOSCOPE

LASER MARKERS

PLC / TERMINALS

HUMAN MACHINE INTERFACES

ENERGY CONSUMPTION VISUALIZATION COMPONENTS

FA COMPONENTS

MACHINE VISION SYSTEMS

UV CURING SYSTEMS

Selection Guide

Fibers

Amplifiers

FX-500

FX-100

FX-300

FX-410

FX-311

**FX-301-F7/
FX-301-F**

FIBER SENSORS

LASER SENSORS

PHOTOELECTRIC SENSORS

MICRO PHOTOELECTRIC SENSORS

AREA SENSORS

LIGHT CURTAINS

PRESSURE / FLOW SENSORS

INDUCTIVE PROXIMITY SENSORS

PARTICULAR USE SENSORS

SENSOR OPTIONS

SIMPLE WIRE-SAVING UNITS

WIRE-SAVING SYSTEMS

MEASUREMENT SENSORS

STATIC CONTROL DEVICES

ENDOSCOPE

LASER MARKERS

PLC / TERMINALS

HUMAN MACHINE INTERFACES

ENERGY CONSUMPTION VISUALIZATION COMPONENTS

FA COMPONENTS

MACHINE VISION SYSTEMS

UV CURING SYSTEMS

Selection Guide

Fibers

Amplifiers

FX-500

FX-100

FX-300

FX-410

FX-311

FX-301-F7 / FX-301-F

Teaching using ON / OFF buttons **SET mode**

Simply press the ON button when an object is present and OFF when it is not. There is no need to switch settings or make judgments between Light-ON (L-on) and Dark-ON (d-on).

<Setting example>

Thru-beam type / Retroreflective type

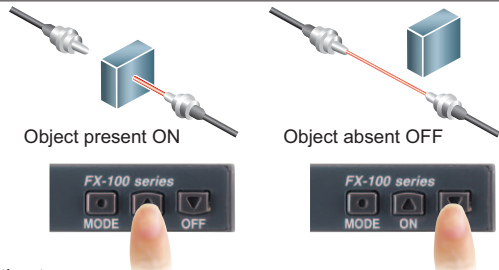

Reflective type

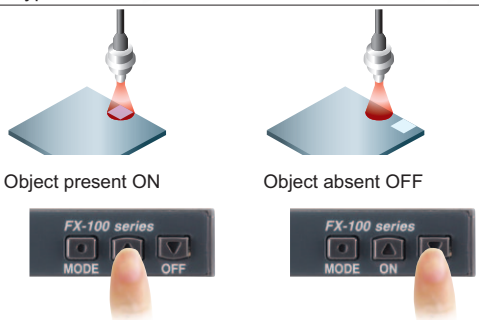

Teaching is possible even without work.

Limit teaching function

This carries out teaching and sets threshold values only when no object is present (when the incident light amount is stable). This is useful when sensing objects if there are other objects in the background and when sensing minute objects. Teaching can also be carried out using external input.

Save maintenance time
Threshold tracking function **PRO mode**

This function seeks changes in the light emitting amount resulting from changes in the environment over long periods (such as dust levels), so that the incident light intensity can be checked at desired intervals and the threshold values can be reset automatically. Reduces the number of man-hours needed for maintenance.

* Becomes active when the output operation is set to on, the beams are not received, and when using semi-transparent or mirrored reflective cable.

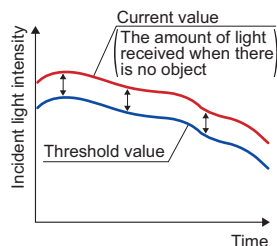

Resolves variation in incident light intensity display
GETA function **PRO mode**

Even when performing the same sensing operation, there may be variances in the digital values of the fiber amp. There is no problem with the sensor itself, but the operator may find it troubling. Given value can be corrected with the GETA function, so the apparent variation can be eliminated and the creation of operation manuals can proceed smoothly.

Variations in the amount of light received



Unify at 500 using the GETA function

Correcting an incident light intensity display of '500' to display as '1000'

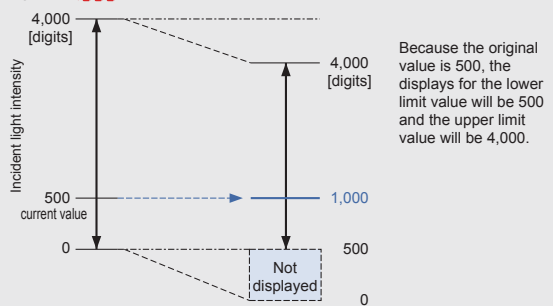

Stable detection of minute objects or transparent objects
Attenuation function **SET mode**

If the light receiving level becomes saturated when sensing over short distances or when sensing transparent objects or minute objects, the light emitting amount can be reduced so that stable sensing can be provided without needing to change the response time. On previous models, there was only one light reduction level, but now there are 3 levels plus an automatic mode. As before, even when the fiber and distance settings needed to be altered for proper sensing, this function can allow simple settings alterations.

【Light receiving level saturated】

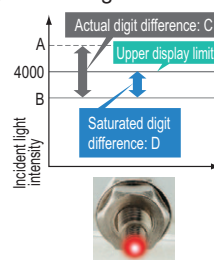

【Stable sensing】

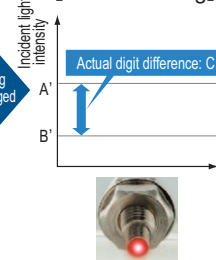

Light emitting amount changed



Interference prevention function SET mode

FX-101: Interference prevention for up to 3 units
FX-102: Interference prevention for up to 4 units

The emission frequencies can be set separately for each unit in order to avoid interference. The emitted light flashes while setting is in progress, so that you can see at a glance which fiber sensor is currently being set. There is no need to place the amplifiers close together like there was before, and so the amplifiers can be set up apart from each other.

* When the emission frequencies are changed, the response times will also change.

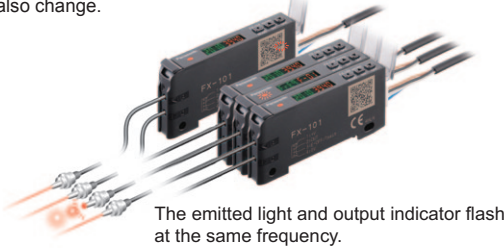

Multi-function external input PRO mode

Settings such as emission halt, limit / auto teaching, 2-point teaching and ECO settings can be carried out via external input. Also, the threshold value can be memorized.

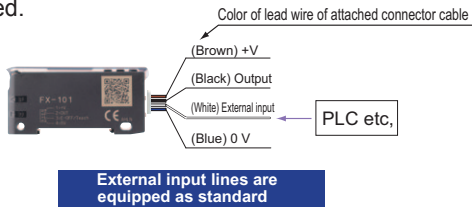

Digital display inversion setting PRO mode

The viewing orientation of the digital display can be inverted in accordance with the setting direction of the amplifier.

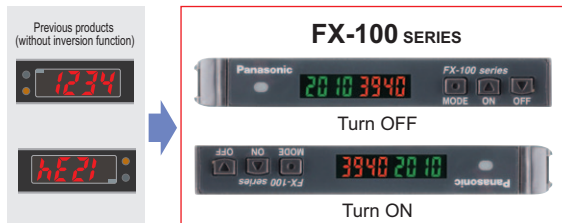

Alert function PRO mode

When the amount light received approaches the threshold value, the display can be made to blink in order to alert the operator.

<When using at a shift amount of 20% and a threshold value of 1,000>

The amount of light received ranges from about 900 to 1,100 when the digital indicator flashes.

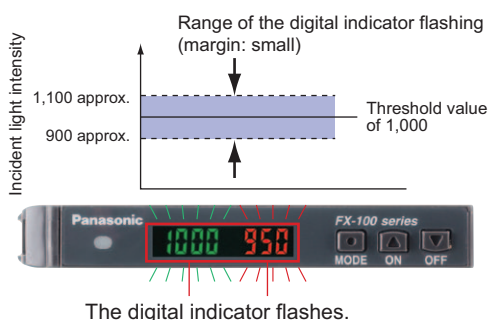

Setting copy function to reduce man-hours and human error PRO mode

By attaching a fiber sensor to each device that is to be the fiber sensor master, the master sensor settings can be copied along with data transmissions. By synchronizing the settings on all the devices, trouble from setting errors can be prevented, meaning fewer changes to the instruction manuals even when equipment design is changed.

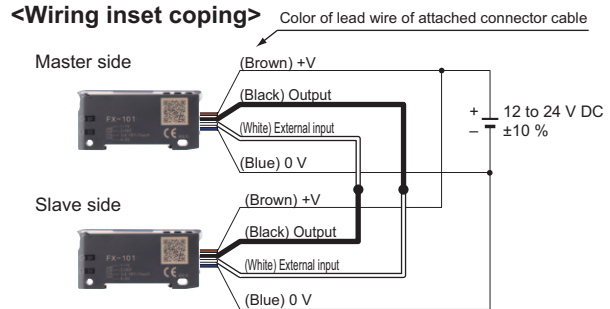

Copiable setting

Threshold value, output operation setting, timer operation setting, timer period setting, light-emitting amount selection setting (attenuation function), shift setting, ECO setting, digital display inversion setting, and threshold value margin setting (alert function)

Flexible mounting without bracket

You can choose either DIN rail mounting or mounting with M3 screws through penetrating holes on the side of the amplifier. When mounting directly or installing only one amplifier or installing to a moving part, there is no slippage.



Use normal or long distance varieties

Response time and sensing range differ with standard or long sensing range types. Select the best type for your needs.

Model No.	Type	Sensing range (FT-B8)	Response time
FX-101	Standard type	400 mm 15.748 in	Fastest 250 μs
FX-102	Long sensing range type	1,150 mm 45.276 in	Fastest 2.5 ms

Electricity consumption saving possibilities ECO

After setting, if about 20 seconds go by without any key operations taking place the digital display will turn off and energy consumption is kept under 600 mW. (When illuminated it is under 720 mW)

FIBER SENSORS

LASER SENSORS

PHOTOELECTRIC SENSORS

MICRO PHOTOELECTRIC SENSORS

AREA SENSORS

LIGHT CURTAINS

PRESSURE / FLOW SENSORS

INDUCTIVE PROXIMITY SENSORS

PARTICULAR USE SENSORS

SENSOR OPTIONS

SIMPLE WIRE-SAVING UNITS

WIRE-SAVING SYSTEMS

MEASUREMENT SENSORS

STATIC CONTROL DEVICES

ENDOSCOPE

LASER MARKERS

PLC / TERMINALS

HUMAN MACHINE INTERFACES

ENERGY CONSUMPTION VISUALIZATION COMPONENTS

FA COMPONENTS

MACHINE VISION SYSTEMS

UV CURING SYSTEMS

Selection Guide

Fibers

Amplifiers

FX-500

FX-100

FX-300



FX-410

FX-311

FX-301-F7/ FX-301-F

ORDER GUIDE

Amplifiers

Type	Appearance	Model No.	Emitting element	Output
Standard type		FX-101 (Note 2)	Red LED	NPN open-collector transistor
		FX-101-Z (Note 3)		NPN open-collector transistor
		FX-101P (Note 2)		PNP open-collector transistor
		FX-101P-Z (Note 3)		PNP open-collector transistor
Long sensing range type		FX-101-CC2		NPN open-collector transistor
		FX-101P-CC2		PNP open-collector collector transistor
		FX-102 (Note 2)		NPN open-collector transistor
		FX-102-Z (Note 3)		NPN open-collector transistor
		FX-102P (Note 2)		PNP open-collector transistor
		FX-102P-Z (Note 3)		PNP open-collector transistor
		FX-102-CC2		NPN open-collector transistor
		FX-102P-CC2		PNP open-collector transistor

Notes: 1) The connector attached cable **CN-14A-C2** is supplied with the amplifier.

2) Make sure to use the optional connector attached cable **CN-14A(-R)-C** or the connector **CN-14A**, or a connector manufactured by J.S.T. Mfg. Co., Ltd. (contact: SPHD-001T-P0.5, housing: PAP-04V-S)

3) Make sure to use the optional M8 connector attached cable **CN-24A-C**.

Accessory

• **CN-14A-C2**

(Connector attached cable 2 m 6.562 ft)

* Only include cable set type



• **FC-FX-1** (Protection cover)

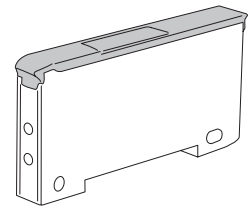

OPTIONS

Designation	Model No.	Description	
Connector attached cable	CN-14A-C1	1 m 3.281 ft	0.02 mm ² 4-core cable with connector on one end Cable outer diameter: \varnothing 3.7 mm \varnothing 0.146 in
	CN-14A-C2 (Note 1)	2 m 6.562 ft	
	CN-14A-C3	3 m 9.843 ft	
	CN-14A-C5	5 m 16.404 ft	
Connector attached cable (Flexible type)	CN-14A-R-C1	1 m 3.281 ft	
	CN-14A-R-C2	2 m 6.562 ft	
	CN-14A-R-C3	3 m 9.843 ft	
	CN-14A-R-C5	5 m 16.404 ft	
M8 connector attached cable	CN-24A-C2	2 m 6.562 ft	For M8 plug-in connector type The connector on one end Cable outer diameter: \varnothing 4 mm \varnothing 0.157 in
	CN-24A-C5	5 m 16.404 ft	
Connector	CN-14A	Set of 10 housings and 40 contacts	
Amplifier mounting bracket	MS-DIN-4	Mounting bracket for amplifier	
End plates	MS-DIN-E	When it moves depending on the way it is installed on a DIN rail, these end plates ensure that all amplifiers are mounted together in a secure and fully connected manner.	
		Two pcs. per set	
Copy unit (Note 2)	SC-SU1	Copy the controller settings to other controllers.	

Notes: 1) The connector attached cable **CN-14A-C2** is supplied with the cable set type **FX-10**-CC2.

2) Refer to the copy unit **SC-SU1** pages for details.

Recommended connector

Contact: SPHD-001T-P0.5, Housing: PAP-04V-S (Manufactured by J.S.T. Mfg. Co., Ltd.)

Note: Contact the manufacturer for details of the recommended products.

Recommended crimping tool

Model No.: YC-610R (Manufactured by J.S.T. Mfg. Co., Ltd.)

Note: Contact the manufacturer for details of the recommended products.

M8 connector attached cable

• **CN-24A-C**

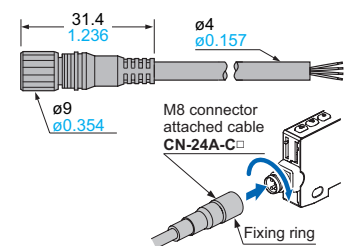

Amplifier mounting bracket

• **MS-DIN-4**

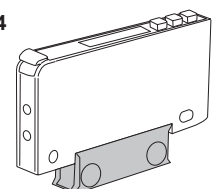

Connector attached cable

• **CN-14A(-R)-C**

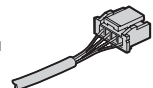

Connector



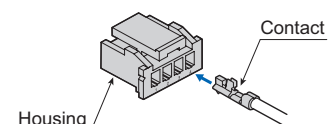



















• **CN-14A**



LIST OF FIBERS

Thru-beam type (one pair set)

Fibers are listed in alphabetic order. Refer to p.5~ "Fiber Selection" for details of each fiber.

Model No.	Sensing range (mm in) (Note 1)		Type	Fiber cable length  Free-cut	Dimensions
	Standard type FX-101 	Long sensing range type FX-102 			
FT-30	135 5.315	400 15.748	Super quality, $\phi 0.5$ mm $\phi 0.020$ in, Flexible	2 m 6.562 ft	P.90
FT-31	130 5.118	340 13.386	M3, Flexible	 2 m 6.562 ft	P.90
FT-40	320 12.598	870 34.252	Super quality, $\phi 1$ mm $\phi 0.039$ in, Flexible	2 m 6.562 ft	P.90
FT-41	300 11.811	800 31.496	Metal-free	 2 m 6.562 ft	P.90
FT-42	300 11.811	800 31.496	M4, Flexible		P.90
FT-A8	1,500 59.055	3,500 137.795 (Note 2)	Wide beam	 2 m 6.562 ft	P.90
FT-A30	3,500 137.795 (Note 2)	3,500 137.795 (Note 2)			P.90
FT-AFM2	280 11.024	720 28.346	Array	 2 m 6.562 ft	P.90
FT-AFM2E	240 9.449	670 26.378			P.90
FT-B8	400 15.748	1,150 45.276	M4	 2 m 6.562 ft	P.90
FT-E12	6 0.236	19 0.748	Ultra-small dia.		P.91
FT-E13	6 0.236	19 0.748	Ultra-small dia., Flexible	 1 m 3.281 ft	P.91
FT-E22	15 0.591	60 2.362	Ultra-small dia.	1 m 3.281 ft	P.91
FT-E23	22 0.866	80 3.150	Ultra-small dia., Flexible	 1 m 3.281 ft	P.91
FT-FM2	300 11.811	800 31.496	M4	 2 m 6.562 ft	P.91
FT-FM2S	300 11.811	800 31.496	M4, Sleeve		P.91
FT-FM2S4	300 11.811	800 31.496			P.91
FT-FM10L	9,300 366.142	15,000 590.551	M14, Long sensing range	 10 m 32.81 ft	P.91
FT-H13-FM2	250 9.843	700 27.559	Heat-resistant, 130 °C 266 °F	 2 m 6.562 ft	P.91
FT-H20-J20-S (Note 3)	135 5.315	420 16.535	Heat-resistant, Joint 200 °C 392 °F	 200 mm 7.874 in (Note 4)	P.92
FT-H20-J30-S (Note 3)	135 5.315	420 16.535		 300 mm 11.811 in (Note 4)	P.92
FT-H20-J50-S (Note 3)	135 5.315	420 16.535		 500 mm 19.685 in (Note 4)	P.92
FT-H20-M1	210 8.268	540 21.260	Heat-resistant, 200 °C 392 °F	1 m 3.281 ft	P.92
FT-H20-VJ50-S (Note 3)	150 5.906	500 19.685	Heat-resistant, Joint 200 °C 392 °F Side-view	 500 mm 19.685 in (Note 4)	P.92
FT-H20-VJ80-S (Note 3)	150 5.906	500 19.685		 800 mm 31.496 in (Note 4)	P.92
FT-H20W-M1	100 3.937	300 11.811	Heat-resistant, 200 °C 392 °F	1 m 3.281 ft	P.92
FT-H30-M1V-S (Note 5)	110 4.331	280 11.024	Vacuum-resistant, Heat-resistant		P.92
FT-H35-M2	170 6.693	490 19.291	Heat-resistant, 350 °C 662 °F Sleeve	2 m 6.562 ft	P.92
FT-H35-M2S6	170 6.693	490 19.291			P.92
FT-HL80Y	990 38.976	2,340 92.126	Chemical-resistant, Heat-resistant	 2 m 6.562 ft (Note 6)	P.92
FT-K8	1,000 39.370	3,000 118.110	Narrow beam Side-view	 2 m 6.562 ft	P.93
FT-KV1	135 5.315	500 19.685			P.93
FT-KV8	1,000 39.370	3,000 118.110			P.93
FT-L80Y	1,100 43.307	2,600 102.362	Chemical-resistant	 2 m 6.562 ft (Note 6)	P.93
FT-NFM2	130 5.118	280 11.024	M3	 2 m 6.562 ft	P.93
FT-NFM2S	130 5.118	280 11.024	M3, Sleeve		P.93
FT-NFM2S4	130 5.118	280 11.024			P.93
FT-P2	120 4.724	330 12.992	$\phi 1.5$ mm $\phi 0.059$ in, Flexible	1 m 3.281 ft	P.93
FT-P40	80 3.150	240 9.449	M3, Flexible	 2 m 6.562 ft	P.93
FT-P60	130 5.118	300 11.811	M4, Flexible		P.93
FT-P80	230 9.055	650 25.591			P.93
FT-P81X	260 10.236	800 31.496	M4, Tough flexible	1 m 3.281 ft	P.94

- Notes: 1) Note that the sensing range of the free-cut type fiber may be reduced by 20 % max. depending upon how the fiber is cut.
 2) The fiber cable length practically limits the sensing range to 3,500 mm **137.795** in long.
 3) Heat-resistant joint fibers and ordinary-temperature fibers (**FT-FM2**) are sold as a set.
 4) This is the fiber length (fixed length) for heat-resistant fibers. The ordinary-temperature fibers are free-cut to 2 m **6.562** ft.
 5) Sold as a set comprising vacuum type fiber + photo-terminal (**FV-BR1**) + fiber at atmospheric side (**FT-J8**).
 6) The allowable cutting range is 500 mm **19.685** in from the end that the amplifier inserted.

FIBER SENSORS

LASER SENSORS

PHOTO-ELECTRIC SENSORS

MICRO PHOTO-ELECTRIC SENSORS

AREA SENSORS

LIGHT CURTAINS

PRESSURE / FLOW SENSORS

INDUCTIVE PROXIMITY SENSORS

PARTICULAR USE SENSORS

SENSOR OPTIONS

SIMPLE WIRE-SAVING UNITS

WIRE-SAVING SYSTEMS

MEASUREMENT SENSORS

STATIC CONTROL DEVICES

ENDOSCOPE

LASER MARKERS

PLC / TERMINALS

HUMAN MACHINE INTERFACES

ENERGY CONSUMPTION VISUALIZATION COMPONENTS

FA COMPONENTS

MACHINE VISION SYSTEMS

UV CURING SYSTEMS

Selection Guide

Fibers

Amplifiers

FX-500**FX-100****FX-300****FX-410****FX-311**FX-301-F/
FX-301-F

LIST OF FIBERS

Thru-beam type (one pair set)



Fibers are listed in alphabetic order. Refer to p.5~ "Fiber Selection" for details of each fiber.

Model No.	Sensing range (mm in) (Note 1)		Type	Fiber cable length ✂️: Free-cut	Dimensions	
	Standard type FX-101 □	Long sensing range type FX-102 □				
FT-PS1	40 1.575	90 3.543	ø1 mm ø0.039 in, Flexible	500 mm 19.685 in	P.93	
FT-R80	180 7.087	430 16.929	M4, Elbow	✂️ 2 m 6.562 ft	P.94	
FT-S20	135 5.315	400 15.748	Super quality, ø0.5 mm ø0.020 in, Flexible	2 m 6.562 ft	P.94	
FT-S21	130 5.118	340 13.386	ø1.5 mm ø0.059 in, Flexible	✂️ 2 m 6.562 ft	P.94	
FT-S30	320 12.598	870 34.252	Super quality, ø1 mm ø0.039 in, Flexible	2 m 6.562 ft	P.94	
FT-SFM2	300 11.811	800 31.496	ø2.5 mm ø0.098 in	✂️ 2 m 6.562 ft	P.94	
FT-SFM2L	760 29.921	2,400 94.488	ø2.5 mm ø0.098 in, Long sensing range		P.94	
FT-SFM2SV2	180 7.087	470 18.504	Side-view		P.94	
FT-SNFM2	130 5.118	280 11.024	ø1.5 mm ø0.059 in		P.95	
FT-T80	300 11.811	800 31.496	M3	✂️ 2 m 6.562 ft	P.95	
FT-V10	1,000 39.370	2,350 92.520	Side-view		P.95	
FT-V22	140 5.512	380 14.961			1 m 3.281 ft	P.95
FT-V41	40 1.575	120 4.724			✂️ 2 m 6.562 ft	P.95
FT-V80Y	340 13.386	800 31.496	Chemical-resistant, Side-view	✂️ 2 m 6.562 ft (Note 3)	P.95	
FT-W4	80 3.150	220 8.661	M3, Sharp bending	✂️ 2 m 6.562 ft	P.95	
FT-W8	260 10.236	650 25.591	M4, Sharp bending		P.95	
FT-WA8	1,500 59.055	3,500 137.795 (Note 2)	Wide beam		P.95	
FT-WA30	3,500 137.795 (Note 2)	3,500 137.795 (Note 2)			P.95	
FT-WKV8	700 27.559	2,200 86.614	Narrow beam, Sharp bending		P.96	
FT-WR80	215 8.465	570 22.441	M4, Square head, Sharp bending		P.96	
FT-WR80L	430 16.929	1,150 45.276			P.96	
FT-WS3	150 5.906	600 23.622	ø3 mm ø0.118 in, Sharp bending		P.96	
FT-WS4	80 3.150	220 8.661	ø1.5 mm ø0.059 in, Sharp bending		P.96	
FT-WS8	260 10.236	650 25.591	ø2.5 mm ø0.098 in, Sharp bending		P.96	
FT-WS8L	600 23.622	1,500 59.055	ø3 mm ø0.118 in, Sharp bending	P.96		
FT-WV42	30 1.181	80 3.150	Side-view, Sharp bending	P.96		
FT-WZ4	230 9.055	670 26.378	Rectangular, Compact, Sharp bending	✂️ 1 m 3.281 ft	P.96	
FT-WZ4HB	80 3.150	230 9.055		P.97		
FT-WZ7	330 12.992	1,000 39.370		P.97		
FT-WZ7HB	190 7.480	580 22.835		P.97		
FT-WZ8	330 12.992	950 37.402		P.97		
FT-WZ8E	700 27.559	2,100 82.677		P.97		
FT-WZ8H	1,200 47.244	2,800 110.236		✂️ 2 m 6.562 ft	P.97	
FT-Z8	360 14.173	1,000 39.370		Rectangular, Flexible	P.97	
FT-Z8E	800 31.496	1,850 72.835			P.97	
FT-Z8H	1,400 55.118	3,100 122.047			P.97	
FT-Z802Y	520 20.472	3,100 122.047	Chemical-resistant, Rectangular		P.97	

Notes: 1) Note that the sensing range of the free-cut type fiber may be reduced by 20 % max. depending upon how the fiber is cut.



2) The fiber cable length practically limits the sensing range to 3,500 mm 137.795 in long.

3) The allowable cutting range is 500 mm 19.685 in from the end that the amplifier inserted.

LIST OF FIBERS

Retroreflective type 









Fibers are listed in alphabetic order. Refer to p.5~ "Fiber Selection" for details of each fiber.

Model No.	Sensing range (mm in) (Note 1) (Note 2)		Type	Fiber cable length  Free-cut	Dimensions
	Standard type FX-101	Long sensing range type FX-102			
FR-KV1	15 to 200 0.591 to 7.874	15 to 360 0.591 to 14.173	Wafer mapping	 2 m 6.562 in	P.98
FR-KZ21	20 to 200 0.787 to 7.874	20 to 200 0.787 to 7.874	Narrow beam, Top sensing		P.98
FR-KZ21E	20 to 200 0.787 to 7.874	20 to 200 0.787 to 7.874	Narrow beam, Side sensing		P.98
FR-WKZ11	100 to 550 3.937 to 21.654	100 to 830 3.937 to 32.677	Sharp bending		P.98

- Notes: 1) Note that the sensing range of the free-cut type fiber may be reduced by 20 % max. depending upon how the fiber is cut. The sensing range of **FR-WKZ11** is specified for the **RF-13**. The sensing range of **FR-KZ21**, **FR-KZ21E** is specified for the attached reflector **RF-003**. The sensing range of **FR-KV1** is specified for the attached reflector. Refer to p.166 for sensing range when **FR-WKZ11** is used in combination with a reflector (optional).
- 2) The sensing range of retroreflective type is the possible setting range for the attached reflector. The fiber can detect an object less than setting range for the reflector. However, note that if there are any white or highly-reflective surfaces near the fiber head, reflected incident light may affect the fiber head. If this occurs, adjust the threshold value of the amplifier unit before use.

Reflective type 

Fibers are listed in alphabetic order. Refer to p.5~ "Fiber Selection" for details of each fiber.

Model No.	Sensing range (mm in) (Note 1) (Note 2)		Type	Fiber cable length  Free-cut	Dimensions
	Standard type FX-101	Long sensing range type FX-102			
FD-30	45 1.772	155 6.102	Super quality, M3, Flexible	2 m 6.562 ft	P.99
FD-31	35 1.378	140 5.512	M3, Flexible	 2 m 6.562 ft	P.99
FD-40	45 1.772	155 6.102	Super quality, M4, Flexible	2 m 6.562 ft	P.99
FD-41	35 1.378	140 5.512	M4, Flexible	 2 m 6.562 ft	P.99
FD-60	140 5.512	420 16.535	Super quality, M6, Flexible	2 m 6.562 ft	P.99
FD-61	120 4.724	410 16.142	M6, Flexible	 2 m 6.562 ft	P.99
FD-A15	125 4.921	250 9.843	Wide beam		P.99
FD-AFM2	105 4.134	285 11.220	Array, Top sensing	 2 m 6.562 ft	P.99
FD-AFM2E	85 3.346	245 9.646	Array, Side sensing		P.99
FD-B8	170 6.693	440 17.323	M6	1 m 3.281 ft	P.100
FD-E12	3.5 0.138	13 0.512	Ultra-small dia.		P.100
FD-E22	16 0.630	45 1.772	M3, High precision	500 mm 19.685 in	P.100
FD-EG1	18 0.709	50 1.969			P.100
FD-EG2	10 0.394	30 1.181			P.100
FD-EG3	7 0.276	22 0.866	M3, Sleeve	1 m 3.281 ft	P.100
FD-EN500S1	1 0.039	4 0.157			P.100
FD-ENM1S1	15 0.591	48 1.890	Liquid sensing, Mountable on pipe	 2 m 6.562 ft	P.100
FD-F4	Applicable pipe diameter: Outer dia. $\phi 6$ to $\phi 26$ mm $\phi 0.236$ to $\phi 1.024$ in transparent pipe (PFA (fluorine resin) or equivalently transparent pipe, wall thickness 1 mm 0.039 in)				P.100
FD-F41	Applicable pipe diameter: Outer dia. $\phi 6$ to $\phi 26$ mm $\phi 0.236$ to $\phi 1.024$ in transparent pipe (PVC (vinyl chloride), fluorine resin, polycarbonate, acrylic, glass, wall thickness 1 to 3 mm 0.039 to 0.118 in)		P.100		
FD-F41Y	$\phi 4$ mm $\phi 0.157$ in Protective tube: Fluorine resin, length 500 mm 19.685 in (cuttable) Liquid surface not contacted: Beam received, Liquid surface contacted: Beam interrupted		Liquid/Liquid leak sensing		P.101
FD-F8Y			Liquid sensing	 2 m 6.562 ft (Note 3)	P.101
FD-FA90	Applicable pipe diameter: Outer dia. $\phi 8$ mm $\phi 0.315$ in or more transparent pipe (When used with the tying bands: $\phi 8$ to $\phi 80$ mm $\phi 0.315$ to $\phi 3.150$ in) [PFA (fluorine resin), including translucent] Liquid absent: Beam received, Liquid present: Beam interrupted		Liquid/Liquid leak sensing	 2 m 6.562 ft	P.101
FD-FM2	100 3.937	410 16.142	M6		P.101

- Notes: 1) The standard sensing objects of the sensing ranges vary depending on the fibers.
 2) Note that the sensing range of the free-cut type fiber may be reduced by 20 % max. depending upon how the fiber is cut.
 3) The allowable cutting range is 1,000 mm **39.370 in** from the end that the amplifier inserted.

FIBER SENSORS

LASER SENSORS

PHOTO-ELECTRIC SENSORS

MICRO PHOTO-ELECTRIC SENSORS

AREA SENSORS

LIGHT CURTAINS

PRESSURE / FLOW SENSORS

INDUCTIVE PROXIMITY SENSORS

PARTICULAR USE SENSORS

SENSOR OPTIONS

SIMPLE WIRE-SAVING UNITS

WIRE-SAVING SYSTEMS

MEASUREMENT SENSORS

STATIC CONTROL DEVICES

ENDOSCOPE

LASER MARKERS

PLC / TERMINALS

HUMAN MACHINE INTERFACES

ENERGY CONSUMPTION VISUALIZATION COMPONENTS

FA COMPONENTS

MACHINE VISION SYSTEMS

UV CURING SYSTEMS

Selection Guide

Fibers

Amplifiers

FX-500

FX-100

FX-300

FX-410

FX-311

FX-301-F7/ FX-301-F

LIST OF FIBERS

Reflective type



Fibers are listed in alphabetic order. Refer to p.5~ "Fiber Selection" for details of each fiber.

Model No.	Sensing range (mm in) (Note 1) (Note 2)		Type	Fiber cable length ✂️: Free-cut	Dimensions
	Standard type FX-101 □	Long sensing range type FX-102 □			
FD-FM2S	100 3.937	345 13.583	M6, Sleeve	✂️ 2 m 6.562 ft	P.101
FD-FM2S4	100 3.937	345 13.583			P.101
FD-G4	50 1.969	120 4.724	M4, High precision	✂️ 1 m 3.281 ft (Note 3)	P.101
FD-G6	50 1.969	120 4.724	M3, High precision		P.102
FD-G6X	45 1.772	160 6.299	Tough flexible	✂️ 2 m 6.562 ft	P.102
FD-G40	50 1.969	120 4.724	Metal-free		P.101
FD-G60	100 3.937	410 16.142	Heat-resistant, 130 °C 266 °F	✂️ 2 m 6.562 ft	P.102
FD-H13-FM2	100 3.937	280 11.024	Heat-resistant, 180 °C 356 °F		P.102
FD-H18-L31	0 to 10 0.000 to 0.394	0 to 25 0.000 to 0.984	Heat-resistant, 180 °C 356 °F	✂️ 1 m 3.281 ft	P.102
FD-H20-21	90 3.543	280 11.024	Heat-resistant, M4 200 °C 392 °F		P.102
FD-H20-M1	120 4.724	300 11.811	M6	✂️ 3 m 9.843 ft	P.102
FD-H25-L43	4 to 16 0.157 to 0.630	4 to 23 0.157 to 0.906	Heat-resistant, Convergent reflective		P.103
FD-H25-L45	7 to 35 0.276 to 1.378	7 to 38 0.276 to 1.496	Vacuum-resistant, Heat-resistant	✂️ 1 m 3.281 ft	P.103
FD-H30-KZ1V-S (Note 4)	25 to 80 0.984 to 3.150	10 to 220 0.394 to 8.661	Heat-resistant, 300 °C 572 °F		P.103
FD-H30-L32	2 to 9 0.079 to 0.354	0 to 17 0.000 to 0.669	Vacuum-resistant, Convergent reflective	✂️ 3 m 9.843 ft	P.103
FD-H30-L32V-S (Note 4)	2.5 to 6.5 0.098 to 0.256	0 to 11 0.000 to 0.433	M4, Sleeve		P.104
FD-H35-20S	85 3.346	200 7.874	Heat-resistant, 350 °C 662 °F	✂️ 2 m 6.562 ft	P.104
FD-H35-M2	75 2.953	280 11.024	M6, Sleeve		P.104
FD-H35-M2S6	75 2.953	280 11.024	Liquid/Liquid leak sensing	✂️ 2 m 6.562 ft	P.104
FD-HF40Y	ø4 mm ø0.157 in Protective tube: Fluorine resin, length 500 mm 19.685 in (cuttable) Liquid surface not contacted: Beam received, Liquid surface contacted: Beam interrupted		Convergent reflective		P.104
FD-L4	5 to 8 0.197 to 0.315 (Convergent point 6 0.236)	1 to 17 0.039 to 0.669 (Convergent point 6 0.236)	Convergent reflective		P.104
FD-L41	3 to 14 0.118 to 0.551 (Convergent point 8 0.315)	1.5 to 16 0.059 to 0.630 (Convergent point 8 0.315)			P.104
FD-L43	0 to 19 0.000 to 0.748	0 to 25 0.000 to 0.984			P.104
FD-L44	0 to 6 0.000 to 0.236	0 to 8 0.000 to 0.315			P.104
FD-L44S	0 to 4.5 0.000 to 0.177	0 to 5.5 0.000 to 0.217			P.104
FD-L45	0 to 40 0.000 to 1.575	0 to 50 0.000 to 1.969			✂️ 3 m 9.843 ft
FD-L45A	—	10 to 33 0.394 to 1.299 (Note 5)			✂️ 4 m 13.124 ft
FD-L46	16 to 30 0.630 to 1.181	12 to 50 0.472 to 1.969			✂️ 3 m 9.843 ft
FD-L47	28 1.102	30 1.181		P.105	
FD-NFM2	35 1.378	100 3.937		M4	P.105
FD-NFM2S	35 1.378	100 3.937	M4, Sleeve	✂️ 2 m 6.562 ft	
FD-NFM2S4	35 1.378	100 3.937		P.105	
FD-P2	25 0.984	65 2.559	ø1.5 mm ø0.059 in , Flexible	✂️ 1 m 3.281 ft	P.105
FD-P40	8 0.315	30 1.181	M3, Flexible	✂️ 2 m 6.562 ft	P.105
FD-P50	45 1.772	150 5.906	ø3 mm ø0.118 in , Flexible		P.105
FD-P60	45 1.772	150 5.906	M4, Flexible	✂️ 1 m 3.281 ft	P.105
FD-P80	90 3.543	200 7.874	M6, Flexible		P.106
FD-P81X	70 2.756	220 8.661	M6, Tough flexible	✂️ 2 m 6.562 ft	P.106
FD-R80	70 2.756	180 7.087	M6, Elbow		P.106
FD-S30	45 1.772	155 6.102	Super quality, ø3 mm ø0.118 in , Flexible	✂️ 2 m 6.562 ft	P.106
FD-S31	35 1.378	140 5.512	ø3 mm ø0.118 in , Flexible	✂️ 2 m 6.562 ft	P.106

Notes: 1) The standard sensing objects of the sensing ranges vary depending on the fibers.

2) Note that the sensing range of the free-cut type fiber may be reduced by 20 % max. depending upon how the fiber is cut.

3) The allowable cutting range is 700 mm **27.559 in** from the end that the amplifier inserted.

4) Sold as a set comprising vacuum type fiber + photo-terminal (**FV-BR1**) + fiber at atmospheric side (**FT-J8**).

5) The sensing range is changed due to tilt of sensing object.

LIST OF FIBERS

Reflective type



Fibers are listed in alphabetic order. Refer to p.5~ “Fiber Selection” for details of each fiber.

Model No.	Sensing range (mm in) (Note 1) (Note 2)		Type	Fiber cable length ✂: Free-cut	Dimensions	
	Standard type FX-101 □	Long sensing range type FX-102 □				
FD-S80	100 3.937	345 13.583	ø3 mm ø 0.118 in	✂ 2 m 6.562 ft	P.106	
FD-SFM2SV2	30 1.181	90 3.543	Side-view		P.106	
FD-SNFM2	35 1.378	100 3.937	ø2.5 mm ø 0.098 in		P.106	
FD-T40	35 1.378	100 3.937	M3		P.106	
FD-T80	110 4.331	345 13.583	M4		P.106	
FD-V41	25 0.984	70 2.756	Side-view		P.106	
FD-W8	80 3.150	230 9.055	M6, Sharp bending		P.107	
FD-W44	15 0.591	40 1.575	M4, Sharp bending		P.107	
FD-WG4	28 1.102	75 2.953	M4, High precision		P.107	
FD-WKZ1	20 to 180 0.787 to 7.087	20 to 480 0.787 to 18.898	Long sensing range, Rectangular		P.107	
FD-WL41	7 to 12 0.276 to 0.472 (Convergent point 8 0.315)	6 to 13.5 0.236 to 0.531 (Convergent point 8 0.315)	Convergent reflective	✂ 1 m 3.281ft	P.107	
FD-WL48	1 to 4.5 0.039 to 0.177	0.5 to 6.5 0.020 to 0.256			P.107	
FD-WS8	80 3.150	230 9.055	ø3 mm ø 0.118 in , Sharp bending	✂ 2 m 6.562 ft	P.107	
FD-WSG4	28 1.102	75 2.953	ø3 mm ø 0.118 in , High precision		P.107	
FD-WT4	15 0.591	40 1.575	M3, Sharp bending		P.107	
FD-WT8	80 3.150	230 9.055	M4, Sharp bending		P.107	
FD-WV42	6 0.236	20 0.787	Side-view, Sharp bending		P.108	
FD-WZ4	2 to 20 0.079 to 0.787	1 to 70 0.039 to 2.756	Rectangular, Compact Sharp bending		✂ 1 m 3.281ft	P.108
FD-WZ4HB	2 to 20 0.079 to 0.787	1 to 70 0.039 to 2.756			P.108	
FD-WZ7	1 to 55 0.039 to 2.165	160 6.299			✂ 2 m 6.562 ft	P.108
FD-WZ7HB	1 to 60 0.039 to 2.362	0.5 to 180 0.020 to 7.087			P.108	

Notes: 1) The standard sensing objects of the sensing ranges vary depending on the fibers.
 2) Note that the sensing range of the free-cut type fiber may be reduced by 20 % max. depending upon how the fiber is cut.

Sensing ranges (mm in) when using in combination with the FR-WKZ11 reflector (optional)

Reflector \ Amplifier	FX-101 □	FX-102 □
FR-WKZ11 + RF-210	100 to 700 3.937 to 27.559	100 to 1,100 3.937 to 43.307
FR-WKZ11 + RF-220	100 to 1,300 3.937 to 51.181	100 to 2,600 3.937 to 102.362
FR-WKZ11 + RF-230	100 to 2,000 3.937 to 78.740	100 to 4,000 3.937 to 157.480

FIBER SENSORS

LASER SENSORS

PHOTO-ELECTRIC SENSORS

MICRO PHOTO-ELECTRIC SENSORS

AREA SENSORS

LIGHT CURTAINS

PRESSURE / FLOW SENSORS

INDUCTIVE PROXIMITY SENSORS

PARTICULAR USE SENSORS

SENSOR OPTIONS

SIMPLE WIRE-SAVING UNITS

WIRE-SAVING SYSTEMS

MEASUREMENT SENSORS

STATIC CONTROL DEVICES

ENDOSCOPE

LASER MARKERS

PLC / TERMINALS

HUMAN MACHINE INTERFACES

ENERGY CONSUMPTION VISUALIZATION COMPONENTS

FA COMPONENTS

MACHINE VISION SYSTEMS

UV CURING SYSTEMS

Selection Guide

Fibers

Amplifiers

FX-500

FX-100

FX-300

FX-410

FX-311

FX-301-F7/ FX-301-F

FIBER OPTIONS

FIBER SENSORS

LASER SENSORS

PHOTO-ELECTRIC SENSORS

MICRO PHOTO-ELECTRIC SENSORS

AREA SENSORS

LIGHT CURTAINS

PRESSURE / FLOW SENSORS

INDUCTIVE PROXIMITY SENSORS

PARTICULAR USE SENSORS

SENSOR OPTIONS

SIMPLE WIRE-SAVING UNITS

WIRE-SAVING SYSTEMS

MEASUREMENT SENSORS

STATIC CONTROL DEVICES

ENDOSCOPE

LASER MARKERS

PLC / TERMINALS

HUMAN MACHINE INTERFACES

ENERGY CONSUMPTION VISUALIZATION COMPONENTS

FA COMPONENTS

MACHINE VISION SYSTEMS

UV CURING SYSTEMS

Selection Guide

Fibers

Amplifiers

FX-500

FX-100



FX-300

FX-410

FX-311

FX-301-F7/ FX-301-F

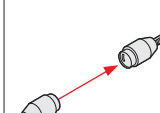
Lens (For thru-beam type fiber)

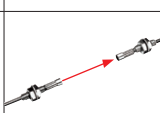
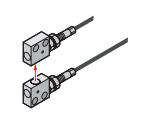
Designation	Model No.	Description
For thru-beam type fiber	Expansion lens (Note 1)	<p>FX-LE1</p>  <p>Increases the sensing range by 5 times or more.</p> <ul style="list-style-type: none"> Ambient temperature: -60 to +350 °C -76 to +662 °F (Note 4)
	Super-expansion lens (Note 1)	<p>FX-LE2</p>  <p>Tremendously increases the sensing range with large diameter lenses.</p> <ul style="list-style-type: none"> Ambient temperature: -60 to +350 °C -76 to +662 °F (Note 4)
	Side-view lens	<p>FX-SV1</p>  <p>Beam axis is bent by 90°.</p> <ul style="list-style-type: none"> Ambient temperature: -60 to +300 °C -76 to +572 °F (Note 4)
	Expansion lens for vacuum-resistant fiber (Note 1)	<p>FV-LE1</p>  <p>Sensing range increases by 4 times or more.</p> <ul style="list-style-type: none"> Ambient temperature: -60 to +350 °C -76 to +662 °F (Note 4)
Side-view lens for vacuum-resistant fiber	<p>FV-SV2</p>  <p>Beam axis is bent by 90°.</p> <ul style="list-style-type: none"> Ambient temperature: -60 to +300 °C -76 to +572 °F (Note 4) 	

Sensing range (mm in) [Lens on both sides]

Fiber	Amplifier	FX-101□	FX-102□
FT-B8		2,200 86.614	3,500 137.795 (Note 2)
FT-FM2, FT-T80		3,000 118.110	3,500 137.795 (Note 2)
FT-R80		1,900 74.803	3,500 137.795 (Note 2)
FT-W8		3,000 118.110	3,500 137.795 (Note 2)
FT-P80, FT-P60		3,500 137.795 (Note 2)	3,500 137.795 (Note 2)
FT-P81X		1,600 62.992 (Note 2)	1,600 62.992 (Note 2)
FT-H35-M2		2,000 78.740	3,500 137.795 (Note 2)
FT-H20W-M1		1,300 51.181	1,600 62.992 (Note 2)
FT-H20-M1		1,600 62.992 (Note 2)	1,600 62.992 (Note 2)
FT-H20-J20-S, FT-H20-J30-S, FT-H20-J50-S		1,000 39.370	3,500 137.795 (Note 2)

Sensing range (mm in) [Lens on both sides]

Fiber	Amplifier	FX-101□	FX-102□
FT-B8, FT-FM2, FT-R80, FT-W8, FT-P80, FT-P60		3,500 137.795 (Note 2)	3,500 137.795 (Note 2)
FT-P81X		1,600 62.992 (Note 2)	1,600 62.992 (Note 2)
FT-H35-M2		3,500 137.795 (Note 2)	3,500 137.795 (Note 2)
FT-H20W-M1, FT-H20-M1		1,600 62.992 (Note 2)	1,600 62.992 (Note 2)
FT-H13-FM2		3,500 137.795 (Note 2)	3,500 137.795 (Note 2)
FT-H20-J20-S, FT-H20-J30-S, FT-H20-J50-S		3,500 137.795 (Note 2)	3,500 137.795 (Note 2)

Sensing range (mm in) [Lens on both sides]

Fiber	Amplifier	FX-101□	FX-102□
FT-B8		530 20.866	1,450 57.087
FT-FM2, FT-T80		550 21.654	1,700 66.929
FT-W8		450 17.717	1,300 51.181
FT-P80		420 16.535	1,400 55.118
FT-P60		300 11.811	850 33.465
FT-P81X		550 21.654	1,700 66.929
FT-H35-M2		280 11.024	800 31.496
FT-H20W-M1		140 5.512	400 15.748
FT-H20-M1		280 11.024	840 33.071
FT-H20-J20-S, FT-H20-J30-S, FT-H20-J50-S		150 5.906	410 16.142

Sensing range (mm in) [Lens on both sides] (Note 3)

Fiber	Amplifier	FX-101□	FX-102□
FT-H30-M1V-S		450 17.717	1,600 62.992

Sensing range (mm in) [Lens on both sides] (Note 3)

Fiber	Amplifier	FX-101□	FX-102□
FT-H30-M1V-S		450 17.717	1,600 62.992

- Notes: 1) Be careful when installing the thru-beam type fiber equipped with the expansion lens, as the beam envelope becomes narrow and alignment is difficult. Especially when installing a fiber with many cores (sharp bending fibers and heat-resistant glass fiber), please be sure to use it only after you have adjusted it sufficiently.
- 2) The fiber cable length practically limits the sensing range to 3,500 mm **137.795 in** long (**FT-H20W-M1, FT-P81X** and **FT-H20-M1**: 1,600 mm **62.992 in**).
- 3) The fiber cable length for the **FT-H30-M1V-S** is 1 m **3.281 ft**. The sensing ranges in **FX-102□** (long sensing range type) take into account the length of the **FT-J8** atmospheric side fiber.
- 4) For details on the ambient temperatures for the fibers which being combined, refer to p.76~.

FIBER OPTIONS

Lens (For reflective type fiber)

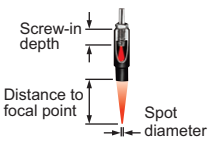
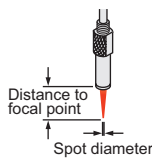
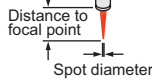
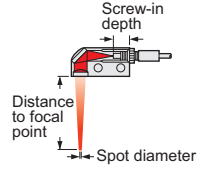
Designation	Model No.	Description															
For reflective type fiber	Pinpoint spot lens	FX-MR1	 <p>Pinpoint spot of $\varnothing 0.5$ mm $\varnothing 0.020$ in. Enables detection of minute objects or small marks. • Distance to focal point: 6 ± 1 mm 0.236 ± 0.039 in • Applicable fibers: FD-WG4, FD-G4 • Ambient temperature: -40 to $+70$ °C -40 to $+158$ °F (Note 2)</p>														
	Zoom lens	FX-MR2	 <p>The spot diameter is adjustable from $\varnothing 0.7$ to $\varnothing 2$ mm $\varnothing 0.028$ to $\varnothing 0.079$ in according to how much the fiber is screwed in. • Applicable fibers: FD-WG4, FD-G4 • Ambient temperature: -40 to $+70$ °C -40 to $+158$ °F (Note 2) • Accessory: MS-EX-3 (mounting bracket)</p> <table border="1" style="width: 100%; margin-top: 10px;"> <caption>Sensing range for FX-101□ (mm in) (Note 1)</caption> <thead> <tr> <th>Screw-in depth</th> <th>Distance to focal point</th> <th>Spot diameter</th> </tr> </thead> <tbody> <tr> <td>7 mm 0.276 in</td> <td>18.5 0.728 approx.</td> <td>$\varnothing 0.7$ $\varnothing 0.028$</td> </tr> <tr> <td>12 mm 0.472 in</td> <td>27 1.063 approx.</td> <td>$\varnothing 1.2$ $\varnothing 0.047$</td> </tr> <tr> <td>14 mm 0.551 in</td> <td>43 1.693 approx.</td> <td>$\varnothing 2.0$ $\varnothing 0.079$</td> </tr> </tbody> </table>	Screw-in depth	Distance to focal point	Spot diameter	7 mm 0.276 in	18.5 0.728 approx.	$\varnothing 0.7$ $\varnothing 0.028$	12 mm 0.472 in	27 1.063 approx.	$\varnothing 1.2$ $\varnothing 0.047$	14 mm 0.551 in	43 1.693 approx.	$\varnothing 2.0$ $\varnothing 0.079$		
	Screw-in depth	Distance to focal point	Spot diameter														
	7 mm 0.276 in	18.5 0.728 approx.	$\varnothing 0.7$ $\varnothing 0.028$														
	12 mm 0.472 in	27 1.063 approx.	$\varnothing 1.2$ $\varnothing 0.047$														
14 mm 0.551 in	43 1.693 approx.	$\varnothing 2.0$ $\varnothing 0.079$															
Finest spot lens	FX-MR3	 <p>Extremely fine spot of $\varnothing 0.3$ mm $\varnothing 0.012$ in approx. achieved. • Applicable fibers: FD-WG4, FD-G4, FD-EG1, FD-EG2, FD-EG3, FD-G6X, FD-G6 • Ambient temperature: -40 to $+70$ °C -40 to $+158$ °F (Note 2)</p> <table border="1" style="width: 100%; margin-top: 10px;"> <caption>Sensing range for FX-101□ (mm in) (Note 1)</caption> <thead> <tr> <th>Fiber model No.</th> <th>Distance to focal point</th> <th>Spot diameter</th> </tr> </thead> <tbody> <tr> <td>FD-EG3</td> <td>7.5 ± 0.5 0.295 ± 0.020</td> <td>$\varnothing 0.15$ $\varnothing 0.006$ approx.</td> </tr> <tr> <td>FD-EG2</td> <td>7.5 ± 0.5 0.295 ± 0.020</td> <td>$\varnothing 0.2$ $\varnothing 0.008$ approx.</td> </tr> <tr> <td>FD-EG1</td> <td>7.5 ± 0.5 0.295 ± 0.020</td> <td>$\varnothing 0.3$ $\varnothing 0.012$ approx.</td> </tr> <tr> <td>FD-WG4/G4, FD-G6X/G6</td> <td>7.5 ± 0.5 0.295 ± 0.020</td> <td>$\varnothing 0.5$ $\varnothing 0.020$ approx.</td> </tr> </tbody> </table>	Fiber model No.	Distance to focal point	Spot diameter	FD-EG3	7.5 ± 0.5 0.295 ± 0.020	$\varnothing 0.15$ $\varnothing 0.006$ approx.	FD-EG2	7.5 ± 0.5 0.295 ± 0.020	$\varnothing 0.2$ $\varnothing 0.008$ approx.	FD-EG1	7.5 ± 0.5 0.295 ± 0.020	$\varnothing 0.3$ $\varnothing 0.012$ approx.	FD-WG4/G4, FD-G6X/G6	7.5 ± 0.5 0.295 ± 0.020	$\varnothing 0.5$ $\varnothing 0.020$ approx.
Fiber model No.	Distance to focal point	Spot diameter															
FD-EG3	7.5 ± 0.5 0.295 ± 0.020	$\varnothing 0.15$ $\varnothing 0.006$ approx.															
FD-EG2	7.5 ± 0.5 0.295 ± 0.020	$\varnothing 0.2$ $\varnothing 0.008$ approx.															
FD-EG1	7.5 ± 0.5 0.295 ± 0.020	$\varnothing 0.3$ $\varnothing 0.012$ approx.															
FD-WG4/G4, FD-G6X/G6	7.5 ± 0.5 0.295 ± 0.020	$\varnothing 0.5$ $\varnothing 0.020$ approx.															
Finest spot lens	FX-MR6	 <p>Extremely fine spot of $\varnothing 0.1$ mm $\varnothing 0.004$ in approx. achieved. • Applicable fibers: FD-WG4, FD-G4, FD-EG1, FD-EG2, FD-EG3, FD-G6X, FD-G6 • Ambient temperature: -20 to $+60$ °C -4 to $+140$ °F (Note 2)</p> <table border="1" style="width: 100%; margin-top: 10px;"> <caption>Sensing range for FX-101□ (mm in) (Note 1)</caption> <thead> <tr> <th>Fiber model No.</th> <th>Distance to focal point</th> <th>Spot diameter</th> </tr> </thead> <tbody> <tr> <td>FD-EG3</td> <td>7 ± 0.5 0.276 ± 0.020</td> <td>$\varnothing 0.1$ $\varnothing 0.004$ approx.</td> </tr> <tr> <td>FD-EG2</td> <td>7 ± 0.5 0.276 ± 0.020</td> <td>$\varnothing 0.15$ $\varnothing 0.006$ approx.</td> </tr> <tr> <td>FD-EG1</td> <td>7 ± 0.5 0.276 ± 0.020</td> <td>$\varnothing 0.2$ $\varnothing 0.008$ approx.</td> </tr> <tr> <td>FD-WG4/G4, FD-G6X/G6</td> <td>7 ± 0.5 0.276 ± 0.020</td> <td>$\varnothing 0.4$ $\varnothing 0.016$ approx.</td> </tr> </tbody> </table>	Fiber model No.	Distance to focal point	Spot diameter	FD-EG3	7 ± 0.5 0.276 ± 0.020	$\varnothing 0.1$ $\varnothing 0.004$ approx.	FD-EG2	7 ± 0.5 0.276 ± 0.020	$\varnothing 0.15$ $\varnothing 0.006$ approx.	FD-EG1	7 ± 0.5 0.276 ± 0.020	$\varnothing 0.2$ $\varnothing 0.008$ approx.	FD-WG4/G4, FD-G6X/G6	7 ± 0.5 0.276 ± 0.020	$\varnothing 0.4$ $\varnothing 0.016$ approx.
Fiber model No.	Distance to focal point	Spot diameter															
FD-EG3	7 ± 0.5 0.276 ± 0.020	$\varnothing 0.1$ $\varnothing 0.004$ approx.															
FD-EG2	7 ± 0.5 0.276 ± 0.020	$\varnothing 0.15$ $\varnothing 0.006$ approx.															
FD-EG1	7 ± 0.5 0.276 ± 0.020	$\varnothing 0.2$ $\varnothing 0.008$ approx.															
FD-WG4/G4, FD-G6X/G6	7 ± 0.5 0.276 ± 0.020	$\varnothing 0.4$ $\varnothing 0.016$ approx.															
Zoom lens (Side-view type)	FX-MR5	 <p>FX-MR2 is converted into a side-view type and can be mounted in a very small space. • Applicable fibers: FD-WG4, FD-G4 • Ambient temperature: -40 to $+70$ °C -40 to $+158$ °F (Note 2)</p> <table border="1" style="width: 100%; margin-top: 10px;"> <caption>Sensing range for FX-101□ (mm in) (Note 1)</caption> <thead> <tr> <th>Screw-in depth</th> <th>Distance to focal point</th> <th>Spot diameter</th> </tr> </thead> <tbody> <tr> <td>8 mm 0.315 in</td> <td>13 0.512 approx.</td> <td>$\varnothing 0.5$ $\varnothing 0.020$</td> </tr> <tr> <td>10 mm 0.394 in</td> <td>15 0.591 approx.</td> <td>$\varnothing 0.8$ $\varnothing 0.031$</td> </tr> <tr> <td>14 mm 0.551 in</td> <td>30 1.181 approx.</td> <td>$\varnothing 3.0$ $\varnothing 0.118$</td> </tr> </tbody> </table>	Screw-in depth	Distance to focal point	Spot diameter	8 mm 0.315 in	13 0.512 approx.	$\varnothing 0.5$ $\varnothing 0.020$	10 mm 0.394 in	15 0.591 approx.	$\varnothing 0.8$ $\varnothing 0.031$	14 mm 0.551 in	30 1.181 approx.	$\varnothing 3.0$ $\varnothing 0.118$			
Screw-in depth	Distance to focal point	Spot diameter															
8 mm 0.315 in	13 0.512 approx.	$\varnothing 0.5$ $\varnothing 0.020$															
10 mm 0.394 in	15 0.591 approx.	$\varnothing 0.8$ $\varnothing 0.031$															
14 mm 0.551 in	30 1.181 approx.	$\varnothing 3.0$ $\varnothing 0.118$															

Notes: 1) The sensing ranges are the values when used in combination with **FX-101□** (standard type). Please contact our office for details on sensing ranges for other types of amplifier.

2) For details on the ambient temperatures for the fibers which being combined, refer to p.76~.

FIBER SENSORS

LASER SENSORS

PHOTO-ELECTRIC SENSORS

MICRO PHOTO-ELECTRIC SENSORS

AREA SENSORS

LIGHT CURTAINS

PRESSURE / FLOW SENSORS

INDUCTIVE PROXIMITY SENSORS

PARTICULAR USE SENSORS

SENSOR OPTIONS

SIMPLE WIRE-SAVING UNITS

WIRE-SAVING SYSTEMS

MEASUREMENT SENSORS

STATIC CONTROL DEVICES

ENDOSCOPE

LASER MARKERS

PLC / TERMINALS

HUMAN MACHINE INTERFACES

ENERGY CONSUMPTION VISUALIZATION COMPONENTS

FA COMPONENTS

MACHINE VISION SYSTEMS

UV CURING SYSTEMS

Selection Guide

Fibers

Amplifiers

FX-500

FX-100

FX-300

FX-410

FX-311

FX-301-F7/ FX-301-F

SPECIFICATIONS

Item	Model No.	Type	Standard type		Long sensing range type	
				Cable set		Cable set
		NPN output	FX-101(-Z) (Note 5)	FX-101-CC2	FX-102(-Z) (Note 5)	FX-102-CC2
		PNP output	FX-101P(-Z) (Note 5)	FX-101P-CC2	FX-102P(-Z) (Note 5)	FX-102P-CC2
Supply voltage			12 to 24 V DC $\pm 10\%$ Ripple P-P 10% or less			
Power consumption			Normal operation: 720 mW or less (Current consumption 30 mA or less at 24 V supply voltage) ECO mode: 600 mW or less (Current consumption 25 mA or less at 24 V supply voltage)			
Output		<NPN output type> NPN open-collector transistor • Maximum sink current: 100 mA • Applied voltage: 30 V DC or less (between output and 0 V) • Residual voltage: 1.5 V or less (at 100 mA sink current)	<PNP output type> PNP open-collector transistor • Maximum source current: 100 mA • Applied voltage: 30 V DC or less (between output and +V) • Residual voltage: 1.5 V or less (at 100 mA source current)			
Output operation		Selectable either Light-ON or Dark-ON, at SET mode				
Short-circuit protection		Incorporated				
External input		<NPN output type> NPN non-contact input • Signal condition High: +8 V to +V DC or Open Low: 0 to +2 V DC (Source current 0.5 mA or less) • Input impedance: 10 k Ω approx.	<PNP output type> PNP non-contact input • Signal condition High: +4 V to +V DC (Sink current 0.5 to 3 mA) Low: 0 to +0.6 V DC or Open • Input impedance: 10 k Ω approx.			
Response time		Emission frequency 0: 250 μ s or less (factory default setting) Emission frequency 1: 450 μ s or less Emission frequency 2: 500 μ s or less Emission frequency 3: 600 μ s or less	Emission frequency 1: 2.5 ms or less (factory default setting) Emission frequency 2: 2.8 ms or less Emission frequency 3: 3.2 ms or less Emission frequency 4: 5.0 ms or less			
Sensitivity setting		2-point teaching / Limit teaching / Full-auto teaching				
Operation indicator		Orange LED (lights up when the output is ON)				
Digital display		4 digits (green) + 4 digits (red) LCD display				
Fine sensitivity adjustment function		Incorporated				
Timer function		ON-delay / OFF-delay timer, switchable either effective or ineffective [Timer period: 1 ms, 5 ms, 10 ms, 20 ms, 40 ms, 50 ms, 100 ms, 500 ms, 1,000 ms]				
Attenuation function		3-level + Auto setting				
Interference prevention function		Incorporated Emission frequency selection method (Note 2) (Functions at emission frequency 1, 2 or 3)	Incorporated Emission frequency selection method (Note 2) (Functions at emission frequency 1, 2, 3 or 4)			
Environmental resistance	Ambient temperature	-10 to +55 °C +14 to +131 °F (If 4 to 7 units are mounted close together: -10 to +50 °C +14 to +122 °F, if 8 to 16 units are mounted close together: -10 to +45 °C +14 to +113 °F) (No dew condensation or icing allowed), Storage: -20 to +70 °C -4 to +158 °F				
	Ambient humidity	35 to 85 % RH, Storage: 35 to 85 % RH				
	Ambient illuminance	Incandescent light: 3,000 lx at the light-receiving face				
	Voltage withstandability	1,000 V AC for one min. between all supply terminals connected together and enclosure (Note 3)				
	Insulation resistance	20 M Ω , or more, with 250 V DC megger between all supply terminals connected together and enclosure (Note 3)				
	Vibration resistance	10 to 150 Hz frequency, 0.75 mm 0.030 in amplitude in X, Y and Z directions for two hours each				
	Shock resistance	98 m/s ² acceleration (10 G approx.) in X, Y and Z directions for five times each				
Emitting element (modulated)		Red LED (Peak emission wavelength: 632 nm 0.025 mil)				
Material		Enclosure: Polycarbonate, Key switch: Polycarbonate, Fiber lock lever: PBT				
Connecting method		Connector (Note 4)				
Cable length		Total length up to 100 m 328.084 ft is possible with 0.3 mm ² , or more, cable.				
Weight		Net weight: 15 g approx. Gross weight: 35 g approx.	Net weight: 15 g approx. Gross weight: 75 g approx.	Net weight: 15 g approx. Gross weight: 35 g approx.	Net weight: 15 g approx. Gross weight: 75 g approx.	
Accessory		—————	CN-14A-C2 (Connector attached cable, 2 m 6.562 ft long): 1pc.	—————	CN-14A-C2 (Connector attached cable, 2 m 6.562 ft long): 1pc.	

Notes: 1) Where measurement conditions have not been specified precisely, the conditions used were an ambient temperature of +23 °C +73.4 °F.

2) When using the interference prevention function, set the emission frequencies for the amplifiers to be covered by the interference prevention function to different frequency values.

However, the interference prevention function does not operate at emission frequency 0 (factory default setting) for the **FX-101(P)(-Z)** / **FX-101(P)-CC2**.

3) The voltage withstandability and the insulation resistance values given in the above table are for the amplifier only.

4) Connector attached cable **CN-14A-C2** is not attached to the models that have no "-CC2" at the end of the model Nos.

Make sure to use the optional connector attached cable **CN-14A(-R)-C** or the connector **CN-14A**, or a connector manufactured by J.S.T. Mfg., Ltd. (contact: SPHD-001T-P0.5, housing: PAP-04V-S).

5) Model Nos. having the suffix "-Z" are M8 plug-in connector type. Make sure to use the optional M8 attached connector cable **CN-24A-C**.

I/O CIRCUIT AND WIRING DIAGRAMS

FX-10□(-Z/-CC2)

NPN output type

I/O circuit diagram

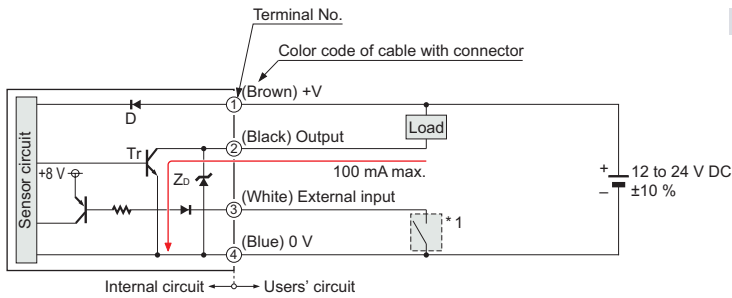

Symbols ... D : Reverse supply polarity protection diode
 Zd: Surge absorption zener diode
 Tr: NPN output transistor

* 1

Non-voltage contact or NPN open-collector transistor

High (+8 V to +V DC, or open): Ineffective
 Low ([0 to +2 V DC (source current 0.5 mA or less)]: Effective

Terminal arrangement diagram

Connector type

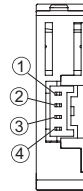

Terminal No.	Function
①	+V
②	Output
③	External input
④	0 V

M8 plug-in connector type

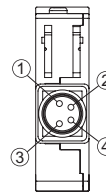

Terminal No.	Function
①	+V
②	Output
③	External input
④	0 V

FX-10□P(-Z/-CC2)

PNP output type

I/O circuit diagram

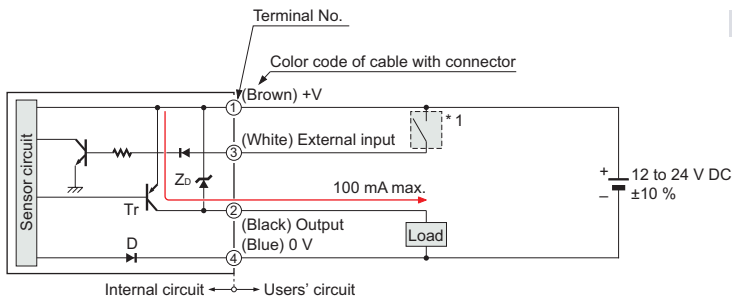

Symbols ... D : Reverse supply polarity protection diode
 Zd: Surge absorption zener diode
 Tr: PNP output transistor

* 1

Non-voltage contact or PNP open-collector transistor

High [+4 V to +V DC (sink current 0.5 to 3 mA)]: Effective
 Low (0 to +0.6 V DC, or open): Ineffective

Terminal arrangement diagram

Connector type

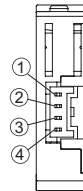

Terminal No.	Function
①	+V
②	Output
③	External input
④	0 V

M8 plug-in connector type

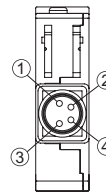

Terminal No.	Function
①	+V
②	Output
③	External input
④	0 V

- FIBER SENSORS
- LASER SENSORS
- PHOTO-ELECTRIC SENSORS
- MICRO PHOTO-ELECTRIC SENSORS
- AREA SENSORS
- LIGHT CURTAINS
- PRESSURE / FLOW SENSORS
- INDUCTIVE PROXIMITY SENSORS
- PARTICULAR USE SENSORS
- SENSOR OPTIONS
- SIMPLE WIRE-SAVING UNITS
- WIRE-SAVING SYSTEMS
- MEASUREMENT SENSORS
- STATIC CONTROL DEVICES
- ENDSCOPE
- LASER MARKERS
- PLC / TERMINALS
- HUMAN MACHINE INTERFACES
- ENERGY CONSUMPTION VISUALIZATION COMPONENTS
- FA COMPONENTS
- MACHINE VISION SYSTEMS
- UV CURING SYSTEMS
- Selection Guide
- Fibers
- Amplifiers
- FX-500**
- FX-100**
- FX-300**
- FX-410**
- FX-311**
- FX-301-F7/
FX-301-F

SENSING CHARACTERISTICS (TYPICAL)

Contact our office for sensing characteristics that are not contained here.

FIBER SENSORS
LASER SENSORS
PHOTO-ELECTRIC SENSORS
MICRO PHOTO-ELECTRIC SENSORS
AREA SENSORS
LIGHT CURTAINS
PRESSURE / FLOW SENSORS
INDUCTIVE PROXIMITY SENSORS
PARTICULAR USE SENSORS
SENSOR OPTIONS
SIMPLE WIRE-SAVING UNITS
WIRE-SAVING SYSTEMS
MEASUREMENT SENSORS
STATIC CONTROL DEVICES
ENDOSCOPE
LASER MARKERS
PLC / TERMINALS
HUMAN MACHINE INTERFACES
ENERGY CONSUMPTION VISUALIZATION COMPONENTS
FA COMPONENTS
MACHINE VISION SYSTEMS
UV CURING SYSTEMS
Selection Guide
Fibers
Amplifiers
FX-500
FX-100
FX-300
FX-410
FX-311
FX-301-F7 / FX-301-F

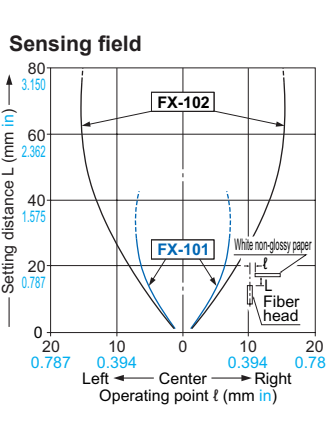
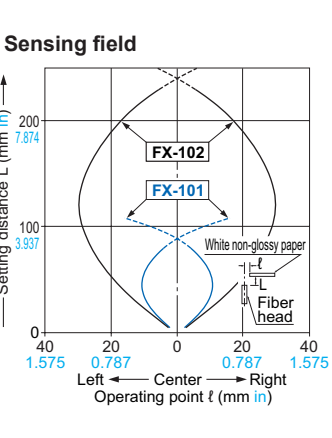
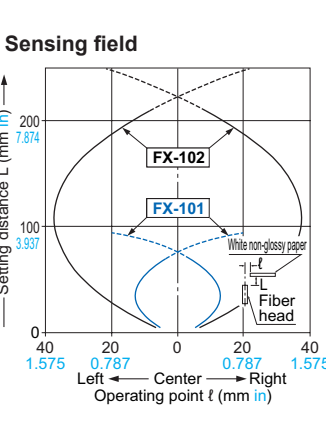
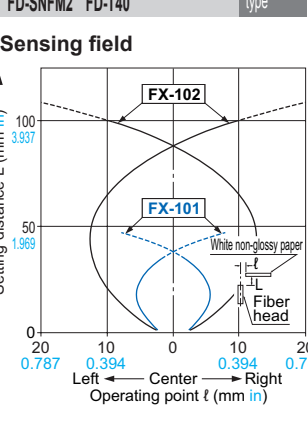
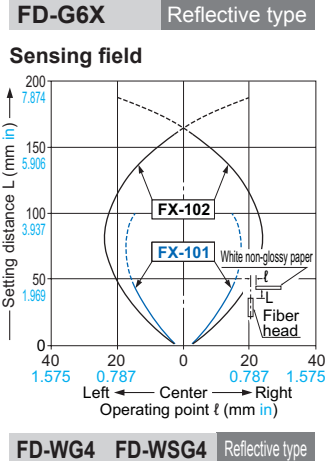
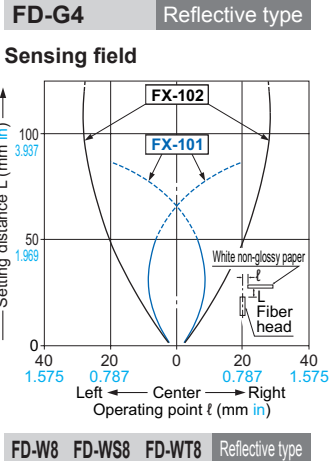
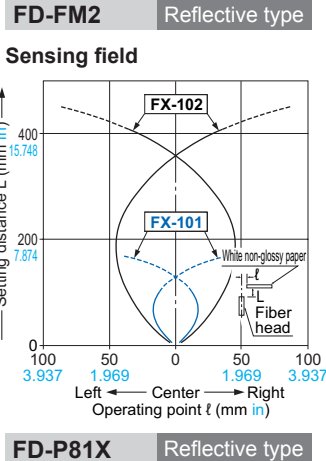
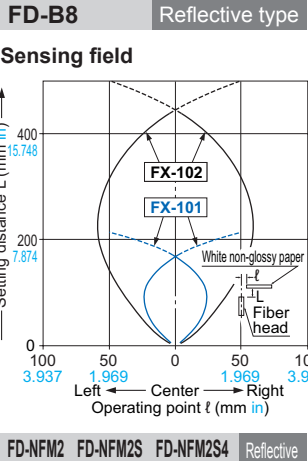
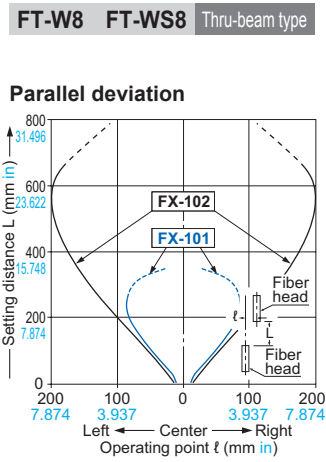
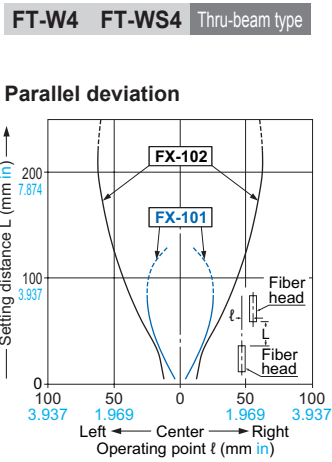
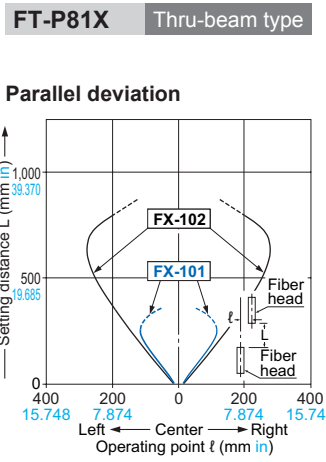
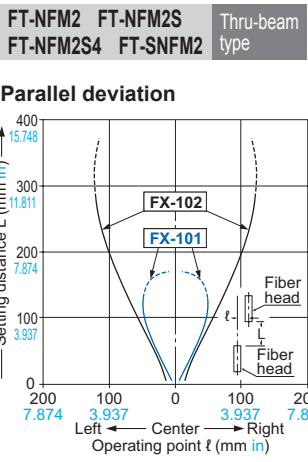
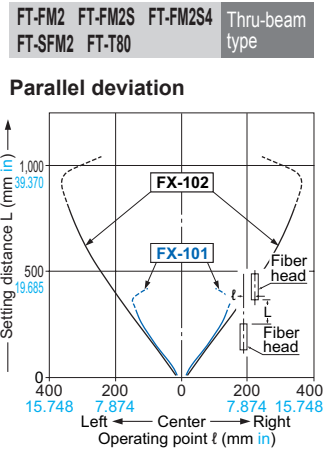
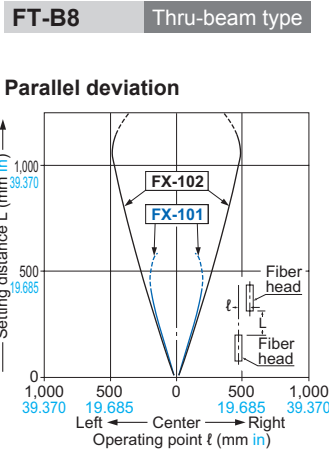
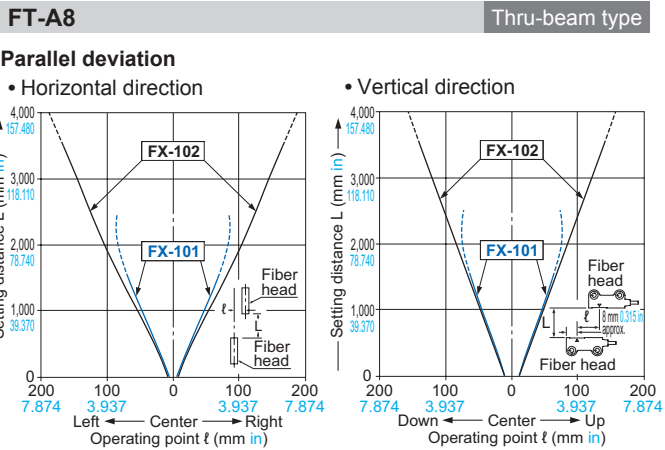

PRECAUTIONS FOR PROPER USE



- Never use this product as a sensing device for personnel protection.
- In case of using sensing devices for personnel protection, use products which meet laws and standards, such as OSHA, ANSI or IEC etc., for personnel protection applicable in each region or country.

Using in combination with the FX-300 / FX-410 series

- The **FX-100** series does not use the horizontal connectors that are used with the **FX-300 / FX-410** series. Please note that horizontal connection cannot be performed using a connector attached cable. In addition, the optical communication function is not equipped on the **FX-100** series, so it is unable to perform interference prevention for use with the **FX-300 / FX-410** series. If using the **FX-100** series together with the **FX-300 / FX-410** series side-by-side, please set the same models together in groups.

Mounting

<When using a DIN rail>

How to mount the amplifier

- ① Fit the rear part of the mounting section of the amplifier on a 35 mm **1.378 in** width DIN rail.
- ② Press down the rear part of the mounting section of the unit on the 35 mm **1.378 in** width DIN rail and fit the front part of the mounting section to the DIN rail.

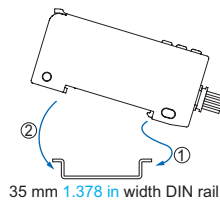

How to remove the amplifier

- ① Push the amplifier forward.
- ② Lift up the front part of the amplifier to remove it.

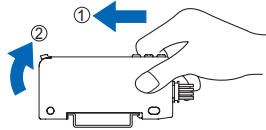

Note: Take care that if the front part is lifted without pushing the amplifier forward, the hook on the rear portion of the mounting section is likely to break.

<When using screws with washers>

- Use M3 screws with washers for mounting. The tightening torque should be 0.5 N·m or less.

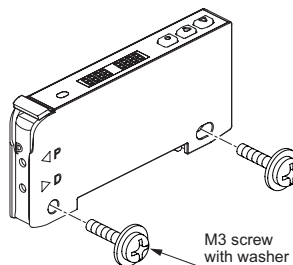

Refer to General precautions, and to the "Operation Guide" on our website for details pertaining to operating instructions for the amplifier.

Wiring

- Make sure that the power supply is OFF while adding or removing the amplifiers.
- Note that if a voltage exceeding the rated range is applied, or if an AC power supply is directly connected, the product may get burnt or damaged.
- Note that short-circuit of the load or wrong wiring may burn or damage the product.
- Do not run the wires together with high-voltage lines or power lines, or put them in the same raceway. This can cause malfunction due to induction.
- Verify that the supply voltage variation is within the rating.
- If power is supplied from a commercial switching regulator, ensure that the frame ground (F.G.) terminal of the power supply is connected to an actual ground.
- In case noise generating equipment (switching regulator, inverter motor, etc.) is used in the vicinity of this product, connect the frame ground (F.G.) terminal of the equipment to an actual ground.
- Make sure to use the quick-connection cable (optional) for the connection of the controller. Extension up to total 100 m **328.084 ft** is possible with 0.3 mm² or more, cable. However, in order to reduce noise, make the wiring as short as possible.

Part description

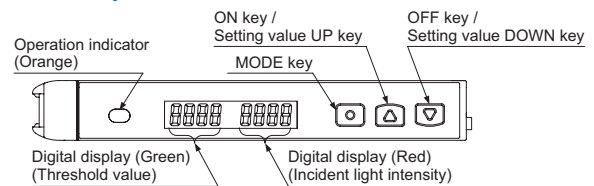

Setting mode

- Setting mode appears after the MODE key is pressed for 2 sec. in RUN mode.

Setting item	Factory setting	Description
Teaching mode	LRch	Threshold value can be set in 2-point teaching, limit teaching, or full-auto teaching.
Output operation setting	L_d d_on [Dark-ON]	Light-ON or Dark-ON can be set.
Timer operation setting	dELY non [Without timer]	Without timer, ON delay timer, or OFF delay timer can be set.
Timer setting	ond 10 [ON-delay timer: 10 ms] ofd 10 [OFF-delay timer: 10 ms]	In case of setting ON-delay timer or OFF-delay timer in the timer operation setting mode, timer can be set. When timer is not set, this mode is not displayed.
Emission amount setting	PEL IIII Level 3	Setting for reduced intensity of emission amount is possible when the incident light intensity is saturated.
Emission frequency setting	FX-101 FrEQ F-0 0 (Response time: 250 μs or less) FX-102 FrEQ F-01 1 (Response time: 2.5 ms or less)	In case of using the fiber heads in parallel, interference can be prevented by setting different emission frequency. However, when emission frequency 0 is set, interference cannot be prevented. Response time corresponds to emission frequency.

FIBER SENSORS

LASER SENSORS

PHOTO-ELECTRIC SENSORS

MICRO PHOTO-ELECTRIC SENSORS

AREA SENSORS

LIGHT CURTAINS

PRESSURE / FLOW SENSORS

INDUCTIVE PROXIMITY SENSORS

PARTICULAR USE SENSORS

SENSOR OPTIONS

SIMPLE WIRE-SAVING UNITS

WIRE-SAVING SYSTEMS

MEASUREMENT SENSORS

STATIC CONTROL DEVICES

ENDOSCOPE

LASER MARKERS

PLC / TERMINALS

HUMAN MACHINE INTERFACES

ENERGY CONSUMPTION VISUALIZATION COMPONENTS

FA COMPONENTS

MACHINE VISION SYSTEMS

UV CURING SYSTEMS

Selection Guide

Fibers

Amplifiers

FX-500

FX-100

FX-300

FX-410

FX-311

FX-301-F7/
FX-301-F

PRECAUTIONS FOR PROPER USE

PRO mode

- PRO mode appears after the MODE key is pressed for 4 sec. in RUN mode.

Setting item	Factory setting	Description
Shift setting	[Shift amount 15 %]	Shift amount can be selected from 0 to 80 % in the limit teaching. Select 0 % when it is desired to set the present incident light intensity as a threshold value.
External input setting	[Emission halt]	External input can be selected from emission halt, limit teaching [+], limit teaching [-], full-auto teaching, ECO (Note 1), 2-point teaching or emission amount test. When setting the incident light intensity test "E-ESE", output turns ON / OFF every 100ms when the rate of incident light intensity and threshold value is less than half of the set shift amount (for example, when the rate of incident light intensity and threshold value is within ±10 % for 20 % of shift amount) at external input.
Threshold value-storing setting mode (Note 2)	[OFF]	Threshold value set at the limit teaching, full-auto teaching or 2-point teaching by external input is stored. When selecting Auto in the emission amount setting mode, the set emission amount level is also stored.
Threshold value follow-up cycle setting (Note 3)	[OFF]	When incident light intensity exceeds threshold value, this mode can change the threshold value with each set cycle depending on variations of the incident light intensity. The follow-up shift amount is same as the one set in the shift setting mode. However, the threshold value is not stored.
GETA function setting (Note 4, 5)	[OFF]	Variations can be reduced by correcting the present incident light intensity in each amplifier to a target value. Target value to offset incident light intensity can be selected from 0 to 2,000 by 100 unit each. For example, if the target value is set to 2,000 when the incident light intensity is 1,500, the incident light intensity becomes 2,000.
ECO setting	[OFF]	It is possible to light up / turn off the digital display. When ECO setting mode is ON, the display turns off in 20 sec. approx. in RUN mode. To light up the display again, press any key for 2 sec. or more.
Digital display inversion setting	[OFF]	Digital display can be inverted.
Threshold value margin setting	[OFF]	Margin for threshold value to the present incident light intensity can be checked. When there is no margin, it is possible to make the digital display blink. OFF : Set to "OFF": does not function. GRN : Green blinks. RED : Red blinks. RLt : Red and green blink. In-t : When conducting limit teaching or 2-point teaching by external input, in case the rate of reference incident light intensity and threshold value after teaching is 200% or more, or in case it is less than half of the shift amount, output turns ON / OFF every 100 ms. (Note 6)
Setting copy	[NO]	The settings of the master side amplifier can be copied to the slave side amplifier. For details, refer to "Setting copy function".
Reset	[NO]	Returns to default settings (factory settings.)

- Notes: 1) When ECO is selected at the external input setting mode, key operation on the main body is invalid during external input.
- 2) This mode is not indicated unless any of "LtcP", "Ltc-", "Ruto" or "2-Pt" is set at the external input setting mode.
- 3) If the incident light intensity becomes "300" or less, the follow-up operation stops. In that condition, threshold value [digital display (green)] blinks. This function can be used when thru-beam type or retroreflective type fiber is applied to this product. If reflective type fiber is applied, the function cannot be used depending on use conditions.
- 4) If MODE key is pressed in RUN mode when GETA function is used, the incident light intensity before setting GETA function is displayed on the red digital display for 2 sec. approx.
- 5) When GETA function is used in saturation of incident light intensity (4,000 or more.), "HRrd" is indicated on the red digital display. Correction value is up to 4,000.
- 6) This mode does not operate unless any of "LtcP", "Ltc-" or "2-Pt" is set at the external input setting mode.

Refer to General precautions, and to the "Operation Guide" on our website for details pertaining to operating instructions for the amplifier.

Setting copy function

- This can copy the settings of the master side amplifier to the slave side amplifier. Refer to the copy unit **SC-SU1** for details.

- Be sure to use the setting copy function between the identical models (Between **FX-101** models or **FX-102** models). This function cannot be used between different models.
- Only one sensor can be connected on slave side with a master side sensor for the setting copy function.
- Threshold value, output operation setting, timer operation setting, timer setting, light-emitting amount setting, shift setting, external input setting, threshold value margin setting, ECO setting, digital display inversion setting, and threshold value margin setting can be copied.

<Setting procedures>

- ① Set the setting copy mode of the master side amplifier to "Copy sending ON", and press the MODE key so that "COPY" is shown on the digital display and the sensor is in copy ready state. For the setting method, refer to "Operation guide".
- ② Turn off the master side amplifier.
- ③ Connect the master side amplifier with the slave side amplifier as shown below.

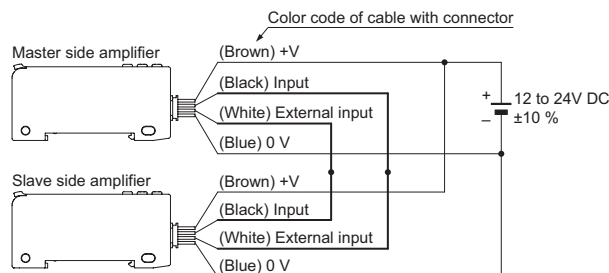

- ④ Turn on the master side amplifier and the slave side amplifier at the same time. (Note)
- ⑤ "COPY" is shown on the green digital display of the master side amplifier and 4-digit code is shown on the red digital display of it, then the copying starts. During copy communication, "COPY" is shown on the green digital display of the slave side amplifier, and the ongoing copy communication indicator ("I" → "H" → "III" → "IIII" → "IIII" → "IIII" → "IIII") is displayed on the red digital display.
- ⑥ When the copying is completed, "GOOD" is shown on the green digital display of the slave side amplifier, while the 4-digit code (the same code as the master side amplifier) is shown on the red digital display of it.
- ⑦ Turn off the power of the master side amplifier and the slave side amplifier and disconnect the wire.

* If copying the settings to another amplifier repeatedly, follow the steps ③ to ⑦.

Note: Take care that if the power is not turned on at the same time, the setting contents may not be copied.

<To cancel the setting copy mode of the master side amplifier>

- ① While the slave side amplifier is disconnected, turn on the power of the master side amplifier.
- ② Press the MODE key for 2 sec. approx.

PRECAUTIONS FOR PROPER USE

Others

- Do not use during the initial transient time (0.5 sec.) after the power supply is switched on.
- Take care that the product is not directly exposed to fluorescent lamp from a rapid-starter lamp, a high frequency lighting device or sunlight etc., as it may affect the sensing performance.
- This product is suitable for indoor use only.
- Avoid dust, dirt, and steam.
- Take care that the product does not come in contact with oil, grease, organic solvents, such as thinner, etc., strong acid or alkaline.
- This product cannot be used in an environment containing inflammable or explosive gases.
- Never disassemble or modify this product.
- EEPROM is adopted to this product. It is not possible to conduct teaching 100 thousand times or more, because of the EEPROM's lifetime.

Quick setting function

- The quick setting function makes it possible to set the content of the SET Mode (output operation, timer operation, amount of light emitted, and frequency of light emitted) simply by selecting a setting number.
- While in the RUN Mode, pressing and holding both the ON key (⏻) and OFF key (⏷) simultaneously for 2 seconds will switch to the quick setting function.

<Table of quick setting numbers>

No.	Output operation	Timer	Emission amount setting
-00-	D-ON	non	Level 3 (OFF)
-01-	D-ON	non	Level 2 (ON)
-02-	D-ON	ofd 10 ms	Level 3 (OFF)
-03-	D-ON	ofd 10 ms	Level 2 (ON)
-04-	D-ON	ofd 40 ms	Level 3 (OFF)
-05-	D-ON	ofd 40 ms	Level 2 (ON)
-06-	D-ON	ond 10 ms	Level 3 (OFF)
-07-	D-ON	ond 10 ms	Level 2 (ON)
-08-	D-ON	ond 40 ms	Level 3 (OFF)
-09-	D-ON	ond 40 ms	Level 2 (ON)
-10-	L-ON	ond 40 ms	Level 2 (ON)
-11-	L-ON	ond 40 ms	Level 3 (OFF)
-12-	L-ON	ond 10 ms	Level 2 (ON)
-13-	L-ON	ond 10 ms	Level 3 (OFF)
-14-	L-ON	ofd 40 ms	Level 2 (ON)
-15-	L-ON	ofd 40 ms	Level 3 (OFF)
-16-	L-ON	ofd 10 ms	Level 2 (ON)
-17-	L-ON	ofd 10 ms	Level 3 (OFF)
-18-	L-ON	non	Level 2 (ON)
-19-	L-ON	non	Level 3 (OFF)

Refer to General precautions, and to the "Operation Guide" on our website for details pertaining to operating instructions for the amplifier.

Code setting function

- The code setting function makes it possible to set the output operation, timer operation, amount of light emitted, frequency of light emitted, ECO setting, external input, and amount of shift by selecting a code of one's choice.
- While in the RUN Mode, pressing and holding both the ON key (⏻) and OFF key (⏷) simultaneously for 4 seconds will switch to the code setting function.

<Code table>



Code	1st digit		2nd digit		ECO	3rd digit	4th digit	
	Output operation	Timer (Note 1)	Emission frequency					
			FX-101□	FX-102□				
0	D-ON	non	Level 3 (OFF)	0	1	OFF	Emission halt	5 %
1		ond 10 ms		1	2		Limit teaching [+]	10 %
2		ond 40 ms		2	3		Limit teaching [-]	15 %
3		ofd 10 ms		3	4		Full-auto teaching	20 %
4	L-ON	ofd 40 ms	Level 2 (ON)	0	1	ON	ECO	25 %
5		non		1	2		Emission halt	30 %
6		ond 10 ms		2	3		Limit teaching [+]	35 %
7		ond 40 ms		3	4		Limit teaching [-]	40 %
8	Auto	ofd 10 ms	Level 1	0	1	OFF	Full-auto teaching	45 %
9		ofd 40 ms		1	2		ECO	50 %
a				2	3		2-point teaching	
b				3	4		Incident light intensity test	
c	Auto		Auto	0	1	ON	2-point teaching	
d				1	2		Incident light intensity test	
e				2	3			
f				3	4			

Notes: 1) When the present setting is out of the code setting range, "-" is shown. When "-" is selected, the set content of the digit is not changed.
 2) The factory setting is "0002".

FIBER SENSORS

LASER SENSORS

PHOTO-ELECTRIC SENSORS

MICRO PHOTO-ELECTRIC SENSORS

AREA SENSORS

LIGHT CURTAINS

PRESSURE / FLOW SENSORS

INDUCTIVE PROXIMITY SENSORS

PARTICULAR USE SENSORS

SENSOR OPTIONS

SIMPLE WIRE-SAVING UNITS

WIRE-SAVING SYSTEMS

MEASUREMENT SENSORS

STATIC CONTROL DEVICES

ENDOSCOPE

LASER MARKERS

PLC / TERMINALS

HUMAN MACHINE INTERFACES

ENERGY CONSUMPTION VISUALIZATION COMPONENTS

FA COMPONENTS

MACHINE VISION SYSTEMS

UV CURING SYSTEMS

Selection Guide

Fibers

Amplifiers

FX-500

FX-100

FX-300

FX-410

FX-311

FX-301-F7/
FX-301-F

DIMENSIONS (Unit: mm in)

The CAD data in the dimensions can be downloaded from our website.

FX-101□ FX-102□ Amplifier

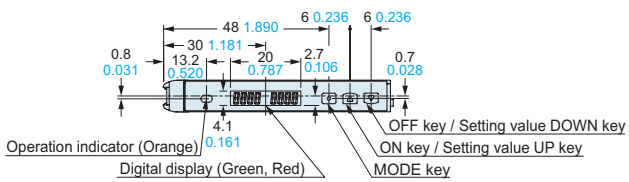

FX-101(P)-Z FX-102(P)-Z Amplifier

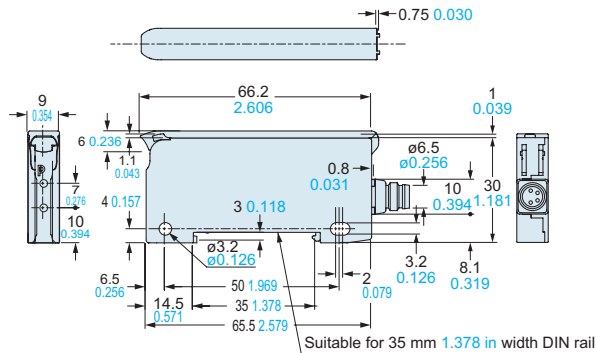
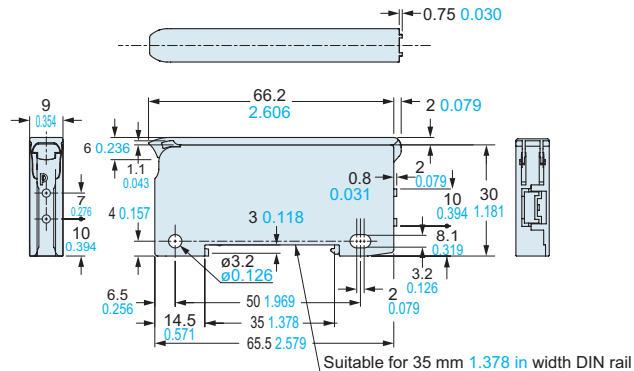
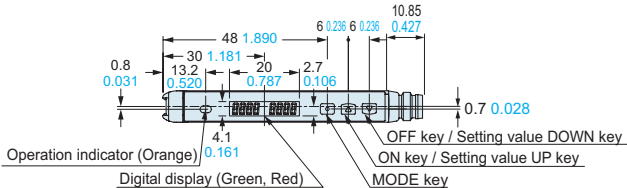

MS-DIN-4 Amplifier mounting bracket (Optional)

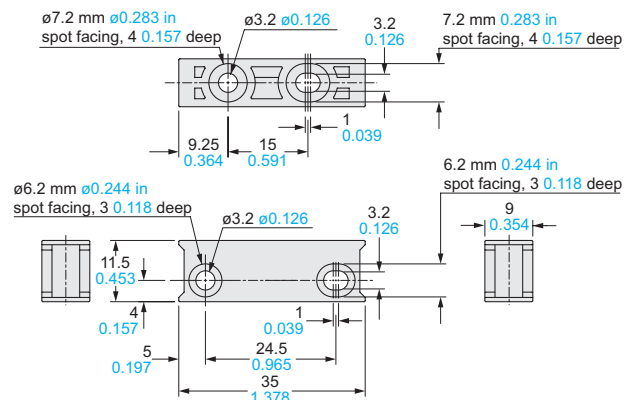

MS-DIN-E End plate (Optional)

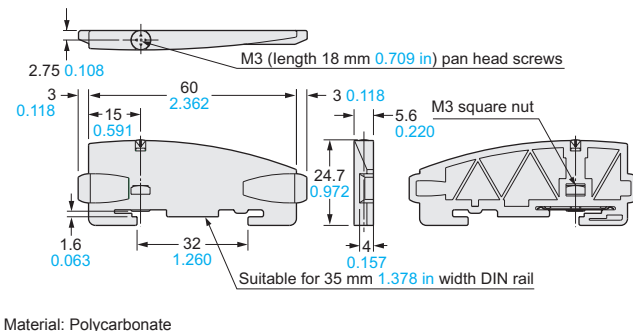

CN-14A-C□ CN-14A-R-C□ Connector attached cable (Optional)

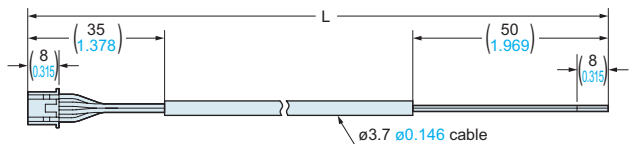

CN-14A-C2 is attached **FX-101(P)-CC2 / FX-102(P)-CC2**

• Length L

Model No.	Length L
CN-14A(-R)-C1	1,000 39.370
CN-14A(-R)-C2	2,000 78.740
CN-14A(-R)-C3	3,000 118.110
CN-14A(-R)-C5	5,000 196.850

- FIBER SENSORS
- LASER SENSORS
- PHOTO-ELECTRIC SENSORS
- MICRO PHOTO-ELECTRIC SENSORS
- AREA SENSORS
- LIGHT CURTAINS
- PRESSURE / FLOW SENSORS
- INDUCTIVE PROXIMITY SENSORS
- PARTICULAR USE SENSORS
- SENSOR OPTIONS
- SIMPLE WIRE-SAVING UNITS
- WIRE-SAVING SYSTEMS
- MEASUREMENT SENSORS
- STATIC CONTROL DEVICES
- ENDOSCOPE
- LASER MARKERS
- PLC / TERMINALS
- HUMAN MACHINE INTERFACES
- ENERGY CONSUMPTION VISUALIZATION COMPONENTS
- FA COMPONENTS
- MACHINE VISION SYSTEMS
- UV CURING SYSTEMS
- Selection Guide
- Fibers
- Amplifiers
- FX-500
- FX-100
- FX-300
- FX-410
- FX-311
- FX-301-F7 / FX-301-F

MEMO

