

Stepper Motors

Overview,
Product
Series

AC Input
Motor &
Driver

0.36°/Geared
Q_{STEP}
AR

0.36°/Geared
Q_{STEP}
Absolute
AZ

0.72°/Geared
RKII

DC Input
Motor &
Driver

0.36°/Geared
Q_{STEP}
AR

0.36°/Geared
Q_{STEP}
Absolute
AZ

0.72°/0.36°
/Geared
CRK

1.8°/Geared
RBK

1.8°/0.9°
/Geared
CMK

0.72°
All-in-One
PKA

Motor Only

1.8°, 0.9°
PKP Series/PK Series

1.8°/0.9°
PKP/PK

Geared
PKP Series

Geared
PKP

0.72°, 0.36°
PKP Series

0.72°/0.36°
PKP

Accessories

Page

1.8°, 0.9° PKP Series/PK Series	A-234
Geared PKP Series	A-256
0.72°, 0.36° PKP Series	A-266

1.8°/0.9°/Geared Stepper Motors PKP Series/PK Series

<Additional Information>

- Technical reference → Page H-1
- Regulations & Standards → Page I-2

● For detailed information about regulations and standards, please see the Oriental Motor website.

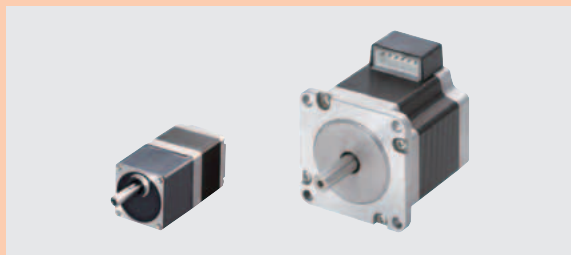

View Expanded Product Information, Specifications, CAD, Accessories & more online. Visit www.orientalmotor.com/catalog or use the QR code and select "1.8°/0.9°/Geared Stepper Motor PKP/PK Series".

High-Torque 1.8°, 0.9 and Spur Gear (**SH** Type) stepper motors, offer the optimum performance and value. In addition to offering high torque, the **PKP/PK** Series stepper motors offer more variety of electrical specifications, more frame sizes and encoder products for the right solution in stepper motors.

- **PKP** Series Offers 1.2~1.7 Times More Torque
- **1.8°** (200 pulse/rev) & **0.9°** (400 pulse/rev)
- **SH** Geared (Spur) Type for Inertia Matching & Higher Torque
- Bipolar (4 lead wires) or Unipolar (5 or 6 lead wires) Available
- Encoders Standard – 200 or 400 Lines of Resolution

Features

Standard Type

By using a high-torque motor, a torque increase of 1.2 to 1.7 times the **PK** Series standard type of the same size (max. holding torque) has been achieved.

Speed - Torque Characteristics Comparison of the Same Size

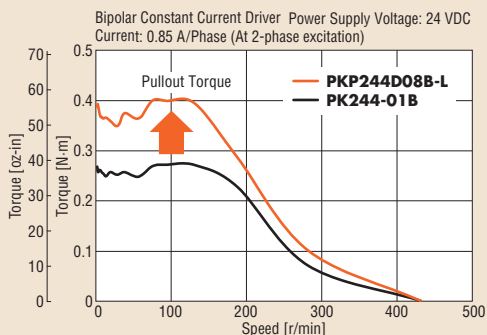

Max. Holding Torque Comparison

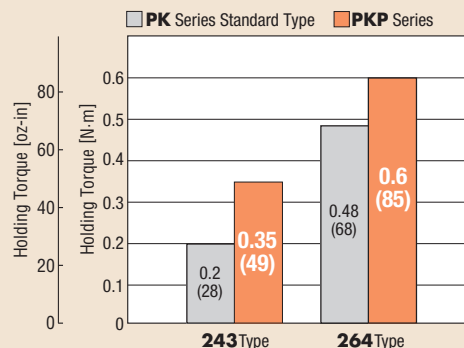

● The Advantages of Using a High-Torque Motor

● Reduced Power Consumption and Heat Output

If the running current of a **PKP** Series motor is decreased and the motor is operated at the same torque as the **PK** Series standard type, current consumption and heat output can be reduced.

Characteristics Diagrams of Decreased Running Current in PKP Series Motors

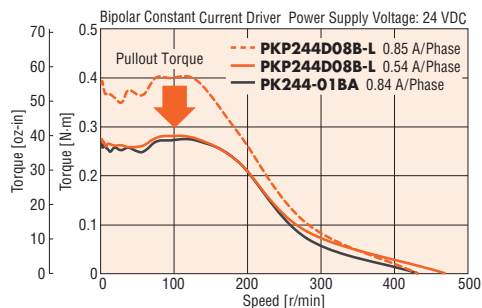

Power consumption can be reduced

Comparison of driver power consumption when low-speed torque is tailored to the **PK** Series standard type

Power consumption reduced by **20%** (at low speed)

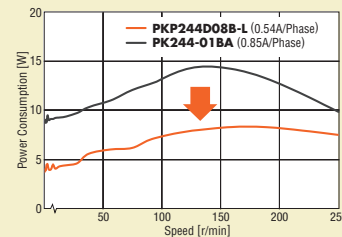

Heat Output can be reduced

Comparison of motor surface heat output when low-speed torque is tailored to the **PK** Series standard type

Temperature increases of **10°C (18°F)** and more are suppressed

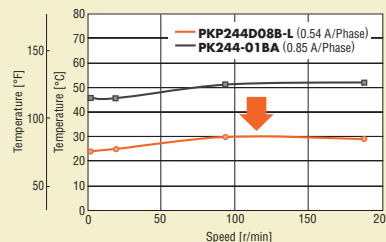

• **Downsizing**

The **PKP** Series provides torque equivalent to a motor of the next larger frame size, contributing to downsizing of equipment.

Torque Characteristics Comparison of **PKP244D15A-L** and **PK264-02A**

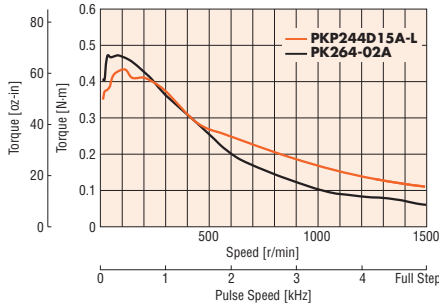

Provides torque equivalent to the next larger frame size!

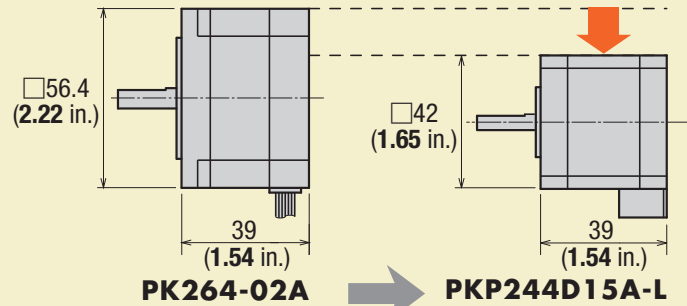

High-Resolution Type (0.9°/Step)

This is a high resolution stepper motor with a basic step angle of 0.9°. Stopping accuracy is improved.

● **Increased Resolution (Compared to Standard Type)**

The number of rotor teeth has doubled to 100 compared to 50 with the standard type. As a result, the basic step angle becomes 0.9°/step, which is half that of the standard type.

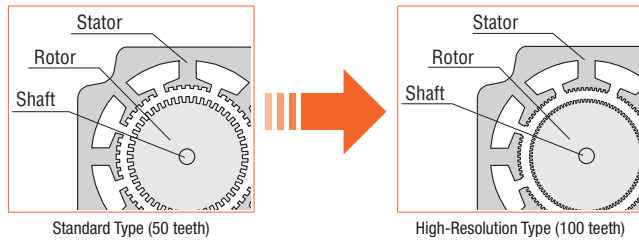

● **Avoidance of Resonance Regions**

If the pulse speed is within a resonance region, vibration may increase. Resonance regions can be avoided by switching to a 0.9° high-resolution type stepper motor.

● **Improved Stopping Accuracy (Compared to Standard Type)**

The stopping accuracy improves as the torque increases while minimizing the negative effect of the frictional load.

Comparison of Angle – Torque Characteristics

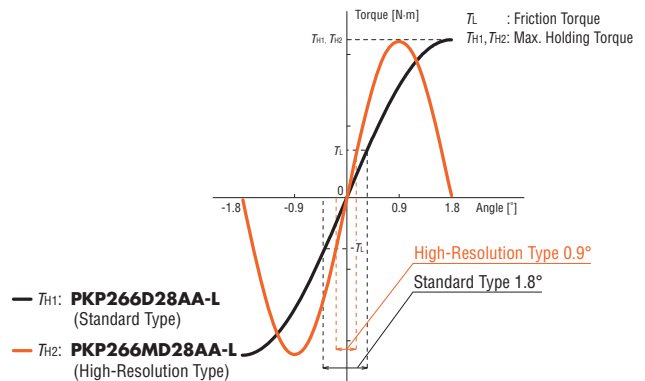

SH Geared Type

The **SH** geared type is effective for reducing speed, increasing torque, achieving higher resolution and reducing vibration.

● **Broader Permissible Speed Range than Conventional Products**

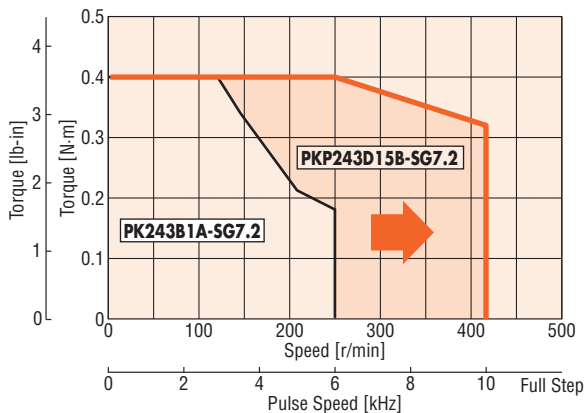

● **Backlash Accuracy Guaranteed**

Backlash, which was a reference value in conventional products, is now a specification value.

Unit = arcmin (degrees)

Frame Size \ Gear Ratio	3.6	7.2	9	10	18	36
28 mm (1.10 in.)	—	—	—	90 (1.5°)	—	—
42 mm (1.65 in.)	—	90 (1.5°)	—	60 (1°)	—	—
60 mm (2.36 in.)	—	70 (1.17°)	—	45 (0.75°)	—	—

Overview, Product Series

AC Input Motor & Driver

0.36°/Geared **Q_{STEP} AR**

0.36°/Geared **Q_{STEP} Absolute AZ**

0.72°/Geared **RKII**

DC Input Motor & Driver

0.36°/Geared **Q_{STEP} AR**

0.36°/Geared **Q_{STEP} Absolute AZ**

0.72°/0.36°/Geared **CRK**

1.8°/Geared **RBK**

1.8°/0.9°/Geared **CMK**

0.72° All-in-One **PKA**

Motor Only

1.8°/0.9° **PKP/PK**

Geared **PKP**

0.72°/0.36° **PKP**

Accessories

Product Line Equipped with Additional Functions to Further Broaden Applications

● Motor Connection*1 / Configuration

◇ Motor Connector

Motor lead wire connector can be inserted*1 and the locking mechanism prevents accidental removal*2.

◇ Wiring Configuration Options

Bipolar – 4 lead wires

Unipolar – 6 lead wires*1

*1 Except for motor frame size of 20 mm (0.79 in.)

*2 Only motor frame sizes of 35 mm (1.38 in.), 42 mm (1.65 in.), 56.4 mm (2.22 in.) and 60 mm (2.36 in.)

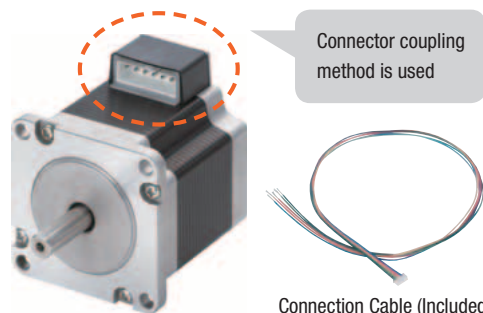

● Encoder Option

An Incremental Encoder is offered as a standard product with TTL output.

200 or 400 lines of resolution are available, with 2-channel or 3-channel encoder.

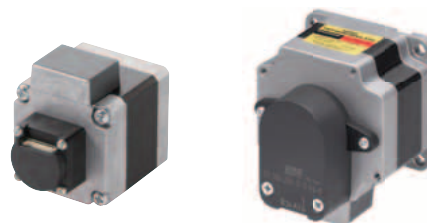

Product Line of Motors

Motor Product Line (Basic Step Angle)	Series/Frame Size, Wiring Type											
	PKP 20 mm (0.79 in.)		PKP 28 mm (1.10 in.)		PKP 35 mm (1.38 in.)		PKP 42 mm (1.65 in.)		PKP 56.4 (60*1) mm [2.22 (2.36) in.]		PK 85 (90*1) mm [3.35 (3.54) in.]	
	Bipolar	Unipolar	Bipolar	Unipolar	Bipolar	Unipolar	Bipolar	Unipolar	Bipolar	Unipolar	Bipolar	Unipolar
Standard Type (1.8°)	●	●	●	●	●	●	●	●	●	●	●	●
 With Encoder	●	●	–	–	●	●	●	●	●	●	●	–
High-Resolution Type (0.9°)	–	–	–	–	–	–	●	●	●	●	–	–
SH Geared Type (0.5°~0.05°)	–	–	●	●	–	–	●	●	●	●	–	●*2

*1 **SH** Geared type

*2 See website for 90 mm (3.54 in.) **SH** Geared type product name, specifications and drawings.

● For unipolar specifications, please see the Oriental Motor website.

System Configuration

These accessories allow 1.8°/0.9°/Geared stepper motors to be used for various operations.

* Not supplied

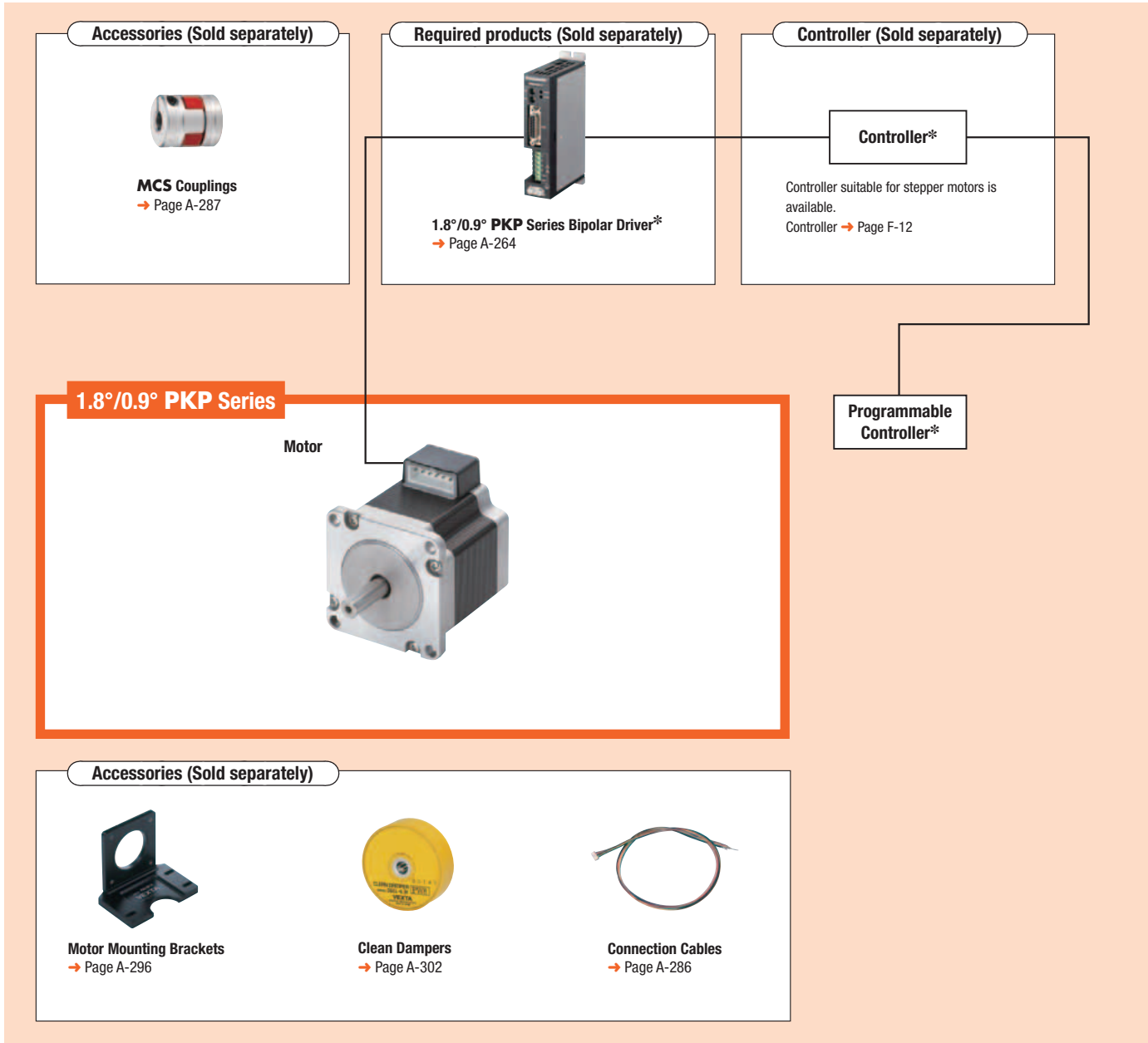

Overview, Product Series

AC Input Motor & Driver

0.36°/Geared *Q_{STEP}* AR

0.36°/Geared *Q_{STEP}* Absolute AZ

0.72°/Geared RKII

DC Input Motor & Driver

0.36°/Geared *Q_{STEP}* AR

0.36°/Geared *Q_{STEP}* Absolute AZ

0.72°/0.36°/Geared CRK

1.8°/Geared RBK

1.8°/0.9°/Geared CMK

0.72° All-in-One PKA

Motor Only

1.8°/0.9° PKP/PK

Geared PKP

0.72°/0.36° PKP

Accessories

● Example of System Configuration

1.8°/0.9° PKP Series	Sold Separately		
	Motor Mounting Bracket	Flexible Coupling	Clean Damper
PKP264D28BA-L \$58.00	PAL2P-2 \$17.00	MCS20F0408 \$50.00	D6CL-6.3F \$42.00

● The system configuration shown above is an example. Other combinations are also available.

Product Number

● **PKP Series**

◇ Standard Type, High-Resolution Type

PKP 2 6 4 M D 28 A A-L

① ② ③ ④ ⑤ ⑥ ⑦ ⑧ ⑨ ⑩

①	Series Name	PKP: PKP Series	
②	2: 2-phase		
③	Motor Frame Size	1: 20 mm (0.79 in.) 3: 35 mm (1.38 in.) 6: 56.4 mm (2.22 in.)	2: 28 mm (1.10 in.) 4: 42 mm (1.65 in.)
④	Motor Case Length		
⑤	Motor Type	M: High-Resolution Type Blank: Standard Type	
⑥	Winding Type	D: Bipolar U: Unipolar	
⑦	Winding Specification		
⑧	Configuration	A: Single Shaft B: Double Shaft	
⑨	U.S.A. Version (Inch shaft)	A: Imperial Blank: Metric	
⑩	Connection Cable	L: Included Connection Cable	

◇ Standard Type with Encoder

Motor Frame Size 20 mm (0.79 in.)

PKP 2 1 3 D 15 A - R2E - L

① ② ③ ④ ⑤ ⑥ ⑦ ⑧ ⑨

①	Series Name	PKP: PKP Series	
②	2: 2-phase		
③	Motor Frame Size	1: 20 mm (0.79 in.)	
④	Motor Case Length		
⑤	Winding Type	D: Bipolar U: Unipolar	
⑥	Winding Specification		
⑦	Configuration	A: Single Shaft	
⑧	Encoder Resolution	R2E: 200 P/R	
⑨	Connection Cable	L: Included Connection Cable	

Motor Frame Size

35 mm (1.38 in.), 42 mm (1.65 in.), 56.4 mm (2.22 in.)

PKP 2 6 4 U10 A A-R 1 5-L

① ② ③ ④ ⑤ ⑥ ⑦ ⑧ ⑨ ⑩ ⑪ ⑫

①	Series Name	PKP: PKP Series	
②	2: 2-phase		
③	Motor Frame Size	3: 35 mm (1.38 in.) 6: 56.4 mm (2.22 in.)	4: 42 mm (1.65 in.)
④	Motor Case Length		
⑤	Winding Type	D: Bipolar U: Unipolar	
⑥	Winding Specification		
⑦	Configuration	A: Single Shaft	
⑧	U.S.A. Version (Inch shaft)	A: Imperial Blank: Metric	
⑨	Encoder Version		
⑩	Encoder Output	1: 2-Channel A, B 2: 3-Channel A, B, Index	
⑪	Encoder Resolution	5: 200 R/P 6: 400 R/P	
⑫	Connection Cable	L: Included Connection Cable	

◇ **SH Geared Type**

PKP 2 4 3 U 09 B-SG 18-L

① ② ③ ④ ⑤ ⑥ ⑦ ⑧ ⑨ ⑩

①	Series Name	PKP: PKP Series	
②	2: 2-phase		
③	Motor Frame Size	2: 28 mm (1.10 in.) 6: 60 mm (2.36 in.)	4: 42 mm (1.65 in.)
④	Motor Case Length		
⑤	Winding Type	D: Bipolar U: Unipolar	
⑥	Winding Specification		
⑦	Configuration	A: Single Shaft B: Double Shaft	
⑧	Gearhead Type	SG: SH Geared Type	
⑨	Gear Ratio		
⑩	Connection Cable	L: Included Connection Cable	

● **PK Series**

◇ Standard Type

PK 2 9 6 D B A

① ② ③ ④ ⑤ ⑥ ⑦

①	Series Name	PK: PK Series	
②	2: 2-phase		
③	Motor Frame Size	9: 85 mm (3.35 in.)	
④	Motor Case Length		
⑤	Winding Type	D: Bipolar	
⑥	Configuration	A: Single Shaft B: Double Shaft	
⑦	U.S.A. Version (Inch shaft)		

◇ Standard Type with Encoder

PK 2 9 6 D A A R 1 5

① ② ③ ④ ⑤ ⑥ ⑦ ⑧ ⑨ ⑩

①	Series Name	PK: PK Series	
②	2: 2-phase		
③	Motor Frame Size	9: 85 mm (3.35 in.)	
④	Motor Case Length		
⑤	Winding Type	D: Bipolar	
⑥	Configuration	A: Single Shaft	
⑦	U.S.A. Version (Inch shaft)		
⑧	Encoder Version		
⑨	Encoder Output	1: 2 Channel 2: 3 Channel	
⑩	Encoder Resolution	5: 200 R/P 6: 400 R/P	

◇ **SH Geared Type**

PK 2 9 6 A 1 - SG 18

① ② ③ ④ ⑤ ⑥ ⑦ ⑧

①	Series Name	PK: PK Series	
②	2: 2-phase		
③	Motor Frame Size	9: 85 mm (3.35 in.)	
④	Motor Case Length		
⑤	Configuration	A: Single Shaft B: Double Shaft	
⑥	Winding Specification		
⑦	Gearhead Type	SG: SH Geared Type	
⑧	Gear Ratio		

Product Line

● Standard Type, Standard Type with Encoder (1.8°)

◇ Bipolar

Product Name (Single Shaft)	List Price	Product Name (Double Shaft)	List Price
PKP213D05A	\$65.00	PKP213D05B	\$67.00
PKP214D06A	\$72.00	PKP214D06B	\$74.00
PKP223D06A-L	\$46.00	PKP223D06B-L	\$48.00
PKP223D15A-L	\$50.00	PKP223D15B-L	\$52.00
PKP224D06A-L	\$49.00	PKP224D06B-L	\$51.00
PKP224D15A-L	\$54.00	PKP224D15B-L	\$56.00
PKP225D06A-L	\$54.00	PKP225D06B-L	\$56.00
PKP225D15A-L	\$57.00	PKP225D15B-L	\$59.00
PKP233D08A-L	\$45.00	PKP233D08B-L	\$47.00
PKP233D15A-L	\$48.00	PKP233D15B-L	\$50.00
PKP235D08A-L	\$52.00	PKP235D08B-L	\$54.00
PKP235D15A-L	\$55.00	PKP235D15B-L	\$57.00
PKP243D02A-L	\$46.00	PKP243D02B-L	\$48.00
PKP243D04A-L	\$46.00	PKP243D04B-L	\$48.00
PKP243D06A-L	\$46.00	PKP243D06B-L	\$48.00
PKP243D15A-L	\$48.00	PKP243D15B-L	\$50.00
PKP244D02A-L	\$47.00	PKP244D02B-L	\$49.00
PKP244D05A-L	\$47.00	PKP244D05B-L	\$49.00
PKP244D08A-L	\$47.00	PKP244D08B-L	\$49.00
PKP244D15A-L	\$49.00	PKP244D15B-L	\$51.00
PKP245D03A-L	\$53.00	PKP245D03B-L	\$55.00
PKP245D05A-L	\$53.00	PKP245D05B-L	\$55.00
PKP245D08A-L	\$53.00	PKP245D08B-L	\$55.00
PKP245D15A-L	\$55.00	PKP245D15B-L	\$57.00
PKP246D08A-L	\$55.00	PKP246D08B-L	\$57.00
PKP246D15A-L	\$57.00	PKP246D15B-L	\$59.00
PKP264D07AA-L	\$56.00	PKP264D07BA-L	\$58.00
PKP264D14AA-L	\$56.00	PKP264D14BA-L	\$58.00
PKP264D21AA-L	\$56.00	PKP264D21BA-L	\$58.00
PKP264D28AA-L	\$56.00	PKP264D28BA-L	\$58.00
PKP264D42AA-L	\$56.00	PKP264D42BA-L	\$58.00
PKP266D07AA-L	\$62.00	PKP266D07BA-L	\$64.00
PKP266D14AA-L	\$62.00	PKP266D14BA-L	\$64.00
PKP266D21AA-L	\$62.00	PKP266D21BA-L	\$64.00
PKP266D28AA-L	\$62.00	PKP266D28BA-L	\$64.00
PKP266D42AA-L	\$62.00	PKP266D42BA-L	\$64.00
PKP268D07AA-L	\$78.00	PKP268D07BA-L	\$80.00
PKP268D14AA-L	\$78.00	PKP268D14BA-L	\$80.00
PKP268D21AA-L	\$78.00	PKP268D21BA-L	\$80.00
PKP268D28AA-L	\$78.00	PKP268D28BA-L	\$80.00
PKP268D42AA-L	\$78.00	PKP268D42BA-L	\$80.00
PK296DAA	\$137.00	PK296DBA	\$141.00
PK299DAA	\$205.00	PK299DBA	\$211.00
PK2913DAA	\$299.00	PK2913DBA	\$308.00

◇ Bipolar with Encoder

Product Name (2ch Encoder)	List Price	Product Name (3ch Encoder)	List Price
PKP213D05A-R2E-L	\$148.00	-	-
PKP214D06A-R2E-L	\$155.00	-	-
PKP233D08A-R1□-L	\$121.00	PKP233D08A-R2□-L	\$131.00
PKP233D15A-R1□-L	\$121.00	PKP233D15A-R2□-L	\$131.00
PKP235D08A-R1□-L	\$130.00	PKP235D08A-R2□-L	\$140.00
PKP235D15A-R1□-L	\$130.00	PKP235D15A-R2□-L	\$140.00
PKP243D02A-R1□-L	\$123.00	PKP243D02A-R2□-L	\$133.00
PKP243D04A-R1□-L	\$123.00	PKP243D04A-R2□-L	\$133.00
PKP243D06A-R1□-L	\$123.00	PKP243D06A-R2□-L	\$133.00
PKP243D15A-R1□-L	\$123.00	PKP243D15A-R2□-L	\$133.00
PKP244D02A-R1□-L	\$124.00	PKP244D02A-R2□-L	\$134.00
PKP244D05A-R1□-L	\$124.00	PKP244D05A-R2□-L	\$134.00
PKP244D08A-R1□-L	\$124.00	PKP244D08A-R2□-L	\$134.00
PKP244D15A-R1□-L	\$124.00	PKP244D15A-R2□-L	\$134.00
PKP245D03A-R1□-L	\$133.00	PKP245D03A-R2□-L	\$143.00
PKP245D05A-R1□-L	\$133.00	PKP245D05A-R2□-L	\$143.00
PKP245D08A-R1□-L	\$133.00	PKP245D08A-R2□-L	\$143.00
PKP245D15A-R1□-L	\$133.00	PKP245D15A-R2□-L	\$143.00
PKP246D08A-R1□-L	\$135.00	PKP246D08A-R2□-L	\$145.00
PKP246D15A-R1□-L	\$135.00	PKP246D15A-R2□-L	\$145.00
PKP264D07AA-R1□-L	\$138.00	PKP264D07AA-R2□-L	\$148.00
PKP264D14AA-R1□-L	\$138.00	PKP264D14AA-R2□-L	\$148.00
PKP264D21AA-R1□-L	\$138.00	PKP264D21AA-R2□-L	\$148.00
PKP264D28AA-R1□-L	\$138.00	PKP264D28AA-R2□-L	\$148.00
PKP266D07AA-R1□-L	\$144.00	PKP266D07AA-R2□-L	\$154.00
PKP266D14AA-R1□-L	\$144.00	PKP266D14AA-R2□-L	\$154.00
PKP266D21AA-R1□-L	\$144.00	PKP266D21AA-R2□-L	\$154.00
PKP266D28AA-R1□-L	\$144.00	PKP266D28AA-R2□-L	\$154.00
PKP268D07AA-R1□-L	\$164.00	PKP268D07AA-R2□-L	\$174.00
PKP268D14AA-R1□-L	\$164.00	PKP268D14AA-R2□-L	\$174.00
PKP268D21AA-R1□-L	\$164.00	PKP268D21AA-R2□-L	\$174.00
PKP268D28AA-R1□-L	\$164.00	PKP268D28AA-R2□-L	\$174.00
PK296DAAR1□	\$203.00	PK296DAAR2□	\$213.00
PK299DAAR1□	\$273.00	PK299DAAR2□	\$283.00
PK2913DAAR1□	\$370.00	PK2913DAAR2□	\$380.00

● Either 5 (200 P/R) or 6 (400 P/R) indicating the encoder resolution is entered where the box □ is located within the product name.

Overview, Product Series

AC Input Motor & Driver

0.36°/Geared
Q_{STEP}
AR

0.36°/Geared
Q_{STEP}
Absolute
AZ

0.72°/Geared
RKII

DC Input Motor & Driver

0.36°/Geared
Q_{STEP}
AR

0.36°/Geared
Q_{STEP}
Absolute
AZ

0.72°/0.36°
/Geared
CRK

1.8°/Geared
RBK

1.8°/0.9°
/Geared
CMK

0.72°
All-in-One
PKA

Motor Only

1.8°/0.9°
PKP/PK

Geared
PKP

0.72°/0.36°
PKP

Accessories

The following items are included with each product.

Motor, Motor Connection Cable*1, Encoder Connection Cable*2, Operating Manual

*1 Only for connector-coupled motor

*2 Only for products with an encoder (PK29 DAAR encoder cable sold separately)

● High-Resolution Type (0.9°)

◇ Bipolar

Product Name (Single Shaft)	List Price	Product Name (Double Shaft)	List Price
PKP243MD06A-L	\$46.00	PKP243MD06B-L	\$48.00
PKP243MD15A-L	\$48.00	PKP243MD15B-L	\$50.00
PKP244MD08A-L	\$47.00	PKP244MD08B-L	\$49.00
PKP244MD15A-L	\$49.00	PKP244MD15B-L	\$51.00
PKP264MD14AA-L	\$56.00	PKP264MD14BA-L	\$58.00
PKP264MD28AA-L	\$56.00	PKP264MD28BA-L	\$58.00
PKP266MD14AA-L	\$62.00	PKP266MD14BA-L	\$64.00
PKP266MD28AA-L	\$62.00	PKP266MD28BA-L	\$64.00
PKP268MD14AA-L	\$78.00	PKP268MD14BA-L	\$80.00
PKP268MD28AA-L	\$78.00	PKP268MD28BA-L	\$80.00

● SH Geared Type

◇ Bipolar

Product Name (Single Shaft)	List Price	Product Name (Double Shaft)	List Price
PKP223D06A-SG7.2-L	\$168.00	PKP223D06B-SG7.2-L	\$170.00
PKP223D06A-SG9-L	\$168.00	PKP223D06B-SG9-L	\$170.00
PKP223D06A-SG10-L	\$168.00	PKP223D06B-SG10-L	\$170.00
PKP223D06A-SG18-L	\$182.00	PKP223D06B-SG18-L	\$184.00
PKP223D06A-SG36-L	\$182.00	PKP223D06B-SG36-L	\$184.00
PKP223D15A-SG7.2-L	\$168.00	PKP223D15B-SG7.2-L	\$170.00
PKP223D15A-SG9-L	\$168.00	PKP223D15B-SG9-L	\$170.00
PKP223D15A-SG10-L	\$168.00	PKP223D15B-SG10-L	\$170.00
PKP223D15A-SG18-L	\$182.00	PKP223D15B-SG18-L	\$184.00
PKP223D15A-SG36-L	\$182.00	PKP223D15B-SG36-L	\$184.00
PKP243D06A-SG3.6-L	\$157.00	PKP243D06B-SG3.6-L	\$159.00
PKP243D06A-SG7.2-L	\$157.00	PKP243D06B-SG7.2-L	\$159.00
PKP243D06A-SG9-L	\$157.00	PKP243D06B-SG9-L	\$159.00
PKP243D06A-SG10-L	\$157.00	PKP243D06B-SG10-L	\$159.00
PKP243D06A-SG18-L	\$177.00	PKP243D06B-SG18-L	\$179.00
PKP243D06A-SG36-L	\$177.00	PKP243D06B-SG36-L	\$179.00
PKP243D15A-SG3.6-L	\$157.00	PKP243D15B-SG3.6-L	\$159.00
PKP243D15A-SG7.2-L	\$157.00	PKP243D15B-SG7.2-L	\$159.00
PKP243D15A-SG9-L	\$157.00	PKP243D15B-SG9-L	\$159.00
PKP243D15A-SG10-L	\$157.00	PKP243D15B-SG10-L	\$159.00
PKP243D15A-SG18-L	\$177.00	PKP243D15B-SG18-L	\$179.00
PKP243D15A-SG36-L	\$177.00	PKP243D15B-SG36-L	\$179.00
PKP264D07A-SG3.6-L	\$160.00	PKP264D07B-SG3.6-L	\$163.00
PKP264D07A-SG7.2-L	\$160.00	PKP264D07B-SG7.2-L	\$163.00
PKP264D07A-SG9-L	\$160.00	PKP264D07B-SG9-L	\$163.00
PKP264D07A-SG10-L	\$160.00	PKP264D07B-SG10-L	\$163.00
PKP264D07A-SG18-L	\$169.00	PKP264D07B-SG18-L	\$172.00
PKP264D07A-SG36-L	\$169.00	PKP264D07B-SG36-L	\$172.00
PKP264D14A-SG3.6-L	\$160.00	PKP264D14B-SG3.6-L	\$163.00
PKP264D14A-SG7.2-L	\$160.00	PKP264D14B-SG7.2-L	\$163.00
PKP264D14A-SG9-L	\$160.00	PKP264D14B-SG9-L	\$163.00
PKP264D14A-SG10-L	\$160.00	PKP264D14B-SG10-L	\$163.00
PKP264D14A-SG18-L	\$169.00	PKP264D14B-SG18-L	\$172.00
PKP264D14A-SG36-L	\$169.00	PKP264D14B-SG36-L	\$172.00
PKP264D28A-SG3.6-L	\$160.00	PKP264D28B-SG3.6-L	\$163.00
PKP264D28A-SG7.2-L	\$160.00	PKP264D28B-SG7.2-L	\$163.00
PKP264D28A-SG9-L	\$160.00	PKP264D28B-SG9-L	\$163.00
PKP264D28A-SG10-L	\$160.00	PKP264D28B-SG10-L	\$163.00
PKP264D28A-SG18-L	\$169.00	PKP264D28B-SG18-L	\$172.00
PKP264D28A-SG36-L	\$169.00	PKP264D28B-SG36-L	\$172.00

The following items are included with each product.

Motor, Connection Cable*, Operating Manual

*Only for connector-coupled motor

● Standard Type, Standard Type with Encoder (1.8°)

◇ Unipolar

Product Name (Single Shaft)	List Price	Product Name (Double Shaft)	List Price
PKP213U05A	\$65.00	PKP213U05B	\$67.00
PKP214U06A	\$72.00	PKP214U06B	\$74.00
PKP223U09A-L	\$50.00	PKP223U09B-L	\$52.00
PKP224U09A-L	\$54.00	PKP224U09B-L	\$56.00
PKP225U09A-L	\$57.00	PKP225U09B-L	\$59.00
PKP233U12A-L	\$48.00	PKP233U12B-L	\$50.00
PKP235U12A-L	\$55.00	PKP235U12B-L	\$57.00
PKP243U04A-L	\$48.00	PKP243U04B-L	\$50.00
PKP243U06A-L	\$48.00	PKP243U06B-L	\$50.00
PKP243U09A-L	\$48.00	PKP243U09B-L	\$50.00
PKP244U04A-L	\$49.00	PKP244U04B-L	\$51.00
PKP244U08A-L	\$49.00	PKP244U08B-L	\$51.00
PKP244U12A-L	\$49.00	PKP244U12B-L	\$51.00
PKP245U05A-L	\$55.00	PKP245U05B-L	\$57.00
PKP245U08A-L	\$55.00	PKP245U08B-L	\$57.00
PKP245U12A-L	\$55.00	PKP245U12B-L	\$57.00
PKP246U12A-L	\$57.00	PKP246U12B-L	\$59.00
PKP264U10AA-L	\$56.00	PKP264U10BA-L	\$58.00
PKP264U20AA-L	\$56.00	PKP264U20BA-L	\$58.00
PKP264U30AA-L	\$56.00	PKP264U30BA-L	\$58.00
PKP266U10AA-L	\$62.00	PKP266U10BA-L	\$64.00
PKP266U20AA-L	\$62.00	PKP266U20BA-L	\$64.00
PKP266U30AA-L	\$62.00	PKP266U30BA-L	\$64.00
PKP268U10AA-L	\$78.00	PKP268U10BA-L	\$80.00
PKP268U20AA-L	\$78.00	PKP268U20BA-L	\$80.00
PKP268U30AA-L	\$78.00	PKP268U30BA-L	\$80.00

● High-Resolution Type (0.9°)

◇ Unipolar

Product Name (Single Shaft)	List Price	Product Name (Double Shaft)	List Price
PKP243MU09A-L	\$48.00	PKP243MU09B-L	\$50.00
PKP244MU12A-L	\$49.00	PKP244MU12B-L	\$51.00
PKP264MU20AA-L	\$56.00	PKP264MU20BA-L	\$58.00
PKP266MU20AA-L	\$62.00	PKP266MU20BA-L	\$64.00
PKP268MU20AA-L	\$78.00	PKP268MU20BA-L	\$80.00

◇ Unipolar with Encoder

Product Name (2ch Encoder)	List Price	Product Name (3ch Encoder)	List Price
PKP213U05A-R2E-L	\$148.00	-	-
PKP214U06A-R2E-L	\$155.00	-	-
PKP233U12A-R1□-L	\$121.00	PKP233U12A-R2□-L	\$131.00
PKP235U12A-R1□-L	\$130.00	PKP235U12A-R2□-L	\$140.00
PKP243U04A-R1□-L	\$123.00	PKP243U04A-R2□-L	\$133.00
PKP243U06A-R1□-L	\$123.00	PKP243U06A-R2□-L	\$133.00
PKP243U09A-R1□-L	\$123.00	PKP243U09A-R2□-L	\$133.00
PKP244U04A-R1□-L	\$124.00	PKP244U04A-R2□-L	\$134.00
PKP244U08A-R1□-L	\$124.00	PKP244U08A-R2□-L	\$134.00
PKP244U12A-R1□-L	\$124.00	PKP244U12A-R2□-L	\$134.00
PKP245U05A-R1□-L	\$133.00	PKP245U05A-R2□-L	\$143.00
PKP245U08A-R1□-L	\$133.00	PKP245U08A-R2□-L	\$143.00
PKP245U12A-R1□-L	\$133.00	PKP245U12A-R2□-L	\$143.00
PKP246U12A-R1□-L	\$135.00	PKP246U12A-R2□-L	\$145.00
PKP264U10AA-R1□-L	\$138.00	PKP264U10AA-R2□-L	\$148.00
PKP264U20AA-R1□-L	\$138.00	PKP264U20AA-R2□-L	\$148.00
PKP264U30AA-R1□-L	\$138.00	PKP264U30AA-R2□-L	\$148.00
PKP266U10AA-R1□-L	\$144.00	PKP266U10AA-R2□-L	\$154.00
PKP266U20AA-R1□-L	\$144.00	PKP266U20AA-R2□-L	\$154.00
PKP266U30AA-R1□-L	\$144.00	PKP266U30AA-R2□-L	\$154.00
PKP268U10AA-R1□-L	\$164.00	PKP268U10AA-R2□-L	\$174.00
PKP268U20AA-R1□-L	\$164.00	PKP268U20AA-R2□-L	\$174.00
PKP268U30AA-R1□-L	\$164.00	PKP268U30AA-R2□-L	\$174.00

● Either 5 (200 P/R) or 6 (400 P/R) indicating the encoder resolution is entered where the box □ is located within the product name.

● SH Geared Type

◇ Unipolar

Product Name (Single Shaft)	List Price	Product Name (Double Shaft)	List Price
PKP223U09A-SG7.2-L	\$168.00	PKP223U09B-SG7.2-L	\$170.00
PKP223U09A-SG9-L	\$168.00	PKP223U09B-SG9-L	\$170.00
PKP223U09A-SG10-L	\$168.00	PKP223U09B-SG10-L	\$170.00
PKP223U09A-SG18-L	\$182.00	PKP223U09B-SG18-L	\$184.00
PKP223U09A-SG36-L	\$182.00	PKP223U09B-SG36-L	\$184.00
PKP243U09A-SG3.6-L	\$157.00	PKP243U09B-SG3.6-L	\$159.00
PKP243U09A-SG7.2-L	\$157.00	PKP243U09B-SG7.2-L	\$159.00
PKP243U09A-SG9-L	\$157.00	PKP243U09B-SG9-L	\$159.00
PKP243U09A-SG10-L	\$157.00	PKP243U09B-SG10-L	\$159.00
PKP243U09A-SG18-L	\$177.00	PKP243U09B-SG18-L	\$179.00
PKP243U09A-SG36-L	\$177.00	PKP243U09B-SG36-L	\$179.00
PKP264U10A-SG3.6-L	\$160.00	PKP264U10B-SG3.6-L	\$163.00
PKP264U10A-SG7.2-L	\$160.00	PKP264U10B-SG7.2-L	\$163.00
PKP264U10A-SG9-L	\$160.00	PKP264U10B-SG9-L	\$163.00
PKP264U10A-SG10-L	\$160.00	PKP264U10B-SG10-L	\$163.00
PKP264U10A-SG18-L	\$169.00	PKP264U10B-SG18-L	\$172.00
PKP264U10A-SG36-L	\$169.00	PKP264U10B-SG36-L	\$172.00
PKP264U20A-SG3.6-L	\$160.00	PKP264U20B-SG3.6-L	\$163.00
PKP264U20A-SG7.2-L	\$160.00	PKP264U20B-SG7.2-L	\$163.00
PKP264U20A-SG9-L	\$160.00	PKP264U20B-SG9-L	\$163.00
PKP264U20A-SG10-L	\$160.00	PKP264U20B-SG10-L	\$163.00
PKP264U20A-SG18-L	\$169.00	PKP264U20B-SG18-L	\$172.00
PKP264U20A-SG36-L	\$169.00	PKP264U20B-SG36-L	\$172.00
PK296A1A-SG3.6	\$257.00	PK296B1A-SG3.6	\$261.00
PK296A1A-SG7.2	\$257.00	PK296B1A-SG7.2	\$261.00
PK296A1A-SG9	\$257.00	PK296B1A-SG9	\$261.00
PK296A1A-SG10	\$257.00	PK296B1A-SG10	\$261.00
PK296A1A-SG18	\$257.00	PK296B1A-SG18	\$261.00
PK296A1A-SG36	\$268.00	PK296B1A-SG36	\$272.00
PK296A2A-SG3.6	\$257.00	PK296B2A-SG3.6	\$261.00
PK296A2A-SG7.2	\$257.00	PK296B2A-SG7.2	\$261.00
PK296A2A-SG9	\$257.00	PK296B2A-SG9	\$261.00
PK296A2A-SG10	\$257.00	PK296B2A-SG10	\$261.00
PK296A2A-SG18	\$257.00	PK296B2A-SG18	\$261.00
PK296A2A-SG36	\$268.00	PK296B2A-SG36	\$272.00

The following items are included with each product.

Motor, Motor Connection Cable*1, Encoder Connection Cable*2, Operating Manual

*1 Only for connector-coupled motor

*2 Only for products with an encoder

Overview, Product Series

AC Input Motor & Driver

0.36°/Geared *Q*STEP AR

0.36°/Geared *Q*STEP Absolute AZ

0.72°/Geared RKII

DC Input Motor & Driver

0.36°/Geared *Q*STEP AR

0.36°/Geared *Q*STEP Absolute AZ

0.72°/0.36°/Geared CRK

1.8°/Geared RBK

1.8°/0.9°/Geared CMK

0.72° All-in-One PKA

Motor Only

1.8°/0.9° PKP/PK

Geared PKP

0.72°/0.36° PKP

Accessories

Step Angle 1.8° Frame Size 20 mm (0.79 in.) Bipolar 4 Lead Wires

Specifications

Product Name -Single/Double Shaft -with Encoder	Motor Length mm (in.)	Holding Torque N·m (oz·in)	Rated Current A/phase	Voltage VDC	Resistance Ω/phase	Inductance mH/phase	Rotor Inertia J kg·m ² (oz·in ²)	Lead Wires
PKP213D05A PKP213D05B PKP213D05A-R2E-L	30 (1.18)	0.02 (2.8)	0.5	4.25	8.5	4.1	1.6×10 ⁻⁷ (0.0088) [1.66×10 ⁻⁷ (0.0091)]	4
PKP214D06A PKP214D06B PKP214D06A-R2E-L	40 (1.57)	0.036 (5.1)	0.6	3.9	6.5	2.9×10 ⁻⁷ (0.0159) [2.96×10 ⁻⁷ (0.0162)]		

● The brackets [] indicate the specifications for the encoder type.

Speed – Torque Characteristics (Reference values)

PKP213D

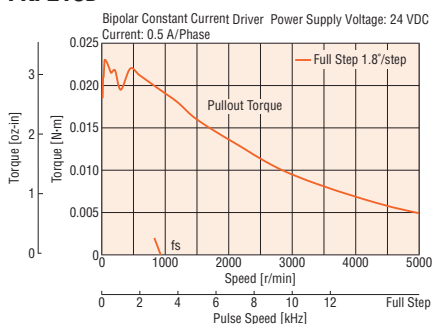

PKP214D

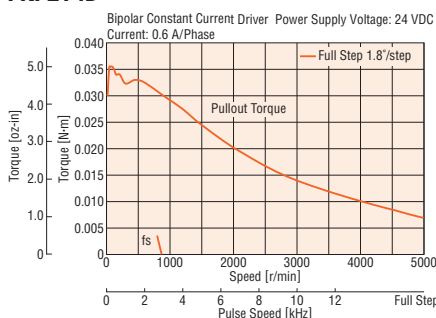

Note

- Data for the speed – torque characteristics is based on Oriental Motor's internal measurement conditions. If the conditions are changed, the characteristics may also change as a result.
- Depending on the driving conditions, a considerable amount of heat may be generated by the motor. Be sure to keep the temperature of the motor case under 100°C (212°F).

Dimensions Unit = mm (in.)

Motor

2D & 3D CAD

Product Name	L1	L2	Mass kg (lb.)	2D CAD
PKP213D05A	30	—	0.05	B976
PKP213D05B	(1.18)	38 (1.50)	(0.110)	
PKP214D06A	40	—	0.07	B978
PKP214D06B	(1.57)	48 (1.89)	(0.154)	

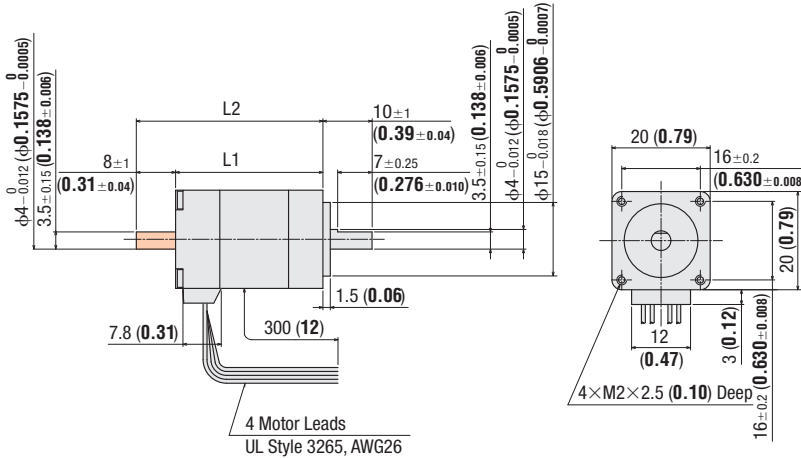

- These dimensions are for double shaft products. For single shaft products, ignore the areas.
- Back shaft of double shaft products have a flat the whole length.

Motor with Encoder

2D CAD

Product Name	Motor Product Name	L	Mass kg (lb.)	2D CAD
PKP213D05A-R2E-L	PKP213D05A-R2E	46.5 (1.83)	0.06 (0.132)	B1100
PKP214D06A-R2E-L	PKP214D06A-R2E	56.5 (2.22)	0.08 (0.176)	B1101

- Applicable Connector (Molex)

	Encoder
Connector Housing	51021-0800
Contact	50079-8100
Crimp Tool	57067-3000

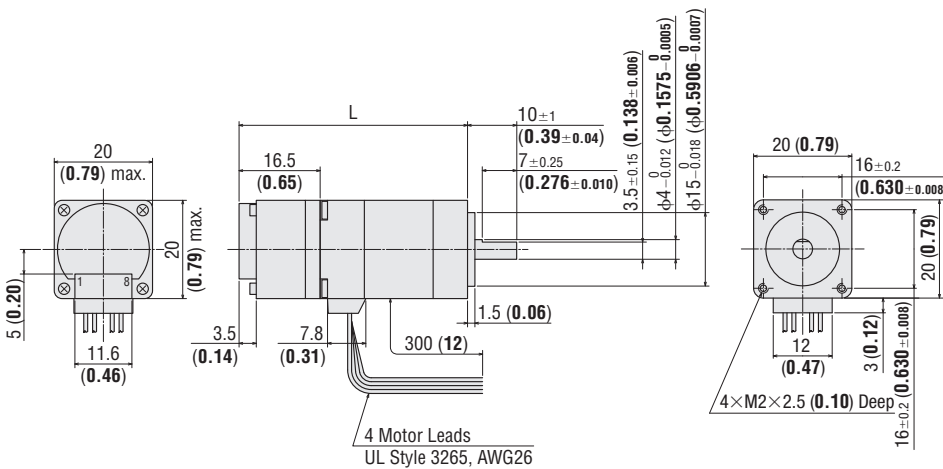

- Included
Connection cable for encoder

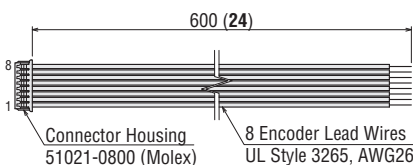

Overview, Product Series

AC Input Motor & Driver

0.36°/Geared
Q5STEP AR

0.36°/Geared
Q5STEP Absolute AZ

0.72°/Geared
RKII

DC Input Motor & Driver

0.36°/Geared
Q5STEP AR

0.36°/Geared
Q5STEP Absolute AZ

0.72°/0.36°/Geared
CRK

1.8°/Geared
RBK

1.8°/0.9°/Geared
CMK

0.72° All-in-One
PKA

Motor Only

1.8°/0.9°
PKP/PK

Geared
PKP

0.72°/0.36°
PKP

Accessories

Step Angle 1.8° Frame Size 28 mm (1.10 in.) Bipolar 4 Lead Wires

Specifications

Product Name Single/Double Shaft	Motor Length mm (in.)	Holding Torque N·m (oz·in)	Rated Current	Voltage	Resistance	Inductance	Rotor Inertia J kg·m ² (oz·in ²)	Lead Wires
			A/phase	VDC	Ω/phase	mH/phase		
PKP223D06□-L	32 (1.26)	0.065 (9.2)	0.67	3.8	5.6	4	9×10 ⁻⁷ (0.049)	4
PKP223D15□-L			1.5	1.8	1.2	0.74		
PKP224D06□-L	40 (1.57)	0.097 (13.7)	0.67	4.6	6.8	4.8		
PKP224D15□-L			1.5	2.32	1.55	0.85		
PKP225D06□-L	51.5 (2.03)	0.11 (15.6)	0.67	6.2	9.2	5.6	18×10 ⁻⁷ (0.098)	
PKP225D15□-L			1.5	3	2.05	1		

- Enter **A** (single shaft) or **B** (double shaft) in the box □ within the product name.
- A 0.6 m (2 ft.) motor connection cable is included with these products.

Speed – Torque Characteristics (Reference values)

PKP223D

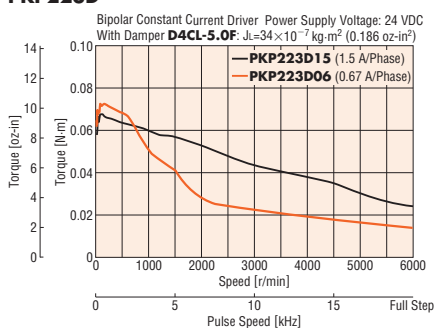

PKP224D

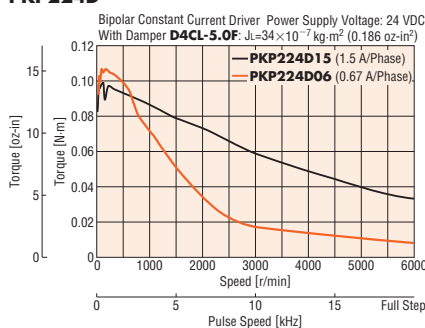

PKP225D

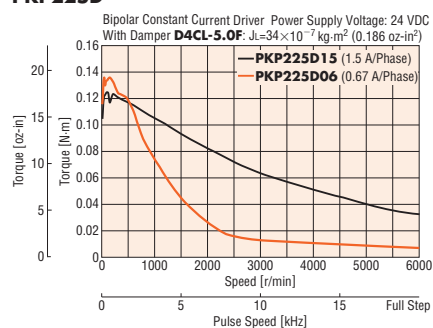

Note

- Data for the speed – torque characteristics is based on Oriental Motor's internal measurement conditions. If the conditions are changed, the characteristics may also change as a result.
- If there is a "With damper" entry in the speed – torque characteristics, the data is for a double shaft motor when a clean damper is equipped.
- Depending on the driving conditions, a considerable amount of heat may be generated by the motor. Be sure to keep the temperature of the motor case under 100°C (212°F).

Dimensions Unit = mm (in.)

Motor

2D & 3D CAD

Product Name	Motor Product Name	L1	L2	Mass kg (lb.)	2D CAD
PKP223D06A-L	PKP223D06A	32 (1.26)	—	0.11 (0.24)	B980
PKP223D06B-L	PKP223D06B		42 (1.65)		
PKP223D15A-L	PKP223D15A		—		
PKP223D15B-L	PKP223D15B		42 (1.65)		
PKP224D06A-L	PKP224D06A	40 (1.57)	—	0.14 (0.31)	B981
PKP224D06B-L	PKP224D06B		50 (1.97)		
PKP224D15A-L	PKP224D15A		—		
PKP224D15B-L	PKP224D15B		50 (1.97)		
PKP225D06A-L	PKP225D06A	51.5 (2.03)	—	0.2 (0.44)	B982
PKP225D06B-L	PKP225D06B		61.5 (2.42)		
PKP225D15A-L	PKP225D15A		—		
PKP225D15B-L	PKP225D15B		61.5 (2.42)		

Motor Applicable Connector

Connector Housing: 51065-0600 (Molex)

Contact: 50212-8100 (Molex)

Crimp Tool: 63819-0500 (Molex)

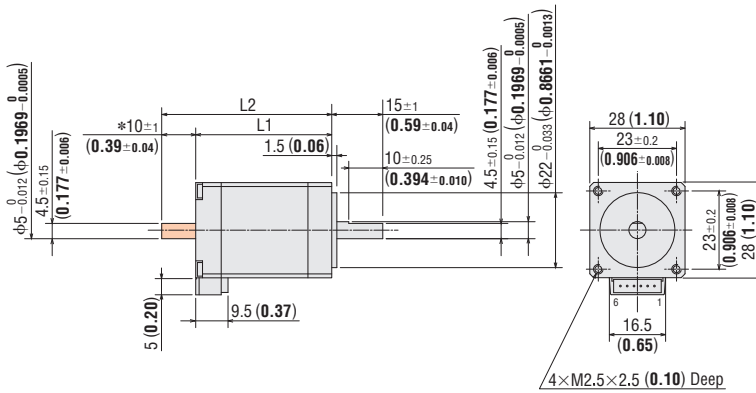

* The length of machining on the double shaft model is 10±0.25 (0.394±0.010).

● These dimensions are for double shaft products. For single shaft products, ignore the shaded areas.

Connection Cables (Included)

Cable for Motor

- Bipolar 4 Lead Wires
- LC2B06A

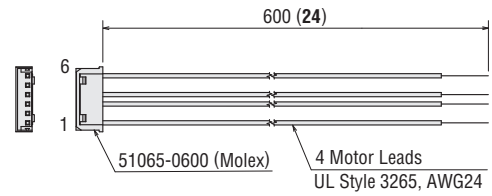

Overview, Product Series

AC Input Motor & Driver

0.36°/Geared
*Q*STEP
AR

0.36°/Geared
*Q*STEP
Absolute
AZ

0.72°/Geared
RKII

DC Input Motor & Driver

0.36°/Geared
*Q*STEP
AR

0.36°/Geared
*Q*STEP
Absolute
AZ

0.72°/0.36°
/Geared
CRK

1.8°/Geared
RBK

1.8°/0.9°
/Geared
CMK

0.72°
All-in-One
PKA

Motor Only

1.8°/0.9°
PKP/PK

Geared
PKP

0.72°/0.36°
PKP

Accessories

Step Angle 1.8° Frame Size 35 mm (1.38 in.) Bipolar 4 Lead Wires

Specifications

Product Name -Single/Double Shaft -with Encoder	Motor Length mm (in.)	Holding Torque N·m (oz·in)	Rated Current A/phase	Voltage VDC	Resistance Ω/phase	Inductance mH/phase	Rotor Inertia J kg·m ² (oz·in ²)	Lead Wires
PKP233D08□-L PKP233D08A-R□□-L	37 (1.46)	0.2 (28)	0.85	4.6	5.4	5.6	24×10 ⁻⁷ (0.131)	4
PKP233D15□-L PKP233D15A-R□□-L			1.5	2.43	1.62	1.5		
PKP235D08□-L PKP235D08A-R□□-L	52 (2.05)	0.37 (52)	0.85	5.8	6.8	8	50×10 ⁻⁷ (0.27)	
PKP235D15□-L PKP235D15A-R□□-L			1.5	3.6	2.4	2.6		

- Enter **A** (single shaft) or **B** (double shaft) in the box □ within the product name.
- Enter the encoder code (**15**, **16**, **25** or **26**) in the box □□ within the product name.
- A 0.6 m (2 ft.) motor connection cable and encoder cable (if applicable) is included with these products.

Speed – Torque Characteristics (Reference values)

PKP233D

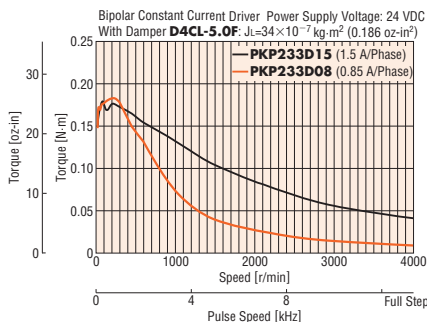

PKP235D

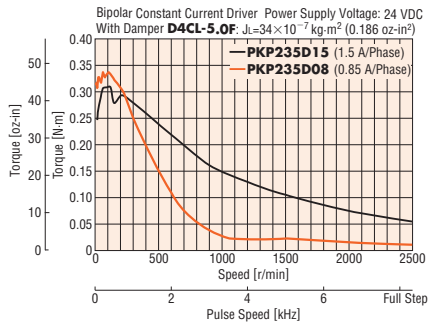

Note

- Data for the speed – torque characteristics is based on Oriental Motor's internal measurement conditions. If the conditions are changed, the characteristics may also change as a result.
- If there is a "With damper" entry in the speed – torque characteristics, the data is for a double shaft motor when a clean damper is equipped. (For encoder-equipped motors, the data represents the addition of load inertia equivalent to a clean damper.)
- Depending on the driving conditions, a considerable amount of heat may be generated by the motor. Be sure to keep the temperature of the motor case under 100°C (212°F).

Dimensions Unit = mm (in.)

● Motor

2D & 3D CAD

Product Name	Motor Product Name	L1	L2	Mass kg (lb.)	2D CAD
PKP233D08A-L	PKP233D08A	37 (1.46)	—	0.18 (0.4)	B983
PKP233D08B-L	PKP233D08B		52 (2.05)		
PKP233D15A-L	PKP233D15A		—		
PKP233D15B-L	PKP233D15B	52 (2.05)	52 (2.05)	0.285 (0.63)	B984
PKP235D08A-L	PKP235D08A		—		
PKP235D08B-L	PKP235D08B		67 (2.67)		
PKP235D15A-L	PKP235D15A	—	—	—	—
PKP235D15B-L	PKP235D15B		67 (2.67)		

● Motor Applicable Connector
 Connector Housing: 51103-0600 (Molex)
 Contact: 50351-8100 (Molex)
 Crimp Tool: 63811-8100 (Molex)

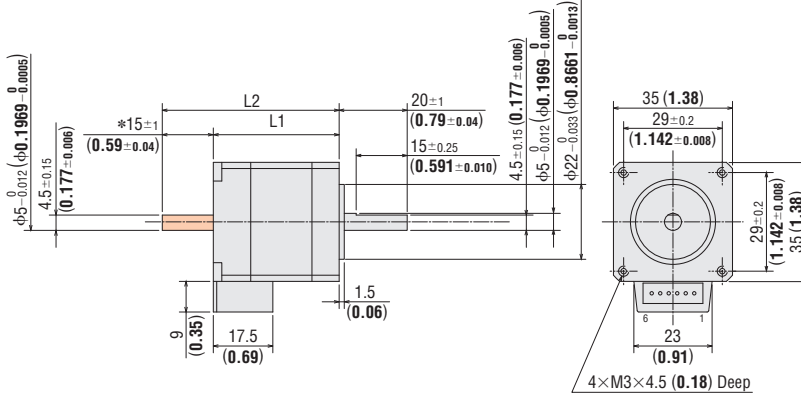

* The length of machining on the double shaft product is 15±0.25 (0.591±0.010).
 ● These dimensions are for double shaft products. For single shaft products, ignore the shaded areas.

● Motor with Encoder

2D CAD

Product Name	Motor Product Name	L1	L2	Mass kg (lb.)	2D CAD
PKP233D08A-R <input type="checkbox"/> -L	PKP233D08A-R <input type="checkbox"/>	37 (1.46)	53.8 (2.12)	0.2 (0.44)	B1019
PKP233D15A-R <input type="checkbox"/> -L	PKP233D15A-R <input type="checkbox"/>				
PKP235D08A-R <input type="checkbox"/> -L	PKP235D08A-R <input type="checkbox"/>	52 (2.05)	68.8 (1.96)	0.31 (0.67)	B1020
PKP235D15A-R <input type="checkbox"/> -L	PKP235D15A-R <input type="checkbox"/>				

● Enter the encoder code (**15**, **16**, **25** or **26**) in the box within the product name.
 ● Motor Applicable Connector
 Connector Housing: 51103-0600 (Molex)
 Contact: 50351-8100 (Molex)
 Crimp Tool: 63811-8100 (Molex)
 ● Encoder Applicable Connector
 Connector Housing: 50-57-9405 (Molex)
 Contact: 16-02-0104 (Molex)
 Crimp Tool: 63811-8700 (Molex)

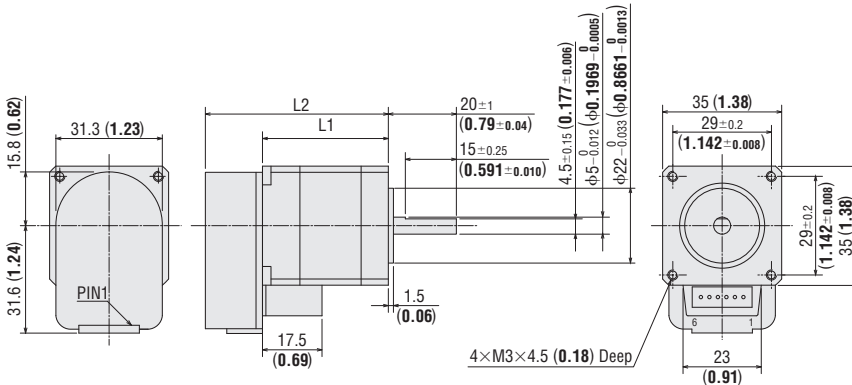

● Connection Cables (Included)

◇ Cable for Motor

- Bipolar 4 Lead Wires
LC2B06B

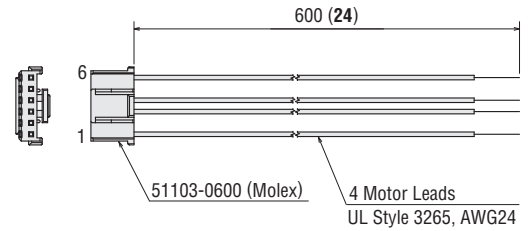

◇ Cable for Encoder

- 2-Channel Encoder Cable
LCR04060A

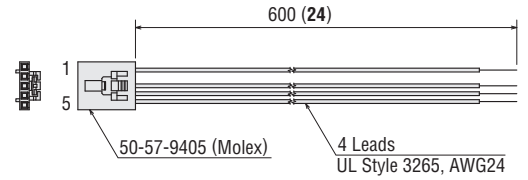

- 3-Channel Encoder Cable
LCR05060A

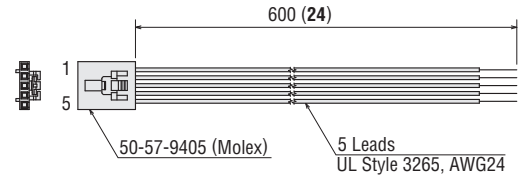

Overview, Product Series

AC Input Motor & Driver

0.36°/Geared *Q*STEP AR

0.36°/Geared *Q*STEP Absolute AZ

0.72°/Geared RKII

DC Input Motor & Driver

0.36°/Geared *Q*STEP AR

0.36°/Geared *Q*STEP Absolute AZ

0.72°/0.36°/Geared CRK

1.8°/Geared RBK

1.8°/0.9°/Geared CMK

0.72° All-in-One PKA

Motor Only

1.8°/0.9° PKP/PK

Geared PKP

0.72°/0.36° PKP

Accessories

Step Angle 1.8° Frame Size 42 mm (1.65 in.) Bipolar 4 Lead Wires

Specifications

Product Name -Single/Double Shaft -with Encoder	Motor Length mm (in.)	Holding Torque N·m (oz-in)	Rated Current A/phase	Voltage VDC	Resistance Ω/phase	Inductance mH/phase	Rotor Inertia J kg·m ² (oz-in ²)	Lead Wires
PKP243D02□-L PKP243D02A-R□□-L	33 (1.3)	0.32 (45)	0.28	16.8	60	132	36×10 ⁻⁷ (0.197)	4
PKP243D04□-L PKP243D04A-R□□-L			0.42	9.24	22	49.6		
PKP243D06□-L PKP243D06A-R□□-L			0.67	6.3	9.4	20		
PKP243D15□-L PKP243D15A-R□□-L			1.5	2.85	1.9	5		
PKP244D02□-L PKP244D02A-R□□-L	39 (1.54)	0.48 (68)	0.28	16.8	60	114.4	57×10 ⁻⁷ (0.31)	
PKP244D05□-L PKP244D05A-R□□-L			0.57	8.21	14.4	30.4		
PKP244D08□-L PKP244D08A-R□□-L			0.85	6.8	8	15.6		
PKP244D15□-L PKP244D15A-R□□-L			1.5	3.9	2.6	4.9		
PKP245D03□-L PKP245D03A-R□□-L	47 (1.85)	0.58 (82)	0.35	16.8	48	132	83×10 ⁻⁷ (0.45)	
PKP245D05□-L PKP245D05A-R□□-L			0.57	9.12	16	45.2		
PKP245D08□-L PKP245D08A-R□□-L			0.85	6.46	7.6	20		
PKP245D15□-L PKP245D15A-R□□-L			1.5	3.6	2.4	6.6		
PKP246D08□-L PKP246D08A-R□□-L	59 (2.32)	0.93 (132)	0.85	10	12	26	114×10 ⁻⁷ (0.62)	
PKP246D15□-L PKP246D15A-R□□-L			1.5	5.8	3.87	8		

- Enter **A** (single shaft) or **B** (double shaft) in the box □ within the product name.
- Enter the encoder code (**15**, **16**, **25** or **26**) in the box □□ within the product name.
- A 0.6 m (2 ft.) motor connection cable and encoder cable (if applicable) is included with these products.

Speed – Torque Characteristics (Reference values)

PKP243D

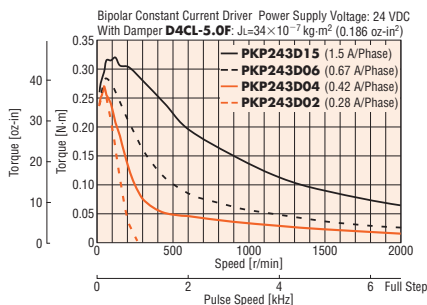

PKP244D

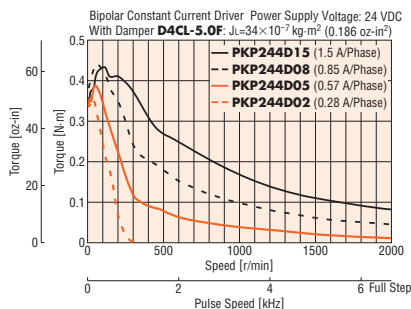

PKP245D

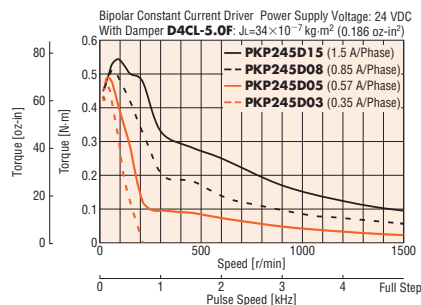

PKP246D

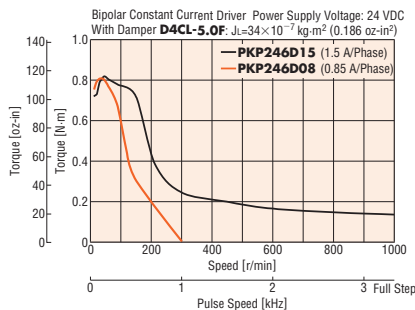

Note

- Data for the speed – torque characteristics is based on Oriental Motor's internal measurement conditions. If the conditions are changed, the characteristics may also change as a result.
- If there is a "With damper" entry in the speed – torque characteristics, the data is for a double shaft motor when a clean damper is equipped. (For encoder-equipped motors, the data represents the addition of load inertia equivalent to a clean damper.)
- Depending on the driving conditions, a considerable amount of heat may be generated by the motor. Be sure to keep the temperature of the motor case under 100°C (212°F).

Dimensions Unit = mm (in.)

● Motor

2D & 3D CAD

Product Name	Motor Product Name	L1	L2	Mass kg (lb.)	2D CAD
PKP243D02A-L	PKP243D02A	33 (1.30)	—	0.25 (0.55)	B968
PKP243D02B-L	PKP243D02B		48 (1.89)		
PKP243D04A-L	PKP243D04A		—		
PKP243D04B-L	PKP243D04B		48 (1.89)		
PKP243D06A-L	PKP243D06A		—		
PKP243D06B-L	PKP243D06B		48 (1.89)		
PKP243D15A-L	PKP243D15A	39 (1.54)	—	0.3 (0.66)	B969
PKP243D15B-L	PKP243D15B		48 (1.89)		
PKP244D02A-L	PKP244D02A		—		
PKP244D02B-L	PKP244D02B		54 (2.13)		
PKP244D05A-L	PKP244D05A		—		
PKP244D05B-L	PKP244D05B		54 (2.13)		
PKP244D08A-L	PKP244D08A	47 (1.85)	—	0.39 (0.86)	B970
PKP244D08B-L	PKP244D08B		54 (2.13)		
PKP244D15A-L	PKP244D15A		—		
PKP244D15B-L	PKP244D15B		54 (2.13)		
PKP245D03A-L	PKP245D03A		—		
PKP245D03B-L	PKP245D03B		62 (2.44)		
PKP245D05A-L	PKP245D05A	59 (2.32)	—	0.5 (1.1)	B971
PKP245D05B-L	PKP245D05B		62 (2.44)		
PKP245D08A-L	PKP245D08A		—		
PKP245D08B-L	PKP245D08B		62 (2.44)		
PKP245D15A-L	PKP245D15A		—		
PKP245D15B-L	PKP245D15B		62 (2.44)		
PKP246D08A-L	PKP246D08A	59 (2.32)	—	0.5 (1.1)	B971
PKP246D08B-L	PKP246D08B		74 (2.91)		
PKP246D15A-L	PKP246D15A		—		
PKP246D15B-L	PKP246D15B	74 (2.91)			

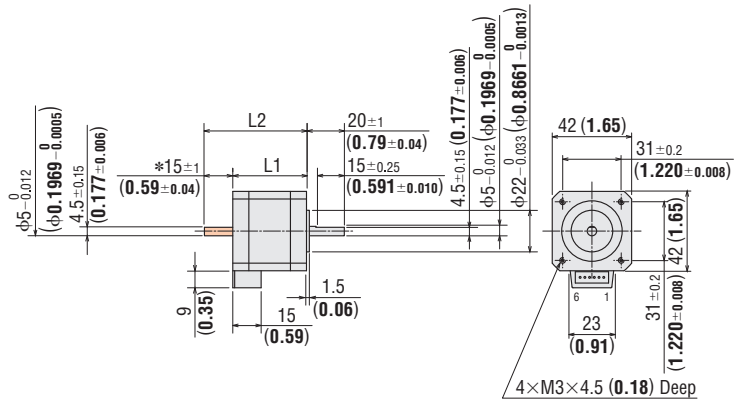

* The length of machining on the double shaft product is 15±0.25 (0.591±0.010).

- These dimensions are for double shaft products. For single shaft products, ignore the areas.
- Applicable Connector
Connector Housing: 51103-0600 (Molex)
Contact: 50351-8100 (Molex)
Crimp Tool: 63811-8100 (Molex)

● Motor with Encoder

2D CAD

Product Name	Motor Product Name	L1	L2	Mass kg (lb.)	2D CAD
PKP243D02A-R□□-L	PKP243D02A-R□□	33 (1.30)	49.8 (1.89)	0.27 (0.59)	B1021
PKP243D04A-R□□-L	PKP243D04A-R□□				
PKP243D06A-R□□-L	PKP243D06A-R□□				
PKP243D15A-R□□-L	PKP243D15A-R□□	39 (1.54)	55.8 (2.55)	0.32 (0.70)	B1022
PKP244D02A-R□□-L	PKP244D02A-R□□				
PKP244D05A-R□□-L	PKP244D05A-R□□				
PKP244D08A-R□□-L	PKP244D08A-R□□	47 (1.85)	63.8 (2.51)	0.41 (0.90)	B1023
PKP244D15A-R□□-L	PKP244D15A-R□□				
PKP245D03A-R□□-L	PKP245D03A-R□□				
PKP245D05A-R□□-L	PKP245D05A-R□□	59 (2.32)	75.8 (2.98)	0.52 (1.14)	B1024
PKP245D08A-R□□-L	PKP245D08A-R□□				
PKP245D15A-R□□-L	PKP245D15A-R□□				

- Enter the encoder code (**15**, **16**, **25** or **26**) in the box within the product name.
- Motor Applicable Connector
Connector Housing: 51103-0600 (Molex)
Contact: 50351-8100 (Molex)
Crimp Tool: 63811-8100 (Molex)
- Encoder Applicable Connector
Connector Housing: 50-57-9405 (Molex)
Contact: 16-02-0104 (Molex)
Crimp Tool: 63811-8700 (Molex)

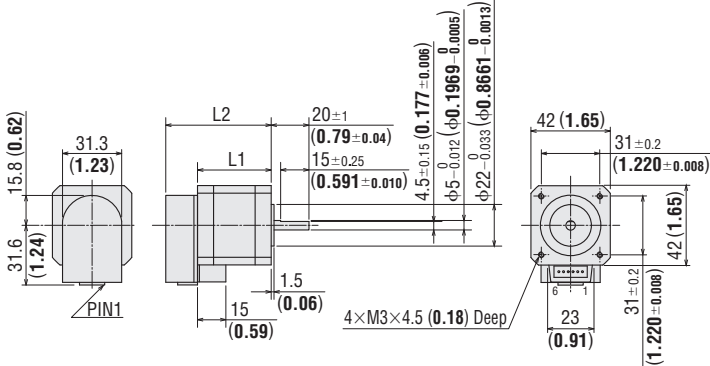

● Connection Cables (Included)

◇ Cable for Motor

- Bipolar 4 Lead Wires
LC2B06B

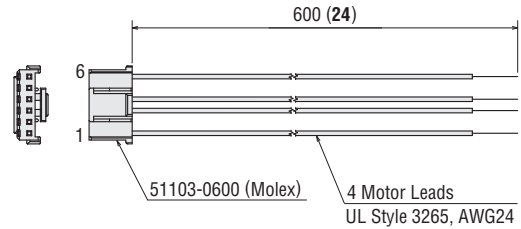

◇ Cable for Encoder

- 2-Channel Encoder Cable
LCR04060A

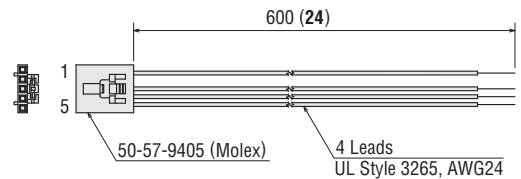

- 3-Channel Encoder Cable
LCR05060A

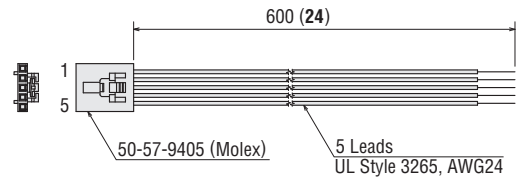

Overview, Product Series

AC Input Motor & Driver

0.36°/Geared *Q*STEP AR

0.36°/Geared *Q*STEP Absolute AZ

0.72°/Geared RKII

DC Input Motor & Driver

0.36°/Geared *Q*STEP AR

0.36°/Geared *Q*STEP Absolute AZ

0.72°/0.36°/Geared CRK

1.8°/Geared RBK

1.8°/0.9°/Geared CMK

0.72° All-in-One PKA

Motor Only

1.8°/0.9° PKP/PK

Geared PKP

0.72°/0.36° PKP

Accessories

Step Angle 1.8° Frame Size 56.4 mm (2.22 in.) Bipolar 4 Lead Wires

Specifications

Product Name -Single/Double Shaft -with Encoder	Motor Length mm (in.)	Holding Torque N·m (oz·in)	Rated Current A/phase	Voltage VDC	Resistance Ω/phase	Inductance mH/phase	Rotor Inertia J kg·m ² (oz·in ²)	Lead Wires
PKP264D07□A-L PKP264D07AA-R□□-L	39 (1.54)	0.6 (85)	0.71	8.31	11.7	28.8	120×10 ⁻⁷ (0.66)	4
PKP264D14□A-L PKP264D14AA-R□□-L			1.4	4.06	2.9	7.2		
PKP264D21□A-L PKP264D21AA-R□□-L			2.1	2.73	1.3	3.2		
PKP264D28□A-L PKP264D28AA-R□□-L			2.8	2	0.73	1.8		
PKP264D42□A-L -			4.2	1.38	0.33	0.8		
PKP266D07□A-L PKP266D07AA-R□□-L			54 (2.13)	1.4 (198)	0.71	11.5		
PKP266D14□A-L PKP266D14AA-R□□-L	1.4	5.6			4	11.6		
PKP266D21□A-L PKP266D21AA-R□□-L	2.1	3.86			1.84	5.32		
PKP266D28□A-L PKP266D28AA-R□□-L	2.8	2.8			1	2.9		
PKP266D42□A-L -	4.2	1.84			0.44	1.3		
PKP268D07□A-L PKP268D07AA-R□□-L	76 (2.99)	2.3 (320)			0.71	13.2	18.6	
PKP268D14□A-L PKP268D14AA-R□□-L			1.4	6.86	4.9	17.6		
PKP268D21□A-L PKP268D21AA-R□□-L			2.1	4.41	2.1	7.84		
PKP268D28□A-L PKP268D28AA-R□□-L			2.8	3.4	1.23	4.4		
PKP268D42□A-L -			4.2	2.2	0.53	2		

- Enter **A** (single shaft) or **B** (double shaft) in the box □ within the product name.
- Enter the encoder code (**15**, **16**, **25** or **26**) in the box □□ within the product name.
- A 0.6 m (2 ft.) motor connection cable and encoder cable (if applicable) is included with these products.

Speed – Torque Characteristics (Reference values)

PKP264D

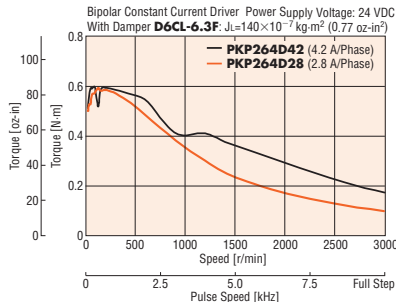

PKP264D

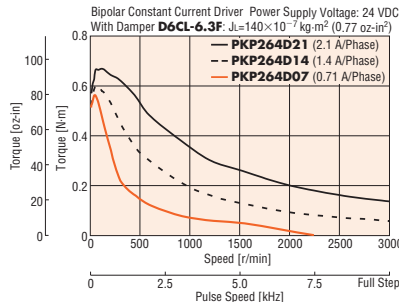

PKP266D

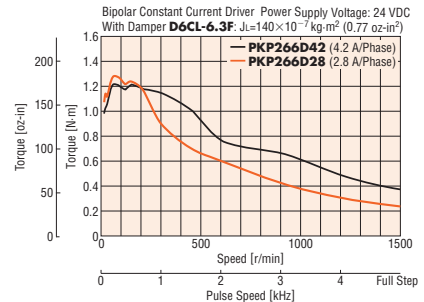

PKP266D

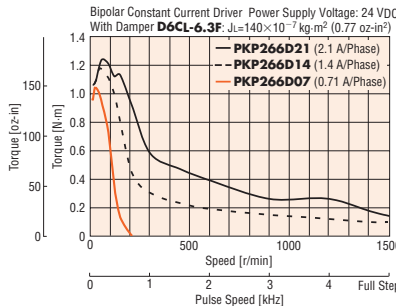

PKP268D

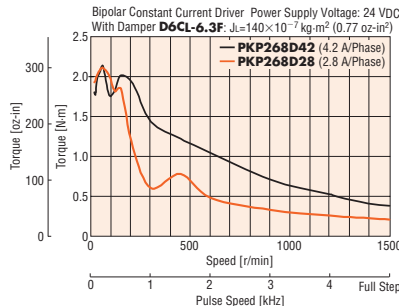

PKP268D

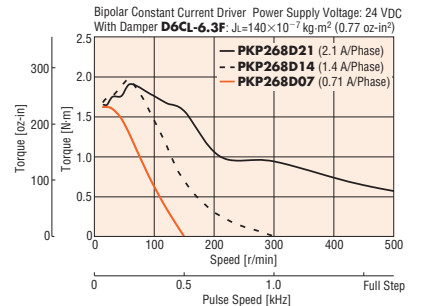

Note

- Data for the speed – torque characteristics is based on Oriental Motor's internal measurement conditions. If the conditions are changed, the characteristics may also change as a result.
- If there is a "With damper" entry in the speed – torque characteristics, the data is for a double shaft motor when a clean damper is equipped. (For encoder-equipped motors, the data represents the addition of load inertia equivalent to a clean damper.)
- Depending on the driving conditions, a considerable amount of heat may be generated by the motor. Be sure to keep the temperature of the motor case under 100°C (212°F).

Dimensions Unit = mm (in.)

● Motor

2D & 3D CAD

Product Name	Motor Product Name	L1	L2	Mass kg (lb.)	2D CAD
PKP264D07AA-L	PKP264D07AA	39 (1.54)	-	0.46 (1.01)	B1028
PKP264D07BA-L	PKP264D07BA		55 (2.17)		
PKP264D14AA-L	PKP264D14AA		-		
PKP264D14BA-L	PKP264D14BA		55 (2.17)		
PKP264D21AA-L	PKP264D21AA		-		
PKP264D21BA-L	PKP264D21BA		55 (2.17)		
PKP264D28AA-L	PKP264D28AA		-		
PKP264D28BA-L	PKP264D28BA		55 (2.17)		
PKP264D42AA-L	PKP264D42AA		-		
PKP264D42BA-L	PKP264D42BA		55 (2.17)		
PKP266D07AA-L	PKP266D07AA	54 (2.13)	-	0.73 (1.61)	B1029
PKP266D07BA-L	PKP266D07BA		70 (2.76)		
PKP266D14AA-L	PKP266D14AA		-		
PKP266D14BA-L	PKP266D14BA		70 (2.76)		
PKP266D21AA-L	PKP266D21AA		-		
PKP266D21BA-L	PKP266D21BA		70 (2.76)		
PKP266D28AA-L	PKP266D28AA		-		
PKP266D28BA-L	PKP266D28BA		70 (2.76)		
PKP266D42AA-L	PKP266D42AA		-		
PKP266D42BA-L	PKP266D42BA		70 (2.76)		
PKP268D07AA-L	PKP268D07AA	76 (2.99)	-	1.1 (2.40)	B1030
PKP268D07BA-L	PKP268D07BA		92 (3.62)		
PKP268D14AA-L	PKP268D14AA		-		
PKP268D14BA-L	PKP268D14BA		92 (3.62)		
PKP268D21AA-L	PKP268D21AA		-		
PKP268D21BA-L	PKP268D21BA		92 (3.62)		
PKP268D28AA-L	PKP268D28AA		-		
PKP268D28BA-L	PKP268D28BA		92 (3.62)		
PKP268D42AA-L	PKP268D42AA		-		
PKP268D42BA-L	PKP268D42BA		92 (3.62)		

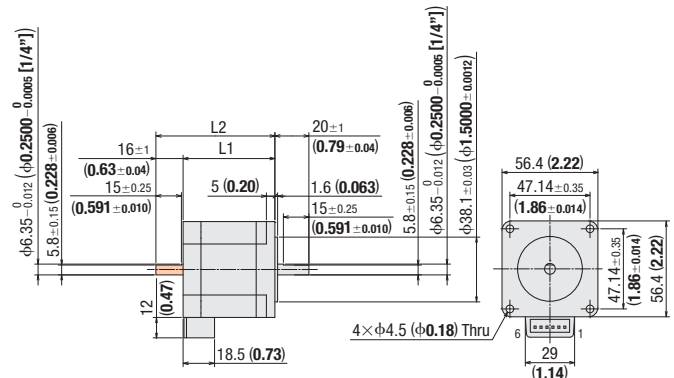

● These dimensions are for double shaft products. For single shaft products, ignore the shaded areas.

● Applicable Connector
 Connector Housing: 51067-0600 (Molex)
 Contact: 50217-9101 (Molex)
 Crimp Tool: 63811-8300 (Molex)

● Motor with Encoder

2D CAD

Product Name	Motor Product Name	L1	L2	Mass kg (lb.)	2D CAD
PKP264D07AA-R- <input type="checkbox"/> -L	PKP264D07AA-R- <input type="checkbox"/>	39 (1.54)	55.8 (2.20)	0.48 (1.06)	B1025
PKP264D14AA-R- <input type="checkbox"/> -L	PKP264D14AA-R- <input type="checkbox"/>				
PKP264D21AA-R- <input type="checkbox"/> -L	PKP264D21AA-R- <input type="checkbox"/>				
PKP264D28AA-R- <input type="checkbox"/> -L	PKP264D28AA-R- <input type="checkbox"/>	54 (2.13)	70.8 (2.79)	0.75 (1.65)	B1026
PKP266D07AA-R- <input type="checkbox"/> -L	PKP266D07AA-R- <input type="checkbox"/>				
PKP266D14AA-R- <input type="checkbox"/> -L	PKP266D14AA-R- <input type="checkbox"/>				
PKP266D21AA-R- <input type="checkbox"/> -L	PKP266D21AA-R- <input type="checkbox"/>	76 (2.99)	92.8 (3.65)	1.12 (2.5)	B1027
PKP266D28AA-R- <input type="checkbox"/> -L	PKP266D28AA-R- <input type="checkbox"/>				
PKP268D07AA-R- <input type="checkbox"/> -L	PKP268D07AA-R- <input type="checkbox"/>				
PKP268D14AA-R- <input type="checkbox"/> -L	PKP268D14AA-R- <input type="checkbox"/>				
PKP268D21AA-R- <input type="checkbox"/> -L	PKP268D21AA-R- <input type="checkbox"/>				
PKP268D28AA-R- <input type="checkbox"/> -L	PKP268D28AA-R- <input type="checkbox"/>				

● Enter the encoder code (15, 16, 25 or 26) in the box within the product name.
 ● Motor Applicable Connector
 Connector Housing: 51067-0600 (Molex)
 Contact: 50217-9101 (Molex)
 Crimp Tool: 63811-8300 (Molex)
 ● Encoder Applicable Connector
 Connector Housing: 50-57-9405 (Molex)
 Contact: 16-02-0104 (Molex)
 Crimp Tool: 63811-8700 (Molex)

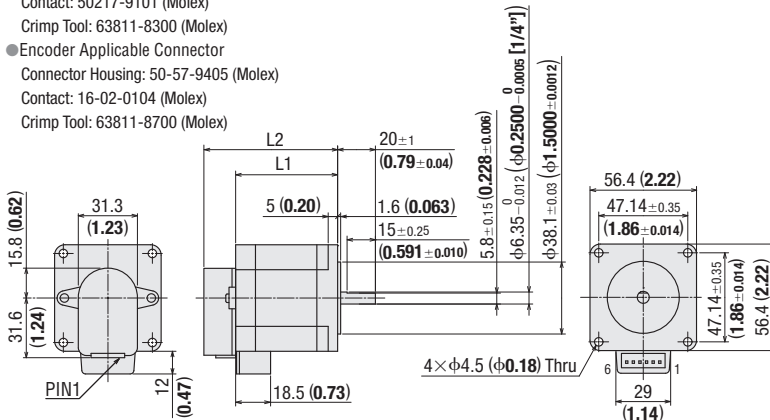

● Connection Cables (Included)

◇ Cable for Motor

- Bipolar 4 Lead Wires
LC2B06C

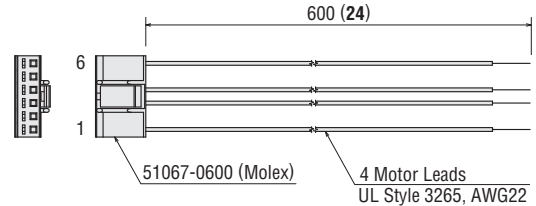

◇ Cable for Encoder

- 2-Channel Encoder Cable
LCR4060A

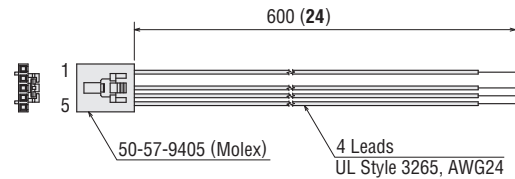

- 3-Channel Encoder Cable
LCR05060A

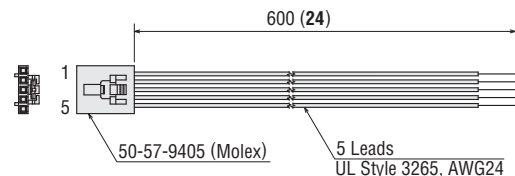

Overview,
Product
Series

AC Input
Motor &
Driver

0.36°/Geared
Q_{STEP}
AR

0.36°/Geared
Q_{STEP}
Absolute
AZ

0.72°/Geared
RKII

DC Input
Motor &
Driver

0.36°/Geared
Q_{STEP}
AR

0.36°/Geared
Q_{STEP}
Absolute
AZ

0.72°/0.36°
/Geared
CRK

1.8°/Geared
RBK

1.8°/0.9°
/Geared
CMK

0.72°
All-in-One
PKA

Motor Only

1.8°/0.9°
PKP/PK

Geared
PKP

0.72°/0.36°
PKP

Accessories

Step Angle 1.8° Frame Size 85 mm (3.35 in.) Bipolar 4 Lead Wires

Specifications

Product Name -Single/Double Shaft -with Encoder	Motor Length mm (in.)	Holding Torque N·m (oz·in)	Rated Current A/phase	Voltage VDC	Resistance Ω/phase	Inductance mH/phase	Rotor Inertia J kg·m ² (oz·in ²)	Lead Wires
PK296D □ A PK296DAAR □□	66 (2.6)	2.2 (31.0)	4.5	1.1	0.24	1.5	1400×10 ⁻⁷ (7.7)	4
PK299D □ A PK299DAAR □□	96 (3.78)	4.4 (62.0)		1.5	0.33	2.5	2700×10 ⁻⁷ (14.8)	
PK2913D □ A PK2913DAAR □□	126 (4.96)	6.6 (93.0)		2.22	0.49	4.2	4000×10 ⁻⁷ (22)	

- Enter **A** (single shaft) or **B** (double shaft) in the box □ within the product name.
- Enter the encoder code (**15**, **16**, **25** or **26**) in the box □□ within the product name.
- A 0.6 m (2 ft.) encoder cable (if applicable) sold separately.

Speed – Torque Characteristics (Reference values)

PK296D

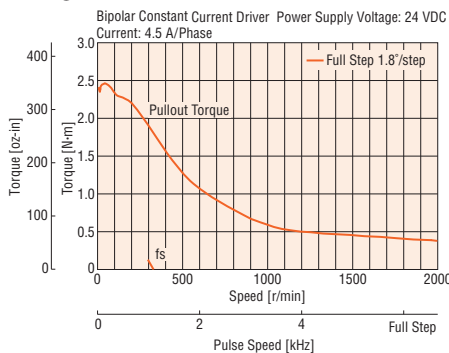

PK299D

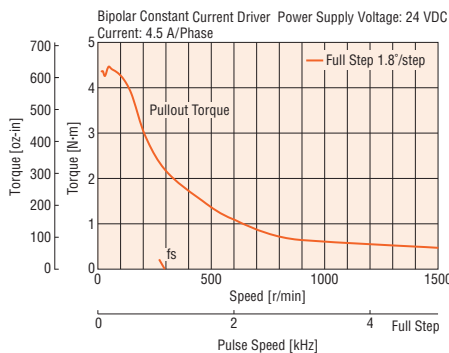

PK2913D

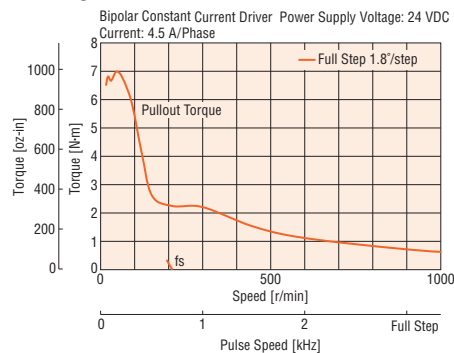

Note

- Data for the speed – torque characteristics is based on Oriental Motor's internal measurement conditions. If the conditions are changed, the characteristics may also change as a result.
- Pay attention to heat dissipation from the motor as there will be a considerable amount of heat under certain conditions. Be sure to keep the temperature of the motor case under 100°C (212°F).

Dimensions Unit = mm (in.)

Motor

2D & 3D CAD

Product Name	L1	L2	Mass kg (lb.)	2D CAD
PK296DAA	66 (2.60)	-	1.7 (3.7)	B122U
PK296DBA		100 (3.94)		
PK299DAA	96 (3.78)	-	2.8 (6.2)	B123U
PK299DBA		130 (5.12)		
PK2913DAA	126 (4.96)	-	3.8 (8.4)	B124U
PK2913DBA		160 (6.3)		

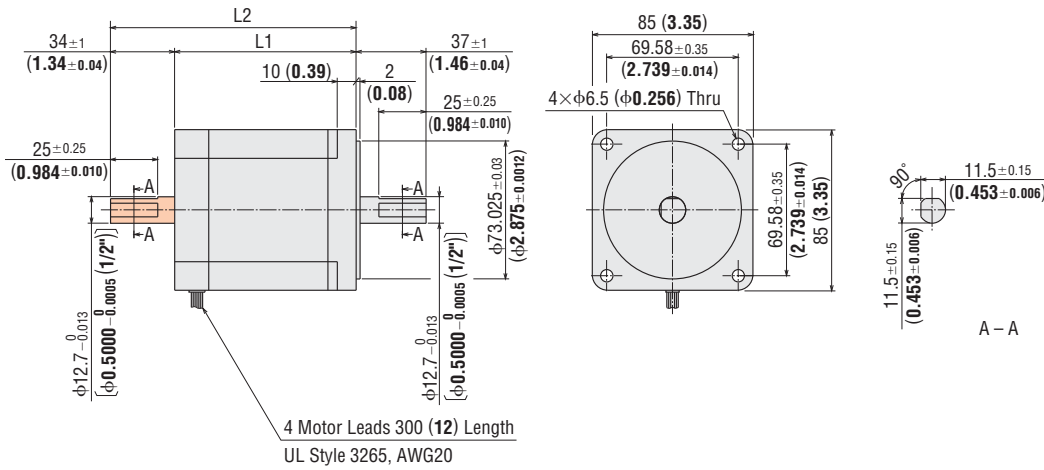

- These dimensions are for the double shaft products.
For the single shaft products, ignore the areas.

Motor with Encoder

2D CAD

Product Name	L1	L2	Mass kg (lb.)	2D CAD
PK296DAAR 	66 (2.60)	82.5 (3.25)	1.72 (3.79)	B775
PK299DAAR 	96 (3.78)	112.5 (4.43)	2.82 (6.22)	B776
PK2913DAAR 	126 (4.96)	142.5 (5.61)	3.82 (8.42)	B777

- Enter the encoder code (**15**, **16**, **25** or **26**) in the box within the product name.
- Encoder Applicable Connector
Connector Housing: 50-57-9405 (Molex)
Contact: 16-02-0104 (Molex)
Crimp Tool: 63811-8700 (Molex)
- Optional Encoder Cables are available.
→ Page A-286

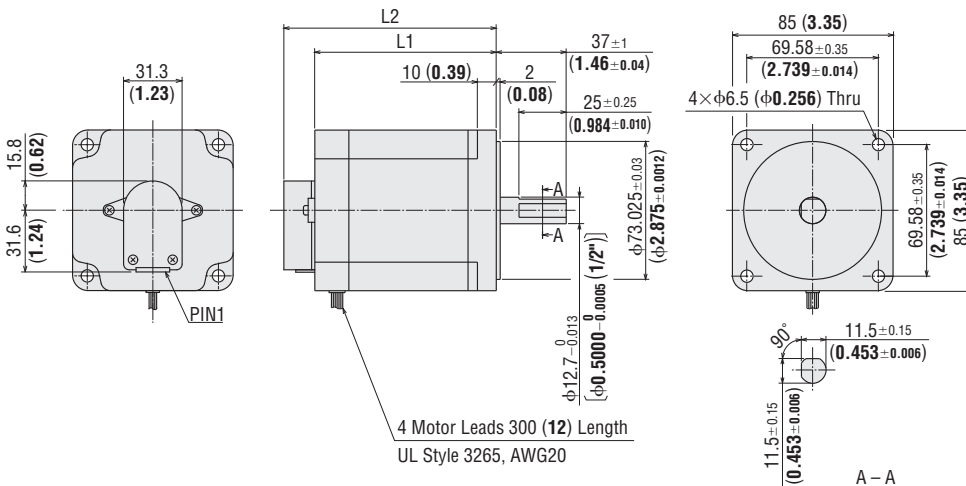

Overview,
Product
Series

AC Input
Motor &
Driver

0.36°/Geared
*Q*_{STEP}
AR

0.36°/Geared
*Q*_{STEP}
Absolute
AZ

0.72°/Geared
RKII

DC Input
Motor &
Driver

0.36°/Geared
*Q*_{STEP}
AR

0.36°/Geared
*Q*_{STEP}
Absolute
AZ

0.72°/0.36°
/Geared
CRK

1.8°/Geared
RBK

1.8°/0.9°
/Geared
CMK

0.72°
All-in-One
PKA

Motor Only

1.8°/0.9°
PKP/PK

Geared
PKP

0.72°/0.36°
PKP

Accessories

Step Angle 0.9° Frame Size 42 mm (1.65 in.) Bipolar 4 Lead Wires

Specifications

Product Name Single/Double Shaft	Motor Length mm (in.)	Holding Torque N·m (oz·in)	Rated Current A/phase	Voltage VDC	Resistance Ω/phase	Inductance mH/phase	Rotor Inertia J kg·m ² (oz·in ²)	Lead Wires
PKP243MD06□-L	33	0.3	0.67	6.3	9.4	26.4	36×10 ⁻⁷ (0.197)	4
PKP243MD15□-L	(1.3)	(42)	1.5	2.85	1.9	6.6		
PKP244MD08□-L	39	0.42	0.85	6.8	8	24	57×10 ⁻⁷ (0.31)	
PKP244MD15□-L	(1.54)	(59)	1.5	3.9	2.6	7.6		

- Enter **A** (single shaft) or **B** (double shaft) in the box □ within the product name.
- A 0.6 m (2 ft.) motor connection cable is included with these products.

Speed – Torque Characteristics (Reference values)

PKP243MD

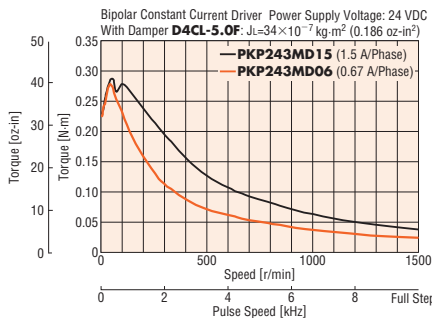

PKP244MD

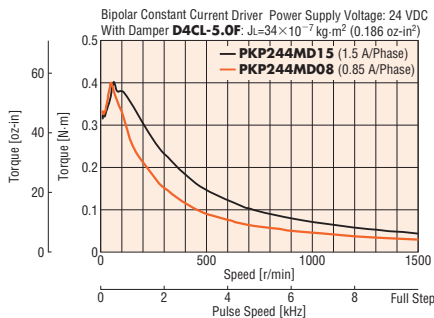

Note

- Data for the speed – torque characteristics is based on Oriental Motor's internal measurement conditions. If the conditions are changed, the characteristics may also change as a result.
- If there is a "With damper" entry in the speed – torque characteristics, the data is for a double shaft motor when a clean damper is equipped.
- Depending on the driving conditions, a considerable amount of heat may be generated by the motor. Be sure to keep the temperature of the motor case under 100°C (212°F).

Dimensions Unit = mm (in.)

Motor

2D & 3D CAD

Product Name	Motor Product Name	L1	L2	Mass kg (lb.)	2D CAD
PKP243MD06A-L	PKP243MD06A	—	—	0.25 (0.55)	B968
PKP243MD06B-L	PKP243MD06B	33 (1.30)	48 (1.89)		
PKP243MD15A-L	PKP243MD15A	—	48 (1.89)		
PKP243MD15B-L	PKP243MD15B	—	—	0.3 (0.66)	B969
PKP244MD08A-L	PKP244MD08A	—	—		
PKP244MD08B-L	PKP244MD08B	39 (1.54)	54 (2.13)		
PKP244MD15A-L	PKP244MD15A	—	54 (2.13)		
PKP244MD15B-L	PKP244MD15B	—	—		

Connection Cables (Included)

◇ Cable for Motor

- Bipolar 4 Lead Wires
LC2B06B

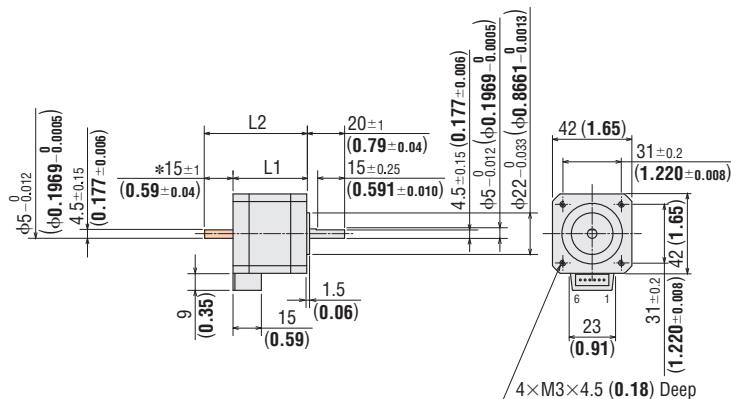
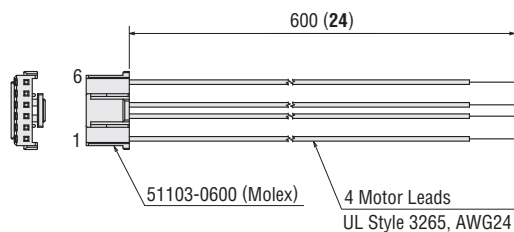

* The length of machining on the double shaft product is 15±0.25 (0.591±0.010).

- These dimensions are for double shaft products. For single shaft products, ignore the shaded areas.

● Applicable Connector

- Connector Housing: 51103-0600 (Molex)
- Contact: 50351-8100 (Molex)
- Crimp Tool: 63811-8100 (Molex)

Step Angle 0.9° Frame Size 56.4 mm (2.22 in.) Bipolar 4 Lead Wires

Specifications

Product Name Single/Double Shaft	Motor Length mm (in.)	Holding Torque N·m (oz-in)	Rated Current	Voltage	Resistance	Inductance	Rotor Inertia J kg·m ² (oz-in ²)	Lead Wires
			A/phase	VDC	Ω/phase	mH/phase		
PKP264MD14 □ A-L	39 (1.54)	0.6 (85)	1.4	4.06	2.9	8.4	120×10 ⁻⁷ (0.66)	4
PKP264MD28 □ A-L			2.8	2	0.73	2.1		
PKP266MD14 □ A-L	54 (2.13)	1.32 (187)	1.4	5.6	4	15.6	290×10 ⁻⁷ (1.59)	
PKP266MD28 □ A-L			2.8	2.8	1	3.9		
PKP268MD14 □ A-L	76 (2.99)	2.23 (325)	1.4	6.86	4.9	22.4	490×10 ⁻⁷ (2.7)	
PKP268MD28 □ A-L			2.8	3.4	1.23	5.6		

- Enter **A** (single shaft) or **B** (double shaft) in the box □ within the product name.
- A 0.6 m (2 ft.) motor connection cable is included with these products.

Speed – Torque Characteristics (Reference values)

PKP264MD

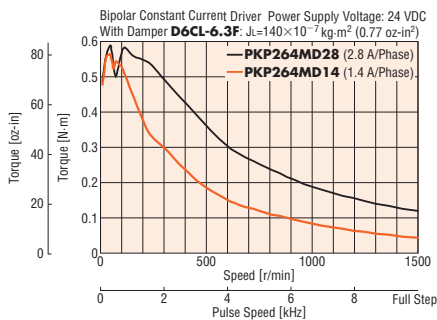

PKP266MD

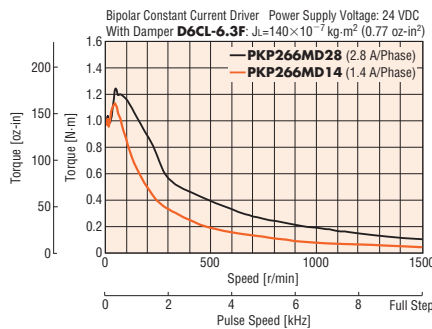

PKP268MD

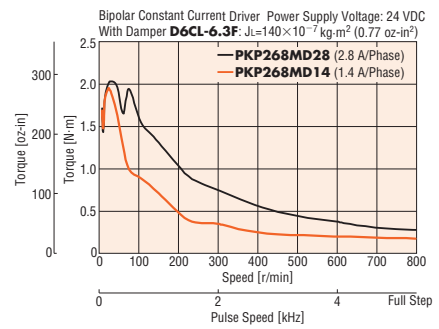

Note

- Data for the speed – torque characteristics is based on Oriental Motor's internal measurement conditions. If the conditions are changed, the characteristics may also change as a result.
- If there is a "With damper" entry in the speed – torque characteristics, the data is for a double shaft motor when a clean damper is equipped.
- Depending on the driving conditions, a considerable amount of heat may be generated by the motor. Be sure to keep the temperature of the motor case under 100°C (212°F).

Dimensions Unit = mm (in.)

● Motor

Product Name	Motor Product Name	L1	L2	Mass kg (lb.)	2D CAD
PKP264MD14AA-L	PKP264MD14AA	39 (1.54)	—	0.46 (1.01)	B1028
PKP264MD14BA-L	PKP264MD14BA		55 (2.17)		
PKP264MD28AA-L	PKP264MD28AA	54 (2.13)	—	0.73 (1.61)	B1029
PKP264MD28BA-L	PKP264MD28BA		55 (2.17)		
PKP266MD14AA-L	PKP266MD14AA	54 (2.13)	—	0.73 (1.61)	B1029
PKP266MD14BA-L	PKP266MD14BA		70 (2.76)		
PKP266MD28AA-L	PKP266MD28AA	76 (2.99)	—	1.1 (2.40)	B1030
PKP266MD28BA-L	PKP266MD28BA		70 (2.76)		
PKP268MD14AA-L	PKP268MD14AA	76 (2.99)	—	1.1 (2.40)	B1030
PKP268MD14BA-L	PKP268MD14BA		92 (3.62)		
PKP268MD28AA-L	PKP268MD28AA	92 (3.62)	—	1.1 (2.40)	B1030
PKP268MD28BA-L	PKP268MD28BA		92 (3.62)		

● Connection Cables (Included)

◇ Cable for Motor

- Bipolar 4 Lead Wires
- LC2B06C

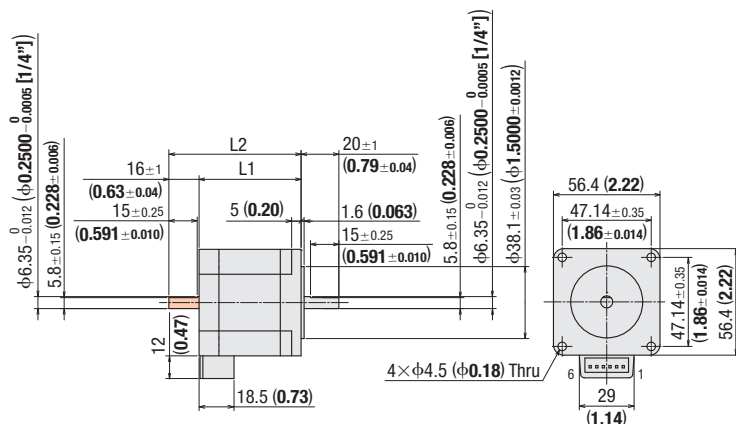
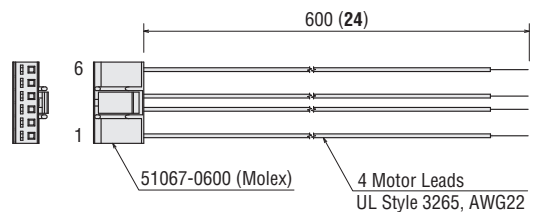

● These dimensions are for double shaft products. For single shaft products, ignore the shaded areas.

Overview, Product Series

AC Input Motor & Driver

0.36°/Geared **Q₅STEP AR**

0.36°/Geared **Q₅STEP Absolute AZ**

0.72°/Geared **RKII**

DC Input Motor & Driver

0.36°/Geared **Q₅STEP AR**

0.36°/Geared **Q₅STEP Absolute AZ**

0.72°/0.36°/Geared **CRK**

1.8°/Geared **RBK**

1.8°/0.9°/Geared **CMK**

0.72° All-in-One **PKA**

Motor Only

1.8°/0.9° **PKP/PK**

Geared **PKP**

0.72°/0.36° **PKP**

Accessories

SH Geared Type Frame Size 28 mm (1.10 in.) Bipolar 4 Lead Wires

Specifications

Product Name -Single Shaft -Double Shaft	Holding Torque N·m (oz·in)	Rated Current A/phase	Voltage VDC	Resistance Ω/phase	Inductance mH/phase	Rotor Inertia J kg·m ² (oz·in ²)	Gear Ratio	Step Angle	Backlash arcmin (degrees)	Speed Range r/min	Lead Wires
PKP223D06A-SG7.2-L PKP223D06B-SG7.2-L	0.3 (42)	0.67	3.8	5.6	4	9×10 ⁻⁷ (0.049)	7.2	0.25°	90 (1.5°)	0~416	4
PKP223D15A-SG7.2-L PKP223D15B-SG7.2-L		1.5	1.8	1.2	0.74						
PKP223D06A-SG9-L PKP223D06B-SG9-L		0.67	3.8	5.6	4		9	0.2°		0~333	
PKP223D15A-SG9-L PKP223D15B-SG9-L		1.5	1.8	1.2	0.74						
PKP223D06A-SG10-L PKP223D06B-SG10-L		0.67	3.8	5.6	4		10	0.18°		0~300	
PKP223D15A-SG10-L PKP223D15B-SG10-L		1.5	1.8	1.2	0.74						
PKP223D06A-SG18-L PKP223D06B-SG18-L	0.4 (56)	0.67	3.8	5.6	4		18	0.1°	0~166		
PKP223D15A-SG18-L PKP223D15B-SG18-L		1.5	1.8	1.2	0.74						
PKP223D06A-SG36-L PKP223D06B-SG36-L		0.67	3.8	5.6	4		36	0.05°		0~83	
PKP223D15A-SG36-L PKP223D15B-SG36-L		1.5	1.8	1.2	0.74						

● A 0.6 m (2 ft.) motor connection cable is included with these products.

Speed – Torque Characteristics (Reference values)

PKP223D-SG7.2

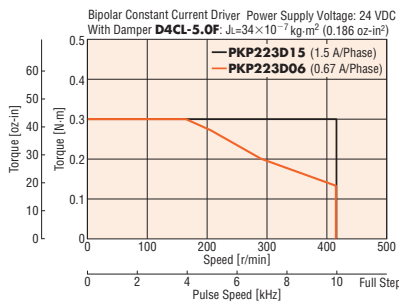

PKP223D-SG9

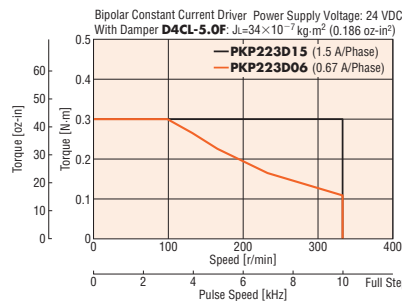

PKP223D-SG10

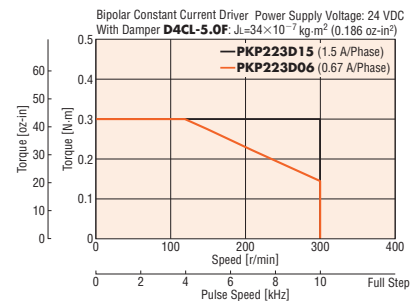

PKP223D-SG18

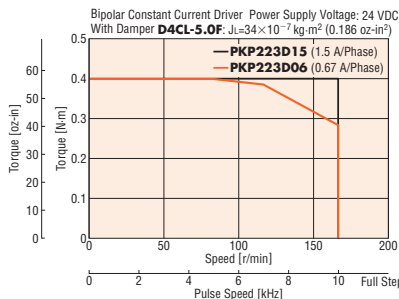

PKP223D-SG36

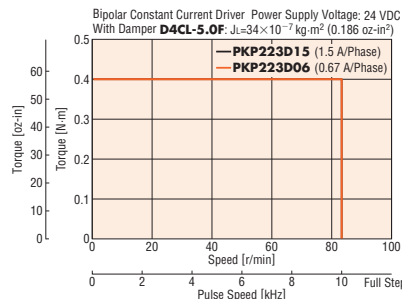

● Enter the current in the box , enter **A** (single shaft) or **B** (double shaft) into the box .

Note

- Data for the speed – torque characteristics is based on Oriental Motor’s internal measurement conditions. If the conditions are changed, the characteristics may also change as a result.
- If there is a "With damper" entry in the speed – torque characteristics, the data is for a double shaft motor when a clean damper is equipped.
- Depending on the driving conditions, a considerable amount of heat may be generated by the motor. Be sure to keep the temperature of the motor case under 100°C (212°F).

Dimensions Unit = mm (in.)

● Gearmotor

2D & 3D CAD

Product Name	Motor Product Name	Gear Ratio	Mass kg (lb.)	2D CAD
PKP223D06A-SG□-L	PKP223D06A-SG□	7.2, 9, 10, 18, 36	0.16 (0.35)	B985
PKP223D06B-SG□-L	PKP223D06B-SG□			
PKP223D15A-SG□-L	PKP223D15A-SG□			
PKP223D15B-SG□-L	PKP223D15B-SG□			

● A number indicating the gear ratio is entered where the box □ is located within the product name.

● Applicable Connector

Connector Housing: 51065-0600 (Molex)
Contact: 50212-8100 (Molex)
Crimp Tool: 63819-0500 (Molex)

● Connection Cables (Included)

◇ Cable for Motor

- Bipolar 4 Lead Wires
LC2B06B

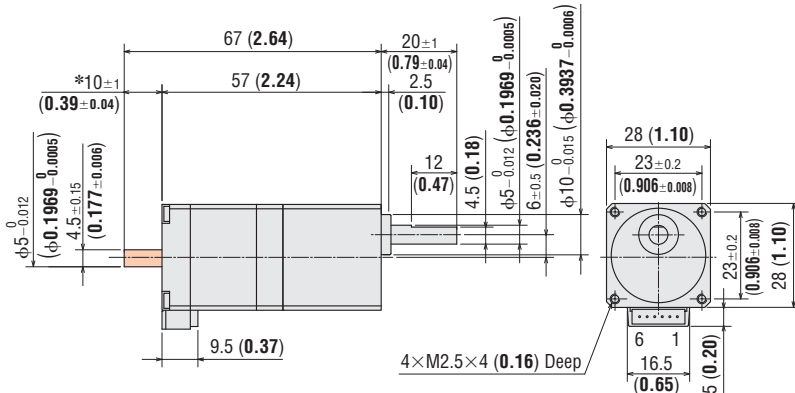
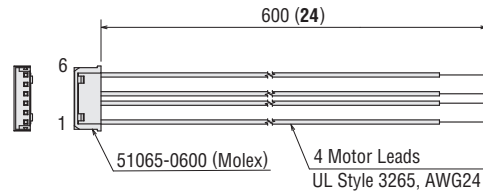

*The length of machining on the double shaft product is 10 ± 0.25 (0.394 ± 0.010).

- These dimensions are for double shaft products.
For single shaft products, ignore the areas.

Overview,
Product
Series

AC Input
Motor &
Driver

0.36°/Geared
*Q*STEP
AR

0.36°/Geared
*Q*STEP
Absolute
AZ

0.72°/Geared
RKII

DC Input
Motor &
Driver

0.36°/Geared
*Q*STEP
AR

0.36°/Geared
*Q*STEP
Absolute
AZ

0.72°/0.36°
/Geared
CRK

1.8°/Geared
RBK

1.8°/0.9°
/Geared
CMK

0.72°
All-in-One
PKA

Motor Only

1.8°/0.9°
PKP/PK

Geared
PKP

0.72°/0.36°
PKP

Accessories

SH Geared Type Frame Size 42 mm (1.65 in.) Bipolar 4 Lead Wires

Specifications

Product Name	Holding Torque N·m (lb·in)	Rated Current A/phase	Voltage VDC	Resistance Ω/phase	Inductance mH/phase	Rotor Inertia J kg·m ² (oz·in ²)	Gear Ratio	Step Angle	Backlash arcmin (degrees)	Speed Range r/min	Lead Wires						
PKP243D06A-SG3.6-L PKP243D06B-SG3.6-L PKP243D15A-SG3.6-L PKP243D15B-SG3.6-L	0.2 (1.77)	0.67	2.95	4.4	9.2	36×10 ⁻⁷ (0.197)	3.6	0.5°	90 (1.5°)	0~833	4						
PKP243D06A-SG7.2-L PKP243D06B-SG7.2-L PKP243D15A-SG7.2-L PKP243D15B-SG7.2-L		1.5	0.87	0.58	1.1							7.2	0.25°	0~416			
PKP243D06A-SG9-L PKP243D06B-SG9-L PKP243D15A-SG9-L PKP243D15B-SG9-L		0.67	2.95	4.4	9.2										9	0.2°	0~333
PKP243D06A-SG10-L PKP243D06B-SG10-L PKP243D15A-SG10-L PKP243D15B-SG10-L		1.5	0.87	0.58	1.1												
PKP243D06A-SG18-L PKP243D06B-SG18-L PKP243D15A-SG18-L PKP243D15B-SG18-L	0.67	2.95	4.4	9.2	18		0.1°	0~166									
PKP243D06A-SG36-L PKP243D06B-SG36-L PKP243D15A-SG36-L PKP243D15B-SG36-L	1.5	0.87	0.58	1.1					36	0.05°		0~83					
PKP243D06A-SG3.6-L PKP243D06B-SG3.6-L PKP243D15A-SG3.6-L PKP243D15B-SG3.6-L	0.67	2.95	4.4	9.2									0.56 (4.9)	0.18°	0~300		
PKP243D06A-SG7.2-L PKP243D06B-SG7.2-L PKP243D15A-SG7.2-L PKP243D15B-SG7.2-L	1.5	0.87	0.58	1.1												0.8 (7.0)	0.1°
PKP243D06A-SG9-L PKP243D06B-SG9-L PKP243D15A-SG9-L PKP243D15B-SG9-L	0.67	2.95	4.4	9.2	0.8 (7.0)		0.05°	0~83									
PKP243D06A-SG10-L PKP243D06B-SG10-L PKP243D15A-SG10-L PKP243D15B-SG10-L	1.5	0.87	0.58	1.1					0.8 (7.0)	0.05°		0~83					

● A 0.6 m (2 ft.) motor connection cable is included with these products.

Speed – Torque Characteristics (Reference values)

PKP243D SG3.6

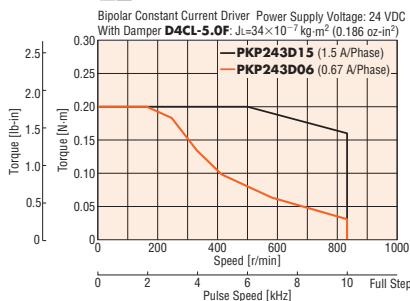

PKP243D SG7.2

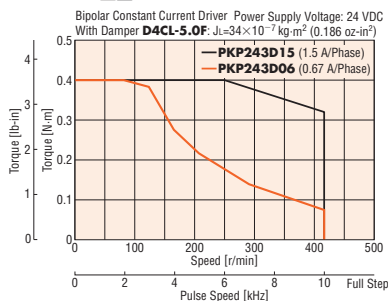

PKP243D SG9

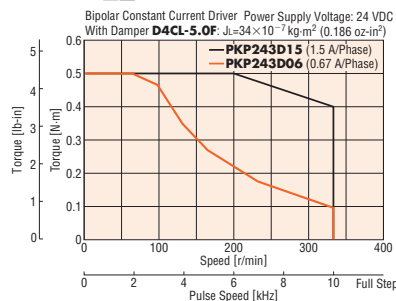

PKP243D SG10

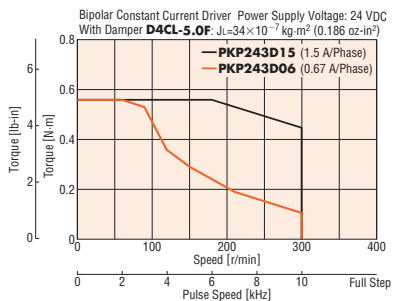

PKP243D SG18

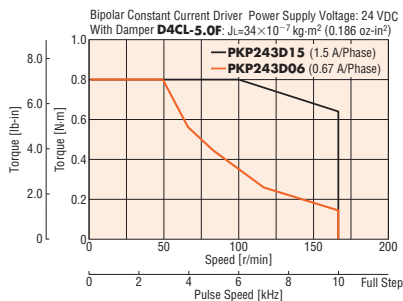

PKP243D SG36

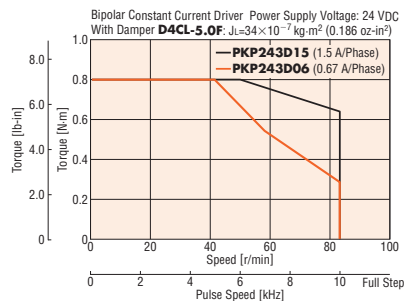

● Enter the current in the box , enter **A** (single shaft) or **B** (double shaft) into the box .

Note

- Data for the speed – torque characteristics is based on Oriental Motor's internal measurement conditions. If the conditions are changed, the characteristics may also change as a result.
- If there is a "With damper" entry in the speed – torque characteristics, the data is for a double shaft motor when a clean damper is equipped.
- Depending on the driving conditions, a considerable amount of heat may be generated by the motor. Be sure to keep the temperature of the motor case under 100°C (212°F).

Dimensions Unit = mm (in.)

● Gearmotor

2D & 3D CAD

Product Name	Motor Product Name	Gear Ratio	Mass kg (lb.)	2D CAD
PKP243D06A-SG□-L	PKP243D06A-SG□	3.6, 7.2, 9, 10, 18, 36	0.35 (0.77)	B986
PKP243D06B-SG□-L	PKP243D06B-SG□			
PKP243D15A-SG□-L	PKP243D15A-SG□			
PKP243D15B-SG□-L	PKP243D15B-SG□			

● A number indicating the gear ratio is entered where the box □ is located within the product name.

● Applicable Connector
 Connector Housing: 51103-0600 (Molex)
 Contact: 50351-8100 (Molex)
 Crimp Tool: 63811-8100 (Molex)

● Motor

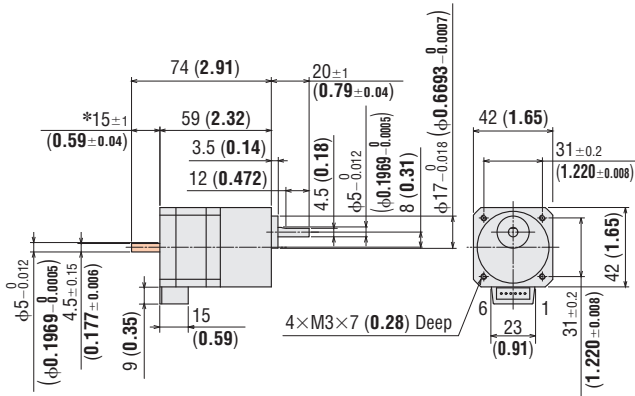

*The length of machining on the double shaft product is 15±0.25 (0.591±0.010).

● These dimensions are for double shaft products.
 For single shaft products, ignore the areas.

● Connection Cables (Included)

◇ Cable for Motor

- Bipolar 4 Lead Wires
LC2B06B

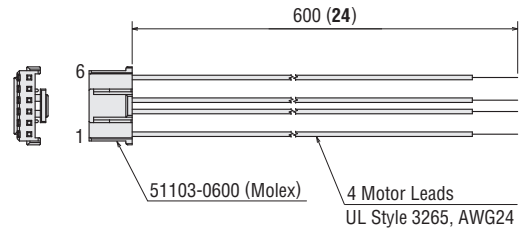

Overview, Product Series

AC Input Motor & Driver

0.36°/Geared
*Q*STEP
AR

0.36°/Geared
*Q*STEP
Absolute
AZ

0.72°/Geared
RKII

DC Input Motor & Driver

0.36°/Geared
*Q*STEP
AR

0.36°/Geared
*Q*STEP
Absolute
AZ

0.72°/0.36°
/Geared
CRK

1.8°/Geared
RBK

1.8°/0.9°
/Geared
CMK

0.72°
All-in-One
PKA

Motor Only

1.8°/0.9°
PKP/PK

Geared
PKP

0.72°/0.36°
PKP

Accessories

SH Geared Type

Frame Size 60 mm (2.36 in.) Bipolar 4 Lead Wires

Specifications

Product Name -Single Shaft -Double Shaft	Holding Torque N·m (lb·in)	Rated Current A/phase	Voltage VDC	Resistance Ω/phase	Inductance mH/phase	Rotor Inertia J kg·m ² (oz·in ²)	Gear Ratio	Step Angle	Backlash arcmin (degrees)	Speed Range r/min	Lead Wires
PKP264D07A-SG3.6-L PKP264D07B-SG3.6-L	1 (8.8)	0.71	8.31	11.7	28.8	120×10 ⁻⁷ (0.66)	3.6	0.5°	70 (1.17°)	0~833	4
PKP264D14A-SG3.6-L PKP264D14B-SG3.6-L		1.4	3.08	2.2	4.5						
PKP264D28A-SG3.6-L PKP264D28B-SG3.6-L		2.8	0.92	0.33	0.8						
PKP264D07A-SG7.2-L PKP264D07B-SG7.2-L		0.71	8.31	11.7	28.8						
PKP264D14A-SG7.2-L PKP264D14B-SG7.2-L	2 (17.7)	1.4	3.08	2.2	4.5		7.2	0.25°		0~416	
PKP264D28A-SG7.2-L PKP264D28B-SG7.2-L		2.8	0.92	0.33	0.8						
PKP264D07A-SG9-L PKP264D07B-SG9-L		0.71	8.31	11.7	28.8						
PKP264D14A-SG9-L PKP264D14B-SG9-L	2.5 (22)	1.4	3.08	2.2	4.5		9	0.2°		0~333	
PKP264D28A-SG9-L PKP264D28B-SG9-L		2.8	0.92	0.33	0.8						
PKP264D07A-SG10-L PKP264D07B-SG10-L	2.7 (23)	0.71	8.31	11.7	28.8		10	0.18°	45 (0.75°)	0~300	
PKP264D14A-SG10-L PKP264D14B-SG10-L		1.4	3.08	2.2	4.5						
PKP264D28A-SG10-L PKP264D28B-SG10-L		2.8	0.92	0.33	0.8						
PKP264D07A-SG18-L PKP264D07B-SG18-L	3 (26)	0.71	8.31	11.7	28.8		18	0.1°		0~166	
PKP264D14A-SG18-L PKP264D14B-SG18-L		1.4	3.08	2.2	4.5						
PKP264D28A-SG18-L PKP264D28B-SG18-L		2.8	0.92	0.33	0.8						
PKP264D07A-SG36-L PKP264D07B-SG36-L	4 (35)	0.71	8.31	11.7	28.8		36	0.05°		0~83	
PKP264D14A-SG36-L PKP264D14B-SG36-L		1.4	3.08	2.2	4.5						
PKP264D28A-SG36-L PKP264D28B-SG36-L		2.8	0.92	0.33	0.8						

●A 0.6 m (2 ft.) motor connection cable is included with these products.

Speed – Torque Characteristics (Reference values)

PKP264D--SG3.6

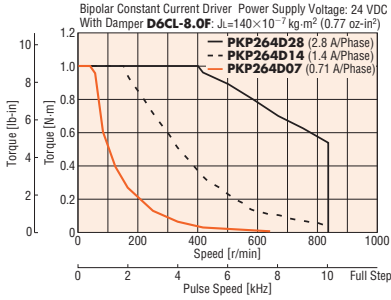

PKP264D--SG7.2

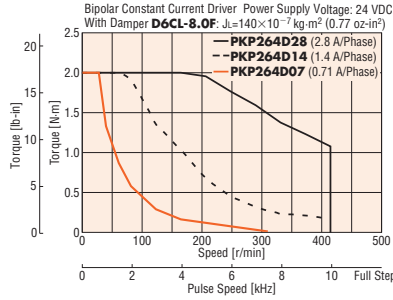

PKP264D--SG9

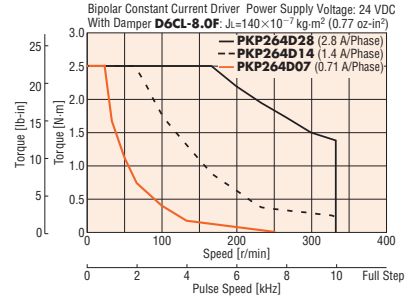

PKP264D--SG10

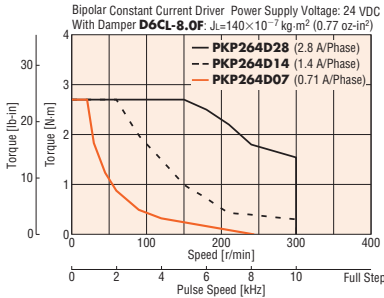

PKP264D--SG18

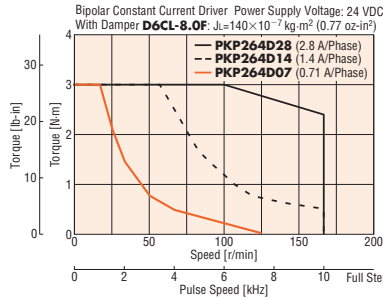

PKP264D--SG36

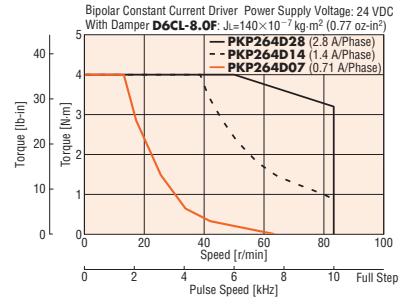

Enter the current in the box , enter **A** (single shaft) or **B** (double shaft) into the box .

Note

- Data for the speed – torque characteristics is based on Oriental Motor's internal measurement conditions. If the conditions are changed, the characteristics may also change as a result.
- If there is a "With damper" entry in the speed – torque characteristics, the data is for a double shaft motor when a clean damper is equipped.
- Depending on the driving conditions, a considerable amount of heat may be generated by the motor. Be sure to keep the temperature of the motor case under 100°C (212°F).

Dimensions Unit = mm (in.)

Gearmotor

Product Name	Motor Product Name	Gear Ratio	Mass kg (lb.)	2D CAD
PKP264D07A-SG <input type="checkbox"/> -L	PKP264D07A-SG <input type="checkbox"/>	3.6, 7.2, 9, 10, 18, 36	0.76 (1.67)	B987
PKP264D07B-SG <input type="checkbox"/> -L	PKP264D07B-SG <input type="checkbox"/>			
PKP264D14A-SG <input type="checkbox"/> -L	PKP264D14A-SG <input type="checkbox"/>			
PKP264D14B-SG <input type="checkbox"/> -L	PKP264D14B-SG <input type="checkbox"/>			
PKP264D28A-SG <input type="checkbox"/> -L	PKP264D28A-SG <input type="checkbox"/>			
PKP264D28B-SG <input type="checkbox"/> -L	PKP264D28B-SG <input type="checkbox"/>			

A number indicating the gear ratio is entered where the box is located within the product name.

Applicable Connector

- Connector Housing: 51067-0600 (Molex)
- Contact: 50217-9101 (Molex)
- Crimp Tool: 63811-8300 (Molex)

Motor

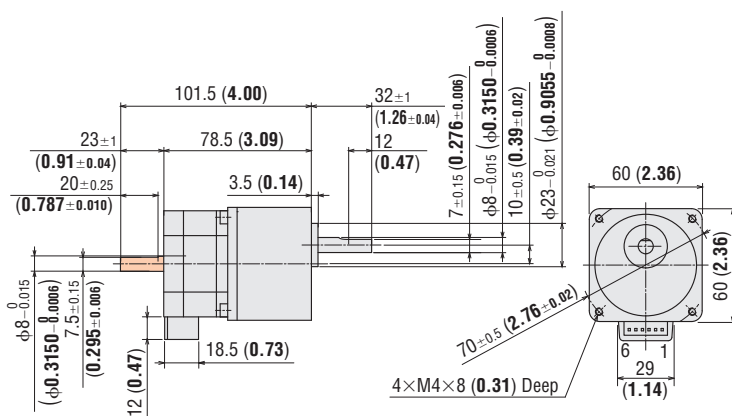

These dimensions are for double shaft products. For single shaft products, ignore the areas.

Connection Cables (Included)

Cable for Motor

- Bipolar 4 Lead Wires LC2B06C

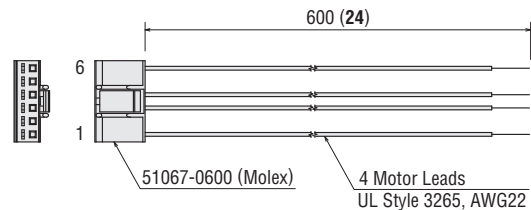

Overview, Product Series

AC Input Motor & Driver

0.36°/Geared *Q*STEP AR

0.36°/Geared *Q*STEP Absolute AZ

0.72°/Geared RKII

DC Input Motor & Driver

0.36°/Geared *Q*STEP AR

0.36°/Geared *Q*STEP Absolute AZ

0.72°/0.36°/Geared CRK

1.8°/Geared RBK

1.8°/0.9°/Geared CMK

0.72° All-in-One PKA

Motor Only

1.8°/0.9° PKP/PK

Geared PKP

0.72°/0.36° PKP

Accessories

General Specifications

Item	Specification	
Heat-Resistant Class	130 (B)	
Insulation Resistance	100 MΩ or more when 500 VDC megger is applied between the windings and the case under normal ambient temperature and humidity.	
Dielectric Strength	Sufficient to withstand 1.0 kVAC at 60Hz applied between the windings and the case for 1 minute, under normal ambient temperature and humidity. (0.5 kV for models with a frame size of 42 mm (1.65 in.))	
Operating Environment (In operation)	Ambient Temperature	-10~+50°C (+14~+122°F) (non-freezing)
	Ambient Humidity	85% max. (non-condensing)
	Atmosphere	No corrosive gases or dust. The product should not be exposed to water, oil or other liquids.
Temperature Rise	<ul style="list-style-type: none"> • PKP21□, PKP243, PKP245, and SH geared type: Temperature rise of the windings is 80°C (176°F) or less (measured by the resistance change method) at the rated voltage, at standstill, and 2-phases excited. • PK29□, PKP22□, PKP23□, PKP244, PKP246, PKP26□: Temperature rise of the windings is 80°C (176°F) or less (measured by the resistance change method) at the rated current, at standstill, and 2-phases excited. <p>The following motors are measured with a radiation plate (material aluminum). PKP22□ and PKP23□: 115×115×5 mm (4.53×4.53×0.20 in.) PKP244 and PKP246: 175×175×5 mm (6.89×6.89×0.20 in.) PKP26□: 250×250×10mm (9.84×9.84×0.39 in.)</p>	
Stop Position Accuracy*1	±3 arcmin (±0.05°) [PKP21 □: ±5 arcmin (±0.083°)]	
Shaft Runout	0.05 mm (0.002 in.) T.I.R.*4	
Radial Play*2	0.025 mm (0.001 in.) maximum (load 5 N (1.12 lb.))	
Axial Play*3	0.075 mm (0.003 in.) maximum (load 10 N (2.2 lb.)) [The load for PKP21 □ is 1 N (0.225 lb.)]	
Concentricity of Installing Pilot to the Shaft	0.075 mm (0.003 in.) T.I.R.*4	
Perpendicularity of Installation Surface to the Shaft	0.075 mm (0.003 in.) T.I.R.*4	

*1 This value is for full step under no load. (The value changes with the size of the load.)

*2 Radial Play: Displacement in shaft position in the radial direction when a 5 N (1.12 lb.) load is applied in the vertical direction to the tip of the motor shaft.

*3 Axial Play: Displacement in shaft position in the axial direction when a 10 N (2.2 lb.) [**PKP21**□ is 1 N (0.225 lb.)] load is applied to the motor shaft in the axial direction.

*4 T. I. R. (Total Indicator Reading): The total dial gauge reading when the measurement section is rotated one revolution centered on the reference axis center.

Note

● Do not measure insulation resistance or perform the dielectric strength test while the motor and driver are connected. Also, do not conduct these tests on the motor encoder section.

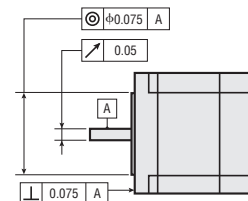

Permissible Radial Load and Permissible Axial Load

→ Page A-16

Inner Wiring Diagram for Motor

● Bipolar 4 Lead Wires

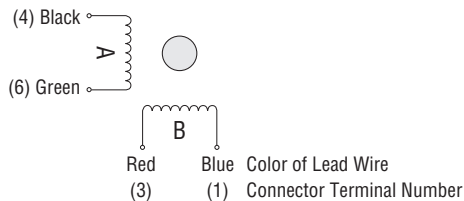

Encoder Specifications

- Motor Frame Size: 20 mm (0.79 in.), 35 mm (1.38 in.), 42 mm (1.65 in.), 56.4 mm (2.22 in.)

Item	Encoder Code	Specification					
		R2E	R2F	R15	R16	R25	R26
Type		Incremental					
Resolution		200 P/R	400 P/R	200 P/R	400 P/R	200 P/R	400 P/R
Output		3-Channel A, B, Z		2-Channel A, B		3-Channel A, B, Index	
Input Current		45 mA		27 mA (Typ.)			
Input Voltage		5 VDC ± 10%					
Output Type		Voltage Output Power			TTL		
Output Voltage (TTL)	Low	0.5 VDC		0.5 VDC, 8 mA			
	High	4.3 VDC		2.0 VDC, -8 mA			
Response Frequency		100 kHz		300 kHz (Max.)			

Encoder Pin-Outs

- Motor Frame Size: 20 mm (0.79 in.)

Motor Pin No.	Lead Wire Color of Connection Cable for Encoder	Encoder Code R2E, R2F
1	Black	GND
2	Red	A
3	Brown	N.C.
4	Green	B
5	Blue	N.C.
6	Yellow	Z
7	Orange	N.C.
8	White	Vcc

● These are colors of the supplied leads wire connection cable for the encoder

- Motor Frame Size: 35 mm (1.38 in.), 42 mm (1.65 in.), 56.4 mm (2.22 in.), 60 mm (2.36 in.)*, 85 mm (3.35 in.)

Motor Pin No.	Lead Wire Color of Connection Cable for Encoder	Encoder Code	
		R15, R16	R25, R26
1	Brown	GND	
2	Purple	—	Index Channel
3	Blue	A Channel	
4	Orange	+5 VDC Power	
5	Yellow	B Channel	

*SH Geared type

Overview, Product Series

AC Input Motor & Driver

0.36°/Geared Q_{STEP} AR

0.36°/Geared Q_{STEP} Absolute AZ

0.72°/Geared RKII

DC Input Motor & Driver

0.36°/Geared Q_{STEP} AR

0.36°/Geared Q_{STEP} Absolute AZ

0.72°/0.36°/Geared CRK

1.8°/Geared RBK

1.8°/0.9°/Geared CMK

0.72° All-in-One PKA

Motor Only

1.8°/0.9° PKP/PK

Geared PKP

0.72°/0.36° PKP

Accessories

Driver Options

■ Bipolar (20~75 VDC)



Product Name	List Price
RBD215A-K	\$330.00
RBD242A-V	\$330.00

■ Unipolar (24 VDC)



Product Name	List Price
CMD2109P	\$184.00
CMD2112P	\$184.00
CMD2120P	\$184.00

● Pins and connector are included with the driver.

Connection Cable Set



As an accessory for DC input drivers, lead wires with a connector are available. These lead wires allow for easy connection of the motor, power supply and input/output signals without crimping. The connection cable set includes three connection cables (for motor, power supply and input/output signals).

● Product Line

Product Name	List Price	Applicable Driver	Length m (ft.)	AWG
LCS01CMK2	\$27.00	CMD2109P CMD2112P CMD2120P	0.6 (2)	22

Overview,
Product
Series

AC Input
Motor &
Driver

0.36°/Geared
Q_{STEP}
AR

0.36°/Geared
Q_{STEP}
Absolute
AZ

0.72°/Geared
RKII

DC Input
Motor &
Driver

0.36°/Geared
Q_{STEP}
AR

0.36°/Geared
Q_{STEP}
Absolute
AZ

0.72°/0.36°
/Geared
CRK

1.8°/Geared
RBK

1.8°/0.9°
/Geared
CMK

0.72°
All-in-One
PKA

Motor Only

1.8°/0.9°
PKP/PK

Geared
PKP

0.72°/0.36°
PKP

Accessories