

Microwave RFID System V690





RFID System for Microwave Communications at 600 Kbps at Up To 5 Meters

- Microwave communications at up to 5 m at 2,450 MHz with excellent noise resistance.
- Memory capacity of 8 Kbytes to store assembly, inspection, sorting, and other production data on production lines.
- ID Tags meeting IEC IP67 (JEM IP67g) requirements and providing low battery voltage warnings.
- Many versatile functions, such as a first-in first out function, multi-access, and selection of low-power mode (2 m mode) or high-power mode (5 m mode.)

Note: The use of the V690 in may be subject to radio regulations and EMC restrictions in individual countries. Contact your OMRON representative for details.



Ordering Information

Product	Model		Shape/Specification	
ID Tag	V690-D8KR01A		86×54×13.8 mm	<ul style="list-style-type: none"> • 8-Kbyte memory • Built-in lithium battery • Degree of protection: IP67 (IP67g)
R/W Antenna	V690-HMG01A		280×280×60 mm	<ul style="list-style-type: none"> • Degree of protection IP62 (with the connector inserted in the downward direction) • 0.5-m cable • Watertight connector
RS-422A/RS-485 Link Unit	V690-L01		122×82×45 mm	<ul style="list-style-type: none"> • Degree of protection: IP30 (with the connector connected)
RS-232C Connecting Cables	V690-A40		2 m	<ul style="list-style-type: none"> • Material: Vinyl chloride • The connector on the Antenna end is watertight. The connector on the host end is not watertight.
	V690-A41		3 m	
	V690-A42		5 m	
	V690-A43		10 m	
	V690-A44		15 m	
RS-422A/RS-485 Link Unit Connecting Cables	V690-A50		2 m	
	V690-A51		3 m	
	V690-A52		5 m	
	V690-A53		10 m	
	V690-A54		20 m	
	V690-A55		30 m	
	V690-A56	50 m		

System Configuration

■ 1-to-1 Host Communications via RS-232C

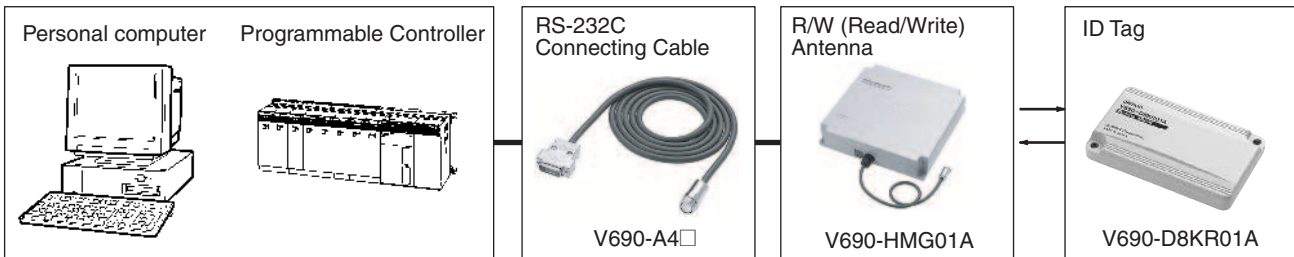

■ 1-to-n RS-422 (4-wire)/RS-485 (2-wire) Host Communications

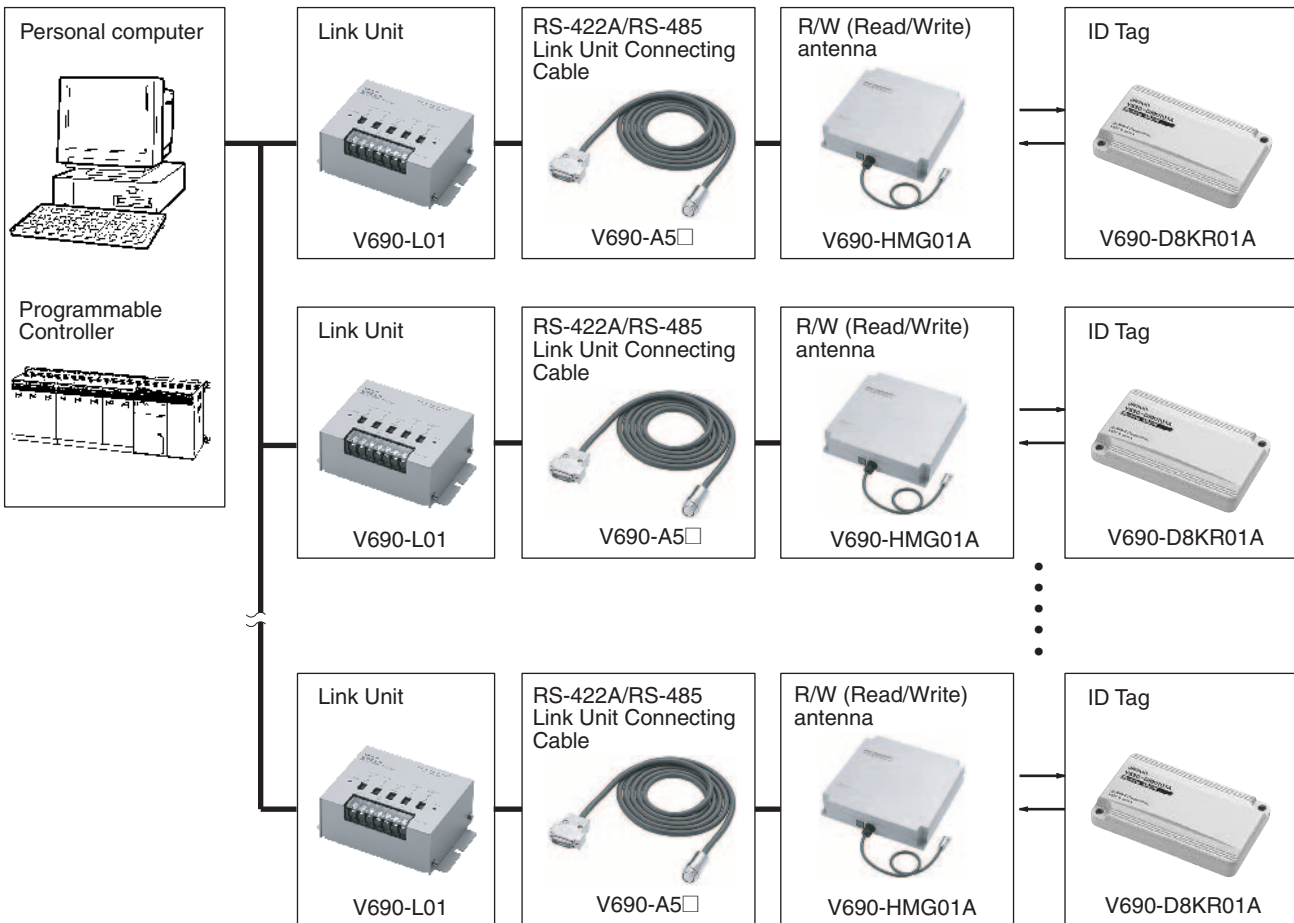

Specifications

■ Ratings

Communications Performance

Item	Specification
Frequency	2,450-MHz band (2,434.25 to 2,465.75 MHz)
Modulated transmission output	Low-power mode (2 m mode): 5 mW High-power mode (5 m mode): 10 mW
Polarized wave	Circularly polarized wave
Communications distance	Low-power mode (2 m mode): 0.2 to 2.0 m (reference value) High-power mode (5 m mode): 0.2 to 5.0 m (reference value) (See note.)
Baud rate	600 Kbps
Communications error check	CRC cyclic redundancy check on 16 bits bi-directionally

Note: Reference values are give under the following conditions.

- Temperature: 20 ±5°C
- The Tag is rotated so that the OMRON logo is located vertically.
- The Tag is located on the central axis of the antenna located 1.5 m above the floor in a room with minimal electromagnetic noise.

Read/Write Antenna

Item	Specifications
Interface specifications	RS-232C (Connect a Link Unit to the Read/Write Antenna when communicating via RS-485 or RS-422A). Baud rate: 4.8, 9.6, 19.2, 38.4, 57.6, or 115.2 Kbps
Power supply voltage	24 VDC
Permissible power supply voltage range	20.4 to 26.4 VDC
Current consumption	0.5 A max.
Ambient temperature	Operating: -20 to 60°C (with no icing) Storage: -20 to 60°C (with no icing)
Ambient humidity	Operating: 35% to 85% (with no condensation) Storage: 35% to 85% (with no condensation)
Insulation resistance	20 MΩ min. (at 100 VDC) between cable and casing
Dielectric strength	1,000 VAC (50/60 Hz) for 1 minute between cable and casing
Degree of protection	IP62 (IEC60529) (See note.)
Vibration resistance	10 to 150 Hz, 0.35-mm single amplitude at 50 m/s ² max. in X, Y, and Z directions 10 times for 8 minutes each
Shock resistance	150 m/s ² in X, Y, and Z directions 3 times each (18 times in total)
Indicator	Power supply, radio transmission, host transmission, and Tag transmission
Cable length	0.5 m
Weight	2.6 kg max. (with 0.5-m cable and connectors)

Note: The degree of protection is with the connector inserted in the downward direction.

ID Tags

Item	Specification
Memory capacity	8 Kbytes
Memory type	SRAM (volatile memory with battery back-up)
Battery life (Reference value)	5 years at 25°C. The battery is not replaceable. A low battery voltage warning is provided. Refer to page 6 for details on the battery life.
Ambient temperature	Operating: -20 to 60°C while the ID Tag is communicating and -25 to 70°C while the ID Tag is not communicating (with no icing) Storage: -25 to 70°C (with no icing)
Ambient humidity	Operating: 35% to 85% (with no condensation) Storage: 35% to 85% (with no condensation)
Degree of protection	IP67 (IEC60529)/IP67g (JEM1030) (See note.)
Vibration resistance	Destruction: 10 to 2,000 Hz, 0.75-mm single amplitude at 150 m/s ² in X, Y, and Z directions 10 times for 15 minutes each
Shock resistance	500 m/s ² in X, Y, and Z directions 3 times each (18 times in total)
Weight	75 g max.

Note: The degree of protection is with the ID Tag located on a flat plane.

RS-422A/RS-485 Link Unit

Item	Specifications
Interface specifications	RS-422A, RS-485
Power supply voltage	24 VDC
Permissible power supply voltage range	20.4 to 26.4 VDC
Power consumption	6 W max.
Ambient temperature	Operating: 0 to 55°C (with no icing) Storage: -10 to 65°C (with no icing)
Ambient humidity	Operating: 35% to 85% (with no condensation) Storage: 35% to 85% (with no condensation)
Insulation resistance	20 MΩ min. (at 100 VDC) between the terminals, except the ground terminal, and the casing
Dielectric strength	1,000 VAC (50/60 Hz) for 1 minute between the terminals, except the ground terminal, and the casing
Degree of protection	IP30 (IEC60529) (See note.)
Vibration resistance	10 to 150 Hz, 0.35-mm single amplitude at 50 m/s ² max. in X, Y, and Z directions 10 times for 8 minutes each
Shock resistance	150 m/s ² in X, Y, and Z directions 3 times each (18 times in total)
Ground	Ground at a resistance of less than 100 Ω
Weight	450 g max.

Note: The degree of protection is when the Link Unit is connected through the V690-A5 Connector.

Communications Distance and Installation Environment

- The communications distance varies with the actual installation environment. The reason is that radio waves are reflected by metals and the ground and absorbed by water and human bodies. Before using the RFID System, locate the Antenna and Tag at the set distance and check the radio environment.
- A communications test command is available for the V690-HMG01A R/W Antenna, which makes it possible to check the on-site radio environment.

Refer to the User's Manual (Cat. No. Z149) for details.

Engineering Data

■ Communications Data

Communications Range (Reference)

Low-power Mode (2 m Mode)

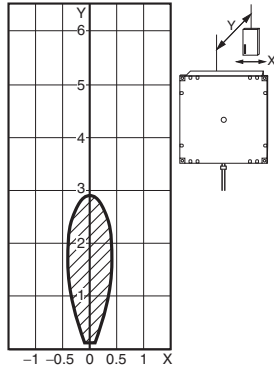

High-power Mode (5 m Mode)

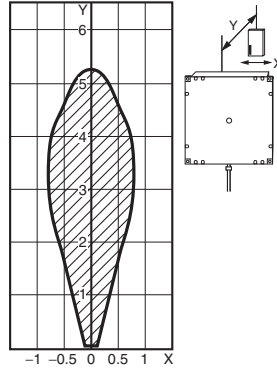

Temperature Influence (Reference)

Low-power Mode (2 m Mode)

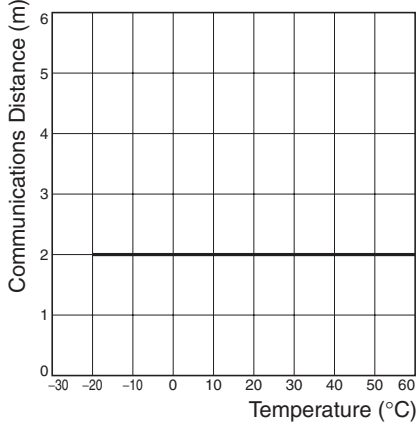

High-power Mode (5 m Mode)

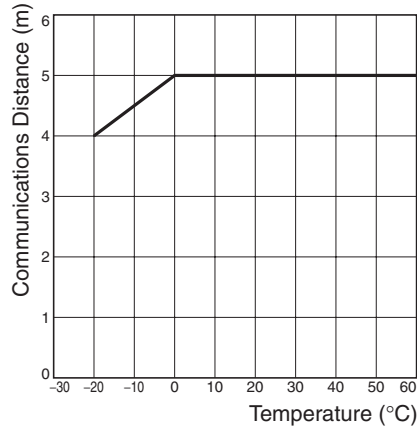

Communications Time

The time required from starting to send a command until the response is completed is called the turn-around time (TAT). The TAT can be calculated by totaling the communications times of the Read/Write Antenna and ID Tag. The communications times depend on the number of bytes being processed and the amount of data. See below for details.

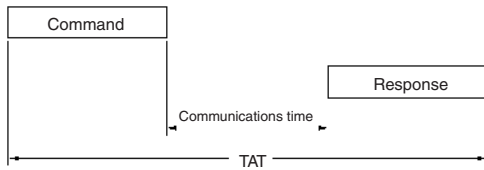

Single Tag

The following communications times are required provided that the Tag set to sleep after each command is executed, and the auto repeat and the repeat input trigger functions are used. The letter N is the number of bytes.

Command	Communications time (ms)
Read and write (with no read verification)	$t=11+0.03 \times N$
Write (with read verification)	$t=13+0.06 \times N$
ID code Read	$t=10$ (ms)
Communications test	$t=1,100$ (ms)

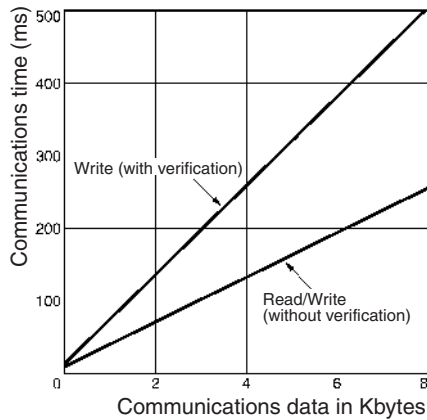

Maximum Tag Movement Speed

The maximum speed of a Tag passing over the communications range of the Antenna is obtained from the following formula.
 Max. movement speed = Movement distance within communications range / Communications time

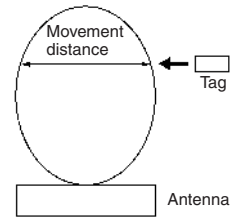

• Calculation Example

Obtain the possible movement distance of the Tag provided that the distance between the Antenna and Tag is 1 m and 32-byte data is read. The range width is 0.8 m at a communications distance of 2 m in the 2 m mode. The communications time to read the 32-byte data is 12 ms.

$$\text{Max. movement speed} = \frac{0.8 \text{ m}}{12 \text{ ms}} = \frac{0.8 \text{ m}}{0.012 \times 1/60 \text{ (min)}} = 4 \text{ km/min (240 km/h)}$$

Note: The speed obtained from the above formula is for reference only. Use the RFID System to confirm the actual movement speed of the Tags.

Battery Life

Communications Data and Battery Life (Ambient Temperature: 25°C)

Conditions: 256-byte write data (in single trigger operation with no verification)

Single Tag

The Tag is set to sleep after each command is executed.

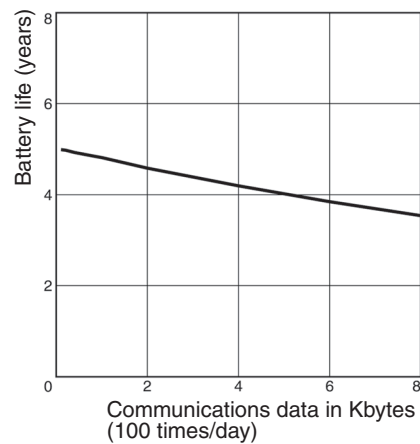

Dimensions

Note: All units are in millimeters unless otherwise indicated.

V690-HMG01A Read/Write Antenna

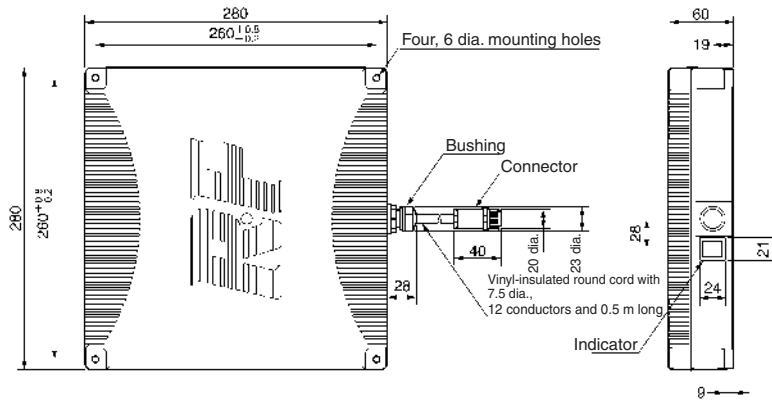

V690-D8KR01A ID Tag

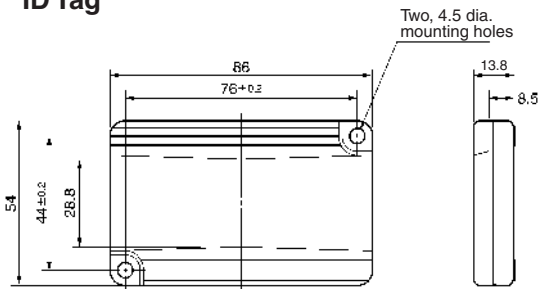

V690-L01 RS-422A/RS-485 Link Unit

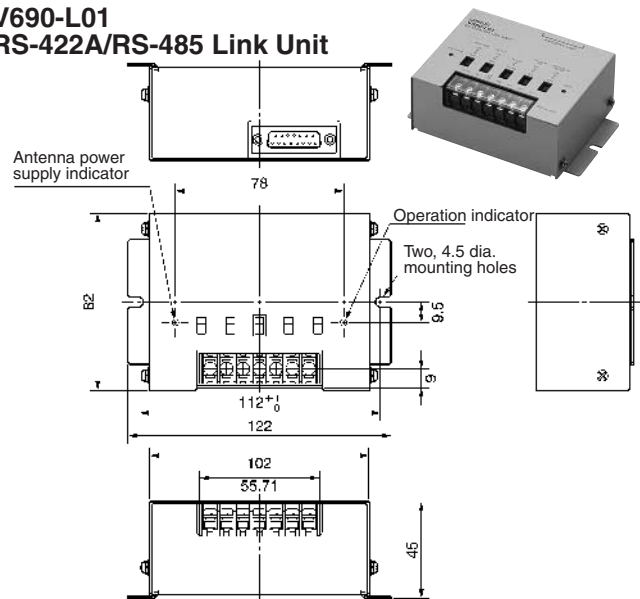

V690-A40 V690-A43 V690-A41 V690-A44 V690-A42



RS-232C Connecting Cable

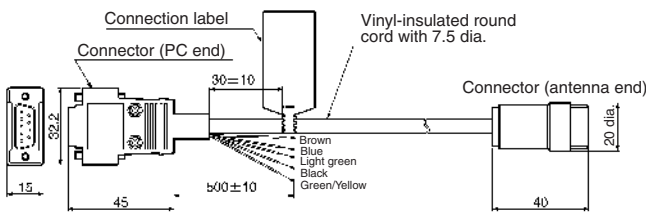

V690-A50 V690-A54 V690-A51 V690-A55 V690-A52 V690-A56 V690-A53



RS-422A/RS-485 Link Unit Connecting Cable

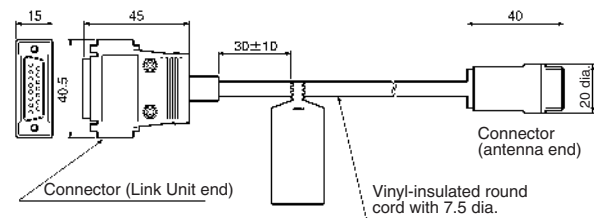

Safety Precautions

⚠ WARNING

Do not disassemble, pressurize, deform, heat over 212°F (100°C), or dispose in fire. The built-in lithium battery may cause fire or explosion hazards.



■ Precautions for Safe Use

Be sure to observe the following precautions to ensure safe use.

1. Do not use the System in an environment subject to flammable, explosive, or corrosive gases.
2. Do not attempt to take the System apart, to repair the System, or to modify the System in any way.
3. Be sure that all the mounting screws and terminal block screws are securely tightened.
4. Use crimp terminals of the specified size for wiring.
5. Be sure that the following precautions are observed for the 24-VDC power supply:
 - Be sure that the DC Power Supply Unit exclusively designed for the V690 Series is used and is not connected to any other device.
 - Be sure that the power supply voltage is within the rated range of 24 VDC +10% and -15%.

■ Precautions for Correct Use

1. Do not install the V690-HMG01A, V690-D8KR01A, or V690-L01 in the following locations:
 - Locations subject to direct sunlight.
 - Locations subject to high humidity or condensation.
 - Locations subject to shock or vibration.
2. Check the usage environment in advance for the following points:

Communications between the Antenna and the Tag use the 2450-MHz frequency range. Some wireless equipment, such as wireless LANs, cellular phones, personal handyphone systems, and transceivers, and some motors and switching supplies generate electrical noise that will affect communications with the Tag. Check the effects of equipment such as this prior to using the System near any of them.

Also, to minimize the effect of this noise, observe the following precautions.

 - Connect metal objects located in the vicinity to a ground of 100 Ω or less.
 - Do not wire the lines of the RFID System alongside high-tension or power lines.
3. Effect of the usage environment on communications distance:
 - The communications distance varies depending on the actual usage environment because metal objects and the ground's surface reflect the signals, and water and people absorb them. Prior to use, place the Antenna and the Tag at the set distance and check the signal environment.
 - The V690-HMG01A Read/Write Antenna is equipped with a communications test command for use in checking the signal environment.
4. Be sure to connect the ground terminal to a ground of 100 Ω or less. Not connecting the ground terminal to a ground of 100 Ω or less may lower the performance of the System.
5. Cleaning the V690-HMG01A, V690-D8KR01A, or V690-L01:
 - Do not use paint thinner or any other organic solvent to clean the product. Doing so may damage the paint coating on the casing or the resin parts of the product.

■ Mutual Interference Caused by Wireless LANs and Cellular Phones

The 2,450 MHz frequency band (2,434.25 to 2,465.75 MHz) used by the V690 Microwave RFID System is designed for wireless LANs, for local area radio stations (license required), for amateur radio stations (license required), for mobile object identification, and for specified low-power radio stations (no license required) as well as industrial, scientific, or medical equipment, such as microwave ovens. Therefore, radio interference is expected in this frequency band. Moreover, cellular phone and personal handyphone systems (900 to 1900 MHz) may generate radio interference.

1. On-site Checks

- Before using the V690, make sure that wireless LANs, in-plant licensed radio stations (microwave RFID systems) that discriminate moving objects, or specified low-power radio stations that require no licenses are not being operated in the vicinity of the V690.
- If the V690 interferes with in-plant licensed radio stations for moving objects, promptly change the channel in use or stop the transmission and contact your OMRON representative for remedies (e.g., the location of partition boards) to eliminate the interference.
- If the V690 has any problems, such as interference with second-generation low-power data communications systems or specified low-power radio stations, contact your OMRON representative.

2. Product Label and Caution Label

The product is provided with a product label and caution label. Attach the product label to a conspicuous location on the Antenna. Attach the caution label near the Antenna so that it will be conspicuous as well.



Meanings of Product Label Code

- 2.4: Indicates that it is a radio installation using the 2.4-GHz band.
- RFID: Indicates that the radio station is for the discrimination of moving objects.
- 10 mW: Indicates the antenna output.
- □□□: Indicates the frequency band as shown below. The V690 Antenna uses the 2,450-MHz band. Therefore, the box in the center is filled in.

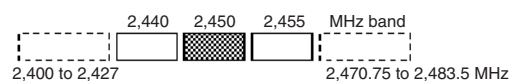

Warranty and Application Considerations

Read and Understand this Catalog

Please read and understand this catalog before purchasing the products. Please consult your OMRON representative if you have any questions or comments.

Warranty and Limitations of Liability

WARRANTY

OMRON's exclusive warranty is that the products are free from defects in materials and workmanship for a period of one year (or other period if specified) from date of sale by OMRON.

OMRON MAKES NO WARRANTY OR REPRESENTATION, EXPRESS OR IMPLIED, REGARDING NON-INFRINGEMENT, MERCHANTABILITY, OR FITNESS FOR PARTICULAR PURPOSE OF THE PRODUCTS. ANY BUYER OR USER ACKNOWLEDGES THAT THE BUYER OR USER ALONE HAS DETERMINED THAT THE PRODUCTS WILL SUITABLY MEET THE REQUIREMENTS OF THEIR INTENDED USE. OMRON DISCLAIMS ALL OTHER WARRANTIES, EXPRESS OR IMPLIED.

LIMITATIONS OF LIABILITY

OMRON SHALL NOT BE RESPONSIBLE FOR SPECIAL, INDIRECT, OR CONSEQUENTIAL DAMAGES, LOSS OF PROFITS, OR COMMERCIAL LOSS IN ANY WAY CONNECTED WITH THE PRODUCTS, WHETHER SUCH CLAIM IS BASED ON CONTRACT, WARRANTY, NEGLIGENCE, OR STRICT LIABILITY.

In no event shall the responsibility of OMRON for any act exceed the individual price of the product on which liability is asserted. IN NO EVENT SHALL OMRON BE RESPONSIBLE FOR WARRANTY, REPAIR, OR OTHER CLAIMS REGARDING THE PRODUCTS UNLESS OMRON'S ANALYSIS CONFIRMS THAT THE PRODUCTS WERE PROPERLY HANDLED, STORED, INSTALLED, AND MAINTAINED AND NOT SUBJECT TO CONTAMINATION, ABUSE, MISUSE, OR INAPPROPRIATE MODIFICATION OR REPAIR.

Application Considerations

SUITABILITY FOR USE

OMRON shall not be responsible for conformity with any standards, codes, or regulations that apply to the combination of products in the customer's application or use of the products.

Take all necessary steps to determine the suitability of the product for the systems, machines, and equipment with which it will be used.

Know and observe all prohibitions of use applicable to this product.

NEVER USE THE PRODUCTS FOR AN APPLICATION INVOLVING SERIOUS RISK TO LIFE OR PROPERTY WITHOUT ENSURING THAT THE SYSTEM AS A WHOLE HAS BEEN DESIGNED TO ADDRESS THE RISKS, AND THAT THE OMRON PRODUCTS ARE PROPERLY RATED AND INSTALLED FOR THE INTENDED USE WITHIN THE OVERALL EQUIPMENT OR SYSTEM.

Disclaimers

PERFORMANCE DATA

Performance data given in this catalog is provided as a guide for the user in determining suitability and does not constitute a warranty. It may represent the result of OMRON's test conditions, and the users must correlate it to actual application requirements. Actual performance is subject to the OMRON *Warranty and Limitations of Liability*.

CHANGE IN SPECIFICATIONS

Product specifications and accessories may be changed at any time based on improvements and other reasons. Consult with your OMRON representative at any time to confirm actual specifications of purchased product.

DIMENSIONS AND WEIGHTS

Dimensions and weights are nominal and are not to be used for manufacturing purposes, even when tolerances are shown.

ERRORS AND OMISSIONS

The information in this document has been carefully checked and is believed to be accurate; however, no responsibility is assumed for clerical, typographical, or proofreading errors, or omissions.

ALL DIMENSIONS SHOWN ARE IN MILLIMETERS.

To convert millimeters into inches, multiply by 0.03937. To convert grams into ounces, multiply by 0.03527.

Cat. No. Z188-E1-01 **In the interest of product improvement, specifications are subject to change without notice.**

OMRON Corporation

Industrial Automation Company

**FA Auto-Identification Components Department
Sensing Devices & Components Division H.Q.**

Shiokoji Horikawa, Shimogyo-ku,
Kyoto, 600-8530 Japan
Tel: (81)75-344-7069/Fax: (81)75-344-7107

Printed in Japan
1003-0.3M (1003)