

# Temperature Monitoring Relay

## K8AK-TH

### Compact and Slim Relay Ideal for Temperature Alarms and Monitoring

- Excessive temperature increases can be prevented and abnormal temperatures can be monitored.
- Temperature monitoring in slim design with a width of just 22.5 mm.
- Rotary switches simplifies temperature settings.
- Universal-input support for thermocouple or platinum resistance thermometer sensor input.
- Change the output relay between normally open and normally closed operation.
- Alarm status identification with LED indicator.
- Self-holding output.



Refer to *Safety Precautions* on page 8.



For the most recent information on models that have been certified for safety standards, refer to your OMRON website.

## Ordering Information

### K8AK-TH (Temperature Input Models)

Power supply voltage	Type	Output relays	Input types	Setting units (setting range)	Model
100 to 240 VAC	Temperature input	1 relay	Thermocouple or platinum resistance thermometer	Setting unit: 1°C or 1°F (0 to 999°C/°F)	K8AK-TH11S 100-240VAC
			Thermocouple	Setting unit: 10°C/°F*	K8AK-TH12S 100-240VAC
24 VAC/DC			Thermocouple or platinum resistance thermometer	Setting unit: 1°C or 1°F (0 to 999°C/°F)	K8AK-TH11S 24VAC/DC
			Thermocouple	Setting unit: 10°C/°F*	K8AK-TH12S 24VAC/DC

\* Refer to *Setting Ranges* on page 3 for the setting ranges.

**Note:** When ordering, designate the power supply specification. Different Relay models are used for 100 to 240 VAC and 24 VAC/VDC.

# K8AK-TH

## Specifications

### Ratings

Item	Power supply voltage	100 to 240 VAC 50/60 Hz	24 VAC 50/60 Hz or 24 VDC
Allowable voltage range		85% to 110% of power supply voltage	
Power consumption		5 VA max.	2 W max. (24 VDC), 4 VA max. (24 VAC)
Sensor inputs	K8AK-TH11S	Thermocouple: K, J, T, E; Platinum-resistance thermometer: Pt100, Pt1000	
	K8AK-TH12S	Thermocouple: K, J, T, E, B, R, S, PLII	
Output relay		One SPDT relay (5 A at 250 VAC, resistive load)	
External inputs (for latch setting)	Contact input	ON: 1 kΩ max., OFF: 100 kΩ min.	
	Non-contact input	ON residual voltage: 1.5 V max., OFF leakage current: 0.1 mA max. Leakage current: Approx. 10 mA	
Setting method		Rotary switch setting (set of three switches)	
Indicators		Power (PWR): Green LED, Relay output (ALM): Red LED	
Other functions		Alarm Mode (upper limit/lower limit), non-fail safe/fail safe selection, output latch, setting protection, temperature unit °C/°F	
Ambient operating temperature		-20 to 55°C (with no condensation or icing)	
Ambient operating humidity		Relative humidity: 25% to 85%	
Storage temperature		-25 to 65°C (with no condensation or icing)	

### Characteristics

Measurement accuracy		K8AK-TH11S: ±1% of the setting range or ±4°C, whichever is larger K8AK-TH12S: ±1% of the setting range (±1% FS)
hysteresis width		2°C
Output relay		Rated load Resistive load 5 A at 250 VAC 5 A at 30 VDC Maximum switching capacity: 1,250 VA, 150 W Minimum load: 5 VDC, 10 mA (reference values) Mechanical life: 10 million operations min. Electrical life: 5 A at 250 VAC or 30 VDC: 50,000 operations 3 A at 250 VAC/30 VDC: 100,000 operations
Sampling cycle		100 ms
Insulation resistance		20 MΩ (at 500 V) between charged terminals and exposed uncharged parts 20 MΩ (at 500 V) between any charged terminals (i.e., between input, output, and power supply terminals) 20 MΩ (at 500 V) between contacts (open)
Dielectric strength		2,300 VAC, 50/60 Hz for 1 min between terminals of different charge
Vibration resistance		Vibration of 10 to 55 Hz and acceleration of 50 m/s <sup>2</sup> for 5 min with 10 sweeps each in X, Y, and Z directions
Shock resistance		100 m/s <sup>2</sup> , 3 times each in 6 directions along 3 axes
Weight		Approx. 160 g
Degree of protection		IP20
Memory protection		Non-volatile memory (number of writes: 1 million)
Safety Standards	Approved standards	UL 61010-1 Installation environment (pollution level 2, installation category II)
	EMC	EN 61326-1
	Application standards	UL 61010-1, Korean Radio Waves Act (Act 10564), CSA: C22.2 No.14, CCC: GB14048.5
Terminal screw tightening torque		0.49 to 0.59 N·m
Crimp terminals		Two solid wires of 2.5 mm <sup>2</sup> or two ferrules of 1.5 mm <sup>2</sup> with insulation sleeves can be tightened together.
Case color		N1.5
Case material		PC and ABS, UL 94 V-0
Mounting		Mounts to DIN Track.
Dimensions		22.5 × 100 × 90 mm (W × D × H)

## Setting Ranges

### ●K8AK-TH11S

#### Centigrade

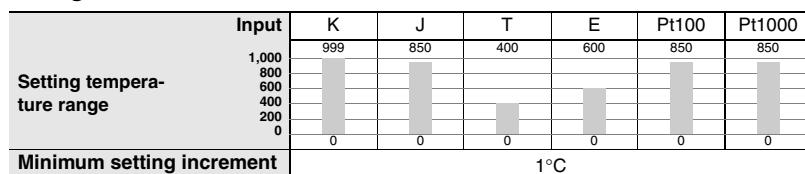

#### Fahrenheit

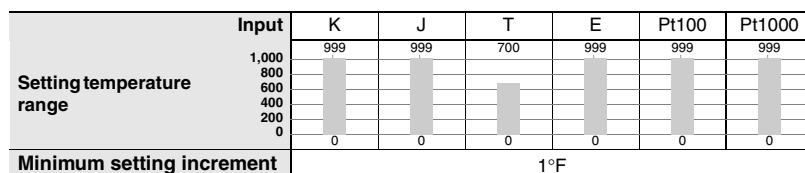

### ●K8AK-TH12S

#### Centigrade

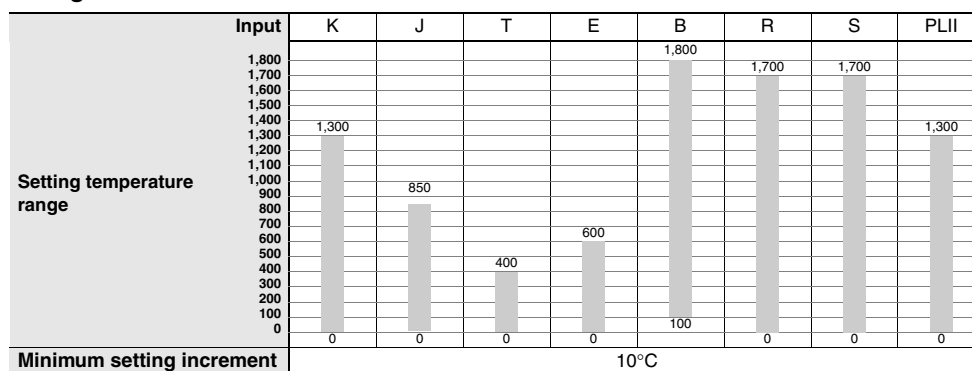

#### Fahrenheit

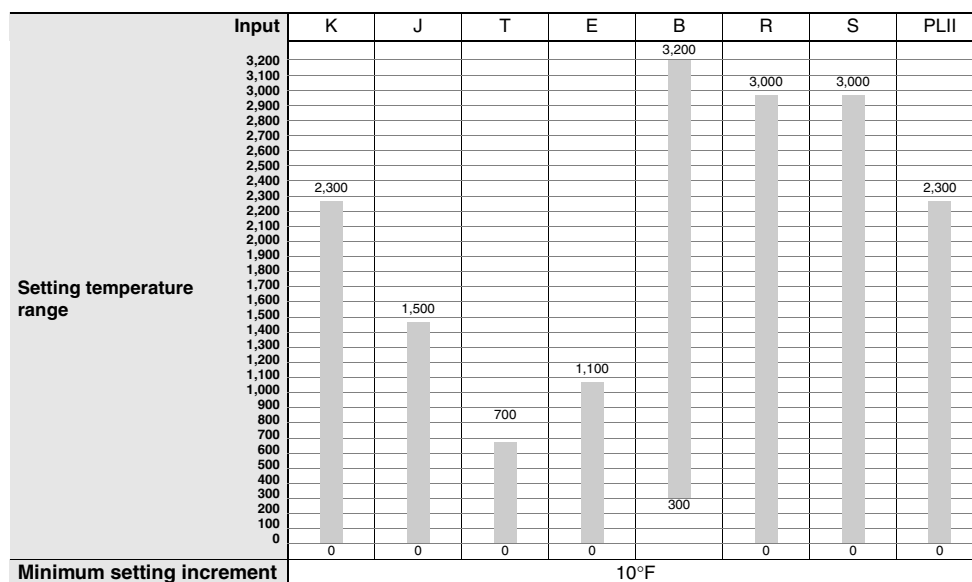

### ●Temperature Input Range

TH11S Input type	°C		°F	
	Lower limit	Upper limit	Lower limit	Upper limit
K	-20	1019	-40	1039
J	-20	870	-40	1039
T	-20	420	-40	740
E	-20	620	-40	1039
Pt100	-20	870	-40	1039
Pt1000	-20	870	-40	1039
---	---	---	---	---
---	---	---	---	---

TH12S Input type	°C		°F	
	Lower limit	Upper limit	Lower limit	Upper limit
K	-20	1320	-40	2340
J	-20	870	-40	1540
T	-20	420	-40	740
E	-20	620	-40	1140
B	0	1820	0	3240
R	-20	1720	-40	3040
S	-20	1720	-40	3040
PLII	-20	1320	-40	2340

# K8AK-TH

## Connections

### Wiring Diagrams

K8AK-TH11S

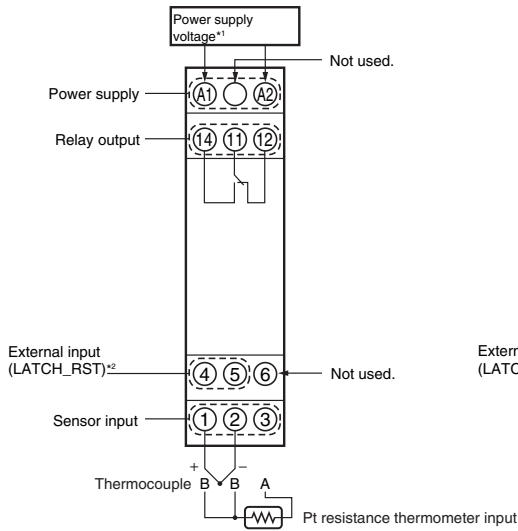

K8AK-TH12S

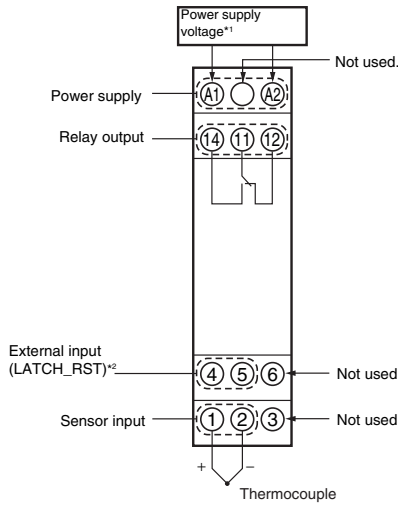

\*1 The input power supply depends on the model: 100 to 240 VAC or 24 VAC/VDC (no polarity)

\*2 Wiring of the external input terminals is as shown below.

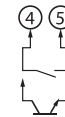

### Timing Charts

■ Temperature Alarm: Hysteresis: 2°C/°F

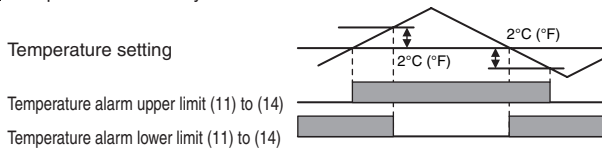

■ Changing between Normally Open and Normally Closed

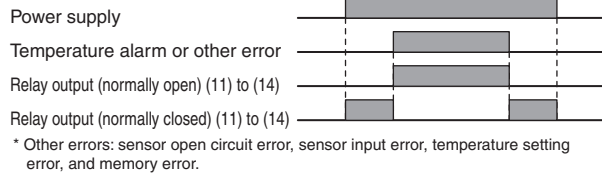

■ Latched Operation: Relay outputs remain latched even after the alarm or error is reset.

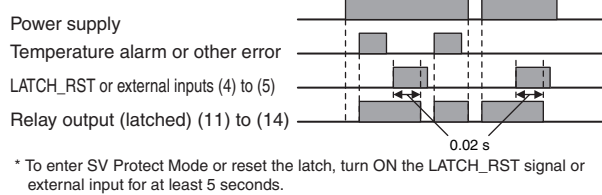

■ Operation of Indicators

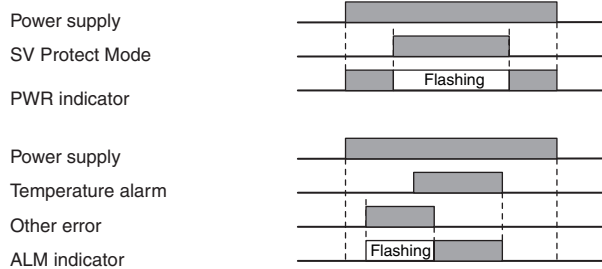

## Nomenclature

### Front Operations

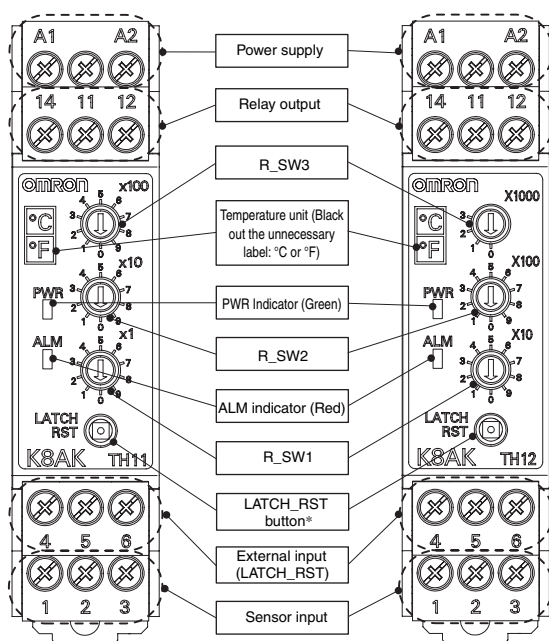

### ●Error (ALM indicator: Flashing)

One of the following items 1 to 3 has occurred.

1. The sensor circuit is disconnected or the temperature setting is out of the specified range.
2. The temperature setting is out of the specified range.
3. There is a problem in the internal circuits.

#### Corrections

1. Disable SV Protect Mode.
2. Disable the latch.
3. Check for incorrect wiring, circuit disconnections, short circuits, and whether the input type and temperature settings are correct.
4. If the wiring and settings are correct, reset the power supply.

If the Unit resumes normal operation, the problem may have been caused by noise.

If the Unit does not resume normal operation, it must be replaced.

\* The non-volatile memory stores the event when a latched output is disabled, or the SV Protect Mode is enabled or disabled. An error may occur if the data is updated more than one million times.

\* If you press and hold the LATCH\_RST button for 5 seconds or longer, the SV Protect Mode will go into effect.

When SV Protect Mode is enabled, the PWR indicator flashes.

To disable the SV Protect Mode, press and hold the LATCH\_RST Button for at least 5 seconds.

### ●Alarm Setting Rotary Switch



Point the arrow to the required number.

**Note: 1.** Use solid-core wires of 2.5-mm<sup>2</sup> max. or ferrules with an insulation sleeve to wire to this terminal. To ensure the dielectric strength of the connection, do not expose more than 8 mm of wire for insertion into the terminal.

For a solid wire of 2.5-mm<sup>2</sup> of max.

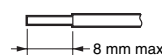

For ferrules with an insulation sleeve.

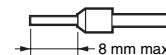

Recommended Ferrules

Phoenix Contact

AI 1.5-8BK (for AWG16)

•AI 1-8RD (for AWG18)

•AI 0,75-8GY (for AWG18)

2. Screw tightening torque: 0.49 to 0.59 N·m

# K8AK-TH

## Operation Method

### Function Selection DIP Switch

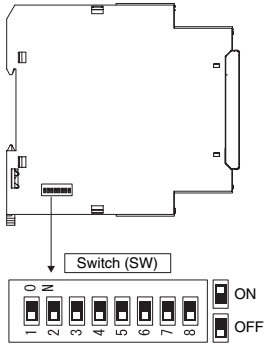

\* Default settings: All OFF

Turn OFF the power to the Temperature Monitoring Relay before you change the switch settings on the side panel. The switch settings made on the side panel take effect when the power is turned ON. Use a precision screwdriver to manipulate the switches and button.

#### ● Settings

K8AK-TH11S

R_SW3	100°C/°F units (0 to 9)
R_SW2	10°C/°F units (0 to 9)
R_SW1	1°C/°F units (0 to 9)

\* Default: 0°C

	SW						
	1	2	3	4	5	6	7
Upper limit alarm	<input type="checkbox"/>						
Lower limit alarm	<input type="checkbox"/>						
With latching	<input type="checkbox"/>						
Without latching	<input type="checkbox"/>						
Energized	<input type="checkbox"/>						
Non-energized	<input type="checkbox"/>						
°C	<input type="checkbox"/>						
°F	<input type="checkbox"/>						
Input type							
K	<input type="checkbox"/>	<input type="checkbox"/>	<input type="checkbox"/>				
J	<input type="checkbox"/>	<input type="checkbox"/>	<input type="checkbox"/>				
T	<input type="checkbox"/>	<input type="checkbox"/>	<input type="checkbox"/>				
E	<input type="checkbox"/>	<input type="checkbox"/>	<input type="checkbox"/>				
Pt100	<input type="checkbox"/>	<input type="checkbox"/>	<input type="checkbox"/>				
Pt1000	<input type="checkbox"/>	<input type="checkbox"/>	<input type="checkbox"/>				
Not used.	<input type="checkbox"/>	<input type="checkbox"/>	<input type="checkbox"/>				
Not used.	<input type="checkbox"/>	<input type="checkbox"/>	<input type="checkbox"/>				

\* Default: All OFF.  
\* SW8: Not used.

K8AK-TH12S

R_SW3	1,000°C/°F units (0 to 3) * A temperature setting error occurs if this switch is set to a value from 4 to 9.
R_SW2	100°C/°F units (0 to 9)
R_SW1	10°C/°F units (0 to 9)

\* Default: 0°C

	SW						
	1	2	3	4	5	6	7
Upper limit alarm	<input type="checkbox"/>						
Lower limit alarm	<input type="checkbox"/>						
With latching	<input type="checkbox"/>						
Without latching	<input type="checkbox"/>						
Energized	<input type="checkbox"/>						
Non-energized	<input type="checkbox"/>						
°C	<input type="checkbox"/>						
°F	<input type="checkbox"/>						
Input type							
K	<input type="checkbox"/>	<input type="checkbox"/>	<input type="checkbox"/>				
J	<input type="checkbox"/>	<input type="checkbox"/>	<input type="checkbox"/>				
T	<input type="checkbox"/>	<input type="checkbox"/>	<input type="checkbox"/>				
E	<input type="checkbox"/>	<input type="checkbox"/>	<input type="checkbox"/>				
B	<input type="checkbox"/>	<input type="checkbox"/>	<input type="checkbox"/>				
R	<input type="checkbox"/>	<input type="checkbox"/>	<input type="checkbox"/>				
S	<input type="checkbox"/>	<input type="checkbox"/>	<input type="checkbox"/>				
PLII	<input type="checkbox"/>	<input type="checkbox"/>	<input type="checkbox"/>				

\* Default: All OFF.  
\* SW8: Not used.

Safety standards	EN 61010-1
EMC	EMI EN 61326-1
	EMS EN 61326-1

## Functions

### ●SV Protection

This function protects (i.e., prohibits changing) the alarm setting, operating method, and modes for the Temperature Monitoring Relay that have been set on the rotary switches and DIP switch.

The protection function is activated by pressing the output latch reset button on the Temperature Monitoring Relay for at least 5 s or by turning ON the input to the external input terminal for at least 5 s.

The power indicator will flash when the protection is activated.

The protection function can be released by pressing the output latch reset button on the Temperature Monitoring Relay for at least 5 s or by turning ON the input to the external input terminal for at least 5 s.

The power indicator will light while the protection is being reset.

## Dimensions

(Unit: mm)

**Note:** All units are in millimeters unless otherwise indicated.

### Temperature Monitoring Relay

K8AK-TH

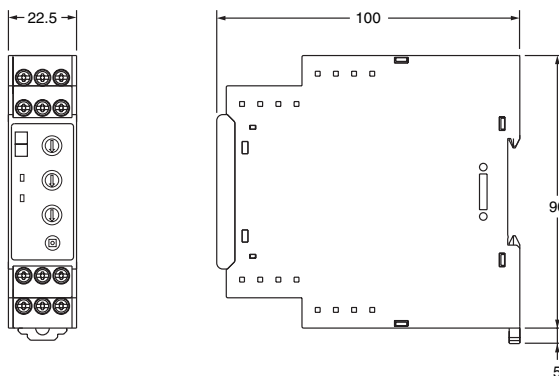

### Track Mounting Products (Sold Separately)

#### ●DIN Tracks

PFP-100N

PFP-50N

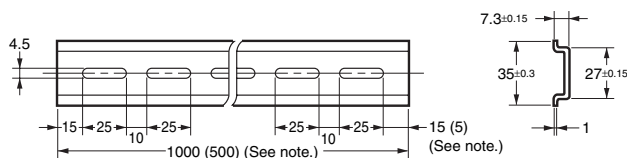
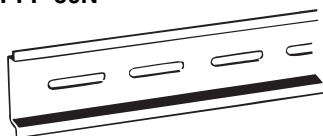

\* Dimensions in parentheses are for the PFP-50N.





## Safety Precautions

Be sure to read the precautions for all models in the website at the following URL: <http://www.ia.omron.com/>.

### Warning Indications

 <b>CAUTION</b>	Indicates a potentially hazardous situation which, if not avoided, may result in minor or moderate injury or in property damage.
<b>Precautions for Safe Use</b>	Supplementary comments on what to do or avoid doing, to use the product safely.
<b>Precautions for Correct Use</b>	Supplementary comments on what to do or avoid doing, to prevent failure to operate, malfunction, or undesirable effects on product performance.

### Meaning of Product Safety Symbols

	Used to warn of the risk of electric shock under specific conditions.
	Used for general prohibitions for which there is no specific symbol.
	Used to indicate prohibition when there is a risk of minor injury from electrical shock or other source if the product is disassembled.
	Used for general mandatory action precautions for which there is no specified symbol.

### CAUTION

Electrical shock may cause minor injury.  
Do not touch terminals while electricity is being supplied.



There is a risk of minor electrical shock, fire, or device failure.  
Do not allow any pieces of metal, conductors, or cutting chips that occur during the installation process to enter the product.



Explosions may cause minor injuries. Do not use the product in locations with inflammable or explosive gases.

There is a risk of minor electrical shock, fire, or device failure.  
Do not disassemble, modify, repair, or touch the inside of the product.



Loose screws may cause fires. Tighten terminal screws to the specified torque of 0.49 to 0.59 N·m.



Use of excessive torque may damage the terminal screws.  
Tighten terminal screws to the specified torque of 0.49 to 0.59 N·m.



If the setting does not match the element to be monitored, the product may behave unexpectedly and damage the machine or cause accidents. Set the Temperature Monitoring Relay as described below.



- Adjust each set value on the Temperature Monitoring Relay correctly for the element that is to be monitored.
- Turn OFF the power to the Temperature Monitoring Relay before you change the switch settings on the side panel. The switch settings made on the side panel take effect when the power is turned ON.

If the Temperature Monitoring Relay fails, monitoring and alarm outputs may fail to operate. This may result in physical damage to the facilities, equipment, or other devices that are connected to it. To reduce this risk, inspect the product regularly. To make the product fail-safe, take alternative safety measures, such as the installation of monitoring devices on a separate circuit.



Use of the product beyond its life may result in contact welding or burning. Make sure to consider the actual operating conditions and use the product within its rated load and electrical life count. The life of the output relay varies significantly with the switching capacity and switching conditions.





### Precautions for Safe Use

1. Do not use or store the product in the following locations.
  - Locations subject to water or oil
  - Locations subject to direct radiant heat from heating equipment
  - Outdoor locations or under direct sunlight
  - Locations subject to dust or corrosive gases (particularly sulfurizing gases, ammonia, etc.)
  - Locations subject to rapid temperature changes
  - Locations prone to icing and dew condensation
  - Locations subject to excessive vibration or shock
2. Use and store the product in a location where the ambient temperature and humidity are within the specified ranges. If applicable, provide forced cooling.
3. Mount the product in the correct direction.
4. Check terminal polarity when wiring and wire all connections correctly. The power supply terminals do not have polarity.
5. Do not wire the input and output terminals incorrectly.
6. Make sure the power supply voltage and loads are within the specifications and ratings for the product.
7. Make sure the type of the thermocouple matches the input type that the Temperature Monitoring Relay is designed for.
8. If you need to extend the length of the lead wires on the thermocouple, make sure to match the type of thermocouple and always use compensating conductors.
9. To extend the lead wires on the platinum resistance thermometer, use lead wires with a low resistance ( $5\ \Omega$  or less per wire), and make the resistance equal on all three lead wires.
10. Make sure the crimp terminals for wiring are of the specified size.
11. Do not connect anything to terminals that are not being used.
12. Use a power supply that will reach the rated voltage within 1 second after the power is turned ON.
13. After you turn ON the power, it takes 2 seconds for the outputs of the Temperature Monitoring Relay to stabilize. Take this time into account when you design the control panel.
14. Allow at least 30 minutes for the product to warm up. During this time, the temperature measurements will be incorrect.
15. Keep wiring separate from high voltages and power lines that draw large currents.  
Do not place product wiring in parallel with or in the same path as high-voltage or high-current lines.
16. Do not install the product near equipment that generates high frequencies or surges.
17. The product may cause incoming radio wave interference. Do not use the product near radio wave receivers.
18. Install an external switch or circuit breaker and label it clearly so that the operator can quickly turn OFF the power supply.
19. When cleaning the product, do not use thinners or solvents. Use commercial alcohol.
20. When discarding the product, properly dispose of it as industrial waste.
21. Make sure the power and output indicators operate correctly.  
Depending on the application environment, the indicators and other plastic parts may wear prematurely and become difficult to see. Check and replace these parts regularly.
22. The terminal blocks may heat up to  $65^{\circ}\text{C}$ . Use care when handling them.

### Precautions for Correct Use

#### Observe the following operating methods to prevent failure and malfunction.

1. Use the power supply voltage, input power, and other power supplies and converters with suitable capacities and rated outputs.
2. Use a precision screwdriver or similar tool to adjust the rotary switches.

#### Mounting and Removing

- Mounting to DIN Track
  1. Catch the upper hook on the DIN Track.
  2. Push the product onto the Track until the hooks lock into place.

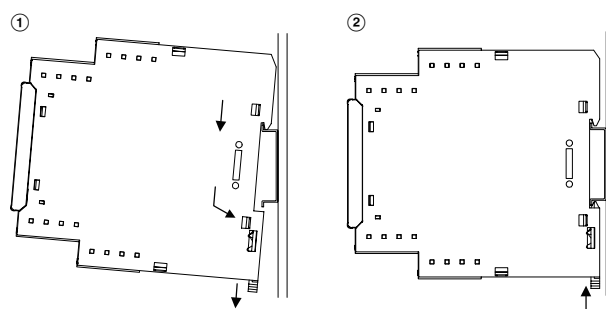

- Removing from the DIN Track  
Pull down on the bottom hook with a flat-blade screwdriver and lift up on the product.

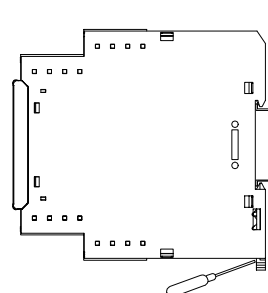

Applicable DIN Tracks:  
PFP-100N (100 cm)  
PFP-50N (50 cm)



# Terms and Conditions Agreement

## **Read and understand this catalog.**

Please read and understand this catalog before purchasing the products. Please consult your OMRON representative if you have any questions or comments.

## **Warranties.**

- (a) Exclusive Warranty. Omron's exclusive warranty is that the Products will be free from defects in materials and workmanship for a period of twelve months from the date of sale by Omron (or such other period expressed in writing by Omron). Omron disclaims all other warranties, express or implied.
- (b) Limitations. OMRON MAKES NO WARRANTY OR REPRESENTATION, EXPRESS OR IMPLIED, ABOUT NON-INFRINGEMENT, MERCHANTABILITY OR FITNESS FOR A PARTICULAR PURPOSE OF THE PRODUCTS. BUYER ACKNOWLEDGES THAT IT ALONE HAS DETERMINED THAT THE PRODUCTS WILL SUITABLY MEET THE REQUIREMENTS OF THEIR INTENDED USE.

Omron further disclaims all warranties and responsibility of any type for claims or expenses based on infringement by the Products or otherwise of any intellectual property right. (c) Buyer Remedy. Omron's sole obligation hereunder shall be, at Omron's election, to (i) replace (in the form originally shipped with Buyer responsible for labor charges for removal or replacement thereof) the non-complying Product, (ii) repair the non-complying Product, or (iii) repay or credit Buyer an amount equal to the purchase price of the non-complying Product; provided that in no event shall Omron be responsible for warranty, repair, indemnity or any other claims or expenses regarding the Products unless Omron's analysis confirms that the Products were properly handled, stored, installed and maintained and not subject to contamination, abuse, misuse or inappropriate modification. Return of any Products by Buyer must be approved in writing by Omron before shipment. Omron Companies shall not be liable for the suitability or unsuitability or the results from the use of Products in combination with any electrical or electronic components, circuits, system assemblies or any other materials or substances or environments. Any advice, recommendations or information given orally or in writing, are not to be construed as an amendment or addition to the above warranty.

See <http://www.omron.com/global/> or contact your Omron representative for published information.

## **Limitation on Liability; Etc.**

OMRON COMPANIES SHALL NOT BE LIABLE FOR SPECIAL, INDIRECT, INCIDENTAL, OR CONSEQUENTIAL DAMAGES, LOSS OF PROFITS OR PRODUCTION OR COMMERCIAL LOSS IN ANY WAY CONNECTED WITH THE PRODUCTS, WHETHER SUCH CLAIM IS BASED IN CONTRACT, WARRANTY, NEGLIGENCE OR STRICT LIABILITY.

Further, in no event shall liability of Omron Companies exceed the individual price of the Product on which liability is asserted.

## **Suitability of Use.**

Omron Companies shall not be responsible for conformity with any standards, codes or regulations which apply to the combination of the Product in the Buyer's application or use of the Product. At Buyer's request, Omron will provide applicable third party certification documents identifying ratings and limitations of use which apply to the Product. This information by itself is not sufficient for a complete determination of the suitability of the Product in combination with the end product, machine, system, or other application or use. Buyer shall be solely responsible for determining appropriateness of the particular Product with respect to Buyer's application, product or system. Buyer shall take application responsibility in all cases.

NEVER USE THE PRODUCT FOR AN APPLICATION INVOLVING SERIOUS RISK TO LIFE OR PROPERTY OR IN LARGE QUANTITIES WITHOUT ENSURING THAT THE SYSTEM AS A WHOLE HAS BEEN DESIGNED TO ADDRESS THE RISKS, AND THAT THE OMRON PRODUCT(S) IS PROPERLY RATED AND INSTALLED FOR THE INTENDED USE WITHIN THE OVERALL EQUIPMENT OR SYSTEM.

## **Programmable Products.**

Omron Companies shall not be responsible for the user's programming of a programmable Product, or any consequence thereof.

## **Performance Data.**

Data presented in Omron Company websites, catalogs and other materials is provided as a guide for the user in determining suitability and does not constitute a warranty. It may represent the result of Omron's test conditions, and the user must correlate it to actual application requirements. Actual performance is subject to the Omron's Warranty and Limitations of Liability.

## **Change in Specifications.**

Product specifications and accessories may be changed at any time based on improvements and other reasons. It is our practice to change part numbers when published ratings or features are changed, or when significant construction changes are made. However, some specifications of the Product may be changed without any notice. When in doubt, special part numbers may be assigned to fix or establish key specifications for your application. Please consult with your Omron's representative at any time to confirm actual specifications of purchased Product.

## **Errors and Omissions.**

Information presented by Omron Companies has been checked and is believed to be accurate; however, no responsibility is assumed for clerical, typographical or proofreading errors or omissions.

**OMRON Corporation Industrial Automation Company**

Tokyo, JAPAN

Contact: [www.ia.omron.com](http://www.ia.omron.com)

**Regional Headquarters**

**OMRON EUROPE B.V.**

Wegalaan 67-69-2132 JD Hoofddorp  
The Netherlands

Tel: (31)2356-81-300/Fax: (31)2356-81-388

**OMRON ELECTRONICS LLC**

One Commerce Drive Schaumburg,  
IL 60173-5302 U.S.A.

Tel: (1) 847-843-7900/Fax: (1) 847-843-7787

**OMRON ASIA PACIFIC PTE. LTD.**

No. 438A Alexandra Road # 05-05/08 (Lobby 2),  
Alexandra Technopark,  
Singapore 119967

Tel: (65) 6835-3011/Fax: (65) 6835-2711

**OMRON (CHINA) CO., LTD.**

Room 2211, Bank of China Tower,  
200 Yin Cheng Zhong Road,  
PuDong New Area, Shanghai, 200120, China  
Tel: (86) 21-5037-2222/Fax: (86) 21-5037-2200

**Authorized Distributor:**

© OMRON Corporation 2014 All Rights Reserved.  
In the interest of product improvement,  
specifications are subject to change without notice.

**Cat. No. N187-E1-01**

0114 (0114)