

MICROHAWK® ID-40

SPECIFICATIONS AND OPTIONS

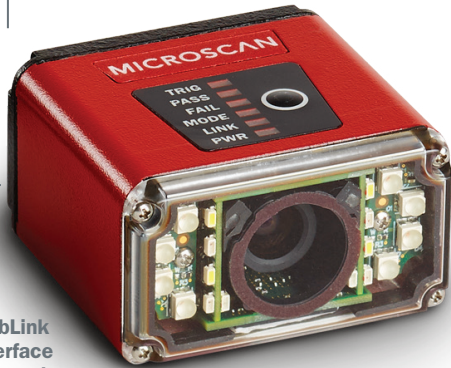

WebLink Interface Onboard

Ultra-Compact
Height: 25 mm (0.98")
Width: 45 mm (1.77")
Length: 45 mm (1.77")

Integrated LEDs

DIMENSIONS

Height: 25 mm (0.98")
Width: 45 mm (1.77")
Length: 45 mm (1.77")
Weight: 68 g (2.40 oz.)

ENCLOSURE

IP-65/67, Aluminum

ENVIRONMENTAL

Operating Temperature: 0° to 45° C (32° to 113° F)
Storage Temperature: -50° to 75° C (-58° to 167° F)
Humidity: 5% to 95% (non-condensing)

EMISSIONS

EN 55022:2010 Class B Limits

ELECTRICAL

4.75-30 VDC, 200 mV p-p max ripple, 150 mA at 24 VDC (typ.)

CONNECTOR

M12 12-Pin Power, M12 8-Pin Ethernet

PASSIVE PoE

24 Volt Passive Power over Ethernet, Type B. Requires passive PoE power supply.

COMMUNICATION

RS-232, Ethernet TCP/IP, EtherNet/IP, PROFINET I/O

DISCRETE I/O

3 in/3 out: Optoisolated Trigger and Input Common; New Master: Bi-directional, Optoisolated, 4.5-28 V rated (10 mA @ 28 VDC); Outputs (1, 2, 3): Bi-directional, Optoisolated, 1-28 V rated ($I_{CE} < 100$ mA at 24 VDC, current limited by user)

ILLUMINATION

High-Output LEDs: Inner: 4 Red (625 nm), 4 White; Outer: 8 Red, White, Blue, or IR

INDICATORS

TRIG, PASS, FAIL, MODE, LINK, PWR LEDs, 2 Target Pattern LEDs; 2 Good Read Green Flash LEDs

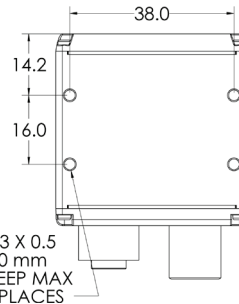
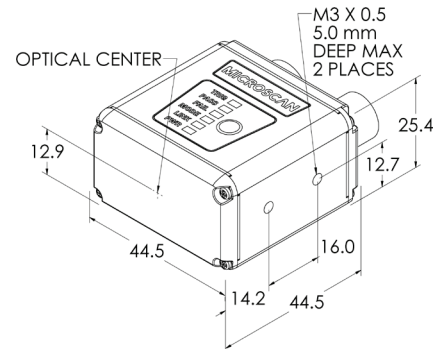

Note: Nominal dimensions in MM are shown. Typical tolerances apply.

SPEED

Standard: Up to 10 FPS
High-Speed: Max. Sensor FPS

DECODER

Standard (High-Contrast 1D)
 Plus (High-Contrast 1D/2D)
 X-Mode (Poor or Damaged 1D/2D + DPM)

OPTICS

Standard Density (SD), High-Density (HD), Ultra-High-Density (UHD)

SENSOR OPTIONS

WVGA (Mono): CMOS 0.34 MP (752 x 480)
SXGA (Mono): CMOS 1.2 MP (1280 x 960)
QXSGA (Color): CMOS 5 MP (2592 x 1944)

SHUTTER

Global (WVGA, SXGA), Rolling (QXSGA)

EXPOSURE TIME

50 - 100,000, Default: 2,500 µs

FOCUS

Fixed Focus: SD, HD (50-300 mm); UHD (64 or 400 mm)
Autofocus: SD, HD (50-300 mm); UHD (40-150 mm)

FRAMES PER SECOND

WVGA: Up to 60
SXGA: Up to 42
QXSGA: Up to 5

SYMBOLOGIES

2D: Data Matrix (ECC 0-200), QR Code, Micro QR Code, Aztec Code
Stacked: PDF417, MicroPDF417, GS1 Databar (Composite and Stacked)
Linear: Code 39, Code 128, BC412, Interleaved 2 of 5, UPC/EAN, Codabar, Code 93, Pharmacode, PLANET, POSTNET, Japanese Postal, Australia Post, Royal Mail, Intelligent Mail, KIX

SAFETY AND QUALITY

FCC, CE, UL, RoHS-Compliant

QMS CERTIFICATION

www.microscan.com/quality

CONNECTOR A M12 12-Pin Plug:

Pin	Function
9	Host Rx/D
10	Host Tx/D
2	Power
7	Ground
1	Trigger
8	Input Common
3	Default
4	New Master
5	Output 1
11	Output 2
6	Output 3
12	Output Common

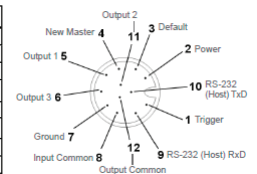

CONNECTOR B M12 8-Pin Socket:

Pin	Function
1	Reserved
2	Terminated
3	Reserved
4	TX (-)
5	RX (+)
6	TX (-)
7	Terminated
8	RX (-)

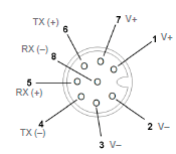

©2019 Omron Microscan Systems, Inc. SP092F-EN-0119
 Specifications are subject to change. For complete technical information, please see the User Manual.
 Warranty - For current warranty information about this product, please visit www.microscan.com/warranty.

OMRON

MICROSCAN

www.microscan.com

MICROHAWK® ID-40 FIELD OF VIEW AND READ RANGE CHARTS

WVGA High-Density and Standard Density Fixed Focus

Focus Distance		WVGA HIGH-DENSITY						WVGA STANDARD DENSITY					
		Field of View		Typical 2D Mil Size	Depth of Field (mm)		Min. 2D Mil Size	Field of View		Typical 2D Mil Size	Depth of Field (mm)		Min. 2D Mil Size
in.	mm	in.	mm	mil size	Inside	Outside	mil size	in.	mm	mil size	Inside	Outside	mil size
2.0	50	1.4	35	7.5	43	58	5	2.0	50	10	38	65	7.5
2.5	64	1.5	38	7.5	55	73	5	2.2	55	10	49	78	7.5
3.2	81	1.9	49	10	65	97	7.5	2.8	70	15	56	106	10
4.0	102	2.6	65	10	83	121	10	3.7	94	20	52	152	15
5.2	133	3.1	80	15	90	176	10	4.5	115	20	78	187	15
7.5	190	4.5	114	20	133	246	15	6.5	165	30	128	252	20
11.8	300	7.1	180	30	179	422	30	10.2	260	40	219	381	30

Example Read Range

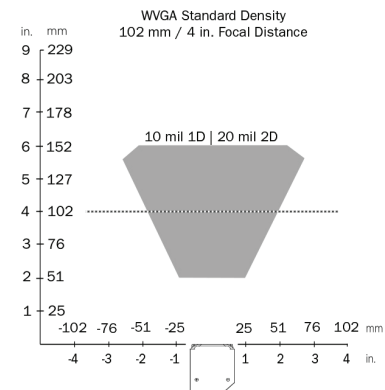

SXGA High-Density and Standard Density Fixed Focus

Focus Distance		SXGA HIGH-DENSITY						SXGA STANDARD DENSITY					
		Field of View		Typical 2D Mil Size	Depth of Field (mm)		Min. 2D Mil Size	Field of View		Typical 2D Mil Size	Depth of Field (mm)		Min. 2D Mil Size
in.	mm	in.	mm	mil size	Inside	Outside	mil size	in.	mm	mil size	Inside	Outside	mil size
2.0	50	1.5	37	5	47	55	3.3	2.1	53	7.5	37	64	5
2.5	64	1.6	41	5	58	70	3.3	2.3	59	7.5	49	78	5
3.2	81	2.0	52	7.5	70	92	5	2.9	75	7.5	60	102	7.5
4.0	102	2.7	69	7.5	88	116	5	3.9	100	10	74	131	7.5
5.2	133	3.4	85	10	107	159	7.5	4.8	123	10	88	161	10
7.5	190	4.8	122	15	137	243	10	6.9	175	15	115	265	15
11.8	300	7.6	192	20	185	400	15	10.9	277	20	224	427	20

Example Read Range

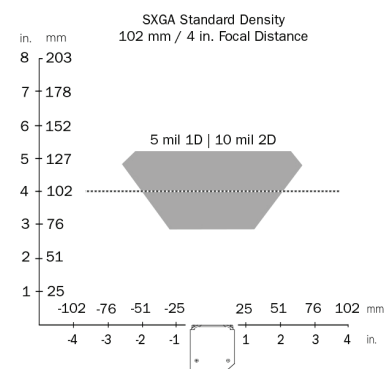

QXSGA High-Density and Standard Density Fixed Focus

Focus Distance		QXSGA HIGH-DENSITY						QXSGA STANDARD DENSITY					
		Field of View		Typical 2D Mil Size	Depth of Field (mm)		Min. 2D Mil Size	Field of View		Typical 2D Mil Size	Depth of Field (mm)		Min. 2D Mil Size
in.	mm	in.	mm	mil size	Inside	Outside	mil size	in.	mm	mil size	Inside	Outside	mil size
2.0	50	1.4	35	5	46	55	3.3	2.0	51	5	43	59	3.3
2.5	64	1.5	39	5	59	68	3.3	2.2	57	5	55	72	3.3
3.2	81	2.0	50	5	74	87	3.3	2.8	72	5	69	92	5
4.0	102	2.6	66	5	94	110	3.3	3.8	96	7.5	80	124	5
5.2	133	3.2	81	7.5	112	153	5	4.6	117	7.5	107	159	7.5
7.5	190	4.6	116	10	154	227	7.5	6.6	168	10	150	231	10
11.8	300	7.2	184	15	227	373	10	10.4	265	15	203	397	15

Example Read Range

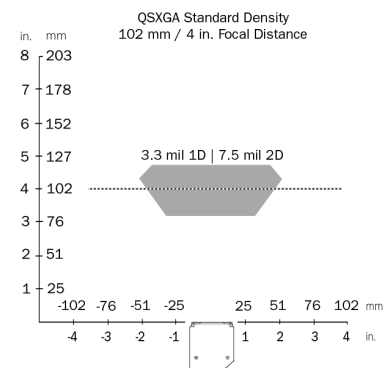

SXGA Ultra-High-Density Fixed Focus

SXGA UHD - 64 MM				
Min. 1D Element	Depth of Field (mm)		Field of View	
	Inside	Outside	Hor.	Vert.
2	63.5	64.5	16.5	12.5
2.5	62.5	66		
3	62.5	66		
3.3	62.5	67		

SXGA UHD - 400 MM				
Min. 2D Element	Depth of Field (mm)		Field of View	
	Inside	Outside	Hor.	Vert.
7.5	360	415	114	86
10	351	429		
15	325	451		
20	309	466		
30	293	512		
40	303	563		

Note: Minimum 1D element is typically 1/2 the size of minimum 2D element. Example: 10 mil 2D = 5 mil 1D.

Omron Microscan and all product names and logos as noted are trademarks or registered trademarks of Omron Microscan Systems, Inc. All other trademarks are the property of their respective owners.

MICROHAWK® ID-40 FIELD OF VIEW AND READ RANGE CHARTS

WVGA High-Density and Standard Density Autofocus

Object Distance Std Models		WVGA HIGH-DENSITY AUTOFOCUS			
		Horizontal Field of View		Vertical Field of View	
in.	mm	in.	mm	in.	mm
2.0	50	1.3	33.5	0.8	21.5
2.5	64	1.7	42.0	1.0	26.5
3.2	81	2.1	52.5	1.3	33.0
4.0	102	2.6	65.0	1.6	41.0
5.2	133	3.3	84.5	2.1	53.5
7.5	190	4.7	119.5	3.0	75.0
11.8	300	7.4	187.0	4.6	117.0

Object Distance Std Models		WVGA STANDARD DENSITY AUTOFOCUS			
		Horizontal Field of View		Vertical Field of View	
in.	mm	in.	mm	in.	mm
2.0	50	2.1	52.5	1.3	34.0
2.5	64	2.6	65.5	1.6	41.5
3.2	81	3.2	82.0	2.0	51.0
4.0	102	4.0	102.0	2.5	64.0
5.2	133	5.2	132.0	3.2	82.0
7.5	190	7.3	185.0	4.5	115.5
11.8	300	11.3	288.0	7.1	180.0

Symbol Size (mils)	WVGA High-Density Read Range Testings			
	IE (mm)	PPE	OE (mm)	PPE
3.3	50	1.9	53	1.8
5	50	2.8	57	2.5
7.5	50	4.2	61	3.6
10	50	5.6	64	4.6
15	50	8.5	71	6.3

Symbol Size (mils)	WVGA Standard Density Read Range Testings			
	IE (mm)	PPE	OE (mm)	PPE
5	50	1.8	60	1.5
7.5	50	2.7	69	2
10	50	3.6	77	2.5
15	50	5	92	3.1
20	50	7.2	99	4

SXGA High-Density and Standard Density Autofocus

Object Distance Std Models		SXGA HIGH-DENSITY AUTOFOCUS			
		Horizontal Field of View		Vertical Field of View	
in.	mm	in.	mm	in.	mm
2.0	50	1.4	36.5	1.1	27.4
2.5	64	1.8	46.0	1.4	34.5
3.2	81	2.3	57.2	1.7	42.9
4.0	102	2.8	71.4	2.1	53.6
5.2	133	3.6	90.5	2.7	67.9
7.5	190	5.0	127.0	3.8	95.3
11.8	300	7.8	198.4	5.9	148.8

Object Distance Std Models		SXGA STANDARD DENSITY AUTOFOCUS			
		Horizontal Field of View		Vertical Field of View	
in.	mm	in.	mm	in.	mm
2.0	50	2.3	57.2	1.7	42.9
2.5	64	2.9	73.0	2.2	54.8
3.2	81	3.5	88.9	2.6	66.7
4.0	102	4.3	109.5	3.2	82.2
5.2	133	5.6	141.3	4.2	106.0
7.5	190	7.9	200.0	5.9	150.0
11.8	300	12.4	314.3	9.3	235.7

Symbol Size (mils)	SXGA High-Density Read Range Testings			
	IE (mm)	PPE	OE (mm)	PPE
3.3	50	3.0	NA	NA
5	50	4.6	144	1.7
7.5	50	6.8	208	1.8
10	50	9.2	291	1.7
15	50	13.9	374	2

Symbol Size (mils)	SXGA Standard Density Read Range Testings			
	IE (mm)	PPE	OE (mm)	PPE
5	50	2.7	94	1.6
7.5	50	4.4	143	1.7
10	50	5.6	186	1.7
15	50	8.7	282	1.7
20	50	11.5	308	2.1

SXGA Ultra-High-Density Fixed Autofocus

SXGA UHD AUTOFOCUS			
Min. 2D Element mil size	Horizontal Field of View (mm)		Read Range (mm)
	Inside	Outside	
2	10	24	40 - 104
3.3	10	36	40 - 146
5	10	39	40 - 150

