

# OMRON

Open Network for High-Speed Control

# CompoNet

Fast and Intelligent

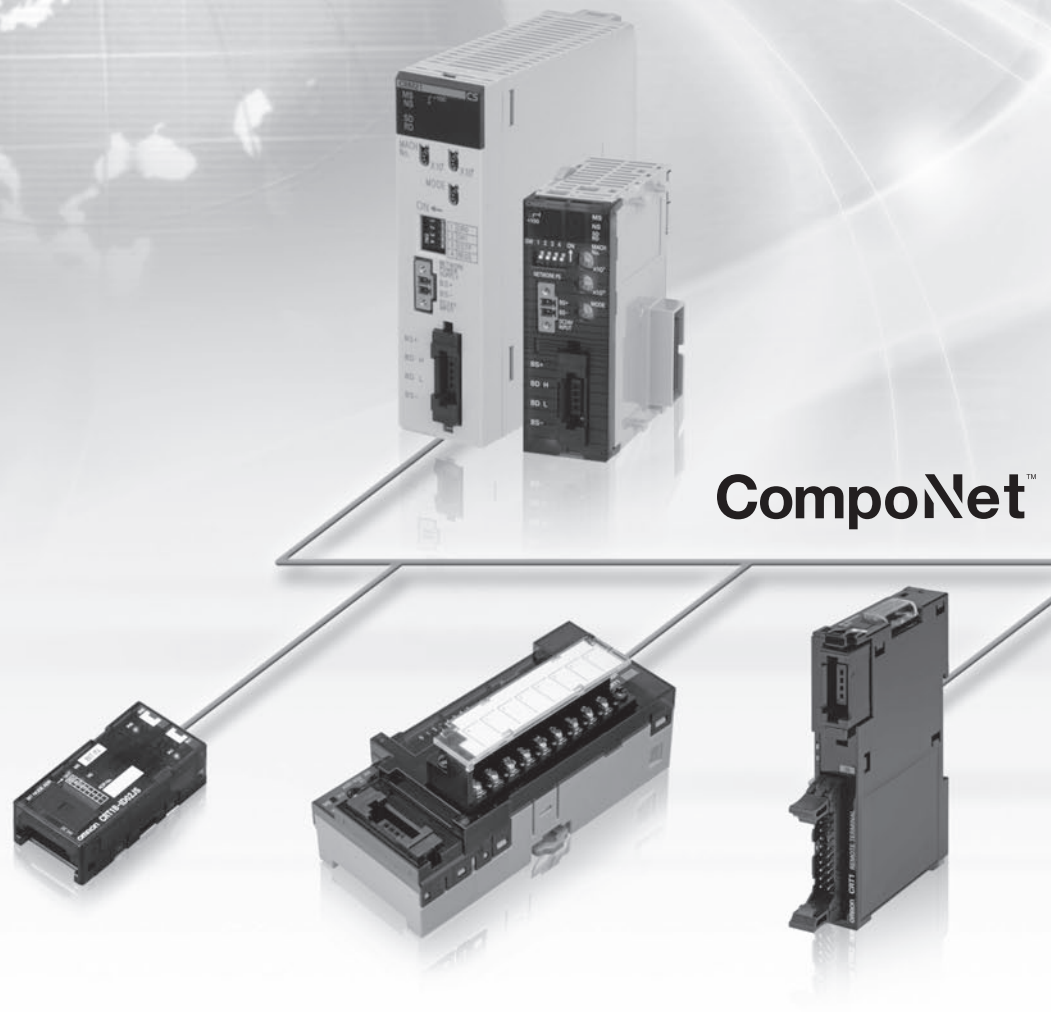

**CompoNet™**

realizing



# Communications Specifications

Item	Specification
Communications protocol	CompoNet Network protocol
Types of communications	Remote I/O communications (programless, constant sharing of data with Slave Units) and message communications (explicit message communications as required with Slave Units and FINS message communications as required with controllers) *1
Baud rate	4 Mbps *2, 3 Mbps, 1.5 Mbps, 93.75 kbps
Modulation	Base-band
Coding	Manchester code
Error control	Manchester code rules, CRC
Communications media *3	The following media can be used. <ul style="list-style-type: none"> <li>• Round cable I 2-wire 0.75 mm<sup>2</sup></li> <li>• Round cable II 4-wire 0.75 mm<sup>2</sup></li> <li>• Flat Cable I</li> </ul>
Communications distance and wiring	Refer to <i>Cable Types, Baud Rates, and Maximum Distances</i> in the <i>Master Unit Operation Manual</i> .
Connectable Master Units	CompoNet Master Units
Connectable Slave Units	CompoNet Slave Units
Maximum I/O capacity	Word Slave Units: 1,024 inputs and 1,024 outputs (2,048 I/O points total) Bit Slave Units: 256 inputs and 256 outputs (512 I/O points total)
Maximum number of nodes	Word Slave Units: 64 input nodes and 64 output nodes Bit Slave Units: 128 input nodes and 128 output nodes Repeater Units: 64 nodes
Bits allocated per node address	Word Slave Units: 16 bits Bit Slave Units: 2 bits
Maximum number of nodes per trunk line or sub-trunk line	32 nodes (Slave Units and Repeater Units)
Applicable node addresses	Word Slave Units: IN0 to IN63 and OUT0 to OUT63 Bit Slave Units: IN0 to IN127 and OUT0 to OUT127 Repeater Units: 0 to 63
Repeater Unit application conditions	Up to 64 Repeater Units can be connected per network (i.e., per Master Unit). Up to 32 Repeater Units can be connected per trunk line or per sub-trunk line. When Repeater Units are connected in series from the Master Unit, up to two extra segment layers can be created (i.e., up to 2 Repeater Units are allowed between a Slave Unit and the Master Unit).
Signal lines	Two lines: BDH (communications data high) and BDL (communications data low)
Power lines	Two lines: BS+ and BS- (power for communications and internal Slave Unit circuits) <ul style="list-style-type: none"> <li>• Power is supplied from the Master Unit or Repeater Units.</li> </ul>
Communications power supply voltage	24 VDC ±10%
Connection forms	Round cable II (4-wire) or Flat cable I at baud rate of 93.75 kbits/s: No restrictions Other cables or baud rates: Trunk line and branch lines Connections for Slave Units and Repeater Units: T-branch or multidrop connections

\*1 FINS message communications are supported by CJ-series Controllers only.

\*2 A baud rate of 4 Mbps is not supported for branch lines and thus cannot be used for Slave Units with Cables (i.e., Bit Slave Units).

\*3 Round cable I, round cable II and Flat Cable I are all different types of cable. To use more than one type of cable at a time, Repeater Units must be used to separate them on trunk lines and sub-trunk lines.

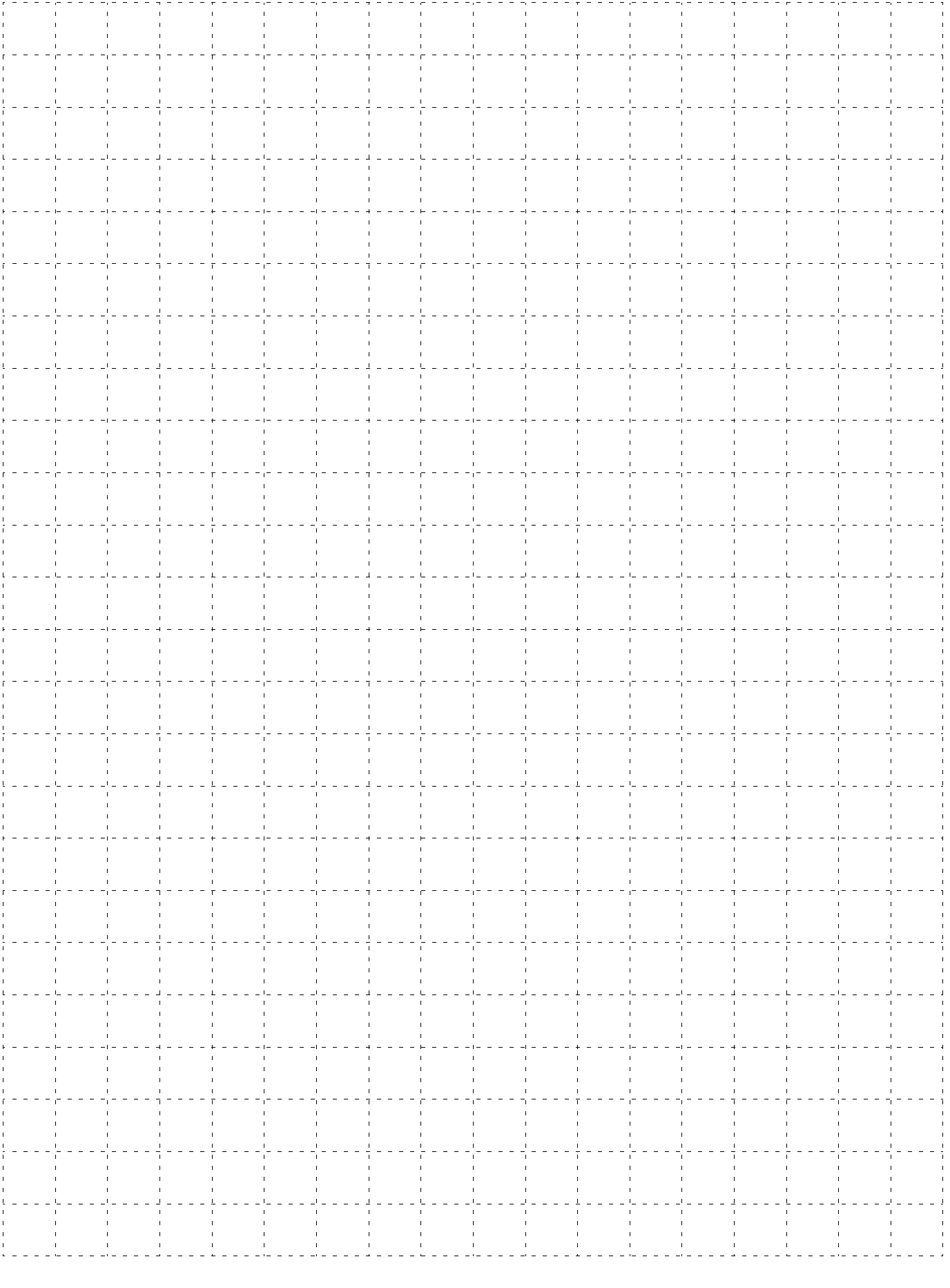

---

# CompoNet Master Units

---

CJ-series CompoNet Master Units.....	5
■CJ1W-CRM21	
CS-series CompoNet Master Units.....	6
■CS1W-CRM21	
CompoNet Master Board for PCI Bus/CompactPCI Bus.....	7
■3G8F7-CRM21	

## CJ/CS-series Master Unit Specifications

Item	Model	CJ1W-CRM21	CS1W-CRM21
Applicable Controller		NJ *1 / CJ-series	CS-series
Unit classification		CJ-series Special I/O Unit	CS-series Special I/O Unit
Current consumption (Power supplied from Power Supply Unit)		400 mA max. at 5 VDC	
Communications power supply connector		One connector for the communications power supply is required for a Slave or Repeater Unit on the trunk line when using Round Cable II or Flat Cable I. *2	
Communications power supply connector allowable current capacity		5 A max. (4 A max. for UL rating) When UL standards are being applied to your equipment, be sure the maximum allowable current is 4 A.	
Maximum number of mountable Master Units		One word number assigned: 40 Units Two word numbers assigned: 40 Units Four word numbers assigned: 24 Units Eight word numbers assigned: 12 Units	One word number assigned: 80 Units Two word numbers assigned: 48 Units Four word numbers assigned: 24 Units Eight word numbers assigned: 12 Units
Mounting location		According to NJ/CJ/CS-series Special I/O Unit specifications.	
Communications power ON/OFF monitoring		The ON/OFF status of the communications power supply can be detected at the communications power supply connector.	
Data stored in Master Unit (built-in EEPROM)		1) The following device parameters: <ul style="list-style-type: none"> <li>• Registration Table</li> <li>• Registration Table Check Type</li> <li>• Registered Slave Unit Participation Monitoring Time, Registered Slave Unit Participation Standby Mode, and Event Disable Setting</li> <li>• Software Settings Table</li> <li>• Manual I/O Communications Start Mode</li> <li>• Communications Error Input Data Zero Clear Mode</li> <li>• Network settings</li> </ul> 2) Part of error history (depends on type of error; mainly serious error related to communications stopping)	
Noise immunity		Conforms to IEC 61000-4-4 2 kV (applied to power supply).	
Vibration resistance		10 to 61.2 Hz with single-amplitude of 0.1 mm, 61.2 to 150 Hz and 14.7 m/s <sup>2</sup> in X, Y, and Z directions for 80 min each (sweep time of 8 min × 10 sweeps = 80 min)	
Shock resistance		196 m/s <sup>2</sup> (3 times each in X, Y, and Z directions)	
Dielectric strength		500 VAC (between isolated circuits)	
Insulation resistance		20 MΩ min. (between isolated circuits)	
Ambient operating temperature		0 to 55°C	
Ambient operating humidity		10 to 90% (no condensation)	
Ambient operating atmosphere		No corrosive gases	
Storage temperature		-20 to 75°C	
Weight		130 g max. (Master Unit only)	190 g max. (Master Unit only)

\*1 Supported only CPU Units with unit version 1.01 or later and the Sysmac Studio version 1.02 or higher.

\*2 Communications power does not need to be supplied to the Master Unit.

# CJ-series CompoNet Master Units

## CJ1W-CRM21

### NJ/CJ-series CompoNet Master Units Increase the Range of Applicability of Sensors and Actuators.

The NJ/CJ-series CompoNet Master Unit manages the CompoNet network, controls communications between the Controller and Slave Units, and handles I/O data and message data.

- Setup is simple. Make the master's mode settings and set the baud rate, and you're ready to go.
- Control up to 2,560 I/O points and 384 nodes with one Master Unit.
- Intuitive memory mapping with separate areas for Word Slave Units and Bit Slave Units.
- Seven-segment display helps with startup and enables prompt detection of problems.
- Collect information from Slave Units using message communications, or use message communications to set parameters.
- Inherits the ease of use of the CompoBus/S.
- Flexible I/O allocations with software setting function.



### Ordering Information

Name	Specifications		Number of unit numbers allocated	Power consumption (A)			Model
	Types of communications	Maximum number of I/O points per Master Unit		5-V system	24-V system	26-V system	
CJ1 Special I/O Unit *	<ul style="list-style-type: none"> <li>• Remote I/O communications</li> <li>• Message communications</li> </ul>	Word Slave Units: 1,024 inputs and 1,024 outputs (2,048 I/O points total) Bit Slave Units: 256 inputs and 256 outputs (512 I/O points total)	1, 2, 4, or 8	0.4	---		CJ1W-CRM21

\* These Units are also available with a DCN-TB4 Terminal Conversion Adapter included in the package. Add "(-B)" to the end of the model number to receive the Adapter as well.

### Dimensions

(Unit: mm)

#### CJ1W-CRM21

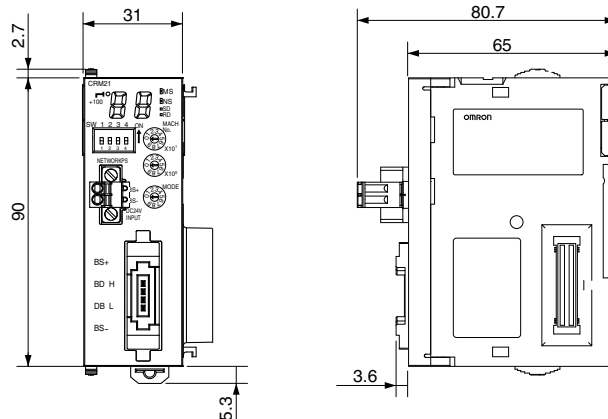

# CS-series CompoNet Master Units

## CS1W-CRM21

### CS-series CompoNet Master Units Increase the Range of Applicability of Sensors and Actuators.

The CS-series CompoNet Master Unit manages the CompoNet network, controls communications between the PLC and Slave Units, and handles I/O data and message data.

- Setup is simple. Make the master's mode settings and set the baud rate, and you're ready to go.
- Control up to 2,560 I/O points and 384 nodes with one Master Unit.
- Intuitive memory mapping with separate areas for Word Slave Units and Bit Slave Units.
- Seven-segment display helps with startup and enables prompt detection of problems.
- Collect information from Slave Units using message communications, or use message communications to set parameters.
- Inherits the ease of use of the CompoBus/S.
- Flexible I/O allocations with software setting function.



### Ordering Information

Name	Specifications		Number of unit numbers allocated	Power consumption (A)			Model
	Types of communications	Maximum number of I/O points per Master Unit		5-V system	24-V system	26-V system	
CS1 Special I/O Unit *	<ul style="list-style-type: none"> <li>• Remote I/O communications</li> <li>• Message communications</li> </ul>	Word Slave Units: 1,024 inputs and 1,024 outputs (2,048 I/O points total) Bit Slave Units: 256 inputs and 256 outputs (512 I/O points total)	1, 2, 4, or 8	0.4	/	---	CS1W-CRM21

\* These Units are also available with a DCN-TB4 Terminal Conversion Adapter included in the package. Add "(-B)" to the end of the model number to receive the Adapter as well.

### Dimensions

(Unit: mm)

#### CS1W-CRM21

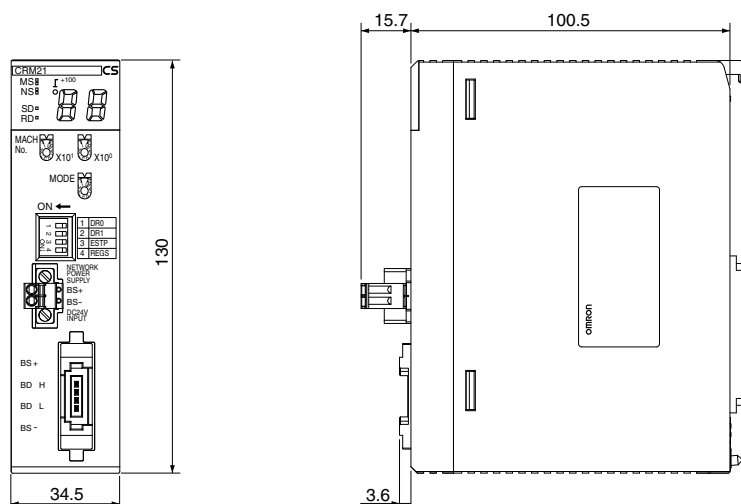



# CompoNet Master Board for PCI Bus/CompactPCI Bus 3G8F7-CRM21

## CompoNet Master Board for PC which provides ultra-high speed control

- Windows-base environment. Compatible with other OS, too when shared memory area is used.
- Combine PC with High-speed communication network "CompoNet" to achieve further fast communications.
- Familiar C/C++/VB based programming.



### Ordering Information

Name	Specification	Model
CompoNet Master Board for PCI Bus	PCI bus Rev2.2 5V	3G8F7-CRM21

### General Specifications

Item	Specifications
	3G8F7-CRM21 (PCI)
Bus specification	PCI bus Rev2.2 5 V
Number of mountable boards	4 pieces
Compatible OS	Microsoft Windows 2000 / XP (32 Bit version) / Vista (32 Bit version) / 7 (32 Bit version) Other OS can be used, when the shared memory interface is directly accessed.
Weight	90 g max.
Operation voltage	Internal power supply: 5 VDC±5% 3.3 VDC is not used.
Consumption current	Internal power supply: 5 VDC and 1.5 A max Communications power supply: 24 VDC and 80 mA max
Vibration resistance	10 to 57 Hz, Amplitude 0.075 mm, 57 to 150 Hz Acceleration 9.8 m/s <sup>2</sup> , 80 min in each direction of X, Y and Z (8 min of each sweep time × 10 sweeps = total 80 min)
Shock resistance	147 m/s <sup>2</sup> , 3 times in each direction of X, Y and Z.
Ambient operating temperature	0 to 55°C
Ambient operating humidity	0% to 80% RH (with no condensation)
Ambient operating atmosphere	No corrosive gas
Storage temperature	-20 to +60°C

### Development Environment

- Microsoft Visual C++ (Ver 6.0 to Ver 2008)
- Microsoft Visual Basic (Ver 6.0)
- CodeGear C++Builder (Ver 5 to Ver 2009)

#### Precautions for Correct Use

When you use the Board in an OS other than Windows by directly accessing the shared memory interface, provide the development environment applicable for the OS.

Dimensions

(unit: mm)

3G8F7-CRM21 (PCI)

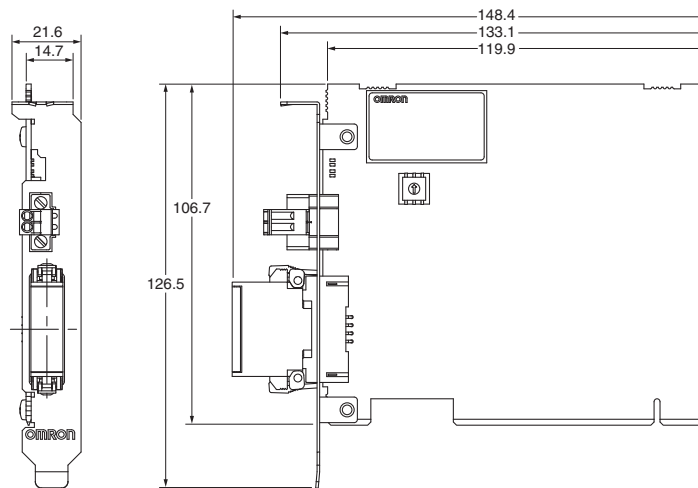

---

# CompoNetGatewayUnit

---

Overview of Gateway Unit .....	10
CompoNet Setting .....	11
CompoNet Gateway Unit for CC-Link.....	12
■GQ-CRM21	

## Overview of Gateway Unit

The CompoNet Gateway Unit works as a converter to connect CompoNet with another network with different protocol. The GQ-CRM21 CompoNet Gateway Unit for CC-Link provides one CC-Link port and one CompoNet port. It cyclically transfers I/O data between the CompoNet Slave Units and the CC-Link Master Unit.

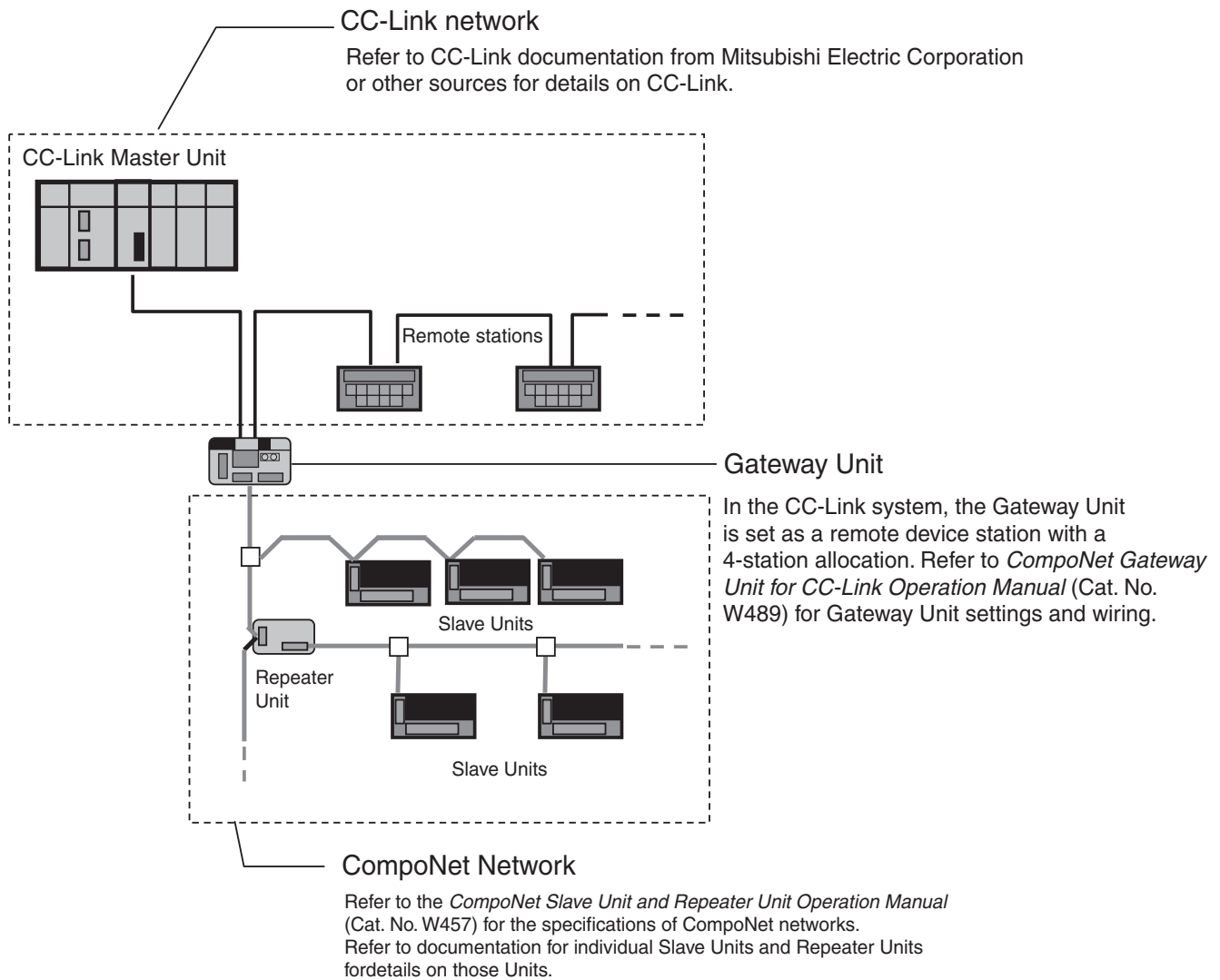

- “CC-Link” is a registered trademark of Mitsubishi Electric Corporation.
- “GX-Developer” is a registered trademark of Mitsubishi Electric Corporation.

## CompoNet Setting

### ■ Setting the Communications Mode

To use the Gateway Unit, select the communications mode with the setting switches on the Gateway Unit. The below table lists the number of Slave Units (Word Slave Units and Bit Slave Units) and Control Points (the range of buffer memory allocated to the Gateway Unit in the CC-Link Master Unit) in each communications mode. (Refer to *CompoNet Gateway Unit for CC-Link Operation Manual* (Cat. No. W489) for details.)

The expanded cyclic setting (a network parameter set with the GX-Developer) in the CC-Link station information must be changed according to the communications mode.

Mode number	Name	Connectable node addresses	Number of connected nodes	Control Points	CC-Link version and expanded cyclic setting
0	Communications mode 0	Word Slave Unit: IN 0 to IN 63 and OUT 0 to OUT 63 Bit Slave Unit: IN 0 to IN 127 and OUT 0 to OUT 127	Word Slave Unit IN 64/OUT 64 Bit Slave Unit IN 128/OUT 128	Word Slave Unit: 1,024 inputs and 1,024 outputs Bit Slave Unit: 256 inputs and 256 outputs	Version 2, octuple (default)
1	Communications mode 1	Word Slave Unit: IN 0 to IN 31 and OUT 0 to OUT 31 Bit Slave Unit: IN 0 to IN 95 and OUT 0 to OUT 95	Word Slave Unit IN 32/OUT 32 Bit Slave Unit IN 96/OUT 96	Word Slave Unit: 512 inputs and 512 outputs Bit Slave Unit: 192 inputs and 192 outputs	Version 2, quadruple
2	Communications mode 2	Word Slave Unit: IN 0 to IN 15 and OUT 0 to OUT 15 Bit Slave Unit: IN 0 to IN 47 and OUT 0 to OUT 47	Word Slave Unit IN 16/OUT 16 Bit Slave Unit IN 48/OUT 48	Word Slave Unit: 256 inputs and 256 outputs Bit Slave Unit: 96 inputs and 96 outputs	Version 2, double
3	Communications mode 3	Word Slave Unit: IN 0 to IN 7 and OUT 0 to OUT 7 Bit Slave Unit: IN 0 to IN 15 and OUT 0 to OUT 15	Word Slave Unit IN 8/OUT 8 Bit Slave Unit IN 16/OUT 16	Word Slave Unit: 128 inputs and 128 outputs Bit Slave Unit: 32 inputs and 32 outputs	Version 1
4	Communications mode 4	Word Slave Unit: IN 0 to IN 63 and OUT 0 to OUT 63 Bit Slave Unit: IN 0 to IN 127 and OUT 0 to OUT 127	Word Slave Unit IN 64/OUT 64 Bit Slave Unit IN 128/OUT 128	Word Slave Unit: 1,024 inputs and 1,024 outputs Bit Slave Unit: 256 inputs and 256 outputs	Version 2, quadruple
5	Communications mode 5	Word Slave Unit: IN 0 to IN 31 and OUT 0 to OUT 31 Bit Slave Unit: IN 0 to IN 95 and OUT 0 to OUT 95	Word Slave Unit IN 32/OUT 32 Bit Slave Unit IN 96/OUT 96	Word Slave Unit: 512 inputs and 512 outputs Bit Slave Unit: 192 inputs and 192 outputs	Version 2, double
6	Communications mode 6	Word Slave Unit: IN 0 to IN 15 and OUT 0 to OUT 15 Bit Slave Unit: IN 0 to IN 47 and OUT 0 to OUT 47	Word Slave Unit IN 16/OUT 16 Bit Slave Unit IN 48/OUT 48	Word Slave Unit: 256 inputs and 256 outputs Bit Slave Unit: 96 inputs and 96 outputs	Version 1
7 to 9	Reserved	---	---	---	---

CompoNet Gateway Unit for CC-Link

# GQ-CRM21

## "Easy" and "Flexible" system expansion with linked CC-Link and CompoNet.

- Branching is easily made with CompoNet. Wiring material cost can be reduced.
- Bit-level I/O distribution reduces wiring in the system.
- A wide variety of CompoNet Slave Units contribute to system size reduction.
- Seven-segment Display on the Gateway Unit helps to detect errors on site.
- The Participation Flags and Communications Error Flags can be checked at the Host Controller to detect the location and content of the error.



### Ordering Information

Name	Specifications					Model
	CC-Link Communications Specification			CompoNet Communications Specification		
	Station Type	Number of stations occupied	CC-Link Version	Types of communications	Maximum I/O capacity	
CompoNet Gateway Unit for CC-Link	Remote device stations	4	Version 1.10 or 2.00 (Selected using mode switch.)	Remote I/O Communications	Word Slave Units: 2,048 I/O points total (1,024 inputs and 1,024 outputs) Bit Slave Units: 512 I/O points total (256 inputs and 256 outputs)	GQ-CRM21

### Master Unit Specifications

Item	Specification
Unit power supply voltage	21.6 to 26.4 VDC (24 VDC±10%) (Supplied from power supply connector.)
Current consumption	Communications power supply
	Internal current power consumption
Noise immunity	Conforms to IEC 61000-4-4, 2.0 kV
Vibration resistance	Malfunction: 10 to 60 Hz with 0.7-mm double amplitude, 60 to 150 Hz, 50 m/s <sup>2</sup> for 80 min in X, Y, and Z directions
Shock resistance	150 m/s <sup>2</sup> , 3 times in 6 directions on 3 axes
Dielectric strength	500 VAC
Installation method	Mounted to DIN Track or by using M4 screws
Ambient operating temperature	0 to 55 °C
Ambient operating humidity	10% to 90% (with no condensation)
Ambient storage temperature	-25 to 65 °C
Weight	110 g max.
Ambient operating atmosphere	No corrosive gases

Component Names and Functions

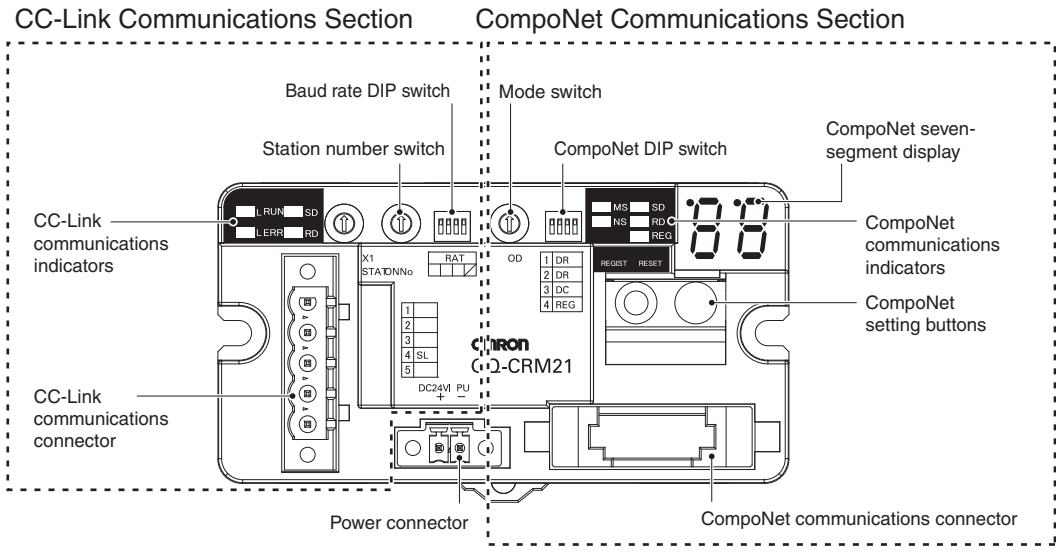

Dimensions

(Unit: mm)

GQ-CRM21

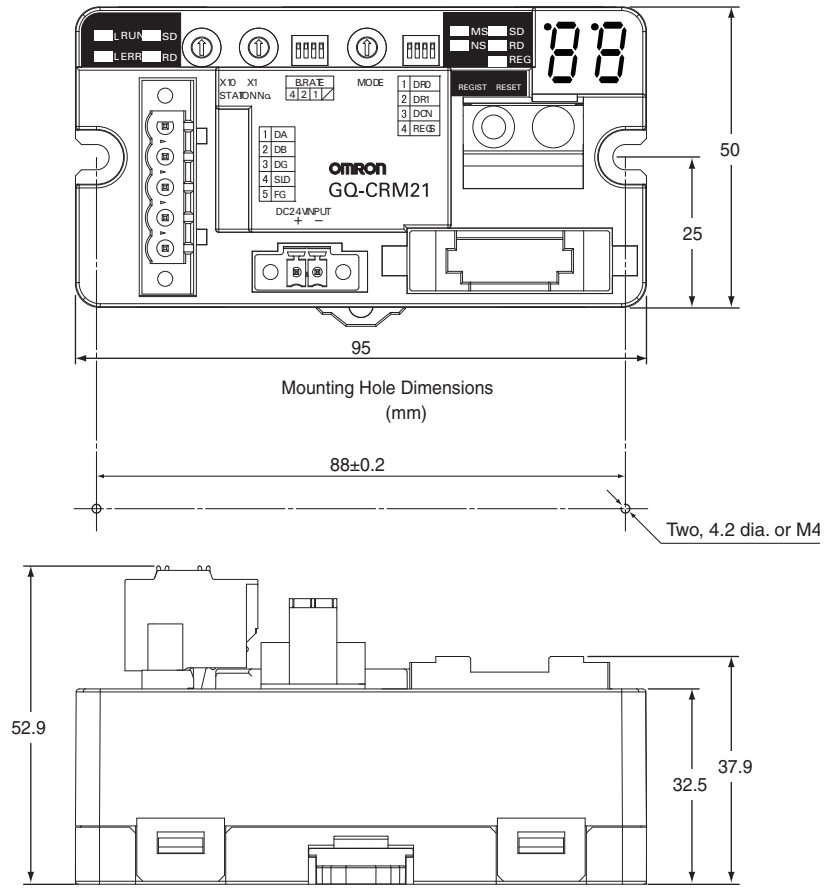

## CC-Link Communications Specifications

Item	Specification
Version	CC-Link version 1.10 or 2.00 (Selected using mode switch.)
Baud rate	156 kbps, 625 kbps, 2.5 Mbps, 5 Mbps, or 10 Mbps
Communications method	Broadcast polling
Synchronization method	Frame synchronization
Encoding	NRZI
Transmission path	Bus (Conforms to RS-485.)
Transmission format	Conforms to HDLC.
Communications media	CC-Link cable (shielded, 3-core twisted-pair cable)
Number of connected nodes	Depends on specifications of the CC-Link master station.
Remote stations	1 to 61 (Four station numbers are allocated starting from the specified station number.)
Error control	CRC ( $X^{16} + X^{12} + X^5 + 1$ )
RAS functions	Automatic recovery function, slave cutoff, data link status checks, offline testing
Allocated station numbers	Allocated four stations numbers as a remote device station



# CompoNet Slave Unit

Smart Functions .....	16
What Are Smart Functions? .....	27
Basic Specification of Slave Units .....	30
Digital I/O Slave Units with Screw Terminal Blocks (2-tier Terminal Block/Relay Output/SSR Output) .....	31
■CRT1-□D08(-1)/□D16(-1)/ROS□/ROF□	
Digital I/O Slave Units with Screw Terminal Blocks (3-tier Terminal Block) .....	38
■CRT1-□D08TA(-1)/□D16TA(-1)/□D08TAH(-1)/□D16TAH(-1)	
Digital I/O Slave Units with e-CON Connectors .....	43
■CRT1-□D16S(-1)/□D32S(-1)/□D16SH(-1)/□D32SH(-1)	
Digital I/O Slave Units with e-CON Connector (Vertical type) .....	50
■CRT1-VID08S(-1)/VOD08S(-1)	
Digital I/O Slave Units with MIL Connector (Vertical type) .....	52
■CRT1-VID16ML(-1)/VOD16ML(-1)	
Digital I/O Slave Units with MIL Connector (Vertical type) .....	54
■CRT1-VID32ML(-1)/VOD32ML(-1)/VMD32ML(-1)	
Digital I/O Slaves Units with Clamp Terminals .....	57
■CRT1-□D08SL(-1)/□D16SL(-1)	
Analog I/O Slave Units .....	61
■CRT1-AD04/DA02	
Analog I/O Slave Units with MIL Connectors/e-CON Connectors .....	63
■CRT1-VAD04□□/-VDA02□□	
Temperature Input Units .....	67
■CRT1-TS04T/-TS04P	
Expansion Units .....	70
■XWT-VOD08S(-1)/VMD08S(-1)/VOD16ML(-1)/VMD16ML(-1)	
SmartSlice GRT1-series .....	72
■GRT1-CRT	
■Slice I/O Units	
Bit Slave Units with Compact Connectors .....	76
■CRT1B-□D02JS(-1)/□D04JS(-1)	
Bit Slave Units with e-CON Connectors .....	84
■CRT1B-□D02S(-1)	
Repeater Unit .....	88
■CRS1-RPT01	
Sensor Communications Unit .....	91
■ZS-CRT	
■E3X-CRT	
Multi-function Compact Inverter MX2-Series V1 type CompoNet Communication Unit .....	95
■3G3AX-MX2-CRT-E	
High-function General-purpose Inverter RX-Series V1 type CompoNet Communication Unit .....	96
■3G3AX-RX-CRT-E	

## Smart Functions

The Slave Units provide Smart Functions that powerfully aid in everything from building the system and initial system startup to preventive system maintenance. The Smart Functions include functions for monitoring the operation time, changes in operating values, and other values, as well as functions that provide warnings for maintenance based on ON/OFF counts, total operating time, and other counted values.

### ■ CompoNet Slave Unit Functions

Yes: Supported, ---: Not supported

Function	Unit	Digital I/O Slave Units				
		2-tier Terminal block				
		CRT1-□D08(-1)		CRT1-□D16(-1)		
		Input Units	Output Units	Input Units	Output Units	I/O Units
Operation Time Monitor				Yes		
Contact Operation Monitor*				Yes		
Total ON Time Monitor*				Yes		
Automatic Baud Rate Detection				Yes		
Unit Conduction Time Monitor				Yes		
Naming Units				Yes		
Naming Connected Devices				Yes		
Network Power Voltage Monitor				Yes		
I/O Power Status Monitor				Yes		
Communications Error History Monitor				Yes		
Input Filter		Yes	---	Yes	---	Yes
Communications Error Output		---	Yes	---	Yes	Yes
Preventing Malfunctions Caused by Inrush Current at I/O Startup		Yes	---	Yes	---	Yes
Power Short-circuit Detection				---		
Unconnected Line Detection				---		
Load Short-circuit Detection				---		
Disconnected Line Detection				---		
Removable Terminal Block Structure				Yes		
Expansion Using Expansion Units			---		Yes	---
Scaling				---		
Last Maintenance Date				Yes		
Cumulated Count				---		
Moving Average				---		
Setting the Number of AD Conversion Points				---		
Rate of Change				---		
Comparator				---		
Peak/Bottom Hold				---		
Top/Valley Hold				---		
User Adjustment				---		
Top/Valley Count				---		
Temperature Range Total Time Count				---		
Input Temperature Variation Detection				---		
Input Error Detection Disable Function				---		

#### Reducing System Startup Time

- Network Power Voltage Monitor
- Input Filter
- Preventing Malfunctions Caused by Inrush Current at Startup
- Automatic Baud Rate Detection
- Scaling
- User Adjustment
- Cumulative Counter
- Moving Average
- Setting the Number of AD Conversion Point
- Peak/Bottom Hold
- Top/Valley Hold
- Rate of Change

#### Reducing Downtime

- Naming Units
- Naming Connected Devices
- I/O Power Status Monitor
- Power Short-circuit Detection
- Unconnected Line Detection
- Disconnected Line Detection

#### Improving Maintenance

- Operation Time Monitor
- Contact Operation Monitor
- Unit Conduction Time Monitor
- Total ON Time Monitor
- Network Power Voltage Monitor
- Communications Error History Monitor
- Last Maintenance Date
- Comparator
- Communications Error Output

\* The Contact Operation Monitor and the Total ON Time Monitor cannot be used at the same time for the same contact.

Yes: Supported, ---: Not supported

Function	Unit			
	Digital I/O Slave Units			
	2-tier Terminal block			
	CRT1-ROS08	CRT1-ROS16	CRT1-ROF08	CRT1-ROF16
	Output Units		Output Units	
Operation Time Monitor	Yes		Yes	
Contact Operation Monitor*	Yes		Yes	
Total ON Time Monitor*	Yes		Yes	
Automatic Baud Rate Detection	Yes		Yes	
Unit Conduction Time Monitor	Yes		Yes	
Naming Units	Yes		Yes	
Naming Connected Devices	Yes		Yes	
Network Power Voltage Monitor	Yes		Yes	
I/O Power Status Monitor	---		---	
Communications Error History Monitor	Yes		Yes	
Input Filter	---		---	
Communications Error Output	Yes		Yes	
Preventing Malfunctions Caused by Inrush Current at I/O Startup	---		---	
Power Short-circuit Detection	---		---	
Unconnected Line Detection	---		---	
Load Short-circuit Detection	---		---	
Disconnected Line Detection	---		---	
Removable Terminal Block Structure	Yes		Yes	
Expansion Using Expansion Units	---	Yes	---	Yes
Scaling	---		---	
Last Maintenance Date	Yes		Yes	
Cumulated Count	---		---	
Moving Average	---		---	
Setting the Number of AD Conversion Points	---		---	
Rate of Change	---		---	
Comparator	---		---	
Peak/Bottom Hold	---		---	
Top/Valley Hold	---		---	
User Adjustment	---		---	
Top/Valley Count			---	
Temperature Range Total Time Count			---	
Input Temperature Variation Detection			---	
Input Error Detection Disable Function			---	

\* The Contact Operation Monitor and the Total ON Time Monitor cannot be used at the same time for the same contact.

Yes: Supported, ---: Not supported

Function	Unit	Digital I/O Slave Units			
		3-tier Terminal block			
		CRT1-□D08TA(-1) (without Short-circuit and Disconnected Line Detection)		CRT1-□D08TAH(-1) (with Short-circuit and Disconnected Line Detection)	
		Input Units	Output Units	Input Units	Output Units
Operation Time Monitor		Yes			
Contact Operation Monitor*		Yes			
Total ON Time Monitor*		Yes			
Automatic Baud Rate Detection		Yes			
Unit Conduction Time Monitor		Yes			
Naming Units		Yes			
Naming Connected Devices		Yes			
Network Power Voltage Monitor		Yes			
I/O Power Status Monitor		Yes			
Communications Error History Monitor		Yes			
Input Filter		Yes	---	Yes	---
Communications Error Output		---	Yes	---	Yes
Preventing Malfunctions Caused by Inrush Current at I/O Startup		Yes	---	Yes	---
Power Short-circuit Detection		---		Yes	---
Unconnected Line Detection		---		Yes	---
Load Short-circuit Detection		---		---	Yes
Disconnected Line Detection		---		---	Yes
Removable Terminal Block Structure		Yes			
Expansion Using Expansion Units		---			
Scaling		---			
Last Maintenance Date		Yes			
Cumulated Count		---			
Moving Average		---			
Setting the Number of AD Conversion Points		---			
Rate of Change		---			
Comparator		---			
Peak/Bottom Hold		---			
Top/Valley Hold		---			
User Adjustment		---			
Top/Valley Count		---			
Temperature Range Total Time Count		---			
Input Temperature Variation Detection		---			
Input Error Detection Disable Function		---			

\* The Contact Operation Monitor and the Total ON Time Monitor cannot be used at the same time for the same contact.

Yes: Supported, ---: Not supported

Function	Unit					
	Digital I/O Slave Units					
	3-tier Terminal block					
	CRT1-□D16TA(-1) (without Short-circuit and Disconnected Line Detection)			CRT1-□D16TAH(-1) (with Short-circuit and Disconnected Line Detection)		
	Input Units	Output Units	I/O Units	Input Units	Output Units	I/O units
Operation Time Monitor	Yes					
Contact Operation Monitor*	Yes					
Total ON Time Monitor*	Yes					
Automatic Baud Rate Detection	Yes					
Unit Conduction Time Monitor	Yes					
Naming Units	Yes					
Naming Connected Devices	Yes					
Network Power Voltage Monitor	Yes					
I/O Power Status Monitor	Yes					
Communications Error History Monitor	Yes					
Input Filter	Yes	---	Yes	Yes	---	Yes
Communications Error Output	---	Yes	Yes	---	Yes	Yes
Preventing Malfunctions Caused by Inrush Current at I/O Startup	Yes	---	Yes	Yes	---	Yes
Power Short-circuit Detection	---			Yes	---	Yes
Unconnected Line Detection	---			Yes	---	Yes
Load Short-circuit Detection	---			---	Yes	Yes
Disconnected Line Detection	---			---	Yes	Yes
Removable Terminal Block Structure	Yes					
Expansion Using Expansion Units	---					
Scaling	---					
Last Maintenance Date	Yes					
Cumulated Count	---					
Moving Average	---					
Setting the Number of AD Conversion Points	---					
Rate of Change	---					
Comparator	---					
Peak/Bottom Hold	---					
Top/Valley Hold	---					
User Adjustment	---					
Top/Valley Count	---					
Temperature Range Total Time Count	---					
Input Temperature Variation Detection	---					
Input Error Detection Disable Function	---					

\* The Contact Operation Monitor and the Total ON Time Monitor cannot be used at the same time for the same contact.

Yes: Supported, ---: Not supported

Function	Unit	Digital I/O Slave Units	
		Units with e-CON Connectors	
		CRT1-V□D08S(-1)	
		Input Units	Output Units
Operation Time Monitor		Yes	
Contact Operation Monitor*		Yes	
Total ON Time Monitor*		Yes	
Automatic Baud Rate Detection		Yes	
Unit Conduction Time Monitor		Yes	
Naming Units		Yes	
Naming Connected Devices		Yes	
Network Power Voltage Monitor		Yes	
I/O Power Status Monitor		---	Yes
Communications Error History Monitor		Yes	
Input Filter		Yes	---
Communications Error Output		---	Yes
Preventing Malfunctions Caused by Inrush Current at I/O Startup		Yes	---
Power Short-circuit Detection		---	
Unconnected Line Detection		---	
Load Short-circuit Detection		---	
Disconnected Line Detection		---	
Removable Terminal Block Structure		---	
Expansion Using Expansion Units		---	
Scaling		---	
Last Maintenance Date		Yes	
Cumulated Count		---	
Moving Average		---	
Setting the Number of AD Conversion Points		---	
Rate of Change		---	
Comparator		---	
Peak/Bottom Hold		---	
Top/Valley Hold		---	
User Adjustment		---	
Top/Valley Count		---	
Temperature Range Total Time Count		---	
Input Temperature Variation Detection		---	
Input Error Detection Disable Function		---	

\* The Contact Operation Monitor and the Total ON Time Monitor cannot be used at the same time for the same contact.

Yes: Supported, ---: Not supported

Function	Digital I/O Slave Units					
	Units with e-CON Connectors					
	CRT1-□D16S(-1) (without Short-circuit and Disconnected Line Detection)			CRT1-□D16SH(-1) (with Short-circuit and Disconnected Line Detection)		
	Input Units	Output Units	I/O Units	Input Units	Output Units	I/O units
Operation Time Monitor	Yes					
Contact Operation Monitor*	Yes					
Total ON Time Monitor*	Yes					
Automatic Baud Rate Detection	Yes					
Unit Conduction Time Monitor	Yes					
Naming Units	Yes					
Naming Connected Devices	Yes					
Network Power Voltage Monitor	Yes					
I/O Power Status Monitor	---	Yes	Yes	---	Yes	Yes
Communications Error History Monitor	Yes					
Input Filter	Yes	---	Yes	Yes	---	Yes
Communications Error Output	---	Yes	Yes	---	Yes	Yes
Preventing Malfunctions Caused by Inrush Current at I/O Startup	Yes	---	Yes	Yes	---	Yes
Power Short-circuit Detection	---			Yes	---	Yes
Unconnected Line Detection	---			Yes	---	Yes
Load Short-circuit Detection	---			---	Yes	Yes
Disconnected Line Detection	---			---	Yes	Yes
Removable Terminal Block Structure	---					
Expansion Using Expansion Units	---					
Scaling	---					
Last Maintenance Date	Yes					
Cumulated Count	---					
Moving Average	---					
Setting the Number of AD Conversion Points	---					
Rate of Change	---					
Comparator	---					
Peak/Bottom Hold	---					
Top/Valley Hold	---					
User Adjustment	---					
Top/Valley Count	---					
Temperature Range Total Time Count	---					
Input Temperature Variation Detection	---					
Input Error Detection Disable Function	---					

\* The Contact Operation Monitor and the Total ON Time Monitor cannot be used at the same time for the same contact.

Function	Digital I/O Slave Units					
	Units with e-CON Connectors					
	CRT1-□D32S(-1) (without Short-circuit and Disconnected Line Detection)			CRT1-□D32SH(-1) (with Short-circuit and Disconnected Line Detection)		
	Input Units	Output Units	I/O Units	Input Units	Output Units	I/O units
Operation Time Monitor	Yes					
Contact Operation Monitor*	Yes					
Total ON Time Monitor*	Yes					
Automatic Baud Rate Detection	Yes					
Unit Conduction Time Monitor	Yes					
Naming Units	Yes					
Naming Connected Devices	Yes					
Network Power Voltage Monitor	Yes					
I/O Power Status Monitor	---	Yes	Yes	---	Yes	Yes
Communications Error History Monitor	Yes					
Input Filter	Yes	---	Yes	Yes	---	Yes
Communications Error Output	---	Yes	Yes	---	Yes	Yes
Preventing Malfunctions Caused by Inrush Current at I/O Startup	Yes	---	Yes	Yes	---	Yes
Power Short-circuit Detection	---			Yes	---	Yes
Unconnected Line Detection	---			Yes	---	Yes
Load Short-circuit Detection	---			---	Yes	Yes
Disconnected Line Detection	---			---	Yes	Yes
Removable Terminal Block Structure	---					
Expansion Using Expansion Units	---					
Scaling	---					
Last Maintenance Date	Yes					
Cumulated Count	---					
Moving Average	---					
Setting the Number of AD Conversion Points	---					
Rate of Change	---					
Comparator	---					
Peak/Bottom Hold	---					
Top/Valley Hold	---					
User Adjustment	---					
Top/Valley Count	---					
Temperature Range Total Time Count	---					
Input Temperature Variation Detection	---					
Input Error Detection Disable Function	---					

\* The Contact Operation Monitor and the Total ON Time Monitor cannot be used at the same time for the same contact.



Yes: Supported, ---: Not supported

Function	Digital I/O Slave Units				
	Units with MIL Connectors				
	CRT1-V□D16ML(-1)		CRT1-V□D32ML(-1)		
	Input Units	Output Units	Input Units	Output Units	I/O Units
Operation Time Monitor	Yes				
Contact Operation Monitor*	Yes				
Total ON Time Monitor*	Yes				
Automatic Baud Rate Detection	Yes				
Unit Conduction Time Monitor	Yes				
Naming Units	Yes				
Naming Connected Devices	Yes				
Network Power Voltage Monitor	Yes				
I/O Power Status Monitor	Yes				
Communications Error History Monitor	Yes				
Input Filter	Yes	---	Yes	---	Yes
Communications Error Output	---	Yes	---	Yes	Yes
Preventing Malfunctions Caused by Inrush Current at I/O Startup	Yes	---	Yes	---	Yes
Power Short-circuit Detection	---				
Unconnected Line Detection	---				
Load Short-circuit Detection	---				
Disconnected Line Detection	---				
Removable Terminal Block Structure	---				
Expansion Using Expansion Units	---				
Scaling	---				
Last Maintenance Date	Yes				
Cumulated Count	---				
Moving Average	---				
Setting the Number of AD Conversion Points	---				
Rate of Change	---				
Comparator	---				
Peak/Bottom Hold	---				
Top/Valley Hold	---				
User Adjustment	---				
Top/Valley Count	---				
Temperature Range Total Time Count	---				
Input Temperature Variation Detection	---				
Input Error Detection Disable Function	---				

\* The Contact Operation Monitor and the Total ON Time Monitor cannot be used at the same time for the same contact.

Yes: Supported, ---: Not supported

Function	Unit	Digital I/O Slave Units				
		Units with Screw-less Clamp Terminals				
		CRT1-□D08SL(-1)		CRT1-□D16SL(-1)		
		Input Units	Output Units	Input Units	Output Units	I/O Units
Operation Time Monitor		Yes				
Contact Operation Monitor*		Yes				
Total ON Time Monitor*		Yes				
Automatic Baud Rate Detection		Yes				
Unit Conduction Time Monitor		Yes				
Naming Units		Yes				
Naming Connected Devices		Yes				
Network Power Voltage Monitor		Yes				
I/O Power Status Monitor		Yes				
Communications Error History Monitor		Yes				
Input Filter		Yes	---	Yes	---	Yes
Communications Error Output		---	Yes	---	Yes	Yes
Preventing Malfunctions Caused by Inrush Current at I/O Startup		Yes	---	Yes	---	Yes
Power Short-circuit Detection		---				
Unconnected Line Detection		---				
Load Short-circuit Detection		---				
Disconnected Line Detection		---				
Removable Terminal Block Structure		Yes				
Expansion Using Expansion Units		---				
Scaling		---				
Last Maintenance Date		Yes				
Cumulated Count		---				
Moving Average		---				
Setting the Number of AD Conversion Points		---				
Rate of Change		---				
Comparator		---				
Peak/Bottom Hold		---				
Top/Valley Hold		---				
User Adjustment		---				
Top/Valley Count		---				
Temperature Range Total Time Count		---				
Input Temperature Variation Detection		---				
Input Error Detection Disable Function		---				

\* The Contact Operation Monitor and the Total ON Time Monitor cannot be used at the same time for the same contact.

Yes: Supported, ---: Not supported

Function	Unit					
	Analog I/O Slave Units					
	Units with 2-tier Terminal block		Units with e-CON Connectors		Units with MIL Connectors	
	CRT1-AD04 CRT1-DA02		CRT1-VAD04S CRT1-VDA02S		CRT1-VAD04ML CRT1-VDA02ML	
	Input Units	Output Units	Input Units	Output Units	Input Units	Output Units
Operation Time Monitor	---					
Contact Operation Monitor*	---					
Total ON Time Monitor*	---					
Automatic Baud Rate Detection	Yes					
Unit Conduction Time Monitor	Yes					
Naming Units	Yes					
Naming Connected Devices	Yes					
Network Power Voltage Monitor	Yes					
I/O Power Status Monitor	---					
Communications Error History Monitor	Yes					
Input Filter	---					
Communications Error Output	---	Yes	---	Yes	---	Yes
Preventing Malfunctions Caused by Inrush Current at I/O Startup	---					
Power Short-circuit Detection	---					
Unconnected Line Detection	---					
Load Short-circuit Detection	---					
Disconnected Line Detection	Yes	---	Yes	---	Yes	---
Removable Terminal Block Structure	Yes					
Expansion Using Expansion Units	---					
Scaling	Yes					
Last Maintenance Date	Yes					
Cumulated Count	Yes					
Moving Average	Yes	---	Yes	---	Yes	---
Setting the Number of AD Conversion Points	Yes	---	Yes	---	Yes	---
Rate of Change	Yes	---	Yes	---	Yes	---
Comparator	Yes	---	Yes	---	Yes	---
Peak/Bottom Hold	Yes	---	Yes	---	Yes	---
Top/Valley Hold	Yes	---	Yes	---	Yes	---
User Adjustment	Yes					
Top/Valley Count	---					
Temperature Range Total Time Count	---					
Input Temperature Variation Detection	---					
Input Error Detection Disable Function	---					

\* The Contact Operation Monitor and the Total ON Time Monitor cannot be used at the same time for the same contact.

Yes: Supported, ---: Not supported

Function	Unit	Bit Slave Units		Bit Slaves with Compact Connectors						Repeater Unit	Sensor Communication Unit
	SmartSlice GRT1 Series	CRT1B-□D02S(-1)		CRT1B-□D02JS(-1)			CRT1B-□D04JS(-1)			CRS1-RPT01	E3X-CRT
		Input Units	Output Units	Input Units	Output Units	I/O units	Input Units	Output Units	I/O units		
Operation Time Monitor	---	Yes		---			---			---	---
Contact Operation Monitor*	---	Yes		---			---			---	---
Total ON Time Monitor*	---	Yes		---			---			---	---
Automatic Baud Rate Detection	Yes	Yes		Yes			Yes			Yes	Yes
Unit Conduction Time Monitor	Yes	Yes		---			---			Yes	Yes
Naming Units	Yes	Yes		---			---			Yes	Yes
Naming Connected Devices	---	Yes		---			---			---	Yes
Network Power Voltage Monitor	---	Yes		---			---			Yes	Yes
I/O Power Status Monitor	---	---		---			---			---	---
Communications Error History Monitor	Yes	Yes		---			---			Yes	Yes
Input Filter	---	Yes	---	Yes	---	Yes	Yes	---	Yes	---	---
Communications Error Output	---	---	Yes	---	Yes	Yes	---	Yes	Yes	---	---
Preventing Malfunctions Caused by Inrush Current at I/O Startup	---	Yes	---	---			---			---	---
Power Short-circuit Detection	---	Yes	---	---			---			---	---
Unconnected Line Detection	---	---		---			---			---	---
Load Short-circuit Detection	---	---	Yes	---			---			---	---
Disconnected Line Detection	---	---		---			---			---	---
Removable Terminal Block Structure	---	---		---			---			---	---
Expansion Using Expansion Units	---	---		---			---			---	---
Scaling	---	---		---			---			---	---
Last Maintenance Date	---	Yes		---			---			Yes	---
Cumulated Count	---	---		---			---			---	---
Moving Average	---	---		---			---			---	---
Setting the Number of AD Conversion Points	---	---		---			---			---	---
Rate of Change	---	---		---			---			---	---
Comparator	---	---		---			---			---	---
Peak/Bottom Hold	---	---		---			---			---	---
Top/Valley Hold	---	---		---			---			---	---
User Adjustment	---	---		---			---			---	---
Top/Valley Count	---	---		---			---			---	---
Temperature Range Total Time Count	---	---		---			---			---	---
Input Temperature Variation Detection	---	---		---			---			---	---
Input Error Detection Disable Function	---	---		---			---			---	---

\* The Contact Operation Monitor and the Total ON Time Monitor cannot be used at the same time for the same contact.

# What Are Smart Functions?

## Smart Functions

### Network Power Voltage Monitor

The Network Power Voltage Monitor function stores the present value, minimum value, and maximum value of the network power voltage in the Slave Unit memory. If a monitor voltage is set using the CX-Integrator, the monitor voltage is stored in the Slave Unit memory. (The default is 14 V.) If the voltage drops below the monitor voltage, a flag in a status area in the Slave Unit will turn ON to notify the Master Unit. The notification details can be read using the CX-Integrator or using explicit messages.

- Note 1.** The minimum communications power voltage for the CompoNet network itself is 14 V, so if the network power voltage drops below 14 V, it may not be possible to read a measurement value using the CX-Integrator.
- 2.** The maximum and minimum values of the network power voltage are cleared when the network power is turned OFF.

### Unit Conduction Time Monitor

The cumulative time that power is ON to the Slave Unit's internal circuits can be stored in the Slave Unit memory. (This data can be read using the CX-Integrator or using explicit messages.) The monitor value is also stored in the Slave Unit memory so once the total time reaches the monitor value, a flag in a status area in the Slave Unit turns ON to notify the Master Unit.

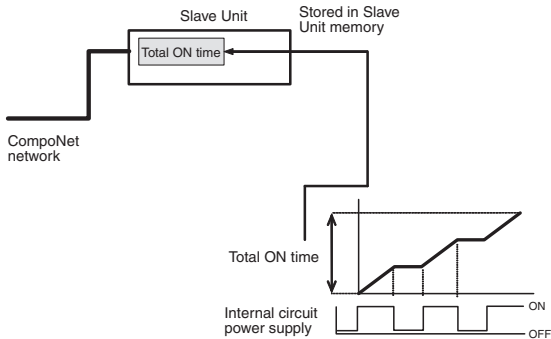

### Naming Units

The user can set any name for each Unit (up to 32 characters) as a comment. The name is stored in the Slave Unit memory. The CX-Integrator or explicit messages can be used to read/write the name (i.e., the comment).

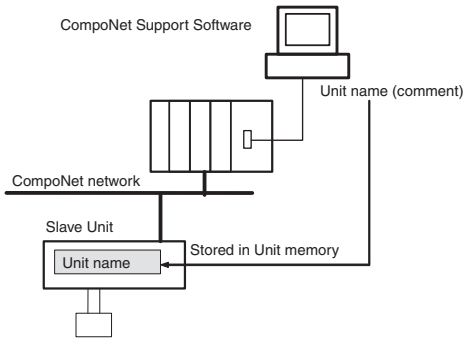

### Naming Connected Devices

The user can set any name for each I/O contact in the Unit (up to 32 characters). These names are stored in the Slave Unit memory. Connected devices can be checked for each I/O contact, which is useful for remote maintenance and other applications where, for example, devices with errors need to be identified. The CX-Integrator or explicit messages can be used to read/write the name (i.e., comment).

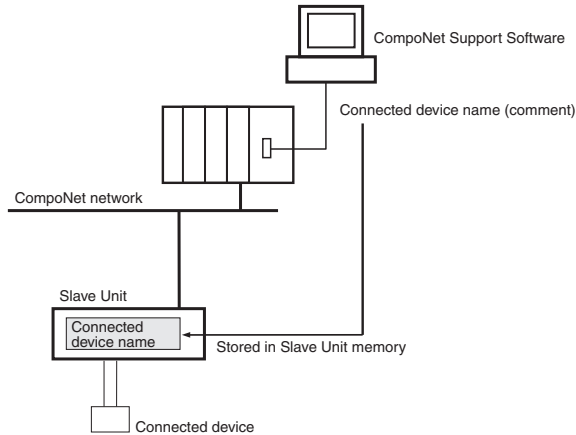

### Communications Error History Monitor

Enables storing the error (communication failure details, the communications power supply voltage at the time of failure, and the Unit conduction time) for the most recent 4 communication failures within the slave unit. The communications error history can be read using the CX-Integrator.

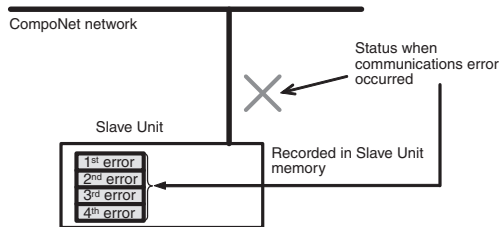

### Last Maintenance Date

This function can be used to write the date maintenance was last performed in the Slave Unit memory. This makes it easier to decide when the next maintenance should be performed next. This maintenance date can be written using the CX-Integrator.

### Contact Operation Monitor (Digital I/O Slave, Bit Slave Input Units Only)

The number of times each input contact or output contact is turned ON can be counted (resolution: 50 Hz max.) and stored in Slave Unit memory. (This data can be read using the CX-Integrator or using explicit messages.)

A monitor value can also be stored in the Slave Unit memory so once the number of contact operations reaches the monitor value, a flag in a status area in the Slave Unit turns ON to notify the Master Unit. The notification details can be read using the CX-Integrator or using explicit messages.

- No. of times measured: 0 to 4,294,967,295 (Stored data: 0000 0000 to FFFF FFFF hex)
- Measurement unit: No. of operations

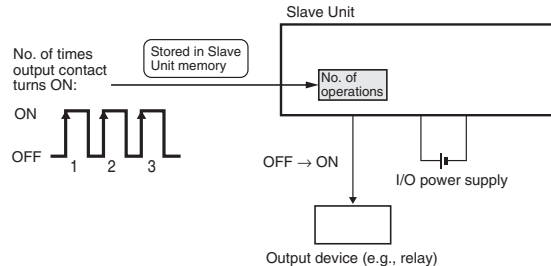

- Note 1.** The contact operation monitor and the total ON time monitor cannot both be used for the same contact at the same time. Select only one of these functions under the *Detection Mode*.
- 2.** This function does not operate if the I/O power is not turned ON.

● **Total ON Time Monitor (Digital I/O Slave, Bit Slave Input Units Only)**

This function totals the time that each input and output contact is ON (unit: s) and stores this total time in the Slave Unit memory. (This data can be read using the CX-Integrator or using explicit messages.)

A monitor value can also be stored in the Slave Unit memory so once the set total time has been reached, a flag in a status area in the Slave Unit turns ON to notify the Master Unit. The notification details can be read using the CX-Integrator or using explicit messages.

- Measurement time: 0 to 4,294,967,295 s (Stored data: 0000 0000 to FFFF FFFF Hex)
- Measurement unit: s

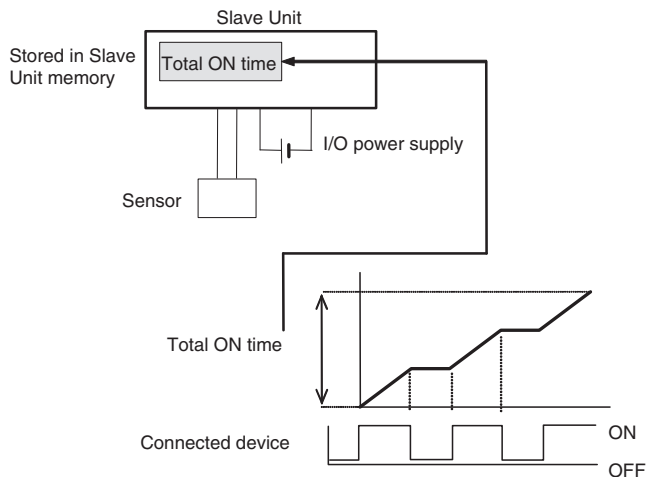

- Note 1.** The total ON time monitor and the contact operation monitor cannot both be used for the same contact at the same time. Select only one of these functions under the *Detection Mode*.
- 2.** This function does not operate if the I/O power is not turned ON.
- 3.** The Total ON Time Monitor Function checks at 1 second intervals whether or not the connected device is turned ON.

● **Input Filter (Digital I/O Slave, Bit Slave Input Units Only)**

An input value is read more than once during a set time interval. The input value can be set to be enabled only when all the read values are the same.

This function operates for all input points in one Slave Unit.

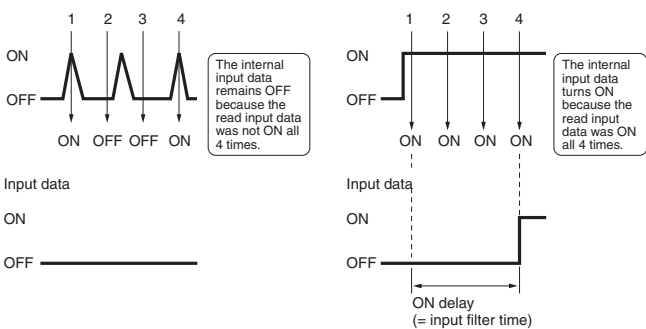

● **Error Prevention for Surge Current at Startup (Digital I/O Slave Units and Bit Slave Input Units Only)**

This function can be used to prevent reading inputs while the I/O power is OFF and for 100 ms after the I/O power is turned ON (i.e., until the Slave Unit stabilizes). It helps avoid input errors caused by inrush current from connected devices when the I/O power supply is turned ON. This function is enabled or disabled by the CX-Integrator or by explicit messages.

● **I/O Power Status Monitor (Digital I/O Slave Units Only)**

The I/O power status monitor function can be used to detect whether the I/O power is ON.

When the I/O power is turned OFF, a flag in a status area in the Slave Unit turns ON to notify the Master Unit. The notification details can be read using the CX-Integrator or using explicit messages.

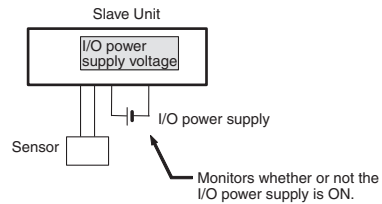

**Note:** A detection voltage cannot be set for the I/O power supply.

● **Sensor Power Short-circuit Detection (Bit Slave Units Only)**

This function monitors the current in the sensor power supply section and detects a power supply short-circuit if the current per input contact exceeds a rated value. Power supply short-circuit detection functions in two different ways depending on Unit specifications. For some Units, the I/O power supply is turned OFF to the entire Unit if a short-circuit is detected for even one input. For other Units, the I/O power is turned OFF individually for each input.

For information on load short-circuit detection, refer to the power short-circuit protection and input device power supply specifications for the applicable Unit.

An indicator on the Slave Unit can be used to see if a power supply short-circuit has been detected. Also, if a short-circuit has been detected, an internal status bit will turn ON in the Slave Unit to inform the Master Unit. The current status can be read using the CX-Integrator or an explicit message. Once the cause of the short-circuit has been removed, operation will recover automatically and power will be output to the connector where the short-circuit was detected.

**Note:** Use a power supply device with a rating of 100 W or higher as the communications power supply for network power supply. A short-circuit is detected if a current that exceeds a specified value flows in the sensor power supply output of the Unit. Also, the communications power supply may temporarily turn OFF when a short circuit occurs. Operation will automatically be restored once the cause of the short circuit has been removed, but implement an external circuit so that the system operates safely while the outputs are turned OFF. Use the following formula as a guide for Sensor communications power supply capacity.

- Total network current = Total Unit current consumption + Total Sensor current consumption
- Communications power supply capacity used  $\geq$  (Total network current + (Short-circuit detection current)) • (CompoNet network voltage used)

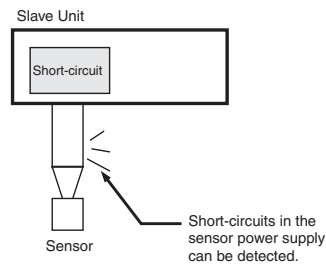

● **Load Short-circuit Detection (Output Only) (Bit Slave Units Only)**

This function monitors the load current in the output section and detects a load short-circuit if the current per contact (or common) exceeds a rated value. If a load short-circuited is detected, the outputs are turned OFF to prevent damage to the Unit output circuits. Load short-circuit detection functions in two different ways depending on Unit specifications. For some Units, the outputs are turned OFF for the entire Unit if a short-circuit is detected for even one output. For other Units, the outputs are turned OFF individually. For information on load short-circuit detection, refer to the rated output current and internal circuits in the specifications for the applicable Unit.

An indicator on the Slave Unit can be used to see if a load short-circuit has been detected. Also, if a short-circuit has been detected, an internal status bit will turn ON in the Slave Unit to inform the Master Unit. The current status can be read using the CX-Integrator or an explicit message. Once the cause of the short-circuit has been removed, operation will recover automatically and power will be output to the connector where the short-circuit was detected.

**Note:** An OMRON S82J-series Power Supply device is recommended for the I/O power supply. Load short-circuits may not be detected if a power supply with vertical-drop overcurrent protection characteristics is used. If a power supply device with vertical-drop overcurrent protection characteristics is used, use one with a rating of 100 W min.

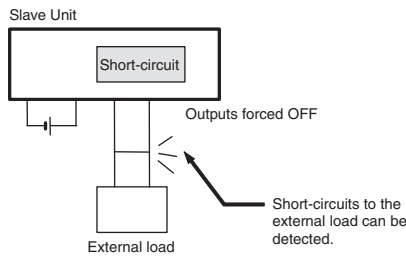

# Basic Specification of Slave Units

## Performance Specifications

Item	Specification
Communications power supply voltage	14 to 26.4 VDC
I/O power supply voltage *1	20.4 to 26.4 VDC (24 VDC -15%/+10%)
Noise immunity	Conforms to IEC 61000-4-4, 2 kV (power line).
Vibration resistance	10 to 60 Hz with double-amplitude of 0.7 mm, 60 to 150 Hz and 50 m/s <sup>2</sup> in X, Y, and Z directions for 80 min each
Shock resistance	150 m/s <sup>2</sup> (3 times each in 6 directions on 3 axes)
Dielectric strength	500 VAC (between isolated circuits)
Insulation resistance	20 M $\Omega$ min. (between isolated circuits)
Ambient operating temperature	-10 to 55°C
Ambient operating humidity	25% to 85% (with no condensation)
Ambient operating atmosphere	No corrosive gases
Storage temperature	-25 to 65°C
Storage humidity	25% to 85% (with no condensation)
Terminal block screw tightening torque *2	M3 wiring screws: 0.5 N·m M3 mounting screws: 0.5 N·m
Installation	Mounted on 35-mm DIN Track or Mounting Bracket, or secured with M4 screws (depending on model)

\*1 The I/O power supply is called the sensor power supply in information for the CRT1-VAD04S.

\*2 Applicable only to Slaves to which screw terminal blocks are mounted.

Some of the specifications are different for the CRT1-ROS08/ROS16 (with relay outputs) and the CRT1-ROF08/ROF16 (with SSR outputs). Refer to the pages of specifications for individual Slaves for details.



Digital I/O Slave Units with Screw Terminal Blocks (2-tier Terminal Block/Relay Output/SSR Output)

# CRT1-□D08(-1)/□D16(-1)/ROS□/ROF□

## Visualize the actual worksite status! Simple and Intelligent I/O Slave Units.

In addition to the Digital I/O Slave Unit's basic digital ON/OFF signals, collect useful information from the Slave Unit to improve equipment operating rates and maintainability.

- Communications connector and removable I/O terminal block enable faster startup times and improved maintainability.
- One Expansion Unit can be added to each Digital I/O Slave Unit to increase system configuration flexibility.
- Collect various preventive maintenance data required to improve productivity, such as information on equipment deterioration due to aging and equipment operating time data.
- Simplify startup with the communications power supply monitoring function.

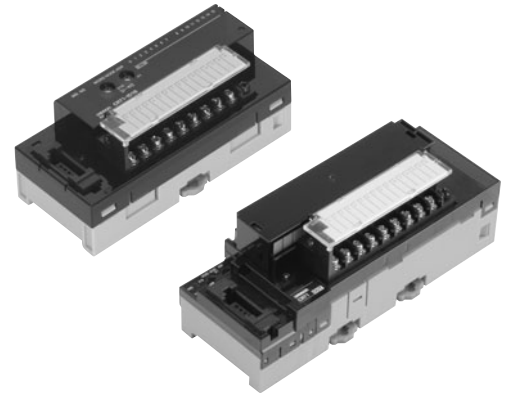

### Ordering Information

Name	Specifications			Model
Two-tier Screw Terminal Block	Inputs	8 inputs	NPN	CRT1-ID08
			PNP	CRT1-ID08-1
	Outputs	8 outputs	NPN	CRT1-OD08
			PNP	CRT1-OD08-1
	Inputs	16 inputs	NPN	CRT1-ID16 *
			PNP	CRT1-ID16-1 *
	Outputs	16 outputs	NPN	CRT1-OD16 *
			PNP	CRT1-OD16-1 *
Inputs/Outputs	8 inputs/ 8 outputs	NPN	CRT1-MD16	
		PNP	CRT1-MD16-1	
Screw Terminal Block with Relay Outputs	Outputs	8 outputs	Contacts	CRT1-ROS08
		16 outputs		CRT1-ROS16
Screw Terminal Block with SSR Outputs	Outputs	8 outputs	SSR	CRT1-ROF08
		16 outputs		CRT1-ROF16

\* These Units are also available with a DCN-TB4 Terminal Conversion Adapter included in the package. Add "(-B)" to the end of the model number to receive the Adapter as well.

### ● Expansion Units

One Expansion Unit can be combined with one Digital I/O Slave Unit (CRT1-ID16(-1), CRT1-OD16(-1), CRT1-ROS16, or CRT1-ROF16). The following Expansion Units are available. They can be combined in various ways for flexible I/O capacity expansion.

Model	I/O points	Input capacity	Output capacity
XWT-ID08	8 DC inputs (NPN)	8	0
XWT-ID08-1	8 DC inputs (PNP)	8	0
XWT-OD08	8 transistor outputs (NPN)	0	8
XWT-OD08-1	8 transistor outputs (PNP)	0	8
XWT-ID16	16 DC inputs (NPN)	16	0
XWT-ID16-1	16 DC inputs (PNP)	16	0
XWT-OD16	16 transistor outputs (NPN)	0	16
XWT-OD16-1	16 transistor outputs (PNP)	0	16

**Performance Specifications** for CRT1-ROS08/ROS16 (with relay outputs) and CRT1-ROF08/ROF16 (with SSR outputs)

For Basic Performance Specifications of Slave Units, refer to page 30.

● **Relay Output**

Item	Specification
Communications power supply voltage	14 to 26.4 VDC
Noise immunity	Conforms to IEC 61000-4-4, 2 kV (power line).
Vibration resistance	10 to 55 Hz with double-amplitude of 0.7 mm X, Y, and Z directions for 80 min each
Shock resistance	100 m/s <sup>2</sup> (3 times in 6 directions on 3 axes)
Dielectric strength	500 VAC (between isolated circuits)
Insulation resistance	20 MΩ min. (between isolated circuits)
Ambient operating temperature	-10 to 55°C
Ambient operating humidity	25% to 85% (with no condensation)
Ambient operating atmosphere	No corrosive gases
Storage temperature	-25 to 65°C
Storage humidity	25% to 85% (with no condensation)
Terminal block screws tightening torque	M3 wiring screws: 0.5 N·m M3 mounting screws: 0.5 N·m

● **SSR Output**

Item	Specification
Communications power supply voltage	14 to 26.4 VDC
Noise immunity	Conforms to IEC 61000-4-4, 2 kV (power line).
Vibration resistance	10 to 60 Hz with double-amplitude of 0.7 mm, 60 to 150 Hz and 50 m/s <sup>2</sup> in X, Y, and Z directions for 80 min each
Shock resistance	150 m/s <sup>2</sup> (3 times in 6 directions on 3 axes)
Dielectric strength	500 VAC (between isolated circuits)
Insulation resistance	20 MΩ min. (between isolated circuits)
Ambient operating temperature	-10 to 55°C
Ambient operating humidity	25% to 85% (with no condensation)
Ambient operating atmosphere	No corrosive gases
Storage temperature	-25 to 65°C
Storage humidity	25% to 85% (with no condensation)
Terminal block screws tightening torque	M3 wiring screws: 0.5 N·m M3 mounting screws: 0.5 N·m

**Input Section Specifications**

● **Eight-point Input Units (2-tier Terminal Block)**

Item	Specification	
Model	CRT1-ID08	CRT1-ID08-1
I/O capacity	8 inputs	
Internal I/O common	NPN	PNP
ON voltage	15 VDC min. (between each input terminal and the V terminal)	15 VDC min. (between each input terminal and the G terminal)
OFF voltage	5 VDC max. (between each input terminal and the V terminal)	5 VDC max. (between each input terminal and the G terminal)
OFF current	1.0 mA max.	
Input current	At 24 VDC: 6.0 mA max./input At 17 VDC: 3.0 mA min./input	
ON delay	1.5 ms max.	
OFF delay	1.5 ms max.	
Number of circuits per common	8 inputs/common	
Isolation method	Photocoupler	
Input indicator	LED (yellow)	
Installation	DIN Track	
Power supply type	Multi-power supply	
Communications power supply current consumption	30 mA max. for 24-VDC power supply voltage 50 mA max. for 14-VDC power supply voltage	
I/O power supply current consumption	5 mA max. for 24-VDC power supply voltage	
Weight	160 g max.	

● **Sixteen-point Input Units (2-tier Terminal Block)**

Item	Specification	
Model	CRT1-ID16	CRT1-ID16-1
I/O capacity	16 inputs	
Internal I/O common	NPN	PNP
ON voltage	15 VDC min. (between each input terminal and the V terminal)	15 VDC min. (between each input terminal and the G terminal)
OFF voltage	5 VDC max. (between each input terminal and the V terminal)	5 VDC max. (between each input terminal and the G terminal)
OFF current	1 mA max.	
Input current	At 24 VDC: 6.0 mA max./input At 17 VDC: 3.0 mA max./input	
ON delay	1.5 ms max.	
OFF delay	1.5 ms max.	
Number of circuits per common	16 inputs/common	
Isolation method	Photocoupler	
Input indicator	LED (yellow)	
Installation	DIN Track mounting	
Power supply type	Multi-power supply	
Communications power supply current consumption	55 mA max. for 24-VDC power supply voltage 85 mA max. for 14-VDC power supply voltage	
I/O power supply current consumption	5 mA max. for 24-VDC power supply voltage	
Weight	141 g max.	

## Output Section Specifications

### ● Eight-point Output Units (2-tier Terminal Block)

Item	Specification	
Model	CRT1-OD08	CRT1-OD08-1
I/O capacity	8 outputs	
Internal I/O common	NPN	PNP
Rated output current	0.5 A/output, 2 A/common	
Residual voltage	1.2 V max. (0.5 A DC, between each output terminal and the G terminal)	1.2 V max. (0.5 A DC, between each output terminal and the V terminal)
Leakage current	0.1 mA max.	
ON delay	0.5 ms max.	
OFF delay	1.5 ms max.	
Number of circuits per common	8 outputs/common	
Isolation method	Photocoupler	
Output indicators	LED (yellow)	
Installation	DIN Track	
Power supply type	Multi-power supply	
Communications power supply current consumption	35 mA max. for 24-VDC power supply voltage 55 mA max. for 14-VDC power supply voltage	
I/O power supply current consumption	15 mA max. for 24-VDC power supply voltage	
Output handling for communications errors	Select either hold or clear from CX-Integrator.	
Weight	160 g max.	

### ● Sixteen-point Output Units (2-tier Terminal Block)

Item	Specification	
Model	CRT1-OD16	CRT1-OD16-1
I/O capacity	16 outputs	
Internal I/O common	NPN	PNP
Rated output current	0.5 A/output, 4 A/common	
Residual voltage	1.2 V max. (0.5 A DC, between each output terminal and the G terminal)	1.2 V max. (0.5 A DC, between each output terminal and the V terminal)
Leakage current	0.1 mA max.	
ON delay	0.5 ms max.	
OFF delay	1.5 ms max.	
Number of circuits per common	16 outputs/common	
Isolation method	Photocoupler	
Output indicators	LED (yellow)	
Installation	DIN Track mounting	
Power supply type	Multi-power supply	
Communications power supply current consumption	55 mA max. for 24-VDC power supply voltage 85 mA max. for 14-VDC power supply voltage	
I/O power supply current consumption	15 mA max. for 24-VDC power supply voltage	
Output handling for communications errors	Hold or clear can be selected. (CX-Integrator)	
Weight	141 g max.	

### ● Eight-point Output Units (Relay Outputs)

Item	Specification
Model	CRT1-ROS08
I/O capacity	8 outputs
Mounted Relays	DRTA-NY5W-K (5 VDC)
Rated load	Resistive load 250 VAC, 2 A, common: 8 A 30 VDC, 2 A, common: 8 A
Rated ON current	3 A
Maximum contact voltage	250 VAC, 125 VDC
Maximum contact current	3 A
Maximum switching capacity	750 VA AC, 90 W DC
Minimum applicable load (reference value)	5 VDC, 1 mA
Mechanical service life	20,000,000 operations min.
Electrical service life	100,000 operations min.
Installation method	DIN Track
Communications power supply current consumption	95 mA max. for 24-VDC power supply voltage 150 mA max. for 14-VDC power supply voltage
Output hold for communications errors	Select either hold or clear from CX-Integrator.
Weight	170 g max.

### ● Sixteen-point Output Units (Relay Outputs) (per Output)

Item	Specification
Model	CRT1-ROS16
I/O capacity	16 outputs
Mounted Relays	DRTA-NY5W-K (5 VDC)
Rated load	Resistive load 250 VAC, 2 A, common: 8 A 30 VDC, 2 A, common: 8 A
Rated ON current	3 A
Maximum contact voltage	250 VAC, 125 VDC
Maximum contact current	3 A
Maximum switching capacity	750 VA AC, 90 W DC
Minimum applicable load (reference value)	5 VDC, 1 mA
Mechanical service life	20,000,000 operations min.
Electrical service life	100,000 operations min.
Installation	DIN Track mounting
Communications power supply current consumption	155 mA max. for 24-VDC power supply voltage 255 mA max. for 14-VDC power supply voltage
Output hold for communications errors	Hold or clear can be selected. (CX-Integrator)
Weight	260 g max.

● Eight-point Output Units (SSR Outputs) (per Output)

Item	Specification
Model	CRT1-ROF08
I/O capacity	8 outputs
Load voltage	24 to 265 VAC
Load current	0.3 A
Inrush current resistivity	50 A (60 Hz)
Installation method	DIN Track
Communications power supply current consumption	60 mA max. for 24-VDC power supply voltage 90 mA max. for 14-VDC power supply voltage
Output hold for communications errors	Select either hold or clear from CX-Integrator.
Weight	160 g max.

**Note:** The SSRs cannot be replaced.

● Sixteen-point Output Units (SSR Outputs) (per Output)

Item	Specification
Model	CRT1-ROF16
I/O capacity	16 outputs
Load voltage	24 to 265 VAC
Load current	0.3 A
Inrush current resistivity	50 A (60 Hz)
Installation	DIN Track mounting
Communications power supply current consumption	85 mA max. for 24-VDC power supply voltage 130 mA max. for 14-VDC power supply voltage
Output hold for communications errors	Hold or clear can be selected. (CX-Integrator)
Weight	250 g max.

**Note:** The SSRs cannot be replaced.

**Load Current vs. Ambient Temperature**

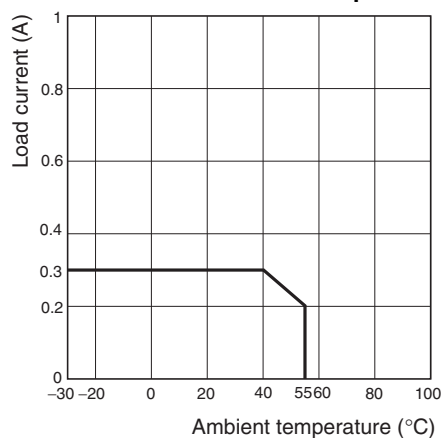

## Input and Output Section Specifications

### ● Eight-point Input and Eight-point Output Units (2-tier Terminal Block)

#### CRT1-MD16/CRT1-MD16-1

#### Common Specifications

Item	Specification	
Model	CRT1-MD16	CRT1-MD16-1
Installation	DIN Track	
Communications power supply current consumption	35 mA max. for 24-VDC power supply voltage 60 mA max. for 14-VDC power supply voltage	
Weight	170 g max.	

#### Input Section Specifications

Item	Specification	
Model	CRT1-MD16	CRT1-MD16-1
I/O capacity	8 inputs	
Internal I/O common	NPN	PNP
ON voltage	15 VDC min. (between each input terminal and the V terminal)	15 VDC min. (between each input terminal and the G terminal)
OFF voltage	5 VDC max. (between each input terminal and the V terminal)	5 VDC max. (between each input terminal and the G terminal)
OFF current	1.0 mA max.	
Input current	At 24 VDC: 6.0 mA max./input At 17 VDC: 3.0 mA min./input	
ON delay	1.5 ms max.	
OFF delay	1.5 ms max.	
Number of circuits per common	8 inputs/common	
Isolation method	Photocoupler	
Input indicator	LED (yellow)	
Power supply type	Multi-power supply	
I/O power supply current consumption	5 mA max. for 24-VDC power supply voltage	

#### Output Section Specifications

Item	Specification	
Model	CRT1-MD16	CRT1-MD16-1
I/O capacity	8 outputs	
Internal I/O common	NPN	PNP
Rated output current	0.5 A/output, 2A/common	
Residual voltage	1.2 V max. (0.5 A DC, between each output terminal and the G terminal)	1.2 V max. (0.5 A DC, between each output terminal and the V terminal)
Leakage current	0.1 mA max.	
ON delay	0.5 ms max.	
OFF delay	1.5 ms max.	
Number of circuits per common	8 outputs/common	
Isolation method	Photocoupler	
Output indicators	LED (yellow)	
I/O power supply current consumption	15 mA max. for 24-VDC power supply voltage	
Output handling for communications errors	Select either hold or clear from CX-Integrator.	

Dimensions

(Unit: mm)

CRT1-ID08 (-1)  
 CRT1-OD08 (-1)

When a DCN4-TB4 Open Type Connectors Is Mounted

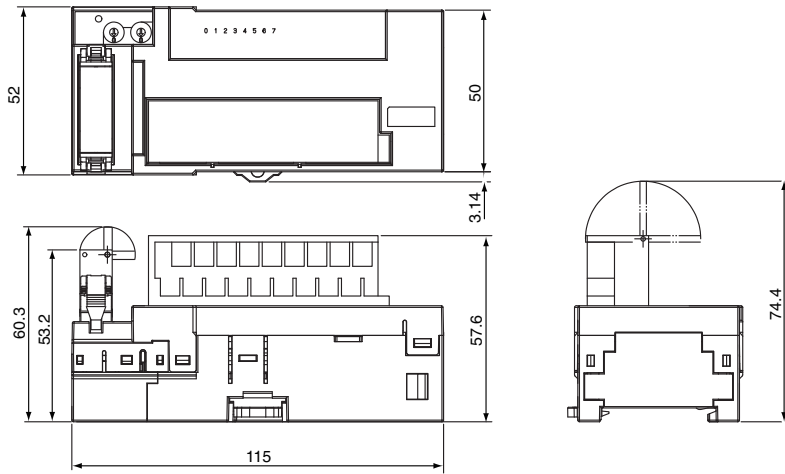

CRT1-ID16 (-1)  
 CRT1-OD16 (-1)

When a DCN4-TB4 Open Type Connectors Is Mounted

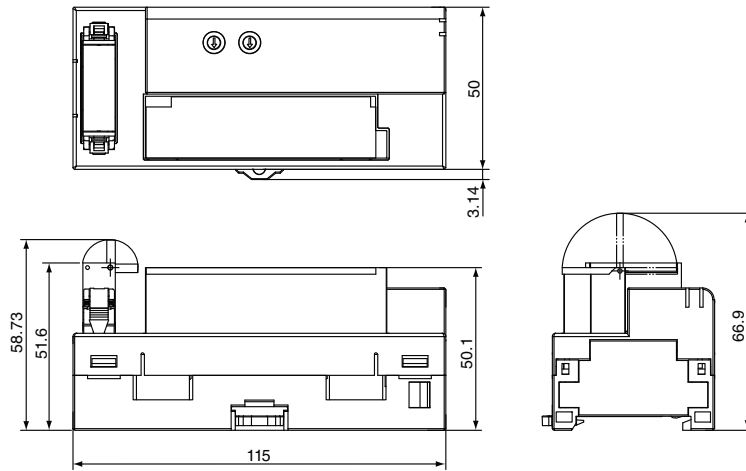

CRT1-MD16 (-1)

When a DCN4-TB4 Open Type Connectors Is Mounted

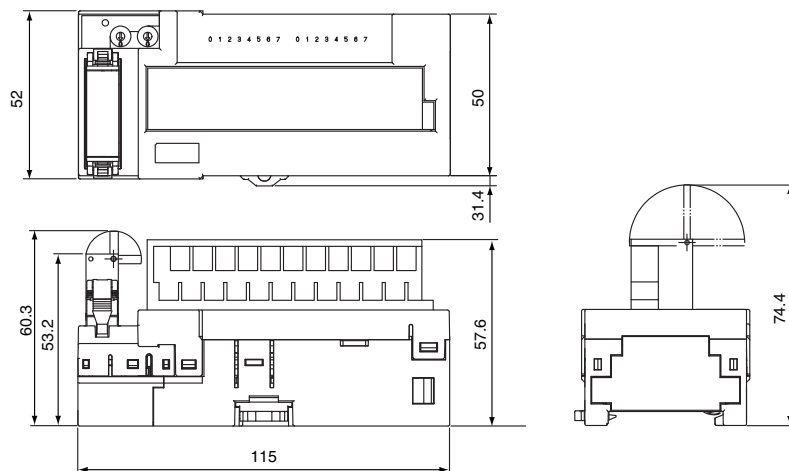

CRT1-ROS08  
 CRT1-ROF08

When a DCN4-TB4 Open Type Connectors Is Mounted

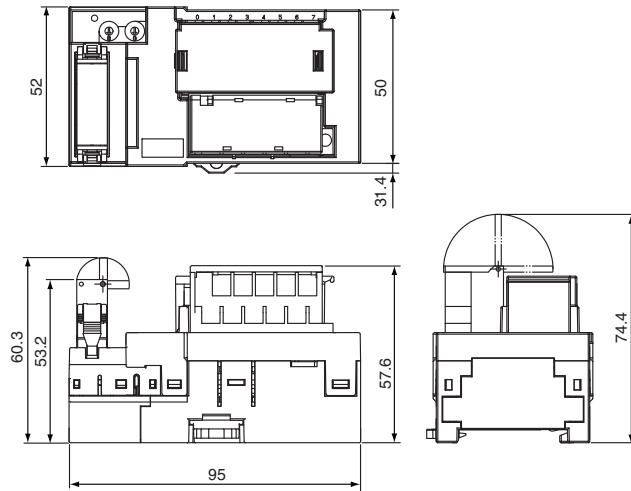

CRT1-ROS16  
 CRT1-ROF16

When a DCN4-TB4 Open Type Connectors Is Mounted

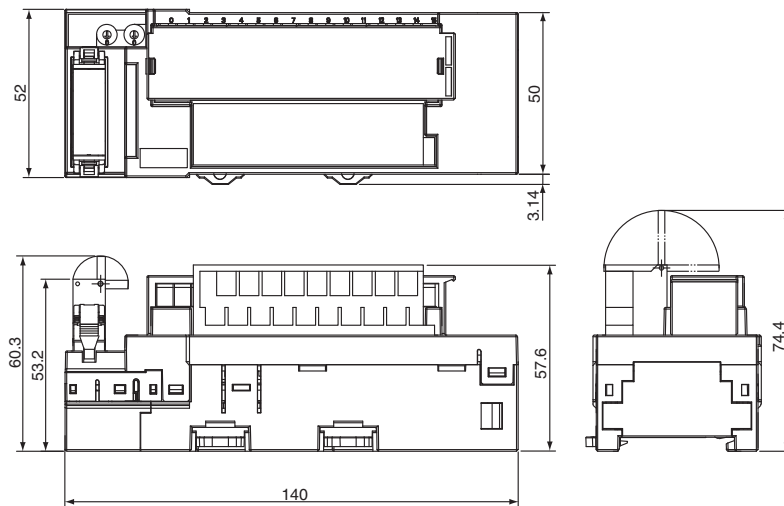

Digital I/O Slave Units with Screw Terminal Blocks (3-tier Terminal Block)

**CRT1-□D08TA(-1)/□D16TA(-1)/□D08TAH(-1)/□D16TAH(-1)**

**With the relay terminal blocks, doubling up wires on terminals is not necessary!  
Smart Slave Units with Easy-to-understand Wiring Locations with One Common for Every Point.**

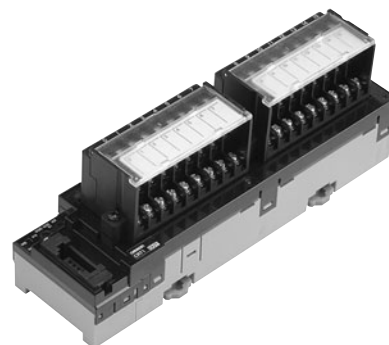

**Doubling up wires on terminals is unnecessary and wiring locations are easy to understand with these Smart Slaves with 3-tier Terminal Blocks.**

- Easy-to-understand wiring. No doubling up of wires. Easy-to-understand wiring locations.
- Simplify startup with the communications power supply monitor (Smart function).
- Collect various preventive maintenance data required to improve productivity, such as information on equipment deterioration due to aging and equipment operating time data (Smart function).
- The communications baud rate is set without using switches and addresses are set using rotary switches, so setting errors are reduced.
- Communications connector and removable I/O terminal block enable maintenance without disconnecting wiring.

**Ordering Information**

Name	Specifications				Model	
Three-tier Screw Terminal Block	Inputs	8 inputs	NPN	Without Short-circuit and Disconnected Line Detection	CRT1-ID08TA	
			PNP		CRT1-ID08TA-1	
	Outputs	8 outputs	NPN		CRT1-OD08TA	
			PNP		CRT1-OD08TA-1	
	Inputs	16 inputs	NPN		CRT1-ID16TA	
			PNP		CRT1-ID16TA-1	
	Outputs	16 outputs	NPN		CRT1-OD16TA	
			PNP		CRT1-OD16TA-1	
	Inputs/ Outputs	8 inputs/ 8 outputs	NPN		CRT1-MD16TA	
			PNP		CRT1-MD16TA-1	
	Inputs	8 inputs	NPN		With Short-circuit and Disconnected Line Detection	CRT1-ID08TAH
			PNP			CRT1-ID08TAH-1
	Outputs	8 outputs	NPN			CRT1-OD08TAH
			PNP			CRT1-OD08TAH-1
	Inputs	16 inputs	NPN			CRT1-ID16TAH
			PNP			CRT1-ID16TAH-1
Outputs	16 outputs	NPN	CRT1-OD16TAH			
		PNP	CRT1-OD16TAH-1			
Inputs/ Outputs	8 inputs/ 8 outputs	NPN	CRT1-MD16TAH			
		PNP	CRT1-MD16TAH-1			

**Performance Specifications**

For Basic Performance Specifications of Slave Units, refer to page 30.



## Input Section Specifications

### ● Eight-point Input Units (3-tier Terminal Block)

Item	Specification			
Model	CRT1-ID08TA	CRT1-ID08TA-1	CRT1-ID08TAH-1	CRT1-ID08TAH-1
I/O capacity	8 inputs			
Internal I/O common	NPN	PNP	NPN	PNP
ON voltage	15 VDC min. (between each input terminal and the V terminal)	15 VDC min. (between each input terminal and the G terminal)	10.5 VDC min. (between each input terminal and the V terminal)	10.5 VDC min. (between each input terminal and the G terminal)
OFF voltage	5 VDC max. (between each input terminal and the V terminal)	5 VDC max. (between each input terminal and the G terminal)	---	---
OFF current	1.0 mA max.			
Input current	At 24 VDC: 6.0 mA max./input At 17 VDC: 3.0 mA min./input			
ON delay	1.5 ms max.			
OFF delay	1.5 ms max.			
Power supply short-circuit detection	---		Operates at 50 mA/point min.	
Disconnection detection	---		Operates at 0.3 mA/point max.	
Number of circuits per common	8 inputs/common			
Isolation method	Photocoupler			
Input indicator	LED (yellow)			
Installation	DIN Track			
Power supply type	Multi-power supply			
Current supplied to input devices	100 mA/point		50 mA/point	
Communications power supply current consumption	30 mA max. for 24-VDC power supply voltage 50 mA max. for 14-VDC power supply voltage		35 mA max. for 24-VDC power supply voltage 60 mA max. for 14-VDC power supply voltage	
I/O power supply current consumption	5 mA max. for 24-VDC power supply voltage		25 mA max. for 24-VDC power supply voltage	
Weight	190 g max.		200 g max.	

### ● Sixteen-point Input Units (3-tier Terminal Block)

Item	Specification			
Model	CRT1-ID16TA	CRT1-ID16TA-1	CRT1-ID16TAH	CRT1-ID16TAH-1
I/O capacity	16 inputs			
Internal I/O common	NPN	PNP	NPN	PNP
ON voltage	15 VDC min. (between each input terminal and the V terminal)	15 VDC min. (between each input terminal and the G terminal)	10.5 VDC min. (between each input terminal and the V terminal)	10.5 VDC min. (between each input terminal and the G terminal)
OFF voltage	5 VDC max. (between each input terminal and the V terminal)	5 VDC max. (between each input terminal and the G terminal)	---	---
OFF current	1.0 mA max.			
Input current	At 24 VDC: 6.0 mA max./input At 17 VDC: 3.0 mA min./input			
ON delay	1.5 ms max.			
OFF delay	1.5 ms max.			
Power supply short-circuit detection	---		Operates at 50 mA/point min.	
Disconnection detection	---		Operates at 0.3 mA/point max.	
Number of circuits per common	8 inputs/common			
Isolation method	Photocoupler			
Input indicator	LED (yellow)			
Installation	DIN Track			
Power supply type	Multi-power supply			
Communications power supply current consumption	40 mA max. for 24-VDC power supply voltage 55 mA max. for 14-VDC power supply voltage		40 mA max. for 24-VDC power supply voltage 70 mA max. for 14-VDC power supply voltage	
I/O power supply current consumption	5 mA max. for 24-VDC power supply voltage		25 mA max. for 24-VDC power supply voltage	
Weight	330 g max.		340 g max.	

## Output Section Specifications

### ● Eight-point Output Units (3-tier Terminal Block)

Item	Specification			
Model	CRT1-OD08TA	CRT1-OD08TA-1	CRT1-OD08TAH	CRT1-OD08TAH-1
I/O capacity	8 outputs			
Internal I/O common	NPN	PNP	NPN	PNP
Rated output current	0.5 A/output, 2 A/common			
Residual voltage	1.2 V max. (0.5 A DC, between each output terminal and the G terminal)	1.2 V max. (0.5 A DC, between each output terminal and the V terminal)	1.2 V max. (0.5 A DC, between each output terminal and the G terminal)	1.2 V max. (0.5 A DC, between each output terminal and the V terminal)
Leakage current	0.1 mA max.			
ON delay	0.5 ms max.			
OFF delay	1.5 ms max.			
Load short-circuit detection	---		Supported.	
Disconnection detection	---		Operates at 3 mA/point max. (Does not operate at over 3 mA.)	
Number of circuits per common	8 outputs/common			
Isolation method	Photocoupler			
Output indicators	LED (yellow)			
Installation	DIN Track			
Power supply type	Multi-power supply			
Current supplied to output devices	100 mA/point			
Communications power supply current consumption	35 mA max. for 24-VDC power supply voltage 55 mA max. for 14-VDC power supply voltage			
I/O power supply current consumption	15 mA max. for 24-VDC power supply voltage		15 mA max. for 24-VDC power supply voltage	35 mA max. for 24-VDC power supply voltage
Output handling for communications errors	Select either hold or clear from CX-Integrator.			
Weight	190 g max.			

### ● Sixteen-point Output Unit (3-tier Terminal Block)

Item	Specification			
Model	CRT1-OD16TA	CRT1-OD16TA-1	CRT1-OD16TAH	CRT1-OD16TAH-1
I/O capacity	16 outputs			
Internal I/O common	NPN	PNP	NPN	PNP
Rated output current	0.5 A/output, 2 A/common			
Residual voltage	1.2 V max. (0.5 A DC, between each output terminal and the G terminal)	1.2 V max. (0.5 A DC, between each output terminal and the V terminal)	1.2 V max. (0.5 A DC, between each output terminal and the G terminal)	1.2 V max. (0.5 A DC, between each output terminal and the V terminal)
Leakage current	0.1 mA max.			
ON delay	0.5 ms max.			
OFF delay	1.5 ms max.			
Number of circuits per common	8 outputs/common			
Load short-circuit detection	---		Supported.	
Disconnection detection	---		Operates at 3 mA/point max. (Does not operate at over 3 mA.)	
Isolation method	Photocoupler			
Output indicators	LED (yellow)			
Installation	DIN Track			
Power supply type	Multi-power supply			
Communications power supply current consumption	45 mA max. for 24-VDC power supply voltage 65 mA max. for 14-VDC power supply voltage		40 mA max. for 24-VDC power supply voltage 70 mA max. for 14-VDC power supply voltage	
I/O power supply current consumption	15 mA max. for 24-VDC power supply voltage			35 mA max. for 24-VDC power supply voltage
Output handling for communications errors	Select either hold or clear from CX-Integrator.			
Weight	330 g max.			

## Input and Output Section Specifications

### ● 8-point Input and 8-point Output Units (3-tier Terminal Block)

#### Common Specifications

Item	Specification			
Model	CRT1-MD16TA	CRT1-MD16TA-1	CRT1-MD16TAH	CRT1-MD16TAH-1
Installation	DIN Track			
Communications power supply current consumption	40 mA max. for 24-VDC power supply voltage 60 mA max. for 14-VDC power supply voltage		40 mA max. for 24-VDC power supply voltage 70 mA max. for 14-VDC power supply voltage	
Weight	330 g max.		340 g max.	

#### Input Section Specifications

Item	Specification			
Model	CRT1-MD16TA	CRT1-MD16TA-1	CRT1-MD16TAH	CRT1-MD16TAH-1
I/O capacity	8 inputs			
Internal I/O common	NPN	PNP	NPN	PNP
ON voltage	15 VDC min. (between each input terminal and the V terminal)	15 VDC min. (between each input terminal and the G terminal)	10.5 VDC min. (between each input terminal and the V terminal)	10.5 VDC min. (between each input terminal and the G terminal)
OFF voltage	5 VDC max. (between each input terminal and the V terminal)	5 VDC max. (between each input terminal and the G terminal)	---	---
OFF current	1.0 mA max.			
Input current	At 24 VDC: 6.0 mA max./input At 17 VDC: 3.0 mA min./input			
ON delay	1.5 ms max.			
OFF delay	1.5 ms max.			
Power supply short-circuit detection	---		Operates at 50 mA/point min.	
Disconnection detection	---		Operates at 0.3 mA/point max.	
Number of circuits per common	8 inputs/common			
Isolation method	Photocoupler			
Input indicator	LED (yellow)			
Power supply type	Multi-power supply			
I/O power supply current consumption	5 mA max. for 24-VDC power supply voltage		25 mA max. for 24-VDC power supply voltage	

#### Output Section Specifications

Item	Specification			
Model	CRT1-MD16TA	CRT1-MD16TA-1	CRT1-MD16TAH	CRT1-MD16TAH-1
I/O capacity	8 outputs			
Internal I/O common	NPN	PNP	NPN	PNP
Rated output current	0.5 A/output, 2 A/common			
Residual voltage	1.2 V max. (0.5 A DC, between each output terminal and the G terminal)	1.2 V max. (0.5 A DC, between each output terminal and the V terminal)	1.2 V max. (0.5 A DC, between each output terminal and the G terminal)	1.2 V max. (0.5 A DC, between each output terminal and the V terminal)
Leakage current	0.1 mA max.			
ON delay	0.5 ms max.			
OFF delay	1.5 ms max.			
Load short-circuit detection	---		Supported.	
Disconnection detection	---		Operates at 3 mA/point max. (Does not operate at over 3 mA.)	
Number of circuits per common	8 outputs/common			
Isolation method	Photocoupler			
Output indicators	LED (yellow)			
I/O power supply current consumption	15 mA max. for 24-VDC power supply voltage			35 mA max. for 24-VDC power supply voltage
Output handling for communications errors	Select either hold or clear from CX-Integrator.			

Dimensions

(Unit: mm)

CRT1-ID08TA (-1)  
 CRT1-OD08TA(-1)

When a DCN4-TB4 Open Type Connectors Is Mounted

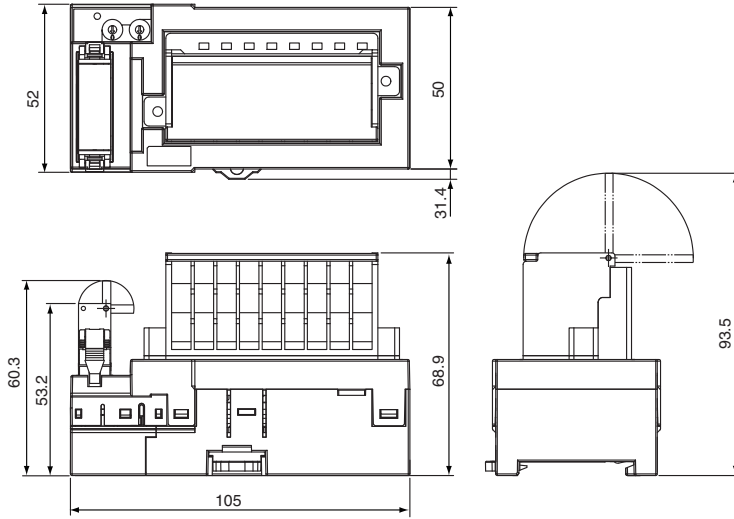

CRT1-ID16TA(-1)  
 CRT1-OD16TA(-1)  
 CRT1-MD16TA(-1)

When a DCN4-TB4 Open Type Connectors Is Mounted

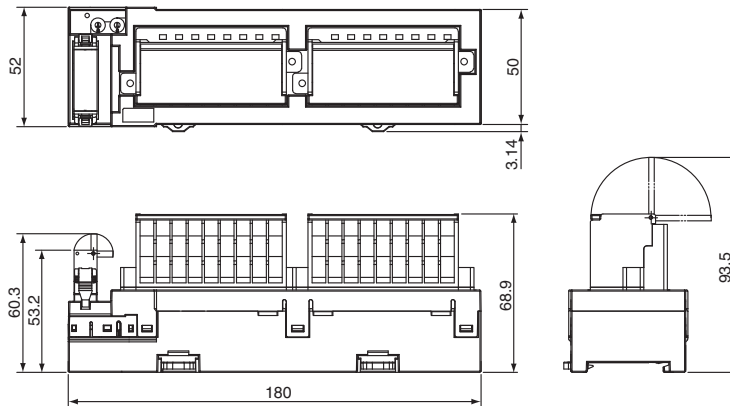

Digital I/O Slave Units with e-CON Connectors

# CRT1-□D16S(-1)/□D32S(-1)/□D16SH(-1)/□D32SH(-1)

## Industry-standard Sensor Connectors for Easy Connection to Pre-wired Sensors without Special Tools.

- A digital I/O terminal with industry-standard e-CON connectors.
- Easy to install without the use of special tools. Reduces wiring work.
- Equipped with load short-circuit detection.

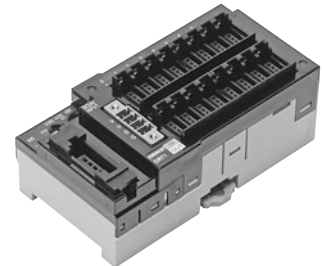

### Ordering Information

Name	Specifications			Model	
e-CON Connectors	Inputs	16 inputs	NPN	Without Short-circuit and Disconnected Line Detection	CRT1-ID16S
			PNP		CRT1-ID16S-1
	Outputs	16 outputs	NPN		CRT1-OD16S
			PNP		CRT1-OD16S-1
	Inputs/ Outputs	8 inputs / 8 outputs	NPN		CRT1-MD16S
			PNP		CRT1-MD16S-1
	Inputs	32 inputs	NPN		CRT1-ID32S
			PNP		CRT1-ID32S-1
	Outputs	32 outputs	NPN		CRT1-OD32S
			PNP		CRT1-OD32S-1
	Inputs/ Outputs	16 inputs / 16 outputs	NPN	CRT1-MD32S	
			PNP	CRT1-MD32S-1	
	Inputs	16 inputs	NPN	With Short-circuit and Disconnected Line Detection	CRT1-ID16SH
			PNP		CRT1-ID16SH-1
	Outputs	16 outputs	NPN		CRT1-OD16SH
			PNP		CRT1-OD16SH-1
	Inputs/ Outputs	8 inputs / 8 outputs	NPN		CRT1-MD16SH
			PNP		CRT1-MD16SH-1
	Inputs	32 inputs	NPN		CRT1-ID32SH
			PNP		CRT1-ID32SH-1
Outputs	32 outputs	NPN	CRT1-OD32SH		
		PNP	CRT1-OD32SH-1		
Inputs/ Outputs	16 inputs / 16 outputs	NPN	CRT1-MD32SH		
		PNP	CRT1-MD32SH-1		

**Note.** Output power supply connectors (Phoenix Contact K.K.) are provided with Output Units and I/O Units.

Slave External I/O Connections in the appendix for applicable connectors.

### Performance Specifications

For Basic Performance Specifications of Slave Units, refer to page 30.

## Input Section Specifications

### ● Sixteen-point Input Units

Item	Specification			
Model	CRT1-ID16S	CRT1-ID16S-1	CRT1-ID16SH	CRT1-ID16SH-1
I/O capacity	16 inputs			
Internal I/O common	NPN	PNP	NPN	PNP
ON voltage	10.5 VDC min. (between each input terminal and the V terminal)	10.5 VDC min. (between each input terminal and the G terminal)	10.5 VDC min. (between each input terminal and the V terminal)	10.5 VDC min. (between each input terminal and the G terminal)
OFF current	1 mA max.			
Input current	At 24 VDC: 6.0 mA max./input At 11 VDC: 3.0 mA min./input			
ON delay	1.5 ms max.			
OFF delay	1.5 ms max.			
Power supply short-circuit detection	---		Operates at 50 mA/point min.	
Disconnection detection	---		Operates at 0.3 mA/point max.	
Number of circuits per common	16 inputs/common			
Isolation method	Photocoupler			
Input indicator	LED (yellow)			
Installation	DIN Track			
Power supply type	Network power supply			
Power short-circuit protection	Operates at 50 mA/point min.			
Current supplied to input devices	50 mA/input			
Communications power supply current consumption	110 mA max. for 24-VDC power supply voltage 125 mA max. for 14-VDC power supply voltage		125 mA max. for 24-VDC power supply voltage 145 mA max. for 14-VDC power supply voltage	
Weight	110 g max.			

### ● Thirty-two-point Input Units

Item	Specification			
Model	CRT1-ID32S	CRT1-ID32S-1	CRT1-ID32SH	CRT1-ID32SH-1
I/O capacity	32 inputs			
Internal I/O common	NPN	PNP	NPN	PNP
ON voltage	10.5 VDC min. (between each input terminal and the V terminal)	10.5 VDC min. (between each input terminal and the G terminal)	10.5 VDC min. (between each input terminal and the V terminal)	10.5 VDC min. (between each input terminal and the G terminal)
OFF current	1.0 mA max.			
Input current	At 24 VDC: 6.0 mA max./input At 11 VDC: 3.0 mA min./input			
ON delay	1.5 ms max.			
OFF delay	1.5 ms max.			
Power supply short-circuit detection	---		Operates at 50 mA/point min.	
Disconnection detection	---		Operates at 0.3 mA/point max.	
Number of circuits per common	32 inputs/common			
Isolation method	Photocoupler			
Input indicator	LED (yellow)			
Installation	DIN Track			
Power short-circuit protection	Operates at 50 mA/point min.			
Power supply type	Network power supply			
Current supplied to input devices	50 mA/input			
Communications power supply current consumption	195 mA max. for 24-VDC power supply voltage 200 mA max. for 14-VDC power supply voltage		210 mA max. for 24-VDC power supply voltage 235 mA max. for 14-VDC power supply voltage	
Weight	180 g max.			

## Output Section Specifications

### ● Sixteen-point Output Unit

Item	Specification			
Model	CRT1-OD16S	CRT1-OD16S-1	CRT1-OD16SH	CRT1-OD16SH-1
I/O capacity	16 outputs			
Internal I/O common	NPN	PNP	NPN	PNP
Rated output current	0.5 A/output, 4 A/common			
Residual voltage	1.2 V max. (0.5 A DC, between each output terminal and the G terminal)	1.2 V max. (0.5 A DC, between each output terminal and the V terminal)	1.2 V max. (0.5 A DC, between each output terminal and the G terminal)	1.2 V max. (0.5 A DC, between each output terminal and the V terminal)
Leakage current	0.1 mA max.			
ON delay	0.5 ms max.			
OFF delay	1.5 ms max.			
Load short-circuit detection	---		Supported.	
Disconnection detection	---		Operates at 3 mA/point max. (Does not operate at over 3 mA.)	
Number of circuits per common	16 outputs/common			
Isolation method	Photocoupler			
Output indicators	LED (yellow)			
Installation	DIN Track			
Power supply type	Multi-power supply			
Current supplied to output devices	100 mA/output			
Communications power supply current consumption	40 mA max. for 24-VDC power supply voltage 60 mA max. for 14-VDC power supply voltage		40 mA max. for 24-VDC power supply voltage 65 mA max. for 14-VDC power supply voltage	
I/O power supply current consumption	20 mA max. for 24-VDC power supply voltage		15 mA max. for 24-VDC power supply voltage	60 mA max. for 24-VDC power supply voltage
Output handling for communications errors	Select either hold or clear from CX-Integrator.			
Weight	110 g max.			

### ● Thirty-two-point Output Unit

Item	Specification			
Model	CRT1-OD32S	CRT1-OD32S-1	CRT1-OD32SH	CRT1-OD32SH-1
I/O capacity	32 outputs			
Internal I/O common	NPN	PNP	NPN	PNP
Rated output current	0.5 A/output, 4 A/common			
Residual voltage	1.2 V max. (0.5 A DC, between each output terminal and the G terminal)	1.2 V max. (0.5 A DC, between each output terminal and the V terminal)	1.2 V max. (0.5 A DC, between each output terminal and the G terminal)	1.2 V max. (0.5 A DC, between each output terminal and the V terminal)
Leakage current	0.1 mA max.			
ON delay	0.5 ms max.			
OFF delay	1.5 ms max.			
Load short-circuit detection	---		Supported.	
Disconnection detection	---		Operates at 3 mA/point max. (Does not operate at over 3 mA.)	
Number of circuits per common	16 outputs/common			
Isolation method	Photocoupler			
Output indicators	LED (yellow)			
Installation	DIN Track			
Power supply type	Multi-power supply			
Current supplied to output devices	100 mA/output			
Communications power supply current consumption	50 mA max. for 24-VDC power supply voltage 80 mA max. for 14-VDC power supply voltage		50 mA max. for 24-VDC power supply voltage 90 mA max. for 14-VDC power supply voltage	
I/O power supply current consumption	15 mA max. for 24-VDC power supply voltage		60 mA max. for 24-VDC power supply voltage	
Output handling for communications errors	Select either hold or clear from CX-Integrator.			
Weight	170 g max.			

## Input and Output Section Specifications

### ● 8-point Input and 8-point Output Units

#### Common Specifications

Item	Specification			
Model	CRT1-MD16S	CRT1-MD16S-1	CRT1-MD16SH	CRT1-MD16SH-1
Installation	DIN Track			
Communications power supply current consumption	75 mA max. for 24-VDC power supply voltage 95 mA max. for 14-VDC power supply voltage		95 mA max. for 24-VDC power supply voltage 115 mA max. for 14-VDC power supply voltage	
Weight	120 g max.			

#### Input Section Specifications

Item	Specification			
Model	CRT1-MD16S	CRT1-MD16S-1	CRT1-MD16SH	CRT1-MD16SH-1
I/O capacity	8 inputs			
Internal I/O common	NPN	PNP	NPN	PNP
ON voltage	10.5 VDC min. (between each input terminal and the V terminal)	10.5 VDC min. (between each input terminal and the G terminal)	10.5 VDC min. (between each input terminal and the V terminal)	10.5 VDC min. (between each input terminal and the G terminal)
OFF current	1.0 mA max.			
Input current	At 24 VDC: 6.0 mA max./input At 11 VDC: 3.0 mA min./input			
ON delay	1.5 ms max.			
OFF delay	1.5 ms max.			
Power supply short-circuit detection	---		Operates at 50 mA/point min.	
Disconnection detection	---		Operates at 0.3 mA/point max.	
Number of circuits per common	8 inputs/common			
Isolation method	Photocoupler			
Input indicator	LED (yellow)			
Power supply type	Network power supply			
Power short-circuit protection	Operates at 50 mA/point min.			
Current supplied to input devices	50 mA/input			

#### Output Section Specifications

Item	Specification			
Model	CRT1-MD16S	CRT1-MD16S-1	CRT1-MD16SH	CRT1-MD16SH-1
I/O capacity	8 outputs			
Internal I/O common	NPN	PNP	NPN	PNP
Rated output current	0.5 A/output, 2 A/common			
Residual voltage	1.2 V max. (0.5 A DC, between each output terminal and the G terminal)	1.2 V max. (0.5 A DC, between each output terminal and the V terminal)	1.2 V max. (0.5 A DC, between each output terminal and the G terminal)	1.2 V max. (0.5 A DC, between each output terminal and the V terminal)
Leakage current	0.1 mA max.			
ON delay	0.5 ms max.			
OFF delay	1.5 ms max.			
Load short-circuit detection	---		Supported.	
Disconnection detection	---		Operates at 3 mA/point max. (Does not operate at over 3 mA.)	
Number of circuits per common	8 outputs/common			
Isolation method	Photocoupler			
Output indicators	LED (yellow)			
Power supply type	Multi-power supply			
Current supplied to output devices	100 mA/output			
I/O power supply current consumption	15 mA max. for 24-VDC power supply voltage			35 mA max. for 24-VDC power supply voltage
Output handling for communications errors	Select either hold or clear from CX-Integrator.			



**● 16-point Input and 16-point Output Units**
**Common Specifications**

Item	Specification			
Model	CRT1-MD32S	CRT1-MD32S-1	CRT1-MD32SH	CRT1-MD32SH-1
Installation	DIN Track			
Communications power supply current consumption	120 mA max. for 24-VDC power supply voltage 140 mA max. for 14-VDC power supply voltage		135 mA max. for 24-VDC power supply voltage 155 mA max. for 14-VDC power supply voltage	
Weight	180 g max.			

**Input Section Specifications**

Item	Specification			
Model	CRT1-MD32S	CRT1-MD32S-1	CRT1-MD32SH	CRT1-MD32SH-1
I/O capacity	16 inputs			
Internal I/O common	NPN	PNP	NPN	PNP
ON voltage	10.5 VDC min. (between each input terminal and the V terminal)	10.5 VDC min. (between each input terminal and the G terminal)	10.5 VDC min. (between each input terminal and the V terminal)	10.5 VDC min. (between each input terminal and the G terminal)
OFF current	1.0 mA max.			
Input current	At 24 VDC: 6.0 mA max./input At 11 VDC: 3.0 mA min./input			
ON delay	1.5 ms max.			
OFF delay	1.5 ms max.			
Power supply short-circuit detection	---		Operates at 50 mA/point min.	
Disconnection detection	---		Operates at 0.3 mA/point max.	
Number of circuits per common	16 inputs/common			
Isolation method	Photocoupler			
Input indicator	LED (yellow)			
Power supply type	Network power supply			
Power short-circuit protection	Operates at 50 mA/point min.			
Current supplied to input devices	50 mA/input			

**Output Section Specifications**

Item	Specification			
Model	CRT1-MD32S	CRT1-MD32S-1	CRT1-MD32SH	CRT1-MD32SH-1
I/O capacity	16 outputs			
Internal I/O common	NPN	PNP	NPN	PNP
Rated output current	0.5 A/output, 4 A/common			
Residual voltage	1.2 V max. (0.5 A DC, between each output terminal and the G terminal)	1.2 V max. (0.5 A DC, between each output terminal and the V terminal)	1.2 V max. (0.5 A DC, between each output terminal and the G terminal)	1.2 V max. (0.5 A DC, between each output terminal and the V terminal)
Leakage current	0.1 mA max.			
ON delay	0.5 ms max.			
OFF delay	1.5 ms max.			
Load short-circuit detection	---		Supported.	
Disconnection detection	---		Operates at 3 mA/point max. (Does not operate at over 3 mA.)	
Number of circuits per common	16 outputs/common			
Isolation method	Photocoupler			
Output indicators	LED (yellow)			
Power supply type	Multi-power supply			
Current supplied to output devices	100 mA/output			
I/O power supply current consumption	20 mA max. for 24-VDC power supply voltage		15 mA max. for 24-VDC power supply voltage	60 mA max. for 24-VDC power supply voltage
Output handling for communications errors	Select either hold or clear from CX-Integrator.			

Dimensions

(Unit: mm)

CRT1-ID16S (-1)  
 CRT1-ID16SH (-1)

When a DCN4-TB4 Open Type Connectors Is Mounted

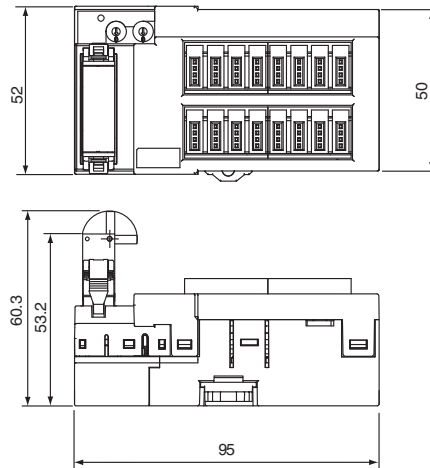

CRT1-MD16S (-1)  
 CRT1-MD16SH (-1)  
 CRT1-OD16S (-1)  
 CRT1-OD16SH (-1)

When a DCN4-TB4 Open Type Connectors Is Mounted

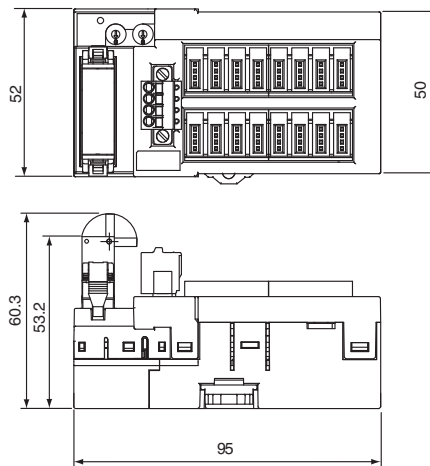

CRT1-ID32S (-1)  
 CRT1-ID32SH (-1)

When a DCN4-TB4 Open Type Connectors Is Mounted

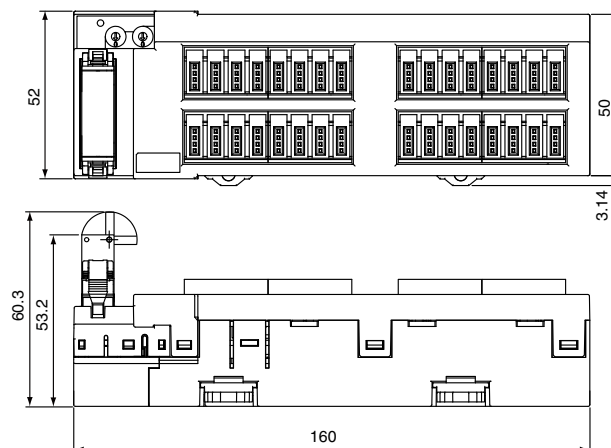

CRT1-OD32S (-1)  
 CRT1-OD32SH (-1)

When a DCN4-TB4 Open Type Connectors Is Mounted

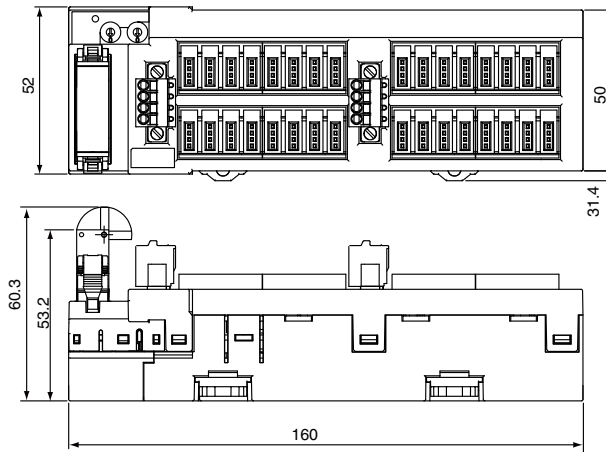

CRT1-MD32S (-1)  
 CRT1-MD32SH (-1)

When a DCN4-TB4 Open Type Connectors Is Mounted

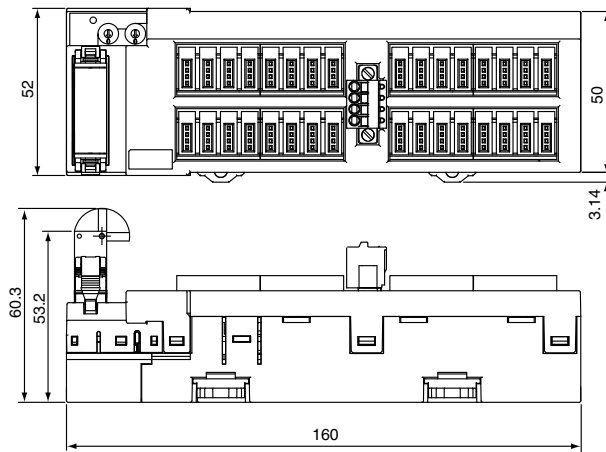

Digital I/O Slave Units with e-CON Connector (Vertical type)

# CRT1-VID08S(-1)/VOD08S(-1)

## A vertical slave unit of little wiring and size

Industrial standard e-CON connectors allow direct connection of the unit to sensing devices without use of terminal blocks. This minimizes requirement in installation space and wiring work.

- Industrial standard e-CON connectors require less wiring work.
- Connector interface of input and output sections can downsize the unit.
- Various data such as network status at start-up, equipment operation and deterioration can be provided.
- DIN tracks and metal fixtures allow flexible installation.



## Ordering Information

Name	Specifications			Model
e-CON Connectors *	Inputs	8 inputs	NPN	Without Short-circuit and Disconnected Line Detection
			PNP	
	Outputs	8 outputs	NPN	
			PNP	
Mounting Bracket	Unit with e-CON Connectors CRT1-V□D08S(-1)			CRT1-ATT02

\* These Units are also available with a DCN-TB4 Terminal Conversion Adapter included in the package. Add "(-B)" to the end of the model number to receive the Adapter as well.

Slave External I/O Connections in the appendix for applicable connectors.

## Performance Specifications

For Basic Performance Specifications of Slave Units, refer to page 30.

### Input Section Specifications

Item	Specification	
Model	CRT1-VID08S	CRT1-VID08S-1
I/O capacity	8 inputs	
Internal I/O common	NPN	PNP
ON voltage	10.5 VDC min. (between each input terminal and the V terminal)	10.5 VDC min. (between each input terminal and the G terminal)
OFF voltage	5 VDC max. (between each input terminal and the V terminal)	5 VDC max. (between each input terminal and the G terminal)
OFF current	1.0 mA max.	
Input current	At 24 VDC: 6.0 mA max./input At 11 VDC: 3.0 mA min./input	
ON delay	1.5 ms max.	
OFF delay	1.5 ms max.	
Number of circuits per common	8 inputs/common	
Isolation method	Photocoupler	
Input indicator	LED (yellow)	
Installation	DIN Track or Mounting Bracket	
Power supply type	Network power supply	
Power short-circuit protection	Operates at 50 mA/point min.	
Current supplied to input devices	50 mA/input	
Communications power supply current consumption	35 mA max. for 24-VDC power supply voltage 50 mA max. for 14-VDC power supply voltage	
Weight	80 g max.	

### Output Section Specifications

Item	Specification	
Model	CRT1-VOD08S	CRT1-VOD08S-1
I/O capacity	8 outputs	
Internal I/O common	NPN	PNP
Rated output current	0.3 A/output, 2 A/common	
Residual voltage	1.2 V max. (0.3 A DC, between each output terminal and the G terminal)	1.2 V max. (0.3 A DC, between each output terminal and the V terminal)
Leakage current	0.1 mA max.	
ON delay	0.5 ms max.	
OFF delay	1.5 ms max.	
Number of circuits per common	8 outputs/common	
Isolation method	Photocoupler	
Output indicators	LED (yellow)	
Installation	DIN Track or Mounting Bracket	
Power supply type	Multi-power supply	
Current supplied to output devices	100 mA/output	
Communications power supply current consumption	40 mA max. for 24-VDC power supply voltage 60 mA max. for 14-VDC power supply voltage	
I/O power supply current consumption	15 mA max. for 24-VDC power supply voltage	
Output handling for communications errors	Select either hold or clear from CX-Integrator.	
Weight	80 g max.	

### Dimensions

(Unit: mm)

CRT1-VID08S (-1)  
CRT1-VOD08S (-1)

When a DCN4-TB4 Open Type Connectors Is Mounted

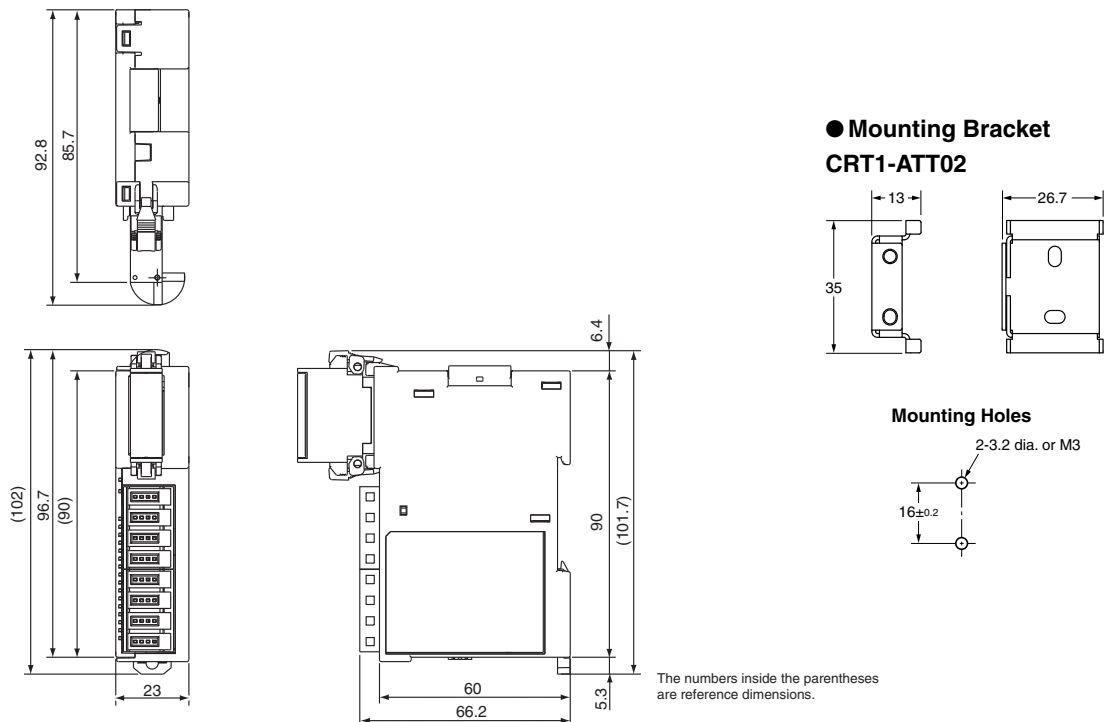

Digital I/O Slave Units with MIL Connector (Vertical type)

# CRT1-VID16ML(-1)/VOD16ML(-1)

**Thinnest in the industry!**

**Ultimately little space and wiring are required.**

MIL connectors expand I/O interface options to include direct connection to actuators and to terminal block conversion units.

- Super thin width of 15 mm could downsize the control panel.
- Connector interface between the communications unit and the I/O units can reduce start-up time and raise maintenance ability.
- Various maintenance data such as operation status and deterioration of equipment can be collected to improve productivity.
- DIN tracks and metal fixtures allow flexible installation.
- Wide range of connection styles are available including direct connection to actuators and to terminal block conversion units.



## Ordering Information

Name	Specifications			Model
MIL Connector *	Inputs	16 inputs	NPN	CRT1-VID16ML
			PNP	CRT1-VID16ML-1
	Outputs	16 outputs	NPN	CRT1-VOD16ML
			PNP	CRT1-VOD16ML-1
Mounting Bracket	Unit with MIL Connectors			CRT1-ATT01

\* These Units are also available with a DCN-TB4 Terminal Conversion Adapter included in the package. Add "(-B)" to the end of the model number to receive the Adapter as well.

Slave External I/O Connections in the appendix for applicable connectors.

## Performance Specifications

For Basic Performance Specifications of Slave Units, refer to page 30.

## Input Section Specifications

Item	Specification	
Model	CRT1-VID16ML	CRT1-VID16ML-1
I/O capacity	16 inputs	
Internal I/O common	NPN	PNP
ON voltage	17 VDC min. (between each input terminal and the V terminal)	17 VDC min. (between each input terminal and the G terminal)
OFF voltage	5 VDC max. (between each input terminal and the V terminal)	5 VDC max. (between each input terminal and the G terminal)
OFF current	1.0 mA max.	
Input current	At 24 VDC: 6.0 mA max./input At 17 VDC: 3.0 mA min./input	
ON delay	1.5 ms max.	
OFF delay	1.5 ms max.	
Number of circuits per common	16 inputs/common	
Isolation method	Photocoupler	
Input indicator	LED (yellow)	
Installation	DIN Track or Mounting Bracket	
Power supply type	Multi-power supply	
Communications power supply current consumption	40 mA max. for 24-VDC power supply voltage 60 mA max. for 14-VDC power supply voltage	
I/O power supply current consumption	5 mA max. for 24-VDC power supply voltage	
Weight	80 g max.	

## Output Section Specifications

Item	Specification	
Model	CRT1-VOD16ML	CRT1-VOD16ML-1
I/O capacity	16 outputs	
Internal I/O common	NPN	PNP
Rated output current	0.3 A/output, 2 A/common *	
Residual voltage	1.2 V max. (0.3 A DC, between each output terminal and the G terminal)	1.2 V max. (0.3 A DC, between each output terminal and the V terminal)
Leakage current	0.1 mA max.	
ON delay	0.5 ms max.	
OFF delay	1.5 ms max.	
Number of circuits per common	16 outputs/common	
Isolation method	Photocoupler	
Output indicators	LED (yellow)	
Installation	DIN Track or Mounting Bracket	
Power supply type	Multi-power supply	
Communications power supply current consumption	45 mA max. for 24-VDC power supply voltage 65 mA max. for 14-VDC power supply voltage	
I/O power supply current consumption	15 mA max. for 24-VDC power supply voltage	
Output handling for communications errors	Select either hold or clear from CX-Integrator.	
Weight	70 g max.	

\* Do not use a total external load current of more than 2 A, and do not use more than 1 A per V terminal or G terminal.

## Dimensions

(Unit: mm)

CRT1-VID16ML (-1)  
CRT1-VOD16ML (-1)

When a DCN4-TB4 Open Type Connectors Is Mounted

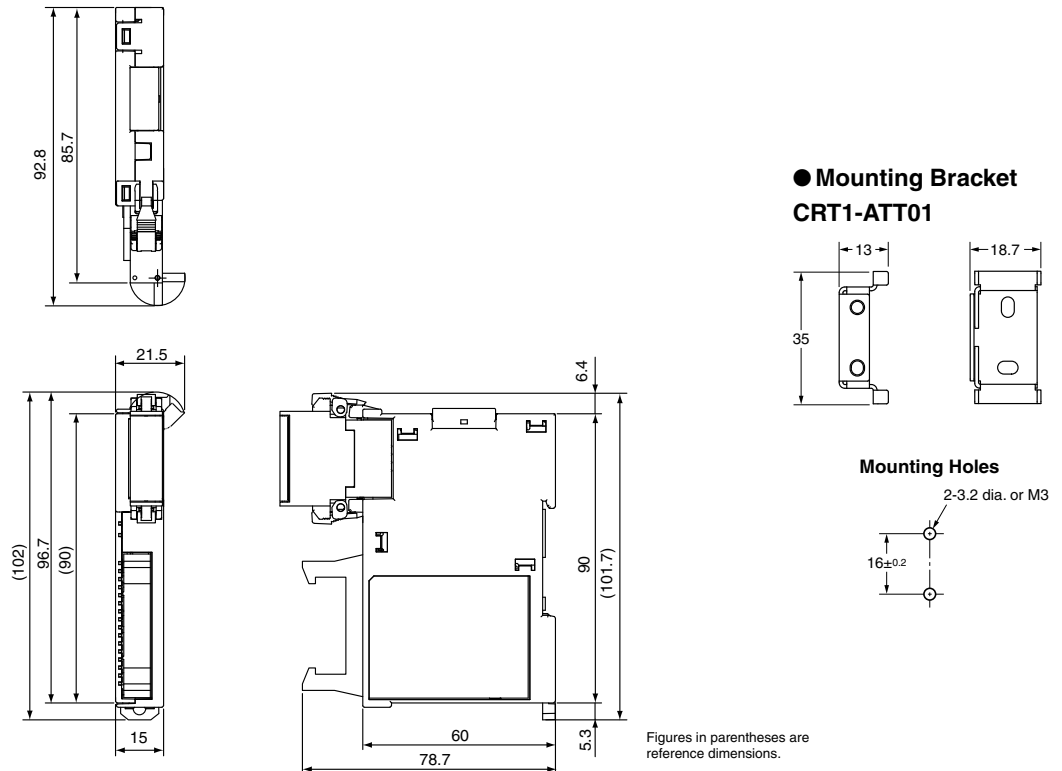

Digital I/O Slave Units with MIL Connector (Vertical type)

# CRT1-VID32ML(-1)/VOD32ML(-1)/VMD32ML(-1)

## Aggregation of multi-I/O points!

## A compact and little wiring slave with 32 points and MIL connector

MIL connectors expand I/O interface options to include collective connection of multiple I/O points to boards as well as direct connection to actuators via branching cables.

- Super compact slave with 32 points and MIL connector (35 mm wide x 60 mm deep x 80 mm high)
- Aggregation of multi I/O points enables connection to actuators and boards.
- Connector interface between the communications unit and the I/O units greatly reduces wiring man-hour.
- DIN tracks and metal fixtures allow flexible installation.
- Various maintenance data such as operation status and deterioration of equipment can be collected to improve productivity.



## Ordering Information

Name	Specifications			Model
MIL Connector *	Inputs	32 inputs	NPN	CRT1-VID32ML
			PNP	CRT1-VID32ML-1
	Outputs	32 outputs	NPN	CRT1-VOD32ML
			PNP	CRT1-VOD32ML-1
	Inputs/ Outputs	16 inputs/ 16 outputs	NPN	CRT1-VMD32ML
			PNP	CRT1-VMD32ML-1
Mounting Bracket	Unit with MIL Connectors CRT1-V□D32ML(-1)			SRT1-ATT02

\* These Units are also available with a DCN-TB4 Terminal Conversion Adapter included in the package. Add "(-B)" to the end of the model number to receive the Adapter as well.

Slave External I/O Connections in the appendix for applicable connectors.

## Performance Specifications

For Basic Performance Specifications of Slave Units, refer to page 30.



**Input Section Specifications**

Item	Specification	
Model	CRT1-VID32ML	CRT1-VID32ML-1
I/O capacity	32 inputs	
Internal I/O common	NPN	PNP
ON voltage	17 VDC min. (between each input terminal and the V terminal)	17 VDC min. (between each input terminal and the G terminal)
OFF voltage	5 VDC max. (between each input terminal and the V terminal)	5 VDC max. (between each input terminal and the G terminal)
OFF current	1.0 mA max.	
Input current	At 24 VDC: 6.0 mA max./input At 17 VDC: 3.0 mA min./input	
ON delay	1.5 ms max.	
OFF delay	1.5 ms max.	
Number of circuits per common	32 inputs/common	
Number of simultaneous inputs	32 max. *	
Isolation method	Photocoupler	
Input indicator	LED (yellow)	
Installation	DIN Track or Mounting Bracket	
Power supply type	Multi-power supply	
Communications power supply current consumption	40 mA max. for 24-VDC power supply voltage 60 mA max. for 14-VDC power supply voltage	
I/O power supply current consumption	2 mA max. for 24-VDC power supply voltage	
Weight	120 g max.	

\* When Units Are Mounted Facing Upwards:  
If 16 points may be turned ON simultaneously, the distance between the Units must be restricted depending on the ambient operating temperature, as shown in the following graph. For example, when the ambient operating temperature is 55°C, a space of at least 10 mm is required between Units.

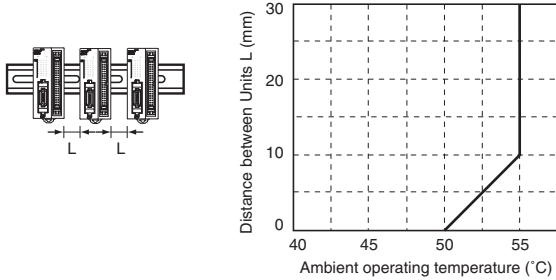

**Output Section Specifications**

Item	Specification	
Model	CRT1-VOD32ML	CRT1-VOD32ML-1
I/O capacity	32 outputs	
Internal I/O common	NPN	PNP
Rated output current	0.3 A/output, 4 A/common *	
Residual voltage	1.2 V max. (0.3 A DC, between each output terminal and the G terminal)	1.2 V max. (0.3 A DC, between each output terminal and the V terminal)
Leakage current	0.1 mA max.	
ON delay	0.5 ms max.	
OFF delay	1.5 ms max.	
Number of circuits per common	32 outputs/common	
Isolation method	Photocoupler	
Output indicators	LED (yellow)	
Installation	DIN Track or Mounting Bracket	
Power supply type	Multi-power supply	
Communications power supply current consumption	50 mA max. for 24-VDC power supply voltage 80 mA max. for 14-VDC power supply voltage	
I/O power supply current consumption	6.5 mA max. for 24-VDC power supply voltage	
Output handling for communications errors	Select either hold or clear from CX-Integrator.	
Weight	100 g max.	

\* Do not use a total external load current of more than 4 A, and do not use more than 1 A per V terminal or G terminal.

**Input and Output Section Specifications**

● Sixteen-point Input and Sixteen-point Output Units

Common Specifications

Item	Specification	
Model	CRT1-VMD32ML	CRT1-VMD32ML-1
Installation	DIN Track or Mounting Bracket	
Communications power supply current consumption	45 mA max. for 24-VDC power supply voltage 70 mA max. for 14-VDC power supply voltage	
Weight	110 g max.	

**Input Section Specifications**

Item	Specification	
Model	CRT1-VMD32ML	CRT1-VMD32ML-1
I/O capacity	16 inputs	
Internal I/O common	NPN	PNP
ON voltage	17 VDC min. (between each input terminal and the V terminal)	17 VDC min. (between each input terminal and the G terminal)
OFF voltage	5 VDC min. (between each input terminal and the V terminal)	5 VDC min. (between each input terminal and the G terminal)
OFF current	1.0 mA max.	
Input current	At 24 VDC: 6.0 mA max./input At 17 VDC: 3.0 mA min./input	
ON delay	1.5 ms max.	
OFF delay	1.5 ms max.	
Number of circuits per common	16 inputs/common	
Number of simultaneous inputs	16 max. *	
Isolation method	Photocoupler	
Input indicator	LED (yellow)	
Power supply type	Multi-power supply	
I/O power supply current consumption	2 mA max.	

\* When Slave Units are mounted facing upwards, and 16 inputs may all turn ON, leave the specified distance between Units according to the ambient temperature.

**Output Section Specifications**

Item	Specification	
Model	CRT1-VMD32ML	CRT1-VMD32ML-1
I/O capacity	16 outputs	
Internal I/O common	NPN	PNP
Rated output current	0.3 A/output, 2 A/common *	
Residual voltage	1.2 V max. (0.3 A DC, between each output terminal and the G terminal)	1.2 V max. (0.3 A DC, between each output terminal and the V terminal)
Leakage current	0.1 mA max.	
ON delay	0.5 ms max.	
OFF delay	1.5 ms max.	
Number of circuits per common	16 outputs/common	
Isolation method	Photocoupler	
Output indicators	LED (yellow)	
Power supply type	Multi-power supply	
I/O power supply current consumption	6.5 mA max. for 24-VDC power supply voltage	
Output handling for communications errors	Select either hold or clear from CX-Integrator.	

\* Do not use a total external load current of more than 2 A, and do not use more than 1 A per V terminal or G terminal.

**Dimensions**

(Unit: mm)

- CRT1-VID32ML (-1)
- CRT1-VOD32ML (-1)
- CRT1-VMD32ML (-1)

When a DCN4-TB4 Open Type Connectors Is Mounted

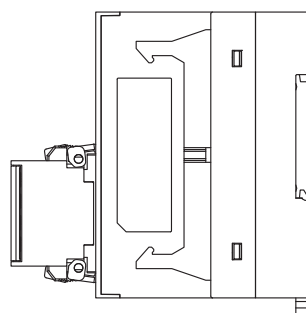
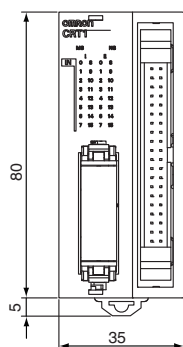
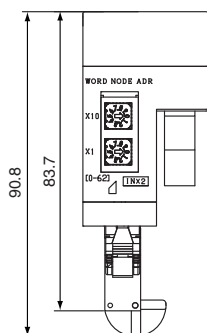

● Mounting Bracket  
SRT2-ATT02

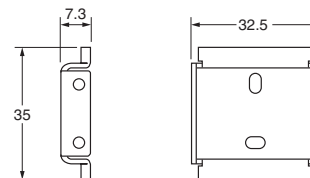

Mounting Holes

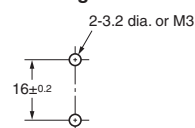

Digital I/O Slaves Units with Clamp Terminals

# CRT1-□D08SL(-1)/□D16SL(-1)

## Screw-less Terminal Wiring Further Reduces Wiring Work and Saves Labor at the Production Site.

- Screw-less (M3) design reduces the need for extra tightening.
- Removable terminal block gives powerful support to maintenance work.
- One-step wiring. Wire simply by inserting the ferrules.
- Applicable wire: AWG24 to AWG16 (cross-section: 0.2 to 1.25 mm<sup>2</sup>)

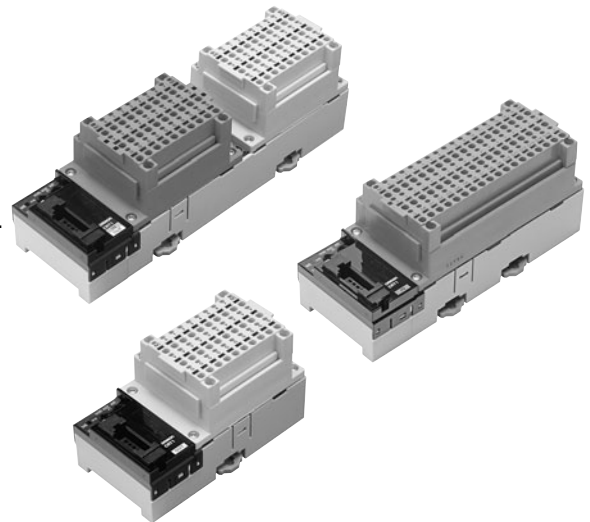

### Ordering Information

Name	Specifications			Model
Clamp Terminals	Inputs	8 inputs	NPN	CRT1-ID08SL
			PNP	CRT1-ID08SL-1
	Outputs	8 outputs	NPN	CRT1-OD08SL
			PNP	CRT1-OD08SL-1
	Inputs	16 inputs	NPN	CRT1-ID16SL
			PNP	CRT1-ID16SL-1
	Outputs	16 outputs	NPN	CRT1-OD16SL
			PNP	CRT1-OD16SL-1
	Inputs/ Outputs	8 inputs/ 8 outputs	NPN	CRT1-MD16SL
			PNP	CRT1-MD16SL-1

Slave External I/O Connections in the appendix for applicable ferrules.

### Performance Specifications

For Basic Performance Specifications of Slave Units, refer to page 30.

## Input Section Specifications

### ● Eight-point Input Units

Item	Specification	
	CRT1-ID08SL	CRT1-ID08SL-1
Model	CRT1-ID08SL	CRT1-ID08SL-1
I/O capacity	8 inputs	
Internal I/O common	NPN	PNP
ON voltage	15 VDC min. (between each input terminal and the V terminal)	15 VDC min. (between each input terminal and the G terminal)
OFF voltage	5 VDC max. (between each input terminal and the V terminal)	5 VDC max. (between each input terminal and the G terminal)
OFF current	1 mA max.	
Input current	At 24 VDC: 6.0 mA max./input At 17 VDC: 3.0 mA min./input	
ON delay	1.5 ms max.	
OFF delay	1.5 ms max.	
Number of circuits per common	8 inputs/common	
Isolation method	Photocoupler	
Input indicator	LED (yellow)	
Installation	DIN Track	
Power supply type	Multi-power supply	
Current supplied to input devices	100 mA/input	
Communications power supply current consumption	30 mA max. for 24-VDC power supply voltage 50 mA max. for 14-VDC power supply voltage	
I/O power supply current consumption	15 mA max. for 24-VDC power supply voltage	
Weight	170 g max.	

### ● Sixteen-point Input Units

Item	Specification	
	CRT1-ID16SL	CRT1-ID16SL-1
Model	CRT1-ID16SL	CRT1-ID16SL-1
I/O capacity	16 inputs	
Internal I/O common	NPN	PNP
ON voltage	15 VDC min. (between each input terminal and the V terminal)	15 VDC min. (between each input terminal and the G terminal)
OFF voltage	5 VDC max. (between each input terminal and the V terminal)	5 VDC max. (between each input terminal and the G terminal)
OFF current	1.0 mA max.	
Input current	At 24 VDC: 6.0 mA max./input At 17 VDC: 3.0 mA max./input	
ON delay	1.5 ms max.	
OFF delay	1.5 ms max.	
Number of circuits per common	16 inputs/common	
Isolation method	Photocoupler	
Input indicator	LED (yellow)	
Installation	DIN Track mounting	
Power supply type	Multi-power supply	
Communications power supply current consumption	35 mA max. for 24-VDC power supply voltage 55 mA max. for 14-VDC power supply voltage	
I/O power supply current consumption	15 mA max. for 24-VDC power supply voltage	
Weight	250 g max.	

## Output Section Specifications

### ● Eight-point Output Units

Item	Specification	
	CRT1-OD08SL	CRT1-OD08SL-1
Model	CRT1-OD08SL	CRT1-OD08SL-1
I/O capacity	8 outputs	
Internal I/O common	NPN	PNP
Rated output current	0.5 A/output, 2 A/common	
Residual voltage	1.2 V max. (0.5 A DC, between each output terminal and the G terminal)	1.2 V max. (0.5 A DC, between each output terminal and the V terminal)
Leakage current	0.1 mA max.	
ON delay	0.5 ms max.	
OFF delay	1.5 ms max.	
Number of circuits per common	8 outputs/common	
Isolation method	Photocoupler	
Output indicators	LED (yellow)	
Installation	DIN Track	
Power supply type	Multi-power supply	
Current supplied to output devices	100 mA/output	
Communications power supply current consumption	35 mA max. for 24-VDC power supply voltage 55 mA max. for 14-VDC power supply voltage	
I/O power supply current consumption	25 mA max. for 24-VDC power supply voltage	
Output handling for communications errors	Select either hold or clear from CX-Integrator.	
Weight	170 g max.	

### ● Sixteen-point Output Unit

Item	Specification	
	CRT1-OD16SL	CRT1-OD16SL-1
Model	CRT1-OD16SL	CRT1-OD16SL-1
I/O capacity	16 outputs	
Internal I/O common	NPN	PNP
Rated output current	0.5 A/output, 4 A/common	
Residual voltage	1.2 V max. (0.5 A DC, between each output terminal and the G terminal)	1.2 V max. (0.5 A DC, between each output terminal and the V terminal)
Leakage current	0.1 mA max.	
ON delay	0.5 ms max.	
OFF delay	1.5 ms max.	
Number of circuits per common	16 outputs/common	
Isolation method	Photocoupler	
Output indicators	LED (yellow)	
Installation	DIN Track mounting	
Power supply type	Multi-power supply	
Communications power supply current consumption	35 mA max. for 24-VDC power supply voltage 60 mA max. for 14-VDC power supply voltage	
I/O power supply current consumption	30 mA max. for 24-VDC power supply voltage	
Output handling for communications errors	Hold or clear can be selected. (CompoNet Support Software)	
Weight	250 g max.	

## Input and Output Section Specifications

### ● Eight-point Input and Eight-point Output Units

#### Common Specifications

Item	Specification	
Model	CRT1-MD16SL	CRT1-MD16SL-1
Installation	DIN Track	
Communications power supply current consumption	35 mA max. for 24-VDC power supply voltage 60 mA max. for 14-VDC power supply voltage	
Weight	290 g max.	

#### Input Specifications

Item	Specification	
Model	CRT1-MD16SL	CRT1-MD16SL-1
I/O capacity	8 inputs	
Internal I/O common	NPN	PNP
ON voltage	15 VDC min. (between each input terminal and the V terminal)	15 VDC min. (between each input terminal and the G terminal)
OFF voltage	5 VDC min. (between each input terminal and the V terminal)	5 VDC min. (between each input terminal and the G terminal)
OFF current	1.0 mA max.	
Input current	At 24 VDC: 6.0 mA max./input At 11 VDC: 3.0 mA min./input	
ON delay	1.5 ms max.	
OFF delay	1.5 ms max.	
Number of circuits per common	8 inputs/common	
Isolation method	Photocoupler	
Input indicator	LED (yellow)	
Power supply type	Multi-power supply	
Current supplied to input devices	100 mA/input	
I/O power supply current consumption	15 mA max. for 24-VDC power supply voltage	

#### Output Specifications

Item	Specification	
Model	CRT1-MD16SL	CRT1-MD16SL-1
I/O capacity	8 outputs	
Internal I/O common	NPN	PNP
Rated output current	0.5 A/output, 2 A/common	
Residual voltage	1.2 V max. (0.5 A DC, between each output terminal and the G terminal)	1.2 V max. (0.5 A DC, between each output terminal and the V terminal)
Leakage current	0.1 mA max.	
ON delay	0.5 ms max.	
OFF delay	1.5 ms max.	
Number of circuits per common	8 outputs/common	
Isolation method	Photocoupler	
Output indicators	LED (yellow)	
Power supply type	Multi-power supply	
Current supplied to output devices	100 mA/output	
I/O power supply current consumption	25 mA max. for 24-VDC power supply voltage	
Output handling for communications errors	Select either hold or clear from CX-Integrator.	

Dimensions

(Unit: mm)

CRT1-ID08SL (-1)  
 CRT1-OD08SL (-1)

When a DCN4-TB4 Open Type Connectors Is Mounted

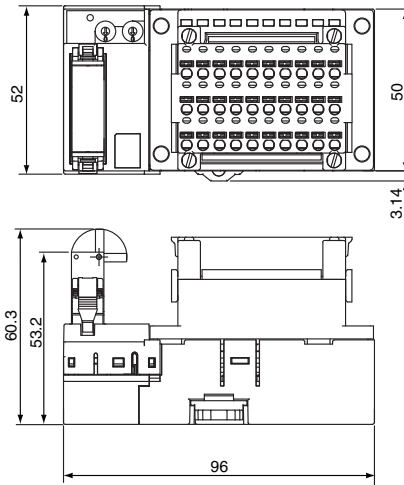

CRT1-ID16SL (-1)  
 CRT1-OD16SL (-1)

When a DCN4-TB4 Open Type Connectors Is Mounted

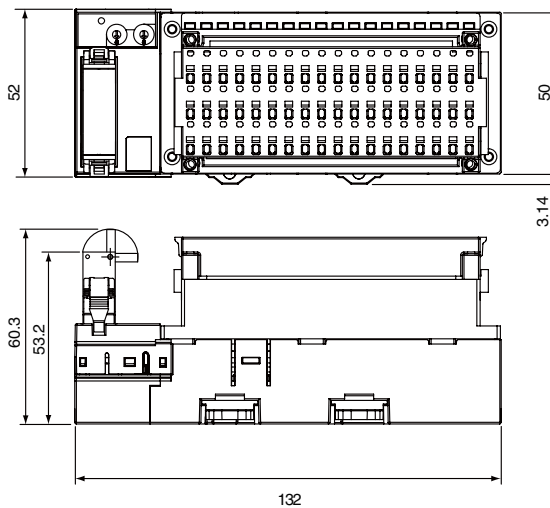

CRT1-MD16SL (-1)

When a DCN4-TB4 Open Type Connectors Is Mounted

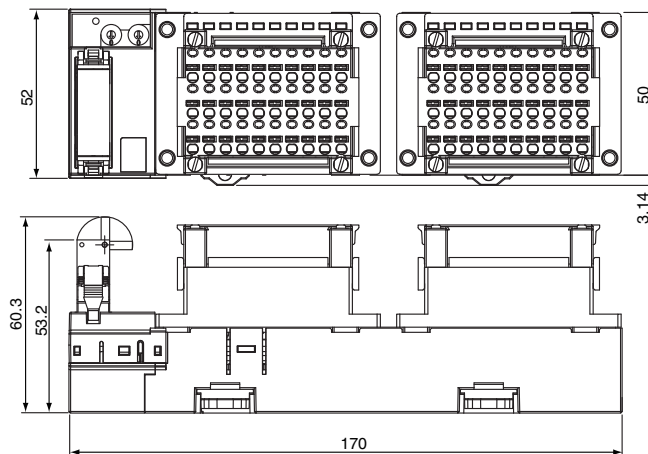

# Analog I/O Slave Units

# CRT1-AD04/DA02

## Convert to Smart for Smarter Processing! Simple and Intelligent Analog I/O Slaves

In addition to analog data input and output, Analog I/O Slave Units can use a variety of functions internally, such as scaling, that previously required processing in ladder programming at the host PLC.

- Analog processing equivalent to digital panel meters is supported, such as with the scaling function.
- Use deviation and cumulative counter functions for analog calculations, such as for equipment error prediction and flow rate applications.
- The user adjustment function can be used to compensate offsets in inputs or outputs.
- Easily change the input or output range with a switch setting.

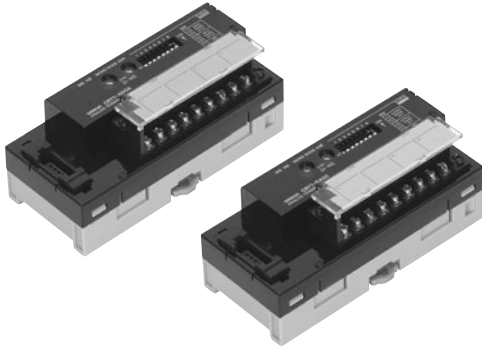

### Ordering Information

Name	Specifications		Model
Analog I/O Slave Units *	Analog inputs	4 inputs	CRT1-AD04
	Analog outputs	2 outputs	CRT1-DA02

\* These Units are also available with a DCN-TB4 Terminal Conversion Adapter included in the package. Add "(-B)" to the end of the model number to receive the Adapter as well.

### Performance Specifications

For Basic Performance Specifications of Slave Units, refer to page 30.

## Input Section Specifications

Item	Specification		
	Voltage input	Current input	
Model	CRT1-AD04		
Input signal ranges	0 to 5 V 1 to 5 V 0 to 10 V -10 to 10 V	0 to 20 mA 4 to 20 mA	
Maximum signal input	±15 V	±30 mA	
Input impedance	1 M Ω min.	Approx. 250 Ω	
Resolution	1/6,000 (full scale)		
Overall accuracy	25°C	±0.3% FS	±0.4% FS
	-10 to 55°C	±0.6% FS	±0.8% FS
Conversion cycle	1 ms/1 points		
AD conversion data	-10 to 10 V range: F448 to 0BB8 hex full scale (-3,000 to 3,000) Other ranges: 0000 to 1770 hex full scale (0 to 6,000) AD conversion range: ±5% FS of the above data ranges.		
Isolation method	Photocoupler isolation (between input and communications lines) No isolation between input signal wires		
Mounting	DIN Track mounting		
Power supply type	Multi-power supply		
Communications power current consumption	110 mA max. for 24-VDC power supply 175 mA max. for 14-VDC power supply		
Weight	153 g		

## Output Section Specifications

Item	Specification		
	Voltage output	Current output	
Model	CRT1-DA02		
Output signal ranges	0 to 5 V 1 to 5 V 0 to 10 V -10 to 10 V	0 to 20 mA 4 to 20 mA	
External output allowable load resistance	1 kΩ min.	600 Ω max.	
Resolution	1/6,000 (full scale)		
Overall accuracy	25°C	±0.4% FS	±0.4% FS *
	-10 to 55°C	±0.8% FS	±0.8% FS *
Conversion cycle	2 ms/2 points		
DA conversion data	-10 to 10 V range: F448 to 0BB8 hex full scale (-3,000 to 3,000) Other ranges: 0000 to 1770 hex full scale (0 to 6,000) AD conversion range: ±5% FS of the above data ranges.		
Isolation method	Photocoupler isolation (between output and communications lines) No isolation between output signal wires.		
Mounting	DIN Track mounting		
Power supply type	Multi-power supply		
Communications power current consumption	125 mA max. for 24-VDC power supply 205 mA max. for 14-VDC power supply		
Weight	155 g		

\* The specified accuracy does not apply below 0.2 mA when using the 0 to 20 mA range.

## Dimensions

(Unit: mm)

CRT1-AD04

CRT1-DA02

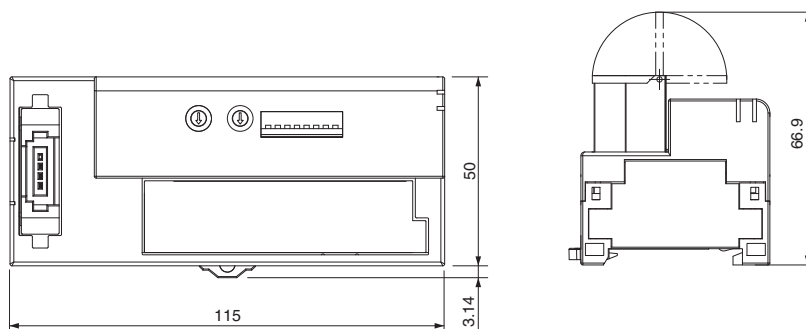



# Analog I/O Slave Units with MIL Connectors/e-CON Connectors

# CRT1-VAD04□□/-VDA02□□

## Analog Slave Units with the Industry's Narrowest Width Help Save Space in Equipment and Panels

- The series includes Slave Units with a width of only 15 mm, the narrowest in the industry. Models with e-CON connectors boast a width of only 23 mm, making them the smallest in their class to save even more space.
- I/O interface wiring can be performed easily with either MIL connectors or e-CON connectors.
- Just make a few switch settings to complete Unit setup.
- Enhanced Smart functions in a slim body. Reduce your total cost of operation by collecting maintenance data by using only the Slave Unit.



### Ordering Information

Name	Specifications		Model
	Input/Output	Points	
MIL Connector Type	Analog Inputs	4 inputs	CRT1-VAD04ML
	Analog Outputs	2 outputs	CRT1-VDA02ML
e-CON Connector Type	Analog Inputs	4 inputs	CRT1-VAD04S
	Analog Outputs	2 outputs	CRT1-VDA02S
Mounting Bracket	Unit with MIL Connectors		CRT1-ATT01
	Unit with e-CON Connectors		CRT1-ATT02

Slave External I/O Connections in the appendix for applicable connectors.

### Performance Specifications

For Basic Performance Specifications of Slave Units, refer to page 30.

## Input Section Specifications

### ● Four-point Analog Input Unit (with MIL Connectors) CRT1-VAD04ML

Item	Specification	
	Voltage input	Current input
Input signal ranges	0 to 5 V 1 to 5 V 0 to 10 V -10 to 10 V	0 to 20 mA 4 to 20 mA
Maximum signal input	±15 V	±30 mA
Input impedance	1 MΩ min.	Approx. 250 Ω
Resolution	1/6,000 (full scale)	
Overall accuracy	25°C	±0.3% FS
	-10 to 55°C	±0.6% FS
Conversion cycle	1 ms/ 1 point	
AD conversion data	-10 to 10 V range: F448 to 0BB8 hex full scale (-3,000 to 3,000) Other ranges: 0000 to 1770 hex full scale (0 to 6,000) AD conversion range: ±5% FS of the above data ranges.	
Isolation method	Photocoupler isolation (between input and communications lines) No isolation between input signal wires	
Mounting	DIN Track mount or mount for Mounting Bracket	
Power supply type	Multi-power supply	
Communications power current consumption	75 mA max. for 24-VDC power supply 115 mA max. for 14-VDC power supply	
Weight	70 g max.	

### ● Four-point Analog Input Unit (with e-CON Connectors) CRT1-VAD04S

Item	Specification	
	Voltage input	Current input
Input signal ranges	0 to 5 V 1 to 5 V 0 to 10 V -10 to 10 V	0 to 20 mA 4 to 20 mA
Maximum signal input	±15 V	±30 mA
Input impedance	1 MΩ min.	Approx. 250 Ω
Resolution	1/6,000 (full scale)	
Overall accuracy	25°C	±0.3% FS
	-10 to 55°C	±0.6% FS
Conversion cycle	1 ms/ 1 point	
AD conversion data	-10 to 10 V range: F448 to 0BB8 hex full scale (-3,000 to 3,000) Other ranges: 0000 to 1770 hex full scale (0 to 6,000) AD conversion range: ±5% FS of the above data ranges.	
Isolation method	Photocoupler isolation (between input and communications lines) No isolation between input signal wires	
Mounting	DIN Track mount or mount for Mounting Bracket	
Power supply type	Multi-power supply	
Communications power current consumption	75 mA max. for 24-VDC power supply 115 mA max. for 14-VDC power supply	
Sensor power supply current *	Less than 200 mA (for each CH)	
Weight	85 g max.	

\* In order to provide power to the sensor through the I/O connector, a 24-VDC power supply must be connected to the sensor power supply connector.

## Output Section Specifications

### ● Two-point Analog Output Unit (with MIL Connectors) CRT1-VDA02ML

Item	Specification	
	Voltage Output	Current Output
Output signal ranges	0 to 5 V 1 to 5 V 0 to 10 V -10 to 10 V	0 to 20 mA 4 to 20 mA
External output allowable load resistance	1 kΩ min.	600 Ω max.
Resolution	1/6,000 (full scale)	
Overall accuracy	25°C	±0.4% FS
	-10 to 55°C	±0.8% FS
Conversion cycle	2 ms/ 2 points	
DA conversion data	-10 to 10 V range: F448 to 0BB8 hex full scale (-3,000 to 3,000) Other ranges: 0000 to 1770 hex full scale (0 to 6,000) DA conversion range: ±5% FS of the above data ranges.	
Isolation method	Photocoupler isolation (between output and communications lines) No isolation between output signal wires.	
Mounting	DIN Track mount or mount for Mounting Bracket	
Power supply type	Multi-power supply	
Communications power current consumption	105 mA max. for 24-VDC power supply 170 mA max. for 14-VDC power supply	
Weight	75 g max.	

\* The specified accuracy does not apply below 0.2 mA when using the 0 to 20 mA range.

### ● Two-point Analog Output Unit (with e-CON Connectors) CRT1-VDA02S

Item	Specification	
	Voltage Output	Current Output
Output signal ranges	0 to 5 V 1 to 5 V 0 to 10 V -10 to 10 V	0 to 20 mA 4 to 20 mA
External output allowable load resistance	1 kΩ min.	600 Ω max.
Resolution	1/6,000 (full scale)	
Overall accuracy	25°C	±0.4% FS
	-10 to 55°C	±0.8% FS
Conversion cycle	2 ms/ 2 points	
DA conversion data	-10 to 10 V range: F448 to 0BB8 hex full scale (-3,000 to 3,000) Other ranges: 0000 to 1770 hex full scale (0 to 6,000) DA conversion range: ±5% FS of the above data ranges.	
Isolation method	Photocoupler isolation (between output and communications lines) No isolation between output signal wires.	
Mounting	DIN Track mount or mount for Mounting Bracket	
Power supply type	Multi-power supply	
Communications power current consumption	105 mA max. for 24-VDC power supply 170 mA max. for 14-VDC power supply	
Weight	85 g max.	

\* The specified accuracy does not apply below 0.2 mA when using the 0 to 20 mA range.

Dimensions

● Four-point Analog Input Unit (with MIL Connectors)  
**CRT1-VAD04ML**

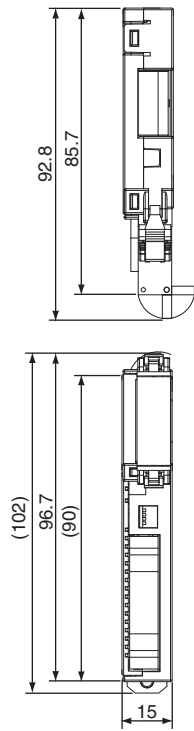

When a DCN4-TB4 Open Type Connectors Is Mounted

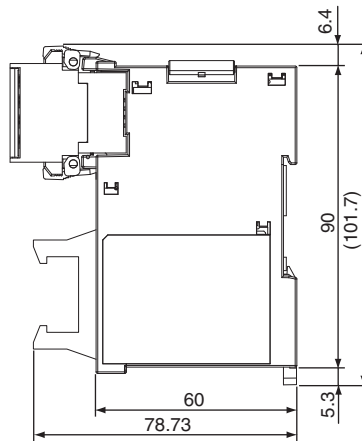

● Mounting Bracket  
**CRT1-ATT01**

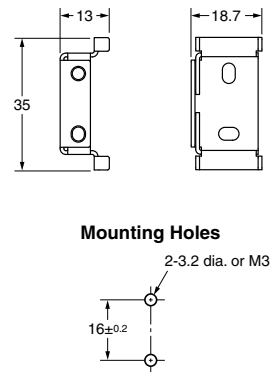

Note: The numbers inside the parentheses are reference dimensions.

● Two-point Analog Output Unit (with MIL Connectors)  
**CRT1-VDA02ML**

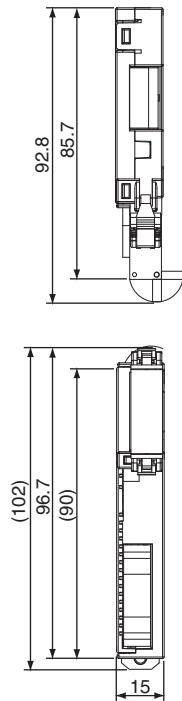

When a DCN4-TB4 Open Type Connectors Is Mounted

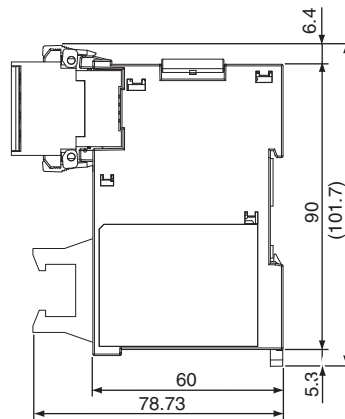

● Mounting Bracket  
**CRT1-ATT01**

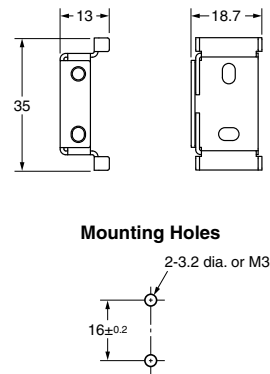

Note: The numbers inside the parentheses are reference dimensions.

● Four-point Analog Input Unit (with e-CON Connectors)

CRT1-VAD04S

When a DCN4-TB4 Open Type Connectors Is Mounted

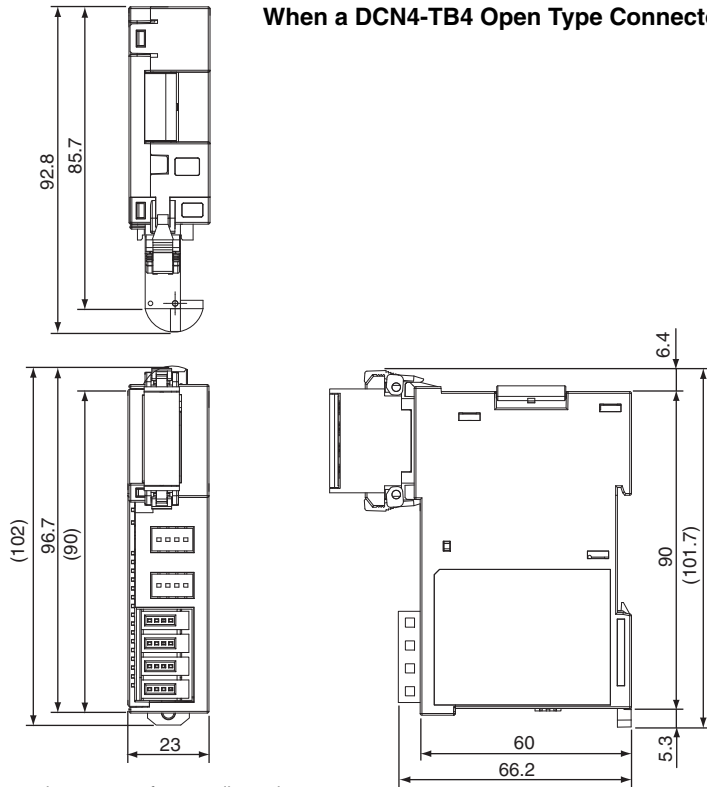

● Mounting Bracket  
CRT1-ATT02

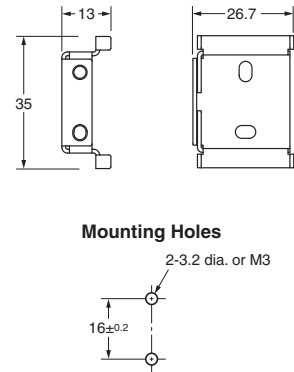

Note: The numbers inside the parentheses are reference dimensions.

● Two-point Analog Output Unit (with e-CON Connectors)

CRT1-VDA02S

When a DCN4-TB4 Open Type Connectors Is Mounted

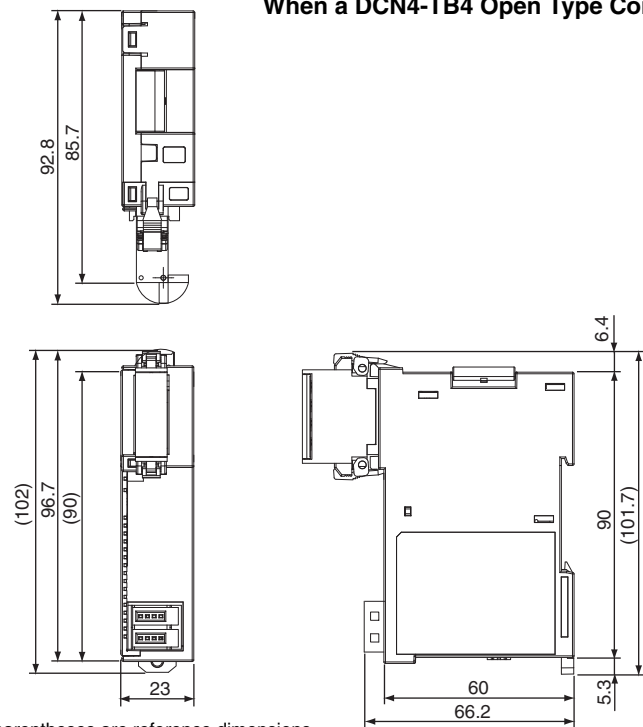

● Mounting Bracket  
CRT1-ATT02

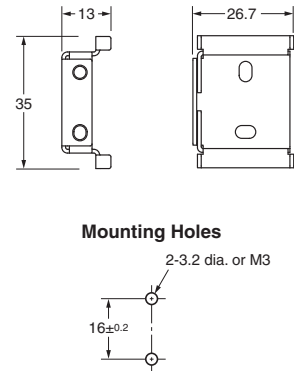

Note: The numbers inside the parentheses are reference dimensions.

Temperature Input Units  
**CRT1-TS04T/-TS04P**

**High-speed Transfer of Temperature Data with CompoNet.**

**Enhanced Smart Functions.**

You can use either of two types of temperature input sensors: Thermocouple and resistance thermometer. Each Unit provides four temperature inputs. Plus, the Units support scaling, comparators, and other data processing, reducing the processing load on the ladder program.

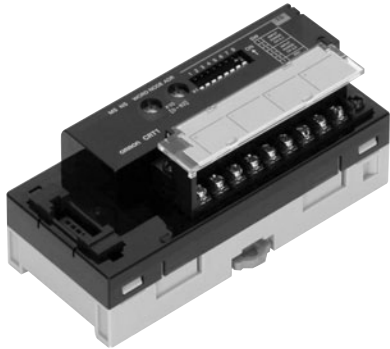

- Product lineup includes models with thermocouple inputs and models with resistance thermometer inputs.
- The node address, input types, and other settings can all be made using the switches on the Slave. (No Support Software is required.)
- Detachable terminal blocks enable easy maintenance without the need to remove wiring.
- Smart functions in the Slave reduce ladder programming and make maintenance easier. For example, scaling to convert input data to desired values, comparators to compare process values with preset upper and lower limits, and integrator to calculate the heat values of equipment or Sensors by from the temperature and measurement time.
- The Sensor open-circuit detection function reduces wiring errors.

**Ordering Information**

Name	Specifications			Model
	Input/Output	Points	Specifications	
Temperature Input Unit	Thermocouple Input	4 inputs	Switchable between R, S, K, J, T, E, B, N, L, U, W, and PL2	CRT1-TS04T
	Platinum-resistance thermometer input		PT100 (-200 to 850°C) PT100 (-200 to 200°C)	CRT1-TS04P

**Performance Specifications**

For Basic Performance Specifications of Slave Units, refer to page 30.

## Specifications

Item	model	CRT1-TS04T	CRT1-TS04P														
Input type		Switchable between R, S, K, J, T, E, B, N, L, U, W, and PL2 When set with CX-Integrator: Input types can be set individually for each input. When set with DIP switch: The same input type setting applies to all 4 inputs.	Switchable between PT100 (-200 to 850°C) and PT100 (-200 to 200°C) When set with CX-Integrator: Input types can be set individually for each input. When set with DIP switch: The same input type setting applies to all 4 inputs.														
Indicator accuracy		(±0.3% of indication value or ±1°C, whichever is larger) ±1 digit max. <b>Indicator Accuracy in Exceptional Cases</b> <table border="1"> <thead> <tr> <th>Input type and temperature range</th> <th>Input accuracy</th> </tr> </thead> <tbody> <tr> <td>K, T, and N below -100°C</td> <td>±2°C ±1 digit max.</td> </tr> <tr> <td>U and L</td> <td>±2°C ±1 digit max.</td> </tr> <tr> <td>R and S below 200°C</td> <td>±3°C ±1 digit max.</td> </tr> <tr> <td>B below 400°C</td> <td>Not specified.</td> </tr> <tr> <td>W</td> <td>±0.3% of indication value or ±3°C (whichever is larger) ±1 digit max.</td> </tr> <tr> <td>PL2</td> <td>±0.3% of indication value or ±2°C (whichever is larger) ±1 digit max.</td> </tr> </tbody> </table>	Input type and temperature range	Input accuracy	K, T, and N below -100°C	±2°C ±1 digit max.	U and L	±2°C ±1 digit max.	R and S below 200°C	±3°C ±1 digit max.	B below 400°C	Not specified.	W	±0.3% of indication value or ±3°C (whichever is larger) ±1 digit max.	PL2	±0.3% of indication value or ±2°C (whichever is larger) ±1 digit max.	-200 to 850°C input range: (±0.3% of indication value or ±0.8°C, whichever is larger) ±1 digit max. -200 to 200°C input range: (±0.3% of indication value or ±0.5°C, whichever is larger) ±1 digit max.
Input type and temperature range	Input accuracy																
K, T, and N below -100°C	±2°C ±1 digit max.																
U and L	±2°C ±1 digit max.																
R and S below 200°C	±3°C ±1 digit max.																
B below 400°C	Not specified.																
W	±0.3% of indication value or ±3°C (whichever is larger) ±1 digit max.																
PL2	±0.3% of indication value or ±2°C (whichever is larger) ±1 digit max.																
Conversion cycle		250 ms/4 points															
Temperature conversion data		Binary data (4-digit hexadecimal when Normal Display Mode is selected or 8-digit hexadecimal when 1/100 Display Mode is selected.)															
Isolation method		Between input and communication lines: Photocoupler isolation Between temperature input signals: Photocoupler isolation															
Mounting method		35-mm DIN track mounting															
Communications power supply current		75 mA max. at 24 VDC 110 mA max. at 14 VDC	75 mA max. at 24 VDC 110 mA max. at 14 VDC														
Weight		148 g max.	147 g max.														

### Effects of Mounting Direction on Accuracy

A cold junction compensator is included in the Terminal Block of the CRT1-TS04T. The input accuracy depends on the mounting direction if only the Unit is replaced.

Mounting direction	Input accuracy														
Mounted normally	As specified in the Performance Specifications.														
Mounted in any direction other than the above	±0.3% of indication value or ±2°C (whichever is larger) ±1 digit max. <b>Indicator Accuracy in Exceptional Cases</b> <table border="1"> <thead> <tr> <th>Input type and temperature range</th> <th>Input accuracy</th> </tr> </thead> <tbody> <tr> <td>K, T, and N below -100°C</td> <td>±3°C ±1 digit max.</td> </tr> <tr> <td>U and L</td> <td>±3°C ±1 digit max.</td> </tr> <tr> <td>R and S below 200°C</td> <td>±4°C ±1 digit max.</td> </tr> <tr> <td>B below 400°C</td> <td>Not specified.</td> </tr> <tr> <td>W</td> <td>±0.3% of indication value or ±4°C (whichever is larger) ±1 digit max.</td> </tr> <tr> <td>PL2</td> <td>±0.3% of indication value or ±3°C (whichever is larger)</td> </tr> </tbody> </table>	Input type and temperature range	Input accuracy	K, T, and N below -100°C	±3°C ±1 digit max.	U and L	±3°C ±1 digit max.	R and S below 200°C	±4°C ±1 digit max.	B below 400°C	Not specified.	W	±0.3% of indication value or ±4°C (whichever is larger) ±1 digit max.	PL2	±0.3% of indication value or ±3°C (whichever is larger)
Input type and temperature range	Input accuracy														
K, T, and N below -100°C	±3°C ±1 digit max.														
U and L	±3°C ±1 digit max.														
R and S below 200°C	±4°C ±1 digit max.														
B below 400°C	Not specified.														
W	±0.3% of indication value or ±4°C (whichever is larger) ±1 digit max.														
PL2	±0.3% of indication value or ±3°C (whichever is larger)														

Dimensions

CRT1-TS04T  
 CRT1-TS04P

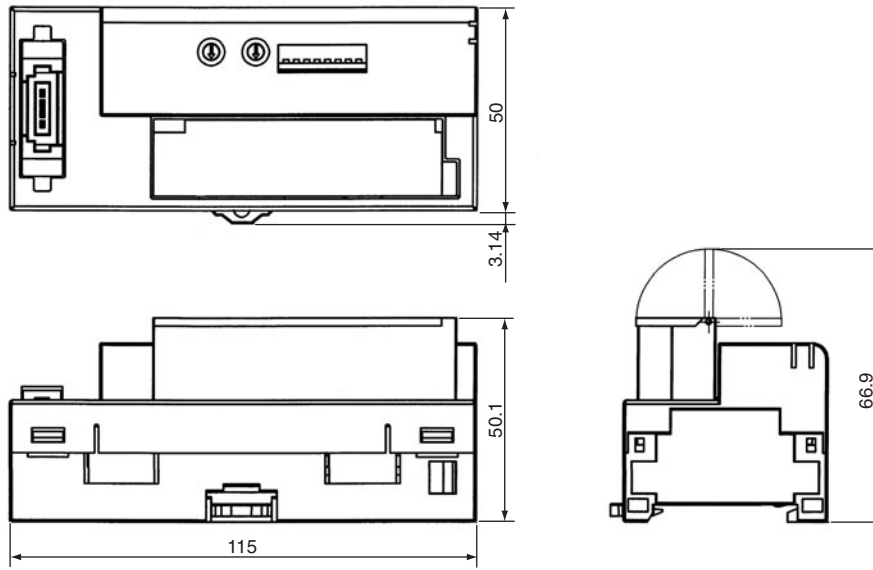

## Expansion Units

# XWT-ID08(-1)/OD08(-1)/ID16(-1)/OD16(-1)

## Expansion I/O Units make expansion easy!

One Expansion Unit can be added to each Digital I/O Slave Unit. This makes a variety of I/O combinations possible, such as 16 inputs + 8 outputs, extending the range of possible system configurations.

- Flexible expansion with many different combinations.
- Removable I/O terminal block enables faster startup time and improved maintainability.
- Collect various preventive maintenance data required to improve productivity, such as information on equipment deterioration due to aging and equipment operating time data.

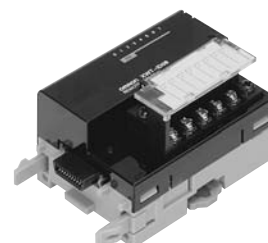

## Ordering Information

Name		Specifications			Model
Expansion Units	Inputs	8 inputs	NPN	One Expansion Unit can be mounted to one CRT1-ID16(-1), CRT1-OD16(-1), CRT1-ROS16, or CRT1-ROF16 Digital I/O Slave.	XWT-ID08
			PNP		XWT-ID08-1
	Outputs	8 outputs	NPN		XWT-OD08
			PNP		XWT-OD08-1
	Inputs	16 inputs	NPN		XWT-ID16
			PNP		XWT-ID16-1
	Outputs	16 outputs	NPN		XWT-OD16
			PNP		XWT-OD16-1

## Performance Specifications

For Basic Performance Specifications of Slave Units, refer to page 30.

## Input Section Specifications

Item	Specification			
Model	XWT-ID08	XWT-ID08-1	XWT-ID16	XWT-ID16-1
Internal I/O common	NPN	PNP	NPN	PNP
I/O capacity	8 inputs		16 inputs	
ON voltage	15 VDC min. (between each input terminal and the V terminal)	15 VDC min. (between each input terminal and the G terminal)	15 VDC min. (between each input terminal and the V terminal)	15 VDC min. (between each input terminal and the G terminal)
OFF voltage	5 VDC max. (between each input terminal and the V terminal)	5 VDC max. (between each input terminal and the G terminal)	5 VDC max. (between each input terminal and the V terminal)	5 VDC max. (between each input terminal and the G terminal)
OFF current	1.0 mA max.			
Input current	At 24 VDC: 6.0 mA max./input At 17 VDC: 3.0 mA max./input			
ON delay	1.5 ms max.			
OFF delay	1.5 ms max.			
Number of circuits per common	8 inputs/common		16 inputs/common	
Communications power supply current consumption	5 mA max. (24 VDC), 5 mA max. (11 VDC)		10 mA max. (24 VDC), 15 mA max. (11 VDC)	
Weight	80 g max.		120 g max.	



**Output Section Specifications**

Item	Specification			
Model	XWT-OD08	XWT-OD08-1	XWT-OD16	XWT-OD16-1
Internal I/O common	NPN	PNP	NPN	PNP
I/O capacity	8 outputs		16 outputs	
Rated output current	0.5 A/output, 2.0 A/common		0.5 A/output, 4.0 A/common	
Residual voltage	1.2 V max. (0.5 A DC, between each output terminal and the G terminal)	1.2 V max. (0.5 A DC, between each output terminal and the V terminal)	1.2 V max. (0.5 A DC, between each output terminal and the G terminal)	1.2 V max. (0.5 A DC, between each output terminal and the V terminal)
Leakage current	0.1 mA max.			
ON delay	0.5 ms max.			
OFF delay	1.5 ms max.			
Number of circuits per common	8 outputs/common		16 outputs/common	
Communications power supply current consumption	5 mA max. (24 VDC), 5 mA max. (11 VDC)		10 mA max. (24 VDC), 15 mA max. (11 VDC)	
Weight	80 g max.		120 g max.	

**Dimensions**

(Unit: mm)

**XWT-ID08 (-1)  
XWT-OD08 (-1)**

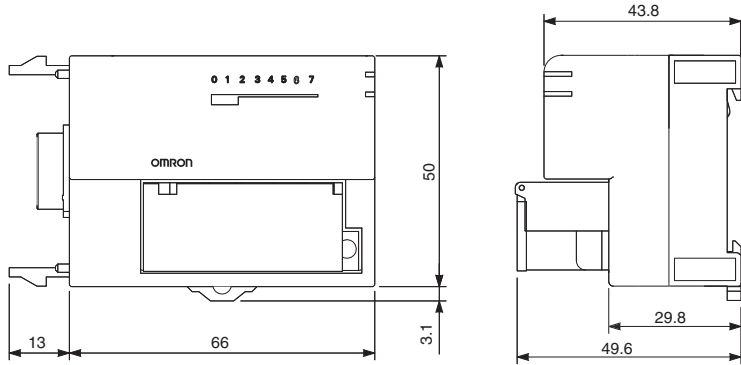

**XWT-ID16 (-1)  
XWT-OD16 (-1)**

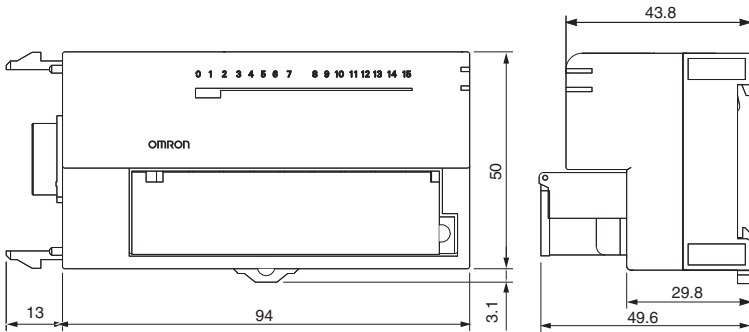

# SmartSlice GRT1-series

**Flexible I/O Configuration Matched to the Application to Down-size Panels, Lower Costs, and Reduce Wiring Work.**

## System Configuration

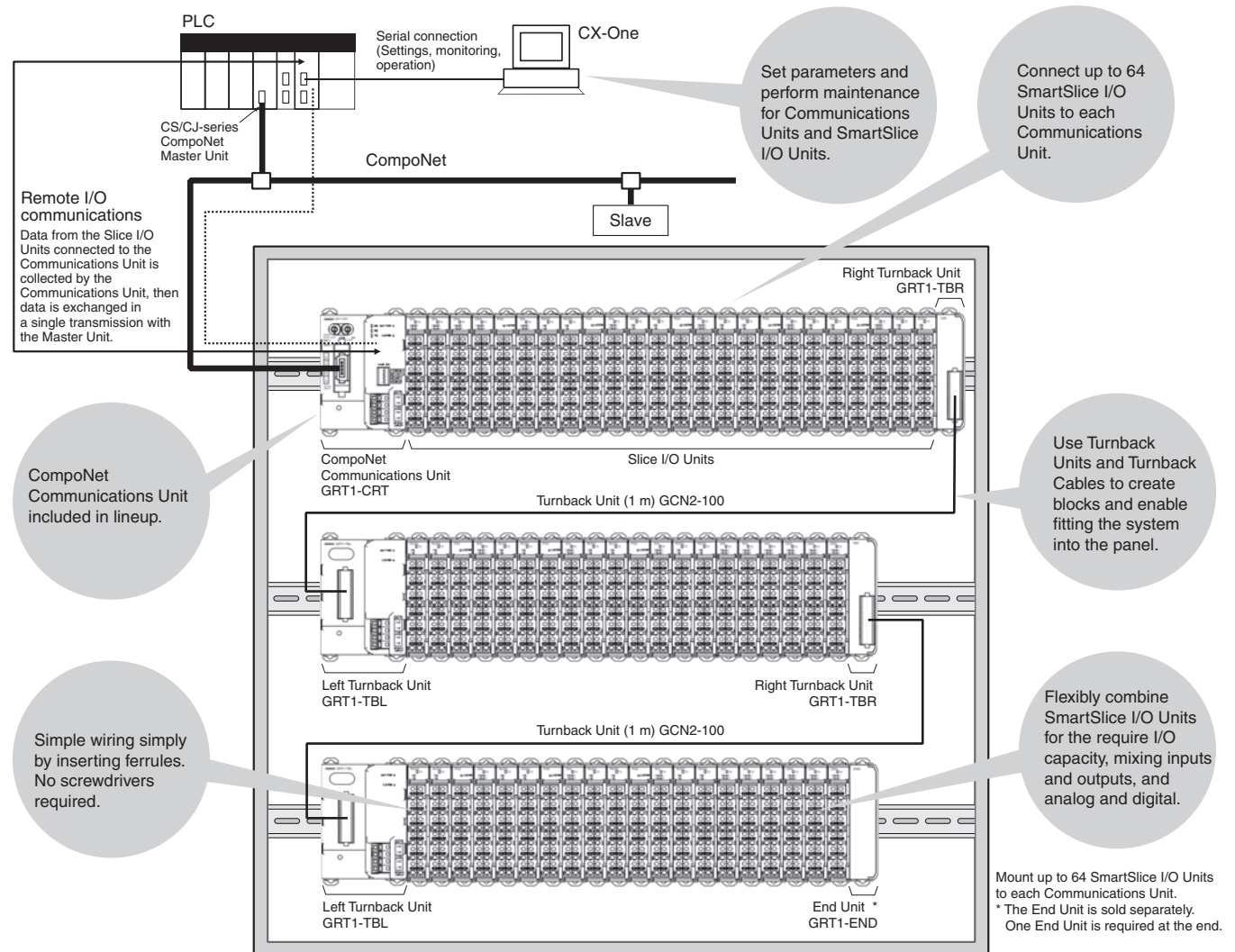

## Internal Circuit Configuration

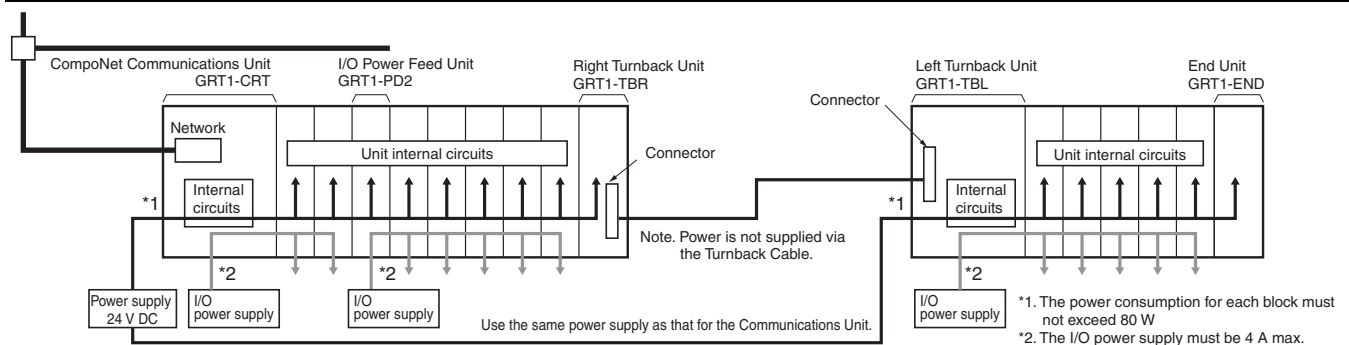

# SmartSlice CompoNet Communications Unit GRT1-CRT

The CompoNet-compliant unit can interface up to 256 inputs and 256 outputs at one node.

- Connects to up to 64 SmartSlice I/O Units.
- Concentrate I/O at one Slave: Up to 256 inputs and 256 outputs.
- Mix different I/O types at one Slave to help save space.
- Just set the node address for easy startup.
- Replace SmartSlice I/O Units online while continuing communications, minimizing system downtime.
- Smart function provided to monitor operating status, facilitating preventive maintenance and increasing operating rates.
- Register dummy SmartSlice I/O to reduce design work for future expansions.



## Ordering Information

Name	Specifications	Model
CompoNet Communications Unit	Connects to up to 64 SmartSlice I/O Units (Inputs: 32 bytes maximum, Outputs: 32 bytes maximum)	GRT1-CRT

## Specifications

Item	Model	GRT1-DRT
Network power supply voltage		14 to 26.4 V DC
Unit power supply voltage		20.4 to 26.4 V DC (24 V +10%/–15%)
I/O power supply voltage		20.4 to 26.4 V DC * (24 V +10%/–15%)
Noise immunity		Conforms to IEC 61000-4-4, 2 kV (power line)
Vibration resistance+		10 to 60 Hz, 0.7-mm double amplitude 60 to 150 Hz: 50 m/s <sup>2</sup>
Shock resistance		150 m/s <sup>2</sup>
Dielectric strength		500 V AC between isolated circuits
Insulation resistance		20 MΩ min. between isolated circuits
Ambient operating temperature		–10 to 55°C (with no icing or condensation)
Ambient operating humidity		25% to 85%
Ambient operating environment		No corrosive gases
Ambient storage temperature		–25 to 65°C (with no icing or condensation)
Mounting method		35-mm DIN track mounting

\* For power supply input to the Slice I/O Units.

## Specifications of the CompoNet Communications Unit

Item	Specification
I/O points	Inputs: 32 bytes maximum (including status and areas which the Unit does not use) Output: 32 bytes maximum (including areas which the Unit does not use)
Maximum number of SmartSlice I/O Units	64 (Do not count the End Unit.)
Status area	1 word (This word shows the status of the CompoNet Communications Unit.)
Parameter backup and restore	You can back up or restore a maximum of 2 KB of data for one CompoNet Communications Unit.
Baud rate	The CompoNet Communications Unit uses the baud rate of the CompoNet Master Unit (93.75 kbps, 1.5 Mbps, 3 Mbps, or 4 Mbps).
Communications media	You can use these cables: Round Cable I (JIS C 3306, VCTF 2-core 0.75-mm <sup>2</sup> twisted-pair cable) Round Cable II (JIS C 3306, VCTF 4-core 0.75-mm <sup>2</sup> twisted-pair cable) Flat Cable I (without sheath, DCA4-4F10) <b>Note:</b> The Round Cable I, Round Cable II and Flat Cable I are different types of cable. You must use a Repeater to divide a branch line from the main line to use more than one type of cable.
Indicators	MS (green/red): This indicator shows the status of the CompoNet Communications Unit. NS (green/red): This indicator shows the communications status of the CompoNet network. TS (green/red): This indicator shows the status of the SmartSlice I/O Terminal. UNIT PWR (green): This indicator shows the status of the Unit power supply. I/O PWR (green): This indicator shows the status of the I/O power supply.
Switches	Rotary switches: There are two rotary switches. You use them to set the node address. DIP switch: There is one DIP switch with four pins. You use them to set the operating mode.
Connectors	There is one CompoNet communications connector.
Terminals	Clamp terminals for Unit power supply (24 VDC) Clamp terminals for I/O power supply (24 VDC)
Power consumption	2.5 W
Power consumption for each SmartSlice I/O Terminal block	80 W max. (You must divide the I/O Terminal into blocks to use more than 80 W.)
SmartSlice I/O Terminal blocks	Main block and a maximum of two expansion blocks
Current consumption for I/O power supply	4 A max.
Weight	137 g
Accessories	None







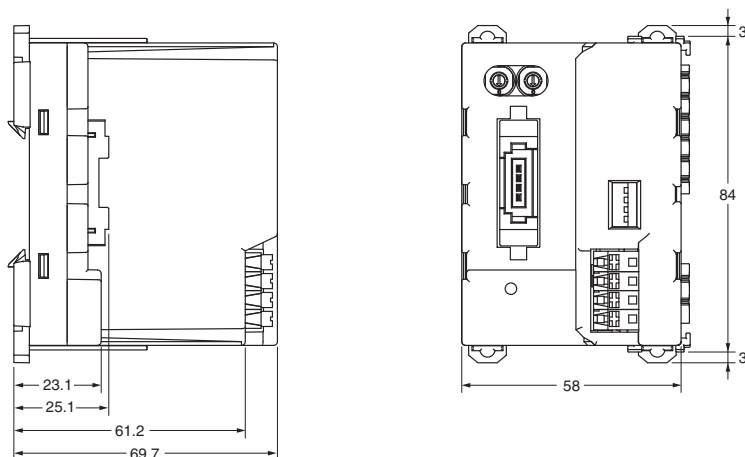

## Dimensions

(Unit: mm)

### GRT1-CRT



SmartSlice Ordering Information

Name		Appearance	Specifications	Model
CompoNet Communication Unit			Up to 64 Slice I/O Units can be connected (Inputs: 32 bytes maximum, Output: 32 bytes maximum)	GRT1-CRT
Slice I/O Units	Digital I/O Units		4 inputs NPN	GRT1-ID4
			4 inputs PNP	GRT1-ID4-1
			4 outputs NPN	GRT1-OD4
			4 outputs PNP	GRT1-OD4-1
			8 inputs NPN	GRT1-ID8
			8 inputs PNP	GRT1-ID8-1
			8 outputs NPN	GRT1-OD8
			8 outputs PNP	GRT1-OD8-1
			Relay Outputs 2 points	GRT1-ROS2
			AC Input 4 points	GRT1-IA4-1 GRT1-IA4-2
	Analog I/O Units		Analog inputs (current/voltage)	GRT1-AD2
			Analog outputs (current)	GRT1-DA2C
			Analog output (voltage)	GRT1-DA2V
	Temperature Input (Resistance Thermometers)		Temperature input (Resistance thermometer:Pt100) 2 points	GRT1-TS2P
			Temperature input (Resistance thermometer:Pt1000) 2 points	GRT1-TS2PK
Thermocouple Input 2 points			GRT1-TS2T	
Counter Units		Counter inputs: 1, External outputs: 1 NPN	GRT1-CT1	
		Counter inputs: 1, External outputs: 1 PNP	GRT1-CT1-1	
System Units	Turnback Units		Right Turnback Unit (Mounts to the right side of Slice I/O Terminal.)	GRT1-TBR
			Left Turnback Unit (Mounts to the left side of Slice I/O Terminal. Can supply power to I/O Units.)	GRT1-TBL
	Turnback Cable *1	---	1 m	GCN2-100
	I/O Power Feed Unit		Use when the total current consumption of the I/O Power Supply exceeds 4 A, or to make the I/O Power Supply a separate system.	GRT1-PD2
				GRT1-PD2G
				GRT1-PD8
GRT1-PD8-1				
End Unit *2		Use to add V/G terminals for I/O power supply.	GRT1-PC8	
			GRT1-PC8-1	
Option	Terminal Block	---	Package of 5 Terminal Blocks	GRT1-BT1-5

\*1 Use the Turnback Cable together with the Turnback Units.

\*2 The End Unit is sold separately. It is not provided with the Communications Unit.

Bit Slave Units with Compact Connectors

# CRT1B-□D02JS(-1)/□D04JS(-1)

## Bit slave of smallest class in industry Innovation in wiring for any type of machinery

- Available in 2 types: 2-point Bit Slave Unit and 4-point Bit Slave Unit.
- Compact size for installation in limited space. Save space and wiring since bit slave can be installed near I/O devices.
- Industry first bit slave connectable with round cables which can be easily purchased at a lower price. Connectable with flat cables, too for easy wiring. Cables are selectable depending on applications.



### Ordering Information

Name	Specifications			Model	
Compact Connectors	Inputs	2 inputs	NPN	CRT1B-ID02JS	
		2 outputs	PNP	CRT1B-ID02JS-1	
	Outputs	2 inputs	NPN	CRT1B-OD02JS	
		2 outputs	PNP	CRT1B-OD02JS-1	
	Inputs/Outputs	1 input/1 output	NPN	CRT1B-MD02JS	
		1 input/1 output	PNP	CRT1B-MD02JS-1	
	Inputs	4 inputs	NPN	CRT1B-ID04JS	
		4 outputs	PNP	CRT1B-ID04JS-1	
	Outputs	4 inputs	NPN	CRT1B-OD04JS	
		4 outputs	PNP	CRT1B-OD04JS-1	
	Inputs/Outputs	2 inputs/2 outputs	NPN	CRT1B-MD04JS	
		2 inputs/2 outputs	PNP	CRT1B-MD04JS-1	
	Mounting Bracket				CRT1-ATT03

#### ● Peripheral Devices

##### For Round Cable I

Name	Model
Open Type Connector (for Unit connection) (Honda Tsushin Kogyo Co.,Ltd.)	HCN-TB4LMZG+ *1
Terminating Resistor	DRS1-T

##### For Round Cable II

Name	Model
Open Type Connector (for Unit connection) (Honda Tsushin Kogyo Co.,Ltd.)	HCN-TB4LMZG+ *1
Terminating Resistor	DCN4-TM4 *2
Flat Connector Socket	DCN4-TR4 *2

Note: The DCN4-MD4 Multidrop Connector cannot be used with Bit Slaves with Compact Connectors. Use Open Type Connector from Honda Tsushin Kogyo Co., Ltd.

##### For Flat Cable I

Name	Model
Flat Connector Socket	DCN4-TR4 *2
Flat Connector Plug	DCN4-BR4 *2
Flat Multidrop Connector Plug	DCN4-MR4 *2
Terminating Resistor	DCN4-TM4 *2
Special Tools	DWT-A01

Note: The DCN4-MD4 Multidrop Connector cannot be used with Bit Slaves with Compact Connectors.

\*1 For information of HCN-TB4LMZG+, contact to Honda Tsushin Kogyo Co.,Ltd. Tel:+81-52-242-2111

\*2 The minimum quantity packaged is 10 Connectors.Oder the Connectors in multiples of 10.

● Compact Connectors

The compact connectors use XA-series Connectors from JST Mfg. Co., Ltd. Special cable connectors must be attached for cables connecting to external devices if a Slave Unit with Compact Connectors is used.

Name		Applicable cable range			Model	Crimping Tool
		mm <sup>2</sup>	AWG#	Wire sheath external diameter		
Contacts	Loose terminal	0.08 to 0.33	28 to 22	1.2 to 1.9	BXA-001T-P0.6	YC-692R
	Chain terminal				SXA-001T-P0.6	YRS-692
	Loose terminal	0.22 to 0.5	24 to 20	1.5 to 1.9	BXA-01T-P0.6	YC-701R
	Chain terminal				SXA-01T-P0.6	YRS-701
Housing	---	---	---	---	XAP-03V-1	---

- Note 1. Automated Crimp Tools are also available. For details, contact the manufacturer.  
 2. For information on the processing procedure, refer to the instruction manual included with the tool or contact the manufacturer (JST Mfg. Co., Ltd.).

**Performance Specifications**

For Basic Performance Specifications of Slave Units, refer to page 30.

**Input Section Specifications**

Item	Specification			
	CRT1B-ID02JS	CRT1B-ID02JS-1	CRT1B-ID04JS	CRT1B-ID04JS-1
Model	CRT1B-ID02JS	CRT1B-ID02JS-1	CRT1B-ID04JS	CRT1B-ID04JS-1
I/O capacity	2 inputs		4 inputs	
Internal I/O common	NPN	PNP	NPN	PNP
ON voltage	10.5 VDC min. (between each input terminal and the V terminal)	10.5 VDC min. (between each input terminal and the G terminal)	10.5 VDC min. (between each input terminal and the V terminal)	10.5 VDC min. (between each input terminal and the G terminal)
OFF voltage	---	---	---	---
OFF current	1.0 mA max.		1.0 mA max.	
Input current	3.0 mA min./input (at 10.5 VDC)		3.0 mA min./input (at 10.5 VDC)	
Sensor power supply voltage	Communications power supply voltage 0 V (max.) Communications power supply voltage -1 V (min.)		Communications power supply voltage 0 V (max.) Communications power supply voltage -1 V (min.)	
ON delay	1.5 ms max.		1.5 ms max.	
OFF delay	1.5 ms max.		1.5 ms max.	
Number of circuits per common	2 inputs/common		4 inputs/common	
Power short-circuit detection	Not supported.		Not supported.	
Isolation method	No isolation		No isolation	
Input indicators	LEDs (yellow)		LEDs (yellow)	
Degree of protection	IEC standard IP20		IEC standard IP20	
Installation	M4 screw mounting using CRT1B-ATT03 Mounting Bracket		M4 screw mounting using CRT1B-ATT03 Mounting Bracket	
Power supply type	Network power supply		Network power supply	
Communications power supply current consumption *	25 mA max. for 24-VDC power supply voltage 30 mA max. for 14-VDC power supply voltage		35 mA max. for 24-VDC power supply voltage 40 mA max. for 14-VDC power supply voltage	
Input device supply current	50 mA/point (G terminal)	50 mA/point (V terminal)	50 mA/point (G terminal)	50 mA/point (V terminal)
Weight	16 g max.		21 g max.	

\* The current consumption is for Bit Slave Unit communications current when all inputs are OFF, i.e., it does not include input device current consumption. The communications power supply is also used for the I/O power supply for sensors. Be sure to consider the sensor current consumption and the number of sensors connected in addition to the communications power.

The power supply current consumption is expressed by the following formula.

$$\text{Communications power supply current consumption} = \text{Bit Slave Unit communications current consumption} + (\text{Bit Slave Unit input current} \times \text{number of inputs used}) + (\text{sensor current consumption} \times \text{number of sensors used})$$

## Output Section Specifications

Item	Specification			
Model	CRT1B-OD02JS	CRT1B-OD02JS-1	CRT1B-OD04JS	CRT1B-OD04JS-1
I/O capacity	2 outputs		4 outputs	
Internal I/O common	NPN	PNP	NPN	PNP
Rated output current	0.1 A/output		0.1 A/output	
Load power supply voltage	Communications power supply voltage 0 V (max.) Communications power supply voltage -1.2 V (min.)		Communications power supply voltage 0 V (max.) Communications power supply voltage -1.2 V (min.)	
Residual voltage	1.2 V max. (0.1 A DC, between each output terminal and G terminal)	1.2 V max. (0.1 A DC, between each output terminal and V terminal)	1.2 V max. (0.1 A DC, between each output terminal and G terminal)	1.2 V max. (0.1 A DC, between each output terminal and V terminal)
Leakage current	0.1 mA max.		0.1 mA max.	
ON delay	0.5 ms max.		0.5 ms max.	
OFF delay	1.5 ms max.		1.5 ms max.	
Number of circuits per common	2 outputs/common		4 outputs/common	
Load short-circuit detection	Not supported.		Not supported.	
Isolation method	No isolation		No isolation	
Output indicators	LEDs (yellow)		LEDs (yellow)	
Degree of protection	IEC standard IP20		IEC standard IP20	
Installation	M4 screw mounting using CRT1B-ATT03 Mounting Bracket		M4 screw mounting using CRT1B-ATT03 Mounting Bracket	
Power supply type	Network power supply		Network power supply	
Communications power supply current consumption (See note.)	25 mA max. for 24-VDC power supply voltage 30 mA max. for 14-VDC power supply voltage		30 mA max. for 24-VDC power supply voltage 35 mA max. for 14-VDC power supply voltage	
Output device supply current	30 mA/point (G terminal)	30 mA/point (V terminal)	30 mA/point (G terminal)	30 mA/point (V terminal)
Weight	16 g max.		21 g max.	

\* The current consumption is for Bit Slave Unit communications current when all outputs are OFF, i.e., it does not include the output device load current consumption. The communications power supply is also used for the I/O power supply for actuators. Be sure to consider the actuator load current consumption and the number of sensors connected in addition to the communications power. The power supply current consumption is expressed by the following formula.

Communications power supply current consumption = Bit Slave Unit communications current consumption + (actual load current × number of actuators used)



## Input and Output Section Specifications

### ● 1-point Input and 1-point Output units

#### Input Section Specification

Item	Specification	
	CRT1B-MD02JS	CRT1B-MD02JS-1
Model	CRT1B-MD02JS	CRT1B-MD02JS-1
I/O capacity	1 input	
Internal I/O common	NPN	PNP
ON voltage	10.5 VDC min. (between each input terminal and the V terminal)	10.5 VDC min. (between each input terminal and the G terminal)
OFF voltage	---	---
OFF current	1.0 mA max.	
Input current	3.0 mA min./input (at 10.5 VDC)	
Sensor power supply voltage	Communications power supply voltage 0 V (max.) Communications power supply voltage -1 V (min.)	
ON delay	1.5 ms max.	
OFF delay	1.5 ms max.	
Number of circuits per common	1 input/common	
Power short-circuit detection	Not supported.	
Isolation method	No isolation	
Input indicators	LEDs (yellow)	
Degree of protection	IEC standard IP20	
Installation	M4 screw mounting using CRT1B-ATT03 Mounting Bracket	
Power supply type	Network power supply	
Communications power supply current consumption *	25 mA max. for 24-VDC power supply voltage 30 mA max. for 14-VDC power supply voltage	
Input device supply current	50 mA/point (G terminal)	50 mA/point (V terminal)
Weight	16 g max.	

#### Output Section Specification

Item	Specification	
	CRT1B-MD02JS	CRT1B-MD02JS-1
Model	CRT1B-MD02JS	CRT1B-MD02JS-1
I/O capacity	1 output	
Internal I/O common	NPN	PNP
Rated output current	0.1 A/output	
Load power supply voltage	Communications power supply voltage 0 V (max.) Communications power supply voltage -1.2 V (min.)	
Residual voltage	1.2 V max. (DC, 0.1 A, between each output terminal and G terminal)	1.2 V max. (DC, 0.1 A, between each output terminal and V terminal)
Leakage current	0.1 mA max.	
ON delay	0.5 ms max.	
OFF delay	1.5 ms max.	
Number of circuits per common	1 output/common	
Load short-circuit detection	Not supported.	
Isolation method	No isolation	
Output indicators	LEDs (yellow)	
Degree of protection	IEC standard IP20	
Installation	M4 screw mounting using CRT1B-ATT03 Mounting Bracket	
Power supply type	Network power supply	
Output device supply current	30 mA/point (G terminal)	30 mA/point (V terminal)

\* The current consumption is for Bit Slave Unit communications current when all inputs are OFF, i.e., it does not include input device current consumption. The communications power supply is also used for the I/O power supply for sensors. Be sure to consider the sensor current consumption and the number of sensors connected in addition to the communications power. The power supply current consumption is expressed by the following formula.

Communications power supply current consumption = Bit Slave Unit communications current consumption + (Bit Slave Unit input current × number of inputs used) + (sensor current consumption × number of sensors used)

● 2-points Inputs and 2-points Outputs units

Input Section Specification

Item	Specification	
Model	CRT1B-MD04JS	CRT1B-MD04JS-1
I/O capacity	2 inputs	
Internal I/O common	NPN	PNP
ON voltage	10.5 VDC min. (between each input terminal and the V terminal)	10.5 VDC min. (between each input terminal and the G terminal)
OFF voltage	---	---
OFF current	1.0 mA max.	
Input current	3.0 mA min./input (at 10.5 VDC)	
Sensor power supply voltage	Communications power supply voltage 0 V (max.) Communications power supply voltage -1 V (min.)	
ON delay	1.5 ms max.	
OFF delay	1.5 ms max.	
Number of circuits per common	2 inputs/common	
Power short-circuit detection	Not supported.	
Isolation method	No isolation	
Input indicators	LEDs (yellow)	
Degree of protection	IEC standard IP20	
Installation	M4 screw mounting using CRT1B-ATT03 Mounting Bracket	
Power supply type	Network power supply	
Communications power supply current consumption *	35 mA max. for 24-VDC power supply voltage 40 mA max. for 14-VDC power supply voltage	
Input device supply current	50 mA/point (G terminal)	50 mA/point (V terminal)
Weight	21 g max.	

Output Section Specification

Item	Specification	
Model	CRT1B-MD04JS	CRT1B-MD04JS-1
I/O capacity	2 outputs	
Internal I/O common	NPN	PNP
Rated output current	0.1 A/output	
Load power supply voltage	Communications power supply voltage 0 V (max.) Communications power supply voltage -1.2 V (min.)	
Residual voltage	1.2 V max. (DC, 0.1 A, between each output terminal and G terminal)	1.2 V max. (DC, 0.1 A, between each output terminal and V terminal)
Leakage current	0.1 mA max.	
ON delay	0.5 ms max.	
OFF delay	1.5 ms max.	
Number of circuits per common	2 outputs/common	
Load short-circuit detection	Not supported.	
Isolation method	No isolation	
Output indicators	LEDs (yellow)	
Degree of protection	IEC standard IP20	
Installation	M4 screw mounting using CRT1B-ATT03 Mounting Bracket	
Power supply type	Network power supply	
Output device supply current	30 mA/point (G terminal)	30 mA/point (V terminal)

\* The current consumption is for Bit Slave Unit communications current when all inputs are OFF, i.e., it does not include input device current consumption. The communications power supply is also used for the I/O power supply for sensors. Be sure to consider the sensor current consumption and the number of sensors connected in addition to the communications power. The power supply current consumption is expressed by the following formula.

Communications power supply current consumption = Bit Slave Unit communications current consumption + (Bit Slave Unit input current × number of inputs used) + (sensor current consumption × number of sensors used)

**Wiring**

Wire colors have been changed according to revisions in the JIS standards for photoelectric and proximity sensors. The colors in parentheses are the wire colors prior to the revisions.

The I/O connector section uses compact connectors. Pin arrangements and signals are shown below. The figure of connector shows the side to insert cables.

● **2-points Inputs/4-points Inputs type**

**CRT1B-ID02JS (NPN)**  
**CRT1B-ID04JS (NPN)**

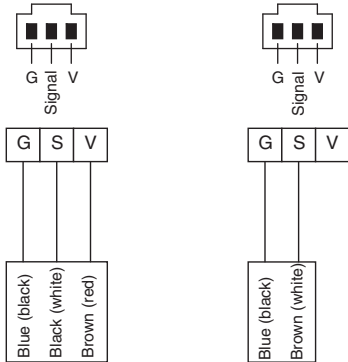

3-wire sensor with NPN output (photoelectric sensor or proximity sensor)

2-wire sensor (e.g., limit switch)

**CRT1B-ID02JS-1 (PNP)**  
**CRT1B-ID04JS-1 (PNP)**

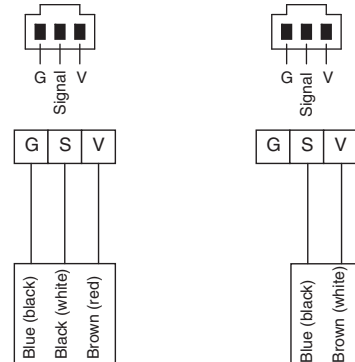

3-wire sensor with PNP output (photoelectric sensor or proximity sensor)

2-wire sensor (e.g., limit switch)

● **2-points Outputs/4-points Outputs type**

**CRT1B-OD02JS (NPN)**  
**CRT1B-OD04JS (NPN)**

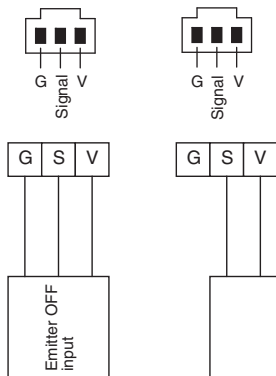

Photoelectric sensor, emitter, etc.

Solenoid, valve, etc.

**CRT1B-OD02JS-1 (PNP)**  
**CRT1B-OD04JS-1 (PNP)**

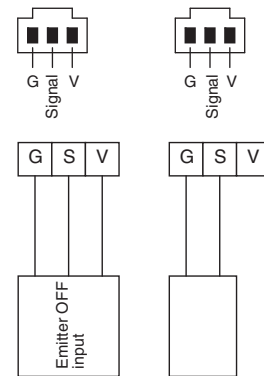

Photoelectric sensor, emitter, etc.

Solenoid, valve, etc.

● 1-point Input/1-point Output type, 2-points Inputs/2-points Outputs type

**CRT1B-MD02JS (NPN)**

**CRT1B-MD04JS (NPN)**

Input Connectors

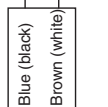
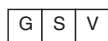
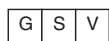
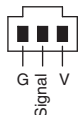
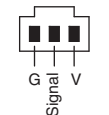

3-wire sensor with NPN output (photoelectric sensor or proximity sensor)

2-wire sensor (e.g., limit switch)

Output Connectors

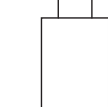
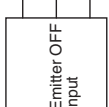
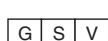
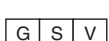
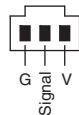
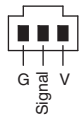

Photoelectric sensor, emitter, etc.

Solenoid, valve, etc.

**CRT1B-MD02JS-1 (PNP)**

**CRT1B-MD04JS-1 (PNP)**

Input Connectors

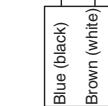
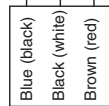
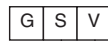
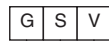
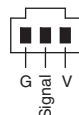
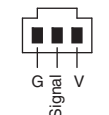

3-wire sensor with PNP output (photoelectric sensor or proximity sensor)

2-wire sensor (e.g., limit switch)

Output Connectors

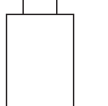
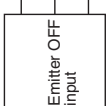
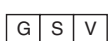
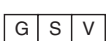
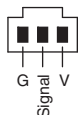
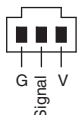

Photoelectric sensor, emitter, etc.

Solenoid, valve, etc.

Dimensions

(Unit: mm)

● 2-points Inputs, 2-points Outputs, 1-point Input/1-point Output type

- CRT1B-ID02JS
- CRT1B-ID02JS-1
- CRT1B-OD02JS
- CRT1B-OD02JS-1
- CRT1B-MD02JS
- CRT1B-MD02JS-1

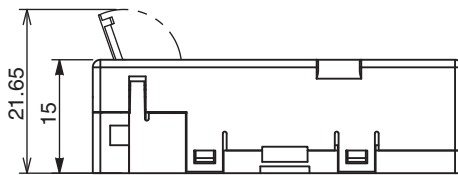
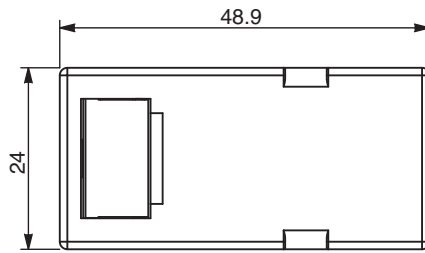

● 4-points Inputs, 4-points Outputs, 2-points Inputs/2-points Outputs type

- CRT1B-ID04JS
- CRT1B-ID04JS-1
- CRT1B-OD04JS
- CRT1B-OD04JS-1
- CRT1B-MD04JS
- CRT1B-MD04JS-1

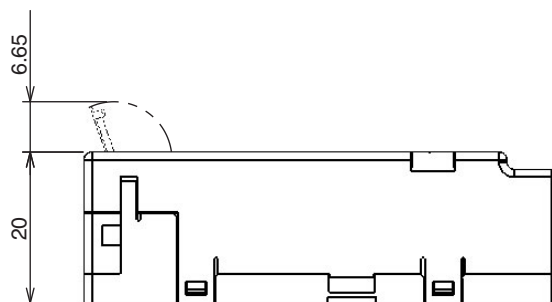
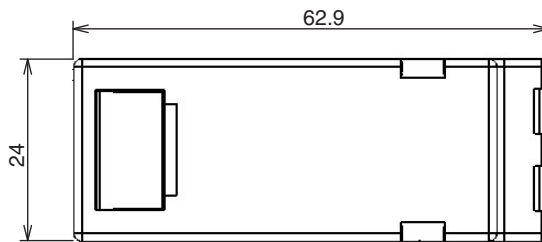

Bit Slave Units with e-CON Connectors

# CRT1B-□D02S(-1)

## Simple and Intelligent Bit Slaves with Industry-standard e-CON connectors.

Slave Units capable of 2-point bit-level distribution. The I/O power supply is supplied from the communications power in the previously connected flat cable, and has a short-circuit detection function for protection.

- Industry-standard e-CON connectors
- Short-circuit protection safeguards the network from I/O short circuits.
- Simple communications connections with flat cable and connectors.
- Bit-level distribution to support essentially any application.



### Ordering Information

Name	Specifications			Model
Bit Slave Units with e-CON Connectors	Inputs	2 inputs	NPN	CRT1B-ID02S
			PNP	CRT1B-ID02S-1
	Outputs	2 outputs	NPN	CRT1B-OD02S
			PNP	CRT1B-OD02S-1

### Performance Specifications

For Basic Performance Specifications of Slave Units, refer to page 30.

## Input Section Specifications

Item	Specification	
Model	CRT1B-ID02S	CRT1B-ID02S-1
I/O capacity	2 inputs	
Internal I/O common	NPN	PNP
ON voltage	10.5 VDC min. (between each input terminal and the V terminal)	10.5 VDC min. (between each input terminal and the G terminal)
OFF voltage	5 VDC max. (between each input terminal and the V terminal)	5 VDC max. (between each input terminal and the G terminal)
OFF current	1.0 mA max.	
Input current	3.0 mA max./input (at 10.5 VDC)	
Sensor power supply voltage	Communications power supply voltage + 0 V (max.) Communications power supply voltage - 1 V (min.)	
ON delay	1.5 ms max.	
OFF delay	1.5 ms max.	
Number of circuits per common	2 inputs/common	
Power short-circuit detection	Supported	
Isolation method	No isolation	
Input indicators	LEDs (yellow)	
Degree of protection	IEC standard IP20	
Installation	Screw installation (M4)	
Power supply type	Network power supply	
Communications power supply current consumption *	65 mA max. for 24-VDC power supply voltage 80 mA max. for 14-VDC power supply voltage	45 mA max. for 24-VDC power supply voltage 65 mA max. for 14-VDC power supply voltage
Weight	70 g max.	

\* The current consumption is for Bit Slave Unit communications current when all inputs are OFF, i.e., it does not include input device current consumption. The communications power supply is also used for the I/O power supply for sensors. Be sure to consider the sensor current consumption and the number of sensors connected in addition to the communications power.

The power supply current consumption is expressed by the following formula.

Communications power supply current consumption = Bit Slave Unit communications current consumption + (Bit Slave Unit input current x number of inputs used) + (sensor current consumption x number of sensors used)

## Output Section Specifications

Item	Specification	
Model	CRT1B-OD02S	CRT1B-OD02S-1
I/O capacity	2 outputs	
Internal I/O common	NPN	PNP
Rated output current	0.2 A/output	
Load power supply voltage	Communications power supply voltage + 0 V (max.) Communications power supply voltage – 1.2 V (min.)	
Residual voltage	1.2 V max. (0.2 A DC, between each output terminal and the BS-	1.2 V max. (0.2 A DC, between each output terminal and the BS+
Leakage current	0.1 mA max.	
ON delay	0.5 ms max.	
OFF delay	1.5 ms max.	
Number of circuits per common	2 outputs/common	
Load power short-circuit detection	Supported	
Isolation method	No isolation	
Output indicators	LEDs (yellow)	
Degree of protection	IEC standard IP20	
Installation	Screw installation (M4)	
Power supply type	Network power supply	
Communications power supply current consumption *	55 mA max. for 24-VDC power supply voltage 75 mA max. for 14-VDC power supply voltage	55 mA max. for 24-VDC power supply voltage 70 mA max. for 14-VDC power supply voltage
Weight	59 g max.	

\* The current consumption is for Bit Slave Unit communications current when all outputs are OFF, i.e., it does not include output device load current consumption. The communications power supply is also used for the I/O power supply for actuators. Be sure to consider the actuator load current consumption and the number of actuators connected in addition to the communications power.

The power supply current consumption is expressed by the following formula.

Communications power supply current consumption = Bit Slave Unit communications current consumption + (Bit Slave Unit input current x number of inputs used) + (actuator load current x number of actuators used)



Dimensions

(Unit: mm)

CRT1B-ID02S(-1)  
CRT1B-OD02S(-1)

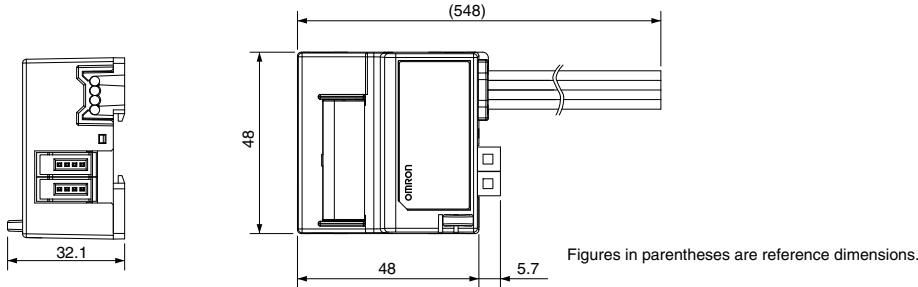

Repeater Unit

# CRS1-RPT01

## Simple and Intelligent Repeater Units Extend the Network

Repeater Units can make CompoNet Networks easier to wire, and extend cable length.

When Repeater Units are connected in series from the Master Unit, up to two extra segment layers can be created (i.e., up to 2 Repeater Units are allowed between a Slave Unit and the Master Unit).

- Expand the network to up to 1,500 m using two segment layers of Repeater Units (baud rate: 93.75 kbps).
- Avoid total system breakdown caused by errors in lower-level Units.
- Repeater Units allow a different cable types to be used in the same network.
- Implement various network layouts by branching lines or extending the trunk line.
- Display a network configuration list or identify error locations by using the setting and monitoring software for CompoNet.
- Monitor the power supply for the entire network with communications power supply monitoring function.



### Ordering Information

Name	Specifications	Model
Repeater Unit	A sub-trunk line can be connected downstream (for trunk-branch line configuration) or further branching is enabled downstream (for configurations with no wiring restrictions) in the same way as for a Master Unit. A Repeater Unit can be used to branch the trunk line and increase the number of connected Units, as well as to extend the length of the communications line.	CRS1-RPT01 *

\* These Units are also available with a DCN-TB4 Terminal Conversion Adapter included in the package. Add "(-B)" to the end of the model number to receive the Adapter as well.

## Specifications

Item	Specification
Model	CRS1-RPT01
Communications ports	Upstream port (port 1): Trunk line or sub-trunk line Downstream port (port 2): Sub-trunk line (Can be wired with the same communications specifications as the Master Unit.) Different types of communications cable can be connected to the upstream and downstream ports.
Maximum number of layers	Up to two extra segment layers can be created from the Master Unit.
Number of nodes per network (per Master Unit)	64 nodes
Number of nodes per trunk line or sub-trunk line	32 nodes (Including Slave Units)
Communications power supply connector	One downstream communications port power supply connector <b>Note:</b> Communications power for the Repeater Unit is supplied from the BS+ and BS- terminals on the upstream port communications connector (PORT1).
Communications power supply connector allowable current capacity	5 A max.
Noise immunity	Conforms to IEC 61000-4-4 2 kV (power line).
Vibration resistance	10 to 150 Hz with double-amplitude of 0.7 mm or 50 m/s <sup>2</sup>
Shock resistance	150 m/s <sup>2</sup>
Dielectric strength	500 VAC (between isolated circuits)
Insulation resistance	20 MΩ min. (between isolated circuits)
Ambient operating temperature	-10 to 55°C
Ambient operating humidity	25% to 85% (with no condensation)
Ambient operating atmosphere	No corrosive gases
Storage temperature	-25 to 65°C
Storage humidity	25% to 85% (with no condensation)
Installation	DIN Track or M4 screws
Weight	73 g
Communications power supply voltage	14 to 26.4 VDC
Communications power supply current consumption	95 mA max.

### ● Slave Port Communications Power Supply Connector

This connector supplies communications power to Slave Units and Repeater Units connected to the Slave port communications connector (port 2).

BS+	Communications power supply +
BS-	Communications power supply -

**Note:** Communications power for the Repeater Unit is supplied from the BS+ and BS- terminals on the upstream port communications connector (port 1).

### Recommended Ferrules

The following ferrules are recommended for the communications power supply cable.

Product number	Applicable power cable size	Crimping tool	Manufacturer
A10,5-10 WH	0.5 mm (AWG20)	CRIMPFOX UD6 (Product No. 1204436) or CRIMPFOX ZA3 series	Phoenix Contact K.K.
H0.5/16 orange	0.5 mm (AWG20)	Crimper PZ1.5 (Product No. 900599)	Weidmueller Japan Co.,Ltd.

The following screwdriver is recommended for use when removing ferrules.

Product number	Manufacturer
XW4Z-00C	OMRON Corporation

**Dimensions**

(Unit: mm)

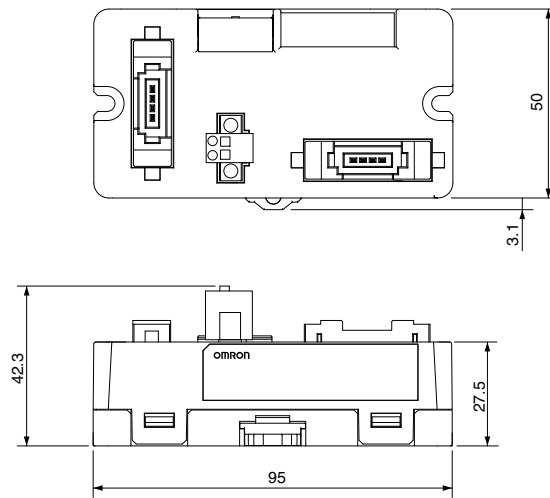
**CRS1-RPT01**

# Sensor Communications Unit ZS-CRT

## A Communications Gateway that Connects Smart Sensors to CompoNet

High-Speed Smart Sensor measurement data collection at the PLC or PT.

- Start up simply by connecting the communications cable.
- Supports triggered measurements and acquisition of judgment results, and features control signal lines that do not require wiring.



### Ordering Information

Name	I/O classification	Allocated bits	Internal circuit power supply	I/O power supply voltage	Connected Controller model	Model
Sensor Communications Unit	Input and output	160 bits max.	Supplied along with communications power	24 VDC	ZS-LDC□□ ZS-MDC□□ ZS-HLDC□□ ZFV-CA□□ *	ZS-CRT

\* ZFV-CA□□ was discontinued.

### Performance Specifications

Item	Specification
Communications power supply voltage	14 to 26.4 VDC
Communications power supply current consumption	200 mA max.
Connected Controller models	ZS-LDC□□ (Ver. 2.300 or later), ZS-MDC□□ (Ver. 2.200 or later), ZS-HLDC□□ (Ver. 1.030 or later), ZFV-CA□□ (Ver. 1.300 or later)
Functions	Constant monitoring function for measurement results, trigger measurement monitoring function, message communications function
Indicators	MS (green/red), NS (green/red), and USB (green/red)
Vibration resistance	10 to 150 Hz with double-amplitude of 0.7 mm or 50 m/s <sup>2</sup>
Shock resistance	150 m/s <sup>2</sup>
Dielectric strength	1,000 VAC 50/60 Hz for 1 min
Insulation resistance	30 MΩ min.
Ambient operating temperature	00 to 50°C
Ambient operating humidity	25% to 85% (with no condensation)
Storage temperature	-15 to 65°C (No icing or condensation)
Storage humidity	25% to 85% (with no condensation)
Installation	Mounted on 35-mm DIN Track
Degree of protection	IP20
Material	Case: ABS
Accessories	Instruction Manual, ferrite core
Weight	Approx. 130 g

Dimensions

(Unit: mm)

ZS-CRT

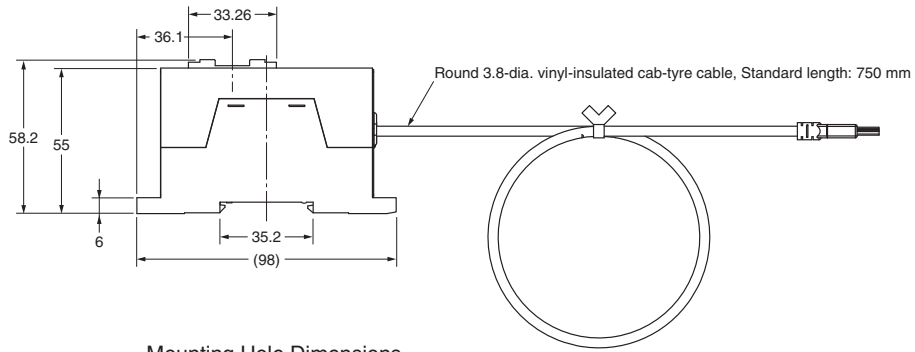
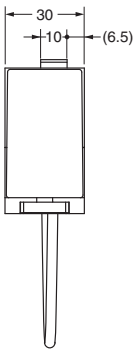
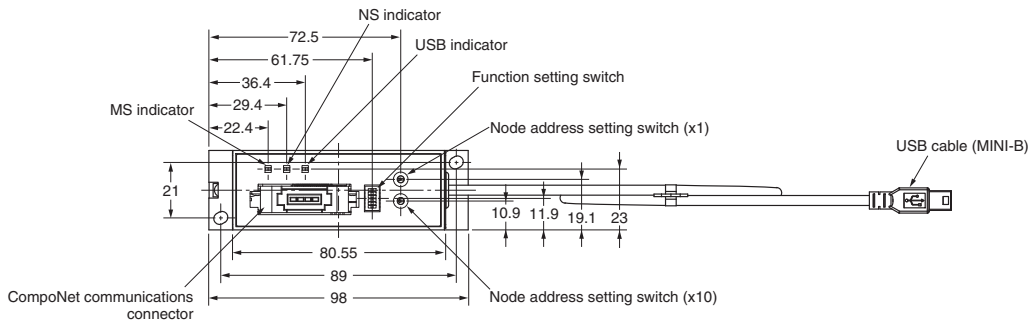

Mounting Hole Dimensions

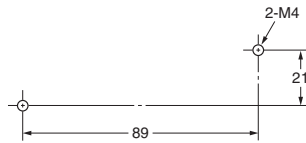

# Sensor Communication Unit (CompoNet) E3X-CRT

## CompoNet Sensor Communications Unit that Simplifies Sensor Setting Management

- Transmit ON/OFF signals to a PLC without a program (CompoNet communication slave function).
- Supports operations such as reading, writing, and teaching detection amounts, threshold values, and function settings (by way of the explicit message function).
- Supports wire saving by requiring only the wiring necessary to connect the communication cable to the amplifier placed next to the E3X-CRT.
- Supports connection 16 pcs amplifier (max).\*

\* Change by operation mode



### Ordering Information

#### ● CompoNet Slave Sensor Communication Unit

I/O Classification	Allocated bits	Internal circuit power supply	Power Supply Voltage	Model
Change by operation model *		Supplied along with communications power	24VDC	E3X-CRT

\* The E3X-CRT has two operating modes; I/O mode 1 and I/O mode 2. The following table gives the differences between these modes.

Mode	I/O Classification	Allocated bits	Connection amplifier number (max)
I/O mode1	Input Unit	Input: 32bit	15
I/O mode2	Input and Output Unit	Input: 64bit Output: 64bit	16

#### ● Supports Sensor Amplifier

Unit	Characteristic	Connection Method	Power Supply	Model
Standard fiber amplifier	Simple setting and operation Fiber Amplifier	Connect to a communication unit Only by connector	Supplied along with a power supply connector.	E3X-HD0
2CH Fiber amplifier	Supports connection 2CH fiber Amplifier			E3X-MDA0
High-function fiber amplifier	Supports setting 2 thresholds fiber Amplifier			E3X-DA0-S *
Laser sensor amplifier	Laser type digital Sensor Amplifier			E3C-LDA0
Proximity sensor amplifier	High Precision Proximity Sensor Amplifier			E2C-EDA0

**Note.** Limitation about amplifier setting: See the E3X-ECT User's manual (Man No.E413).

\* High-function fiber amplifier (E3X-DA0-S) was discontinued.

### Ratings and Specifications

<b>Communications power</b>	DC14-26.4V(supply from communication connector)
<b>Power supply wattage and current</b>	2.4 W (max) (Not include sensors current) 100 mA (max) DC24V (Not include sensors current)
<b>Communication method</b>	CompoNet
<b>Function</b>	I/O communication, explicit message, Sensor Error Output
<b>Indicators</b>	MS (green/red), NS (green/red), SS (Sensor Status) (green/red)
<b>Vibration resistance</b>	10 to 150 Hz with double-amplitude of 0.7 mm or 50 m/s <sup>2</sup> 80 minutes
<b>Shock resistance</b>	150 m/s <sup>2</sup> 3 directions each 3 times
<b>Dielectric strength</b>	AC 500V 50/60Hz 1min
<b>Insulation resistance</b>	20 MΩ min.

<b>Ambient operating temperature</b>	0 to 55°C *
<b>Ambient operating humidity</b>	25-85% (with no condensation)
<b>Storage temperature</b>	-30 to +70°C (No icing or condensation)
<b>Storage humidity</b>	25 to 85% (No icing or condensation)
<b>Installation</b>	Mounted on 35-mm DIN Track
<b>Accessories</b>	Connector Cover, Brackets for DIN
<b>Weight (packed state/unit only)</b>	220/95 g (max)

\* Limitation of the temperature by connection amplifiers number below.

- 1 to 2 : 0 to 55 °C,
- 3 to 10: 0 to 50 °C,
- 11 to 16: 0 to 45 °C

Dimensions

(Unit: mm)

E3X-CRT

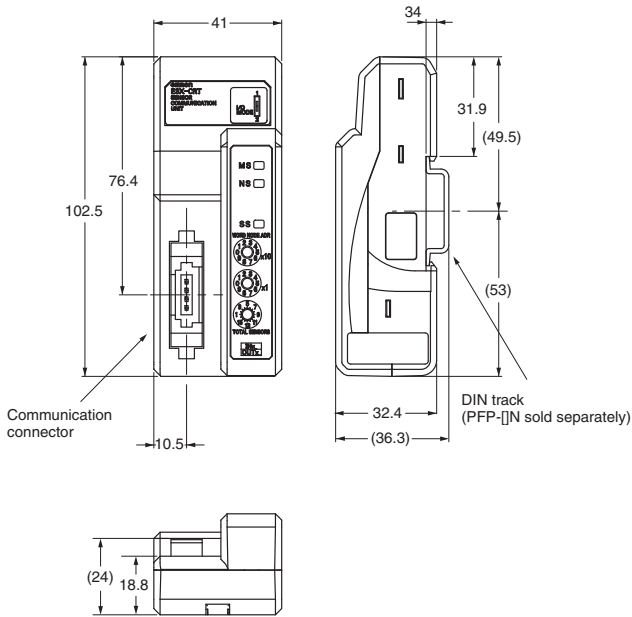

E3X-HD0

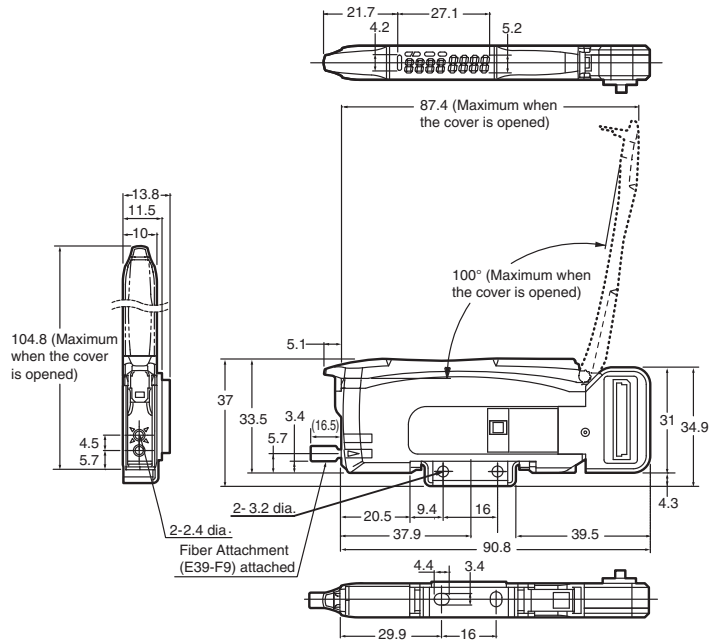

E3C-LDA0

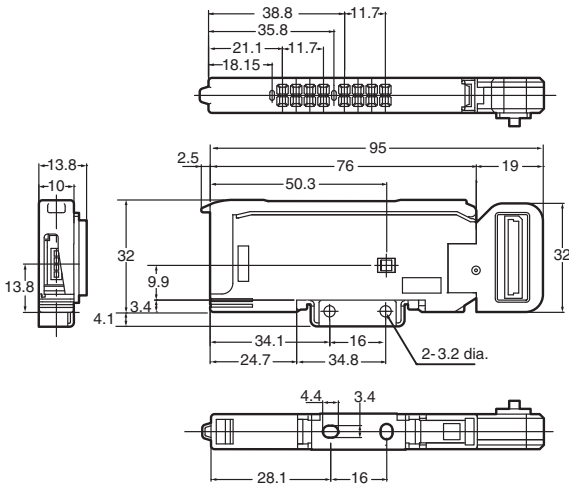

E3X-MDA0

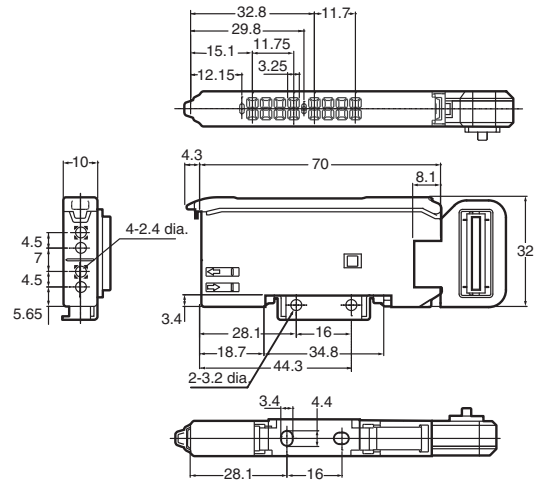

E2C-EDA0

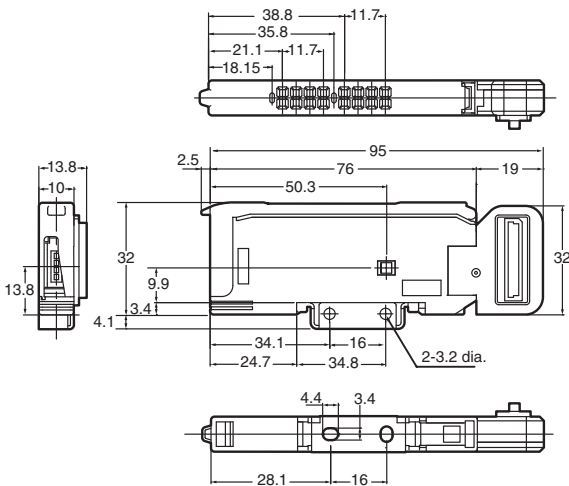

E3X-DA0-S \*

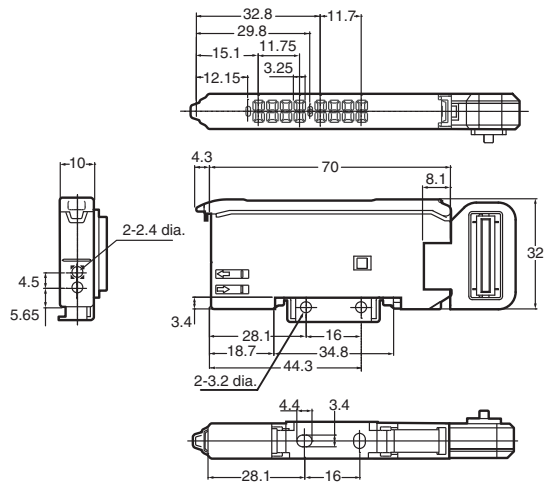

\* High-function fiber amplifier (E3X-DA0-S) was discontinued.



# Multi-function Compact Inverter MX2-Series V1 type CompoNet Communication Unit 3G3AX-MX2-CRT-E

## Support for open network with CompoNet Communications Unit

- Reduced wiring of Multi-function compact inverter MX2 series \*1
- 8 types of remote I/O functions  
The unique remote I/O functions in addition to remote I/O functions of CompoNet communications standard
- Parameter edit via CompoNet by using support tool CX-Drive \*2



\*1 CompoNet communication unit can be used with the inverter 3G3MX2 of unit version 1.1 or higher.  
\*2 CX-Drive can be used with version 2.6 or higher.

## Ordering Information

Name	Mountable Inverter	Model
CompoNet communication unit	MX2-series	3G3AX-MX2-CRT-E

## Performance Specifications

Power supply	Supplied from the inverter
Protective structure	IP20
Ambient Operating Temperature	-10 to 50°C
Ambient Storage Temperature	-20 to 65°C
Ambient Operating Humidity	20 to 90%RH (with no condensation)
Vibration Resistance	5.9m/s <sup>2</sup> (0.6G) , 10 to 55Hz
Application Environment	At a maximum altitude of 1,000 m; indoors (without corrosive gases or dust)
Insulation Resistance	500VAC (between isolated circuits)
Weight	100 g max. (Shipping weight: approx. 170 g)
Number of Words allocated	Initial setting IN:2CH/OUT:2CH (At maximum setting IN:8CH/OUT:8CH)

Note. For detail, refer to the MX2-series Catalog (Cat. No.I916).

## Dimensions

(Unit: mm)

### 3G3AX-MX2-CRT-E

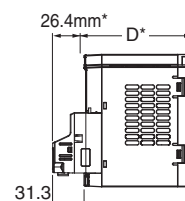
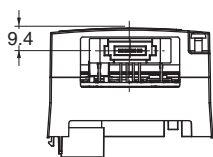
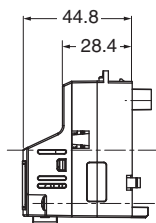
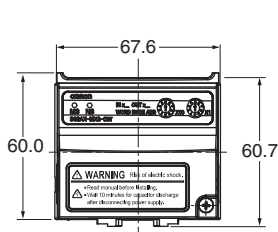

Note. After the CompoNet Communication Unit is installed, dimension D of the inverter increases by 26.4 mm. (Dimension D of the inverter varies depending on the capacity. Refer to the MX2-series USER'S MANUAL(Cat.No.I570))

# High-function General-purpose Inverter RX-Series V1 type CompoNet Communication Unit 3G3AX-RX-CRT-E

## Support for open network with CompoNet Communications Unit

- Reduced wiring of High-function General-purpose Inverter RX-Series V1 type \*1
- 8 types of remote I/O functions

The unique remote I/O functions in addition to remote I/O functions of CompoNet communications standard

- Parameter edit via CompoNet by using support tool CX-Drive \*2

\*1 It is not possible to use a CompoNet Communication Unit with a RX-series (Model without "-V1").  
\*2 CX-Drive can be used with version 2.6 or higher.



## Ordering Information

Name	Mountable Inverter	Model
CompoNet communication unit	RX-Series V1 type	3G3AX-RX-CRT-E

## Performance Specifications

Power supply	Supplied from the inverter
Protective structure	IP20
Ambient Operating Temperature	-10 to 50°C
Ambient Storage Temperature	-20 to 65°C
Ambient Operating Humidity	20 to 90%RH (with no condensation)
Vibration Resistance	5.9m/s <sup>2</sup> (0.6G) , 10 to 55Hz
Application Environment	At a maximum altitude of 1,000 m; indoors (without corrosive gases or dust)
Insulation Resistance	500VAC (between isolated circuits)
Weight	100 g max. (Shipping weight: approx. 170 g)
Number of Words allocated	Initial setting IN:2CH/OUT:2CH (At maximum setting IN:8CH/OUT:8CH)

Note. For detail, refer to the RX-Series V1 type Catalog (Cat. No. I919).

## Dimensions

(Unit: mm)

### 3G3AX-RX-CRT-E

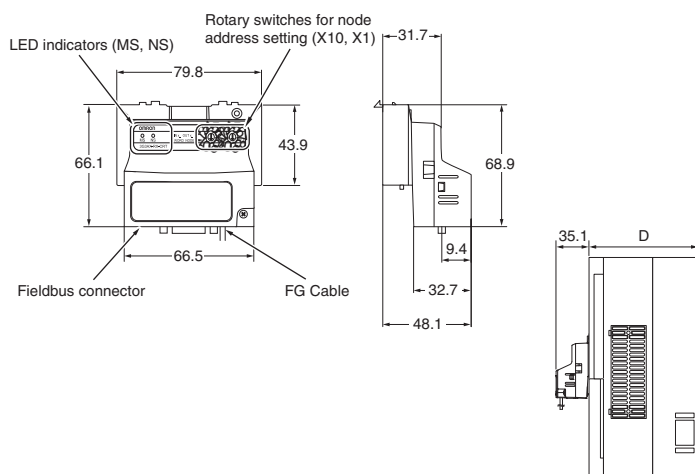

Note. After the CompoNet Communication Unit is installed, dimension D of the inverter increases by 35.1 mm. (Dimension D of the inverter varies depending on the capacity. Refer to the RX-Series V1 type USER'S MANUAL (Cat.No. I578))

---

# Appendix

---

CompoNet Network Configuration Elements .....	98
Types of Node Addresses for CompoNet Networks.....	99
CompoNet Network Specification .....	100
Communications and I/O Power Supply Wiring .....	101
Connecting External I/O for Slave Units.....	103
■ Connecting to e-CON Connector Terminals	
■ Connecting to MIL Connector Terminals	
■ Connecting to Screw-less Clamp Terminal Blocks	

## CompoNet Network Configuration Elements

A CompoNet Network is a remote I/O system that consists of the following elements.

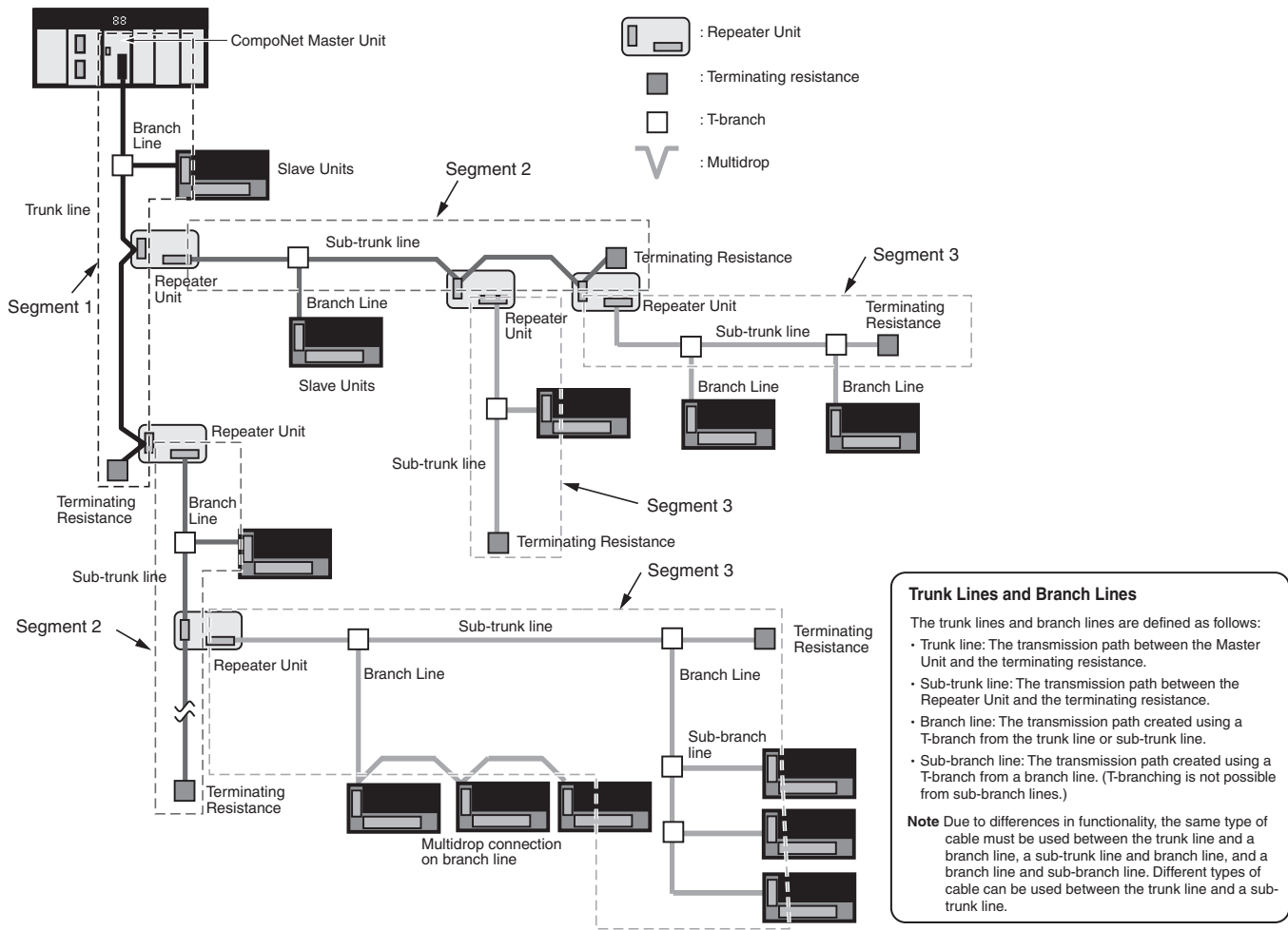

### Segment

#### ■ Segment layers

When Repeater Units are used, the CompoNet Network is divided into segments by the Repeater Units.

Each segment is connected to the network, but is isolated electrically.

Three layers of these isolated segments can be configured, called segments 1, 2, and 3, counted in order from the Master Unit.

Repeater Units can be used to add a maximum of two extra segment layers.

Including Repeater Units connected using multidrop connections, a maximum of 64 Repeater Units can be connected in a single network (i.e., to a single Master Unit).

#### ■ Number of Units Per Segment

Within the same segment, you can connect up to 32 slave ports (upstream port on Slave Units or Repeater Units) to one master port (downstream ports on Master Unit or Repeater Unit).

## Types of Node Addresses for CompoNet Networks

The following types of node addresses are used when setting node addresses for CompoNet networks.

Node address type	Address range	Applicable slaves
Word input slave Word mixed slave	0 to 63	Input slaves or I/O slaves that are allocated inputs or outputs in 16-point units
Word output slave	0 to 63	Output slaves that are allocated outputs in 16-point units
Bit input slave Bit mixed slave	0 to 127	Input slaves or I/O slaves that are allocated inputs or outputs in 2-point units
Bit output slave	0 to 127	Output slaves that are allocated outputs in 2-point units
Repeater Unit	0 to 63	Repeater Units

**■ Node address types for mixed slaves are the same as those for input slaves.**

- Word input slaves and word mixed slaves have the same node address type.
- Bit input slaves and bit mixed slaves have the same node address type.
- If a Word Input Expansion Unit (XWT-ID16 or XWT-ID08) is connected to a word output slave, it is treated as a mixed slave. The node address type will be a word mixed slave instead of a word output slave.

**■ The same node addresses can sometimes be used as long as the node address types are different.**

The same node address can be used for different node address types as long as the allocated words or bits do not overlap. The same node address cannot be used for word mixed slaves and word output slaves because the allocated words overlap. The same thing applies to bit mixed slaves and bit output slaves.

- Example 1: You can use a word input slave with a node address of 0 and a word output slave with a node address of 0 at the same time.
- Example 2: You can use a word mixed slave with a node address of 1 and a bit mixed slave with a node address of 1 at the same time.
- Example 3: You can use a word input slave with a node address of 2 and a Repeater with a node address of 2 at the same time.

**■ The same node address cannot be used for slaves with the same node address type.**

- Example 1: You cannot use two word input slaves with a node address of 1.
- Example 2: You cannot use a bit input slave with a node address of 2 and a bit mixed slave with a node address of 2 at the same time.

**■ Nodes for which the bit or word allocations overlap cannot be used at the same time.**

- Example 1: A 64-point word output slave with a node address of 2 is allocated the words for node addresses 2, 3, 4, and 5 for word output slaves. Therefore, word output slaves with node addresses of 3, 4, and 5 cannot be used at the same time.
- Example 2: Example 2: A word mixed slave with 32 inputs, 32 outputs, and a node address of 0 uses node addresses 0 and 1 for both word mixed slaves and word output slaves. Therefore, word input slaves, word mixed slaves, and word output slaves with a node address of 1 cannot be used at the same time.

## CompoNet Network Specification

Slave Unit I/O information and status information is allocated in the Special I/O Unit memory area or a user-specified area of the CPU Unit to which the Master Unit is mounted.

The area is determined by the unit number of the Master Unit as a Special I/O Unit and by the communications mode number. The user specifies the communications mode number using the CompoNet Support Software. The bits used by Slave Units are determined by the node address for each Slave Unit.

The relationship between communications mode numbers, the number of connected nodes, and the number of points that can be controlled is described next.

Communications mode number	Mode name	Connectable node addresses	Control points	Memory area	Number of unit numbers used by each Master Unit
0	Mode 0	Word Slave Units: IN0 to IN7 and OUT0 to OUT7	128 inputs and 128 outputs (Word Slave Units)	Special I/O Unit Area (First word depends on unit number of Master Unit.)	2
1	Mode 1	Word Slave Units: IN0 to IN15 and OUT0 to OUT15	256 inputs and 256 outputs (Word Slave Units)		4
2	Mode 2	Word Slave Units: IN0 to IN31 and OUT0 to OUT31	512 inputs and 512 outputs (Word Slave Units)		8
3	Mode 3	Word Slave Units: IN0 to IN15 and OUT0 to OUT15 Bit Slave Units: IN0 to IN63 and OUT0 to OUT63	256 inputs and 256 outputs (Word Slave Units) 128 inputs and 128 outputs (Word Slave Units)		8
4	Reserved	---	---	---	---
5	Reserved	---	---	---	---
6	Reserved	---	---	---	---
7	Reserved	---	---	---	---
8	Software Setting Mode	Can be set within the following ranges: Word Slave Units: IN0 to IN63 and OUT0 to OUT63 Bit Slave Units: IN0 to IN127 and OUT0 to OUT127	Can be set within the following ranges: Word Slave Units: 1,024 inputs and 1,024 outputs Bit Slave Units: 256 inputs and 256 outputs	Can be allocated anywhere in the CIO, DM, WR, or HR Area. Status and parameters are allocated in the Special I/O Unit Area. <b>Note:</b> Status and parameters are allocated in the Special I/O Unit Area.	1
9	Reserved	---	---	---	---

- Note 1.** In a CompoNet Network, Word Slave Units have 16 bits per node address. Bit Slave Units have two bits allocated per node address.
2. Do not use the reserved communications mode numbers (4 to 7 and 9). A communications mode setting error (H4 at the 7-segment LED indicator) will occur if any of these mode numbers is set.
  3. CompoNet Network for CompoNet Gateway Unit, refer to the CompoNet Gateway Unit page.

# Communications and I/O Power Supply Wiring

The following power supplies are required to operate the CompoNet Network.

- Communications power supply: Used for communications with individual Units and for internal circuit operations of Units.
- I/O power supply: Used for I/O operations for Units with external I/O.

The method for supplying communications power and I/O power depends on the types of cable and Slave Unit that are used. The differences are shown in the following table.

Power supply method	Cable types	Communications power supply	I/O power supply
Multi-power supply	Flat Cable I, II Round Cable II	Supplied through the Communications Cable by supplying power to the Master Unit.	Supplied to individual Units separately from the communications power supply.
	Round Cable I	Supplied to Units individually	
Network power supply	Flat Cable I, II Round Cable II	The communications power supply and the I/O power supply are provided together through Communications Cable.	
	Round Cable I	Cannot be used.	

## Connection Locations for Communications Power Supply

### ■ Round Cable II Flat Cable

Connect a 24-VDC power supply to the Master Unit's communications power supply connector (BS+ and BS-). This provides communications power to each Slave Unit and Repeater Unit connected by Round Cable II or Flat Cable. Connect only one communications power supply for the trunk line. The cable between the communications power supply and the communications power supply connector must be no longer than 3 m.

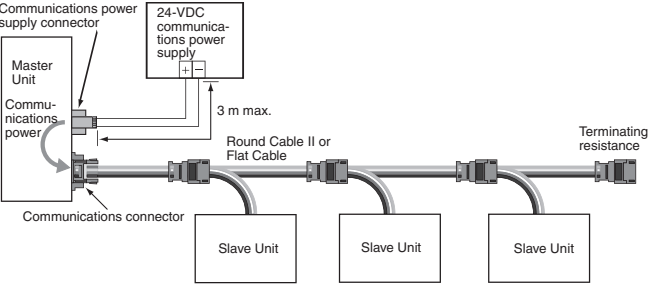

When Repeater Units are used, communications power to sub-trunk lines is supplied by the downstream port communications power supply connectors (BS+ and BS-) of the Repeater Units. The cable between the communications power supply and the communications power supply connector must be no longer than 3 m.

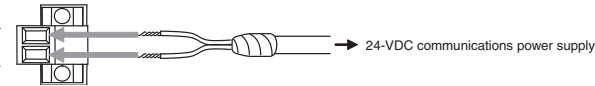
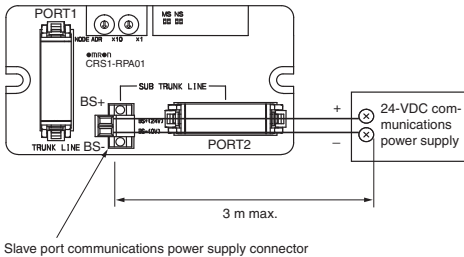

### ■ Round Cable I

A 24-VDC power supply is connected individually to each Slave Unit. Power does not need to be supplied to the Master Unit.

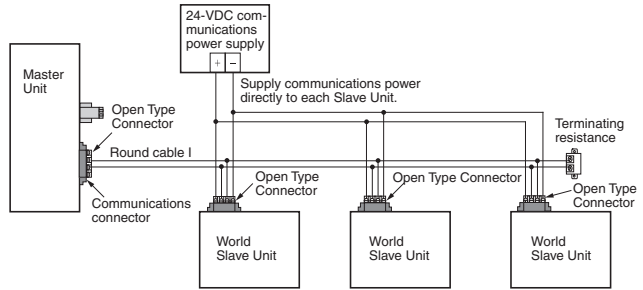

Before connecting the power supply, first connect a DCN4-TB4 Open Type Connector to the communications connector to convert it to a screw terminal block.

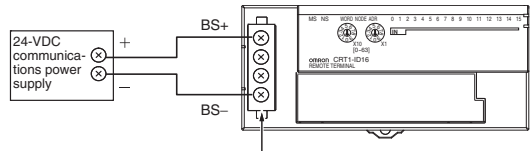

Connect an Open Type Connector here.

When using a Repeater Unit, supply power through the BS+ and BS- terminals of the Repeater Unit's PORT1 connector.

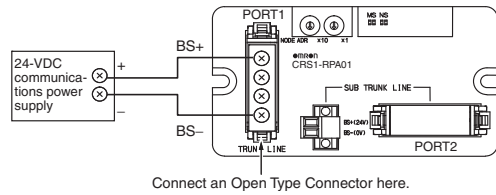

Connect an Open Type Connector here.

### ● Ferrules

The following ferrules are recommended for the communications power supply cable.

Model	Applicable wire size	Crimping tool	Manufacturer
A10, 5-10 WH	0.5 mm/AWG20	CRIMPFOX UD6 (product number 1204436) or the CRIMPFOX ZA3 Series	Phoenix Contact K.K.
H 0.5/16 orange	0.5 mm/AWG20	Crimper PZ 1.5 (Product number 900599)	Weidmuellr Japan Co.,Ltd.

The following screwdriver is recommended for removing ferrules.

Model	Manufacturer
XW4Z-00C	OMRON Corporation

## Restrictions

The following restrictions apply when supplying communications power through Round Cable II or Flat Cable.

- The communications power supply can be connected at only one location for the trunk line and one location each for the sub-trunk lines.
- Communications power to the trunk line can be supplied only through the communications power supply connector on the Master Unit. Communications power to a sub-trunk line can be supplied only through the slave port communications power supply connector on the Repeater Unit. Communications power cannot be supplied at any other location.

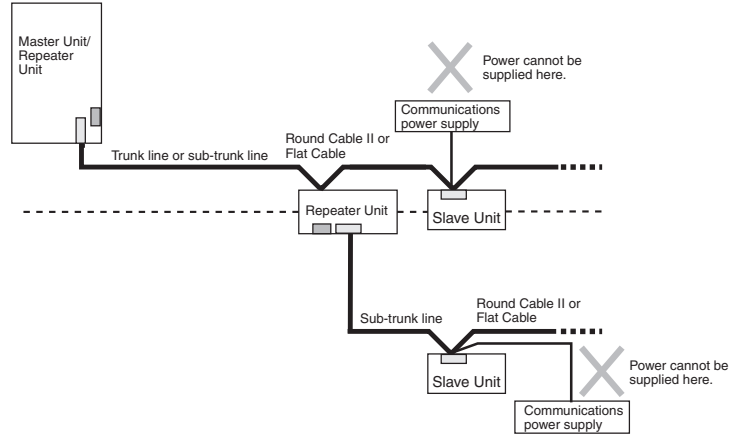
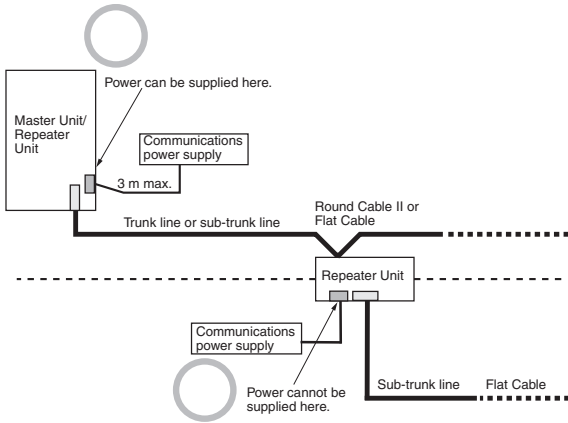

- Use separate power supplies for the Master Unit trunk line and for each sub-trunk line (i.e., for the trunk line on the Master side of the Repeater Unit and the sub-trunk line on the Slave side).

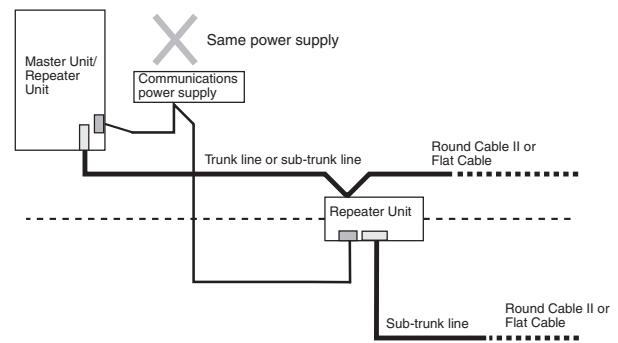
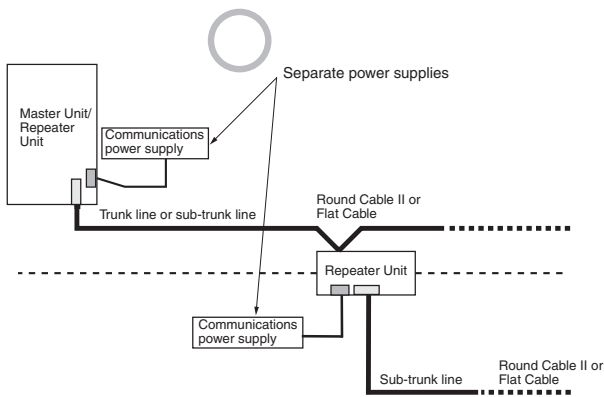

Transmission quality will not be maintained and communications errors may occur if this restriction is not observed.



## Connecting External I/O for Slave Units

### Connecting to e-CON Connector Terminals

For Slave Units with e-CON connector terminals, a special cable connector must be attached to an external device cable. Follow the procedure below to attach the connector to the cable.

#### ■ Checking the Cable Connector and Cable Wire Size

The wire size and sheath diameter of applicable cables depend on the type of cable connector. Use the following table to check that the cable connector and external device cable wire size and sheath diameter are compatible.

##### ● Tyco Electronics Connectors

Model	Housing color	Applicable wire range	
3-1473562-4	Orange	sheath outer diameter: 0.9 to 1.0 mm	Cross-sectional area: 0.08 to 0.5 mm <sup>2</sup>
1-1473562-4	Red	sheath outer diameter: 0.9 to 1.0 mm	
1473562-4	Yellow	sheath outer diameter: 1.0 to 1.15 mm	
2-1473562-4	Blue	sheath outer diameter: 1.15 to 1.35 mm	
4-1473562-4	Green	sheath outer diameter: 1.35 to 1.60 mm	

##### ● Sumitomo 3M Connectors

Model	Housing color	Applicable wire range
37104-3101-000FL	Red	AWG26 (0.14 mm <sup>2</sup> ) to AWG24 (0.2 mm <sup>2</sup> ), sheath outer diameter: 0.8 to 1.0 mm
37104-3122-000FL	Yellow	AWG26 (0.14 mm <sup>2</sup> ) to AWG24 (0.2 mm <sup>2</sup> ), sheath outer diameter: 1.0 to 1.2 mm
37104-3163-000FL	Orange	AWG26 (0.14 mm <sup>2</sup> ) to AWG24 (0.2 mm <sup>2</sup> ), sheath outer diameter: 1.2 to 1.6 mm
37104-2124-000FL	Green	AWG22 (0.3 mm <sup>2</sup> ) to AWG20 (0.5 mm <sup>2</sup> ), sheath outer diameter: 1.0 to 1.2 mm
37104-2165-000FL	Blue	AWG22 (0.3 mm <sup>2</sup> ) to AWG20 (0.5 mm <sup>2</sup> ), sheath outer diameter: 1.2 to 1.6 mm
37104-2206-000FL	Gray	AWG22 (0.3 mm <sup>2</sup> ) to AWG20 (0.5 mm <sup>2</sup> ), sheath outer diameter: 1.6 to 2.0 mm

##### ● OMRON Connectors

Model	Specification	Applicable wire range
XN2A-1470	Spring clamp type	Stranded wire AWG28 (0.08 mm <sup>2</sup> ) to AWG20 (0.5 mm <sup>2</sup> ), sheath outer diameter: 1.5 mm max.

## Connecting to MIL Connector Terminals

Use any of the following methods to connect to a MIL connector.

- Use an OMRON MIL Cable.
- Pressure-weld a Flat Cable to a MIL Socket.
- Pressure-weld a loose-wire cable to a MIL connector.

### ■ Using OMRON MIL Cable

- Connecting Relay Terminals

The MIL Cables for connecting OMRON Relay Terminals are shown in the following table. Select the appropriate Cable depending on the combination of Remote I/O Terminals and Relay Terminals that are used.

CRT1-□D16ML(-1)

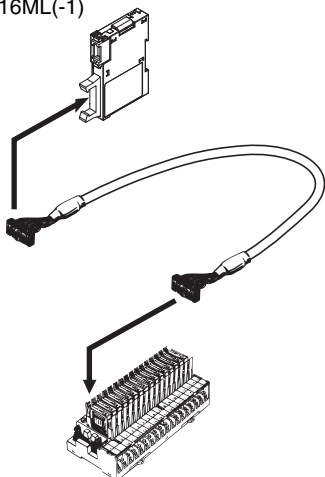

CRT1-□D32ML(-1)

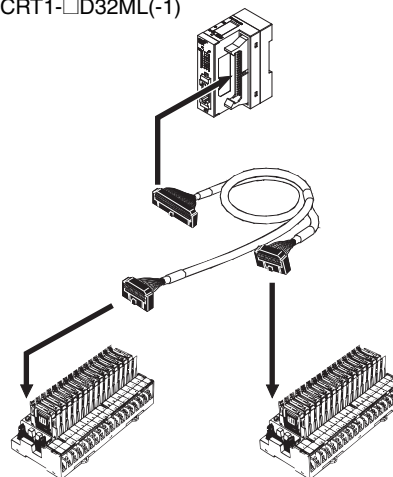

Slave model	MIL Cable model	Connected Relay Terminal	Remarks
CRT1-VID16ML	XW2Z-RI□C	G7TC-ID16 G7TC-IA16	---
CRT1-VOD16ML/ XWT-VOD16ML	XW2Z-RO□C	G7TC-OC16/OC08 G7OD-SOC16/VSOC16 G7OD-FOM16/VFOM16 G7OA-ZOC16-3 G7OD-SOC08 G7OR-SOC08	---
CRT1-VOD16ML-1/ XWT-VOD16ML-1	XW2Z-RI□C	G7TC-OC16-1	---
	XW2Z-RO□C	G7OD-SOC16-1 G7OD-FOM16-1 G7OA-ZOC16-4	
CRT1-VID32ML	XW2Z-RI50-25-D1 (50 cm) XW2Z-RI75-50-D1 (75 cm)	G7TC-ID16 G7TC-IA16	---
CRT1-VOD32ML	XW2Z-RO50-25-D1 (50 cm) XW2Z-RO75-50-D1 (75 cm)	G7TC-OC16/OC08 G7OD-SOC16/VSOC16 G7OD-FOM16/VFOM16 G7OA-ZOC16-3 G7OD-SOC08 G7OR-SOC08	---
CRT1-VOD32ML-1	XW2Z-RO50-25-D1 (50 cm) XW2Z-RO75-50-D1 (75 cm)	G7OD-SOC16-1 G7OD-FOM16-1 G7OA-ZOC16-4	---
	XW2Z-RI50-25-D1 (50 cm) XW2Z-RI75-50-D1 (75 cm)	G7TC-OC16-1	
CRT1-VMD32ML	XW2Z-RM50-25-D1 (50 cm) XW2Z-RM75-50-D1 (75 cm)	Inputs: G7TC-ID16 G7TC-IA16 Outputs: G7TC-OC16/OC08 G7OD-SOC16/VSOC16 G7OD-FOM16/VFOM16 G7OA-ZOC16-3 G7OD-SOC08 G7OR-SOC08	Inputs and outputs are distinguished by color. Input tube color: Red Output tube color: Yellow
CRT1-VMD32ML-1	XW2Z-RM50-25-D2 (50 cm) XW2Z-RM75-50-D2 (75 cm)	Inputs: G7OA-ZIM16-5 G7OD-SOC16-1 G7OD-FOM16-1 G7OA-ZOC16-4	Inputs and outputs are distinguished by color. Input tube color: Red Output tube color: Yellow

**Note:** Including models whose production were discontinued.

- Connecting to a Connector-Terminal Block Conversion Unit  
The following Connector-Terminal Block Conversion Units are available.  
For details, refer to the *SYSMAC Selection Guide* (Cat. No. X066).

Type	Series
Slim	XW2D
Through-type	XW2B
With common terminal	XW2C
Three-tier with common terminal	XW2E
Screw-less clamp terminals	XW2F
e-CON connector	XW2N

- Connecting Loose Wires to Devices  
The following table shows the Cables available when the Slave Unit has a MIL connector and the other device has loose wires. Use these Cables as needed.

Slave model	MIL Cable model	Remarks
CRT1-V□D16ML/ XWT-V□D16ML	XW2Z-RA200C (2 m) XW2Z-RA500C (5 m)	Loose wire size: AWG24 Loose wires are cut.
	XW2Z-RY100C (1 m) XW2Z-RY150C (1.5 m) XW2Z-RY200C (2 m) XW2Z-RY300C (3 m) XW2Z-RY500C (5 m)	Forked terminals are attached to the loose wires. Forked terminal: 161071-M2 (JST Mfg. Co., Ltd.)
CRT1-V□D32ML	XW2Z-RA200C-D1 (2 m) XW2Z-RA500C-D1 (5 m)	Loose wire size: AWG28 Loose wires are cut.
	XW2Z-RY100C-D1 (1 m) XW2Z-RY200C-D1 (2 m) XW2Z-RY500C-D1 (5 m)	Forked terminals are attached to the loose wires. Forked terminal: 161071-M2 (JST Mfg. Co., Ltd.)
CRT1-VDA02ML	10 pins	Indicated cable is not available
CRT1-VAD04ML	16 pins	

**■ Pressure-welding a Flat Cable to a MIL Socket**

To make your own connecting cable by pressure-welding the flat cable to the MIL socket, use the components shown in the table below and follow the directions.

- Required Components

Number of connector pins	Model	
10 pins	No polarity guide	XG4M-1031-T
	Uses polarity guide	XG4M-1030-T
16 pins	XG4M-1630-T	
20 pins	XG4M-2030-T	
40 pins	XG4M-4030-T	

### ■ Pressure-welding a Loose-wire Cable to a MIL Connector

To prepare a connecting cable by pressure-welding a loose-wire cable to a MIL connector, assemble the connector from the components shown in the following table.

• 10-pin Cable

Component		Wire size: AWG24	Wire size: AWG28 to AWG26
Socket	No polarity guide	XG5M-1031-N	XG5M-1034-N
	Uses polarity guide	XG5M-1032-N	XG5M-1035-N
Semi-cover *		XG5S-0501	

• 16-pin Cable

Component		Wire size: AWG24	Wire size: AWG28 to AWG26
Socket		XG5M-1632-N	XG5M-1635-N
Semi-cover *		XG5S-0801	

• 20-pin Cable

Component		Wire size: AWG24	Wire size: AWG28 to AWG26
Socket		XG5M-2032-N	XG5M-2035-N
Semi-cover *		XG5S-1001	
Hood Cover		XG5S-2012	

• 40-pin Cable

Component		Wire size: AWG24	Wire size: AWG28 to AWG26
Socket		XG5M-4032-N	XG5M-4035-N
Semi-cover *		XG5S-2001	
Hood Cover		XG5S-4022	

\* Two Semi-covers are required per connector.

For details on individual components, refer to the *Connectors Group Catalog* (Cat. No. G015).

## Connecting to Screw-less Clamp Terminal Blocks

For Slave Units with screw-less clamp terminal blocks, the terminal blocks can be easily wired by inserting pin terminals. Follow the procedure below to connect the external device cable to a screw-less clamp terminal block.

### ■ Applicable Pin Terminals

When wiring an external device cable to a screw-less clamp terminal block, special pin terminals must be placed on the cable wires. The applicable pin terminals are listed in the following table.

Name	Applicable wire size	Crimp tool	Manufacturer
H0.5/14 orange	0.5 mm <sup>2</sup> /AWG20	PZ6 roto	Weidmuellr Japan Co.,Ltd.
H0.75/14 white	0.75 mm <sup>2</sup> /AWG18		
H1.5/14 red	1.5 mm <sup>2</sup> /AWG16		

The pin terminal conductor should be about 8 to 10 mm in length.

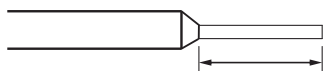

Conductor length: 8 to 10 mm

---

# Ordering Information

---

CompoNet Master Units.....	108
CompoNet Master Board .....	108
CompoNet Gateway Units.....	108
■ CompoNet Gateway Unit for CC-Link.....	108
CompoNet Slave Units.....	108
■ Word Slave Units.....	108
■ Bit Slave Units .....	112
■ Repeater Unit .....	112
■ SmartSlice GRT1 Series .....	113
■ Sensor Communications Unit.....	114
■ Inverter .....	114
■ Software .....	114
Peripheral Devices .....	115
■ Communications Cables.....	115
● For Flat Cable I.....	115
● For Round Cable I.....	116
● For Round Cable II.....	116
■ Mounting Bracket.....	116

---

## ● International Standards

- The standards are abbreviated as follows: U: UL, U1: UL (Class I Division 2 Products for Hazardous Locations), C: CSA, UC: cULus, UC1: cULus (Class I Division 2 Products for Hazardous Locations), CU: cUL, N: NK, L: Lloyd, and CE: EC Directives.
- Contact your OMRON representative for further details and applicable conditions for these standards.

## ● EC Directives

The EC Directives applicable to PLCs include the EMC Directives and the Low Voltage Directive. OMRON complies with these directives described below.

### ● EMC Directives

#### Applicable Standards

EMI : EN61131-2  
EN61000-6-4  
EMS: EN61131-2  
EN61000-6-2

PLCs are electrical devices that are incorporated in machines and manufacturing installations. OMRON PLCs conform to the related EMC standards so that the devices and machines into which they are built can more easily conform to EMC standards. The actual PLCs have been checked for conformity to EMC standards. Whether these standards are satisfied for the actual system, however, must be checked by the customer.

EMC-related performance will vary depending on the configuration, wiring, and other conditions of the equipment or control panel in which the PLC is installed. The customer must, therefore, perform final checks to confirm that the overall machine or device conforms to EMC standards.

Note: The applicable EMS standards depend on the product.



### ● Low Voltage Directive

#### Applicable Standard:EN61131-2

Devices that operate at voltages from 50 to 1,000 VAC or 75 to 150 VDC must satisfy the appropriate safety requirements. With PLCs, this applies to Power Supply Units and I/O Units that operate in these voltage ranges.

These Units have been designed to conform to EN61131-2, which is the applicable standard for PLCs.

## CompoNet Master Units

Name	Appearance	Specifications		Number of unit numbers allocated	Power consumption (A)			Model	Standards
		Type of communications	Maximum number of I/O points per Master Unit		5-V system	24-V system	26-V system		
CJ1 Special I/O Unit *		<ul style="list-style-type: none"> <li>Remote I/O communications</li> <li>Message communications</li> </ul>	Word Slave Units: 1,024 inputs and 1,024 outputs (2,048 I/O points total) Bit Slave Units: 256 inputs and 256 outputs (512 I/O points total)	1, 2, 4, or 8	0.4	---		CJ1W-CRM21	CE, U, U1, L, N
CS1 Special I/O Unit *		<ul style="list-style-type: none"> <li>Remote I/O communications</li> <li>Message communications</li> </ul>	Word Slave Units: 1,024 inputs and 1,024 outputs (2,048 I/O points total) Bit Slave Units: 256 inputs and 256 outputs (512 I/O points total)	1, 2, 4, or 8	0.4		---	CS1W-CRM21	CE, U, U1, L, N

\* These Units are also available with a DCN-TB4 Terminal Conversion Adapter included in the package. Add "(-B)" to the end of the model number to receive the Adapter as well.

## CompoNet Master Board

Name	Appearance	Specification	Model	Standards
PCI Bus type		PCI bus Rev2.2 5V	3G8F7-CRM21	CE

## CompoNet Gateway Units

### CompoNet Gateway Unit for CC-Link

Name	Appearance	Model	Standards
CompoNet Gateway Unit for CC-Link		GQ-CRM21	CE, UI, C



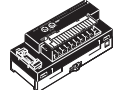

## CompoNet Slave Units

### Word Slave Units

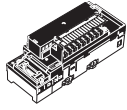

### Digital I/O Slave Units

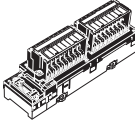
Name	Appearance	Specifications			Model	Standards	
Two-tier Screw Terminal Block		Inputs	8 inputs	NPN	---	CRT1-ID08	CE, U, U1, N
				PNP		CRT1-ID08-1	
		Outputs	8 outputs	NPN	CRT1-OD08		
				PNP	CRT1-OD08		
		Inputs	16 inputs	NPN	CRT1-ID16 *	CE, U, U1, C, N	
				PNP	CRT1-ID16-1 *		
		Outputs	16 outputs	NPN	CRT1-OD16 *		
				PNP	CRT1-OD16-1 *		
Inputs/Outputs	8 inputs/8 outputs	NPN	CRT1-MD16	CE, U, U1, N			
		PNP	CRT1-MD16-1				

\* These Units are also available with a DCN-TB4 Terminal Conversion Adapter included in the package. Add "(-B)" to the end of the model number to receive the Adapter as well.

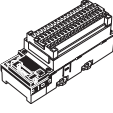

Name	Appearance	Specifications			Model	Standards		
Screw Terminal Block with Relay Outputs		Outputs	8 outputs	Contacts	---	CRT1-ROS08	CE, UC, UC1, N	
			16 outputs			CRT1-ROS16		
Screw Terminal Block with SSR Outputs		Outputs	8 outputs	SSR		CRT1-ROF08	---	
			16 outputs			CRT1-ROF16		
Three-tier Screw Terminal Block		Inputs	8 inputs	NPN	Without Short-circuit and Disconnected Line Detection	CRT1-ID08TA	CE, UC, UC1	
				PNP		CRT1-ID08TA-1		
		Outputs	8 outputs	NPN		CRT1-OD08TA		
				PNP		CRT1-OD08TA-1		
		Inputs	16 inputs	NPN		CRT1-ID16TA		
				PNP		CRT1-ID16TA-1		
		Outputs	16 outputs	NPN		CRT1-OD16TA		
				PNP		CRT1-OD16TA-1		
		Inputs/Outputs	8 inputs/8 outputs	NPN		CRT1-MD16TA		
				PNP		CRT1-MD16TA-1		
		Inputs	8 inputs	NPN		With Short-circuit and Disconnected Line Detection		CRT1-ID08TAH
				PNP				CRT1-ID08TAH-1
		Outputs	8 outputs	NPN				CRT1-OD08TAH
				PNP				CRT1-OD08TAH-1
Inputs	16 inputs	NPN	CRT1-ID16TAH					
		PNP	CRT1-ID16TAH-1					
Outputs	16 outputs	NPN	CRT1-OD16TAH					
		PNP	CRT1-OD16TAH-1					
Inputs/Outputs	8 inputs/8 outputs	NPN	CRT1-MD16TAH					
		PNP	CRT1-MD16TAH-1					
e-CON Connectors		Inputs	16 inputs	NPN	Without Short-circuit and Disconnected Line Detection		CRT1-ID16S	CE, UC, UC1
				PNP			CRT1-ID16S-1	
		Outputs	16 outputs	NPN			CRT1-OD16S	
				PNP			CRT1-OD16S-1	
		Inputs/outputs	8 inputs /8 outputs	NPN		CRT1-MD16S		
				PNP		CRT1-MD16S-1		
		Inputs	32 inputs	NPN		CRT1-ID32S		
				PNP		CRT1-ID32S-1		
		Outputs	32 outputs	NPN		CRT1-OD32S		
				PNP		CRT1-OD32S-1		
		Inputs/outputs	16 inputs /16 outputs	NPN		CRT1-MD32S		
				PNP		CRT1-MD32S-1		
		Inputs	16 inputs	NPN		With Short-circuit and Disconnected Line Detection	CRT1-ID16SH	
				PNP			CRT1-ID16SH-1	
		Outputs	16 outputs	NPN			CRT1-OD16SH	
				PNP			CRT1-OD16SH-1	
		Inputs/outputs	8 inputs /8 outputs	NPN			CRT1-MD16SH	
				PNP			CRT1-MD16SH-1	
Inputs	32 inputs	NPN	CRT1-ID32SH					
		PNP	CRT1-ID32SH-1					
Outputs	32 outputs	NPN	CRT1-OD32SH					
		PNP	CRT1-OD32SH-1					
Inputs/outputs	16 inputs /16 outputs	NPN	CRT1-MD32SH					
		PNP	CRT1-MD32SH-1					
e-CON Connectors		Inputs	8 inputs	NPN	Without Short-circuit and Disconnected Line Detection		CRT1-VID08S *	CE, UC, UC1
				PNP			CRT1-VID08S-1 *	
		Outputs	8 outputs	NPN			CRT1-VOD08S *	
				PNP			CRT1-VOD08S-1 *	

\* These Units are also available with a DCN-TB4 Terminal Conversion Adapter included in the package. Add "(-B)" to the end of the model number to receive the Adapter as well.

Name	Appearance	Specifications			Model	Standards	
MIL Connector		Inputs	16 inputs	NPN	---	CRT1-VID16ML *	CE, UC, UC1, N
				PNP		CRT1-VID16ML-1 *	
		Outputs	16 outputs	NPN		CRT1-VOD16ML *	
				PNP		CRT1-VOD16ML-1 *	
MIL Connector		Inputs	32 inputs	NPN	---	CRT1-VID32ML *	CE, UC, UC1, N
				PNP		CRT1-VID32ML-1 *	
		Outputs	32 outputs	NPN		CRT1-VOD32ML *	
				PNP		CRT1-VOD32ML-1 *	
		Inputs/Outputs	16 inputs/16 outputs	NPN		CRT1-VMD32ML *	
				PNP		CRT1-VMD32ML-1 *	
Clamp Terminal Blocks		Inputs	8 inputs	NPN	---	CRT1-ID08SL	U, CE, N
				PNP		CRT1-ID08SL-1	
		Outputs	8 outputs	NPN		CRT1-OD08SL	
				PNP		CRT1-OD08SL-1	
		Inputs	16 inputs	NPN		CRT1-ID16SL	
				PNP		CRT1-ID16SL-1	
		Outputs	16 outputs	NPN		CRT1-OD16SL	
				PNP		CRT1-OD16SL-1	
		Inputs/Outputs	8 inputs/8 outputs	NPN		CRT1-MD16SL	
				PNP		CRT1-MD16SL-1	

\* These Units are also available with a DCN-TB4 Terminal Conversion Adapter included in the package. Add "(-B)" to the end of the model number to receive the Adapter as well.

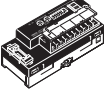
● Analog I/O Slave Units

Name	Appearance	Specifications		Model	Standards
Analog I/O Slave Units		Analog inputs	4 inputs	CRT1-AD04 *	CE, U, U1, C, N
		Analog outputs	2 outputs	CRT1-DA02 *	
MIL Connector Type		Analog inputs	4 inputs	CRT1-VAD04ML	CE, UC, UC1
		Analog outputs	2 outputs	CRT1-VDA02ML	
e-CON Connector Type		Analog inputs	4 inputs	CRT1-VAD04S	
		Analog outputs	2 outputs	CRT1-VDA02S	

\* These Units are also available with a DCN-TB4 Terminal Conversion Adapter included in the package. Add "(-B)" to the end of the model number to receive the Adapter as well.



● Temperature Input Units

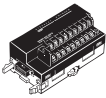

Name	Appearance	Specifications			Model	Standards
Temperature Input Units		Thermocouple Input	4 inputs	Switchable between (R, S, K, J, T, E, B, N, L, U, W, PL2)	CRT1-TS04T	CE, UC, UC1, N
		Platinum-resistance thermometer input		PT100 (-200 to 850°C) PT100 (-200 to 2000°C)	CRT1-TS04P	

● Expansion Units

Name	Appearance	Specifications				Model	Standards
Expansion Units		Inputs	8 inputs	NPN	One Expansion Unit can be mounted to one CRT1-ID16(-1), CRT1-OD16(-1), CRT1-ROS16, or CRT1-ROF16 Digital I/O Slave.	XWT-ID08	CE, UC, UC1, N
				PNP		XWT-ID08-1	
		Outputs	8 outputs	NPN		XWT-OD08	
				PNP		XWT-OD08-1	
		Inputs	16 inputs	NPN		XWT-ID16	
				PNP		XWT-ID16-1	
		Outputs	16 outputs	NPN		XWT-OD16	
				PNP		XWT-OD16-1	

■ Bit Slave Units

● Compact Connectors

Name	Appearance	Specifications			Model	Standards
Compact Connectors		Inputs	2 inputs	NPN	CRT1B-ID02JS	CE
			2 outputs	PNP	CRT1B-ID02JS-1	
		Outputs	2 inputs	NPN	CRT1B-OD02JS	
			2 outputs	PNP	CRT1B-OD02JS-1	
		Inputs/Outputs	1 input/1 output	NPN	CRT1B-MD02JS	
			1 input/1 output	PNP	CRT1B-MD02J-1	
		Inputs	4 inputs	NPN	CRT1B-ID04JS	
			4 outputs	PNP	CRT1B-ID04JS-1	
		Outputs	4 inputs	NPN	CRT1B-OD04JS	
			4 outputs	PNP	CRT1B-OD04JS-1	
		Inputs/Outputs	2 inputs/2 outputs	NPN	CRT1B-MD04JS	
			2 inputs/2 outputs	PNP	CRT1B-MD04JS-1	
e-CON connectors		Inputs	2 inputs	NPN	CRT1B-ID02S	CE, U
			2 inputs	PNP	CRT1B-ID02S-1	
		Outputs	2 outputs	NPN	CRT1B-OD02S	
			2 outputs	PNP	CRT1B-OD02S-1	

■ Repeater Unit

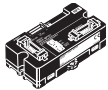
Name	Appearance	Specifications	Model	Standards
Repeater Unit		<p>A sub-trunk line can be connected downstream (for trunk-branch line configuration) or further branching is enabled downstream (for configurations with no wiring restrictions) in the same way as for a Master Unit.</p> <p>A Repeater Unit can be used to branch the trunk line and increase the number of connected Units, as well as to extend the length of the communications line.</p>	CRS1-RPT01 *	CE, U, U1, L, N





\* These Units are also available with a DCN-TB4 Terminal Conversion Adapter included in the package. Add "(-B)" to the end of the model number to receive the Adapter as well.

■ SmartSlice GRT1 Series





● CompoNet Communications Unit

Name	Appearance	Specifications	Model	Standards
CompoNet Communication Unit		Up to 64 Slice I/O Units can be connected (Inputs: 32 bytes maximum, Output: 32 bytes maximum)	GRT1-CRT	CE, UC1, L

● Slice I/O Units

Name	Appearance	Specifications	Model	Standards	
Slice I/O Units	Digital I/O Units		4 inputs NPN	GRT1-ID4	CE, UC1, L, N
			4 inputs PNP	GRT1-ID4-1	
			4 outputs NPN	GRT1-OD4	
			4 outputs PNP	GRT1-OD4-1	
			8 inputs NPN	GRT1-ID8	CE, UC, L
			8 inputs PNP	GRT1-ID8-1	
			8 outputs NPN	GRT1-OD8	
			8 outputs PNP	GRT1-OD8-1	
			Relay Outputs 2 points	GRT1-ROS2	CE, UC1, L, N
			AC Input 4 points	GRT1-IA4-1	CE, UC1, L
	GRT1-IA4-2				
	Analog I/O Units		Analog inputs (current/voltage)	GRT1-AD2	CE, UC1, L
			Analog outputs (current)	GRT1-DA2C	
			Analog output (voltage)	GRT1-DA2V	
	Temperature Input (Resistance Thermometers)		Temperature input (Resistance thermometer:Pt100) 2 points	GRT1-TS2P	CE, UC1, L
			Temperature input (Resistance thermometer:Pt1000) 2 points	GRT1-TS2PK	
			Thermocouple Input 2 points	GRT1-TS2T	CE, UC, L
	Counter Units		Counter inputs: 1, External outputs: 1 NPN	GRT1-CT1	CE, UC, L
			Counter inputs: 1, External outputs: 1 PNP	GRT1-CT1-1	



● System Units

Name	Appearance	Specifications	Model	Standards	
System Units	Turnback Units		Right Turnback Unit (Mounts to the right side of Slice I/O Terminal.)	GRT1-TBR	CE, UC1, L, N
			Left Turnback Unit (Mounts to the left side of Slice I/O Terminal. Can supply power to I/O Units.)	GRT1-TBL	
	Turnback Cable *1	---	1 m	GCN2-100	UC, CE, L, N
	I/O Power Feed Unit		Use when the total current consumption of the I/O Power Supply exceeds 4 A, or to make the I/O Power Supply a separate system.	GRT1-PD2	CE, UC1, L, N
				GRT1-PD2G	
			Use to add V/G terminals for I/O power supply.	GRT1-PD8	CE, UC, L
				GRT1-PD8-1	
End Unit *2		Necessary for terminating the Slice I/O Terminal.	GRT1-PC8	CE, UC1, L, N	
			GRT1-PC8-1		
Option	Terminal Block	---	Package of 5 Terminal Blocks	GRT1-BT1-5	---

\*1 Use the Turnback Cable together with the Turnback Units.

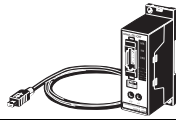

\*2 The End Unit is sold separately. It is not provided with the Communications Unit.

■ Sensor Communications Unit

Name	Appearance	I/O classification	Allocated bits	Internal circuit power supply	I/O Power supply voltage	Connected Controller model	Model	Standards
Sensor Communications Unit		Input and output	160 bits max.	Supplied along with communications power	DC24V	ZS-LDC□□ ZS-MDC□□ ZS-HLDC□□ ZFV-CA□□ *	ZS-CRT	---
		Change by operation mode				E3X-HD0 E3X-MDA0 E3X-DA0-S * E3C-LDA0 E2C-EDA0	E3X-CRT	CE

\* ZFV-CA□□ and E3X-DA0-S were discontinued.

■ Inverter

Name	Appearance	Mountable Inverter	Model	Standards
For MX2 CompoNet Communication Unit		Multi-function Compact Inverter MX2-Series	3G3AX-MX2-CRT-E	U, CE
For RX-V1 CompoNet Communication Unit		High-function General-purpose Inverter RX-Series V1 type	3G3AX-RX-CRT-E	

■ Software

● How to Select Required Support Software for Your Controller

The required Support Software depends on the Controller to connect. Please check the following table when purchasing the Support Software.

Item	Omron PLC System	Omron Machine Automation Controller System
Controller	CS, CJ, CP, and other series	NJ-series
Software	FA Integrated Tool Package CX-One	Automation Software Sysmac Studio

● FA Integrated Tool Package CX-One

Product name	Specifications			Model	Standards
		Number of licenses	Media		
FA Integrated Tool Package CX-One Ver.4.□	The CX-One is a comprehensive software package that integrates Support Software for OMRON PLCs and components. CX-One runs on the following OS. OS: Windows 7 (32-bit/64-bit version) / Windows 8 (32-bit/64-bit version) / Windows 8.1 (32-bit/64-bit version) / Windows 10 (32-bit/64-bit version) CX-One Version 4.□ includes CX-Integrator Ver.3.□. For details, refer to the CX-One catalog (Cat. No. R134)	1 license *1	DVD *2	CXONE-AL01D-V4	---

\*1. Multi licenses (3, 10, 30, or 50 licenses) and DVD media without licenses are also available for the CX-One.

\*2. The CX-One is also available on CD (CXONE-AL□□C-V4).

● Automation Software Sysmac Studio

Please purchase a DVD and required number of licenses the first time you purchase the Sysmac Studio. DVDs and licenses are available individually. Each model of licenses does not include any DVD.

Product name	Specifications			Model	Standards
		Number of licenses	Media		
Sysmac Studio Standard Edition Ver.1.□□	The Sysmac Studio is the software that provides an integrated environment for setting, programming, debugging and maintenance of machine automation controllers including the NJ/NX-series CPU Units, NY-series Industrial PC, EtherCAT Slave, and the HMI. Sysmac Studio runs on the following OS. OS: Windows 7 (32-bit/64-bit version) / Windows 8 (32-bit/64-bit version) / Windows 8.1 (32-bit/64-bit version) / Windows 10 (32-bit/64-bit version) *1 The Sysmac Studio Standard Edition DVD includes Support Software to set up EtherNet/IP Units, DeviceNet slaves, Serial Communications Units, and Support Software for creating screens on HMIs (CX-Designer). Refer to your OMRON website for details.	---	Sysmac Studio (32-bit) DVD	SYSMAC-SE200D	---
		---	Sysmac Studio (64-bit) DVD	SYSMAC-SE200D-64	---
		1 license *2	---	SYSMAC-SE201L	---

\*1. Model "SYSMAC-SE200D-64" runs on Windows 10 (64 bit).

\*2. Multi licenses are available for the Sysmac Studio (3, 10, 30, or 50 licenses).







Peripheral Devices

■ Communications Cables

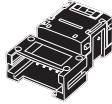
Name	Appearance	Specification	Model	Standards
Flat Cable I		4-conductor flat cable (UL2555) Length: 100 m Conductor diameters: 0.75 mm <sup>2</sup> × 2, 0.5 mm <sup>2</sup> × 2	DCA4-4F10	---

Note. Also can be used with general-purpose round cable I (VCTF 2-conductor cable).



● For Flat Cable I

Name	Appearance	Specification	Model	Standards
Flat Connector Socket		Use this Connector in a set with a DCN4-BR4 Flat Connector Plug for the following applications. <ul style="list-style-type: none"> <li>• Extending the trunk line or a sub-trunk line</li> <li>• T-branching from the trunk line or a sub-trunk line</li> <li>• T-branching a sub-branch line from a branch line</li> </ul> Use this Connector independently for the following applications. <ul style="list-style-type: none"> <li>• Used when connecting a DCN4-TM4 Terminating Resistor to the end of the trunk line or a sub-trunk line.</li> </ul>	DCN4-TR4 *	---
Flat Connector Plug		Use this Connector in a set with a DCN4-TR4 Flat Connector Socket for the following applications. <ul style="list-style-type: none"> <li>• Extending the trunk line or a sub-trunk line</li> <li>• T-branching from the trunk line or a sub-trunk line</li> <li>• T-branching a sub-branch line from a branch line</li> </ul> Use this Connector independently for the following applications. <ul style="list-style-type: none"> <li>• Connecting Communications Cable to a Unit</li> <li>• Connecting Communications Cable to a DCN4-MD4 Multidrop Connector (when a multidrop connection is used)</li> </ul>	DCN4-BR4 *	
Multidrop Connector		Use Multidrop Connectors for multi-drop wiring of Slave Units or Repeater Units to trunk lines, sub-trunk lines, or branch lines.	DCN4-MD4 *	
Multidrop Connector Plug		Connecting Communications Cable to a Unit in a multidrop connection This connector can be used with the following Units:Bit Slave Units with Compact Connectors (CRT1B-□D0□JS(-1))	DCN4-MR4	
Terminating Resistance		This is a Connector-type Terminating Resistor for Flat Cable I or Round Cable II. It is connected to a DCN4-TR4 Flat Connector Socket at the end of a trunk line or sub-trunk line.	DCN4-TM4 *	
Special Tools		This is the crimping tool for the following connectors: <ul style="list-style-type: none"> <li>• DCN4-TR4(-1) Flat Connector Socket</li> <li>• DCN4-BR4 Flat Connector Plug</li> <li>• DCN4-BR4D Conversion Connector for Standard Thin Cable and Flat Cable</li> </ul>	DWT-A01	

Note. Multidrop Connectors (DCN4-MD4) are not connectable with Bit Slave Units with Compact Connectors, Use Multidrop Connector Plugs (DCN4-MR4) instead.

\* The minimum quantity packaged is 10 Connectors. Order the Connectors in multiples of 10.





● For Round Cable I

Name	Appearance	Application	Model	Standards
Open Type Connector (for connecting Units)		Converts the Unit's communications connector into a screw terminal block to enable connecting round cable to a Slave Unit or Repeater Unit.	DCN4-TB4 *	---
Terminating Resistor		This is a Terminal Block-type Terminating Resistor for Round cable I or Round cable II. It is connected to the end of a trunk line or sub-trunk line round cable.	DRS1-T	U

**Note:** The DCN4-TB4 Multidrop Connector cannot be used with Bit Slaves with Compact Connectors. Use Open Type Connector (for Unit connection) HCN-TB4LMZG+ from Honda Tsushin Kogyo Co., Ltd. Tel:+81-52-242-2111

\* The minimum quantity packaged is 10 Connectors. Order the Connectors in multiples of 10.

● For Round Cable II

Name	Appearance	Application	Model	Standards
Open Type Connector (for connecting Units)		Converts the Unit's communications connector into a screw terminal block to enable connecting round cable to a Slave Unit or Repeater Unit.	DCN4-TB4 *	---
Flat Connector Socket		Use this Connector in a set with a DCN4-BR4 Flat Connector Plug for the following applications. <ul style="list-style-type: none"> <li>• Extending the trunk line or a sub-trunk line</li> <li>• T-branching from the trunk line or a sub-trunk line</li> <li>• T-branching a sub-branch line from a branch line</li> </ul>	DCN4-TR4 *	
		Use this Connector independently for the following applications. <ul style="list-style-type: none"> <li>• Used when connecting a DCN4-TM4 Terminating Resistor to the end of the trunk line or a sub-trunk line.</li> </ul>		
Terminating Resistance		This is a Connector-type Terminating Resistor for Flat Cable I or Round cable II. It is connected to a DCN4-TR4 Flat Connector Socket at the end of a trunk line or sub-trunk line.	DCN4-TM4 *	
		This is a Terminal Block-type Terminating Resistor for Round cable I or Round cable II. It is connected to the end of a trunk line or sub-trunk line round cable.	DRS1-T	
Special Tools		This is the crimping tool for the following connectors: <ul style="list-style-type: none"> <li>• DCN4-TR4(-1) Flat Connector Socket</li> <li>• DCN4-BR4 Flat Connector Plug</li> <li>• DCN4-BR4D Conversion Connector for Standard Thin Cable and Flat Cable</li> </ul>	DWT-A01	

**Note.** The DCN4-TB4 Multidrop Connector cannot be used with Bit Slaves with Compact Connectors. Use Open Type Connector (for Unit connection) HCN-TB4LMZG+ from Honda Tsushin Kogyo Co., Ltd. Tel:+81-52-242-2111

\* The minimum quantity packaged is 10 Connectors. Order the Connectors in multiples of 10.

■ Mounting Bracket

Name	Appearance	Application	Model	Standards
Mounting Bracket	---	Unit with e-CON Connectors: For CRT1-V□D08S(-1)/VAD04S/VDA02S	CRT1-ATT02	---
		Unit with MIL Connectors: For CRT1-V□D016ML(-1)/VAD04ML/VDA02ML	CRT1-ATT01	
		Unit with MIL Connectors: For CRT1-V□D32ML(-1)	SRT2-ATT02	
		Bit Slaves with Compact Connectors: For CRT1B-□D02JS(-1), CRT1B-□D04JS(-1)	CRT1-ATT03	

## Related Manuals

### Manuals

Cat. No.	Model	Name
W457	CRT1 Series	CRT2 Series CompoNet Slave Units and Repeater Unit Operation Manual
W493	CJ1W-CRM21	CJ1W-CRM22 CJ-series CompoNet Master Units Operation Manual for NJ-series CPU Unit
W456	CS1W-CRM21/CJ1W-CRM21	CompoNet Master Units OPERATION MANUAL
W485	3G8F7-CRM21 (for PCI Bus)/3G8F8-CRM21 (for CompactPCI Bus)	CompoNet Master Board USER'S MANUAL
W489	GQ-CRM21	CC-Link-CompoNet GateWay Unit USER'S MANUAL
W342	SYSMAC CS/CJ/CP Series, SYSMAC One NSJ Series	SYSMAC CS/CJ/CP/NSJ Series Communications Commands REFERENCE MANUAL
W504	SYSMAC-SE2□□□	SYSMAC-SE2□□□ Sysmac Studio Version 1 OPERATION MANUAL
W464	CXONE-AL□□D-V4	CS/CJ/CP/NSJ Series CX-Integrator Ver.2.□ OPERATION MANUAL
W455	SmartSlice GRT1 Series	Slice I/O Units OPERATION MANUAL
W476	GRT1-CRT	SmartSlice CompoNet Communications Units OPERATION MANUAL
I582	3G3AX-MX2-CRT-E/3G3AX-RX-CRT-E	MX2-Series V1 type/RX-Series V1 type CompoNet Communication Unit User's Manual

## Read and Understand this Catalog

Please read and understand this catalog before purchasing the product. Please consult your OMRON representative if you have any questions or comments.

## Warranty and Limitations of Liability

### WARRANTY

OMRON's exclusive warranty is that the products are free from defects in materials and workmanship for a period of one year (or other period if specified) from date of sale by OMRON. OMRON MAKES NO WARRANTY OR REPRESENTATION, EXPRESS OR IMPLIED, REGARDING NON-INFRINGEMENT, MERCHANTABILITY, OR FITNESS FOR PARTICULAR PURPOSE OF THE PRODUCTS. ANY BUYER OR USER ACKNOWLEDGES THAT THE BUYER OR USER ALONE HAS DETERMINED THAT THE PRODUCTS WILL SUITABLY MEET THE REQUIREMENTS OF THEIR INTENDED USE. OMRON DISCLAIMS ALL OTHER WARRANTIES, EXPRESS OR IMPLIED.

### LIMITATIONS OF LIABILITY

OMRON SHALL NOT BE RESPONSIBLE FOR SPECIAL, INDIRECT, OR CONSEQUENTIAL DAMAGES, LOSS OF PROFITS OR COMMERCIAL LOSS IN ANY WAY CONNECTED WITH THE PRODUCTS, WHETHER SUCH CLAIM IS BASED ON CONTRACT, WARRANTY, NEGLIGENCE, OR STRICT LIABILITY.

In no event shall the responsibility of OMRON for any act exceed the individual price of the product on which liability is asserted.

IN NO EVENT SHALL OMRON BE RESPONSIBLE FOR WARRANTY, REPAIR, OR OTHER CLAIMS REGARDING THE PRODUCTS UNLESS OMRON'S ANALYSIS CONFIRMS THAT THE PRODUCTS WERE PROPERLY HANDLED, STORED, INSTALLED, AND MAINTAINED AND NOT SUBJECT TO CONTAMINATION, ABUSE, MISUSE, OR INAPPROPRIATE MODIFICATION OR REPAIR.

## Application Considerations

### SUITABILITY FOR USE

OMRON shall not be responsible for conformity with any standards, codes, or regulations that apply to the combination of the product in the customer's application or use of the product.

At the customer's request, OMRON will provide applicable third party certification documents identifying ratings and limitations of use that apply to the products. This information by itself is not sufficient for a complete determination of the suitability of the products in combination with the end product, machine, system, or other application or use.

The following are some examples of applications for which particular attention must be given. This is not intended to be an exhaustive list of all possible uses of the products, nor is it intended to imply that the uses listed may be suitable for the products:

- Outdoor use, uses involving potential chemical contamination or electrical interference, or conditions or uses not described in this document.
- Nuclear energy control systems, combustion systems, railroad systems, aviation systems, medical equipment, amusement machines, vehicles, safety equipment, and installations subject to separate industry or government regulations.
- Systems, machines, and equipment that could present a risk to life or property.  
Please know and observe all prohibitions of use applicable to the products.

NEVER USE THE PRODUCT FOR AN APPLICATION INVOLVING SERIOUS RISK TO LIFE OR PROPERTY WITHOUT ENSURING THAT THE SYSTEM AS A WHOLE HAS BEEN DESIGNED TO ADDRESS THE RISKS, AND THAT THE OMRON PRODUCT IS PROPERLY RATED AND INSTALLED FOR THE INTENDED USE WITHIN THE OVERALL EQUIPMENT OR SYSTEM.

### PROGRAMMABLE PRODUCTS

OMRON shall not be responsible for the user's programming of a programmable product, or any consequence thereof.

## Disclaimers

### CHANGE IN SPECIFICATIONS

Product specifications and accessories may be changed at any time based on improvements and other reasons. Consult with your OMRON representative at any time to confirm actual specifications of purchased product.

### DIMENSIONS AND WEIGHTS

Dimensions and weights are nominal and are not to be used for manufacturing purposes, even when tolerances are shown.

### PERFORMANCE DATA

Performance data given in this catalog is provided as a guide for the user in determining suitability and does not constitute a warranty. It may represent the result of OMRON's test conditions, and the users must correlate it to actual application requirements. Actual performance is subject to the OMRON Warranty and Limitations of Liability.



This catalog mainly provides information that is necessary for selecting suitable models, and does not contain precautions for correct use. Always read the precautions and other required information provided in product operation manuals before using the product.

- The application examples provided in this catalog are for reference only. Check functions and safety of the equipment before use.
- Never use the products for any application requiring special safety requirements, such as nuclear energy control systems, railroad systems, aviation systems, medical equipment, amusement machines, vehicles, safety equipment, or other application involving serious risk to life or property, without ensuring that the system as a whole has been designed to address the risks, and that the OMRON products are properly rated and installed for the intended use within the overall equipment or system.

**Note: Do not use this document to operate the Unit.**

**OMRON Corporation Industrial Automation Company**  
Kyoto, JAPAN

Contact: [www.ia.omron.com](http://www.ia.omron.com)

**Regional Headquarters**

**OMRON EUROPE B.V.**

Wegalaan 67-69, 2132 JD Hoofddorp

The Netherlands

Tel: (31)2356-81-300/Fax: (31)2356-81-388

**OMRON ELECTRONICS LLC**

2895 Greenspoint Parkway, Suite 200

Hoffman Estates, IL 60169 U.S.A.

Tel: (1) 847-843-7900/Fax: (1) 847-843-7787

**OMRON ASIA PACIFIC PTE. LTD.**

No. 438A Alexandra Road # 05-05/08 (Lobby 2),

Alexandra Technopark,

Singapore 119967

Tel: (65) 6835-3011/Fax: (65) 6835-2711

**OMRON (CHINA) CO., LTD.**

Room 2211, Bank of China Tower,

200 Yin Cheng Zhong Road,

PuDong New Area, Shanghai, 200120, China

Tel: (86) 21-5037-2222/Fax: (86) 21-5037-2200

**Authorized Distributor:**

© OMRON Corporation 2015-2021 All Rights Reserved.

In the interest of product improvement, specifications are subject to change without notice.

**CSM\_17\_10**

**Cat. No. P056-E1-10**

0421(1006)