

Simple Wiring to Connect CJ1M-CPU22/23 and Servomotor

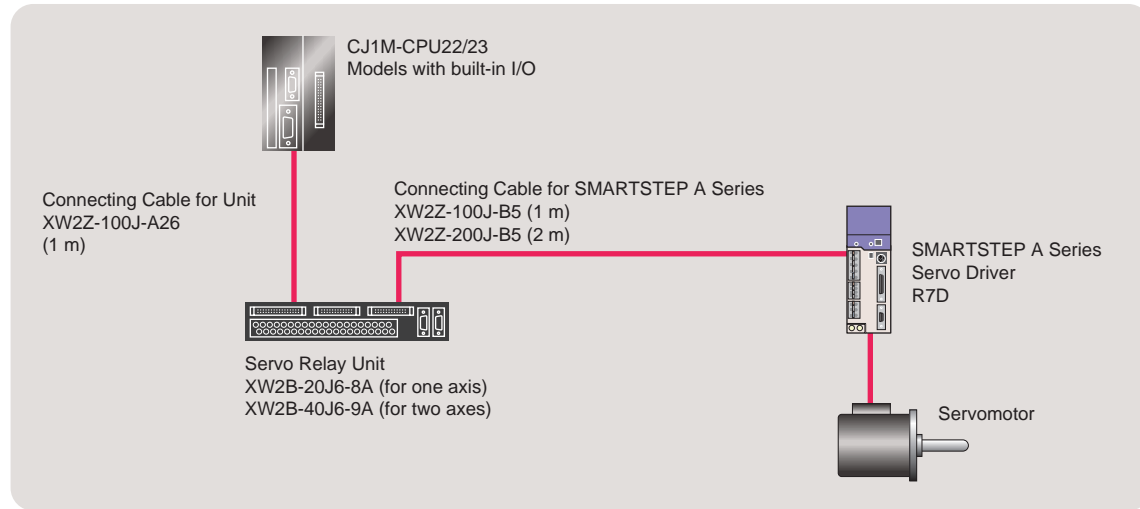

For connections other than those involving Servo Drivers and Servomotors, wire to terminal blocks using an XW2Z-□□K Connecting Cable and an XW2D-40G6 or XW2B-40G5/4 Connector Terminal Conversion Unit.

New!

OMRON

SYSMAC
CJ1M
Programmable Controllers

Packed with ideal functions for machine control.

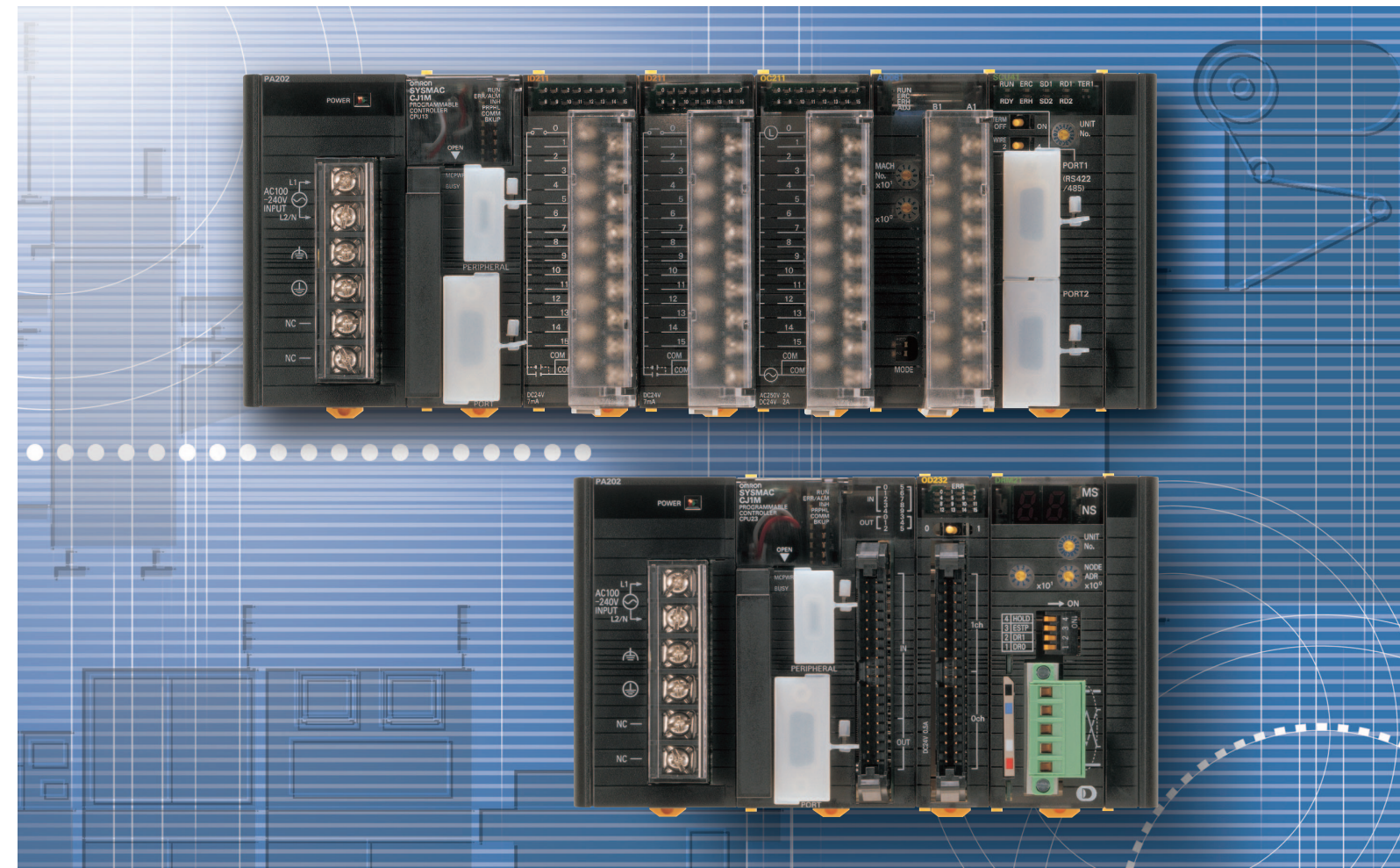

Note: Do not use this document to operate the Unit.

OMRON Corporation

FA Systems Division H.Q.
66 Matsumoto
Mishima-city, Shizuoka 411-8511
Japan
Tel: (81)55-977-9181
Fax: (81)55-977-9045

Regional Headquarters

OMRON EUROPE B.V.
Wegalaan 67-69, NL-2132 JD Hoofddorp
The Netherlands
Tel: (31)2356-81-300/Fax: (31)2356-81-388

OMRON ELECTRONICS LLC
1 East Commerce Drive, Schaumburg, IL 60173
U.S.A.
Tel: (1)847-843-7900/Fax: (1)847-843-8568

OMRON ASIA PACIFIC PTE. LTD.
83 Clemenceau Avenue,
#11-01, UE Square,
Singapore 239920
Tel: (65)6835-3011/Fax: (65)6835-2711

Authorized Distributor:

Note: Specifications subject to change without notice.

Cat. No. R100-E1-02
Printed in Japan
1002-3M

Fast! Small! Seamless! The CJ1 Series has expanded to meet the requirements of compact and general-purpose devices and to support the downsizing of machinery with greater added value.



Maintenance improved using Memory Cards (compact flash cards).

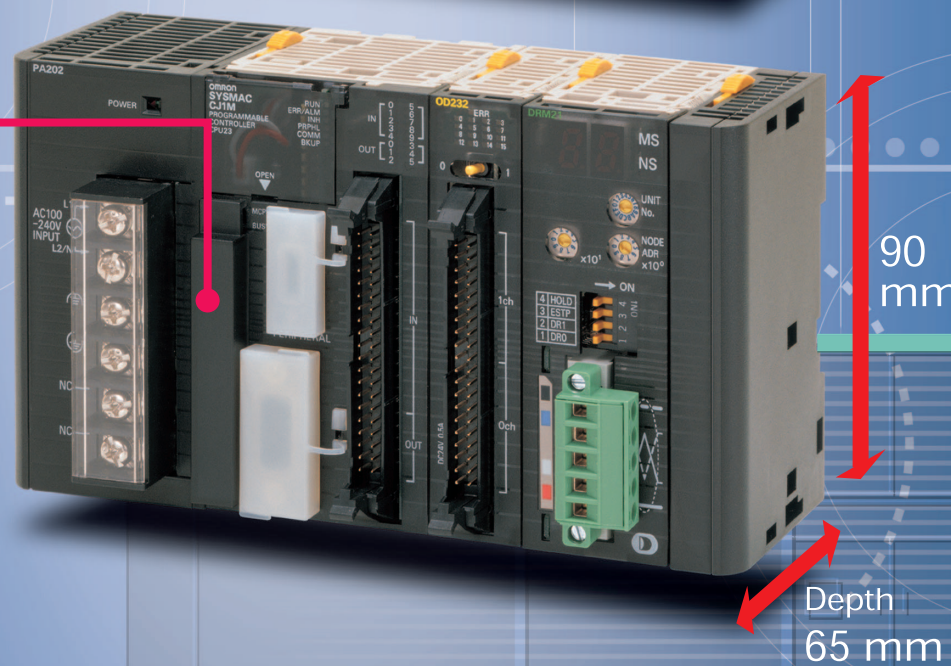

MORE COMPACT

Contributing to Machine Downsizing

Even though the CPU Unit is only 31-mm wide, it is equipped with RS-232C and peripheral ports as well as an interface for Memory Cards.

CJ1M-CPU12 (10 Ksteps)
CJ1M-CPU13 (20 Ksteps)



Approx. **50%** of the volume of the CQM1H.

Compact design that allows use in devices of shoulder-width dimensions or smaller.

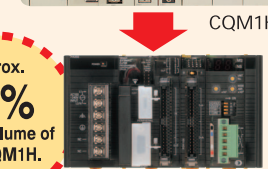

Built-in Positioning Functions

Lineup includes CPU Unit with built-in pulse input/output functions. This CPU Unit can be used for simple positioning, allowing further downsizing.

- Pulse output function: 100 kHz, 2 axes
- Counter function: Phase differential, 50 kHz, 2 axes
Single phase, 100 kHz, 2 axes
- Interrupt functions: 4 points
These functions can be used at the same time.

CJ1M-CPU22 (10 Ksteps)
CJ1M-CPU23 (20 Ksteps)

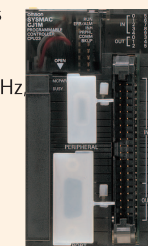

MORE FLEXIBLE

Combining Units with Greater Efficiency

The CJ1M does not require a backplane, allowing Units to be combined flexibly. Despite not having a backplane, it is still possible to leave words empty for future expansion.

- Systems can be expanded to include more I/O without making any changes to existing I/O word allocations.

Uses the same construction as the CQM1 — no backplane required.



Empty words can be set using CX-Programmer.

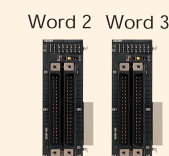

Words in the I/O Area can be left empty to allow Units to be added here in the future.

Choose the Units to suit the application.



The CJ1M's memory allocations, instructions, and I/O Units are compatible with CJ1G/H models. This means that existing programs and equipment can be easily reused in small and large-scale installations.

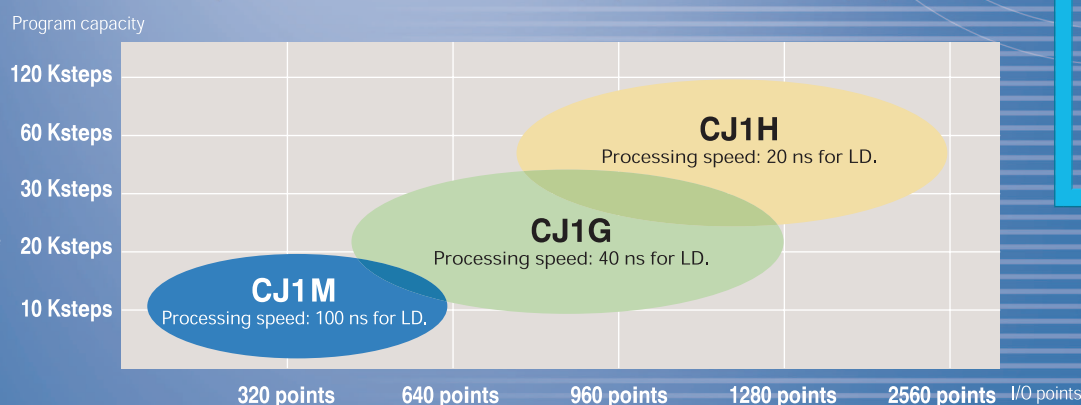

More freedom and higher precision — pulse I/O control provides greater added value to machines.

- Packaging equipment
- Foodstuff equipment

- Substrate transfer equipment

- Electronic component assembly equipment
- Inspection equipment

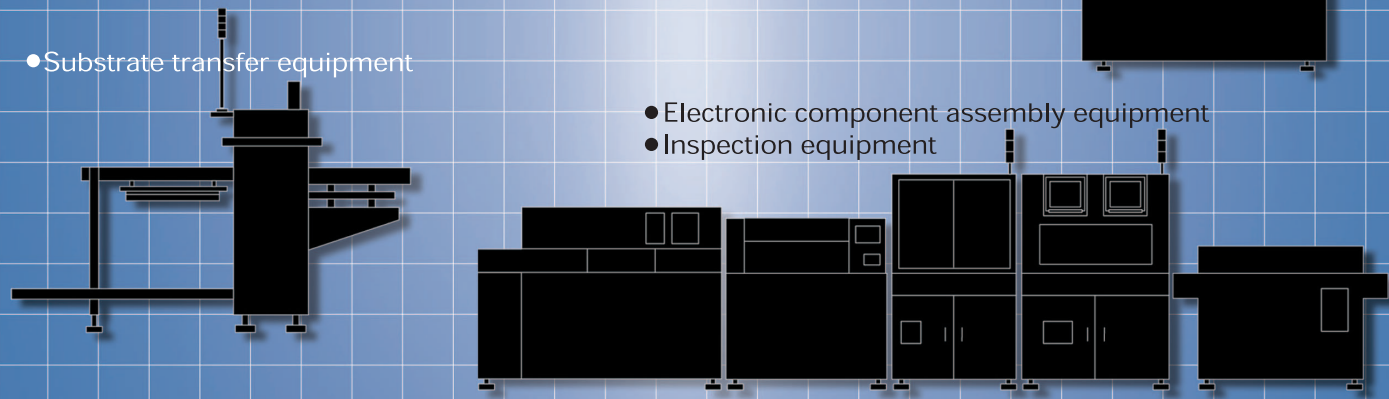

Pulse Output Function

Supported by CJ1M-CPU22/CPU23

Pulses can be output at 100 kHz for two axes with a minimum startup time of 46 μs.

■ Origin Search Function (ORG)

- Origin search can be executed with just one instruction (ORG).
- Using error counter reset output minimizes position displacement when performing origin search with a servomotor.

■ Positioning with Trapezoidal Acceleration/Deceleration (PLS2)

Positioning is easy with special instruction (PLS2).

Trapezoidal positioning with different acceleration and deceleration times is possible.

Positioning where the target speed is not reached is also possible (triangular control).

Positioning for substrate racks

Positioning for the rail width in substrate transfer equipment

- The minimum startup time (i.e., the time between instruction execution and pulse output) is 46 μs, with an impressive 70 μs for trapezoidal acceleration/deceleration.

■ Interrupt Feeding (ACC + PLS2)

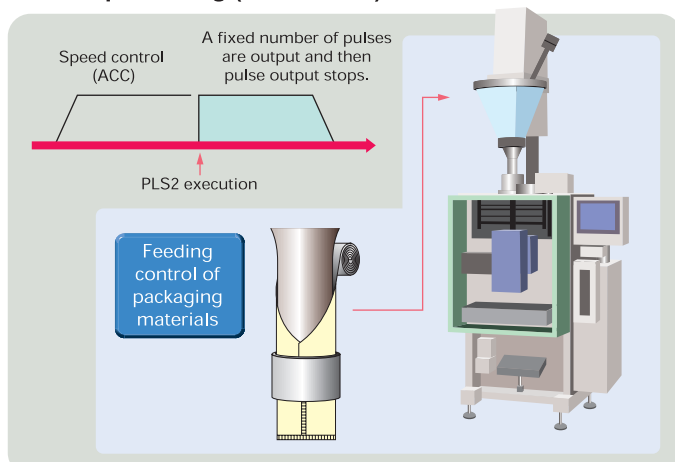

■ Changing the Target Position during Positioning (PLS2 + PLS2)

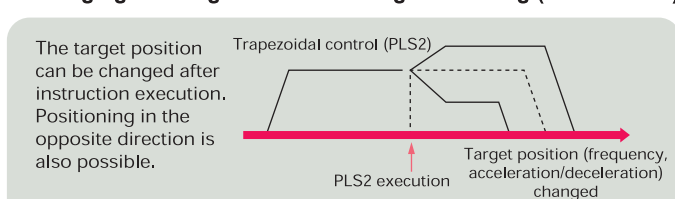

Positioning Control Based on Data Measured after Startup

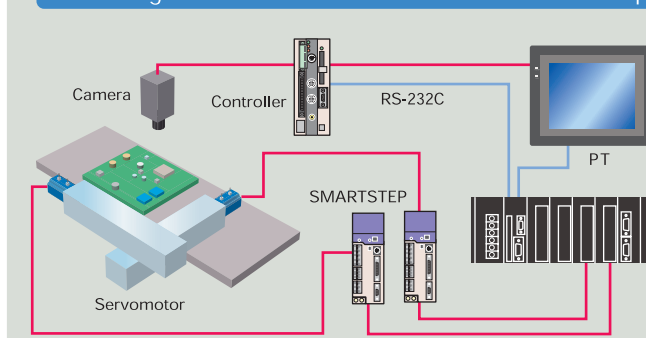

Control with Standby at Reference Position for Errors

High-speed Counter Input Function

Supported by CJ1M-CPU22/CPU23

100-kHz single-phase and 50-kHz phase-differential counter input are possible for two axes.

■ Linear Mode

Use either 100-kHz single-phase input or 50-kHz phase-differential input for high-speed line driver input. (With 24-VDC input, 60-kHz single-phase input and 30-kHz phase-differential input are available.)

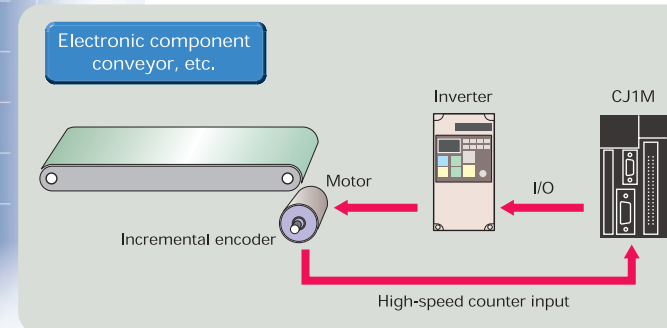

■ Circular Mode

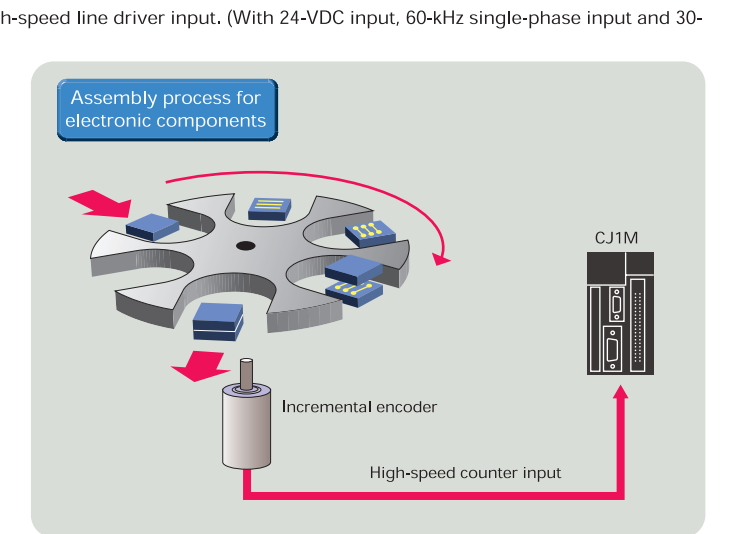

■ Frequency (Speed) Measurement Function

Measurement of the rate of rotation in inspection applications and display of the conveyor speed for tact time are possible without using a special speed calculation device. The present count value can be monitored during high-speed count input using the PRV (HIGH-SPEED COUNTER PV READ) instruction.

Interrupt Input Function

Supported by CJ1M-CPU22/CPU23

Four interrupt inputs or four quick-response inputs (pulse width: 30-μs min.) can be used.

- Interrupt tasks can be started on the rising edge or falling edge of interrupt input signals allowing precise recording and judgement of inspection data (e.g., for electronic components).

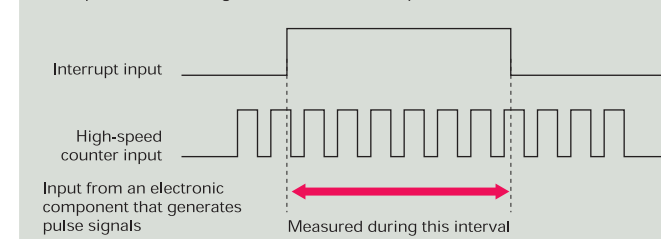

● Application Example

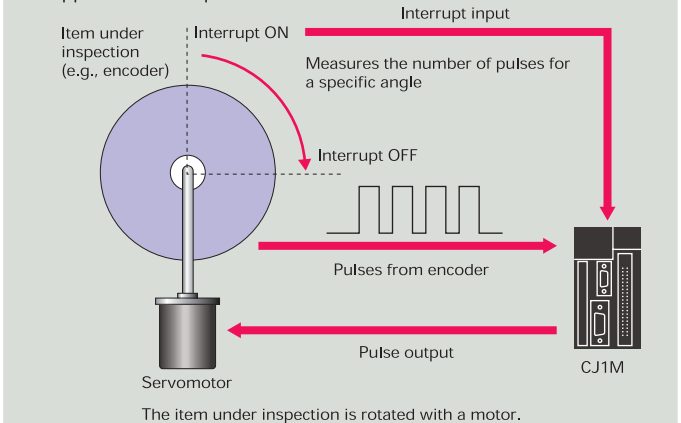

Lineup Includes Quick-response Input Unit

In applications where signals are exchanged with inspection equipment, it is sometimes necessary to have several points receiving short pulse signals that cannot be handled as regular I/O. The Quick-response Input Unit helps meet this requirement.

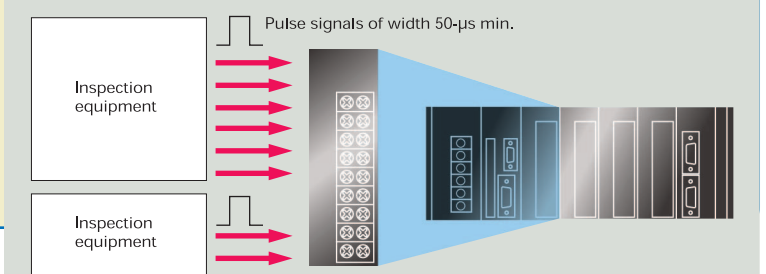

Maintenance improved using Memory Cards (compact flash cards).

Memory Cards make it easy to change programs.

Using compact flash cards allows programs to be changed by email as well as post.

Example of Memory Card Application

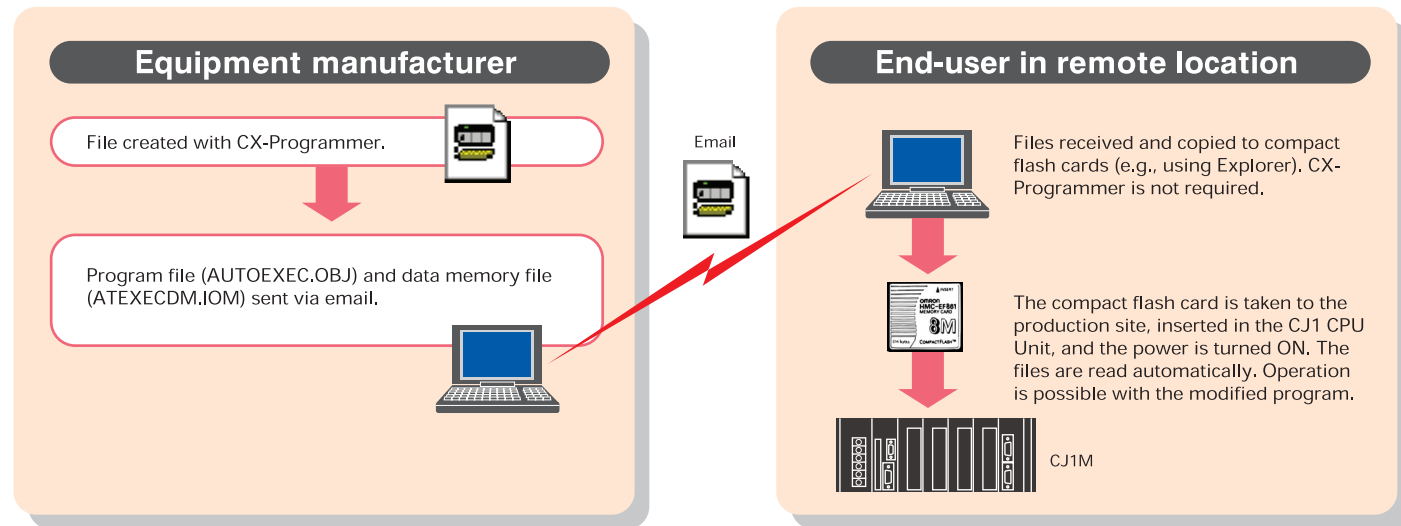

Programs can be written to a compact flash card without a PLC being present. The cards can be used with PC card slots, which are built into most laptop computers, and so special peripheral devices are not required.

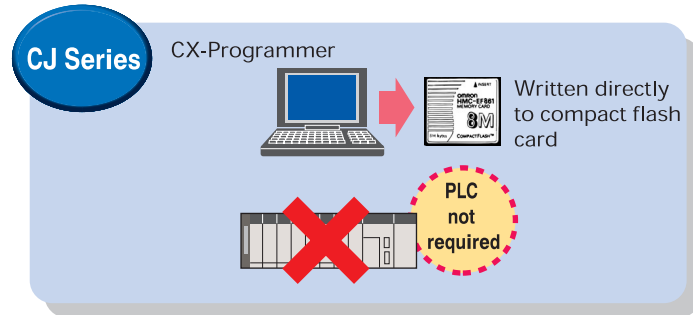
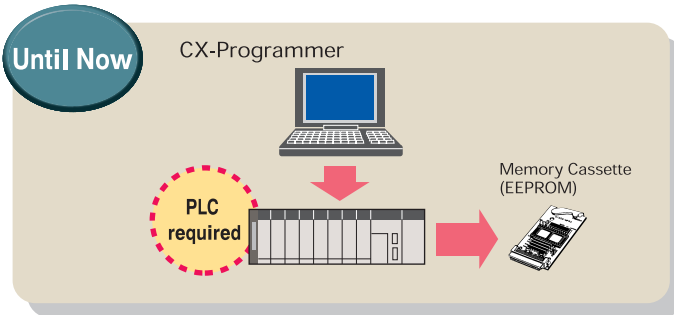

Logging possible for production conditions and inspection data.

A computer is not required at the production site, enabling downsizing and cost reductions.

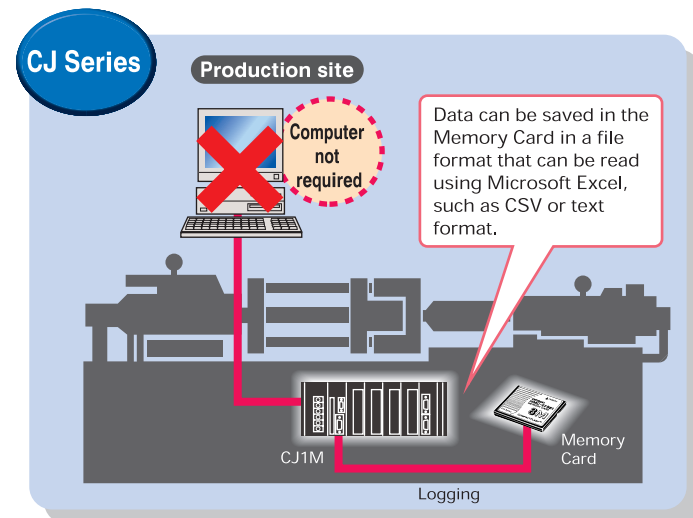
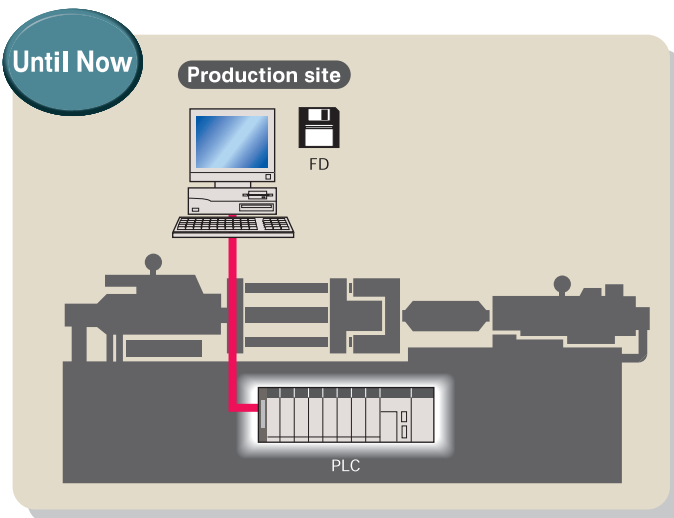

Serial PLC Link Function

Supported by the CJ1M CPU Unit's built-in RS-232C Board.

Serial PLC Links can be used for exclusive control between loaders and unloaders in substrate transfer equipment and for the exchange of temperatures and times between conveyor ovens.

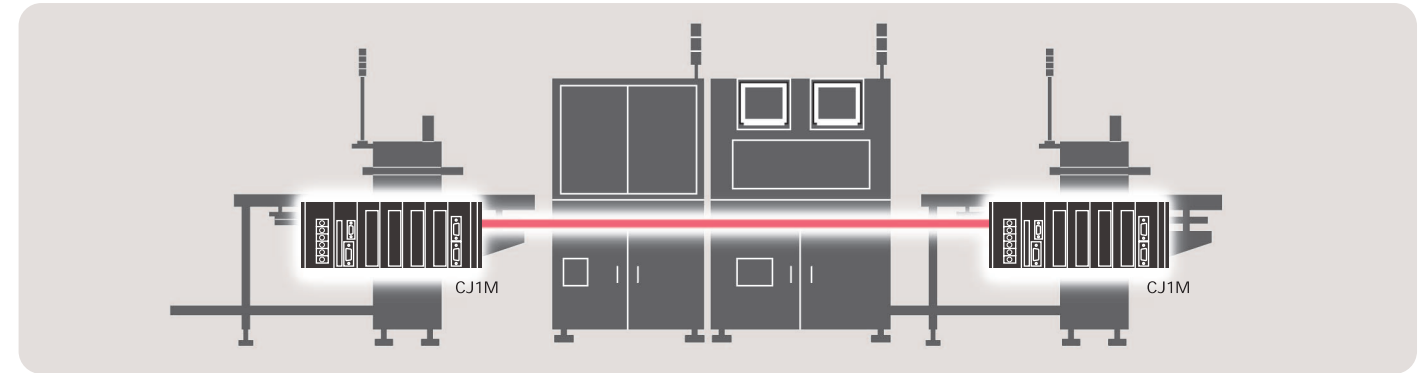

Data can be exchanged via Serial PLC Links involving up to nine CJ1M PLCs using the built-in RS-232C Boards. Up to ten words per PLC can be allocated to the Serial PLC Links. RS-232C can be converted to RS-422A easily using a CJ1W-CIF11 RS-422A Converter.

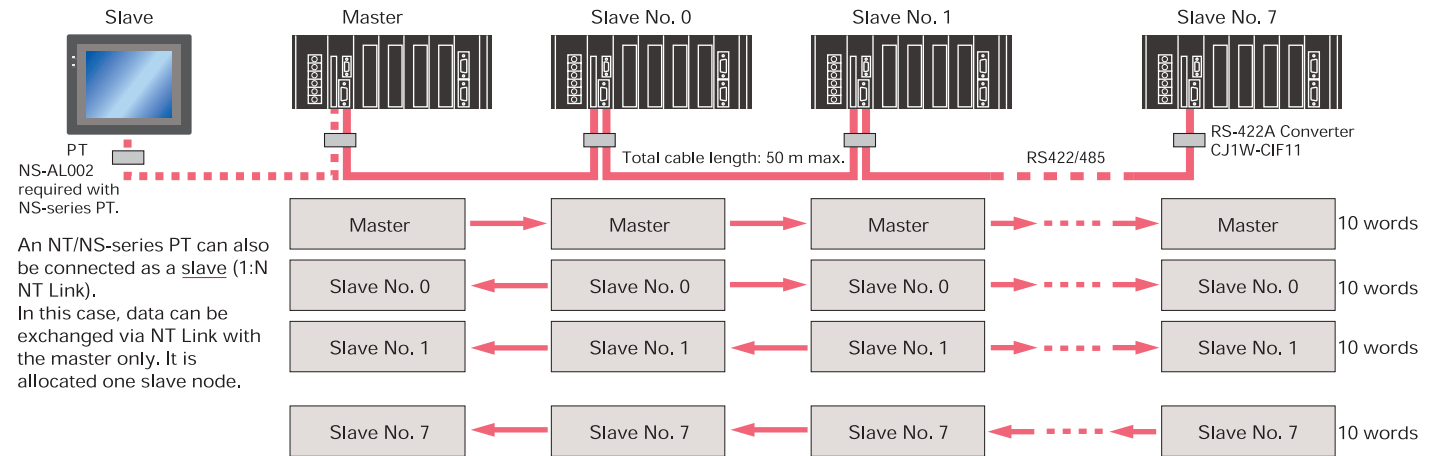

Cam switch control is easy with ladder instructions.

CJM1 instruction

The BCMP (UNSIGNED BLOCK COMPARE) instruction can also be used for angle comparisons and comparison data settings that straddle 0 (BCMP2).

The comparison data (i.e., the source data, S) is compared with 256 sets of upper and lower limits, and the corresponding bits are turned ON if the source data is within range. If the upper limit is less than the lower limit, a comparison straddling 0 (degrees) is performed.

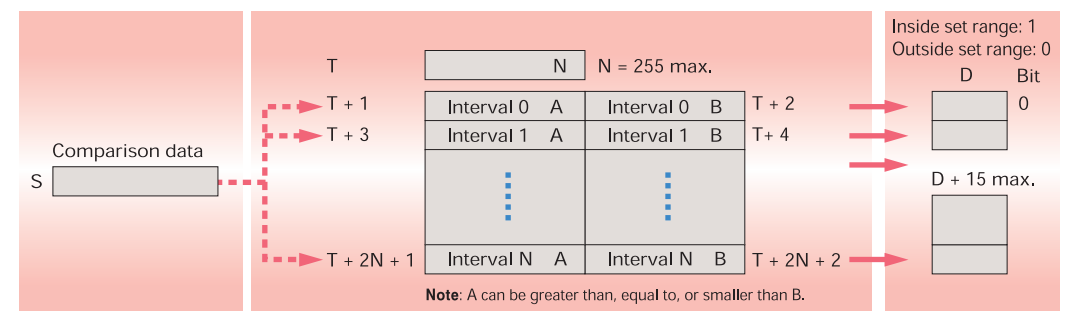

Comparison Data Example

- **Angle Data**
Controlling machinery with timing regulated by angle (cam switch control)
- **Repeated Timer Startup**
Controlling machinery with timing regulated by timer (rotary timer control)

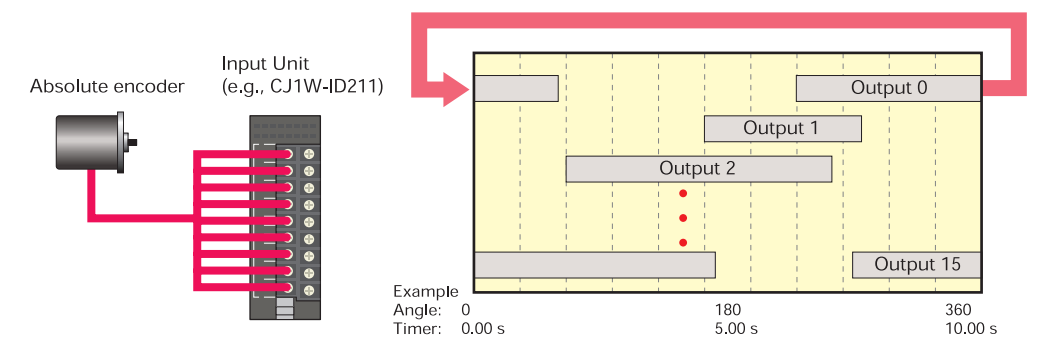

CJ1 M/CJ-series Lineup

Power Supply Unit

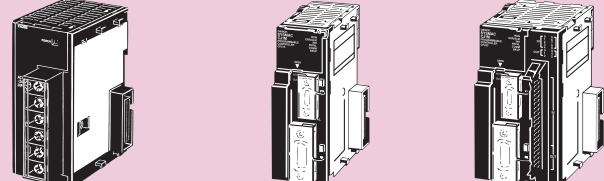

CJ1W-PA202 (14 W, AC)
CJ1W-PA205R (25 W, AC)
CJ1W-PD025 (25 W, DC)

CPU Unit

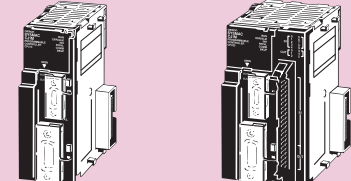

CJ1M-CPU12 (10 Ksteps)
CJ1M-CPU13 (20 Ksteps)
Models with Built-in I/O
CJ1M-CPU22 (10 Ksteps)
CJ1M-CPU23 (20 Ksteps)

Memory Card



HMC-EF172/372/672

End Cover



CJ1W-TER01
(included with CPU Unit)

End Plate

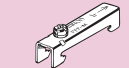

PFP-M
(included with CPU Unit)

I/O Control Unit

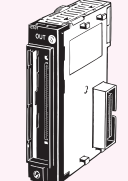

CJ1W-IC101 (required for expansion)

DIN Track

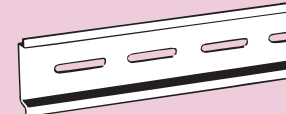

PFP-50N/100N/100N2

RS-422A Converter

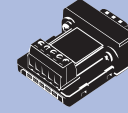

CJ1W-CIF11
(non-isolated converter for converting RS-232C to RS-422/485)

CPU Rack

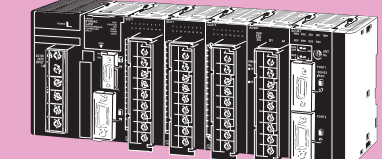

I/O Connecting Cable

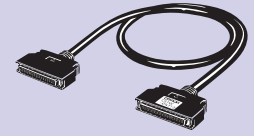

CS1W-CN□□3
(30 cm, 70 cm, 2 m, 3 m, 5 m, 10 m, 12 m)

Expansion Rack

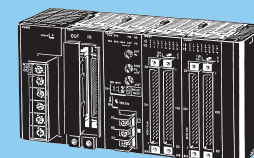

Expansion is possible with the CJ1M-CPU13/23 only.

Power Supply Unit

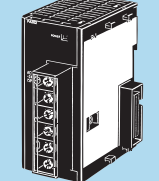

CJ1W-PA205R
CJ1W-PA202
CJ1W-PD025

I/O Interface Unit

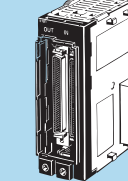

CJ1W-II101

End Cover



CJ1W-TER01
(included with I/O Interface Unit)

End Plate



PFP-M
(included with I/O Interface Unit)

DIN Track

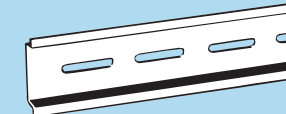

PFP-50N/100N/100N2

Basic I/O Units (Allocated words: CIO 0000 to CIO 0039. Allocated in word units (16 bits) according to the mounting position, starting from the left.)

• Input Units

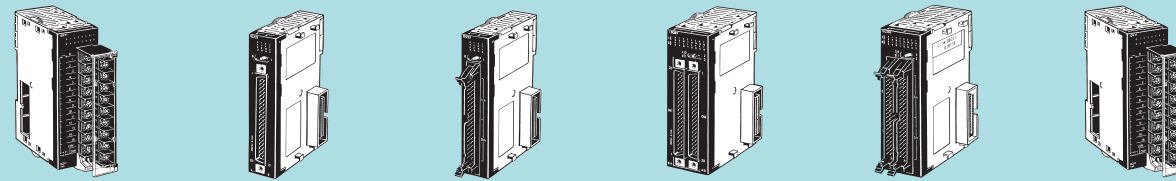

16-point DC Input Unit CJ1W-ID211
32-point DC Input Unit CJ1W-ID231
32-point DC Input Unit CJ1W-ID232
64-point DC Input Unit CJ1W-ID261
64-point DC Input Unit CJ1W-ID262
8/16-point AC Input Units CJ1W-IA111/201

• Output Units

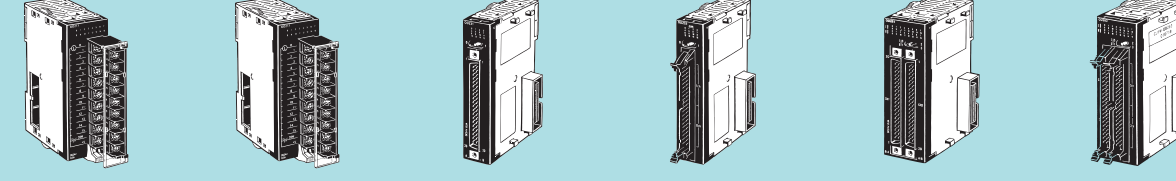

8-point Transistor Output Units CJ1W-OD201/202
16-point Transistor Output Units CJ1W-OD211/212
32-point Transistor Output Unit CJ1W-OD231
32-point Transistor Output Units CJ1W-OD232/233
64-point Transistor Output Unit CJ1W-OD261
64-point Transistor Output Unit CJ1W-OD263

Interrupt Input Unit

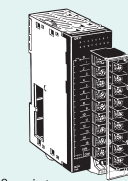

16-point Interrupt Input Unit CJ1W-INT01

Quick-response Input Unit

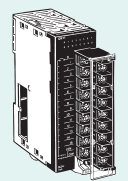

16-point Quick-response Input Unit CJ1W-IDP01

Special I/O Units (Allocated words: CIO 2000 to CIO 2959, 10 words per Unit. Allocated according to unit number.)

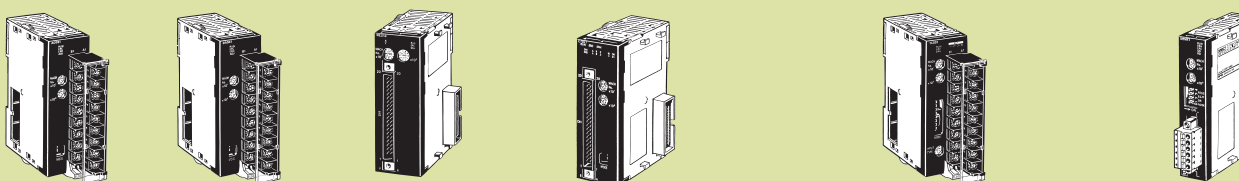

Analog Input Units CJ1W-AD081-V1 (8 points), CJ1W-AD041-V1 (4 points)
Analog Output Units CJ1W-DA041 (4 points), CJ1W-DA021 (2 points)
Position Control Units CJ1W-NC4□3 (4 axes), CJ1W-NC2□3 (2 axes), CJ1W-NC1□3 (1 axis)
High-speed Counter Unit CJ1W-CT021 (2 axes)
Temperature Control Units CJ1W-TC001/002 (4 loops, thermocouple input), CJ1W-TC003/004 (2 loops, thermocouple input, heater burnout detection), CJ1W-TC101/201 (4 loops, platinum resistance thermometer input), CJ1W-TC103/104 (2 loops, platinum resistance thermometer input, heater burnout detection)
CompoBus/S Master Unit CJ1W-SRM21

CPU Bus Units (Allocated words: CIO 1500 to CIO 1899, 25 words per Unit. Allocated according to unit number.)



Serial Communications Units CJ1W-SCU41 (one RS-232C port and one RS-422/485 port), CJ1W-SCU21 (two RS-232C ports)
Ethernet Unit CJ1W-ETN11
Controller Link Unit CJ1W-CLK21
DeviceNet Unit CJ1W-DRM21

Connections to Programming Devices

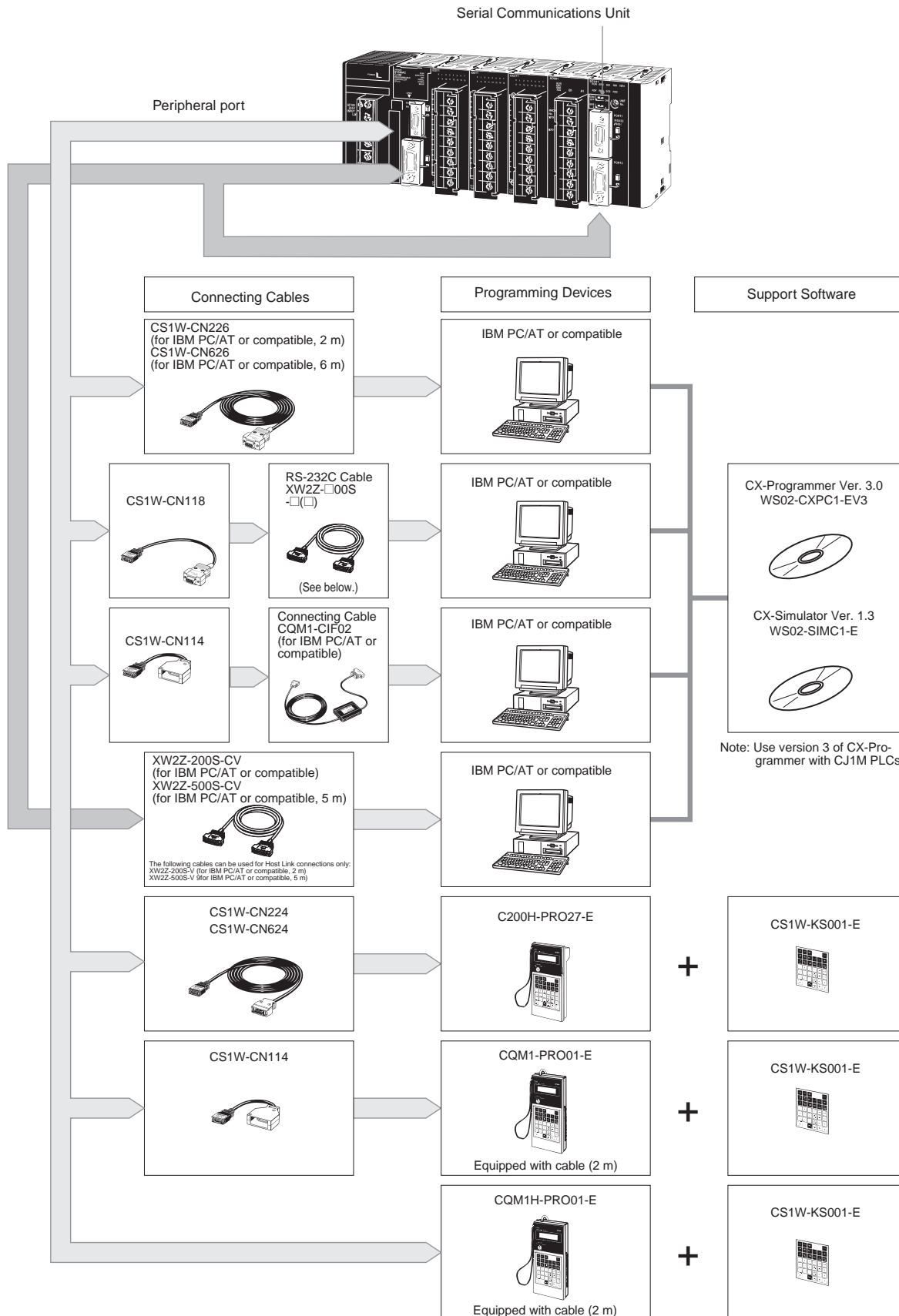

CJ1M CPU Units

CJ1M-CPU12/13
CJ1M-CPU22/23

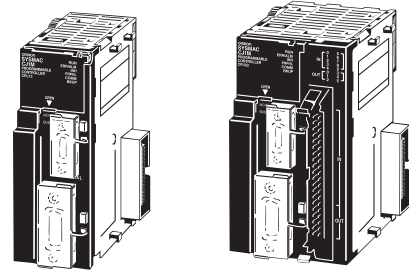

CPU Units

Model	Number of I/O points	Maximum number of Expansion Racks	Maximum number of connectable Units	Program capacity	Data memory capacity	LD instruction processing speed	Built-in ports	Mountable options	Built-in I/O
CJ1M-CPU12	320	None	10 Units	10 Ksteps	32 Kwords (DM only, no EM)	100 ns	Peripheral port and RS-232C port	Memory Card (compact flash)	None
CJ1M-CPU13	640	1 Unit	CPU Rack: 10 Units Expansion Rack: 10 Units	20 Ksteps					
CJ1M-CPU22	320	None	10 Units	10 Ksteps	32 Kwords (DM only, no EM)	100 ns	Peripheral port and RS-232C port	Memory Card (compact flash)	10 inputs and 6 outputs Inputs: 4 interrupt inputs (pulse catch); 2 high-speed counter inputs (Phase differential: 50 kHz; Single phase: 100 kHz) Outputs: 2 pulse outputs (2 points for positioning, 100-kHz speed control, and PWM output)
CJ1M-CPU23	640	1 Unit	CPU Rack: 10 Units Expansion Rack: 10 Units	20 Ksteps					

Dimensions

CPU Unit

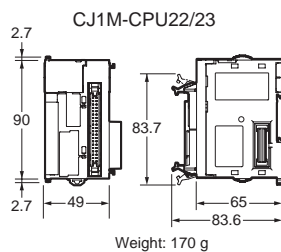
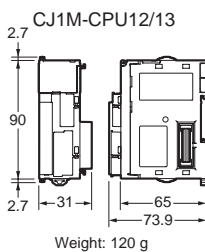

End Plate

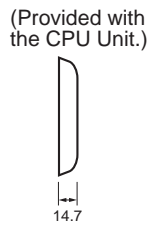

RS-422A Converter

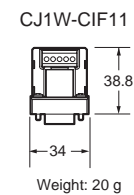

Rack Dimensions

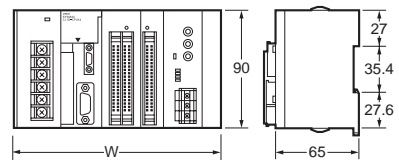

Unit Dimensions

Power Supply Units

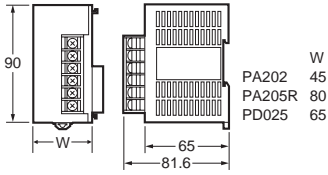

8/16-point Basic I/O Units

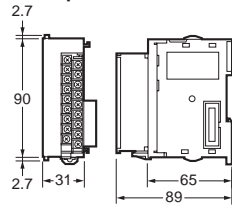

Width W (mm) When Used with a CJ1W-PA202 Power Supply Unit (AC, 14 W)

Number of I/O Units with 31-mm width	CJ1M-CPU12/13	CJ1M-CPU22/23
1	121.7	139.7
2	152.7	170.7
3	183.7	201.7
4	214.7	232.7
5	245.7	263.7
6	276.7	294.7
7	307.7	325.7
8	338.7	356.7
9	369.7	387.7
10	400.7	418.7

32-point I/O Units

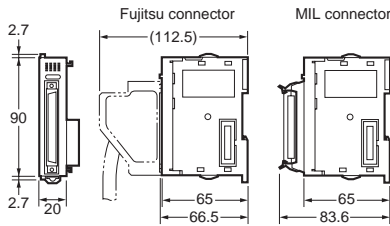

64-point Basic I/O Units

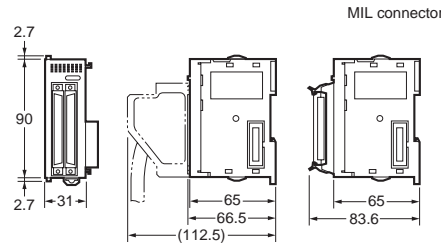

I/O Units with 20-mm width:
 32-point Basic I/O Units
 CompoBus/S Master Units
 I/O Units with 31-mm width:
 Basic I/O Units other than the above
 Special I/O Units
 CPU Bus Units

Current Consumption

CPU Unit Current Consumption

Model	Current consumption at 5 V	Current consumption at 24 V
CJ1M-CPU12/ CPU13	0.58 A	-
CJ1M-CPU22/ CPU23	0.64 A	-

Power Supply Unit Capacity

Model		Current consumption at 5 V	Current consumption at 24 V
CJ1W-PA202	Maximum current output	2.8 A	0.4 A
	Maximum power output	14 W	
CJ1W-PA205R	Maximum current output	5.0 A	0.8 A
	Maximum power output	25 W	
CJ1W-PD025	Maximum current output	5.0 A	0.8 A
	Maximum power output	25 W	

Calculation Example for Power and Current Consumption

The configuration in this example is possible with the CJ1W-PA202 Power Supply Unit (14 W).

Model	Specification	Current consumption at 5 V	Current consumption at 24 V
CJ1W-CPU23	CPU Unit	0.64 A	-
CJ1W-CIF11	RS-422A Converter	0.04 A	-
CJ1W-ID211	16-point DC Input Unit	0.08 A	-
CJ1W-ID261	64-point DC Input Unit	0.09 A	-
CJ1W-OC211	16-point Relay Output Unit	0.11 A	0.096 A
CJ1W-OD211	16-point Relay Output Unit	0.10 A	-
CJ1W-OD261	64-point Transistor Output Unit	0.17 A	-
CJ1W-AD08-V1	8-point Analog Input Unit	0.42 A	-
CJ1W-NC413	4-axis Position Control Unit	0.36 A	-
Total current consumption		2.01 A	0.096 A
Total power consumption		12.35 W	

Common Specifications

Item		Specification	
Control method		Stored program	
I/O control method		Cyclic scan and immediate processing are both possible.	
Programming		Ladder diagram	
Instruction length		1 to 7 steps per instruction	
Ladder instructions		Approx. 400 (3-digit function codes)	
Execution time	Basic instructions	0.1 μs min.	
	Special instructions	0.3 μs min.	
Overhead time		0.5 ms	
Unit connection method		No backplane (Units joined together with connectors.)	
Mounting method		DIN track mounting (screw mounting not possible)	
Number of tasks		288 (cyclic tasks: 32, interrupt tasks: 256)	
Interrupt types		Scheduled interrupts: Interrupts generated at a specified interval based on the CPU Unit's built-in clock. I/O interrupts: Interrupts from Interrupt Input Units or from built-in inputs (CJ1M-CPU22/23 only). Power OFF interrupts: Interrupt executed when CPU Unit's power is turned OFF. External interrupts: Interrupts from Special I/O Units and CPU Bus Units.	
Calling subroutines from multiple tasks		Supported using global subroutines.	
CIO (Core I/O) Area	I/O Area	640 (40 words): CIO 00000 to CIO 003915 (words CIO 0000 to CIO 039) Setting of first rack words can be changed from default (CIO 0000) to CIO 0000 to CIO 0999. I/O bits are allocated to Basic I/O Units.	These bits can be used as work bits when not used for the applications described on the left.
	Built-in I/O Area	10 input bits: CIO 296000 to CIO 296009 6 output bits: CIO 296100 to CIO 296105 Built-in I/O bits are allocated to the CPU Unit's built-in inputs and outputs (CJ1M-CPU22/23 only).	
	Link Area	3,200 (200 words): CIO 100000 to CIO 119915 (words CIO 1000 to CIO 1199) Link bits are used for data links in Controller Link systems.	
	CPU Bus Unit Area	6,400 (400 words): CIO 150000 to CIO 189915 (words CIO 1500 to CIO 1899)	
	Special I/O Unit Area	15,360 (960 words): CIO 200000 to CIO 295915 (words CIO 2000 to CIO 2959) Special I/O Unit bits are allocated to Special I/O Units (10 words per Unit).	
	Serial PLC Link Area	90 (90 words): CIO 310000 to CIO 318900 (words CIO 3100 to CIO 3189) Serial PLC Link words are used for data links in Serial PLC Link systems.	
	DeviceNet Area	9,600 (600 words): CIO 320000 to CIO 379915 (words CIO 3200 to CIO 3799) DeviceNet bits are allocated to Slaves for DeviceNet Unit remote I/O communications when the master function is used with fixed allocations. Fixed allocation setting 1 Outputs: CIO 3200 to CIO 3263 Inputs: CIO 3300 to CIO 3363 Fixed allocation setting 2 Outputs: CIO 3400 to CIO 3463 Inputs: CIO 3500 to CIO 3563 Fixed allocation setting 3 Outputs: CIO 3600 to CIO 3663 Inputs: CIO 3700 to CIO 3763	

Item	Specification
Internal I/O Area (work bits)	4,800 (300 words): CIO 120000 to CIO 149915 (words CIO 1200 to CIO 1499) 37,504 (2,344 words): CIO 380000 to CIO 614315 (words CIO 3800 to CIO 6143) These bits in the CIO Area are used as work bits in programming to control program execution. They cannot be used for external I/O.
Work Area	8,192 (512 words): W00000 to W51115 (words W000 to W511) These bits are used as work bits in programming to control program execution. They cannot be used for external I/O. Note: When using work bits in programming, use bits in the Work Area first before using bits from other areas.
Holding Area	8,192 (512 words): H00000 to H51115 (words H000 to H511) Holding bits are used to control program execution, and maintain their ON/OFF status when PLC is turned OFF or the operating mode is changed.
Auxiliary Area	Read-only: 7,168 (448 words): A00000 to A44715 (words A000 to A447) Read/write: 8,192 bits (512 words): A44800 to A95915 (words A448 to A959) Auxiliary bits are allocated specific functions.
Temporary Area	16 bits (TR0 to TR15) Temporary bits are used to store ON/OFF execution conditions at program branches.
Timer Area	4,096: T0000 to T4095 (used for timers only)
Counter Area	4,096: C0000 to C4095 (used for counters only)
DM Area	32 Kwords: D00000 to D32767 Special I/O Unit DM Area: D20000 to D29599 (100 words × 96 Units). Used to set parameters for Special I/O Units. CPU Bus Unit DM Area: D30000 to D31599 (100 words × 16 Units). Used to set parameters for CPU Bus Units.
Index Registers	IR0 to IR15 Store PLC memory addresses for indirect addressing.
Task Flag Area	32 (TK0000 to TK0031) Task Flags are read-only flags that are ON when the corresponding cyclic task is being executed and OFF when the corresponding task is not being executed or is in standby status.
Trace Memory	4,000 words (trace data: 31 bits, 6 words)
File Memory	Memory Cards: OMRON Memory Cards with 8-MB, 15-MB, 30-MB, or 48-MB capacities can be used. (MS-DOS format).

These bits can be used as work bits when not used for the applications described on the left.

Used as a general-purpose data area for reading and writing data in word units (16 bits). Words in the DM Area maintain their status when the PLC is turned OFF or the operating mode is changed.

Function Specifications

Item	Specification
Constant cycle time	Possible: 1 to 32,000 ms (unit: 1 ms)
Cycle time monitoring	Possible (Unit stops operating if cycle is too long): 10 to 40,000 ms (unit: 10 ms)
I/O refreshing	Cyclic refreshing, immediate refreshing, refreshing by IORF(097). The CPU BUS UNIT I/O REFRESH (DLNK) instruction can be used to refresh CPU Bus Units (including allocated CIO and DM Area words) when required in the program.
Special refreshing for CPU Bus Units	Data links for Control Link Units, remote I/O communications for DeviceNet Units, and other special data for CPU Bus Units are refreshed at the following times. During I/O refresh period or when CPU BUS UNIT I/O REFRESH (DLNK) instruction is executed.
I/O memory holding when changing operating modes	Possible (using the IOM Hold Bit in the Auxiliary Area)
Load OFF	All outputs from Output Units can be turned OFF when the CPU Unit is in RUN, MONITOR, or PROGRAM mode.
Input time constant setting	Time constants can be set for inputs from CJ-series Basic I/O Units. The time constant can be increased to reduce influence of noise and chattering or it can be decreased to detect shorter pulses on inputs.
Operating mode setting at power-up	Possible (By default, the CPU Unit will start in RUN mode if a Programming Console is not connected.)
Built-in flash memory	User program and parameter areas (e.g., PC Setup) are automatically backed up and restored.

Item	Specification	
Memory Card functions	Automatically reading programs (autoboot) from the Memory Card when the power is turned ON.	Possible
	Program replacement during PLC operation	Possible
	Memory Card storage data	User program: Program file format PC Setup and other parameters: Data file format I/O memory: Data file format (binary), text format, CSV format CPU Bus Unit data: Special format
	Memory Card read/write method	User program instructions, Programming Devices (including CX-Programmer and Programming Console), Host Link computers, AR Area control bits, easy backup operation
Filing	Memory Card data can be handled as files.	
Debugging	Force-set/reset, differential monitoring, data tracing (scheduled, each cycle, or when instruction is executed)	
Online editing	One or more program blocks in user programs can be overwritten when CPU Unit is in PROGRAM or MONITOR mode. This function is not supported for block program areas. With the CX-Programmer, more than one program circuit can be edited at the same time.	
Program protection	Overwrite protection: Set using DIP switch. Copy protection: Password set using CX-Programmer.	
Error check	User-defined errors (i.e., user can define fatal errors and non-fatal errors) The FPD(269) instruction can be used to check execution time and logic of each programming circuit. Error status can be simulated with the FAL and FALS instructions.	
Error log	Up to 20 errors are stored in error log. Information includes error code, error details, and time error occurred. It is possible to set whether or not FAL errors are stored in the error log.	
Serial communications	Built-in peripheral port: Programming Device (e.g., CX-Programmer or Programming Console), Host Links, NT Links Built-in RS-232C port: Programming Device (e.g., CX-Programmer), Host Links, no-protocol communications, NT Links, Serial PLC Links	
	Serial Communications Unit (sold separately): Protocol macros, Host Links, NT Links	
Clock	Provided on all models. Accuracy: ± 1.5 min/mo. at 25°C. Note: 1. The accuracy varies with the temperature. 2. Used to store time when power is turned ON and when errors occur.	
Power OFF detection time	10 to 25 ms (not fixed)	
Power OFF detection delay time	0 to 10 ms (user-defined, default: 0 ms)	
Memory protection	Held areas: User program, holding bits, Data Memory, and status of counter Completion Flags and present values. Note: If the IOM Hold Bit in the Auxiliary Area is ON, and the PC Setup is set to maintain the IOM Hold Bit status when power is turned ON, the contents of the CIO Area, Work Area, part of the Auxiliary Area, timer Completion Flags and PVs, Index Registers, and Data Registers will be saved.	
Sending commands to a Host Link computer	FINS commands can be sent to a computer connected via Host Link System by executing Network Communications Instructions from PLC.	
Remote programming and monitoring	Host Link communications can be used for remote programming and remote monitoring through a Controller Link System or Ethernet network.	
Three-level communications	Host Link communications can be used for remote programming and remote monitoring from devices on networks up to two levels away (Controller Link Network, Ethernet Network, or other network).	
Storing comments in CPU Unit	I/O comments can be stored in Memory Cards.	
Program check	Program checks are performed for items such as no END instruction and instruction errors. CX-Programmer can also be used to check programs.	
Control output signals	RUN output: The internal contacts will turn ON (close) while the CPU Unit is operating. (Possible only with CJ1W-PA205R Power Supply Unit.)	
Battery life	5 years at 25°C (The battery life depends on the ambient operating temperature; 0.75 year min.) (Battery Set: CJ1W-BAT01) Note: Use a replacement battery for which no more than 2 years have expired since the date of manufacture.	
Self-diagnostics	CPU errors (watchdog timer), I/O bus errors, memory errors, and battery errors	
Other functions	Storage of the number of times power has been interrupted. (Stored in A514.)	

CJ1M-CPU22/23 Specifications

Built-in I/O Allocation Areas

I/O point		IN0	IN1	IN2	IN3	IN4	IN5	IN6	IN7	IN8	IN9	OUT1	OUT2	OUT3	OUT4	OUT5	OUT6
Word		2960											2961				
Bit		0	1	2	3	4	5	6	7	8	9	0	1	2	3	4	5
Input	General-purpose input	General-purpose input 0	General-purpose input 1	General-purpose input 2	General-purpose input 3	General-purpose input 4	General-purpose input 5	General-purpose input 6	General-purpose input 7	General-purpose input 8	General-purpose input 9	-	-	-	-	-	-
	Interrupt input	Interrupt input 0	Interrupt input 1	Interrupt input 2	Interrupt input 3	-	-	-	-	-	-	-	-	-	-	-	-
	Quick-response input	Quick-response input 0	Quick-response input 1	Quick-response input 2	Quick-response input 3	-	-	-	-	-	-	-	-	-	-	-	-
	High-speed counter input	-	-	High-speed counter input 1 (phase Z or reset)	High-speed counter input 0 (phase Z or reset)	-	-	High-speed counter input 1 (phase A incremental, or count input)	High-speed counter input 1 (phase B decremental, or direction input)	High-speed counter input 0 (phase A incremental, or count input)	High-speed counter input 0 (phase B decremental, or direction input)	-	-	-	-	-	-
Output	General-purpose output	-	-	-	-	-	-	-	-	-	-	General-purpose output 0	General-purpose output 1	General-purpose output 2	General-purpose output 3	General-purpose output 4	General-purpose output 5
	Pulse output	CW/CCW	-	-	-	-	-	-	-	-	-	Pulse output 0 (CW)	Pulse output 0 (CCW)	Pulse output 1 (CW)	Pulse output 1 (CCW)	-	-
		Pulse + direction	-	-	-	-	-	-	-	-	-	Pulse output 0 (pulse)	Pulse output 1 (pulse)	Pulse output 0 (direction)	Pulse output 1 (direction)	-	-
		Pulse with variable duty factor (PWM) output	-	-	-	-	-	-	-	-	-	-	-	-	-	-	PWM output 0
Origin search		Origin search 0 (origin input signal)	Origin search 0 (origin proximity input signal)	Origin search 1 (origin input signal)	Origin search 1 (origin proximity input signal)	Origin search 0 (positioning completion signal)	Origin search 1 (positioning completion signal)	-	-	-	-	-	-	-	-	Origin search 0 (error counter reset output)	Origin search 1 (error counter reset output)

Built-in Input Specifications

Interrupt Inputs and Quick-response Inputs

Item	Specification	
Number of interrupt and quick-response input points	4 total	
Interrupt inputs	Interrupt input mode	At the rising or falling edge of the input signal, the CPU Unit's cyclic program is interrupted and the corresponding I/O interrupt task (task number 140 to 143) is executed. The response time (i.e., the time from the input condition being satisfied until execution of the interrupt task) is 93 μs min.
	Counter mode	The number of rising or falling edges of the input signal are counted incrementally or decrementally, and when the count has been reached, the corresponding interrupt task (task number 140 to 143) is executed. The input response frequency is 1 kHz.
Quick-response input	Signals less than the cycle time (30 μs min.) can be treated as ON signals for one cycle.	

High-speed Counter Input

Item		Specification			
Number of high-speed counter inputs		2 (high-speed counters 0 and 1)			
Counter modes (set in the PC Setup)		Phase differential inputs (phase-A, -B, and -Z inputs)	Up and down pulse inputs (incremental pulse, decremental pulse, and reset inputs)	Pulse + direction inputs (pulse, direction, and reset inputs)	Incremental pulse input (incremental pulse and reset inputs)
Response frequency	Line driver input	50 kHz	100 kHz	100 kHz	100 kHz
	24-VDC input	30 kHz	60 kHz	60 kHz	60 kHz
Counter type		Linear counter or circular counter (set in the PC Setup)			
Counting range		Linear counter: 8000 0000 to 7FFF FFFF Hex Circular counter: 0000 0000 to circular counter set value (The circular counter set value is set in the PC Setup in the range 0000 0001 to FFFF FFFF Hex.)			
High-speed counter present value storage words		High-speed counter 0: A270 (lower digits) and A271 (upper digits) High-speed counter 1: A272 (lower digits) and A273 (upper digits) Target value comparison inputs and range comparison inputs are possible for these values. Note: The present values are updated each cycle as part of common processing. Use the PRV instruction to read the latest value.			
Control method	Target value comparison	Up to 48 target values and interrupt task numbers can be registered.			
	Range comparison	Up to 8 upper limits, lower limits, and interrupt task numbers can be registered.			
Counter reset method		Z-phase signal + software reset: Counter reset when the Z-phase input is turned ON with the reset bit (see below) ON. Software reset: Counter reset when the reset bit (see below) turns ON. Reset bit: A531, bit 00 (high-speed counter 0); A531, bit 01 (high-speed counter 1)			

Built-in Output Specifications

Positioning and Speed Control Functions

Item	Specification
Output frequency	1 Hz to 100 kHz (1 to 100 Hz: 1-Hz units; 100 Hz to 4 kHz: 10-Hz units; 4 to 100 kHz: 100-Hz units)
Frequency acceleration/ deceleration rate	1 Hz to 2 kHz (every 4 ms), set in 1-Hz units Acceleration and deceleration for the PLS2 instruction can be set individually.
Changing set values during instruction execution	The target frequency, acceleration/deceleration rate, and target position can be changed. The target frequency and acceleration/deceleration rate can only be changed for positioning at a constant speed.
Pulse output method	CW/CCW or pulse + direction
Number of output pulses	Relative coordinate specifications: 0000 0000 to 7FFF FFFF Hex (2,147,483,647 in either incremental or decremental direction) Absolute coordinate specifications: 8000 0000 to 7FFF FFFF Hex (-2,147,483,648 to 2,147,483,647)
Instruction for origin search/reset	ORG (ORIGIN SEARCH): Used to perform origin searches or origin resets according to set parameters.
Instructions for positioning and speed control	PLS2 (PULSE OUTPUT): Used to output pulses for trapezoidal positioning with individually set acceleration and deceleration rates. PULS (SET PULSES): Used to set the number of output pulses. SPED (SPEED OUTPUT): Used to output pulses without acceleration or deceleration. (The number of pulses must be set beforehand using the PULS instruction to perform positioning.) ACC (ACCELERATION CONTROL): Used to control the acceleration/deceleration rate. INI (MODE CONTROL): Used to stop pulse output.
Pulse output present value storage area	AR Area Words Pulse output 0: A276 (lower 4 digits) and A277 (upper 4 digits) Pulse output 1: A278 (lower 4 digits) and A279 (upper 4 digits) The present values are updated each cycle as part of overhead processing. The pulse output present value can be read to specified words using PRV (HIGH-SPEED COUNTER PV READ).

Pulse with Variable Duty Factor (PWM) Output Function

Item	Specification
Duty ratio	0% to 100%, set in 1% units
Frequency	0.1 to 999.9 Hz, set in 0.1-Hz units
Instruction for PWM	PWM (PULSE WITH VARIABLE DUTY FACTOR): Used to output pulses with the specified duty factor.

Hardware Specifications

Input Specifications

Item	Specification				
Number of input points	10 points				
Input type	24-VDC input or line driver input (switched with wiring)				
	24-VDC input		Line driver input		
	Input points	IN0 to IN5	IN6 to IN9	IN0 to IN5	IN6 to IN9
Input voltage	20.4 to 26.4 VDC			Conforms to RS-422 line driver (equivalent to AM26LS31). The power supply voltage on the connected side must be 5 V±5%.	
Input impedance	3.6 kΩ	4.0 kΩ			
Input current (typ.)	6.2 mA	4.1 mA	13 mA	10 mA	
ON voltage (min.)	17.4 VDC min./3 mA min.			-	
ON voltage (max.)	5.0 VDC/1 mA max.			-	
Response speed (for general-purpose input)	ON response time	8 ms max. (Select 0, 0.05, 1, 2, 4, 8, 16, or 32 ms in PC Setup.)			
	OFF response time	8 ms max. (Select 0, 0.05, 1, 2, 4, 8, 16, or 32 ms in PC Setup.)			

Circuit Configuration

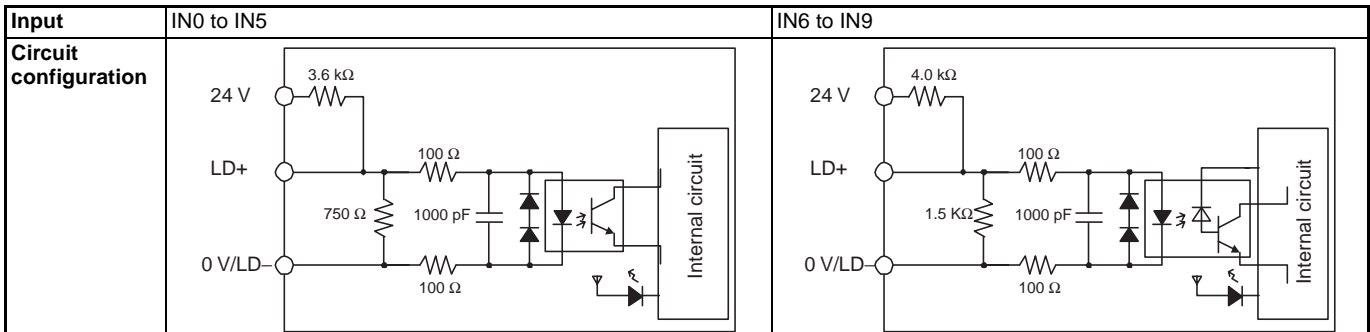

General-purpose Output
Specifications: Transistor Outputs
(Sinking)

Outputs	OUT0 to OUT3	OUT4 to OUT5
Rated voltage	5 to 24 VDC	
Allowable voltage range	4.75 to 26.4 V	
Maximum switching current	0.3 A per point, 1.8 A per Unit	
Outputs per common	6 points	
Maximum inrush current	3.0 A per point for 10 ms max.	
Leakage current	0.1 mA max.	
Residual voltage	0.6 V max.	
ON response time	0.1 ms max.	
OFF response time	0.1 ms max.	
Fuse	None	

External power supply	10.2 to 26.4 VDC, 50 mA min.
Circuit configuration	

Pulse Output Specifications (OUT0 to OUT3)

Item	Specification
Maximum switching capacity	30 mA, 4.75 to 26.4 VDC
Minimum switching capacity	30 mA, 4.75 to 26.4 VDC
Maximum output frequency	100 kHz
Output waveform	