

MICO Electronic auxiliary circuit, 4 channels IN: 24VDC OUT: 24V/1-2-3-4ADC

MICO 4.4
4 channels
Current adjustment 1, 2, 3, 4 A

Image

- Fire protection (EN 60950-1)
- Operating voltage protection (EN 61131-2)
- Operating condition capacity (EN 61131-1)

Vicarious picture

Approvals**Technical Data**

Operating voltage	24 V DC
Operating voltage range	18...30 V DC
Number of channels	4 channels
Current adjustment	1 A, 2 A, 3 A, 4 A, by countersunk rotary switch, sealed
Inrush capacity	max. 20 mF (per channel)
Group alarm output	potential free alarm output 30 V AC/DC, 100 mA
Remote restart (ON)	10...30 V DC
Impulse length	min. 20 ms

General data

Connection	Spring clamp terminals
Input terminals	2 × 16 mm ²
Output terminals	per output 1 × 4 mm ²
Alarm terminals	2.5 mm ²
Bridging concept	two sides, with spring clamp terminals or bridge set (max. 40 A)
Mounting method	DIN-rail mountable TH35 (EN 60715)
Temperature range	0...+55 °C (storage temperature -40...+80 °C)

Commercial data

Net weight	160
Weight unit	gram
Basic unit	pc.
Customs tariff number	85363010
Unit (piece)	1
Limited value	1

All data on this data sheet was compiled carefully.

Liability regarding correctness, completeness, and actuality is limited to gross negligence. Created: 12/12

Circuit diagram

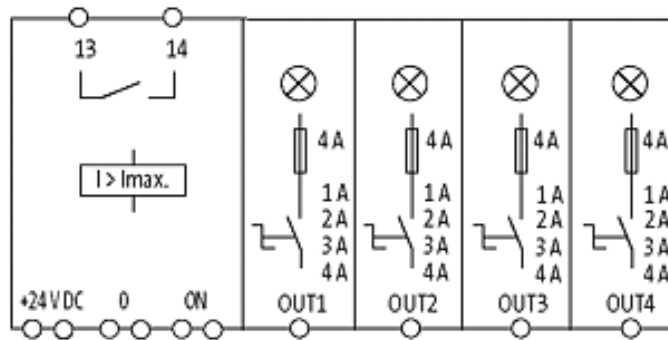

Dimension drawing

