

3.1 EPIC® D A - V I N C I H - A

Gehäuse / Housing / Boîtiers

Qualität und Funktionalität sind maßgebend für die Gehäuseserie H-A. Diese Rechtecksteckverbinder überzeugen durch eine kompakte Gehäuseform und eine innovative Bügelgeneration. Dazu bieten die Gehäuse einen hohen mechanischen Schutz vor schädlichen Einflüssen.

Quality and functionality are crucial for the H-A housing series. The impressive features of these rectangular connectors are their compact shape and a new generation of locking levers. Furthermore, the housings provide high mechanical protection against damaging influences.

La qualité et la fonctionnalité donnent la mesure à la série de boîtiers H-A. Ces connecteurs multiples carrés persuadent par leur forme de boîtier compacte et par une génération d'étrier innovatrice. De plus, ces boîtiers offrent une très grande protection mécanique contre les influences nocives.

3

3.1 EPIC® D A - V I N C I H - A

Gehäuse / Housing / Boîtiers

Technische Daten:

Vorschriften: DIN 43652

Schutzart: IP 65 (H-A 3 / 10 / 16 / 32 / 48)

Werkstoff:

H-A 3: Zinkdruckguss, pulverbeschichtet / Thermoplast, Brandverhalten nach UL 94 V-0, max. Umgebungstemperatur +65 °C

H-A 10 – 48: Aluminiumlegierung, pulverbeschichtet

Technical Data:

Specifications: DIN 43652

Protection class: IP 65 (H-A 3 / 10 / 16 / 32 / 48)

Material:

H-A 3: Die cast zinc, powder coated / Thermoplast, flame retardent material rated UL 94 V-0, max. ambient air temperature +65 °C

H-A 10 – 48: aluminium alloy, powder coated

Caractéristiques techniques:

Règlements: DIN 43652

Degré de protection: IP 65 (H-A 3 / 10 / 16 / 32 / 48)

Matière:

H-A 3: Zinc moulé par injection, recouvert par pulvérisation / plastique thermoformé, résistance au feu suivant UL 94 V-0, max. température de l'air ambiant +65 °C

H-A 10 – 48: Alliage aluminium, recouvert par pulvérisation

3

3.1 EPIC® D A - V I N C I H - A

Gehäuse / Housing / Boîtiers



EPIC® H-A3 Kunststoffgehäuse

EPIC® H-A3 Metallgehäuse

H-A 3: Zinkdruckguss, pulverbeschichtet (grau) / Thermoplast, Brandverhalten nach UL 94 V-0, max. Umgebungstemperatur +65 °C

H-A 3: Die cast zinc, powder coated (grey) / Thermoplast, flame retardant material rated UL 94 V-0, max. ambient air temperature +65 °C

H-A 3: Zinc moulé par injection, recouvert par pulvérisation (grise) / plastique thermoformé, résistance au feu suivant UL 94 V-0, max. température de l'air ambiant +65 °C

Für den industriellen Einsatz in anspruchsvoller Umgebung
For industrial applications in demanding environments.
Pour une exploitation industrielle dans un environnement exigeant.

Entsprechend DIN EN 50262; auch in metrischer Ausführung mit M20-Gewinde.

According to DIN EN 50262; now also available with metric thread M20.

Selon DIN EN 50262; maintenant aussi disponible avec pas métrique M20.

EPIC® Standardgehäuse

H-A 10 – 48: Aluminiumlegierung, pulverbeschichtet (grau), Bügel und Bolzen aus verzinktem Stahl

H-A 10 – 48: aluminium alloy, powder coated (grey), locking levers and bolts made of zinc plated steel

H-A 10 – 48: Alliage aluminium, recouvert par pulvérisation (grise), leviers et ergots acier recouvert par zinc

Für den industriellen Einsatz in anspruchsvoller Umgebung
For industrial applications in demanding environments.
Pour une exploitation industrielle dans un environnement exigeant.

Entsprechend DIN EN 50262; jetzt auch in metrischer Ausführung mit M20-, M25- und M32-Gewinde.

According to DIN EN 50262; now also available with metric thread M20, M25 and M32.

Selon DIN EN 50262; maintenant aussi disponible avec pas métrique M20, M25 et M32.



PG

M

EPIC® EP: (Environmental Protected / für erhöhte Umwelthanforderungen)

H-A 10 – 48: Aluminiumlegierung, pulverbeschichtet (schwarz), Bügel und Bolzen aus Edelstahl

H-A 10 – 48: aluminium alloy, powder coated (black), locking levers and bolts made of stainless steel

H-A 10 – 48: Alliage aluminium, recouvert par pulvérisation (noir), leviers et ergots acier inox

Für den industriellen Einsatz in stark beanspruchter Umgebung mit aggressiver Atmosphäre
For industrial applications in extremely demanding environments with aggressive atmospheres

Pour l'exploitation industrielle dans un environnement très sollicité à atmosphère agressive

Entsprechend DIN EN 50262; auch in metrischer Ausführung mit M20-, M25-, M32- und M40-Gewinde.

According to DIN EN 50262; now also available with metric thread M20, M25, M32 and M40.

Selon DIN EN 50262; maintenant aussi disponible avec pas métrique M20, M25, M32 et M40.



PG

M

Auf Anfrage
On request
sur demande

3.1 EPIC® D A - V I N C I H - A

Tüllengehäuse / Hood / Capot

VERGLEICH DER KLEMMBEREICHE FÜR EINSCHNITTDICHTUNGEN PG (DIN 46320) ZU METRISCH Comparison of the thread dimensions for split seals PG thread (DIN 46320)/ metric thread Comparaison de la dimension du filetage pour joints multiples pas PG (DIN 46320)/pas métrique

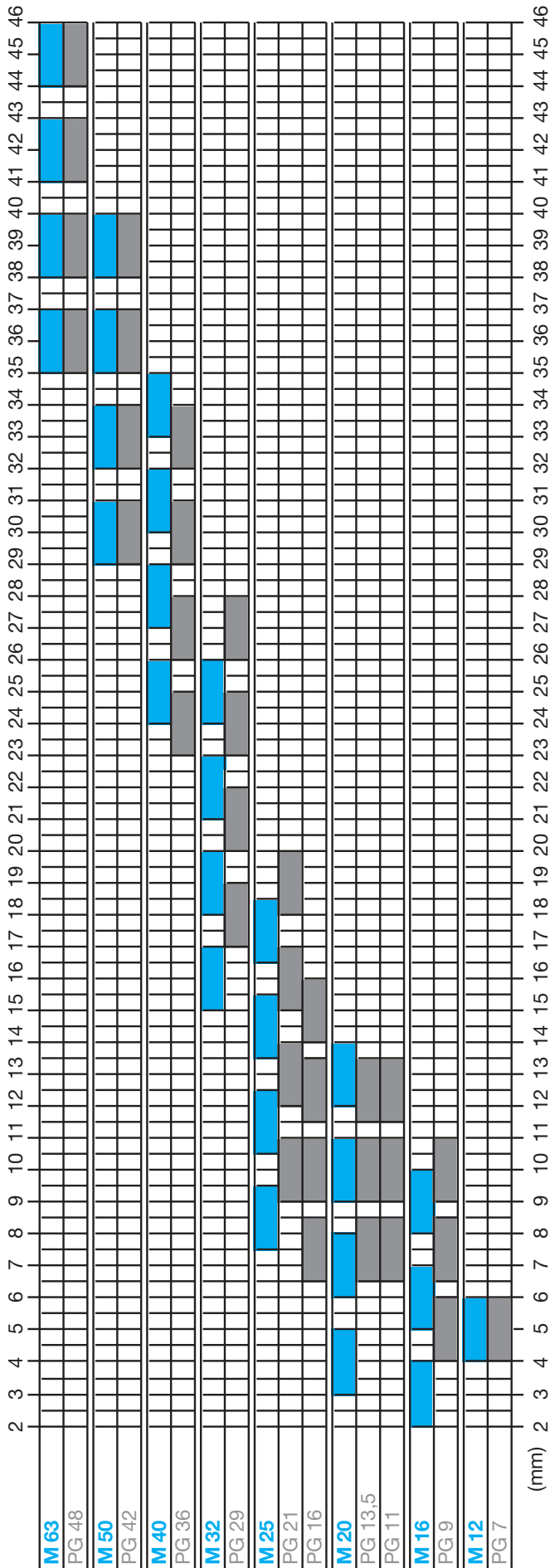

3.1 EPIC® D A - V I N C I H - A

Tüllengehäuse / Hood / Capot



PG



M

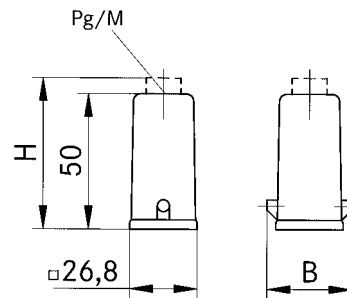

EPIC® H-A Gehäuse: Tüllengehäuse (Kabeleingang gerade)

EPIC® H-A housings: hood (top entry)

Boîtiers EPIC® H-A: capot (sortie verticale)

H-A 3

Artikel <i>part article</i>	Art.Nr. <i>part No. N° art.</i>	PG	M	Material <i>material matière</i>	Farbe <i>colour couleur</i>	Verschraubung <i>cable gland presse-étoupe</i>	B	H
H-A 3 MTgv	10512100	11		Zinkdruckguss / zinc die cast / zinc moulé par injection	grau/grey/grise		33,5	
H-A 3 Tgv	10425500	11		Thermoplast / thermoplastic / plastique thermoformé	schwarz/black/noir		36	
H-A 3 Tgv	10426000	11		Thermoplast / thermoplastic / plastique thermoformé	grau/grey/grise		36	
H-A 3 MTgv	10426500	11		Zinkdruckguss / zinc die cast / zinc moulé par injection	grau/grey/grise	●	33,5	57
H-A 3 Tgv	10426700	11		Thermoplast / thermoplastic / plastique thermoformé	schwarz/black/noir	●	36	62
H-A 3 Tgv	10426400	11		Thermoplast / thermoplastic / plastique thermoformé	grau/grey/grise	●	36	62
H-A 3 MTgv M20	19512100		20	Zinkdruckguss / zinc die cast / zinc moulé par injection	grau/grey/grise		33,5	
H-A 3 Tgv M20	19425500		20	Thermoplast / thermoplastic / plastique thermoformé	schwarz/black/noir		36	
H-A 3 Tgv M20	19426000		20	Thermoplast / thermoplastic / plastique thermoformé	grau/grey/grise		36	
H-A 3 MTgv M20	19426500		20	Zinkdruckguss / zinc die cast / zinc moulé par injection	grau/grey/grise	●	33,5	57

Einsätze / Inserts / Inserts: 1.1: H-A 3, H-A 4 / 1.2: H-Q 5 / 1.3: STA 6 / 1.8: H-D 7, H-D 8

Kabelverschraubung / Cable gland / Presse-étoupe: 5.1: Metr. & PG

3.1 EPIC® D A - V I N C I H - A

Tüllengehäuse / Hood / Capot



PG



M

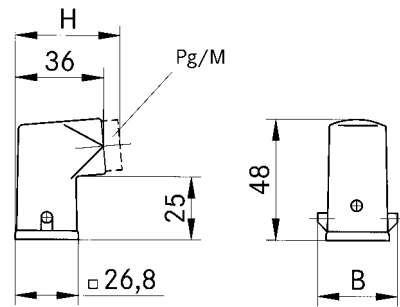

EPIC® H-A Gehäuse: Tüllengehäuse (Kabeleingang seitlich)

EPIC® H-A housings: hood (side entry)

Boîtiers EPIC® H-A: capot (sortie latérale)

H-A 3

Artikel <i>part article</i>	Art.Nr. <i>part No. N° art.</i>	PG	M	Material <i>material matière</i>	Farbe <i>colour couleur</i>	Verschraubung <i>cable gland presse-étoupe</i>	B	H
H-A 3 MTs	10512300	11		Zinkdruckguss / <i>zinc die cast / zinc moulé par injection</i>	grau/grey/grise		33,5	
H-A 3 Ts	10427300	11		Thermoplast / <i>thermoplastic / plastique thermoformé</i>	schwarz/black/noir		36	
H-A 3 Ts	10427000	11		Thermoplast / <i>thermoplastic / plastique thermoformé</i>	grau/grey/grise		36	
H-A 3 MTs	10427500	11		Zinkdruckguss / <i>zinc die cast / zinc moulé par injection</i>	grau/grey/grise	●	33,5	43
H-A 3 Ts	10620600	11		Thermoplast / <i>thermoplastic / plastique thermoformé</i>	schwarz/black/noir	●	36	48
H-A 3 Ts	10427100	11		Thermoplast / <i>thermoplastic / plastique thermoformé</i>	grau/grey/grise	●	36	48
H-A 3 MTs	19512300		20	Zinkdruckguss / <i>zinc die cast / zinc moulé par injection</i>	grau/grey/grise		33,5	
H-A 3 Ts	19427300		20	Thermoplast / <i>thermoplastic / plastique thermoformé</i>	schwarz/black/noir		36	
H-A 3 Ts	19427000		20	Thermoplast / <i>thermoplastic / plastique thermoformé</i>	grau/grey/grise		36	
H-A 3 MTs	19427500		20	Zinkdruckguss / <i>zinc die cast / zinc moulé par injection</i>	grau/grey/grise	●	33,5	43

Einsätze / *Inserts / Inserts*: 1.1: H-A 3, H-A 4 / 1.2: H-Q 5 / 1.3: STA 6 / 1.8: H-D 7, H-D 8

Kabelverschraubung / *Cable gland / Presse-étoupe*: 5.1: Metr. & PG

3.1 EPIC® D A - V I N C I H - A

Tüllengehäuse / Hood / Capot



PG



M

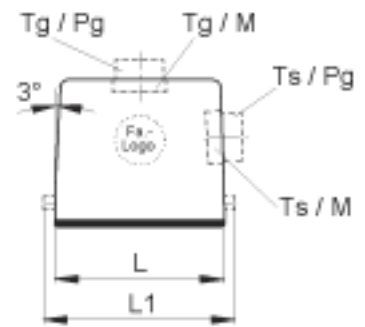

EPIC® H-A Gehäuse: Tüllengehäuse (Kabeleingang gerade, Bolzen für Längsbügel)

EPIC® H-A housings: hood (top entry, bolts for single locking lever)

Boîtiers EPIC® H-A: capot (sortie verticale, ergots pour simple levier)

H-A 10

Artikel <i>part article</i>	Art.Nr. <i>part No. N° art.</i>	PG	M	ZW	L	L1	L2	L3	L4	B	B1	B2	B3	B4	B5	H	H1	H2	S	d
H-A 10 TG 13,5	10446000	13,5		●	63	73				29,5						53,3				
H-A 10 TG 16	10446100	16		●	63	73				29,5						53,3				
H-A 10 TG M20	19446000		20		63	73				29,5						53,3				
H-A 10 TG M25	19446100		25		63	73				29,5						53,3				

Einsätze / *Inserts / Inserts*: 1.1: H-A 10 / 1.3: STA 14 / 1.8: H-D 15

Deckel / *Cover / Couvercle*: 6.1: H-A 10

Kabelverschraubung / *Cable gland / Presse-étoupe*: 5.1: Metr. & PG

H-A 16

Artikel <i>part article</i>	Art.Nr. <i>part No. N° art.</i>	PG	M	ZW	L	L1	L2	L3	L4	B	B1	B2	B3	B4	B5	H	H1	H2	S	d
H-A 16 TG 16	10565000	16		●	79	89				29,5						58,3				
H-A 16 TG 21	10565300	21		●	79	89				29,5						58,3				
H-A 16 TG M20	19565000		20		79	89				29,5						58,3				
H-A 16 TG M25	19565300		25		79	89				29,5						58,3				

Einsätze / *Inserts / Inserts*: 1.1: H-A 16 / 1.3: STA 20 / 1.8: H-D 25

Deckel / *Cover / Couvercle*: 6.1: H-A 16

Kabelverschraubung / *Cable gland / Presse-étoupe*: 5.1: Metr. & PG

3.1 EPIC® D A - V I N C I H - A

Tüllengehäuse / Hood / Capot



PG



M

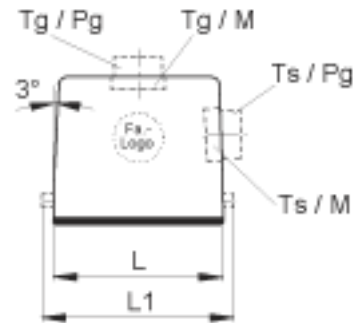
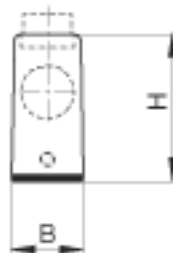

EPIC® H-A Gehäuse: Tüllengehäuse (Kabeleingang gerade, Bolzen für Längsbügel, hohe Bauform)

EPIC® H-A housings: hood (top entry, bolts for single locking lever, high version)

Boîtiers EPIC® H-A: capot (sortie verticale, ergots pour simple levier, version haute)

H-A 10

Artikel <i>part article</i>	Art.Nr. <i>part No. N° art.</i>	PG	M	ZW	L	L1	L2	L3	L4	B	B1	B2	B3	B4	B5	H	H1	H2	S	d
H-A 10 TGH 16	70460200	16		●	63	73				29,5						67,3				
H-A 10 TGH 21	70460400	21		●	63	73				29,5						67,3				
H-A 10 TGH M20	79460200		20		63	73				29,5						67,3				
H-A 10 TGH M25	79460400		25		63	73				29,5						67,3				

Einsätze / *Inserts / Inserts*: 1.1: H-A 10 / 1.3: STA 14 / 1.8: H-D 15

Deckel / *Cover / Couvercle*: 6.1: H-A 10

Kabelverschraubung / *Cable gland / Presse-étoupe*: 5.1: Metr. & PG

H-A 16

Artikel <i>part article</i>	Art.Nr. <i>part No. N° art.</i>	PG	M	ZW	L	L1	L2	L3	L4	B	B1	B2	B3	B4	B5	H	H1	H2	S	d
H-A 16 TGH 16	70490200	16		●	79	89				29,5						72,3				
H-A 16 TGH 21	70490400	21		●	79	89				29,5						72,3				
H-A 16 TGH M20	79490200		20		79	89				29,5						72,3				
H-A 16 TGH M25	79490400		25		79	89				29,5						72,3				

Einsätze / *Inserts / Inserts*: 1.1: H-A 16 / 1.3: STA 20 / 1.8: H-D 25

Deckel / *Cover / Couvercle*: 6.1: H-A 16

Kabelverschraubung / *Cable gland / Presse-étoupe*: 5.1: Metr. & PG

3.1 EPIC® D A - V I N C I H - A

Tüllengehäuse / Hood / Capot



PG



M

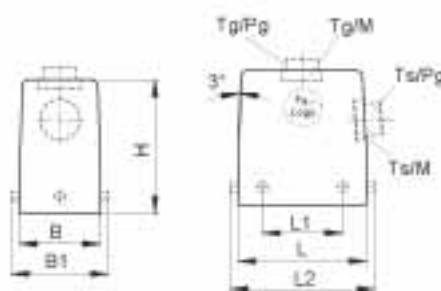

EPIC® H-A Gehäuse: Tüllengehäuse (Kabeleingang gerade, Bolzen für Querbügel)

EPIC® H-A housings: hood (top entry, bolts for double locking lever)

Boîtiers EPIC® H-A: capot (sortie verticale, ergots pour double levier)

H-A 32

Artikel part article	Art.Nr. part No. N° art.	PG	M	ZW	L	L1	L2	L3	L4	B	B1	B2	B3	B4	B5	H	H1	H2	S	d
H-A 32 TG 21	10582000	21		●																
H-A 32 TG 21	10582001	21			82	49,6				56	70,8					75				
H-A 32 TG 29	10583000	29		●																
H-A 32 TG M25	19582000		25																	
H-A 32 TG M32	19583000		32		82	49,6				56	70,8					75				
H-A 32 TG M40	79520600		40																	

Einsätze / Inserts / Inserts: 1.1: H-A 32 / 1.3: 2 x STA 20 / 1.8: H-D 50

Deckel / Cover / Couvercle: 6.1: H-A 32

Kabelverschraubung / Cable gland / Presse-étoupe: 5.1: Metr. & PG

H-A 48

Artikel part article	Art.Nr. part No. N° art.	PG	M	ZW	L	L1	L2	L3	L4	B	B1	B2	B3	B4	B5	H	H1	H2	S	d
H-A 48 TG 29	10631800	29		●	93,5	64,5				79	89,5					95				
H-A 48 TG 29	10631900	29			93,5	64,5				79	89,5					95				
H-A 48 TG M32	19631800		32		93,5	64,5				79	89,5					95				
H-A 48 TG M40	19636600		40		93,5	64,5				79	89,5					95				

Einsätze / Inserts / Inserts: 1.1: H-A 48

Kabelverschraubung / Cable gland / Presse-étoupe: 5.1: Metr. & PG

3.1 EPIC® D A - V I N C I H - A

Tüllengehäuse / Hood / Capot



PG



M

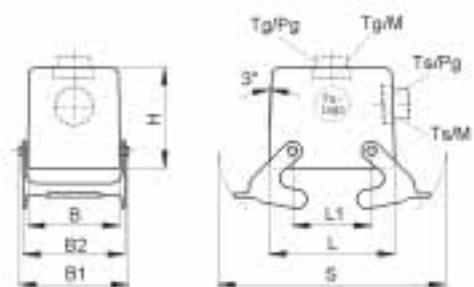

EPIC® H-A Gehäuse: Tüllengehäuse (Kabeleingang gerade, Querbügel)

EPIC® H-A housings: hood (top entry, double locking lever)

Boîtiers EPIC® H-A: capot (sortie verticale, double levier)

H-A 32

Artikel part article	Art.Nr. part No. N° art.	PG	M	ZW	L	L1	L2	L3	L4	B	B1	B2	B3	B4	B5	H	H1	H2	S	d
H-A 32 TGB 29	10585000	29	●	82	49,6					56	70,8	66				75				124,5
H-A 32 TGB M32	19585000		32		82	49,6				56	70,8	66				75				124,5
H-A 32 TGB M40	79525800		40																	

Einsätze / Inserts / Inserts: 1.1: H-A 32 / 1.3: 2 x STA 20 / 1.8: H-D 50

Deckel / Cover / Couvercle: 6.1: H-A 32

Kabelverschraubung / Cable gland / Presse-étoupe: 5.1: Metr. & PG

3.1 EPIC® D A - V I N C I H - A

Tüllengehäuse / Hood / Capot

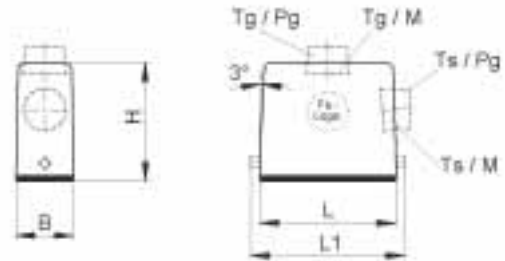

PG / M

EPIC® H-A Gehäuse: Tüllengehäuse (Kabeleingang seitlich, Bolzen für Längsbügel)

EPIC® H-A housings: hood (side entry, bolts for single locking lever)

Boîtiers EPIC® H-A: capot (sortie latérale, ergots pour simple levier)

H-A 10

Artikel <i>part article</i>	Art.Nr. <i>part No. N° art.</i>	PG	M	ZW	L	L1	L2	L3	L4	B	B1	B2	B3	B4	B5	H	H1	H2	S	d
H-A 10 TS 16	10445000	16		●	63	73				29,5						53,3				
H-A 10 TS 21	10445500	21		●																
H-A 10 TS M20	19445000		20	●	63	73				29,5						53,3				
H-A 10 TS M25	19445500		25	●																

Einsätze / *Inserts / Inserts*: 1.1: H-A 10 / 1.3: STA 14 / 1.8: H-D 15

Deckel / *Cover / Couvercle*: 6.1: H-A 10

Kabelverschraubung / *Cable gland / Presse-étoupe*: 5.1: Metr. & PG

H-A 16

Artikel <i>part article</i>	Art.Nr. <i>part No. N° art.</i>	PG	M	ZW	L	L1	L2	L3	L4	B	B1	B2	B3	B4	B5	H	H1	H2	S	d
H-A 16 TS 16	10564000	16		●	79	89				29,5						58,3				
H-A 16 TS 21	10564500	21		●																
H-A 16 TS M20	19564000		20	●	79	89				29,5						58,3				
H-A 16 TS M25	19564500		25	●																

Einsätze / *Inserts / Inserts*: 1.1: H-A 16 / 1.3: STA 20 / 1.8: H-D 25

Deckel / *Cover / Couvercle*: 6.1: H-A 16

Kabelverschraubung / *Cable gland / Presse-étoupe*: 5.1: Metr. & PG

3.1 EPIC® D A - V I N C I H - A

Tüllengehäuse / Hood / Capot



PG



M

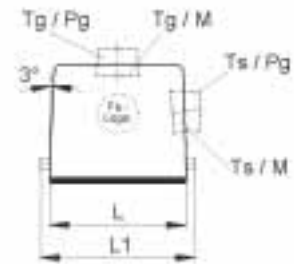

EPIC® H-A Gehäuse: Tüllengehäuse (Kabeleingang seitlich, Bolzen für Längsbügel, hohe Bauform)
EPIC® H-A housings: hood (side entry, bolts for single locking lever, high version)
Boîtiers EPIC® H-A: capot (sortie latérale, ergots pour simple levier, version haute)

H-A 10

Artikel part article	Art.Nr. part No. N° art.	PG	M	ZW	L	L1	L2	L3	L4	B	B1	B2	B3	B4	B5	H	H1	H2	S	d
H-A 10 TSH 16	70462200	16		●	63	73				29,5						67,3				
H-A 10 TSH 21	70462400	21		●	63	73				29,5						67,3				
H-A 10 TSH M20	79462200		20		63	73				29,5						67,3				
H-A 10 TSH M25	79462400		25		63	73				29,5						67,3				

Einsätze / Inserts / Inserts: 1.1: H-A 10 / 1.3: STA 14 / 1.8: H-D 15

Deckel / Cover / Couvercle: 6.1: H-A 10

Kabelverschraubung / Cable gland / Presse-étoupe: 5.1: Metr. & PG

H-A 16

Artikel part article	Art.Nr. part No. N° art.	PG	M	ZW	L	L1	L2	L3	L4	B	B1	B2	B3	B4	B5	H	H1	H2	S	d
H-A 16 TSH 16	70492200	16		●	79	89				29,5						72,3				
H-A 16 TSH 21	70492400	21		●	79	89				29,5						72,3				
H-A 16 TSH M20	79492200		20		79	89				29,5						72,3				
H-A 16 TSH M25	79492400		25		79	89				29,5						72,3				

Einsätze / Inserts / Inserts: 1.1: H-A 16 / 1.3: STA 20 / 1.8: H-D 25

Deckel / Cover / Couvercle: 6.1: H-A 16

Kabelverschraubung / Cable gland / Presse-étoupe: 5.1: Metr. & PG

3.1 EPIC® D A - V I N C I H - A

Tüllengehäuse / Hood / Capot



PG



M

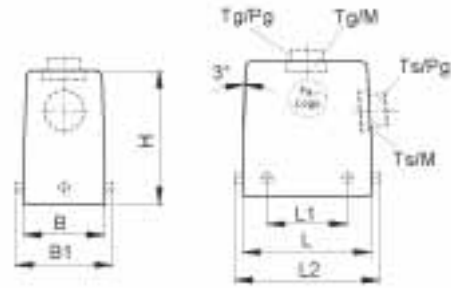

EPIC® H-A Gehäuse: Tüllengehäuse (Kabeleingang seitlich, Bolzen für Querbügel)

EPIC® H-A housings: hood (side entry, bolts for double locking lever)

Boîtiers EPIC® H-A: capot (sortie latérale, ergots pour double levier)

H-A 32

Artikel part article	Art.Nr. part No. N° art.	PG	M	ZW	L	L1	L2	L3	L4	B	B1	B2	B3	B4	B5	H	H1	H2	S	d
H-A 32 TS 21	10576000	21		●																
H-A 32 TS 21	10576200	21			82	49,6				56	70,8					75				
H-A 32 TS 29	10577000	29		●																
H-A 32 TS M25	19576000		25																	
H-A 32 TS M32	19577000		32		82	49,6				56	70,8					75				
H-A 32 TS M40	19577500		40																	

Einsätze / Inserts / Inserts: 1.1: H-A 32 / 1.3: 2 x STA 20 / 1.8: H-D 50

Deckel / Cover / Couvercle: 6.1: H-A 32

Kabelverschraubung / Cable gland / Presse-étoupe: 5.1: Metr. & PG

H-A 48

Artikel part article	Art.Nr. part No. N° art.	PG	M	ZW	L	L1	L2	L3	L4	B	B1	B2	B3	B4	B5	H	H1	H2	S	d
H-A 48 TS 29	10630800	29		●	93,5	64,5				79	89,5					95				
H-A 48 TS 29	10630900	29																		
H-A 48 TS M32	19630800		32		93,5	64,5				79	89,5					95				
H-A 48 TS M40	19635600		40																	

Einsätze / Inserts / Inserts: 1.1: H-A 48

Kabelverschraubung / Cable gland / Presse-étoupe: 5.1: Metr. & PG

3.1 EPIC® D A - V I N C I H - A

Tüllengehäuse / Hood / Capot



PG



M

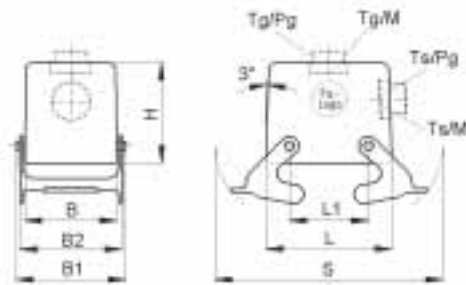

EPIC® H-A Gehäuse: Tüllengehäuse (Kabeleingang seitlich, Querbügel)

EPIC® H-A housings: hood (side entry, double locking lever)

Boîtiers EPIC® H-A: capot (sortie latérale, double levier)

H-A 32

Artikel part article	Art.Nr. part No. N° art.	PG	M	ZW	L	L1	L2	L3	L4	B	B1	B2	B3	B4	B5	H	H1	H2	S	d
H-A 32 TSB 21	10578000	21		●	82	49,6				56	70,8	66				75				124,5
H-A 32 TSB 29	10579000	29		●																
H-A 32 TSB M25	19578000		25		82	49,6				56	70,8	66				75				124,5
H-A 32 TSB M32	19579000		32																	
H-A 32 TSB M40	79527800		40																	

Einsätze / Inserts / Inserts: 1.1: H-A 32 / 1.3: 2 x STA 20 / 1.8: H-D 50

Deckel / Cover / Couvercle: 6.1: H-A 32

Kabelverschraubung / Cable gland / Presse-étoupe: 5.1: Metr. & PG

3.1 EPIC® D A - V I N C I H - A

Anbaugehäuse / Panel mount base / Embase encastrée

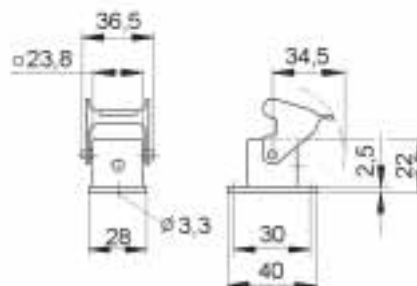

EPIC® H-A Gehäuse: Anbaugehäuse
EPIC® H-A housings: panel mount base
Boîtiers EPIC® H-A: embase encastrée

H-A 3

Artikel <i>part</i> <i>article</i>	Art.Nr. <i>part No.</i> <i>N° art.</i>	Material <i>material</i> <i>matière</i>	Farbe <i>colour</i> <i>couleur</i>	Verschraubung <i>cable gland</i> <i>presse-étoupe</i>	B	H
H-A 3 MAg	10422500	Zinkdruckguss / <i>zinc die cast</i> / <i>zinc moulé par injection</i>	grau/ <i>grey</i> / <i>grise</i>			
H-A 3 Ag	10422200	Thermoplast / <i>thermoplastic</i> / <i>plastique thermoformé</i>	schwarz/ <i>black</i> / <i>noir</i>			
H-A 3 Ag	10422000	Thermoplast / <i>thermoplastic</i> / <i>plastique thermoformé</i>	grau/ <i>grey</i> / <i>grise</i>			

Einsätze / *Inserts* / *Inserts*: 1.1: H-A 3, H-A 4 / 1.2: H-Q5 / 1.3: STA 6 / 1.8: H-D 7, H-D 8
 Deckel / *Cover* / *Couvercle*: 6.1: H-A 3

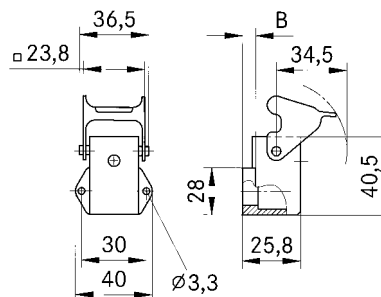

EPIC® H-A Gehäuse: Anbaugehäuse (gewinkelt)
EPIC® H-A housings: panel mount base (angled)
Boîtiers EPIC® H-A: embase encastrée (sortie latérale)

H-A 3

Artikel <i>part</i> <i>article</i>	Art.Nr. <i>part No.</i> <i>N° art.</i>	Material <i>material</i> <i>matière</i>	Farbe <i>colour</i> <i>couleur</i>	Verschraubung <i>cable gland</i> <i>presse-étoupe</i>	B	H
H-A 3 MAgs	10423500	Zinkdruckguss / <i>zinc die cast</i> / <i>zinc moulé par injection</i>	grau/ <i>grey</i> / <i>grise</i>		3,5	
H-A 3 Ags	10423100	Thermoplast / <i>thermoplastic</i> / <i>plastique thermoformé</i>	schwarz/ <i>black</i> / <i>noir</i>		3,5	
H-A 3 Ags	10423000	Thermoplast / <i>thermoplastic</i> / <i>plastique thermoformé</i>	grau/ <i>grey</i> / <i>grise</i>		3,5	

Einsätze / *Inserts* / *Inserts*: 1.1: H-A 3, H-A 4 / 1.2: H-Q5 / 1.3: STA 6 / 1.8: H-D 7, H-D 8
 Deckel / *Cover* / *Couvercle*: 6.1: H-A 3

3.1 EPIC® D A - V I N C I H - A

Anbaugehäuse / Panel mount base / Embase encastrée

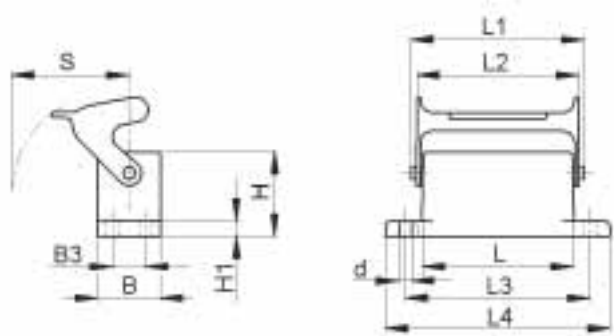

EPIC® H-A Gehäuse: Anbaugehäuse (Längsbügel)
EPIC® H-A housings: panel mount base (single locking lever)
Boîtiers EPIC® H-A: embase encastrée (simple levier)

H-A 10

Artikel part article	Art.Nr. part No. N° art.	L	L1	L2	L3	L4	B	B1	B2	B3	B4	B5	H	H1	H2	S	d
H-A 10 AG-LB	10442000	63	74,4	71,4	70	81	29,5			17,5			25	3,5		36,5	3,6

Einsätze / Inserts / Inserts: 1.1: H-A 10 / 1.3: STA 14 / 1.8: H-D 15
 Deckel / Cover / Couvercle: 6.1: H-A 10

H-A 16

Artikel part article	Art.Nr. part No. N° art.	L	L1	L2	L3	L4	B	B1	B2	B3	B4	B5	H	H1	H2	S	d
H-A 16 AG-LB	10462000	79	90,4	87,8	86	96	29,5			17,5			25	3,5		36,5	3,6

Einsätze / Inserts / Inserts: 1.1:H-A 16 / 1.3: STA 20 / 1.8: H-D 25
 Deckel / Cover / Couvercle: 6.1: H-A 16

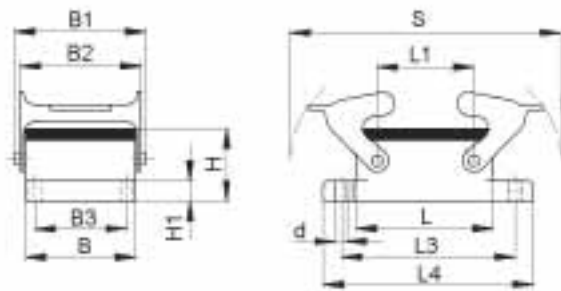

EPIC® H-A Gehäuse: Anbaugehäuse (Querbügel)
EPIC® H-A housings: panel mount base (double locking lever)
Boîtiers EPIC® H-A: embase encastrée (double levier)

H-A 32

Artikel part article	Art.Nr. part No. N° art.	L	L1	L2	L3	L4	B	B1	B2	B3	B4	B5	H	H1	H2	S	d
H-A 32 AG	10472000	82	49,6		92	102	56	70,8	66	42			25,4	4		124,5	4,3

Einsätze / Inserts / Inserts: 1.1: H-A 32 / 1.3: 2 x STA 20 / 1.8: H-D 50
 Deckel / Cover / Couvercle: 6.1: H-A 32

H-A 48

Artikel part article	Art.Nr. part No. N° art.	L	L1	L2	L3	L4	B	B1	B2	B3	B4	B5	H	H1	H2	S	d
H-A 48 AG	10625500	93,5	64,5		110	124	79	93,8	87,8	65			30,3	5		136,5	5,5

3.1 EPIC® D A - V I N C I H - A

Anbaugehäuse / Panel mount base / Embase encastrée

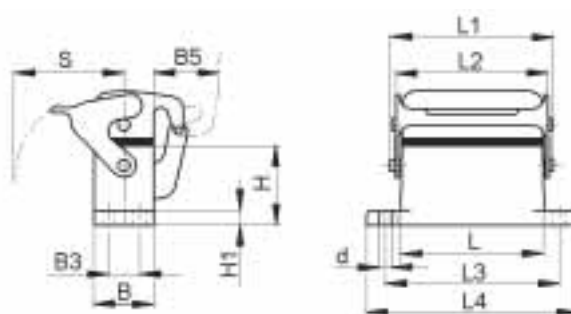

EPIC® H-A Gehäuse: Anbaugehäuse (Schutzdeckel, Längsbügel)

EPIC® H-A housings: panel mount base (cover, single locking lever)

Boîtiers EPIC® H-A: embase encastrée (couvercle, simple levier)

H-A 10

Artikel part article	Art.Nr. part No. N° art.	L	L1	L2	L3	L4	B	B1	B2	B3	B4	B5	H	H1	H2	S	d
H-A 10 AD-LB	70444000	63	74,4	71,4	70	81	29,5			17,5		25	25	3,5		36,5	3,6

Einsätze / Inserts / Inserts: 1.1: H-A 10 / 1.3: STA 14 / 1.8: H-D 15

H-A 16

Artikel part article	Art.Nr. part No. N° art.	L	L1	L2	L3	L4	B	B1	B2	B3	B4	B5	H	H1	H2	S	d
H-A 16 AD-LB	70474000	79	90,4	87,5	86	96	29,5			17,5		25	25	3,5		36,5	3,6

Einsätze / Inserts / Inserts: 1.1:H-A 16 / 1.3: STA 20 / 1.8: H-D 25

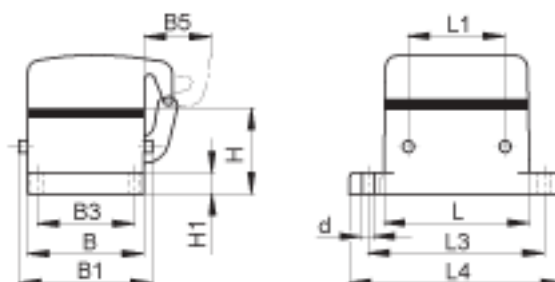

EPIC® H-A Gehäuse: Anbaugehäuse (Schutzdeckel, Bolzen für Querbügel)

EPIC® H-A housings: panel mount base (cover, bolts for double locking lever)

Boîtiers EPIC® H-A: embase encastrée (couvercle, ergots pour double levier)

H-A 32

Artikel part article	Art.Nr. part No. N° art.	L	L1	L2	L3	L4	B	B1	B2	B3	B4	B5	H	H1	H2	S	d
H-A 32 AD-BO	70503000	82	49,6		92	102	56			42		29	25,4	4			4,3

Einsätze / Inserts / Inserts: 1.1: H-A 32 / 1.3: 2 x STA 20 / 1.8: H-D 50

3.1 EPIC® D A - V I N C I H - A

Sockelgehäuse / Surface mount base / Embase en saillie



PG / M

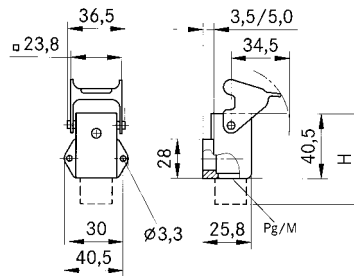

EPIC® H-A Gehäuse: Sockelgehäuse

EPIC® H-A housings: surface mount base

Boîtiers EPIC® H-A: embase en saillie

H-A 3

Artikel part article	Art.Nr. part No. N° art.	PG	M	Material material matière	Farbe colour couleur	Verschraubung cable gland presse-étoupe	B	H
H-A 3 MAgsv	10512700	11		Zinkdruckguss / zinc die cast / zinc moulé par injection	grau/grey/grise		3,5	51,5
H-A 3 Agsv	10424000	11		Thermoplast / thermoplastic / plastique thermoformé	grau/grey/grise		5,0	56
H-A 3 MAgsv	10424500	11		Zinkdruckguss / zinc die cast / zinc moulé par injection	grau/grey/grise	●	3,5	57,5
H-A 3 Agsv	10424200	11		Thermoplast / thermoplastic / plastique thermoformé	grau/grey/grise	●	5,0	65
H-A 3 MAgsv M20	19512700		20	Zinkdruckguss / zinc die cast / zinc moulé par injection	grau/grey/grise		3,5	54,5
H-A 3 Agsv M20	19421900		20	Thermoplast / thermoplastic / plastique thermoformé	grau/grey/grise	●	5,0	56
H-A 3 MAgsv M20	19424500		20	Zinkdruckguss / zinc die cast / zinc moulé par injection	grau/grey/grise	●	3,5	60,5

Einsätze / Inserts / Inserts: 1.1: H-A 3, H-A 4 / 1.2: H-Q5 / 1.3: STA 6 / 1.8: H-D 7, H-D 8

Deckel / Cover / Couvercle: 6.1: H-A 3

Kabelverschraubung / Cable gland / Presse-étoupe: 5.1: Metr. & PG

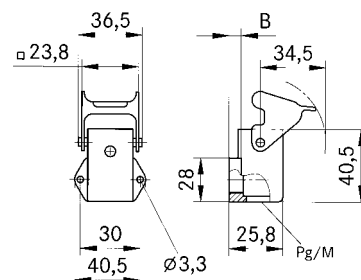

EPIC® H-A 3 Gehäuse: Sockelgehäuse mit offenem Boden

EPIC® H-A 3 housings: surface mount base with open bottom

Boîtiers EPIC® H-A 3: embase en saillie avec sol ouvert

H-A 3

Artikel part article	Art.Nr. part No. N° art.	M	Material material matière	Farbe colour couleur	Verschraubung cable gland presse-étoupe	B	H
H-A 3 MAgsv M20	19517200	20	Zinkdruckguss / zinc die cast / zinc moulé par injection	grau/grey/grise		3,5	
H-A 3 Agsv M20	19515200	20	Thermoplast / thermoplastic / plastique thermoformé	grau/grey/grise		5,0	

3.1 EPIC® D A - V I N C I H - A

Sockelgehäuse / Surface mount base / Embase en saillie



PG / M

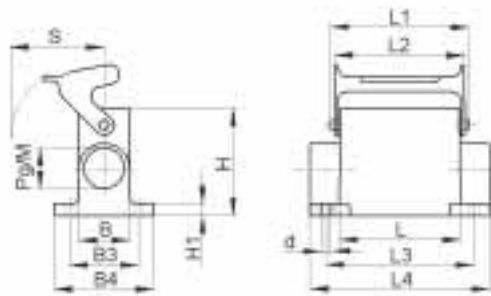

EPIC® H-A Gehäuse: Sockelgehäuse (1 Kabeleingang, Längsbügel)

EPIC® H-A housings: surface mount base (1 cable entry, single locking lever)

Boîtiers EPIC® H-A: embase en saillie (1 entrée de câble, simple levier)

H-A 10

Artikel part article	Art.Nr. part No. N° art.	PG	M	L	L1	L2	L3	L4	B	B1	B2	B3	B4	B5	H	H1	H2	S	d
H-A 10 SGR-LB 16	10448100	16		63	74,4	71,4	48	80	29,5			40	50		57	3,5		36,5	4,5
H-A 10 SGR-LB 21	10448000	21																	
H-A 10 SGR-LB M20	19448100		20	63	74,4	71,4	48	80	29,5			40	50		57	3,5		36,5	4,5
H-A 10 SGR-LB M25	19448000		25																

Einsätze / Inserts / Inserts: 1.1: H-A 10 / 1.3: STA 14 / 1.8: H-D 15

Deckel / Cover / Couvercle: 6.1: H-A 10

Kabelverschraubung / Cable gland / Presse-étoupe: 5.1: Metr. & PG

H-A 16

Artikel part article	Art.Nr. part No. N° art.	PG	M	L	L1	L2	L3	L4	B	B1	B2	B3	B4	B5	H	H1	H2	S	d
H-A 16 SGR-LB 16	10567100	16		79	90,4	87,8	64	96	29,5			40	50		57	3,5		36,5	4,5
H-A 16 SGR-LB 21	10567000	21																	
H-A 16 SGR-LB M20	19567100		20	79	90,4	87,8	64	96	29,5			40	50		57	3,5		36,5	4,5
H-A 16 SGR-LB M25	19567000		25																

Einsätze / Inserts / Inserts: 1.1: H-A 16 / 1.3: STA 20 / 1.8: H-D 25

Deckel / Cover / Couvercle: 6.1: H-A 16

Kabelverschraubung / Cable gland / Presse-étoupe: 5.1: Metr. & PG

3.1 EPIC® D A - V I N C I H - A

Sockelgehäuse / Surface mount base / Embase en saillie



PG / M

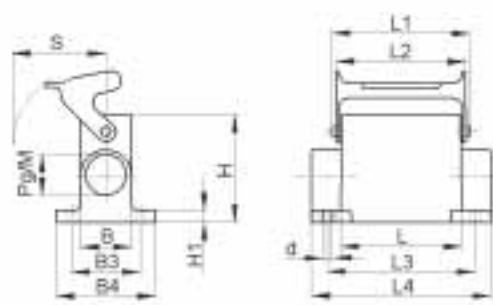

EPIC® H-A Gehäuse: Sockelgehäuse (2 Kabeleingänge, Längsbügel)

EPIC® H-A housings: surface mount base (2 cable entries, single locking lever)

Boîtiers EPIC® H-A: embase à encastrer (2 entrées de câble, simple levier)

H-A 10

Artikel part article	Art.Nr. part No. N° art.	PG	M	L	L1	L2	L3	L4	B	B1	B2	B3	B4	B5	H	H1	H2	S	d
H-A 10 SGRL-LB 16	10450100	16		63	74,4	71,4	48	80	29,5			40	50		57	3,5		36,5	4,5
H-A 10 SGRL-LB M20	19450100		20	63	74,4	71,4	48	80	29,5			40	50		57	3,5		36,5	4,5

Einsätze / Inserts / Inserts: 1.1: H-A 10 / 1.3: STA 14 / 1.8: H-D 15

Deckel / Cover / Couvercle: 6.1: H-A 10

Kabelverschraubung / Cable gland / Presse-étoupe: 5.1: Metr. & PG

H-A 16

Artikel part article	Art.Nr. part No. N° art.	PG	M	L	L1	L2	L3	L4	B	B1	B2	B3	B4	B5	H	H1	H2	S	d
H-A 16 SGRL-LB 16	10568100	16		79	90,4	87,8	64	96	29,5			40	50		57	3,5		36,5	4,5
H-A 16 SGRL-LB 21	10568000	21		79	90,4	87,8	64	96	29,5			40	50		57	3,5		36,5	4,5
H-A 16 SGRL-LB M20	19568100		20	79	90,4	87,8	64	96	29,5			40	50		57	3,5		36,5	4,5
H-A 16 SGRL-LB M25	19568000		25	79	90,4	87,8	64	96	29,5			40	50		57	3,5		36,5	4,5

Einsätze / Inserts / Inserts: 1.1: H-A 16 / 1.3: STA 20 / 1.8: H-D 25

Deckel / Cover / Couvercle: 6.1: H-A 16

Kabelverschraubung / Cable gland / Presse-étoupe: 5.1: Metr. & PG

3.1 EPIC® D A - V I N C I H - A

Sockelgehäuse / Surface mount base / Embase en saillie



PG / M

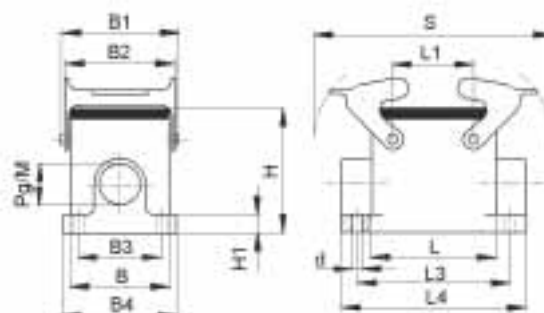

EPIC® H-A Gehäuse: Sockelgehäuse (1 Kabeleingang, Querbügel)

EPIC® H-A housings: surface mount base (1 cable entry, double locking lever)

Boîtiers EPIC® H-A: embase en saillie (1 entrée de câble, double levier)

H-A 32

Artikel part article	Art.Nr. part No. N° art.	PG	M	ZW	L	L1	L2	L3	L4	B	B1	B2	B3	B4	B5	H	H1	H2	S	d
H-A 32 SGR 21	10474000	21		●	82	49,6		94	106	56	70,8	66	46	57		75	4		124,5	5,5
H-A 32 SGR 29	10474100	29		●																
H-A 32 SGR M25	19474000		25	●																
H-A 32 SGR M32	19474100		32	●	82	49,6		94	106	56	70,8	66	46	57		75	4		124	5,5
H-A 32 SGR M40	79505800		40																	

Einsätze / Inserts / Inserts: 1.1: H-A 32 / 1.3: 2 x STA 20 / 1.8: H-D 50

Deckel / Cover / Couvercle: 6.1: H-A 32

Kabelverschraubung / Cable gland / Presse-étoupe: 5.1: Metr. & PG

H-A 48

Artikel part article	Art.Nr. part No. N° art.	PG	M	ZW	L	L1	L2	L3	L4	B	B1	B2	B3	B4	B5	H	H1	H2	S	d
H-A 48 SGR 29	10633800	29		●																
H-A 48 SGR M32	19633800		32	●	93,5	64,5		112	124,5	79	93,8	87,8	67	81		72	5		136,5	5,5
H-A 48 SGR M40	19638600		40																	

Einsätze / Inserts / Inserts: 1.1: H-A 48

Kabelverschraubung / Cable gland / Presse-étoupe: 5.1: Metr. & PG

3.1 EPIC® D A - V I N C I H - A

Sockelgehäuse / Surface mount base / Embase en saillie



PG / M

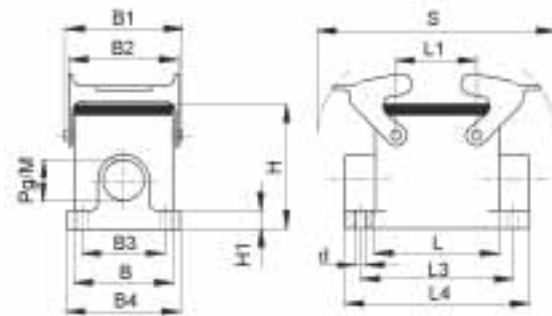

EPIC® H-A Gehäuse: Sockelgehäuse (2 Kabeleingänge, Querbügel)

EPIC® H-A housings: surface mount base (2 cable entries, double locking lever)

Boîtiers EPIC® H-A: embase en saillie (2 entrées de câble, double levier)

H-A 32

Artikel part article	Art.Nr. part No. N° art.	PG	M	ZW	L	L1	L2	L3	L4	B	B1	B2	B3	B4	B5	H	H1	H2	S	d
H-A 32 SGRL 21	10482000	21		●	82	49,6		94	106	56	70,8	66	46	57		75	4		124,5	5,5
H-A 32 SGRL M25	19482000		25	●	82	49,6		94	106	56	70,8	66	46	57		75	4		124,5	5,5
H-A 32 SGRL M40	79506800		40																	

Einsätze / Inserts / Inserts: 1.1: H-A 32 / 1.3: 2 x STA 20 / 1.8: H-D 50

Deckel / Cover / Couvercle: 6.1: H-A 32

Kabelverschraubung / Cable gland / Presse-étoupe: 5.1: Metr. & PG

H-A 48

Artikel part article	Art.Nr. part No. N° art.	PG	M	ZW	L	L1	L2	L3	L4	B	B1	B2	B3	B4	B5	H	H1	H2	S	d
H-A 48 SGRL M40	19639600		40		93,5	64,5		112	124,5	79	93,8	87,8	67	81		72	5		136,5	5,5

Einsätze / Inserts / Inserts: 1.1: H-A 48

Kabelverschraubung / Cable gland / Presse-étoupe: 5.1: Metr. & PG

3.1 EPIC® D A - V I N C I H - A

Sockelgehäuse / Surface mount base / Embase en saillie



PG / M

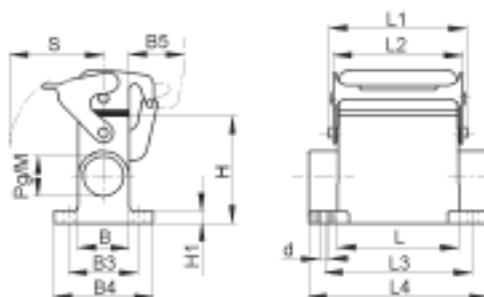

EPIC® H-A Gehäuse: Sockelgehäuse (Schutzdeckel, 1 Kabeleingang, Längsbügel)

EPIC® H-A housings: surface mount base (cover, 1 cable entry, single locking lever)

Boîtiers EPIC® H-A: embase en saillie (couverture, 1 entrée de câble, simple levier)

H-A 10

Artikel part article	Art.Nr. part No. N° art.	PG	M	L	L1	L2	L3	L4	B	B1	B2	B3	B4	B5	H	H1	H2	S	d	
H-A 10 SDR-LB 16	70455200	16		63	74,4	71,4	48	80	29,5			40	50	25	57	3,5		36,5	4,5	
H-A 10 SDR-LB 21	70455400	21																		
H-A 10 SDR-LB M20	79455200		20	63	74,4	71,4	48	80	29,5			40	50	25	57	3,5		36,5	4,5	
H-A 10 SDR-LB M25	79455400		25																	

Einsätze / Inserts / Inserts: 1.1: H-A 10 / 1.3: STA 14 / 1.8: H-D 15

Kabelverschraubung / Cable gland / Presse-étoupe: 5.1: Metr. & PG

H-A 16

Artikel part article	Art.Nr. part No. N° art.	PG	M	L	L1	L2	L3	L4	B	B1	B2	B3	B4	B5	H	H1	H2	S	d	
H-A 16 SDR-LB 16	70485200	16		79	90,4	87,8	64	96	29,5			40	50	25	57	3,5		36,5	4,5	
H-A 16 SDR-LB 21	70485400	21																		
H-A 16 SDR-LB M20	79485200		20	79	90,4	87,8	64	96	29,5			40	50	25	57	3,5		36,5	4,5	
H-A 16 SDR-LB M25	79485400		25																	

Einsätze / Inserts / Inserts: 1.1: H-A 16 / 1.3: STA 20 / 1.8: H-D 25

Kabelverschraubung / Cable gland / Presse-étoupe: 5.1: Metr. & PG

3.1 EPIC® D A - V I N C I H - A

Sockelgehäuse / Surface mount base / Embase en saillie



PG / M

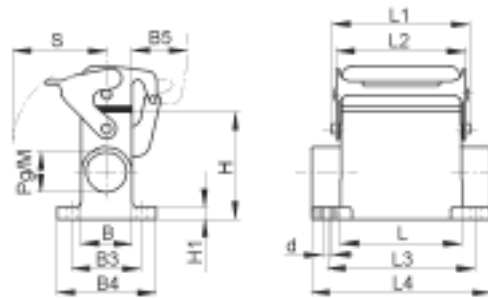

EPIC® H-A Gehäuse: Sockelgehäuse (Schutzdeckel, 2 Kabeleingänge, Längsbügel)

EPIC® H-A housings: surface mount base (cover, 2 cable entries, single locking lever)

Boîtiers EPIC® H-A: embase en saillie (couvercle, 2 entrées de câble, simple levier)

H-A 10

Artikel part article	Art.Nr. part No. N° art.	PG	M	L	L1	L2	L3	L4	B	B1	B2	B3	B4	B5	H	H1	H2	S	d
H-A 10 SDRL-LB 16	70456200	16		63	74,4	71,4	48	80	29,5			40	50	25	57	3,5		36,5	4,5
H-A 10 SDRL-LB 21	70456400	21																	
H-A 10 SDRL-LB M20	79456200		20	63	74,4	71,4	48	80	29,5			40	50	25	57	3,5		36,5	4,5
H-A 10 SDRL-LB M25	79456400		25																

Einsätze / Inserts / Inserts: 1.1: H-A 10 / 1.3: STA 14 / 1.8: H-D 15

Kabelverschraubung / Cable gland / Presse-étoupe: 5.1: Metr. & PG

H-A 16

Artikel part article	Art.Nr. part No. N° art.	PG	M	L	L1	L2	L3	L4	B	B1	B2	B3	B4	B5	H	H1	H2	S	d
H-A 16 SDRL-LB 16	70486200	16		79	90,4	87,8	64	96	29,5			40	50	25	57	3,5		36,5	4,5
H-A 16 SDRL-LB 21	70486400	21																	
H-A 16 SDRL-LB M20	79486200		20	79	90,4	87,8	64	96	29,5			40	50	25	57	3,5		36,5	4,5
H-A 16 SDRL-LB M25	79486400		25																

Einsätze / Inserts / Inserts: 1.1: H-A 16 / 1.3: STA 20 / 1.8: H-D 25

Kabelverschraubung / Cable gland / Presse-étoupe: 5.1: Metr. & PG

3.1 EPIC® D A - V I N C I H - A

Sockelgehäuse / Surface mount base / Embase en saillie



PG / M

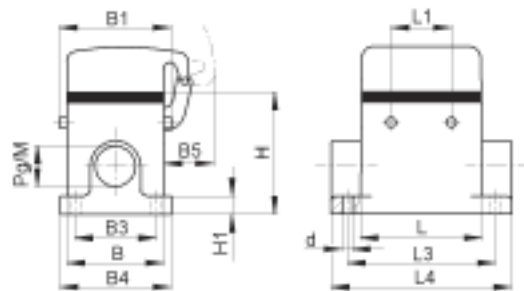

EPIC® H-A Gehäuse: Sockelgehäuse (Schutzdeckel, 1 Kabeleingang, Bolzen für Querbügel)

EPIC® H-A housings: surface mount base (cover, 1 cable entry, bolts for double locking lever)

Boîtiers EPIC® H-A: embase en saillie (couvercle, 1 entrée de câble, ergots pour double levier)

H-A 32

Artikel part article	Art.Nr. part No. N° art.	PG	M	ZW	L	L1	L2	L3	L4	B	B1	B2	B3	B4	B5	H	H1	H2	S	d
H-A 32 SDR-BO 21	70515200	21		●	82	49,6		94	106	56	70,8		46	57	29	75	4			5,5
H-A 32 SDR-BO 29	70515400	29		●																
H-A 32 SDR-BO M25	79515200		25	●																
H-A 32 SDR-BO M32	79515400		32	●	82	49,6		94	106	56	70,8		46	57	29	75	4			5,5
H-A 32 SDR-BO M40	79515600		40																	

Einsätze / Inserts / Inserts: 1.1: H-A 32 / 1.3: 2 x STA 20 / 1.8: H-D 50

Kabelverschraubung / Cable gland / Presse-étoupe: 5.1: Metr. & PG

EPIC® H-A Gehäuse: Sockelgehäuse (Schutzdeckel, 2 Kabeleingänge, Bolzen für Querbügel)

EPIC® H-A housings: surface mount base (cover, 2 cable entries, bolts for double locking lever)

Boîtiers EPIC® H-A: embase en saillie (couvercle, 2 entrées de câble, ergots pour double levier)

H-A 32

Artikel part article	Art.Nr. part No. N° art.	PG	M	ZW	L	L1	L2	L3	L4	B	B1	B2	B3	B4	B5	H	H1	H2	S	d
H-A 32 SDRL-BO 21	70516200	21		●	82	49,6		94	106	56	70,8		46	57	29	75	4			5,5
H-A 32 SDRL-BO 29	70516400	29		●																
H-A 32 SDRL-BO M25	79516200		25	●																
H-A 32 SDRL-BO M32	79516400		32	●	82	49,6		94	106	56	70,8		46	57	29	75	4			5,5
H-A 32 SDRL-BO M40	79516600		40																	

Einsätze / Inserts / Inserts: 1.1: H-A 32 / 1.3: STA 20 / 1.8: H-D 50

Kabelverschraubung / Cable gland / Presse-étoupe: 5.1: Metr. & PG

3.1 EPIC® D A - V I N C I H - A

Kupplungsgehäuse / Cable coupler hood / Capot prolongateur



PG



M

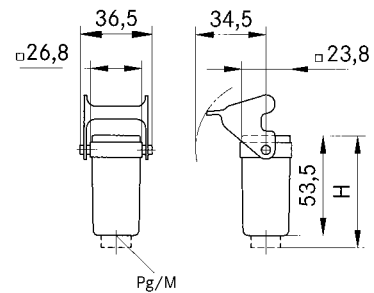

EPIC® H-A Gehäuse: Kupplungsgehäuse (Kabeleingang gerade)

EPIC® H-A housings: cable coupler hood (top entry)

Boîtiers EPIC® H-A: capot prolongateur (sortie verticale)

H-A 3

Artikel part article	Art.Nr. part No. N° art.	PG	M	Material material matière	Farbe colour couleur	Verschraubung cable gland presse-étoupe	B	H
H-A 3 MTgvb	10512900	11		Zinkdruckguss / zinc die cast / zinc moulé par injection	grau/grey/grise			
H-A 3 Tgvb	10429200	11		Thermoplast / thermoplastic / plastique thermoformé	schwarz/black/noir			
H-A 3 Tgvb	10429000	11		Thermoplast / thermoplastic / plastique thermoformé	grau/grey/grise			
H-A 3 MTgvb	10429500	11		Zinkdruckguss / zinc die cast / zinc moulé par injection	grau/grey/grise	●		60
H-A 3 Tgvb	10620300	11		Thermoplast / thermoplastic / plastique thermoformé	schwarz/black/noir	●		65
H-A 3 Tgvb	10429100	11		Thermoplast / thermoplastic / plastique thermoformé	grau/grey/grise	●		65
H-A 3 MTgvb M20	19512900		20	Zinkdruckguss / zinc die cast / zinc moulé par injection	grau/grey/grise			
H-A 3 Tgvb M20	19429000		20	Thermoplast / thermoplastic / plastique thermoformé	grau/grey/grise			
H-A 3 Tgvb M20	19429200		20	Thermoplast / thermoplastic / plastique thermoformé	schwarz/black/noir			

Einsätze / Inserts / Inserts: 1.1: H-A 3, H-A 4 / 1.2: H-Q5 / 1.3: STA 6 / 1.8: H-D 7, H-D 8

Deckel / Cover / Couvercle: 6.1: H-A 3

Kabelverschraubung / Cable gland / Presse-étoupe: 5.1: Metr. & PG

3.1 EPIC® D A - V I N C I H - A

Kupplungsgehäuse / Cable coupler hood / Capot prolongateur



PG



M

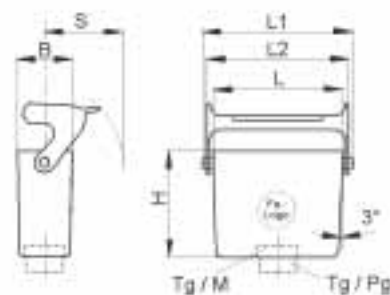

EPIC® H-A Gehäuse: Kupplungsgehäuse (Kabeleingang gerade, Längsbügel)

EPIC® H-A housings: cable coupler hood (top entry, single locking lever)

Boîtiers EPIC® H-A: capot prolongateur (sortie verticale, simple levier)

H-A 10

Artikel part article	Art.Nr. part No. N° art.	PG	M	ZW	L	L1	L2	L3	L4	B	B1	B2	B3	B4	B5	H	H1	H2	S	d
H-A 10 TBF-LB 13,5	10439000	13,5		●	63	74,4	71,4			29,5						48				36,5
H-A 10 TBF-LB 16	70450000	16		●																
H-A 10 TBF-LB M20	19439000		20		63	74,4	71,4			29,5						48				36,5
H-A 10 TBF-LB M25	79450000		25																	

Einsätze / Inserts / Inserts: 1.1: H-A 10 / 1.3: STA 14 / 1.8: H-D 15

Deckel / Cover / Couvercle: 6.1: H-A 10

Kabelverschraubung / Cable gland / Presse-étoupe: 5.1: Metr. & PG

H-A 16

Artikel part article	Art.Nr. part No. N° art.	PG	M	ZW	L	L1	L2	L3	L4	B	B1	B2	B3	B4	B5	H	H1	H2	S	d
H-A 16 TBF-LB 16	10563000	16		●	79	90,4	87,8			29,5						53				36,5
H-A 16 TBF-LB M20	19563000		20		79	90,4	87,8			29,5						53				36,5
H-A 16 TBF-LB M25	19563200		25																	

Einsätze / Inserts / Inserts: 1.1: H-A 16 / 1.3: STA 20 / 1.8: H-D 25

Deckel / Cover / Couvercle: 6.1: H-A 16

Kabelverschraubung / Cable gland / Presse-étoupe: 5.1: Metr. & PG

3.1 EPIC® D A - V I N C I H - A

Kupplungsgehäuse / Cable coupler hood / Capot prolongateur



PG



M

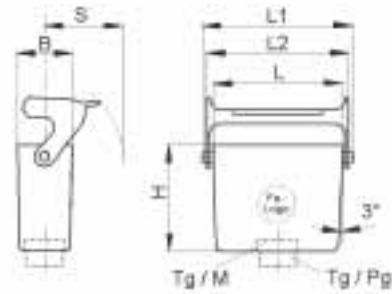

EPIC® H-A Gehäuse: Kupplungsgehäuse (Kabeleingang gerade, Längsbügel, hohe Bauform)

EPIC® H-A housings: cable coupler hood (top entry, single locking lever, high version)

Boîtiers EPIC® H-A: capot prolongateur (sortie verticale, simple levier, version haute)

H-A 10

Artikel part article	Art.Nr. part No. N° art.	PG	M	ZW	L	L1	L2	L3	L4	B	B1	B2	B3	B4	B5	H	H1	H2	S	d
H-A 10 TBFH-LB 21	70450400	21		●	63	74,4	71,4			29,5						62			36,5	
H-A 10 TBFH-LB M25	79450400		25		63	74,4	71,4			29,5						62			36,5	

Einsätze / Inserts / Inserts: 1.1: H-A 10 / 1.3: STA 14 / 1.8: H-D 15

Deckel / Cover / Couvercle: 6.1: H-A 10

Kabelverschraubung / Cable gland / Presse-étoupe: 5.1: Metr. & PG

H-A 16

Artikel part article	Art.Nr. part No. N° art.	PG	M	ZW	L	L1	L2	L3	L4	B	B1	B2	B3	B4	B5	H	H1	H2	S	d
H-A 16 TBFH-LB 16	70480200	16		●	79	90,4	87,8			29,5						67			36,5	
H-A 16 TBFH-LB 21	70480400	21		●	79	90,4	87,8			29,5						67			36,5	
H-A 16 TBFH-LB M20	79480200		20		79	90,4	87,8			29,5						67			36,5	
H-A 16 TBFH-LB M25	79480400		25		79	90,4	87,8			29,5						67			36,5	

Einsätze / Inserts / Inserts: 1.1: H-A 16 / 1.3: STA 20 / 1.8: H-D 25

Deckel / Cover / Couvercle: 6.1: H-A 16

Kabelverschraubung / Cable gland / Presse-étoupe: 5.1: Metr. & PG

3.1 EPIC® D A - V I N C I H - A

Kupplungsgehäuse / Cable coupler hood / Capot prolongateur



EPIC® H-A Gehäuse: Kupplungsgehäuse (Kabeleingang gerade, Querbügel)

EPIC® H-A housings: cable coupler hood (top entry, double locking lever)

Boîtiers EPIC® H-A: capot prolongateur (sortie verticale, double levier)

H-A 32

Artikel part article	Art.Nr. part No. N° art.	PG	M	ZW	L	L1	L2	L3	L4	B	B1	B2	B3	B4	B5	H	H1	H2	S	d
H-A 32 TBF 21	10588000	21		●	82	49,6				56	70,8	66				76,5			124,5	
H-A 32 TBF 29	10588500	29		●																
H-A 32 TBF M25	19588000		25																	
H-A 32 TBF M32	19588500		32		82	49,6				56	70,8	66				76,5			124,5	
H-A 32 TBF M40	79510400		40																	

Einsätze / Inserts / Inserts: 1.1: H-A 32 / 1.3: 2 x STA 20 / 1.8: H-D 50

Deckel / Cover / Couvercle: 6.1: H-A 32

Kabelverschraubung / Cable gland / Presse-étoupe: 5.1: Metr. & PG

3.2 EPIC® D A - V I N C I H - B

Gehäuse / Hood / Capot

Solide Bauform und ein umfangreiches Programm an passenden Einsätzen sind die markanten Merkmale dieses Gehäuses. Diese Bauform lässt sich aus dem Industriestandard nicht mehr wegdenken. Die Gehäuse der H-B Serie gibt es in sechs verschiedenen Gehäusegrößen.

The striking characteristics of these mount bases are a sturdy construction and a comprehensive range of corresponding inserts. This style is used in all industrial applications. The H-B series housings are available in six different sizes.

Une forme de construction solide et un programme important d'inserts adéquats sont les caractéristiques marquantes de ce boîtier. Cette forme de construction est devenue indispensable au standard industriel. Les boîtiers de la série H-B sont disponibles en six tailles différentes.

3



3.2 EPIC® D A - V I N C I H - B

Gehäuse / Hood / Capot

Technische Daten:

Vorschriften: DIN 43652

Schutzart: IP 65

Werkstoff: H-B 6 – 48: Aluminiumlegierung, pulverbeschichtet

Technical Data

Specifications: DIN 43652

Protection class: IP 65

Material: H-B 6 – 48: aluminium alloy, powder coated

Caractéristiques techniques

Règlements: DIN 43652

Degré de protection: IP 65

Matière: H-B 6 – 48: Alliage aluminium, recouvert par pulvérisation

3.2 EPIC® D A - V I N C I H - B

Gehäuse / Hood / Capot



PG

M

EPIC® Standardgehäuse

Aluminiumlegierung, pulverbeschichtet (grau), Bügel und Bolzen aus verzinktem Stahl

Aluminium alloy, powder coated (grey), locking levers and bolts made of zinc plated steel

Alliage aluminium, recouvert par pulvérisation (grise), leviers et ergots acier recouvert par zinc

Für den industriellen Einsatz in anspruchsvoller Umgebung.

For industrial applications in demanding environments.

Pour une exploitation industrielle dans un environnement exigeant.

Entsprechend DIN EN 50262; auch in metrischer Ausführung mit M20-, M25-, M32- und M40-Gewinde.

According to DIN EN 50262; also available with metric thread M20, M25, M32 and M40.

Selon DIN EN 50262; maintenant aussi disponible avec pas métrique M20, M25, M32 et M40.



PG

M

EPIC® EP: (Environmental Protected/für erhöhte Umweltaanforderungen)

Aluminiumlegierung, pulverbeschichtet (schwarz), Bügel und Bolzen aus Edelstahl

Aluminium alloy, powder coated (black), locking levers and bolts made of stainless steel

Alliage aluminium, recouvert par pulvérisation (noir), leviers et ergots acier inox

Für den industriellen Einsatz in stark beanspruchter Umgebung mit aggressiver Atmosphäre.

For industrial applications in extremely demanding environments with aggressive atmospheres.

Pour l'exploitation industrielle dans un environnement très sollicité à atmosphère agressive.

Entsprechend DIN EN 50262; auch in metrischer Ausführung mit M20-, M25-, M32 und M40-Gewinde.

According to DIN EN 50262; now also available with metric thread M20, M25, M32 and M40.

Selon DIN EN 50262; maintenant aussi disponible avec pas métrique M20, M25, M32 et M40.

**Auf Anfrage
On request
sur demande**

3.2 EPIC® D A - V I N C I H - B

Gehäuse / Hood / Capot



PG



M

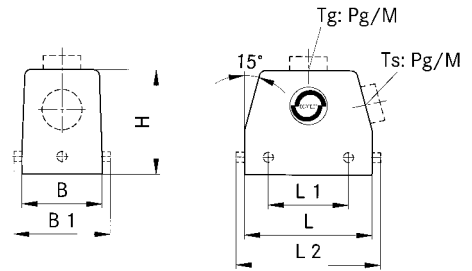

EPIC® H-B Gehäuse: Tüllengehäuse (Kabeleingang gerade, Bolzen für Längsbügel)

EPIC® H-B housings: hood (top entry, bolts for single locking lever)

Boîtiers EPIC® H-B: capot (sortie verticale, ergots pour simple levier)

H-B 6

Artikel part article	Art.Nr. part No. N° art.	PG	M	ZW	L	L1	L2	L3	L4	B	B1	B2	B3	B4	B5	H	H1	H2	S	d
H-B 6 TG 13,5	10011000	13,5		●	60		74,8			43				45		52				
H-B 6 TG 16	10021000	16		●																
H-B 6 TG M20	19011000		20		60		74,8			43						52				
H-B 6 TG M25	19021000		25																	

Einsätze / Inserts / Inserts: 1.4: H-BE 6 / 1.5: H-EE 10 / 1.9: H-DD 24 / 1.10: MC 6

Deckel / Cover / Couvercle: 6.1: H-BE 6

Kabelverschraubung / Cable gland / Presse-étoupe: 5.1: Metr. & PG

H-B 10

Artikel part article	Art.Nr. part No. N° art.	PG	M	ZW	L	L1	L2	L3	L4	B	B1	B2	B3	B4	B5	H	H1	H2	S	d
H-B 10 TG-RO 16	10040900	16		●	73		90			43				45		52				
H-B 10 TG-RO 21	10040700	21		●																
H-B 10 TG-RO M20	19040900		20		73		90			43				45		52				
H-B 10 TG-RO M25	19040700		25																	

Einsätze / Inserts / Inserts: 1.4: H-BE 10 / 1.5: H-EE 18 / 1.7: H-BVE 3 / 1.9: H-DD 42 / 1.10: MC 10

Kabelverschraubung / Cable gland / Presse-étoupe: 5.1: Metr. & PG



PG



M

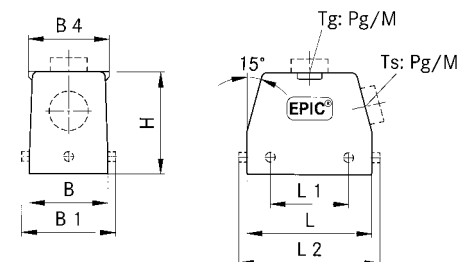

H-B 16

Artikel part article	Art.Nr. part No. N° art.	PG	M	ZW	L	L1	L2	L3	L4	B	B1	B2	B3	B4	B5	H	H1	H2	S	d
H-B 16 TG-RO 21	10080900	21		●	93,3		110			43						61				
H-B 16 TG-RO M25	19080900		25		93,3		110			43						61				

Einsätze / Inserts / Inserts: 1.4: H-BE 16 / 1.5: H-EE 32 / 1.6: H-BS 6 / 1.7: H-BVE 6 / 1.8: H-D 40 / 1.9: H-DD 72 / 1.10: MC 16

Kabelverschraubung / Cable gland / Presse-étoupe: 5.1: Metr. & PG

3.2 EPIC® D A - V I N C I H - B

Gehäuse / Hood / Capot



PG



M

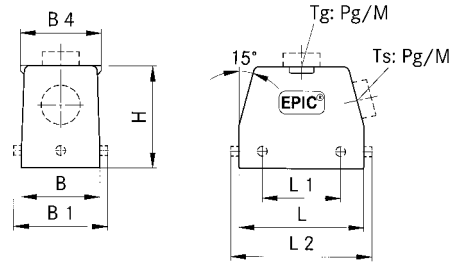

EPIC® H-B Gehäuse: Tüllengehäuse (Kabeleingang gerade, Bolzen für Längsbügel)

EPIC® H-B housings: hood (top entry, bolts for single locking lever)

Boîtiers EPIC® H-B: capot (sortie verticale, ergots pour simple levier)

H-B 24

Artikel part article	Art.Nr. part No. N° art.	PG	M	ZW	L	L1	L2	L3	L4	B	B1	B2	B3	B4	B5	H	H1	H2	S	d
H-B 24 TG-RO 21	10121900	21		●	120	137				43				45		61				
H-B 24 TG-RO 29	10111900	29		●																
H-B 24 TG-RO M25	19121900		25		120	137				43				45		61				
H-B 24 TG-RO M32	19111900		32																	

Einsätze / Inserts / Inserts: 1.4: H-BE 48 / 1.5: H-EE 46 / 1.7: H-BVE 10 / 1.8: H-D 64 / 1.9: H-DD 108 / 1.10: MC 24

Kabelverschraubung / Cable gland / Presse-étoupe: 5.1: Metr. & PG

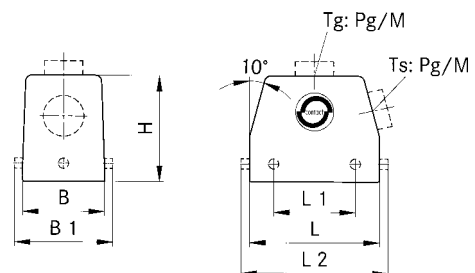

H-B 48

Artikel part article	Art.Nr. part No. N° art.	PG	M	ZW	L	L1	L2	L3	L4	B	B1	B2	B3	B4	B5	H	H1	H2	S	d
H-B 48 TG 29	10155000	29		●																
H-B 48 TG 36	10156000	36		●	132	152				90				45		105				
H-B 48 TG 36	10156200	36																		
H-B 48 TG 42	10157000	42																		
H-B 48 TG M32	19155000		32																	
H-B 48 TG M40	19156000		40		132	152				90				45		105				
H-B 48 TG M50	19157000		50																	

Einsätze / Inserts / Inserts: 1.4: H-BE 48 / 1.5: H-EE 92 / 1.7: 2 x H-BVE 10 / 1.8: H-D 128 / 1.9: H-DD 216 / 1.10: 2 x MC 24

Kabelverschraubung / Cable gland / Presse-étoupe: 5.1: Metr. & PG

3.2 EPIC® D A - V I N C I H - B

Gehäuse / Hood / Capot



PG



M

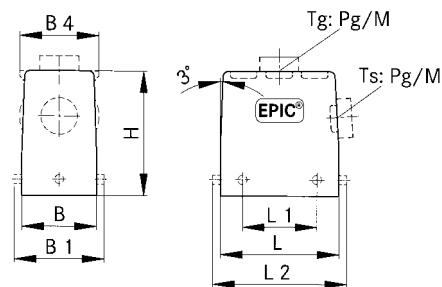

EPIC® H-B Gehäuse: Tüllengehäuse (Kabeleingang gerade, Bolzen für Längsbügel, hohe Bauform)

EPIC® H-B housings: hood (top entry, bolts for single locking lever, high version)

Boîtiers EPIC® H-B: capot (sortie verticale, ergots pour simple levier, version haute)

H-B 6

Artikel part article	Art.Nr. part No. N° art.	PG	M	ZW	L	L1	L2	L3	L4	B	B1	B2	B3	B4	B5	H	H1	H2	S	d
H-B 6 TGH 21	70020200	21		●	60		74,8			43				45		72				
H-B 6 TGH 29	70020400	29		●																
H-B 6 TGH M25	79020200		25		60		74,8			43						72				
H-B 6 TGH M32	79020400		32																	

Einsätze / Inserts / Inserts: 1.4: H-BE 6 / 1.5: H-EE 10 / 1.9: H-DD 24 / 1.10: MC 6

Deckel / Cover / Couvercle: 6.1: H-B 6

Kabelverschraubung / Cable gland / Presse-étoupe: 5.1: Metr. & PG

H-B 10

Artikel part article	Art.Nr. part No. N° art.	PG	M	ZW	L	L1	L2	L3	L4	B	B1	B2	B3	B4	B5	H	H1	H2	S	d
H-B 10 TGH-RO 21	70044200	21		●	73		90			43				45		72				
H-B 10 TGH-RO 29	70044400	29		●																
H-B 10 TGH-RO M25	79044200		25		73		90			43				45		72				
H-B 10 TGH-RO M32	79044400		32																	

Einsätze / Inserts / Inserts: 1.4: H-BE 10 / 1.5: H-EE 18 / 1.7: H-BVE 3 / 1.9: H-DD 42 / 1.10: MC 10

Kabelverschraubung / Cable gland / Presse-étoupe: 5.1: Metr. & PG

3.2 EPIC® D A - V I N C I H - B

Gehäuse / Hood / Capot



PG



M

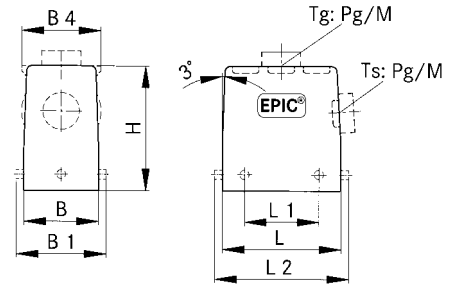

EPIC® H-B Gehäuse: Tüllengehäuse (Kabeleingang gerade, Bolzen für Längsbügel, hohe Bauform)

EPIC® H-B housings: hood (top entry, bolts for single locking lever, high version)

Boîtiers EPIC® H-B: capot (sortie verticale, ergots pour simple levier, version haute)

H-B 16

Artikel part article	Art.Nr. part No. N° art.	PG	M	ZW	L	L1	L2	L3	L4	B	B1	B2	B3	B4	B5	H	H1	H2	S	d
H-B 16 TGH-RO 21	70094200	21		●	93,3		110			43				45		76				
H-B 16 TGH-RO 29	70094400	29		●																
H-B 16 TGH-RO M25	79094200		25																	
H-B 16 TGH-RO M32	79094400		32		93,3		110			43				45		76				
H-B 16 TGH-RO M40	79094600		40																	

Einsätze / Inserts / Inserts: 1.4: H-BE 16 / 1.5: H-EE 32 / 1.6: H-BS 6 / 1.7: H-BVE 6 / 1.8: H-D 40 / 1.9: H-DD 72 / 1.10: MC 16
Kabelverschraubung / Cable gland / Presse-étoupe: 5.1: Metr. & PG

H-B 24

Artikel part article	Art.Nr. part No. N° art.	PG	M	ZW	L	L1	L2	L3	L4	B	B1	B2	B3	B4	B5	H	H1	H2	S	d
H-B 24 TGH-RO 21	70144400	21		●	120		137			43				45		76				
H-B 24 TGH-RO 29	70144600	29		●																
H-B 24 TGH-RO M25	79144400		25																	
H-B 24 TGH-RO M32	79144600		32		120		137			43				45		76				
H-B 24 TGH-RO M40	79144800		40																	

Einsätze / Inserts / Inserts: 1.4: H-BE 24 / 1.5: H-EE 46 / 1.7: H-BVE 10 / 1.8: H-D 64 / 1.9: H-DD 108 / 1.10: MC 24
Kabelverschraubung / Cable gland / Presse-étoupe: 5.1: Metr. & PG

3.2 EPIC® D A - V I N C I H - B

Gehäuse / Hood / Capot



PG / M

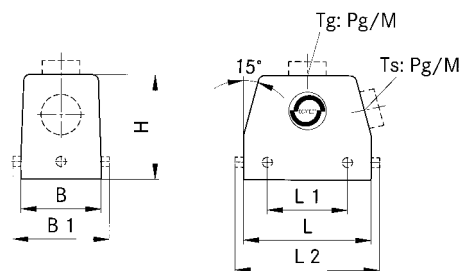

EPIC® H-B Gehäuse: Tüllengehäuse (Kabeleingang seitlich, Bolzen für Längsbügel)

EPIC® H-B housings: hood (side entry, bolts for single locking lever)

Boîtiers EPIC® H-B: capot (sortie latérale, ergots pour simple levier)

H-B 6

Artikel part article	Art.Nr. part No. N° art.	PG	M	ZW	L	L1	L2	L3	L4	B	B1	B2	B3	B4	B5	H	H1	H2	S	d
H-B 6 TS 13,5	10012000	13,5		●	60		74,8			43						52				
H-B 6 TS 16	10022000	16		●																
H-B 6 TS M20	19012000		20	●	60		74,8			43						52				
H-B 6 TS M25	19022000		25	●																

Einsätze / Inserts / Inserts: 1.4: H-BE 6 / 1.5: H-EE 10 / 1.9: H-DD 24 / 1.10: MC 6

Deckel / Cover / Couvercle: 6.1: H-B 6

Kabelverschraubung / Cable gland / Presse-étoupe: 5.1: Metr. & PG

H-B 10

Artikel part article	Art.Nr. part No. N° art.	PG	M	ZW	L	L1	L2	L3	L4	B	B1	B2	B3	B4	B5	H	H1	H2	S	d
H-B 10 TS-RO 16	10042900	16		●	73		90			43						52				
H-B 10 TS-RO 21	10042800	21		●																
H-B 10 TS-RO M20	19042900		20	●	73		90			43						52				
H-B 10 TS-RO M25	19042800		25	●																

Einsätze / Inserts / Inserts: 1.4: H-BE 10 / 1.5: H-EE 18 / 1.7: H-BVE 3 / 1.9: H-DD 42 / 1.10: MC 10

Kabelverschraubung / Cable gland / Presse-étoupe: 5.1: Metr. & PG



PG / M

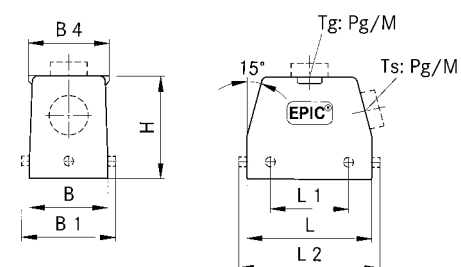

H-B 16

Artikel part article	Art.Nr. part No. N° art.	PG	M	ZW	L	L1	L2	L3	L4	B	B1	B2	B3	B4	B5	H	H1	H2	S	d
H-B 16 TS-RO 21	10082900	21		●	93,3		110			43				45		61				
H-B 16 TS-RO 29	10092900	29		●																
H-B 16 TS-RO M25	19082900		25	●	93,3		110			43				45		61				
H-B 16 TS-RO M32	19092900		32	●																

Einsätze / Inserts / Inserts: 1.4: H-BE 16 / 1.5: H-EE 32 / 1.6: H-BS 6 / 1.7: H-BVE 6 / 1.8: H-D 40 / 1.9: H-DD 72 / 1.10: MC 16

Kabelverschraubung / Cable gland / Presse-étoupe: 5.1: Metr. & PG

3.2 EPIC® D A - V I N C I H - B

Gehäuse / Hood / Capot



PG / M

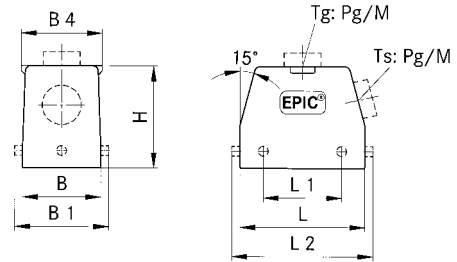

EPIC® H-B Gehäuse: Tüllengehäuse (Kabeleingang seitlich, Bolzen für Längsbügel)

EPIC® H-B housings: hood (side entry, bolts for single locking lever)

Boîtiers EPIC® H-B: capot (sortie latérale, ergots pour simple levier)

H-B 24

Artikel part article	Art.Nr. part No. N° art.	PG	M	ZW	L	L1	L2	L3	L4	B	B1	B2	B3	B4	B5	H	H1	H2	S	d
H-B 24 TS-RO 21	10113900	21		●	120		137			43				45		61				
H-B 24 TS-RO 29	10123900	29		●																
H-B 24 TS-RO M25	19113900		25	●	120		137			43				45		61				
H-B 24 TS-RO M32	19123900		32	●																

Einsätze / Inserts / Inserts: 1.4: H-BE 24 / 1.5: H-EE 46 / 1.7: H-BVE 10 / 1.8: H-D 64 / 1.9: H-DD 108 / 1.10: MC 24

Kabelverschraubung / Cable gland / Presse-étoupe: 5.1: Metr. & PG



PG



M

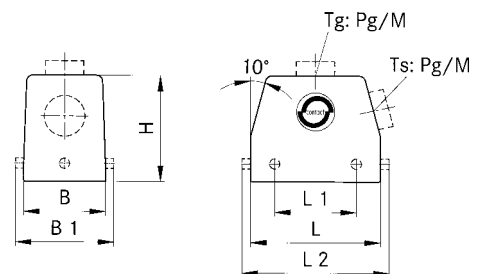

EPIC® H-B Gehäuse: Tüllengehäuse (Kabeleingang seitlich, Bolzen für Längsbügel)

EPIC® H-B housings: hood (side entry, bolts for single locking lever)

Boîtiers EPIC® H-B: capot (sortie latérale, ergots pour simple levier)

H-B 48

Artikel part article	Art.Nr. part No. N° art.	PG	M	ZW	L	L1	L2	L3	L4	B	B1	B2	B3	B4	B5	H	H1	H2	S	d
H-B 48 TS 29	10158000	29		●																
H-B 48 TS 36	10159000	36		●	132		152			90						105				
H-B 48 TS 36	10159200	36																		
H-B 48 TS 42	10160000	42		●																
H-B 48 TS M32	19158000		32																	
H-B 48 TS M40	19159000		40		132		152			90						105				
H-B 48 TS M50	19160000		50																	

Einsätze / Inserts / Inserts: 1.4: H-BE 48 / 1.5: H-EE 92 / 1.7: 2 x H-BVE 10 / 1.8: H-D 128 / 1.9: H-DD 216 / 1.10: 2 x MC 24

Kabelverschraubung / Cable gland / Presse-étoupe: 5.1: Metr. & PG

3.2 EPIC® D A - V I N C I H - B

Gehäuse / Hood / Capot



PG



M

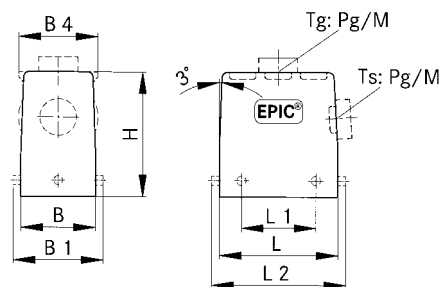

EPIC® H-B Gehäuse: Tüllengehäuse (Kabeleingang seitlich, Bolzen für Längsbügel, hohe Bauform)
EPIC® H-B housings: hood (side entry, bolts for single locking lever, high version)
Boîtiers EPIC® H-B: capot (sortie latérale, ergots pour simple levier, version haute)

H-B 6

Artikel part article	Art.Nr. part No. N° art.	PG	M	ZW	L	L1	L2	L3	L4	B	B1	B2	B3	B4	B5	H	H1	H2	S	d
H-B 6 TSH 21	70022200	21		●	60		74,8			43					45		72			
H-B 6 TSH 29	70022400	29		●																
H-B 6 TSH M25	79022200		25		60		74,8			43					45		72			
H-B 6 TSH M32	79022400		32																	

Einsätze / Inserts / Inserts: 1.4: H-BE 6 / 1.5: H-EE 10 / 1.9: H-DD 24 / 1.10: MC 6

Deckel / Cover / Couvercle: 6.1: H-B 6

Kabelverschraubung / Cable gland / Presse-étoupe: 5.1: Metr. & PG

H-B 10

Artikel part article	Art.Nr. part No. N° art.	PG	M	ZW	L	L1	L2	L3	L4	B	B1	B2	B3	B4	B5	H	H1	H2	S	d
H-B 10 TSH-RO 21	70054200	21		●	73		90			43					45		72			
H-B 10 TSH-RO 29	70054400	29		●																
H-B 10 TSH-RO M25	79054200		25		73		90			43					45		72			
H-B 10 TSH-RO M32	79054400		32																	

Einsätze / Inserts / Inserts: 1.4: H-BE 10 / 1.5: H-EE 10 / 1.7: H-BVE 3 / 1.9: H-DD 42 / 1.10: MC 10

Kabelverschraubung / Cable gland / Presse-étoupe: 5.1: Metr. & PG

H-B 16

Artikel part article	Art.Nr. part No. N° art.	PG	M	ZW	L	L1	L2	L3	L4	B	B1	B2	B3	B4	B5	H	H1	H2	S	d
H-B 16 TSH-RO 21	70104200	21		●	93,3		110			43					45		76			
H-B 16 TSH-RO 29	70104400	29		●																
H-B 16 TSH-RO M25	79104200		25																	
H-B 16 TSH-RO M32	79104400		32		93,3		110			43					45		76			
H-B 16 TSH-RO M40	79104800		40																	

Einsätze / Inserts / Inserts: 1.4: H-BE 16 / 1.5: H-EE 32 / 1.6: H-BS 6 / 1.7: H-BVE 6 / 1.8: H-D 40 / 1.9: H-DD 72 / 1.10: MC 16

Kabelverschraubung / Cable gland / Presse-étoupe: 5.1: Metr. & PG

H-B 24

Artikel part article	Art.Nr. part No. N° art.	PG	M	ZW	L	L1	L2	L3	L4	B	B1	B2	B3	B4	B5	H	H1	H2	S	d
H-B 24 TSH-RO 21	70154400	21		●	120		137			43					45		76			
H-B 24 TSH-RO 29	70154600	29		●																
H-B 24 TSH-RO M25	79154400		25																	
H-B 24 TSH-RO M32	79154600		32		120		137			43					45		76			
H-B 24 TSH-RO M40	79154800		40																	

Einsätze / Inserts / Inserts: 1.4: H-BE 24 / 1.5: H-EE 46 / 1.7: H-BVE 10 / 1.8: H-D 64 / 1.9: H-DD 108 / 1.10: MC 24

Kabelverschraubung / Cable gland / Presse-étoupe: 5.1: Metr. & PG

3.2 EPIC® D A - V I N C I H - B

Gehäuse / Hood / Capot



PG



M

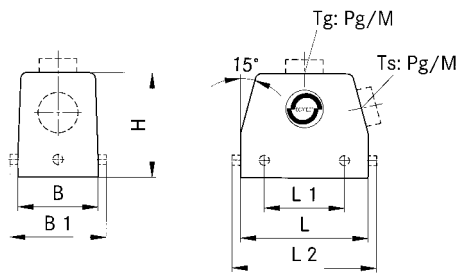

EPIC® H-B Gehäuse: Tüllengehäuse (Kabeleingang gerade, Bolzen für Querbügel)

EPIC® H-B housings: hood (top entry, bolts for double locking lever)

Boîtiers EPIC® H-B: capot (sortie verticale, ergots pour double levier)

H-B 10

Artikel part article	Art.Nr. part No. N° art.	PG	M	ZW	L	L1	L2	L3	L4	B	B1	B2	B3	B4	B5	H	H1	H2	S	d
H-B 10 TG 16	10040000	16		●	73	27				43	57,8			45		52				
H-B 10 TG 21	10040100	21		●																
H-B 10 TG M20	19040000		20		73	27				43	57,8			45		52				
H-B 10 TG M25	19040100		25																	

Einsätze / Inserts / Inserts: 1.4: H-BE 10 / 1.5: H-EE 18 / 1.7: H-BVE 3 / 1.9: H-DD 42 / 1.10: MC 10

Deckel / Cover / Couvercle: 6.1: H-B 10

Kabelverschraubung / Cable gland / Presse-étoupe: 5.1: Metr. & PG



PG



M

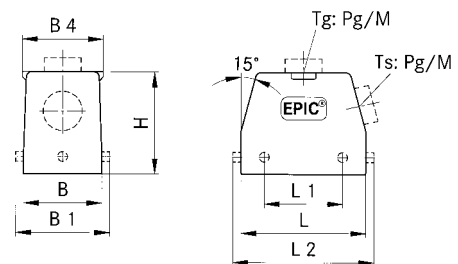

H-B 16

Artikel part article	Art.Nr. part No. N° art.	PG	M	ZW	L	L1	L2	L3	L4	B	B1	B2	B3	B4	B5	H	H1	H2	S	d
H-B 16 TG 21	10080000	21		●	93,3	47,5				43	57,8			45		61				
H-B 16 TG 29	10090000	29		●																
H-B 16 TG M25	19080000		25		93,3	47,5				43	57,8			45		61				
H-B 16 TG M32	19090000		32																	

Einsätze / Inserts / Inserts: 1.4: H-BE 16 / 1.5: H-EE 32 / 1.6: H-BS 6 / 1.7: H-BVE 6 / 1.8: H-D 40 / 1.9: H-DD 72 / 1.10: MC 16

Deckel / Cover / Couvercle: 6.1: H-B 16

Kabelverschraubung / Cable gland / Presse-étoupe: 5.1: Metr. & PG

H-B 24

Artikel part article	Art.Nr. part No. N° art.	PG	M	ZW	L	L1	L2	L3	L4	B	B1	B2	B3	B4	B5	H	H1	H2	S	d
H-B 24 TG 21	10121000	21		●	120	74				43	57,8			45		61				
H-B 24 TG 29	10111000	29		●																
H-B 24 TG M25	19121000		25		120	74				43	57,8			45		61				
H-B 24 TG M32	19111000		32																	

Einsätze / Inserts / Inserts: 1.4: H-BE 24 / 1.5: H-EE 46 / 1.7: H-BVE 10 / 1.8: H-D 64 / 1.9: H-DD 108 / 1.10: MC 24

Deckel / Cover / Couvercle: 6.1: H-B 24

Kabelverschraubung / Cable gland / Presse-étoupe: 5.1: Metr. & PG

3.2 EPIC® D A - V I N C I H - B

Gehäuse / Hood / Capot



PG



M

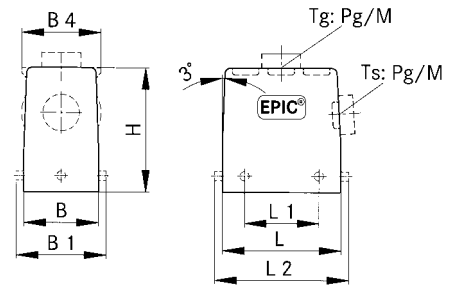

EPIC® H-B Gehäuse: Tüllengehäuse (Kabeleingang gerade, Bolzen für Querbügel, hohe Bauform)

EPIC® H-B housings: hood (top entry, bolts for double locking lever, high version)

Boîtiers EPIC® H-B: capot (sortie verticale, ergots pour double levier, version haute)

H-B 10

Artikel part article	Art.Nr. part No. N° art.	PG	M	ZW	L	L1	L2	L3	L4	B	B1	B2	B3	B4	B5	H	H1	H2	S	d
H-B 10 TGH 21	70050400	21		●	73	27				43	57,8			45		72				
H-B 10 TGH 29	70050600	29		●																
H-B 10 TGH M25	79050400		25		73	27				43	57,8			45		72				
H-B 10 TGH M32	79050600		32																	

Einsätze / Inserts / Inserts: 1.4: H-BE 10 / 1.5: H-EE 18 / 1.7: H-BVE 3 / 1.9: H-DD 42 / 1.10: MC 10

Deckel / Cover / Couvercle: 6.1: H-B 10

Kabelverschraubung / Cable gland / Presse-étoupe: 5.1: Metr. & PG

H-B 16

Artikel part article	Art.Nr. part No. N° art.	PG	M	ZW	L	L1	L2	L3	L4	B	B1	B2	B3	B4	B5	H	H1	H2	S	d
H-B 16 TGH 21	70100200	21		●	93,3	47,5				43	57,8			45		76				
H-B 16 TGH 29	70100400	29		●																
H-B 16 TGH M25	79100200		25																	
H-B 16 TGH M32	79100400		32		93,3	47,5				43	57,8			45		76				
H-B 16 TGH M40	79100800		40																	

Einsätze / Inserts / Inserts: 1.4: H-BE 16 / 1.5: H-EE 32 / 1.6: H-BS 6 / 1.7: H-BVE 6 / 1.8: H-D 40 / 1.9: H-DD 72 / 1.10: MC 16

Deckel / Cover / Couvercle: 6.1: H-B 16

Kabelverschraubung / Cable gland / Presse-étoupe: 5.1: Metr. & PG

H-B 24

Artikel part article	Art.Nr. part No. N° art.	PG	M	ZW	L	L1	L2	L3	L4	B	B1	B2	B3	B4	B5	H	H1	H2	S	d
H-B 24 TGH 21	70150400	21		●	120	74				43	57,8			45		76				
H-B 24 TGH 29	70150600	29		●																
H-B 24 TGH M25	79150400		25																	
H-B 24 TGH M32	79150600		32		120	74				43	57,8			45		76				
H-B 24 TGH M40	79150800		40																	

Einsätze / Inserts / Inserts: 1.4: H-BE 24 / 1.5: H-EE 46 / 1.7: H-BVE 10 / 1.8: H-D 64 / 1.9: H-DD 108 / 1.10: MC 24

Deckel / Cover / Couvercle: 6.1: H-B 24

Kabelverschraubung / Cable gland / Presse-étoupe: 5.1: Metr. & PG

3.2 EPIC® D A - V I N C I H - B

Gehäuse / Hood / Capot



PG



M

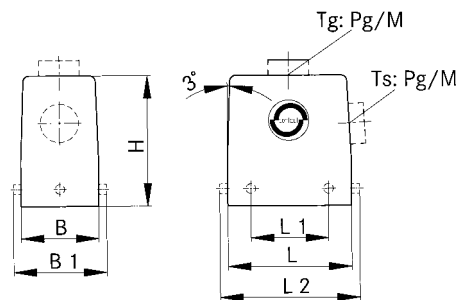

EPIC® H-B Gehäuse: Tüllengehäuse (Kabeleingang gerade, Bolzen für Querbügel)

EPIC® H-B housings: hood (top entry, bolts for double locking lever)

Boîtiers EPIC® H-B: capot (sortie verticale, ergots pour double levier)

H-B 32

Artikel part article	Art.Nr. part No. N° art.	PG	M	ZW	L	L1	L2	L3	L4	B	B1	B2	B3	B4	B5	H	H1	H2	S	d
H-B 32 TG 21	10133000	21		●	93,5	64,5				79	89,5					95				
H-B 32 TG 29	10134000	29		●																
H-B 32 TG M32	19134000		32		93,5	64,5				79	89,5					95				
H-B 32 TG M40	19134400		40																	

Einsätze / Inserts / Inserts: 1.4: H-BE 32 / 1.5: H-EE 64 / 1.6: H-BS 12 / 1.8: H-D 80 / 1.9: H-DD 144 / 1.10: 2 x MC 16

Kabelverschraubung / Cable gland / Presse-étoupe: 5.1: Metr. & PG



PG



M

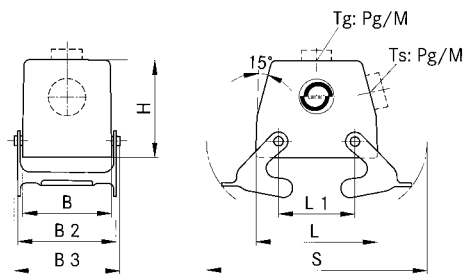

EPIC® H-B Gehäuse: Tüllengehäuse (Kabeleingang gerade, Querbügel)

EPIC® H-B housings: hood (top entry, double locking lever)

Boîtiers EPIC® H-B: capot (sortie verticale, double levier)

H-B 10

Artikel part article	Art.Nr. part No. N° art.	PG	M	ZW	L	L1	L2	L3	L4	B	B1	B2	B3	B4	B5	H	H1	H2	S	d
H-B 10 TGB 16	10041000	16		●	73	27				43	57,8	53				52				116
H-B 10 TGB M20	19041000		20		73	27				43	57,8	53				52				116
H-B 10 TGB M25	79055700		25																	

Einsätze / Inserts / Inserts: 1.4: H-BE 10 / 1.5: H-EE 18 / 1.7: H-BVE 3 / 1.9: H-DD 42 / 1.10: MC 10

Deckel / Cover / Couverture: 6.1: H-B 10

Kabelverschraubung / Cable gland / Presse-étoupe: 5.1: Metr. & PG

3.2 EPIC® D A - V I N C I H - B

Gehäuse / Hood / Capot



PG



M

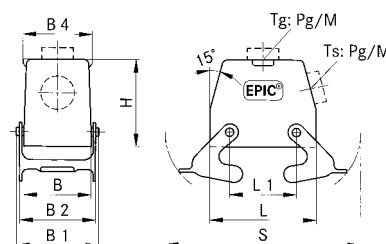

EPIC® H-B Gehäuse: Tüllengehäuse (Kabeleingang gerade, Querbügel)

EPIC® H-B housings: hood (top entry, double locking lever)

Boîtiers EPIC® H-B: capot (sortie verticale, double levier)

H-B 16

Artikel part article	Art.Nr. part No. N° art.	PG	M	ZW	L	L1	L2	L3	L4	B	B1	B2	B3	B4	B5	H	H1	H2	S	d
H-B 16 TGB 21	10081000	21		●	93,3	47,5				43	57,8	53				61				136,5
H-B 16 TGB M25	19081000		25		93,3	47,5				43	57,8	53				61				136,5

Einsätze / Inserts / Inserts: 1.4: H-BE 16 / 1.5: H-EE 32 / 1.6: H-BS 6 / 1.7: H-BVE 6 / 1.8: H-D 40 / 1.9: H-DD 72 / 1.10: MC 16

Deckel / Cover / Couvercle: 6.1: H-B 16

Kabelverschraubung / Cable gland / Presse-étoupe: 5.1: Metr. & PG

H-B 24

Artikel part article	Art.Nr. part No. N° art.	PG	M	ZW	L	L1	L2	L3	L4	B	B1	B2	B3	B4	B5	H	H1	H2	S	d
H-B 24 TGB 21	10122000	21		●	120	74				43	57,8	53				61				163
H-B 24 TGB 29	10112000	29		●																
H-B 24 TGB M25	19122000		25		120	74				43	57,8	53				61				163
H-B 24 TGB M32	19112000		32																	

Einsätze / Inserts / Inserts: 1.4: H-BE 24 / 1.5: H-EE 46 / 1.7: H-BVE 10 / 1.8: H-D 64 / 1.9: H-DD 108 / 1.10: MC 24

Deckel / Cover / Couvercle: 6.1: H-B 24

Kabelverschraubung / Cable gland / Presse-étoupe: 5.1: Metr. & PG

3.2 EPIC® D A - V I N C I H - B

Gehäuse / Hood / Capot



PG



M

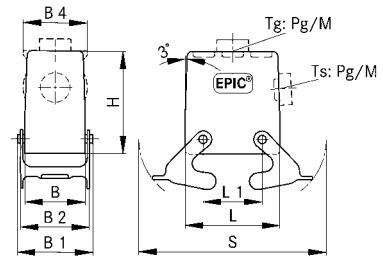

EPIC® H-B Gehäuse: Tüllengehäuse (Kabeleingang gerade, Querbügel, hohe Bauform)

EPIC® H-B housings: hood (top entry, double locking lever, high version)

Boîtiers EPIC® H-B: capot (sortie verticale, double levier, version haute)

H-B 10

Artikel part article	Art.Nr. part No. N° art.	PG	M	ZW	L	L1	L2	L3	L4	B	B1	B2	B3	B4	B5	H	H1	H2	S	d
H-B 10 TGBH 21	70055200	21		●	73	27				43	57,8	53				72				116
H-B 10 TGBH 29	70055400	29		●																
H-B 10 TGBH M25	79055200		25		73	27				43	57,8	53				72				116
H-B 10 TGBH M32	79055400		32																	

Einsätze / Inserts / Inserts: 1.4: H-BE 10 / 1.5: H-EE 18 / 1.7: H-BVE 3 / 1.9: H-DD 42 / 1.10: MC 10

Deckel / Cover / Couvercle: 6.1: H-B 10

Kabelverschraubung / Cable gland / Presse-étoupe: 5.1: Metr. & PG

H-B 16

Artikel part article	Art.Nr. part No. N° art.	PG	M	ZW	L	L1	L2	L3	L4	B	B1	B2	B3	B4	B5	H	H1	H2	S	d
H-B 16 TGBH 21	70105200	21		●	93,3	47,5				43	57,8	53				76				136,5
H-B 16 TGBH 29	70105400	29		●																
H-B 16 TGBH M25	79105200		25		93,3	47,5				43	57,8	53				76				136,5
H-B 16 TGBH M32	79105400		32																	

Einsätze / Inserts / Inserts: 1.4: H-BE 16 / 1.5: H-EE 32 / 1.6: H-BS 6 / 1.7: H-BVE 6 / 1.8: H-D 40 / 1.9: H-DD 72 / 1.10: MC 16

Deckel / Cover / Couvercle: 6.1: H-B 16

Kabelverschraubung / Cable gland / Presse-étoupe: 5.1: Metr. & PG

H-B 24

Artikel part article	Art.Nr. part No. N° art.	PG	M	ZW	L	L1	L2	L3	L4	B	B1	B2	B3	B4	B5	H	H1	H2	S	d
H-B 24 TGBH 21	70155400	21		●	120	74				43	57,8	53				76				163
H-B 24 TGBH 29	70155600	29		●																
H-B 24 TGBH M25	79155400		25		120	74				43	57,8	53				76				163
H-B 24 TGBH M32	79155600		32																	

Einsätze / Inserts / Inserts: 1.4: H-BE 24 / 1.5: H-EE 46 / 1.7: H-BVE 10 / 1.8: H-D 64 / 1.9: H-DD 108 / 1.10: MC 24

Deckel / Cover / Couvercle: 6.1: H-B 24

Kabelverschraubung / Cable gland / Presse-étoupe: 5.1: Metr. & PG

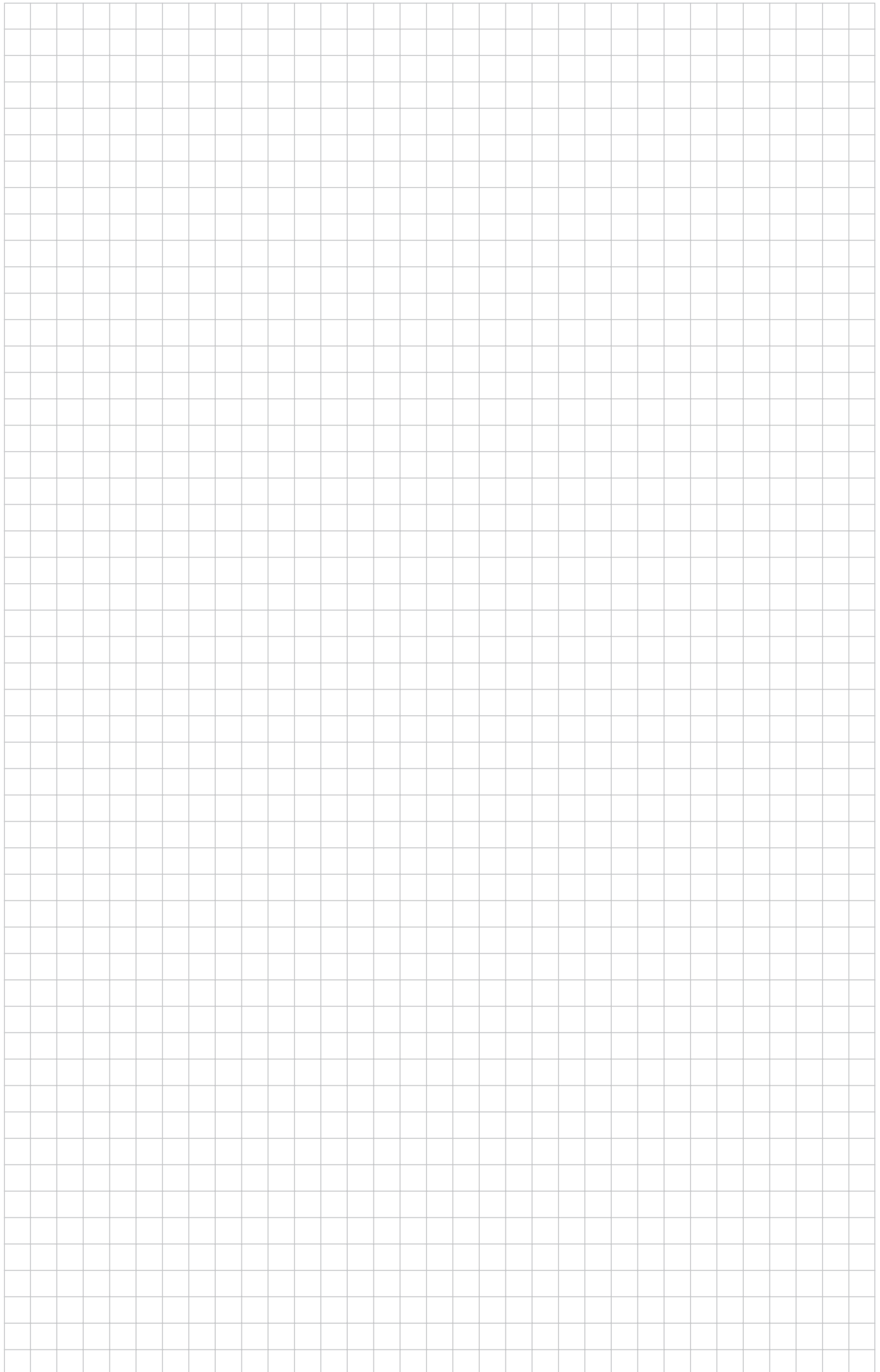

3.2 EPIC® D A - V I N C I H - B

Gehäuse / Hood / Capot



PG / M

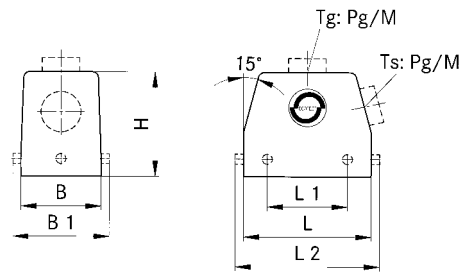

EPIC® H-B Gehäuse: Tüllengehäuse (Kabeleingang seitlich, Bolzen für Querbügel)

EPIC® H-B housings: hood (side entry, bolts for double locking lever)

Boîtiers EPIC® H-B: capot (sortie latérale, ergots pour double levier)

H-B 10

Artikel part article	Art.Nr. part No. N° art.	PG	M	ZW	L	L1	L2	L3	L4	B	B1	B2	B3	B4	B5	H	H1	H2	S	d
H-B 10 TS 16	10042000	16		●	73	27				43	57,8					52				
H-B 10 TS 21	10042100	21		●																
H-B 10 TS M20	19042000		20	●	73	27				43	57,8					52				
H-B 10 TS M25	19042100		25	●																

Einsätze / Inserts / Inserts: 1.4: H-BE 10 / 1.5: H-EE 18 / 1.7: H-BVE 3 / 1.9: H-DD 42 / 1.10: MC 10

Deckel / Cover / Couvercle: 6.1: H-B 10

Kabelverschraubung / Cable gland / Presse-étoupe: 5.1: Metr. & PG



PG / M

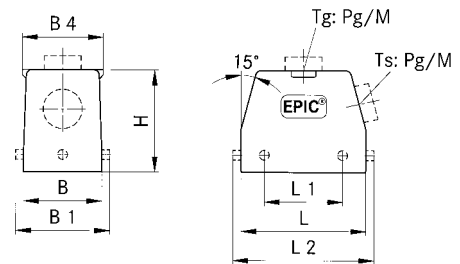

H-B 16

Artikel part article	Art.Nr. part No. N° art.	PG	M	ZW	L	L1	L2	L3	L4	B	B1	B2	B3	B4	B5	H	H1	H2	S	d
H-B 16 TS 21	10082000	21		●	93,3	47,5				43	57,8					61				
H-B 16 TS 29	10092000	29		●																
H-B 16 TS M25	19082000		25	●	93,3	47,5				43	57,8					61				
H-B 16 TS M32	19092000		32	●																

Einsätze / Inserts / Inserts: 1.4: H-BE 16 / 1.5: H-EE 32 / 1.6: H-BS 6 / 1.7: H-BVE 6 / 1.8: H-D 40 / 1.9: H-DD 72 / 1.10: MC 16

Deckel / Cover / Couvercle: 6.1: H-B 16

Kabelverschraubung / Cable gland / Presse-étoupe: 5.1: Metr. & PG

H-B 24

Artikel part article	Art.Nr. part No. N° art.	PG	M	ZW	L	L1	L2	L3	L4	B	B1	B2	B3	B4	B5	H	H1	H2	S	d
H-B 24 TS 21	10113000	21		●	120	74				43	57,8					61				
H-B 24 TS 29	10123000	29		●																
H-B 24 TS M25	19113000		25	●	120	74				43	57,8					61				
H-B 24 TS M32	19123000		32	●																

Einsätze / Inserts / Inserts: 1.4: H-BE 24 / 1.5: H-EE 46 / 1.7: H-BVE 10 / 1.8: H-D 64 / 1.9: H-DD 108 / 1.10: MC 24

Deckel / Cover / Couvercle: 6.1: H-B 24

Kabelverschraubung / Cable gland / Presse-étoupe: 5.1: Metr. & PG

3.2 EPIC® D A - V I N C I H - B

Gehäuse / Hood / Capot



PG



M

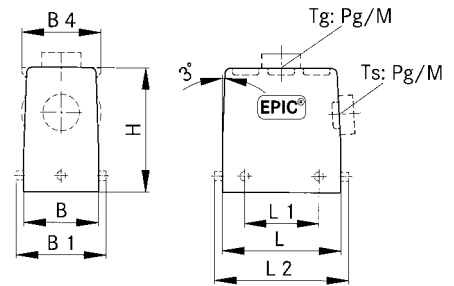

EPIC® H-B Gehäuse: Tüllengehäuse (Kabeleingang seitlich, Bolzen für Querbügel, hohe Bauform)

EPIC® H-B housings: hood (side entry, bolts for double locking lever, high version)

Boîtiers EPIC® H-B: capot (sortie latérale, ergots pour double levier, version haute)

H-B 10

Artikel part article	Art.Nr. part No. N° art.	PG	M	ZW	L	L1	L2	L3	L4	B	B1	B2	B3	B4	B5	H	H1	H2	S	d
H-B 10 TSH 21	70052400	21		●	73	27				43	57,8					72				
H-B 10 TSH 29	70052600	29		●																
H-B 10 TSH M25	79052400		25		73	27				43	57,8					72				
H-B 10 TSH M32	79052600		32																	

Einsätze / Inserts / Inserts: 1.4: H-BE 10 / 1.5: H-EE 18 / 1.7: H-BVE 3 / 1.9: H-DD 42 / 1.10: MC 10

Deckel / Cover / Couvercle: 6.1: H-B 10

Kabelverschraubung / Cable gland / Presse-étoupe: 5.1: Metr. & PG

H-B 16

Artikel part article	Art.Nr. part No. N° art.	PG	M	ZW	L	L1	L2	L3	L4	B	B1	B2	B3	B4	B5	H	H1	H2	S	d
H-B 16 TSH 21	70102200	21		●	93,3	47,5				43	57,8					76				
H-B 16 TSH 29	70102400	29		●																
H-B 16 TSH M25	79102200		25																	
H-B 16 TSH M32	79102400		32		93,3	47,5				43	57,8					76				
H-B 16 TSH M40	79102800		40																	

Einsätze / Inserts / Inserts: 1.4: H-BE 16 / 1.5: H-EE 32 / 1.6: H-BS 6 / 1.7: H-BVE 6 / 1.8: H-D 40 / 1.9: H-DD 72 / 1.10: MC 16

Deckel / Cover / Couvercle: 6.1: H-B 16

Kabelverschraubung / Cable gland / Presse-étoupe: 5.1: Metr. & PG

H-B 24

Artikel part article	Art.Nr. part No. N° art.	PG	M	ZW	L	L1	L2	L3	L4	B	B1	B2	B3	B4	B5	H	H1	H2	S	d
H-B 24 TSH 21	70152400	21		●	120	74				43	57,8					76				
H-B 24 TSH 29	70152600	29		●																
H-B 24 TSH M25	79152400		25																	
H-B 24 TSH M32	79152600		32		120	74				43	57,8					76				
H-B 24 TSH M40	79152800		40																	

Einsätze / Inserts / Inserts: 1.4: H-BE 24 / 1.5: H-EE 46 / 1.7: H-BVE 10 / 1.8: H-D 64 / 1.9: H-DD 108 / 1.10: MC 24

Deckel / Cover / Couvercle: 6.1: H-B 24

Kabelverschraubung / Cable gland / Presse-étoupe: 5.1: Metr. & PG

3.2 EPIC® D A - V I N C I H - B

Gehäuse / Hood / Capot



PG



M

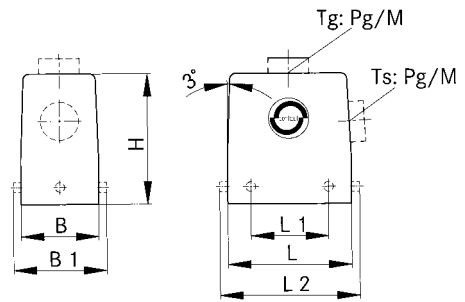

EPIC® H-B Gehäuse: Tüllengehäuse (Kabeleingang seitlich, Bolzen für Querbügel)

EPIC® H-B housings: hood (side entry, bolts for double locking lever)

Boîtiers EPIC® H-B: capot (sortie latérale, ergots pour double levier)

H-B 32

Artikel part article	Art.Nr. part No. N° art.	PG	M	ZW	L	L1	L2	L3	L4	B	B1	B2	B3	B4	B5	H	H1	H2	S	d
H-B 32 TS 21	10135000	21		●																
H-B 32 TS 29	10136000	29		●	93,5	64,5				79	89,5					95				
H-B 32 TS 29	10135600	29																		
H-B 32 TS M25	19135000		25																	
H-B 32 TS M32	19136000		32		93,5	64,5				79	89,5					95				
H-B 32 TS M40	19136200		40																	

Einsätze / Inserts / Inserts: 1.4: H-BE 32 / 1.5: H-EE 64 / 1.6: H-BS 12 / 1.8: H-D 80 / 1.9: H-DD 144 / 1.10: 2 x MC 16

Kabelverschraubung / Cable gland / Presse-étoupe: 5.1: Metr. & PG

3.2 EPIC® D A - V I N C I H - B

Gehäuse / Hood / Capot



PG / M

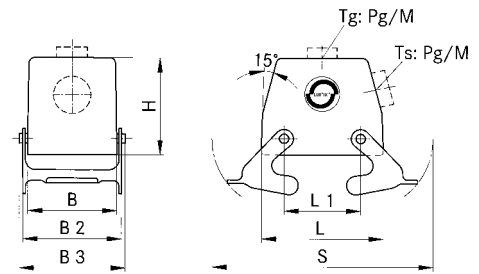

EPIC® H-B Gehäuse: Tüllengehäuse (Kabeleingang seitlich, Querbügel)

EPIC® H-B housings: hood (side entry, double locking lever)

Boîtiers EPIC® H-B: capot (sortie latérale, double levier)

H-B 10

Artikel part article	Art.Nr. part No. N° art.	PG	M	ZW	L	L1	L2	L3	L4	B	B1	B2	B3	B4	B5	H	H1	H2	S	d
H-B 10 TSB 16	10045000	16		●	73	27				43	57,8	53				52				116
H-B 10 TSB M20	19045000		20	●	73	27				43	57,8	53				52				116
H-B 10 TSB M25	79057700		25	●																

Einsätze / Inserts / Inserts: 1.4: H-BE 10 / 1.5: H-EE 18 / 1.7: H-BVE 3 / 1.9: H-DD 42 / 1.10: MC 10

Deckel / Cover / Couvercle: 6.1: H-B 10

Kabelverschraubung / Cable gland / Presse-étoupe: 5.1: Metr. & PG



PG / M

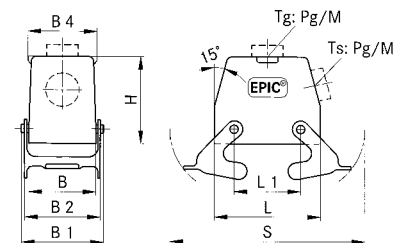

H-B 16

Artikel part article	Art.Nr. part No. N° art.	PG	M	ZW	L	L1	L2	L3	L4	B	B1	B2	B3	B4	B5	H	H1	H2	S	d
H-B 16 TSB 21	10083000	21		●	93,3	47,5				43	57,8	53				61				136,5
H-B 16 TSB M25	19083000		25	●	93,3	47,5				43	57,8	53				61				136,5

Einsätze / Inserts / Inserts: 1.4: H-BE 16 / 1.5: H-EE 32 / 1.6: H-BS 6 / 1.7: H-BVE 6 / 1.8: H-D 40 / 1.9: H-DD 72 / 1.10: MC 16

Deckel / Cover / Couvercle: 6.1: H-B 16

Kabelverschraubung / Cable gland / Presse-étoupe: 5.1: Metr. & PG

H-B 24

Artikel part article	Art.Nr. part No. N° art.	PG	M	ZW	L	L1	L2	L3	L4	B	B1	B2	B3	B4	B5	H	H1	H2	S	d
H-B 24 TSB 21	10114000	21		●	120	74				43	57,8	53				61				163
H-B 24 TSB 29	10124000	29		●																
H-B 24 TSB M25	19114000		25	●	120	74				43	57,8	53				61				163
H-B 24 TSB M32	19124000		32	●																

Einsätze / Inserts / Inserts: 1.4: H-BE 24 / 1.5: H-EE 46 / 1.7: H-BVE 10 / 1.8: H-D 64 / 1.9: H-DD 108 / 1.10: MC 24

Deckel / Cover / Couvercle: 6.1: H-B 24

Kabelverschraubung / Cable gland / Presse-étoupe: 5.1: Metr. & PG

3.2 EPIC® D A - V I N C I H - B

Gehäuse / Hood / Capot

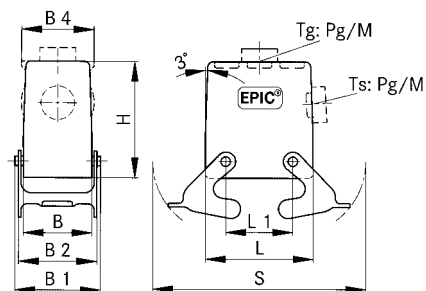

EPIC® H-B Gehäuse: Tüllengehäuse (Kabeleingang seitlich, Querbügel, hohe Bauform)

EPIC® H-B housings: hood (side entry, double locking lever, high version)

Boîtiers EPIC® H-B: capot (sortie latérale, double levier, version haute)

H-B 10

Artikel part article	Art.Nr. part No. N° art.	PG	M	ZW	L	L1	L2	L3	L4	B	B1	B2	B3	B4	B5	H	H1	H2	S	d
H-B 10 TSBH 21	70057200	21		●	73	27				43	57,8	53				72				116
H-B 10 TSBH 29	70057400	29		●																
H-B 10 TSBH M25	79057200		25		73	27				43	57,8	53				72				116
H-B 10 TSBH M32	79057400		32																	

Einsätze / Inserts / Inserts: 1.4: H-BE 10 / 1.5: H-EE 18 / 1.7: H-BVE 3 / 1.9: H-DD 42 / 1.10: MC 10

Deckel / Cover / Couvercle: 6.1: H-B 10

Kabelverschraubung / Cable gland / Presse-étoupe: 5.1: Metr. & PG

H-B 16

Artikel part article	Art.Nr. part No. N° art.	PG	M	ZW	L	L1	L2	L3	L4	B	B1	B2	B3	B4	B5	H	H1	H2	S	d
H-B 16 TSBH 21	70107200	21		●	93,3	47,5				43	57,8	53				76				136,5
H-B 16 TSBH 29	70107400	29		●																
H-B 16 TSBH M25	79107200		25		93,3	47,5				43	57,8	53				76				136,5
H-B 16 TSBH M32	79107400		32																	

Einsätze / Inserts / Inserts: 1.4: H-BE 16 / 1.5: H-EE 32 / 1.6: H-BS 6 / 1.7: H-BVE 6 / 1.8: H-D 40 / 1.9: H-DD 72 / 1.10: MC 16

Deckel / Cover / Couvercle: 6.1: H-B 16

Kabelverschraubung / Cable gland / Presse-étoupe: 5.1: Metr. & PG

H-B 24

Artikel part article	Art.Nr. part No. N° art.	PG	M	ZW	L	L1	L2	L3	L4	B	B1	B2	B3	B4	B5	H	H1	H2	S	d
H-B 24 TSBH 21	70157400	21		●	120	74				43	57,8	53				76				163
H-B 24 TSBH 29	70157600	29		●																
H-B 24 TSBH M25	79157400		25		120	74				43	57,8	53				76				163
H-B 24 TSBH M32	79157600		32																	

Einsätze / Inserts / Inserts: 1.4: H-BE 24 / 1.5: H-EE 46 / 1.7: H-BVE 10 / 1.8: H-D 64 / 1.9: H-DD 108 / 1.10: MC 24

Deckel / Cover / Couvercle: 6.1: H-B 24

Kabelverschraubung / Cable gland / Presse-étoupe: 5.1: Metr. & PG



3.2 EPIC® D A - V I N C I H - B

Anbaugehäuse / Panel mount base / Embase encastrée

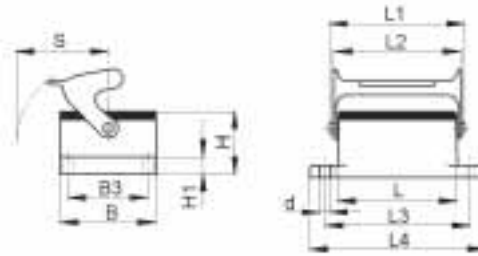

EPIC® H-B Gehäuse: Anbaugehäuse (Längsbügel)
EPIC® H-B housings: panel mount base (single locking lever)
Boîtiers EPIC® H-B: embase encastrée (simple levier)

H-B 6

Artikel part article	Art.Nr. part No. N° art.	PG	L	L1	L2	L3	L4	B	B1	B2	B3	B4	B5	H	H1	H2	S	d
H-B 6 AG-LB	10003000		60	74,8	70	70	80	43			32			27,8	4		44	4,3

Einsätze / Inserts / Inserts: 1.4: H-BE 6 / 1.5: H-EE 10 / 1.9: H-DD 24 / 1.10: MC 6 / 1.11: TB H-BE 6
 Deckel / Cover / Couvercle: 6.1: H-B 6

H-B 10

Artikel part article	Art.Nr. part No. N° art.	PG	L	L1	L2	L3	L4	B	B1	B2	B3	B4	B5	H	H1	H2	S	d
H-B 10 AG-LB	10032900		73	91	88,5	83	93	43			32			27,8	4		50	4,3

Einsätze / Inserts / Inserts: 1.4: H-BE 10 / 1.5: H-EE 18 / 1.7: H-BVE 3 / 1.9: H-DD 42 / 1.10: MC 10 / 1.11: TB H-BE 10

H-B 16

Artikel part article	Art.Nr. part No. N° art.	PG	L	L1	L2	L3	L4	B	B1	B2	B3	B4	B5	H	H1	H2	S	d
H-B 16 AG-LB	10072900		93,3	111	109,5	103	113	43			32			27,8	4		50	4,3

Einsätze / Inserts / Inserts: 1.4: H-BE 16 / 1.5: H-EE 32 / 1.6: H-BS 6 / 1.7: H-BVE 6 / 1.8: H-D 40 / 1.9: H-DD 72 / 1.10: MC 16 / 1.11: TB H-BE 16

H-B 24

Artikel part article	Art.Nr. part No. N° art.	PG	L	L1	L2	L3	L4	B	B1	B2	B3	B4	B5	H	H1	H2	S	d
H-B 24 AG-LB	10102900		120	138	136,5	130	140	43			32			27,8	4		50	4,3

Einsätze / Inserts / Inserts: 1.4: H-BE 24 / 1.5: H-EE 46 / 1.7: H-BVE 10 / 1.8: H-D 64 / 1.9: H-DD 108 / 1.10: MC 24 / 1.11: TB H-BE 24

H-B 48

Artikel part article	Art.Nr. part No. N° art.	PG	L	L1	L2	L3	L4	B	B1	B2	B3	B4	B5	H	H1	H2	S	d
H-B 48 AG-LB	10161000		132	152	139,5	148	165	90			70			39,5	10		105	7

Einsätze / Inserts / Inserts: 1.4: H-BE 48 / 1.5: H-EE 92 / 1.7: 2 x H-BVE 10 / 1.8: H-D 128 / 1.9: H-DD 216 / 1.10: 2 x MC 24 / 1.11: 2 x TB H-BE 24 & 2 x TB H-D 64

3.2 EPIC® D A - V I N C I H - B

Anbaugehäuse / Panel mount base / Embase encastrée

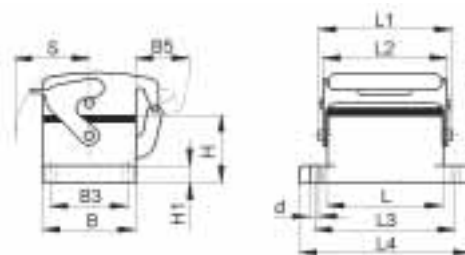

EPIC® H-B Gehäuse: Anbaugehäuse (Schutzdeckel, Längsbügel)

EPIC® H-B housings: panel mount base (cover, single locking lever)

Boîtiers EPIC® H-B: embase encastrée (couvercle, simple levier)

H-B 6

Artikel part article	Art.Nr. part No. N° art.	PG	L	L1	L2	L3	L4	B	B1	B2	B3	B4	B5	H	H1	H2	S	d
H-B 6 AD-LB	10004000		60	74,8	70	70	80	43			32		25	27,8	4		44	4,3

Einsätze / Inserts / Inserts: 1.4: H-BE 6 / 1.5: H-EE 10 / 1.9: H-DD 24 / 1.10: MC 6 / 1.11: TB H-BE 6

H-B 10

Artikel part article	Art.Nr. part No. N° art.	PG	L	L1	L2	L3	L4	B	B1	B2	B3	B4	B5	H	H1	H2	S	d
H-B 10 AD-LB	10033900		73	91	88,5	83	93	43			32		25	27,8	4		50	4,3

Einsätze / Inserts / Inserts: 1.4: H-BE 10 / 1.5: H-EE 18 / 1.7: H-BVE 3 / 1.9: H-DD 42 / 1.10: MC 10 / 1.11: TB H-BE 10

H-B 16

Artikel part article	Art.Nr. part No. N° art.	PG	L	L1	L2	L3	L4	B	B1	B2	B3	B4	B5	H	H1	H2	S	d
H-B 16 AD-LB	10073900		93,3	111	109,5	103	113	43			32		25	27,8	4		50	4,3

Einsätze / Inserts / Inserts: 1.4: H-BE 16 / 1.5: H-EE 32 / 1.6: H-BS 6 / 1.7: H-BVE 6 / 1.8: H-D 40 / 1.9: H-DD 72 / 1.10: MC 16 / 1.11: TB H-BE 16

H-B 24

Artikel part article	Art.Nr. part No. N° art.	PG	L	L1	L2	L3	L4	B	B1	B2	B3	B4	B5	H	H1	H2	S	d
H-B 24 AD-LB	10103900		120	138	136,5	130	140	43			32		25	27,8	4		50	4,3

Einsätze / Inserts / Inserts: 1.4: H-BE 24 / 1.5: H-EE 46 / 1.7: H-BVE 10 / 1.8: H-D 64 / 1.9: H-DD 108 / 1.10: MC 24 / 1.11: TB H-BE 24

H-B 48

Artikel part article	Art.Nr. part No. N° art.	PG	L	L1	L2	L3	L4	B	B1	B2	B3	B4	B5	H	H1	H2	S	d
H-B 48 AD-LB	10152000		132	152	139,5	148	165	90			70		30	39,5	10		105	7

Einsätze / Inserts / Inserts: 1.4: H-BE 48 / 1.5: H-EE 92 / 1.7: 2 x H-BVE 10 / 1.8: H-D 128 / 1.9: H-DD 216 / 1.10: 2 x MC 24 / 1.11: 2 x TB H-BE 24 & 2 x TB H-D 64

3.2 EPIC® D A - V I N C I H - B

Anbaugehäuse / Panel mount base / Embase encastrée

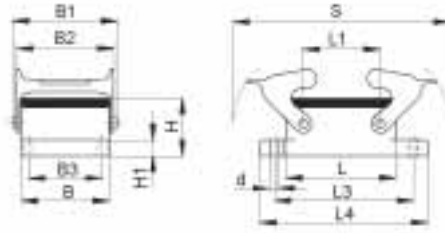

EPIC® H-B Gehäuse: Anbaugehäuse (Querbügel)
EPIC® H-B housings: panel mount base (double locking lever)
Boîtiers EPIC® H-B: embase encastrée (double levier)

H-B 10

Artikel part article	Art.Nr. part No. N° art.	PG	L	L1	L2	L3	L4	B	B1	B2	B3	B4	B5	H	H1	H2	S	d
H-B 10 AG	10032000		73	27		83	93	43	57,8	53	32			27,8	4		116	4,3

Einsätze / Inserts / Inserts: 1.4: H-BE 10 / 1.5: H-EE 18 / 1.7: H-BVE 3 / 1.9: H-DD 42 / 1.10: MC 10 / 1.11: TB H-BE 10
 Deckel / Cover / Couvercle: 6.1: H-B 10

H-B 16

Artikel part article	Art.Nr. part No. N° art.	PG	L	L1	L2	L3	L4	B	B1	B2	B3	B4	B5	H	H1	H2	S	d
H-B 16 AG	10072000		93,3	47,5		103	113	43	57,8	53	32			27,8	4		136,5	4,3

Einsätze / Inserts / Inserts: 1.4: H-BE 16 / 1.5: H-EE 32 / 1.6: H-BS 6 / 1.7: H-BVE 6 / 1.8: H-D 40 / 1.9: H-DD 72 / 1.10: MC 16 /
 1.11: TB H-BE 16
 Deckel / Cover / Couvercle: 6.1: H-B 16

H-B 24

Artikel part article	Art.Nr. part No. N° art.	PG	L	L1	L2	L3	L4	B	B1	B2	B3	B4	B5	H	H1	H2	S	d
H-B 24 AG	10102000		120	74		130	140	43	57,8	53	32			27,8	4		163	4,3

Einsätze / Inserts / Inserts: 1.4: H-BE 24 / 1.5: H-EE 46 / 1.7: H-BVE 10 / 1.8: H-D 64 / 1.9: H-DD 108 / 1.10: MC 24 /
 1.11: TB H-BE 24
 Deckel / Cover / Couvercle: 6.1: H-B 24

H-B 32

Artikel part article	Art.Nr. part No. N° art.	Art.Nr.: EP part No.: EP N° art.: EP	PG	L	L1	L2	L3	L4	B	B1	B2	B3	B4	B5	H	H1	H2	S	d
H-B 32 AG	10132000			93,5	64,5		110	124	79	93,8	87,8	65			30,3	5		136,5	5,5

Einsätze / Inserts / Inserts: 1.4: H-BE 32 / 1.5: H-EE 64 / 1.6: H-BS 12 / 1.8: H-D 80 / 1.9: H-DD 144 / 1.10: 2 x MC 24 /
 1.11: 2 x TB H-BE 16 & 2 x TB H-D 40

3.2 EPIC® D A - V I N C I H - B

Anbaugehäuse / Panel mount base / Embase encastrée

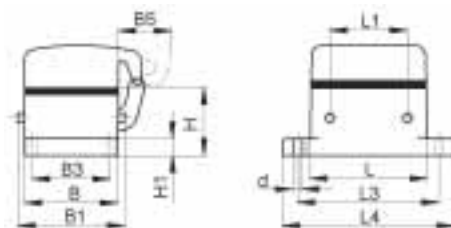

EPIC® H-B Gehäuse: Anbaugehäuse (Schutzdeckel, Bolzen für Querbügel)

EPIC® H-B housings: panel mount base (cover, bolts for double locking lever)

Boîtiers EPIC® H-B: embase encastrée (couvercle, ergots pour double levier)

H-B 10

Artikel part article	Art.Nr. part No. N° art.	PG	L	L1	L2	L3	L4	B	B1	B2	B3	B4	B5	H	H1	H2	S	d
H-B 10 AD-BO	10033000		73	27		83	93	43	57,8		32		25	27,8	4			4,3

Einsätze / Inserts / Inserts: 1.4: H-BE 10 / 1.5: H-EE 18 / 1.7: H-BVE 3 / 1.9: H-DD 42 / 1.10: MC 10 / 1.11: TB H-BE 10

H-B 16

Artikel part article	Art.Nr. part No. N° art.	PG	L	L1	L2	L3	L4	B	B1	B2	B3	B4	B5	H	H1	H2	S	d
H-B 16 AD-BO	10073000		93,3	47,5		103	113	43	57,8		32		25	27,8	4			4,3

Einsätze / Inserts / Inserts: 1.4: H-BE 16 / 1.5: H-EE 32 / 1.6: H-BS 6 / 1.7: H-BVE 6 / 1.8: H-D 40 / 1.9: H-DD 72 / 1.10: MC 16 / 1.11: TB H-BE 16

H-B 24

Artikel part article	Art.Nr. part No. N° art.	PG	L	L1	L2	L3	L4	B	B1	B2	B3	B4	B5	H	H1	H2	S	d
H-B 24 AD-BO	10103000		120	74		130	140	43	57,8		32		25	27,8	4			4,3

Einsätze / Inserts / Inserts: 1.4: H-BE 24 / 1.5: H-EE 46 / 1.7: H-BVE 10 / 1.8: H-D 64 / 1.9: H-DD 108 / 1.10: MC 24 / 1.11: TB H-BE 24

3

3.2 EPIC® D A - V I N C I H - B

Sockelgehäuse / Surface mount base / Embase en saillie



PG / M

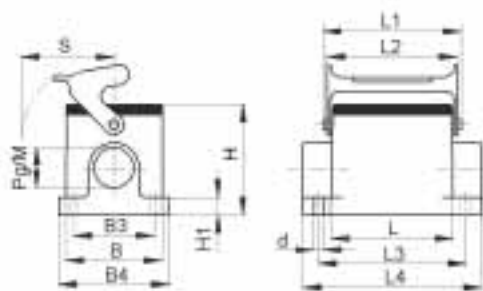

EPIC® H-B Gehäuse: Sockelgehäuse (2 Kabeleingänge, Längsbügel)
EPIC® H-B housings: surface mount base (2 cable entries, single locking lever)
Boîtiers EPIC® H-B: embase en saillie (2 entrées de câble, simple levier)

H-B 6

Artikel part article	Art.Nr. part No. N° art.	PG	M	L	L1	L2	L3	L4	B	B1	B2	B3	B4	B5	H	H1	H2	S	d
H-B 6 SGRL 16	10006000	16		60	74,8	70	70	84	43			40	52		57	4,5		44	5,5
H-B 6 SGRL M20	19006000		20	60	74,8	70	70	84	43			40	52		57	4,5		44	5,5
H-B 6 SGRL M25	79006600		25																

Einsätze / Inserts / Inserts: 1.4: H-BE 6 / 1.5: H-EE 10 / 1.9: H-DD 24 / 1.10: MC 6

Deckel / Cover / Couvercle: 6.1: H-B 6

Kabelverschraubung / Cable gland / Presse-étoupe: 5.1: Metr. & PG

H-B 10

Artikel part article	Art.Nr. part No. N° art.	PG	M	L	L1	L2	L3	L4	B	B1	B2	B3	B4	B5	H	H1	H2	S	d
H-B 10 SGRL-LB 16	10035900	16		73	91	88,5	82	94	43			40	52		57	4,5		50	5,5
H-B 10 SGRL-LB M20	19035900		20	73	91	88,5	82	94	43			40	52		57	4,5		50	5,5
H-B 10 SGRL-LB M25	79061600		25																

Einsätze / Inserts / Inserts: 1.4: H-BE 10 / 1.5: H-EE 18 / 1.7: H-BVE 3 / 1.9: H-DD 42 / 1.10: MC 10

Kabelverschraubung / Cable gland / Presse-étoupe: 5.1: Metr. & PG

H-B 16

Artikel part article	Art.Nr. part No. N° art.	PG	M	L	L1	L2	L3	L4	B	B1	B2	B3	B4	B5	H	H1	H2	S	d
H-B 16 SGRL-LB 21	10075900	21		93	111	109,5	105	117	43			45	57		64	4,5		50	5,5
H-B 16 SGRL-LB M25	19075900		25	93	111	109,5	105	117	43			45	57		64	4,5		50	5,5

Einsätze / Inserts / Inserts: 1.4: H-BE 16 / 1.5: H-EE 32 / 1.6: H-BS 6 / 1.7: H-BVE 6 / 1.8: H-D 40 / 1.9: H-DD 72 / 1.10: MC 16

Kabelverschraubung / Cable gland / Presse-étoupe: 5.1: Metr. & PG

3.2 EPIC® D A - V I N C I H - B

Sockelgehäuse / Surface mount base / Embase en saillie



PG / M

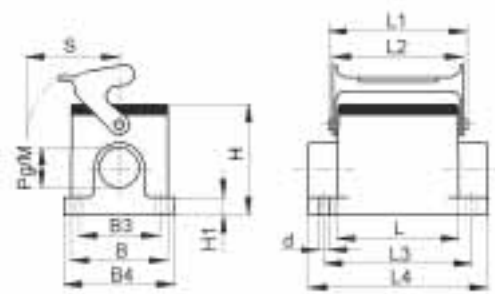

EPIC® H-B Gehäuse: Sockelgehäuse (2 Kabeleingänge, Längsbügel)

EPIC® H-B housings: surface mount base (2 cable entries, single locking lever)

Boîtiers EPIC® H-B: embase en saillie (2 entrées de câble, simple levier)

H-B 24

Artikel part article	Art.Nr. part No. N° art.	PG	M	L	L1	L2	L3	L4	B	B1	B2	B3	B4	B5	H	H1	H2	S	d
H-B 24 SGRL-LB 21	10105900		21	120	138	136,5	132	144	43			45	57		64	4,5		50	5,5
H-B 24 SGRL-LB M25	19105900		25	120	138	136,5	132	144	43			45	57		64	4,5		50	5,5

Einsätze / Inserts / Inserts: 1.4: H-BE 24 / 1.5: H-EE 46 / 1.7: H-BVE 10 / 1.8: H-D 64 / 1.9: H-DD 108 / 1.10: MC 24
Kabelverschraubung / Cable gland / Presse-étoupe: 5.1: Metr. & PG

H-B 48

Artikel part article	Art.Nr. part No. N° art.	PG	M	L	L1	L2	L3	L4	B	B1	B2	B3	B4	B5	H	H1	H2	S	d
H-B 48 SGRL 29	10166000		29		132	152	139,5	111	132	90		106	120		100	12		105	6,5
H-B 48 SGRL 36	10166100		36		132	152	139,5	111	132	90		106	120		100	12		105	6,5
H-B 48 SGRL M32	19166000		32		132	152	139,5	111	132	90		106	120		100	12		105	6,5
H-B 48 SGRL M40	19166100		40		132	152	139,5	111	132	90		106	120		100	12		105	6,5

Einsätze / Inserts / Inserts: 1.4: H-BE 48 / 1.5: H-EE 92 / 1.7: 2 x H-BVE 10 / 1.8: H-D 128 / 1.9: H-DD 216 / 1.10: 2 x MC 24
Kabelverschraubung / Cable gland / Presse-étoupe: 5.1: Metr. & PG

3.2 EPIC® D A - V I N C I H - B

Sockelgehäuse / Surface mount base / Embase en saillie



PG / M

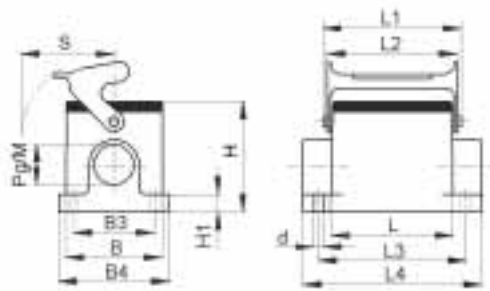

EPIC® H-B Gehäuse: Sockelgehäuse (2 Kabeleingänge, Längsbügel, hohe Bauform)

EPIC® H-B housings: surface mount base (2 cable entries, single locking lever, high version)

Boîtiers EPIC® H-B: embase en saillie (2 entrées de câble, simple levier, version haute)

H-B 6

Artikel part article	Art.Nr. part No. N° art.	PG	M	L	L1	L2	L3	L4	B	B1	B2	B3	B4	B5	H	H1	H2	S	d
H-B 6 SGR LH 21	70006200	21		60	74,8	70	70	84	43			45	58		74	6		44	5,5
H-B 6 SGR LH 29	70006400	29																	
H-B 6 SGR LH M25	79006200		25	60	74,8	70	70	84	43			45	58		74	6		44	5,5
H-B 6 SGR LH M32	79006400		32																

Einsätze / Inserts / Inserts: 1.4: H-BE 6 / 1.5: H-EE 10 / 1.9: H-DD 24 / 1.10: MC 6

Deckel / Cover / Couvercle: 6.1: H-B 6

Kabelverschraubung / Cable gland / Presse-étoupe: 5.1: Metr. & PG

H-B 10

Artikel part article	Art.Nr. part No. N° art.	PG	M	L	L1	L2	L3	L4	B	B1	B2	B3	B4	B5	H	H1	H2	S	d
H-B 10 SGR LH-LB 21	70061200	21		73	91	88,5	82	97	43			45	58		74	6		50	5,5
H-B 10 SGR LH-LB 29	70061400	29																	
H-B 10 SGR LH-LB M25	79061200		25	73	91	88,5	82	97	43			45	58		74	6		50	5,5
H-B 10 SGR LH-LB M32	79061400		32																

Einsätze / Inserts / Inserts: 1.4: H-BE 10 / 1.5: H-EE 18 / 1.7: H-BVE 3 / 1.9: H-DD 42 / 1.10: MC 10

Kabelverschraubung / Cable gland / Presse-étoupe: 5.1: Metr. & PG

3.2 EPIC® D A - V I N C I H - B

Sockelgehäuse / Surface mount base / Embase en saillie



PG / M

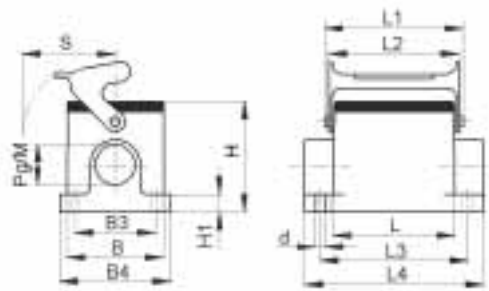

EPIC® H-B Gehäuse: Sockelgehäuse (2 Kabeleingänge, Längsbügel, hohe Bauform)

EPIC® H-B housings: surface mount base (2 cable entries, single locking lever, high version)

Boîtiers EPIC® H-B: embase en saillie (2 entrées de câble, simple levier, version haute)

H-B 16

Artikel part article	Art.Nr. part No. N° art.	PG	M	L	L1	L2	L3	L4	B	B1	B2	B3	B4	B5	H	H1	H2	S	d
H-B 16 SGRLH-LB 21	70111200	21		93,3	111	109,5	105	117	43			45	58		84	6		50	5,5
H-B 16 SGRLH-LB 29	70111400	29																	
H-B 16 SGRLH-LB M25	79111200		25	93,3	111	109,5	105	117	43			45	58		84	6		50	5,5
H-B 16 SGRLH-LB M32	79111400		32																

Einsätze / Inserts / Inserts: 1.4: H-BE 16 / 1.5: H-EE 32 / 1.6: H-BS 6 / 1.7: H-BVE 6 / 1.8: H-D 40 / 1.9: H-DD 72 / 1.10: MC 16
Kabelverschraubung / Cable gland / Presse-étoupe: 5.1: Metr. & PG

H-B 24

Artikel part article	Art.Nr. part No. N° art.	PG	M	L	L1	L2	L3	L4	B	B1	B2	B3	B4	B5	H	H1	H2	S	d
H-B 24 SGRLH-LB 21	70161200	21		120	138	136,5	132	144	43			45	58		84	6		50	5,5
H-B 24 SGRLH-LB 29	70161400	29																	
H-B 24 SGRLH-LB M25	79161200		25	120	138	136,5	132	144	43			45	58		84	6		50	5,5
H-B 24 SGRLH-LB M32	79161400		32																

Einsätze / Inserts / Inserts: 1.4: H-BE 24 / 1.5: H-EE 46 / 1.7: H-BVE 10 / 1.8: H-D 64 / 1.9: H-DD 108 / 1.10: MC 24
Kabelverschraubung / Cable gland / Presse-étoupe: 5.1: Metr. & PG

3.2 EPIC® D A - V I N C I H - B

Sockelgehäuse / Surface mount base / Embase en saillie



PG / M

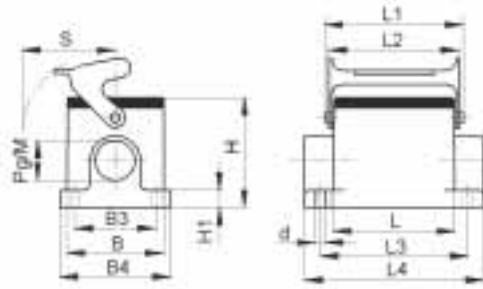

EPIC® H-B Gehäuse: Sockelgehäuse (1 Kabeleingang, Längsbügel)
EPIC® H-B housings: surface mount base (1 cable entry, single locking lever)
Boîtiers EPIC® H-B: embase en saillie (1 entrée de câble, simple levier)

H-B 6

Artikel part article	Art.Nr. part No. N° art.	PG	M	L	L1	L2	L3	L4	B	B1	B2	B3	B4	B5	H	H1	H2	S	d
H-B 6 SGR 16	10005000	16		60	74,8	70	70	84	43			40	52		57	4,5		44	5,5
H-B 6 SGR M20	19005000		20	60	74,8	70	70	84	43			40	52		57	4,5		44	5,5
H-B 6 SGR M25	79005600		25																

Einsätze / Inserts / Inserts: 1.4: H-BE 6 / 1.5: H-EE 10 / 1.9: H-DD 24 / 1.10: MC 6

Deckel / Cover / Couvercle: 6.1: H-B 6

Kabelverschraubung / Cable gland / Presse-étoupe: 5.1: Metr. & PG

H-B 10

Artikel part article	Art.Nr. part No. N° art.	PG	M	L	L1	L2	L3	L4	B	B1	B2	B3	B4	B5	H	H1	H2	S	d
H-B 10 SGR-LB 16	10034900	16		73	91	88,5	82	94	43			40	52		57	4,5		50	5,5
H-B 10 SGR-LB 21	10034700	21		73	91	88,5	82	94	43			40	52		57	4,5		50	5,5
H-B 10 SGR-LB M20	19034900		20	73	91	88,5	82	94	43			40	52		57	4,5		50	5,5
H-B 10 SGR-LB M25	19034700		25																

Einsätze / Inserts / Inserts: 1.4: H-BE 10 / 1.5: H-EE 18 / 1.7: H-BVE 3 / 1.9: H-DD 42 / 1.10: MC 10

Kabelverschraubung / Cable gland / Presse-étoupe: 5.1: Metr. & PG

H-B 16

Artikel part article	Art.Nr. part No. N° art.	PG	M	L	L1	L2	L3	L4	B	B1	B2	B3	B4	B5	H	H1	H2	S	d
H-B 16 SGR-LB 21	10074900	21		93	111	109,5	105	117	43			45	57		64	4,5		50	5,5
H-B 16 SGR-LB M25	19074900		25	93	111	109,5	105	117	43			45	57		64	4,5		50	5,5

Einsätze / Inserts / Inserts: 1.4: H-BE 16 / 1.5: H-EE 32 / 1.6: H-BS 6 / 1.7: H-BVE 6 / 1.8: H-D 40 / 1.9: H-DD 72 / 1.10: MC 16

Kabelverschraubung / Cable gland / Presse-étoupe: 5.1: Metr. & PG

3.2 EPIC® D A - V I N C I H - B

Sockelgehäuse / Surface mount base / Embase en saillie



PG / M

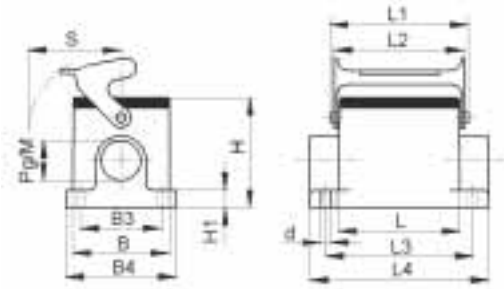

EPIC® H-B Gehäuse: Sockelgehäuse (1 Kabeleingang, Längsbügel)

EPIC® H-B housings: surface mount base (1 cable entry, single locking lever)

Boîtiers EPIC® H-B: embase en saillie (1 entrée de câble, simple levier)

H-B 24

Artikel part article	Art.Nr. part No. N° art.	PG	M	L	L1	L2	L3	L4	B	B1	B2	B3	B4	B5	H	H1	H2	S	d
H-B 24 SGR-LB 21	10104900		21	120	138	136,5	132	144	43			45	57		64	4,5		50	5,5
H-B 24 SGR-LB M25	19104900		25	120	138	136,5	132	144	43			45	57		64	4,5		50	5,5

Einsätze / Inserts / Inserts: 1.4: H-BE 24 / 1.5: H-EE 46 / 1.7: H-BVE 10 / 1.8: H-D 64 / 1.9: H-DD 108 / 1.10: MC 24
Kabelverschraubung / Cable gland / Presse-étoupe: 5.1: Metr. & PG

H-B 48

Artikel part article	Art.Nr. part No. N° art.	PG	M	L	L1	L2	L3	L4	B	B1	B2	B3	B4	B5	H	H1	H2	S	d
H-B 48 SGR 29	10165000		29		132	152	139,5	111	132	90		106	120		100	12		105	6,5
H-B 48 SGR 36	10165100		36		132	152	139,5	111	132	90		106	120		100	12		105	6,5
H-B 48 SGR M32	19165000		32		132	152	139,5	111	132	90		106	120		100	12		105	6,5
H-B 48 SGR M40	19165100		40		132	152	139,5	111	132	90		106	120		100	12		105	6,5

Einsätze / Inserts / Inserts: 1.4: H-BE 48 / 1.5: H-EE 92 / 1.7: 2 x H-BVE 10 / 1.8: H-D 128 / 1.9: H-DD 216 / 1.10: 2 x MC 24
Kabelverschraubung / Cable gland / Presse-étoupe: 5.1: Metr. & PG

3.2 EPIC® D A - V I N C I H - B

Sockelgehäuse / Surface mount base / Embase en saillie



PG / M

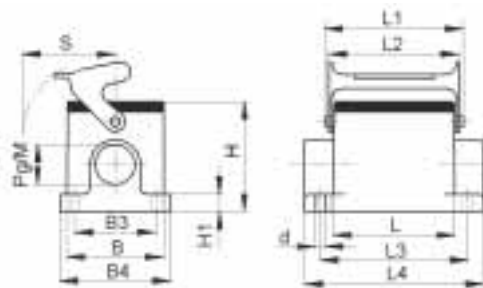

EPIC® H-B Gehäuse: Sockelgehäuse (1 Kabeleingang, Längsbügel, hohe Bauform)

EPIC® H-B housings: surface mount base (1 cable entry, single locking lever, high version)

Boîtiers EPIC® H-B: embase en saillie (1 entrée de câble, simple levier, version haute)

H-B 6

Artikel part article	Art.Nr. part No. N° art.	PG	M	L	L1	L2	L3	L4	B	B1	B2	B3	B4	B5	H	H1	H2	S	d
H-B 6 SGRH-LB 21	70005200	21		60	74,8	70	70	84	43			45	58		74	6		44	5,5
H-B 6 SGRH-LB 29	70005400	29																	
H-B 6 SGRH-LB M25	79005200		25	60	74,8	70	70	84	43			45	58		74	6		44	5,5
H-B 6 SGRH-LB M32	79005400		32																

Einsätze / Inserts / Inserts: 1.4: H-BE 6 / 1.5: H-EE 10 / 1.9: H-DD 24 / 1.10: MC 6

Deckel / Cover / Couvercle: 6.1: H-B 6

Kabelverschraubung / Cable gland / Presse-étoupe: 5.1: Metr. & PG

H-B 10

Artikel part article	Art.Nr. part No. N° art.	PG	M	L	L1	L2	L3	L4	B	B1	B2	B3	B4	B5	H	H1	H2	S	d
H-B 10 SGRH-LB 21	70060200	21		73	91	88,5	82	97	43			45	58		74	6		50	5,5
H-B 10 SGRH-LB 29	70060400	29																	
H-B 10 SGRH-LB M25	79060200		25	73	91	88,5	82	97	43			45	58		74	6		50	5,5
H-B 10 SGRH-LB M32	79060400		32																

Einsätze / Inserts / Inserts: 1.4: H-BE 10 / 1.5: H-EE 18 / 1.7: H-BVE 3 / 1.9: H-DD 42 / 1.10: MC 10

Kabelverschraubung / Cable gland / Presse-étoupe: 5.1: Metr. & PG

3.2 EPIC® D A - V I N C I H - B

Sockelgehäuse / Surface mount base / Embase en saillie



PG / M

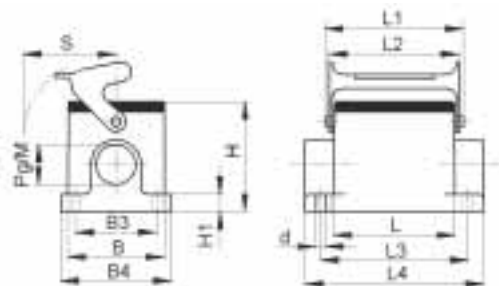

EPIC® H-B Gehäuse: Sockelgehäuse (1 Kabeleingang, Längsbügel, hohe Bauform)

EPIC® H-B housings: surface mount base (1 cable entry, single locking lever, high version)

Boîtiers EPIC® H-B: embase en saillie (1 entrée de câble, simple levier, version haute)

H-B 16

Artikel part article	Art.Nr. part No. N° art.	PG	M	L	L1	L2	L3	L4	B	B1	B2	B3	B4	B5	H	H1	H2	S	d
H-B 16 SGRH-LB 21	70110200	21		93,3	111	109,5	105	117	43			45	58		84	6		50	5,5
H-B 16 SGRH-LB 29	70110400	29																	
H-B 16 SGRH-LB M25	79110200		25	93,3	111	109,5	105	117	43			45	58		84	6		50	5,5
H-B 16 SGRH-LB M32	79110400		32																

Einsätze / Inserts / Inserts: 1.4: H-BE 16 / 1.5: H-EE 32 / 1.6: H-BS 6 / 1.7: H-BVE 6 / 1.8: H-D 40 / 1.9: H-DD 72 / 1.10: MC 16
Kabelverschraubung / Cable gland / Presse-étoupe: 5.1: Metr. & PG

H-B 24

Artikel part article	Art.Nr. part No. N° art.	PG	M	L	L1	L2	L3	L4	B	B1	B2	B3	B4	B5	H	H1	H2	S	d
H-B 24 SGRH-LB 21	70160200	21		120	138	136,5	132	144	43			45	58		84	6		50	5,5
H-B 24 SGRH-LB 29	70160400	29																	
H-B 24 SGRH-LB M25	79160200		25	120	138	136,5	132	144	43			45	58		84	6		50	5,5
H-B 24 SGRH-LB M32	79160400		32																

Einsätze / Inserts / Inserts: 1.4: H-BE 24 / 1.5: H-EE 46 / 1.7: H-BVE 10 / 1.8: H-D 64 / 1.9: H-DD 108 / 1.10: MC 24
Kabelverschraubung / Cable gland / Presse-étoupe: 5.1: Metr. & PG

3.2 EPIC® D A - V I N C I H - B

Sockelgehäuse / Surface mount base / Embase en saillie



PG / M

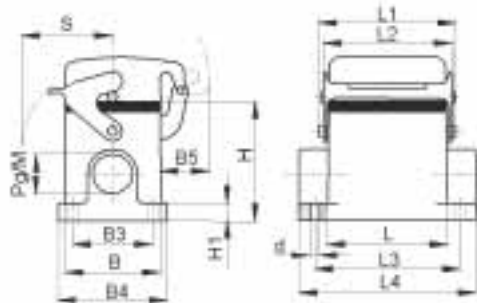

EPIC® H-B Gehäuse: Sockelgehäuse (Schutzdeckel, 2 Kabeleingänge, Längsbügel)

EPIC® H-B housings: surface mount base (cover, 2 cable entries, single locking lever)

Boîtiers EPIC® H-B: embase en saillie (couvercle, 2 entrées de câble, simple levier)

H-B 6

Artikel part article	Art.Nr. part No. N° art.	PG	M	L	L1	L2	L3	L4	B	B1	B2	B3	B4	B5	H	H1	H2	S	d
H-B 6 SDRL-LB 16	10009000	16		60	74,8	70	70	84	43			40	52	25	57	4,5		44	5,5
H-B 6 SDRL-LB M20	19009000		20	60	74,8	70	70	84	43			40	52	25	57	4,5		44	5,5
H-B 6 SDRL-LB M25	79016600		25																

Einsätze / Inserts / Inserts: 1.4: H-BE 6 / 1.5: H-EE 10 / 1.9: H-DD 24 / 1.10: MC 6
Kabelverschraubung / Cable gland / Presse-étoupe: 5.1: Metr. & PG

H-B 10

Artikel part article	Art.Nr. part No. N° art.	PG	M	L	L1	L2	L3	L4	B	B1	B2	B3	B4	B5	H	H1	H2	S	d
H-B 10 SDRL-LB 16	10038900	16		73	91	88,5	82	94	43			40	52	25	57	4,5		50	5,5
H-B 10 SDRL-LB M20	19038900		20	73	91	88,5	82	94	43			40	52	25	57	4,5		50	5,5
H-B 10 SDRL-LB M25	79065600		25	73	91	88,5	82	94	43			40	52	25	57	4,5		50	5,5

Einsätze / Inserts / Inserts: 1.4: H-BE 10 / 1.5: H-EE 18 / 1.7: H-BVE 3 / 1.9: H-DD 42 / 1.10: MC 10
Kabelverschraubung / Cable gland / Presse-étoupe: 5.1: Metr. & PG

H-B 16

Artikel part article	Art.Nr. part No. N° art.	PG	M	L	L1	L2	L3	L4	B	B1	B2	B3	B4	B5	H	H1	H2	S	d
H-B 16 SDRL-LB 21	10078900	21		93	111	109,5	105	117	43			45	57	25	64	4,5		50	5,5
H-B 16 SDRL-LB M25	19078900		25	93	111	109,5	105	117	43			45	57	25	64	4,5		50	5,5

Einsätze / Inserts / Inserts: 1.4: H-BE 16 / 1.5: H-EE 32 / 1.6: H-BS 6 / 1.7: H-BVE 6 / 1.8: H-D 40 / 1.9: H-DD 72 / 1.10: MC 16
Kabelverschraubung / Cable gland / Presse-étoupe: 5.1: Metr. & PG

3.2 EPIC® D A - V I N C I H - B

Sockelgehäuse / Surface mount base / Embase en saillie



PG / M

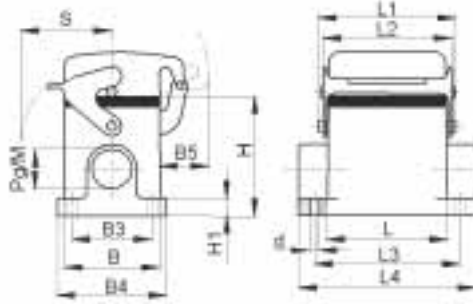

EPIC® H-B Gehäuse: Sockelgehäuse (Schutzdeckel, 2 Kabeleingänge, Längsbügel)

EPIC® H-B housings: surface mount base (cover, 2 cable entries, single locking lever)

Boîtiers EPIC® H-B: embase en saillie (couverture, 2 entrées de câble, simple levier)

H-B 24

Artikel part article	Art.Nr. part No. N° art.	PG	M	L	L1	L2	L3	L4	B	B1	B2	B3	B4	B5	H	H1	H2	S	d
H-B 24 SDRL-LB 21	10109900		21	120	138	136,5	132	144	43			45	57	25	64	4,5		50	5,5
H-B 24 SDRL-LB M25	19109900		25	120	138	136,5	132	144	43			45	57	25	64	4,5		50	5,5

Einsätze / Inserts / Inserts: 1.4: H-BE 24 / 1.5: H-EE 46 / 1.7: H-BVE 10 / 1.8: H-D 64 / 1.9: H-DD 108 / 1.10: MC 24

Kabelverschraubung / Cable gland / Presse-étoupe: 5.1: Metr. & PG

H-B 48

Artikel part article	Art.Nr. part No. N° art.	PG	M	L	L1	L2	L3	L4	B	B1	B2	B3	B4	B5	H	H1	H2	S	d
H-B 48 SDRL 29	10168000		29		132	152	139,5	111	132	90		106	120	30	100	12		105	6,5
H-B 48 SDRL 36	10168100		36		132	152	139,5	111	132	90		106	120	30	100	12		105	6,5
H-B 48 SDRL M32	19168000		32		132	152	139,5	111	132	90		106	120	30	100	12		105	6,5
H-B 48 SDRL M40	19168100		40		132	152	139,5	111	132	90		106	120	30	100	12		105	6,5

Einsätze / Inserts / Inserts: 1.4: H-BE 48 / 1.5: H-EE 92 / 1.7: 2 x H-BVE 10 / 1.8: H-D 128 / 1.9: H-DD 216 / 1.10: 2 x MC 24

Kabelverschraubung / Cable gland / Presse-étoupe: 5.1: Metr. & PG

3.2 EPIC® D A - V I N C I H - B

Sockelgehäuse / Surface mount base / Embase en saillie



PG / M

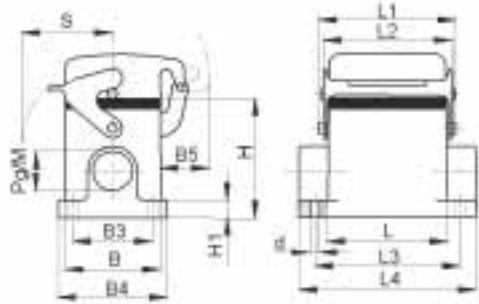

EPIC® H-B Gehäuse: Sockelgehäuse (Schutzdeckel, 2 Kabeleingänge, Längsbügel, hohe Bauform)

EPIC® H-B housings: surface mount base (cover, 2 cable entries, single locking lever, high version)

Boîtiers EPIC® H-B: embase en saillie (couvercle, 2 entrées de câble, simple levier, version haute)

H-B 6

Artikel part article	Art.Nr. part No. N° art.	PG	M	L	L1	L2	L3	L4	B	B1	B2	B3	B4	B5	H	H1	H2	S	d
H-B 6 SDRHL-LB 21	70016200	21		60	74,8	70	70	84	43			45	58	25	74	6		44	5,5
H-B 6 SDRHL-LB 29	70016400	29																	
H-B 6 SDRHL-LB M25	79016200		25	60	74,8	70	70	84	43			45	58	25	74	6		44	5,5
H-B 6 SDRHL-LB M32	79016400		32																

Einsätze / Inserts / Inserts: 1.4: H-BE 6 / 1.5: H-EE 10 / 1.9: H-DD 24 / 1.10: MC 6

Kabelverschraubung / Cable gland / Presse-étoupe: 5.1: Metr. & PG

H-B 10

Artikel part article	Art.Nr. part No. N° art.	PG	M	L	L1	L2	L3	L4	B	B1	B2	B3	B4	B5	H	H1	H2	S	d
H-B 10 SDRHL-LB 21	70065200	21		73	91	88,5	82	97	43			45	58	25	74	6		50	5,5
H-B 10 SDRHL-LB 29	70065400	29																	
H-B 10 SDRHL-LB M25	79065200		25	73	91	88,5	82	97	43			45	58	25	74	6		50	5,5
H-B 10 SDRHL-LB M32	79065400		32																

Einsätze / Inserts / Inserts: 1.4: H-BE 10 / 1.5: H-EE 18 / 1.7: H-BVE 3 / 1.9: H-DD 42 / 1.10: MC 10

Kabelverschraubung / Cable gland / Presse-étoupe: 5.1: Metr. & PG

3.2 EPIC® D A - V I N C I H - B

Sockelgehäuse / Surface mount base / Embase en saillie



PG / M

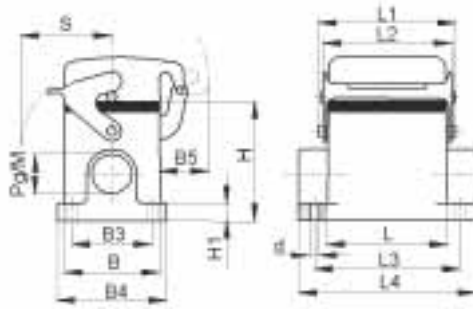

EPIC® H-B Gehäuse: Sockelgehäuse (Schutzdeckel, 2 Kabeleingänge, Längsbügel, hohe Bauform)

EPIC® H-B housings: surface mount base (cover, 2 cable entries, single locking lever, high version)

Boîtiers EPIC® H-B: embase en saillie (couverture, 2 entrées de câble, simple levier, version haute)

H-B 16

Artikel part article	Art.Nr. part No. N° art.	PG	M	L	L1	L2	L3	L4	B	B1	B2	B3	B4	B5	H	H1	H2	S	d	
H-B 16 SDRLH-LB 21	70115200	21		93,3	111	109,5	105	117	43			45	58	25	84	6		50	5,5	
H-B 16 SDRLH-LB 29	70115400	29																		
H-B 16 SDRLH-LB M25	79115200		25	93,3	111	109,5	105	117	43			45	58	25	84	6		50	5,5	
H-B 16 SDRLH-LB M32	79115400		32																	

Einsätze / Inserts / Inserts: 1.4: H-BE 16 / 1.5: H-EE 32 / 1.6: H-BS 6 / 1.7: H-BVE 6 / 1.8: H-D 40 / 1.9: H-DD 72 / 1.10: MC 16
Kabelverschraubung / Cable gland / Presse-étoupe: 5.1: Metr. & PG

H-B 24

Artikel part article	Art.Nr. part No. N° art.	PG	M	L	L1	L2	L3	L4	B	B1	B2	B3	B4	B5	H	H1	H2	S	d	
H-B 24 SDRLH-LB 21	70165200	21		120	138	136,5	132	144	43			45	58	25	84	6		50	5,5	
H-B 24 SDRLH-LB 29	70165400	29																		
H-B 24 SDRLH-LB M25	79165200		25	120	138	136,5	132	144	43			45	58	25	84	6		50	5,5	
H-B 24 SDRLH-LB M32	79165400		32																	

Einsätze / Inserts / Inserts: 1.4: H-BE 24 / 1.5: H-EE 46 / 1.7: H-BVE 10 / 1.8: H-D 64 / 1.9: H-DD 108 / 1.10: MC 24
Kabelverschraubung / Cable gland / Presse-étoupe: 5.1: Metr. & PG

3.2 EPIC® D A - V I N C I H - B

Sockelgehäuse / Surface mount base / Embase en saillie



PG / M

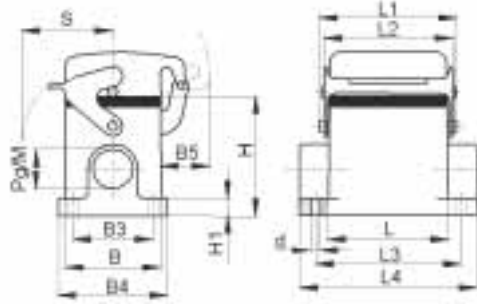

EPIC® H-B Gehäuse: Sockelgehäuse (Schutzdeckel, 1 Kabeleingang, Längsbügel)

EPIC® H-B housings: surface mount base (cover, 1 cable entry, single locking lever)

Boîtiers EPIC® H-B: embase en saillie (couvercle, 1 entrée de câble, simple levier)

H-B 6

Artikel part article	Art.Nr. part No. N° art.	PG	M	L	L1	L2	L3	L4	B	B1	B2	B3	B4	B5	H	H1	H2	S	d
H-B 6 SDR 16	10007000	16		60	74,8	70	70	84	43			40	52	25	57	4,5		44	5,5
H-B 6 SDR M20	19007000		20	60	74,8	70	70	84	43			40	52	25	57	4,5		44	5,5
H-B 6 SDR M25	79015600		25																

Einsätze / Inserts / Inserts: 1.4: H-BE 6 / 1.5: H-EE 10 / 1.9: H-DD 24 / 1.10: MC 6
Kabelverschraubung / Cable gland / Presse-étoupe: 5.1: Metr. & PG

H-B 10

Artikel part article	Art.Nr. part No. N° art.	PG	M	L	L1	L2	L3	L4	B	B1	B2	B3	B4	B5	H	H1	H2	S	d
H-B 10 SDR-LB 16	10036900	16		73	91	88,5	82	94	43			40	52	25	57	4,5		50	5,5
H-B 10 SDR-LB M20	19036900		20	73	91	88,5	82	94	43			40	52	25	57	4,5		50	5,5
H-B 10 SDR-LB M25	79064600		25																

Einsätze / Inserts / Inserts: 1.4: H-BE 10 / 1.5: H-EE 18 / 1.7: H-BVE 3 / 1.9: H-DD 42 / 1.10: MC 10
Kabelverschraubung / Cable gland / Presse-étoupe: 5.1: Metr. & PG

H-B 16

Artikel part article	Art.Nr. part No. N° art.	PG	M	L	L1	L2	L3	L4	B	B1	B2	B3	B4	B5	H	H1	H2	S	d
H-B 16 SDR-LB 21	10076900	21		93	111	109,5	105	117	43			45	57	25	64	4,5		50	5,5
H-B 16 SDR-LB M25	19076900		25	93	111	109,5	105	117	43			45	57	25	64	4,5		50	5,5

Einsätze / Inserts / Inserts: 1.4: H-BE 16 / 1.5: H-EE 32 / 1.6: H-BS 6 / 1.7: H-BVE 6 / 1.8: H-D 40 / 1.9: H-DD 72 / 1.10: MC 16
Kabelverschraubung / Cable gland / Presse-étoupe: 5.1: Metr. & PG

3.2 EPIC® D A - V I N C I H - B

Sockelgehäuse / Surface mount base / Embase en saillie



PG / M

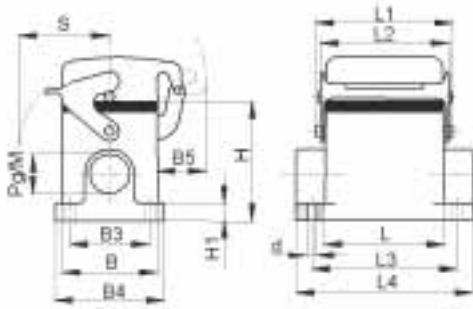

EPIC® H-B Gehäuse: Sockelgehäuse (Schutzdeckel, 1 Kabeleingang, Längsbügel)

EPIC® H-B housings: surface mount base (cover, 1 cable entry, single locking lever)

Boîtiers EPIC® H-B: embase en saillie (couverture, 1 entrée de câble, simple levier)

H-B 24

Artikel part article	Art.Nr. part No. N° art.	PG	M	L	L1	L2	L3	L4	B	B1	B2	B3	B4	B5	H	H1	H2	S	d
H-B 24 SDR-LB 21	10107900		21	120	138	136,5	132	144	43			45	57	25	64	4,5		50	5,5
H-B 24 SDR-LB M25	19107900		25	120	138	136,5	132	144	43			45	57	25	64	4,5		50	5,5

Einsätze / Inserts / Inserts: 1.4: H-BE 24 / 1.5: H-EE 46 / 1.7: H-BVE 10 / 1.8: H-D 64 / 1.9: H-DD 108 / 1.10: MC 24
Kabelverschraubung / Cable gland / Presse-étoupe: 5.1: Metr. & PG

H-B 48

Artikel part article	Art.Nr. part No. N° art.	PG	M	L	L1	L2	L3	L4	B	B1	B2	B3	B4	B5	H	H1	H2	S	d
H-B 48 SDR 29	10167000		29		132	152	139,5	111	132	90		106	120	30	100	12		105	6,5
H-B 48 SDR 36	10167100		36		132	152	139,5	111	132	90		106	120	30	100	12		105	6,5
H-B 48 SDR M32	19167000		32		132	152	139,5	111	132	90		106	120	30	100	12		105	6,5
H-B 48 SDR M 40	19167100		40		132	152	139,5	111	132	90		106	120	30	100	12		105	6,5

Einsätze / Inserts / Inserts: 1.4: H-BE 48 / 1.5: H-EE 92 / 1.7: 2 x H-BVE 10 / 1.8: H-D 128 / 1.9: H-DD 216 / 1.10: 2 x MC 24
Kabelverschraubung / Cable gland / Presse-étoupe: 5.1: Metr. & PG

3.2 EPIC® D A - V I N C I H - B

Sockelgehäuse / Surface mount base / Embase en saillie



PG / M

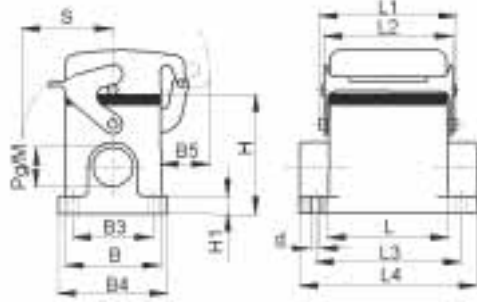

EPIC® H-B Gehäuse: Sockelgehäuse (Schutzdeckel, 1 Kabeleingang, Längsbügel, hohe Bauform)

EPIC® H-B housings: surface mount base (cover, 1 cable entry, single locking lever, high version)

Boîtiers EPIC® H-B: embase en saillie (couvercle, 1 entrée de câble, simple levier, version haute)

H-B 6

Artikel part article	Art.Nr. part No. N° art.	PG	M	L	L1	L2	L3	L4	B	B1	B2	B3	B4	B5	H	H1	H2	S	d
H-B 6 SDRH 21	70015200	21		60	74,8	70	70	84	43			45	58	25	74	6		44	5,5
H-B 6 SDRH 29	70015400	29																	
H-B 6 SDRH M25	79015200		25	60	74,8	70	70	84	43			45	58	25	74	6		44	5,5
H-B 6 SDRH M32	79015400		32																

Einsätze / Inserts / Inserts: 1.4: H-BE 6 / 1.5: H-EE 10 / 1.9: H-DD 24 / 1.10: MC 6

Kabelverschraubung / Cable gland / Presse-étoupe: 5.1: Metr. & PG

H-B 10

Artikel part article	Art.Nr. part No. N° art.	PG	M	L	L1	L2	L3	L4	B	B1	B2	B3	B4	B5	H	H1	H2	S	d
H-B 10 SDRH-LB 21	70064200	21		73	91	88,5	82	97	43			45	58	25	74	6		50	5,5
H-B 10 SDRH-LB 29	70064400	29																	
H-B 10 SDRH-LB M25	79064200		25	73	91	88,5	82	97	43			45	58	25	74	6		50	5,5
H-B 10 SDRH-LB M32	79064400		32																

Einsätze / Inserts / Inserts: 1.4: H-BE 10 / 1.5: H-EE 18 / 1.7: H-BVE 3 / 1.9: H-DD 42 / 1.10: MC 10

Kabelverschraubung / Cable gland / Presse-étoupe: 5.1: Metr. & PG

3.2 EPIC® D A - V I N C I H - B

Sockelgehäuse / Surface mount base / Embase en saillie



PG / M

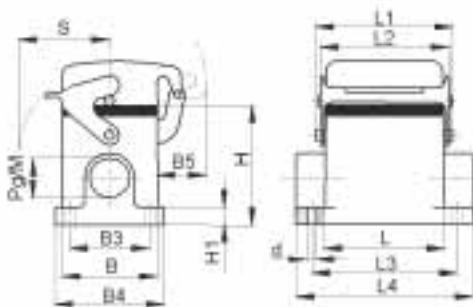

EPIC® H-B Gehäuse: Sockelgehäuse (Schutzdeckel, 1 Kabeleingang, Längsbügel, hohe Bauform)

EPIC® H-B housings: surface mount base (cover, 1 cable entry, single locking lever, high version)

Boîtiers EPIC® H-B: embase en saillie (couverture, 1 entrée de câble, simple levier, version haute)

H-B 16

Artikel part article	Art.Nr. part No. N° art.	PG	M	L	L1	L2	L3	L4	B	B1	B2	B3	B4	B5	H	H1	H2	S	d
H-B 16 SDRH-LB 21	70114200	21		93,3	111	109,5	105	117	43			45	58	25	84	6		50	5,5
H-B 16 SDRH-LB 29	70114400	29																	
H-B 16 SDRH-LB M25	79114200		25	93,3	111	109,5	105	117	43			45	58	25	84	6		50	5,5
H-B 16 SDRH-LB M32	79114400		32																

Einsätze / Inserts / Inserts: 1.4: H-BE 16 / 1.5: H-EE 32 / 1.6: H-BS 6 / 1.7: H-BVE 6 / 1.8: H-D 40 / 1.9: H-DD 72 / 1.10: MC 16
Kabelverschraubung / Cable gland / Presse-étoupe: 5.1: Metr. & PG

H-B 24

Artikel part article	Art.Nr. part No. N° art.	PG	M	L	L1	L2	L3	L4	B	B1	B2	B3	B4	B5	H	H1	H2	S	d
H-B 24 SDRH-LB 21	70164200	21		120	138	136,5	132	144	43			45	58	25	84	6		50	5,5
H-B 24 SDRH-LB 29	70164400	29																	
H-B 24 SDRH-LB M25	79164200		25	120	138	136,5	132	144	43			45	58	25	84	6		50	5,5
H-B 24 SDRH-LB M32	79164400		32																

Einsätze / Inserts / Inserts: 1.4: H-BE 24 / 1.5: H-EE 46 / 1.7: H-BVE 10 / 1.8: H-D 64 / 1.9: H-DD 108 / 1.10: MC 24
Kabelverschraubung / Cable gland / Presse-étoupe: 5.1: Metr. & PG

3.2 EPIC® D A - V I N C I H - B

Sockelgehäuse / Surface mount base / Embase en saillie

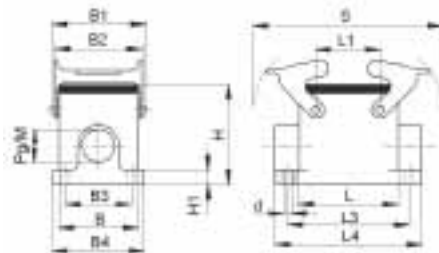

PG / M

EPIC® H-B Gehäuse: Sockelgehäuse (2 Kabeleingänge, Querbügel)
EPIC® H-B housings: surface mount base (2 cable entries, double locking lever)
Boîtiers EPIC® H-B: embase en saillie (2 entrées de câble, double levier)

H-B 10

Artikel part article	Art.Nr. part No. N° art.	PG	M	L	L1	L2	L3	L4	B	B1	B2	B3	B4	B5	H	H1	H2	S	d
H-B 10 SGRL 16	10035000	16		73	27		82	94	43	57,8	53	40	52		57	4,5		116	5,5
H-B 10 SGRL M20	19035000		20	73	27		82	94	43	57,8	53	40	52		57	4,5		116	5,5
H-B 10 SGRL M25	19035100		25																

Einsätze / Inserts / Inserts: 1.4: H-BE 10 / 1.5: H-EE 18 / 1.7: H-BVE 3 / 1.9: H-DD 42 / 1.10: MC 10

Deckel / Cover / Couvercle: 6.1: H-B 10

Kabelverschraubung / Cable gland / Presse-étoupe: 5.1: Metr. & PG

H-B 16

Artikel part article	Art.Nr. part No. N° art.	PG	M	L	L1	L2	L3	L4	B	B1	B2	B3	B4	B5	H	H1	H2	S	d
H-B 16 SGRL 21	10075000	21		93	47,5		105	117	43	57,8	53	45	57		64	4,5		136,5	5,5
H-B 16 SGRL M25	19075000		25	93	47,5		105	117	43	57,8	53	45	57		64	4,5		136,5	5,5

Einsätze / Inserts / Inserts: 1.4: H-BE 16 / 1.5: H-EE 32 / 1.6: H-BS 6 / 1.7: H-BVE 6 / 1.8: H-D 40 / 1.9: H-DD 72 / 1.10: MC 16

Deckel / Cover / Couvercle: 6.1: H-B 16

Kabelverschraubung / Cable gland / Presse-étoupe: 5.1: Metr. & PG

H-B 24

Artikel part article	Art.Nr. part No. N° art.	PG	M	L	L1	L2	L3	L4	B	B1	B2	B3	B4	B5	H	H1	H2	S	d
H-B 24 SGRL 21	10105000	21		120	74		132	144	43	57,8	53	45	57		64	4,5		163	5,5
H-B 24 SGRL M25	19105000		25	120	74		132	144	43	57,8	53	45	57		64	4,5		163	5,5

Einsätze / Inserts / Inserts: 1.4: H-BE 24 / 1.5: H-EE 46 / 1.7: H-BVE 10 / 1.8: H-D 64 / 1.9: H-DD 108 / 1.10: MC 24

Kabelverschraubung / Cable gland / Presse-étoupe: 5.1: Metr. & PG

H-B 32

Artikel part article	Art.Nr. part No. N° art.	PG	M	L	L1	L2	L3	L4	B	B1	B2	B3	B4	B5	H	H1	H2	S	d
H-B 32 SGRL 29	10138000	29																	
H-B 32 SGRL M32	19138000		32	93,5	64,5		112	124,5	79	93,8	87,8	67	81		72	5		136,5	5,5
H-B 32 SGRL M40	19145400		40																

Einsätze / Inserts / Inserts: 1.4: H-BE 32 / 1.5: H-EE 64 / 1.6: H-BS 12 / 1.8: H-D 80 / 1.9: H-DD 144 / 1.10: 2 x MC 16

Kabelverschraubung / Cable gland / Presse-étoupe: 5.1: Metr. & PG

3.2 EPIC® D A - V I N C I H - B

Sockelgehäuse / Surface mount base / Embase en saillie

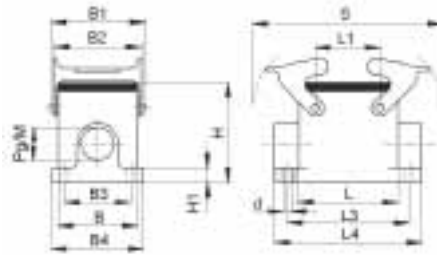

PG / M

EPIC® H-B Gehäuse: Sockelgehäuse (2 Kabeleingänge, Querbügel, hohe Bauform)

EPIC® H-B housings: surface mount base (2 cable entries, double locking lever, high version)

Boîtiers EPIC® H-B: embase en saillie (2 entrées de câble, double levier, version haute)

H-B 10

Artikel part article	Art.Nr. part No. N° art.	PG	M	L	L1	L2	L3	L4	B	B1	B2	B3	B4	B5	H	H1	H2	S	d
H-B 10 SGRLH 21	70036200	21		73	27		82	97	43	57,8	53	45	58		74	6		116	5,5
H-B 10 SGRLH 29	70036400	29																	
H-B 10 SGRLH M25	79036200		25	73	27		82	97	43	57,8	53	45	58		74	6		116	5,5
H-B 10 SGRLH M32	79036400		32																

Einsätze / Inserts / Inserts: 1.4: H-BE 10 / 1.5: H-EE 18 / 1.7: H-BVE 3 / 1.9: H-DD 42 / 1.10: MC 10

Deckel / Cover / Couvercle: 6.1: H-B 10

Kabelverschraubung / Cable gland / Presse-étoupe: 5.1: Metr. & PG

H-B 16

Artikel part article	Art.Nr. part No. N° art.	PG	M	L	L1	L2	L3	L4	B	B1	B2	B3	B4	B5	H	H1	H2	S	d
H-B 16 SGRLH 21	70086200	21		93,3	47,5		105	117	43	57,8	53	45	58		84	6		136,5	5,5
H-B 16 SGRLH 29	70086400	29																	
H-B 16 SGRLH M25	79086200		25	93,3	47,5		105	117	43	57,8	53	45	58		84	6		136,5	5,5
H-B 16 SGRLH M32	79086400		32																

Einsätze / Inserts / Inserts: 1.4: H-BE 16 / 1.5: H-EE 32 / 1.6: H-BS 6 / 1.7: H-BVE 6 / 1.8: H-D 40 / 1.9: H-DD 72 / 1.10: MC 16

Deckel / Cover / Couvercle: 6.1: H-B 16

Kabelverschraubung / Cable gland / Presse-étoupe: 5.1: Metr. & PG

H-B 24

Artikel part article	Art.Nr. part No. N° art.	PG	M	L	L1	L2	L3	L4	B	B1	B2	B3	B4	B5	H	H1	H2	S	d
H-B 24 SGRLH 21	70136200	21		120	74		132	144	43	57,8	53	45	58		84	6		163	5,5
H-B 24 SGRLH 29	70136400	29																	
H-B 24 SGRLH M25	79136200		25	120	74		132	144	43	57,8	53	45	58		84	6		163	5,5
H-B 24 SGRLH M32	79136400		32																

Einsätze / Inserts / Inserts: 1.4: H-BE 24 / 1.5: H-EE 46 / 1.7: H-BVE 10 / 1.8: H-D 64 / 1.9: H-DD 108 / 1.10: MC 24

Deckel / Cover / Couvercle: 6.1: H-B 24

Kabelverschraubung / Cable gland / Presse-étoupe: 5.1: Metr. & PG

3.2 EPIC® D A - V I N C I H - B

Sockelgehäuse / Surface mount base / Embase en saillie

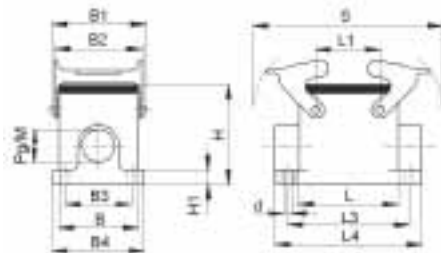

PG / M

EPIC® H-B Gehäuse: Sockelgehäuse (1 Kabeleingang, Querbügel)
EPIC® H-B housings: surface mount base (1 cable entry, double locking lever)
Boîtiers EPIC® H-B: embase en saillie (1 entrée de câble, double levier)

H-B 10

Artikel part article	Art.Nr. part No. N° art.	PG	M	L	L1	L2	L3	L4	B	B1	B2	B3	B4	B5	H	H1	H2	S	d
H-B 10 SGR 16	10034000	16		73	27		82	94	43	57,8	53	40	52		57	4,5		116	5,5
H-B 10 SGR M20	19034000		20	73	27		82	94	43	57,8	53	40	52		57	4,5		116	5,5
H-B 10 SGR M25	19034100		25																

Einsätze / Inserts / Inserts: 1.4: H-BE 10 / 1.5: H-EE 18 / 1.7: H-BVE 3 / 1.9: H-DD 42 / 1.10: MC 10

Deckel / Cover / Couvercle: 6.1: H-B 10

Kabelverschraubung / Cable gland / Presse-étoupe: 5.1: Metr. & PG

H-B 16

Artikel part article	Art.Nr. part No. N° art.	PG	M	L	L1	L2	L3	L4	B	B1	B2	B3	B4	B5	H	H1	H2	S	d
H-B 16 SGR 21	10074000	21		93	47,5		105	117	43	57,8	53	45	57		64	4,5		136,5	5,5
H-B 16 SGR M25	19074000		25	93	47,5		105	117	43	57,8	53	45	57		64	4,5		136,5	5,5

Einsätze / Inserts / Inserts: 1.4: H-BE 16 / 1.5: H-EE 32 / 1.6: H-BS 6 / 1.7: H-BVE 6 / 1.8: H-D 40 / 1.9: H-DD 72 / 1.10: MC 16

Deckel / Cover / Couvercle: 6.1: H-B 16

Kabelverschraubung / Cable gland / Presse-étoupe: 5.1: Metr. & PG

H-B 24

Artikel part article	Art.Nr. part No. N° art.	PG	M	L	L1	L2	L3	L4	B	B1	B2	B3	B4	B5	H	H1	H2	S	d
H-B 24 SGR 21	10104000	21		120	74		132	144	43	57,8	53	45	57		64	4,5		163	5,5
H-B 24 SGR M25	19104000		25	120	74		132	144	43	57,8	53	45	57		64	4,5		163	5,5

Einsätze / Inserts / Inserts: 1.4: H-BE 24 / 1.5: H-EE 46 / 1.7: H-BVE 10 / 1.8: H-D 64 / 1.9: H-DD 108 / 1.10: MC 24

Deckel / Cover / Couvercle: 6.1: H-B 24

Kabelverschraubung / Cable gland / Presse-étoupe: 5.1: Metr. & PG

H-B 32

Artikel part article	Art.Nr. part No. N° art.	PG	M	L	L1	L2	L3	L4	B	B1	B2	B3	B4	B5	H	H1	H2	S	d
H-B 32 SGR 29	10137000	29																	
H-B 32 SGR M32	19137000		32	93,5	64,5		112	124,5	79	93,8	87,8	67	81		72	5		136,5	5,5
H-B 32 SGR M40	19146400		40																

Einsätze / Inserts / Inserts: 1.4: H-BE 32 / 1.5: H-EE 64 / 1.6: H-BS 12 / 1.8: H-D 80 / 1.9: H-DD 144 / 1.10: 2 x MC 16

Kabelverschraubung / Cable gland / Presse-étoupe: 5.1: Metr. & PG

3.2 EPIC® D A - V I N C I H - B

Sockelgehäuse / Surface mount base / Embase en saillie

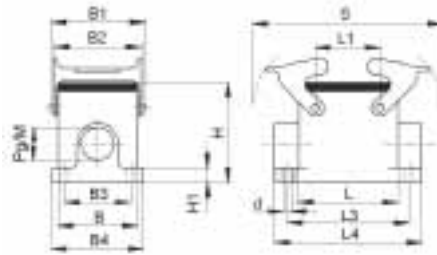

PG / M

EPIC® H-B Gehäuse: Sockelgehäuse (1 Kabeleingang, Querbügel, hohe Bauform)

EPIC® H-B housings: surface mount base (1 cable entry, double locking lever, high version)

Boîtiers EPIC® H-B: embase en saillie (1 entrée de câble, double levier, version haute)

H-B 10

Artikel part article	Art.Nr. part No. N° art.	PG	M	L	L1	L2	L3	L4	B	B1	B2	B3	B4	B5	H	H1	H2	S	d
H-B 10 SGRH 21	70035200	21		73	27		82	97	43	57,8	53	45	58		74	6		116	5,5
H-B 10 SGRH 29	70035400	29																	
H-B 10 SGRH M25	79035200		25	73	27		82	97	43	57,8	53	45	58		74	6		116	5,5
H-B 10 SGRH M32	79035400		32																

Einsätze / Inserts / Inserts: 1.4: H-BE 10 / 1.5: H-EE 18 / 1.7: H-BVE 3 / 1.9: H-DD 42 / 1.10: MC 10

Deckel / Cover / Couvercle: 6.1: H-B 10

Kabelverschraubung / Cable gland / Presse-étoupe: 5.1: Metr. & PG

H-B 16

Artikel part article	Art.Nr. part No. N° art.	PG	M	L	L1	L2	L3	L4	B	B1	B2	B3	B4	B5	H	H1	H2	S	d
H-B 16 SGRH 21	70085200	21		93,3	47,5		105	117	43	57,8	53	45	58		84	6		136,5	5,5
H-B 16 SGRH 29	70085400	29																	
H-B 16 SGRH M25	79085200		25	93,3	47,5		105	117	43	57,8	53	45	58		84	6		136,5	5,5
H-B 16 SGRHM32	79085400		32																

Einsätze / Inserts / Inserts: 1.4: H-BE 16 / 1.5: H-EE 32 / 1.6: H-BS 6 / 1.7: H-BVE 6 / 1.8: H-D 40 / 1.9: H-DD 72 / 1.10: MC 16

Deckel / Cover / Couvercle: 6.1: H-B 16

Kabelverschraubung / Cable gland / Presse-étoupe: 5.1: Metr. & PG

H-B 24

Artikel part article	Art.Nr. part No. N° art.	PG	M	L	L1	L2	L3	L4	B	B1	B2	B3	B4	B5	H	H1	H2	S	d
H-B 24 SGRH 21	70135200	21		120	74		132	144	43	57,8	53	45	58		84	6		163	5,5
H-B 24 SGRH 29	70135400	29																	
H-B 24 SGRH M25	79135200		25	120	74		132	144	43	57,8	53	45	58		84	6		163	5,5
H-B 24 SGRH M32	79135400		32																

Einsätze / Inserts / Inserts: 1.4: H-BE 24 / 1.5: H-EE 46 / 1.7: H-BVE 10 / 1.8: H-D 64 / 1.9: H-DD 108 / 1.10: MC 24

Deckel / Cover / Couvercle: 6.1: H-B 24

Kabelverschraubung / Cable gland / Presse-étoupe: 5.1: Metr. & PG

3.2 EPIC® D A - V I N C I H - B

Sockelgehäuse / Surface mount base / Embase en saillie

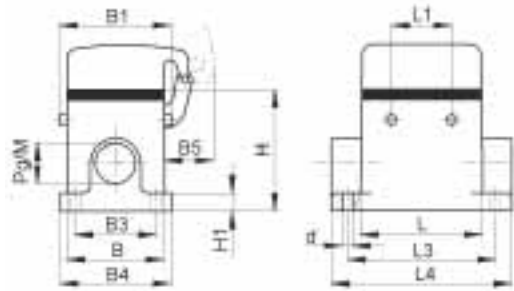

PG / M

EPIC® H-B Gehäuse: Sockelgehäuse (Schutzdeckel, 2 Kabeleingänge, Bolzen für Querbügel)
EPIC® H-B housings: surface mount base (cover, 2 cable entries, bolts for double locking lever)
Boîtiers EPIC® H-B: embase en saillie (couvercle, 2 entrées de câble, ergots pour double levier)

H-B 10

Artikel part article	Art.Nr. part No. N° art.	PG	M	L	L1	L2	L3	L4	B	B1	B2	B3	B4	B5	H	H1	H2	S	d
H-B 10 SDRL-BO 16	10038000	16		73	27		82	94	43	57,8		40	52	25	57	4,5			5,5
H-B 10 SDRL-BO M20	19038000		20	73	27		82	94	43	57,8		40	52	25	57	4,5			5,5
H-B 10 SDRL-BO M25	79046600		25																

Einsätze / Inserts / Inserts: 1.4: H-BE 10 / 1.5: H-EE 18 / 1.7: H-BVE 3 / 1.9: H-DD 42 / 1.10: MC 10
 Kabelverschraubung / Cable gland / Presse-étoupe: 5.1: Metr. & PG

H-B 16

Artikel part article	Art.Nr. part No. N° art.	PG	M	L	L1	L2	L3	L4	B	B1	B2	B3	B4	B5	H	H1	H2	S	d
H-B 16 SDRL-BO 21	70096000	21		93	47,5		105	117	43	57,8		45	57	25	64	4,5			5,5
H-B 16 SDRL-BO M25	79096000		25	93	47,5		105	117	43	57,8		45	57	25	64	4,5			5,5

Einsätze / Inserts / Inserts: 1.4: H-BE 16 / 1.5: H-EE 32 / 1.6: H-BS 6 / 1.7: H-BVE 6 / 1.8: H-D 40 / 1.9: H-DD 72 / 1.10: MC 16
 Kabelverschraubung / Cable gland / Presse-étoupe: 5.1: Metr. & PG

H-B 24

Artikel part article	Art.Nr. part No. N° art.	PG	M	L	L1	L2	L3	L4	B	B1	B2	B3	B4	B5	H	H1	H2	S	d
H-B 24 SDRL-BO 21	10109000	21		120	74		132	144	43	57,8		45	57	25	64	4,5			5,5
H-B 24 SDRL-BO M25	19109000		25	120	74		132	144	43	57,8		45	57	25	64	4,5			5,5

Einsätze / Inserts / Inserts: 1.4: H-BE 24 / 1.5: H-EE 46 / 1.7: H-BVE 10 / 1.8: H-D 64 / 1.9: H-DD 108 / 1.10: MC 24
 Kabelverschraubung / Cable gland / Presse-étoupe: 5.1: Metr. & PG

3.2 EPIC® D A - V I N C I H - B

Sockelgehäuse / Surface mount base / Embase en saillie

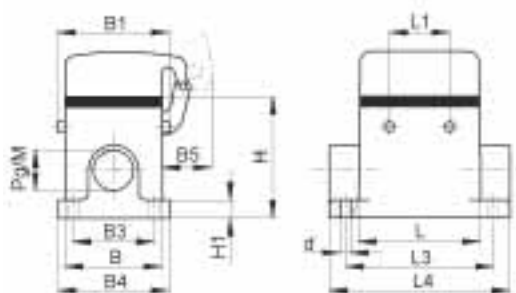

PG / M

EPIC® H-B Gehäuse: Sockelgehäuse (Schutzdeckel, 2 Kabeleingänge, Bolzen für Querbügel, hohe Bauform)

EPIC® H-B housings: surface mount base (cover, 2 cable entries, bolts for double locking lever, high version)

Boîtiers EPIC® H-B: embase en saillie (covercle, 2 entrées de câble, ergots pour double levier, version haute)

H-B 10

Artikel part article	Art.Nr. part No. N° art.	PG	M	L	L1	L2	L3	L4	B	B1	B2	B3	B4	B5	H	H1	H2	S	d
H-B 10 SDR LH-BO 21	70046200	21		73	27		82	97	43	57,8		45	58	25	74	6			5,5
H-B 10 SDR LH-BO 29	70046400	29																	
H-B 10 SDR LH-BO M25	79046200		25	73	27		82	97	43	57,8		45	58	25	74	6			5,5
H-B 10 SDR LH-BO M32	79046400		32																

Einsätze / Inserts / Inserts: 1.4: H-BE 10 / 1.5: H-EE 18 / 1.7: H-BVE 3 / 1.9: H-DD 42 / 1.10: MC 10

Kabelverschraubung / Cable gland / Presse-étoupe: 5.1: Metr. & PG

H-B 16

Artikel part article	Art.Nr. part No. N° art.	PG	M	L	L1	L2	L3	L4	B	B1	B2	B3	B4	B5	H	H1	H2	S	d
H-B 16 SDR LH-BO 21	70096200	21		93,3	47,5		105	117	43	57,8		45	58	25	84	6			5,5
H-B 16 SDR LH-BO 29	70096400	29																	
H-B 16 SDR LH-BO M25	79096200		25	93,3	47,5		105	117	43	57,8		45	58	25	84	6			5,5
H-B 16 SDR LH-BO M32	79096400		32																

Einsätze / Inserts / Inserts: 1.4: H-BE 16 / 1.5: H-EE 32 / 1.6: H-BS 6 / 1.7: H-BVE 6 / 1.8: H-D 40 / 1.9: H-DD 72 / 1.10: MC 16

Kabelverschraubung / Cable gland / Presse-étoupe: 5.1: Metr. & PG

H-B 24

Artikel part article	Art.Nr. part No. N° art.	PG	M	L	L1	L2	L3	L4	B	B1	B2	B3	B4	B5	H	H1	H2	S	d
H-B 24 SDR LH-BO 21	70146200	21		120	74		132	144	43	57,8		45	58	25	84	6			5,5
H-B 24 SDR LH-BO 29	70146400	29																	
H-B 24 SDR LH-BO M25	79146200		25	120	74		132	144	43	57,8		45	58	25	84	6			5,5
H-B 24 SDR LH-BO M32	79146400		32																

Einsätze / Inserts / Inserts: 1.4: H-BE 24 / 1.5: H-EE 46 / 1.7: H-BVE 10 / 1.8: H-D 64 / 1.9: H-DD 108 / 1.10: MC 24

Kabelverschraubung / Cable gland / Presse-étoupe: 5.1: Metr. & PG

3

3.2 EPIC® D A - V I N C I H - B

Sockelgehäuse / Surface mount base / Embase en saillie

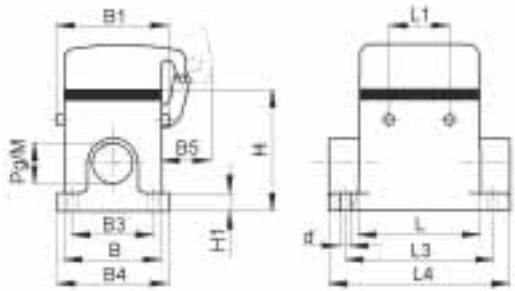

PG / M

EPIC® H-B Gehäuse: Sockelgehäuse (Schutzdeckel, 1 Kabeleingang, Bolzen für Querbügel)

EPIC® H-B housings: surface mount base (cover, 1 cable entry, bolts for double locking lever)

Boîtiers EPIC® H-B: embase en saillie (couvercle, 1 entrée de câble, ergots pour double levier)

H-B 10

Artikel part article	Art.Nr. part No. N° art.	PG	M	L	L1	L2	L3	L4	B	B1	B2	B3	B4	B5	H	H1	H2	S	d
H-B 10 SDR-BO 16	10036000	16		73	27		82	94	43	57,8		40	52	25	57	4,5			5,5
H-B 10 SDR-BO M20	19036000		20	73	27		82	94	43	57,8		40	52	25	57	4,5			5,5
H-B 10 SDR-BO M25	19036100		25																

Einsätze / Inserts / Inserts: 1.4: H-BE 10 / 1.5: H-EE 18 / 1.7: H-BVE 3 / 1.9: H-DD 42 / 1.10: MC 10

Kabelverschraubung / Cable gland / Presse-étoupe: 5.1: Metr. & PG

H-B 16

Artikel part article	Art.Nr. part No. N° art.	PG	M	L	L1	L2	L3	L4	B	B1	B2	B3	B4	B5	H	H1	H2	S	d
H-B 16 SDR-BO 21	10076000	21		93	47,5		105	117	43	57,8		45	57	25	64	4,5			5,5
H-B 16 SDR-BO M25	19076000		25	93	47,5		105	117	43	57,8		45	57	25	64	4,5			5,5

Einsätze / Inserts / Inserts: 1.4: H-BE 16 / 1.5: H-EE 32 / 1.6: H-BS 6 / 1.7: H-BVE 6 / 1.8: H-D 40 / 1.9: H-DD 72 / 1.10: MC 16

Kabelverschraubung / Cable gland / Presse-étoupe: 5.1: Metr. & PG

H-B 24

Artikel part article	Art.Nr. part No. N° art.	PG	M	L	L1	L2	L3	L4	B	B1	B2	B3	B4	B5	H	H1	H2	S	d
H-B 24 SDR-BO 21	10107000	21		120	74		132	144	43	57,8		45	57	25	64	4,5			5,5
H-B 24 SDR-BO M25	19107000		25	120	74		132	144	43	57,8		45	57	25	64	4,5			5,5

Einsätze / Inserts / Inserts: 1.4: H-BE 24 / 1.5: H-EE 46 / 1.7: H-BVE 10 / 1.8: H-D 64 / 1.9: H-DD 108 / 1.10: MC 24

Kabelverschraubung / Cable gland / Presse-étoupe: 5.1: Metr. & PG

3.2 EPIC® D A - V I N C I H - B

Sockelgehäuse / Surface mount base / Embase en saillie

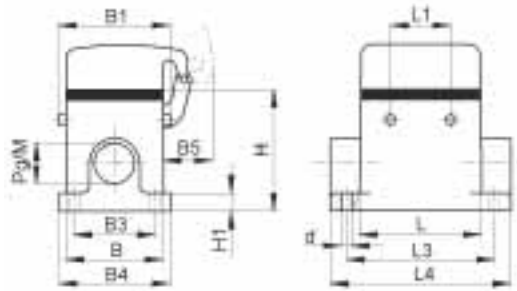

PG / M

EPIC® H-B Gehäuse: Sockelgehäuse (Schutzdeckel, 1 Kabeleingang, Bolzen für Querbügel, hohe Bauform)

EPIC® H-B housings: surface mount base (cover, 1 cable entry, bolts for double locking lever, high version)

Boîtiers EPIC® H-B: embase en saillie (covercle, 1 entrée de câble, ergots pour double levier, version haute)

H-B 10

Artikel part article	Art.Nr. part No. N° art.	PG	M	L	L1	L2	L3	L4	B	B1	B2	B3	B4	B5	H	H1	H2	S	d
H-B 10 SDRH-BO 21	70045200	21		73	27		82	97	43	57,8		45	58	25	74	6			5,5
H-B 10 SDRH-BO 29	70045400	29																	
H-B 10 SDRH-BO M25	79045200		25	73	27		82	97	43	57,8		45	58	25	74	6			5,5
H-B 10 SDRH-BO M32	79045400		32																

Einsätze / Inserts / Inserts: 1.4: H-BE 10 / 1.5: H-EE 18 / 1.7: H-BVE 3 / 1.9: H-DD 42 / 1.10: MC 10

Kabelverschraubung / Cable gland / Presse-étoupe: 5.1: Metr. & PG

H-B 16

Artikel part article	Art.Nr. part No. N° art.	PG	M	L	L1	L2	L3	L4	B	B1	B2	B3	B4	B5	H	H1	H2	S	d
H-B 16 SDRH-BO 21	70095200	21		93,3	47,5		105	117	43	57,8		45	58	25	84	6			5,5
H-B 16 SDRH-BO 29	70095400	29																	
H-B 16 SDRH-BO M25	79095200		25	93,3	47,5		105	117	43	57,8		45	58	25	84	6			5,5
H-B 16 SDRH-BO M32	79095400		32																

Einsätze / Inserts / Inserts: 1.4: H-BE 16 / 1.5: H-EE 32 / 1.6: H-BS 6 / 1.7: H-BVE 6 / 1.8: H-D 40 / 1.9: H-DD 72 / 1.10: MC 16

Kabelverschraubung / Cable gland / Presse-étoupe: 5.1: Metr. & PG

H-B 24

Artikel part article	Art.Nr. part No. N° art.	PG	M	L	L1	L2	L3	L4	B	B1	B2	B3	B4	B5	H	H1	H2	S	d
H-B 24 SDRH-BO 21	70145200	21		120	74		132	144	43	57,8		45	58	25	84	6			5,5
H-B 24 SDRH-BO 29	70145400	29																	
H-B 24 SDRH-BO M25	79145200		25	120	74		132	144	43	57,8		45	58	25	84	6			5,5
H-B 24 SDRH-BO M32	79145400		32																

Einsätze / Inserts / Inserts: 1.4: H-BE 24 / 1.5: H-EE 46 / 1.7: H-BVE 10 / 1.8: H-D 64 / 1.9: H-DD 108 / 1.10: MC 24

Kabelverschraubung / Cable gland / Presse-étoupe: 5.1: Metr. & PG

3.2 EPIC® D A - V I N C I H - B

Kupplungsgehäuse / Cable coupler hood / Capot prolongateur



PG



M

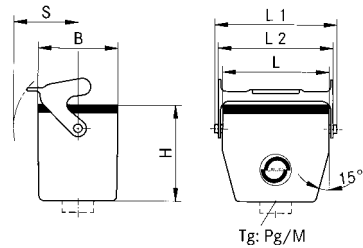

EPIC® H-B Gehäuse: Kupplungsgehäuse (Kabeleingang gerade, Längsbügel)

EPIC® H-B housings: cable coupler hood (top entry, single locking lever)

Boîtiers EPIC® H-B: capot prolongateur (sortie verticale, simple levier)

H-B 6

Artikel part article	Art.Nr. part No. N° art.	PG	M	ZW	L	L1	L2	L3	L4	B	B1	B2	B3	B4	B5	H	H1	H2	S	d
H-B 6 TBF 13,5	10014000	13,5		●	60	74,8	70			43						54,8			44	
H-B 6 TBF 16	10024000	16		●																
H-B 6 TBF M20	19014000		20		60	74,8	70			43						54,8			44	
H-B 6 TBF M25	19024000		25																	

Einsätze / Inserts / Inserts: 1.4: H-BE 6 / 1.5: H-EE 10 / 1.9: H-DD 24 / 1.10: MC 6

Deckel / Cover / Couvercle: 6.1: H-B 6

Kabelverschraubung / Cable gland / Presse-étoupe: 5.1: Metr. & PG

H-B 10

Artikel part article	Art.Nr. part No. N° art.	PG	M	ZW	L	L1	L2	L3	L4	B	B1	B2	B3	B4	B5	H	H1	H2	S	d
H-B 10 TBF-LB 16	10046900	16		●	73	91	88,5			43						54,8			50	
H-B 10 TBF-LB 21	70042200	21		●																
H-B 10 TBF-LB M20	19046900		20		73	91	88,5			43						54,8			50	
H-B 10 TBF-LB M25	79042200		25																	

Einsätze / Inserts / Inserts: 1.4: H-BE 10 / 1.5: H-EE 18 / 1.7: H-BVE 3 / 1.9: H-DD 42 / 1.10: MC 10

Kabelverschraubung / Cable gland / Presse-étoupe: 5.1: Metr. & PG

3.2 EPIC® D A - V I N C I H - B

Kupplungsgehäuse / Cable coupler hood / Capot prolongateur



PG



M

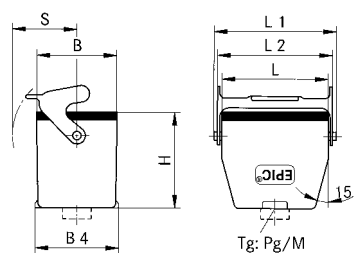

EPIC® H-B Gehäuse: Kupplungsgehäuse (Kabeleingang gerade, Längsbügel)

EPIC® H-B housings: cable coupler hood (top entry, single locking lever)

Boîtiers EPIC® H-B: capot prolongateur (sortie verticale, simple levier)

H-B 16

Artikel part article	Art.Nr. part No. N° art.	PG	M	ZW	L	L1	L2	L3	L4	B	B1	B2	B3	B4	B5	H	H1	H2	S	d
H-B 16 TBF-LB 21	10086900	21		●	93,3	111	109,5			43						63,5			50	
H-B 16 TBF-LB M25	19086900		25		93,3	111	109,5			43						63,5			50	

Einsätze / Inserts / Inserts: 1.4: H-BE 16 / 1.5: H-EE 32 / 1.6: H-BS 6 / 1.7: H-BVE 6 / 1.8: H-D 40 / 1.9: H-DD 72 / 1.10: MC 16
Kabelverschraubung / Cable gland / Presse-étoupe: 5.1: Metr. & PG

H-B 24

Artikel part article	Art.Nr. part No. N° art.	PG	M	ZW	L	L1	L2	L3	L4	B	B1	B2	B3	B4	B5	H	H1	H2	S	d
H-B 24 TBF-LB 21	10127900	21		●	120	138	136,5			43						63,8			50	
H-B 24 TBF-LB 29	10117900		29	●	120	138	136,5			43						63,8			50	
H-B 24 TBF-LB M25	19127900		25		120	138	136,5			43						63,8			50	
H-B 24 TBF-LB M32	19117900		32		120	138	136,5			43						63,8			50	

Einsätze / Inserts / Inserts: 1.4: H-BE 24 / 1.5: H-EE 46 / 1.7: H-BVE 10 / 1.8: H-D 64 / 1.9: H-DD 108 / 1.10: MC 24
Kabelverschraubung / Cable gland / Presse-étoupe: 5.1: Metr. & PG

3.2 EPIC® D A - V I N C I H - B

Kupplungsgehäuse / Cable coupler hood / Capot prolongateur



PG



M

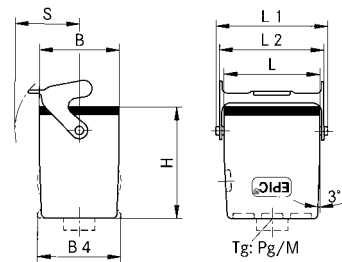

EPIC® H-B Gehäuse: Kupplungsgehäuse (Kabeleingang gerade, Längsbügel, hohe Bauform)

EPIC® H-B housings: cable coupler hood (top entry, single locking lever, high version)

Boîtiers EPIC® H-B: capot prolongateur (sortie verticale, simple levier, version haute)

H-B 6

Artikel part article	Art.Nr. part No. N° art.	PG	M	ZW	L	L1	L2	L3	L4	B	B1	B2	B3	B4	B5	H	H1	H2	S	d
H-B 6 TBFH 21	70010200	21		●	60	74,8	70			43						74,8			44	
H-B 6 TBFH 29	70010400	29		●																
H-B 6 TBFH M25	79010200		25		60	74,8	70			43						74,8			44	
H-B 6 TBFH M32	79010400		32																	

Einsätze / Inserts / Inserts: 1.4: H-BE 6 / 1.5: H-EE 10 / 1.9: H-DD 24 / 1.10: MC 6

Deckel / Cover / Couvercle: 6.1: H-B 6

Kabelverschraubung / Cable gland / Presse-étoupe: 5.1: Metr. & PG

H-B 10

Artikel part article	Art.Nr. part No. N° art.	PG	M	ZW	L	L1	L2	L3	L4	B	B1	B2	B3	B4	B5	H	H1	H2	S	d
H-B 10 TBFH-LB 21	70042400	21		●	73	91	88,5			43						74,8			50	
H-B 10 TBFH-LB 29	70042600	29		●																
H-B 10 TBFH-LB M25	79042400		25		73	91	88,5			43						74,8			50	
H-B 10 TBFH-LB M32	79042600		32																	

Einsätze / Inserts / Inserts: 1.4: H-BE 10 / 1.5: H-EE 18 / 1.7: H-BVE 3 / 1.9: H-DD 42 / 1.10: MC 10

Kabelverschraubung / Cable gland / Presse-étoupe: 5.1: Metr. & PG

3.2 EPIC® D A - V I N C I H - B

Kupplungsgehäuse / Cable coupler hood / Capot prolongateur



PG



M

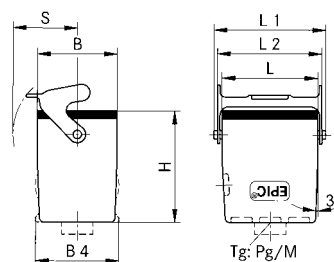

EPIC® H-B Gehäuse: Kupplungsgehäuse (Kabeleingang gerade, Längsbügel, hohe Bauform)

EPIC® H-B housings: cable coupler hood (top entry, single locking lever, high version)

Boîtiers EPIC® H-B: capot prolongateur (sortie verticale, simple levier, version haute)

H-B 16

Artikel part article	Art.Nr. part No. N° art.	PG	M	ZW	L	L1	L2	L3	L4	B	B1	B2	B3	B4	B5	H	H1	H2	S	d
H-B 16 TBFH-LB 21	70092200	21		●	93,3	111	109,5			43						78,8			50	
H-B 16 TBFH-LB 29	70092400	29		●																
H-B 16 TBFH-LB M25	79092200		25		93,3	111	109,5			43						78,8			50	
H-B 16 TBFH-LB M32	79092400		32																	

Einsätze / Inserts / Inserts: 1.4: H-BE 16 / 1.5: H-EE 32 / 1.6: H-BS 6 / 1.7: H-BVE 6 / 1.8: H-D 40 / 1.9: H-DD 72 / 1.10: MC 16
Kabelverschraubung / Cable gland / Presse-étoupe: 5.1: Metr. & PG

H-B 24

Artikel part article	Art.Nr. part No. N° art.	PG	M	ZW	L	L1	L2	L3	L4	B	B1	B2	B3	B4	B5	H	H1	H2	S	d
H-B 24 TBFH-LB 21	70142400	21		●	120	138	136,5			43						78,8			50	
H-B 24 TBFH-LB 29	70142600	29		●																
H-B 24 TBFH-LB M25	79142400		25		120	138	136,5			43						78,8			50	
H-B 24 TBFH-LB M32	79142600		32																	

Einsätze / Inserts / Inserts: 1.4: H-BE 24 / 1.5: H-EE 46 / 1.7: H-BVE 10 / 1.8: H-D 64 / 1.9: H-DD 108 / 1.10: MC 24
Kabelverschraubung / Cable gland / Presse-étoupe: 5.1: Metr. & PG

3.2 EPIC® D A - V I N C I H - B

Kupplungsgehäuse / Cable coupler hood / Capot prolongateur

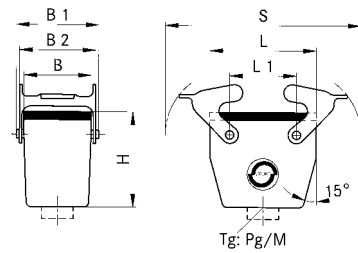

EPIC® H-B Gehäuse: Kupplungsgehäuse (Kabeleingang gerade, Querbügel)

EPIC® H-B housings: cable coupler hood (top entry, double locking lever)

Boîtiers EPIC® H-B: capot prolongateur (sortie verticale, double levier)

H-B 10

Artikel part article	Art.Nr. part No. N° art.	PG	M	ZW	L	L1	L2	L3	L4	B	B1	B2	B3	B4	B5	H	H1	H2	S	d
H-B 10 TBF 16	10046000	16	●		73	27				43	57,8	53				54,8				116
H-B 10 TBF 21	70040200	21	●																	
H-B 10 TBF M20	19046000			20	73	27				43	57,8	53				54,8				116
H-B 10 TBF M25	79040200			25																

Einsätze / Inserts / Inserts: 1.4: H-BE 10 / 1.5: H-EE 18 / 1.7: H-BVE 3 / 1.9: H-DD 42 / 1.10: MC 10

Deckel / Cover / Couvercle: 6.1: H-B 10

Kabelverschraubung / Cable gland / Presse-étoupe: 5.1: Metr. & PG

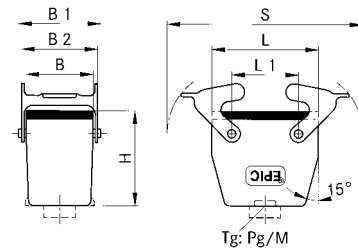

H-B 16

Artikel part article	Art.Nr. part No. N° art.	PG	M	ZW	L	L1	L2	L3	L4	B	B1	B2	B3	B4	B5	H	H1	H2	S	d
H-B 16 TBF 21	10086000	21	●		93,3	47,5				43	57,8	53				63,6				136,5
H-B 16 TBF M25	19086000			25	93,3	47,5				43	57,8	53				63,6				136,5

Einsätze / Inserts / Inserts: 1.4: H-BE 16 / 1.5: H-EE 32 / 1.6: H-BS 6 / 1.7: H-BVE 6 / 1.8: H-D 40 / 1.9: H-DD 72 / 1.10: MC 16

Deckel / Cover / Couvercle: 6.1: H-B 16

Kabelverschraubung / Cable gland / Presse-étoupe: 5.1: Metr. & PG

H-B 24

Artikel part article	Art.Nr. part No. N° art.	PG	M	ZW	L	L1	L2	L3	L4	B	B1	B2	B3	B4	B5	H	H1	H2	S	d
H-B 24 TBF 21	10127000	21	●		120	74				43	57,8	53				63,8				163
H-B 24 TBF 29	10117000	29	●																	
H-B 24 TBF M25	19127000			25	120	74				43	57,8	53				63,8				163
H-B 24 TBF M32	19117000			32																

Einsätze / Inserts / Inserts: 1.4: H-BE 24 / 1.5: H-EE 46 / 1.7: H-BVE 10 / 1.8: H-D 64 / 1.9: H-DD 108 / 1.10: MC 24

Deckel / Cover / Couvercle: 6.1: H-B 24

Kabelverschraubung / Cable gland / Presse-étoupe: 5.1: Metr. & PG

3.2 EPIC® D A - V I N C I H - B

Kupplungsgehäuse / Cable coupler hood / Capot prolongateur



EPIC® H-B Gehäuse: Kupplungsgehäuse (Kabeleingang gerade, Querbügel, hohe Bauform)
EPIC® H-B housings: cable coupler hood (top entry, double locking lever, high version)
Boîtiers EPIC® H-B: capot prolongateur (sortie verticale, double levier, version haute)

H-B 10

Artikel part article	Art.Nr. part No. N° art.	PG	M	ZW	L	L1	L2	L3	L4	B	B1	B2	B3	B4	B5	H	H1	H2	S	d
H-B 10 TBFH 21	70040400	21	●		73	27				43	57,8	53				74,8				116
H-B 10 TBFH 29	70040600	29	●																	
H-B 10 TBFH M25	79040400			25	73	27				43	57,8	53				74,8				116
H-B 10 TBFH M32	79040600			32																

Einsätze / Inserts / Inserts: 1.4: H-BE 10 / 1.5: H-EE 18 / 1.7: H-BVE 3 / 1.9: H-DD 42 / 1.10: MC 10

Deckel / Cover / Couvercle: 6.1: H-B 10

Kabelverschraubung / Cable gland / Presse-étoupe: 5.1: Metr. & PG



H-B 16

Artikel part article	Art.Nr. part No. N° art.	PG	M	ZW	L	L1	L2	L3	L4	B	B1	B2	B3	B4	B5	H	H1	H2	S	d
H-B 16 TBFH 21	70090200	21	●		93,3	47,5				43	57,8	53				78,8				136,5
H-B 16 TBFH 29	70090400	29	●																	
H-B 16 TBFH M25	79090200			25	93,3	47,5				43	57,8	53				78,8				136,5
H-B 16 TBFH M32	79090400			32																

Einsätze / Inserts / Inserts: 1.4: H-BE 16 / 1.5: H-EE 32 / 1.6: H-BS 6 / 1.7: H-BVE 6 / 1.8: H-D 40 / 1.9: H-DD 72 / 1.10: MC 16

Deckel / Cover / Couvercle: 6.1: H-B 16

Kabelverschraubung / Cable gland / Presse-étoupe: 5.1: Metr. & PG

3.2 EPIC® D A - V I N C I H - B

Kupplungsgehäuse / Cable coupler hood / Capot prolongateur



PG



M

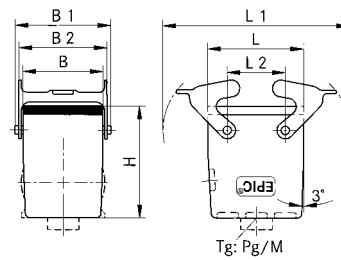

EPIC® H-B Gehäuse: Kupplungsgehäuse (Kabeleingang gerade, Querbügel, hohe Bauform)

EPIC® H-B housings: cable coupler hood (top entry, double locking lever, high version)

Boîtiers EPIC® H-B: capot prolongateur (sortie verticale, double levier, version haute)

H-B 24

Artikel part article	Art.Nr. part No. N° art.	PG	M	ZW	L	L1	L2	L3	L4	B	B1	B2	B3	B4	B5	H	H1	H2	S	d
H-B 24 TBFH 21	70140400	21	●		120	74				43	57,8	53				78,8				163
H-B 24 TBFH 29	70140600	29	●																	
H-B 24 TBFH M25	79140400			25	120	74				43	57,8	53				78,8				163
H-B 24 TBFH M32	79140600			32																

Einsätze / Inserts / Inserts: 1.4: H-BE 24 / 1.5: H-EE 46 / 1.7: H-BVE 10 / 1.8: H-D 64 / 1.9: H-DD 108 / 1.10: MC 24

Deckel / Cover / Couvercle: 6.1: H-B 24

Kabelverschraubung / Cable gland / Presse-étoupe: 5.1: Metr. & PG



PG



M

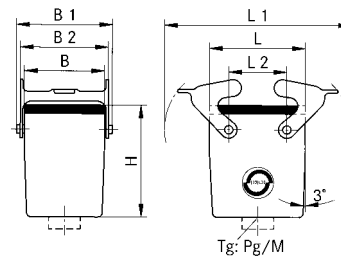

H-B 32

Artikel part article	Art.Nr. part No. N° art.	PG	M	ZW	L	L1	L2	L3	L4	B	B1	B2	B3	B4	B5	H	H1	H2	S	d
H-B 32 TBFH 29	10139500	29	●		93,5	64,5				79	93,8	87,8				97	5			136,5
H-B 32 TBFH M32	19139500			32	93,5	64,5				79	93,8	87,8				97	5			136,5

Einsätze / Inserts / Inserts: 1.4: H-BE 32 / 1.5: H-EE 64 / 1.6: H-BS 12 / 1.8: H-D 80 / 1.9: H-DD 144 / 1.10: 2 x MC 16

Kabelverschraubung / Cable gland / Presse-étoupe: 5.1: Metr. & PG

3.2 EPIC® D A - V I N C I H - B

Tüllengehäuse / Hood / Capot

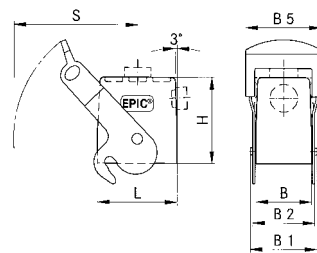

EPIC® H-B Gehäuse: Tüllengehäuse mit Zentralbügel

EPIC® H-B housings: hood with central lever

Boîtiers EPIC® H-B: capot avec levier central

H-B 16

Artikel part article	Art.Nr. part No. N° art.	PG	M	ZW	L	L1	L2	L3	L4	B	B1	B2	B3	B4	B5	H	H1	H2	S	d
H-B 16 TSH-ZB	70124200		21		93,3					43						76				

Einsätze / Inserts / Inserts: 1.4: H-BE 16 / 1.5: H-EE 32 / 1.6: H-BS 6 / 1.7: H-BVE 6 / 1.8: H-D 40 / 1.9: H-DD 72 / 1.10: MC 16

Deckel / Cover / Couvercle: 6.1: H-B 16

Kabelverschraubung / Cable gland / Presse-étoupe: 5.1: Metr. & PG

H-B 24

Artikel part article	Art.Nr. part No. N° art.	PG	M	ZW	L	L1	L2	L3	L4	B	B1	B2	B3	B4	B5	H	H1	H2	S	d
H-B 24 TSH-ZB	70174400		21							43						76				
H-B 24 TSH-ZB	70174200		29		120															

Einsätze / Inserts / Inserts: 1.4: H-BE 24 / 1.5: H-EE 46 / 1.7: H-BVE 10 / 1.8: H-D 64 / 1.9: H-DD 108 / 1.10: MC 24

Deckel / Cover / Couvercle: 6.1: H-B 24

Kabelverschraubung / Cable gland / Presse-étoupe: 5.1: Metr. & PG

3.2 EPIC® D A - V I N C I H - B

Anbaugehäuse / Panel mount base / Embase encastrée

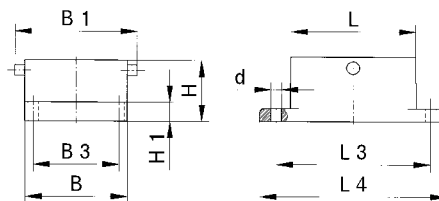

EPIC® H-B Gehäuse: Anbaugehäuse für Zentralbügel
EPIC® H-B housings: panel mount base for central lever
Boîtiers EPIC® H-B: embase encastrée pour levier centralement

H-B 16

Artikel part article	Art.Nr. part No. N° art.	PG	M	ZW	L	L1	L2	L3	L4	B	B1	B2	B3	B4	B5	H	H1	H2	S	d
H-B 16 AG-ZR	70084000				93,3			103	113	43	57,8	53	32			27,8	4			

Einsätze / Inserts / Inserts: 1.4: H-BE 16 / 1.5: H-EE 32 / 1.6: H-BS 6 / 1.7: H-BVE 6 / 1.8: H-D 40 / 1.9: H-DD 72 / 1.10: MC 16
 Deckel / Cover / Couvercle: 6.1: H-B 16
 Kabelverschraubung / Cable gland / Presse-étoupe: 5.1: Metr. & PG

H-B 24

Artikel part article	Art.Nr. part No. N° art.	PG	M	ZW	L	L1	L2	L3	L4	B	B1	B2	B3	B4	B5	H	H1	H2	S	d
H-B 24 AG-ZR	70134000				120			130	140	43	57,8	53	32			27,8	4			

Einsätze / Inserts / Inserts: 1.4: H-BE 24 / 1.5: H-EE 46 / 1.7: H-BVE 10 / 1.8: H-D 64 / 1.9: H-DD 108 / 1.10: MC 24
 Deckel / Cover / Couvercle: 6.1: H-B 24
 Kabelverschraubung / Cable gland / Presse-étoupe: 5.1: Metr. & PG