

Number 1 in efficiency



The new device category!
**The PowerXL™ DE1
Variable Speed Starter**



Powering Business Worldwide

The PowerXL™ DE1 Variable Speed Starter – one device, all the advantages

Ease of use and reliability or variable motor speed and improved energy efficiency? Why not both? Eaton's new device category is closing the gap between conventional motor starters and variable frequency drives. It combines all the benefits in one device: The new PowerXL™ DE1 Variable Speed Starter.

Energy efficiency has never been simpler!

Perfectly equipped for the new ErP Directive

To achieve the energy efficiency required by the ErP Directive, applications with simple functionality such as pumps and fans are facing increased demands for drive technology with variable motor speed. Variable frequency drives are designed for more complex applications and as such require a greater level of expert knowledge. The new PowerXL™ DE1 Variable Speed Starter takes a different approach. It helps users to achieve the required energy efficiency levels for the application at hand by adjusting the motor speed – all without making mounting or commissioning more complex than for a conventional motor starter.



Try out our "Energy Savings Estimator" to see how much you can cut your costs and energy consumption with the DE1 Variable Speed Starter. The free software tool is available at www.eaton.eu/selectiontools

So simple:

- Out-of-the-box commissioning without parameterization
- Trip-free design ensures maximum machine availability
- As easy to install and use as a motor starter
- No special drives, engineering skills or knowledge required

So variable:

- Variable motor speed
- Parameters can be optionally configured using plug-in configuration module
- Optional use of the PowerXL drivesConnect software
- Optional communication via SmartWire-DT and other accessories



The DE1 Variable Speed Starter in 45 mm and 90 mm wide versions up to 1.5 or 7.5 kW

Trip-free design ensures maximum machine availability

No switch-off in borderline situations



Overload, overcurrent, overtemperature or energy recovery – in real life there are always situations that can lead into a trip of the drive system or application. The new DE1 Variable Speed Starter features a trip-free design that automatically prevents tripping in borderline situations. Following features guarantee a maximum of machine availability:



Auto-Reset, e.g. in case of overload

Various application-related faults such as overcurrent at blocked rotor or frequent motor starts are protected by the Variable Speed Starter. After a relevant trip the DE1 will optionally restart up to 9 times automatically and without any manual operation.

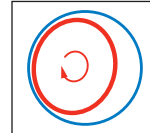

DC regulation in the event of imbalance

Automatic brake ramp extension at high inertia and output frequency boost in case of imbalance within the application to prevent an overvoltage trip.



DC braking, e.g. for wind tunnel applications

A temporary output of DC voltage will brake the motor before starting (protection against overcurrent trips on passively driven motors, such as on the wind tunnel on ventilation systems) and stopping.

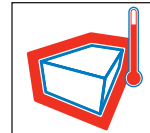

PWM regulation, e.g. in case of high ambient temperatures

Automatic reduction of the PWM frequency (switching frequency) in case of high load and/or high ambient temperatures.

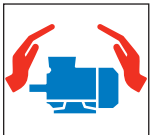

Extensive motor protection

The DE1 Variable Speed Starter offers internal motor protection plus direct thermistor motor protection and short-circuit protection.



60°C without derating

Ambient temperature 60°C do not require derating (for details see chart on page 7)

Commissioning

As easy to use as a motor starter

No special knowledge of drives is required for the new DE1 Variable Speed Starter – either for installation or commissioning. The compact Variable Speed Starter is as easy and convenient to use as a conventional motor starter.

The device is unpacked and simply wired like a motor starter – that's it. The DE1 Variable Speed Starter is ready to go. It couldn't be easier! In addition, the "out-of-the-box commissioning" reduces the chances of installation faults to a minimum and at the same time it makes installation faster and more cost-efficient!



1 Snap the Variable Speed Starter on the DIN-Rail.



2 Connect mains and motor cables.



3 Wire control terminals.



4 Switch on and the motor runs with its speed controlled.

The new PowerXL™ DE1 Variable Speed Starter

Parameterization by screwdriver

DXE-EXT-SET (plug-in configuration module)

Beyond the out-of-the-box commissioning that eliminates the need for parameterization, the user also has the option of using the plug-in DXE-EXT-SET configuration module to adjust the default settings of key parameters such as ramp time, motor protection and control terminal function to fit the current application. All that is needed is a screwdriver.

Furthermore the DE1 naturally also offers the opportunity to carry out the parameterization using the external remote device with LED display, which is part of the PowerXL product portfolio. Furthermore, the drivesConnect software also keeps the new Variable Speed Starter easy to use, just like it does for the entire PowerXL family. The software allows DE1 users the parameterization or readout via laptop, and to copy parameters from one drive to another with the parameter copy stick.



Your Connection to the Future

Integration into the innovative SmartWire-DT communication system

The DE1 has an optional Modbus interface and can communicate to Eaton's innovative SmartWire-DT communication system. For you, that means efficiency at all levels.

- 1 EMS Electronic motor starter
- 2 PKZ Motor-protective circuit-breaker
- 3 PKE Motor-protective circuit-breaker
- 4 DS7 Soft starter
- 5 PowerXL™ DC1 Variable frequency drive
- 6 PowerXL™ DE1 Variable Speed Starter

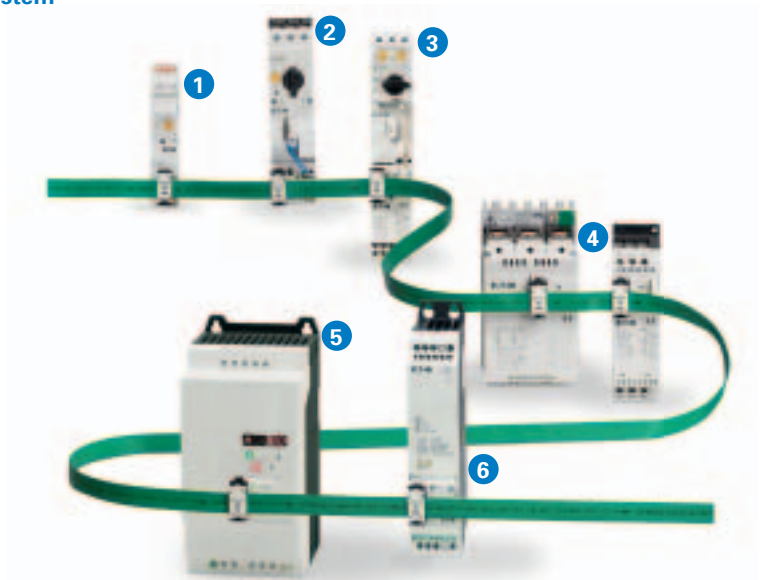

Lean Solutions powered by Eaton

Rely on technology that makes complicated mechanical engineering processes simple: The intelligent SmartWire-DT system shifts the I/O level to the bus subscriber. SmartWire-DT allows for simple and straightforward structures that can be configured quickly while eliminating the I/O level on PLCs. The data transparency achieved this way makes diagnostics and maintenance simpler, cutting the time and resources spent on wiring, testing and commissioning by up to 85%.

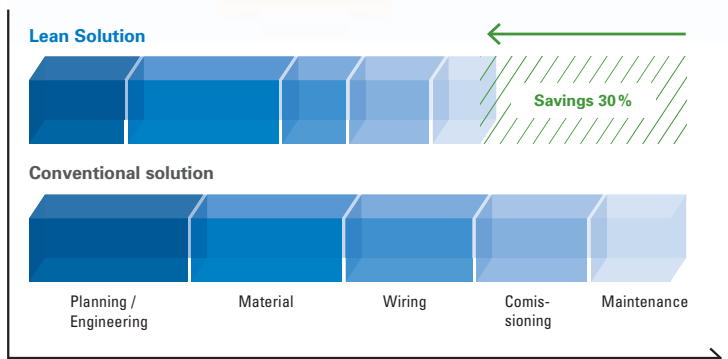

Saving time and costs

The new PowerXL DE1 Variable Speed Starter compared to conventional variable frequency drives



Comparison 1: Standard wiring via terminals
Time required to parameterize the DE1 Variable Speed Starter vs. a standard commercial variable frequency drive (e.g. motor potentiometer function)



Comparison 2: Integration of DE1 into SmartWire-DT vs. standard wiring
Time required for integration of DE1 into SmartWire-DT vs. standard wiring into standard commercial variable frequency drive



■ DE1 Variable Speed Starter ■ Variable frequency drive

So simple, so clever

Ideally suited for applications with limited functionality yet needing variable motor speed

The ErP Directive and the increasing levels of automation in machines are pushing the need for variable frequency drives even for simple applications. The DE1 Variable Speed Starter is the ideal solution in all cases where a variable motor speed is required but where a variable frequency drive would be too complex and its expansive functionality would be definitely oversized.

It is ideally suited even for fixed speed applications:

- reduced starting current at full torque
- for constant speed motors, where the required frequency does not correspond to the line frequency (e.g. high speed motors)
- no thermal overload at a high frequency of starts



Applications in which a direct start is unacceptable for mechanical reasons or due to the overly high start-up current, which, however, do not permit a reduced starting torque.



Applications in which the motors have a constant speed, but in which the frequency does not correspond to the line frequency (such as motors at 18,000 rpm).

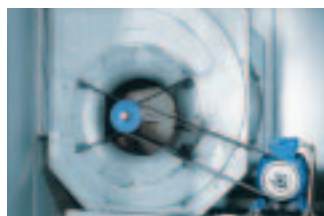

Applications in which a motor starter is currently being used but which will need a variable motor speed going forward to comply with the EU standards.



Applications in which a simple variable frequency drive has been used to date, but for which the functionality of that drive is too complex.

Overview of advantages and specifications

Features



- **Variable motor speed** as ease to use as a motor starter
- **Trip-free design** ensures maximum machine availability
- **Out-of-the-box commissioning** without parameterization
- **Special skills or knowledge of drive systems or variable frequency drives are not required**
- Screwdriver parameterization can be set with an **optional configuration module (DXE-EXT-SET)**
- Full integration into **SmartWire-DT and the PowerXL™ drivesConnect software**
- **For challenging ambient conditions** (such as temperatures from -10 °C to 60 °C)
- **International standards** CE, UL, cUL and cTick

Technical Data

Supply voltage	1 AC 230 V / 3 AC 400/480 V	Relay outputs	1
Line frequency	50/60 Hz ± 10 %	Voltage	230 V AC / 30 V DC
Overload	150 %	Current AC1 / DC1	6A/5A
Output frequency	0...300 Hz	Number of input terminals	4
Switching frequency	1~: 4/8/12/16/24/32 kHz 3~: 10/12/14/16/18/20kHz	Analog input	
Mounting	DIN, mounting plate, side-by-side	Resolution	12-bit
EMC	C1 5m, C2 10m, C3 25m	Voltage	0–10 V, (0) 4–20 mA
Leakage current	< 3.5 mA AC / 10 mA DC	Energy consumption at 10 V	0.12 mA
Short-circuit resistance	Yes	Digital input	
Altitude	2000 m (derating above 1000 m)	High level	9...30 V
Ambient temperature	60 °C (For details see table on page 7)	Energy consumption at 10/24 V	1.15/3 mA
Enclosure	IP 20 / NEMA 0	Maximum load for the internal 10-V power supply	20 mA

Ordering information

Input voltage [V]	Motor [kW]	Motor [HP]	Input phases	Output voltage	Output phases	Output current [A]	Degree of protection	Size	Part no. selection with EMC filter	Article no.	Part no. selection without EMC filter	Article no.
220–240	0.25	0.30	1	220–240	3	1.4	IP20_x	1	DE1-121D4FN-N20N	174327	DE1-121D4NN-N20N	177359
	0.37	0.5	1	220–240	3	2.3	IP20_x	1	DE1-122D3FN-N20N	174328	DE1-122D3NN-N20N	177360
	0.55	0.5	1	220–240	3	2.7	IP20_x	1	DE1-122D7FN-N20N	174329	DE1-122D7NN-N20N	177361
	0.75	0.75	1	220–240	3	4.3	IP20_x	1	DE1-124D3FN-N20N	174330	DE1-124D3NN-N20N	177362
	1.50	2	1	220–240	3	7.0	IP20_x	1	DE1-127D0FN-N20N	174331	DE1-127D0NN-N20N	177363
	2.20	3	1	220–240	3	9.6	IP20_x	2	DE1-129D6FN-N20N	174332	DE1-129D6NN-N20N	177364
400–480	0.37	0.5	3	400–480	3	1.3	IP20_x	1	DE1-341D3FN-N20N	174333	DE1-341D3NN-N20N	177365
	0.75	1	3	400–480	3	2.1	IP20_x	1	DE1-342D1FN-N20N	174334	DE1-342D1NN-N20N	177366
	1.50	2	3	400–480	3	3.6	IP20_x	1	DE1-343D6FN-N20N	174335	DE1-343D6NN-N20N	177367
	2.20	3	3	400–480	3	5.0	IP20_x	2	DE1-345D0FN-N20N	174336	DE1-345D0NN-N20N	177368
	3.00	3	3	400–480	3	6.6	IP20_x	2	DE1-346D6FN-N20N	174337	DE1-346D6NN-N20N	177369
	4.00	5	3	400–480	3	8.5	IP20_x	2	DE1-348D5FN-N20N	174338	DE1-348D5NN-N20N	177370
	5.50	7.5	3	400–480	3	11.3	IP20_x	2	DE1-34011FN-N20N	174339	DE1-34011NN-N20N	177371
	7.50	10	3	400–480	3	16.0	IP20_x	2	DE1-34016FN-N20N*	174340	DE1-34016NN-N20N*	177372

* >50 °C derating

Accessory Articles

Description	Part no.	Article no.	Description	Part no.	Article no.	Description	Part no.	Article no.
DE1 parameterization module	DXE-EXT-SET	174621	Parameter copy stick	DX-COM-STICK	169134	Remote display	DX-KEY-LED	169132

Dimensions

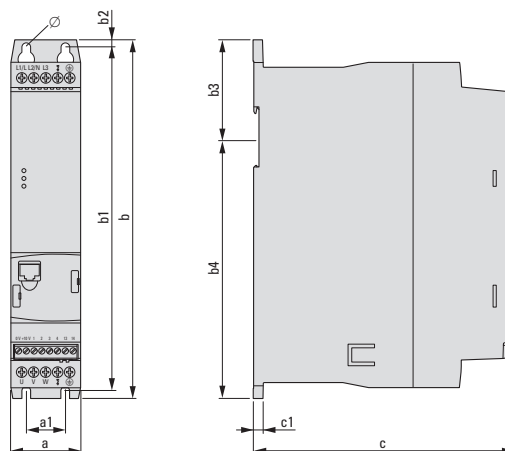

[mm (in)]

	a	a1	b	b1	b2	b3	b4	c	c1	Ø1	Ø2	kg (lbs)
FS1	45 (1.77)	25 (0.98)	230 (9.06)	220 (8.88)	5 (0.2)	64 (2.52)	166 (6.54)	168 (6.61)	6.5 (0.26)	5.1 (0.2)	10 (0.39)	1.04 (2.29)
FS2	90 (3.54)	50 (1.97)	230 (9.06)	220 (8.66)	5 (0.2)	64 (2.52)	166 (6.54)	168 (6.61)	6.5 (0.26)	5.1 (0.2)	10 (0.39)	1.68 (3.7)

Eaton is dedicated to ensuring that reliable, efficient and safe power is available when it's needed most. With unparalleled knowledge of electrical power management across industries, experts at Eaton deliver customized, integrated solutions to solve our customers' most critical challenges.

Our focus is on delivering the right solution for the application. But decision makers demand more than just innovative products. They turn to Eaton for an unwavering commitment to personal support that makes customer success a top priority. For more information, **visit www.eaton.eu**

To contact an Eaton salesperson or local distributor/agent, please visit www.eaton.eu/electrical/customersupport

Eaton Industries GmbH
Hein-Moeller-Str. 7-11
D-53115 Bonn/Germany

© 2014 by Eaton Corporation
All rights reserved
Printed in Germany 12/14
Publication No.: BR040003EN
bb December 2014
Article No.: 179296



Eaton is a registered trademark of Eaton Corporation.

All other trademarks are property of their respective owners.

SmartWire-DT® is a registered trademark of Eaton Corporation.