

## S6 SERIES

The **S6** series, thanks to the excellent detection performances and the variety of power supply and connection possibilities, offers the most complete universal sensor range in the compact 50x50 mm housing.

The operating distance can be set to the optimal value in each model: 2 m diffuse proximity, 25 or 50 cm background suppression, 5 m polarised retroreflex, 1 m retroreflex versions for transparent objects and 20 m through beam.

Proximity models with 12 to 110 cm background suppression are available.

The free voltage versions have a relay output and cable connection.

The versions with 10-30 Vdc power supply present cable connection and NPN/PNP output or M12 connector, with either PNP output with dark/light configuration and PNP double NO-NC output complying to the EN 60947-5-2 standard.



## HIGHLIGHTS

- Background suppression models
- Free voltage versions with relay output
- 10-30 Vdc version with transistor output
- Standard cable or M12 connection

## APPLICATIONS

Ceramics

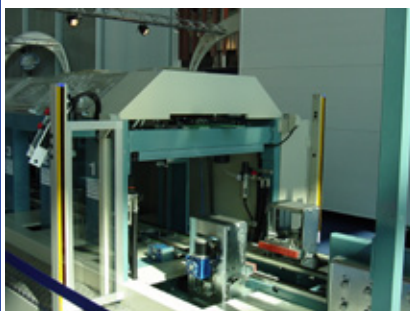

Transportation lines





Beverage & Bottling



Packaging lines



## TECHNICAL DATA

<b>Power supply</b>	10 ... 30 Vdc (d.c. vers.), reverse polarity protection 15 ... 264 Vac (free voltage vers.)
<b>Consumption</b>	30 mA max. (d.c. vers.) 40 mA max. (free voltage vers.)
<b>Light emission</b>	infrared LED 880 nm red LED 660 nm (B3, T1, M10 vers.)
<b>Diffuse proximity operating distance</b>	1 ... 90 cm (C90 vers.) 5 ... 200 cm (C200 vers.)
<b>Background suppression op. distance</b>	10 ... 50 cm (M50 vers.) 3 ... 25 cm (M25 vers.), 10 cm (M10 vers.)
<b>Retroreflex operating distance</b>	0.1 ... 6 m (on R2)
<b>Polarised retroreflex operating distance</b>	0.1 ... 5 m (on R2)
<b>Through beam operating distance</b>	0 ... 20 m
<b>Setting</b>	sensitivity trimmer (G vers. excluded) distance adj. screw (M25, M50, N20 vers.)
<b>Indicators</b>	red OUTPUT LED green STABILITY LED (M, N vers.) red POWER LED (G5 vers.)
<b>Output type</b>	NPN/PNP configurable (d.c. vers.) PNP (S6T vers.) PNP NO-NC (S6R vers.) relay SPDT 250V/3A (free voltage vers.)
<b>Saturation tension</b>	1.5 V max. (d.c. vers.)
<b>Output current</b>	100 mA max., short-circuit protection 3 A max. resistive load (free voltage vers.)
<b>Response time</b>	1 ms max. (d.c. vers.), 2 ms max. (F vers.) 30 ms max. (free voltage vers.)
<b>Switching frequency</b>	500 Hz max., 250 Hz max. (F/G vers. in d.c.) 16 Hz max. (free voltage vers.)
<b>Operating mode</b>	dark/light configurable
<b>Auxiliary functions</b>	'test +' and 'test -' inputs (G vers. in d.c.)
<b>Connection</b>	4-pole M12 connector (S6T/S6R vers.) 2 m Ø 6 mm cable (S6 vers.)
<b>Electric protection</b>	class 1 (free voltage vers.) class 2 (d.c. vers.)
<b>Mechanical protection</b>	IP65
<b>Housing material</b>	ABS
<b>Lens material</b>	PMMA plastic
<b>Weight</b>	40 g max. (connector vers.) 160 g max. (cable vers.)
<b>Operating temperature</b>	-25 ... +55°C
<b>Storage temperature</b>	-25 ... +70°C
<b>Reference standard</b>	EN 60947-5-2
<b>Certifications</b>	  d.c.vers.)

The operating distances indicate the detection distance with excess gain 2.

**DETECTION DIAGRAMS**

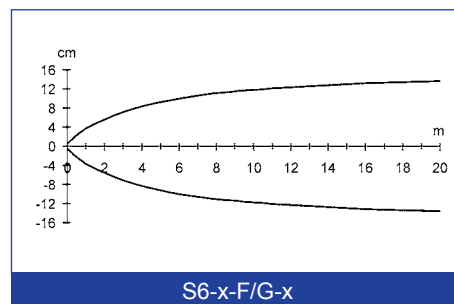
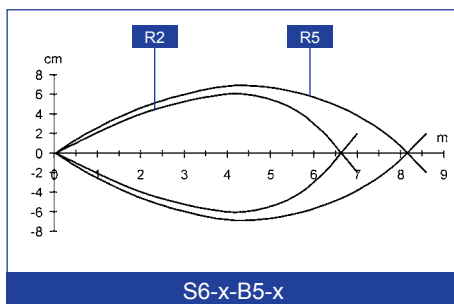
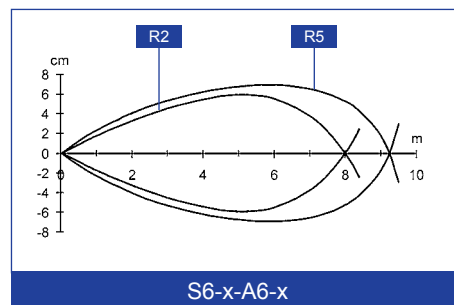
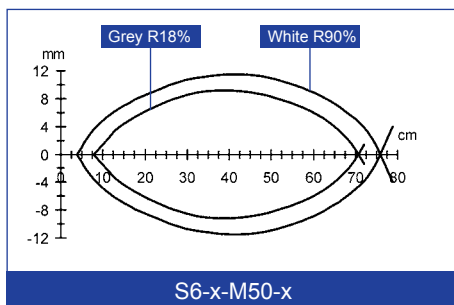
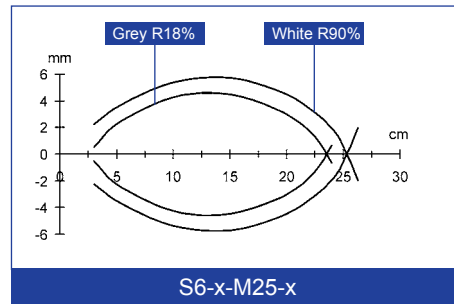
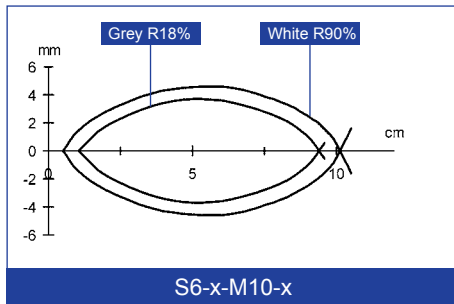
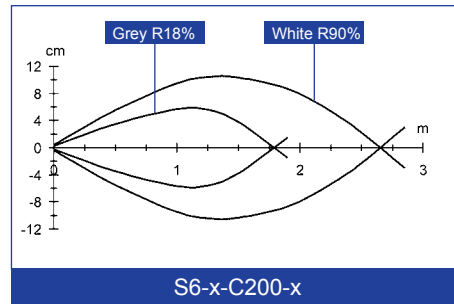
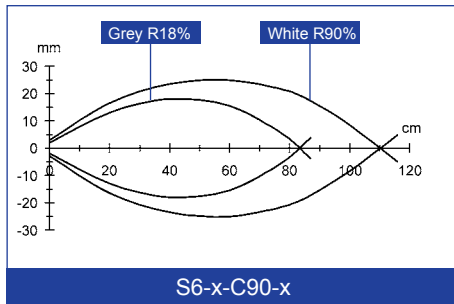

The detection diagrams indicate the typical operating distance with excess gain 1.

## CONNECTIONS

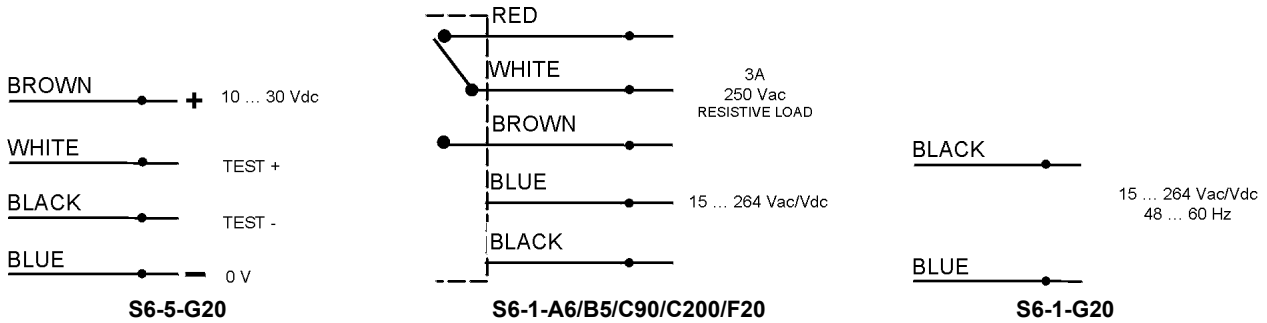
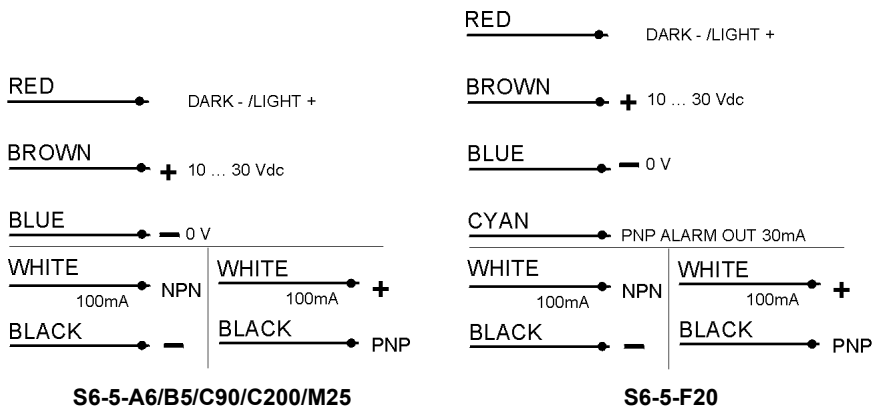

## M12 CONNECTOR

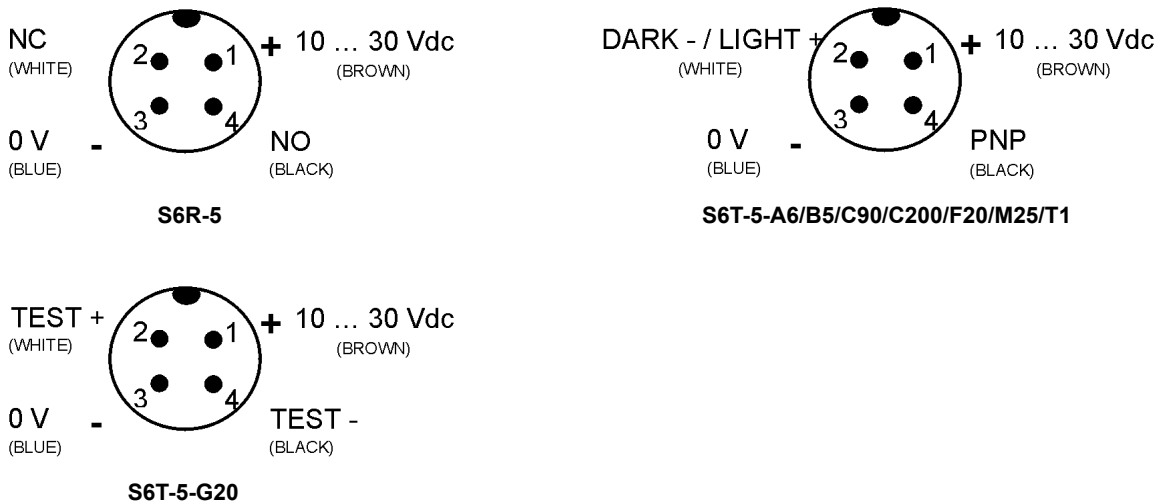

**DIMENSIONS**

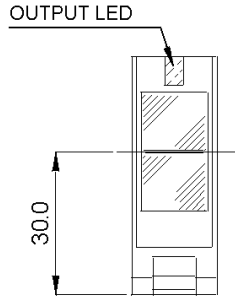
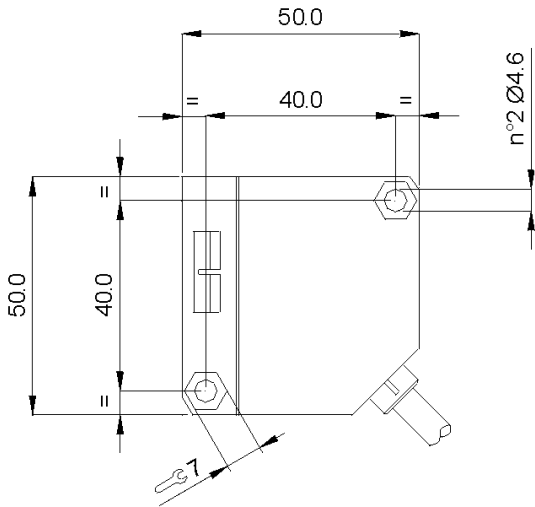

**S6/S6T/S6R-5-M25**

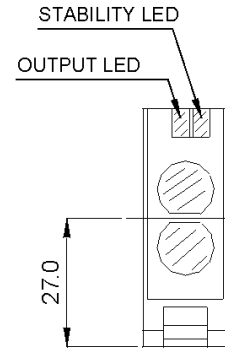

**M12 CONNECTOR  
S6T/S6R-5-xx**

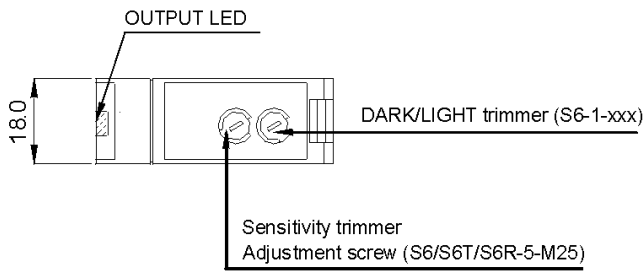
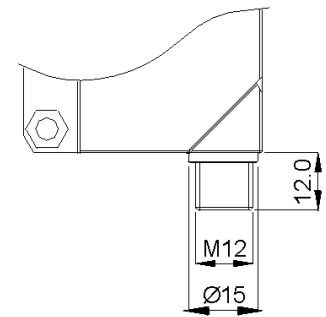

## MODEL SELECTION AND ORDER INFORMATION

### VERSIONS WITH 15 ... 264 Vac/Vdc POWER SUPPLY

MODEL	FUNCTION	CONNECTION	OUTPUT	CODE N°
S6-1-C90	diffuse proximity	cable	relay	S937530090
S6-1-C200	diffuse proximity	cable	relay	950151140
S6-1-A6	retroreflex	cable	relay	S937330090
S6-1-B5	polarised retroreflex	cable	relay	S937420090
S6-1-F20	receiver	cable	relay	S937200090
S6-1-F20	emitter	cable	relay	S937130090

### VERSIONS WITH 15 ... 264 Vac/Vdc POWER SUPPLY

MODEL	FUNCTION	CONNECTION	OUTPUT	CODE N°
S6-5-C90	diffuse proximity	cable	NPN/PNP	S937530000
S6R-5-C90-P	diffuse proximity	M12 connector	PNP NO-NC	950201190
S6T-5-C90-P	diffuse proximity	M12 connector	PNP **	961031020
S6-5-C200	diffuse proximity	cable	NPN/PNP	950201150
S6R-5-C200-P	diffuse proximity	M12 connector	PNP NO-NC	950201200
S6R-5-M10-P	background suppression	M12 connector	PNP NO-NC	950201230
S6-5-M25	background suppression	cable	NPN/PNP	S937830000
S6R-5-M25-P	background suppression	M12 connector	PNP NO-NC	950201220
S6T-5-M25-P	background suppression	M12 connector	PNP **	961041000
S6R-5-M50-P	background suppression	M12 connector	PNP NO-NC	950201250
S6-5-A6	retroreflex	cable	NPN/PNP	S937330000
S6R-5-A6-P	retroreflex	M12 connector	PNP NO-NC	950201170
S6T-5-A6-P	retroreflex	M12 connector	PNP **	961031000
S6-5-B5	polarised retroreflex	cable	NPN/PNP	S937420000
S6R-5-B5-P	polarised retroreflex	M12 connector	PNP NO-NC	950201180
S6T-5-B5-P	polarised retroreflex	M12 connector	PNP **	961031010
S6-5-F20	receiver	cable	NPN/PNP	S937200010
S6R-5-F20-P	receiver *	M12 connector	PNP NO-NC	950201160
S6T-5-F20-P	receiver	M12 connector	PNP **	961211010
S6-5-G20	emitter	cable	-	S937130000
S6T-5-G20	emitter	M12 connector	-	961211000

\* use with S6T-5-G20 emitter

\*\* with dark/light configuration input



The company endeavours to continuously improve and renew its products; for this reason the technical data and contents of this catalogue may undergo variations without prior notice. For correct installation and use, the company can guarantee only the data indicated in the instruction manual supplied with the products.