

MODEL AFCM - ANALOG TO FREQUENCY CONVERTER MODULE

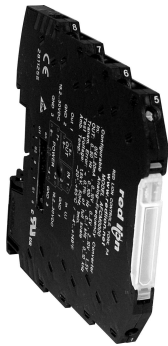

- VOLTAGE/CURRENT TO FREQUENCY CONVERTER
- 3-WAY ISOLATION OF INPUT / OUTPUT SIGNALS
- UNIVERSAL CONVERSION MODULE - INPUTS AND OUTPUTS SELECTED VIA DIP SWITCH SETTINGS
- ULTRA SLIM DESIGN – ONLY 0.244" WIDE
- 19 to 30 VDC POWER



UL Recognized Component,
 File # E257265

DESCRIPTION

The configurable analog to frequency converter is used to convert analog standard signals to frequency signals or pulse width modulated (PWM) signals. Input signal ranges are 0 - 20 mA, 4 - 20 mA, 0 - 10 mA, 2 - 10 mA, 0 - 10 V, 2 - 10 V, 0 - 5 V, or 1 - 5 V.

The DIP switches are accessible on the side of the housing and allow the following parameters to be configured:

- Input signal
- Output values
- Output type (frequency or PWM)
- Filter type (for smoothing interferences on the input signal)
- Input over/under range fault detection

SAFETY SUMMARY

The device may only be installed and put into operation by qualified personnel. The corresponding national regulations must be observed.

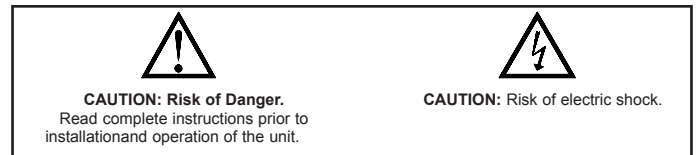

SPECIFICATIONS

INPUT

- INPUT SIGNAL RANGE (Configurable):** 0 - 20 mA, 4 - 20 mA, 0 - 10 mA, 2 - 10 mA, 0 - 10 V, 2 - 10 V, 0 - 5 V, 1 - 5 V
- MAX. INPUT SIGNAL:**
 Current inputs: 100 mA
 Voltage inputs: 30 VDC
- INPUT RESISTANCE:**
 Current inputs: 50 Ω, approx.
 Voltage inputs: 110 KΩ, approx.

OUTPUT

- OUTPUT SIGNAL RANGE (Configurable):**
 Frequencies: 0 - 10 kHz, 0 - 5 kHz, 0 - 2.5 kHz, 0 - 1 kHz, 0 - 500 Hz, 0 - 250 Hz, 0 - 100 Hz, 0 - 50 Hz
 PWM: 7.8 kHz, 3.9 kHz, 1.9 kHz, 977 Hz, 488 Hz, 244 Hz, 122 Hz, 61 Hz
- MIN. LOAD:**
 Frequency: 6 KΩ
 PWM: 2 KΩ
- MAX. LOAD CURRENT:** 20 mA
- OUTPUT:** NPN open collector transistor
- MAX. SWITCHING VOLTAGE:** 30 V
- OVER-RANGE/UNDER-RANGE FAULT DETECTION:** Configurable
- OUTPUT PROTECTION:** Short circuit and polarity protection

GENERAL DATA

- SUPPLY VOLTAGE:** 19.2 - 30 VDC
- NOMINAL VOLTAGE:** 24 VDC
- CURRENT CONSUMPTION:** < 10 mA
- POWER CONSUMPTION:** < 200 mW
- TRANSMISSION ERROR:** < 0.1%
- TEMPERATURE COEFFICIENT (MAX.):** < 0.02%/K
- STEP RESPONSE:**
 0% to 99%: < 15 msec + (1/T)
 With Largest Filter: < 1 sec + (1/T)
- TEST VOLTAGE (INPUT / OUTPUT / SUPPLY):** 1.5 kV, 50 Hz, 1 min
- AMBIENT TEMPERATURE RANGE:**
 Operation: -20 t +65°C (-4 to 148°F)
 Storage: -40 to +85°C (-4 to 183°F)
- FAULT DETECTION:** Red LED under clear cover top

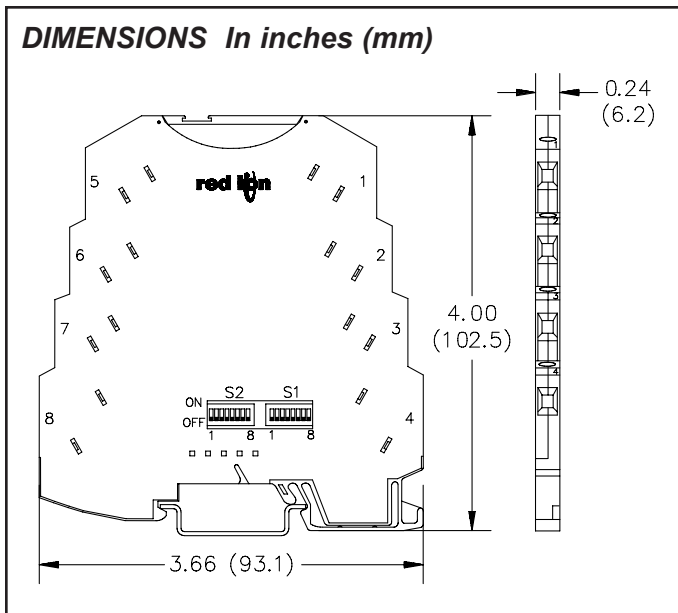

ORDERING INFORMATION

| MODEL NO. | DESCRIPTION | PART NUMBER |
|-----------|--------------------------------------|-------------|
| AFCM | Analog to Frequency Converter Module | AFCM0000 |

11. CERTIFICATIONS AND COMPLIANCES:

Conformance With EMC Guideline 89/336/EEC And Low Voltage Directive 73/23/EEC

Immunity to Interference According to EN 61000-6-2

| | | |
|---------------------------------------|--------------|--------------------------|
| Discharge of static electricity (ESD) | EN 61000-4-2 | Criterion B ¹ |
| Electromagnetic HF field | EN 61000-4-3 | Criterion A ² |
| Fast transients (Burst) | EN 61000-4-4 | Criterion B ¹ |
| Surge voltage capacities (Surge) | EN 61000-4-5 | Criterion B ¹ |
| Conducted disturbance | EN 61000-4-6 | Criterion A ² |

Noise Emission According to EN 61000-6-4

| | | |
|---------------------------|----------|----------------------|
| Noise emission of housing | EN 55011 | Class A ³ |
|---------------------------|----------|----------------------|

¹ Criterion B: Temporary impairment to operational behavior that is corrected by the device itself.

² Criterion A: Normal operating behavior within the defined limits.

³ Class A: Area of application industry.

12. **CONNECTIONS:** Wire Gauge: 24-12 AWG, Stripping length: 0.47" (12 mm)

13. **CONSTRUCTION:** Polybutylenterephthalate PBT, black

14. **MOUNTING:** Standard DIN top hat (T) profile rail according to EN50022 - 35x7.5

15. **WEIGHT:** 2 oz. (54 g)

WIRING CONNECTIONS

Primary power is connected to terminals 7 or 3 (19.2 – 30 VDC) and 8 or 4 (GND 3). For best results, the Power should be relatively “clean” and within the specified variation limits. Drawing power from heavily loaded circuits or from circuits that also power loads that cycle on and off, should be avoided.

The input signal is connected to terminal 1 (In UI) and 2 (GND 1). Connections for the output signal is on terminals 5 (Out f) and 6 (GND 2).

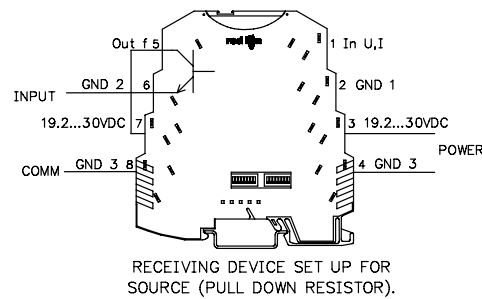
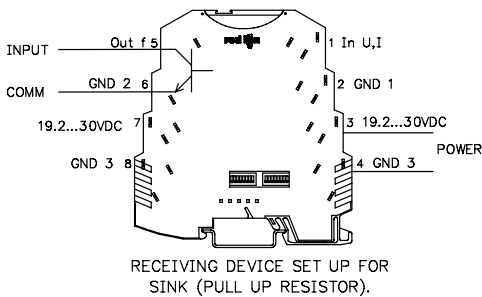

CONFIGURATION

DIP Switch S1

Using DIP switch S1, you can set the input values, and the values for Moving Average Filter and Over sampling.

| 1 | 2 | 3 | 4 | ANALOG IN |
|----|----|----|----|-----------|
| | | | | 0 – 10V |
| | ON | | | 1 – 5V |
| | | ON | | 0 – 5V |
| | ON | ON | | 2 – 10V |
| ON | | | ON | 0 – 20 mA |
| ON | ON | | ON | 4 – 20 mA |
| ON | | ON | ON | 0 – 10 mA |
| ON | ON | ON | ON | 2 – 10 mA |

The moving average filter can group values (1, 2, 4, 6) using moving window averaging to form a new measured value. In moving window averaging, the average of a fixed number of measured values is taken, whereby the oldest value is always dropped and the most recent added.

| 5 | 6 | MOVING WINDOW AVERAGING |
|----|----|-------------------------|
| | | 1 value |
| ON | | 2 values |
| | ON | 4 values |
| ON | ON | 6 values |

| 7 | 8 | OVER SAMPLING |
|----|----|---------------|
| | | 1 value |
| ON | | 10 values |
| | ON | 50 values |
| ON | ON | 100 values |

In order to smooth the measured values, an average can be formed from several measured values (1, 10, 50, 100). This process is called Over sampling. In oversampling, the average is updated every time the selected number of values is reached.

DIP Switch S2

Using DIP switch S2, you can set the output values, the output type and fault detection.

Output Signals

Frequency Output:

Variable frequency/period duration T

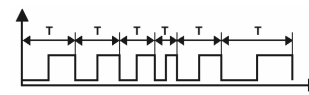

| 1 | 2 | 3 | 4 | FREQUENCY OUTPUT |
|----|----|----|---|------------------|
| | | | | 0 - 10 kHz |
| ON | | | | 0 - 5 kHz |
| | ON | | | 0 - 2.5 kHz |
| ON | ON | | | 0 - 1 kHz |
| | | ON | | 0 - 500 Hz |
| ON | | ON | | 0 - 250 Hz |
| | ON | ON | | 0 - 100 Hz |
| ON | ON | ON | | 0 - 50 Hz |

PWM Output

(Pulse Wide Modulation):

Variable pulse to pause ratio/fixed period duration T

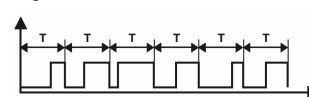

| 1 | 2 | 3 | 4 | PWM OUTPUT |
|----|----|----|----|------------|
| | | | ON | 7.8 Hz |
| ON | | | ON | 3.9 Hz |
| | ON | | ON | 1.9 Hz |
| ON | ON | | ON | 977 Hz |
| | | ON | ON | 488 Hz |
| ON | | ON | ON | 244 Hz |
| | ON | ON | ON | 122 Hz |
| ON | ON | ON | ON | 61 Hz |

Change can only be read by PWM input meters.

Fault Detection

| 5 | 6 | INPUT OVER RANGE |
|----|----|--|
| | | Freeze at 100% measuring range end value |
| ON | | 105% measuring range end value |
| | ON | 110% measuring range end value |
| ON | ON | Fault detection OFF (continues past end value) |

| 7 | 8 | INPUT UNDER RANGE |
|----|----|--|
| | | Freeze at 100% measuring range start value |
| ON | | 105% measuring range end value |
| | ON | 110% measuring range end value |
| ON | ON | Fault detection OFF (stops at start value) |

INSTALLATION

The unit is equipped with a universal mounting foot for attachment to standard DIN style top hat (T) profile rail according to EN50022 - 35 x 7.5 and 35 x 15. The unit should be installed in a location that does not exceed the maximum operating temperature and provides good air circulation. Placing the unit near devices that generate excessive heat should be avoided.

T Rail Installation

To install the AFCM on a “T” style rail, angle the module so that the top groove of the “foot” is located over the lip of the top rail. Push the module toward the rail until it snaps into place. To remove a module from the rail, insert a screwdriver into the slot on the bottom of the “foot”, and pry upwards on the module until it releases from the rail.

